

DEPARTMENT OF THE NAVY

HYDROMECHANICS

THE HYDROGEN-BUBBLE, FLOW-VISUALIZATION TECHNIQUE

○



AERODYNAMICS

by

○

STRUCTURAL MECHANICS

George E. Mattingly

○

Distribution of this document is unlimited

APPLIED MATHEMATICS

HYDROMECHANICS LABORATORY

RESEARCH AND DEVELOPMENT REPORT

○

ACOUSTICS AND VIBRATION

February 1966

Report 2146

GC
1
.D3
no. 2146

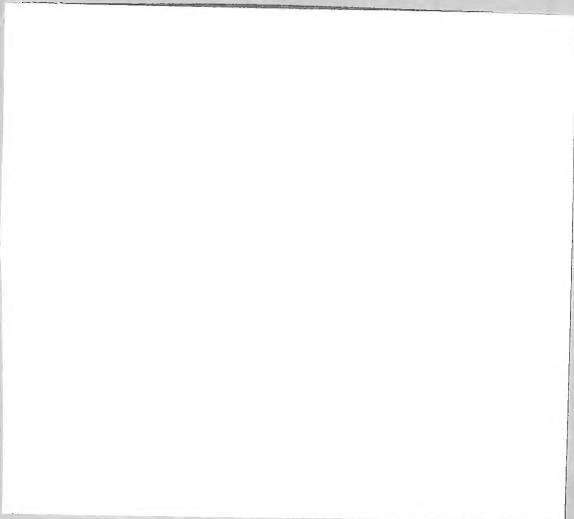

MBL/WHOI



0 0301 0037127 4

THE HYDROGEN-BUBBLE, FLOW-
VISUALIZATION TECHNIQUE

by

George E. Mattingly

Distribution of this document is unlimited

February 1966

Report 2146

TABLE OF CONTENTS

	Page
SUMMARY	1
INTRODUCTION	1
USES AND LIMITATIONS OF THE HYDROGEN-BUBBLE TECHNIQUE	3
TEST FACILITY	12
ELECTRONIC EQUIPMENT	13
LIGHTING	15
PHOTOGRAPHY	16
SOME OPERATIONAL PROCEDURES	17
SOME PRELIMINARY EXPERIMENTAL RESULTS	18
ACKNOWLEDGMENTS	25
REFERENCES	26

LIST OF FIGURES

Figure 1 - Typical Wake Pattern as Seen behind Foil Shape (Freestream velocity is 1 fps)	28
Figure 2 - Platinum Wire Holders	29
Figure 3a- Bubble Patterns for Longitudinal and Transverse Velocity Field	30
Figure 3b- Wire Configuration for Longitudinal and Transverse Velocity Profile Determination	31
Figure 4 - Spider Web Bubble Patterns in the Wake of a Circular Cylinder	32
Figure 5 - Typical Bubble Patterns behind a Two-Inch Plate (Freestream velocity is 16 fps)	33
Figure 6 - Twelve-Inch ID Plexiglas Closed-Jet Test Section with Two-Dimensional Sides Installed	34
Figure 7 - Enlargement of Bubble Patterns in the Wake of a Flat Plate with Sharp Trailing Edge (Freestream velocity is 1 fps)	35
Figure 8 - Leica Camera and Pulse Generation Equipment	36

Figure 9 - Amplifier Unit Built for Hewlett-Packard Pulse Generator Model 214-A	37
Figure 10- Two Sylvania "Sun Guns" Mounted in Drained Test Section . .	38
Figure 11- View Parallel to Stream Velocity (Looking Upstream) of One Lighting Scheme (a) and an Improved Setup (b)	39
Figure 12- Two General Radio Strobotacs Mounted in Hatch of Test Section	40
Figure 13- Cylindrical Bodies	41
Figure 14- Streakline Pattern about a Foil Shape, Aspect Ratio is 10:1 (Freestream velocity is 1 fps)	42
Figure 15- Streakline Patterns of the Flow about a 1-Inch Diameter Cylinder (Freestream velocity is 1 fps)	43
Figure 16- Visual Determination of the Position of the Separation Point (Freestream velocity is 3 fps)	44
Figure 17- Typical Bubble Patterns behind 10:1 Foil Shape Illustrating Deviation from Two-Dimensionality along Foil Span Length .	45

SUMMARY

The hydrogen-bubble visualization technique has been adapted to the 12-inch variable-pressure water tunnel of the David Taylor Model Basin. An outline of this adaptation and the operation of the technique are described.

Photographic techniques and analyses applied to the resulting films are discussed. Sources of error are delineated, particularly with regard to the deceptive streakline patterns that can be formed and especially the results of exceeding the velocity limitation imposed by the shedding phenomena taking place behind the platinum wires. Errors caused by compression and/or stretching of bubble lines along their length are discussed, and procedures are given for recognizing this type of error. In addition, cathode-wire configurations are described by which both longitudinal and transverse velocity profiles can be obtained in steady or unsteady water flows.

Various cathode-wire configurations are described through which qualitative aspects of the flow about bodies as stagnation and separation point motions are depicted.

INTRODUCTION

The uses of visualization techniques for the determination of the characteristics of fluid flows have become quite diversified since Reynolds' transition experiments in the 1880's. The introduction of visible media into fluid flows has been accomplished in many ways for the acquisition of either qualitative and/or quantitative flow characteristics. Injection of dyes into liquids or smoke into gasses through porous bodies or hypodermic needles, the homogenous mixing of visible "unity oil" - (Sp/Gr. = 1) in water, the hypodermic injection of anisol bubbles into boundary layers,

tellurium injection, electrochemiluminescence, etc. are a few examples. The merits of each visualization technique are based upon the extent of the disturbance to the fluid flow caused either by the injection method or by the injected medium itself and upon the accuracy with which the desired flow characteristics can be observed.

In most cases, such visualization techniques as mentioned above are useful for obtaining only the qualitative characteristics of a specific flow. Quantitative characteristics are usually achieved by means of such techniques as hot-wire anemometry or pitot-tube surveys, etc.

Analysis of flow fields by means of dye-injection techniques to exhibit streakline patterns of the flow should be done with care as shown by Hama.^{1*} This is very important in such unsteady flows as exist in boundary layer transition and in the oscillating wakes behind bodies. With a view toward surmounting this ambiguity connected with the streakline patterns and at the same time achieving quantitative measurements such as time variant velocity profiles, the following scheme was introduced by Geller.² A small wire (0.001-in. diameter), positioned in a water flow, energized with a negative voltage and a positively energized terminal positioned in the same flow were so arranged as to construct an electrolysis of the flowing water. Because of the two-to-one ratio of the resulting volumes of gas, hydrogen was chosen to exhibit the fluid motion. This hydrogen gas is produced in the form of very small photographable bubbles on which the predominant force is the drag due to local fluid motion.

This hydrogen-bubble visualization technique can be particularly useful in propeller and hydrofoil research as performed in variable-pressure water tunnels. In addition to such quantitative results as time-variant velocity profiles in water flows, the bubble technique is qualitatively useful for observing flows around bodies. Separation phenomena, oscillating

* References are listed on page 26 .

flow patterns in the wakes of these bodies, and the time and space relationships for these phenomena are examples of the quantitative value of the technique.

Unfortunately, the bubble technique is not without disadvantages, e.g., certain velocity limitations. Included below is a discussion of the velocity limitations and the application of the hydrogen-bubble visualization technique to two-dimensional unsteady flows. A scheme is put forth through which a quantitative analysis of the longitudinal and transverse aspects of an unsteady water flow is achieved.

The following is a description of the hydrogen-bubble visualization technique, its diversified capabilities, and its establishment at the David Taylor Model Basin. The study presented here was carried out under the General Hydromechanics Research Program, S-R009-0101, Task 0103.

USES AND LIMITATIONS OF THE HYDROGEN-BUBBLE TECHNIQUE

Basically, the hydrogen-bubble flow-visualization technique consists of an electrolysis process created by the excitation of cathode and anode terminals wetted by flowing water. The resulting gas formed at the cathode terminal is visible hydrogen gas which may be produced in the form of very small bubbles. Analysis of the forces on a buoyant sphere in a steady slow-speed (Stokes flow) water flow shows that the buoyancy to drag ratio satisfies

$$B/D = g d^2 / 18 \nu U$$

If the bubble size is sufficiently small, say a few thousandths of an inch, the buoyancy force is very small compared to the drag force. Consequently, the motion of the bubbles is dictated by the local water velocity. This predominancy of drag over buoyancy is verified by the negligible rise rate of the small bubbles. Through this predominance of drag over buoyancy, water velocity profiles may be accurately obtained in two-dimensional, low-speed flows.

To avoid altering the true value of the physical quantity being measured, the terminals required for the electrolysis process are chosen to minimize the effect of their presence on the flow. The terminal chosen for the cathode is a very thin wire supported in the water flow at some location where the characteristics of the velocity field are desired, and the anode consists of the metal water tunnel or towing tank wall, or some suitably installed metallic terminal. Many different materials were used as cathode terminals and platinum was found to be most suitable for this purpose because of its corrosion resistance. Other materials used were stainless steel, copper, brass, bronze, and zinc.

When the thin cathode wire is energized with a dc power source, a continuous sheet of hydrogen bubbles is produced in the water. The rows of tiny bubbles which constitute the sheet are distorted according to the local characteristics of the flow field.

Velocity profiles in two-dimensional flows are obtained by pulsing a voltage to such a wire. The cyclic generation of hydrogen along the wire produces patterns like those of Figure 1. Figure 1 shows an actual size view of the bubble patterns in the wake of a symmetrical foil shape (chord-thickness ratio is 10:1) at 0-deg angle of attack. The view is parallel to the trailing edge and perpendicular to the chord of the foil.

Figure 1 illustrates both the qualitative and quantitative aspects of the hydrogen-bubble technique. In addition to the quantitative data, such as the longitudinal velocity profile available at the vertical platinum wire 1/2 inch downstream of the foil trailing edge, qualitative information is provided on the reversal of flow at the platinum wire. This reversed flow which is present at the vertical wire is noted to extend upstream of the wire, past the trailing edge, and into the boundary layer of the foil shape. Such a reversed flow exists because of flow separation and continues as far upstream as the location of the boundary-layer separation point on the foil shape.

Figure 1 also illustrates the manner in which the platinum wire is supported in the wake of the foil shape. The heavy wire or rod frame is constructed and mounted so as to avoid errors induced by vibrations caused

by the flow around it. An insulation (a vinyl plastic coating: Chem-Sol Plastisol material) is applied to the portion of the wire holder which is submerged. The platinum wire is soldered to the horizontal rods that are visible at the top and bottom of the figure. These two horizontal rods are welded to a vertical strut barely visible (and out of the plane of focus) in the right background of the photograph. This vertical strut is positioned so that it is not in the plane of the bubbles (the plane of focus) and, consequently, does not interfere with the bubble patterns near the platinum wire except near the soldered ends. The region behind the platinum wire affected by the horizontal wire supports is easily observed, and the wire is always positioned to utilize the center portion of the bubble patterns for flow analysis. Figure 2 shows four platinum wire holders.

The distance between the bubble rows behind the wire depends on the velocity at the wire and the period of the pulsed voltage.^{2,4} The velocity at the wire is directly proportional to the bubble-row separation and inversely proportional to pulse period; the constant of proportionality is the scale factor encountered in the photograph (see analysis below). For the 0.001-in. wire shown in Figure 1, the diametral Reynolds number is below 40 for velocities in water up to 5 ft/sec. Consequently, there is no vortex shedding behind the wire itself as shown on page 17 of Reference 5. The velocity recovery is assumed to occur within a very short distance downstream of the 0.001-in. diameter wire. By this means, a close approximation of the local longitudinal velocity profile is achieved. Note that the determination of such a longitudinal velocity profile is achieved by these means only when the stretching or compressing of the bubble rows along their length is minute compared to their horizontal translations (see below).

For a Reynolds number, based upon the cylinder diameter, less than 40, the two vortices remain attached to the cylinder independent of the time variable. That is, there is no oscillatory feature in the wake, and disturbances downstream of the cylinder appear to be rapidly damped out near the cylinder. In the range of R_e between 40 and 150, the flow is termed "stable." The flow behind the cylinder is characterized by

a laminar flow and by vortices being shed from the regions downstream of the separation points. The vortex streets in the wake are ultimately dissipated by the viscosity far downstream from the cylinder. In the transition range, encompassing Re from 150 to 300, laminar-turbulent transition begins to appear in the free-stream layer that has separated from the cylinder. For Re from 300 to 10^5 , the flow is characterized by the shedding of vortices consisting of turbulent fluid whose source seems to be the separated shear layer. Therefore, rows of hydrogen bubbles present in the cathode wire wakes for these latter three Re regimes can portray very deceptive patterns of the fluid velocity profiles. Accordingly, it is most desirable to operate the technique in fluid-flow velocities where the diametral Reynolds number is kept below 40. It is apparent that this can be done by controlling the fluid velocity, by selecting a suitable wire diameter, or by altering the kinematic viscosity of the fluid.

In addition to the applicability of the hydrogen-bubble technique to water flows, it has recently been established that the technique operates very successfully in water-glycerine mixtures (personal correspondence and Reference 6). Such mixtures are extremely useful for changing fluid viscosity by means of temperature control. In this glycerine-water mixture, several wire configurations were used to obtain velocity profiles in which there existed an increasing vorticity distribution in time throughout the profile. Of particular significance, however, was the higher degree of photographic clarity and contrast obtainable in such mixtures. The velocities attained in this study were on the order of 6 in./sec.

It is believed that velocities considerably in excess of this value can be investigated in these mixtures without sacrificing the bubble quality. The greatest percentage of glycerine used in the cited study was 40 percent. However, it is felt that higher percentages could be used and acceptable bubble quality retained.

The determination of velocity profiles in two-dimensional flows in which longitudinal and transverse components of velocity are of comparable magnitude should be done with great care. Figure 1 is a good illustration of such a flow. When only longitudinal displacements of successive bubble

rows are taken as indicative of local velocity, large errors can occur. This is due to a visually undetectable stretching or compressing of the bubble rows along their length.

Streamline patterns for steady water flows are also obtainable with the hydrogen-bubble technique. As described in Clutter et al,² it is possible to uniformly "kink" a 0.002 or 0.004-in. diameter wire by feeding it through a pair of gears. A 0.001-in. diameter wire was found to be inadequate in this respect because it would not retain the necessary kinked configuration. When the wire is kinked and such a wire is excited by a dc voltage, electrolysis occurs along the entire length of the wire, but the hydrogen is dragged off the wire by the flow only at the downstream points of the kinks. In a steady flow, the resultant pattern is that of a series of streamlines. In unsteady flow, it is that of a series of streaklines.

Obviously, the larger diameter (0.004 in.) "kinked" wire causes a small disturbance to the flow. Therefore, the use of the kinked wire is limited to a velocity range in which the influence of the wire on the flow can be neglected. It is emphasized that care should be used in the employment of the larger kinked wire for this reason. However, for $Re \leq 40$ such a method does give a rapid means of visualizing the flow field by streakline traces.

When a pulsed excitation is imparted to the kinked wire, the streaklines are changed into dashed lines. These dashed lines are then illustrative of the accelerations and the velocities which exist in the fluid. It was found that discrete dashes could be achieved with a voltage pulse having very small rise and drop times.² Otherwise, dashes with blurred ends result, i.e., the tips and the tails of the white bubble lines are fuzzy. In the work carried out at DTMB it was found, however, that even with very short rise and drop times (less than 15 ms), when the velocity of flow past the kinked wire is sufficiently large, i.e., 10 to 15 ft/sec, the tips and tails of dashes become blurred. This is felt to be the result of vortex shedding from such a wire configuration.

A means of uniquely marking fluid particles so that both components of velocity are illustrated was accomplished by inserting two cathode wires (one kinked, the other straight) in the two-dimensional flow. The resultant bubble pattern is a combination of time and streaklines. (Time lines are the loci of fluid particles which were located at the platinum wire at a previous time (Reference 4).) The two wires were installed so that the resulting hydrogen bubbles were contained in planes which practically coincided. Enough space should be allowed between these plans so that the presence of one wire does not influence the motion of the bubbles from the other wire. The direction of observation should be perpendicular to both planes of bubbles. A sketch is shown in Figure 3a.

The longitudinal displacement of the intersections of bubble lines is proportional to the longitudinal component of velocity, and the transverse displacement of these same intersections is proportional to the transverse component of velocity. The incorporation into this analysis of the longitudinal streaklines from the kinked wire enables determination of the transverse component of velocity at the downstream extremities of the kinked wire. Obviously, this particular technique for marking specific fluid particles will be inadequate when the flow has velocity components of comparable magnitudes in all three spatial directions.

The analysis to obtain the longitudinal and transverse velocity profiles at a single location in steady or unsteady flow then proceeds as follows. As a transverse bubble row is swept off the straight wire, intersections with each of the longitudinal lines are visible looking perpendicular to both planes of bubbles. These intersections are then dragged downstream in accordance with the velocity profile. When the subsequent rows of bubbles are dragged off the straight wire, another series of intersections is observed. Since these intersections are formed after an interval of time equal to the pulse period, the transverse displacement referenced to some visible datum point divided by the pulse period is proportional to the transverse velocity. This velocity is a quasi-steady one taken over the pulse period and, accordingly, the pulse period should be much smaller than the period of any flow oscillations. The initial transverse spacing of the

horizontal bubble lines is that of the wave length of the kink in the kinked wire. Increasing or decreasing this spacing is therefore achieved by suitably adjusting this wave length. A photograph of a spider-web bubble pattern can be seen in the wake of a circular cylinder in Figure 4. Note that an analysis like that described above can be performed only when the two bubble-generating wires are positioned as shown in Figure 3a. The wire configuration shown in Figure 3a and the previously described analysis were successfully employed, and results can be seen in Reference 6.

Another way of achieving these intersecting patterns of hydrogen bubbles is accomplished without the use of kinked wires. If straight (0.001-in. diameter) wires energized with dc excitation are installed like rungs in a ladder (Reference 4) in the flow so that the line of vision is parallel to the rungs, the steady sheet of bubbles from each wire rung appears as a line to the observer. Positioning another wire in the usual manner (shown in Figure 3b), i.e., perpendicular to the direction of vision, enables creation of the transverse rows of bubbles such that an intersection of bubble lines is visible. Additional intersections are obtainable with additional wires. The wires installed as ladder rungs which are oriented parallel to the direction of vision do not have to produce bubbles along their entire length to create these intersections. Wires which are coated with a thin waterproof insulator except for some small interval at the center of the wire suffice for the production of a bubble line as seen by the observer. It is important that the insulation be thin to avoid vorticity shedding from the insulated portions of the rungs. The wire which receives pulsed excitation (viewed perpendicular to its length) can then be positioned in or out of these ribbons of bubbles. Such a scheme has several advantages. One is the lifting of the velocity limitation due to the shedding phenomena behind the 0.004-in. diameter kinked wire. Another is the flexibility of choice of spacing between the longitudinal lines. Positioning the transverse wire in the sheets of bubbles streaming from the rung wires also enables visual determination of whether or not vortex shedding is taking place from the transverse wire, i.e., for $Re > 40$.

As the above scheme for measuring two-dimensional steady or unsteady velocity profiles is accomplished at specific locations in a plane, it is necessary that the bubble-line intersections be sufficiently numerous to enable a "continuous" determination of the velocity field. That is, the separation of the streaklines from the wire rungs and the separation of the time lines have to be such that the resulting quantitative data enable a smooth extrapolation for the velocity value points of measured values. In this way, one is then able to describe velocity profiles by a smooth curve. However, a photograph with an inordinate number of bubble line intersections can be tedious and difficult to interpret for quantitative results.

The velocity field may be calculated in another manner when a motion-picture film strip has been taken of bubble distortions in a particular velocity field. When particular fluid particles, as marked by individual bubbles, are followed from frame to frame, division of the vector distance between bubbles by the small known time interval between frame exposure determines the magnitude and direction of velocity components throughout the field. This procedure and the one previously described for determining velocity profiles from a single frame are greatly expedited by the use of film readers such as the Benson-Lehner Corporation Oscar Model F (GS 1026 G) System. This method of velocity field determination can become extremely difficult, if not impossible, when there are many similarly sized and indistinguishable bubbles on successive film frames. One way to eliminate this difficulty is to use the spider-web bubble patterns to emmesh the desired velocity field. The bubble translations can then be traced relative to some datum point observable on the film frame in a very organized fashion. As previously mentioned, the adjustable grid size enables one to specify the number of intersection points in the velocity field.

The qualitative aspects of higher speed (3 to 5 ft/sec and above this range) oscillating wakes may be observed without a photograph as follows. Consider the flow about a foil shape or flat plate behind which the shedding vortices are moving into the wake so rapidly that physical visualization of the bubble patterns is difficult when a continuous lighting

scheme provides the illumination. Using stroboscopic lighting, let a straight platinum wire, oriented perpendicular to the wake of the body (as shown in Figure 1) be energized with pulsed excitation. If the stroboscopic frequency is adjusted to be equal to the frequency of vortex shedding, the motion of these vortices will cease. Now if the pulsed excitation frequency is adjusted to freeze the bubble rows and space them about $1/4$ in. apart in the free-stream velocity field, the entire bubble pattern will become stationary. The pulse frequency required to achieve a completely frozen bubble pattern must be an integral multiple of the strobe frequency. The spacing of $1/4$ in. between free-stream bubble rows is an approximate value; the spacing should be such that the wake is not excessively congested by needless amounts of hydrogen bubbles. (Should the stroboscopic (or shedding) frequency be desired, it can easily be numerically determined using an EPUT (events per unit time) meter to monitor the stroboscopic output signal.) Figure 5 shows a photograph of such a frozen bubble pattern. The transverse development of the wake in the longitudinal direction is apparent from such a photograph. In light of Hama's work,¹ it is stressed that care should be used in interpreting the photographic results such as those shown in Figure 4.

In order to specify the actual positions of vortices in the wake of such a foil or flat plate body, the following procedure should be used. Let a platinum wire holder configuration (as shown in Figure 3b) be positioned in and perpendicular to the wake of the body. With both wires properly energized, the resulting bubble patterns should be illuminated using the improved lighting scheme discussed in the LIGHTING section. Photograph the spider-web patterns with a motion-picture camera using a film speed chosen to achieve a sufficient number of frames of the cyclic phenomena taking place in the time interval of the shedding period. This could be 10, 20, or 30 frames per second, depending on the continuity desired between film frames. Guiding values for such a film rate can easily be obtained using the stroboscopic illuminating scheme described above. Having this strip of film of the cyclic translations of the bubble line intersections, use a film reader to quantitatively analyze the time variant, two-dimensional velocity fields. The velocity of the wake vortices is obtained by

multiplying their wave length by the frequency of the strobotac lighting which "freezes" their motion. When the velocity of the vortices in the wake is subtracted from this determined velocity field, one is then able to specify the actual centers of rotation of the wake vortices to within the accuracy permitted by the clarity of the photographs. Such a result enables quantitative analysis of the entire wake flow field, provided of course, that the transverse dimension of the wake permits the bubble line intersections to be observable on the screen of the film analyzer. Excessive bubble line congestion can cause this analysis to be tedious, if not impossible. In addition to wake width dimension, which is dependent on body sizes, water speeds, etc., the experimenter may be able to eliminate bubble line congestion by altering the pulsed excitation frequency and/or the spacing between the the platinum wire rungs of the ladder wire configuration.

TEST FACILITY

To achieve a two-dimensional water flow, the test section of the 12-inch variable-pressure water tunnel at the David Taylor Model Basin (Reference 7) was modified in the following manner. A plexiglas circular tube (Figure 6) was installed in the existing open-jet test section to form an axisymmetrical closed-jet test section. Into this plexiglas tube were installed the straight, parallel plexiglas liners that are shown in Figure 6. The perpendicular distance between the liners is 6.66 in. The flow which precedes this test section was made to change smoothly from the circular upstream tunnel shape to the straight-sided plexiglas section by means of two aluminum transition pieces installed in the entrance nozzle.

A pitot survey of the longitudinal velocity distribution revealed that departures from a total average velocity (averaged over the whole test section) were less than 3 percent. Transverse velocity components were not measured. Departures from the average test section velocity occurred primarily in two places. The first occurred near the wall of the test section as could be expected due to the presence of the boundary. The other occurred due to a slowly moving "slug" of water centered in the test section. Similar

departures were found in a previous survey in the open-jet test section, where the deviations from the average were from 3 to 5 percent (see Reference 8). This agreement with the previous survey was comforting in that the two-dimensional section introduced no new departures from the average and, in fact, reduced those known to exist.

ELECTRONIC EQUIPMENT

Because the load resistance (i.e., the electrical resistance across the terminals of the pulse generator) can vary with each water tunnel or towing tank, the electrical specifications of one pulse generator which operates very well in one water tunnel may be insufficient to produce similar bubbles in another water facility. The proper equipment specifications can be obtained as follows. First, an estimate should be made to determine the maximum dimension of the flow fields which are to be visually studied. For instance, in the case of a hydrofoil study, the width of the wake (looking perpendicular to the chord and parallel to the span length) might be the largest dimension. For a visual study of the wake looking perpendicular to the span length, the span length would be the maximum linear dimension needed for the wetted platinum wire. Once this length is determined, a platinum wire of this dimension should be installed in the center of a test section of the water tunnel. This wire is then energized with a dc power supply using the tunnel (or tow channel or suitably installed anode) as the other terminal. Readings of voltage and current taken for different flow velocities allow one to determine the load resistance of the water tunnel or tow channel.

From the load resistance, a desirable size for the lengths of the rows should be determined. It has been found that a value of 0.040 in. is an appropriately photographable width for the rows of hydrogen bubble clusters. The bubble rows in Figure 7 are of this size and therefore the above value was so chosen. This is not a sacred number, however; it is dependent upon the lighting and photographic setup in that whatever can

be made to show the fluid velocity patterns clearly on film will suffice. At some indicative value of the total pressure, the coulomb transfer across the surface area of the wetted wire can then be determined. In the time interval of the pulse width, this coulomb transfer specifies the required current. This current is expressed by:

$$I = \frac{eA (p + \gamma h) L d^2 \gamma}{4 R_u W T}$$

where

- I is the current,
- e is the charge of an electron,
- A is Avogadro's number,
- p is the pressure at the water surface,
- γ is the specific weight of the water,
- h is the depth of the platinum wire,
- d is the width of the hydrogen bubble row,
- L is the length of the hydrogen bubble row,
- R_u is the Universal Gas Constant,
- W is the pulse width, and
- T is the temperature.

Now the power per pulse can be specified and the electrical equipment output determined when line losses are incorporated into the above result.

The hydrogen bubbles observed in the work reported here were produced by several different power supplies. The dc power supply which was used to excite the kinked wire (DIMB unit, Type 140A, Serial 101) transmitted a maximum of 150 V and 500 ma to the wetted wire. A continuously variable voltage amplitude was available by means of this dc power supply. The insertion of a suitable switch in the output of this power supply permitted a polarity reversal which was very helpful in keeping the wetted wire free from platinum oxides.

In addition to the dc power supply, a Hewlett-Packard Model 214A Pulse Generator was used for the pulsed power supply. This unit delivered 0 - 170 V into the approximately 300-ohm load resistance and produced excellent bubble rows for flow velocities up to about 5 ft/sec. The output

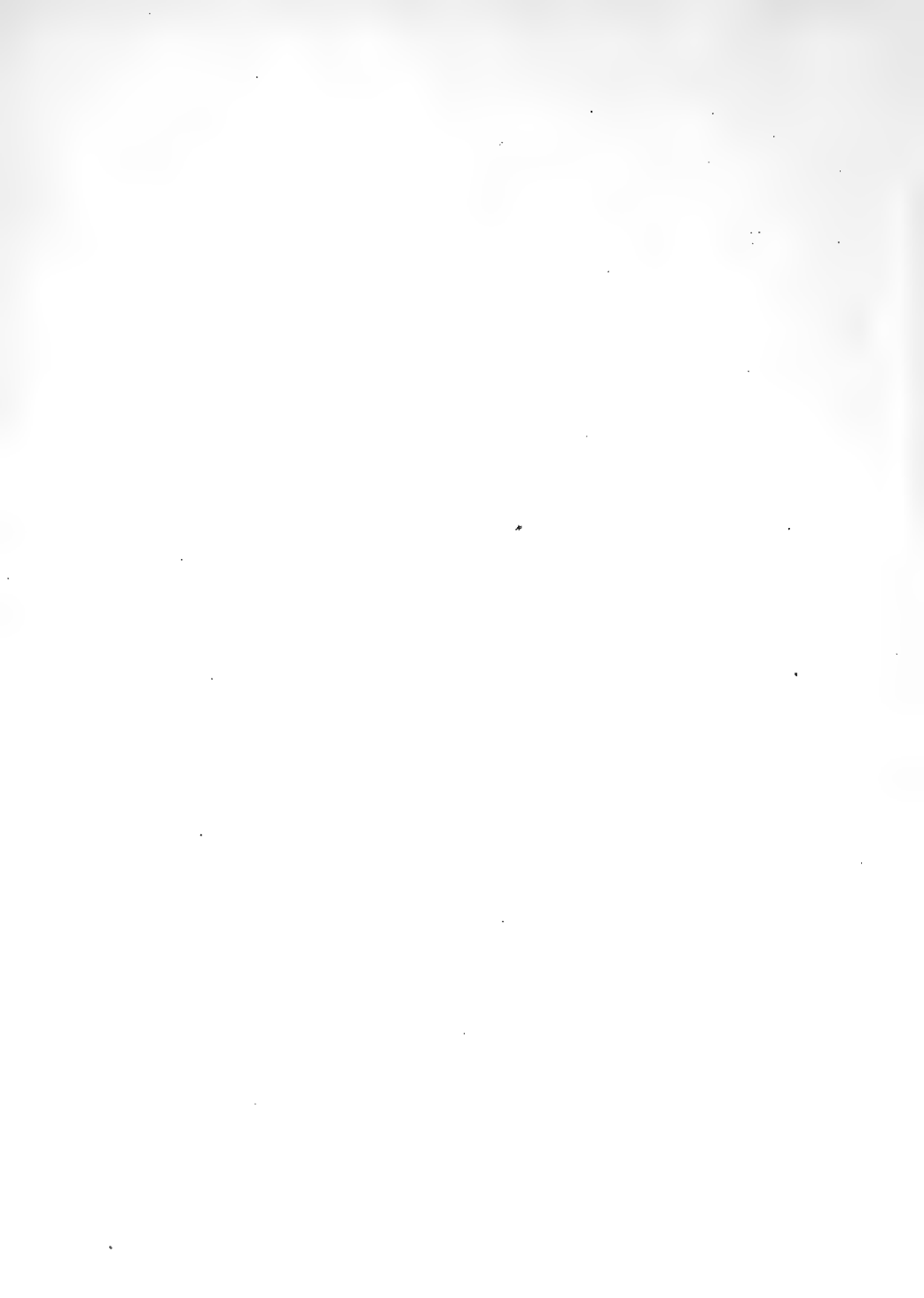

signal of this pulse generator had a reversible polarity and a 10-cps to 1-mcps continuously adjustable repetition rate with a pulse width range from 0.05 to 10.0 ms. The sharply rising and dropping voltage pulse, attained with this instrument, was found to give distinct edges to the bubble rows. The characteristics of the output of this unit, such as pulse width, period, and amplitude, were accurately monitored by a Tektronix RM-503 Oscilloscope (see Figure 8).

For clear and concise bubble rows at higher flow velocities, the output of this pulse generator was amplified by the circuit shown in Figure 9. Through this amplifier, the voltage transmitted to the wetted wire could be increased to more than 400V.

LIGHTING

Ordinary floodlights were found too bulky to mount properly in the hatch of the water tunnel, and they produced insufficient light. Accordingly, the existing tunnel flash tubes (Edgerton, Germeshauser, and Grier FX-22) were installed in the test section of the tunnel in their 28-inch glass tube mounts in the hatch of the water tunnel (see Reference 7). They improved the situation somewhat but could not be focused properly upon the bubble rows. These lights were used for stroboscopic lighting and gave 5000-w, 4800-v flashes.

In order to attain increased clarity between the white bubble rows and the black background, two 100-w Sylvania "sun guns" were mounted beneath the hatch cover and above the water surface. Figure 10 shows two "sun guns" mounted in the drained test sections. These very compact and extremely bright lights proved very satisfactory for flow velocities as high as 5 or 6 ft/sec. Not only can these particular lights withstand water being splashed on them, but they can also operate continuously when completely submerged; the submerging advantage obviously eliminates the water-surface reflection effect. This submerging characteristic is a distinct convenience because the proper illumination of the bubble rows requires that

the light be directed at the bubbles to form an angle of about 125 deg with the line of vision. For this type of illumination, the sketches in Figure 11 show a means of increasing the amount of light properly directed at the bubble rows.

Such an increase in the amount of light would undoubtedly allow a faster shutter speed for photographic purposes. The bubble motions in the higher speed flows would be satisfactorily "stopped" to permit the use of this steady "sun gun" lighting for higher flow velocities.

When higher flow velocities were achieved in the water tunnel, the steady "sun gun" lighting was insufficient. Reference here is to velocities in the range of 10 to 16 ft/sec. To achieve suitable lighting at these velocities, strobotacs were used to slow down and "freeze" the motion of the rapidly moving bubble rows. Figure 12 shows two General Radio Type 1531-A Strobotac units mounted in the tunnel test section. These units were driven synchronously by a General Radio Type 1217-B Unit Pulse Generator. The flash rate was accurately determined by the digital readout of Hewlett-Packard Model 522B Electric Counter. The flexibility available through the continuously variable flash repetition rate and the continuously variable pulse frequency to the wetted wire proved to be extremely helpful in the subsequent film analysis as described below.

PHOTOGRAPHY

The resulting bubble patterns could easily be observed visually and photographically. To achieve sufficient photographic contrast between bubble patterns and the dark background, a unique photographic recipe was developed. The most satisfactory 35-mm still camera was a Leica Model M-2 with a 50-mm Summicron lens and a dual range finder for close focusing. Plus-X film rated at ASA 400 was found to give the best results. This film was developed in Acufine for the recommended time plus 25 percent. The printed results were made by Polycontract "F" paper using a No. 9 filter and developed in D-72.

Motion-picture photography of the bubble motions was successfully accomplished with 35- and 70-mm Mitchell High-Speed FC Chronograph cameras. The chronograph attachment was not used on either of the cameras. Although higher film speeds were available, the 70-mm Mitchell camera was operated at approximately 25 frames per second. This frame speed was found to be acceptable in stopping the flow patterns for free-stream velocities up to about 5 ft/sec. Figure 8 shows the photographic and pulse-generation equipment in the observation booth of the water tunnel. Prints of these motion films enabled observation of the cyclic motion of the separation point on a solid surface, the subsequent roll-up of this fluid into discrete vortices, and the shedding of these vortices into the downstream wake of the body. For reasons of compactness and ease of film handling, the 35-mm Mitchell camera replaced the 70-mm. Film analysis, i.e., the cyclic portrayal of events behind solid bodies, proceeded in exactly the same manner.

SOME OPERATIONAL PROCEDURES

The electrical operation of the technique proceeds as follows. A platinum wire of appropriate length is properly oriented in the velocity field (Figure 3b). A suitably installed anode terminal is connected to the ac or dc power source. In the case of dc power, the amplitude of the voltage is adjusted to form a white and photographable sheet of bubbles. The bubble diameter should be such as to minimize bubble rise due to buoyancy. It is noted that excessively high voltages cause sporadic formation of large bubbles which rise due to their buoyancy. In the case of ac excitation, the pulse frequency should be chosen in accord with an analysis similar to that in Reference 4. The analysis is directed toward optimum measuring conditions and is pertinent when the cross-derivative terms are negligible in the series expansion of the longitudinal velocity. When the pulse frequency has been properly chosen, the pulse width is then adjusted to render the bubble lines photographable without excessive buoyancy effects.

The clarity of the bubble lines is very sensitive to the cleanliness of the cathode wire. Removal of debris which accumulates on the wire can be achieved in several ways. For example, the wire may be removed from the water and carefully etched with a 20-percent solution of nitric acid. However, debris accumulates so frequently that this method becomes cumbersome. When convenient access to the cathode wire or its wire holder is available, a delicate striking of the wire holder with an electrically insulated object suffices to loosen accumulated debris. It is of considerable importance to incorporate this accessibility feature into the design of any closed test section in which the hydrogen-bubble technique is to be used. Another is to strike the metal side of the water tunnel with a small hammer.

The following method, which was discovered quite by accident, is frequently more efficient and incomparably more convenient than any of the others cited. In order to observe the bubble lines from an anode wire, the pulse polarity was reversed on a wire which had been just operating for some time as a cathode hydrogen-generating wire. When the polarity was changed back again, the resulting hydrogen-bubble lines were amazingly concise and distinct. The technical details of such a wire-cleaning procedure were not investigated but it was felt that it was due to an electrostatic repulsion process. Therefore, it has been found very convenient to arrange the energizing circuit so that one has such a means available to clean the wire while it is in the moving flow.

Another method which has been found effective is to energize the wire before the fluid is in motion. The generated hydrogen rises immediately and an upward flow is produced all about the vertical wire which sweeps debris up and off the vertical wire. However, of all these methods, the polarity reversal method is the one most frequently used.

SOME PRELIMINARY EXPERIMENTAL RESULTS

The bodies about which the flow was visualized are shown in Figure 13. The foil shapes are TMB modified NACA 66 profiles. Chord-to-thickness ratios are 10:1 and 5:1; both chord lengths are 6 in. The circular

cylinder is 1 in. in diameter. The two remaining bodies in the figure are both plates. The plate on the right in Figure 13 has dimensions 2 by 1/2 in. and all surfaces are flat; the other also has a 2-in. chord but a thickness of 1/4 in. and a rounded leading edge with a flat trailing edge 1/4 in. thick. The spanwise dimension of all the cylindrical bodies is 6.66 in.

The photographic results for the various cathode-wire configurations and experimental setups are shown in Figure 1 and in Figures 14 through 17. In Figure 1 the flow characteristics downstream of the trailing edge of the 10:1 aspect ratio foil shape are portrayed by the bubble patterns. Instantaneous velocity profiles at the location of the 0.001-in. diameter platinum cathode wire are obtained in the manner previously described. For such an undertaking, an enlargement of the photograph of the bubble patterns in the wake region behind the wire facilitates the velocity determination. Enlargements of different photographs are shown in Figure 7. The bright area in the left side of the photographs is a light reflection off the sharp trailing edge of the plate. The specification of position in such a computation is best done with an observable datum point which appears in the photograph and is located in the plane of the bubbles. For unsteady flows, similar to the one shown in Figure 1, the time-variant velocity profile at one location in the wake is obtainable with a series of photographs encompassing the period of oscillation. An entire wake survey can be obtained with successive locations of the cathode wire downstream of the trailing edge. Although this can be a laborious process, a result of considerable significance is achieved. Such a survey was performed, not in a wake flow, but in a very thick boundary layer, by Hama and Nutant (Reference 3). They were among the first to use the hydrogen-bubble technique and excellent photographic results were obtained in this low-speed investigation.

Figure 14 illustrates a typical bubble pattern about the 10:1 aspect ratio foil shape for a situation in which a kinked wire was positioned upstream of the leading edge and energized with dc voltage. Note the distortions of the mainstream flow due to the presence of the body. In addition, the streaklines demonstrate the involvement of the free-stream flow in the wake region behind the body.

To visualize flow characteristics very close to the body, i.e., in the boundary layer of the body, it is necessary to insert the streaklines into the boundary layer itself. This is done by positioning the kinked wire very close to the leading edge of the body so that the streaklines begin in the stagnation region and are dragged around the body in accordance with the boundary-layer characteristics. Caution should be used, however, in interpreting these streakline patterns. Hama has shown that very deceptive streakline patterns can be obtained in shear flows. That is, streakline rollup patterns can be wrongly interpreted as illustrating concentration of vorticity in shear flows in which there is no wave amplification whatsoever. Streakline patterns about the 1-in. diameter cylinder are shown in Figure 15. In this series of photographs the streaklines portray the cyclic behavior of and the mainstream participation in the flow developments behind the cylinder.

The hydrogen-bubble technique can also be conveniently utilized to determine the position of the separation point of the flow about a body. To use the technique in this manner, however, two wires operating in the flow simultaneously are usually needed. Because of the separation from the body of the streaklines due to boundary-layer characteristics, it becomes necessary to put bubbles into the flow downstream of the separation point. Thus, the streaklines upstream of the position of separation exhibit the expected velocity gradient:

$$\left(\frac{\partial u}{\partial y} \right)_{y=0} > 0$$

where u is the longitudinal velocity of the flow in the boundary layer and y is the transverse coordinate perpendicular to the surface of the body. The position of separation is defined as the position on the body where

$$\left(\frac{\partial u}{\partial y} \right)_{y=0} = 0$$

Downstream of the separation point, the flow is reversed and

$$\left(\frac{\partial u}{\partial y}\right)_{y=0} < 0$$

Therefore, visually, the specification of a positive velocity gradient up to a certain position on the foil surface, and a similar specification of a reversed flow condition proceeding in the opposite direction up to a certain position, indicates that separation must occur between these respective locations.⁹ When the interval between such points is very small, the prediction of the location of the separation point is accurate. Figure 16 shows such an interval between positive and negative velocity gradients. The two wires in the flow are straight and excited with a d-c voltage. One is positioned at the front stagnation point of the foil shape and illustrates a positive velocity gradient. The other is smoothly attached perpendicular to the surface of the foil and supplies bubbles into a reversed flow region. In the thin interval between these groups of bubbles lies the separation point on the surface of the body. The separation streamline is contained between these two groups of hydrogen bubbles. Motion-picture photography of such a separation region obviously enables determination of any cyclic motion of this point and the correlation of such motion with wake phenomena.

One of the more severe limitations of the hydrogen-bubble technique, which has also been found by other investigators,⁴ is the low-velocity flows to which the technique has been confined. This is primarily due to the delicate hardware used to install bubbles in a water flow. To install a 0.001-in. diameter platinum wire in a water flow so that the wire remained straight, the following was done. A heavy rod or steel wire frame, which was adequately insulated from the water, was made into the configuration visible in Figures 1 and 2. The thin cathode wire was soldered across the two cantilevered portions of the wire holder. Before the two ends of the wire were soldered, however, the cantilevered portions of the wire holder were bent together very slightly. When the remaining end of the wire was soldered, these portions of the holder were released and stretched the thin wire taut. As one can easily imagine, the amount of wire-holder bending required extensive practice before competent wire installations

were achieved. The result of such a process was a wire installed as in Figure 1. However, such a configuration required very little lateral drag force to cause breakage of the wire - usually at the solder joint. Sufficient lateral drag force for breakage was produced at water velocities as low as 1 to 3 ft/sec. Obviously, the susceptibility to breakage also depends on the initial wire tension.

To surmount this difficulty, a new wire-support mechanism was devised by Mr. John Coon of the Model Basin. This new manner of positioning wires utilized two rods of elliptical cross section (major axis $1/4$ in., minor axis $1/16$ in.). One such rod was mounted through the top and the other through the bottom of the closed-jet test section. The plexiglas test section was modified to enable positioning the platinum wire at any location in the streamline direction. Because of the elliptic section, rod vibration due to vortex shedding was radically reduced and the increased rigidity of the supports was apparent. A disadvantage of such a support system was that the wire could not be easily stretched into a straight configuration. When this was attempted, breakage usually occurred. The non-taut wire was then used and, although the wire assumed the form of a catenary, an extremely high water velocity could be obtained before breakage occurred. In fact, tunnel velocities as high as 16 ft/sec were achieved. Figure 5 shows the results of such a high-velocity flow situation.

For the above-mentioned velocity profile determination, it is not of critical importance that the cathode wire be straight. The significant features are bubble-line separation in the transverse direction or locations of particular bubble-line intersections in successive film frames, pulse frequency and motion-film rate, and the scale factor encountered in the photography. For the streamwise specification of the location of the computed velocity profile, it is convenient to adjust the catenary-shaped wire so that the vertically sloped section occupies the center of the wake. This provides for initially straight and transverse bubble lines in the wake region at the streamwise location of the wire.

Additional difficulties in using the hydrogen-bubble technique are caused by vortex shedding behind the thin cathode wire. This vortex

shedding causes rapid diffusion of the otherwise distinct edges of the bubble rows. Further problems, which time limitations in the present investigation did not permit studying, related to the possibility of excessive, but undetectable, wire oscillation and the deceptive velocity fields behind these thin wires. It is obvious that such a body in a flow has its own wake and this may obscure the wake profile that is being investigated behind a foil or other shape. However, as seen in the photograph, the delicate hardware can be arranged to install hydrogen bubbles in flows having velocities far beyond speeds of 1 ft/sec. It is logical to expect, therefore, that small, more delicate wires may be similarly installed in flows where velocities reach 10 to 15 ft/sec without introducing the shedding errors that undoubtedly exist behind an 0.001-in. diameter wire in flow velocities of 10 to 15 ft/sec ($R_e > 40$).

The following cathode-wire configuration has been found convenient in determining the general characteristics of the three dimensionality of a supposedly "two-dimensional" flow. The wire should be installed in the flow in such a way that it is parallel to the generatrix of the body about which the flow is being studied. For instance, if the wire is positioned parallel to the trailing edge of the foil shape and perpendicular to the flow direction, the "plan view" of the velocity field can be observed. In fact, this was done by Hama and Nutant and the wire was energized by a pulsed excitation. Figure 17 illustrates such a wire configuration. The excitation of the wire near the trailing edge is with dc voltage. The upstream kinked wire is energized similarly. In this case, the trailing-edge wire is crudely attached to the straight walls of the test section by means of tape. It should be mentioned that photography parallel to the resulting wake bubble patterns produces blurred and apparently poorly focused photographs. This is especially true for the short depth of focus encountered with the necessary shutter openings. As was done in Reference 3, photography should be performed perpendicular to such bubble patterns; unfortunately, time did not permit the alterations

necessary for such photography. However, with the naked eye (or proper photography) one can gain considerable insight into the three dimensionality encountered in the wake of these "two-dimensional" bodies. The literature verifies that such flows can be extremely predominant (Reference 10) in reality.

When experimental investigations are considered in water, it is apparent that with discrete sizing of characteristic body lengths of models, it is important that the water velocities needed to meet specific parameter values are adaptable to the necessary bubble quality. Although it has been definitely verified that velocities can exceed certain values without wire breakage, there is a decrease in bubble quality with increased water velocity, not to mention the increased likelihood of vortex shedding error which undoubtedly occurs at higher flow velocities.

Further flexibility in the bubble technique is attained by allowing a particular portion of a metallic model to act as a cathode terminal (see Reference 2). When this was attempted, the bubbles were unevenly dragged from the body, apparently because of excessive boundary-layer thickness. Therefore, when the model itself is used as a cathode terminal, the local fluid velocity has to be sufficient to drag the bubbles into the flow. A dielectric covering (paint or plastic tape) can easily be applied to the entire surface of the body in the flow with the exception of the region where the bubbles are to be produced. Another way to achieve the same effect is to imbed a platinum wire or other conductor into the surface of a plastic or nonconducting body. One has then only to energize either the entire body or the imbedded conductor with a dc voltage to obtain a steady stream of bubbles from any point on the surface of the body. Pulsed excitation was found rather unsuccessful due to the uneven shedding of bubbles between electric pulses. An attempt was made to utilize the trailing edge of the foil shapes in such a manner, but the velocities in this region for very small angles of attack were apparently insufficient to drag bubbles into the flow evenly all along the entire span of the body. Although the bubbles were not dragged evenly (as a sheet of bubbles) into the flow along the span length, one could observe whether or not the



downstream stagnation streamline intersected the trailing edge of the body. Such an observation resulted from the visible reversed flows on the upper and lower foil surfaces or the absence thereof in the region of the trailing edge of the body. Therefore, determination of the satisfaction or the violation of the Kutta-Joukowski condition is possible; the degree of accuracy depends on the accuracy with which the conductors were positioned on the surface of the foil. Such a determination would undoubtedly employ the definition of separation point and reversed flow discussed earlier and the lighting scheme as sketched in Figure 11. An experiment using essentially this same method for specifying the position of separation is described in Reference 9.

For instance, in the surface of a plastic foil shape, wire conductors which can be energized separately are placed so that they are parallel to the trailing edge and spaced, e.g., 0.010 in. apart; then the point of separation could be determined on this foil to an accuracy of not less than 0.010 in. Such accuracy is achieved by observing between which two wires the velocity gradient is normal to the surface and changes sign.

ACKNOWLEDGMENTS

The author wishes to express his gratitude to Dr. F. R. Hama for stimulating his initial interest in the hydrogen-bubble technique.

Specific thanks also go to Mr. John Coon, who greatly assisted in the establishment of the technique at the Model Basin.

Last, but certainly not least, many thanks for the helpful suggestions, endless patience, and expert photographic experience which were made available to the author by Mr. Berkley Ball of the David Taylor Model Basin.

REFERENCES

1. Hama, F. R., "Streaklines in a Perturbed Shear Flow," Physics of Fluids, Vol. 5, No. 6 (Jan 1962).
2. Clutter, D. W., et al, "Techniques of Flow Visualization Using Water as the Working Medium," Douglas Aircraft Company Report ES-29075 (Apr 1959).
3. Hama, F. R. and Nutant, J. A., "Detailed Flow Field Observation in the Transition Process in a Thick Boundary Layer," Proc. of the 1963 Heat Transfer and Fluid Mechanics Institute, Stanford University Press (1963).
4. Schraub, F. A., et al, "Use of Hydrogen Bubbles for Quantitative Determination of Time Dependent Velocity Fields in Low Water Flows," Report MD-10, Thermo Sciences Division, Department of Mechanical Engineers, Stanford University (Feb 1964).
5. Schlichting, H., "Boundary Layer Theory," Fourth Edition, McGraw Hill Company (1960).
6. Nowell, R. W., "An Investigation of Fluid Motion with Variable Viscosity," M. S. Thesis, Department of Aerospace and Mechanical Sciences, Princeton University (June 1965).
7. Bowers, W. H., "The 12-Inch Variable Pressure Water Tunnel Propeller Testing Procedures," David Taylor Model Basin Report 505 (Nov 1943).
8. Venning, E. and Shields, C. E., "Wake Studies in the 12-Inch Propeller Tunnel," David Taylor Model Basin Report 1536 (Jul 1961).
9. Schubauer, G. B., "Air Flow in a Separating Boundary Layer," NACA Report 527 (21 Annual Report (1935)).

10. Mattingly, G. E., "An Experimental Investigation of the Three-Dimensionality of the Flow Around Circular Cylinders," Institute for Fluid Dynamics and Applied Mathematics Report BN-295 (Jun 1962).

11. Morkovin, M. V., "Flow Around a Circular Cylinder - A Kaleidoscope of Challenging Fluid Phenomena (Including Flow Instabilities and Transition to Turbulence)," Proc. American Society of Mechanical Engineers Symposium on Fully Separated Flows (May 1963).



Figure 1 - Typical Wake Pattern as Seen Behind Foil Shape
(Freestream Velocity is 1 fps)

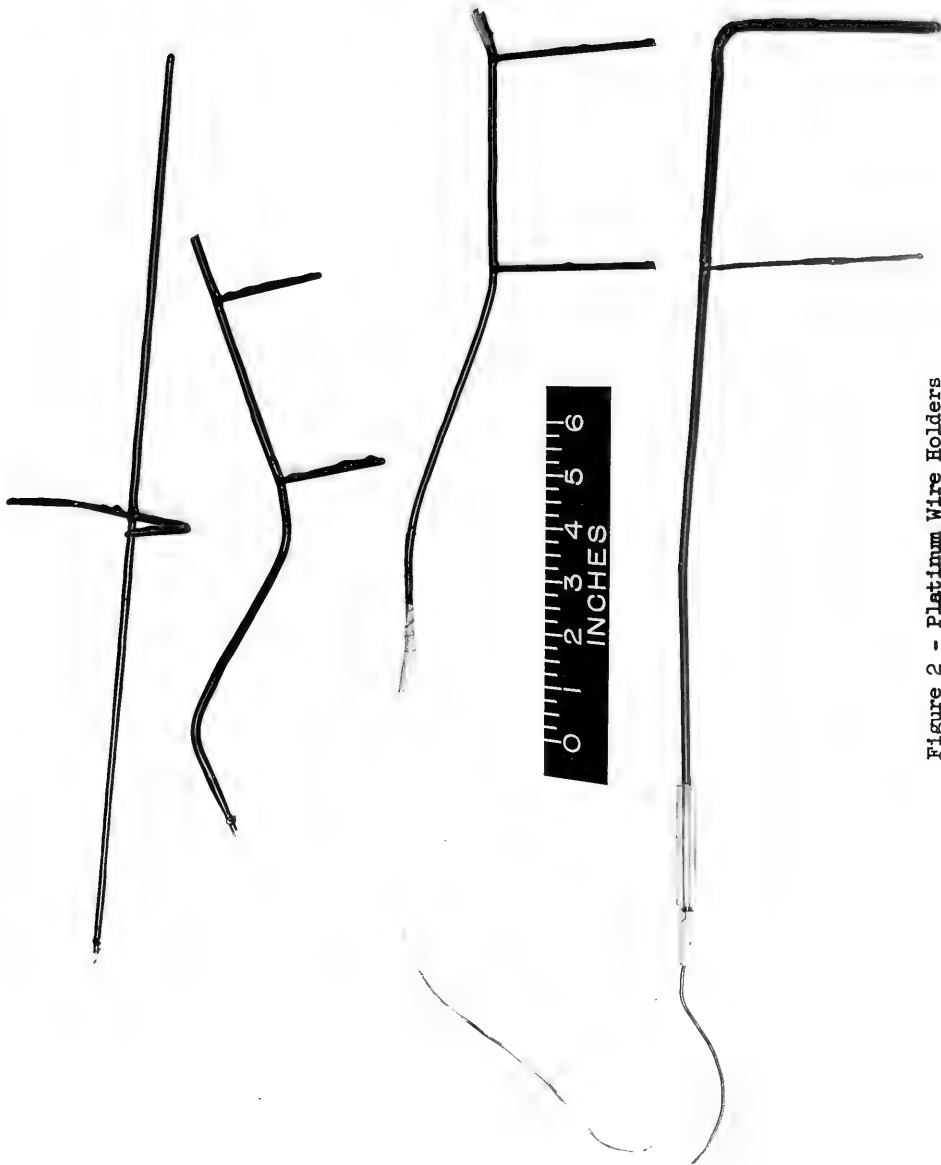

Figure 2 - Platinum Wire Holders



Bubble lines from straight wire positioned behind plane of streaklines. A separate pulsed power source is used.

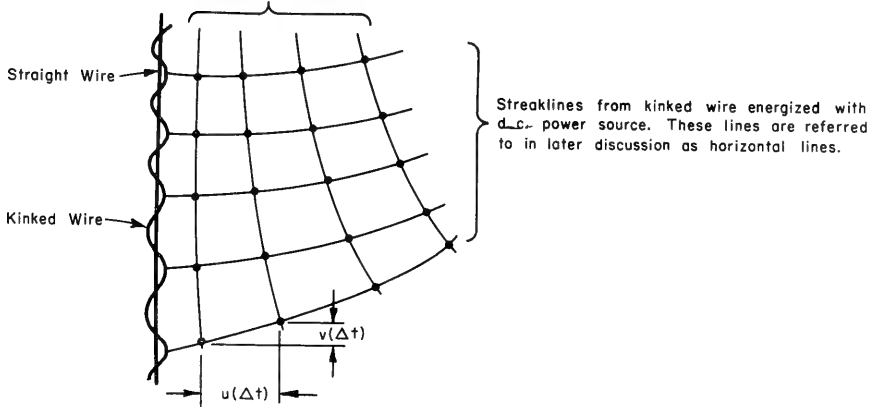

Figure 3a - Bubble Pattern for Longitudinal and Transverse Velocity Field

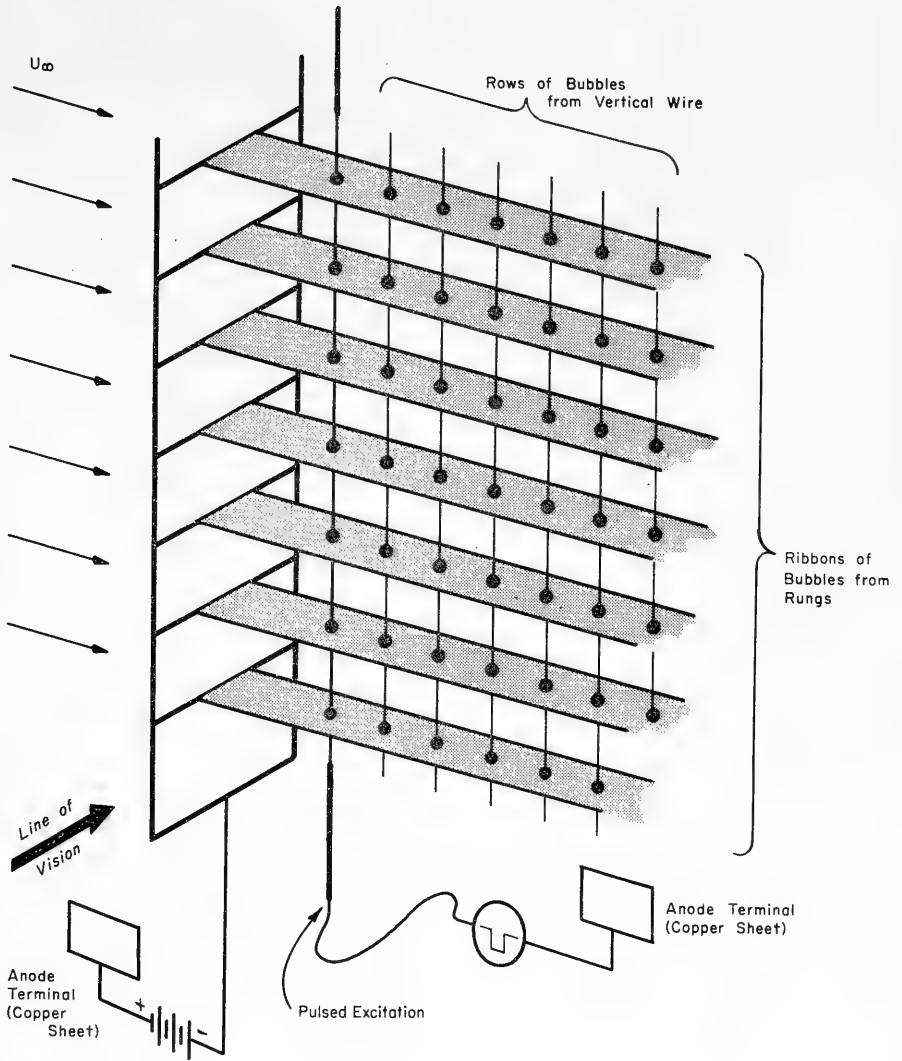
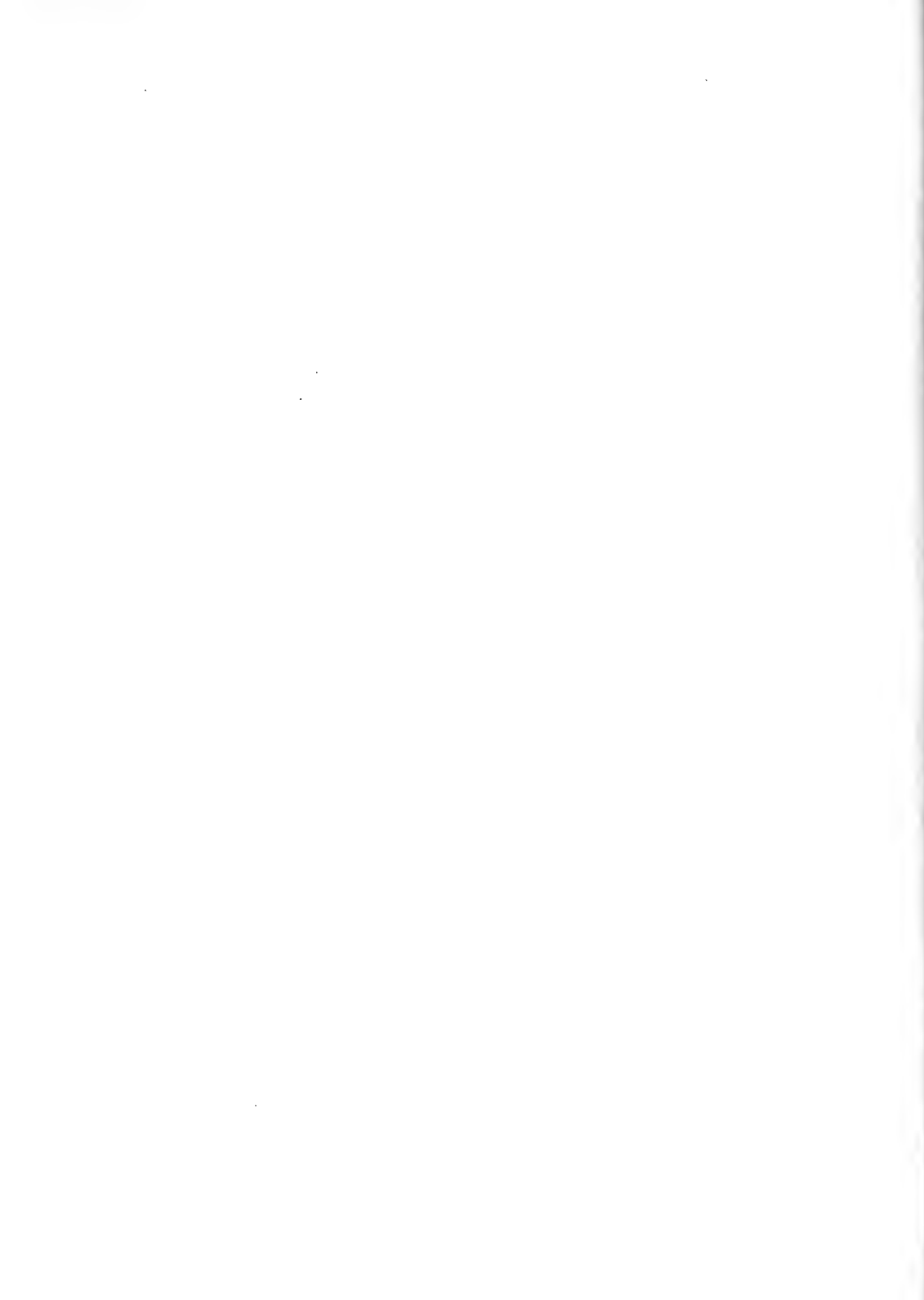

Figure 3b - Wire Configuration for Longitudinal and Transverse Velocity Profile Determination



Figure 4 - Spider Web Bubble Patterns in the Wake of a Circular Cylinder



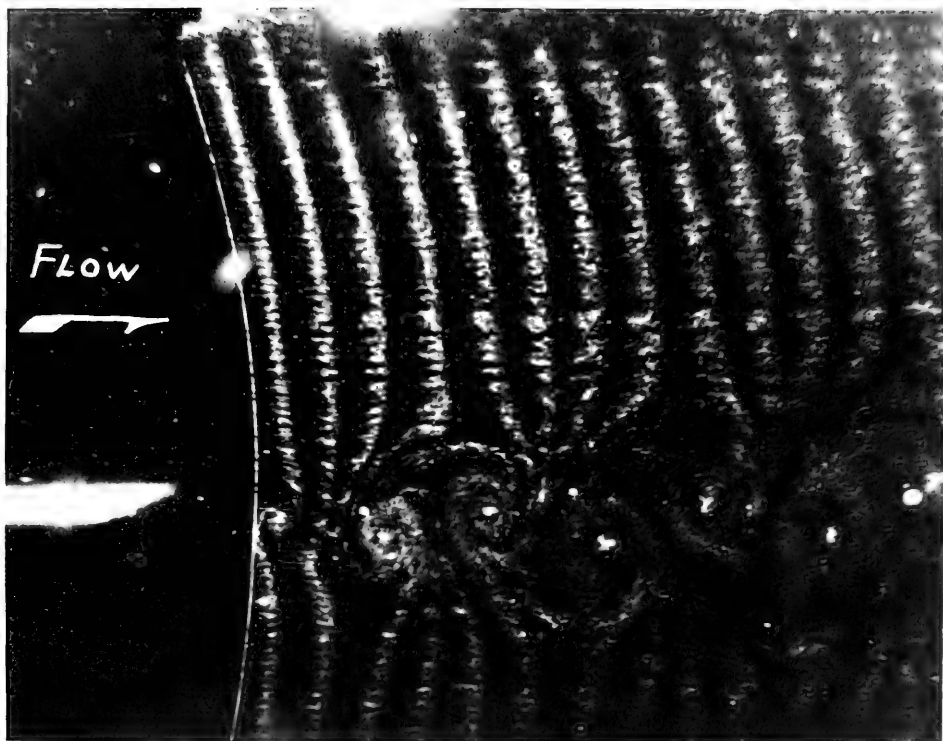
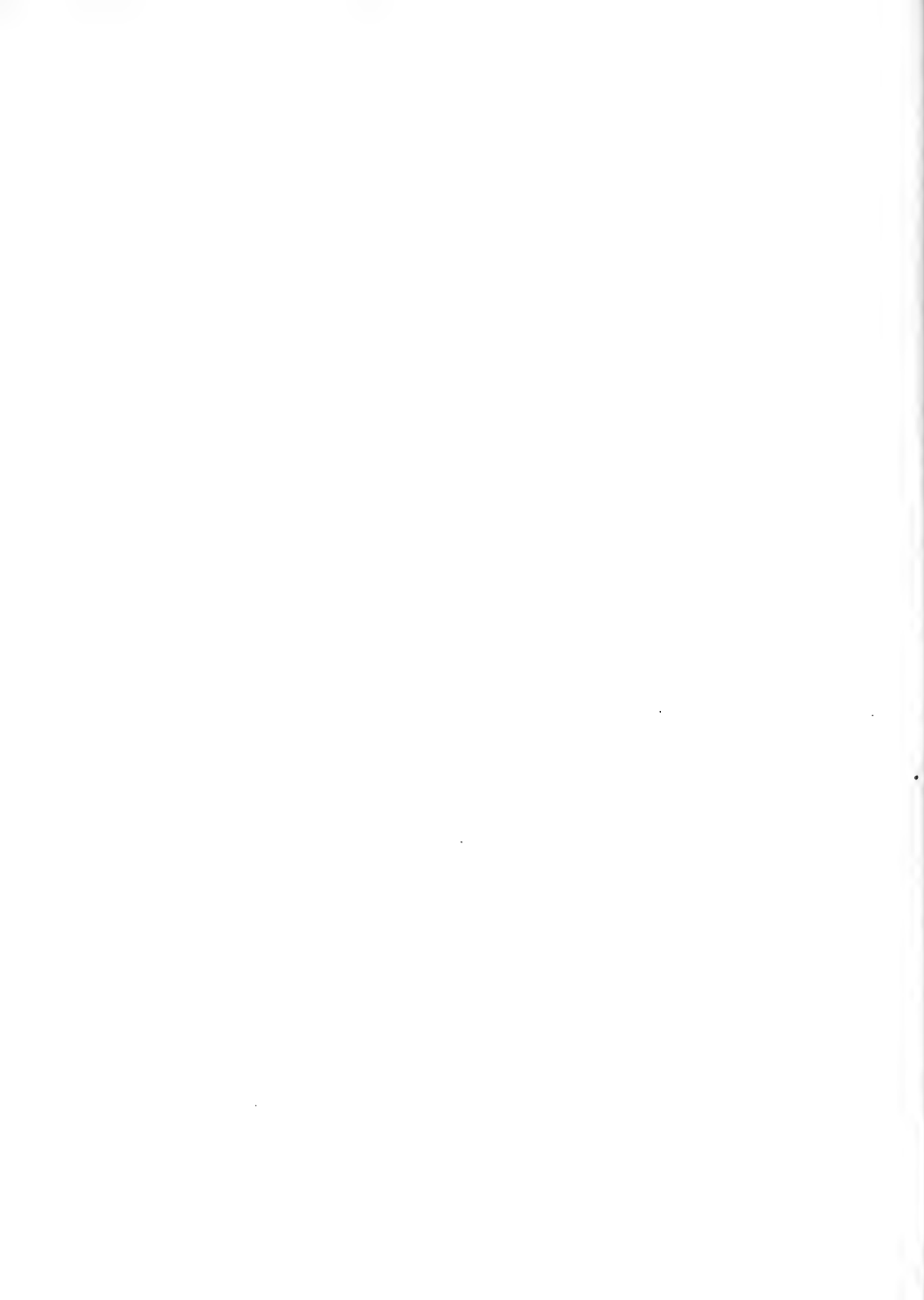

Figure 5 - Typical Bubble Patterns Behind a Two-Inch Plate
(Freestream Velocity is 16 fps)



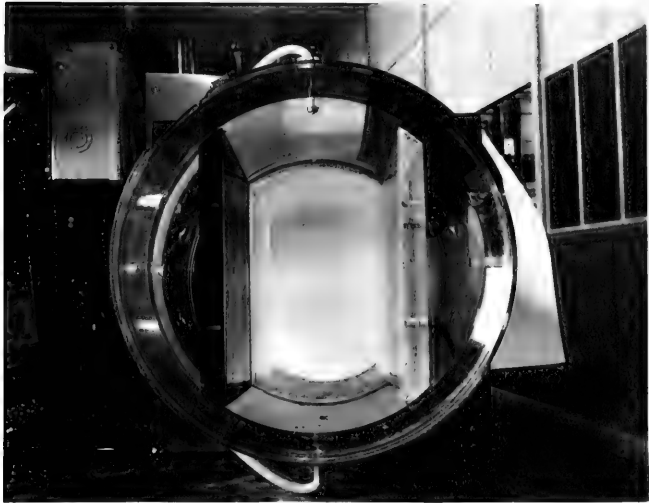

Figure 6 - Twelve-Inch ID Plexiglas Closed-Jet Test Section with Two-Dimensional Sides Installed



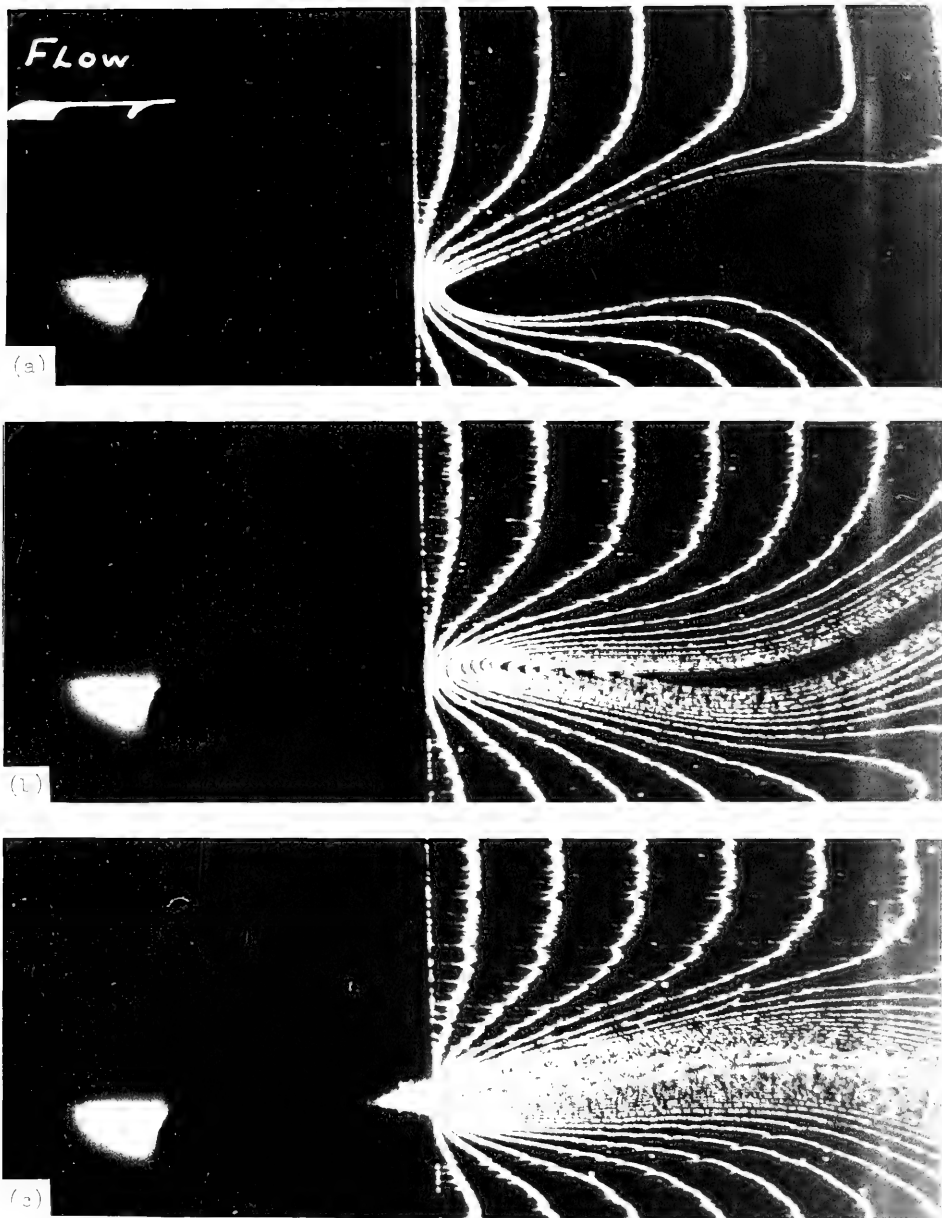

Figure 7 - Enlargement of Bubble Patterns in the Wake of a Flat Plate with Sharp Trailing Edge (Freestream Velocity is 1 fps)





Figure 8 - Leica Camera and Pulse Generation Equipment



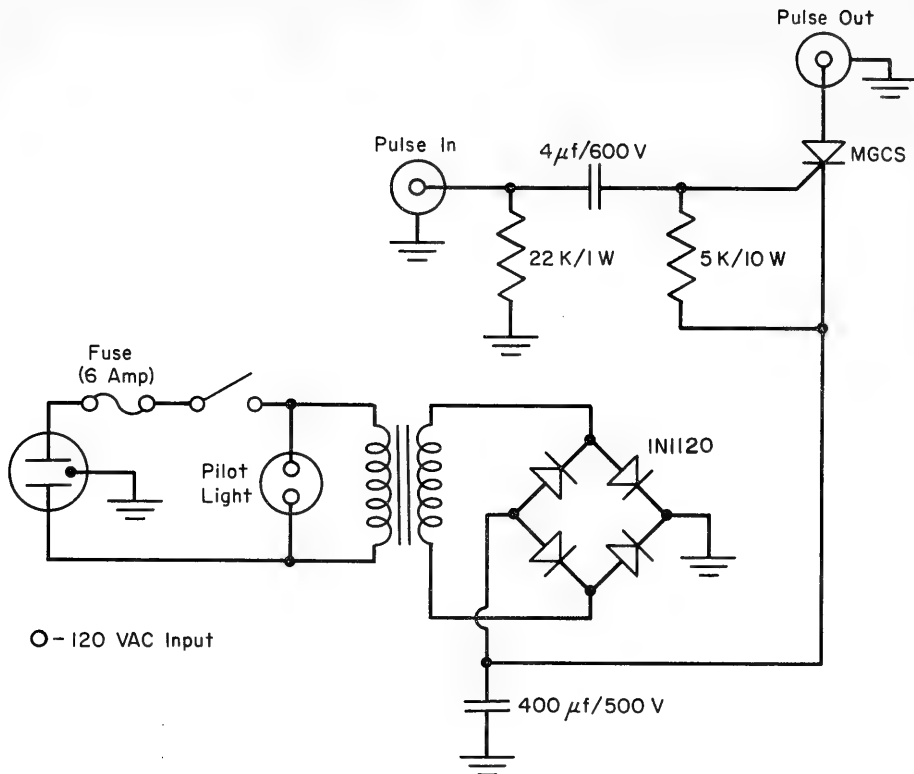

Figure 9 - Amplifier Unit Built for Hewlett-Packard Pulse Generator Model 214-A



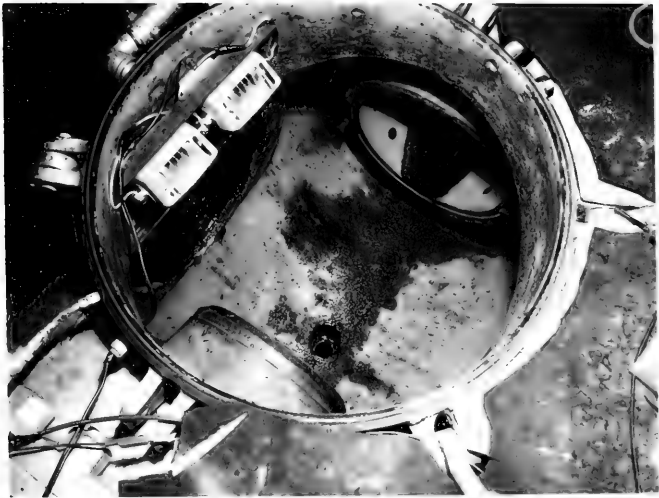

Figure 10 - Two Sylvania "Sun Guns" Mounted in Drained Test Section



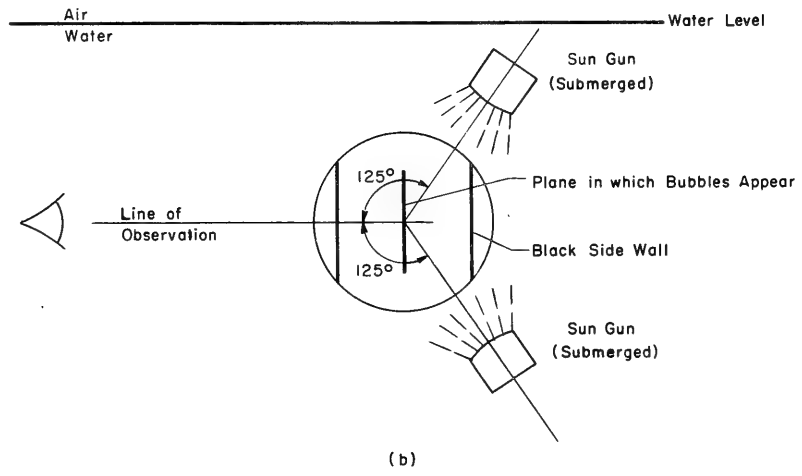
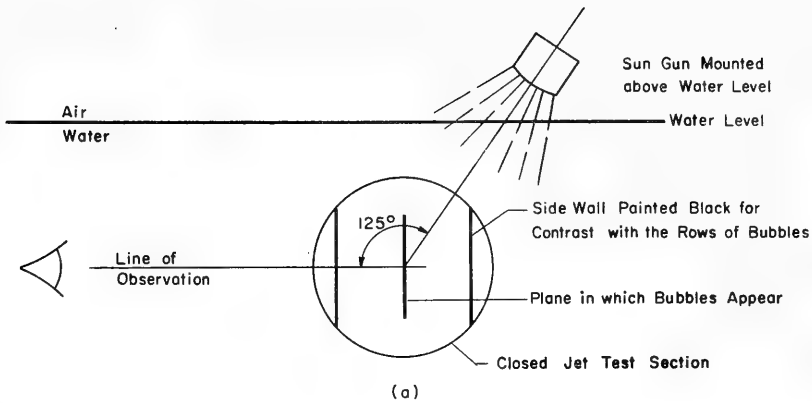

Figure 11 - View Parallel to Stream Velocity (Looking Upstream) of One Lighting Scheme (a) and an Improved Setup (b)

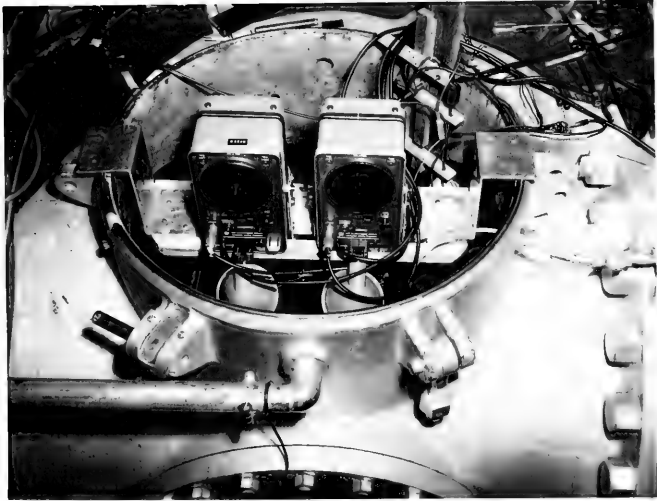

Figure 12 - Two General Radio Strobotacs Mounted in Hatch of Test Section



10:1 Aspect Ratio Foil



5:1 Aspect Ratio Foil

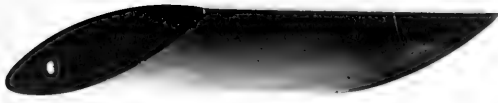

One-Inch-Diameter Circular Cylinder



Plate With Rounded Leading Edge and Blunt Trailing Edge



Blunt Edged Flat Plate



Figure 13 - Cylindrical Bodies



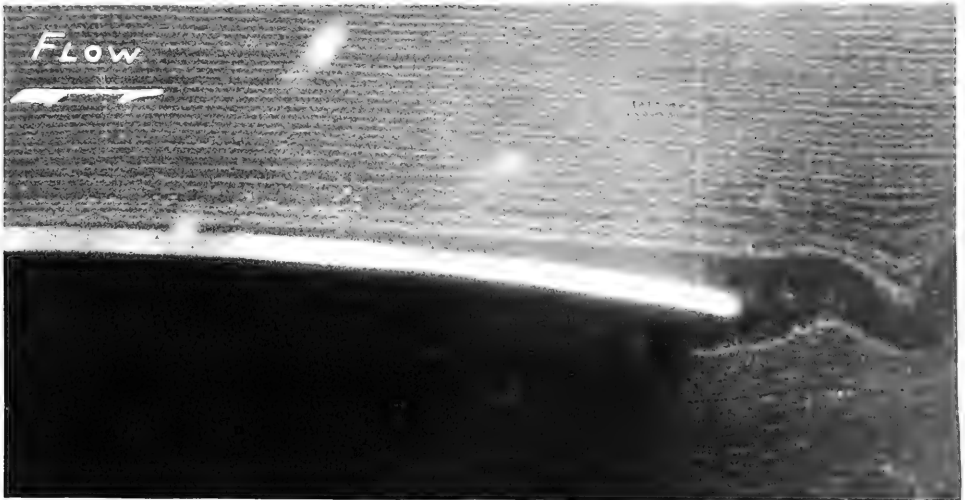

Figure 14 - Streakline Pattern About a Foil Shape, Aspect Ratio is 10:1
(Freestream Velocity is 1 fps)



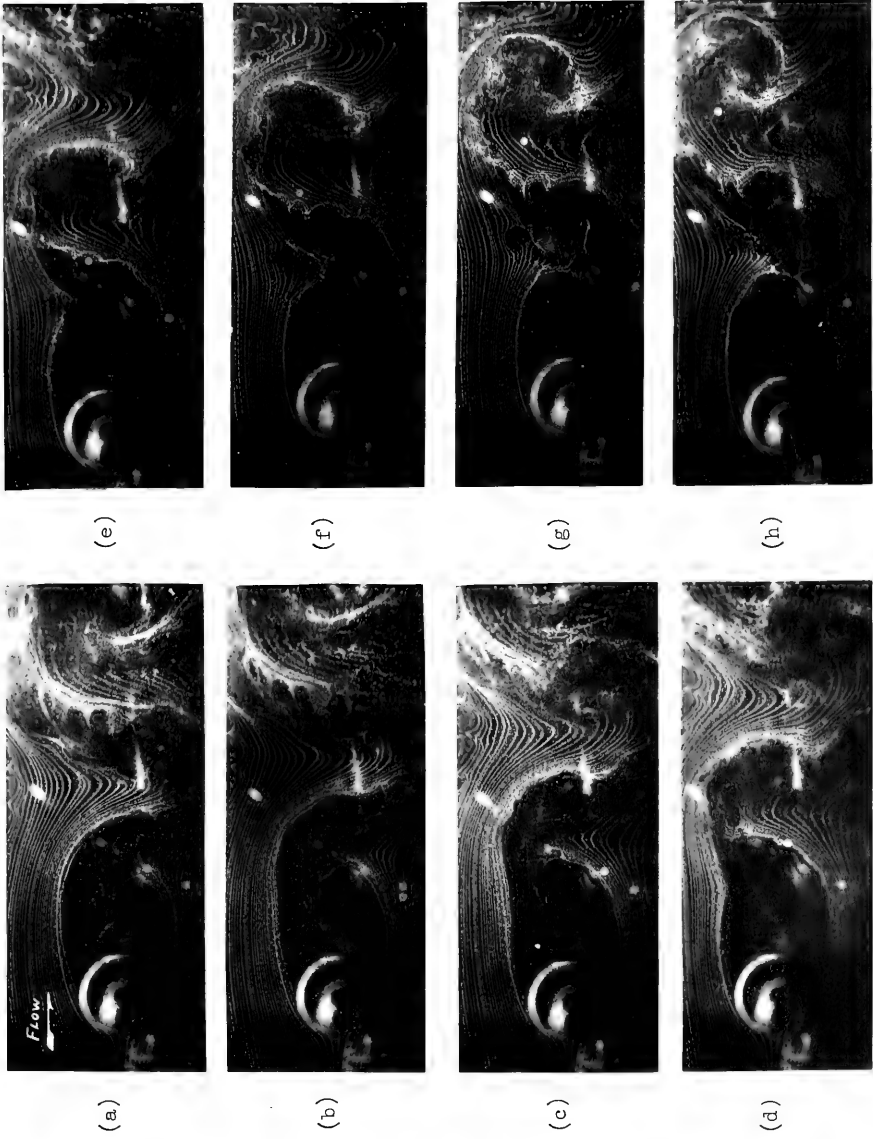

Figure 15 - Streakline Patterns of the Flow About a 1-Inch Diameter Cylinder (Freestream Velocity is 1 fps)



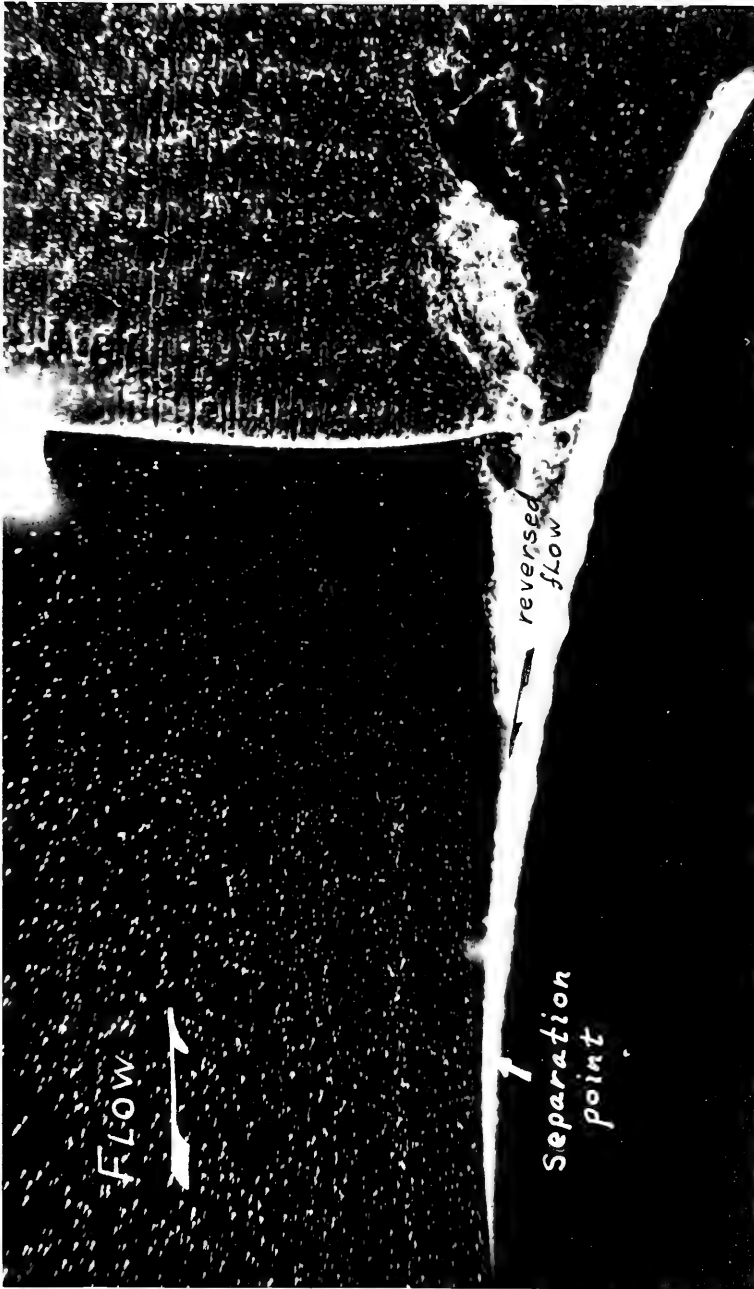

Figure 16 - Visual Determination of the Position of the Separation Point
(Freestream Velocity is 3 fps)





Figure 17 - Typical Bubble Patterns Behind 10:1 Foil Shape Illustrating Deviation from Two-Dimensionality along Foil Span Length



INITIAL DISTRIBUTION

Copies

13 CHBUSHIPS
 3 Tech Lib (Code 210-L)
 1 Lab Mgt (Code 320)
 1 Res & Dev (Code 300)
 1 Chief Sci for R&D (Code 305)
 1 Ship Res Br (Code 341)
 1 Matls, Fuels & Cold Weather (Code 342A)
 1 Ship Sil Br (Code 345)
 1 Prelim Des Sec (Code 421)
 1 Hull Des Br (Code 440)
 1 Sci & Res Sec (Code 442)
 1 Prop Shaft & Brng Br (Code 644)

6 CHBUWEPS
 1 Asst CDR for RDT&E (Code R)
 1 Chief Sci (Code R-12)
 1 Res & Eng Officer (Code RR)
 1 Res Div (Code RRRE)
 1 ASW Officer (Code RU)
 1 Torpedo Div (Code RUTO)

3 CHBUDOCKS
 1 Code D-202
 1 Code D-400
 1 Code D-500

4 CDR, USNOL, White Oak
 1 Dr. A. May (Code BG)
 1 Dr. R. E. Wilson (Code DA)
 1 Dr. D. F. Bleil (Code DR)
 1 Library Div - HL

6 CHONR
 3 Fluid Dynamics Br (Code 438)
 1 Head Power Br (Code 429)
 1 Air Programs (Code 461)
 1 Surface & Amphibious Programs (Code 463)

1 ONR, Boston
 1 ONR, Chicago
 1 ONR, New York
 1 ONR, London
 1 ONR, Pasadena
 1 ONR, San Francisco

8 DIR, USNRL
 1 Tech Information Officer (Code 2000)
 1 Library (Code 2020)
 6 TID (Code 2027)
 4 CDR, USNOTS, China Lake
 1 Mr. J. W. Hicks
 1 Code 5014
 1 Code 4032
 1 Code 753
 6 O in C, USNOTS, Pasadena
 1 Mr. J. W. Hoyt
 1 Research Div
 1 P508
 1 P804
 1 P807
 1 DS 0962 (Lib Sec)
 1 NAVOCEANO
 1 SUPT, USNA, Annapolis
 Attention Library
 1 CO & DIR, USNMEL
 Attention Library
 2 CDR, USNWL, Dahlgren
 1 Tech Lib Div
 1 Computation & Exterior Ballistics Lab (Dr. Hershey)
 1 CO, USNROTC & NAVADMINU, MIT
 1 CO & DIR, USNUSL
 Attention Library
 1 CO & DIR, USNEL
 Attention Code 4223
 1 CO & DIR, USNCEL, Port Hueneme
 1 CO & DIR, USNASL
 1 NAVSHIPYD NORVA
 1 NAVSHIPYD NYK
 1 NAVSHIPYD BNS
 1 NAVSHIPYD PHILA
 1 NAVSHIPYD PTSMH, Design Div
 1 NAVSHIPYD CHASN
 1 CO, USNUOS
 Attention Res. Div.
 1 NAVSHIPYD Long Beach
 1 NAVSHIPYD Pearl
 1 NAVSHIPYD SFRAN
 1 NAVSHIPYD MARE
 1 SUPT, U.S. Merchant Marine Academy, Long Island
 Attention Dept of Engineering

1 CMTF, USCG
1 U. S. Army Corps of Engineers
1 CO, U. S. Army Res Office
1 CDR, Hdqs U. S. Army Transportation Research & Development Command
1 Div, U. S. Army Engineering Research and Development Laboratories
Attention Technical Documents
20 DDC
2 ADM, MARAD
1 Coordinator of Research
1 Div Ship Design
1 DIR, Natl BuStand
Attention Fluid Mechanics Sec
1 USAEC, Oak Ridge, Tenn
Attention Tech Info Ser
1 NASA
Attention Dir Res, Code RR
1 DIR, Langley Res Center, NASA
1 DIR, Ames Res Lab, NASA
1 DIR, Lewis Res Center, NASA
1 DIR, Eng. Science Div, JAIL Science Foundation
1 CDR, Air Force Cambridge Res Center, Cambridge, Mass.
Attention Geophysical Res Library
1 Air Force Office of Science Research, Mechanics Div., Washington, D.C.
1 Eng. Societies Lib, New York
1 SNAME
2 Webb Inst., Naval Architecture
1 Prof. E. V. Lewis
1 Tech. Lib.
3 JHU
1 Prof. S. Corrsin
1 Prof. F. H. Clauser
1 Prof. O. M. Phillips
1 DIR, APL
1 State Univ. of N. Y.
Attention John J. Foody, Chairman, Eng. Dept.
5 CIT
1 Hydro Lab
1 Prof. T. Y. Wu
1 Prof. A. Ellis
1 Prof. A. Acosta
1 Prof. M. Plesset
7 Univ. of Calif., Berkeley
1 Dept Eng
1 Prof. H. A. Schade
1 Prof. J. Johnson
1 Prof. J. U. Wehausen
1 Prof. E. V. Laitone
1 Prof. P. Lieber
1 Prof. M. Holt



1 Univ. of Calif., Los Angeles
 Attention Prof. R. W. Leonard

1 DIR, Scripps Inst., Univ. of Calif., LaJolla

3 Iowa Inst. Hydraulic Research
 1 Prof. H. Rouse
 1 Prof. L. Landweber
 1 Prof. P. G. Hubbard

2 Harvard University
 1 Prof. G. Birkhoff
 1 Prof. S. Goldstein

1 Univ. of Michigan
 Attention Eng Res Inst

1 ORL, Penn State

6 DIR, St. Anthony Falls Hydraulic Lab
 1 J. F. Ripkin
 1 J. N. Wetzel
 1 Prof. E.R.G. Eckert
 2 C. E. Bowers

2 MIT
 1 Prof. P. Mandel
 1 Prof. M.A. Abkowitz

1 Univ. of Maryland
 Inst. for Fluid Mech. & Applied Mech.

1 Cornell Aeronautical Lab
 Attention Mr. W. F. Milliken, Jr.

2 Brown University
 1 Dr. R. E. Meyer
 1 Dr. W. H. Reid

4 SIT
 1 Mr. D. Savitsky
 1 Dr. J. P. Breslin
 1 Dr. D. N. Hu
 1 Dr. S. J. Lukasik

1 DIR, WHOI

1 DIR, Alden Hydraulic Lab, Worcester Polytechnic Inst., Worcester, Mass.

5 Stanford Univ.
 1 Dr. Byrne Perry
 1 Prof. P. Garabedian
 1 Mr. L. I. Schiff
 1 Dr. S. Kline
 1 Prof. E. Y. Hsu

1 Univ. Illinois, Dept of Theoretical and Applied Mechanics
 Attention Dr. J. M. Robertson

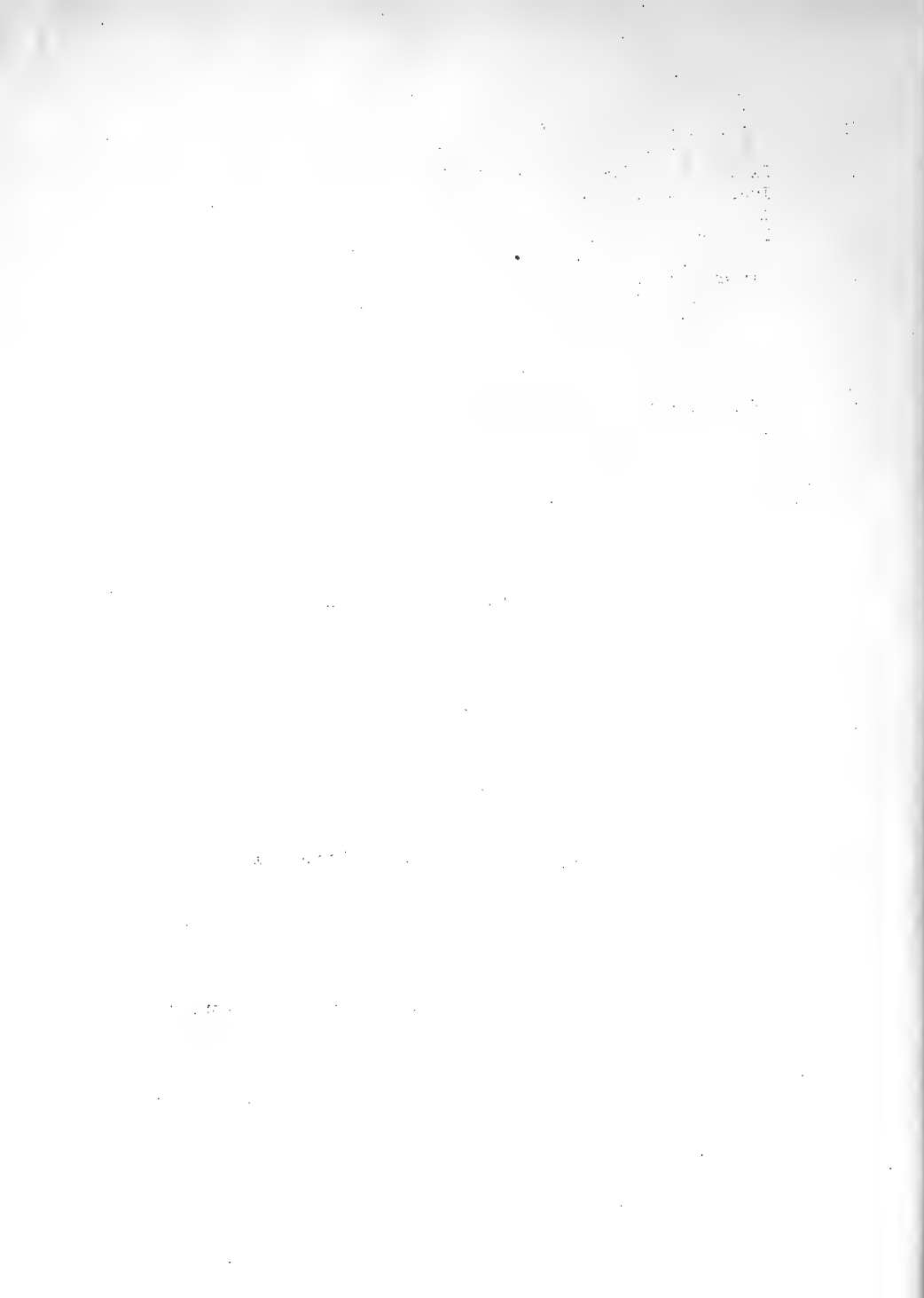

- 1 Rensselaer Polytechnic Inst, Dept of Mathematics
- 1 Southwest Research Institute
- 1 Univ of Colorado, Dept of Aeronautical Eng., Boulder, Colorado
Attention Prof. M. S. Uberoi
- 1 Hydronautics, Inc.
- 1 The Trane Company, La Crosse, Wisconsin
Attention Mary Powell, Librarian
- 1 Jet Propulsion Laboratory, Pasadena, Calif.
Attention Dr. F. R. Hama

DOCUMENT CONTROL DATA - R&D

(Security classification of title, body of abstract and indexing annotation must be entered when the overall report is classified)

1. ORIGINATING ACTIVITY (Corporate author)		2a. REPORT SECURITY CLASSIFICATION	
David Taylor Model Basin		Unclassified	
		2b. GROUP	
3. REPORT TITLE			
The Hydrogen-Bubble, Flow-Visualization Technique			
4. DESCRIPTIVE NOTES (Type of report and inclusive dates)			
Final			
5. AUTHOR(S) (Last name, first name, initial)			
Mattingly, George E.			
6. REPORT DATE		7a. TOTAL NO. OF PAGES	7b. NO. OF REFS
February 1966		50	11
8a. CONTRACT OR GRANT NO.		9a. ORIGINATOR'S REPORT NUMBER(S)	
b. PROJECT NO. S-R009-0101		9b. OTHER REPORT NO(S) (Any other numbers that may be assigned this report)	
c. Task 0103			
d.			
None			
10. AVAILABILITY/LIMITATION NOTICES			
Qualified requesters may obtain copies of this report from DDC.			
11. SUPPLEMENTARY NOTES		12. SPONSORING MILITARY ACTIVITY	
None		Bureau of Ships	
13. ABSTRACT SUMMARY			
<p>The hydrogen-bubble visualization technique has been adapted to the 12-inch variable-pressure water tunnel of the David Taylor Model Basin. An outline of this adaption and the operation of the technique are described.</p> <p>Photographic techniques and analyses applied to the resulting films are discussed. Sources of error are delineated, particularly with regard to the deceptive streakline patterns that can be formed and especially the results of exceeding the velocity limitation imposed by the shedding phenomena taking place behind the platinum wires. Errors caused by compression and/or stretching of bubble lines along their length are discussed, and procedures are given for recognizing this type of error. In addition, cathode-wire configurations are described by which both longitudinal and transverse velocity profiles can be obtained in steady or unsteady water flows.</p> <p>Various cathode-wire configurations are described through which qualitative aspects of the flow about bodies as stagnation and separation point motions are depicted.</p>			

14.	KEY WORDS	LINK A		LINK B		LINK C	
		ROLE	WT	ROLE	WT	ROLE	WT
	Flow visualization						
	Hydrogen bubbles						
	Water tunnel						
	Streaklines						

INSTRUCTIONS

1. **ORIGINATING ACTIVITY:** Enter the name and address of the contractor, subcontractor, grantee, Department of Defense activity or other organization (*corporate author*) issuing the report.

2a. **REPORT SECURITY CLASSIFICATION:** Enter the overall security classification of the report. Indicate whether "Restricted Data" is included. Marking is to be in accordance with appropriate security regulations.

2b. **GROUP:** Automatic downgrading is specified in DoD Directive 5200.10 and Armed Forces Industrial Manual. Enter the group number. Also, when applicable, show that optional markings have been used for Group 3 and Group 4 as authorized.

3. **REPORT TITLE:** Enter the complete report title in all capital letters. Titles in all cases should be unclassified. If a meaningful title cannot be selected without classification, show title classification in all capitals in parenthesis immediately following the title.

4. **DESCRIPTIVE NOTES:** If appropriate, enter the type of report, e.g., interim, progress, summary, annual, or final. Give the inclusive dates when a specific reporting period is covered.

5. **AUTHOR(S):** Enter the name(s) of author(s) as shown on or in the report. Enter last name, first name, middle initial. If military, show rank and branch of service. The name of the principal author is an absolute minimum requirement.

6. **REPORT DATE:** Enter the date of the report as day, month, year, or month, year. If more than one date appears on the report, use date of publication.

7a. **TOTAL NUMBER OF PAGES:** The total page count should follow normal pagination procedures, i.e., enter the number of pages containing information.

7b. **NUMBER OF REFERENCES:** Enter the total number of references cited in the report.

8a. **CONTRACT OR GRANT NUMBER:** If appropriate, enter the applicable number of the contract or grant under which the report was written.

8b, 8c, & 8d. **PROJECT NUMBER:** Enter the appropriate military department identification, such as project number, subproject number, system numbers, task number, etc.

9a. **ORIGINATOR'S REPORT NUMBER(S):** Enter the official report number by which the document will be identified and controlled by the originating activity. This number must be unique to this report.

9b. **OTHER REPORT NUMBER(S):** If the report has been assigned any other report numbers (*either by the originator or by the sponsor*), also enter this number(s).

10. **AVAILABILITY/LIMITATION NOTICES:** Enter any limitations on further dissemination of the report, other than those

imposed by security classification, using standard statements such as:

- (1) "Qualified requesters may obtain copies of this report from DDC."
- (2) "Foreign announcement and dissemination of this report by DDC is not authorized."
- (3) "U. S. Government agencies may obtain copies of this report directly from DDC. Other qualified DDC users shall request through _____."
- (4) "U. S. military agencies may obtain copies of this report directly from DDC. Other qualified users shall request through _____."
- (5) "All distribution of this report is controlled. Qualified DDC users shall request through _____."

If the report has been furnished to the Office of Technical Services, Department of Commerce, for sale to the public, indicate this fact and enter the price, if known.

11. **SUPPLEMENTARY NOTES:** Use for additional explanatory notes.

12. **SPONSORING MILITARY ACTIVITY:** Enter the name of the departmental project office or laboratory sponsoring (*paying for*) the research and development. Include address.

13. **ABSTRACT:** Enter an abstract giving a brief and factual summary of the document indicative of the report, even though it may also appear elsewhere in the body of the technical report. If additional space is required, a continuation sheet shall be attached.

It is highly desirable that the abstract of classified reports be unclassified. Each paragraph of the abstract shall end with an indication of the military security classification of the information in the paragraph, represented as (TS), (S), (C), or (U).

There is no limitation on the length of the abstract. However, the suggested length is from 150 to 225 words.

14. **KEY WORDS:** Key words are technically meaningful terms or short phrases that characterize a report and may be used as index entries for cataloging the report. Key words must be selected so that no security classification is required. Identifiers, such as equipment model designation, trade name, military project code name, geographic location, may be used as key words but will be followed by an indication of technical context. The assignment of links, roles, and weights is optional.

David Taylor Model Basin. Report 2146.

THE HYDROGEN-BUBBLE, FLOW-VISUALIZATION TECHNIQUE, by G.E. Mattingly. Feb 1966. iii, 50p. illus., diags., refs. UNCLASSIFIED

The hydrogen-bubble visualization technique has been adapted to the 12-inch variable-pressure water tunnel of the David Taylor Model Basin. An outline of this adaptation and the operation of the technique are described.

Photographic techniques and analyses applied to the resulting films are discussed. Sources of error are delineated, particularly with regard to the deceptive streakline patterns that can be formed and especially the results of exceeding the velocity limitation imposed by the shedding phenomena taking place behind the platinum wires. Errors caused by compression and/or stretching of bubble lines along their length are discussed, and

1. Flow-Visualization--Techniques
 2. Bubbles--Lines of flow--Visualization
 3. Bubbles--Photography--Streaklines
 4. Water tunnels--U.S.--Techniques
 5. Water tunnels--U.S.--DTMB
- I. Mattingly, G.E.

David Taylor Model Basin. Report 2146.

THE HYDROGEN-BUBBLE, FLOW-VISUALIZATION TECHNIQUE, by G.E. Mattingly. Feb 1966. iii, 50p. illus., diags., refs. UNCLASSIFIED

The hydrogen-bubble visualization technique has been adapted to the 12-inch variable-pressure water tunnel of the David Taylor Model Basin. An outline of this adaptation and the operation of the technique are described.

Photographic techniques and analyses applied to the resulting films are discussed. Sources of error are delineated, particularly with regard to the deceptive streakline patterns that can be formed and especially the results of exceeding the velocity limitation imposed by the shedding phenomena taking place behind the platinum wires. Errors caused by compression and/or stretching of bubble lines along their length are discussed, and

1. Flow-Visualization--Techniques
 2. Bubbles--Lines of flow--Visualization
 3. Bubbles--Photography--Streaklines
 4. Water tunnels--U.S.--Techniques
 5. Water tunnels--U.S.--DTMB
- I. Mattingly, G.E.

David Taylor Model Basin. Report 2146.

THE HYDROGEN-BUBBLE, FLOW-VISUALIZATION TECHNIQUE, by G.E. Mattingly. Feb 1966. iii, 50p. illus., diags., refs. UNCLASSIFIED

The hydrogen-bubble visualization technique has been adapted to the 12-inch variable-pressure water tunnel of the David Taylor Model Basin. An outline of this adaptation and the operation of the technique are described.

Photographic techniques and analyses applied to the resulting films are discussed. Sources of error are delineated, particularly with regard to the deceptive streakline patterns that can be formed and especially the results of exceeding the velocity limitation imposed by the shedding phenomena taking place behind the platinum wires. Errors caused by compression and/or stretching of bubble lines along their length are discussed, and

1. Flow-Visualization--Techniques
 2. Bubbles--Lines of flow--Visualization
 3. Bubbles--Photography--Streaklines
 4. Water tunnels--U.S.--Techniques
 5. Water tunnels--U.S.--DTMB
- I. Mattingly, G.E.

David Taylor Model Basin. Report 2146.

THE HYDROGEN-BUBBLE, FLOW-VISUALIZATION TECHNIQUE, by G.E. Mattingly. Feb 1966. iii, 50p. illus., diags., refs. UNCLASSIFIED

The hydrogen-bubble visualization technique has been adapted to the 12-inch variable-pressure water tunnel of the David Taylor Model Basin. An outline of this adaptation and the operation of the technique are described.

Photographic techniques and analyses applied to the resulting films are discussed. Sources of error are delineated, particularly with regard to the deceptive streakline patterns that can be formed and especially the results of exceeding the velocity limitation imposed by the shedding phenomena taking place behind the platinum wires. Errors caused by compression and/or stretching of bubble lines along their length are discussed, and

1. Flow-Visualization--Techniques
 2. Bubbles--Lines of flow--Visualization
 3. Bubbles--Photography--Streaklines
 4. Water tunnels--U.S.--Techniques
 5. Water tunnels--U.S.--DTMB
- I. Mattingly, G.E.

procedures are given for recognizing this type of error. In addition, cathode-wire configurations are described by which both longitudinal and transverse velocity profiles can be obtained in steady or unsteady water flows.

Various cathode-wire configurations are described through which qualitative aspects of the flow about bodies as stagnation and separation point motions are depicted.

procedures are given for recognizing this type of error. In addition, cathode-wire configurations are described by which both longitudinal and transverse velocity profiles can be obtained in steady or unsteady water flows.

Various cathode-wire configurations are described through which qualitative aspects of the flow about bodies as stagnation and separation point motions are depicted.

procedures are given for recognizing this type of error. In addition, cathode-wire configurations are described by which both longitudinal and transverse velocity profiles can be obtained in steady or unsteady water flows.

Various cathode-wire configurations are described through which qualitative aspects of the flow about bodies as stagnation and separation point motions are depicted.

procedures are given for recognizing this type of error. In addition, cathode-wire configurations are described by which both longitudinal and transverse velocity profiles can be obtained in steady or unsteady water flows.

Various cathode-wire configurations are described through which qualitative aspects of the flow about bodies as stagnation and separation point motions are depicted.

David Taylor Model Basin. Report 2146.

THE HYDROGEN-BUBBLE, FLOW-VISUALIZATION TECHNIQUE, by G.E. Mattingly. Feb 1966. iii, 50p. illus., diagrs., UNCLASSIFIED

The hydrogen-bubble visualization technique has been adapted to the 12-inch variable-pressure water tunnel of the David Taylor Model Basin. An outline of this adaption and the operation of the technique are described.

Photographic techniques and analyses applied to the resulting films are discussed. Sources of error are delineated, particularly with regard to the deceptive streakline patterns that can be formed and especially the results of exceeding the velocity limitation imposed by the shedding phenomena taking place behind the platinum wires. Errors caused by compression and/or stretching of bubble lines along their length are discussed, and

1. Flow--Visualization--Techniques
 2. Bubbles--Lines of flow--Visualization
 3. Bubbles--Photography--Streaklines
 4. Water tunnels--U.S.--Techniques
 5. Water tunnels--U.S.--DTMB
- I. Mattingly, G.E.

David Taylor Model Basin. Report 2146.

THE HYDROGEN-BUBBLE, FLOW-VISUALIZATION TECHNIQUE, by G.E. Mattingly. Feb 1966. iii, 50p. illus., diagrs., UNCLASSIFIED

The hydrogen-bubble visualization technique has been adapted to the 12-inch variable-pressure water tunnel of the David Taylor Model Basin. An outline of this adaption and the operation of the technique are described.

Photographic techniques and analyses applied to the resulting films are discussed. Sources of error are delineated, particularly with regard to the deceptive streakline patterns that can be formed and especially the results of exceeding the velocity limitation imposed by the shedding phenomena taking place behind the platinum wires. Errors caused by compression and/or stretching of bubble lines along their length are discussed, and

1. Flow--Visualization--Techniques
 2. Bubbles--Lines of flow--Visualization
 3. Bubbles--Photography--Streaklines
 4. Water tunnels--U.S.--Techniques
 5. Water tunnels--U.S.--DTMB
- I. Mattingly, G.E.

David Taylor Model Basin. Report 2146.

THE HYDROGEN-BUBBLE, FLOW-VISUALIZATION TECHNIQUE, by G.E. Mattingly. Feb 1966. iii, 50p. illus., diagrs., UNCLASSIFIED

The hydrogen-bubble visualization technique has been adapted to the 12-inch variable-pressure water tunnel of the David Taylor Model Basin. An outline of this adaption and the operation of the technique are described.

Photographic techniques and analyses applied to the resulting films are discussed. Sources of error are delineated, particularly with regard to the deceptive streakline patterns that can be formed and especially the results of exceeding the velocity limitation imposed by the shedding phenomena taking place behind the platinum wires. Errors caused by compression and/or stretching of bubble lines along their length are discussed, and

1. Flow--Visualization--Techniques
 2. Bubbles--Lines of flow--Visualization
 3. Bubbles--Photography--Streaklines
 4. Water tunnels--U.S.--Techniques
 5. Water tunnels--U.S.--DTMB
- I. Mattingly, G.E.

David Taylor Model Basin. Report 2146.

THE HYDROGEN-BUBBLE, FLOW-VISUALIZATION TECHNIQUE, by G.E. Mattingly. Feb 1966. iii, 50p. illus., diagrs., UNCLASSIFIED

The hydrogen-bubble visualization technique has been adapted to the 12-inch variable-pressure water tunnel of the David Taylor Model Basin. An outline of this adaption and the operation of the technique are described.

Photographic techniques and analyses applied to the resulting films are discussed. Sources of error are delineated, particularly with regard to the deceptive streakline patterns that can be formed and especially the results of exceeding the velocity limitation imposed by the shedding phenomena taking place behind the platinum wires. Errors caused by compression and/or stretching of bubble lines along their length are discussed, and

1. Flow--Visualization--Techniques
 2. Bubbles--Lines of flow--Visualization
 3. Bubbles--Photography--Streaklines
 4. Water tunnels--U.S.--Techniques
 5. Water tunnels--U.S.--DTMB
- I. Mattingly, G.E.

procedures are given for recognizing this type of error. In addition, cathode-wire configurations are described by which both longitudinal and transverse velocity profiles can be obtained in steady or unsteady water flows.

Various cathode-wire configurations are described through which qualitative aspects of the flow about bodies as stagnation and separation point motions are depicted.

procedures are given for recognizing this type of error. In addition, cathode-wire configurations are described by which both longitudinal and transverse velocity profiles can be obtained in steady or unsteady water flows.

Various cathode-wire configurations are described through which qualitative aspects of the flow about bodies as stagnation and separation point motions are depicted.

procedures are given for recognizing this type of error. In addition, cathode-wire configurations are described by which both longitudinal and transverse velocity profiles can be obtained in steady or unsteady water flows.

Various cathode-wire configurations are described through which qualitative aspects of the flow about bodies as stagnation and separation point motions are depicted.

procedures are given for recognizing this type of error. In addition, cathode-wire configurations are described by which both longitudinal and transverse velocity profiles can be obtained in steady or unsteady water flows.

Various cathode-wire configurations are described through which qualitative aspects of the flow about bodies as stagnation and separation point motions are depicted.

