

UNIVERSITY OF TORONTO LIBRARY



3 1761 00655978 5

ILLUSTRATED CATALOGUE

AND

GENERAL DESCRIPTION

OF

IMPROVED MACHINE TOOLS

FOR WORKING METAL

DESIGNED AND CONSTRUCTED BY

WILLIAM SELLERS & CO., INCORPORATED,

PHILADELPHIA, PA., U. S. A.

MANUFACTURERS OF

Patent Quick-return Planing-Machines, Lathes, Drill-Presses, Drill- and Tool-Grinding Machines,
Steam-Hammers, Steam- and Hydraulic-Riveters, Punches, and Shears, Bolt-Cutters,
Wheel-Presses, Hoisting-Machines, Swing-Cranes, High-Speed Power Travel-
ling-Cranes, Boring- and Turning-Mills, Cylinder-Borers, Car-Wheel
Borers, Testing-Machines, Injectors for all kinds of Service,
Shafting, Pulleys, Hangers, Couplings, Turn-Tables,
etc., etc., etc.

107217
" " "

PHILADELPHIA:

LEVYTYPE COMPANY, ENGRAVERS AND PRINTERS.

1899.

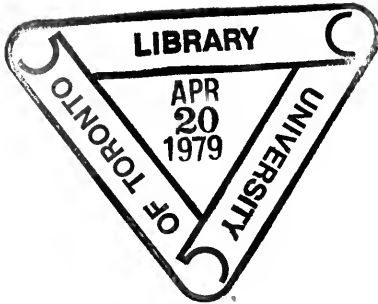

TJ
1190
S46
1899

COPYRIGHT, 1899,
BY
WILLIAM SELLERS & CO., INCORPORATED.

Introduction.

IN presenting a new edition of our Catalogue we have endeavored to illustrate as many as possible of the machines which we have added to our list since our last edition was published; but the progress of machine construction is so rapid that it is impossible to keep a work of this kind thoroughly up to date.

We have in progress at the present time a number of new machines which we would greatly like to illustrate, but which will not be completed in time for the present issue. Besides adding many new and improved tools to our list of manufactures we have thoroughly revised many of our standard products, making those changes in detail which experience has demonstrated would increase their efficiency or durability and substituting new designs where it was found advantageous to do so. At best this publication is necessarily incomplete; it is intended more as an indication of our general line of work, than an exact catalogue of our productions.

If, therefore, intending purchasers should not find herein machines which meet their requirements in capacity or kind, we may nevertheless be prepared to furnish what they want, and we solicit their inquiries and specifications.

WM. SELLERS & CO., INCORPORATED.

AWARDS RECEIVED

BY

WM. SELLERS & CO., Incorporated.

Gold Medal, Franklin Institute, Philadelphia,	-	-	1854
Gold Medal, Maryland Institute, Baltimore,	-	-	1857
Gold Medal, Exposition Universelle, Paris,	-	-	1867
Three Medals, American Institute, New York,	-	-	1869
Five Medals and the Grand Diploma of Honor, Vienna,			1873
Three Medals, International Exhibition, Philadelphia,	-		1876
Grand Prize, Exposition Universelle, Paris,	-	-	1889
Three Medals, World's Columbian Exposition, Chicago,			1893

WM. SELLERS & CO.

INCORPORATED

ENGINEERS

MACHINISTS

WM. SELLERS, President and Engineer,

JOHN SELLERS, JR., Vice-Pres. & Treas. J. SELLERS BANCROFT, Manager,

JUSTUS H. SCHWACKE, Secretary,

COLEMAN SELLERS, JR., Asst. Manager,

D. L. LUKENS, Purchasing Agent,

WILFRED LEWIS, Asst. Engineer.

Bolt and Nut-Screwing Machines.

THE essential features of these machines were first put into practice by us, and for many years we were the only makers of Bolt-Cutting Machines that operated with self-opening dies, and yet cut the bolt as with a solid die. The advantages claimed are,—

1. The dies revolve and the bolt is stationary, which enables the workman to put in a fresh bolt without stopping the machine, and on long bolts is much more convenient than to revolve the bolt.

2. The motion of the dies is always in one direction, and the bolt is cut at one operation. The dies open while they are revolving, consequently they leave no mark on the thread.

3. The dies never run backward. The cutting edge will last much longer than when the motion of the die is reversed.

4. The dies are adjustable, so as to compensate for wear.

5. The dies can be changed without taking off any of the die-holding apparatus, and in less time than they can be changed in a common hand-screwing stock.

6. The bolt-holder is arranged so as always to chuck the bolts in the centre of the dies, thus insuring correct work.

7. The self-acting oil-feeder insures thorough lubrication of the dies, effectually prevents their heating, and is so arranged as to wash the chips out of the die-box.

8. The automatic self-opening attachment insures uniformity in length of bolt threaded.

9. Die-box is provided with four dies, equally spaced, insuring accurate work. Each pair of dies calliper the bolt while being cut, thus making the bolt round and to gauge.

10. Is fitted for use as a nut-tapping machine, with automatic lubrication of the tap.

On the back of the large driving wheel is an index or pointer, which must be set to numbers given on a card sent with each machine. When so set, the bolt will fit a nut cut with the tap of corresponding size sent with machine. An adjustment of the index, one way or the other, will cause the bolt cut to be larger or smaller, thus permitting the thread to be adapted to the use required of it, and also permitting an adjustment of dies to compensate for wear.

Some important improvements have been added to these machines, viz., a slight change in the mode of driving has enabled us to run them at a higher speed, and a novel oil-feeding device supplies the oil to the back of the dies, whence flowing out, it thoroughly lubricates the cutters and the bolt end, and washes out the chips as they are cut from the bolt. A regulating cock in the feed-pipe directs the oil either to the dies as above stated, or to the tap when the machine is used as a nut tapper.

PLATE NO. 1.

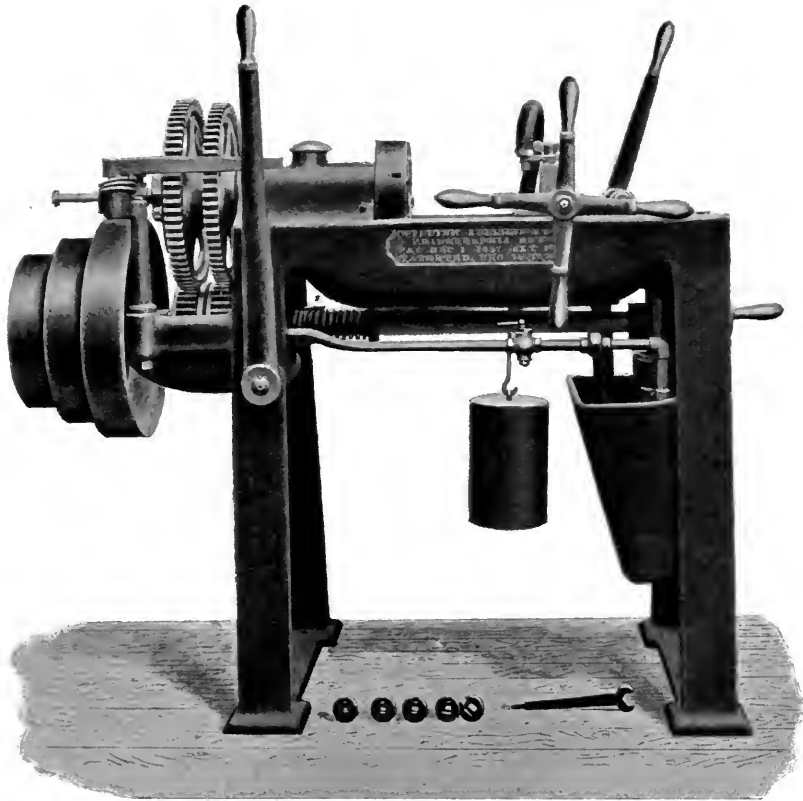

$\frac{3}{4}$ " BOLT AND NUT-SCREWING MACHINE.

With improved die box ; dies adjustable to compensate for wear ; automatic opening device adjustable to suit length of thread required ; self-acting oil feeder for taps and dies ; complete with countershaft, wrenches, oil pump and circulating pipes, with eight sets of taps, tap-holders and dies for bolts and nuts from $\frac{1}{4}$ " to $\frac{3}{4}$ ". Fast and loose pulleys 12" diameter, 4" face. 200 revolutions per minute. Hobs and collars for recutting dies, extra.

Bolt and Nut-Screwing Machines.—Continued.

A convenient adjustable stop-motion is provided to open the dies automatically when a given length of thread has been cut.

These machines are usually fitted with dies for cutting V threads only, and, when not otherwise specified, we furnish taps and dies corresponding with the United States standard, which was recommended for general adoption by the *Franklin Institute of the State of Pennsylvania, December 15, 1864*. We are also prepared to furnish taps and dies for *Whitworth* standard threads.

We can adapt dies for cutting coarse-threaded wood or "lag" screws, and so also dies for cutting square threads; in case of the latter, it is advisable to make the cut with more than once going over, to produce smooth work. Unless specially ordered to the contrary, our machines are always adjusted to cut threads to standard diameters, and if over-sized iron is used in bolts, it should be swaged down to the proper size on part where screw is to be cut.

To sharpen the dies, they must be softened, and then recut with hobs, which we make for this purpose, but which are not included in the price of the machine.

With each machine we send full printed directions for setting the dies and for repairing them. All parts of our bolt machines are made to gauge, and dies fitted to one machine can be used in any other machine of the same size of our make. We can therefore make new dies of any required thread to be used in any one of these machines, without having the machine in which they are to be used to fit them to.

This is of great importance in the case of special dies being needed for any purpose, when the user of the machine has no conveniences for producing new dies. The sharpening or cutting of the dies is readily done by any mechanic, but either blank dies or dies finished ready for use can be furnished to those who do not desire to make them.

Table of Sizes.

Size of Machine.	Range of Cut.	No. of Taps and Dies sent with each	Size of Machine.	Range of Cut.	No. of Taps and Dies sent with each.
$\frac{3}{4}$ "	$\frac{1}{4}$ " to $\frac{3}{4}$ "	8	$2\frac{1}{2}$ "	1 " to $2\frac{1}{2}$ "	8
1 "	$\frac{5}{16}$ " to 1 "	8	3 "	$1\frac{1}{8}$ " to 3 "	9
$1\frac{1}{2}$ "	$\frac{1}{2}$ " to $1\frac{1}{2}$ "	8	4 "	$1\frac{1}{2}$ " to 4 "	9
2 "	$\frac{3}{4}$ " to 2 "	8			

Hobs and collars for recutting dies, extra.

PLATE No. 2.

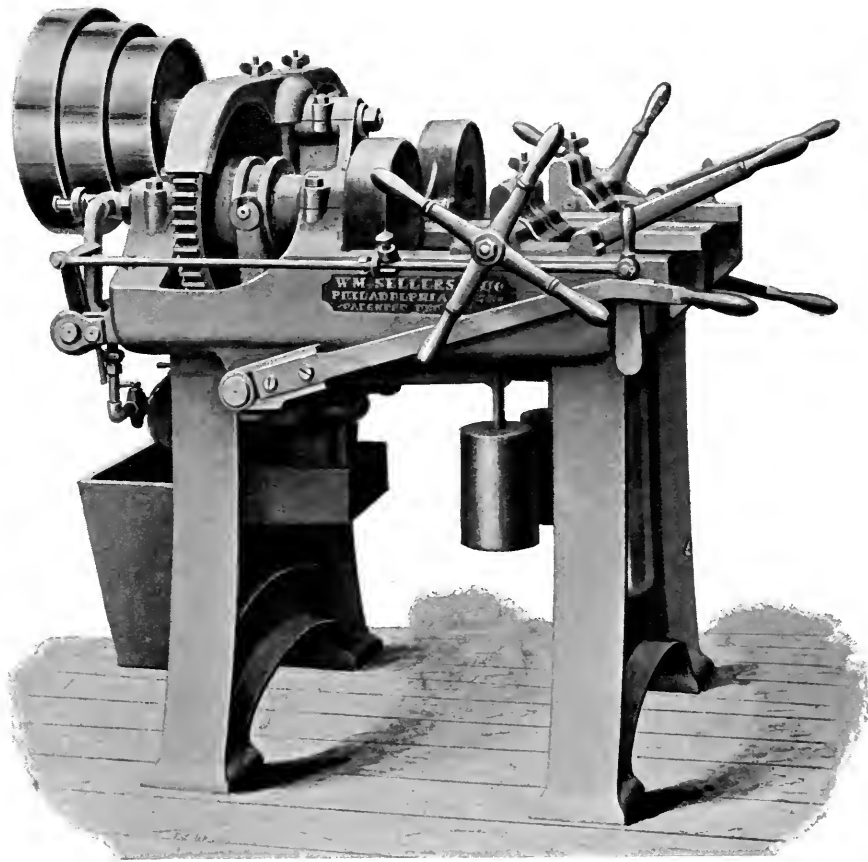

1" PATENT DUPLEX BOLT AND NUT-SCREWING MACHINE.

With improved die box ; dies adjustable for wear ; patent operating device ; automatic die-opening attachment adjustable to length of thread required ; self-acting oil feeders for taps and dies ; heads stopped and started independently ; complete with countershaft, wrenches, oil pump and circulating pipes, eight sets of taps and dies for bolts and nuts from $\frac{5}{16}$ " to 1" ; fast and loose pulleys 12" diameter, 4" face, 280 rotations per minute.

Hobs and collars for recutting dies, extra.

NOTE.—This machine is also built *single*, that is, with one die head and carriage.

PLATE NO. 3.



1 1/2" PATENT BOLT AND NUT-SCREWING MACHINE.

With improved die box ; dies adjustable for wear ; patent operating device ; automatic die-opening device, adjustable to suit length of thread required ; self-acting oil feeders for taps and dies ; complete with countershaft, wrenches, oil pump, circulating pipes and eight sets of taps, tap-holders and dies for bolts and nuts from 1/2" to 1 1/4" ; Fast and loose pulleys on countershaft are 10" diameter, 4" face and should make 200 revolutions per minute.

Hobs and collars for recutting dies, extra.

PLATE NO. 4.

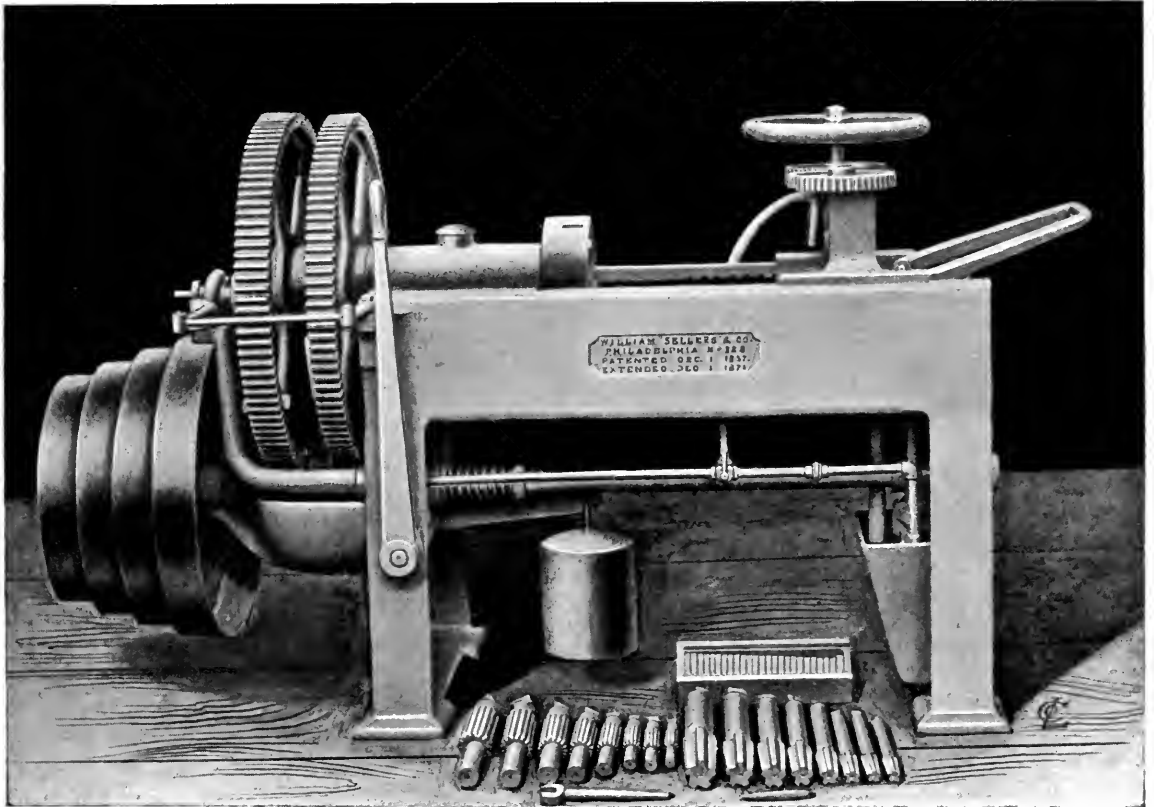
 $2\frac{1}{2}$ " BOLT AND NUT-SCREWING MACHINE.

With improved die box; dies adjustable to compensate for wear; automatic die-opening attachment, adjustable to length of thread required; self-acting oil feeder for taps and dies; complete with countershaft, wrenches, oil pumps, circulating pipes, and eight sets of taps, tap-holders and dies for bolts and nuts from 1" to $2\frac{1}{2}$ ". Fast and loose pulleys are 20" diameter, 4" face; 200 rotations per minute.

Hobs and collars for recutting dies, extra.

Vertical Drill-Presses.

MAXIMUM output of work on a drill press or any other machine tool, demands a power feed which is adjustable to exactly suit the tool, the hardness of the material and the speed. Two or three feeds on a drill press are not enough, because they are rarely exactly right; as a result it is frequently noticed that the operator prefers to feed by hand. If the work to be done is always the same, a fixed rate of feed and a fixed speed will answer, but with holes varying through a large range of diameters in all kinds of material, the ideal feed motion must have an infinite number of variations, differing one from another by the minutest shades. This condition is exactly met by our improved disc feed. Moreover, the changes are made instantly, by shifting a convenient hand lever, and the feed produced is continuous, not intermittent.

Our Vertical Drills are provided with back gear for heavy drilling and boring; but for ordinary work the spindle is driven by belts alone, so that they are noiseless at high speeds, and have that smoothness of motion which is required for very delicate work. The back gear is not usually required except for very large drills.

The steel spindle slides in a sleeve supported in two bearings with the driving wheels between them, so that the steel spindle is not subject to the side strains of belt or gears, and it is so long that the ends never run into the sleeve, thus insuring a constant length of bearing. Our spindles are counterbalanced and move easily and rapidly by hand;—one turn of the nut serves to move the drill $1\frac{1}{2}$ ". The end thrust is taken on a small hard step, which produces less frictional loss than the collars ordinarily employed, and is more easily lubricated.

A convenient gauge is provided for drilling or counterboring a number of holes to a uniform depth, all handles are grouped so as to be most convenient to the operator, and the greatest care is taken to secure accuracy of workmanship.

The tables, being raised and lowered by power, can be set to suit the length of the drill and the height of the work; thus obviating in most cases the use of the long extensions which are required with fixed heads and fixed tables.

PLATE NO. 5.

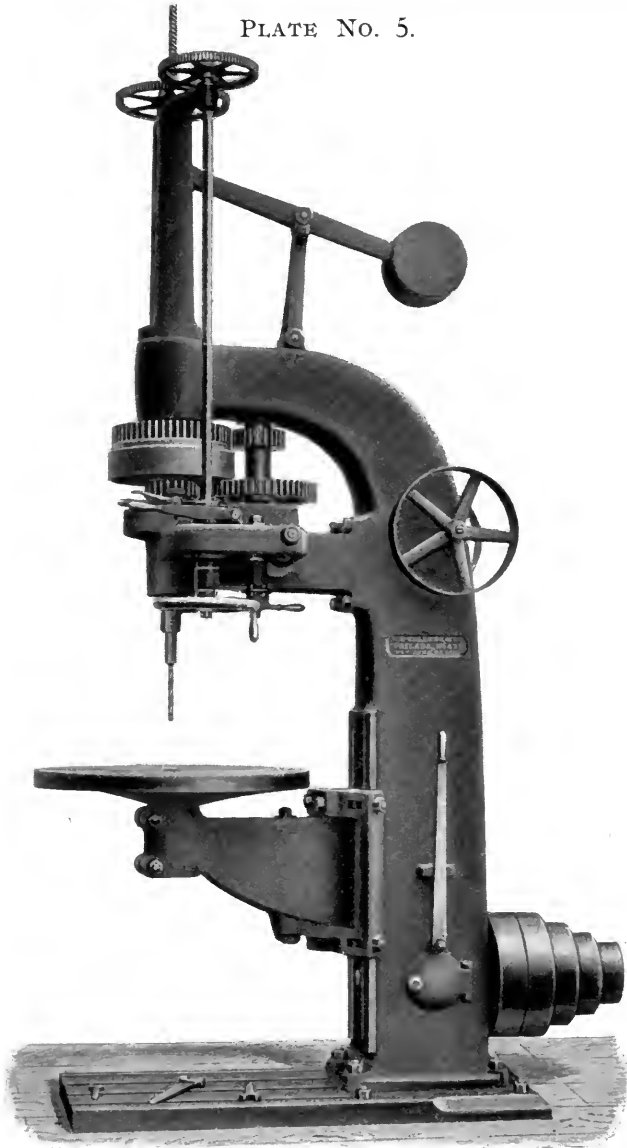

45" VERTICAL DRILLING MACHINE—WITH CIRCULAR TABLE.

Overreach $22\frac{3}{4}$ " from centre of drill to face of upright. Upright secured to slotted floor-plate. Circular table 32" diameter, carried upon bracket raised and lowered by power, and arranged to swing to one side to accommodate work on floor-plate. Vertical adjustment of table, 24". Height of spindle-bearing above floor, 5 feet; diameter of steel spindle, $2\frac{1}{2}$ ". Stroke, $17\frac{1}{4}$ ". Automatic power-feed adjustable instantly and through a great range. Very quick hand traverse. All handles conveniently situated. Furnished with depth-gauge for counter-bores, sample drill socket, countershaft, and set of wrought-iron wrenches. Fast and loose pulleys on countershaft, 10" diameter and 4" face. They should make 110 revolutions per minute. Largest lift of cone pulley on machine is 15" diameter for 3" belt.

PLATE NO. 6.



45" VERTICAL DRILLING MACHINE—WITH COMPOUND TABLE.

Overreach $22\frac{1}{2}$ " from center of dies to face of column.

Upright secured to slotted floor-plate. Compound table 22" square, carried upon bracket raised and lowered by power and arranged to swing to one side to accommodate work on floor-plate; bracket carrying table provided with bearing for lower end of boring-bar. Vertical adjustment of table, 24". Height of spindle bearing above floor-plate, 5 feet. Diameter of steel spindle, $2\frac{1}{2}$ ", stroke of spindle, $17\frac{1}{2}$ ". Automatic power-feed adjustable through a wide range by simple lever.

Furnished with countershaft, wrenches, sample drill-socket and gauge for depth of counter-bores. Fast and loose pulleys 10" diameter, 4" face; 110 rotations per minute.

PLATE No. 7.

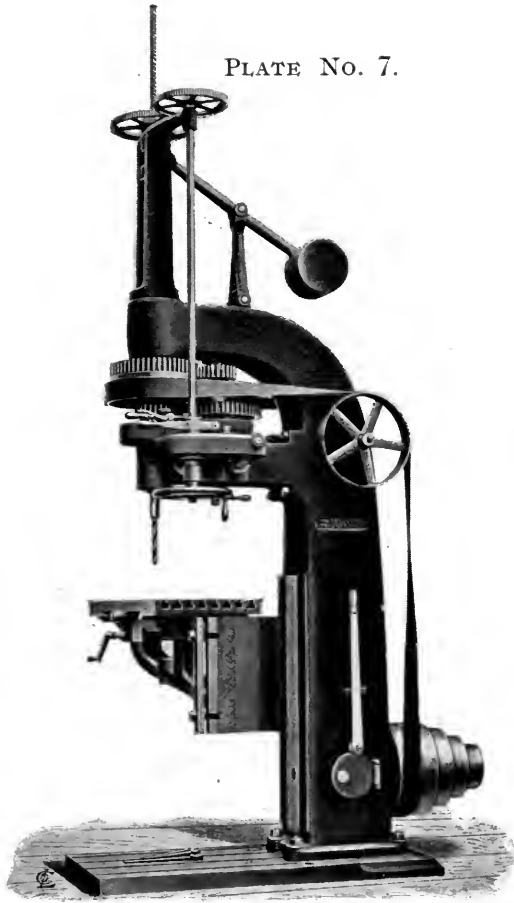

45" VERTICAL DRILLING MACHINE—WITH COMPOUND TABLE.

Shown with table bracket swinging off to one side so as to give access to large work on floor-plate; compound table, 22" square, adjustable by screws in two directions.

Bracket carrying table is provided with a bearing to steady lower end of boring-bar. Vertical adjustment of table, 24"; height of spindle bearing above floor, 5 feet; diameter of steel spindle, 2½"; stroke, 17¼"; automatic power-feed adjustable instantly and through a great range; machine furnished with depth gauge for counterbores, sample drill socket, countershaft, and set of wrenches. Fast and loose pulleys on countershaft, 10" in diameter and 4" face; they should make 110 revolutions per minute. Largest lift of cone pulley on machine is 15" diameter for 3" belt.

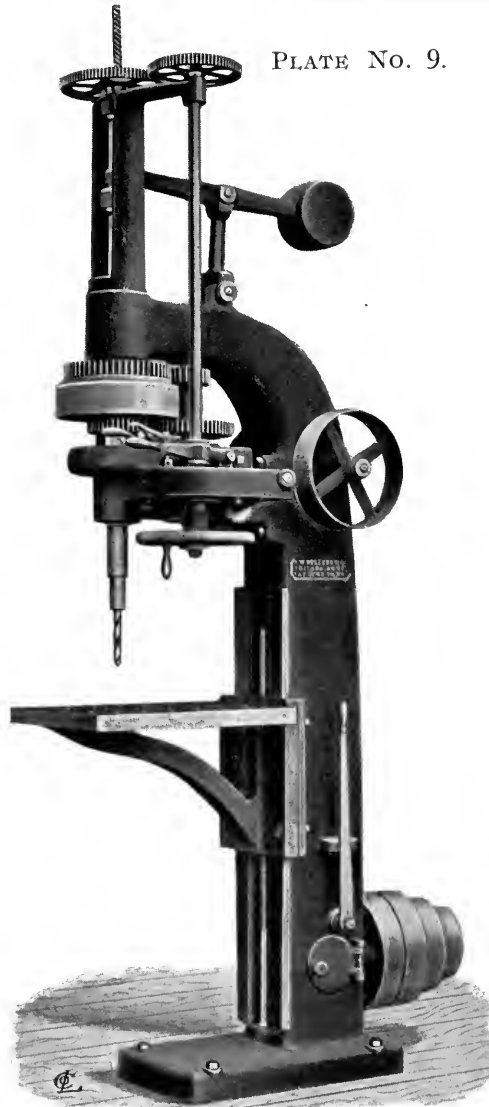

36" VERTICAL DRILLING MACHINE—WITH RECTANGULAR TABLE.

Overreach 18" from centre of drill to face of upright. Plain table 26" long by 18" wide, raised and lowered by power. Travel 30". Diameter of spindle, 2 1/8"; stroke of spindle, 12". Lower bearing 5 feet above floor. Automatic power-feed adjustable instantly and through a great range; very quick hand traverse. All handles conveniently located. When back-gear is out spindle is driven by belt motion direct. Depth gauge for counter-bores, sample drill socket, countershaft, and set of wrenches provided. Fast and loose pulleys on countershaft, 10" diameter, 4" face, and should make 110 revolutions per minute. Largest lift of cone pulley, 13" diameter for 3" belt.



36" VERTICAL DRILLING MACHINE—WITH CIRCULAR TABLE.

Overreach 18" from centre of drill to face of upright; round table 26" diameter, carried on swinging bracket from saddle, raised and lowered by power; travel 30"; diameter of steel spindle, $2\frac{1}{8}$ "; stroke of spindle, 12".

Floor to end of spindle in highest position, 5 feet; automatic power-feed instantly adjustable through wide range; very quick hand traverse; all handles conveniently located.

Rail Drilling Machines.

WHEN the mills first began to roll steel rails, it was soon found that some means must be devised to drill the splice plate holes cheaply and expeditiously. This led to a demand for special drill presses, and we were early in the field with our 2-spindle drills, many of which were sold to the leading mills.

We have kept closely in touch with this branch of manufacture, and have modified our designs to meet the more exacting requirements of modern practice. We illustrate, in the following plates, a number of forms designed for various kinds of work. The service expected of a rail drill is hard, and the treatment accorded it severe. Our machines are all designed to meet these conditions. The construction is simple, the parts strong; the spindle is supported as close as possible to the drills and the gearing is well protected by suitable covers. The saddle carrying the drill spindles is counterbalanced and provided with a simple and efficient feed gearing, which can be instantly engaged or disengaged, while a hand wheel affords an easy means for withdrawing the drills after the completion of the holes. Our spindle thrust is taken on hardened steel steps instead of collars, and frictional resistance greatly reduced thereby.

The speed of these machines is high and the feed per rotation moderate, as these conditions seem to be the most satisfactory for this class of work.

We earnestly recommend the use of our drill grinding machine in connection with these drill presses.

PLATE NO. 11.



TWO-SPINDLE RAIL DRILLING MACHINE.

With rectangular column having projecting base for rail with powerful clamp-vise and adjustable backing for securing rail in proper position. End stop reversible to make machine right or left. Spindles supported throughout, adjustable from 3" to 8" centre to centre. Thrust taken on hardened steel steps instead of collars; no projecting ends to cause bearings to wear "bell mouth." Drills fed simultaneously by powerful feed gear stopped and started by positive feed clutch operating instantaneously. Complete with countershaft and wrenches. Fast and loose pulleys 20" diameter, 4" face, 186 rotations per minute.

PLATE No. 12.

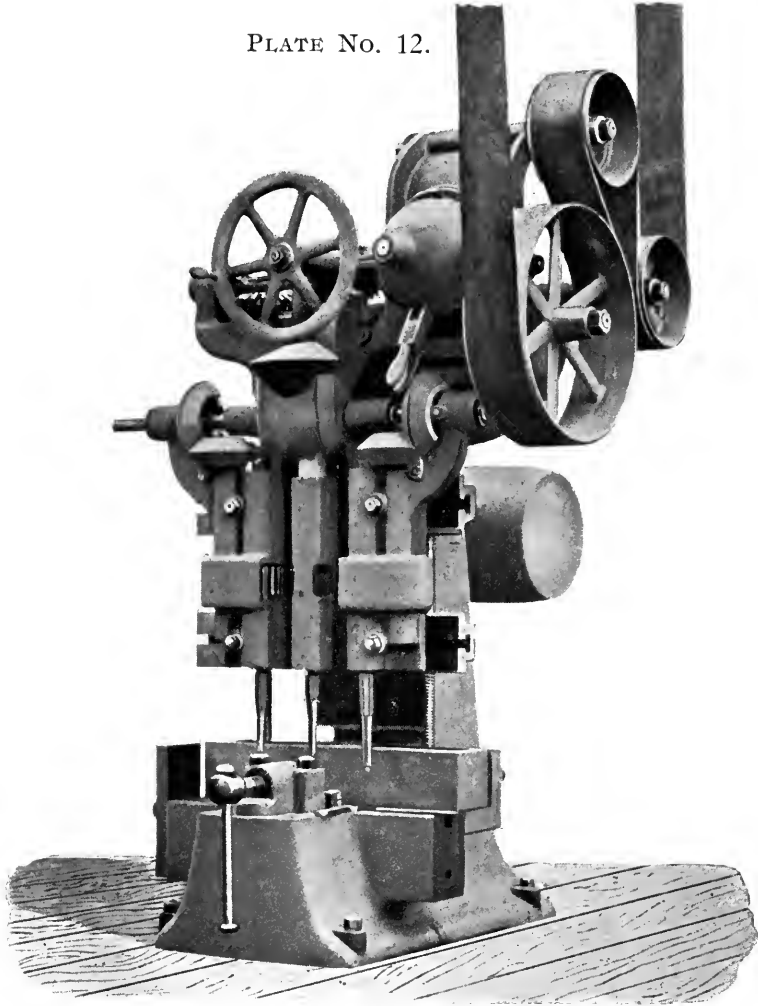

THREE-SPINDLE RAIL DRILLING MACHINE.

Spindles adjustable from 3" to 12" from centre to centre. Powerful vise with adjustable backing plate and reversible end stop. Spindles supported close to rail, no long projecting ends. Hardened steel steps instead of collars. Drills feed simultaneously by powerful feed-gear operated through positive clutch, counterweighted and quickly adjustable by hand. Gears carefully covered. Complete with countershaft and wrenches. Fast and loose pulleys 20" diameter, 5½" face; 250 rotations per minute.

PLATE NO. 13.

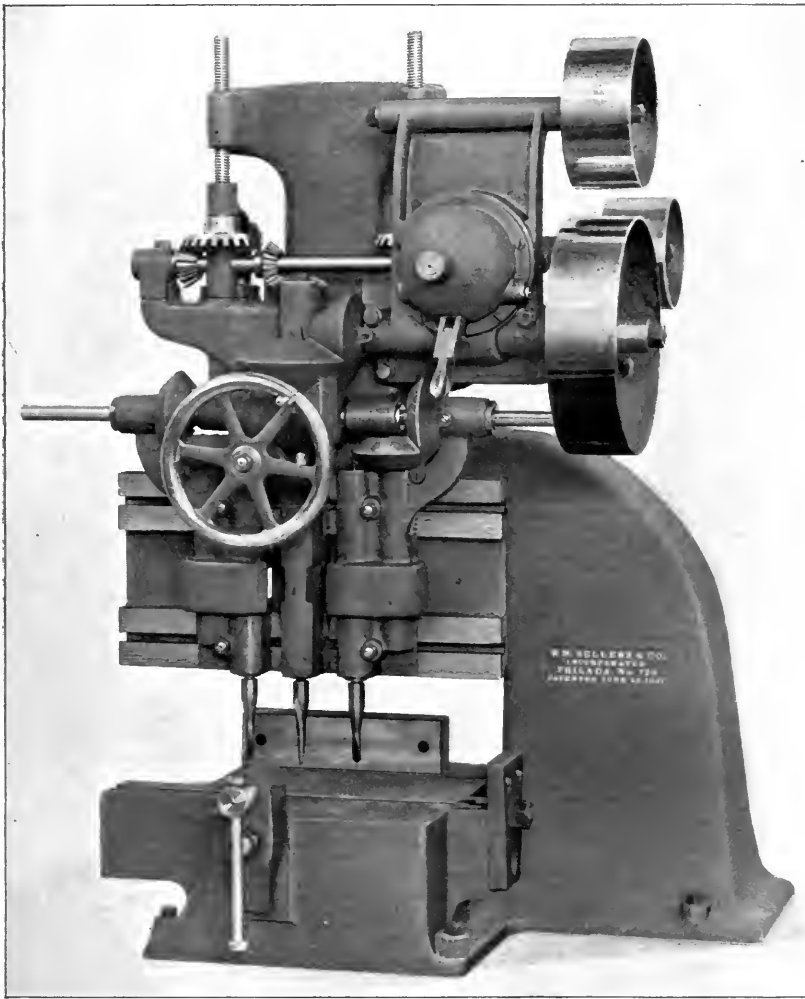

THREE-SPINDLE RAIL DRILLING MACHINE—WITH POST ON ONE SIDE.

Made right and left. Arranged so that rails may be moved back without shifting endwise. Spindles adjustable from 3" to 12" from centre to centre. Drills fed simultaneously. Spindle thrust taken on hardened steel steps, and spindles supported close to discs. Power-feed operated through quick and convenient clutch, head counterbalanced and quickly adjustable by hand. Powerful vise, adjustable backing and substantial end stop. Countershaft, fast and loose pulleys 20" diameter, 5½" face; 250 rotations per minute.

PLATE No. 14.

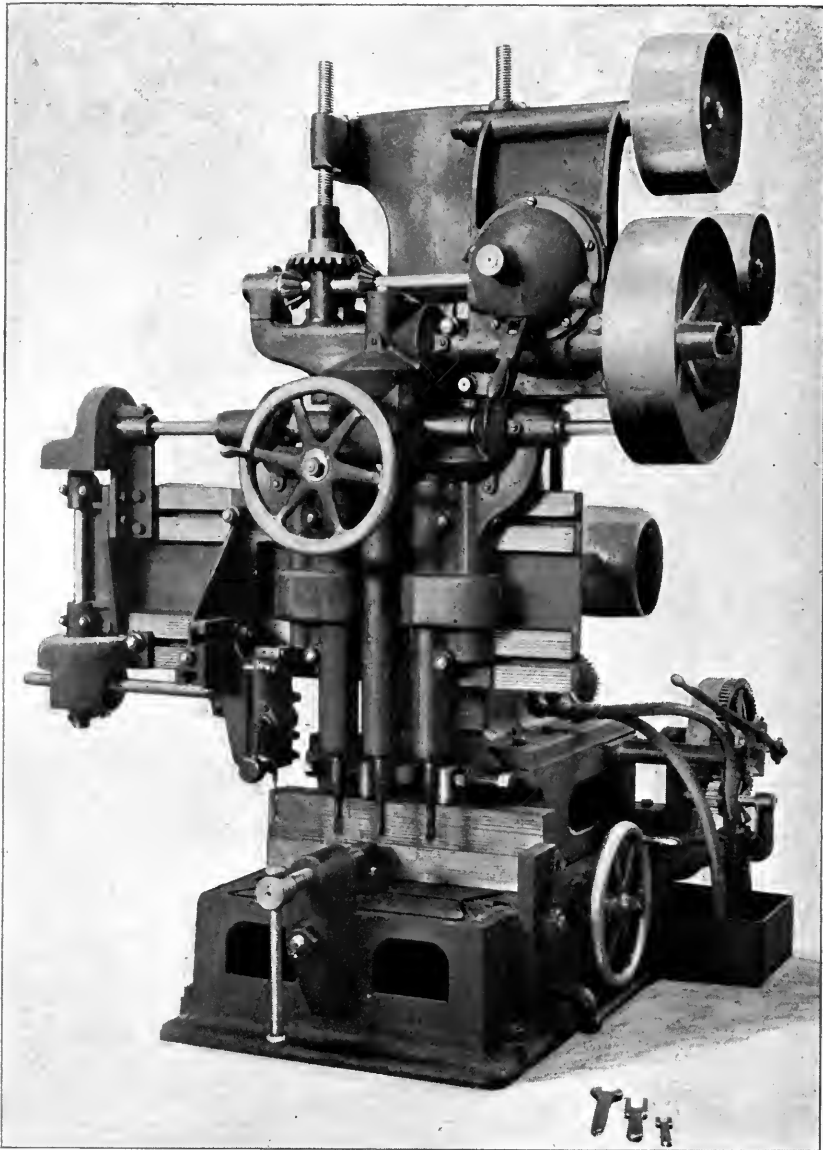

THREE-SPINDLE DRILLING MACHINE.

WITH COMPOUND BASE FOR GIRDER RAILS.

Especially arranged for drilling girder rails up to 12" high. Column adjustable by power through distance of $5\frac{1}{2}$ ", for drilling parallel rows of holes—adjustable by hand in direction of rail length, for right or left lead. Adjustable stops for both movements. Spindles adjustable from 3" to 12" centres. With clamp-vise, end stops, pump, tanks, strainer and circulating pipes. Fast and loose pulleys on countershaft 20" diameter, $5\frac{1}{2}$ " face, 250 rotations per minute.

Auxilliary drilling head for bond wire holes, extra.

PLATE NO. 15.

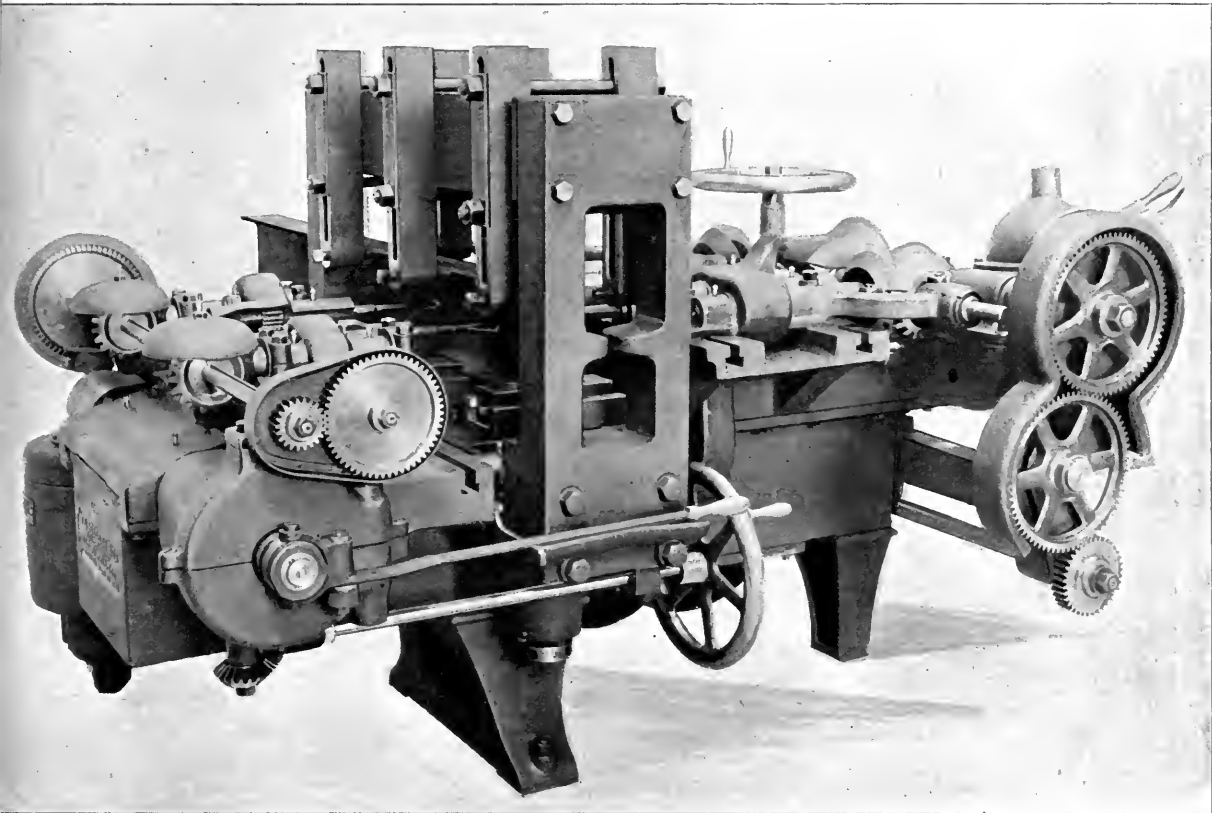

FIVE-SPINDLE DRILLING MACHINE.

FOR GIRDER RAILS—ELECTRIC MOTORS.

Especially designed for girder rails from 3" to 9" high. Arranged with the three drills for splice-plate bolt holes, which are adjustable from 3" to 12", on one side; on the other side are two for bond wire holes which are adjustable either horizontally or vertically. A special adjustable chuck for holding rails is provided. Machines made right and left, wheels carefully protected and handles conveniently arranged. Rail rests on lower flange, is securely clamped, and spindles are fed simultaneously by power; quick hand adjustment for all spindles. Complete with motors, starting boxes and wrenches.

PLATE No. 16.

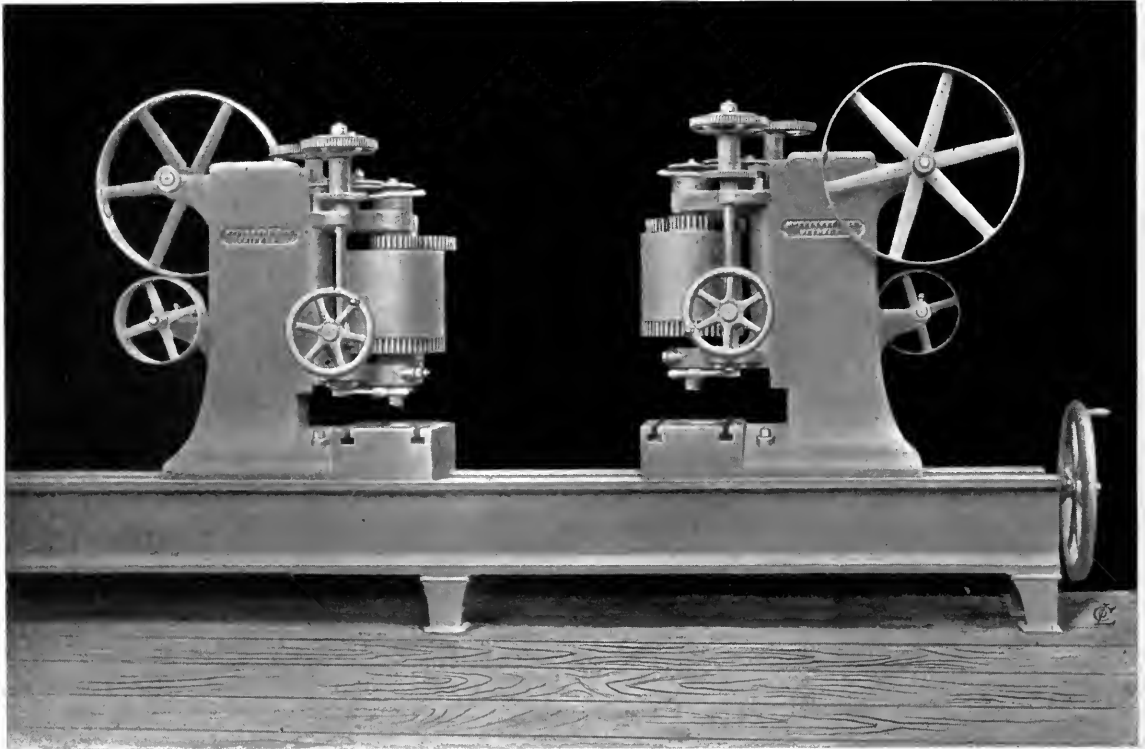

EYE-BAR DRILLING MACHINE.

Drilling-heads counterbalanced by weights inside of uprights. Vertical adjustment of heads, 10". Height from floor to top of table, 27". Adjustable friction feed for heads with quick hand traverse. Diameter of spindle, $2\frac{1}{8}$ ". Ratio of back-gearing, $5\frac{1}{2}$ to 1. Maximum distance between heads to suit requirements.

Especially designed for bridge work. Eye bars put in from front and passed out back when finished. Heads are united by steel bars and can slide freely on bed; the expansion of the bars being the same as that of the bridge links being bored, uniformity in length of finished work is assured. Work is supported upon projections from upright, hence strains are self contained.

PLATE No. 17.

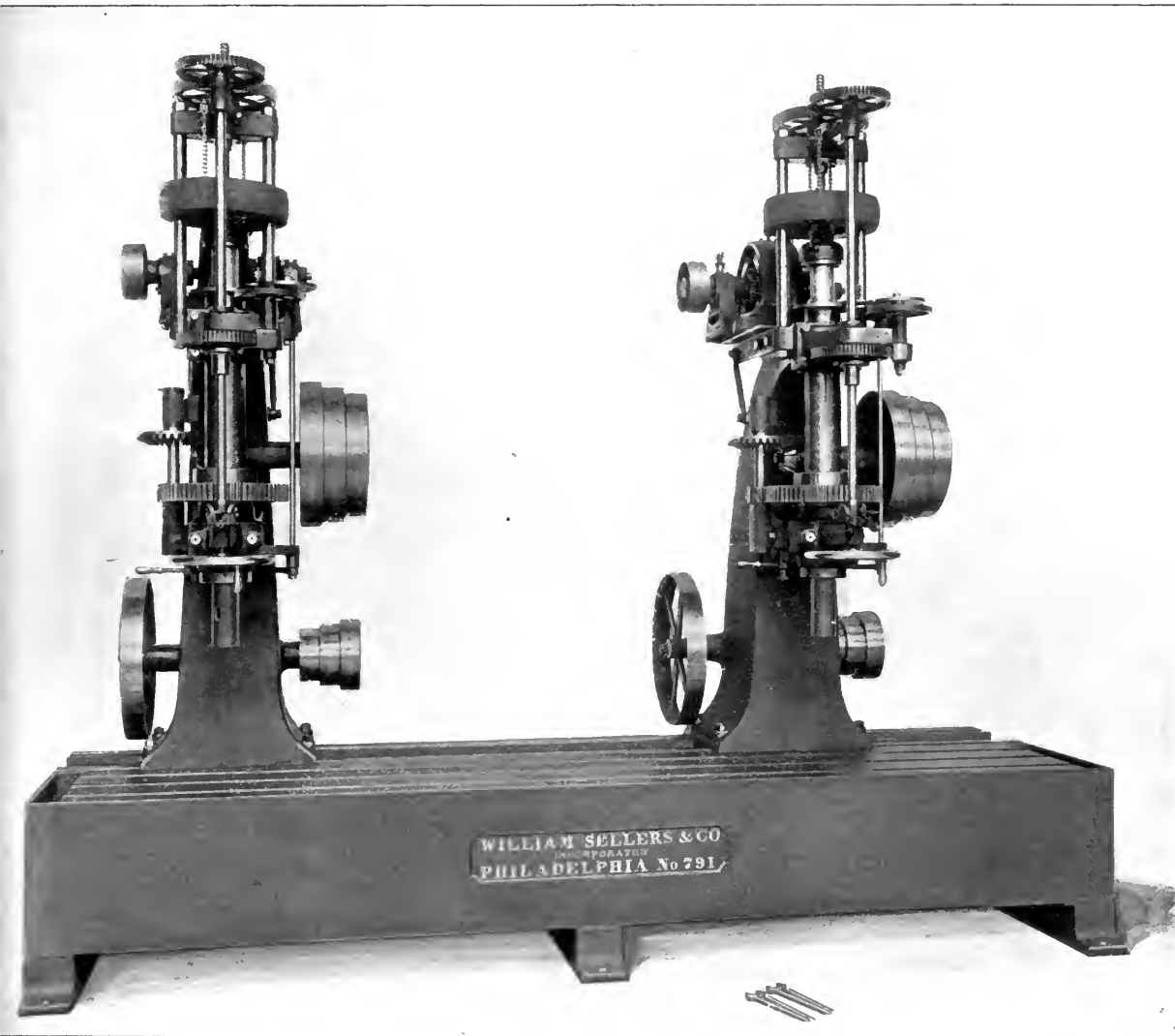

DOUBLE DRILLING MACHINE.
FOR CONNECTING RODS, BRIDGE CHORDS, ETC.

Two powerful drill presses, adjustable along a heavy work table with bolt slots, spindle, $3\frac{1}{2}$ " diameter, 12" stroke. Overreach of spindles, 12" from face of column. Powerful feed adjustable through wide range, and quick hand traverse to counterbalanced spindle. Driven by independent electric motors, or by countershaft when preferred. Very powerful, substantial and convenient.

Multiple Drilling Machines.

WE illustrate in the following pages, a variety of multiple vertical drills, which are made to meet different requirements. Such machines are more or less special in character, and are most useful where frequent repetition is needed, but some are sufficiently general to possess a wide range of usefulness.

The general use of steel in boiler work and the demand for drilled rivet holes, has directed increased attention to this class of machines, and many new arrangements have been devised in consequence ; some for drilling the flat sheets before bending ; others for drilling the rivet holes after the boilers have been partly assembled. We have endeavored in these machines to maintain the high efficiency which we have attained in our other drilling machines, and to adopt only constructions which are durable as well as convenient. In addition to those illustrated, we have other machines for special purposes, such as car truck channels, arch bars, spring seats, boiler tubes, condenser sheets, etc.

PLATE NO. 18.

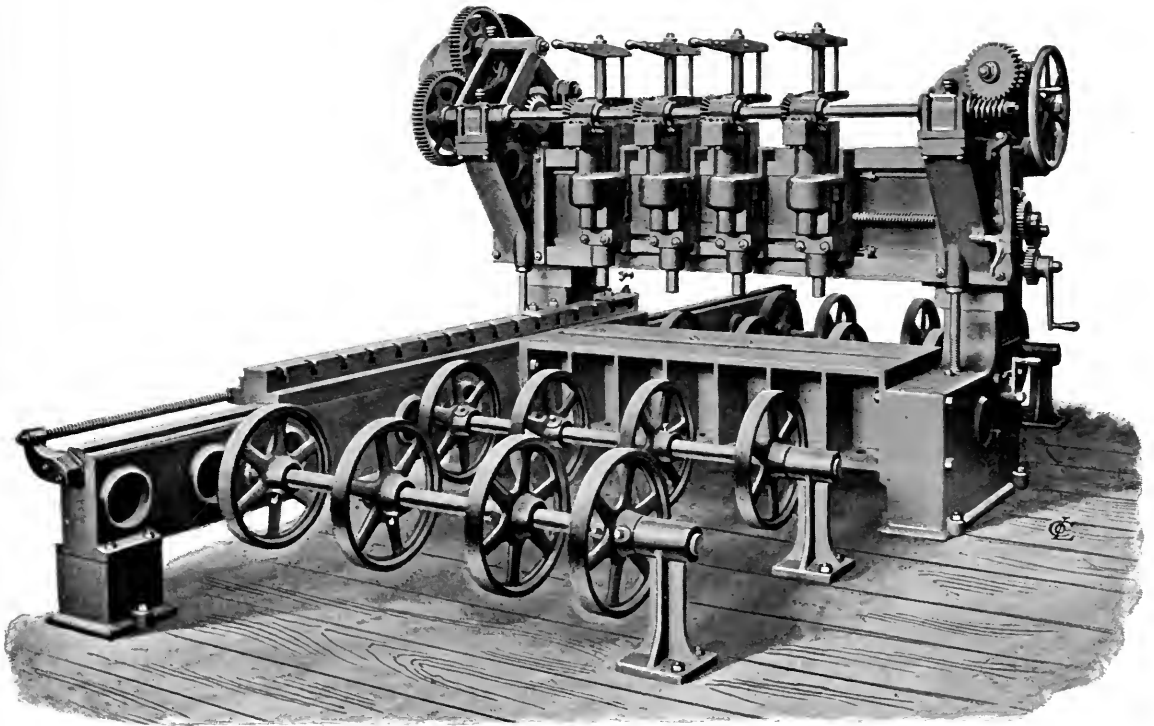

FOUR-SPINDLE VERTICAL DRILLING MACHINE.

For plates 5 feet wide. Height under cross-head in highest position, 12". Spindles are carried upon saddle moving in cross-head by which they may be adjusted simultaneously through dividing gear at the end of the cross-head. Minimum distance between any two adjacent spindles, 6". Total length of saddle, about 4 feet. Guide-bar, 8 feet long, provided with clamps for holding plates. Spindles all adjustable by hand, to suit length of drills used. The machine complete with countershaft, wrought-iron wrenches, change gear for clamping bar and saddle, four sets of supporting rollers, with shafts and stands. Largest lift of cone, 30" diameter, 4" face. Fast and loose pulleys on countershaft, 24" diameter, 5" face. Speed of countershaft, 275 revolutions per minute.

Made also with plain work table, without rollers or spacing mechanism.

PLATE NO. 19.

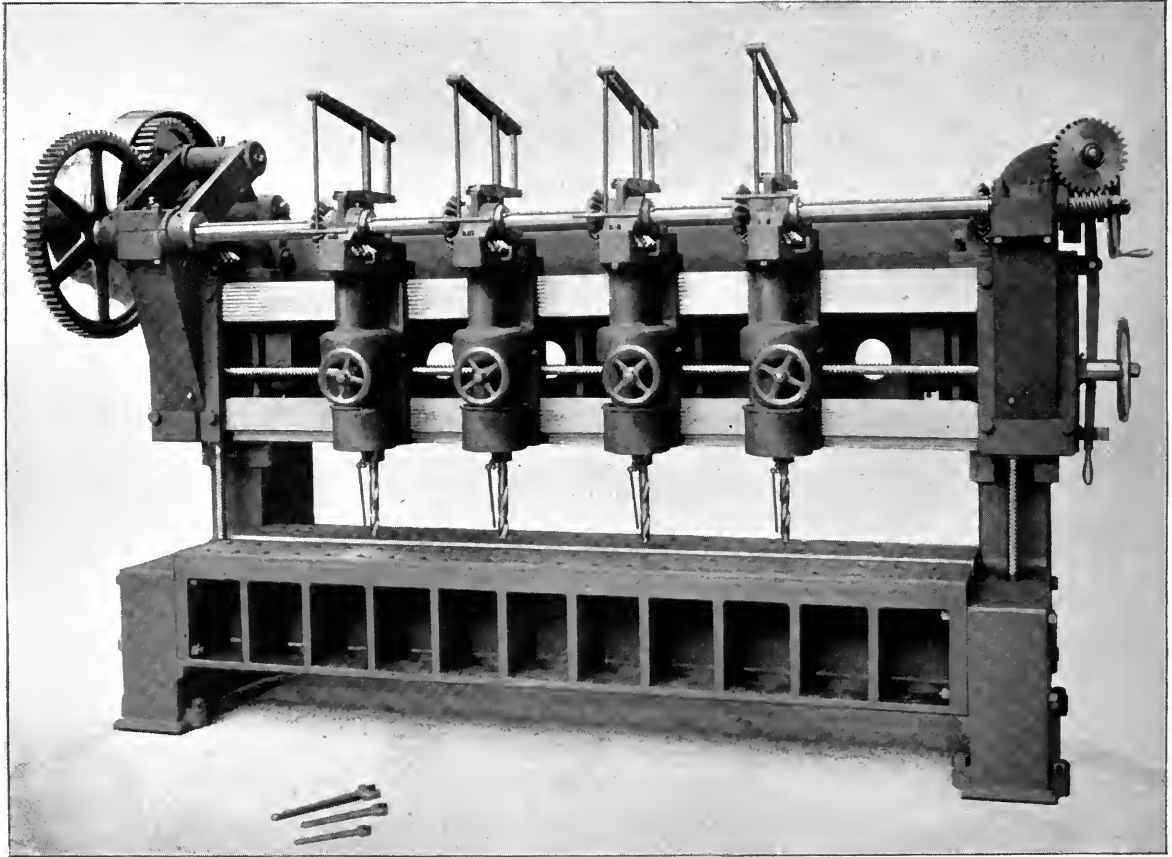

FOUR-SPINDLE VERTICAL DRILLING MACHINE.

For plates 8 feet wide. Spindles $2\frac{1}{8}$ " diameter; 9" stroke, adjustable along cross-head, together or independently; minimum distance from centre to centre, 8". Cross-rail carrying drilling-heads counterbalance and quickly adjustable by hand. Has power-feed through positive gearing. Spindles adjustable independently by our patent holdfast, so that any drill may be withdrawn or replaced without stopping the others.

Plain work-table with slot and bolt-holes. Fast and loose pulleys on counter-shaft, 24" diameter, 6" face; 330 rotations per minute.

PLATE No. 20.

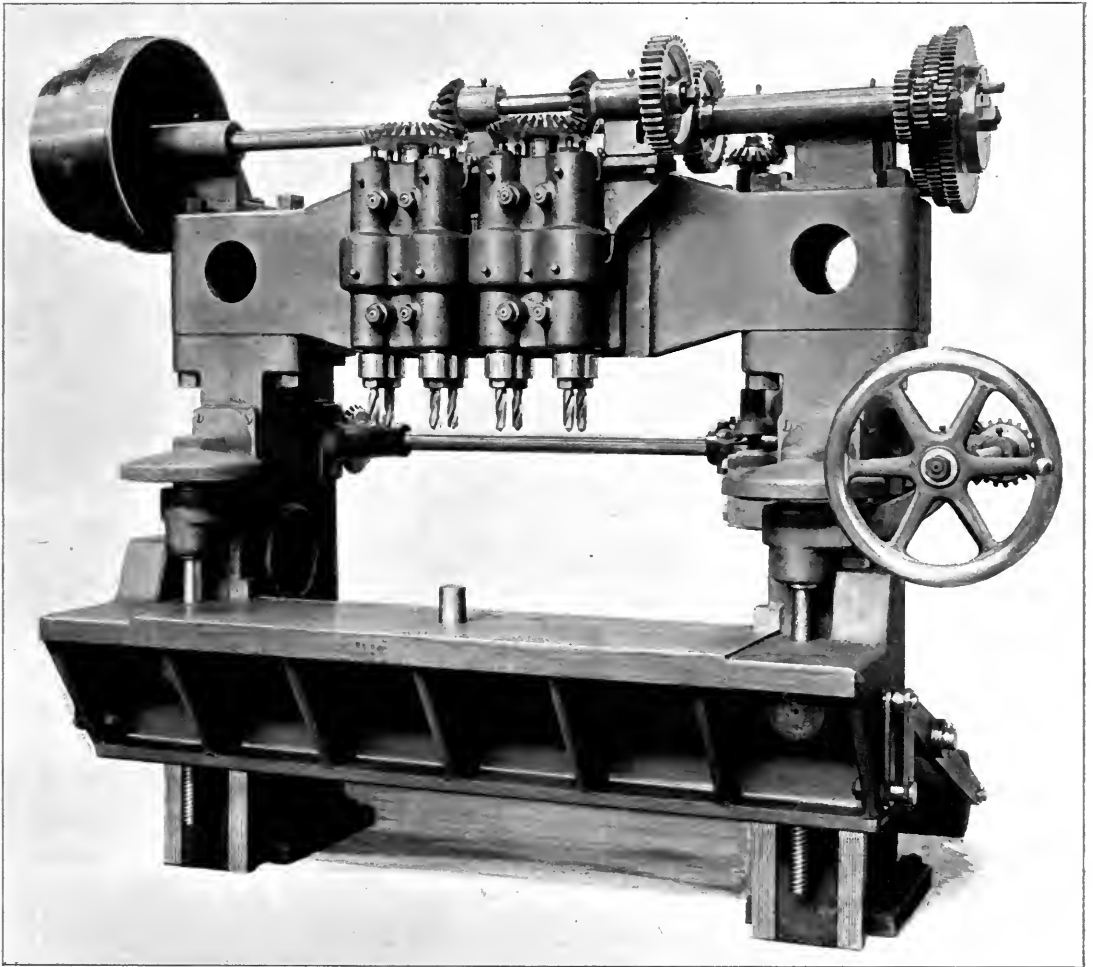

EIGHT-SPINDLE DRILLING MACHINE—FOR SPUR WHEELS.

For drilling connecting bolt holes in parted spur wheels for electric street cars. The half wheel is set in a jig, centered by pin shown in work table and by turning half way round, a second half is brought under the drills, while the finished piece is replaced with another blank. This is an example of a special tool of limited application, but great efficiency. Useful only for duplicating work in large quantities. Speeds and feeds arranged for steel and cast iron.

PLATE No. 21.

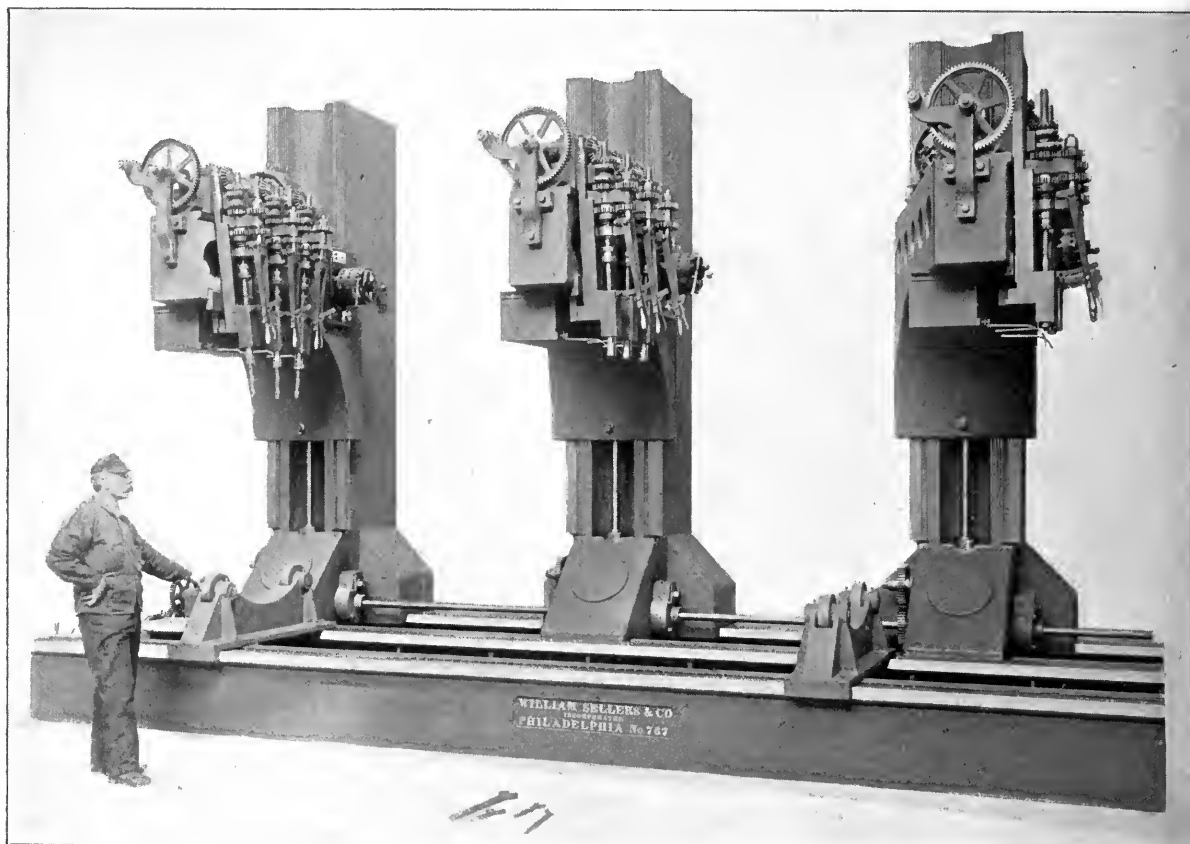

NINE-SPINDLE BOILER-SHELL DRILLING MACHINE.

For drilling transverse seams in cylindrical boilers from 3 ft. to 7 ft. in diameter. Spindles arranged in groups of three on brackets carried upon massive columns. Adjustment for rivet pitches made by swivelling spindles and adjusting them along the brackets. Spindles $1\frac{3}{4}$ " diameter, stroke 8", length of bed 20 ft., complete with roller stands for supporting boiler shell. Electric motor on each bracket for operating spindles. Separate motor for moving columns along bed and raising and lowering brackets to suit changes in diameter. Water tanks and spouts for lubricating drills.

PLATE NO. 22.

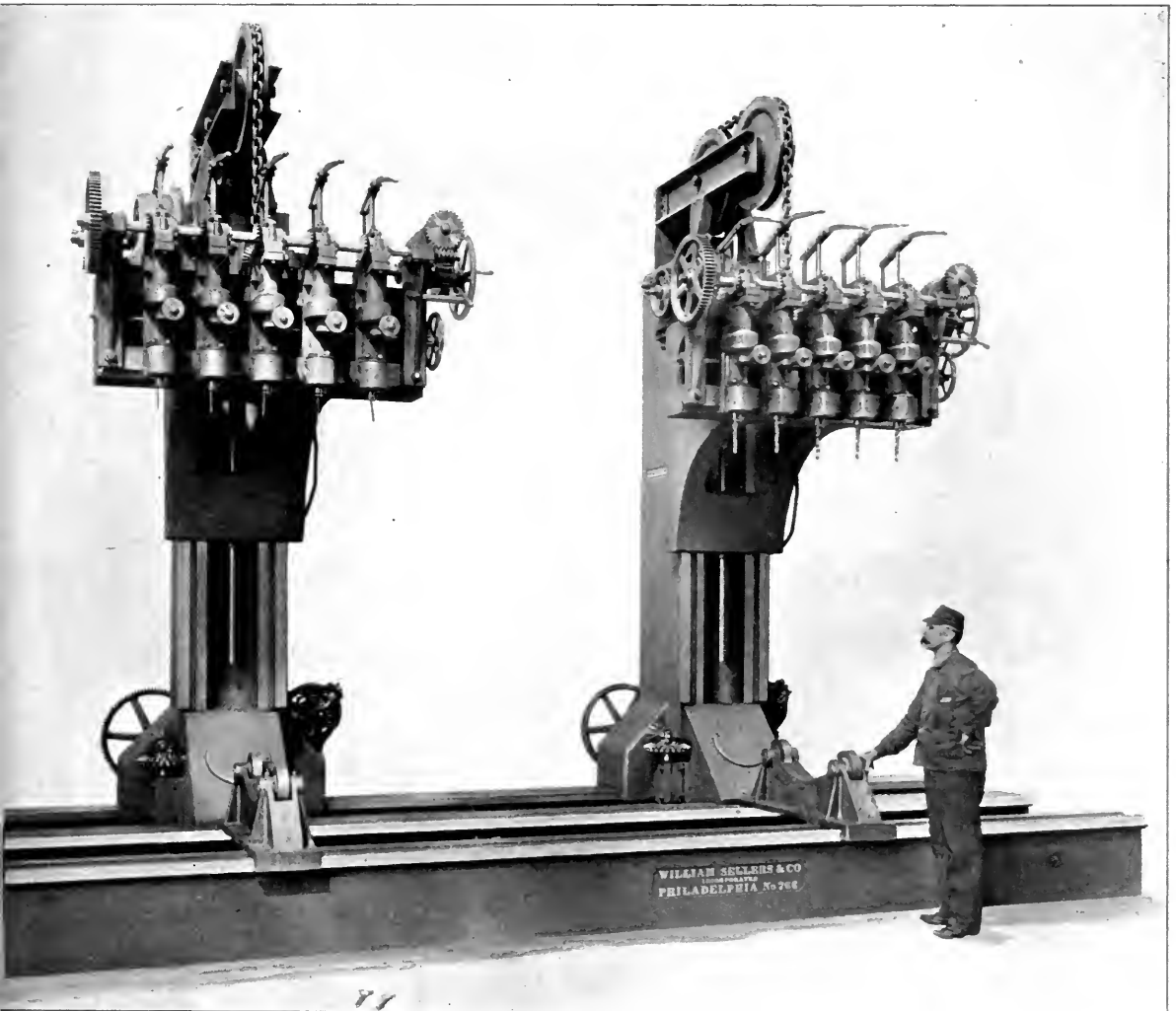

TEN-SPINDLE BOILER-SHELL DRILLING MACHINE.

For longitudinal seams in cylindrical boilers from 3 ft. to 7 ft. in diameter. Spindles in two groups of 5 each, carried by brackets on heavy columns, adjustable along the bed. Diameter of spindles $1\frac{3}{4}$ " , maximum distance between drill centres 12" , minimum 6" , length of bed 20 ft. Each column provided with electric motor for moving it along the bed, and each bracket has a motor for operating the drills. Brackets counterbalanced. Roller stands to carry boilers. Tanks and spouts for lubricating all the drills.

PLATE NO. 23.

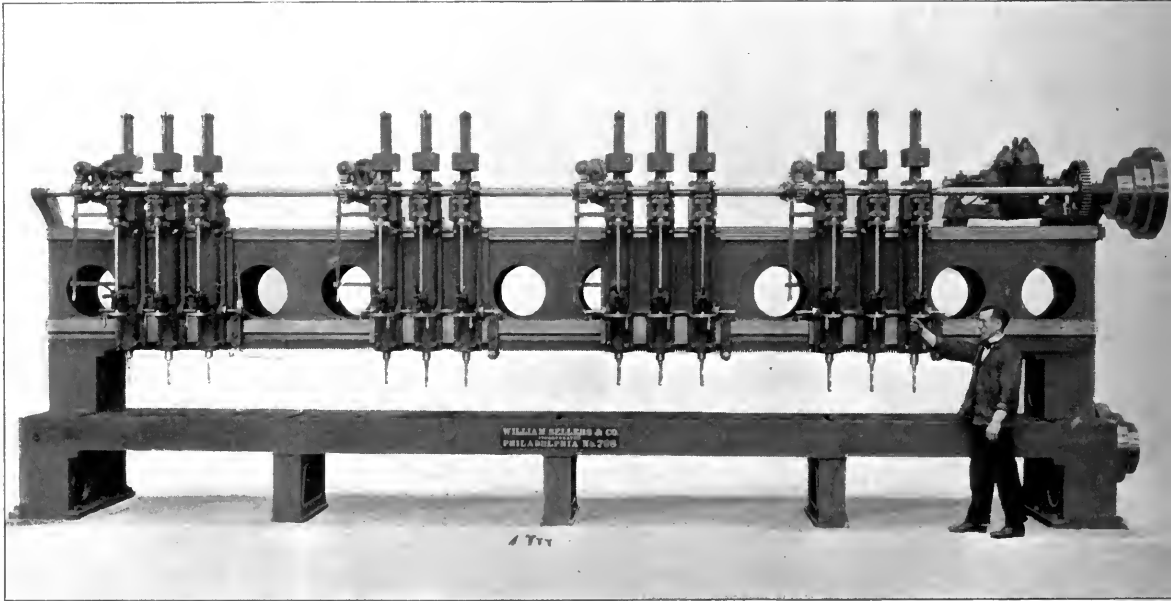

TWELVE-SPINDLE BOILER-PLATE DRILLING MACHINE.

For flat sheets. Drills arranged in four groups of three spindles, each group having its own feed gear; spindles adjustable together or independently. Diameter of spindles, $2\frac{1}{2}$ ". Stroke, 12". Maximum length of sheet, 24 ft. Driven by electric motor. Plain work table with bolt slots and water channels, spindles counterbalanced. Made also with one radial drilling head on each saddle radius adjustable from 13" to 48".

PLATE No. 24.

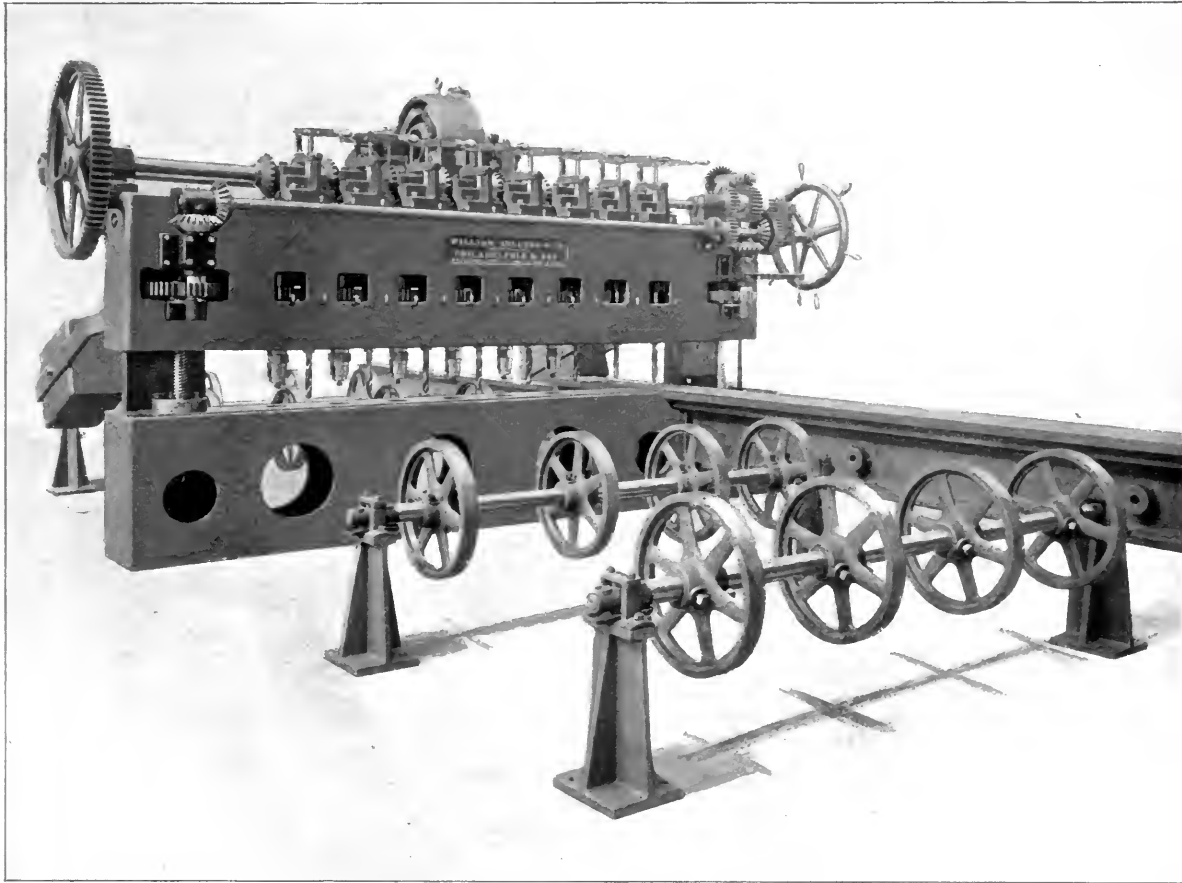

FOURTEEN-SPINDLE DRILLING AND BORING MACHINE.
FOR WATER TUBE BOILERS.

Has eight heavy drilling spindles and six boring cutters for flue holes. Width between uprights 8 feet. Work supported upon rollers and fed by slide 15 feet long arranged with spacing mechanism. Spindles fed together, but drill spindles adjustable independently. Traverse of work 14 feet long. Power feed and hand adjustment. Operated by electric motor.

Universal Drilling Machine.

The Universal Drilling Machine, shown on the opposite page, has been found very convenient for a great variety of work, especially for certain large pieces which it is difficult to move about. Such work is placed either in a pit at one side of the machine or upon a floor-plate. The drilling-head is carried on the end of the radial arm in such a manner that the spindle may be set in a horizontal plane, a vertical plane, or a plane inclined at any angle to the surface of the table; and it may be swung to any angle in either plane. The radial arm is adjustable in height above the table up to 4 feet. These features enable the machine to drill holes in almost any conceivable position within the space covered by its limits of travel.

This machine is driven by a vertical shaft passing through the centre of the column, carrying on its upper end, pulley or bevel gears, as may be required by the location. The column, 15" diameter, is mounted on a table 6 feet in diameter and 30" high, convenient for holding work. The operating cranks and hand wheels are conveniently grouped for easy manipulation and a clutch for stopping and starting is arranged at the base of the column.

The circular table is provided with a door, and forms a convenient closet for tools. The cone-pulleys operating

the spindle are carried on one side of the radial arm, within easy reach of the operator. The cone has four steps for $2\frac{1}{2}$ " belt, and back-gear has a ratio of nine to one.

Made with or without power feed. Radial arm is adjustable horizontally by hand, but is raised or lowered by power or by hand. Extreme radius of drill from centre of column is 8 feet.

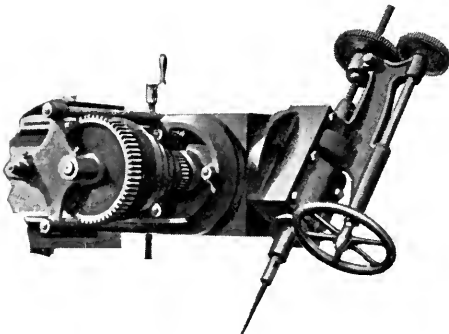
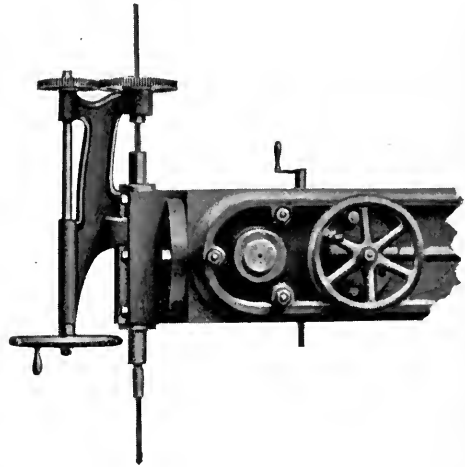
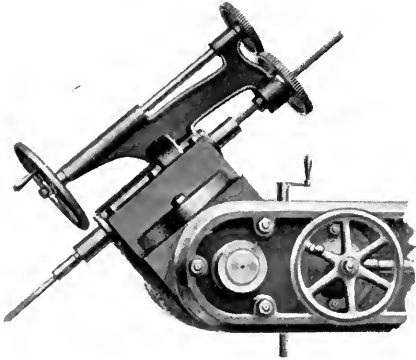

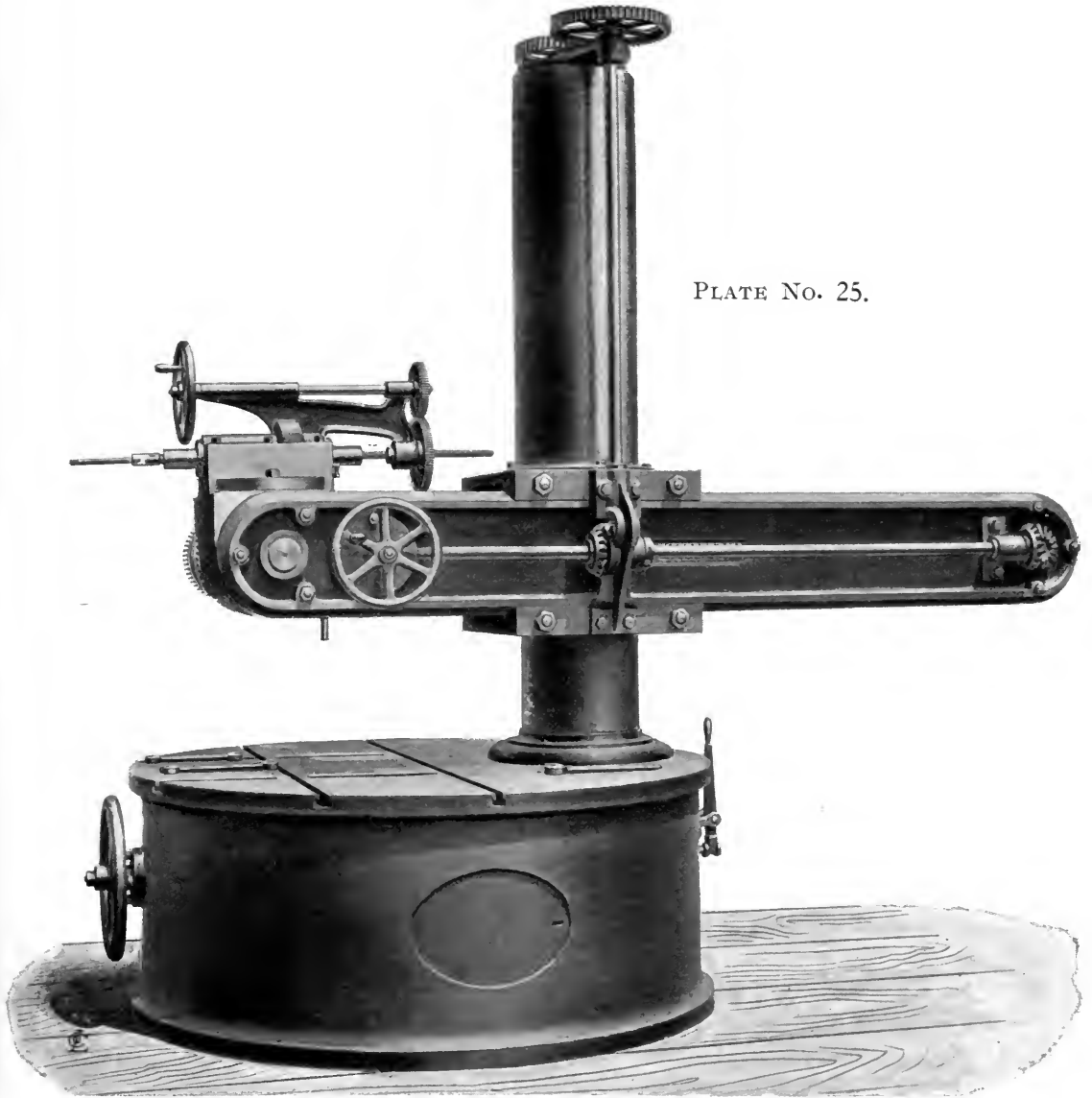

PLATE NO. 25.

UNIVERSAL DRILLING MACHINE.

Will rotate through complete circle. Diameter of drill spindle, $2\frac{1}{2}$ ". Stroke, 12". Largest lift of cone, 12" diameter, for $2\frac{1}{2}$ " belt. Fast and loose pulleys on countershaft, 16" by 4", making 180 revolutions per minute. Complete with countershaft, pulleys and hangers, and set of wrenches.

Radial Drilling Machines.

Three sizes of these tools are shown, viz: 54", 72" and 96"; so-called from the length of the radial arm. In these machines the arm is hinged to a saddle carried upon the face of a rectangular column or upright; it is easily rotated by hand and is raised and lowered by power, by means of a hand lever at the base of the upright. The arm is thus quickly adjusted to the proper height to suit the work, and as the saddle, which carries the arm, is so fitted and is of such length as not to require any clamping to place, this adjustment of height is rendered extremely simple. These points are of great importance in a machine of this kind, since the value of a radial drill consists primarily in the ease with which the tool can be moved to the work or shifted over the various parts of the work requiring to be drilled. In another form of radial drill which is frequently seen, the arm is carried by a sleeve which rotates around a cylindrical column. In this case the height of the arm is fixed, and the work must either be blocked up to suit the height of the machine, or extension pieces must be used to lower the drill to the work; while the large diameter of the bearing surfaces on the column makes the friction of turning unnecessarily great. These objections are both avoided in our machines.

The feed-motion is obtained through our improved adjustable feed-discs. It has a wide range through two series, one when back gear is out, the other when it is in; and can be put on or off instantaneously by a tap of the hand on a lever close to the hand wheel.

All the adjustments of the machine are quickly made, the shifting of the back gear into or out of use being as readily done as on any well-made turning lathe.

We arrange a convenient clamp at the bottom joint of the radial arm to enable it to be secured in position; but if the drills used are correctly formed and run true, the arm needs no clamping to place when drilling.

The machines are provided with substantial, well-braced uprights, secured to a slotted bed or floor-plate. The cone pulley is placed at the foot of the upright, in a convenient position for changing the speed; from this pulley belts are carried to the drill spindle over guide pulleys, and without the intervention of any gear wheels, thus utilizing the system of belt driving, proved to be of so much value on all of our various styles of vertical and horizontal drills.

PLATE No. 26.

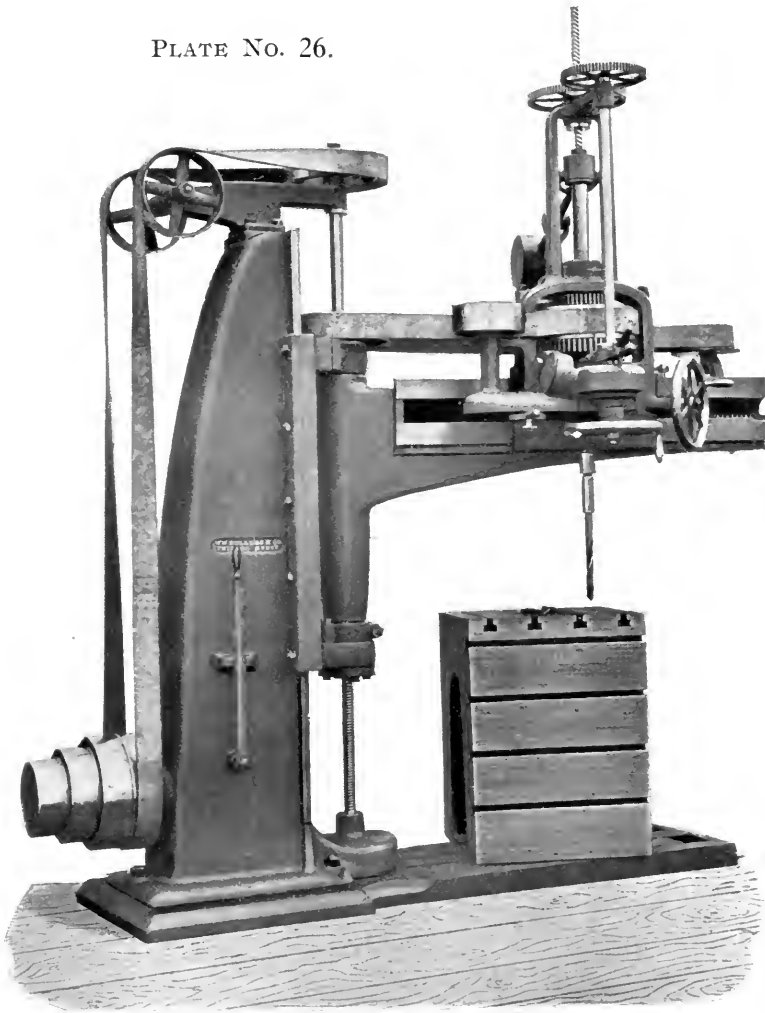

54" RADIAL DRILLING MACHINE.

Upright carried by slotted bed or floor-plate. Maximum overreach of spindle from centre of rotation of arm, 43". Spindle, $2\frac{1}{8}$ " diameter, 12" stroke. Greatest height from floor to nose of spindle, 5 ft. 2". Arm carrying drilling-head adjustable vertically by power. Improved friction feed, counterbalanced spindle. Machine complete with countershaft, wrenches, depth gauge for counterbores, sample drill socket, and slotted table for work, 22" square, 30" high. Fast and loose pulleys on countershaft, 10" diameter, 4" face. They should make 110 revolutions per minute. Largest lift of cone pulley, 13" diameter for 3" belt.

Radial Drilling Machines.—(*Continued.*)

The excellence of design of our radial drills (the result of careful study and modification of the original machine) is universally admitted by all who have used these tools, and is frankly attested by other manufacturers, several of whom have brought out machines which are copies of ours in every respect,—excepting certain important details, which happen to be protected by letters-patent,—thus affording additional proof that the salient features of our machines are recognized as valuable, both by our customers and our competitors.

Among the merits which we claim for our designs, we may briefly call attention to the very convenient grouping of the operating levers and handles, which enables the attendant to move the drill by a hand wheel on the saddle, rotate the arm, vary the feed, throw out the back gear, throw in or throw out the feed, all without moving from his position immediately in front of the drill.

Great attention has been paid to obtaining this convenient arrangement of operating parts, and equal care has been taken to properly proportion the various pieces in order to prevent springing or vibration, to reduce the friction and increase the durability of the machine.

It will be observed that the spindle is brought as close as possible to the face of the swinging arm so as to reduce to a minimum the tendency to twist the arm, and that the hinges or pintles of the arm are small in diameter and far apart, thus insuring, at the same time, great stiffness and ease of turning. The arm itself is proportioned with the view to making it rigid for the severest work to which the machine may be subjected.

The raising or lowering of the arm and the shifting of the belt on the driving-cone do not require the close observation of the drill itself demanded in the other movements, and these are the only operations which take the attendant from his place in front of the drill.

The convenient arrangement of details which we have indicated, conduces to the daily output (without undue effort on the part of the attendant) of the largest amount of work of which such tools are capable, while the generous proportions and correct distribution of metal insures stability of the machine in constant use.

A square table, 30" high, is furnished with slots for holding-bolts on top and one side for convenient and quick clamping of small work.

We make various modifications of these machines for special purposes, thus in one case three uprights each supporting an eight-foot drilling-arm are arranged with a slotted work-table 4 feet wide by 32 feet long for drilling boiler and ship plates. In this arrangement each drilling-head is driven by a separate electric motor.

PLATE NO. 27.

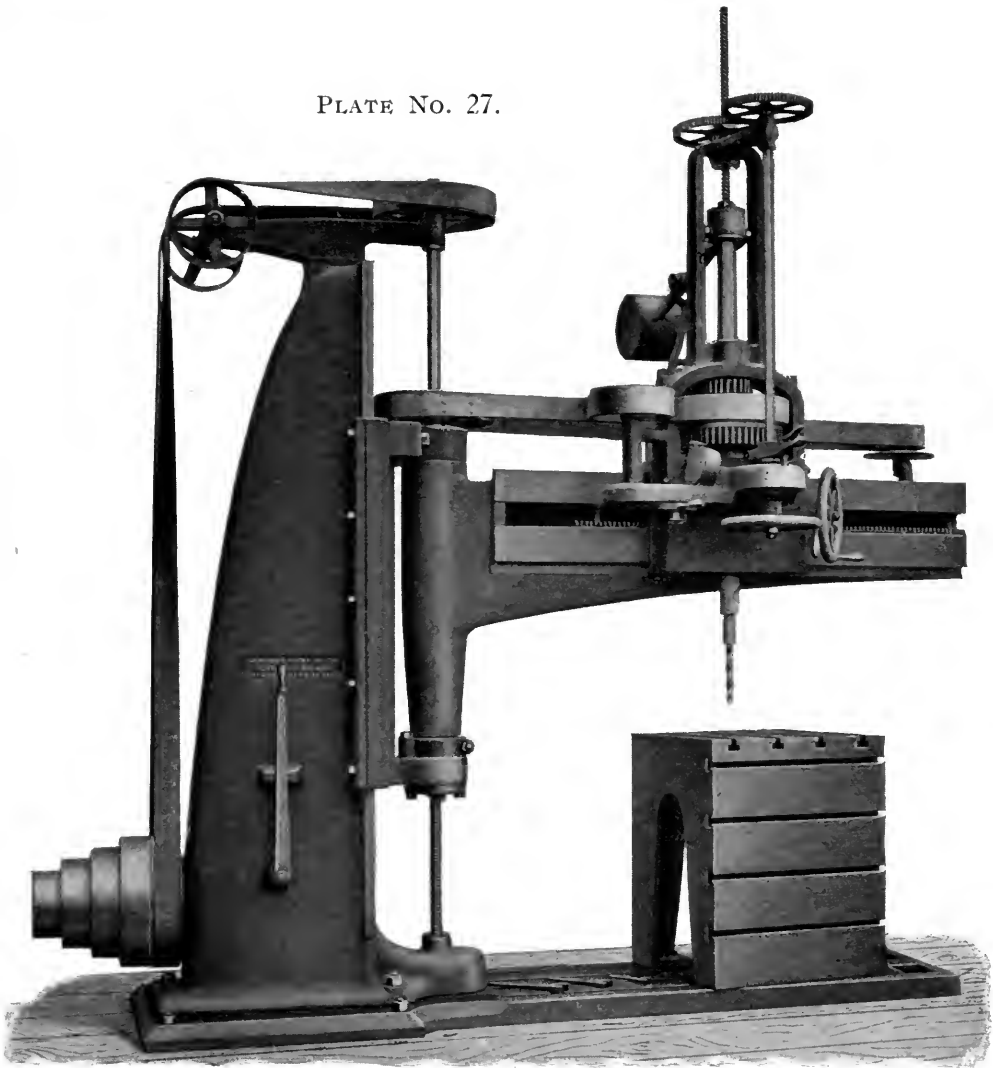

72" RADIAL DRILLING MACHINE.

Upright carried by slotted bed or floor-plate. Maximum overreach of spindle from centre of rotation of arm, 59". Spindle, $2\frac{1}{2}$ " diameter, $17\frac{1}{4}$ " stroke. Greatest height from floor to nose of spindle, 67". Arm carrying drilling-head adjustable vertically by power. Improved friction feed, counterbalanced spindle. Machine complete with countershaft, wrenches, depth-gauge for counterbores, and sample drill socket. Slotted table for work, 24" square, 30" high. Fast and loose pulleys on countershaft, 10" diameter, 4" face. They should make 110 revolutions per minute. Largest lift of cone pulley, 15" diameter, $3\frac{1}{4}$ " belt.

PLATE NO. 28.

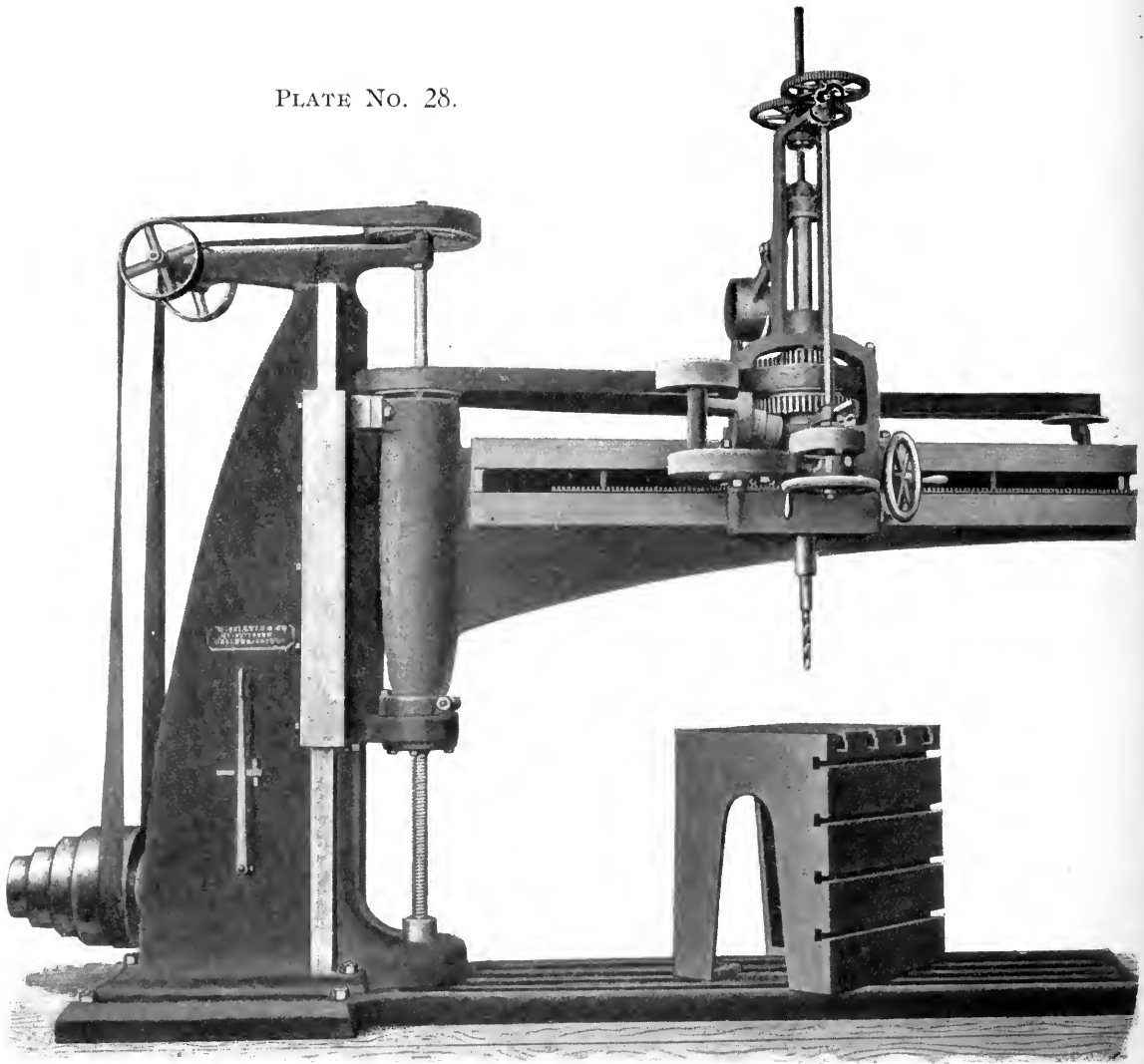

96" RADIAL DRILLING MACHINE.

Upright carried by slotted bed or floor-plate. Maximum overreach of spindle from centre of rotation of arm, 83". Spindle, $2\frac{1}{2}$ " diameter, $17\frac{1}{4}$ " stroke. Greatest height from floor to nose of spindle, 67". Arm carrying drilling-head adjustable vertically by power. Improved friction feed, counterbalanced spindle. Machine complete with countershaft, wrenches, depth gauge for counterbores, and sample drill socket. Slotted table for work, 24" square, 30" high. Fast and loose pulleys on countershaft, 10" diameter, 4" face. They should make 110 revolutions per minute. Largest lift of cone pulley, 15" for $3\frac{1}{4}$ " belt.

PLATE NO. 29.

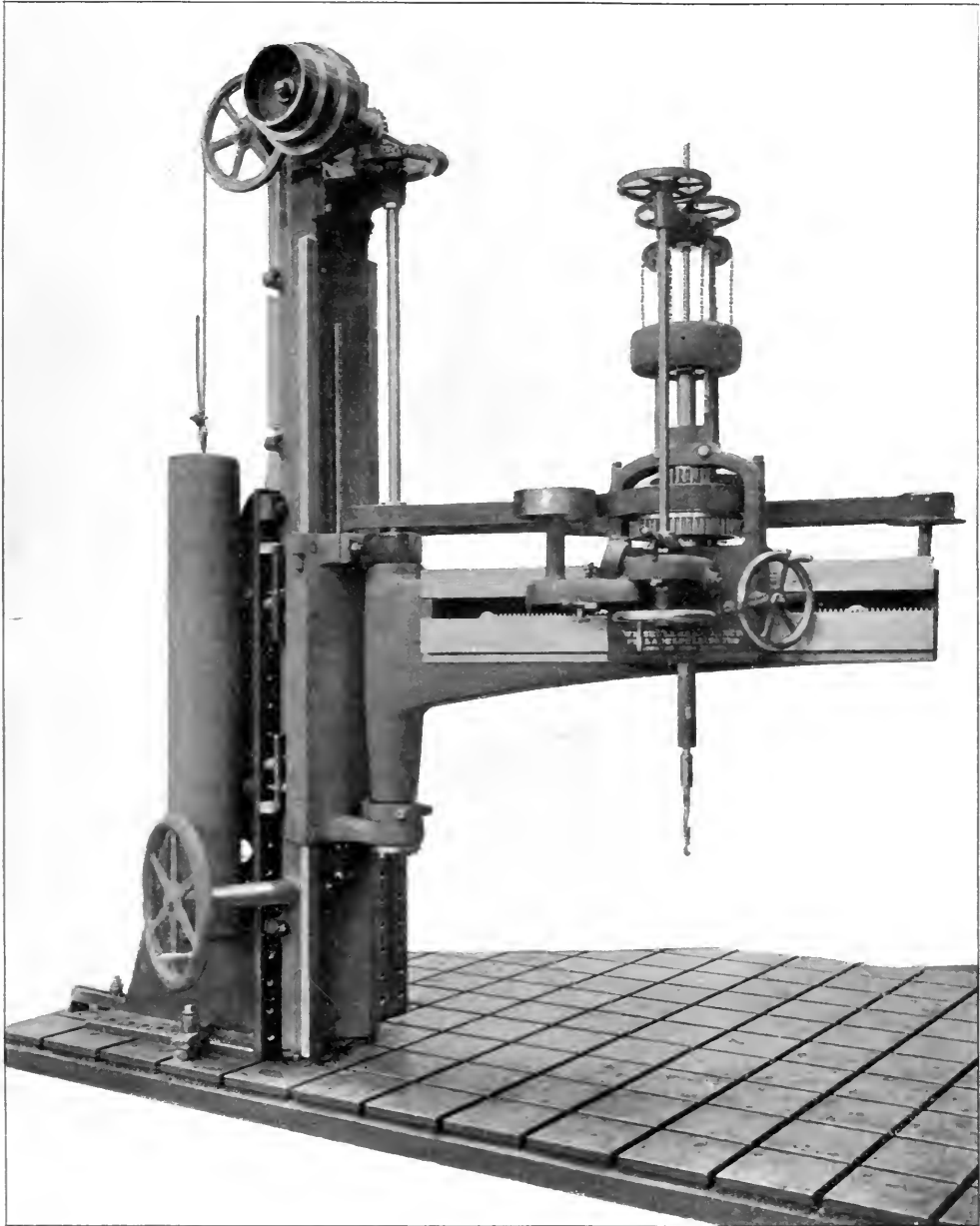

72" RADIAL DRILLING MACHINE—ARRANGED FOR ATTACHING TO A COLUMN.

Can be modified for attachment to a wall. Radial arm counterbalanced and provided with hand wheel and lifting screw for adjustment. Vertical traverse on slide 6 ft. Radius of spindle when saddle is at end of arm is 5 ft 9". Spindle, 2½" diameter, 17" stroke. Power-feed adjustable through wide range by improved feed motion. Belt driven when back gear is out. Complete with wrenches, countershaft and sample drill socket. Fast and loose pulleys, 10" diameter, 4" face. 110 revolutions per minute.

PLATE No. 30.

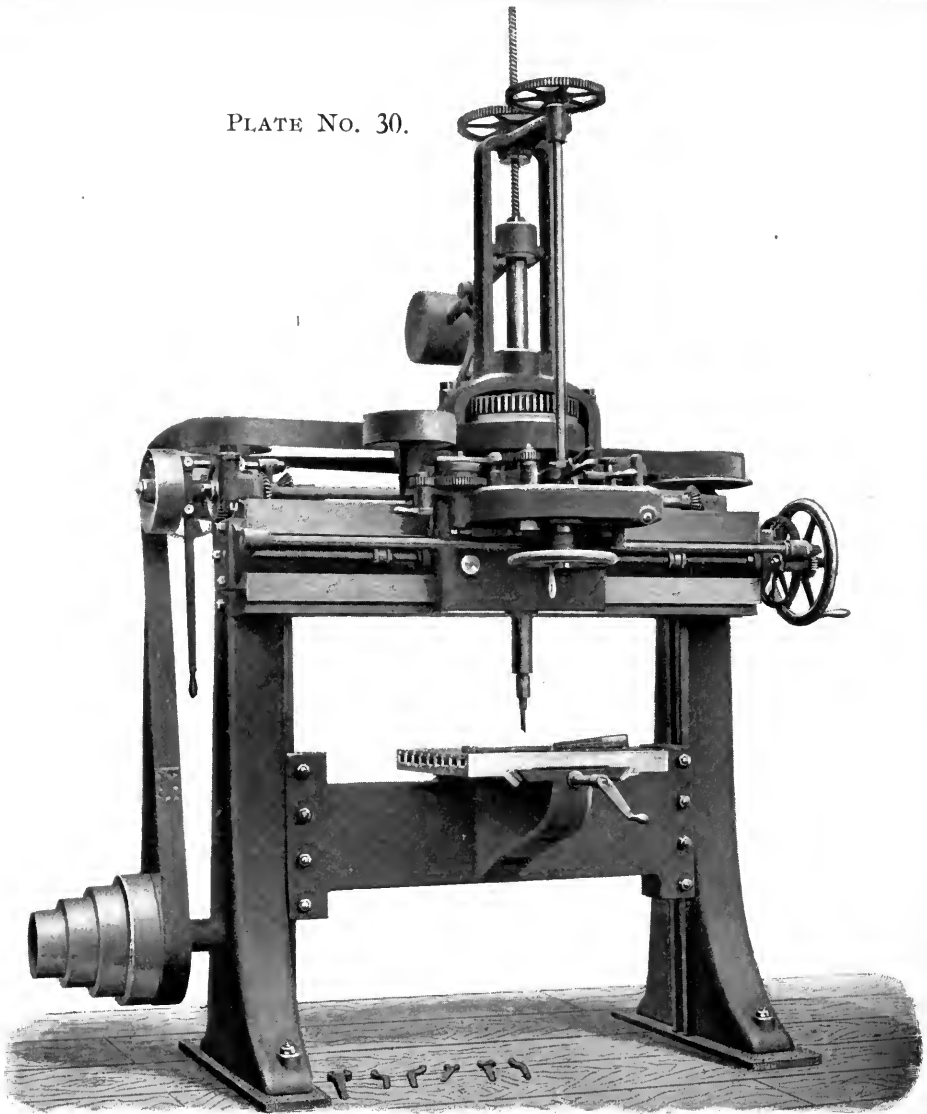

TRAVERSE-DRILL WITH COTTER DRILLING ATTACHMENT.
FOR KEYSEATS, SLOTS, ETC.

Space between uprights, $50\frac{1}{4}$ ". Height of cross-head from floor, 52 ". Overreach of spindle, 10 ". Transverse travel of drill-spindle, 3 ft. Will cotter or drill holes 10 " from the edge of a plate or key-seat cylinders 20 " diameter, of any length. Table, 24 " square, with 24 " motion at right angles to the plane in which the saddle moves; table raised and lowered by power. Complete with countershaft, full set of wrenches, and sample drill socket. Fast and loose pulleys on countershaft, 10 " diameter, 4 " face. Should make 110 revolutions per minute. Quickly convertible into plain vertical drill press when required.

PLATE NO. 31.

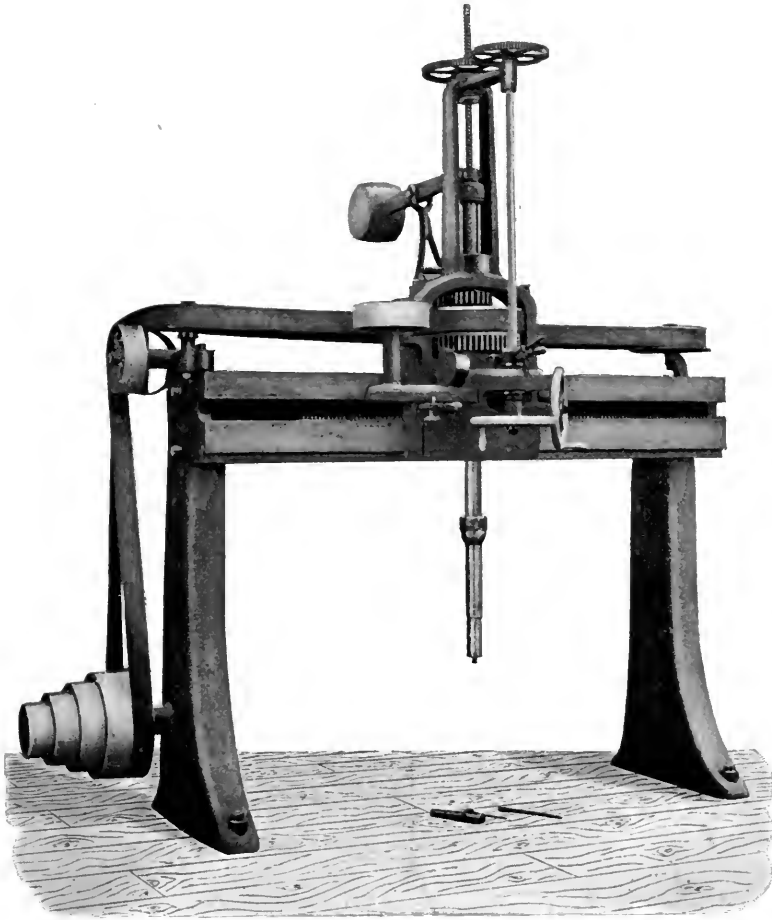

TRAVERSE-DRILL, WITHOUT COTTER ATTACHMENT.

Distance between uprights, 74". Height under cross-head from floor, 52". Diameter of spindle, $2\frac{1}{2}$ " ; stroke of spindle, $17\frac{1}{4}$ ". Feed of saddle along cross-head by hand only. Power feed of spindle through improved friction discs. Machine complete with countershaft, full set of wrenches, and sample drill socket. Fast and loose pulleys on countershaft, 10" diameter, 4" face. Should make 110 revolutions per minute.

Horizontal Drilling and Boring Machines.

These machines, designed to bore and drill horizontally work resting on a table, have been considered by some as coming next to the lathe in usefulness. They will drill work that cannot be operated on in an ordinary vertical drill press, and have all the advantages of a facing lathe for some kinds of work.

Marked advantages which these machines have lie in the nature of the feed-motion, which, by use of the friction feed discs, admits of an infinite variety of feeds, between the finest and the coarsest; in the ready application of the feed, and its quick hand-motion; also in the manner of operating the compound table upon which the work rests, the handles to govern the motion of table being all on one side and within easy reach of the workman.



We provide an outboard bearing when that style of machine is required. This bearing, in the form of a yoke, is carried from the bed-plate, arching over the knee which carries the table; it bolts to the bed-plate, and to the knee also. It can be placed 29" from the face-plate, or it can be moved off to 53"; it does not interfere with the ready adjustment of the table vertically. For use with machines having no "yoke," we make a convenient adjustable bearing, or steady rest, carried by the table, readily applied and quickly set to suit the position of the boring-bar.

The feed-motion is arranged in two series, a fine and a coarse, together covering a wide range. The value of the coarse feed will be felt in all kinds of boring with bars and cutters, inasmuch as it is possible to rough out with a fine feed, and to finish with a light cut and a coarse feed. In this way the finishing cutter is hurried through the work, is less liable to wear in the length of the hole to be bored, and much time is saved. These machines may be used for a great variety of work,—turning, drilling, boring, and milling.

Cylinders may be bored, faced on flanges, drilled and tapped for studs, valve-seat milled off and ports cut out, while for driving-boxes and other bearings, especially for interchangeable work done in jigs or fixtures, the machine is almost indispensable. For facing large surfaces we use a "revolving slide-rest," which may be bolted to the flange on the end of the sleeve in which the spindle slides.

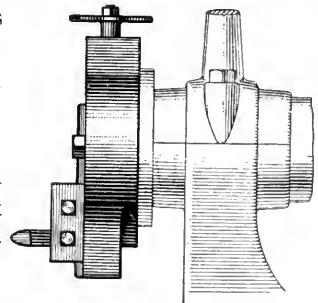
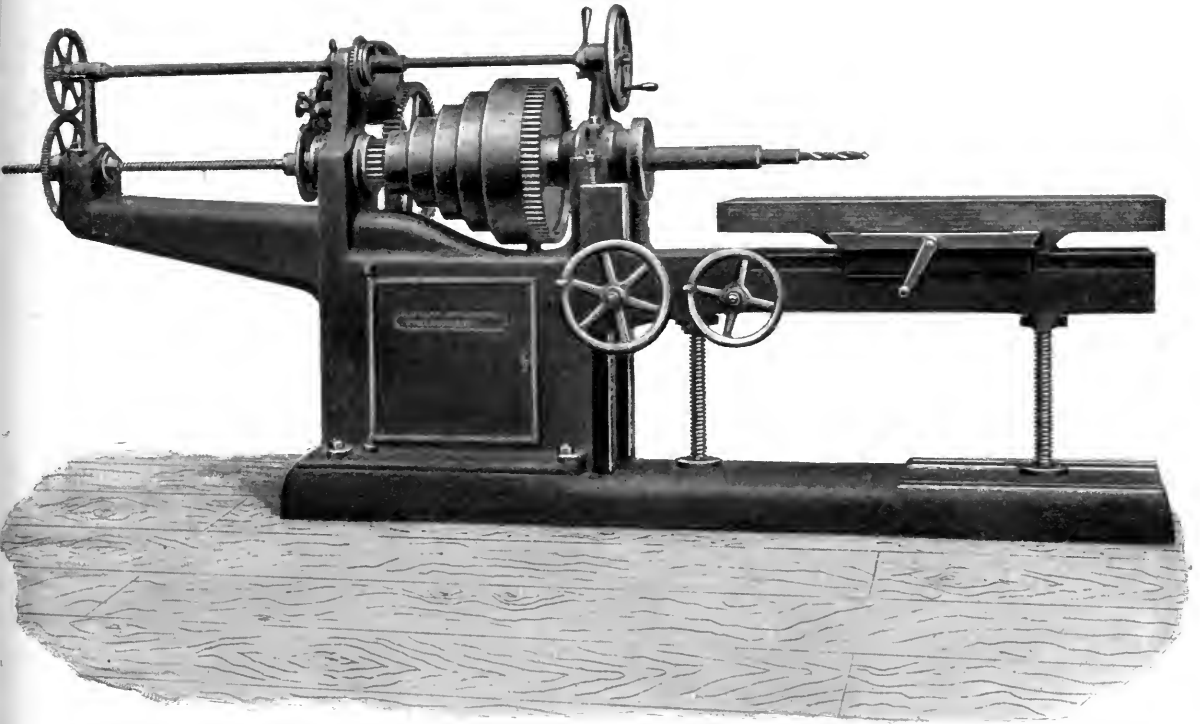

PLATE NO. 32.



HORIZONTAL DRILLING AND BORING MACHINE.

COMPOUND TABLE WITHOUT YOKE SUPPORT.

Spindle, $2\frac{7}{8}$ " diameter, 30" stroke. Slotted table on bracket 48" long by 23" wide. Adjustable along the bracket and across it. Greatest distance from centre of spindle to top of table 21". To top of bracket $26\frac{1}{2}$ ". Has improved friction feed variable from finest drilling feed to over $\frac{1}{2}$ " per turn of spindle for finishing with broad cutter. Very quick hand adjustment and quick clutch for power feed. Complete with countershaft, wrenches and sample drill socket. Fast and loose pulleys on countershaft 16" diameter by 4" face. Should make 75 revolutions per minute. *Revolving slide rest and supports for boring box, extra.*

PLATE NO. 33.

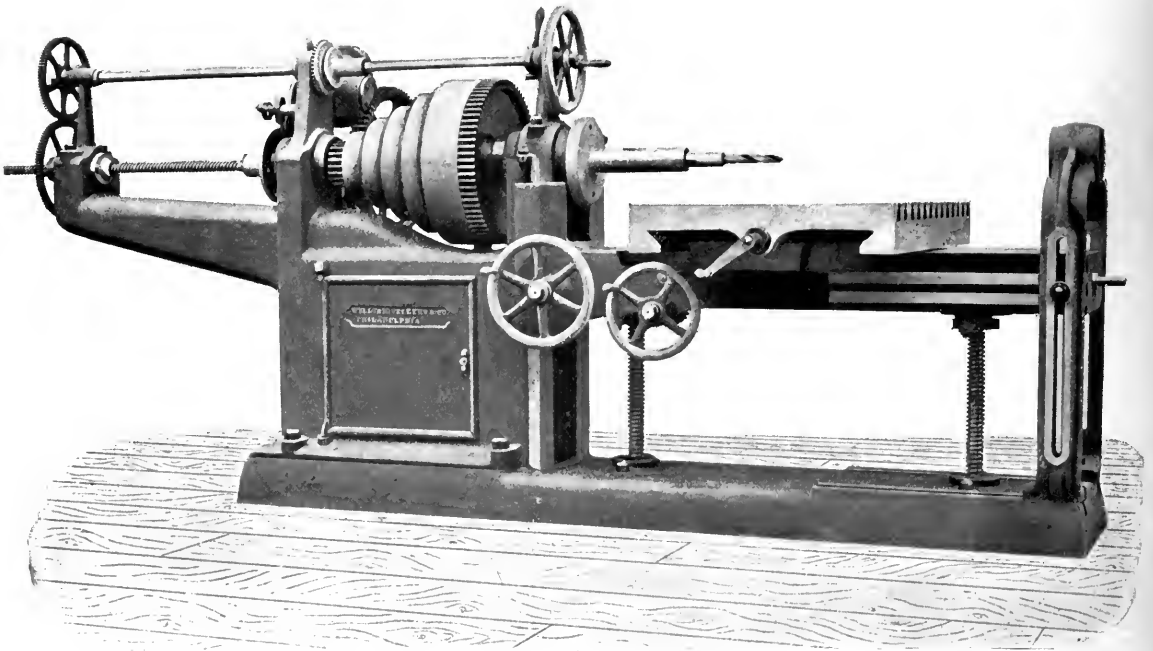

HORIZONTAL DRILLING AND BORING MACHINE.

COMPOUND TABLE WITH YOKE SUPPORT.

With improved variable feed in two series, varying from the finest drilling feed to over $\frac{1}{2}$ " per turn of spindle for finishing. Spindle, $2\frac{7}{8}$ " diameter, 30" stroke. Very quick hand traverse. Power-feed operated instantly by positive clutch. Largest lift of cone, 20" diameter for 3" belt. Ratio of back-gear, about 12 to 1. Slotted table on bracket 48" long by 28" wide; adjustable along the bracket and across it. Height from centre of spindle to top of table in lowest position, 21"; to top of bracket in lowest position, $26\frac{1}{2}$ ". Machine complete with countershaft, yoke support for boring-bar, full set of wrought-iron wrenches, and sample socket for drill. Fast and loose pulleys on countershaft, 16" diameter by 4" face; should make 75 revolutions per minute. Revolving slide-rest for face-plate, extra.

PLATE NO. 34.

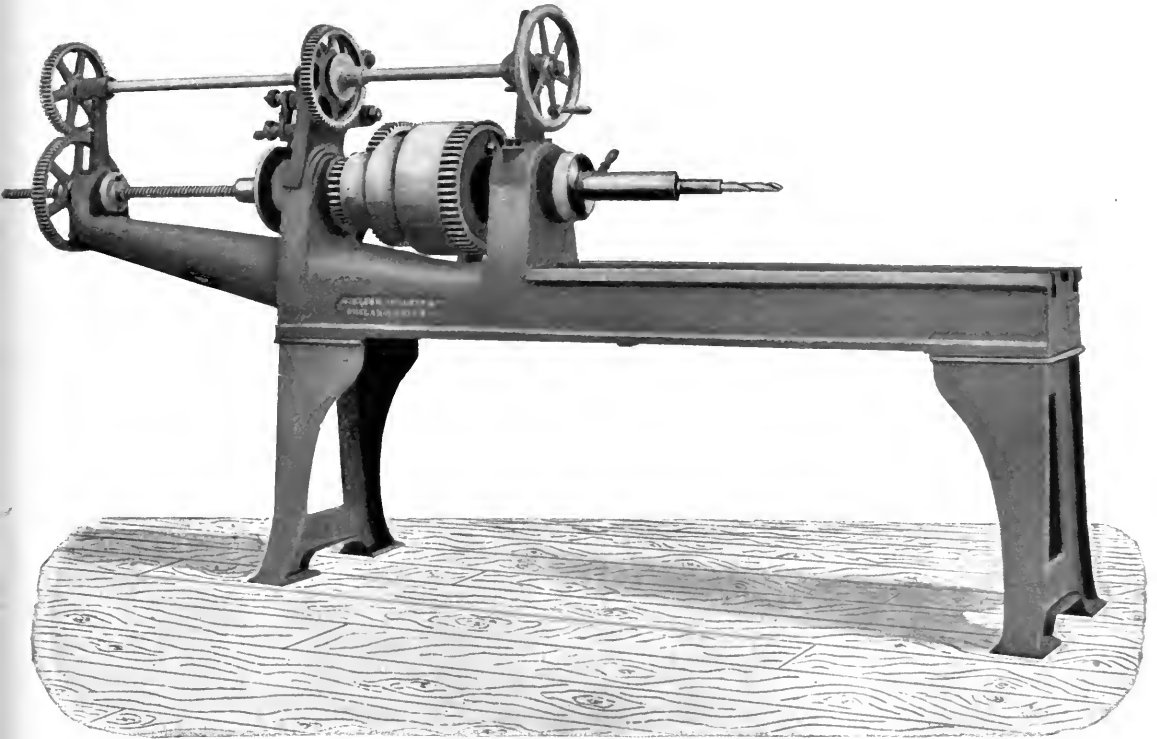

HORIZONTAL DRILLING AND BORING MACHINE.

WITH FIXED TABLE.

Bed projecting beyond head form fixed work table 13" wide, 56" long, with two "tee" slots for holding down work.

With improved self-acting variable feeds, adjustable from .004" to .5" per rotation of spindle. Feeds instantly adjustable to the exact amount required. Quick hand adjustment to spindle and positive clutch for engaging power-feed. Largest lift of cone pulley, 14" for 4" belt. Diameter of spindle, $2\frac{7}{8}$ ". Stroke of spindle, 30". Usual height of spindle above top of table, 8" Machine complete with countershaft, full set of wrenches, and sample socket for drill. Fast and loose pulleys on countershaft, 14" diameter by 4" face, and should make 80 revolutions per minute.

PLATE NO. 35.

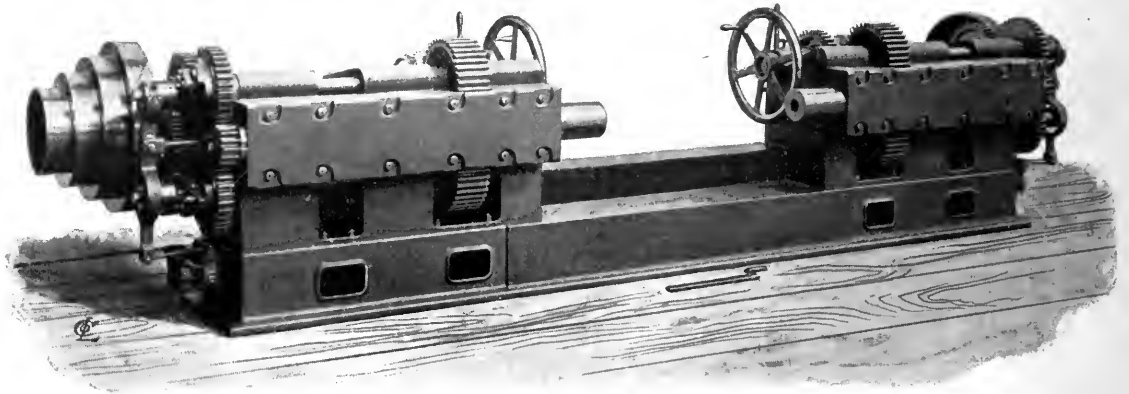

DOUBLE HORIZONTAL DRILL FOR MARINE ENGINE SHAFTS.

Drilling-heads, 4 ft. 6" apart, carried on opposite ends of bed, 12 ft. 6" long. Spindle, $5\frac{3}{8}$ " diameter. Distance from centre of spindle to face of spindle bearing next to shaft, 3", thus enabling holes to be drilled about 3" from outside of shaft. Stroke of spindle, 24". Distance from centre of spindle to top of bed, 15". Two rates of power-feed only. Feeds engaged and disengaged by friction clutches operated by hand-levers. Spindle adjustable rapidly by hand. The heads are driven from separate countershafts. Machine complete with full set of wrenches and countershafts. Largest lift of cone pulleys, 24" diameter, $3\frac{1}{4}$ " face. Ratio of back-gear, $9\frac{6}{10}$ to 1. Fast and loose pulleys on countershafts, 20" in diameter, arranged in sets of three. Fast pulley, 7" face; two loose pulleys, $4\frac{1}{4}$ " face; to be used with open and cross belts for reversing direction of spindle. Speed of countershafts, 240 revolutions per minute.

To be used in connection with separate bed with V-chucks for carrying the shaft, the flanges of which are to be drilled or reamed.

PLATE No. 36.

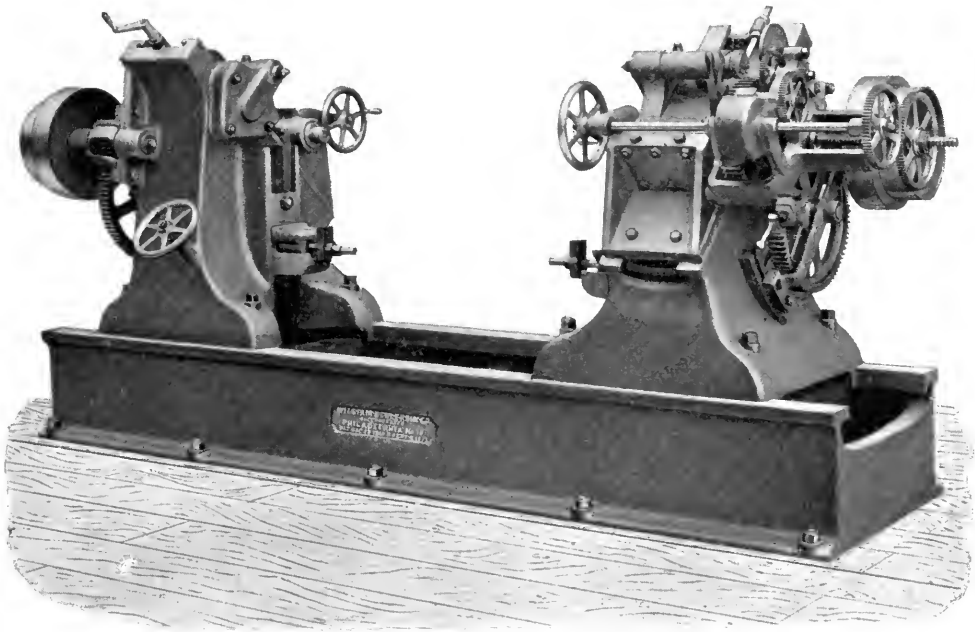

WHEEL-QUARTERING MACHINE FOR LOCOMOTIVE DRIVING-
WHEELS.

Will quarter from 5" radius of crank to 15" ; made for right hand lead or for both right and left lead. Heads adjustable from 18" to 60" gauge, will take wheels up 6 ft. diameter. Spindle 9" stroke, $2\frac{7}{8}$ " diameter. Variable friction feed. Independent countershafts having 19" fast and loose pulleys, $4\frac{1}{2}$ " face. Speed 80 revolutions per minute. Wheels are carried by the tread in adjustable cradles as well as on centres. Cradles provided with convenient clamps.

Horizontal Floor-Boring Machines.

WE have continued to call these "floor" boring machines, because the work in the earlier machines was carried upon a large bed plate level with the shop floor. Many such machines, however, are now built with various forms of elevated work tables either combined with a slotted "floor" plate or sliding upon an elevated bed. In the former case the bed which carries the travelling upright may be moved upon the floor plate, presenting the spindle to the work at any desired horizontal angle. Such machines are necessarily of limited size, because, in a certain sense, they are portable machines. When more horizontal traverse is required, another type of machine is produced in which the bed—upon which the upright slides—is fixed at one end or one side of the slotted floor-plate upon which the work is secured. Machines of this kind have been usually driven from pulleys at one end of the bed, transmitting power through long shafts in the bed and in the upright, and have a large amount of transmitting mechanism, which must be of considerable size to avoid excessive torsional deflection.

The frictional loss in such a machine is entirely out of proportion to the useful work done, and this led us to construct a machine in which long transmitting shafts are entirely avoided, and in which the power is applied directly to the spindle-gearing by means of a belt, driven by an electric motor, carried on the upright of the machine itself.

The screw for horizontal traverse of the upright is a stationary one in the bed, and the nut is rotated.

While these machines are most conveniently operated by electric motors, we also build them with countershafts and cone pulleys when required; but we prefer to belt directly to the moving upright rather than to drive through long shafts in the bed.

The various motions are engaged or disengaged by a simple system of clutches, which enables one at will to throw in any one of the feeds or of the rapid traversing motions, and the whole machine is controlled by the operator, who stands on a convenient platform opposite the spindle. From this point he can run the upright to any position on the bed he desires, and with the utmost nicety; he can raise or lower the saddle to bring the spindle to the proper elevation; this motion being accomplished rapidly and with great accuracy. The great length of horizontal and vertical movements which is usual in such machines, renders this quick movement by power a necessity.

These machines, besides the ordinary drilling-feed, are often provided with

PLATE NO. 37.

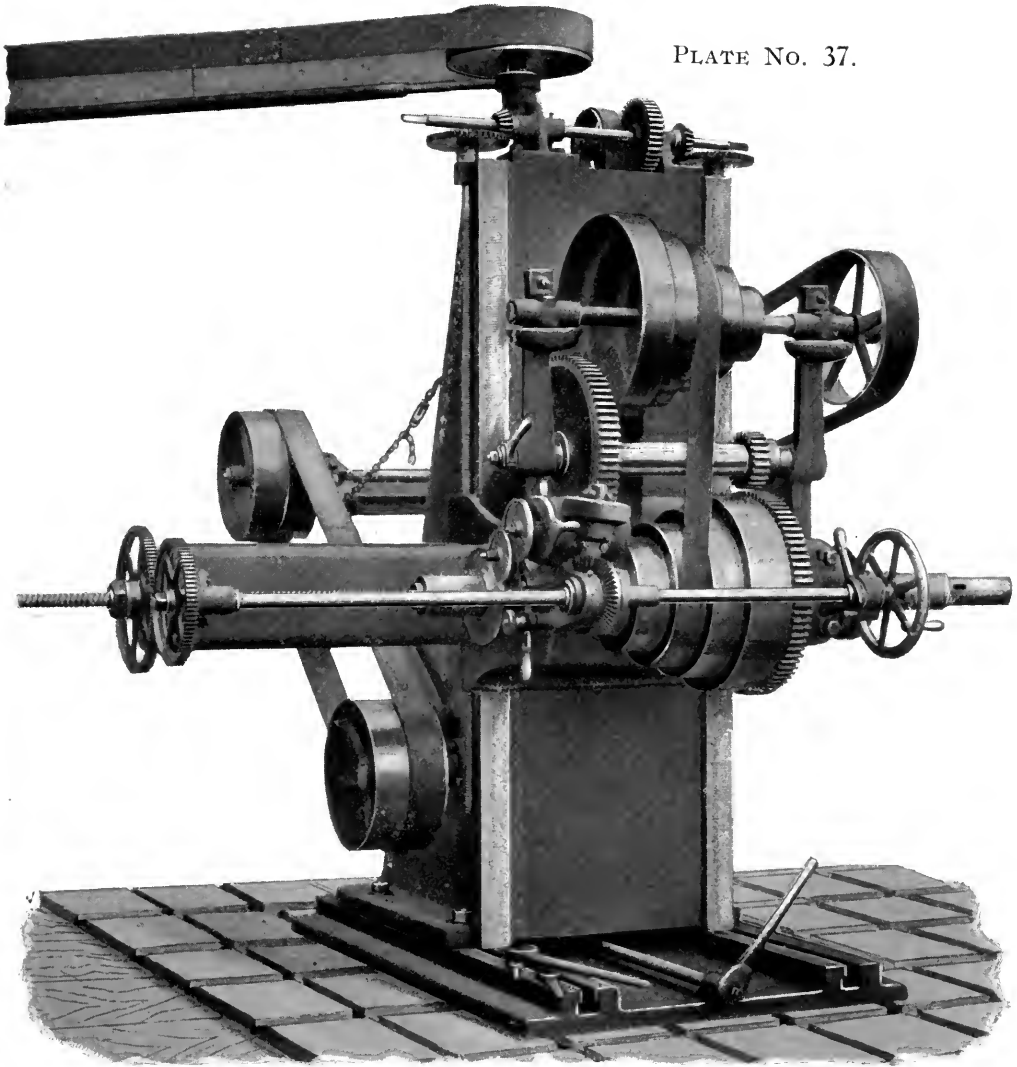

FLOOR-BORING MACHINE—DRIVEN BY BELT AND SWING FRAME.

Minimum height of spindle above floor-plate, 14". Maximum height, 6 ft. 2". Horizontal adjustment of upright on slide, 4 ft. 10". Spindle, 4" diameter, 30" stroke. Largest lift on cone pulley, 20" diameter for 3" belt. Feeds variable by our improved friction arrangement up to $\frac{1}{2}$ " per turn of spindle. Driving pulley, 16" diameter, 4" belt. 75 revolutions per minute. Slotted floor-plate and adjustable support for boring-bar, extra.

Horizontal Floor-Boring Machines.—(*Continued.*)

milling-feeds, both horizontal and vertical, so that they may be used to face off surfaces, or do other milling work not usually covered by ordinary milling machines. The feed in each case is regulated by our improved friction discs. The height of upright and length of bed can be readily made to suit all requirements.

Besides the machines illustrated in the accompanying plates, we are prepared to build larger sizes, with or without milling feeds, and with various arrangements of work tables, boring bar supports, etc.

We are now completing a very large machine of this character, having an 8" spindle, with a traverse or stroke of 8 feet, mounted upon an upright sliding along a bed 7 feet wide and 2 feet deep, for a distance of 22 feet. The vertical traverse of the bar on the face of the upright is 10 feet, and the boring head is provided with a complete series of feeds for drilling and boring, and in addition, power feeds, vertical and horizontal for use in milling, while the machine has sufficient power to operate a large milling or rotary planing head with inserted cutters, carried either on the 8" steel spindle or upon the flanged end of the sleeve. The spindle has a graduated range of speeds from $2\frac{1}{2}$ turns per minute to 160, all controllable in a convenient manner. All of these movements are determined from the operator's platform which is suspended from the boring head itself, the motive power being provided by an electric motor carried on the upright. This machine is intended for use with a large slotted floor-plate, and has in addition, a slotted work table of 6 feet by 10 feet, which is arranged to rotate on a saddle which travels on a supplementary bed of 7 feet wide, arranged at right angles to that which carries the boring head.

The work table has also a cross-traverse of 3 feet either side of the centre. The supplementary bed is further provided with an additional saddle, carrying a second upright, upon which is mounted an outboard support for a boring-bar, capable of taking one 14" diameter, and having a cross-traverse on the bar of 30".

This massive bearing is raised and lowered by a separate motor, and another motor is provided for moving the boring-bar support and the work table along the supplementary bed to the proper position. This machine will be used especially for boring, drilling and facing cylinders for marine engines.

PLATE No. 38.

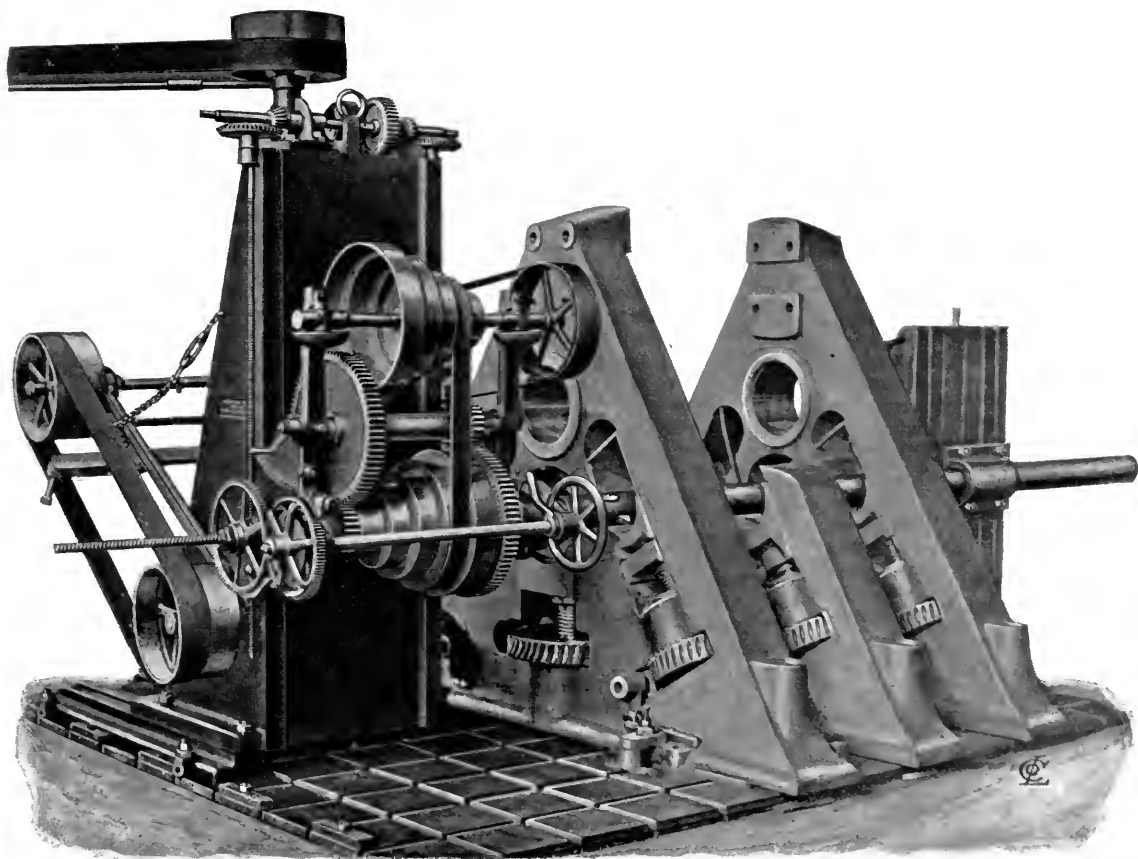

FLOOR-BORING MACHINE.

BELT-DRIVEN WITH WORK IN POSITION UPON FLOOR-PLATE.

This illustration, from actual practice, gives an excellent idea of the usefulness of these machines. Such work as shown in the illustration, may be set upon the floor-plate and the machine moved from one hole to another, so as to insure their parallelism without the necessity of resetting the work.

PLATE

No. 39.

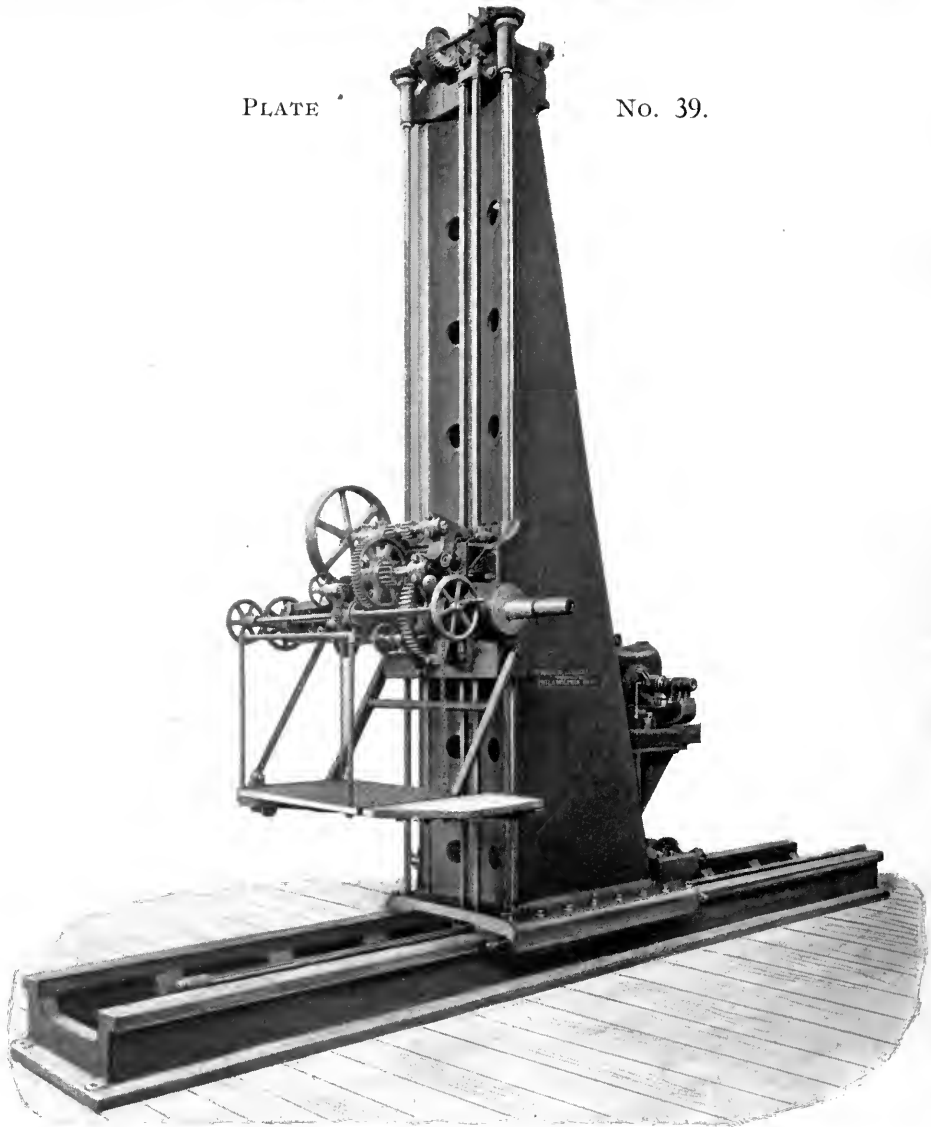

FLOOR-BORING MACHINE ON INDEPENDENT BED.
DRIVEN BY ELECTRIC MOTOR.

Diameter of spindle, 4". Stroke, 30". Face of upright to centre of spindle, 8". Power-feeds variable through a wide range. Quick traverse by power, 20 ft. per minute, up and down the upright, and along the horizontal bed. Thirty speeds, varying from say two rotations of the spindle per minute up to about 180. Machine shown has vertical movement of 11 ft. 6"; horizontal movement of 16 ft. Motor, rheostat for regulating motor, full set of wrought-iron wrenches and sample drill socket. All movements are controlled by operator on hanging platform attached to head.

PLATE

No. 40.

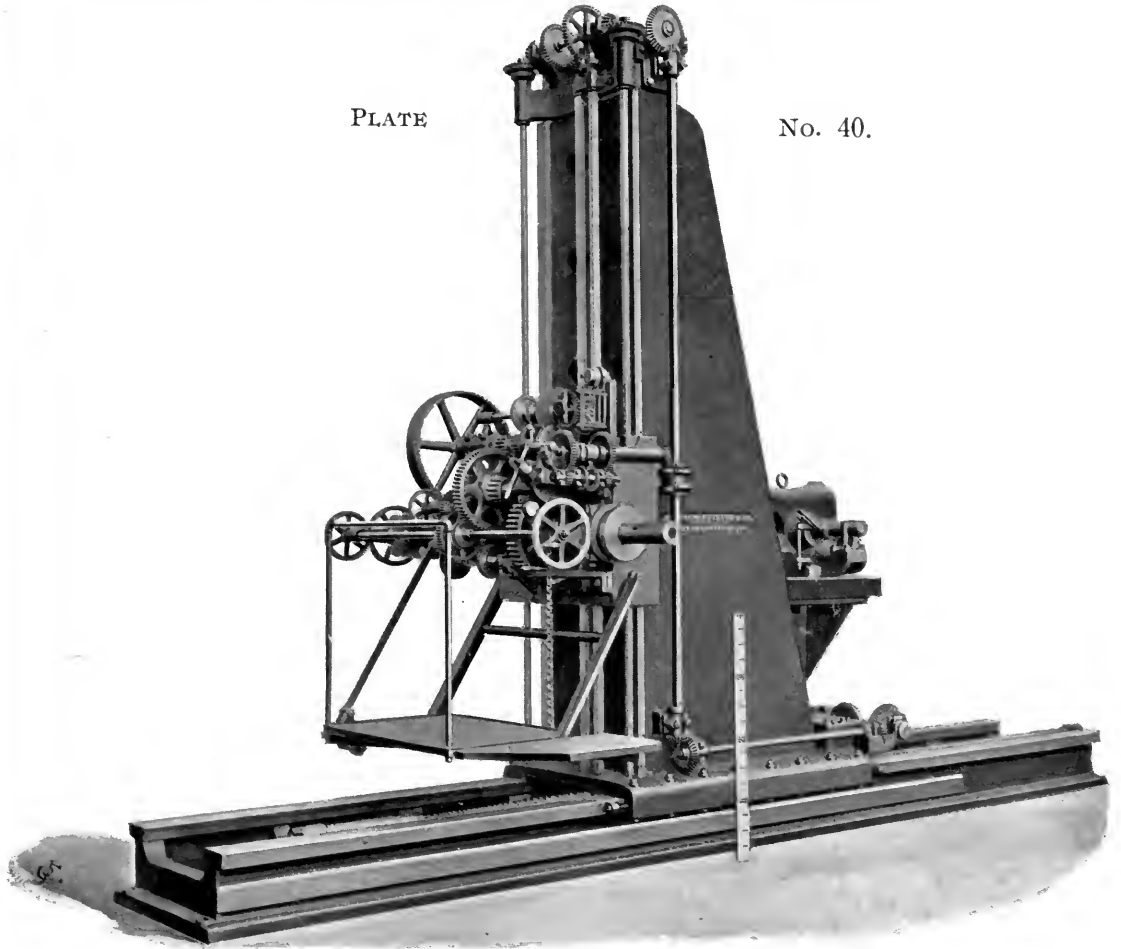

FLOOR-BORING MACHINE WITH MILLING AND BORING FEEDS.
DRIVEN BY ELECTRIC MOTOR.

Diameter of spindle, 4". Stroke, 30". Face of upright to centre of spindle, 8". Power-feeds variable through a wide range. Quick traverse by power, 20 ft. per minute, up and down the upright and along the horizontal bed. Thirty speeds provided, varying from say two rotations of the spindle per minute up to about 180. Machine shown in illustration has vertical movement of 8 ft. and horizontal movement of 14". Arranged with vertical and horizontal feeds for milling surfaces. Milling feeds adjustable through wide range. All movements controlled by operator on platform attached to head. Milling feeds variable by friction gear through wide range. Motor, rheostat for regulating motor, full set of wrenches, and sample drill socket.

PLATE No. 41.

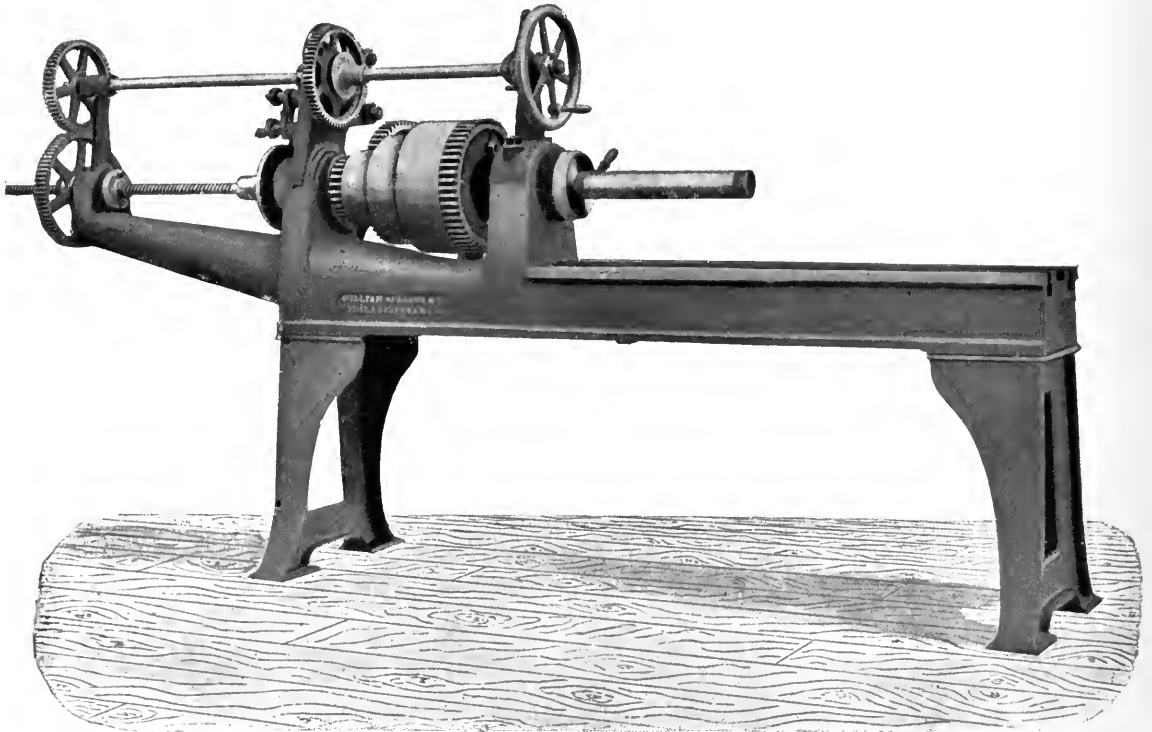

HORIZONTAL BORING MACHINE, WITH FIXED TABLE.

SPINDLE, $2\frac{7}{8}$ " DIAMETER.

With improved self-acting variable feed, operated by friction discs, permitting any variation between fastest and slowest. Feeds arranged in two series, varying in the fine series from .004" to .08", and in the coarse from .02" to .5". Very quick hand traverse. Stroke of spindle, 30". Ordinary height of spindle above table, 8". Made also 10" and 12" high. Table, 56" long beyond boring head, with longitudinal slots for attaching work. Largest lift of cone pulley, 14" for 4" belt. Complete with countershaft and full set of wrenches. Fast and loose pulleys on countershaft, 14" diameter, 4" face, and should make 80 revolutions per minute. *Boring-bars, cutter-heads, chucks for boxes and journal brasses, and outboard supports for boring-bars, extra.*

PLATE No. 42.

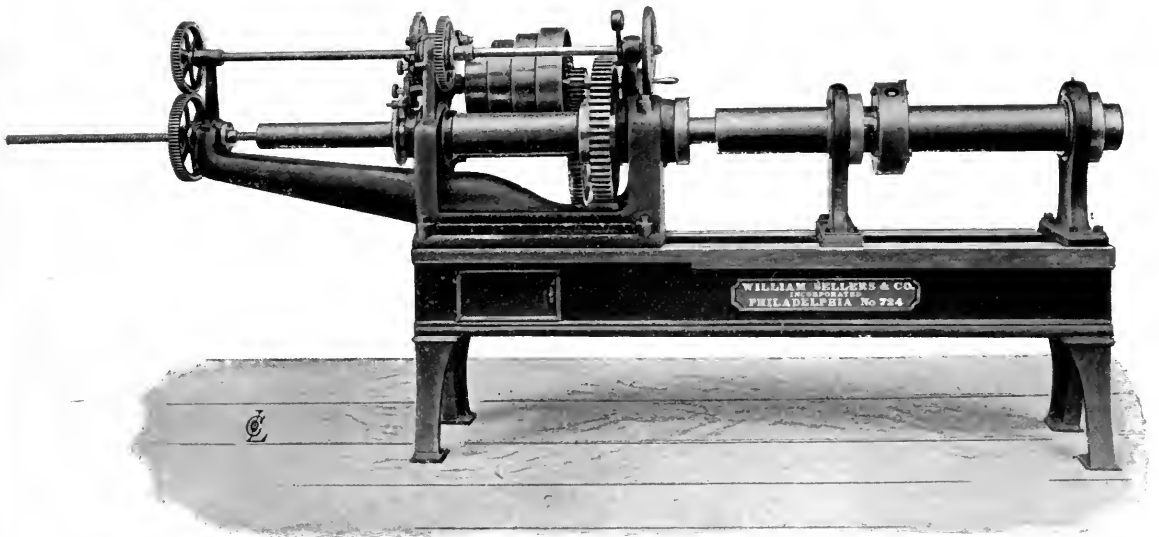

HORIZONTAL BORING-MACHINE, WITH FIXED TABLE.

SPINDLE, 4" DIAMETER.

Table with slots for holding work and boring-bar supports may be varied in length to suit requirements. Height of spindle above table, 16". Stroke, 30". Has improved friction feed giving range from say .004" to coarse finishing feed of nearly $\frac{1}{2}$ ". It is powerfully geared. Has quick hand traverse to spindle. Bed has tool closet with flat key lock. Fast and loose pulleys, 16" diameter, 4" belt. 135 revolutions per minute. *We make a variety of boring bars, cutter heads and supports adapted for various kinds of work.* The illustration shows a $6\frac{7}{8}$ " steel bar with $13\frac{1}{2}$ " cutter heads, adapted for brake cylinders up to say 16" diameter.

PLATE No. 43.

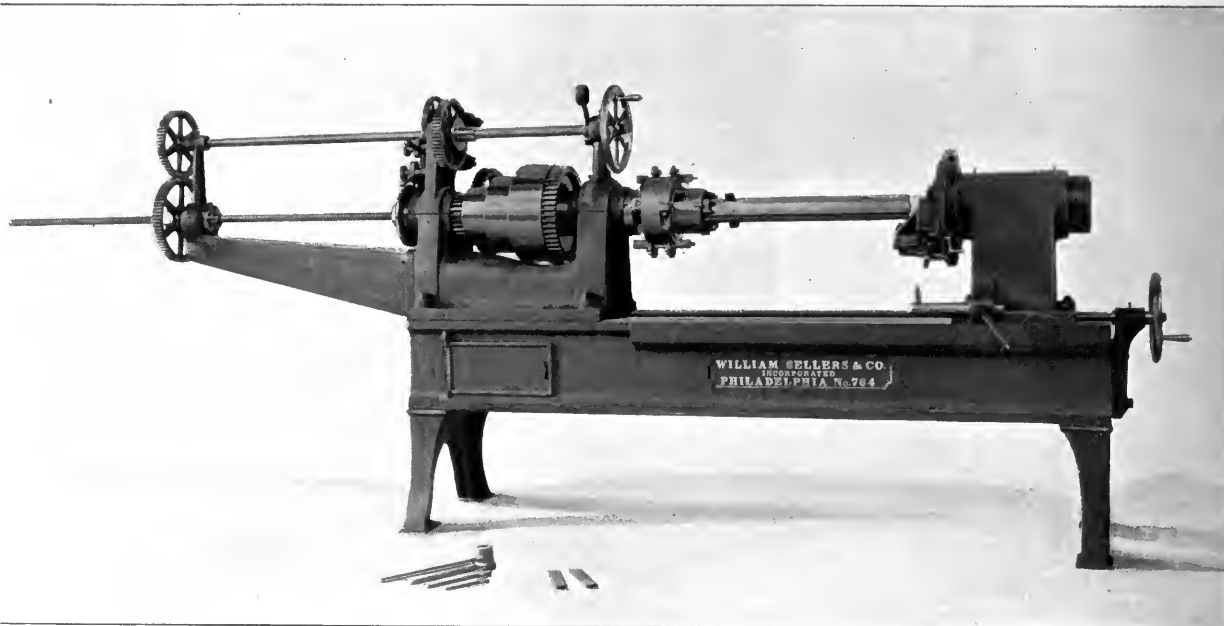

HORIZONTAL BORING MACHINE, WITH FIXED TABLE.

OUTBOARD SUPPORT WITH FACING REST.

Same machine as shown in Plate 42, with modifications for special work. Spindle, 4" diameter, 30" stroke, is slotted to carry cutter head and boring tools. End support for facing rest with star feed adjustable along bed.

PLATE No. 44.

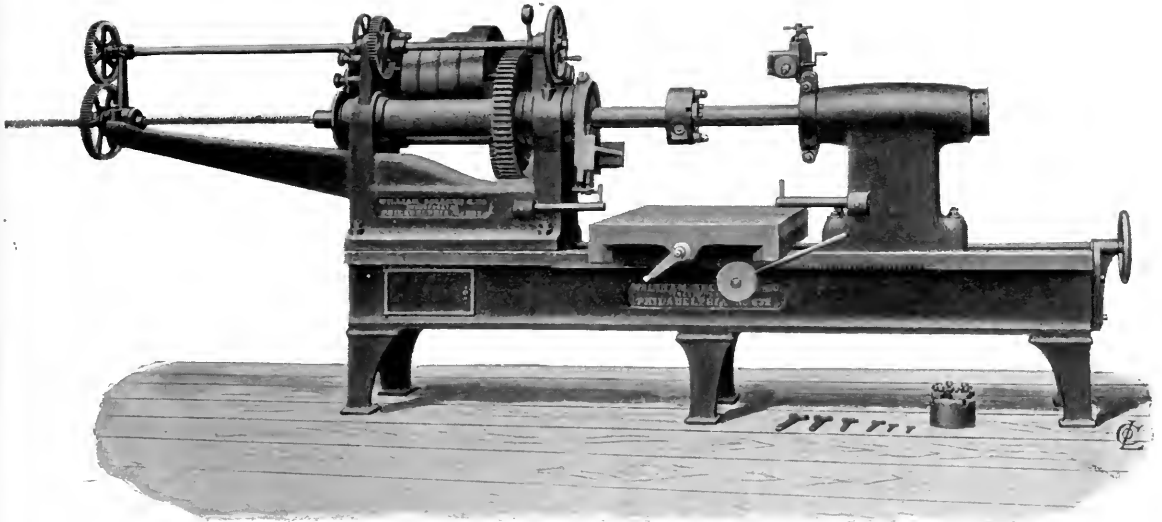

HORIZONTAL BORING-MACHINE, WITH COMPOUND TABLE.

Especially designed for boring and facing cylinders. Outboard support adjustable along the bed by screw, and provided with sleeve carrying facing-rest on enlarged end. Similar facing-rest on sleeve in driving head. Compound table, 28" wide, 48" long, adjustable on bed and provided with cross traverse of 24". Height of boring-bar above table, $15\frac{3}{4}$ ". Complete with boring-bar, countershaft, two facing rests, two cutter heads for cylinders $7\frac{1}{2}$ " to 14" diameter. Fast and loose pulleys on countershaft, 16" diameter, $4\frac{1}{4}$ " face, should make 135 revolutions per minute. Also made with screw contained within the boring bar, thus diminishing the total length occupied by the machine. It has a rapid hand adjustment of the boring-bar; all operating handles are very conveniently arranged. The bed has a tool chest, the door of which is provided with a good lock. It will readily bore cylinders 32" long, and has been very satisfactorily used for pump cylinders from $7\frac{1}{2}$ " to 14" diameter, this range being covered by two cutter heads, each provided with four flat cutters.

PLATE No. 45.

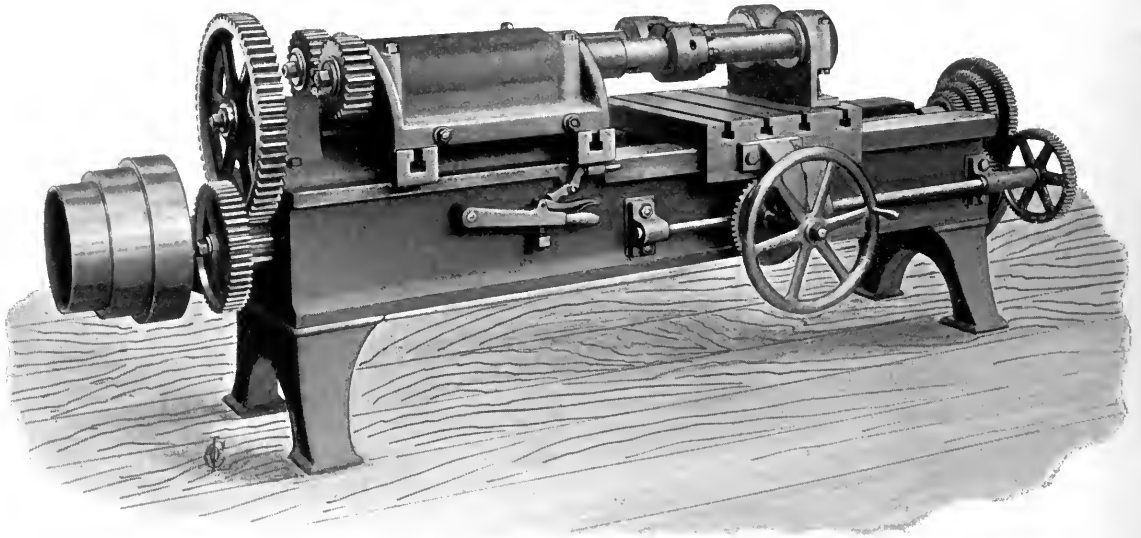

DOUBLE HORIZONTAL BORING MACHINE.

FOR DUPLEX PUMP CYLINDERS.

The work is clamped to the table and fed toward the boring cutters which are in a fixed position on the bars. The distance between boring bars may be varied by changing driving wheels or by substituting other driving heads. Table has quick hand adjustment and geared power feed, giving three changes. Cone, 16" diameter, 3½" face. Detachable boring bars, 3½" diameter. Usual height of bar above table, 7". Complete with countershaft, two bars with cutter heads, outboard support with running bushings, set of wrenches and sample cutters. Fast and loose pulleys, 16" by 4". Should make 290 revolutions per minute.

PLATE NO. 46.

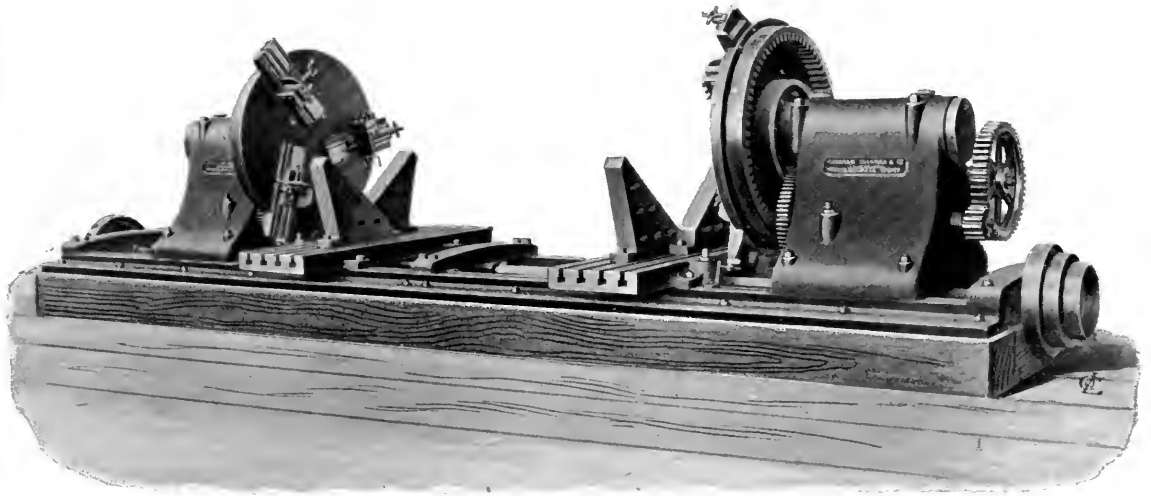

62" FLANGE FACING MACHINE.

For facing simultaneously the flanges of large cast-iron pipes. Two adjustable tables with "V" blocks are provided, in which the pipe can be held, and to which it may be bolted, and the heads are also adjustable to suit the length of pipe to be faced. Heads and tables mounted on shoe-plates, carried upon foundation walls, are each moved by means of a pinion gearing into a vertical rack on one of the shoe-plates. There are three slides on each head, having a movement towards and from the centre, and also a movement perpendicular to the face-plates, which is used for regulating the depth of cut. A star-feed operates the long slides in facing. The machine is complete with shoe-plates for pipes 14 ft. long, and two countershafts, "V" blocks, ratchet wrench for moving heads, and full set of wrought-iron wrenches. The largest lift of the cone-pulleys is 24" diameter, 3½" face, and the ratio of gearing is 70 to 1. Fast and loose pulleys are 20" diameter, 4" belt. Two sets are provided, which should make 120 and 200 revolutions per minute respectively.

PLATE NO. 47.

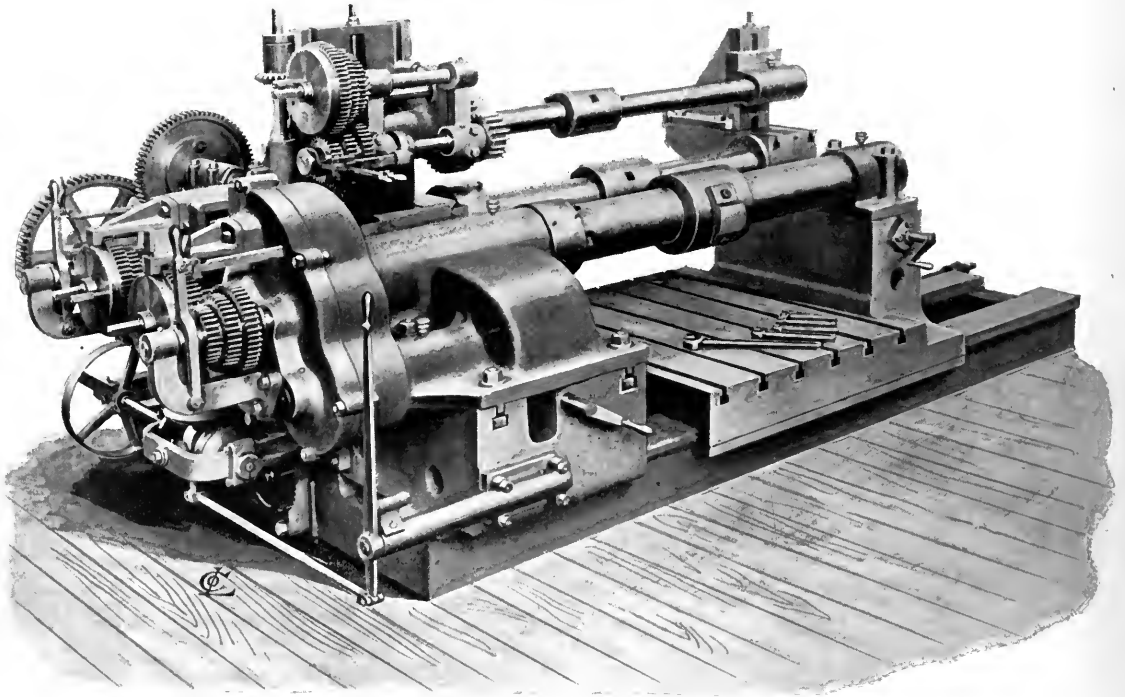

TRIPLE BORING MACHINE—FOR CYLINDERS OF COMPOUND LOCOMOTIVES.

Designed especially for boring the cylinders and valve of the Vaclain Compound Locomotive. The work is carried upon a table, which also supports the outboard bearings for the boring-bars, and is adjustable along the bed to permit power, the work to be lifted from the table. The cutter-heads travel along their respective bars, which are proportioned to suit the diameters of the various cylinders. The bars are bolted to the spindles by flanges. Two bars are adjustable, so as to cover almost every position in which the three cylinders can be arranged. Each bar has its own feed-motion, operated by a lever working a toothed clutch. Back-feed for counterboring the ends of the cylinders. Table 5 ft. long by 4 ft. 1" wide. The height from centre of the lower boring-bars to table, 21". Machine has set of wrought-iron wrenches, three sample bars with cutter-heads complete, and outboard bearings for same. Countershaft has 24" pulleys for 4" belt, and extra countershaft for the table has 16" pulleys, 2½" face; speed of both, 250 revolutions per minute.

PLATE NO. 48.

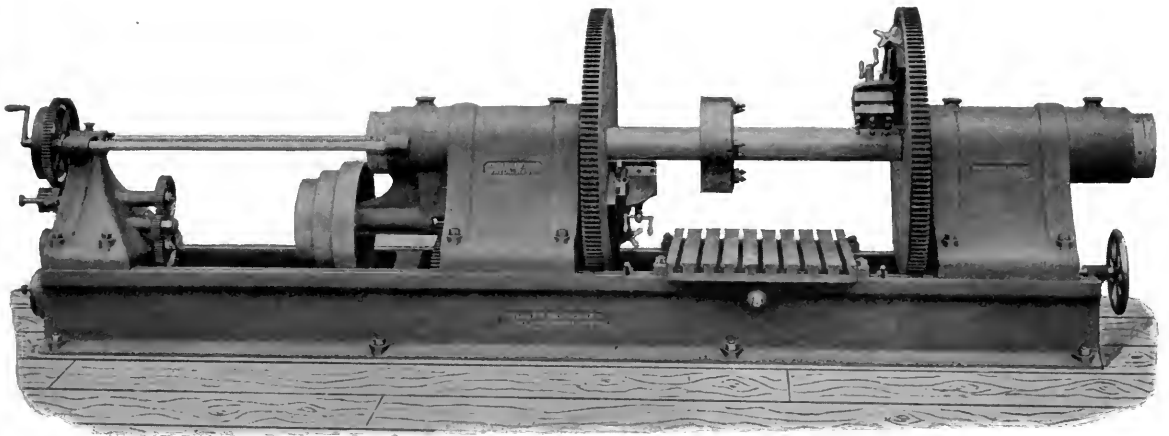

LOCOMOTIVE CYLINDER BORING AND FACING MACHINE.

FOR BORING LOCOMOTIVE CYLINDERS.

Has 6" steel boring-bar driven at both ends of cylinder, independent slide rests for facing both ends; six changes of boring feed with quick hand adjustment; bar withdrawn by hand or power to allow work to be shifted. Complete with countershaft, wrenches and set of cutter heads. Fast and loose pulleys 18" diameter, 4" face; 140 revolutions per minute. *Made in two lengths, for cylinders 36" and 48" long respectively.*

PLATE NO. 49.

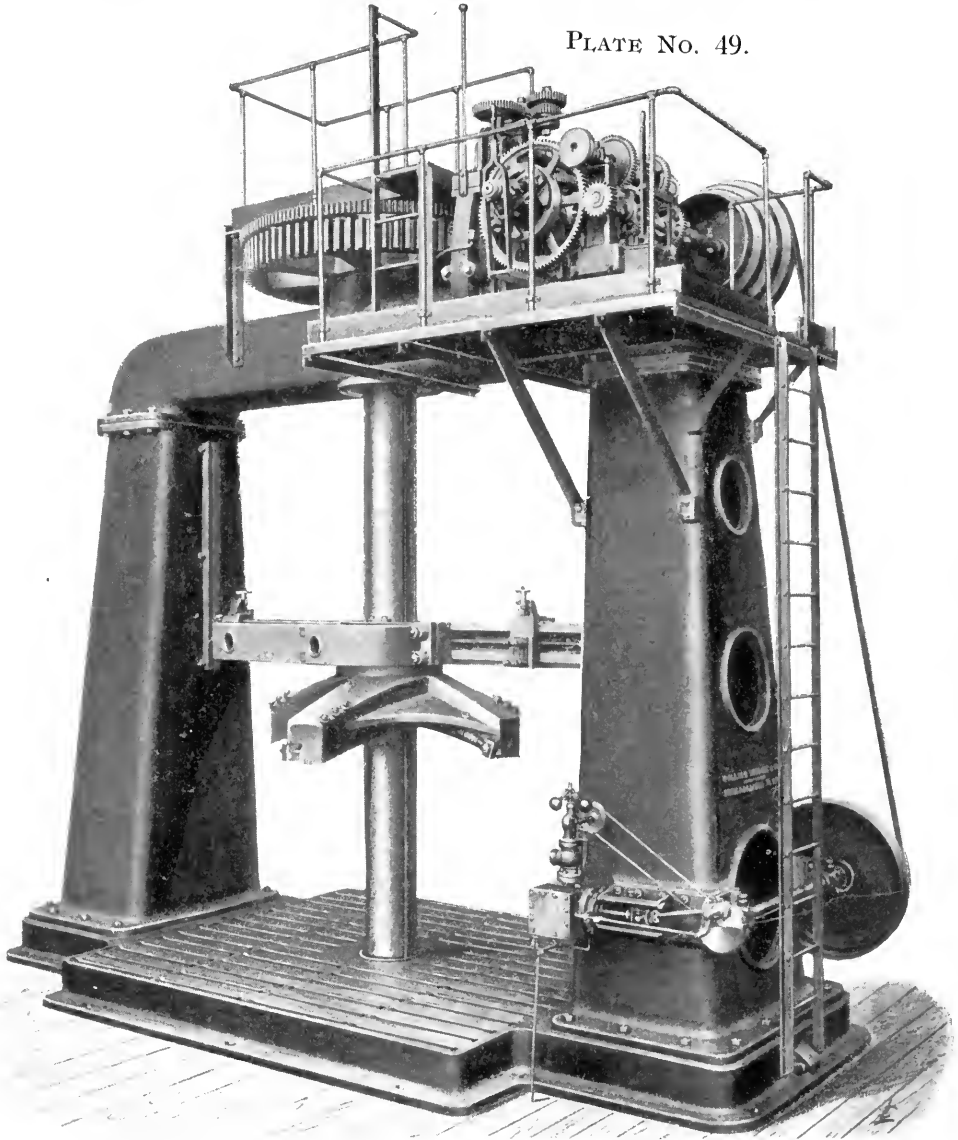

VERTICAL CYLINDER BORING-MACHINE.

For cylinders from 4 ft. to 9 ft. diameter up to 10 ft. long. 13 ft. between upright columns. Boring bar 16" diameter, runs in a bushing in the cross-beam and is supported on a step in the bed plate; it may be withdrawn to clean the work. Three cutter heads for various diameters, and facing arms for turning flanges. Double feed screws, power feeds range from $\frac{1}{16}$ " to $1\frac{3}{8}$ " per turn. Hand adjustment for bar and quick power traverse. Driven by independent 8" by 8" engine or electric motor as preferred.

PLATE No. 50.

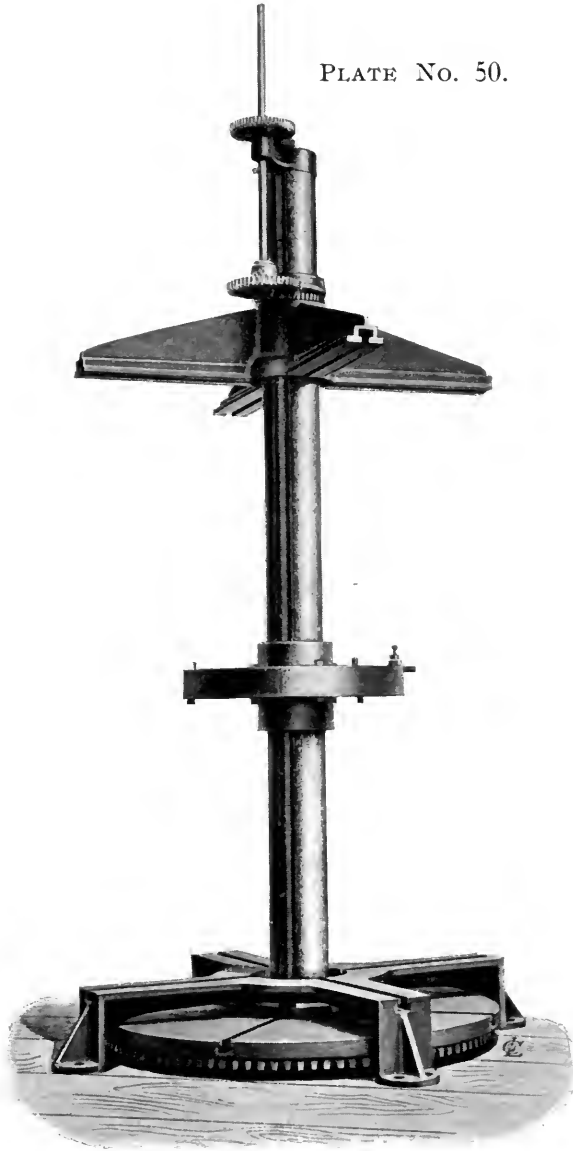

VERTICAL CYLINDER BORING-BAR.

To be used with boring and turning mill or special driving gear. Lower spider supports the work, upper spider bolted to top flange of cylinder centers the bar and operates the feed motion. Bar 10" diameter, 12 ft. long for cylinders up to say 9 ft. long.

PLATE No. 51.

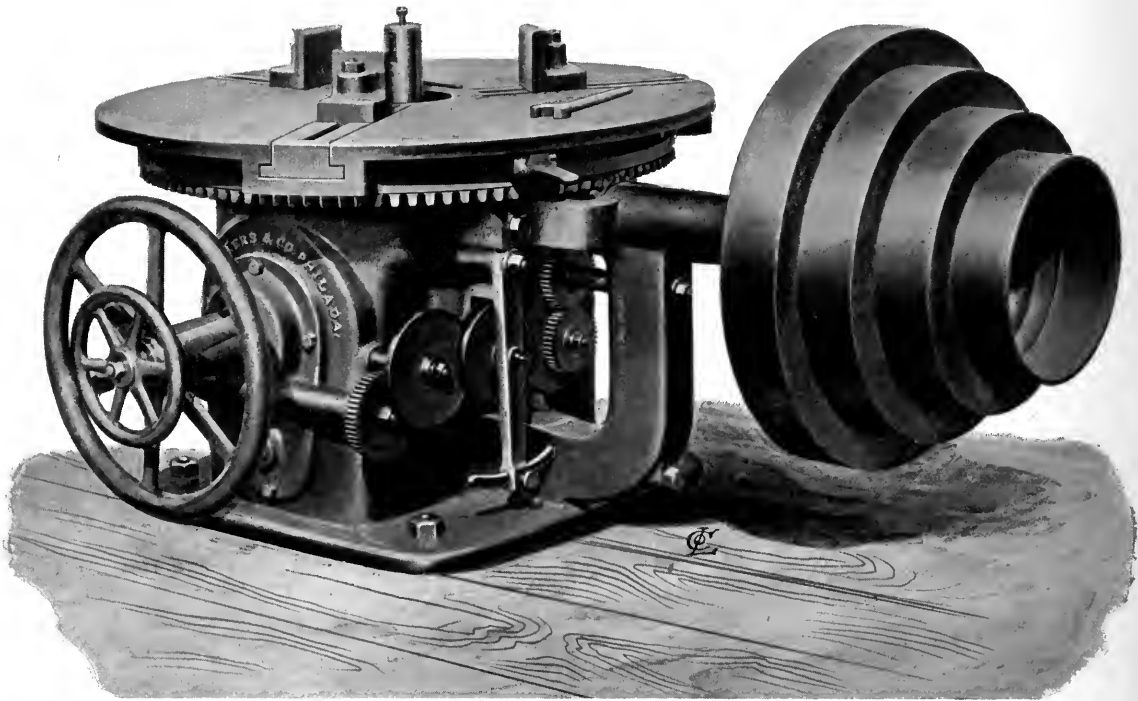

PULLEY BORING MACHINE.

FOR PULLEYS, CAR-WHEELS, AND GENERAL WORK.

Table fitted with universal chuck, taking wheels 36" in diameter. Will bore work up to 6 ft. in diameter if clamped to table. Cross-head for holding boring-bar balanced and arranged with variable power-feed and quick hand-traverse. Sliding surfaces protected from chips, which can fall through bed of machine into pit in foundation. Length of boring-stroke, $14\frac{1}{2}$ ". Machine complete with countershaft, hangers, and full set of wrought-iron wrenches and lever to operate chuck. Sample boring-bar with machine, $2\frac{1}{8}$ " diameter. Fast and loose pulleys on countershaft, 24" diameter for 4" belt. Speed of countershaft, 60 revolutions per minute.

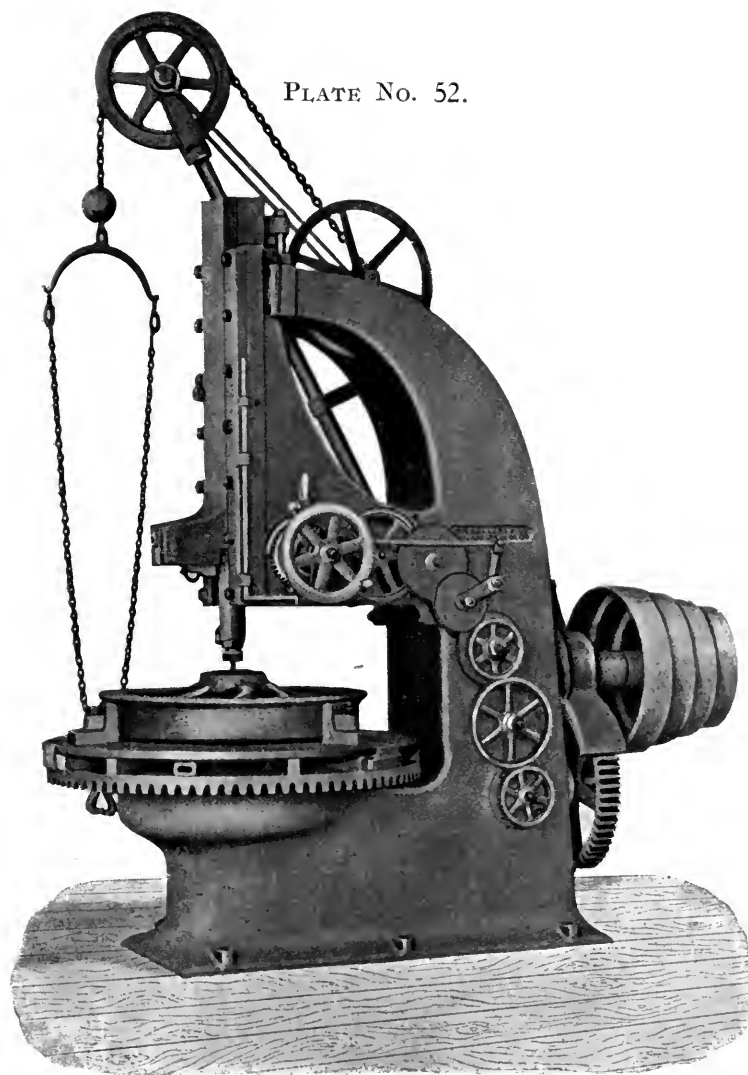

50" CAR-WHEEL BORING-MILL, No. 1.

Table, 50" diameter, with universal chuck for car-wheels, 42" diameter and under. Improved friction-feed with automatic hold-fast. Improved double cutters, quickly changed. Crane attachment, with chain-sling and hooks, arranged to stop automatically at top and bottom of hoist. Facing-rest for ends of hubs. Facing-rest distinct from bar, which may be changed to suit size of holes. 24" by 4" pulleys on countershaft, 134 revolutions per minute; 18" by 6" pulleys, 290 revolutions per minute.

PLATE No 53.

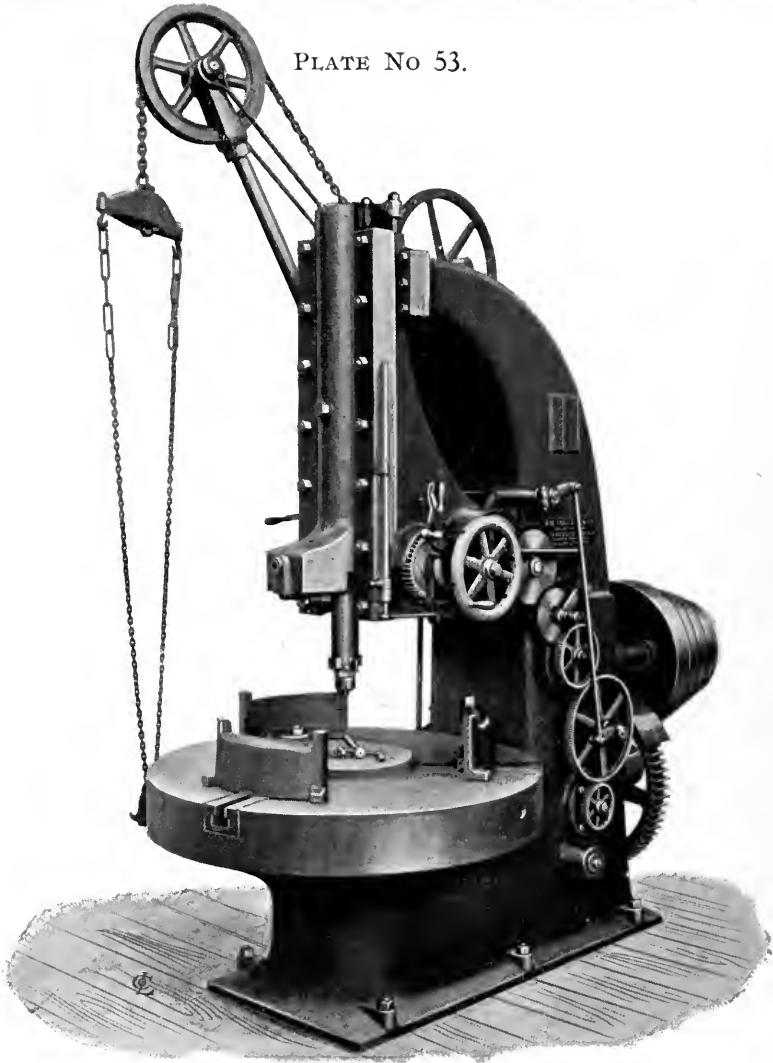

50" CAR-WHEEL BORING-MILL, No. 2.

With self-closing and self-centering chuck for 42" car-wheels. Chuck opens and closes on stopping and starting mill. Table stopped and shut by patent clutch operated by lever—without stopping countershaft. Table, 50". Largest lift of cone-pulley, 24" for 4" belt. Improved friction discs, with automatic hold-fast. Feeds from .04" to .87" per turn of table. Machine complete with countershaft, crane attachment with chain-sling and hooks, arranged to stop automatically at top or bottom of stroke. Slide-rest for facing hubs and gauge for length. Sample boring-bar, 3½" in diameter, with sample set of improved double cutters. Set of wrought-iron wrenches. Two sets of fast and loose pulleys on countershaft. 24" by 4" pulleys, 134 revolutions per minute; 18" by 6" pulleys, 290 revolutions per minute.

PLATE No. 54.

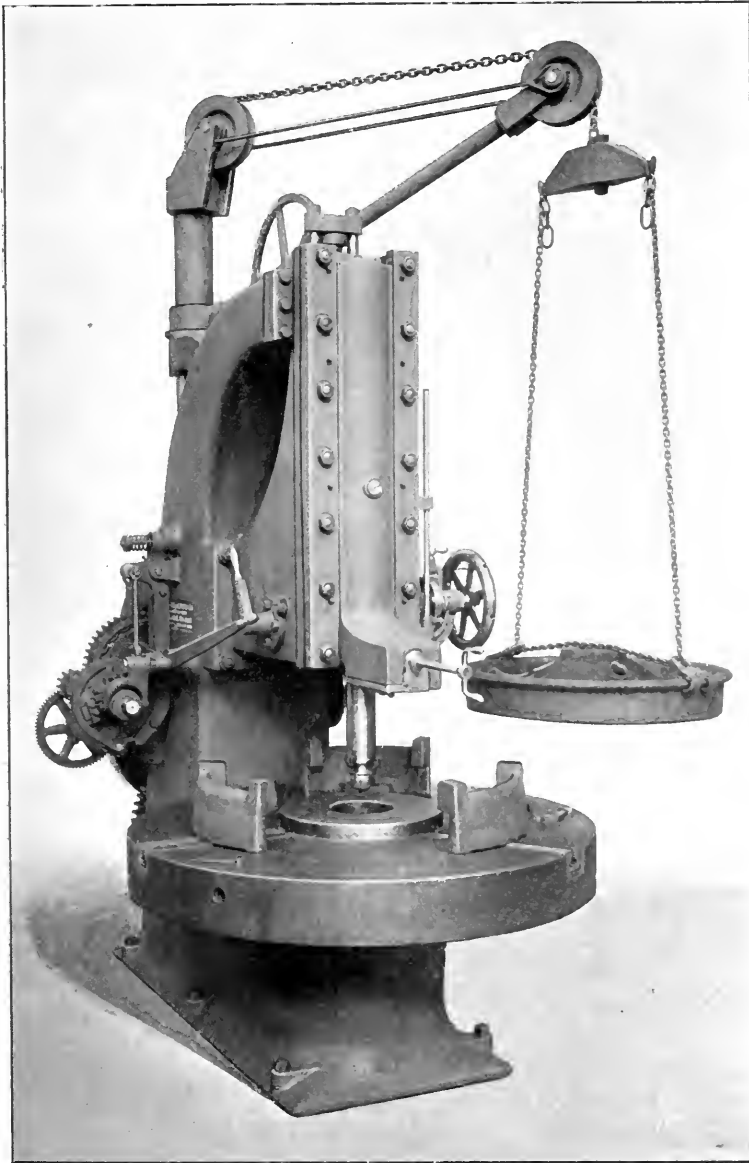

54" CAR-WHEEL BORING-MILL.

With self-closing and self-centering chuck for wheels up to 48" diameter. Opens and closes on stopping and starting machine. Table stopped and started instantly by lever without moving belt shifter. Table 54" diameter. Improved disc feed, with automatic hold-fast for adjusting lever; improved crane device, with automatic stop top and bottom of stroke; all hoisting mechanism on outside of machine and easily accessible; slide rest for facing hubs and gauge for length; sample boring-bar $3\frac{1}{2}$ " diameter, with set of improved double cutters giving four cutting surfaces. May be furnished with or without crane attachment, chain slings and hooks; countershaft has 2 sets of fast and loose pulleys; $34'' \times 4''$, 134 revolutions per minute, and $18'' \times 6''$, 290 revolutions per minute. Full set of wrenches and steel chuck-jaws for full range of work, furnished with machine.

PLATE No. 55.

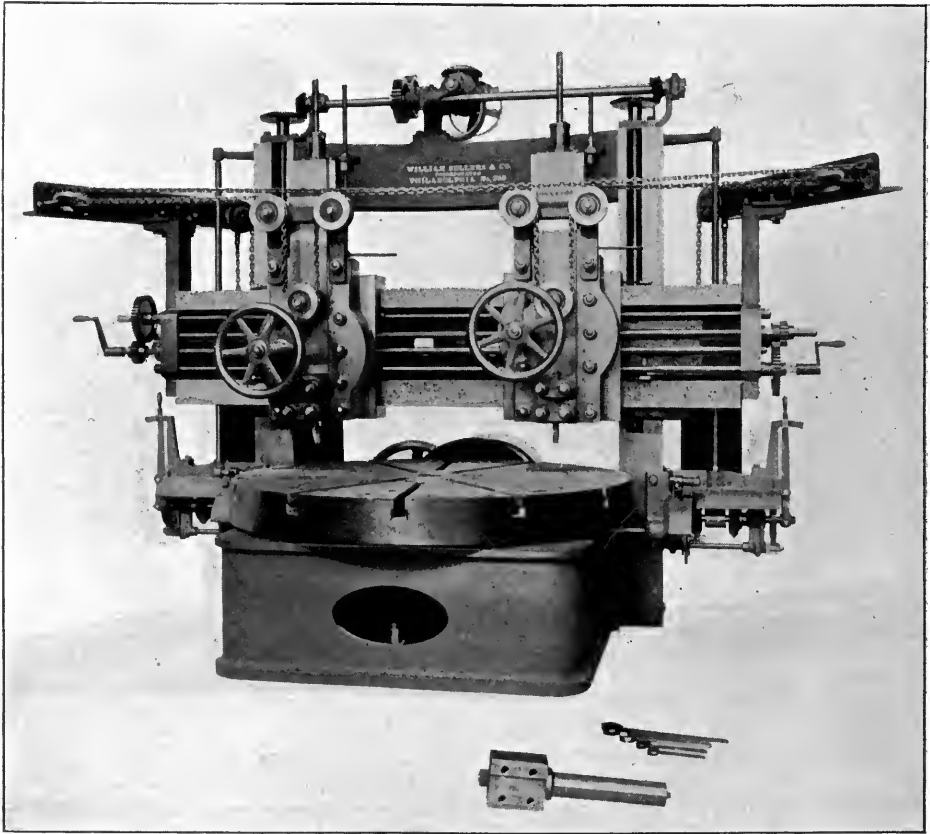

5-FOOT BORING AND TURNING MILL—WITH TWO SADDLES.

Independent feeds for both saddles; table 60" diameter. Table has flat bearings, adjustable step and centre spindle. Power-feeds variable by improved friction disc arrangement through wide range. Self-contained counterbalance with independent weight for each slide. Power vertical feed by screw with opening nut, stroke 22". Hand vertical feed by rack and pinion. Quick acting clutches to engage and disengage feed instantly. Deep cross-head, with long bearings on uprights, raised or lowered by power. Complete with countershaft, cranks, wrenches, boring-bar holder and sample boring-bar.

No part of machine projects below floor except adjusting lever for step, which extends 5" into pit which should be provided for chips.

NOTE.—Made also with one saddle only.

PLATE No. 56.

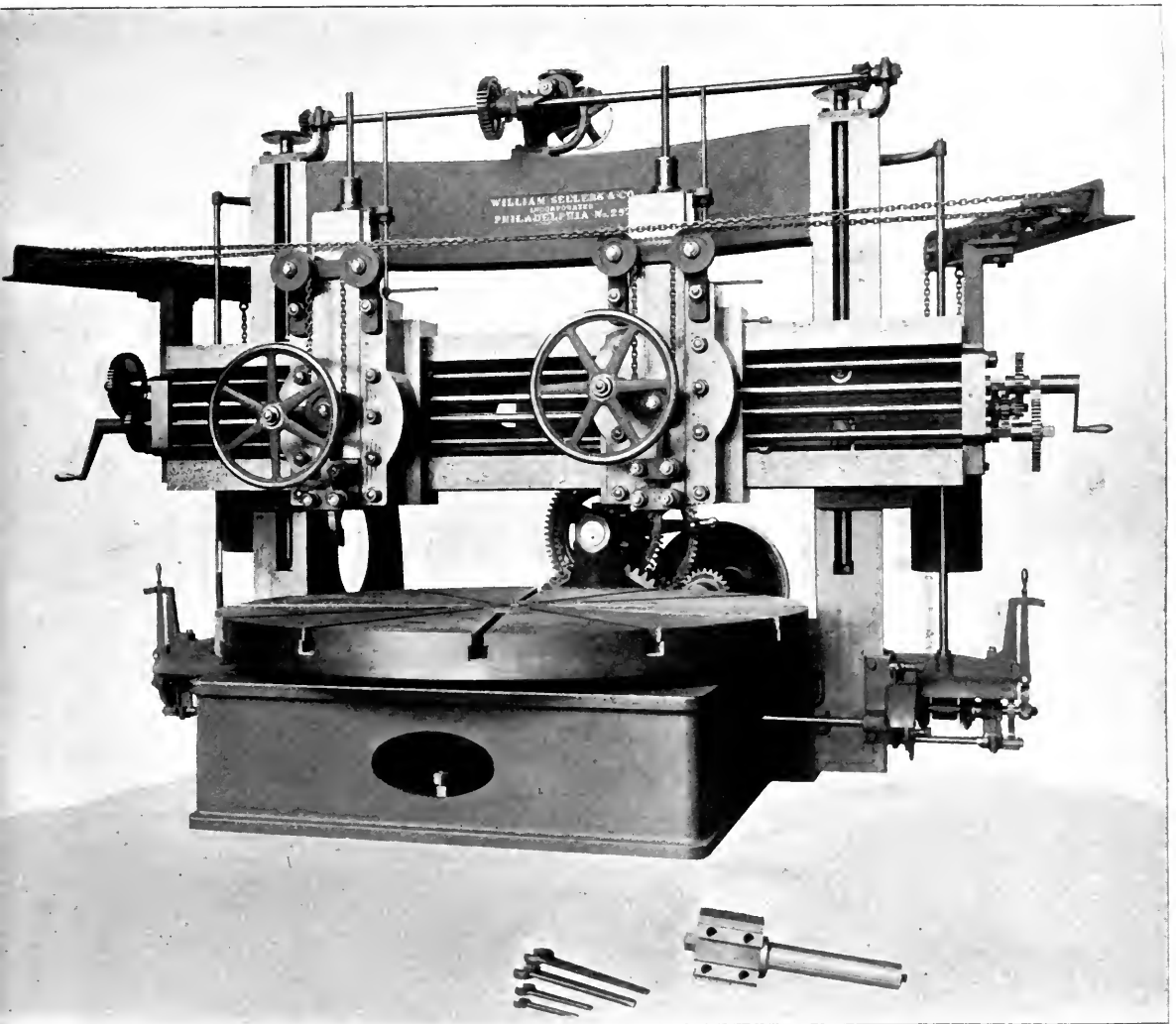

7-FOOT BORING AND TURNING MILL,—WITH TWO SADDLES.

Independent feed for both saddles; table 80" diameter. triple-gear'd with 15 different speeds; has flat ring-bearing, adjustable step and center spindle; power feed by improved friction feed variable through wide range; self-contained counterbalance with independent weights for each slide; extra deep cross-head with heavy bearing for uprights; power feed by screws, quick vertical hand feed by rack and pinion: usual stroke 22"; cross-head raised and lowered by power; no part of machine extends below floor line except adjusting lever for step and no separate foundations are required for any parts; complete with countershaft; cranks, wrenches, boring-bar holder and sample boring-bar. Fast and loose pulleys 22" x 5", 200 revolutions per minute.

Made also with only one saddle. Usual table 72" diameter. Made also with high uprights, giving 72" under cross-head and 36" stroke of slide.

PLATE No. 57.

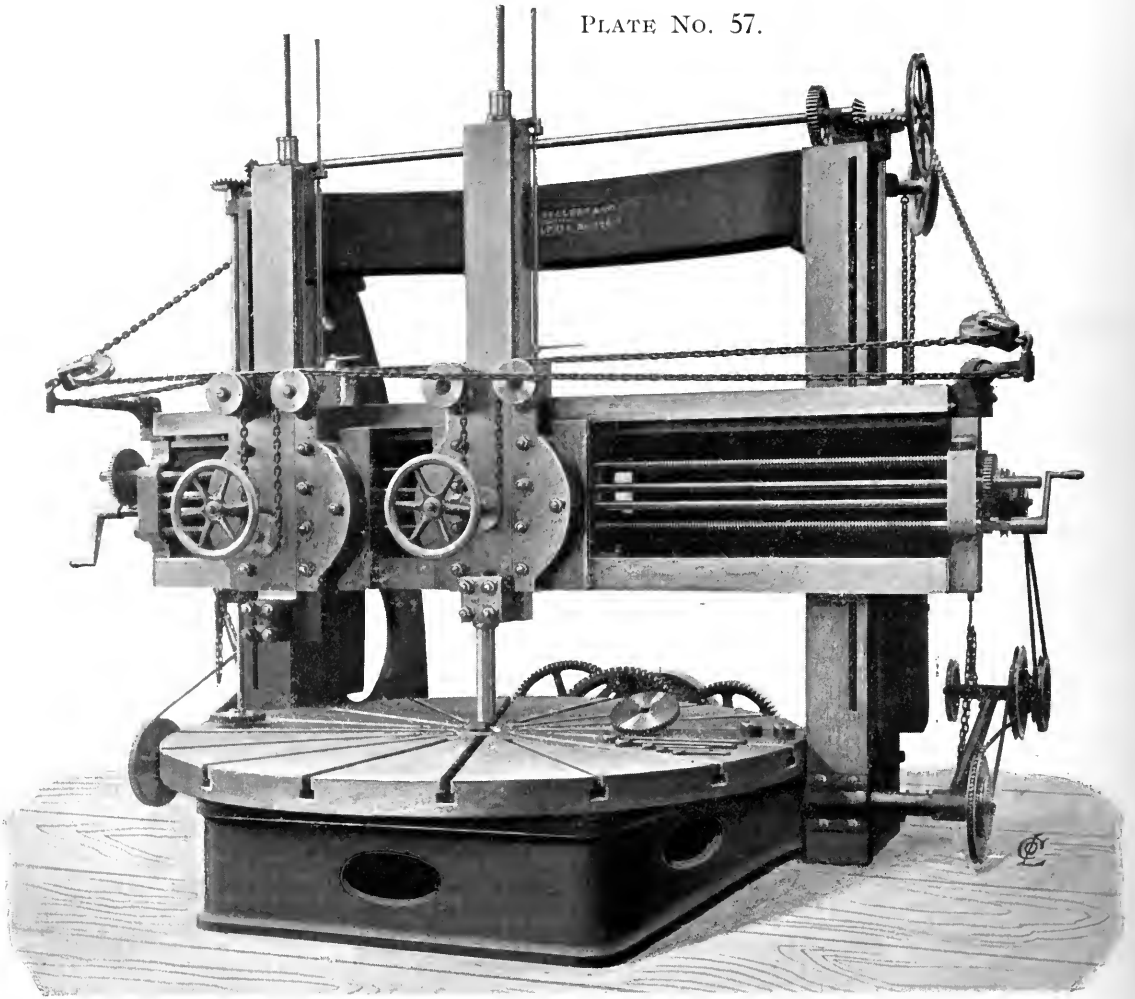

8-FOOT BORING AND TURNING MILL.

With centre spindle, flat bearing and triple driving-gear. Extra heavy cross-head with two saddles; independent feed for each saddle. Table, 96" diameter. Maximum height under cross-head, 55". Steel vertical slides with 48" stroke. Complete with set of wrenches, countershaft, and sample boring-bar. Feeds variable from .02" to .42" per revolution of table. Speed of 22" by 5", fast and loose pulleys on countershaft, 100 rotations per minute. Power lifting device for cross-head. Independent counterweights for slides. No separate foundations required.

Made also with friction feed motion variable from $\frac{1}{4}$ " to $\frac{3}{8}$ " per turn of table. Made also with short uprights, giving 47" under cross-head, and 22" vertical stroke.

PLATE NO. 58.

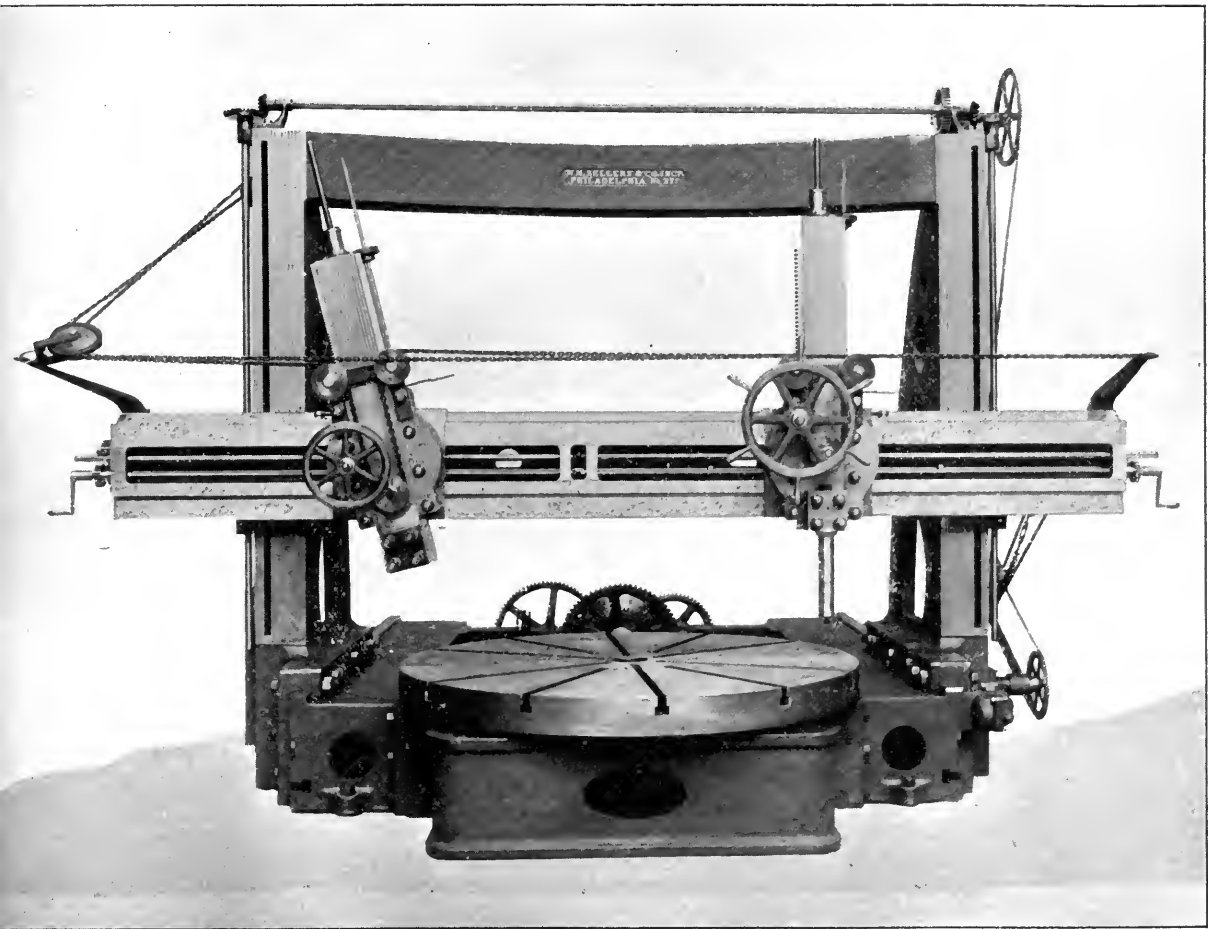

10-FOOT BORING AND TURNING MILL—WITH TWO SADDLES.

Uprights adjustable by power to swing 16 ft. diameter. Steel slide, stroke, 36". Table, 80" diameter with flat bearing and centre spindle. Mill triple geared and self-contained; no separate foundations required. Hand power slotting or key-seating attachment on one saddle. Height under cross-head, 75". Cross-head raised and lowered by power. Complete with countershaft, wrenches, boring-bar holder and sample boring-bar. Made also with independent friction feeds. Made also with fixed uprights, not adjustable on bed. Can be made with 96" table if required.

Our 12-foot mill of this type will take 74" under cross-head, has 36" stroke and 80" or 96" table.

PLATE No. 59.

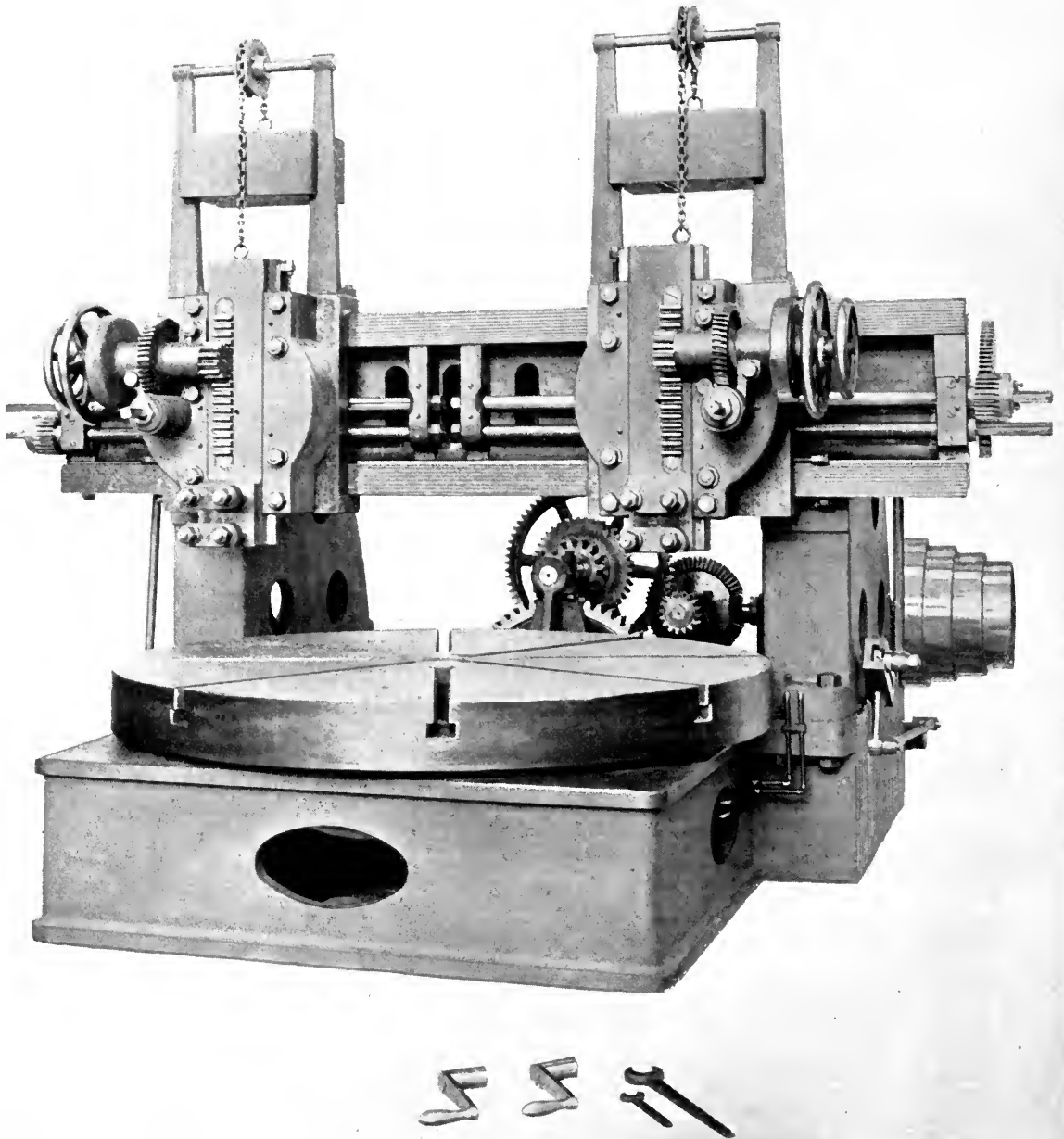

6-FOOT BORING AND TURNING MILL—FOR STEEL RAILWAY TIRES.

Extra heavy, powerfully geared mill for special work; table 72" diameter, cross-head fixed at 18½" above table; two saddles with independent adjustable ratchet feed; vertical stroke 14" four speed cones and two countershaft speeds make 16 speeds of table; mill self-contained; no part projects below floor line and no independent foundations required; complete with countershaft, wrenches and cranks; fast and loose pulleys 16" diameter, 4" belt, making 195 and 218 revolutions per minute respectively. Feeds adjustable from $\frac{1}{16}$ " to $\frac{3}{8}$ " per turn of table.

PLATE NO. 60.

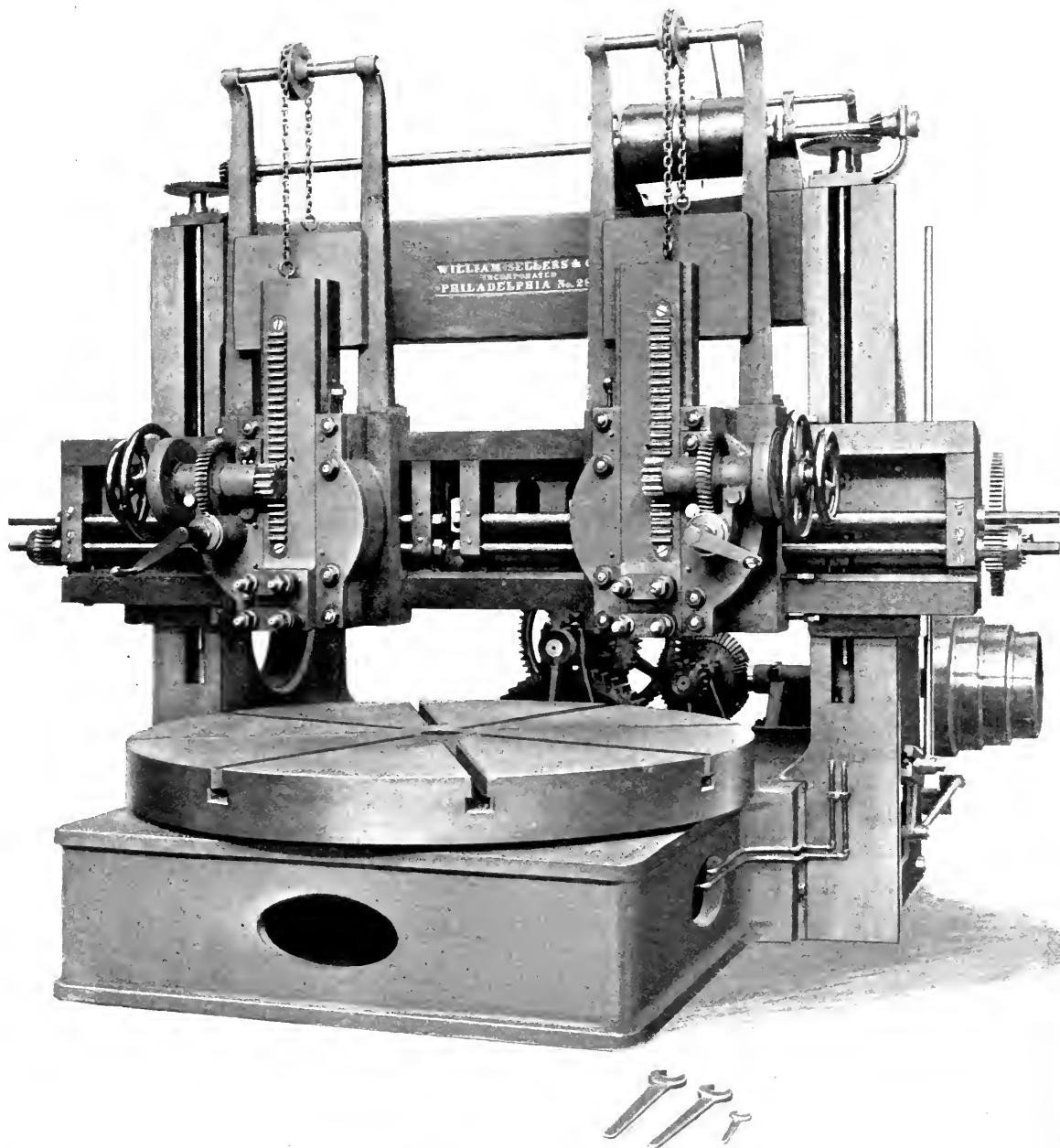

7-FOOT BORING AND TURNING MACHINE—FOR STEEL RAILWAY TIRES, ETC.

Extra heavy, powerfully geared mill for tires and other heavy steel work. Table 72" diameter, maximum height under adjustable saddle 42"; two saddles with independent variable ratchet feed; vertical stroke 23"; cross-head raised and lowered by power; feed variable by $\frac{1}{16}$ " to $\frac{3}{8}$ "; self-contained, no independent foundation required; complete with countershaft, cranks and wrenches. Fast and loose pulleys 16" diameter, 4" belt, 195 revolutions per minute and 218 revolutions per minute respectively, giving 16 distinct table speeds.

PLATE No. 61.

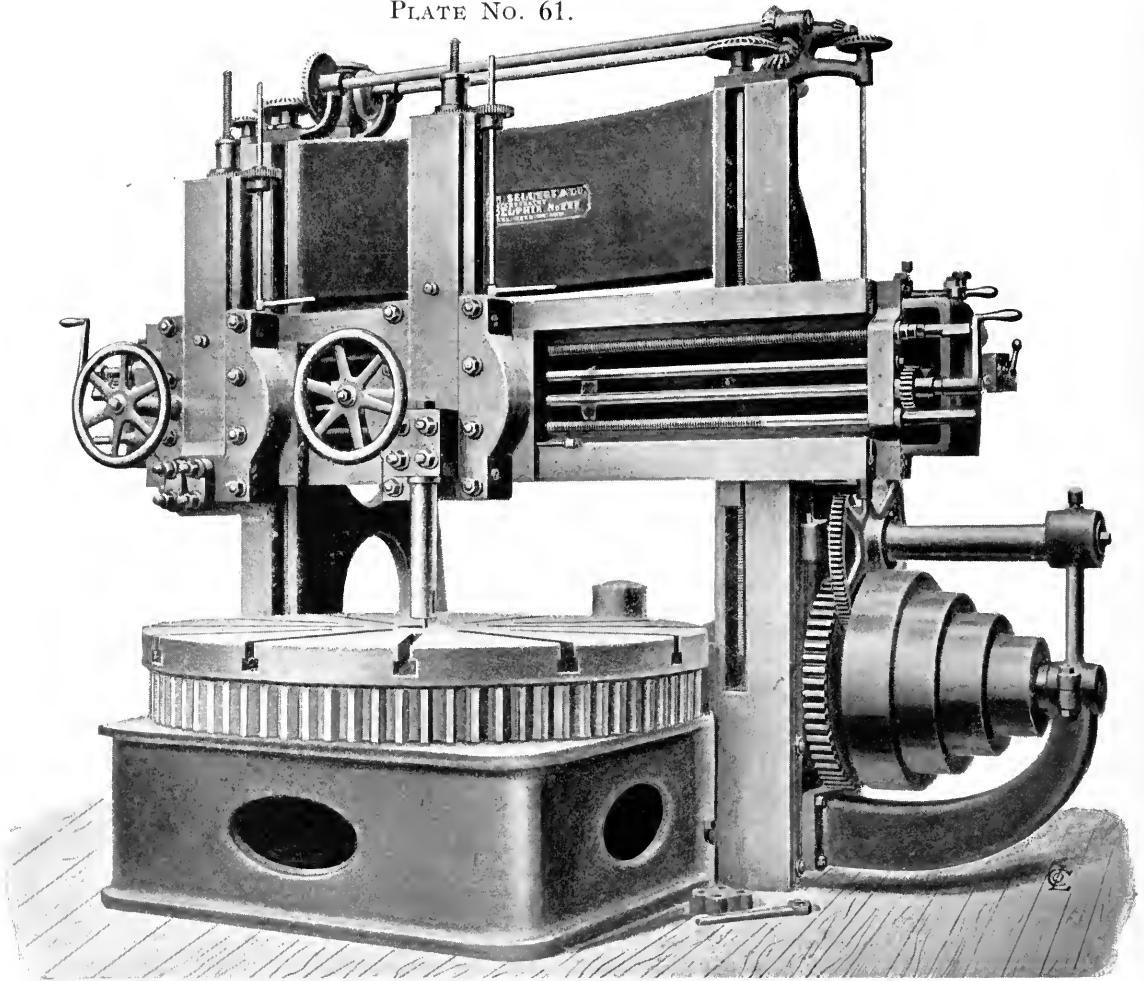

EXTRA HEAVY 5-FOOT MILL—DESIGNED FOR STEEL WORK.

Diameter of table, 61". Height under cross-head in highest position, 36". Steel vertical slides, having 22" stroke. Two saddles on cross-head with independent feed-motions, operated by feeding mechanism at each end of the cross-head. Feed mechanism and driving-gear provided with safety devices. Cross-head lifted by power. Spur driving-gear for table, all cut teeth. Feeds adjustable from .01" to 1" per turn of table. Largest lift of cone-pulley, 24" and 4" face. Wrenches, sample boring-bar, overhead countershaft, and counterbalances for vertical slides. 20" by 5" fast and loose pulleys on countershaft. Should make 110 revolutions per minute. Self-contained; no separate foundation required for step or other parts.

PLATE No. 62.

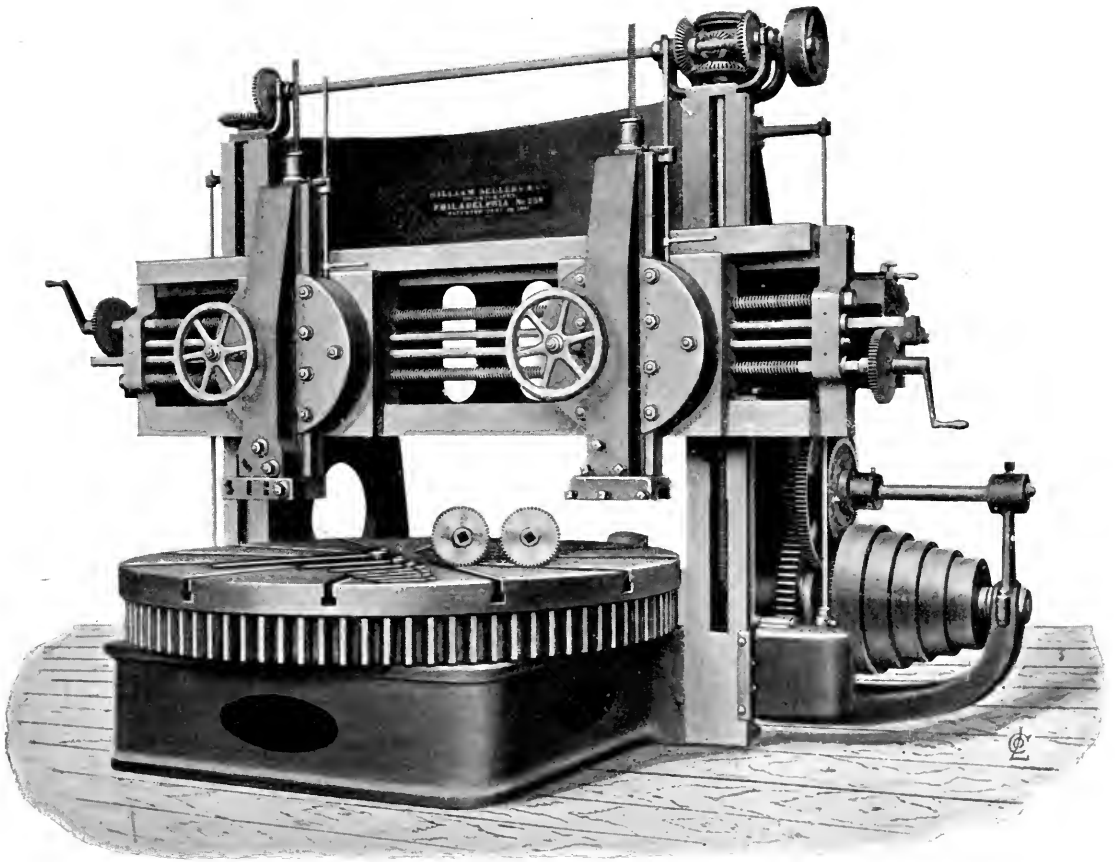

EXTRA HEAVY 7-FOOT BORING MILL—WITH TRIPLE GEARING.

This machine is designed especially for very heavy work in steel, such as locomotive tires. Table, 84" diameter. Height under cross-head in highest position, 39". Depth of cross-head bar, $30\frac{3}{8}$ ". Steel vertical slides of stroke of $26\frac{1}{2}$ ", with special detachable tool-holders, designed for tire and ring work. Cross-head raised and lowered by power. Two saddles, having independent feed-motions, operated from mechanism at both ends of cross-head. Feed mechanism and driving-gear provided with safety devices to prevent breakage by overloading gearing. Cone-pulley has five lifts, and there are two changes of gearing, making 15 distinct speeds. Spur-gearing for table is all cut. Wrenches, complete overhead countershaft and hangers. Speed of countershaft should be 280 revolutions per minute. Fast and loose pulleys on countershaft, 22" diameter, 5" face. *Made also with plain tool-holders and boring-bar.* No separate foundation required for step or other parts.

PLATE NO. 63.

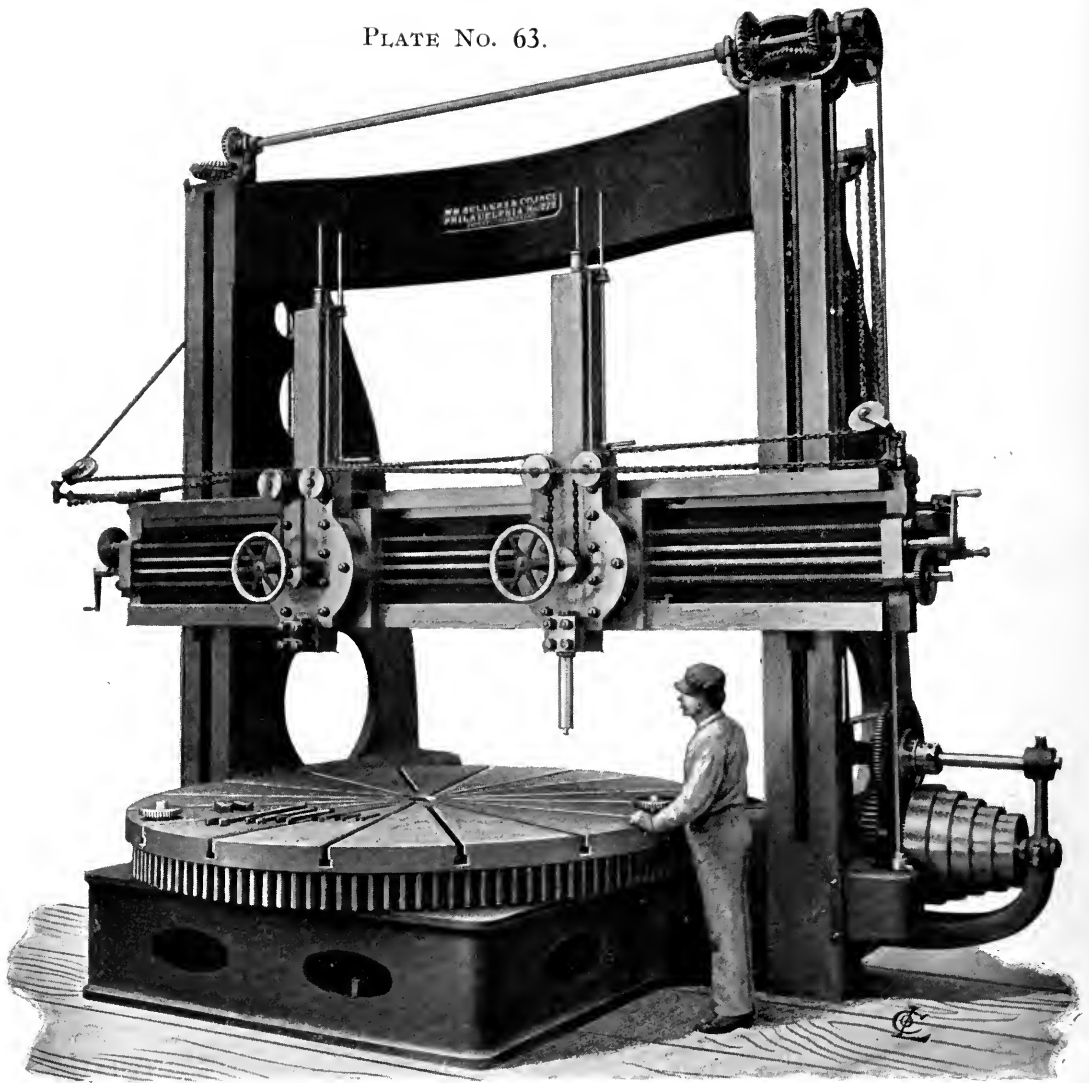

12-FOOT BORING AND TURNING MILL—WITH TWO SADDLES.

Table, 10 ft. diameter. Height under cross-head, 9 ft. $6\frac{3}{4}$ ". Steel vertical slides, 4 ft. stroke. Independent friction feeds of great range. Safety devices in feed and driving gear. Power-lifting device for cross-head have improved friction device. Spur-gear table, all gears cut, pinions of steel. Adjustable centre step, flat bearings and massive spindle. No projection below floor except adjusting lever for spindle step. No separate foundations. Fast and loose pulleys, 22" by 5". 250 revolutions per minute.

NOTE—We are prepared to furnish larger mills of this and other styles.

PLATE No. 64.

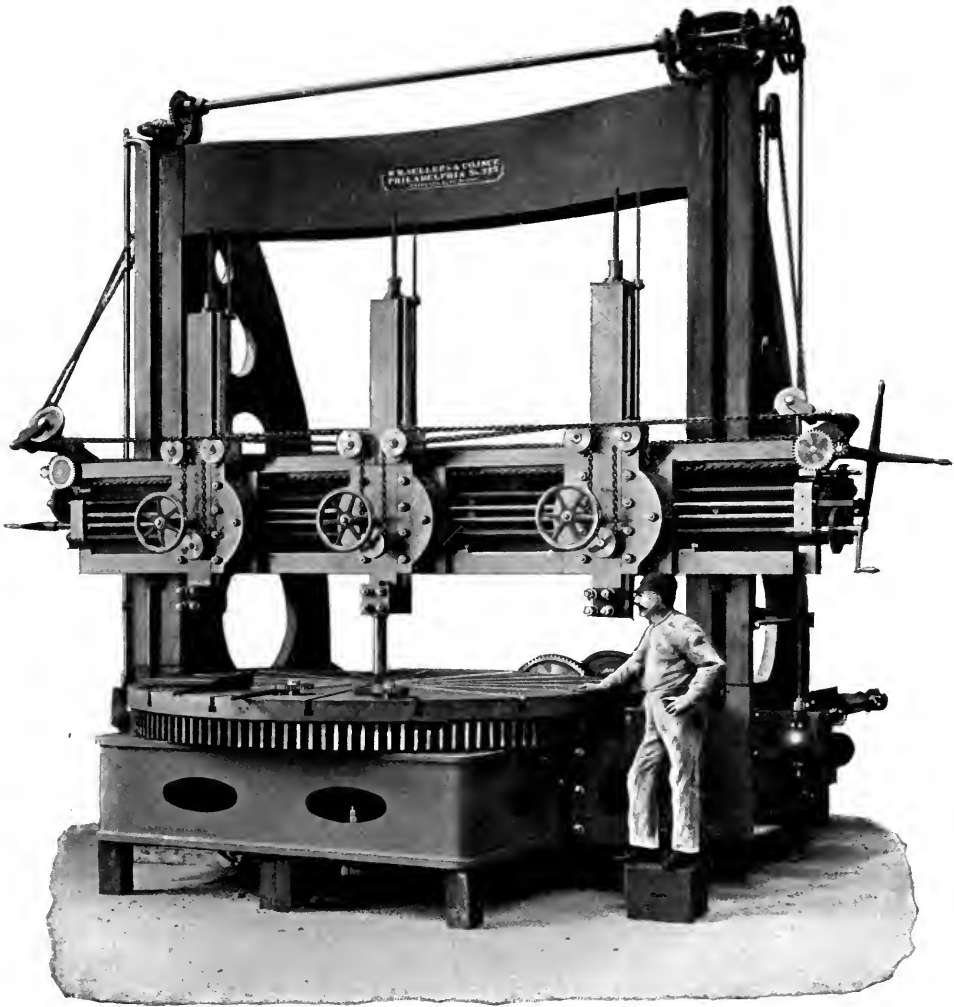

12-FOOT BORING AND TURNING MILL—WITH THREE SADDLES.

Uprights arranged to slide back by power, to turn 16 ft. diameter. Table, 10 ft. diameter. Height under cross-head, 9 ft. 6 $\frac{3}{4}$ ". Steel vertical slides, 4 ft. stroke. Independent feeds of great range. Safety devices in feed and driving-gear. Power lifting gear for cross-head. Pulleys, 22" by 5". 250 revolutions per minute. Quick hand traverse for saddles on cross-head.

Turning and Screw-Cutting Lathes.

IN designing our lathes it has been our object to obtain power, strength, accuracy and durability coupled with great convenience of operation. We have not hesitated to depart from ordinary practice or our own preconceived ideas whenever we thought we could obtain a better construction. We early adopted the "flat" lathe bed because of its manifest advantages, and we think we now know how to correct the real faults of the flat bed as formerly made by us and now by others.

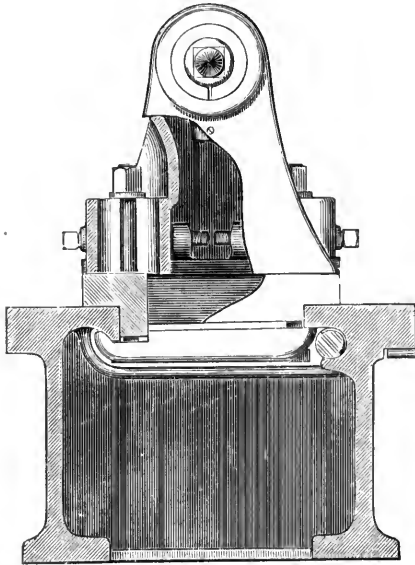

We make vertical guiding surfaces which permit wear on top of bed without affecting alignment or fit of saddle. Our under "V" for the poppet head clamp insures correct alignment of centres, and yet permits free fitting of head. Frequent flanged cross ribs or girts tie our lathe beds effectually; the planed trough supports the lead screw throughout, and the overhanging flanges protect it from dirt and chips. The flat shear permits an increased swing over the rest; a decreased weight of carriage, a greatly extended surface to take wear and insures long service without replaning. We assume four "girts" beyond the livehead as our *shortest length*, and this may be increased to any extent desired by adding the requisite number of girts, the length for each size being set forth in the table below:

Swing over Bed.	Maximum Swing over Slide Rest	SHORTEST LENGTH.		Girts Beyond Live Head.	Distance Between Girt Centres.
		Distance between Centres.	Length of Bed.		
12''	8 $\frac{3}{8}$ ''	2 ft. 4''	4 ft. 7 $\frac{3}{4}$ ''	4	10''
16''	11 $\frac{3}{4}$ ''	3 ft.	5 ft. 10 $\frac{1}{4}$ ''	4	13''
20''	15 $\frac{1}{4}$ ''	3 ft. 3 $\frac{1}{2}$ ''	7 ft 4''	4	16 $\frac{1}{4}$ ''
25''	19 $\frac{1}{4}$ ''	4 ft. 6 $\frac{3}{4}$ ''	9 ft. 1''	4	20 $\frac{1}{2}$ ''
30''	23 $\frac{1}{2}$ ''	5 ft. 5 $\frac{1}{2}$ ''	10 ft. 8 $\frac{3}{8}$ ''	4	24 $\frac{1}{8}$ ''
36''	28''	6 ft. 3 $\frac{1}{2}$ ''	12 ft. 10 $\frac{1}{2}$ ''	4	29''
42''	34 $\frac{1}{2}$ ''	7 ft. 10''	17 ft. 3''	4	33 $\frac{3}{4}$ ''
48''	38 $\frac{1}{2}$ ''	8 ft. 10''	17 ft. 3''	4	38 $\frac{1}{2}$ ''

PLATE NO. 65,

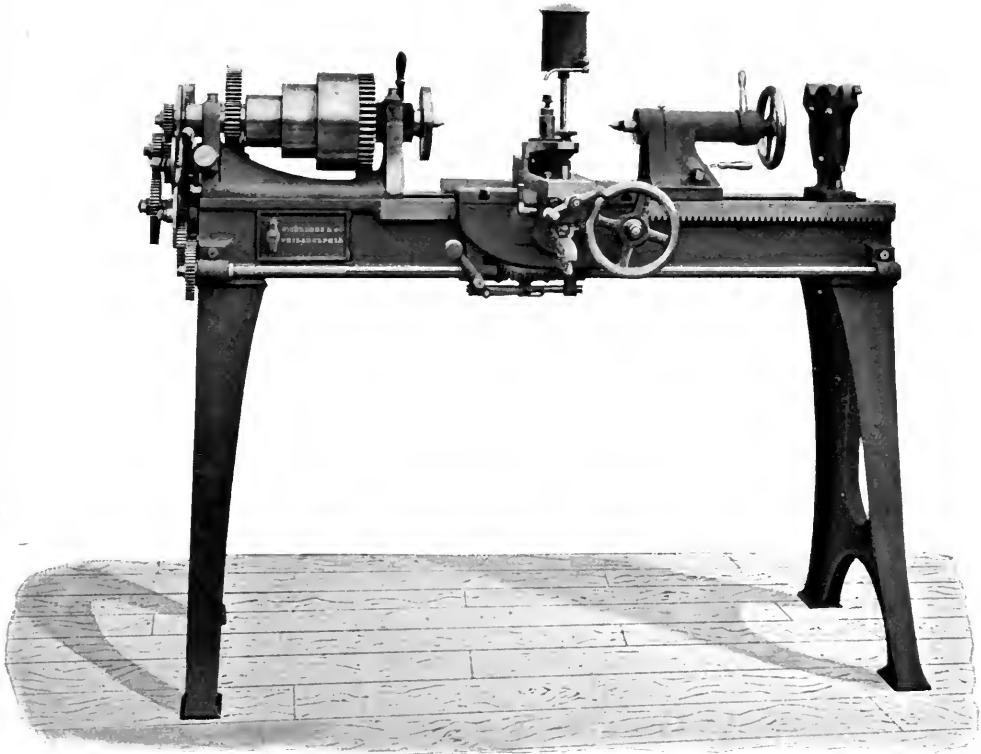

12" PATENT SELF-ACTING SLIDE-LATHE.

TURNING AND SCREW-CUTTING FEEDS.

Flat-top shear, with vertical guiding surfaces. Poppet-head lined by under V clamp; concentric hold-fast for poppet spindle, clamping spindle at both ends of bearing. Independent screw-cutting and turning-feeds, instantly changeable from one to the other when both are in gear with spindle. Longitudinal feed and screw-cutting feed cannot be engaged at the same time. Turning-feed stopped and started instantly by positive clutch; direction of turning-feed controlled by lever on saddle. Lead screw, used for screw-cutting only, supported throughout its entire length and protected from chips. Maximum swing over bed, 12"; over slide-rest, $8\frac{5}{8}$ " diameter. Improved friction discs, giving instantly any feed required between limits. Complete with countershaft, wrenches, full set of change gears, water-can, and steady-rest. Countershaft pulleys, 8" diameter for 3" open and cross belts, should make 160 and 320 turns per minute. Follow-rest and taper attachments, if required, extra.

Turning and Screw-Cutting Lathes.—(Continued.)

As lathes are increased in length, we add extra legs and "drop" bearings for the feed rod as required; the manner in which the screw is supported relieves it from sag whether it be long or short.

LIVEHEAD.

To produce true work in a lathe, it is of the first importance that the spindle shall be true, and we spare no pains in manufacture to produce this result. Our spindles are turned and ground with scrupulous care, and carefully fitted to the composition boxes of hard bronze. The front bearing is a plain cylindrical surface; the back-bearing is slightly conical, carried in a solid bearing of bronze. To prevent end motion of the spindle, we secure to the spindle back of the back-bearing a carefully-made ring or collar of hardened steel. This collar is confined between a hardened steel thrust collar back of it and the back end of the back-bearing in front of it, and all these parts are enclosed in a tight cast-iron tail-block, which serves as an oil-well to insure constant and perfect lubrication. The surfaces which confine the revolving collar front and back of it are so adjusted as to allow perfect freedom of rotary motion, but no perceptible end motion. The securing of the spindle endways is confined to the thickness of one collar only, and this is enclosed in so large a mass of cast-iron as to insure a uniform temperature in all its parts; thus there is no liability to stick or jam, while the expansion of the spindle endways from this collar, if there is any expansion in excess of the head, is allowed for in freedom of end motion in the front journal, which is a little longer than the front bearing in which it runs. In turning work between centres the thrust is taken against the thrust collar back of the fixed collar on the spindle, while in turning chucked work the spindle is held in place endways by the confinement of the one fixed collar on the spindle between the fixed back-thrust and the back end of the back-bearing. With this arrangement of the spindle the change from one kind of turning to another requires no thought to be given to any adjustment of the spindle, to be ready for the changed condition of pressure, as is the case with lathes of ordinary construction. Our back gear is conveniently shifted, and gears and cones are so proportioned as to produce a series of speeds in geometric proportion without overlapping or irregularity. The lead screw is used for screw-cutting only, and therefore retains its accuracy much longer than when it is used for all purposes. The turning feeds are controlled through our improved friction disc feed, giving a wide range of feeds with any variation desired between the extremes.

PLATE NO. 66.

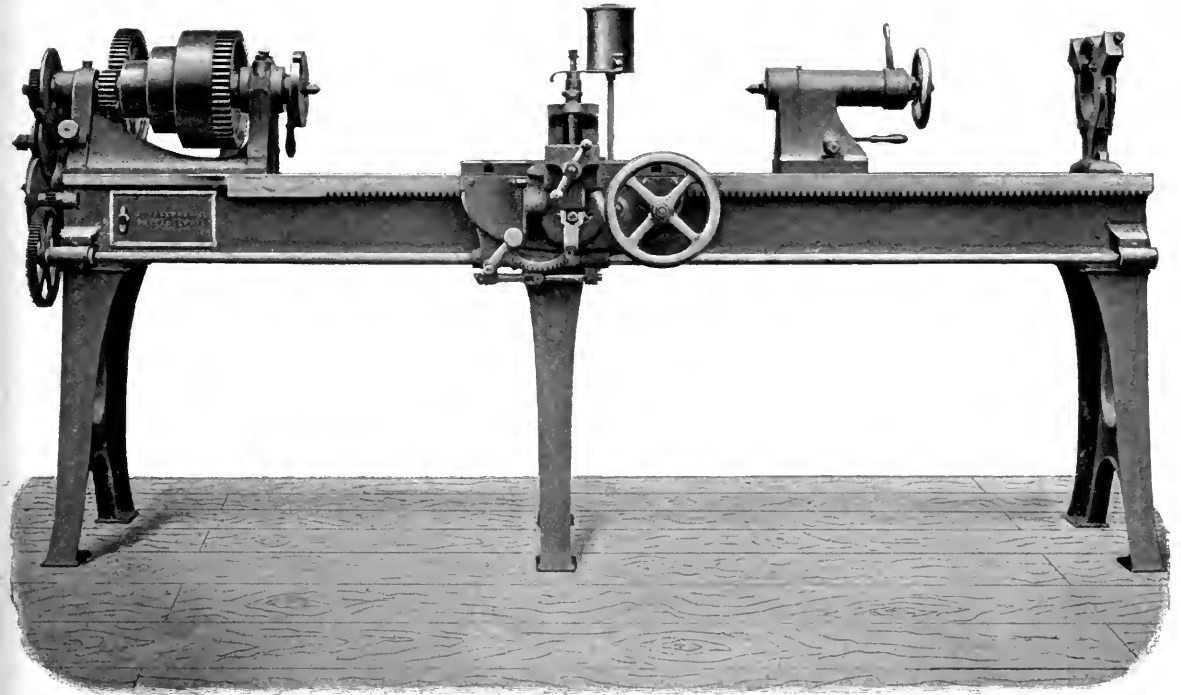

16" SELF-ACTING SLIDE-LATHE—TURNING AND SCREW-CUTTING FEEDS.

Flat-top shear, with vertical guiding surfaces. Poppet-head lined by under V clamp. Concentric hold-fast for poppet-spindle, clamping spindle at both ends of bearing. Independent screw-cutting and turning-feeds, instantly changeable from one to the other, when both are in gear with spindle. Longitudinal feed and screw-cutting feed cannot be engaged at the same time. Turning-feed stopped and started instantly by positive clutch. Direction of turning-feed controlled by lever on saddle. Compound swivelling slide-rest with power cross-feed. Lead screw, used for screw-cutting only, supported throughout its entire length, and protected from chips. Maximum swing over bed, 16". Over slide-rest, 11 $\frac{3}{4}$ " diameter. Improved friction discs, giving instantly any feed required between limits. Largest lift of cone-pulley, 11". Width of belt, 2 $\frac{1}{2}$ ". Complete with countershaft, wrenches, full set of change gears, water-can, extra face-plate, and steady-rest. Countershaft pulleys, 9" diameter for 3" open and cross belts, and should make 145 and 290 revolutions per minute. *Follow-rest and taper attachments, if required, extra.*

Turning and Screw-Cutting Lathes.—(Continued.)

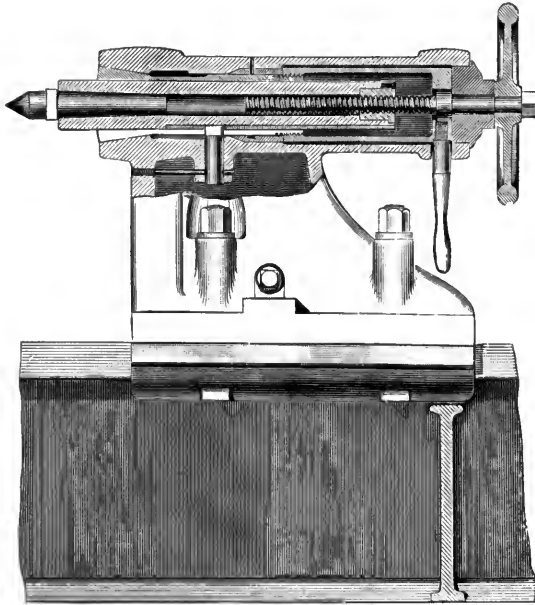

POPPET HEAD OR TAIL STOCK.

We would call especial attention to our concentric hold-fast for the spindle which secures it at two points without displacement of its axial direction while it allows the utmost freedom of movement when unclamped. The upper part is adjustable sidewise for taper turning if desired, without danger of disturbing the parallelism of the spindle. The clamp fitting the under V in the bed insures absolute alignment, and yet allows easy fitting between the sides of the bed.

THE SADDLE AND SLIDE REST.

Except in the 12" size, the saddles are "compound" with a power cross-feed to the lower slide. The turning feed is changed in direction by reversing a lever in the bottom of the apron, while a second lever, conveniently situated, is used to throw in or out either of the turning feeds. This is interlocked with the screw-cutting feed in such a manner that the long feed and the screw-cutting gear can not be thrown in at the same time. The nut for the lead screw is arranged to slide in bearings, and is engaged by an eccentric operated by a short lever. The feed clutch is positive not frictional, and is instantly withdrawn without danger of sticking. It will be noticed that the location of the lead screw, almost directly under the cutting tool and between the bearings of the carriage, enables it to oppose the tool thrust directly and with little tendency to twist the saddle, hence we find that our lathes may be used for coarser pitches than can be cut in lathes with an outside screw.

The foregoing description applies with exactness only to our regular "Engine" lathes between 12" and 48" swing; our larger lathes and the various special lathes we make are more or less modified in details, to suit various conditions and requirements.

PLATE No. 67.

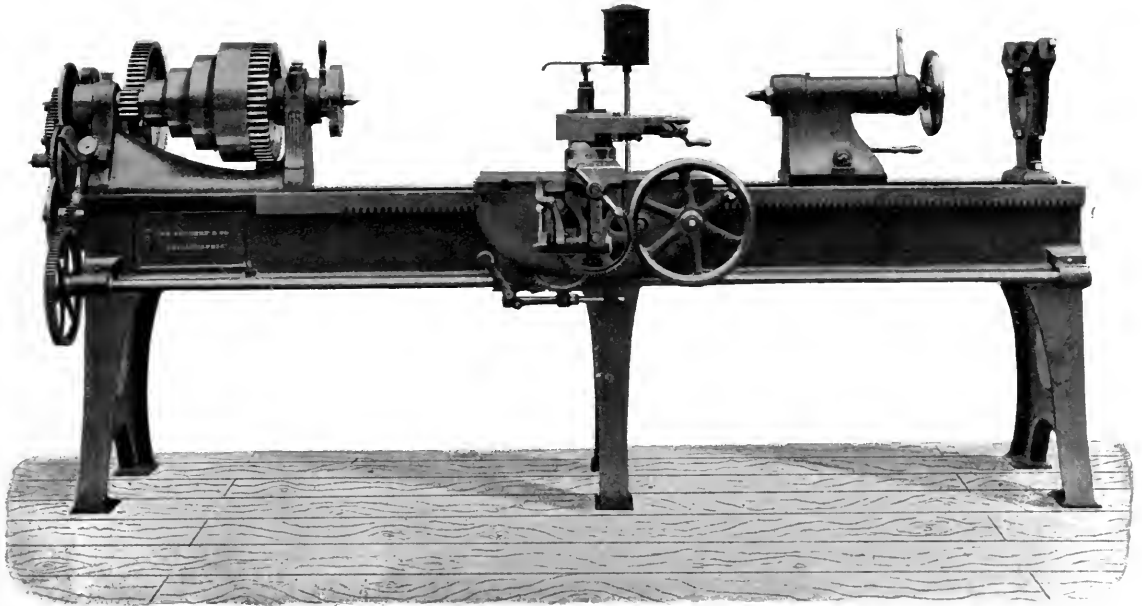

20" SELF-ACTING SLIDE-LATHE—TURNING AND SCREW-CUTTING FEEDS.

Flat-top shear, with vertical guiding surfaces. Poppet-head lined by under V clamp. Concentric hold-fast for poppet spindle, clamping spindle at both ends of bearing. Independent screw-cutting and turning-feeds, instantly changeable from one to the other when both are in gear with spindle. Longitudinal feed and screw-cutting feed cannot be engaged at the same time. Turning-feed stopped and started instantly by positive clutch. Direction of turning-feed controlled by lever on saddle. Compound swivelling slide-rest with power cross-feed. Lead screw used for screw-cutting only, supported through its entire length, and protected from chips. Maximum swing over bed, 20"; over slide-rest, 15½" diameter. Improved friction discs, giving instantly any feed required between limits. Largest lift of cone-pulley, 13". Width of belt, 2½". Complete with countershaft, wrenches, full set of change-gears, water-can, extra face-plate, and steady-rest. Countershaft pulleys, 10" diameter, for 3" open and cross-belts, and should make 112 and 224 revolutions per minute. *Follow-rest and taper attachments*, if required, extra.

PLATE No. 68.

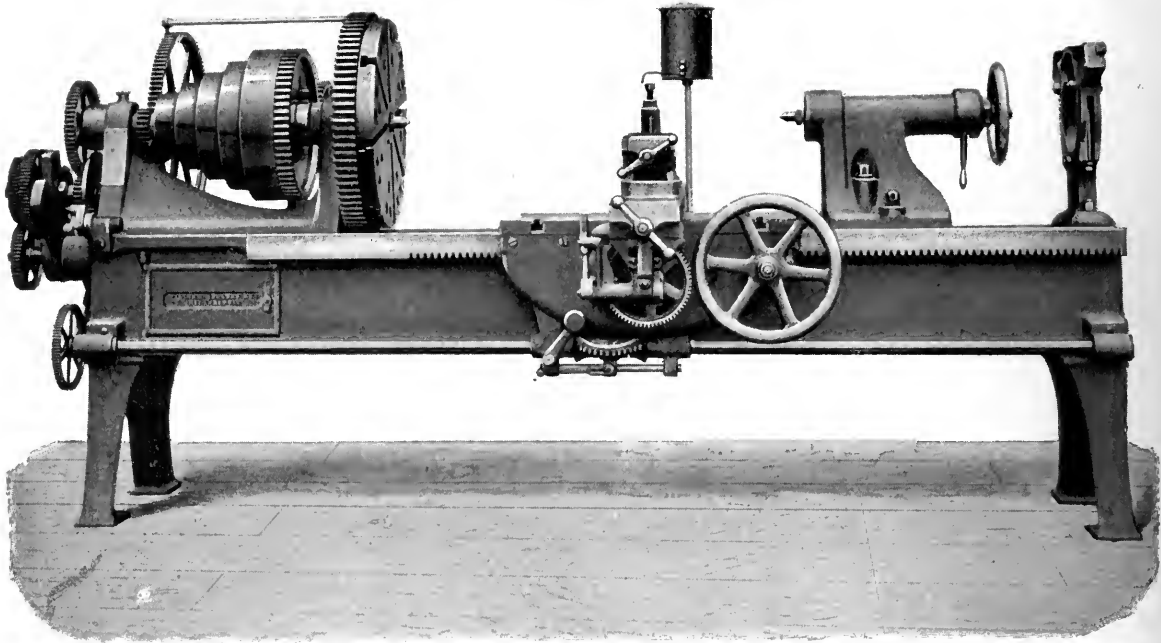

26" LATHE.—TRIPLE-GEARED, TURNING AND SCREW-CUTTING FEEDS.

Flat-top shear, with vertical guiding surfaces. Poppet-head lined by under V clamp. Concentric hold-fast for poppet-spindle at both ends of bearing. Independent screw-cutting and turning feeds, instantly changeable from one to the other, when both are in gear with spindle. Longitudinal feed and screw-cutting feed cannot be engaged at the same time. Turning-feed stopped and started instantly by positive clutch. Direction of turning-feed controlled by lever on saddle. Compound swivelling slide-rest, with power cross-feed. Lead screw, used for screw-cutting only, supported throughout its entire length, and protected from chips. Maximum swing over bed, 25"; over slide-rest, 19 $\frac{1}{4}$ " diameter. Improved friction discs, giving instantly any feed required between limits. Largest lift of cone pulley, 17". Width of belt, 2 $\frac{1}{2}$ ". Complete with counter-shaft, wrenches, full set of change gears, water-can, and steady-rest. Counter-shaft pulleys 14" diameter for 3 $\frac{1}{2}$ " open and cross-belts, and should make 135 and 270 revolutions per minute. *Follow-rest and taper attachments*, if required, extra.

PLATE No. 69.

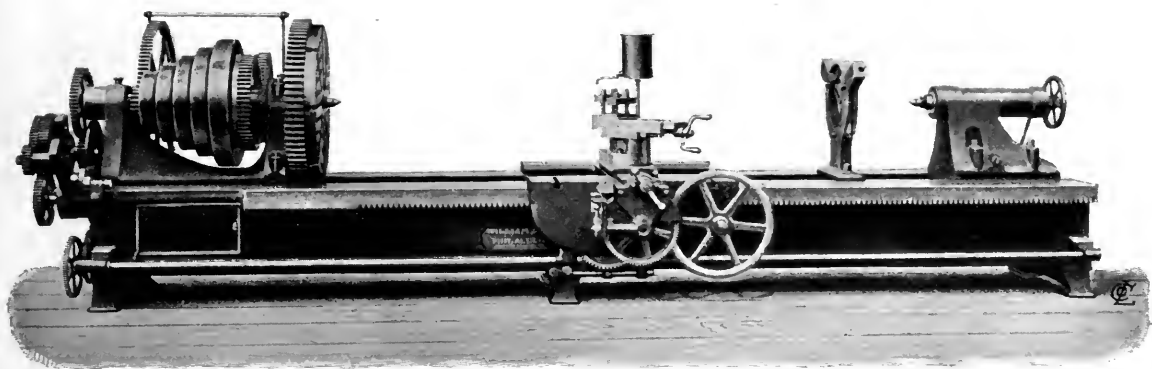

36" LATHE.—TRIPLE-GEARED, TURNING AND SCREW-CUTTING FEEDS.

Flat-top shear, with vertical guiding surfaces. Poppet-head lined by under V clamp. Concentric hold-fast for poppet-spindle at both ends of bearing. Independent screw-cutting and turning feeds, instantly changeable from one to the other, when both are in gear with spindle. Longitudinal feed and screw-cutting feed cannot be engaged at the same time. Turning-feed stopped and started instantly by positive clutch. Direction of turning-feed controlled by lever on saddle. Compound swivelling-rest, with power cross-feed. Lead screw, used for screw-cutting only, supported throughout its length, and protected from chips. Maximum swing over bed, 36", over slide-rest, 28" diameter. Improved friction discs, giving instantly any feed required between limits. Largest lift of cone-pulley, 28". Width of belt, $3\frac{1}{2}$ ". Complete with countershaft, wrenches, full set of change gears, water-can, and steady-rest. Countershaft pulleys, 26" diameter for 4" open and cross-belts, and should make 80 and 160 revolutions per minute. *Follow-rest and taper attachments, if required, extra.*

PLATE No. 70.

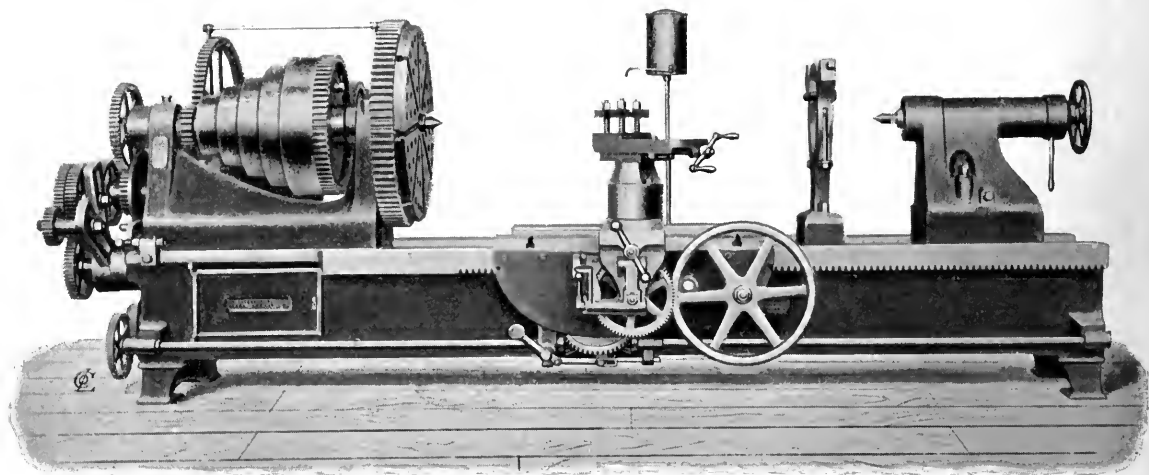

42" LATHE.—TRIPLE-GEARED, TURNING AND SCREW-CUTTING FEEDS.

Flat-top shear, with vertical guiding surfaces. Poppet-head lined by under V clamp. Concentric hold-fast for poppet-spindle, clamping spindle at both ends of bearing. Independent screw-cutting and turning feeds, instantly changeable from one to the other, when both are in gear with spindle. Longitudinal feed and screw-cutting feed cannot be engaged at the same time. Turning-feed stopped and started instantly by positive clutch. Direction of turning-feed controlled by lever on saddle. Compound swivelling slide-rest, with power cross feed. Lead screw, used for screw-cutting only, supported throughout its entire length and protected from chips. Maximum swing over bed, 42" diameter. Improved friction discs, giving instantly any feed required between limits. Largest lift of cone pulley, 28". Width of belt, $3\frac{1}{2}$ ". Complete with countershaft, wrenches, full set of change gears, water-can, and steady-rest. Countershaft pulleys, 26" diameter for 4" open and cross-belts, and should make 80 and 160 revolutions per minute. *Follow-rest and taper attachments, if required, extra.*

PLATE NO. 71.

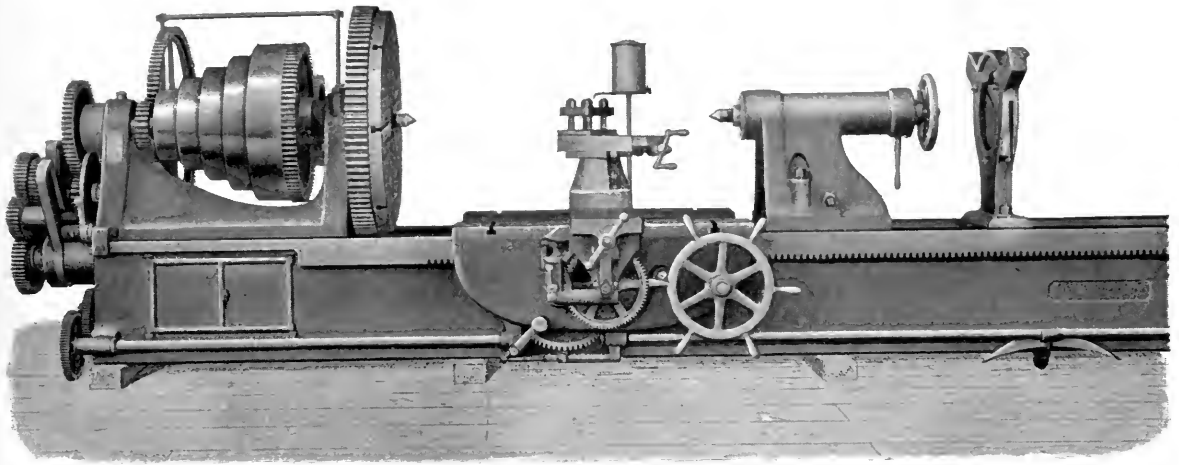

48" LATHE.—TRIPLE-GEARED, TURNING AND SCREW-CUTTING FEEDS.

Flat-top shear, with vertical bearing surfaces. Poppet-head lined by under V clamp. Concentric hold-fast for poppet spindle, clamping spindle at both ends of bearing. Independent screw-cutting and turning-feeds, instantly changeable from one to the other, when both are in gear with spindle. Longitudinal feed and screw-cutting feed cannot be engaged at the same time. Turning-feed stopped and started instantly by positive clutch. Direction of turning-feed controlled by lever on saddle. Compound swivelling slide-rest with power cross-feed. Lead screw, used for screw-cutting only, supported throughout its entire length and protected from chips. Maximum swing over bed, 48". Over slide-rest, 38" diameter. Improved friction discs, giving instantly any feed required between limits. Largest lift of cone-pulley, 32", and width of belt, 5". Complete with countershaft, wrenches, full set of change gears, water-can, and steady-rest. Fast and loose pulleys on countershaft, 26" diameter for 6" open and cross-belts, and should make 90 and 180 revolutions per minute. *Follow-rest and taper attachments*, if required, extra.

PLATE NO. 72

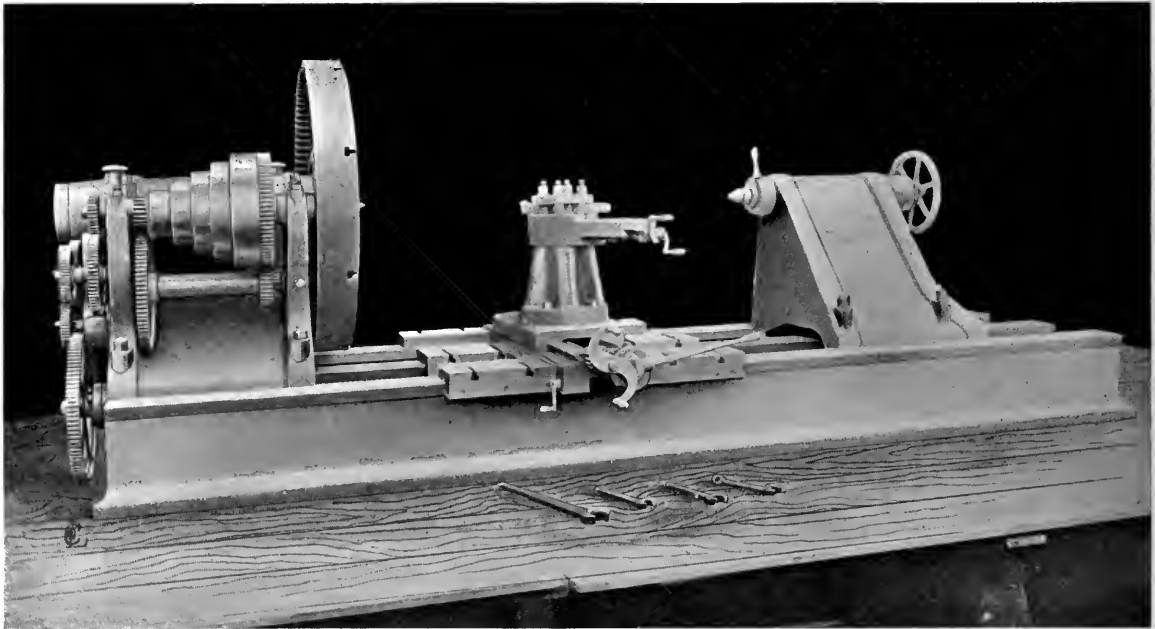

60" LATHE.—SCREW-CUTTING AND TURNING, WITH SCREW-FEED.

Flat-top shear, with three bearings. Head set over to bring thrust of cut within bed at all times. Heavy cast-iron spindle; the cone-pulley and back-shaft drive through face-plate only. 15 changes of speed. Will swing over bed, 60"; will swing over slide-rest, 49". Diameter of largest lift of cone-pulley, 20" for 3" belt. Feeds variable by change gear from 1" per turn of spindle to $\frac{1}{32}$ ". Ratchet lever for moving poppet-head and saddle. Compound slide-rest, power cross feed. Turning-feed can be stopped and started at carriage. Poppet-head arranged to "set over" for turning-taper. Complete with countershaft, full set of wrenches, and ratchet lever. Countershaft pulleys, 16" diameter for $3\frac{1}{2}$ " open and cross-belts. Speeds, 140 and 280 revolutions per minute. This is a strong but simple lathe, useful for general work. *We also make a 72" lathe of the same design.*

PLATE No. 73.

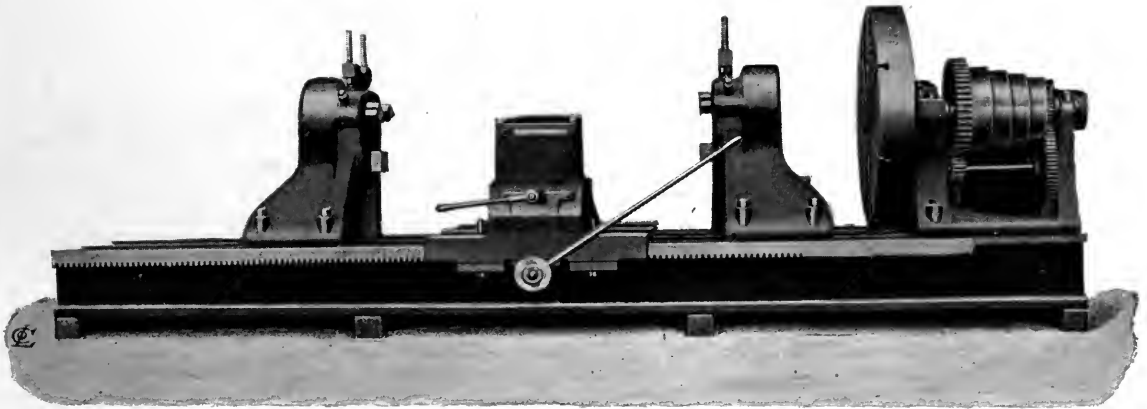

60" ROLL LATHE.

Three bearings on bed, very heavy face-plate, with internal gearing. Four speeds on cone. Ratio of gear reduction, 200 to one. Extra heavy housings for rolls, with adjustable bearings to suit diameter of work, and cradles for matching roll. Heavy Scotch slide-rest with ratchet cross-feed. Rack-feed by hand for carriage along bed, with clamps for locking carriage to place when required. Countershaft pulleys, 24" diameter to 5" belt. Should make 150 revolutions per minute. Height from centre of spindle to top of lathe shear, 31½". Largest lift of cone-pulley, 24" diameter for 4" belt.

PLATE NO. 74.

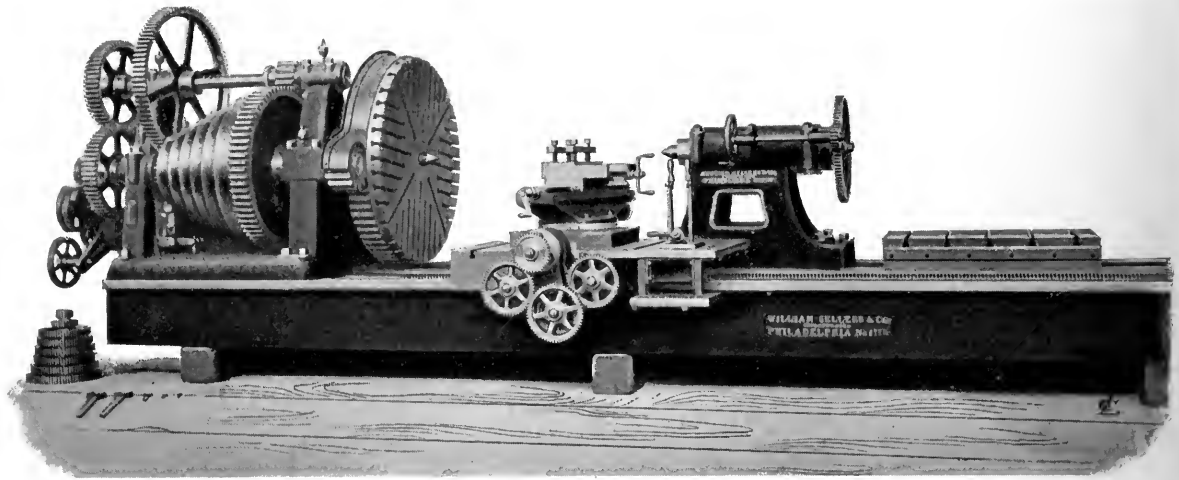

72" LATHE.—SCREW-CUTTING AND TURNING, WITH SCREW-FEED.

Very massive lathe for heaviest class of work. Three bearings to bed and head set over to bring strains of cut always within the bed. Very heavy poppet-head, with capped bearing for boring-bar, $8\frac{1}{2}$ " diameter. Cast-iron spindle, $12\frac{1}{2}$ " diameter. Spindle always driven through face-plate. Ratio of back-gear, 25 to 1; ratio of triple-gear, 125 to 1. Largest lift of cone-pulley, 46" diameter for 5" belt. Carriage arranged to run past poppet-head and steady-rest. Slotted extension to carriage for use when boring large work. All movements of slide-rest and carriage have rapid power adjustments to position; poppet-head movable to place rapidly by power. Compound swivelling rest of massive proportions, with angular feed operated by power. Swing-frame and change gear for changing ratio of feeds carried on saddle. Tapers turned by combination of gearing on carriage. Turning feeds variable from $\frac{1}{8}$ " to 2" per turn of spindle. In screw-cutting lathe, lathe is not reversed; but rest is moved to place by power rapidly, and clutch for screw cutting is so arranged as to insure starting in the right place on the screw. Face-plate and all gears cut from solid. Complete with wrenches, countershaft and steady-rest.

PLATE NO. 75.

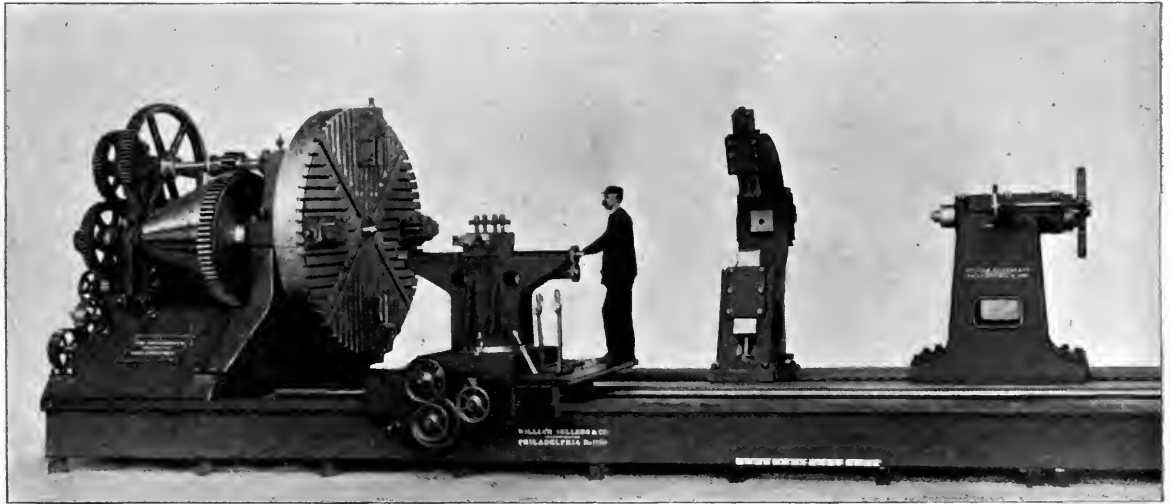

122" LATHE.—SCREW-CUTTING AND TURNING.

Same type as 72" lathe, (plate 74). Longitudinal, cross, and angular-faced by power with rapid power adjustment operated by convenient levers; *poppet-head movable rapidly to place by power*; carriage arranged to run past poppet-head and follow-rest; long tapers turned by combination of cross and longitudinal feed; massive steady-rest with heavy jaws having removable brass shoes; heavy swivelling rest with 48" travel of tool slide on top surface; massive chuck jaws on face-plate, which is 8 ft. 5" diameter and has internal cut teeth, 3" pitch and 12" face; swing over bed, 122" and over carriage, 114"; heavy steel spindles, lead screw, $4\frac{1}{4}$ " diameter. Complete with countershaft, steady-rest, wrenches, and full set of change gears for screw-cutting and turning.

PLATE NO. 76.

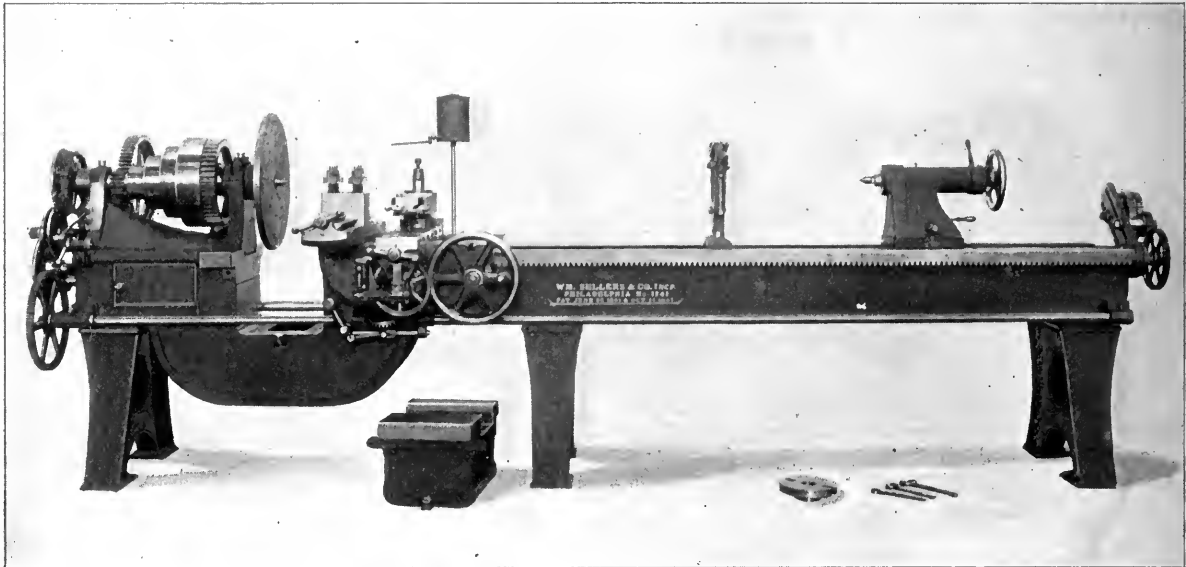

20" GAP LATHE.—GAP OPEN.

This is our regular 20" lathe (see plate 67), with drop bed having gap $12\frac{2}{3}$ " wide, to swing with 42" diameter; *feed-screw operated from rear end* is always ready for use whether gap be open or closed. *Extra rest on carriage* for turning full diameter of gap, has hand cross-feed only; easily removable when not required; length between centres can be made to suit. Complete with countershaft, wrenches, steady-rest, extra slide-rest for full diameter, extra face-plate, and set of change gear. *Made also for turning only.*

PLATE No. 77.

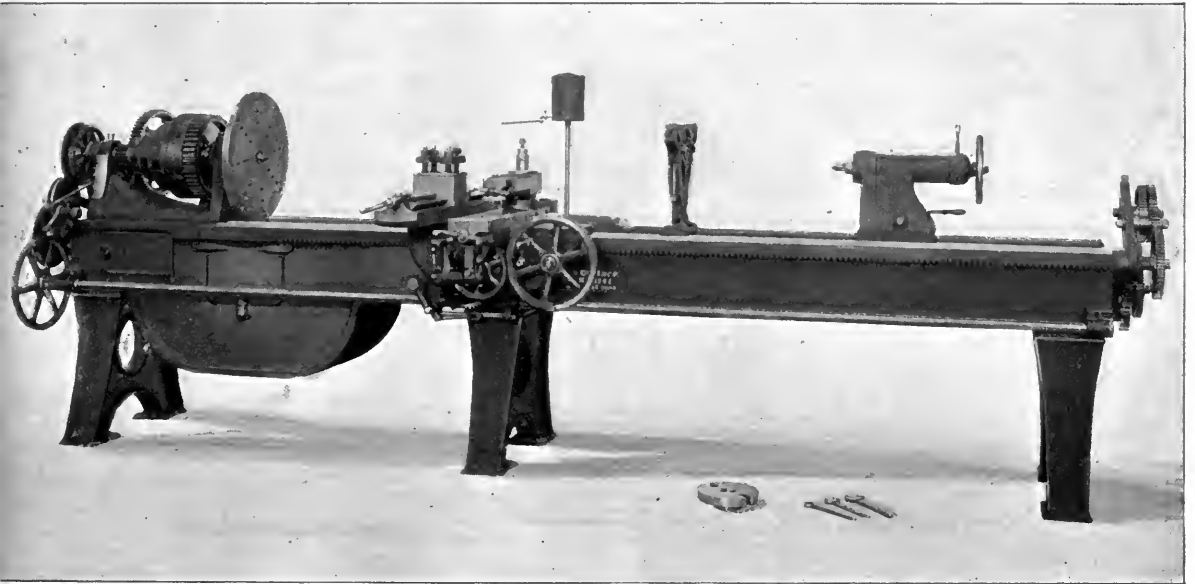

20" GAP LATHE.—GAP CLOSED.

The filling block for closing gap is carefully fitted and dowelled so that when in place the lathe bed is practically continuous (see table, page 80.) *Short lathes made also with sliding beds to open and close gap.*

We are prepared to build all sizes of either pattern, that is, with sliding bed or with breaks, as shown here. Extra rest shown in plate may be easily removed when turning small diameters.

PLATE NO. 78.

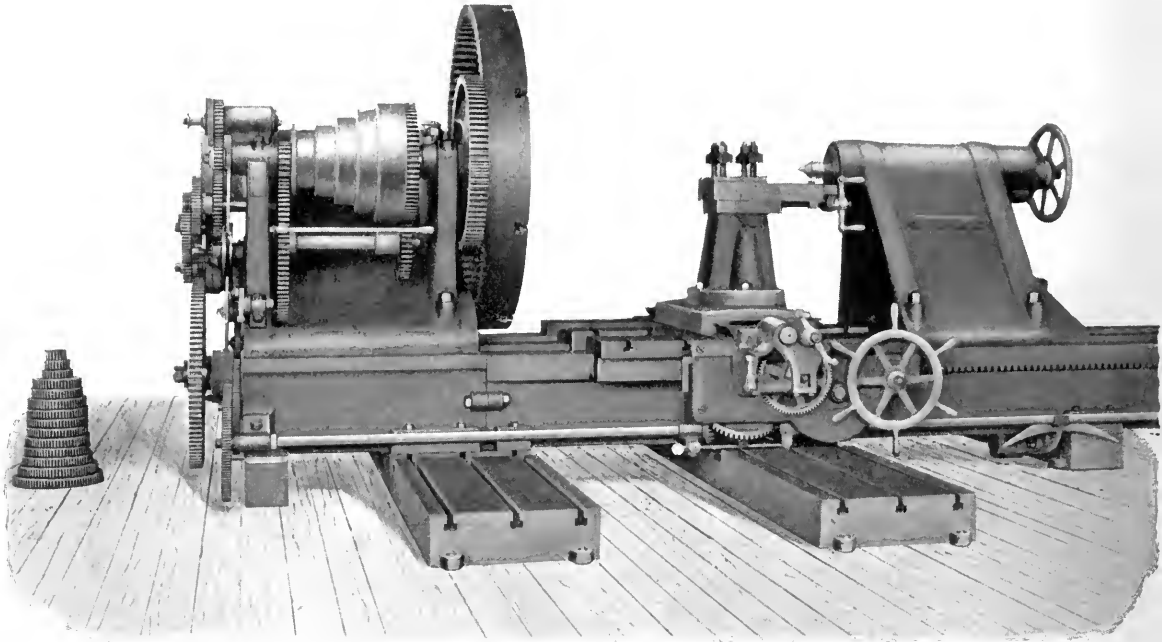

72" SELF-ACTING GAP LATHE.—FOR SCREW-CUTTING AND TURNING.

Independent shaft for turning-feeds operated through improved friction discs. Compound swivelling slide-rest, with automatic cross, longitudinal, and angular feeds. All feeds engaged, disengaged, or reversed at the saddle within convenient reach of the operator. Easy hand adjustment of saddle by rack and pinion. Swing over bed, 72"; swing over slide-rest, 64 $\frac{3}{4}$ " diameter. Ratio of back-gearing about 50 to 1; ratio of triple-gearing, 300 to 1. Largest lift of cone-pulley, 24" diameter for 3 $\frac{1}{2}$ " belt. Complete with countershaft, wrenches, full set of change gear, and ratchet lever for moving poppet-head. Fast and loose pulleys on countershaft, 20" diameter for 4" open and cross belts, and should make 122 and 124 revolutions per minute. As shown in illustration, lathe is arranged with bed in two parts, so as to form gap-lathe when required, bed being supported on shoe-plates at intervals, and arranged so that the long end may be moved to form a gap for large work. See also Plate No. 79.

PLATE No. 79.

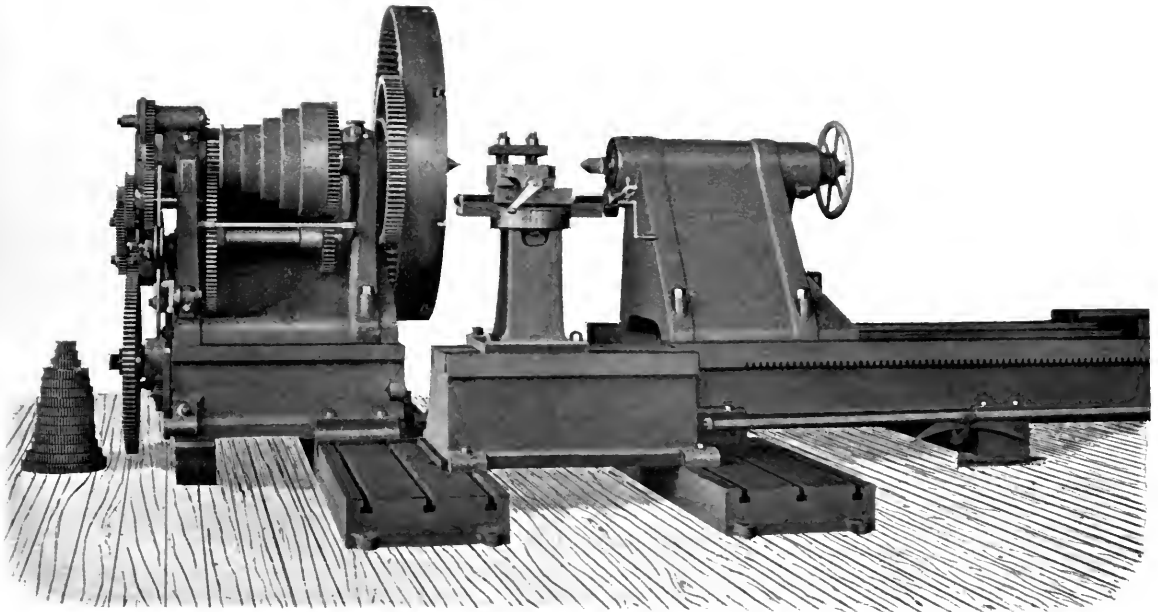

72" SELF-ACTING SLIDE-LATHE.

FOR SCREW-CUTTING AND TURNING.

Arranged as gap lathe to take work 16 ft. diameter by 3 ft. face. Bed is parted and auxiliary bed, carried upon two of the shoe-plates (which are extended for the purpose), supports special rest for turning the large diameters. This rest is provided with ratchet feed, operated from a rock shaft, which is vibrated by a crank on the live head.

For further particulars of lathe, see specification under Plate No. 78.

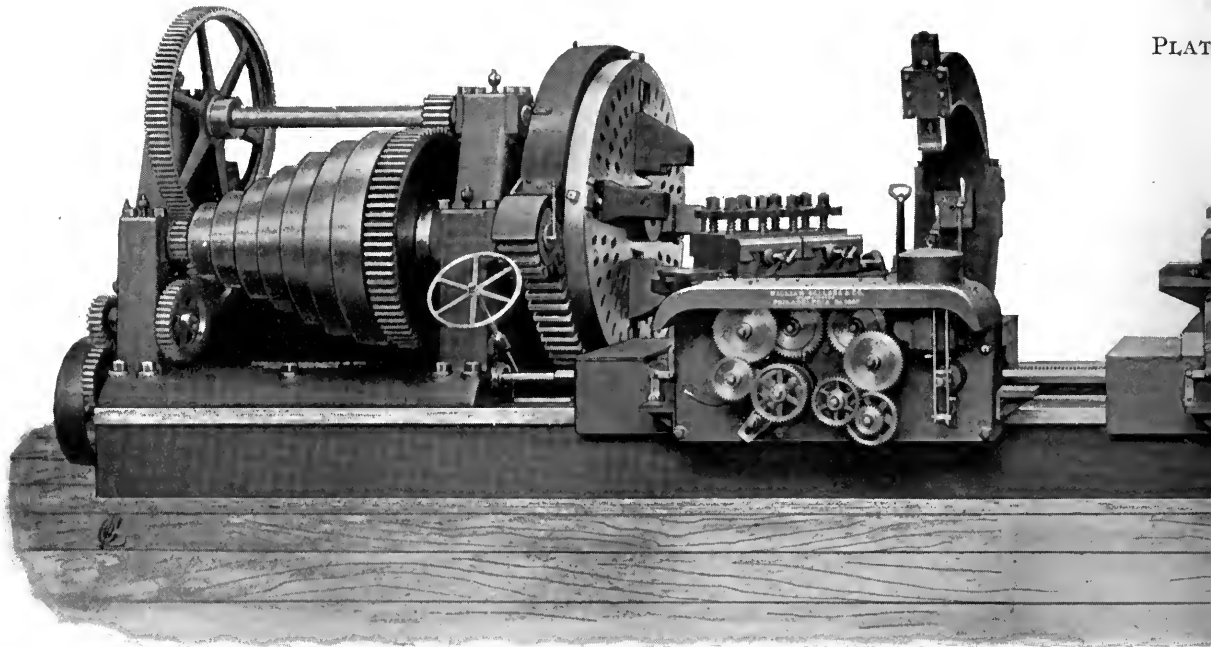

PLAT

8-FOOT TURNING AND BORING

Designed especially to permit the use of broad, flat turning tools fed at right angles to the axis of the gun, which involves very powerful feeding gear, and means of quickly moving the tool carriages and slide-rests by power. **Main Bed**, 73 ft. $10\frac{3}{4}$ " long, 9 ft. wide. **Extension Bed**, for carrying the boring arrangement, 54 ft. 5" long, 5 ft. 2" wide. Main bed has four ways,—two for tool carriage and two for steady-rests, and poppet-head so arranged that tool carriages may pass by poppet-head and steady-rests. Massive and powerful **Live Head** about 9 ft. long, with 20" oil-tempered steel spindle and cast-steel face-plate, with 75 cut teeth, 4" pitch, $10\frac{1}{2}$ " face. Face-plate provided with four powerful clamping jaws, with bronze shoes. Largest lift of cone-pulley, 60" diameter for 8" double belt. Two speeds on countershaft, making 14 turning speeds, arranged in geometrical progression. Breaking pin in driving-gear prevents possible overstrain. The **Tool Carriages** are two in number, each consisting of a saddle sliding directly on the bed, and provided with a swivelling slide-rest, which carries two tool-rests having independent cross adjustment. Length of guide for carriage on bed, 9 ft. Carriage is moved by long nut revolving on a stationary 6" steel screw. This nut receives its feed-motion from a square shaft within the bed, driven at constant speed by gears in the live head, while its quick traverse, 20 ft. per minute, is obtained from a second square shaft, also of constant speed, driven by a separate pulley. The quick traversing mechanism of one carriage can be instantly operated in either direction without disturbing the other carriage, whether it be screw-cutting or turning. All changes for feeds or screw-cutting are made on the saddle, thus making the two tool carriages entirely independent of each other in all their movements. Cross-slide in each saddle is operated by a 3" steel screw, rotated by the square feed-shaft simultaneously and in various relative amounts, taper surfaces may be turned.

80.

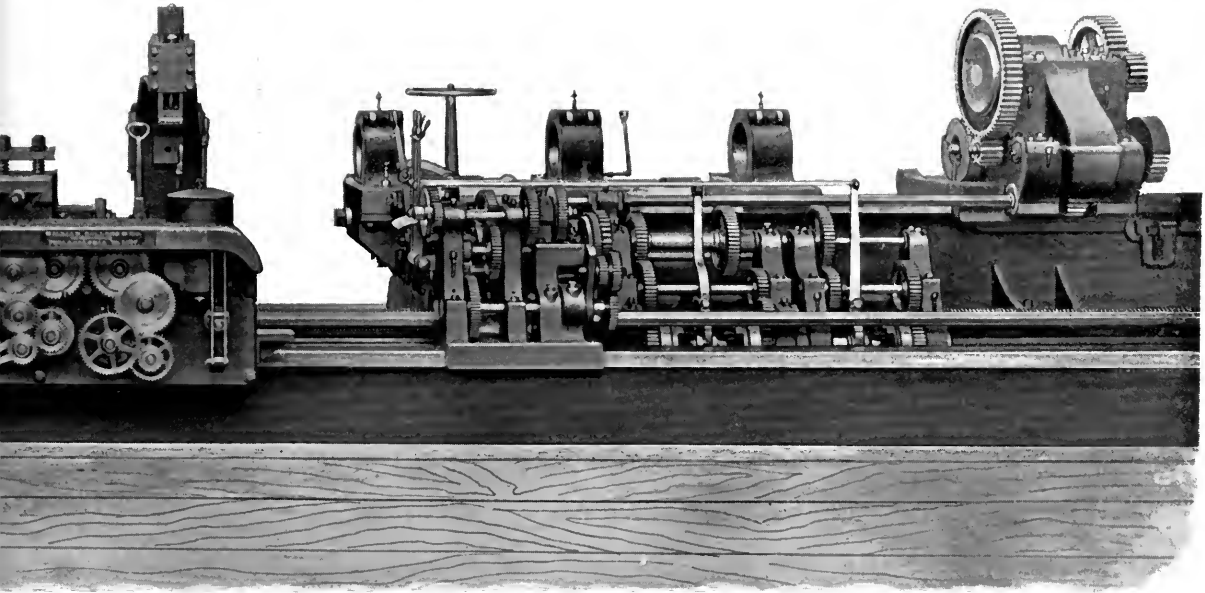

THE.—FOR 16" STEEL CANNON.

When screw-cutting carriage is run back to starting point after each cut by quick traversing mechanism, an indicator is provided for spacing threads and to show proper time for throwing screw-cutting clutch into gear. Levers for rapid traverse and longitudinal feed are interlocked so that they cannot be thrown in together. **Four steady-rests** are provided, taking respectively 61", 54", 40", and 27" diameter. They have adjustable jaws and embrace an arc of over 220 degrees, but are open in front to permit the carriages to run by. **Poppet-head**, supported like the steady-rests upon the two back-bearings of the bed, is provided with a 14" steel spindle and 8" centre. By removing this spindle and thrust block the poppet-head may be used, if desired, as a boring-bar support. It may be moved along the bed like the steady-rests, by the nearest carriage; a coupling bar being provided to join them. **Boring-bench** carried upon the extension bed and operated from a revolving nut on the 6" screw in the main head. All mechanism required for moving the boring-bench, for boring-feeds and for quick traverse of the boring-bar, is bolted to the front side of the boring-bench, its frame-work being also supported by the end of the main bed, upon which it slides as the bench is moved. This mechanism is driven by the feed and quick traverse shafts in the main bed. The boring-bar is supported by a fixed rest at the front end of the bench by a sliding-head, in which it is held and rotated at the rear end, and by two intermediate supports travelling at proportional rates of speed. The boring-bar can be rotated at any speed that may be desired, whereby the rate of boring is rendered independent of the turning-speed. The sliding-head on the end of the boring-bar is moved by a 5" steel screw in the boring-bench. This screw receives both slow motion for feed and quick motion for rapid bar traverse. Boring-bar supports have side extensions, upon which the bar can be rolled when it is desired to examine the bore of the gun.

PLATE No. 81.

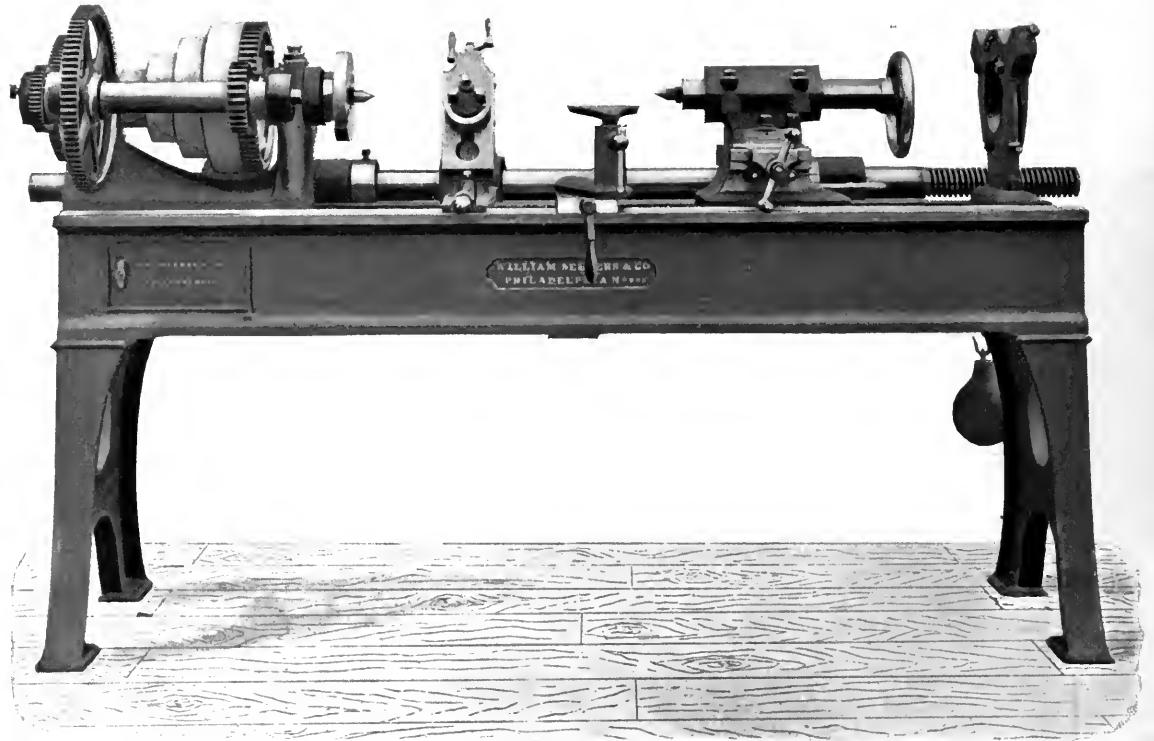

20" DOUBLE-GEARED CHASING LATHE.

Specially designed for brass work. Arranged with chasing attachment. Spindles for holding the chasing hobs are so arranged as to accommodate two different pitches at the same time. Also to cut with single pointed tool, single, double, triple, or quadruple threads. Slide-rest for chasing attachment carried by counter-weighted bar at back of lathe. Poppet-head with square spindle to carry boring tools, when required, provided with swivel-post and mounted on cross-slide to act as slide-rest when desired. Provided also with hand tool-rests, steady-rests, and countershaft. Fast and loose pulleys on countershaft for open and cross belts, 10" diameter for $2\frac{1}{2}$ " belt, and should make 225 revolutions either way. Also made with turret-head in place of compound slide-rest shown. Largest lift of cone-pulley, 13" diameter, $2\frac{1}{2}$ " belt. Well adapted for heavier class of brass work and as injectors, heavy valves, etc. Turret-head has cross-feed and long-feed by hand.

PLATE No. 82.

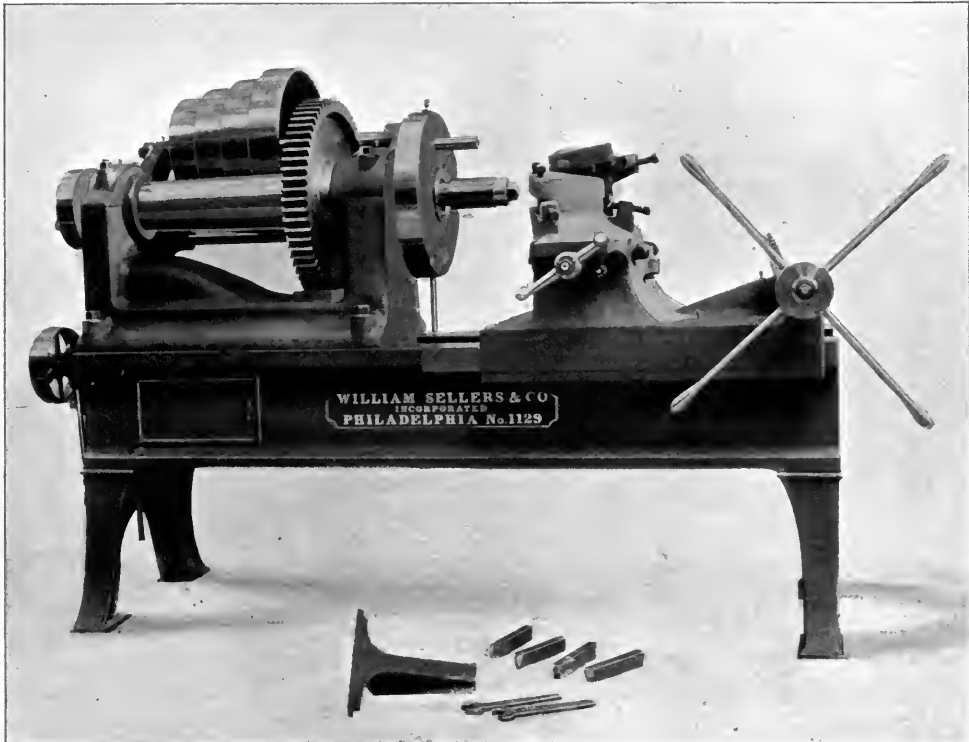

HUB-FACING AND TURNING LATHE.

This is a special tool for facing hubs of steel spur-gears for street car axles and turning them for collars; will swing 32" diameter, carries two roughing and two finishing tools, has setting gauges, screw stops, oil-pump, and expansion mandrel to carry work. Countershaft has 16" pulleys for 4" belt, which should make about 135 rotations per minute.

PLATE NO. 83.

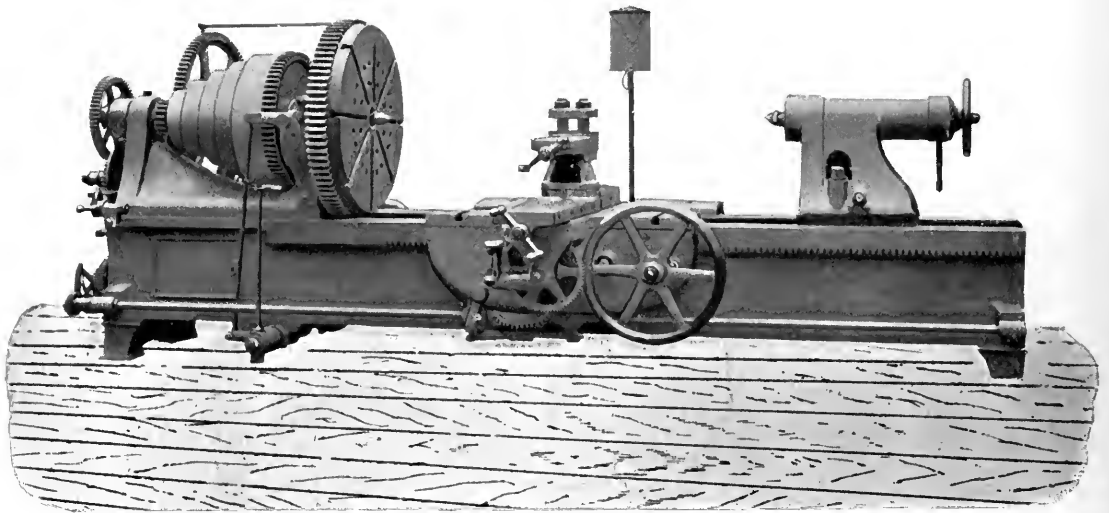

36" SELF-ACTING SLIDE-LATHE.

WITH ROCK-SHAFT TURNING ATTACHMENT. FRONT VIEW.

Specially arranged with vibrating movement to spindle for facing the arms of locomotive rock-shafts and similar work. Lathe, with all turning-feeds complete in every respect. (See Plate No. 69.) Rock-shaft attachment quickly and easily thrown in or out of action. Arc of vibration variable by stops on back of face-plate, from a few degrees to almost a complete circle. Face-plate reversed at about four times the cutting speed. Vibratory motion operated by friction clutches, as in our improved planer motion, and reversal takes place without jar or shock. Hand-shifting lever on front of the lathe permits face-plate to be vibrated as required. A ratchet-feed operated by a variable crank gives the adjustable feed-motion.

PLATE No. 84.

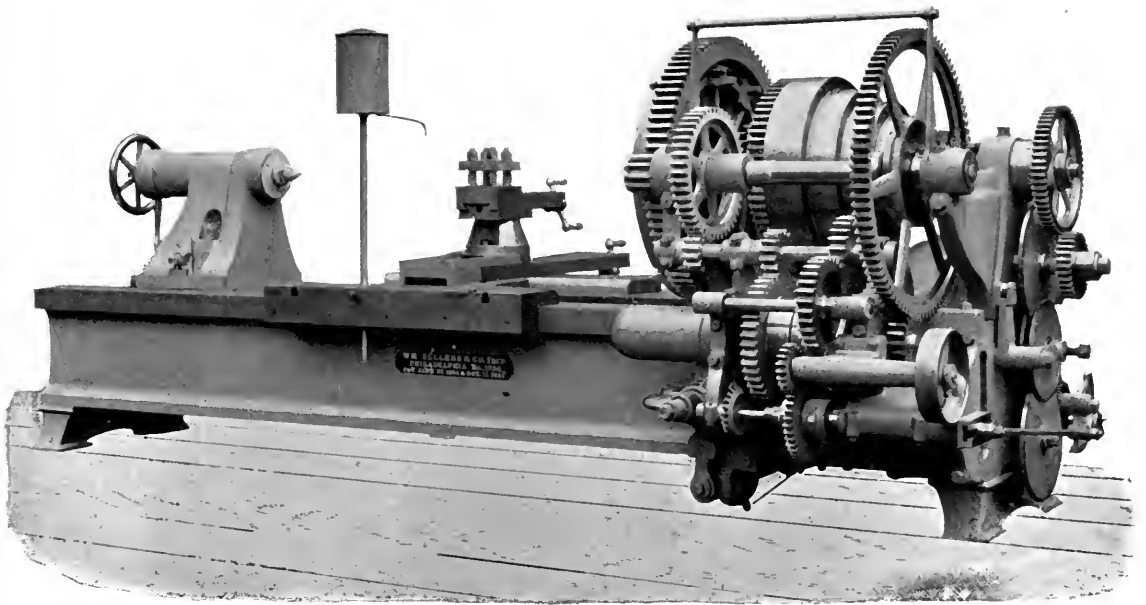

36" SELF-ACTING SLIDE-LATHE.

WITH ROCK-SHAFT TURNING ATTACHMENT. BACK VIEW.

Back view of lathe shown in Plate No. 83, on opposite page. Shows reversing mechanism for operating the vibrating movement of the face-plate. Change from reciprocating to rotary motion quickly accomplished when latter is to be used on cylindrical work.

Machine complete with countershaft, wrenches, water-can, and rock-shaft attachment. Fast and loose pulleys on countershaft, 18" for 4" belt, and should make 100 revolutions per minute.

PLATE NO. 85.

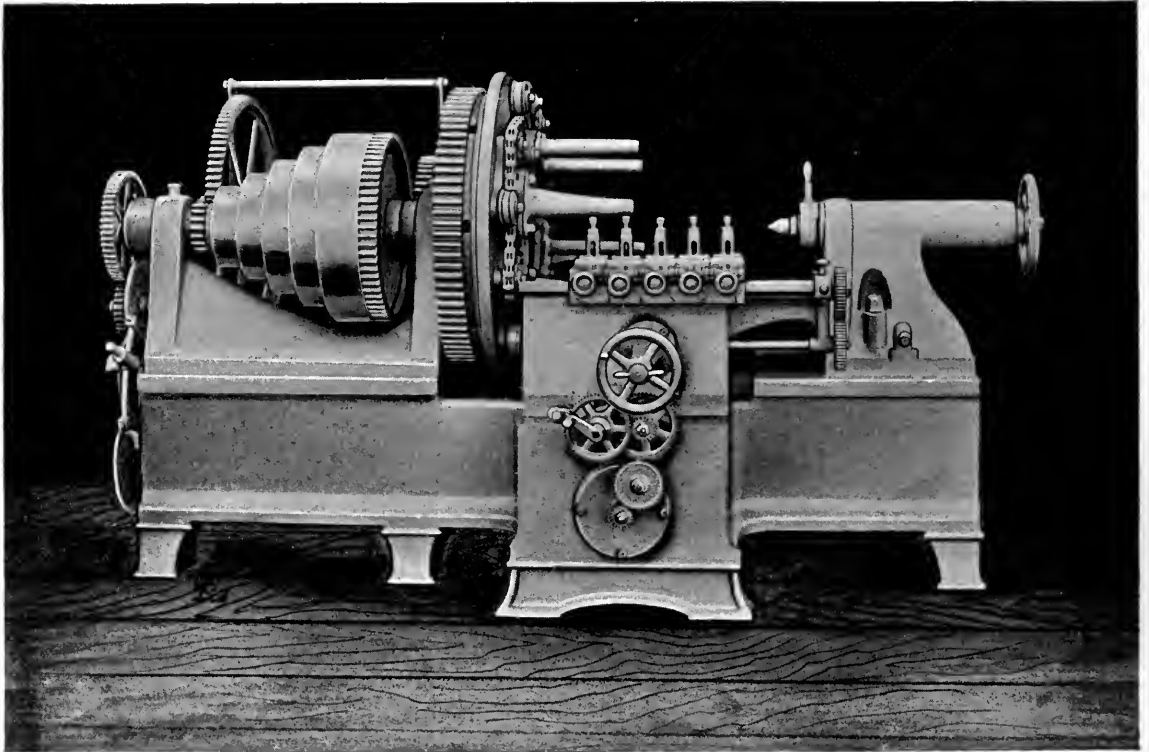

36" PULLEY LATHE.

Special lathe for turning pulleys from 20" diameter to 36". Slide-rest with five independent tool-holders, and former bar to determine shape of pulley face. Frictional turning-feed through improved discs, equalizing drivers for face-plate, with six arms. Largest lift of cone-pulley, 28" for 3½" belt. Triple-gear head. Ratio of triple-gearing, 38 to 1; ratio of back-gearing, 6 to 1. Height from centre to top of bed, 20". Will turn and face up to 24" width of face. Fast and loose pulleys on countershaft, 26" diameter, 4" belt; 80 rotations per minute.

PLATE NO. 86.

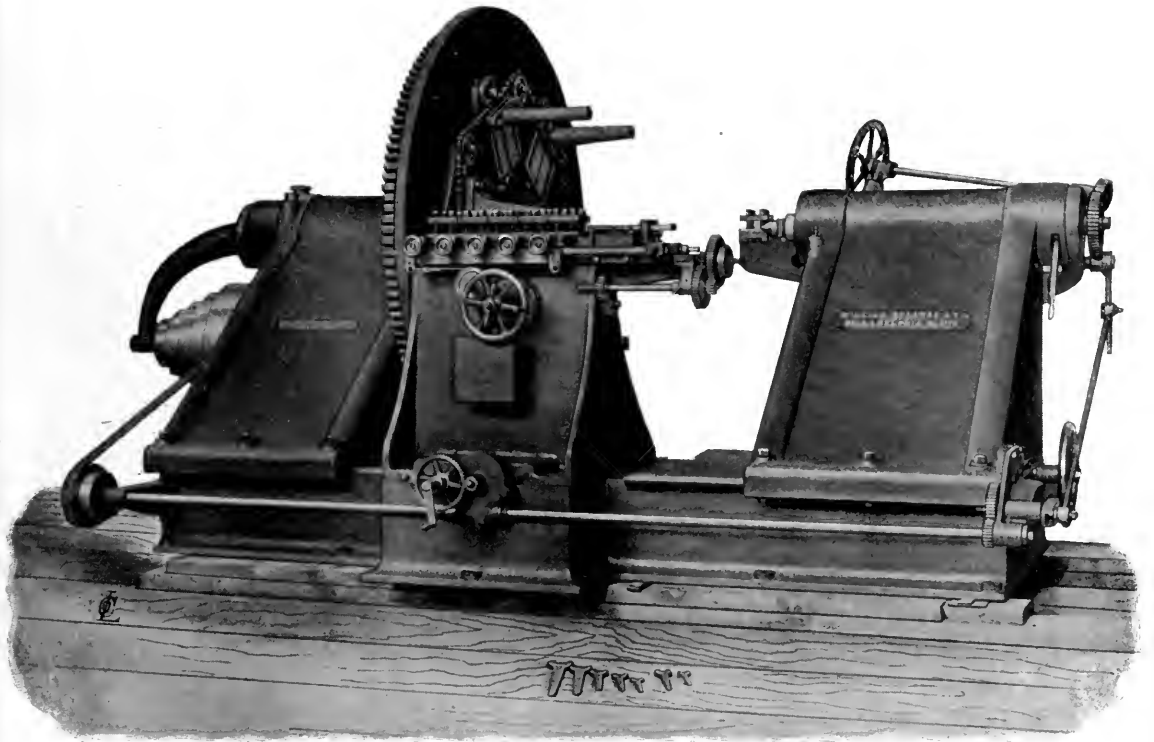

96" SPECIAL PULLEY LATHE.

Cast-iron spindle in live head, 11" in diameter. Live head driven through face-plate giving ten speeds. Largest lift of cone-pulley, 29" for 4½" belt. Height from centre to top of shear, 45½". Will turn and face pulleys from 36" diameter up to 96" diameter by 48" face. Five independent slide-rests on carriage, with former bar to determine shape of pulley face. When required, provided with attachment for turning the outside of pulley-hubs, and with former attachment for turning grooves of rope wheels. Patent holdfast for poppet spindle and equalizing drivers on face-plate. Fast and loose pulleys on counter-shaft, 24" by 7", and should make 135 revolutions per minute.

PLATE No. 87.

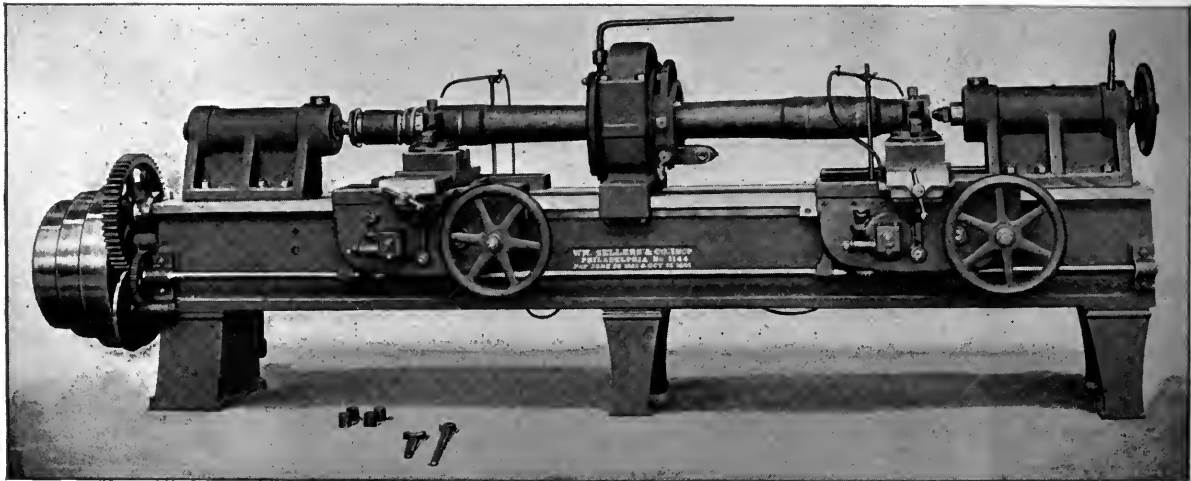

20" DOUBLE AXLE LATHE—WITH CENTRAL DRIVING HEAD.

This is a massive lathe, with deep, heavy bed and special driving arrangement, which clamps the axle securely and in such a manner that its irregularity will not cause the head to bind or the tools to produce taper or eccentric work. Opening in driving head, $9\frac{1}{2}$ ". Will turn, if required, axles as short as 3 ft. Cut steel driving wheel, heavy spindles, powerful gear. Pump and complete water circulating system. Steel racks for feed. Automatic friction feed. Patent double grip holdfast to poppet-head spindle. Tool posts for $1\frac{1}{2}$ " by $1\frac{1}{2}$ " tools. Countershaft has 26" by $4\frac{1}{2}$ " fast and loose pulleys, making 130 revolutions per minute.

PLATE NO. 88.

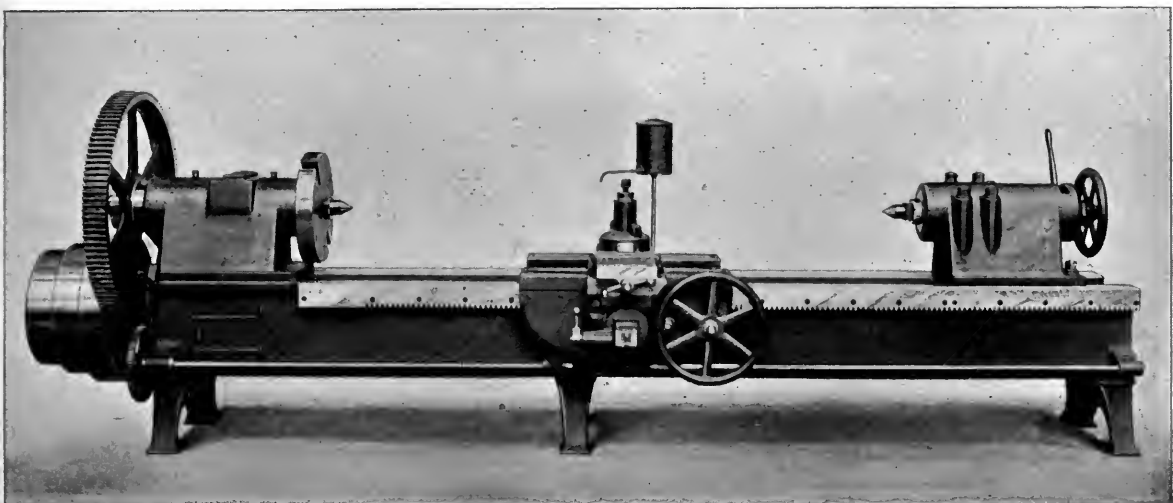

25" TURNING LATHE—FOR DRIVING WHEEL AXLES.

A very massive, powerful lathe, for the heaviest locomotive axles and similar work. Automatic turning-feed variable by our improved disc arrangement from $\frac{1}{16}$ " to $1\frac{1}{2}$ " per turn of axle. The steel feed rack is $\frac{7}{8}$ " pitch, $2\frac{1}{4}$ " face. 6" spindle in live head. $4\frac{9}{16}$ " poppet spindle with patent double grip holdfast. Heavy tool post for $1\frac{1}{2}$ " by $1\frac{1}{2}$ " tools. Water dish around edges of saddle. Steel centres, $2\frac{1}{16}$ " diameter. Six $1\frac{3}{8}$ " holding-down bolts in poppet-head. Swing over carriage, 14" diameter. Usual length between centres, 8 ft. 9". Can be made larger if required. Fast and loose pulleys, 30" diameter, 5" belt, 80 revolutions per minute.

20" AXLE LATHE.—We also make a single lathe of this type, swinging 20" over the bed and 11" over the carriage, for railway car axles. Provided with two carriages and a forming attachment. This lathe is especially adapted to turning the central part of tapered car axles and can be used to advantage in connection with the double lathe (Plate 87), which will turn the axle ends.

PLATE NO. 89.

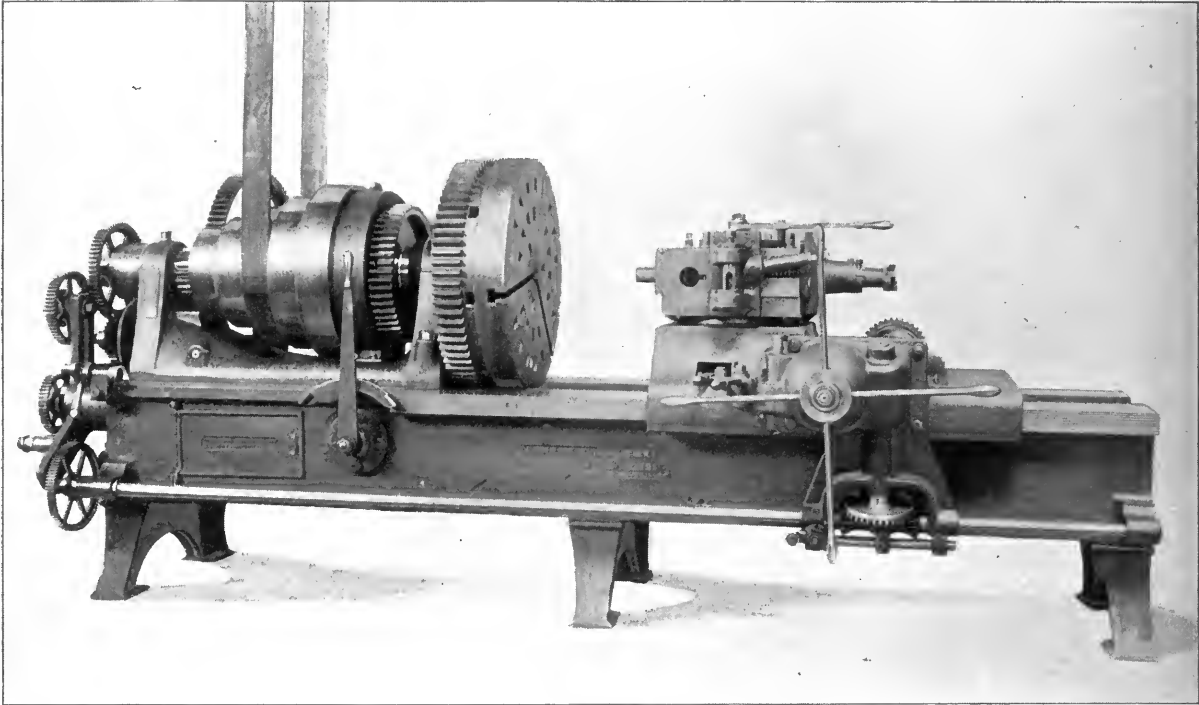

30" PATENT TURRET LATHE.

This machine is designed to handle the heaviest work for which these machines are adapted, and is, we believe, the most rigid and substantial tool of the kind yet built. *Bed* is 11 ft. long. *Swing* 30" over bed. *Livehead* is triple geared with fifteen speeds. It is stopped, started and changed from fast to slow gear by movement of lever. It has independent turning and screw cutting feeds. Turning feeds are controlled by an improved, variable friction arrangement, and feed gearing has safety device to prevent breakage by accidental overloads. Saddle or carriage has quick hand feed through steel rack in the bed, and adjustable automatic stops for turning feeds. It carries a heavy square turret with Richards' patent self-acting lock which takes up lost motion automatically by steel wedges in steel sockets. Each face has a socket for boring bar and a sliding tool holder with hand cross feed.

PLATE No. 90.

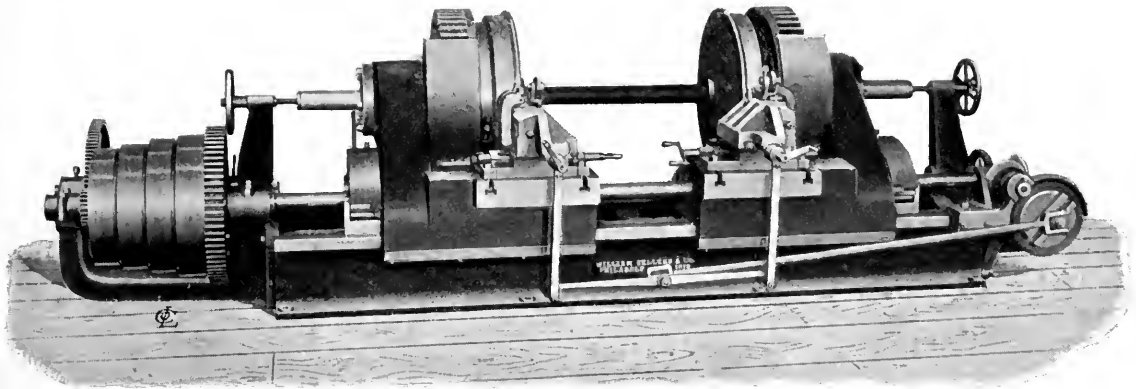
**LATHE FOR STEEL-TIRED CAR-WHEELS.—UP TO 42" DIAMETER.**

This lathe is intended for turning car-wheels with steel tires up to 42" diameter on the tread, and is especially designed for those forms of wheel in which the tread projects beyond the plate on the outside of the wheel. Such wheels are held by expanding a continuous chuck against the inside of the tires, and are supported without any strain on the axles. They are centred by rollers running on any unworn part of the tire, as top of flange, for example, and then bolted fast. There are two driving-heads, each provided with its own slide-rest, arranged to move to and from one another by power upon the bed; the axle of the wheels being supported upon adjustable centres. Face-plates, 43" diameter. Driving-cone, 32" diameter on the largest lift, for 5" belt; and the ratio of the gears in the driving train is 276 to 1. Feeds are provided in both directions, operated by an adjustable crank and ratchet boxes. Height of centres above bed, 26"; capable of turning full width of tire in one broad cut, but arranged for successive narrow feeds also. Complete with countershaft, wrenches, two sample expanding rings for 42" tires. Fast and loose pulleys, 26" diameter, 6" face.

Wheel-Turning Lathes.

THESE lathes are designed for turning locomotive driving-wheels and driving-wheel centres, and for boring centres where no boring mill is accessible.

They are also arranged so that they may be employed to true the bearings of the axles by shifting the saddles on the bed, which, in most cases, can be done without taking the wheels out of the lathe, as the shallowness of our saddles usually permits them to be moved under the wheel flanges. The centres being set close to the back edge of the wide flat bed, the pressure of the cut always falls within the bed surface. The feed is obtained from a rock-shaft placed overhead, either supported by the roof-beams or by columns attached to the lathe heads. Our wheel lathes are of two types, one in which only one of the heads has a steel adjustable spindle, and the other in which both are so provided; the lathes of the latter type are of exceptionally heavy driving power, and are intended more for manufacturers than for repair shops.

The range of sizes which we manufacture is shown in the following table:

Size of Lathe.	Diameter of Face Plates.	Height of Centres above top of Bed.	Length of Bed.	Maximum distance between Face Plates.		
54"	4 ft. 6½"	2 ft. 3½"	16 ft. 2¼"	9 ft. 11"	Made also with Bed 13 ft. 6" long.	
66"	5 ft. 6½"	2 ft. 9½"	14 ft. 10¼"	8 ft. 6"		
79"	6 ft. 6½"	3 ft. 3½"	15 ft. 11¼"	8 ft. 10"		
80"	6 ft. 7½"	3 ft. 4¼"	15 ft. 11¼"	8 ft. 5¼"		2 Sliding Spindles.
100"	8 ft. 2½"	4 ft. 2"	19 ft. 2"	9 ft. 1"		2 Sliding Spindles.

We can arrange any of these for driving by electric motor attached directly to the lathe, and with work shaft carried upon columns; and all sizes of these lathes can be supplied with the following extra attachments: *Patent hoisting attachment; wheel quartering attachment; face-plate slide-rest for facing hubs of crank-pin holes, and splining attachment for key-seating.*

QUARTERING ATTACHMENT.

For wheel-quartering, we furnish a portable horizontal boring machine which can be put in place of one of the slide-rests upon its post, and when so placed its spindle is level with the centre of the lathe. This boring machine has improved friction feed forward and backward, and quick hand return. When ordered with quartering attachment, four slots of one face-plate are planed true and square, so that they may be used with suitable fixtures for setting the wheels,

PLATE No. 91.

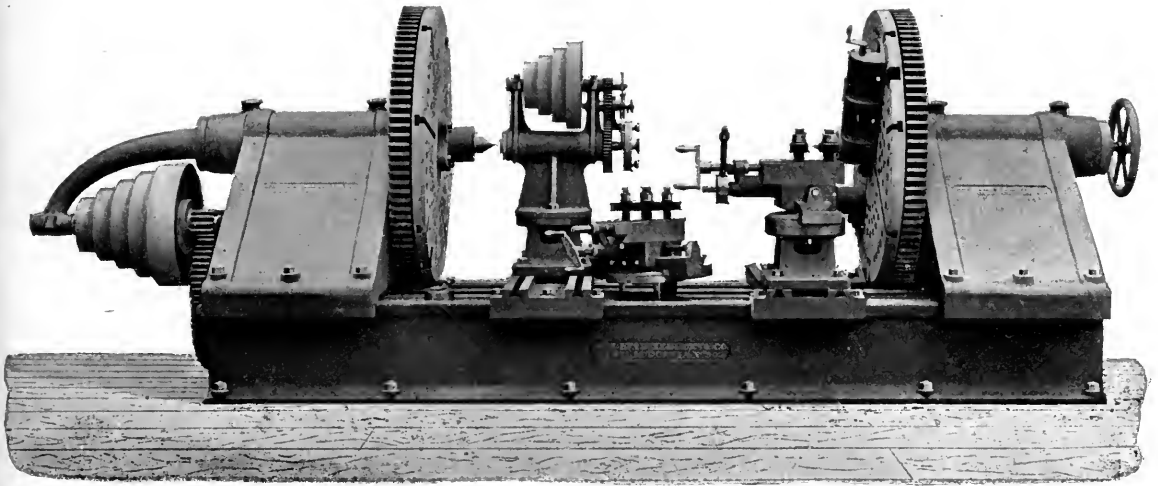

54" WHEEL-TURNING LATHE.

WITH TWO GEARED HEADS, WITH FACE-PLATE 54½" DIAMETER, DRIVEN INDEPENDENTLY.

Two compound slide-rests, self-acting feeds in all directions; will swing 49" over the saddle. Height of centre above top of bed, 27". Head is set over to bring cutting strains all within bed. 8½" cast-iron spindle. Maximum distance between face-plates, 9 ft. 11". Largest lift of cone-pulley, 26½" diameter for 3¾" belt. Complete with countershaft, wrenches, ratchet-boxes, and rock-shaft for feed. Fast and loose pulleys, 20" diameter, 5" face, and should make 50 revolutions per minute. *Wheel-quartering and hub-facing attachment, extra. Splining attachment for hubs of wheels, extra. Patent hoisting attachment for lifting wheels into lathes, extra.* Can be arranged for driving by electric motor attached to bracket on head, the rock-shaft being supported upon columns.

so as to bring the crank-pin holes at exactly ninety degrees. This device, while it can be applied to any size of lathe, is chiefly used for the smaller ones. For the 80" and 100" lathes, we also furnish *outside quartering attachments*, carried upon one or both heads. A single boring machine may be used for right or left hand lead, and the wheels reversed for boring the second hole, or two attachments may be used, boring both holes simultaneously. Extra countershafts, face-plate stops, etc., are furnished with both types.

THE CRANE ATTACHMENT.

We provide in both face-plates circular pockets near to the rim, which pockets are for the purpose of sustaining the ends of a small I-beam, adapted to the gauge of the road. On this I-beam are sling-chains, screw-swivels and hooks to attach to the axle between the wheels. By means of this very simple and not cumbersome device, the wheels on their axles are swung up to the centre by the rotation of the two face-plates through say one-quarter of a revolution. Wheels rolled up to the back of the lathe are thus lifted in with great ease, and they are set down again on the floor in the same manner.

THE FACE-PLATE SLIDE-REST.

Is bolted to a slot in one of the four plates, and can be used to turn the crank-pin boss and wheel hub.

THE SPLINING ATTACHMENT.

This consists of a large opening nut attached to the under surface of one of the saddles, so as to connect it to the driving shaft which is threaded for that purpose. The rotation of the shaft causes the saddle to move a planing tool back and forth, so as to cut a keyseat. Of course this is only important when there are no other tools in the shop better adapted for the work.

PLATE NO. 92.

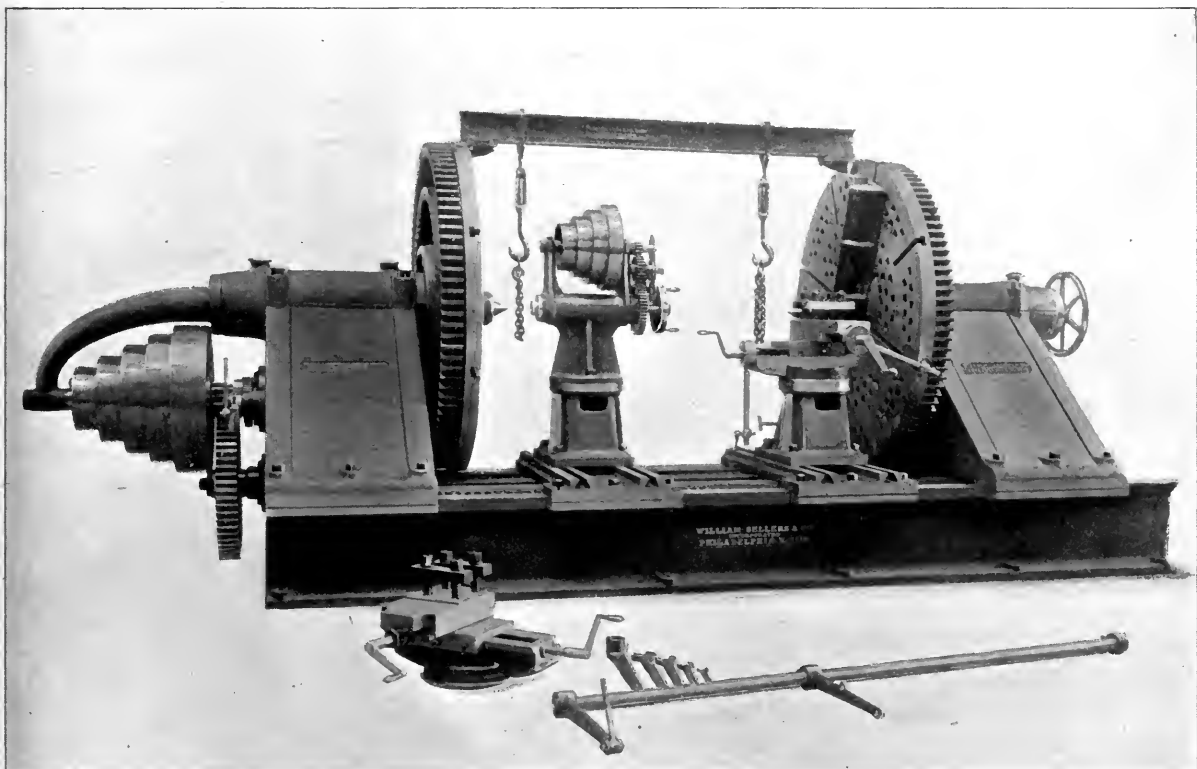

66" WHEEL-TURNING LATHE.

Two compound slide rests, self-acting feeds in all directions; will swing 60" over the saddles. Height of centres over bed, 33½". Heads set over to bring cutting strains within bed. Maximum distance between face plates, 8 ft. 6". Largest lift of cone-pulley, 29" for 4½" belt. Complete with countershaft, rock-shaft for feed motion, wrenches and ratchet levers. Fast and loose pulleys on countershaft, 24" diameter, 7" face, 50 revolutions per minute. We are prepared to furnish the following extras: *Patent hoisting attachment for lifting wheels in rest; wheel quartering attachment to be carried on one of the tool rests; hub facing rest to be carried on face plate; splining attachment; electric motor drive with countershaft, rock-shaft and motor carried by the machine.*

PLATE NO. 93.

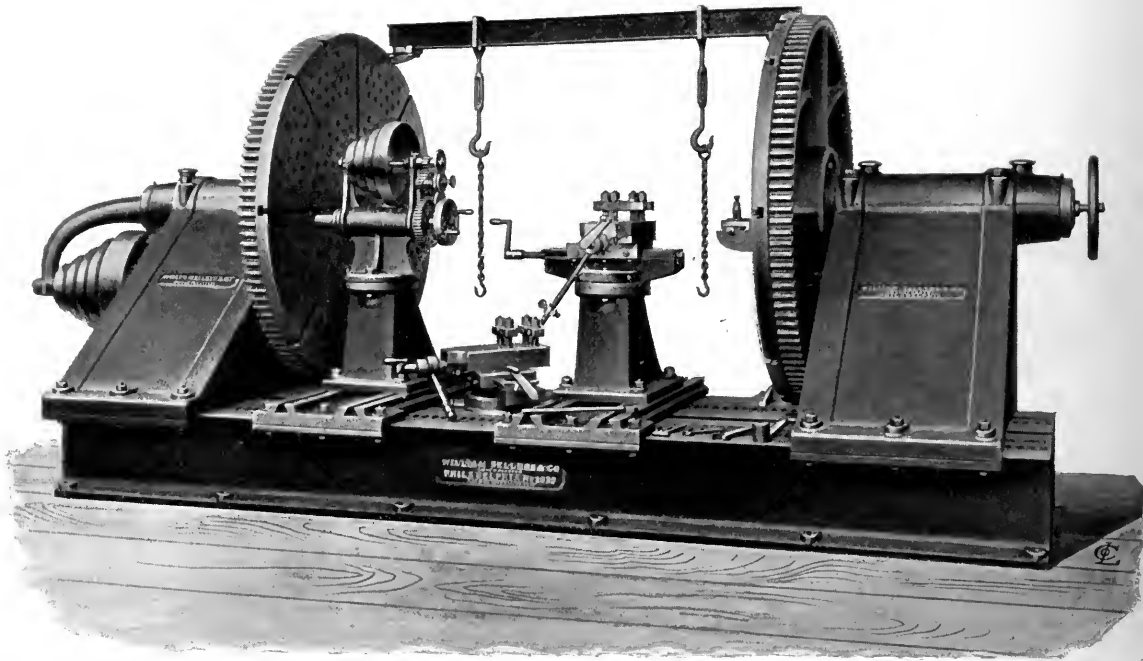

79" WHEEL-TURNING LATHE.

Two compound slide-rests, self-acting feeds in all directions ; will swing 6 ft. over the saddle. Height of centre above top of bed, 3 ft. $3\frac{1}{2}$ " . Head set over to bring cutting strains all within bed. Extension supports for centres. Maximum distance between face-plate, 8 ft. 9". Largest lift of cone-pulley, 29" diameter for $4\frac{1}{2}$ " belt. Complete with countershaft, wrenches, ratchet boxes, and rock-shaft for feed. Fast and loose pulleys on countershaft, 24" by 7". Should make 50 revolutions per minute. *Wheel quartering and hub facing attachment, extra. Splining attachment for hubs of wheels, extra. Patent hoisting attachment for lifting wheels into lathe, extra.* Can also be arranged for operation by electric motor attached to principal live-head.

PLATE No. 95.

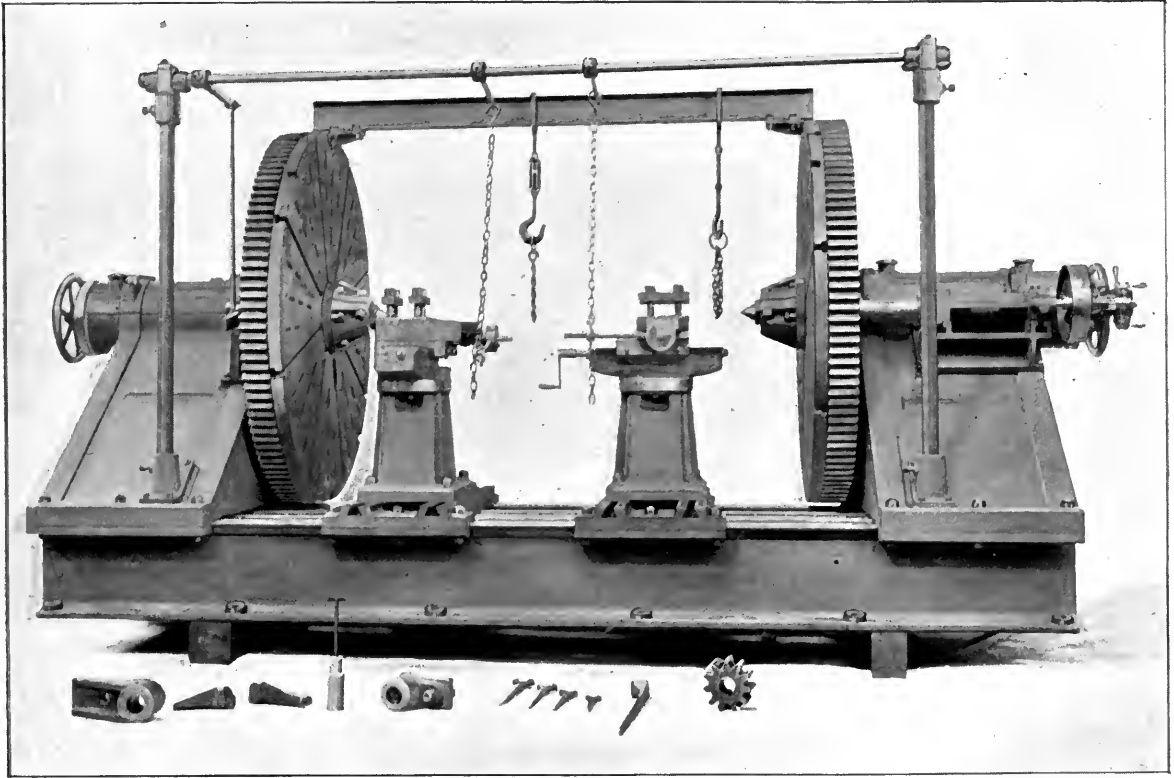

80" WHEEL-TURNING LATHE.

With two geared heads and two compound slide-rests with self-acting feeds. Both heads have heavy steel sliding spindles and steel extensions bolted to face-plate, with clamp for projecting end of spindle. Extra heavy gearing all cut from solid steel. Height of centres, $40\frac{1}{4}$ " , will swing $73\frac{1}{2}$ " over saddle. Complete with countershaft, wrenches, etc. Fast and loose pulleys, 28" diameter for $4\frac{1}{2}$ " belt, make 200 revolutions per minute. Plate shows *outside* boring machine for wheel quartering on right hand head. This is extra and can be furnished for one head or both. *Hoisting or crane attachment shown is also an extra*, Rock-shaft may be carried on columns as indicated, or in hangers attached to rafters or ceiling. May be arranged for motor drive if required.

PLATE No. 96.

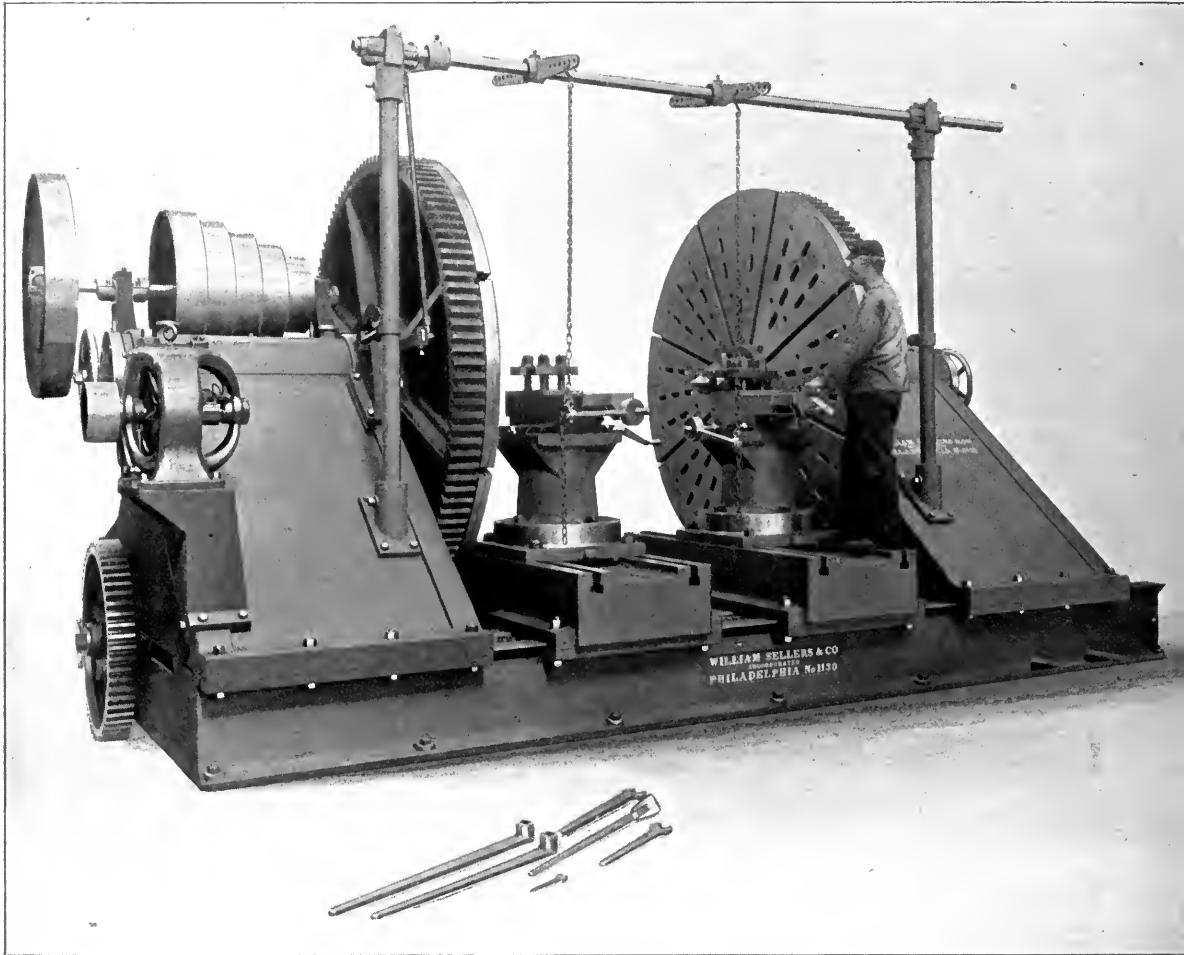

100" WHEEL-TURNING LATHE.

With two powerfully geared heads and two extra heavy compound rests, operated by electric motor attached to machine. Height of centres above bed, 50". Both heads have very large steel sliding spindles, with steel extension bearings and clamps. All gears cut from solid. When operated by countershaft, fast and loose pulleys are 36" diameter by 7½" face, and make 120 revolutions per minute. Rock-shaft may be carried on columns as shown, or by hangers from rafters. *Quartering attachments, single or double, extra. Crane or lifting attachment, extra.*

PLATE No. 97.



GRINDSTONE BOX.

Massive casting in one piece, mounted on three wheels, one of which is arranged to swivel to permit easy moving of box. Ball and socket bearings for arbor, with arbor, clamping washers, nut, and adjustable tool rest, complete except pulleys and stone, which are extra.

Size of Stone.	Face of Stone.	Diameter of Arbor.	Diameter of Washers.	Size of Journal.
42"	6"	2"	10½"	1¾"
48"	7½"	2½"	12"	1¼"
60"	8"	3"	15"	2½"

Patent Drill-Grinding Machine.

TO drill true holes of uniform diameter and the closest approximation to the size of the drill, it is necessary that the two cutting edges of the lips of the drill should be of precisely the same length, and at the same angle with the axis; and to obtain the greatest drilling effect it is requisite that the backing or clearance of the two lips should conform as closely as possible, near to the cutting edges, to the shape of the bottom of the hole produced by the drill, so as to give the greatest strength and support to the cutting edges, yet insure sufficient clearance to enable the drill to cut freely. As the shape of the bottom of the hole is a cone with the apex truncated by the point of the drill, it is evident that the best shape for the end of the lips of the drill will be that of the surface of a similar cone having its axis sufficiently eccentric to the axis of the drill to give the proper clearance to the edge. Our drill-grinding machine is constructed on this principle, and produces the correct shape on every size, from $\frac{5}{16}$ " to 3", of twist, fly, chuck, or any other kind of double-lip drill, without any alteration or adjustment of the holding device. The thickness of the web between the cutting-edges at the point of a drill has a marked effect upon its action, and should be as thin as practicable. Our "*pointing device*" grinds a groove on each side of the web at an angle to the cutting-edge, and also to the axis of the drill, deepest at the point, the width being proportioned to the diameter of the drill, narrow in small drills and wider in large, and determined automatically by the size of the drill itself, without any adjustment.

A machine for grinding drills from $\frac{1}{16}$ " to $\frac{5}{16}$ " diameter is also provided as an attachment to the large machine. This is constructed on the same principles, and will produce the same theoretically correct shapes, so that a complete drill-grinding machine, with all attachments, will accurately grind any kind of double-lip drill from $\frac{1}{16}$ " to 3" diameter, and will reduce the thickness of the point of drills over $\frac{1}{4}$ " diameter, in such manner as not to diminish the strength; both cutting-edges will be of the same length and the point will be in the centre, regardless of the accuracy with which the drill has been forged or milled. The advantage of being able to grind drills which will make holes of uniform diameter is very great when the holes are to be reamed, as it permits the size of the drill to be so proportioned to that of the reamer as to leave the least practical amount of work for the latter. Very little skill on the part of the operator is required, the size of the drill itself in all cases automatically determining its position for correct grinding. The pump and water-supply nozzles enable the work to be done quickly and without risk of drawing the temper of the drills.

The benefit of having the lips and points of drills accurately ground is found not only in superiority of the work, but also in diminished wear on the machines, and the less power required to drive and feed them. Having all drills ground by one man on this machine, increases the output of the drilling machines, the uniformity of the product, and saves drills.

PLATE No. 98.



FRONT VIEW OF PATENT DRILL-GRINDING MACHINE.

WITH POINTING ATTACHMENT.

Produces cutting edges of the correct shape on any kind of double-lip drill from $\frac{5}{16}$ " to 3", without any alteration or adjustment of the holding devices to suit different sizes and kinds, and reduces the thickness of the web at the point symmetrically about the axis.

PLATE No. 99.

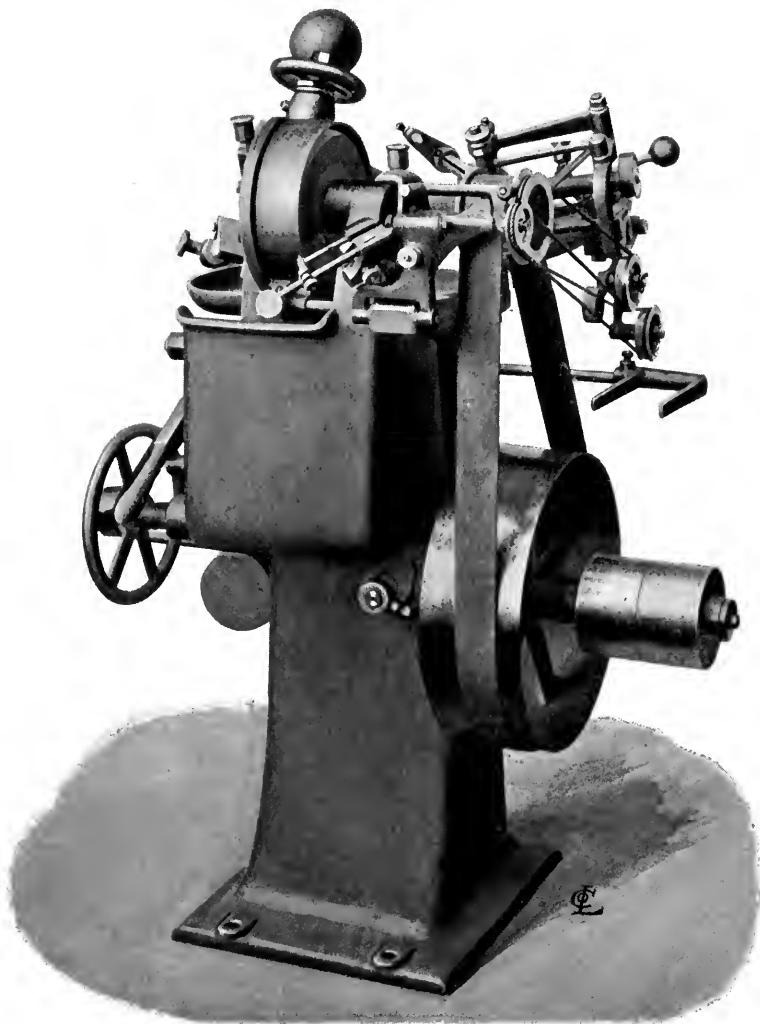

REAR VIEW OF PATENT DRILL-GRINDING MACHINE.

Showing the supplemental machine for grinding drills from $\frac{1}{16}$ " to $\frac{5}{16}$ ". The fast and loose pulleys on the machine are 5" diameter, 3" face, and must be made to run about 560 revolutions per minute.

Universal Tool-Grinding Machines.

THE system of having a separate department for the manufacture, care, inspection, maintenance, and storage of small tools, from which they are delivered to the users only on checks, which serve as receipts to identify the person at fault in case of their loss, breakage, or misuse, has been of such pronounced benefit that it is almost universally adopted. Many years ago we started an effort to bring within this system the lathe and planer tools, and everything in the shape of a cutting tool used on any of the machines in our works. This necessitated a thorough investigation of the shapes and merits of such tools as were at that time distributed among the various machines, and a long series of experiments to determine the best forms and cutting angles, so as to decide just what was the most efficient shape of tool for any definite operation upon any given material. When the desired forms were finally fixed upon, we designed and built a machine by which these forms could be quickly, reliably, and accurately ground by unskilled labor. This machine we placed in our tool department, and by it produced a set of tools such as we believed would answer every requirement of the works. These tools were systematically arranged so that they could be treated with as much consideration as reamers or taps, and when all was ready every machine in the place was relieved of its stock of good, bad, and indifferent tools, thus unearthing tons of the best tool steel, much of which had been absolutely useless for years. Although encountering, at the start, some opposition from men who had pronounced ideas as to the most desirable shapes, which did not coincide with the standards adopted, the system soon proved a great benefit in every respect. While at the beginning we had occasionally to fine a man who would return a tool showing evidence of his having reground it, now we could not induce him to waste the time required to do this. We are convinced that by the adoption of this system we have not only increased the daily output of our machine tools, but also have improved the average quality of the work from them, while at the same time reducing the cost of the cutting-tools and improving the appearance and *esprit* of the shops.

The results of this experience are embodied in our Patent Tool-Grinding Machines, which have been designed to produce and to duplicate with mathematical accuracy the angles and shapes which we have adopted as our standards, or any others that may be desired, and to do this reliably and expeditiously by means of *unskilled labor*.

To efficiently grind steel tools by means of rapid cutting-wheels, it is absolutely necessary that the contact between the two should be a line and not a surface. Hence, if it is desired to grind a plane face of a tool, the wheel must have a cylindrical or conical surface, past which the surface to be ground must be moved in a plane. A plane face of the wheel cannot be used for this purpose,

Universal Tool-Grinding Machines.—(Continued.)

because it and the surface being ground would soon coincide, with the results of no cutting and much heating.

The tool should be clamped in the holder against its base, or the surface upon which it rests when in use, in order to avoid any errors due to want of parallelism of its sides, and to enable it to be reground with a minimum of loss. All of its plane faces should be ground without altering its position in the holder, to insure accuracy of the angles and uniformity in results. This requirement is particularly important in *thread* tools, for the grinding of which these machines are of the utmost benefit. Indeed, if they were capable of nothing else, this one feature of the accurate grinding of thread tools and the consequent maintenance of standards, would make their use profitable.

The tool-holder should be capable of presenting the tool to the wheel in such manner that any face can be so ground as to have a definite, predetermined relation to the other faces and to the shank, and the adjustments necessary to accomplish this must be easily understood and quickly manipulated. It must be so mounted as to enable the tool-face to be easily and quickly reciprocated past the line of cut of the wheel, and to be reliably fed against it and brought to any part of it. The cuts should be light, quick, and frequent, to produce the best results in the shortest time.

Our experiments demonstrated that for roughing-cuts a curved cutting-edge is more efficient than a straight one, and that different materials and different depths of cut require different degrees of curvature; also, that the cut should be a draw-cut and not a gouging-cut, so that the bulk of the metal would be removed ahead of the point of the tool. This adds greatly to its life, the point being the most delicate part. The machines are supplied with holders to be used when grinding curved faces, and gauges for setting the tools in their holders so as to produce our standard shapes as given by the reference tables accompanying the machines, but means are provided for producing any other shapes that may be preferred to those adopted by us. Means are also provided for grinding circular cutting-edges with ease and accuracy; which is a great convenience in forming tools for planing or turning fillets and circular grooves.

For *boring or chasing tools*, which are usually bent at right angles to the shank, a special holder is furnished which, when inserted in the regular holder, enables such tools to be ground in the same manner as the outside turning-tools. The advantage of being able to grind a chasing-tool which will make a female thread having absolutely the same shape and angles as its male mate which has been produced by a tool ground in the same manner, needs no comment.

The only shapes of cutting-edges which cannot be ground on these machines are concave curves and re-entrant angles less than ninety degrees.

A rotary pump forces water to the tool being ground through a system of

PLATE No. 100.



No. 1 UNIVERSAL TOOL-GRINDING MACHINE.

For tools with shanks not over $2\frac{1}{2}$ " by 2". Complete with countershaft, wrenches and the following attachments: *Rotary pump* and jointed pipe system; *chuck for circular and curved tools*; a holder for grinding *bases* of tools; a chuck for grinding a *bent tool* on all faces without changing its position in the chuck; a chuck for holding *splining or key-seating* tools; a *crane* for changing the wheel on its spindle; a *diamond tool* for truing the wheel; twenty-eight sample tools of various shapes, mounted in a frame; *diagrams* giving usual shapes, angles for setting, etc. Fast and loose pulleys, 10" by 6"; 400 revolutions per minute.

Universal Tool-Grinding Machines.—(*Continued.*)

jointed pipes, ending in an adjustable nozzle. This furnishes a large volume of water at low velocity, which can be regulated in amount and directed at will, thus enabling it to be applied in manner and quantity to suit the various conditions, and avoiding the necessity of applying it to the wheel at some distance above the tool, whereby it would attain the velocity of the wheel on reaching the tool and cause an inadmissible amount of splashing. The function of the water is to carry off the heat generated by the grinding, and this arrangement accomplishes this in the most effectual manner and with the least splashing.

The use of such a large quantity of water demands that all working parts should be protected from it, on account of the grit carried along with it. This has been effectually done. In fact, every point about these machines has been carefully studied and thoroughly tried.

The daily product of the machine in our own shops averages something over four hundred tools, which includes new tools and those requiring only a slight retouching, or, in other words, the average requirements of a machine-shop.

THE NO. 1 MACHINE will do all work, after forging, to finish to shape tools whose shanks are not over 2" by 2½". The wheel has two conical grinding surfaces forming a V, with 90 degrees included angle, for convenience in grinding the different faces of tools, for increasing the available grinding surface, and to enable small and delicate splining tools to be ground. The tool-chuck can be rotated about a horizontal axis parallel with the shank of the tool, and can be readily set to any angle by means of a graduated circle and vernier reading to 1/10 degree. It is carried in a frame which can be rotated about a vertical axis passing near the point of the tool, and can be set to 1/10 degree. The frame is carried by two slide-rests at right angles to each other and moving parallel to the tangent planes of the two grinding surfaces. The slide-rests, frame and chuck are all carried by a vertical slide having a long square bearing accurately fitted, and the weight of the moving parts is counterbalanced by a spiral spring, so that, although massive and rigid, it can be reciprocated vertically with surprising ease. The chuck for grinding curved surfaces is inserted in the regular tool-chuck, and a frame carrying a gauge and a roller against which the former-plates work, is put in place in about half a minute. Means are provided by which a tool filed or ground to any desired curved shape can be used as a guide or templet from which a former-plate can be ground in the machine and afterwards used to exactly reproduce the tool or a curve parallel to it. A chuck is provided for grinding the side or base of a tool shank. Also a chuck by which a tool bent at a right angle can be ground the same as a straight tool without changing its position in the chuck. The V shape of the wheels permits the use of a chuck for grinding delicate splining tools.

While the machine is massive and rigid, yet the facilities are such that all

PLATE No. 101.

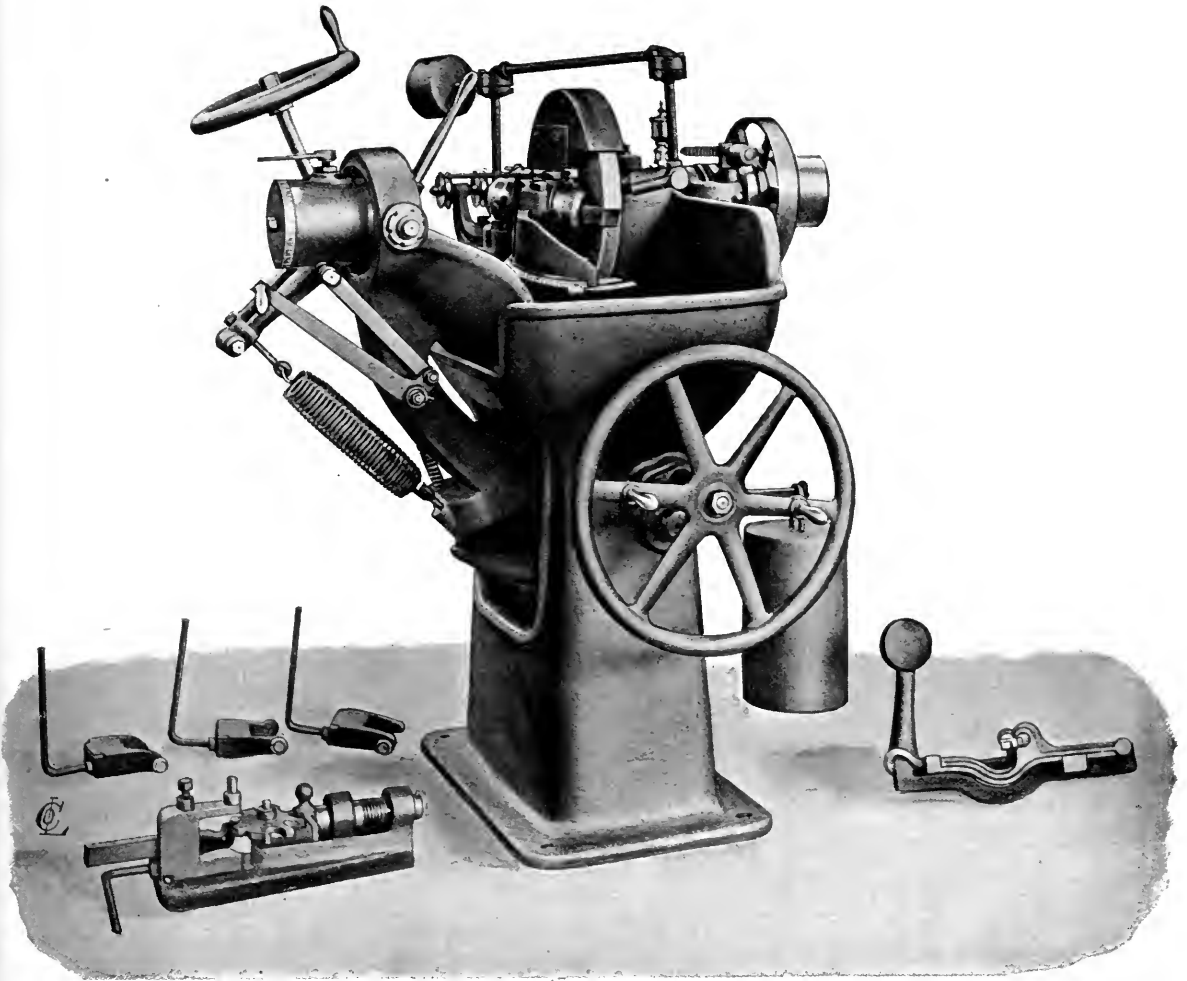

No. 2 UNIVERSAL TOOL-GRINDING MACHINE.

For tools with shanks not over 2" by $1\frac{1}{2}$ ". Grinding wheel of ordinary shape, 15" diameter, with axial reciprocating motion which can be instantly stopped or started. Graduated arcs by which the clearance angles can be read direct. Complete with *rotary pump* and jointed pipe arrangement and the following attachments: Holders for *curved face tools*, one for *straight* right or left hand, one for *bent* right hand, one for bent left hand, and one for *circular* tools. A *gauge* for setting curved face tools in the holders. A *chuck* for grinding any bent tool on all its faces without changing its position in the chuck. *Tables* and *diagrams* giving cutting and clearance angles of all tools. A *diamond tool* for truing wheel, and *frame* with twenty-eight sample tools. Countershaft complete and all necessary wrenches. Fast and loose pulleys, 10" diameter, 5" face, to make 360 revolutions per minute.

Universal Tool-Grinding Machines.—(Continued.)

the operations can be easily and quickly performed, and its stiffness enables it to do very accurate work.

THE NO. 2 MACHINE will do all work, after forging, to finish to shape tools whose shanks are not over $1\frac{1}{2}$ " by 2", excepting those splining tools whose cutting section is so small that it is made as a projection from a cylinder. Two such tools are illustrated in Plate No. 104. With this exception it will do all, within its limit as to size, that the large machine will do. Its movements are all convenient, light, and quick, while at the same time it is amply heavy to do excellent work on any tool which can be held in its chucks. Its design is less expensive in proportion to its capacity than the larger machine, but it will grind the majority of the tools used in a machine shop.

The grinding wheel is of the ordinary shape, the cylindrical surface only being used. The axis has a reciprocating motion which can be instantly stopped or started. This makes smoother work with a coarser wheel, keeps the wheel surface true, and improves the lubrication of the spindle. The chuck for grinding plane faces is so mounted that any angular face can be properly presented to the wheel by reading the graduated circle direct for the required clearance angle.

In addition to the attachments enumerated above, we furnish with each tool-grinding machine, a substantial diamond tool for truing the emery wheel; diagrams mounted on convenient boards showing the grinding angles for all usual forms of tools, and a neat frame containing twenty-eight sample steel tools illustrating the various shapes.

In addition to grinding the tools shown in the plates herewith, various other applications of these machines have been made; among which may be mentioned, *grinding double end cutters for boring bars*, special tools for rotary planers, inserted teeth for heavy saws, round punches, etc., all of which require special chucks or holders, not included in the usual equipment.

Cylindrical punches of hardened steel can be ground to exact diameter with plain flat ends or with centering teats.

PLATE No. 102.

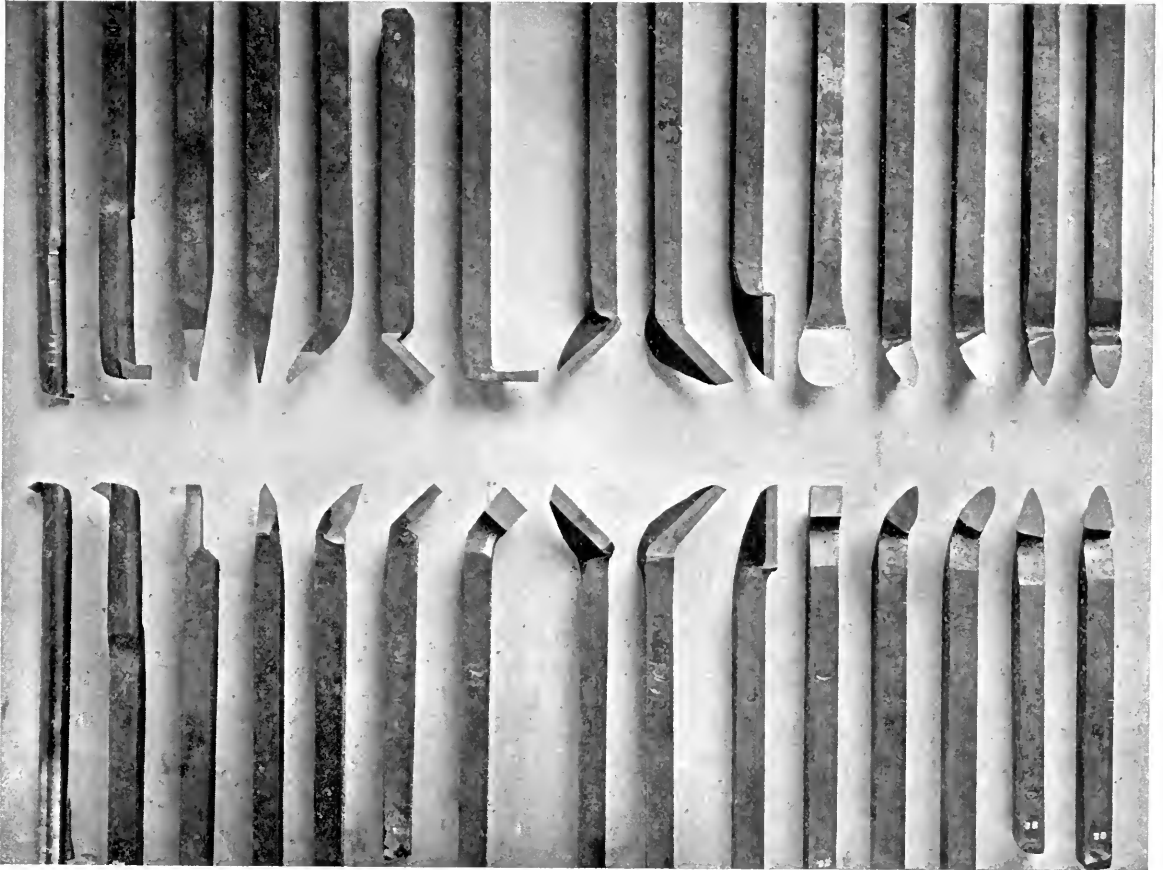

EXAMPLES OF LATHE TOOLS FINISHED TO SHAPE BY THE
TOOL-GRINDING AND SHAPING MACHINE.

PLATE No. 103.

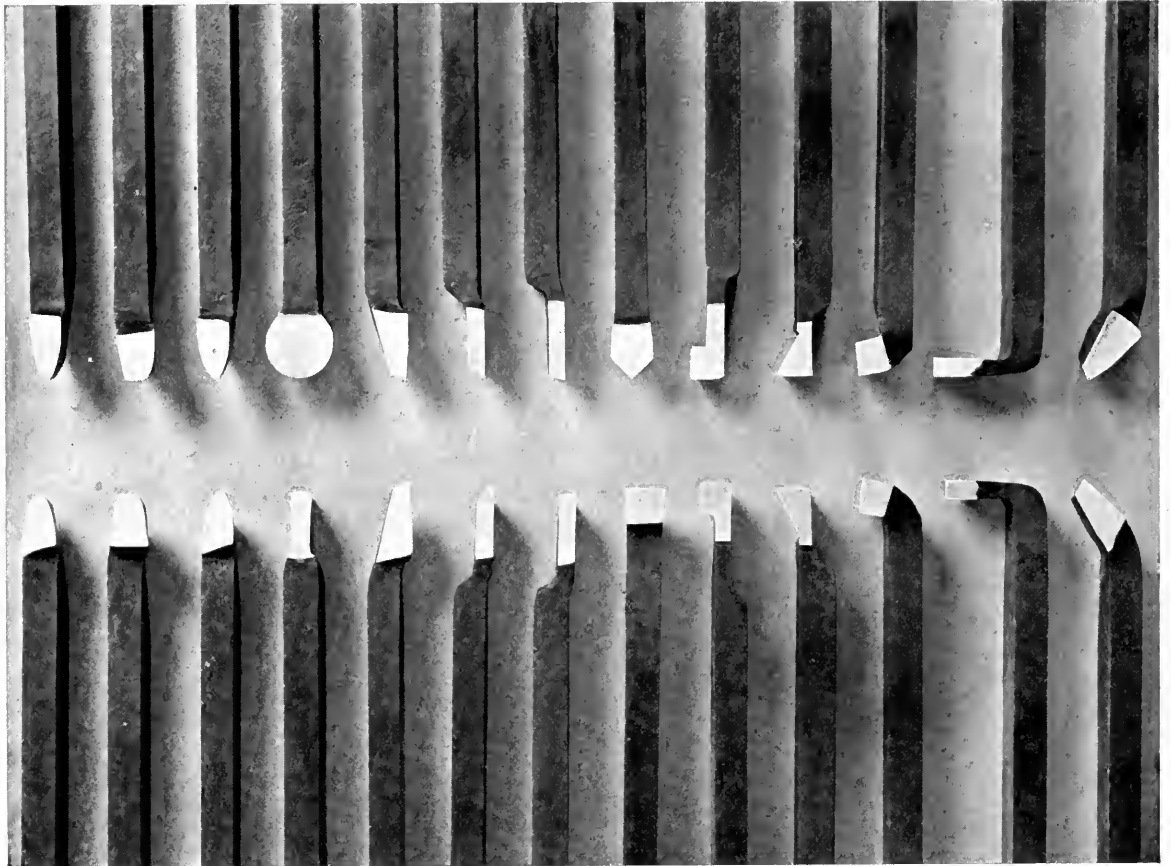

EXAMPLES OF PLANER TOOLS FINISHED TO SHAPE BY THE
TOOL-GRINDING AND SHAPING MACHINE.

PLATE NO. 104.

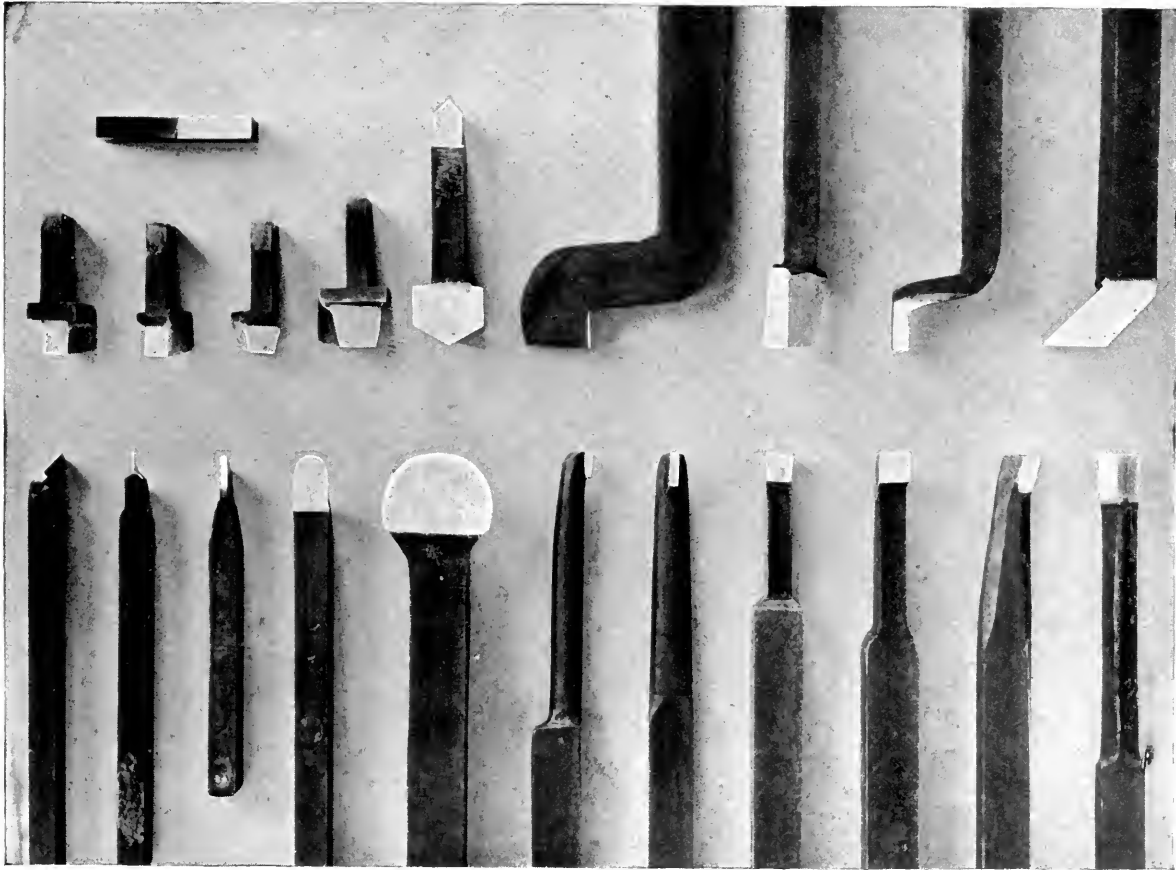

EXAMPLES OF MISCELLANEOUS THREAD, BORING, SLOTTING, AND OTHER
TOOLS OF DIFFICULT SHAPES,
FINISHED BY THE TOOL-GRINDING AND SHAPING MACHINE.

PLATE NO. 105.

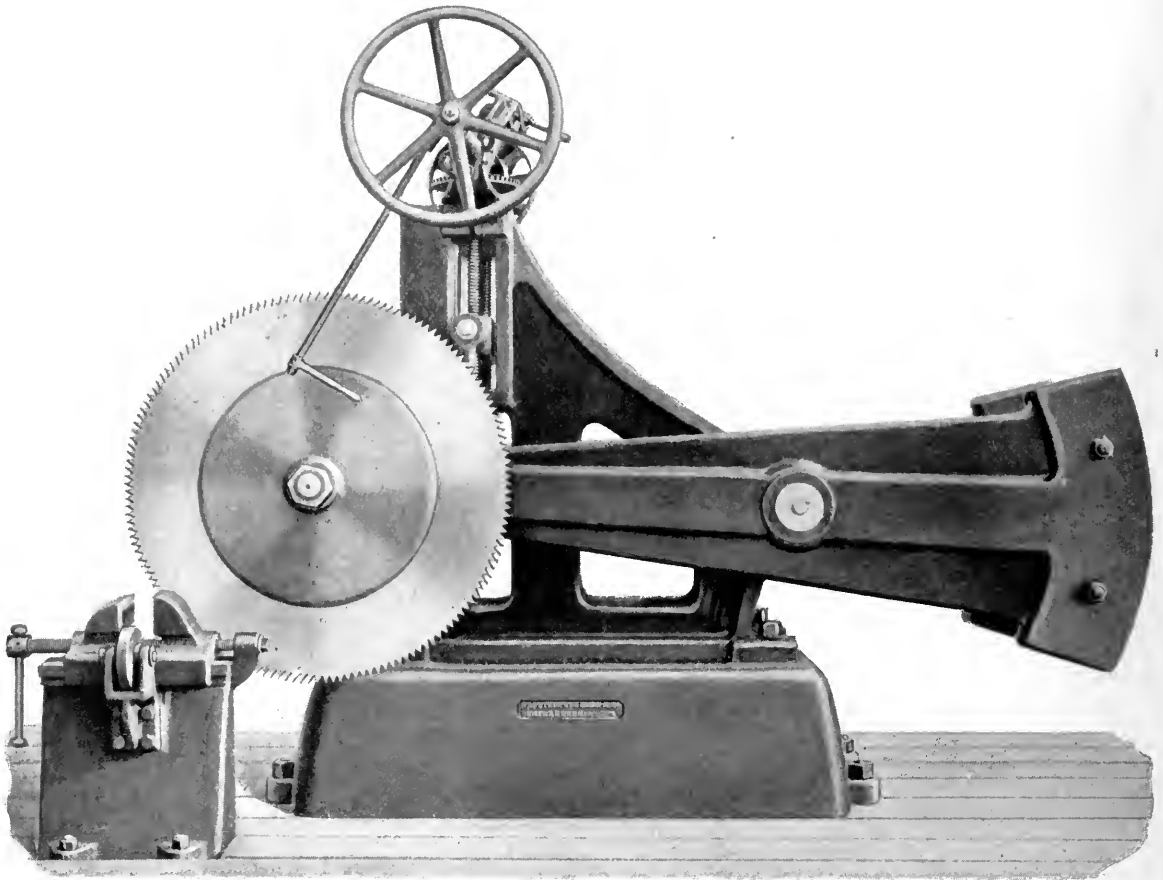

COLD SAW.

Especially adapted for cutting with great rapidity rails, beams, etc., either hot or cold, by melting or burning the steel. The saw, 48" diameter, is carried upon a heavy steel spindle by a balanced swing frame with lifting gears, operated by fast and loose pulleys, open and cross belts. Machine is driven from pulley situated behind it, either on a countershaft or an independent high-speed engine, the latter preferred. The centre of the pulley shaft should be at the same height as the fulcrum shaft carrying the frame of the saw. Every precaution is taken to insure good running at the high velocity required. The pulley is 12" diameter for 12" belt, and should make about 1800 revolutions per minute. For cutting beams we usually use a 60" saw, and provide, instead of a clamp vise, a *bed-plate with bolt slots*.

PLATE No. 106.

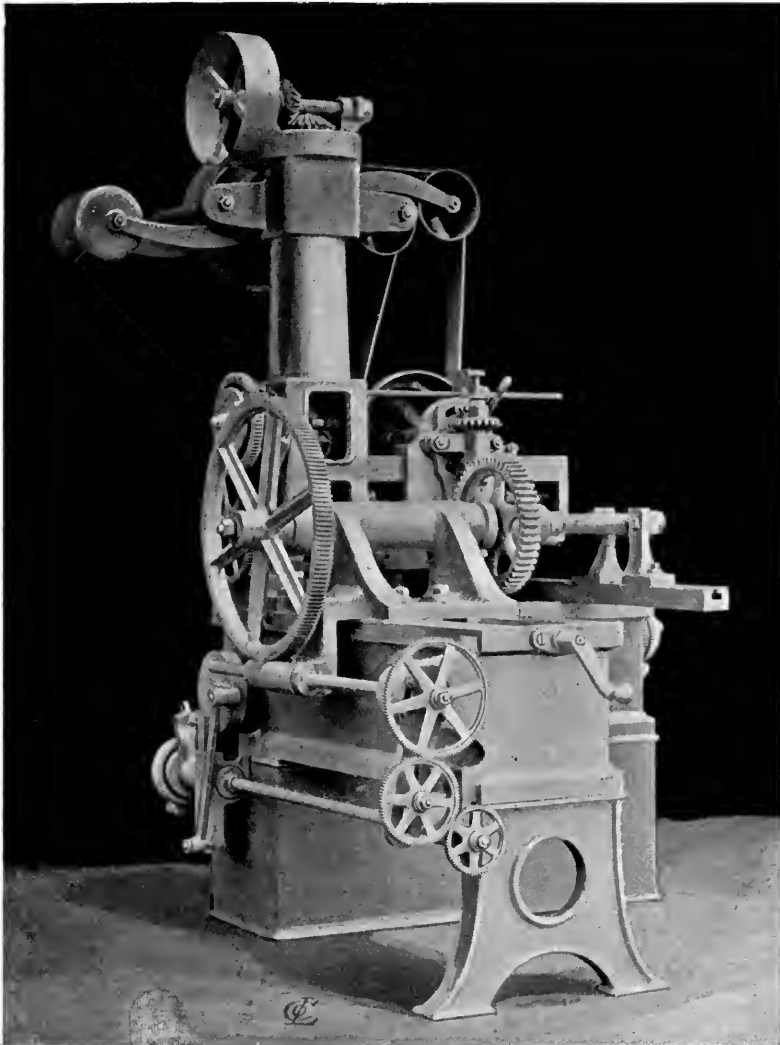

GEAR-CUTTING AND WHEEL-DIVIDING MACHINE.

Automatic in all its motions; arranged to cut bevel and spur wheels to 4 ft. 6" diameter and 12" face. Division made by wheel and tangent screw carefully constructed. One full set of change wheels to effect division of wheels from 10 up to 360 teeth. Feeds self-acting and variable. Complete with countershaft, change wheels, cutter mandrel, sample work arbor, steady rests and wrenches. Fast and loose pulleys, 14" for 4" belt, should make 120 revolutions per minute. Variable feed, three cutting speeds, quick return. One man can attend four machines.

PLATE No. 107.

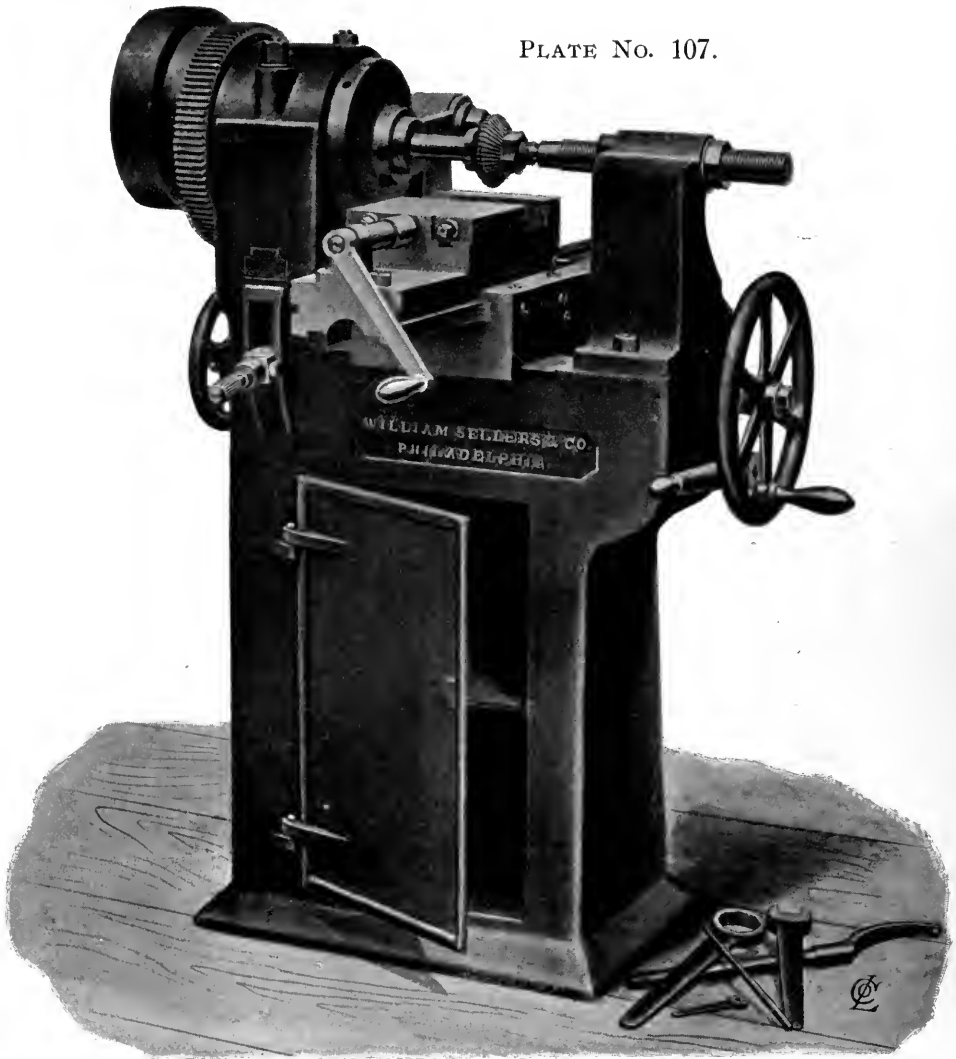

MILLING MACHINE.

WITH SEPARATE OUTBOARD SUPPORT FOR CUTTER MANDREL.

Height from centre of spindle to table, adjustable from 7" to 11". Table, 8½" wide by 29½" long. Cutter mandrel, 1¼" diameter. Traverse of table, 14", operated through power friction feed of wide range. Saddle carrying table, adjustable along bed by hand for 4½". Clamp vise, with hardened steel jaws, 7" long by 1¼" deep. Opening of vise, 3". Table provided with stops to limit stroke, and quick hand traverse for adjustment. Complete with countershaft, wrenches, and clamp vise. Fast and loose pulleys on countershaft, 10" diameter, 4" face, and should make 150 revolutions per minute.

PLATE NO. 108.

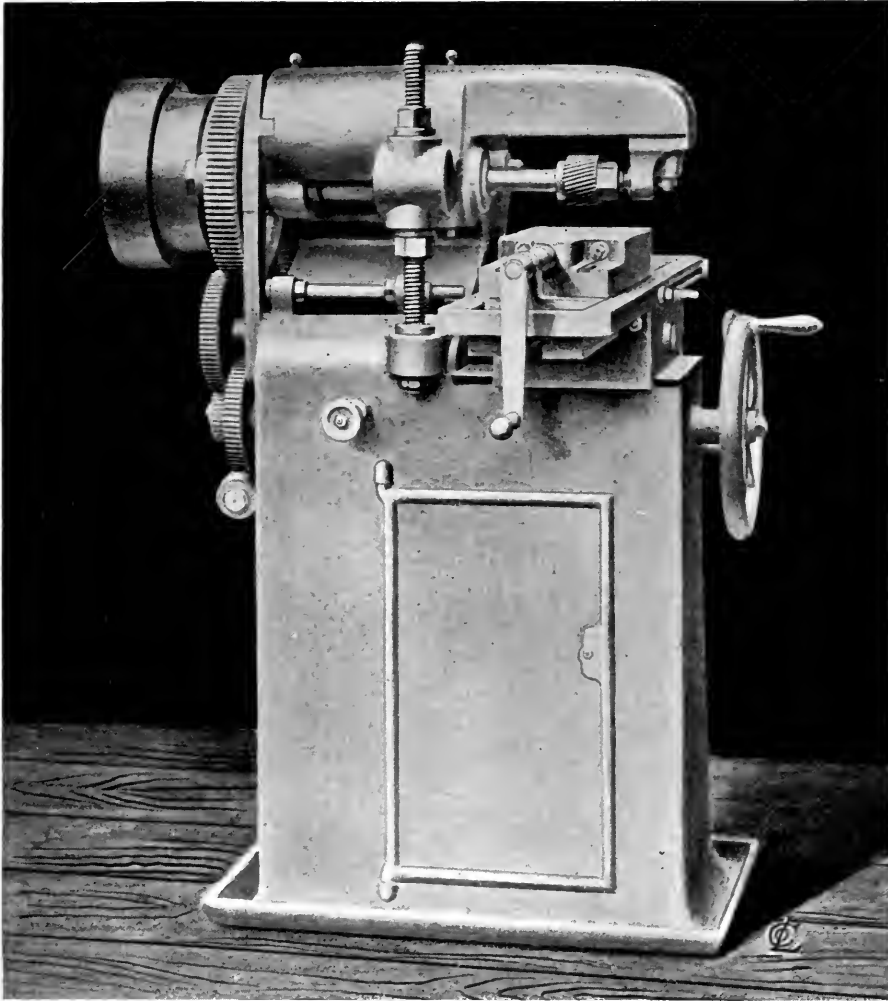

MILLING MACHINE.

Height of spindle adjustable above table from 7" to 11". Longitudinal adjustment, $4\frac{1}{2}$ ". Transverse movement of table across bed, 14". Longitudinal movement by hand; traverse of table by hand or power, with adjustable friction feed and automatic adjustable stop. Vertical and transverse movement adjustable by double screw to take up lost motion. Machine complete with countershaft, clamp vise with jaws 7" long, depth $1\frac{1}{4}$ ", opening 3", cutter mandrel, and wrenches. Fast and loose pulleys on countershaft, 10" diameter, 4" face, and should make 150 revolutions per minute.

PLATE NO. 109.

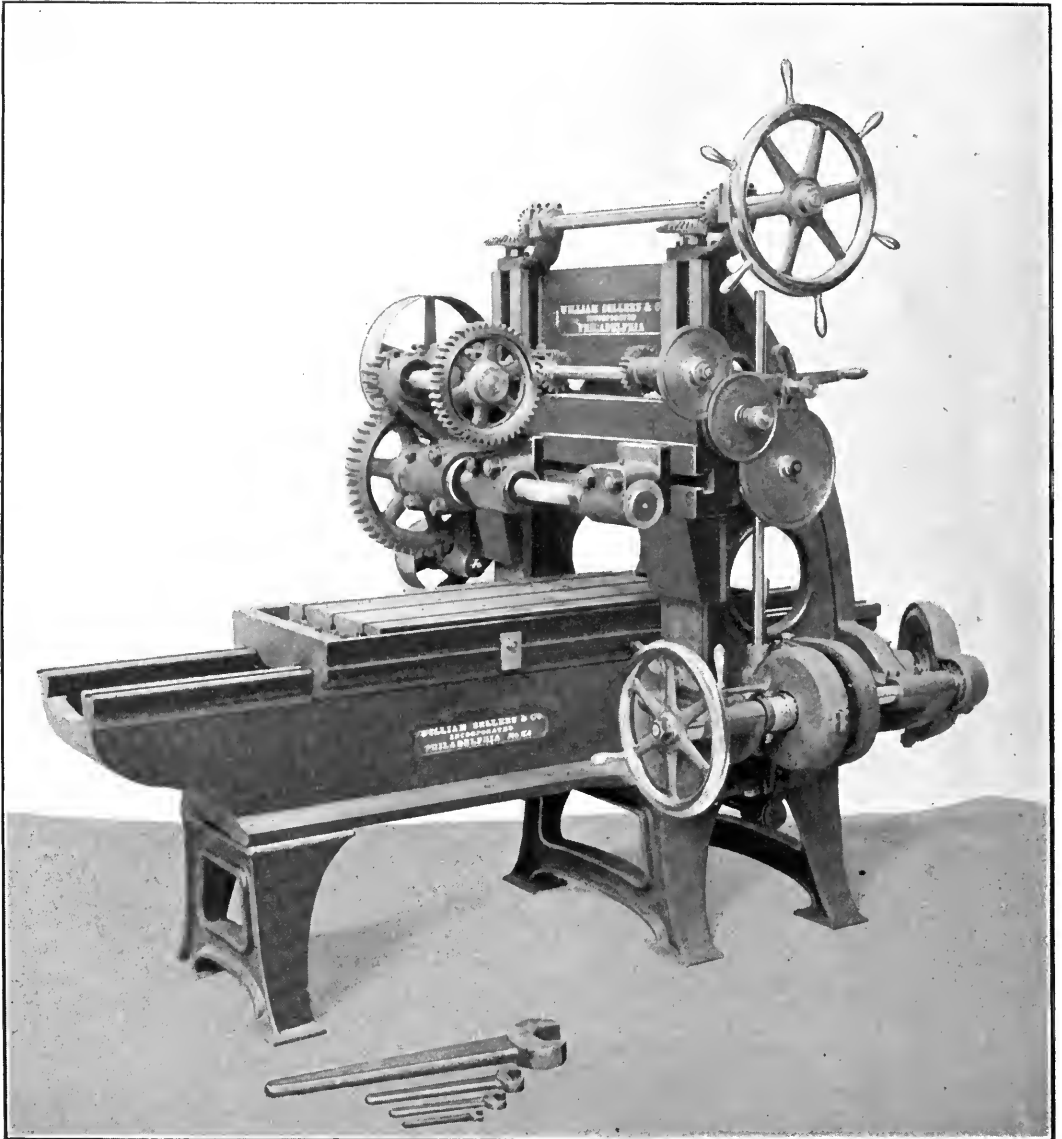

25" SLABBING MACHINE—4 FT. TABLE.

Width between housings, 24". For plain milling on short work. Table made any length required. Spiral pinion drive like that on our planers. Automatic friction feed variable from $\frac{3}{8}$ " to 8" per turn of cutter. Gibbed table and crosshead. Oil pump, tanks and circulating system when required. Automatic knockout stops feed at end of stroke. Quick hand adjustment. Made, when so ordered, with special turn over *damp vise* for milling test coupons from boiler plate. Vise holds specimens aggregating 12" thick. Fast and loose pulleys, 24" diameter for 6" belt. Speed 210 revolutions per minute.

PLATE No. 110.

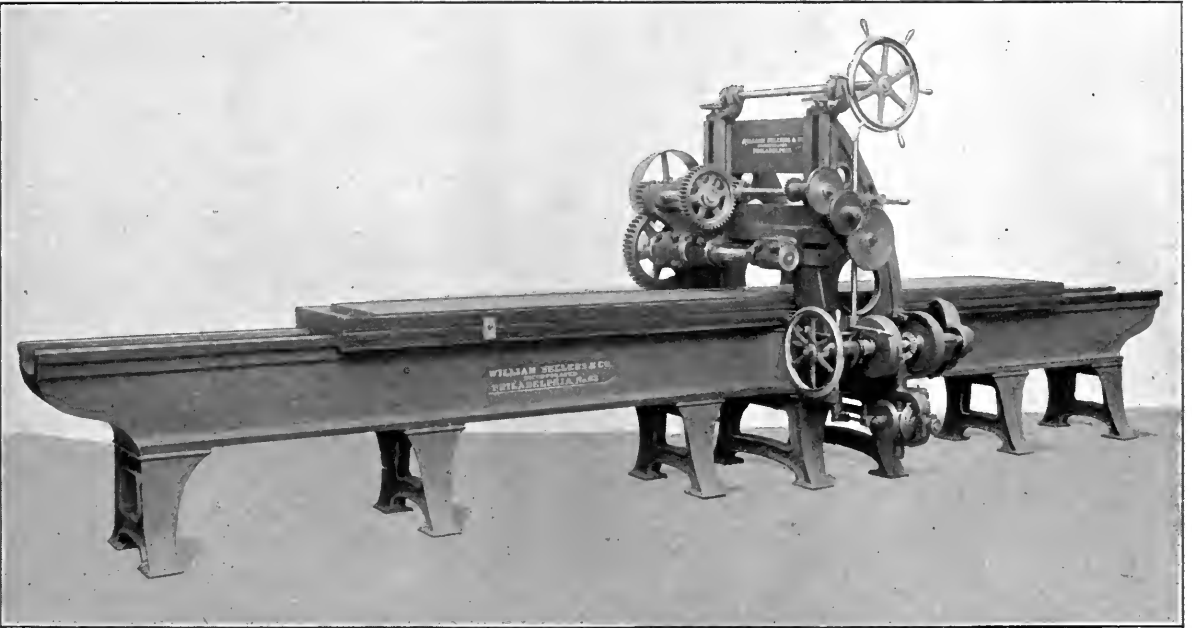

25" SLABBING MACHINE—12 FT. TABLE.

Width between housings, 24". Adapted for milling connecting rods, side bars, etc., cutting keyseats in heavy shafts and other milling operations. Made also with shorter or longer table as required. Table operated by spiral pinion same as our planing machines. Cutter mandrel or arbor 2" diameter; movable supports adjustable to suit width and position of cutter. Improved friction feed, variable from $\frac{3}{8}$ " to 8" per turn of cutter. Table runs in flat bearings with holding-down shoes. Crosshead securely gibbed to uprights. Stop motion for table and friction clutch to prevent recoil. Table has quick power traverse and easy hand adjustment. Automatic stop for feed. Oil pump, circulating pipes and tanks. Will take cutter 8" diameter. Made also for 12" cutter. Made also with variable speed countershaft. Very powerful and efficient. Countershaft pulleys, 16" diameter for 5" belt, should make 250 revolutions per minute, or with variable speed countershaft, 360.

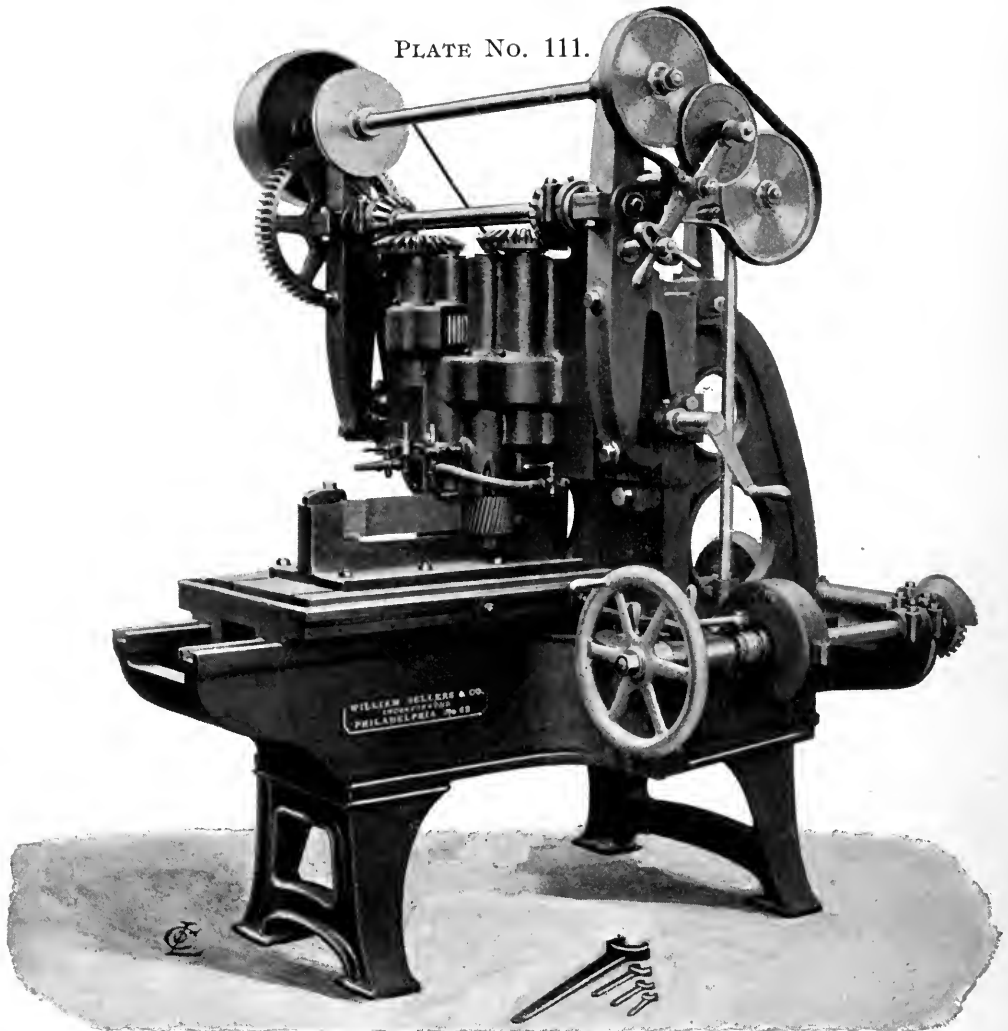

TWO-SPINDLE VERTICAL MILLING MACHINE—FOR TEST SPECIMENS.

The plate coupons are clamped in a chuck to a thickness of about 3". Two cutters are fed together by right and left screws to proper distance as determined by a gauge piece. The automatic feed of the table passes the specimens between the cutters, reducing the central portion to the required width. Variable friction feed, quick hand adjustment, and automatic stop or "knock-out" for end of stroke. Table gibbed to bed, driven by screw and nut, full stroke, 32". Complete with chuck, two sample cutters, wrenches, pump and circulating pipe system, and countershaft. Fast and loose pulleys, 12" diameter, 3½" face. 290 rotations per minute.

PLATE No. 112.

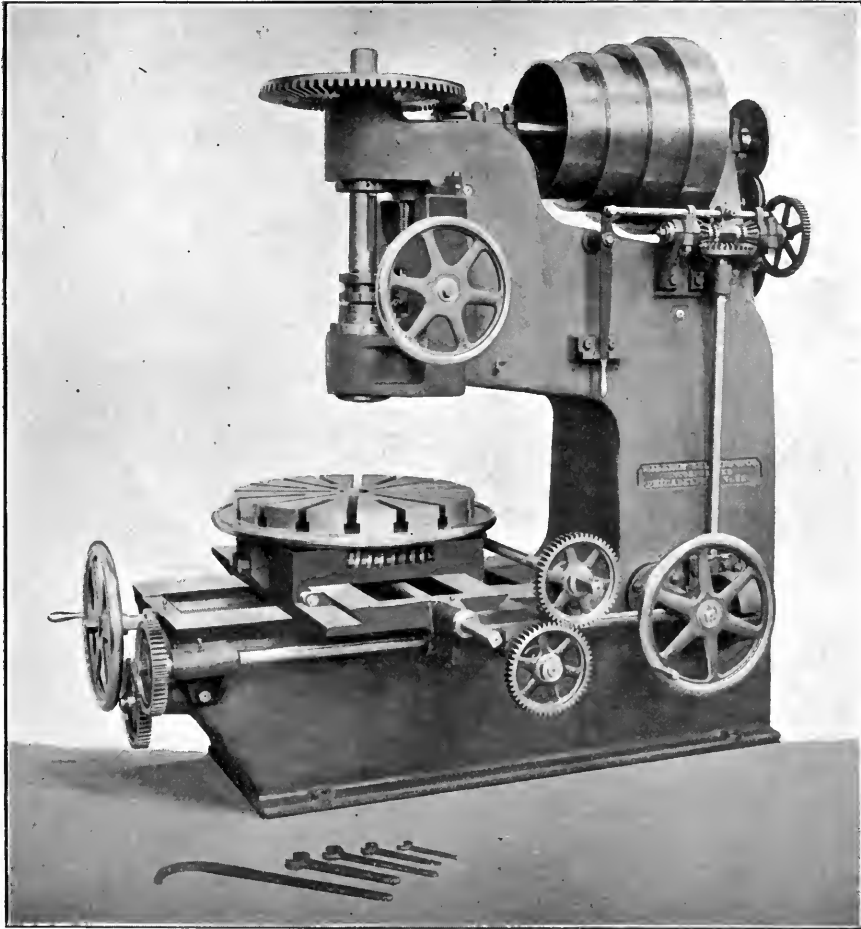

27" VERTICAL MILLING MACHINE.

Overreach of spindle, 27". Circular table, 26" diameter (or 30" if required). Vertical movement of slide carrying spindle, 8". Travel of saddle on bed, 26". Cross travel of table, 28". Power feed to table in all directions through improved friction arrangement. Complete with pump, tank and circulating system, sample arbor for cutter, countershaft and wrenches. Fast and loose pulleys, 22" diameter, 5" face. Speed 150 revolutions per minute.

PLATE No. 113.

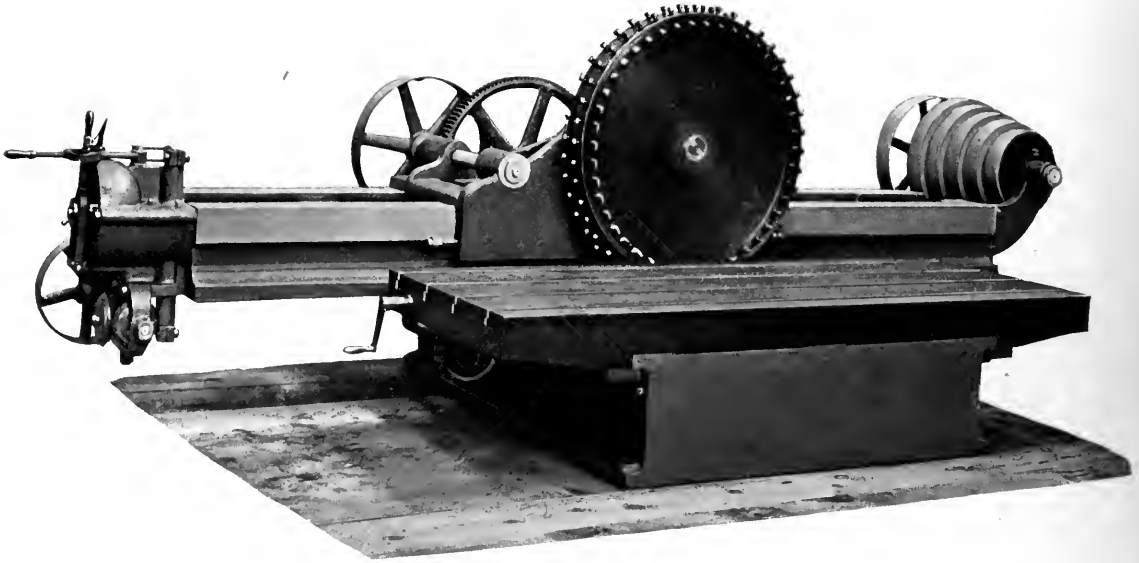

ROTARY PLANER.

WITH 36" CUTTER-HEAD, TO FINISH WORK 6 FEET LONG.

This machine is provided with 44 tools, arranged in a circle of 36" internal diameter. Cutter-head is carried upon a heavy spindle, and supported by an extended bearing which is as large as the head itself, and relieves the spindle of bending strain. The saddle carrying this cutter-head is 54" long, and is gibbed to place with large brass shoes. Cutter-head is driven by belt without use of long shafts and sliding keys. The power feed is adjustable, and varies from $\frac{1}{8}$ " per revolution of the cutter-head to 4". Rapid power traverse is arranged for moving head quickly to place, and the two levers operating the feeding and traversing mechanism are interlocked to prevent both being thrown in at the same time. The table shown in the plate is 8 ft. long by 36" wide, and is adjustable to and from the cutter-head to regulate the amount of feed. Fast and loose pulleys on countershaft are 24" diameter for 4" belt, and should make 260 revolutions per minute.

N. B.—*These machines are made with various lengths of travel and different arrangements for supporting work.*

PLATE NO. 114.

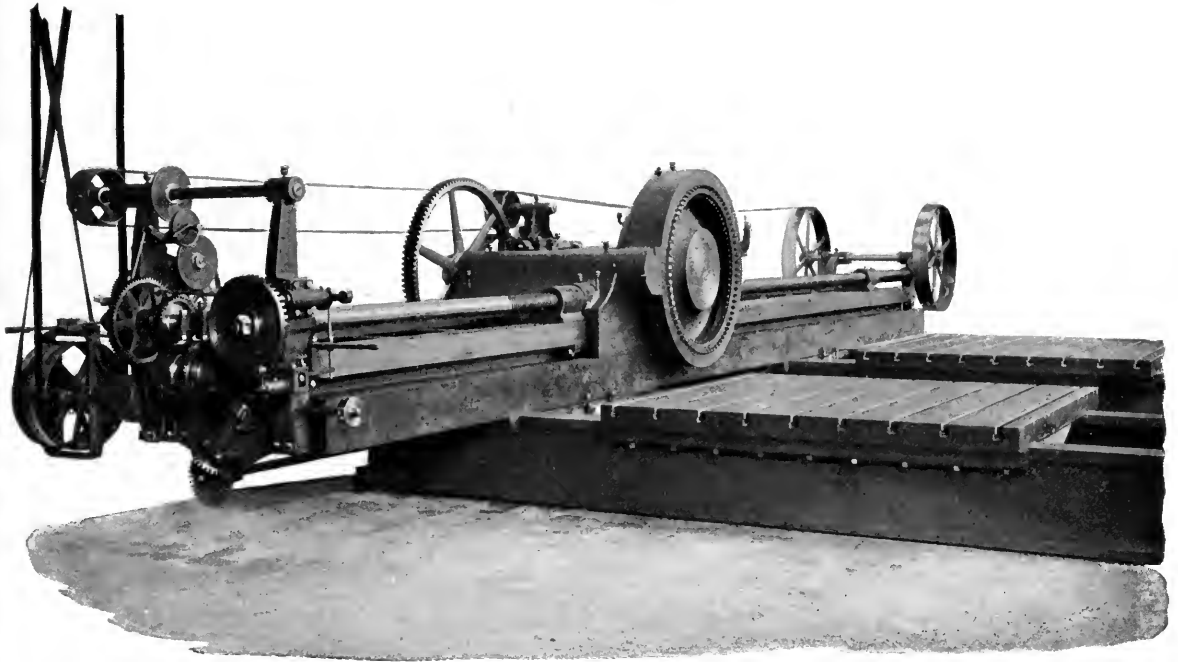

ROTARY PLANER FOR ARMOR PLATES.

The cutter-head having 75 tools, arranged in circle 50" diameter, will plane work 26 ft. long, carried upon two tables, each 8 ft. long by 7 ft. 6" wide. These tables are adjustable to and from the cutter-head by power to regulate depth of cut; the head is provided with power traverse at the rate of 20 ft. per minute for adjustment and variable friction feed. Power is conveyed to head by belts without use of long shafts and sliding bearings. Machine complete with countershaft, wrenches, and sample set of cutters. Fast and loose pulleys on countershaft 24" by 5½" face, and should make 400 revolutions per minute.

NOTE.—The cutter-head and saddle of this machine were designed to meet a demand for a more powerful and more rigid tool than any in the market, and special attention was paid to strength of parts and arrangement and size of bearings. *We make this machine with various forms of table and for bridge-work, arrange it to swivel.*

PLATE NO. 115.

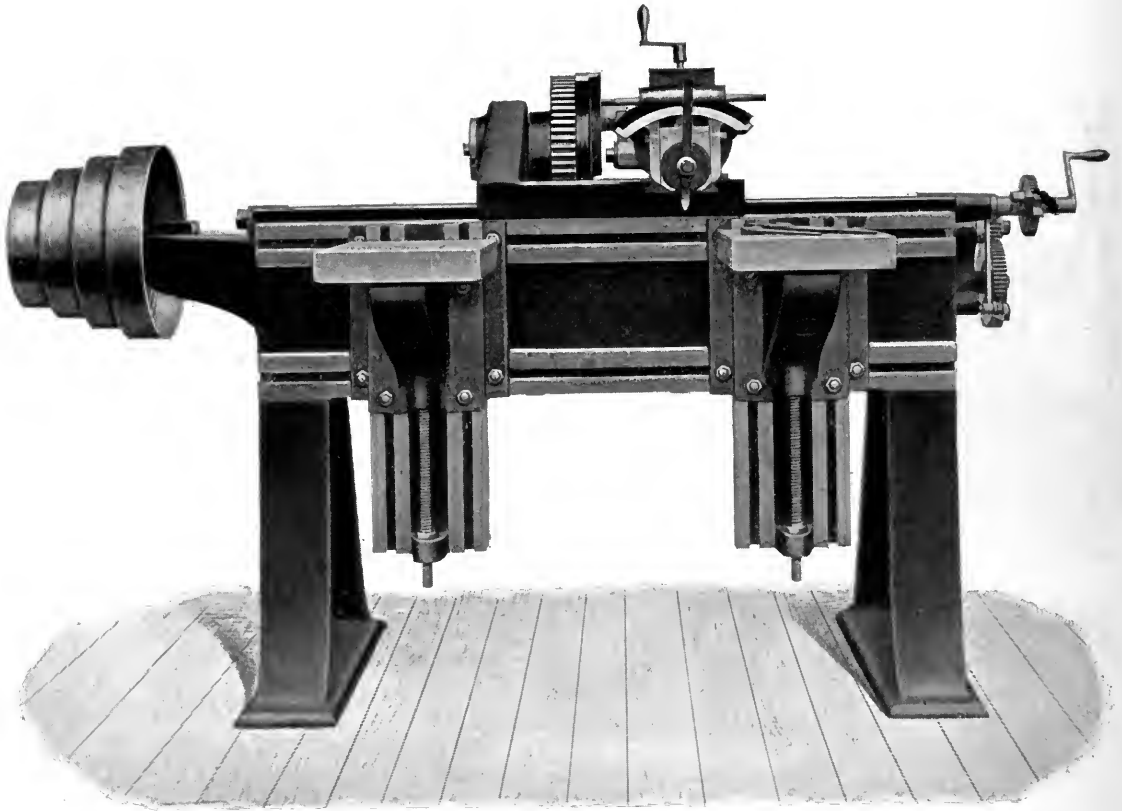

12" SHAPING MACHINE.

Stroke adjustable from 0" to 12", with Whitworth motion, giving uniform cutting speed and quick return. Shaping bar adjustable .18" in addition to the stroke. Bed 4 ft. 10½" long. Movement of saddle on bed, 48". Tables adjustable vertically and horizontally. Extreme distance between outer edges of tables, 58". Greatest distance between table and shaping bar, 13½". Overhang of tables, 19". Vertical feed of tool, 5". Motions for straight, curved, vertical, and angular work. *Revolving hollow spindle in bed to carry mandrels and cones for circular work, damping vise, and centre-heads with index plate, furnished to order.* Countershaft with two sets of fast and loose pulleys, one for short stroke, 8" by 4", to run 200 revolutions, and one for long stroke, 16" by 4", to run 66 revolutions per minute. We also make a smaller shaping machine having 9" stroke. Bed 3 ft. 8" long. Traverse of head, 36".

PLATE NO. 116.

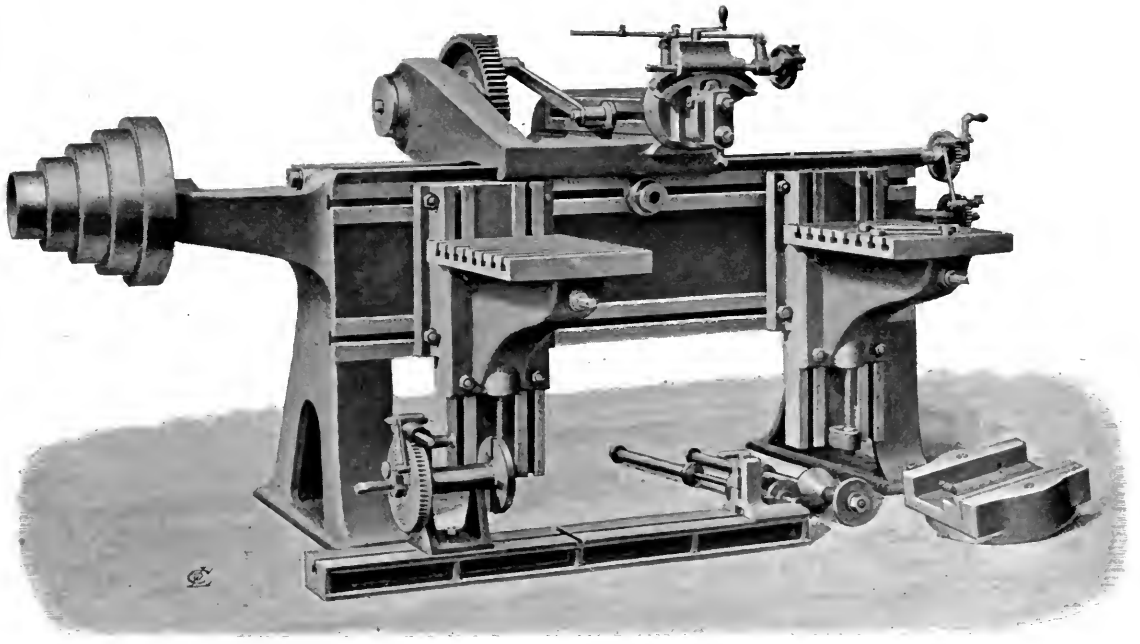

16" SHAPING MACHINE.

Stroke adjustable from 0" to 16", with Whitworth motion, giving uniform cutting speed and quick return. Shaping bar adjustable 25" in addition to the stroke. Bed 6 ft. 5" long. Movement of saddle on bed, 66". Tables adjustable vertically and horizontally. Extreme distance between outer edges of tables, 77". Greatest distance between table and shaping bar, 16½". Overhang of tables, 23". Vertical feed of tool, 6½". Motions for straight, curved, vertical, and angular work. *Revolving hollow spindle in bed to carry mandrels and cones for circular work, clamping vise, and centre-heads with index plate, furnished to order.* Countershaft with two sets of fast and loose pulleys, one for short stroke, 10" by 4", to run 380 revolutions, and one for long stroke, 18" by 4", to run 135 revolutions per minute.

PLATE NO. 117.

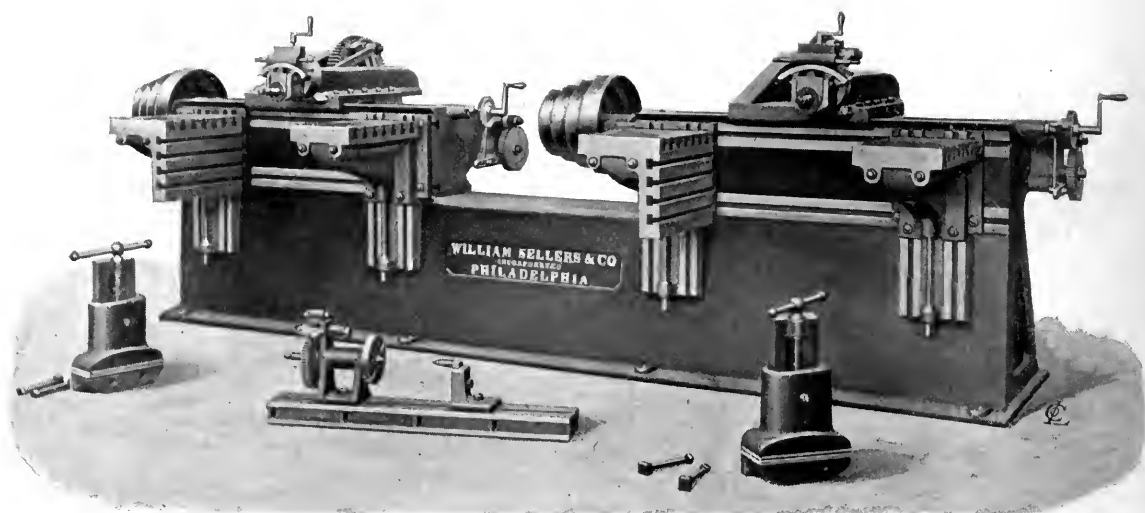

DOUBLE SHAPING MACHINE.

Two 12" shaping machines on one base, 13 ft. long. Stroke of each machine adjustable from 0" to 12", with Whitworth quick return motion. Shaping bar adjustable 18" in addition to stroke. Movement of each saddle, 48". Tables adjustable vertically and horizontally. Extreme distance between outer edges of tables on each machine, 58". Extreme distance between outer edges of outer tables, 13 ft. Overhang of tables, 19". Vertical feed of tools, 5". Motions for straight, curved, vertical, and angular work. Each machine driven independently. Can be used as two machines or as one, according to the length of the pieces to be planed. *Revolving hollow spindle in one or both beds to carry mandrels and cones for circular work*, clamping vise, and centre-heads with index plate furnished to order. Two countershafts, each with two sets of fast and loose pulleys, one for short stroke, 9" by 4", to run 200 revolutions, and one for long stroke, 16" by 4", to run 66 revolutions per minute.

PLATE NO. 118.

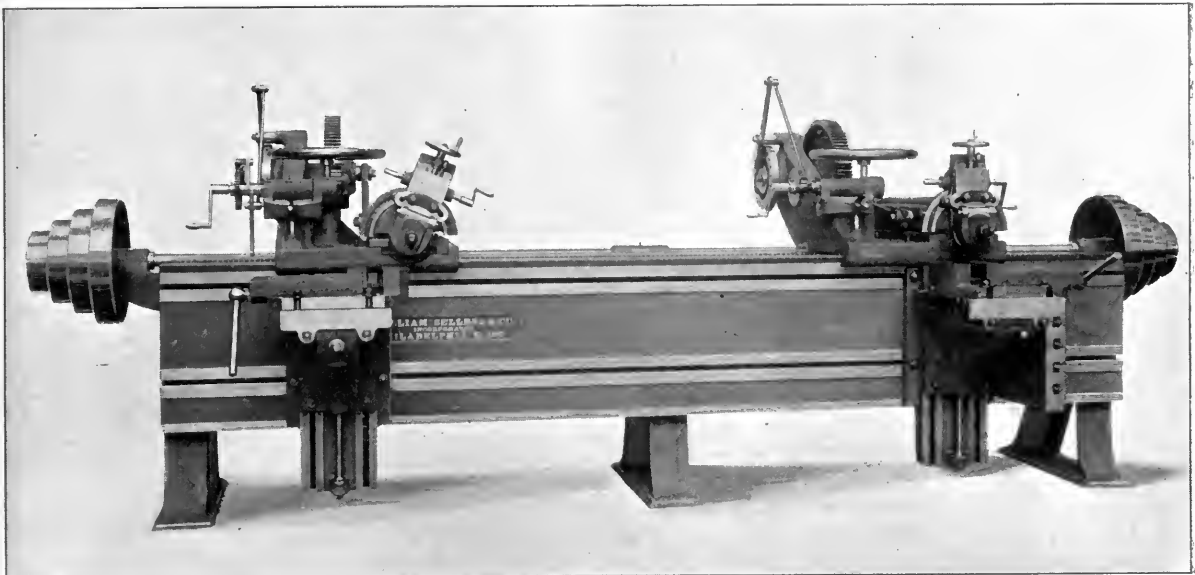

18" DOUBLE SHAPING MACHINE.

With two independent heads driven at opposite ends of the bed, which is 14 ft. long. Two adjustable tables 23" long by 16" wide, one having vertical surface 18" deep. Tables adjustable vertically 12". Vertical travel of tool slide, 7½". Adjustable feed motion carried on travelling head. Rapid traverse by rack and pinion. Very stiff and powerful machine. Two speed countershafts with 20" pulleys, making 140 revolutions per minute, and 12" pulleys making 570 revolutions per minute, all for 4" belt.

Made also with one head, and two tables, bed being 7 ft. long. Can be furnished with circular feed.

PLATE No. 119.

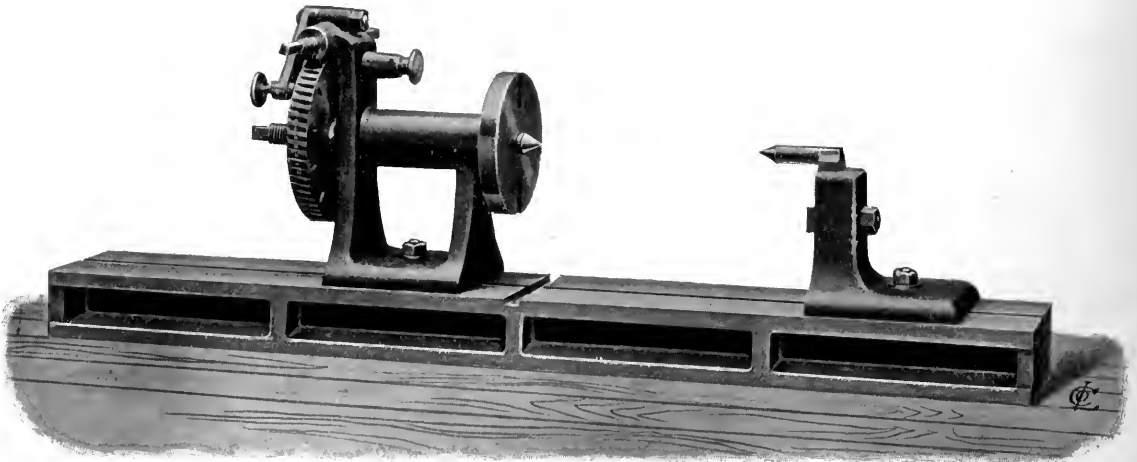

CENTRE-HEADS AND BAR FOR SHAPING MACHINES.

These are of different capacities to suit different sizes of shapers. One head is provided with worm rotating gear, and adjustable centre and a carefully made dividing plate with five or six rows of holes and screw stop; there is also a spring stop, fitting twelve equally spaced slots, useful for a variety of work, as the changes can be made very quickly. One of the centres is adjustable in height for taper work. The diameter of the circle which will swing between the centres is equal to the nominal capacity of the shaper.

SINGLE SHAPERS—USUAL SIZES.

Size and Stroke.	Length to Plane.	Total Length of Bed.	Countershaft Pulleys.	
			Size.	Speed.
9"	36"	3 ft. 8"	6" x 2½"	400
			10" x 2½"	150
12"	48"	4 ft. 10½"	9" x 4"	200
			16" x 4"	66
16"	66"	6 ft. 5"	10" x 4"	380
			18" x 4"	135
18"	72"	7 ft.	12" x 4"	570
			20" x 4"	140

PLATE No. 120.

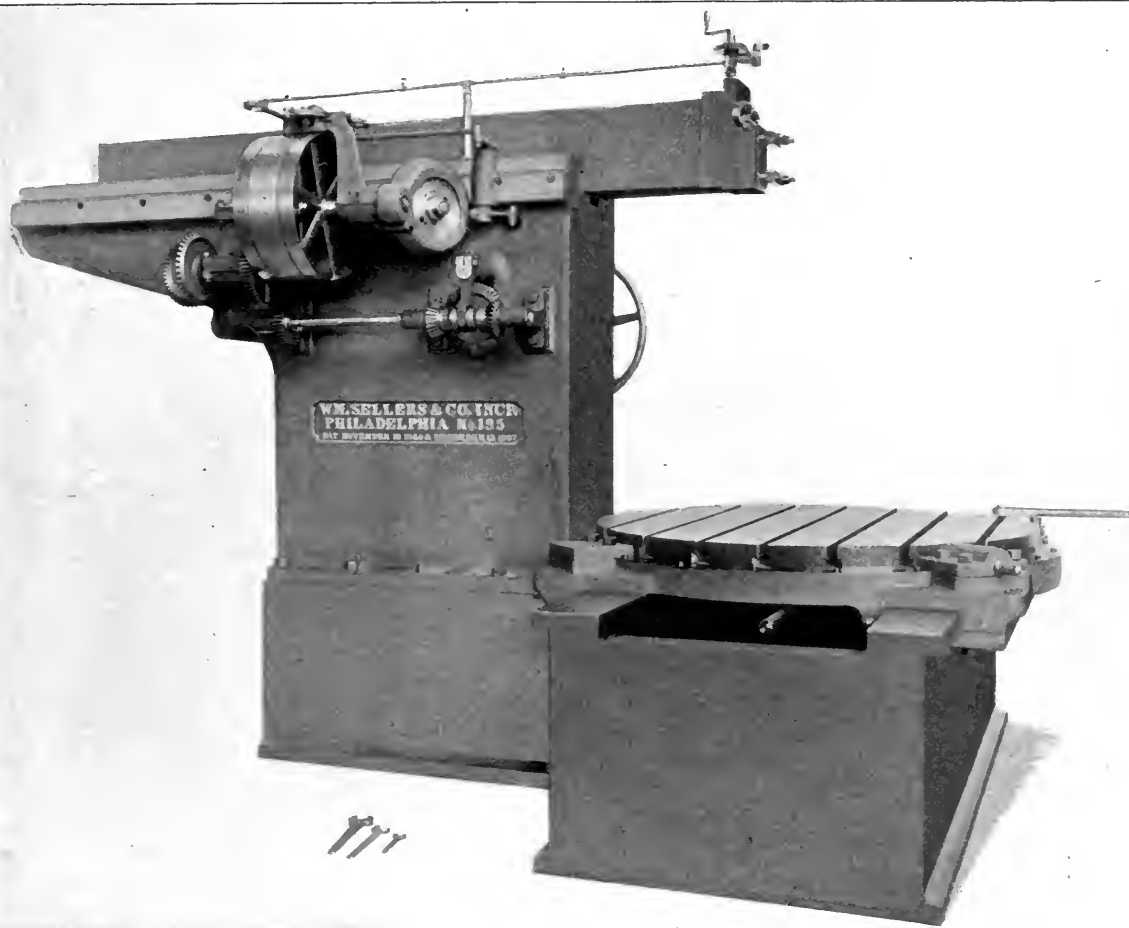

CYLINDER SHAPER.

For planing valve seats and ports on locomotive cylinders. Stroke adjustable to 48" maximum. Bar operated by spiral pinion and rack like our planers. Has *quick return at four times the cutting speed*. Circular table 5 ft. diameter, has 4 ft. traverse on bed. Height from table to underside of bar 46". Vertical stroke of tool slide 6". Table has quick power traverse, hand adjustment and variable power feed from 0" to $\frac{3}{4}$ ". Table rotated by pinion and provided with stop pin to set it at 90 degrees.

PLATE NO. 121.

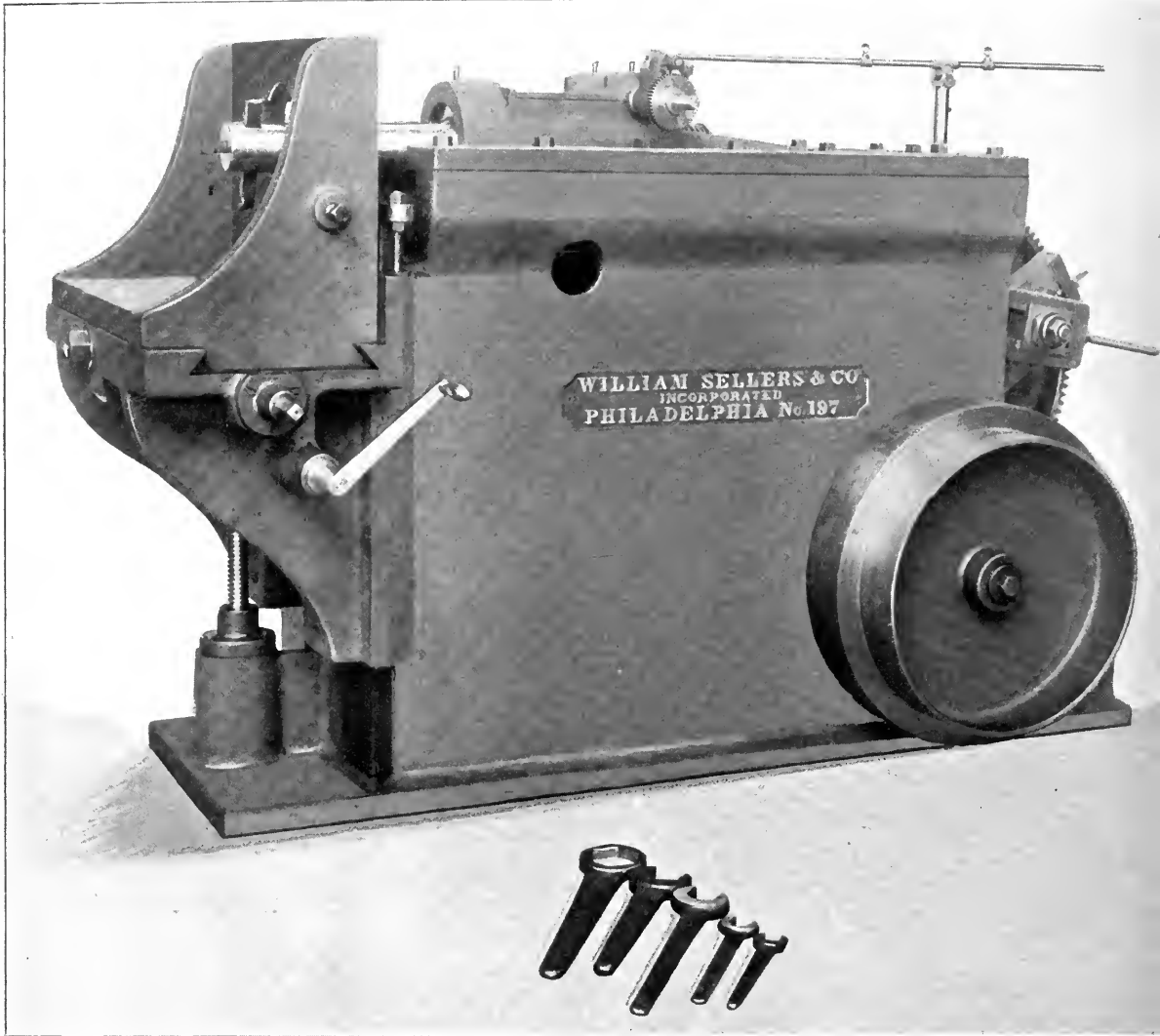

14" DRIVING BOX SHAPER—WITH CIRCULAR FEED.

A very massive and substantial machine especially designed for planing out the semicircular bearing in locomotive driving boxes to take brass bushing. Width between ribs on knee for holding work, 26". Vertical adjustment of bracket, 8". Knee for holding work has cross travel on bracket. Stroke adjustable up to 14" maximum with quick return motion. Cutter bar has automatic circular feed. Machine complete with countershaft, cutter bar and wrenches.

PLATE NO. 122.

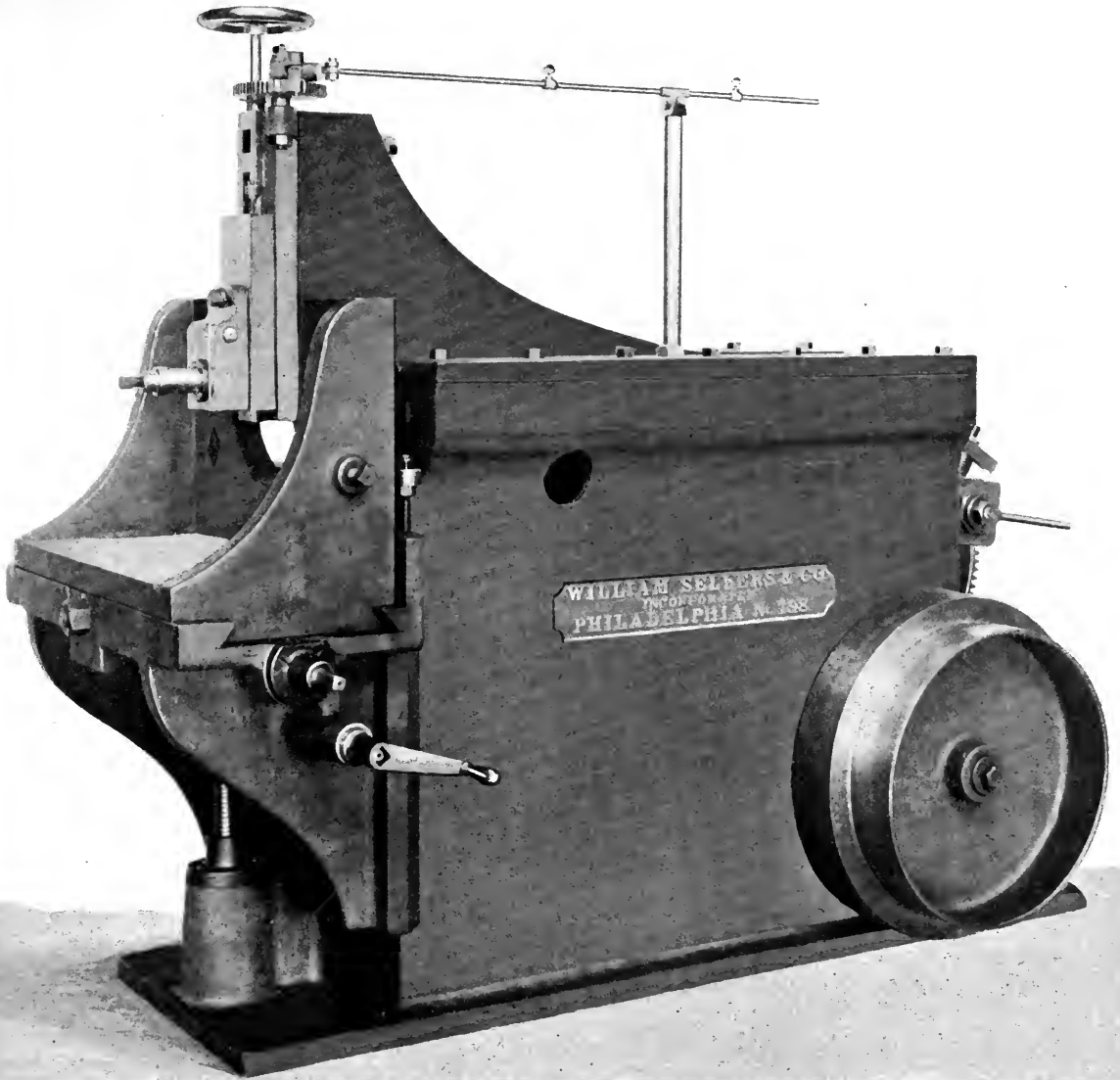

14" DRIVING BOX SHAPER—WITH VERTICAL FEED.

To be used with machine in Plate No. 121, for planing the straight sides of locomotive driving boxes. Tool box has automatic vertical feed with stroke of $8\frac{1}{2}$ ". Knee for work on bracket to carry work is 26" wide between side ribs and has cross travel on bracket. Maximum stroke 14". Quick return.

Slotting Machines.

THE quality and amount of work which can be done by a slotting machine, depend largely upon its design and workmanship. The driving gear should run smoothly, and should move the tool-bar with an approximately uniform speed when the tool is cutting, but with a greatly accelerated speed on the return stroke. We accomplish this by means of carefully cut gears and a properly designed and proportioned Whitworth crank motion. The tool-bar is relatively long and very well fitted to a slide of the same length, the lower end of which should be as close down to the work as possible, in order to give a solid support to the bar. We make this slide adjustable so that its height can be readily changed to suit the work. This avoids the necessity of an excessively heavy bar, and thus facilitates its adjustment by a crank and screw conveniently located. The length of stroke is altered by a crank and screw shifting the crank-pin. The tool-bar is counterbalanced so that all lost motion is taken up.

The circular table has convenient T slots, and a circular trough, which will collect the oil or lubricant used on the tool, and prevent waste and dirt. It is exactly perpendicular to the line of motion of the tool. It is rotated upon its axis by means of a worm, but can be firmly clamped at any desired point; and is carried by a cross-slide, fitted to a longitudinal slide on the bed. All of these sliding pieces have large bearing surfaces carefully scraped together to form a solid mass and to avoid wear. The slides are exactly at right angles and all the movements are such that very accurate work can be done. The crank handles to produce these movements are within reach of the operator when he is in the best position for seeing the work. All the automatic feeds can occur only when the bar is at the top of its stroke, in order that the tool may return through the path it has just cut, and never be dragged over a new surface.

The machine has been designed for ease and quickness of manipulation, because much of the work requires very close attention, and the product depends upon the readiness with which the attendant can do his part in adjusting the work in various positions and keeping the tool under cut as much as possible. The material has been distributed so as to produce the greatest stiffness with the least weight, to make the machine easy to handle, and not to sacrifice convenience to an *appearance* of great weight and strength.

Size.	Stroke.	Diameter of Table exclusive of Water Trough.	Longitudinal Travel of Table.	Transverse Travel of Table.
30''	7½''	20''	14''	14''
36''	10''	24''	17''	17''
42''	12''	28''	20''	20''
48''	13½''	32''	23''	23''
60''	17''	40''	28''	28''
72''	20''	48''	34''	34''

PLATE

No. 123.

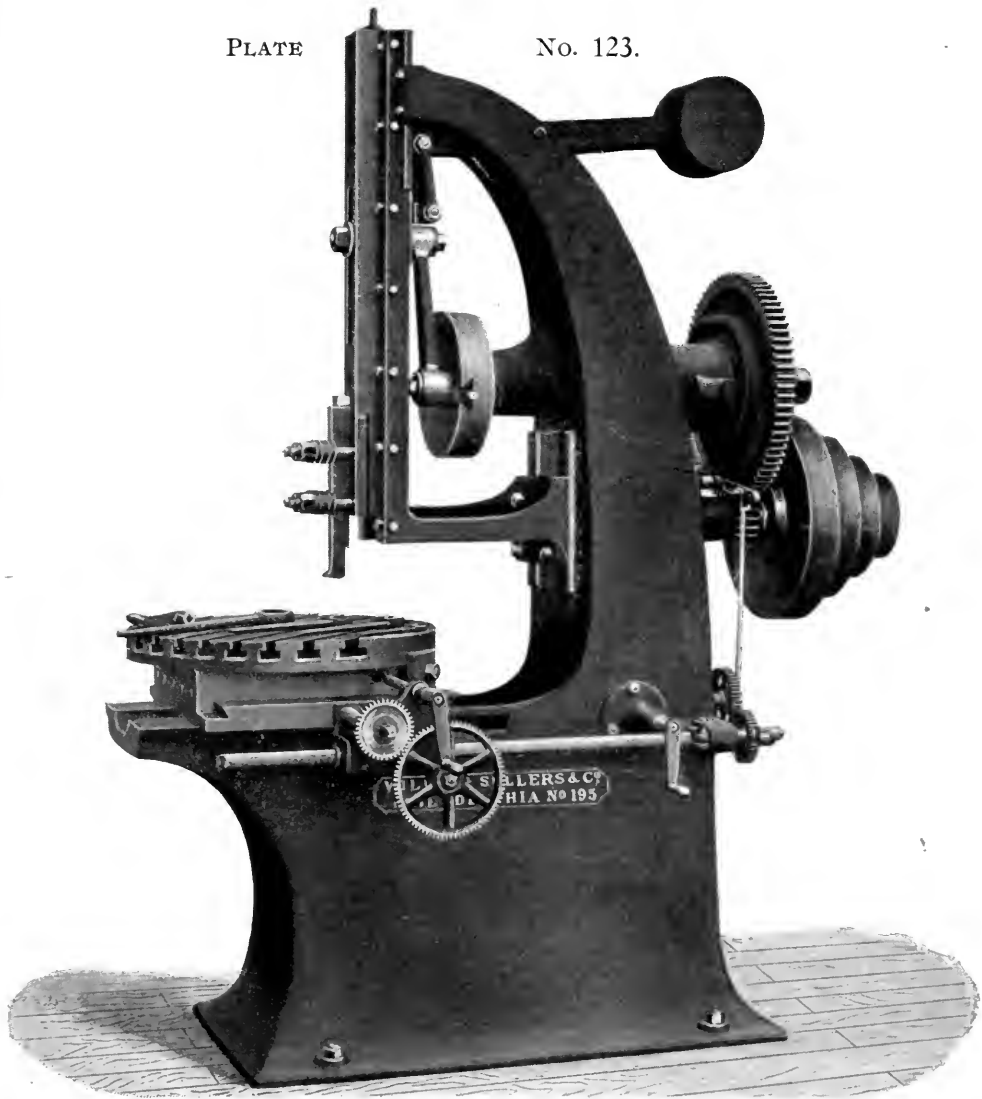

36" SLOTTING MACHINE.

From face of tool to frame, 18". Stroke adjustable from 0" to 10". Uniform cutting speed and quick return. Table, 24" diameter, with rotary, transverse, and longitudinal motions. Variable self-feed occurring at top of stroke, and all crank handles in a convenient position. Table has water-trough not shown in plate. Transverse and longitudinal travel of table, 17". Floor to top of table, 32 $\frac{3}{4}$ ". Extreme height from top of table to underside of frame, 11 $\frac{1}{2}$ ".

PLATE No. 124.

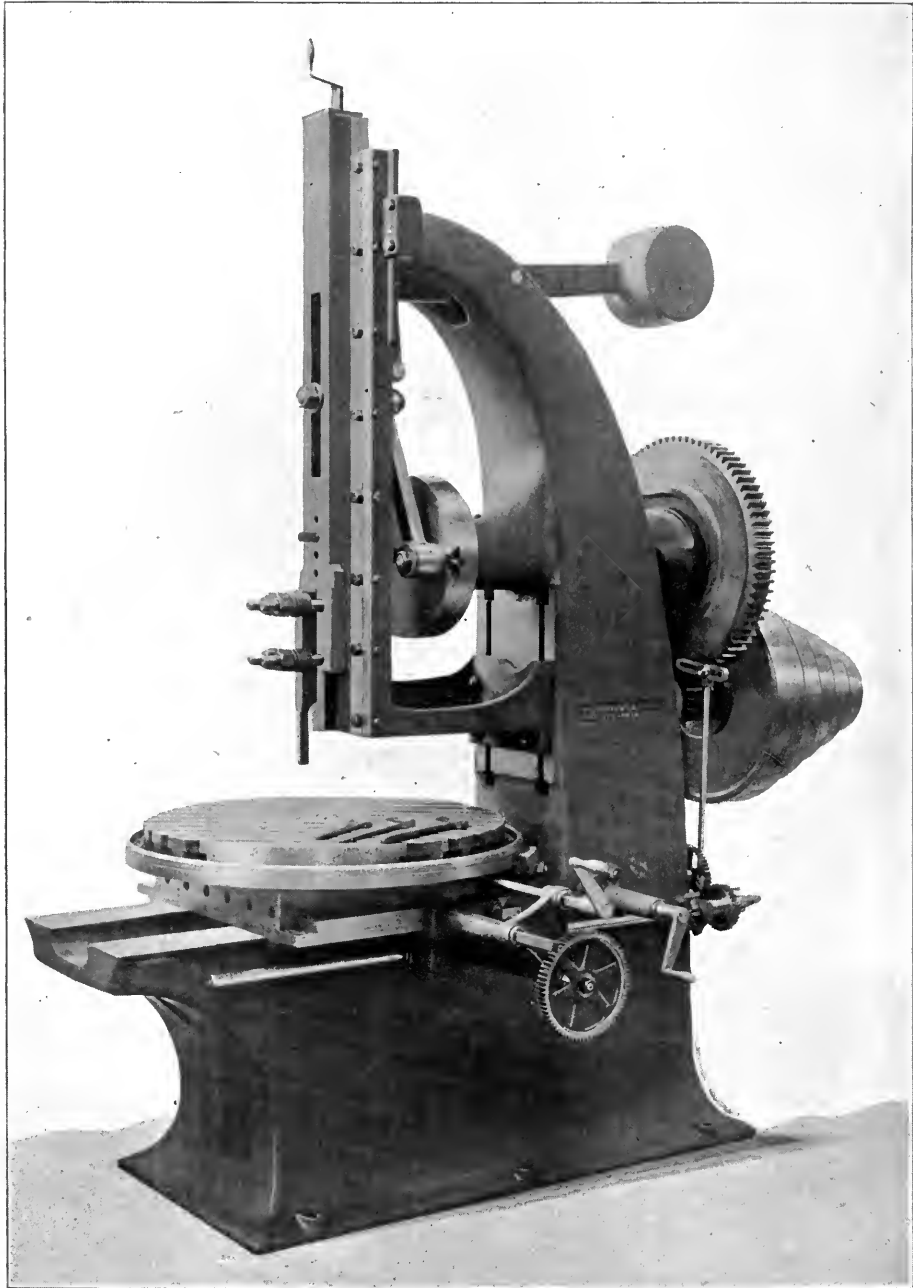

42" SLOTTING MACHINE

From face of tool to frame, 21". Stroke adjustable from 0" to 12". Uniform cutting speed and quick return. Table, 28" diameter, with rotary, transverse and longitudinal motions. Variable self-feed occurring at top of stroke, and all crank handles in a convenient position. Table has water-trough. Transverse and longitudinal travel of table, 20". Floor to top of table, 32½". Extreme height from top of table to underside of frame, 13½".

PLATE

No. 125.

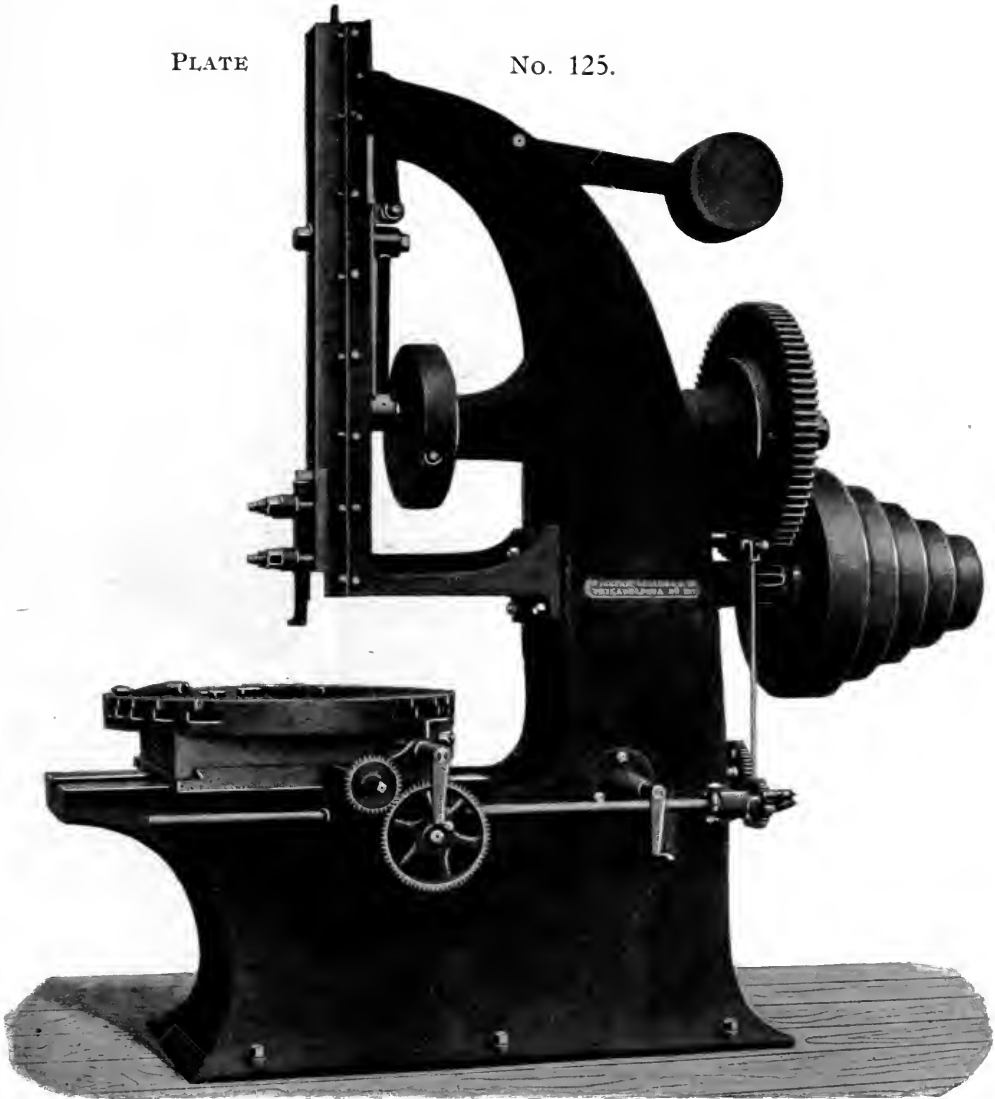

48" SLOTTING MACHINE.

From face of tool to frame, 24". Stroke adjustable from 0" to 13½". Uniform cutting speed and quick return. Table, 32" diameter, with rotary, traverse, and longitudinal motions. Variable self-feed occurring at top of stroke, and all crank handles in a convenient position. Transverse and longitudinal travel of table, 23". Floor to top of table, 32¾". Extreme height from top of table to underside of frame, 15½".

PLATE No. 126.

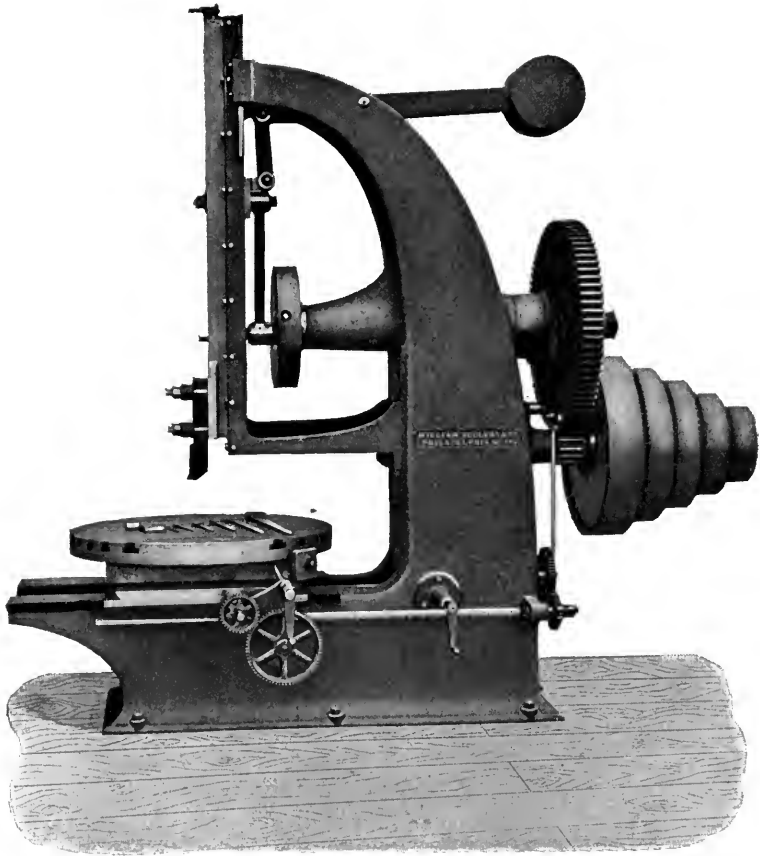

72" SLOTTING MACHINE.

Distance from face of tool to frame, 36". Stroke adjustable from 0" to 20", with Whitworth motion, giving uniform cutting speed and quick return. Compound table, 48" diameter, with water trough. Rotary, transverse, and longitudinal motions, all with variable self-feed occurring at top of stroke, and all crank handles near together in a convenient position. Transverse and longitudinal travel of table, each 34". Height from floor to top of table, 32 $\frac{3}{4}$ ". Extreme height from top of table to underside of frame, 23 $\frac{1}{2}$ ". Complete with countershaft and set of wrenches. Fast and loose pulleys 24" diameter by 7" face. Speed 130 rotations per minute. *Made also with electric motor attached.*

Some Special Slotting Machines.

NOT ILLUSTRATED HERE.

FOR CYLINDER PORTS.—A traverse slotter on fixed uprights 4 ft. 2½" apart, with travelling work table 3 ft. 6" by 4 ft. Maximum stroke of slotting bar, 9". Traverse on crossbar or rail, 3 ft. 6". Height from table to underside of rail, 4 ft. 2½". Travel of table, 6 ft. Driven by electric motor, or by countershaft, if preferred.

FOR LOCOMOTIVE LINKS.—A regular 60" slotter, 15" stroke, with rectangular table 2 ft. 4" by 3 ft. long, with radius bar and adjustable support. Will slot links from 3 ft. to 9 ft. radius. Maximum height from table to underside of adjustable frame, 20". With countershaft and wrenches. Fast and loose pulleys, 20" diameter by 4½" face.

FOR HEAVY SHIP PLATES.—A portable traverse slotter, which may be bolted or clamped directly to the plate and used to slot out ports and other openings. Traverse along crosshead, 4 ft. 10". Adjustable stroke and quick return. Greatest stroke, 9". Driven by electric motor, or rope belt from countershaft.

PLATE No. 127.

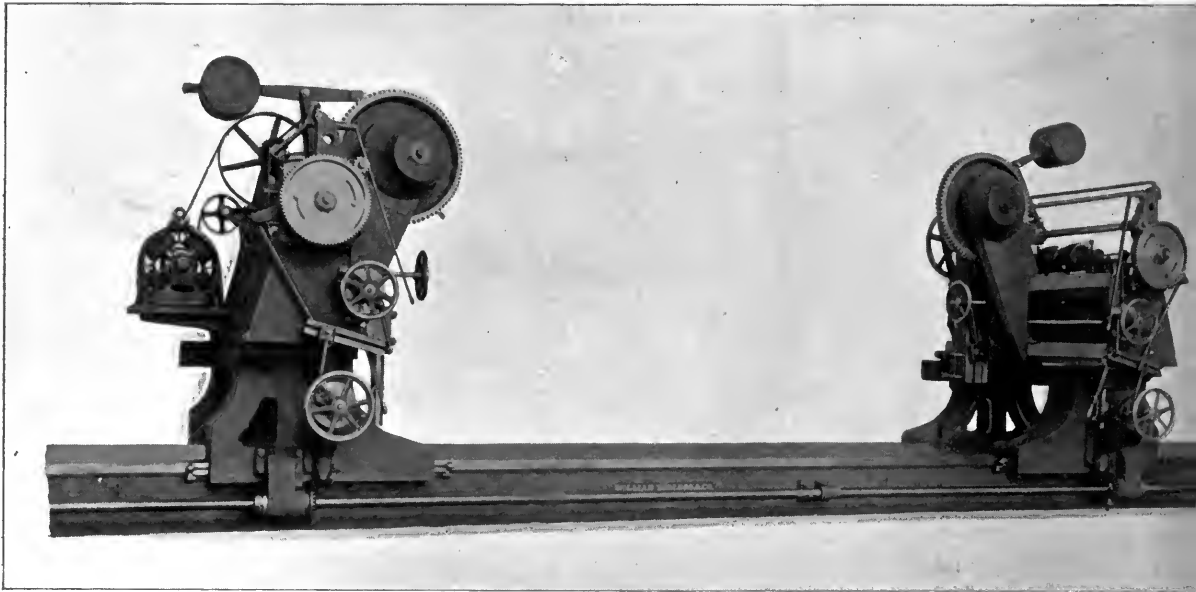

DOUBLE SLOTTING MACHINE

FOR LOCOMOTIVE SIDE FRAMES.

This is an unusually strong and massive machine. Stroke adjustable up to 22". Whitworth quick return. Driven by electric motors attached to travelling heads. Heads provided with quick power traverse to any part of bed. Quick power traverse for saddles on cross rail. Adjustable feed also in both directions. Cross rail swivel, to suit tapers up to $1\frac{1}{4}$ " per foot. Bed 42 ft. long. Travel of heads on bed to suit frames 32 ft. long. Length of bed made to suit longer or shorter work if desired. Made also with three heads—and, if required, arranged to drive by countershaft. We believe this to be the stiffest and strongest frame slotter yet built and at the same time the handiest.

Enlarged view of one head (shown in Plate No. 128, on opposite page). Width between uprights, 48". Total travel of saddle on cross rail, 54". Clear height under cross rail, $23\frac{3}{4}$ ". Guided on one side only with brass taper shoes. Uprights connected by deep crossgirt independent of rail. Motor drive gives complete independence of heads in regard to speed and feed. Feed along bed variable from .014" to .17", and transversely from .006" to .102". Rapid travel controlled by friction clutches.

PLATE NO. 128.

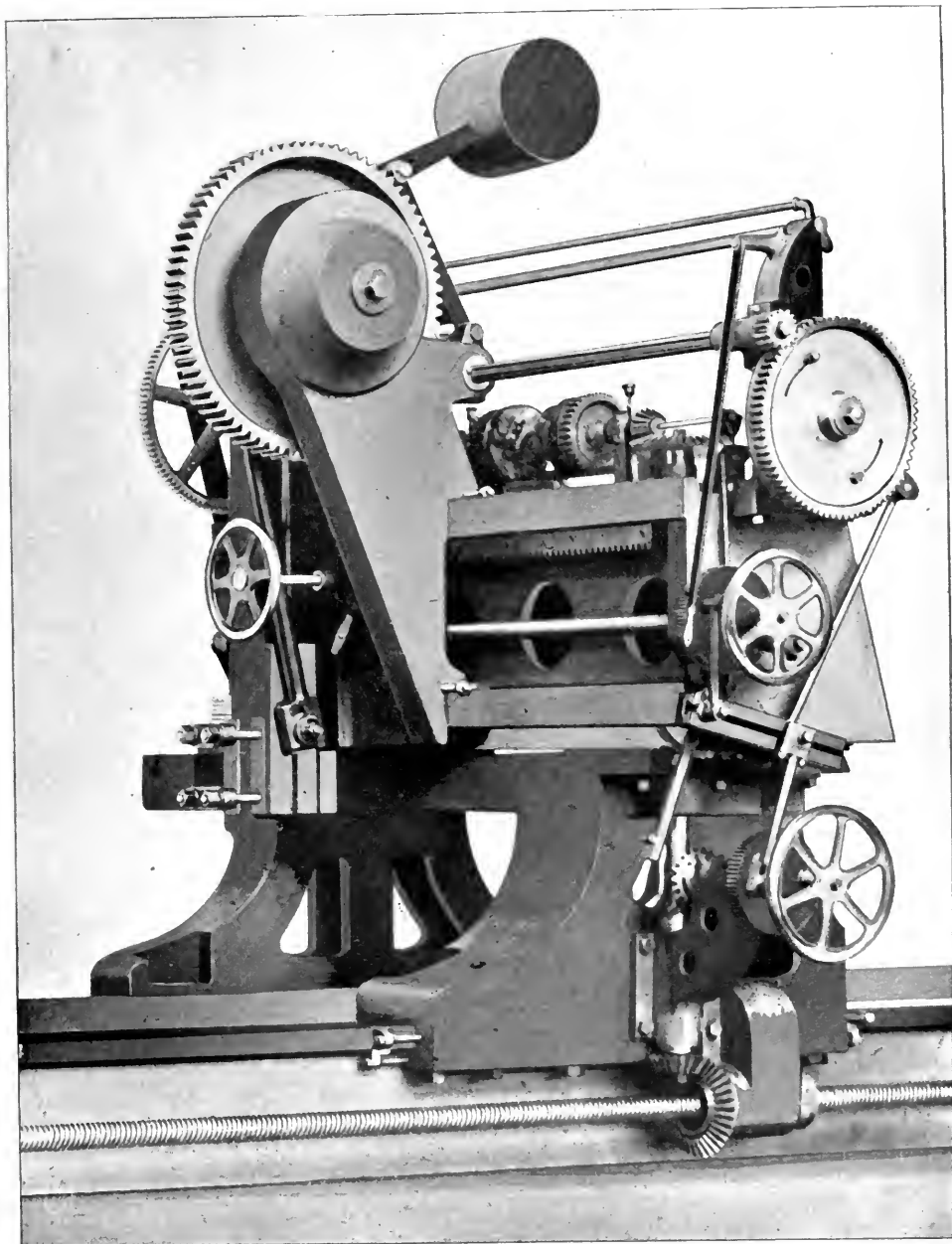

Planing Machines.

SINCE the introduction of our method of driving planer tables by a spiral pinion engaging with an inclined rack, our planing machines have become so well and favorably known that we do not feel it necessary to give at this time an extended description of the details of their construction. We may say, however, that we have kept these machines thoroughly up to date, making from time to time such alterations as were demanded by modern practice. Our planing machines are of two kinds, those in which the driving belts are shifted to reverse the table, and those in which the reversal is accomplished by friction clutches. The second type we call the "Spiral geared planers," because a spiral pinion and spur wheel are used in place of the bevel wheel and pinion of the other type; both make use of our well known table-drive by spiral pinion and inclined rack. Both use, also, our frictional escapement feed motion in which the reversing mechanism is operated at a constant and moderate rate of speed and is entirely independent of the velocity of the table. This enables us to increase the reverse speed of the table to the greatest permissible extent, which in our regular machines is determined by the time required to shift the belt and start up the table in the opposite direction. If the reversing speed be increased beyond a certain point, so much time is lost in reversing at the ends of the stroke, that there is but little or no gain derivable from the increased speed. This is especially noticeable where the stroke of the table is relatively short. We therefore have considered it wise to limit the speed of the reversing motion of these planers to three or four times the usual cutting speed; that is to say, reversing at about 54 to 72 feet per minute, according to the size of the machine. The shifting lever is connected with the feed motion by a clutch which may be disengaged by a half turn of the handle on the end of the lever and the planer table may then be reversed as often as desired without taking up additional feeds. This is often much more convenient than disengaging the pawl in the ratchet feed-box,—the usual method of stopping the feed.

Our planing machines stand parallel with the overhead shafting, thus economizing shop room. When required to drive at right angles to the shafting, mule pulleys can be provided to carry the countershaft belt, or if preferred we can furnish them with driving pulleys at right angles to their usual position. We manufacture

PLATE NO. 129.

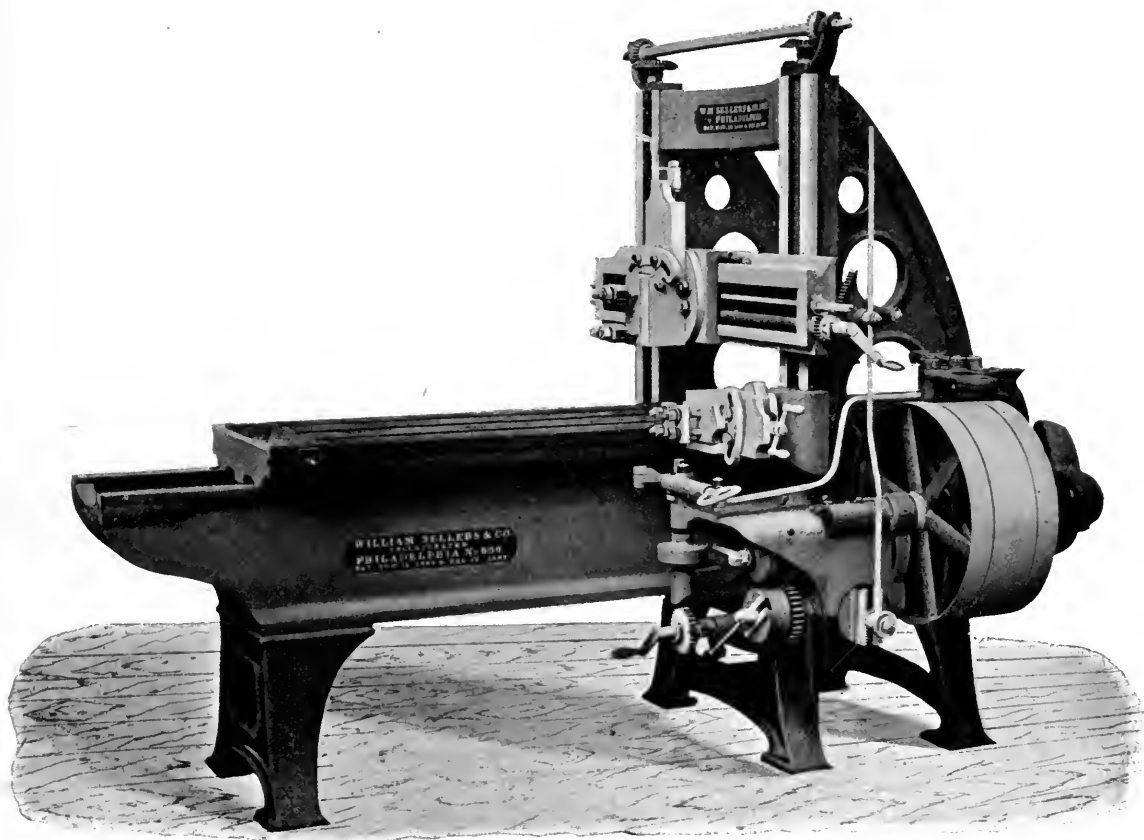

25" x 25" PLANING MACHINE—TO PLANE 6 FEET LONG.

For horizontal, vertical, and angular planing. Improved feed motion; feed takes place at back end of return stroke. Vertical slide-rest on right-hand upright, extra. Usual speed of cut, 18 feet per minute; return speed of table, 72 feet per minute. Complete with countershaft and full set of cranks and wrenches. Made any required length.

Planing Machines.—*Continued.*

a full line of planers of this type, the usual sizes of which are given in the following table, together with the shortest practicable length in each case.

Name of Planer.	Will Plane in Width.	Will Plane in Height.	Shortest Length of Table.
20 inches.	20 inches.	20 inches.	3 feet.
25 “	25 “	25 “	4 “
30 “	30 “	30 “	5 “
36 “	36 “	36 “	5 “
42 “	42 “	42 “	6 “
48 “	48 “	48 “	6 “
54 “	54 “	54 “	7 “
60 “	60 “	60 “	8 “
72 “	72 “	72 “	9 “
84 “	84 “	84 “	10 “
120 “	120 “	120 “	14 “

These machines can be made of any additional length required. They can be furnished with one or two tools upon cross-head, and those above 30" can be provided with vertical slide-rests on one or both of the uprights. When two saddles are used, we generally provide an additional screw to give independent horizontal feed to each saddle, the vertical movement being controlled by the same feed-rod; but in some cases it is preferable to have both saddles on the same screw, in order that they may be moved simultaneously; this we can also accomplish when desired. The projection of the tools on the cross-head and vertical slide-rests is the same, so that the horizontal and vertical tools begin and end their cut at the same time. Planers of 42" and over are provided with power-lifting gear for the cross-heads. All are furnished with countershaft complete and necessary wrenches. Knees, V-blocks, ribs and cross-plates, and other tools are extra. The larger planers may be arranged with electric motor upon a platform supported by the uprights and belting directly to the pulley-shaft.

PLATE No. 130.

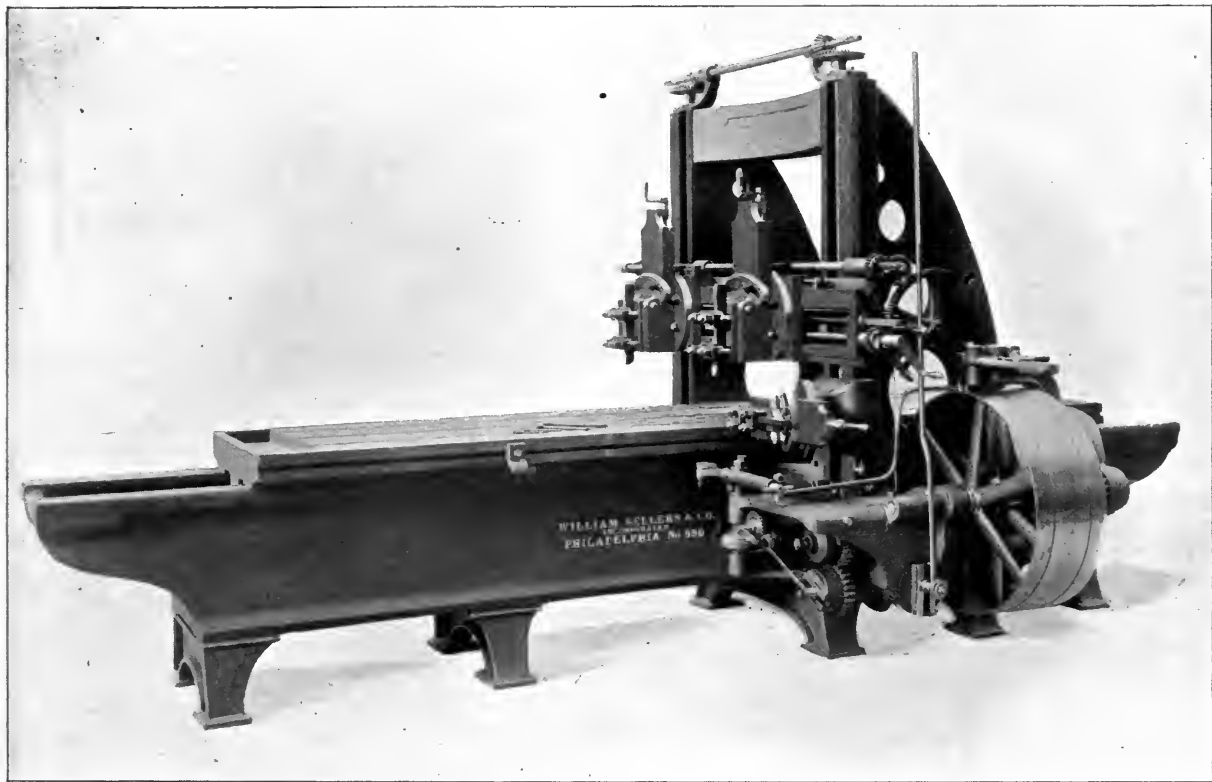

36" x 36" PLANING MACHINE—TO PLANE WORK 10 FEET LONG.

With two saddles on cross-head and one vertical slide-rest. Automatic tool lifter operating at any angle. Separate screw for extra slide-rest. Complete with countershaft and full set of cranks and wrenches. *Second saddle on cross-head* and one or more *vertical slide-rests*, extra. Usual cutting speed 18 ft. per minute, and return speed of table 72 ft. Made any required length.

PLATE No 131.

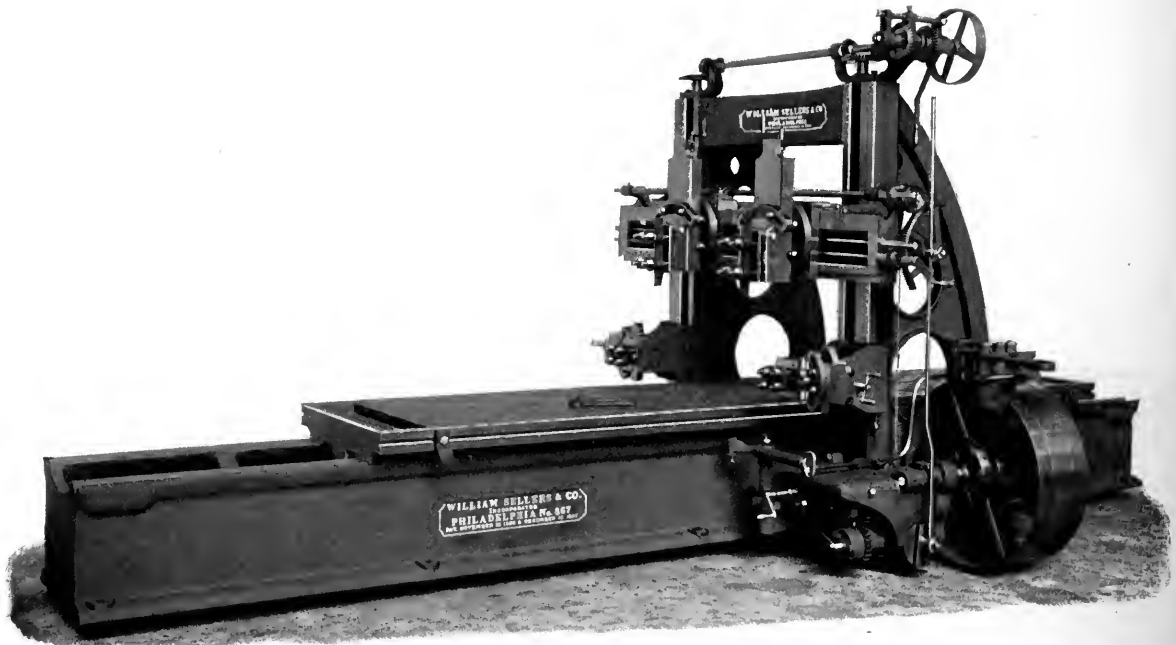

42" x 42" PLANING MACHINE—TO PLANE WORK 12 FEET LONG.

With improved feed motion. Automatic tool lifter operated at any angle. Extra saddle on cross-head and vertical slide-rest on both uprights. Separate screw for extra saddle. Power elevating gear for cross-head. Usual speed of cut, 18 feet per minute; return speed of table, 72 feet per minute. Complete with countershaft and full set of cranks and wrenches. Additional *slide-rest on cross-head and vertical slide-rests*, extra. Made any length desired.

PLATE No. 132.

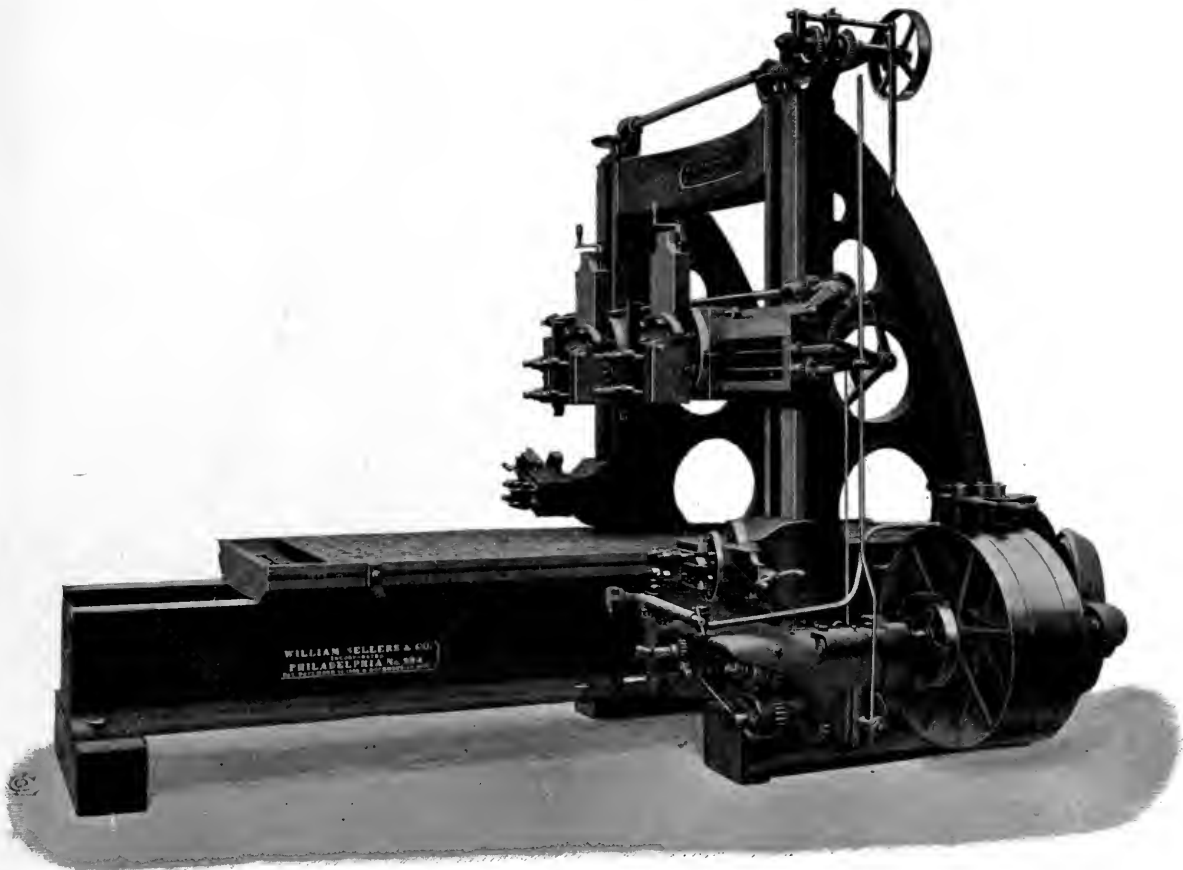

60" x 60" PLANING MACHINE—TO PLANE WORK 10 FEET LONG.

With improved feed motion. Automatic tool lifter, operated at any angle. Extra saddle on cross-head and vertical slide-rest on both uprights. Separate screw for extra saddle. Power elevating gear for cross-head. Usual speed of cut, 18 feet per minute; return speed of table, 72 feet per minute. Complete with countershaft and full set of cranks and wrenches. *Additional slide-rest in cross-head and vertical slide-rests, extra.* Made of any desired length.

PLATE No. 133.

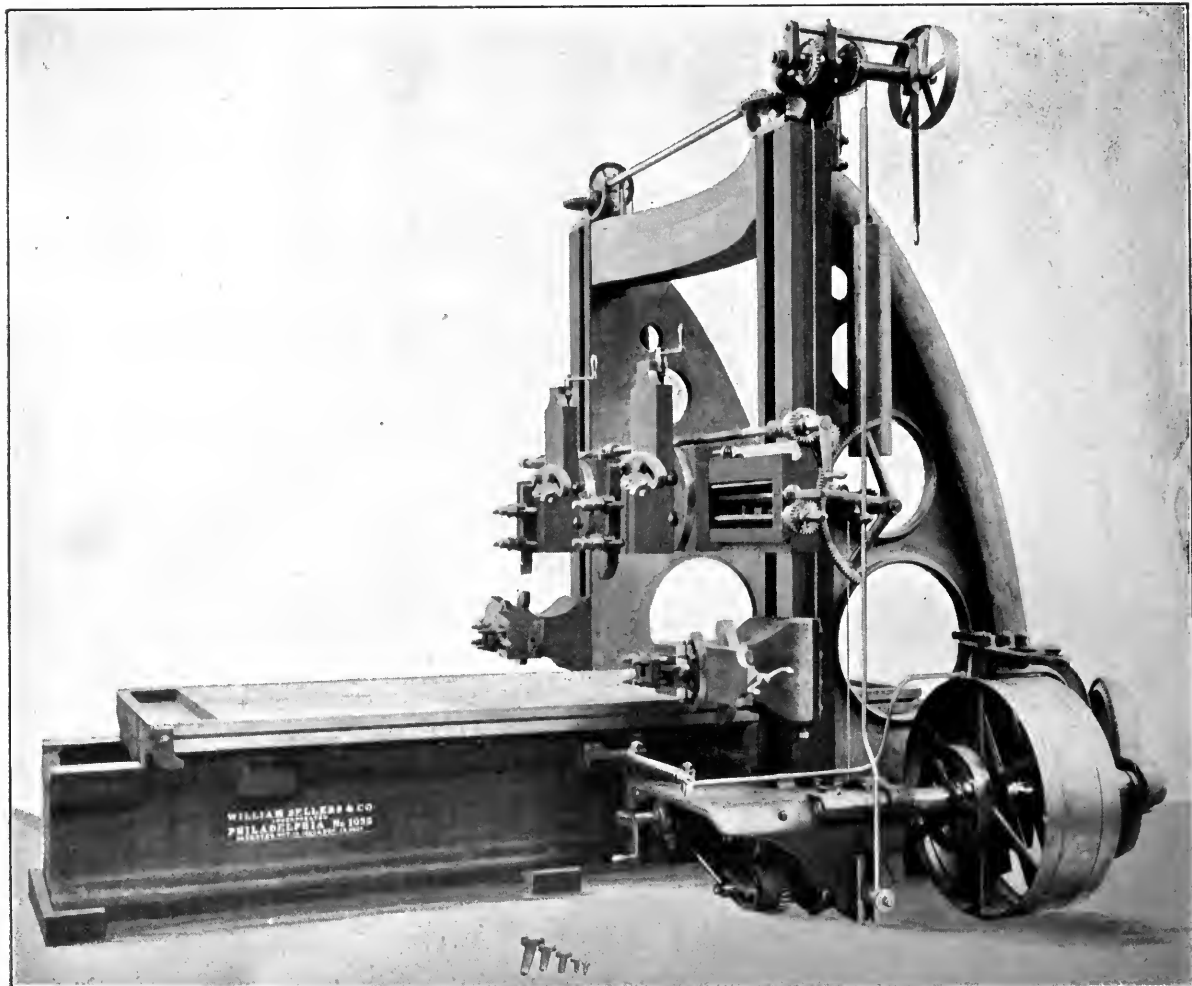

72" x 72" PLANING MACHINE—TO PLANE WORK 7 FEET LONG.

With improved feed motion. Automatic tool lifter. Power raising gear for cross-head. Vertical slide-rests counterbalanced. Usual cutting speed 18 ft. per minute; return speed of table 54 ft. *Second saddle on cross-head and vertical slide-rests, extra.* Made any required length.

PLATE NO. 134.

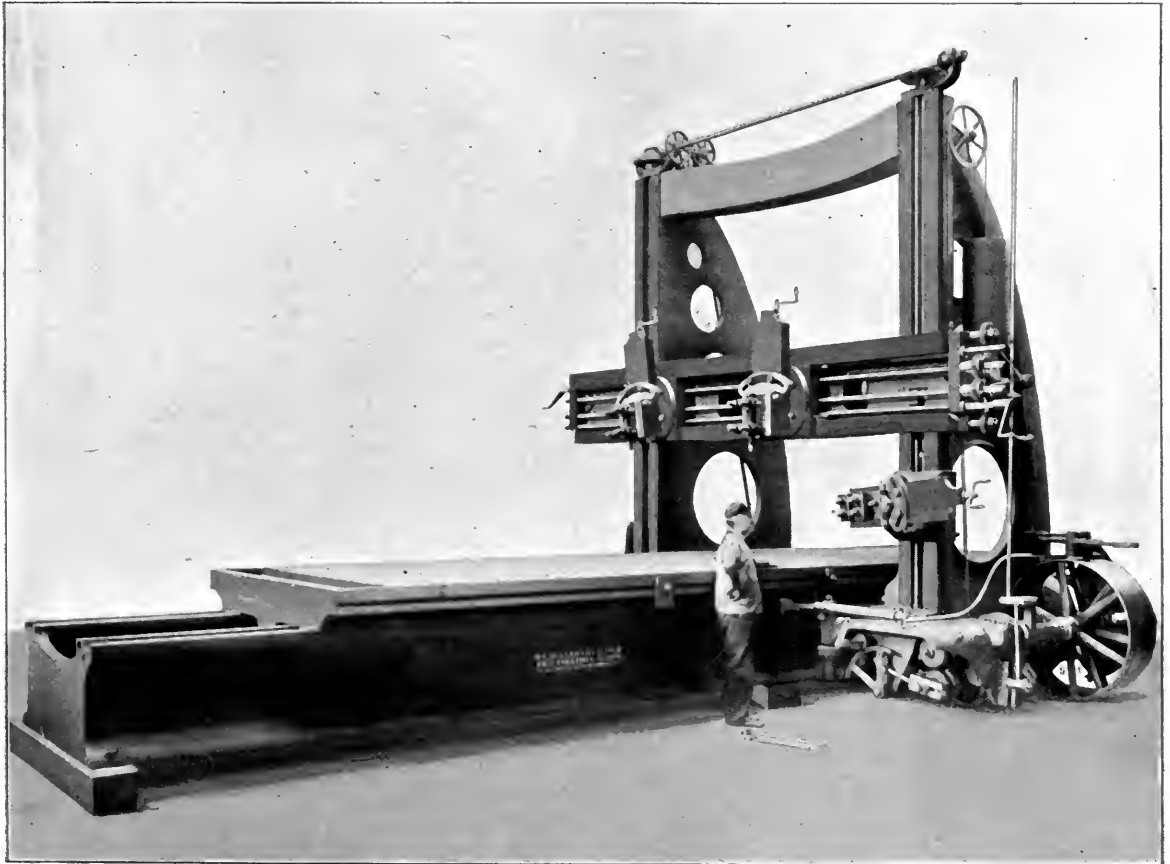

120" x 120" PLANING MACHINE—TO PLANE WORK 25 FEET LONG.

With extra deep patent cross-head with independent feed rods and screws for both saddles. Counterbalanced vertical slide-rest. Power raising gear for cross-head. Improved feed motion. Extra deep bed with patent bearings. Usual cutting speed 18 feet per minute; return speed of table 54 feet. Very massive table. Made any required length.

Patent Spiral-Geared Planing Machines.

IN designing this machine, we sought to produce a planer that would do better and more work than had ever been accomplished, to eliminate "chatter" marks, to increase the driving power and to accelerate greatly the reversing speed. The spiral gearing has produced a smoothness of work which has never been excelled; and, to increase the reversing speed, we operate the mechanism by friction clutches driven by a belt or belts running in the same direction. When a single belt is used, the reversing is accomplished through a train of gearing. The table, the pinion-shaft, and the clutch-shaft are the parts which suffer reversal, the first two move at comparatively slow speeds, while the last is kept as light as possible, and means are provided for absorbing its momentum. When the stop on the table strikes the lever at one end of the stroke, it draws one clutch out of engagement and presses lightly against the other, which is running in the opposite direction. In this way the pinion and clutch-shafts are quickly checked. The table moves forward so as to take up the backlash of the teeth, so that the pulley-shaft is reversed without jar. The reversal of the pulley-shaft is not directly effected by the contact of the stops on the table with the tappets; all that is done by them is to knock off the driving power, then apply the brake, and set in action an escapement by which certain wheels are made to give a semi-revolution, and nothing more. The motion of the table is uniform in either direction; it overruns very slightly, and is brought to rest and started up in the opposite direction quickly, quietly, and entirely without shock. The machine reverses with almost the regularity of a crank shaper. The hand lever permits the table to be controlled with great ease and certainty, stopped, started, and reversed, while a partial rotation of the lever cuts out the feed or starts it as required.

The speed of reverse in these machines is limited only by the amount of power which is considered wise to expend for the purpose. For light machines a reversing speed of eight times the cutting speed, or say, 144 feet, is what we usually provide; but in larger machines this is reduced to six or four times. The cross-heads of these machines are of massive construction, and consist of a practically continuous beam, reinforced on the back by an arch between the uprights, the top and bottom flanges being tied together by a central web. Independent screws and feed-rods are used for the two saddles, so that two cutting tools on the cross-head will be entirely independent of one another in the direction of feeds. The planer may be operated from either side of the bed. Another special feature of these machines is the arrangement of the guides in the bed; one is made flat, the other V shaped, with the V terminating on each side in a nearly vertical surface. The V bearing itself is very flat, thus making the table run easily under light loads; but heavy side cuts tending to shift the table, are resisted by the vertical walls above the V. These machines are heavier and stronger than the corresponding sizes of our other type of planer, and the driving power has been increased to a large extent. We are prepared to manufacture a full line of these machines. The usual sizes correspond with those in the table, page 158.

PLATE No. 135.

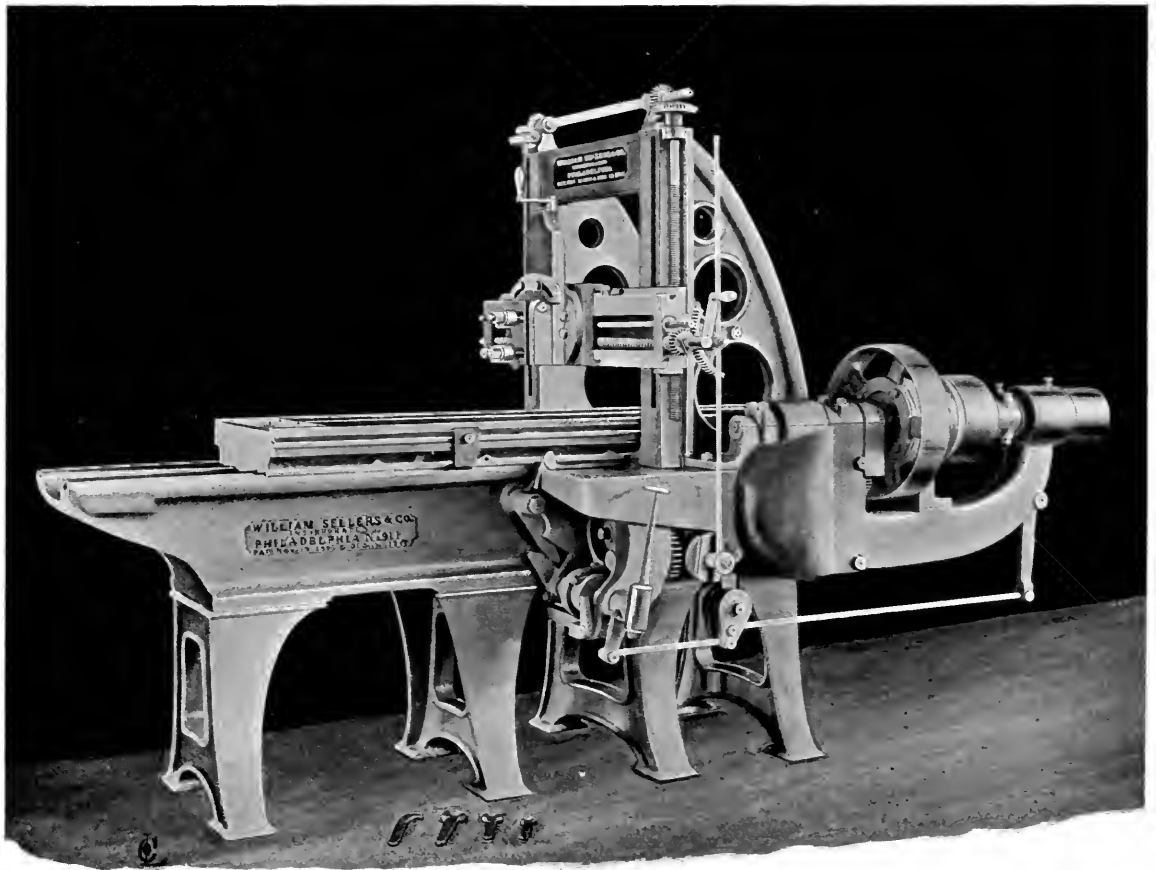

20" x 20" PATENT SPIRAL-GEARED PLANING MACHINE.

TO PLANE WORK 5 FEET LONG.

Driving and reversing gear operated by friction clutches. Return speed of table, 144 feet per minute, or eight times the usual cutting speed. Feed-motion operated from either side of machine. Complete with countershaft and full set of cranks and wrenches. Can be made any length required.

PLATE No. 136.

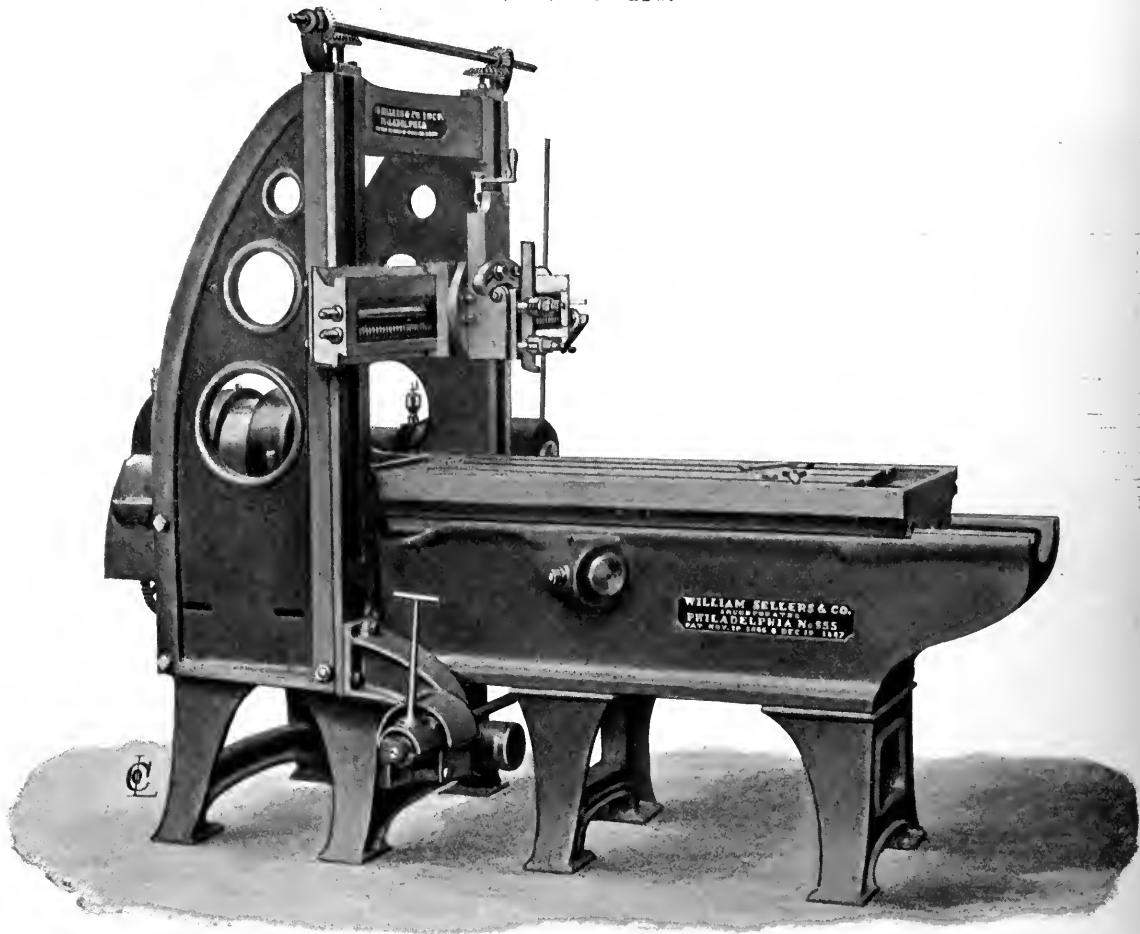

25" x 25" PATENT SPIRAL-GEARED PLANING MACHINE.

TO PLANE WORK 4 FEET LONG.

Single belt driving planing and reversing mechanism through friction clutches. Return speed of table, 144 feet per minute, or eight times usual cutting speed. Table with one flat and one special V bearing having vertical surfaces to take side thrust. Bearings for table protected from dust and dirt. Movement of table and feed can be operated from either side of the machine. Complete with countershaft and full set of cranks and wrenches. *Vertical slide-rest, one or both uprights, extra, if required.* Can be made any length.

PLATE No. 137.

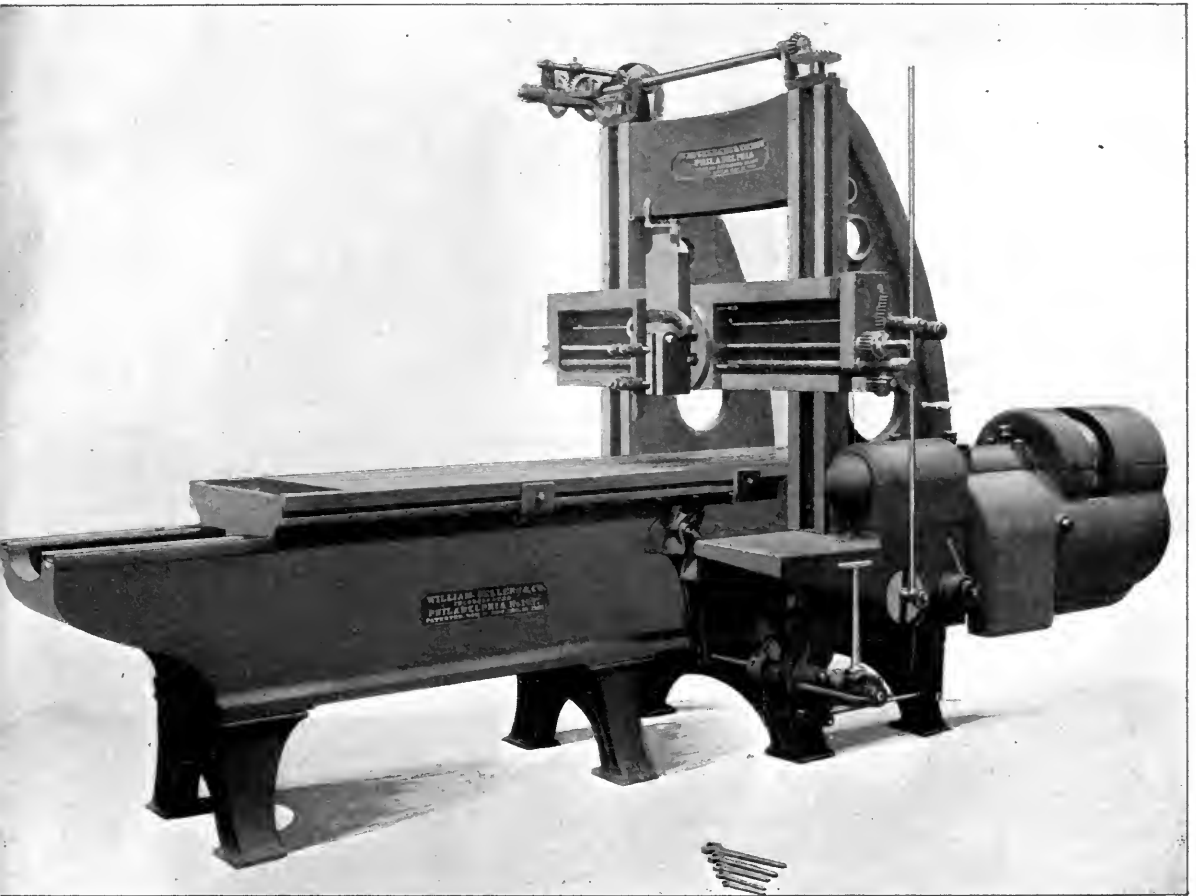
**30' x 30' PATENT SPIRAL-GEARED PLANING MACHINE.**

TO PLANE WORK 8 FEET LONG.

Length made as required. Single driving belt operates planing and reversing mechanism through improved friction clutches. Return speed of table, 144 feet per minute, or eight times usual cutting speed. Patent table with one flat bearing. Both bearings and rack protected from dirt. Operated from either side. Improved cross-head with internal saddle, and separate rod and screw for second saddle. Power frictional raising gears for cross-head. Complete with counter-shaft, cranks and wrenches. *Furnished with one or two saddles on cross-head and with one or two side heads—or vertical slide-rests as required.*

PLATE No. 138.

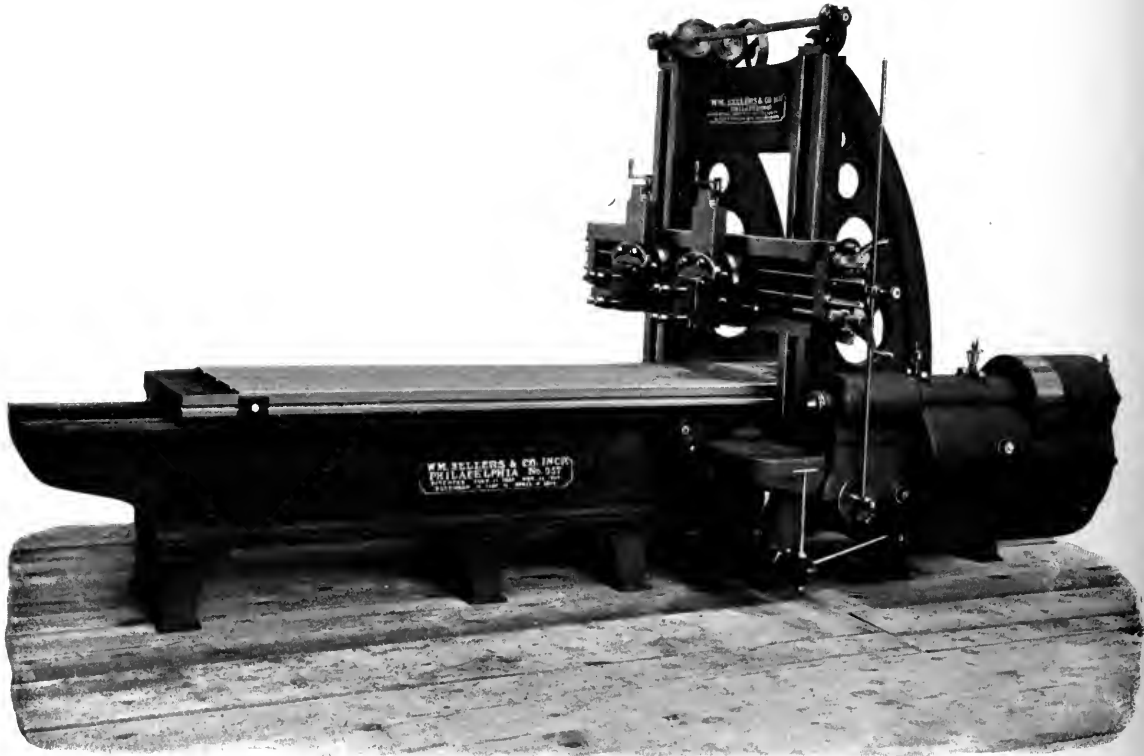

36" x 36" PATENT SPIRAL-GEARED PLANING MACHINE.

TO PLANE WORK 10 FEET LONG.

Single belt drives planing and reversing mechanism through improved friction clutches. Return speed of table, 144 feet per minute, or eight times usual cutting speed. Patent table, with one flat and one special V bearing, with vertical surfaces to take side thrust. Bearings for table protected from dirt. Movement of table and feed-motion can be operated from either side of machine. Improved cross-head, with internal saddles, and separate feed-rods and screws. Improved power frictional raising gear for cross-head. Complete with countershaft, cranks, and wrenches. *Furnished with one or two saddles on cross-head and with or without vertical slide-rests.* Can be made any length desired.

PLATE No. 139.

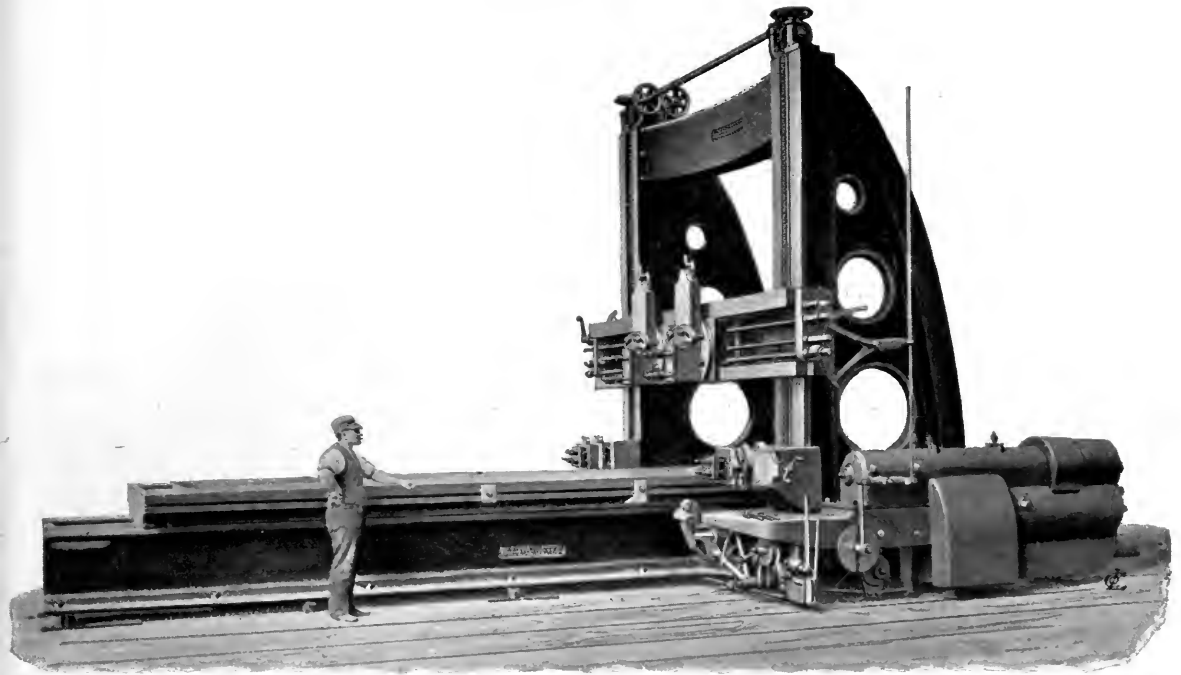

120" x 120" PATENT SPIRAL-GEARED PLANING MACHINE.

TO PLANE WORK 24 FEET LONG.

Two saddles on cross-head and vertical slide-rests on both uprights. Single belt drives planing and reversing mechanism through improved friction clutches. Return speed of table, 72 feet per minute, or four times usual cutting speed. Patent table, with one flat and one special V bearing, with vertical surfaces to take side thrust. Bearings for table protected from dirt. Movements of table and feed-motion can be operated from either side of machine. Massive cross-head of improved construction, with internal saddles and separate feed-rods and screws. Feed of all tools entirely independent in direction and amount. Power frictional raising gear for cross-head. Vertical slide-rests counterbalanced. Complete with countershaft, cranks and wrenches. *This machine can be furnished with one or two saddles on cross-head and with or without vertical slide-rests.* Can also be made to plane any length desired.

PLATE NO. 140.

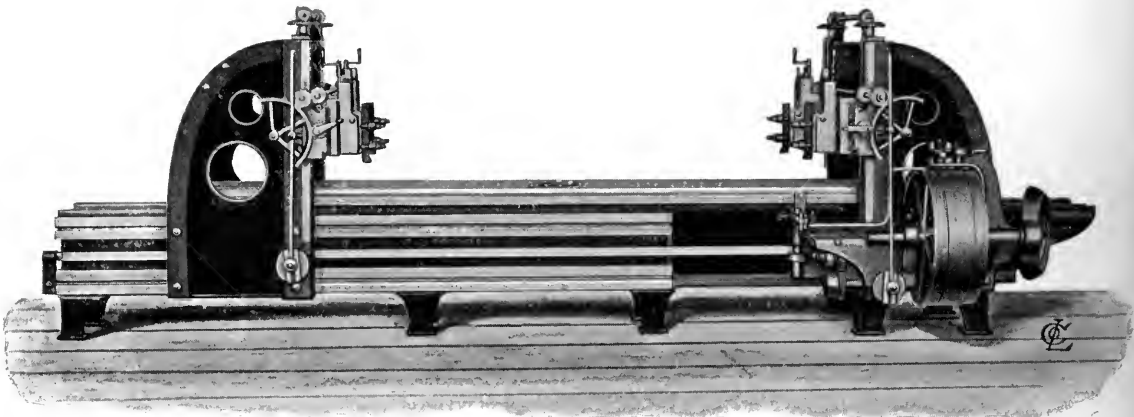

36" ROD PLANER—TO PLANE RODS FROM 3 FEET TO 12 FEET LONG.

Arranged with two sets of uprights ; two cross-heads with two saddles on each. Saddles arranged so that the tools on each cross-head can be brought to 6" from centre to centre. Table driven by spiral pinion, so arranged as to move table at same speed in each direction, as it takes cut both ways. Distance between heads adjustable from 3 feet to maximum. Will plane both ends of two connecting rods at the same time. Very heavy and substantial machine, capable of taking very heavy cuts. Cross-heads are adjustable in height above table. Can be used to advantage on four guide bars at the same time. Complete with countershaft, cranks and wrenches. Fast and loose pulleys, 16" x 4", which should run at 245 revolutions per minute, to produce a cutting speed of 20 feet per minute.

PLATE NO. 141.

**62" x 18" SPIRAL-GEARED LOCOMOTIVE FRAME****PLANING-MACHINE—TO PLANE 35 FEET LONG.**

Table 4 ft. 8" wide, with top plate 3" thick. Width between uprights, 5 ft. 3". Height from top of table to underside of cross-head, 19". Return speed of table, 160 ft. per minute.

This is a powerful, massive machine, capable of taking any cut that the tools will stand. It may be made longer or shorter, as required.

The very rapid return speed of this planer is of great importance on long side frames, and greatly increases the product of this machine over that obtainable upon any other planer yet produced.

PLATE No. 142.

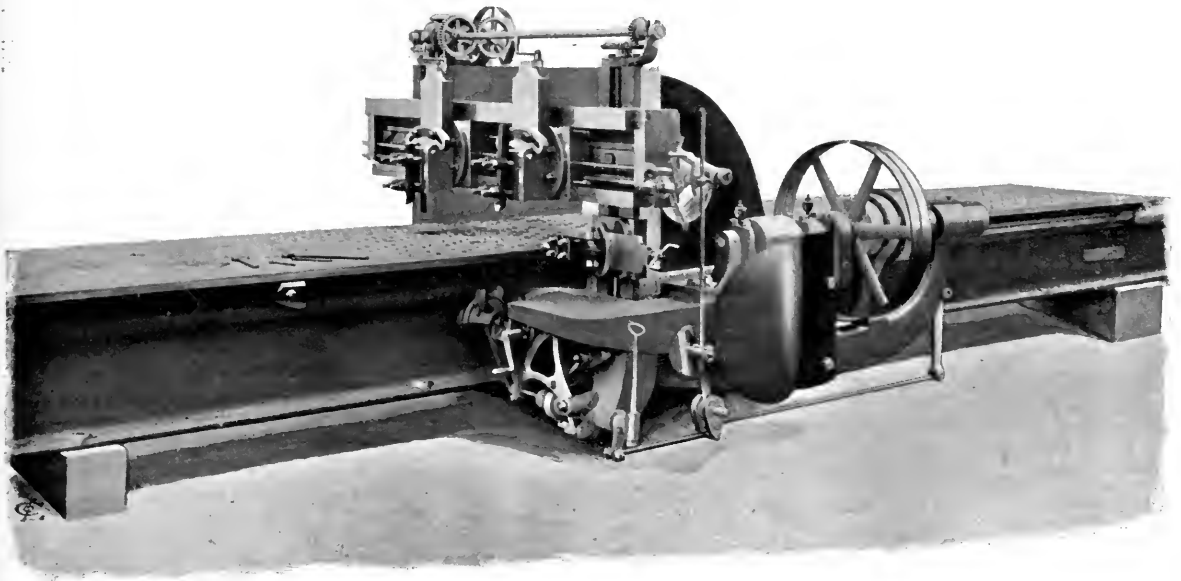
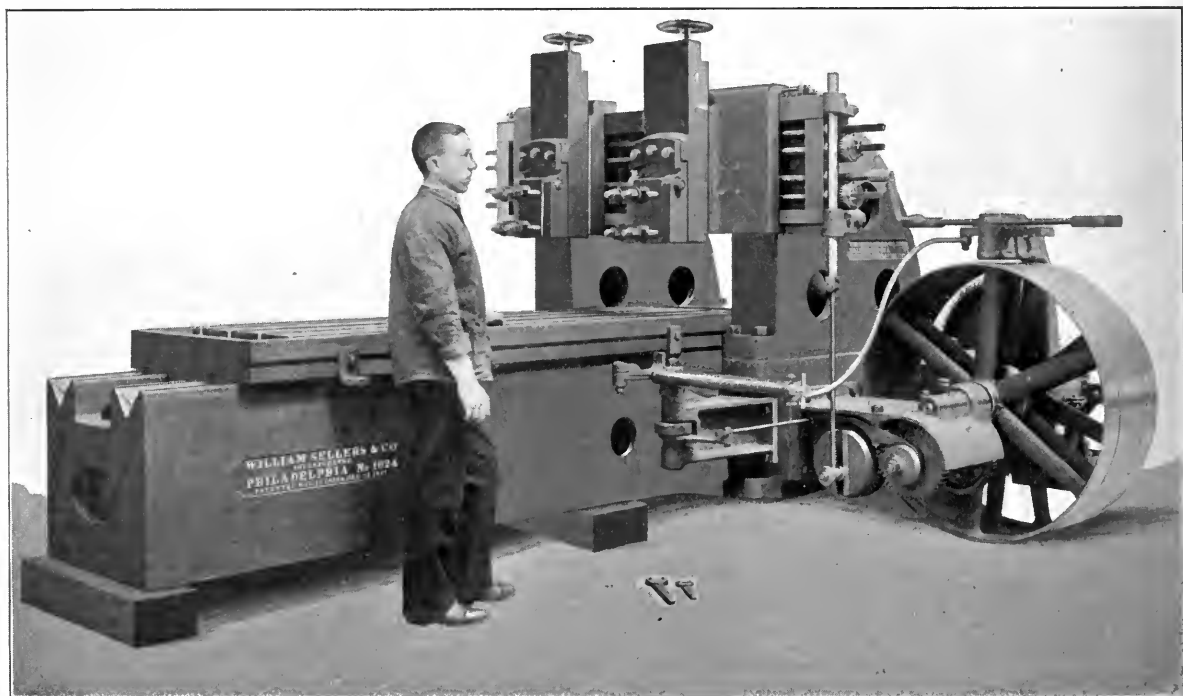

36" x 13" PLANING MACHINE—FOR STEEL RAILS AND SWITCHES.

The machine shown here has table 31" wide for work 8 ft. long. *Made any length required.* This is a very massive and powerful machine, adapted to the heaviest class of work. The cross-head is fixed in height above the table. The saddles are unusually massive, and the steel slide rests are set over to bring the tools close together. Each has its own screw and vertical feed rod. A pump and circulating system are provided to insure a perfect and continuous lubrication of the V bearings. The feed mechanism is of our patent improved type, with frictional escapement. Tool aprons and swivels for same are of steel.

PLATE No. 143.

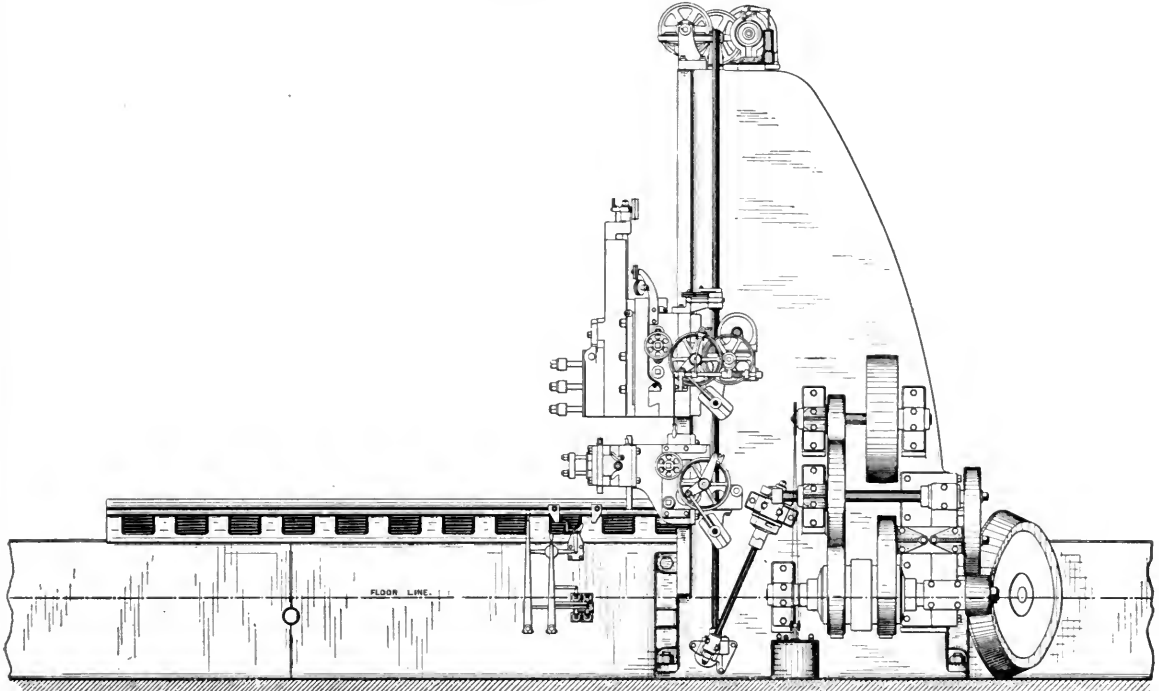

144" x 120" (OR 144") PLANING MACHINE—TO PLANE 25 FT. LONG.

This ponderous machine is especially designed for the heaviest work in armor plate or steel forgings. It is provided with *two saddles* 45" long on the cross rail, which is 42" deep. *The swivel tool slides* on the saddles are 6 ft. long by 20" wide and have a stroke of 3 ft., while the tool apron and clamps are proportioned for a cutter bar 6" square. Each saddle has its own feed screw and rod actuated by an *independent feed motion* at the end of the cross rail, which is 22 ft. 8" long. Each has its own *electric motor* for rapid traverse; while another motor is employed to *raise and lower* the cross rail. *The housings* or uprights of box form are 30" wide on the face, 8 ft. 6" deep, and each is provided with a *slide-rest* having 30" stroke and carrying a tool apron adapted for 4" square cutter bar.

The table is 10 ft. wide and has a cut steel rack 3" pitch, 18" face, driven by a bronze spiral pinion of six teeth on a 9" diagonal shaft. The bearings in the bed for the table and the thrust bearings of the shaft are lubricated by oil supplied by a *small pump and circulating system* with tank, pipes and filter for the oil on its return. *The bed* is 4 ft. deep, 9 ft. wide in the narrow part, has flat ways 16" wide and adjustable shoes. *The driving gear* is operated by a 12" belt from a countershaft or electric motor, and drives through reversing clutches operated by compressed air. Cutting power on four tools 100,000 lbs. *Made of any length.* Can be provided with auxiliary housing on separate bed, for planing work too large to go between main uprights.

PLATE NO. 144.

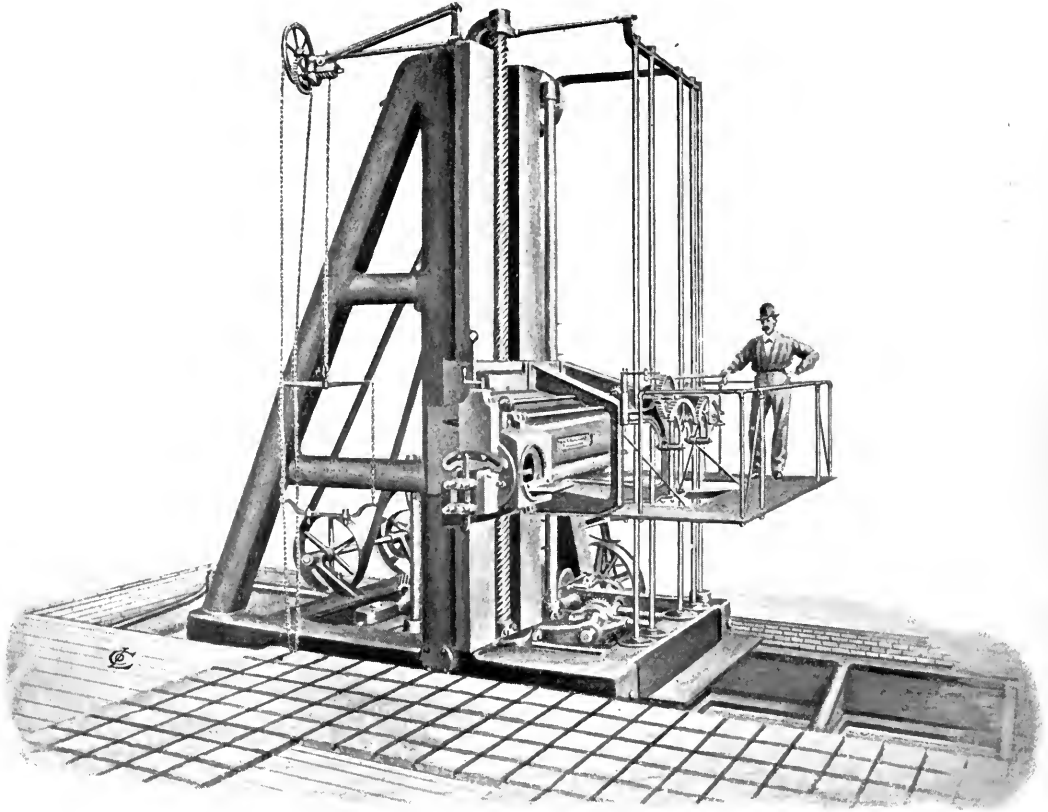

PLANING, SHAPING, AND SLOTTING MACHINE.

TO PLANE 24 FEET; SLOT 12 FEET; SHAPE 6 FEET. (SIDE VIEW.)

Length of bed, 38 ft.; width of bed, 8 ft. $9\frac{1}{2}$ " ; length of saddle on the bed, 14 ft.; height of uprights, 16 ft. Machine is driven by long belt carried under ceiling. Rapid return speed to each movement. The slide-rest and tool-holder can be lifted from end of shaping bar to side or bottom as required by the different kinds of work, a convenient hoisting device being supplied for this purpose. Driving pulley on the machine is 32" by 7", and should make 230 revolutions per minute to give 18 feet of cutting speed. The work is carried upon a heavy slotted floor plate, and the machine moved by power to the proper position. Will operate over surface of 24 feet long, 12 feet high, or a horizontal one 8 feet wide. Especially useful on a variety of large marine work.

PLATE No. 145.

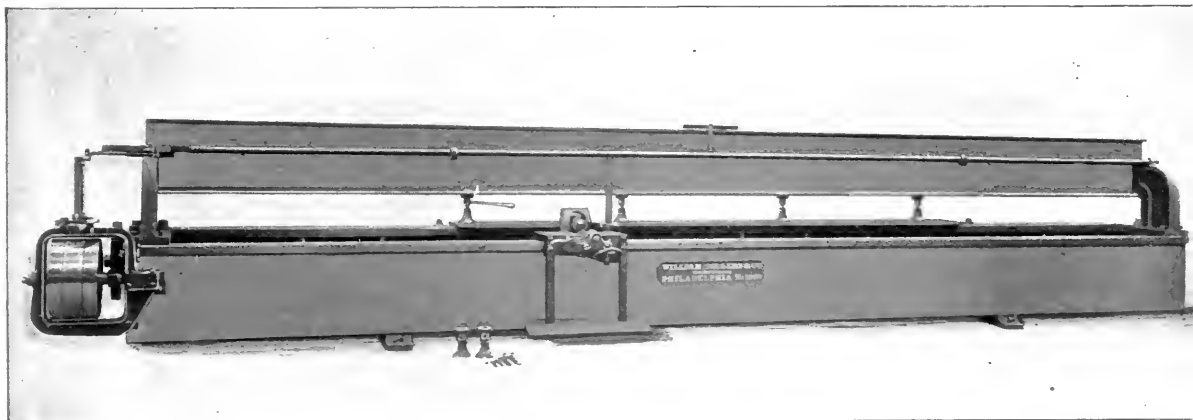

PLATE-PLANING MACHINE.

For plates 23 feet long in one setting. The uprights are offset to permit planing plates of any length in successive settings. The cut is taken in both directions with a single tool in a simple "turn over" holder which may be inclined for producing a bevelled edge. The operator stands on the moving foot board or sits on a convenient saddle attached to the carriage. The tool carriage is provided with hand and automatic reverse. The work is held by independent removable screw jacks which may be grouped in any manner required to produce the best results. This is a very simple but powerful machine adapted for boiler and bridge work and ship plates of moderate thickness.

PLATE No. 146.

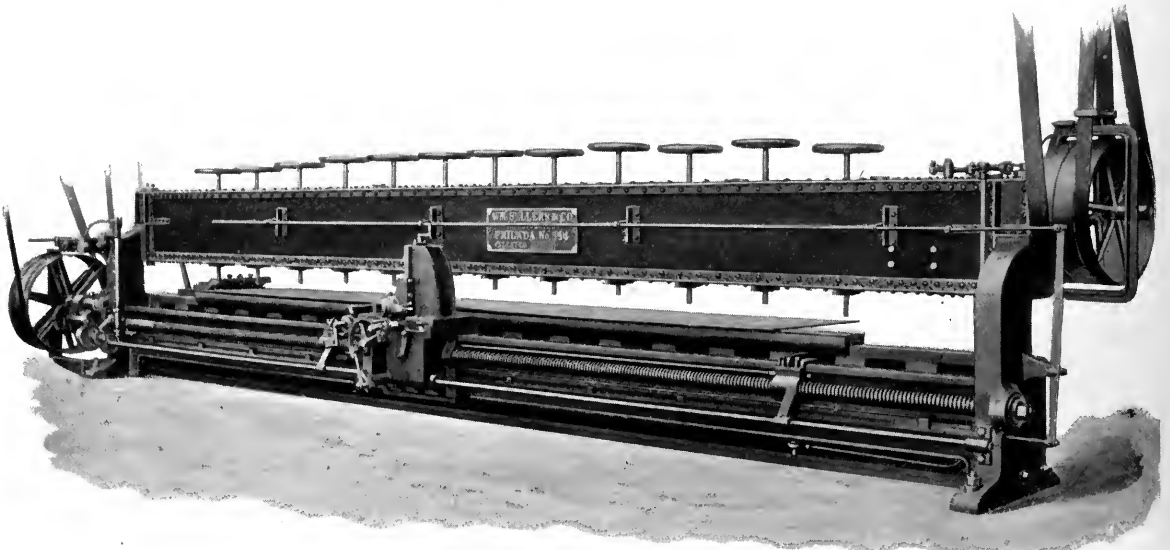

PLATE-PLANING MACHINE—WITH END-PLANING ATTACHMENT FOR

PLATES 22 FT. LONG, 5 FT. WIDE, AND 2" THICK, AT ONE SETTING.

End-planing attachment for plates 5 feet wide. Clamping-beam in form of heavy box-grinder. Saddle operated by large screw, provided, on account of its length, with adjustable intermediate supports. Saddle has two tool-holders arranged for cutting in opposite directions. One is provided with a hand vertical adjustment of 9", for planing angles or bent plates. This tool-holder is arranged to reverse, so that the same tool may be used in cutting each way, if required. Adjustable automatic feed is provided with a self-acting stop-motion, to limit the amount of stroke. A heavy bracket or table on the back of the machine helps to support the plate, while the clamping screws hold the front edge. Complete with necessary countershafts and wrenches. Fast and loose pulleys on countershaft, for edge-planing, 28" diameter, 7" face, and should make 280 revolutions per minute. Fast and loose pulleys on countershaft for butt-planer, 24" diameter by 7" face, also 280 revolutions per minute. Housings are offset so that plates of any length may be planed in successive settings.

PLATE No. 147.

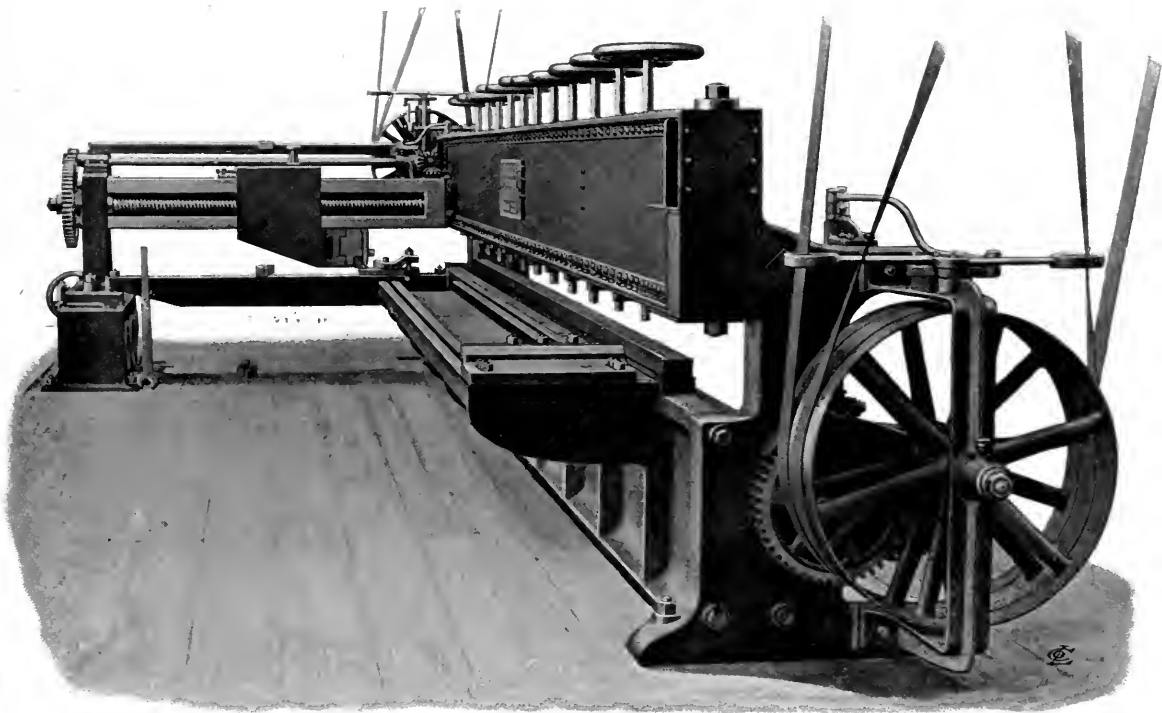

PLATE-PLANING MACHINE—FOR PLATES 22 FEET LONG.

SHOWING END-PLANING ATTACHMENT.

[See specification under Plate No. 146.]

We are prepared to build these machines of various lengths and capacities, and make them with clamping screws, as shown in these plates, or with independent removable screw-jacks, as preferred.

Punching and Shearing Machines.

OUR punching and shearing machines include two types, known as crank and lever machines, to designate the manner of driving. In the first type the vertical slide is driven directly by a crank shaft, and power is received through spur gearing from a pinion-shaft parallel thereto and in line with the machine, while in the second type, the vertical slide is driven indirectly through the intervention of a heavy steel lever by an eccentric shaft across the machine. This eccentric shaft is driven through spur gearing by a pinion-shaft parallel thereto, and at right angles to the position assumed in the first type of machine. Each type has its own peculiar advantages, among which the position of the machine, with reference to the line shafting, will be at once apparent; but for durability and economy of power in heavy service we decidedly prefer and recommend the lever machine, which we believe is demonstrably superior in design.

Our lever punches are usually connected with the operating eccentric positively and do not depend upon the weight of the lever to withdraw the punch. The sliding head, which is unusually long and well guided, may be counter-balanced and moved freely by hand when disconnected from the moving lever, and it is engaged or disengaged by our patent toggle-joint-stop which may be thrown in at any speed without danger and without shock. The toggle is straightened to transmit pressure, and if this be not done it simply "knuckles" and the operator takes the next opportunity to engage it. Clutches and sliding "gag blocks" are liable to partial engagement, and battered or broken edges often result if not more serious accidents. No other stop-motion operates so easily and so safely in large machines. It may be operated at will, allowed to act continuously or automatically disengaged at the completion of each stroke. The slide can be adjusted so that the clearance under the punch may be varied to suit the thickness of the plate or to suit the length of the punch. Our punching and shearing machines are easily convertible, that is they may be arranged with both shearing and punching devices and quickly changed from one to the other.

Our lever machines may be arranged to drive by belts from the line shaft, by independent engine or by electric motors attached to the bearings.

The various machines in the following illustrations are typical, but they by no means represent all of the modifications we have been called upon to make to meet special requirements.

We are prepared to build machines of any class with more or less overreach and more or less clear height between upper and lower jaws. These variables can be adjusted to the requirements of the work or the preference of the purchaser, but the width of the housing is limited to certain fixed dimensions, which serve as an index to the bulk and strength required. Thus, a punching machine 30" overreach might be 22", 28", or 32" wide, and from the illustrations the character of machine referred to in any case will be understood. So also with the combined and crank machines.

PLATE No. 148.

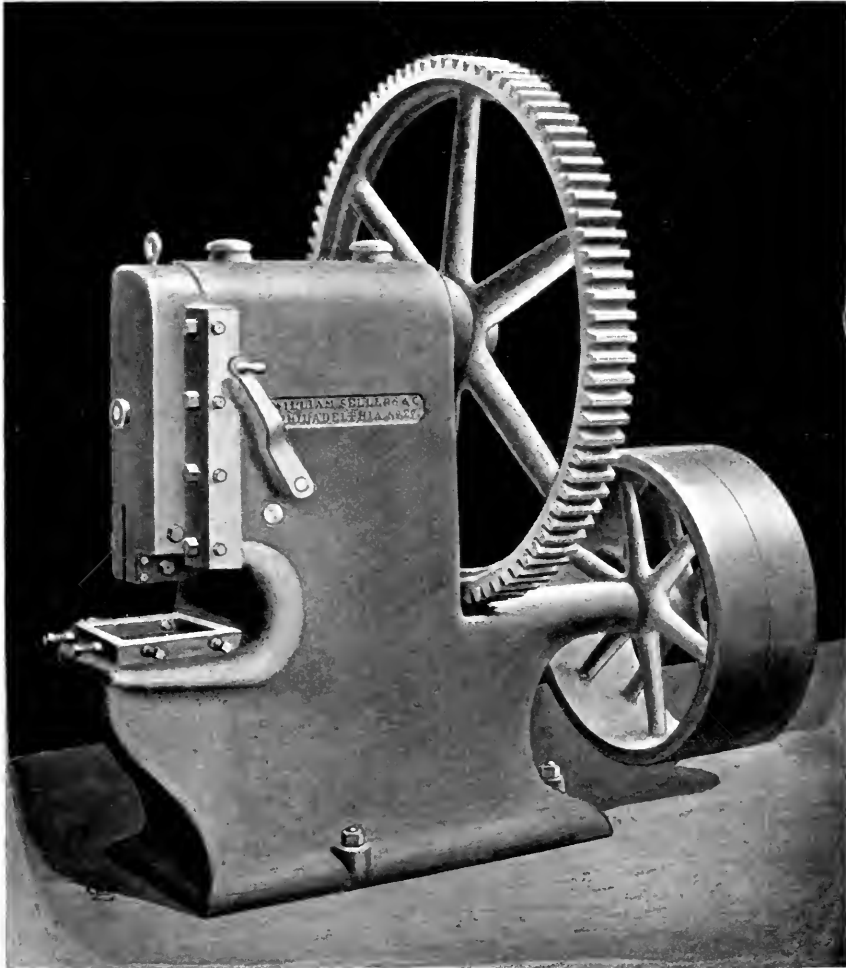

CRANK PUNCHING MACHINE—7" OVERREACH.

Capacity 1" hole in $\frac{1}{2}$ " plate. 36" x 7" fast and loose pulleys should make 144 revolutions per minute. Complete with wrenches, sample punch and die, etc.

PLATE No. 149.



PUNCHING AND SHEARING MACHINE COMBINED.

Overreach, $17\frac{3}{4}$ " for punch and $20\frac{1}{2}$ " for shears. Will shear $\frac{3}{4}$ " plate and punch 1" holes in $\frac{5}{8}$ " plate. 36" x 7" pulleys. 144 revolutions per minute. External punch for flanges and angles. Wrenches, shear blades, punch and die holders, sample punches and dies.

PLATE No. 150.

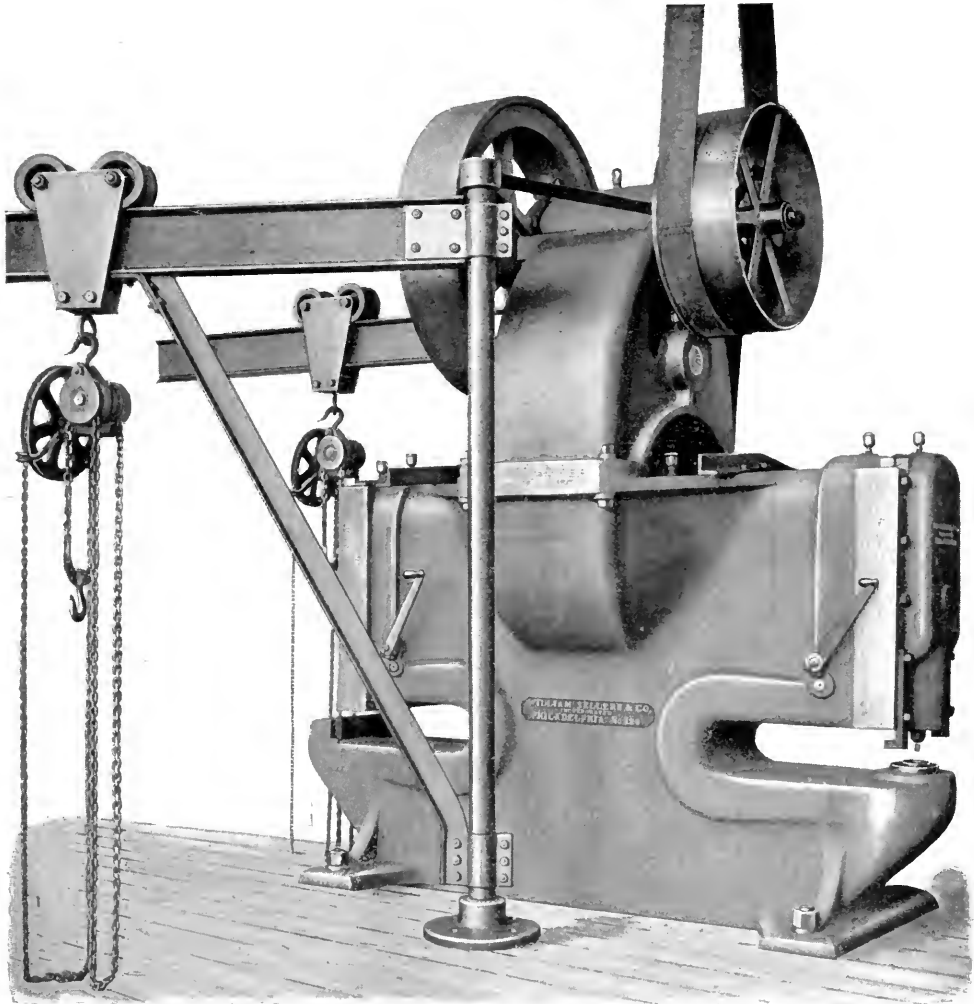

PUNCHING AND SHEARING MACHINE COMBINED—30" OVERREACH.

Capacity, $1\frac{1}{2}$ " hole in $1\frac{1}{2}$ " plates. Will shear $1\frac{1}{2}$ " plate. 36" x 7" pulleys. 200 revolutions per minute. With or without cranes attached. Cranes shown in the plate, 5000 lbs. capacity. Gearing enclosed in housing. Complete with set of shear blades, sample punch, and die.

PLATE NO. 151.

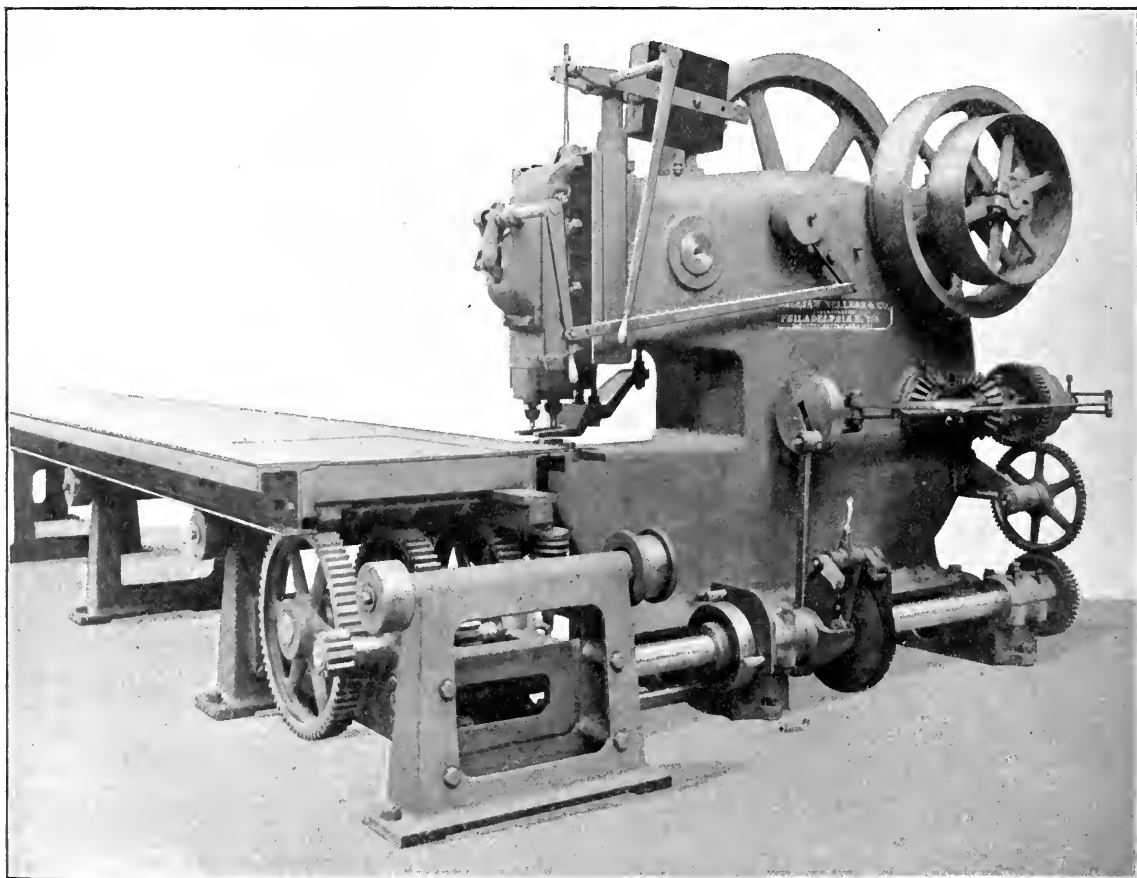

26" PUNCHING MACHINE—WITH AUTOMATIC SPACING TABLE.

Overreach of main punch from back of throat, 26". Capacity, $1\frac{1}{8}$ " hole in 1" steel plate. Front punch for lighter work in flanges and angles. Toggle-joint stop motion, counterbalanced slide raised and lowered by hand lever for setting punches. Two speeds, spacing table 42" wide, operated automatically and arranged with a differential movement to allow for variations of spacing in inner and outer boiler sheets. Table runs on roller stands and is held in place by powerful brake. Punches plates of moderate thickness at rate of 28 holes per minute.

PLATE No. 152.

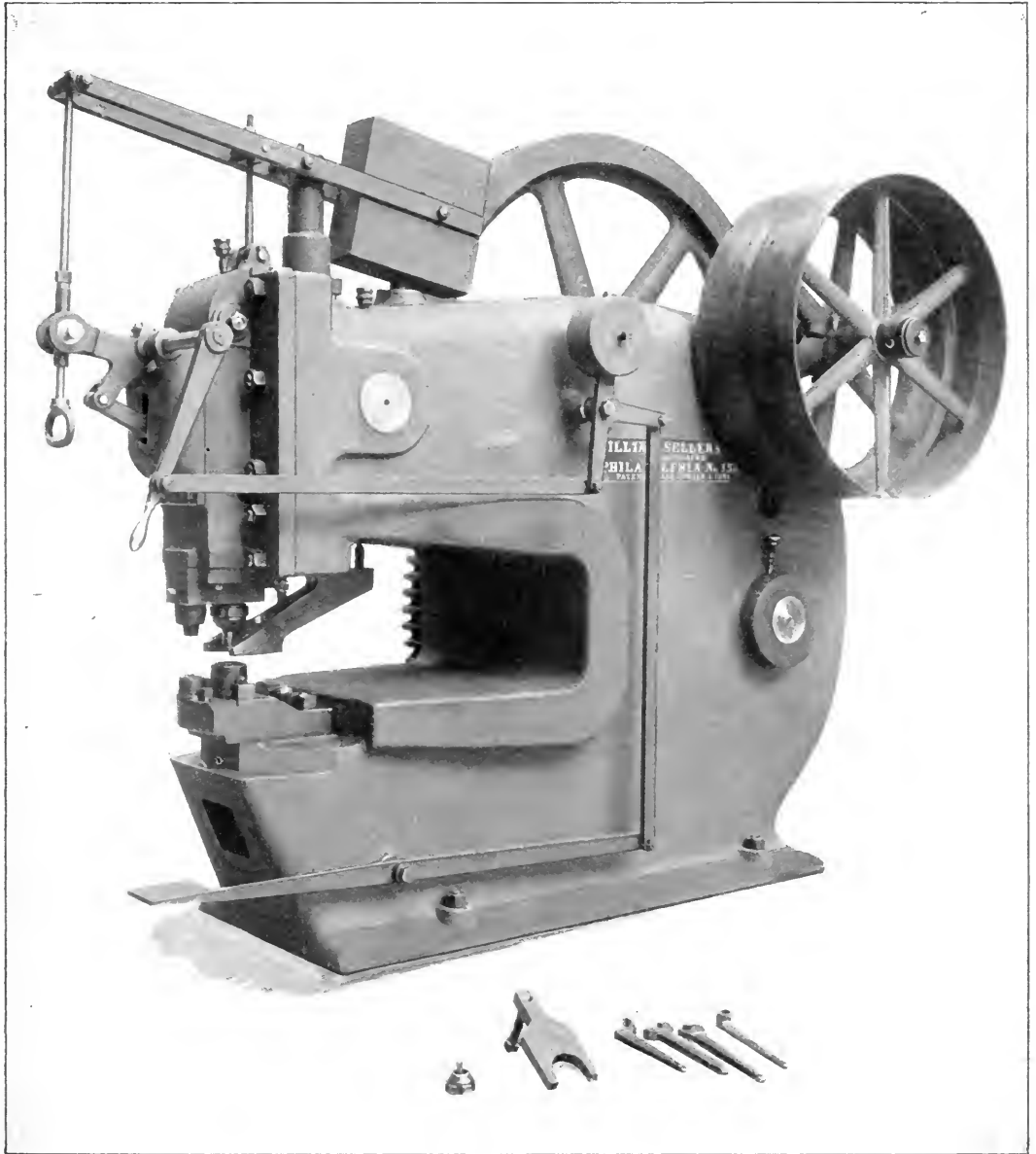

33" PUNCHING MACHINE.

For holes up to $1\frac{3}{4}$ " in $1\frac{1}{2}$ " plate. As shown this machine is especially arranged for punching webs of channels from 6" to 18" wide; has positive drawback and patent toggle-joint stop motion; counterbalanced slide arranged to punch continuously or to throw out automatically after each stroke. Overreach from center of main punch to back of throat 33". Slide may be brought down by hand to try centering of punch. Operated by hand or foot. Fast and loose pulleys on machine $36\frac{1}{2}$ " x 7". Furnished with die and punch holders, sample punch and die, strippers and full set of wrenches.

PLATE No. 153.

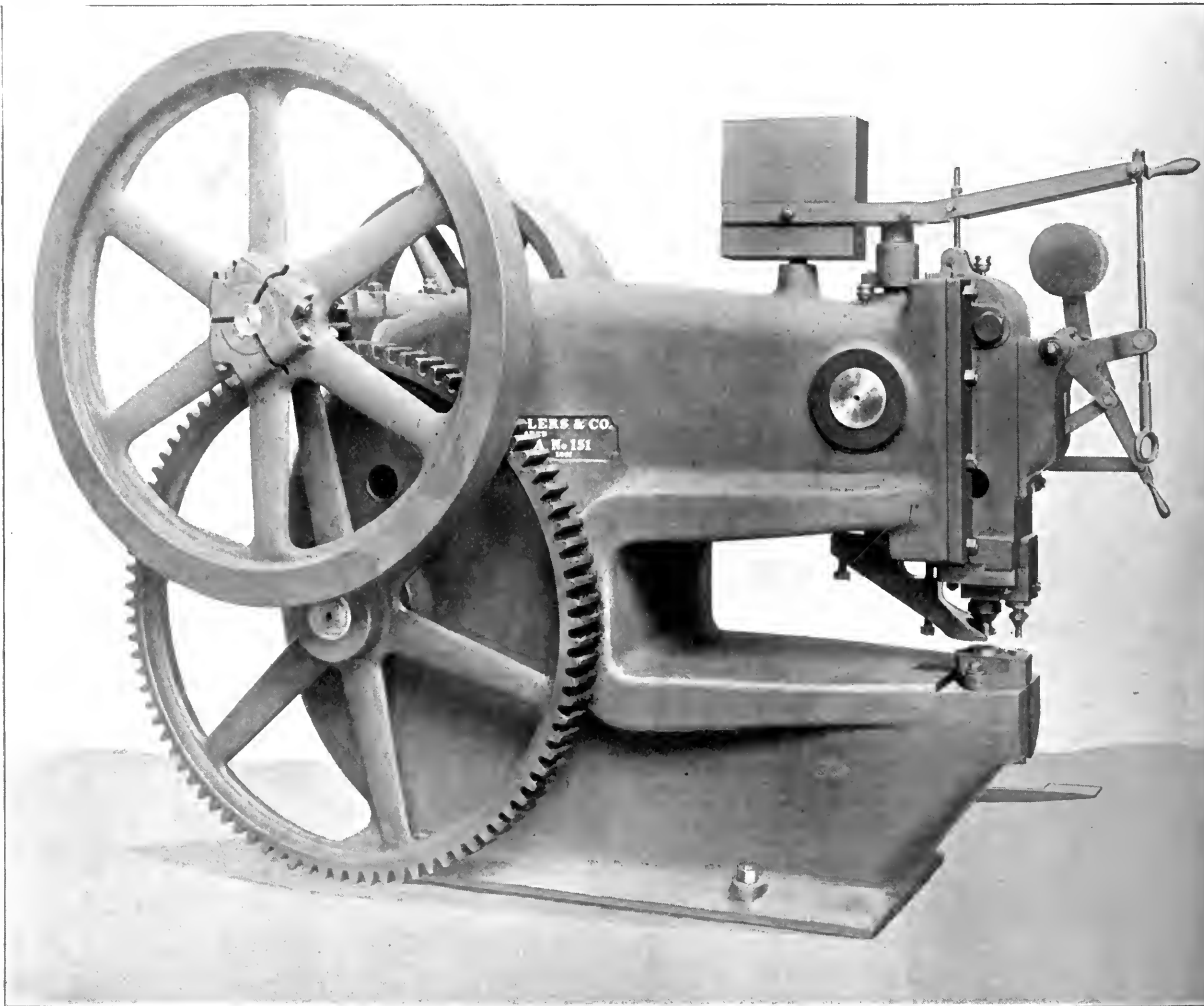

36" PUNCHING MACHINE—ARRANGED FOR SHEARING ATTACHMENT.

Capable of punching $1\frac{1}{2}$ " holes in 1" steel plate with flat punch. Over-reach from centre of main punch holder to back of throat, 36". Front punch for flanges and angles. Toggle-joint stop motion, counterbalanced slide and automatic knockout. Machine operated by hand-lever or treadle. Complete with stripper and two sample punches and dies. 36" by 7" fast and loose pulleys on machine. *Shearing attachment, extra.*

PLATE No. 154.

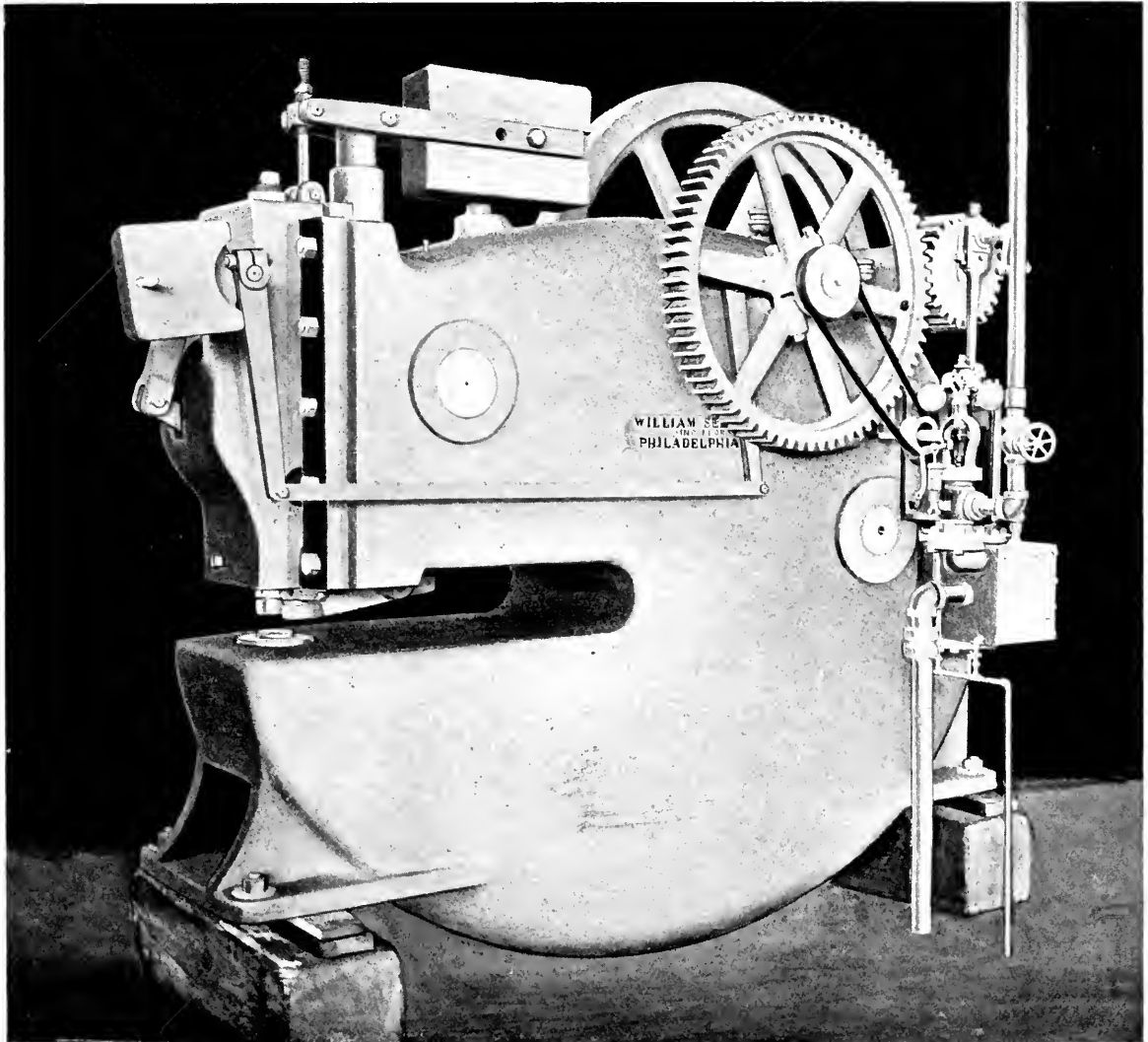

36" LEVER PUNCHING MACHINE—WITH 8" x 8" ENGINE.

Working pressure 400,000 pounds, will punch $1\frac{1}{2}$ " hole in $1\frac{1}{2}$ " steel plate. Has counterbalanced slide and patent toggle-joint stop motion; reversal of front counterweight will cause slide to stop automatically at top of stroke. Double geared. Made also to drive by belt or by electric motor. Head can be arranged to move by hand for setting punch. Overreach altered for different requirements.

PLATE No. 155.

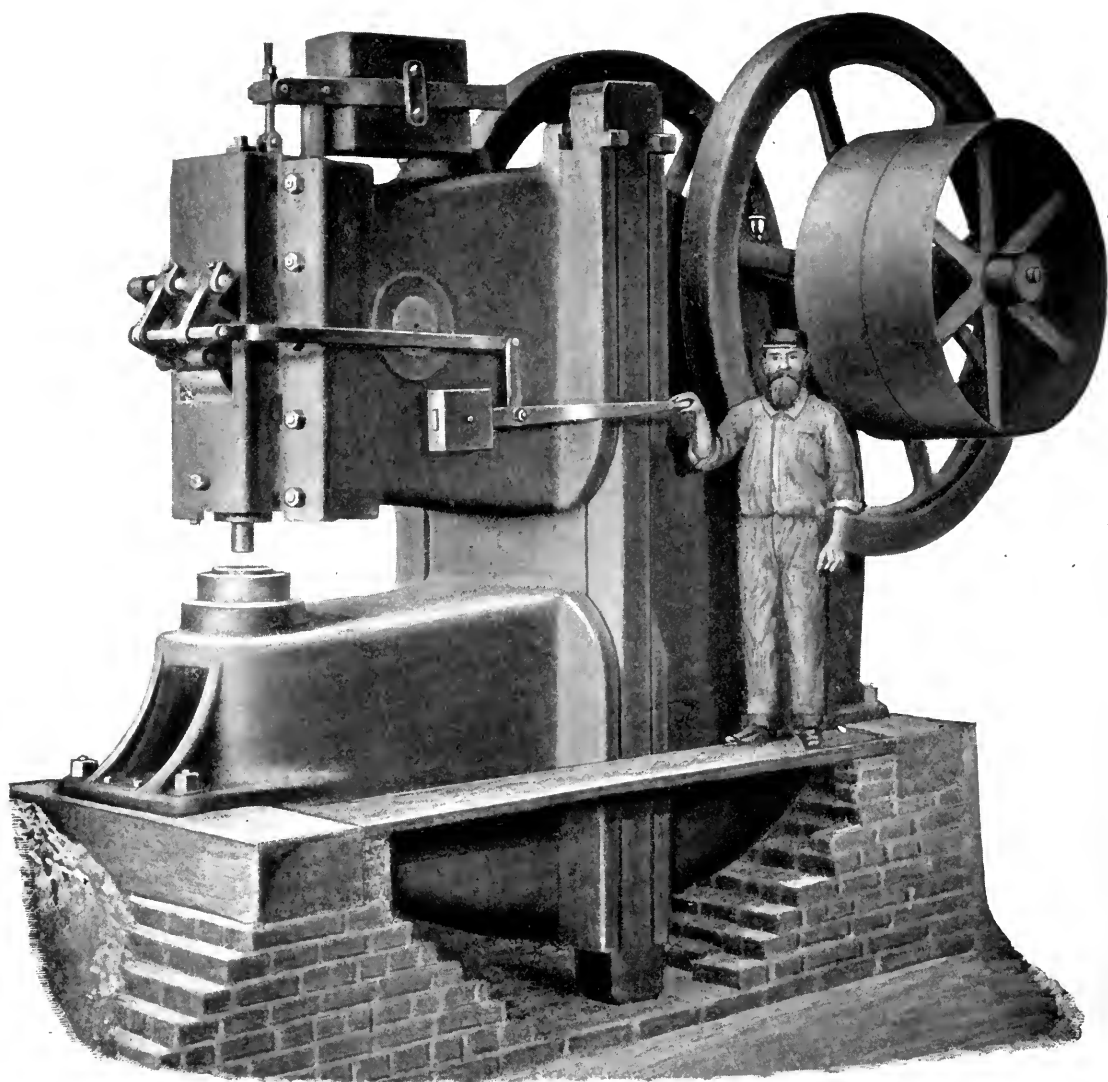

48" LEVER PUNCHING MACHINE.

Working pressure 500,000 pounds, will punch 3" hole in $1\frac{1}{2}$ " plate with flat punch. Made also with special bed and slide for punching flue holes up to 26" diameter in $\frac{3}{4}$ " plate. Has counterbalanced slide and improved toggle-joint stop motion. Bed in two parts connected by 1 bolts and wedges. 48" by 12" pulleys make 120 revolutions per minute.

PLATE No. 156.

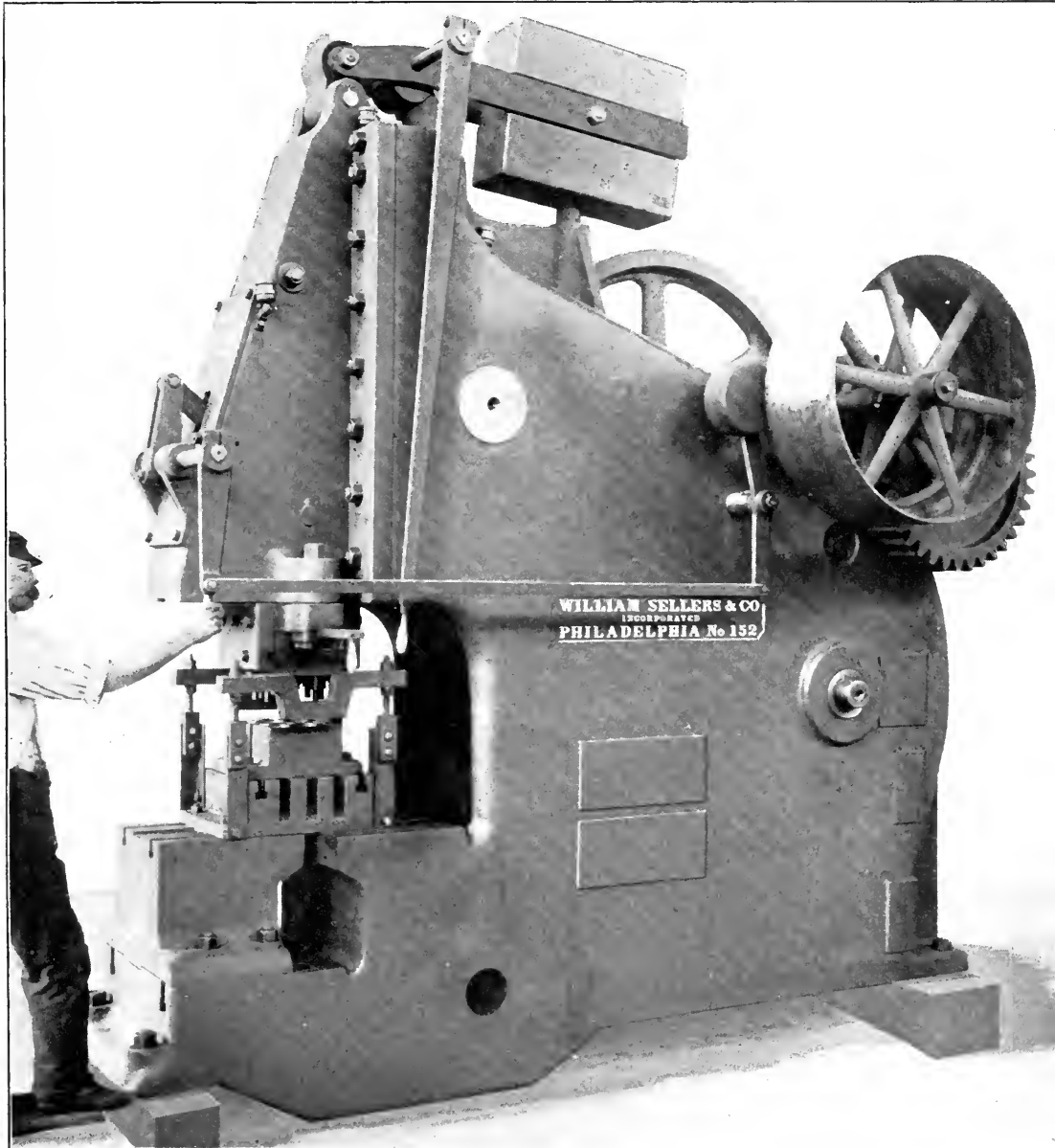

24" I BEAM PUNCHING MACHINE.

With special fixtures for standard beam connections, capacity equal to $2\frac{1}{2}$ " hole in $1\frac{1}{4}$ " steel plate with flat punch. Will punch flanges of beams up to 24" deep and web plates 36" wide. As shown it is arranged for two groups of 5 holes each, the distance between groups being variable to suit thickness of beam for which connections are intended. Made with or without spacing table.

PLATE No. 157.

MULTIPLE PUNCHING MACHINE.

WITH AUTOMATIC SPACING TABLE.

Spacing table 42" wide, carried in roller bearings will space automatically from 0" to 8" by increments of $\frac{1}{16}$ ". Spacing changed at will as work passes through machine. Arranged also for punching angles, channels and beams up to 15" deep. Separate roller supports for beams and angles adjustable simultaneously to required height. Furnished with 10 sliding punch holders with sample punches and dies, and necessary clamping bars and grippers for beams, channels and angles. Will punch web plates 42" wide in one pass, and by reversing plate and making a second pass webs 84" wide may be punched.



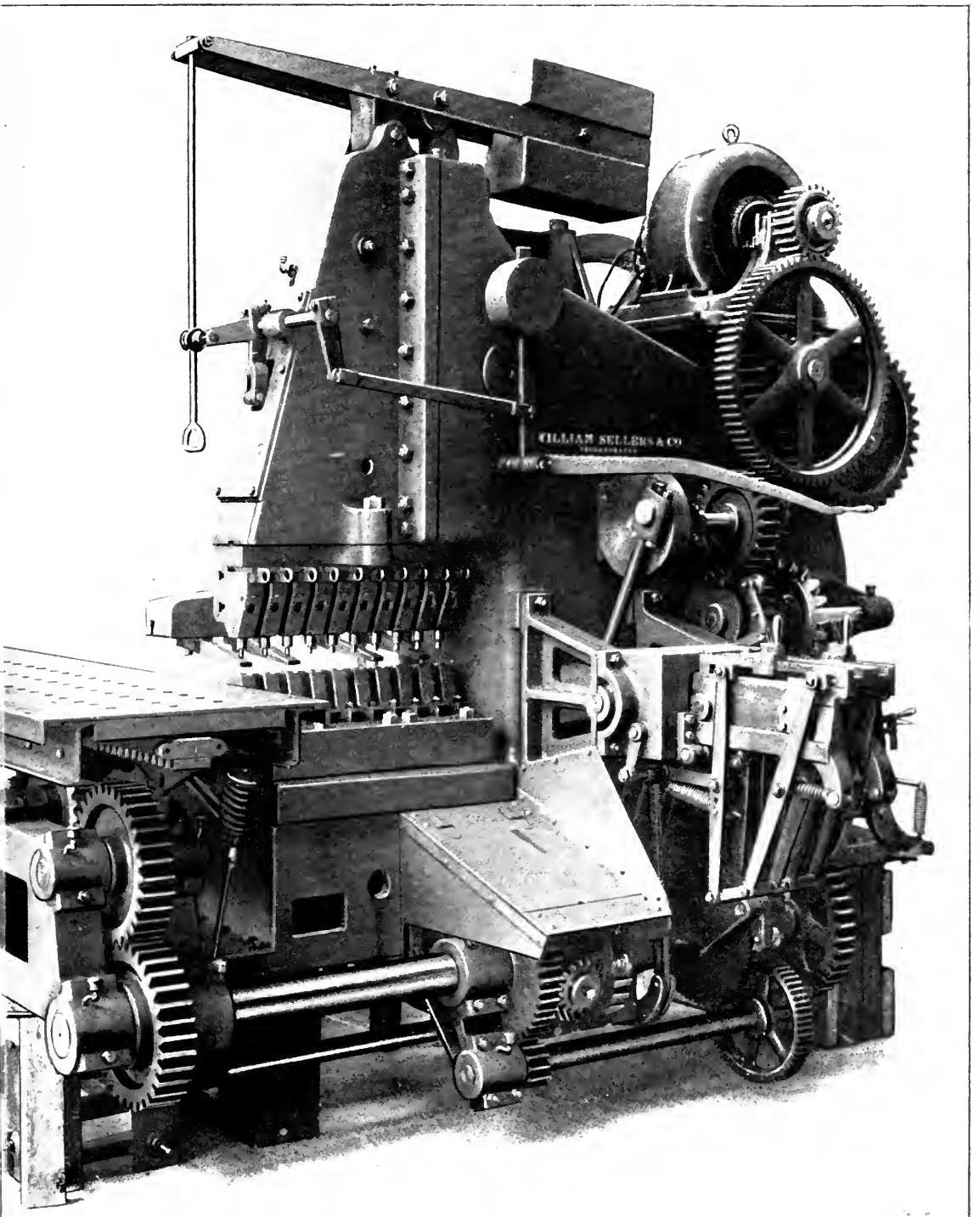

Multiple Punching Machine.

PROBABLY the most complete machine that has been made for punching plate girder work. In combination with a very handy spacing carriage, this machine is made for punching webs and flanges of plate-girders, and the flanges of I-beams or channels placed back to back. The punches are held in special holders bolted to the slide, and arranged so that each punch may be engaged or disengaged as required. Fifteen punches may be used at one time, and web plates punched in one passage through the machine, not only along the edges, but also transversely. Four angles or two channels are punched at the same time. We furnish with this machine, to complete its equipment, the following: *12 cylindrical punch holders, 6 side punch holders, 4 angle punch holders; supporting apparatus for channels, beams, etc., consisting of supporting blocks, die holders, and grips, 6", 8", 10", 12" sizes; four die-blocks with holes to one side for angles; twelve die blocks, with holes central; one stripper bar for plates; one set of angle strippers; one set of blocks for holding adjusting spring to angle stripper; two angle grippers; three plate grippers; one spacing carriage, arranged to space to any multiple of $\frac{1}{4}$ " up to $13\frac{1}{2}$ " between rivet holes; one guide carriage; fourteen stands with rollers complete, to support work and carry rails for supporting carriage; 124 feet of geared rails and 124 feet of plain rails, permitting a traverse of spacing and guide carriage of 62 feet; one blocking piece; two stands without rollers.* If it is desired to work plates longer than 62 feet, additional rails and stands can be provided. To adapt the machine for use as a plate punch, the gap in the centre of the cross-head is filled by a block. The spacing carriage can be set with great readiness to the distance required, and the work punched without templets. There are lifting rollers to raise the work from the dies, so as to clear the fins resulting from the punching, and to enable the spacing device to work freely.

PLATE No. 158.

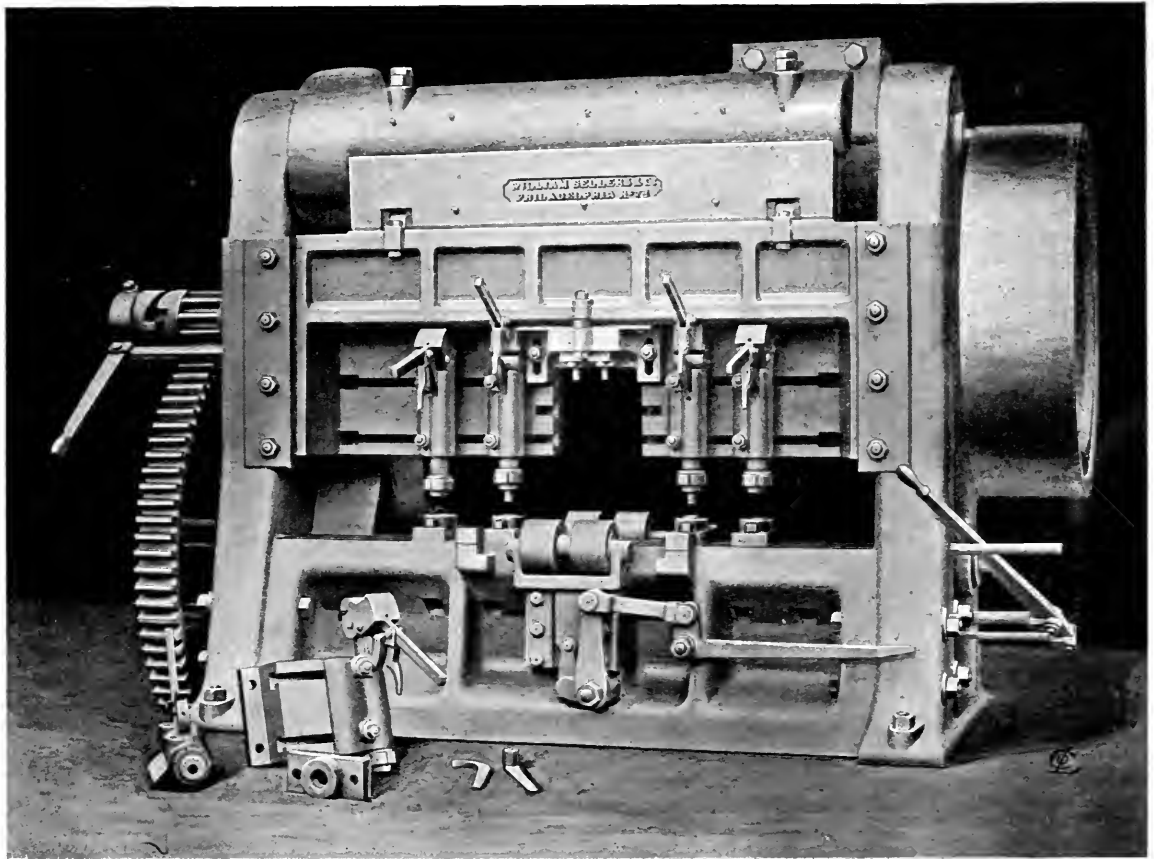

MULTIPLE PUNCHING MACHINE

FOR PLATES, ANGLES, CHANNELS, AND Z-BARS.

Will permit plates 5 ft. 2" wide to pass between housings. Stops and starts by moving cam on cam-shaft, or by clutch on pinion-shaft, as shown. Driving pulley, 42" diameter, 12" face, should make 120 revolutions per minute. Four cylindrical punch holders are shown in position, and one attached to filling-block on floor. Two angle punch holders are indicated in position for punching beam flanges. The rollers and treadle lift the work clear of the dies when it is shifted. No part of the spacing mechanism is indicated in the plate.

PLATE No. 159.

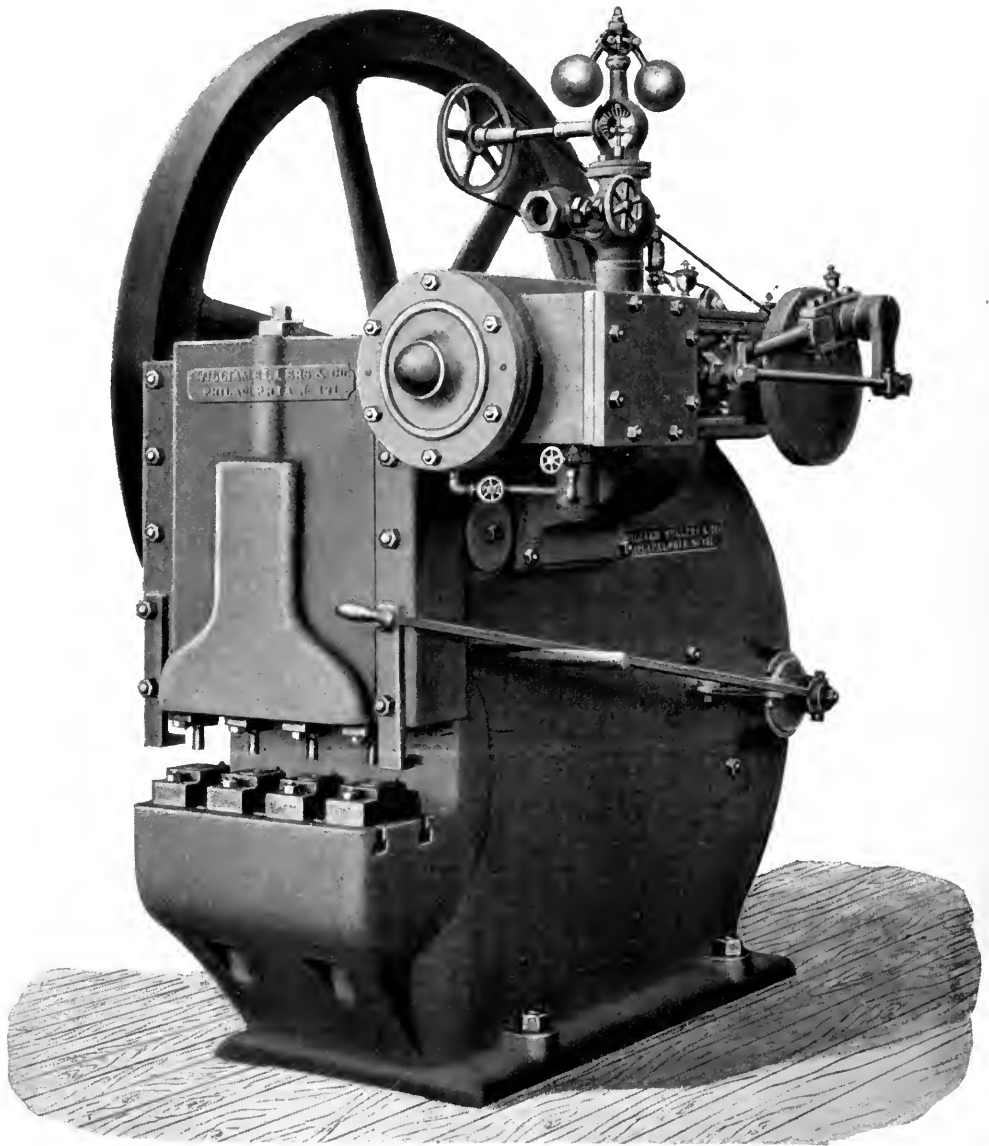

SPLICE PLATE PUNCHING MACHINE.

Driven by independent 10" x 12" engine attached to housing. Greatest distance between outside punches, 20". Complete with 4 punch holders, 4 die holders and 4 sample punches and dies for same.

PLATE No. 160.

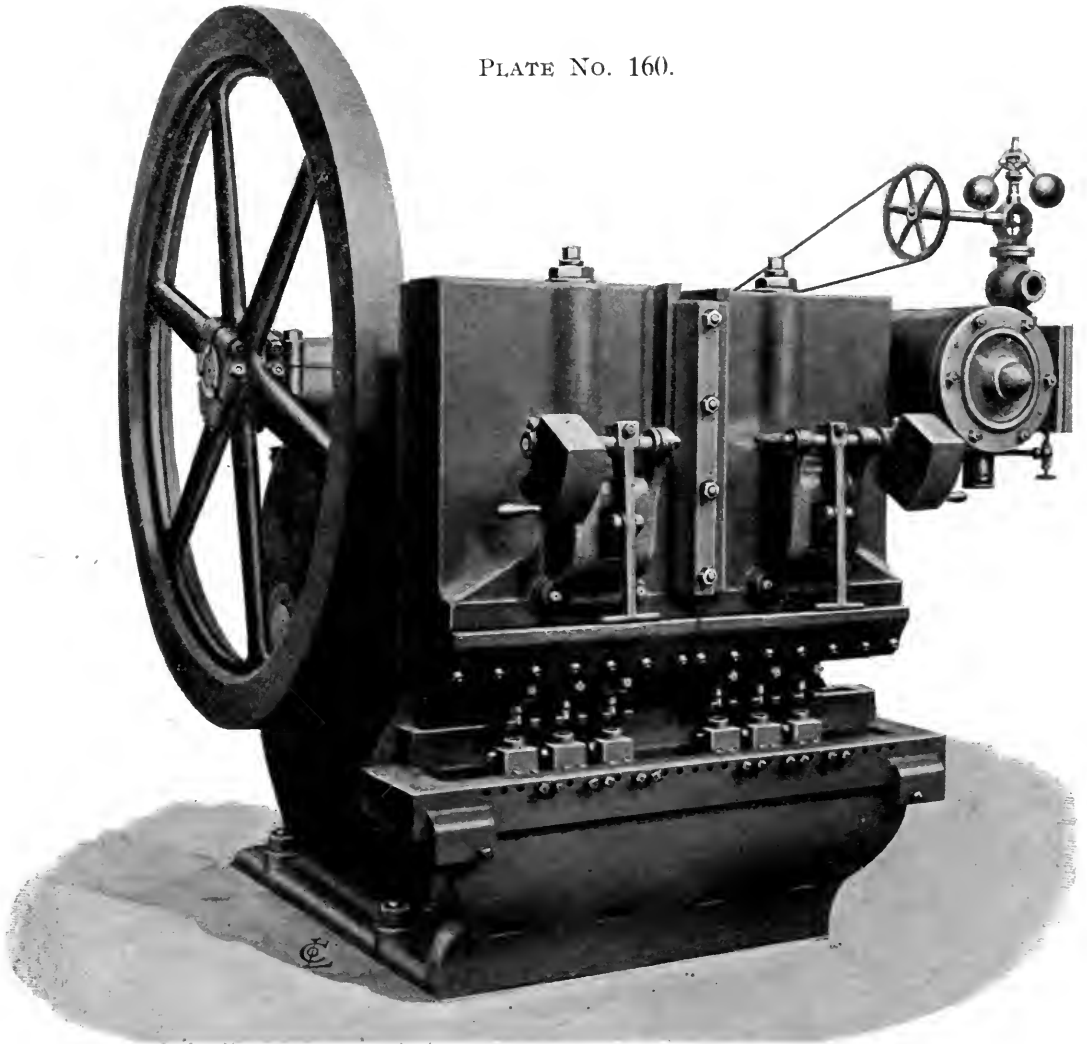

DOUBLE LEVER PUNCHING MACHINE FOR SPLICE PLATES.

Designed for modern heavy railway splice plates, having six holes per plate. Adapted for punching through flat or angle plates. All six holes at one time. Punches and dies adjustable over length of 45". Sliding-heads driven independently by separate levers, operated by patent toggle-joint stop, so that one or both punching heads can be used as desired. Slides of cast-steel. Driven by 10" x 12" engine attached to housing.

PLATE NO. 161.

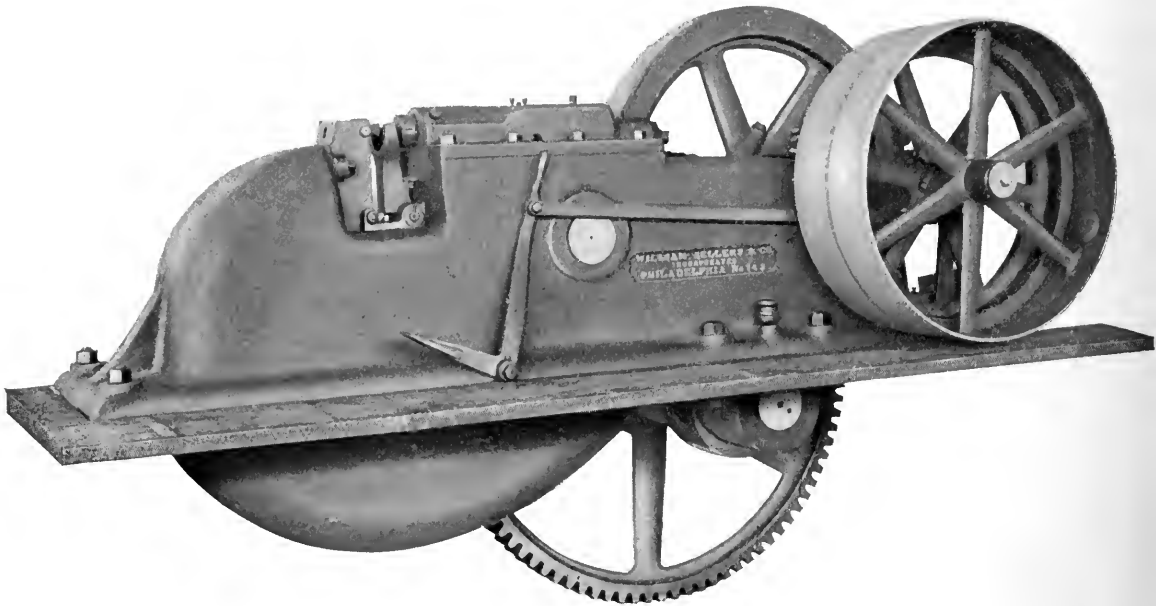

HORIZONTAL PUNCHING MACHINE.

This is a lever punching machine, driven by eccentric and operated by our patent toggle-joint stop motion. It has capacity to punch 1" hole in 1" plate, and an overreach of 10". It is especially designed for fire-box and boiler head work, and is convenient for punching a great variety of other shapes. The toggle-joint may be thrown in by hand or foot. This machine is provided with an adjustable stripper, die holder and sample punch and die. 36" x 7" fast and loose pulleys on machine.

PLATE No. 162.

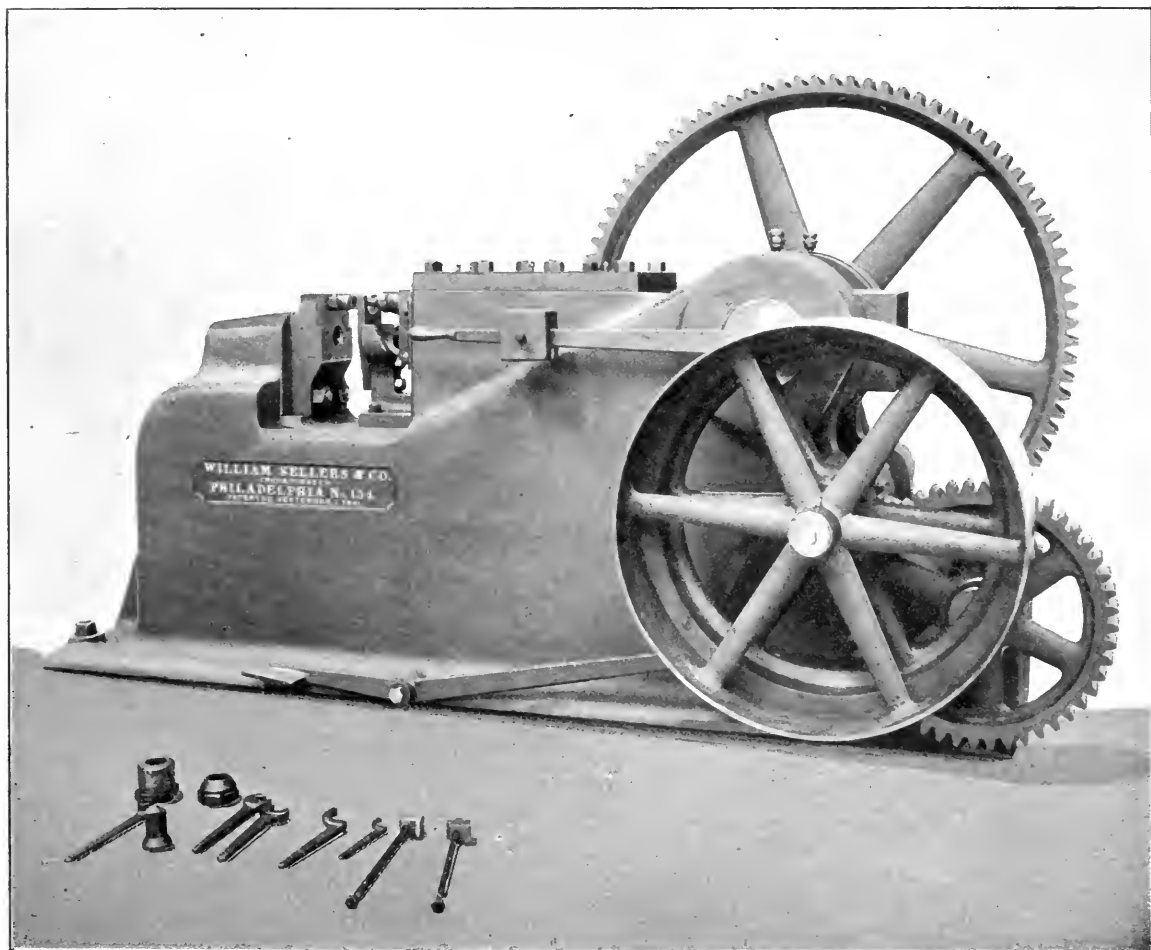

HORIZONTAL PUNCHING MACHINE.

With patent toggle-joint stop motion. Overreach of punch, 10". No part of machine extends below floor. Especially arranged for punching webs and flanges of channels from 6" to 18". Capacity, $1\frac{3}{4}$ " holes in 1" plate.

PLATE NO. 163.

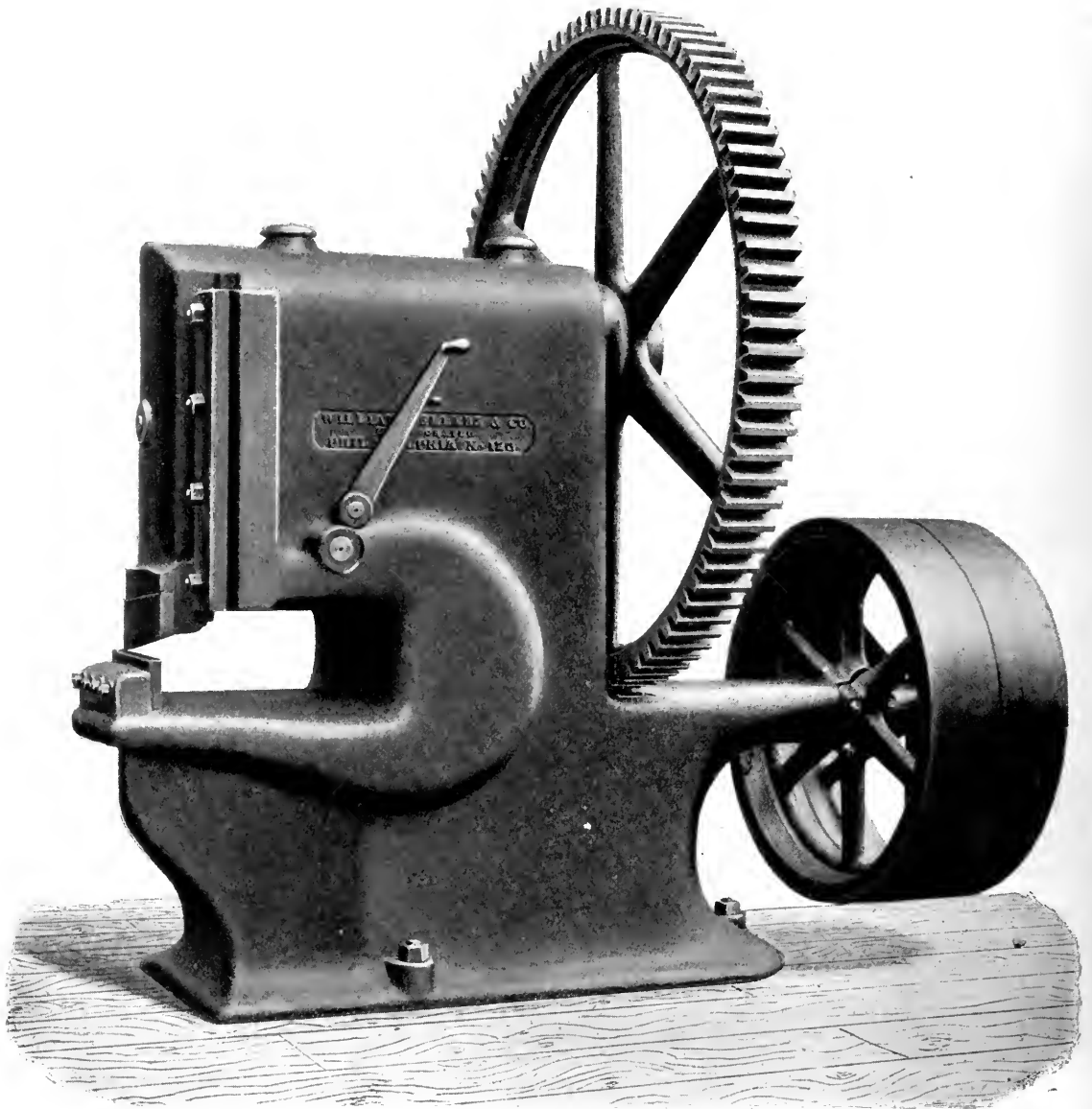

CRANK MOTION SHEAR—18" OVERREACH.

This machine is driven by an eccentric shaft, not by a vibrating lever. It is capable of shearing $\frac{3}{4}$ " plate, and has 36" by 7" fast and loose pulleys, and should make about 150 revolutions per minute.

PLATE No. 164.

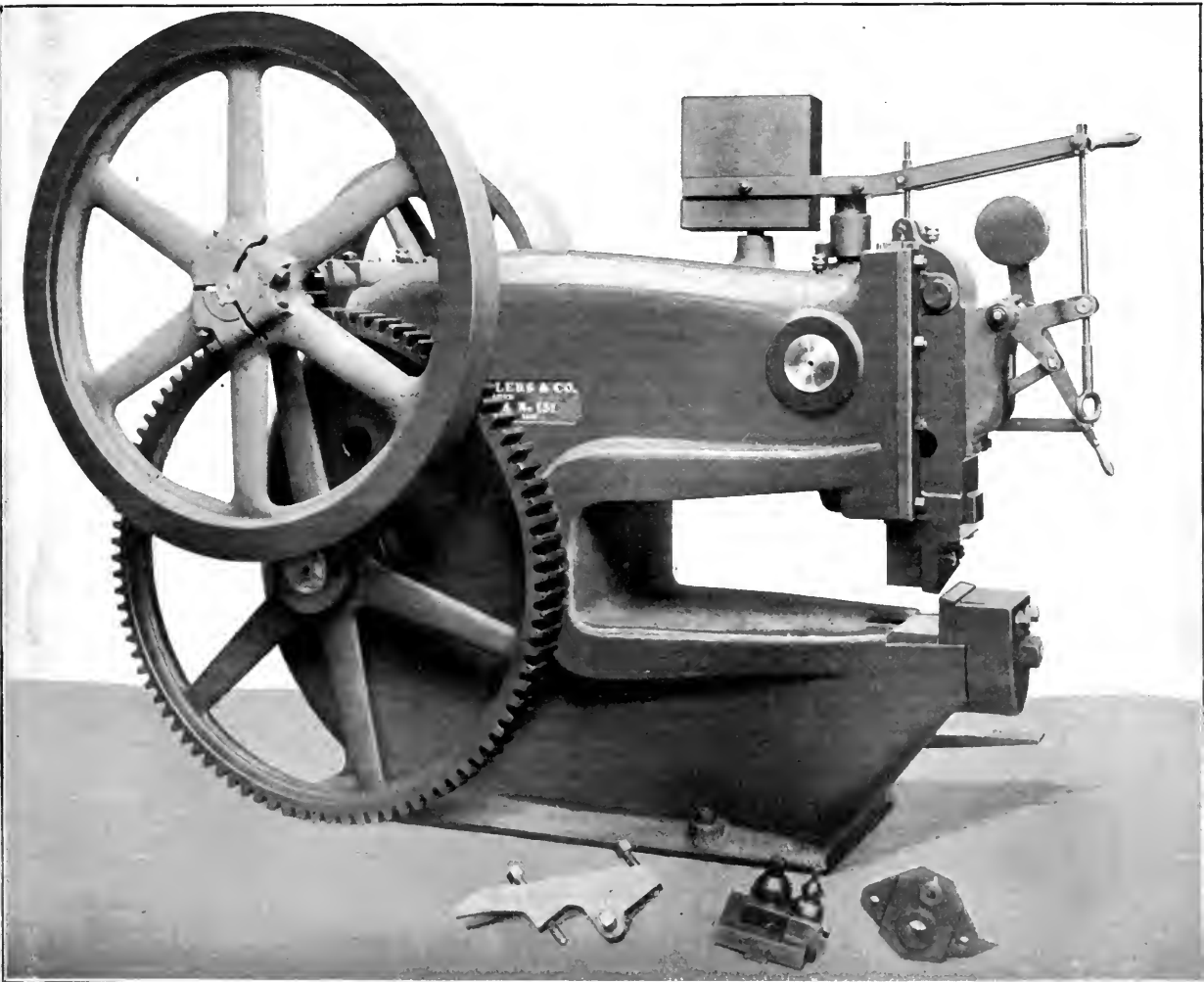

36" SHEARING MACHINE—WITH PUNCHING ATTACHMENT.

For shearing 1" steel plate. 36" overreach. Toggle-joint stop motion and balanced slide. (See Plate No. 153).

PLATE No. 165.

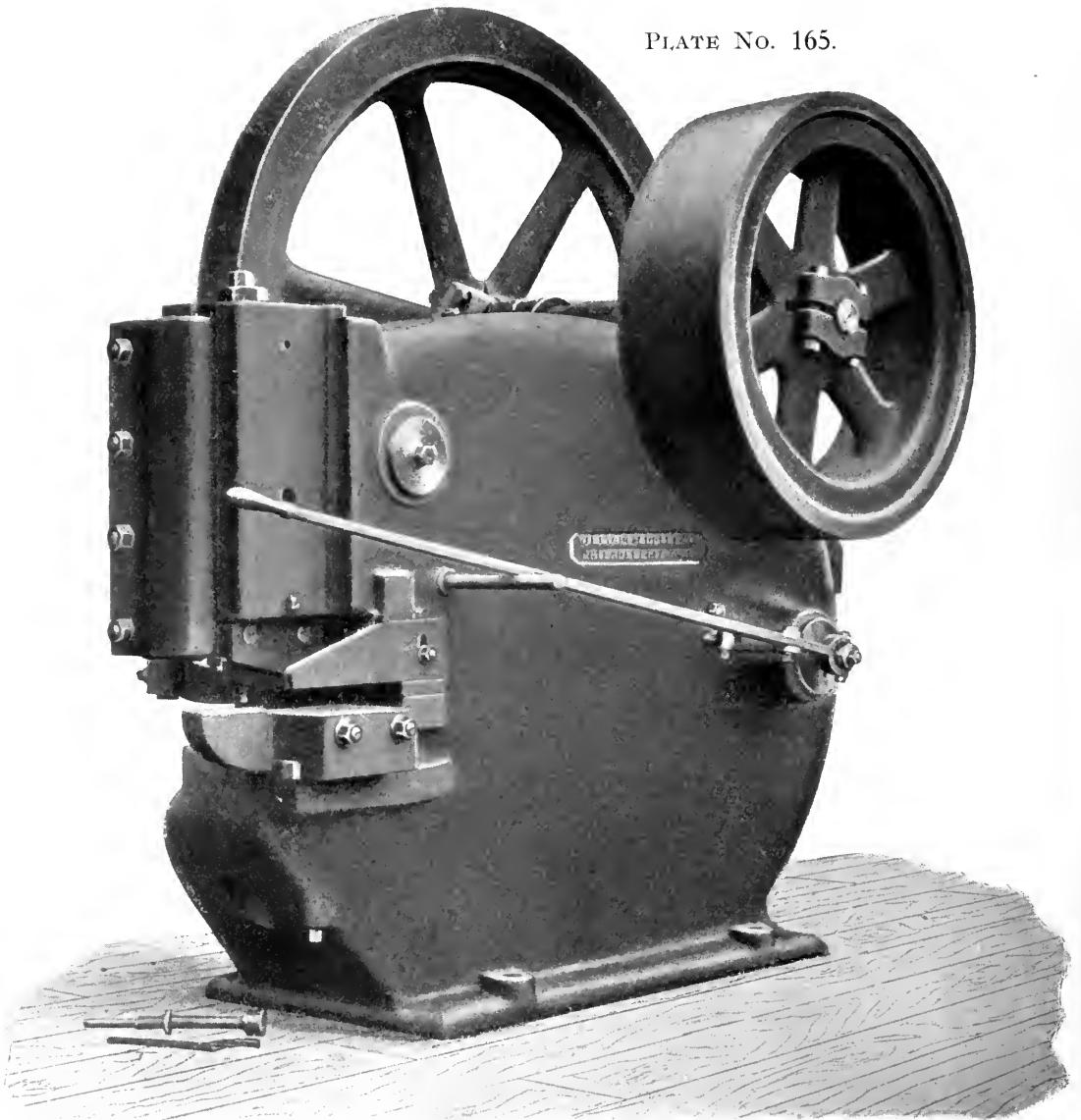

BAR SHEAR—WITH PUNCHING ATTACHMENT.

Driven by belt. Will punch 2" hole in $1\frac{1}{2}$ " plate, or shear 6" by $1\frac{1}{2}$ " bar at one stroke. Has strippers and sample punch, die and shear blade. Belt wheel, 42" by 12".

PLATE NO. 166.

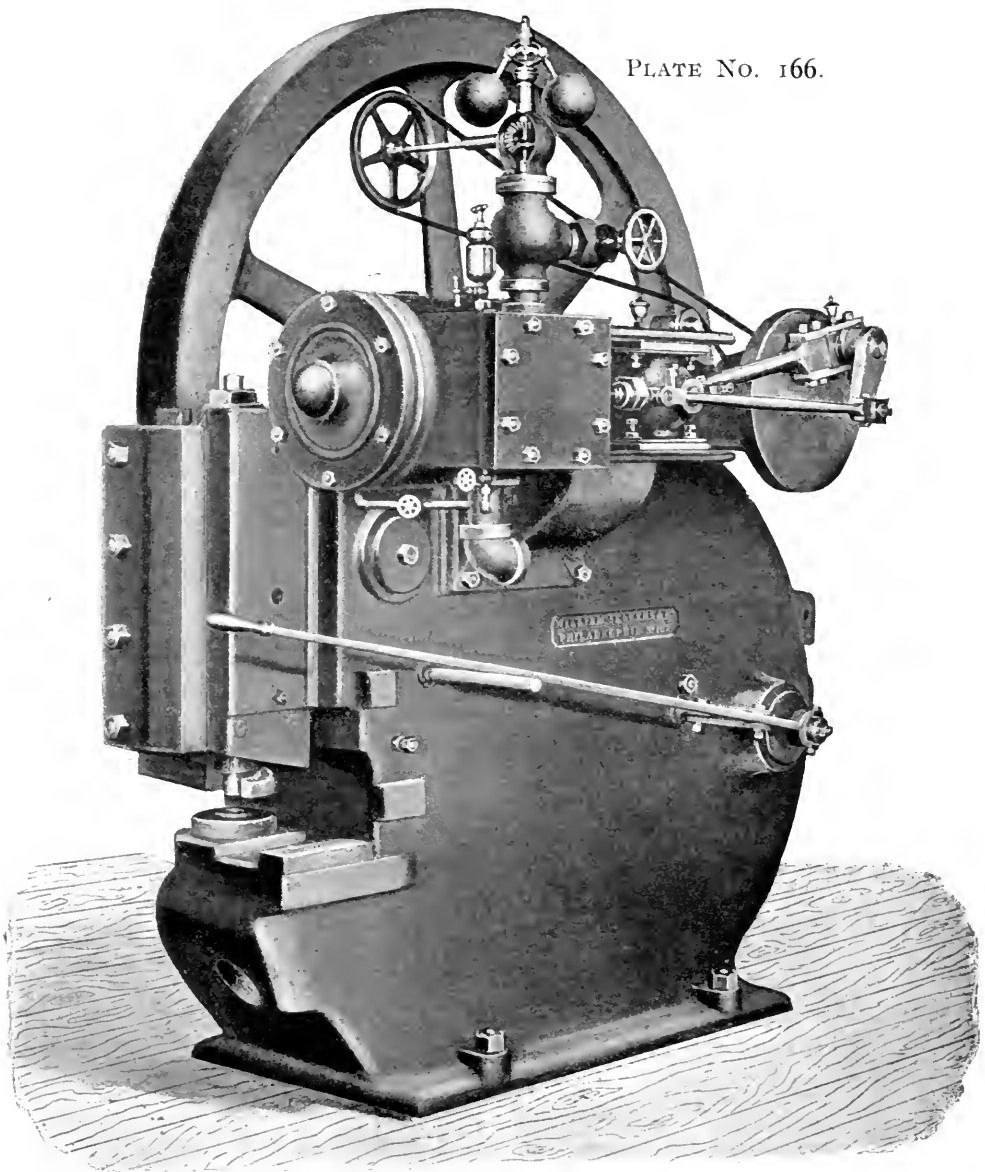

BAR SHEAR—WITH PUNCHING ATTACHMENT.

Driven by independent 10" by 12" engine. Will punch 2" holes in $1\frac{1}{2}$ " plate with flat punch, and shear 6" by $1\frac{1}{2}$ " bar at one stroke. Lower shear blade and block removed to show punch.

PLATE No. 167.

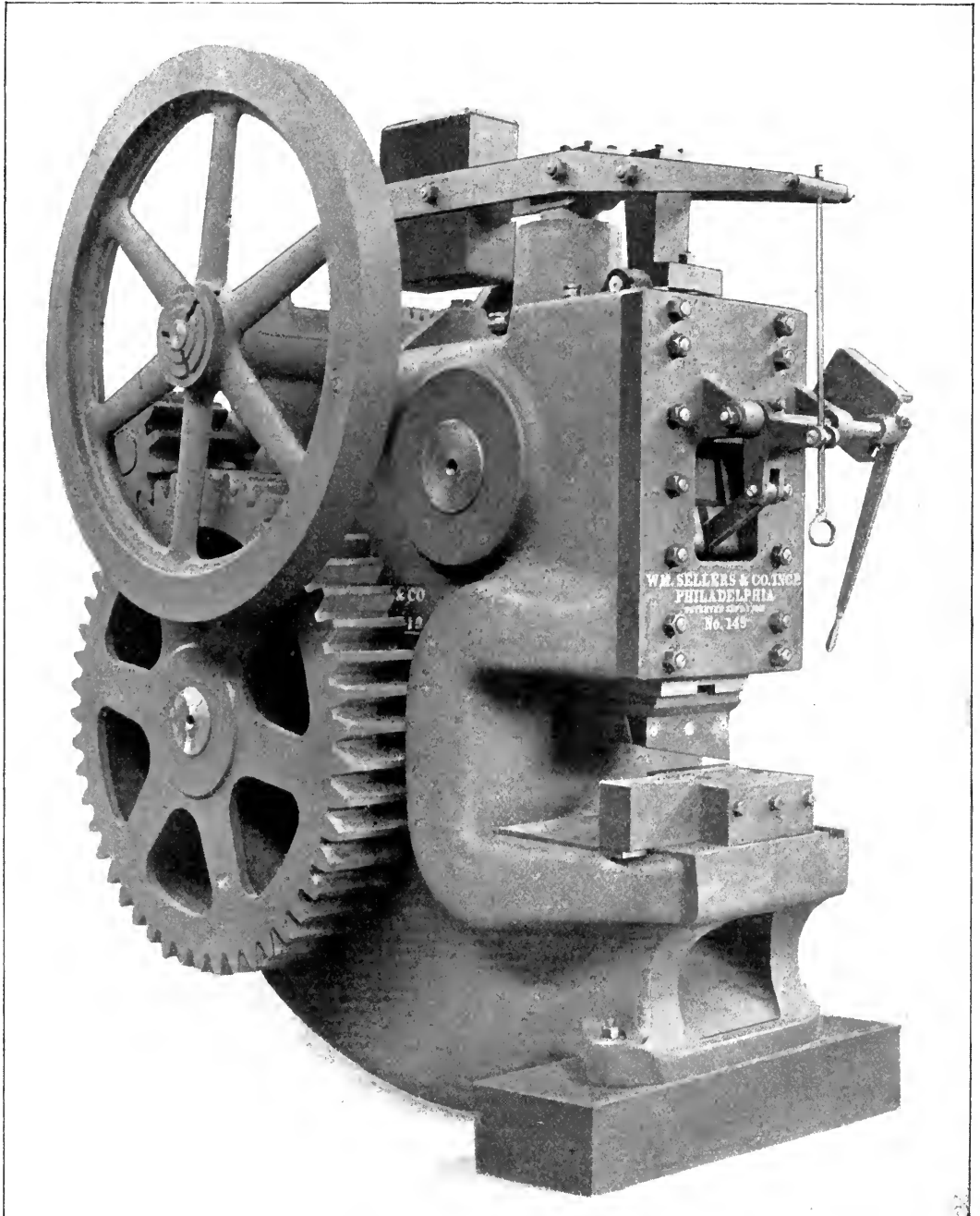

LEVER BAR SHEAR—10" OVERREACH.

For cutting steel bars up to 12" by 2½". Patent toggle-joint stop motion. Fast and loose pulleys, 36" diameter, 7" face, 240 revolutions per minute. Shear blades may be set at right angles to position shown for cutting long bars. Counterbalanced slide.

PLATE NO. 168.

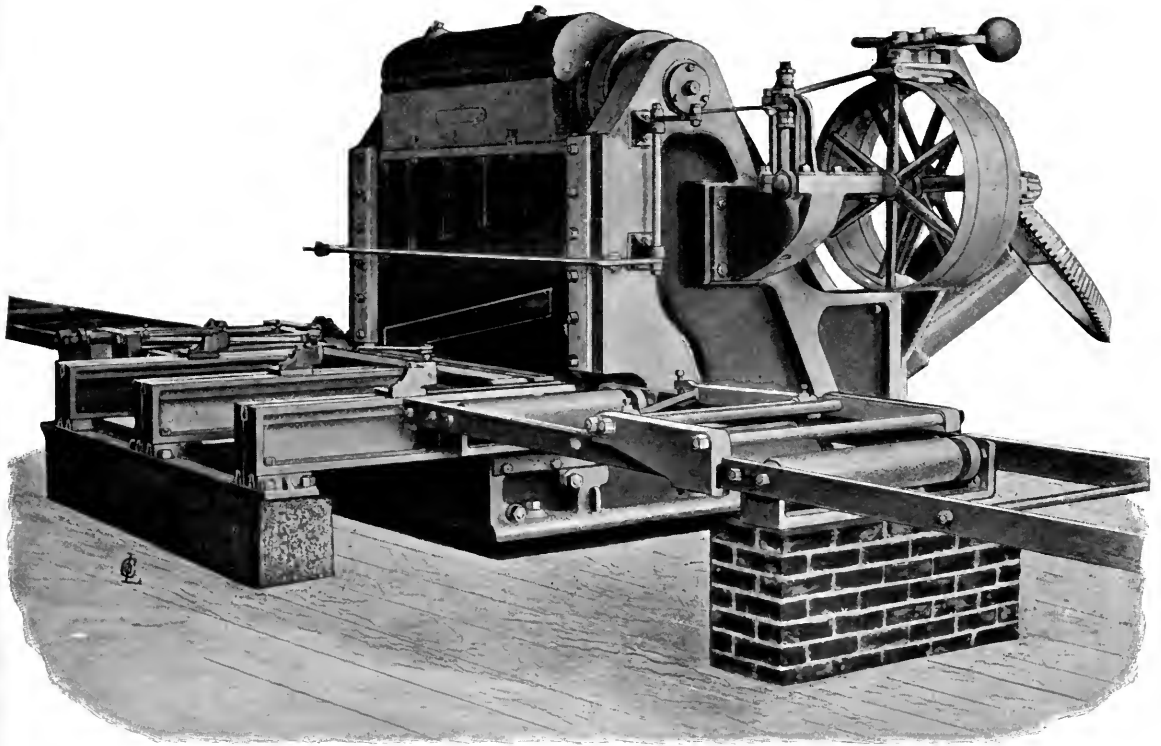

60" PLATE SHEARING MACHINE.

For cutting off plates up to 5 feet wide and trimming plates of any length. In trimming long plates, they should be guided by back and front carriages moving on rails and driven by rack and pinion; the plates being supported on rollers and clamped at moment of shearing. Moving shear blade operated by toothed segment driven by spiral pinion driven by fast and loose pulleys like planer. Will stop at top of stroke. Length of stroke adjustable to suit. Blade completely under control and may be stopped and reversed even after it has entered the cut; an important feature in cutting to an exact line.

Curved blades may be used when trimming circular plates.

PLATE No. 169.

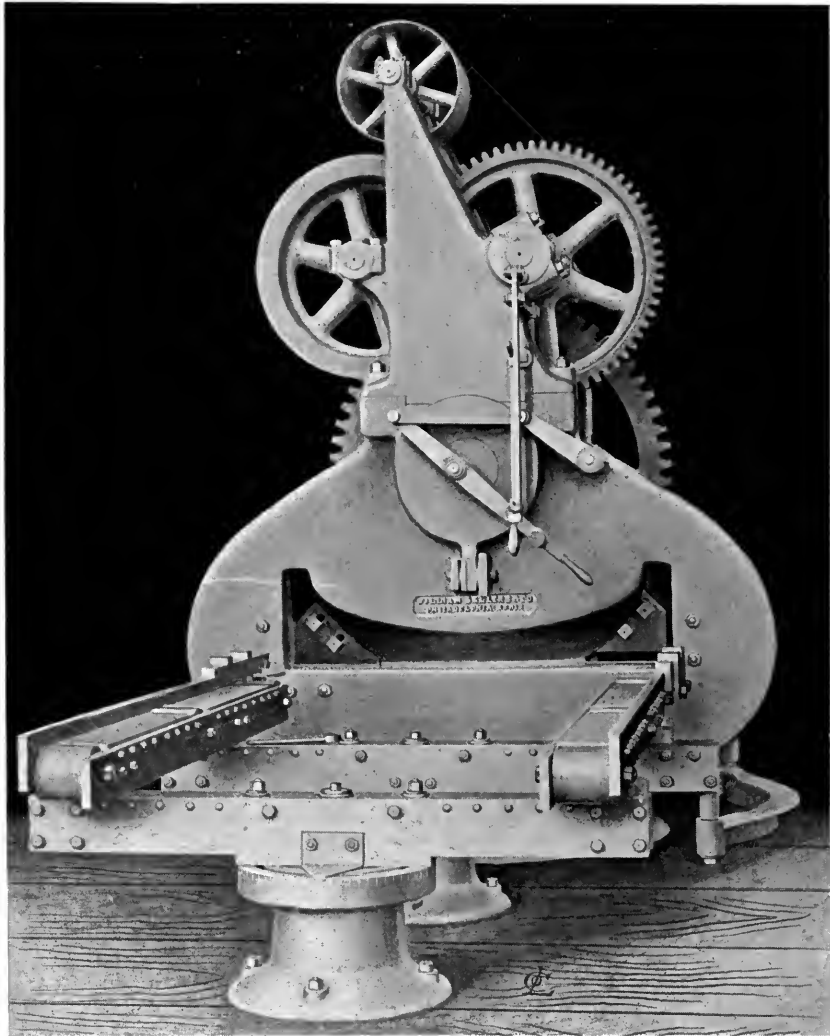

DOUBLE ANGLE SHEAR.

Arranged on swivelling base, with supporting table for work. Will shear 6" by 6" by 1" angles from 30 degrees in either direction to square, without changing the direction of the angle-iron. That is, instead of swinging the angle-iron, the machine is swivelled, thus greatly economizing shop room. Driven by belts from countershaft overhead. Safety arrangement prevents danger of throwing in wrong slide.

PLATE NO. 170.

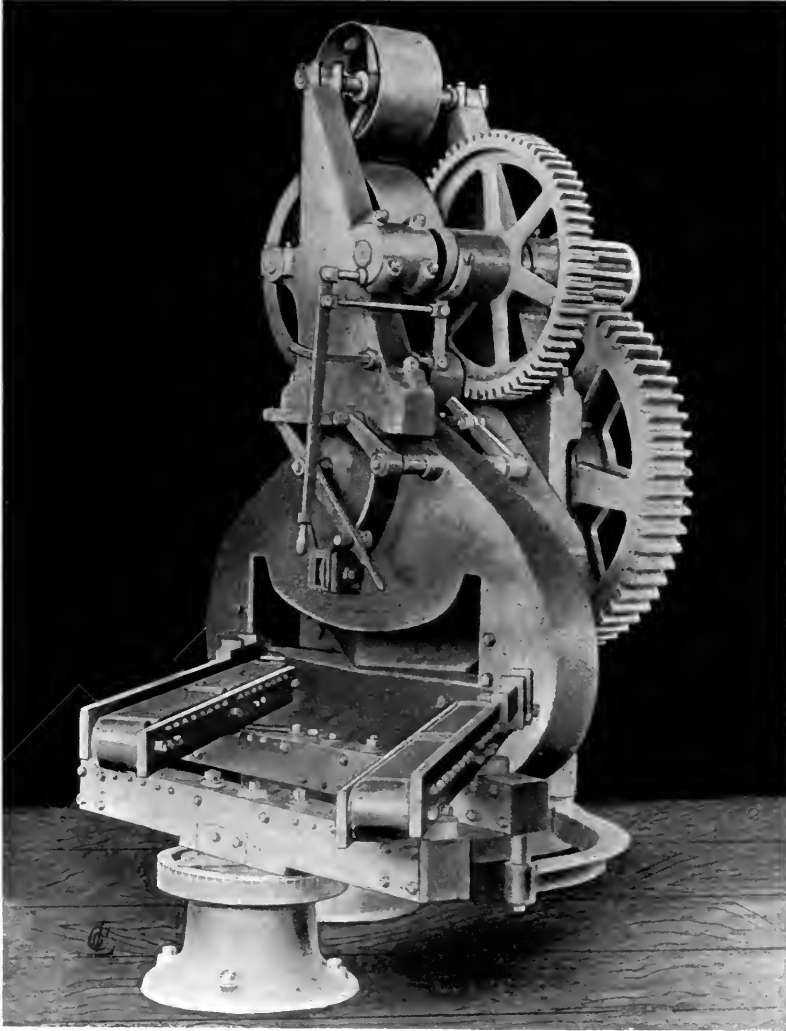

DOUBLE ANGLE SHEAR.

Arranged on swivelling base, with supporting table for work. Will shear 6" by 6" by 1" angles from 30 degrees in either direction to square, without changing the direction of the angle-iron. That is, instead of swinging the angle-iron, the machine is swivelled, thus greatly economizing shop room. Driven by belts from countershaft overhead. Safety arrangement prevents danger of throwing in wrong slide.

Steam Hammers.

THERE are two distinct types of direct-acting steam hammers. One in which the weight of the falling mass is concentrated in a head or "tup," which works between guiding surfaces, and is connected by a piston-rod of relatively small diameter with the steam-piston in a cylinder situated above it. The other type, known as the "Morrison" from the name of its inventor, arranges the falling mass in the form of a large cylindrical bar, of which the piston is an integral part, and is situated near the centre of the length, so that the bar extends above the piston and passes through the upper cylinder head. Hammer bars of this type are guided in the upper and lower heads of the cylinder.

When, in 1861, we first began the manufacture of steam hammers, we selected the Morrison type because in our judgment it possessed marked advantages, and this view our experience has since confirmed. It seems to us that a bar of such massive construction is better able to sustain the various shocks to which a steam hammer is subjected than the slender piston-rod employed in the other type of hammer, while the absence of guides gives unrestricted access to the anvil block from all sides; the strains are concentrated within the frame at the cylinder, instead of divided between the cylinder and the guides, as in the ordinary hammer. We have made many improvements in these hammers during the years that have elapsed since we first began their manufacture, all of which have tended to increase the efficiency and durability of the hammer. We early dispensed with the forged head, with which the English hammers were originally made, and which involved making the lower cylinder head in halves; we secure the hammer head by means of a circular taper wedge, which enables us to set the dovetail at any desired angle, and to renew the head in case the dovetail should be injured by careless keying or in other ways. We have adopted the box form of upright through the whole series of hammers, in place of the I-beam section formerly used, as we think the hollow box is particularly adapted for this purpose. We use an improved balanced piston-valve, packed with steel rings working in a perforated bushing. The valve motion is exceedingly simple, and not likely to get out of adjustment. In order to insure a full exhaust, which is a very important matter, especially where the exhaust pipes are long, we have adopted the Collin patent exhaust arrangement, and furnish with our hammers a suitable nozzle and exhaust pan with pipe connections. In setting up the hammer a thin sheet-iron exhaust pipe should be used, suspended directly over the pan, but not resting upon it. The exhaust pipe is thus relieved of the strain due to the shaking of the hammer, which is injurious to the pipe and tends to choke the exhaust, while at the same time the condensed steam falls down the sides of

PLATE No. 171.

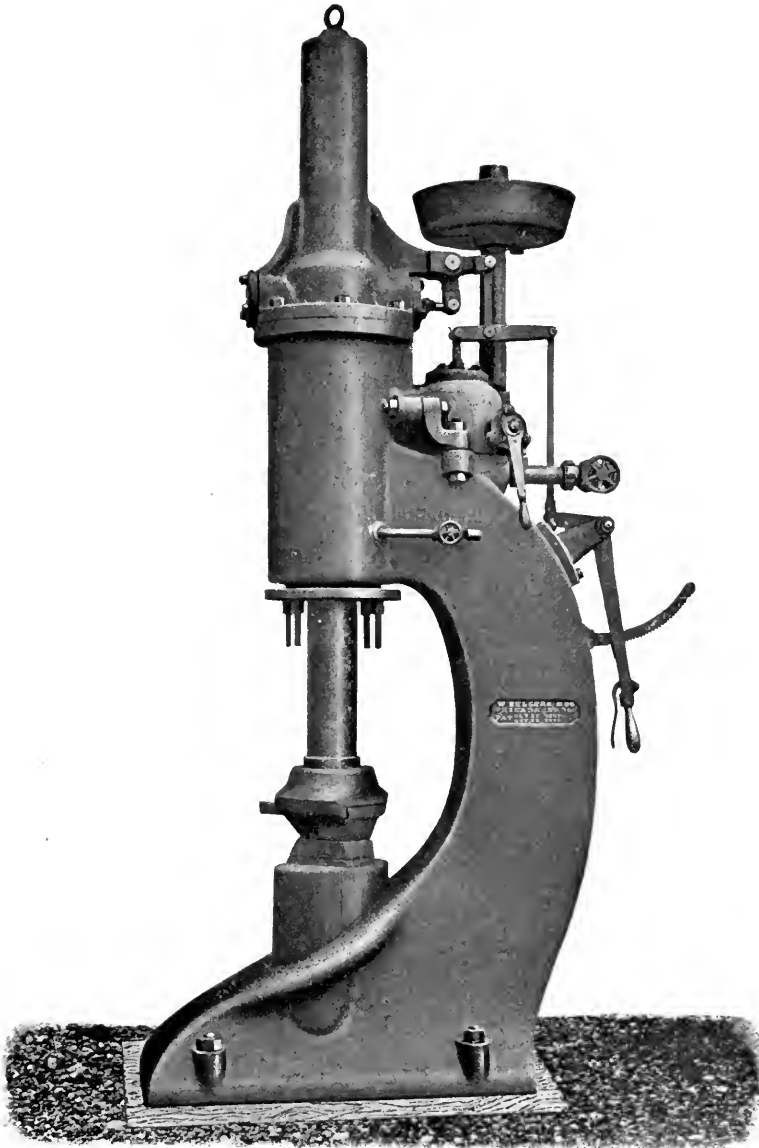

400-LB. HAND AND SELF-ACTING HAMMER.

With cylinder 10" diameter, stroke $15\frac{1}{2}$ ". With steel dies, and steel false top to anvil block. Balanced piston-valve with steel packing rings. Collin exhaust arrangement and quick-closing throttle valve. Check valve in exhaust passage to regulate force of blow.

Steam Hammers.—*Continued.*

the pipe to the pan, whence it finds its way to the drain, and is not thrown in a shower upon the roof, as is usually the case. We furnish with our hammers, unless specially ordered, top and bottom dies of steel castings. For the smaller hammers these are made with peening faces at one end,—that is, for about half its length, the die is narrowed to about half its full width. If required, we can furnish *plain* dies, with parallel sides, in place of those described above. For large hammers, it is generally customary to use the plain dies only. For securing the dies to the anvil block, we recommend the use of crimped steel keys of uniform thickness, that is, without taper, which hold the dies by elastic pressure only. With such keys no injury can be done to the dovetail, but they require to be recrimped from time to time in order to restore their elasticity.

In rating our hammers, we call them by the weight of the falling parts, and not, as is sometimes done, by the assumed value in pounds at which the blow of the hammer is estimated. For example, our 400-pound hammer has a bar which, together with the hammer-head and upper die, weighs 400 pounds. To this, of course, is to be added the pressure of the steam acting on the piston through the whole length of the stroke.

SINGLE-UPRIGHT STEAM HAMMERS.

Our smaller hammers, from 400 pounds up to 3150 pounds weight of bar, are made with a single leg or upright and overhanging cylinder, and unless specially ordered they are provided with automatic valve-gear. The automatic motion in these hammers is obtained from two inclined grooves diametrically opposite each other in the upper part of the bar, which are made to work a brass yoke, whose line of movement passes through the axis of the bar. The horizontal movement of this yoke is transmitted through a bell-crank to the lever which operates the valve in the steam-chest. When the hand-lever is latched in a given position, the movement of the hammer up and down causes a corresponding movement of the valve in the steam-chest, and the hammer will continue to strike with a length of stroke depending upon the point at which the hand-lever is latched.

DOUBLE-UPRIGHT STEAM HAMMERS.

Our hammers of more than 3150 pounds weight of bar are rated, for convenience, in tons of 2000 pounds each, and are made with two legs or uprights, the cylinder being a separate casting bolted between the uprights, which are arranged with flanges to enclose those on the cylinder. These flanges are secured

PLATE No. 172.

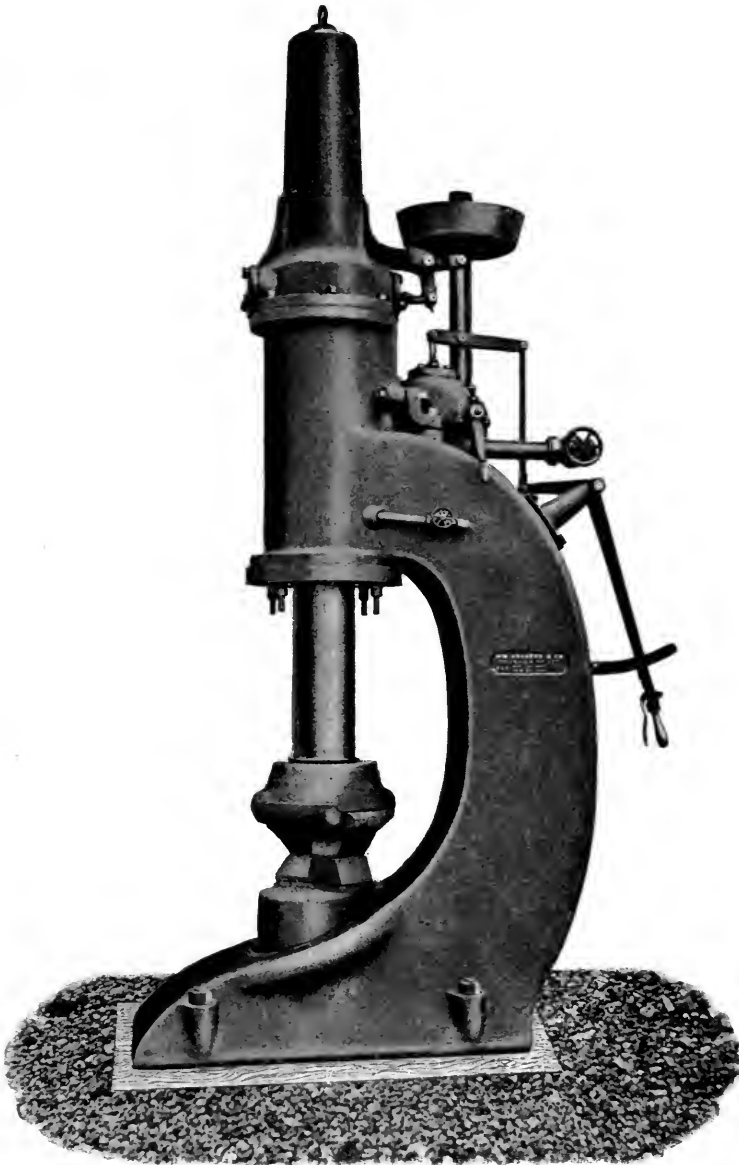

1250-LB. HAND AND SELF-ACTING HAMMER.

1 1/8" cylinder, 20" stroke. Balanced piston-valve with steel packing rings. Choke valve in exhaust to regulate force of blow. Collin exhaust. Quick acting throttle valve. Steel dies and steel false top for anvil.

Steam Hammers.—Continued.

together with short bolts, except at the bottom, where a long steel bolt is used, passing through both uprights and having a nut at each end. To keep this bolt cool and prevent undue expansion, we provide an air circulation around it through proper openings. The uprights are of hollow box construction, and each consists of a curved and a straight portion. The straight or lower part is bolted securely to the foundation plate, and is also connected to the upper or curved part by through-bolts. This separation into two parts strengthens the uprights and eliminates the danger of breakage by unequal expansion. The steam-chest in these hammers is situated over one of the uprights, so that the cranes for handling work may be brought up close to the cylinder on either side without interference. The upper portion of the bar has a flat face, which, fitting the top cylinder head, serves to guide the bar and prevent it from turning.

We would call especial attention to the ample room around the anvil block and under the cylinder, which allows free access and greatly facilitates handling large work. The loose head which holds the hammer die is secured to the bar by the taper wedge-ring used on the smaller sizes. If properly put on, this arrangement holds the head with great security, and will even carry special forging dies of great additional weight.

Sizes of Steam Hammers.

Size or Weight of Hammer Ram.	Length of Stroke.	Height under Frame.	Width between Frames.	Hammer Face.		
400 lb.	15½"	SINGLE UPRIGHT.	SINGLE UPRIGHT.	6¾" x 4½"		
750 "	18"			8¾" x 5½"		
1250 "	20"			9" x 5¾"		
1700 "	23"			10¾" x 6"		
2500 "	30"			13¾" x 8"		
3150 "	30"			13¾" x 8"		
1¾ ton.	3 ft. 2"			6 ft. 10"	7 ft. 6"	16¾" x 10"
2¼ "	3 " 6"			7 " 3¾"	8 " ¾"	17¾" x 11"
3 " "	3 " 11½"			7 " 10½"	9 " 2"	19½" x 12"
4 " "	4 " 6½"			8 " 5½"	9 " 8½"	21½" x 13"
5 " "	5 " "	9 " ¾"	11 " 3"	22½" x 14"		
6 " "	5 " 6"	9 " 8"	12 " 6"	24" x 14¾"		
7 " "	5 " 10"	10 " 8¾"	13 " "	26" x 16"		
10 " "	7 " "	11 " 9"	14 " 8"	29½" x 18"		

PLATE No. 173.

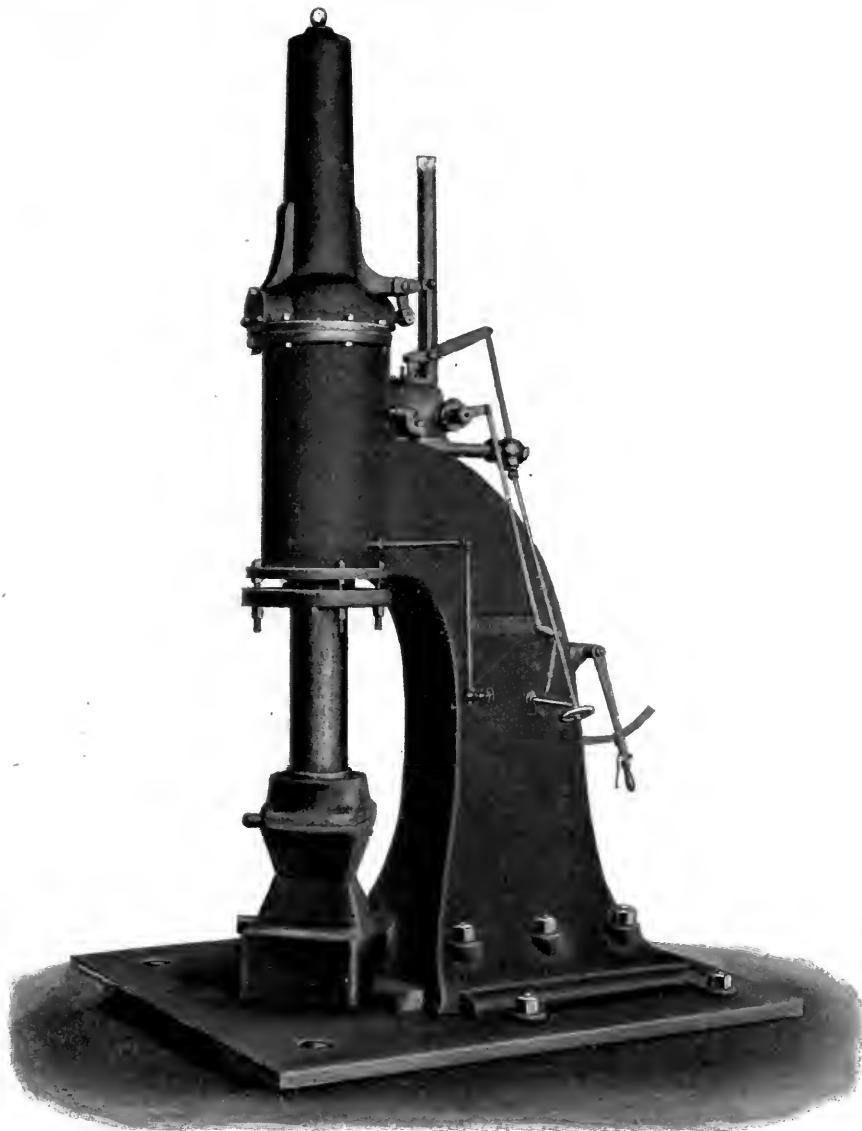

1700 LB. HAND AND SELF-ACTING HAMMER.

13" cylinder, 23" stroke, with separate bed plate. Balanced piston-valve with steel packing rings. Choke valve to regulate force of blow without diminishing velocity. Steel dies and steel false top to anvil block. Quick throttle valve.

PLATE No. 174.

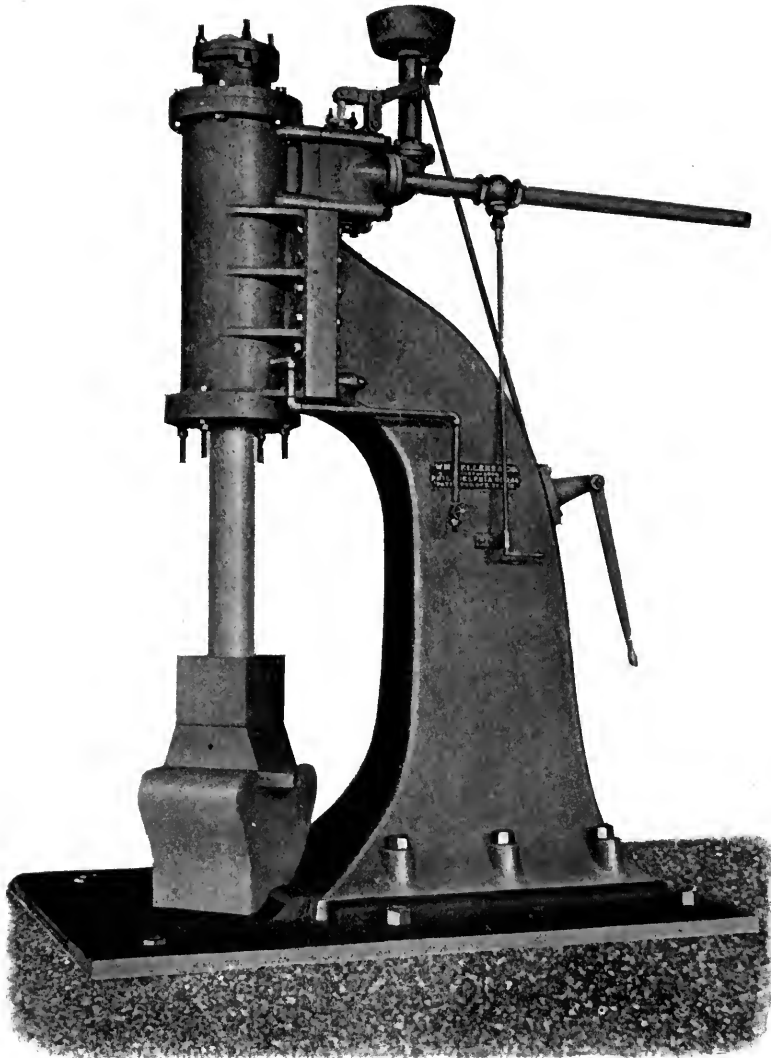

1200-LB. HAND-ACTING HAMMER.

11 $\frac{7}{8}$ " cylinder, 30" stroke. Special dies for forging locomotive frames. Balanced piston valve with packed piston. Collin exhaust.

PLATE NO. 175.

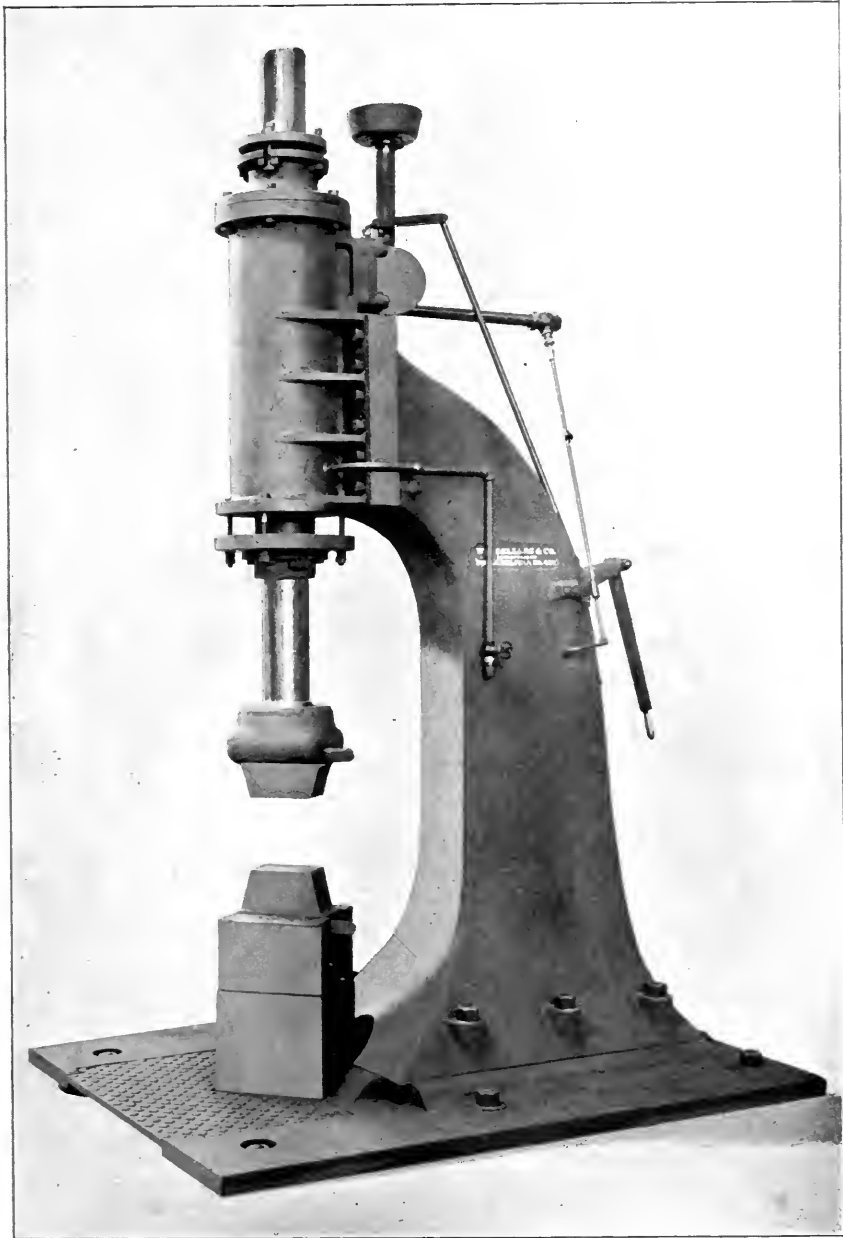

1200-LB. HAND-ACTING HAMMER.

11 $\frac{7}{8}$ " cylinder, 30" stroke, ordinary plain dies; steel false top to anvil block. Separate bed plate. Steam chest with balanced and packed piston valve. Collin exhaust. Quick throttle valve.

PLATE No. 176.

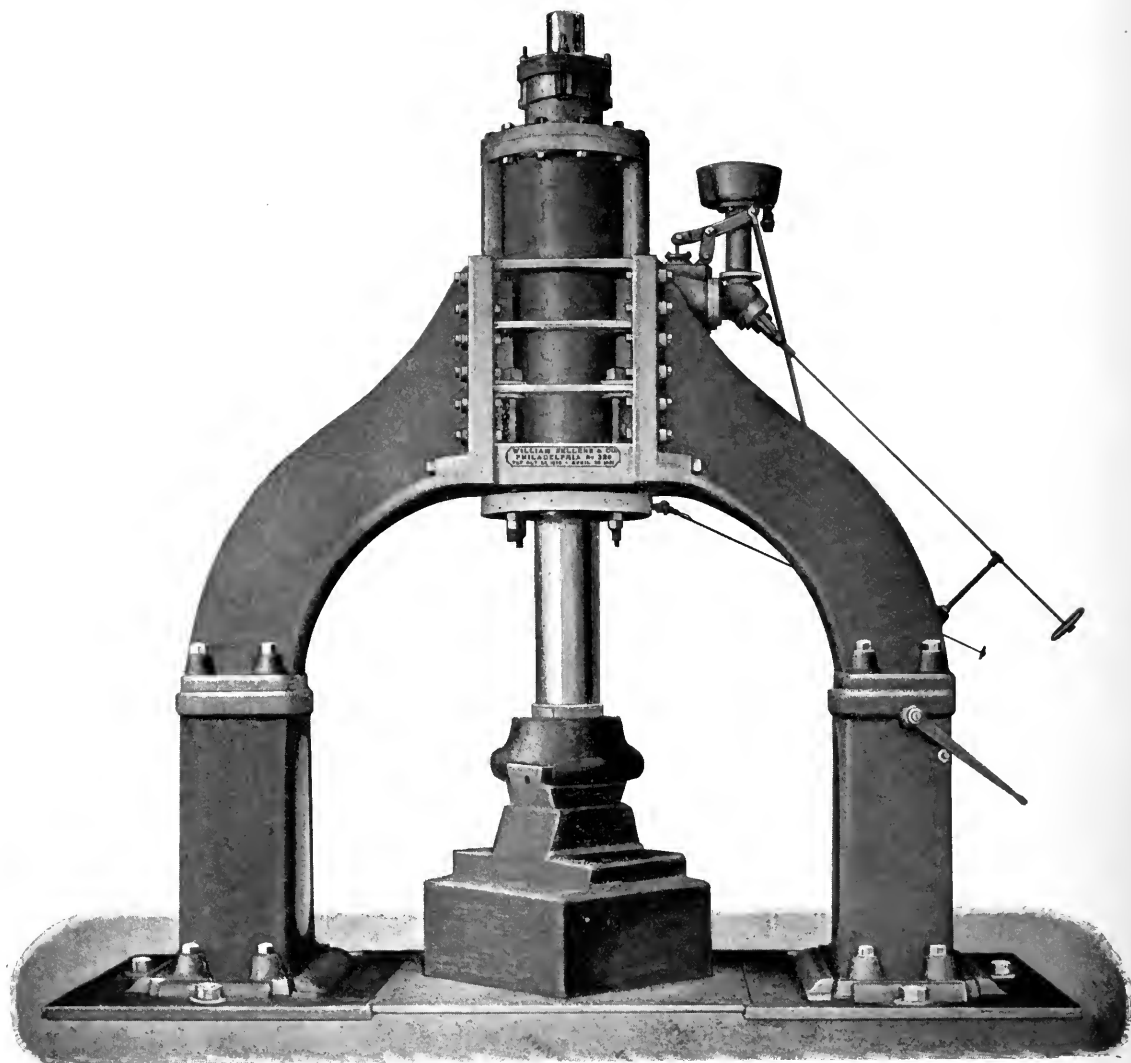

2¼ TON HAND-ACTING STEAM HAMMER.

20 $\frac{5}{8}$ " CYLINDER, 3 FEET 6" STROKE. BED AND ANVIL BLOCK IN POSITION.

Takes steam above and below piston. Has balanced piston valves and patent exhaust arrangement. Box uprights in two pieces.

PLATE NO. 177.

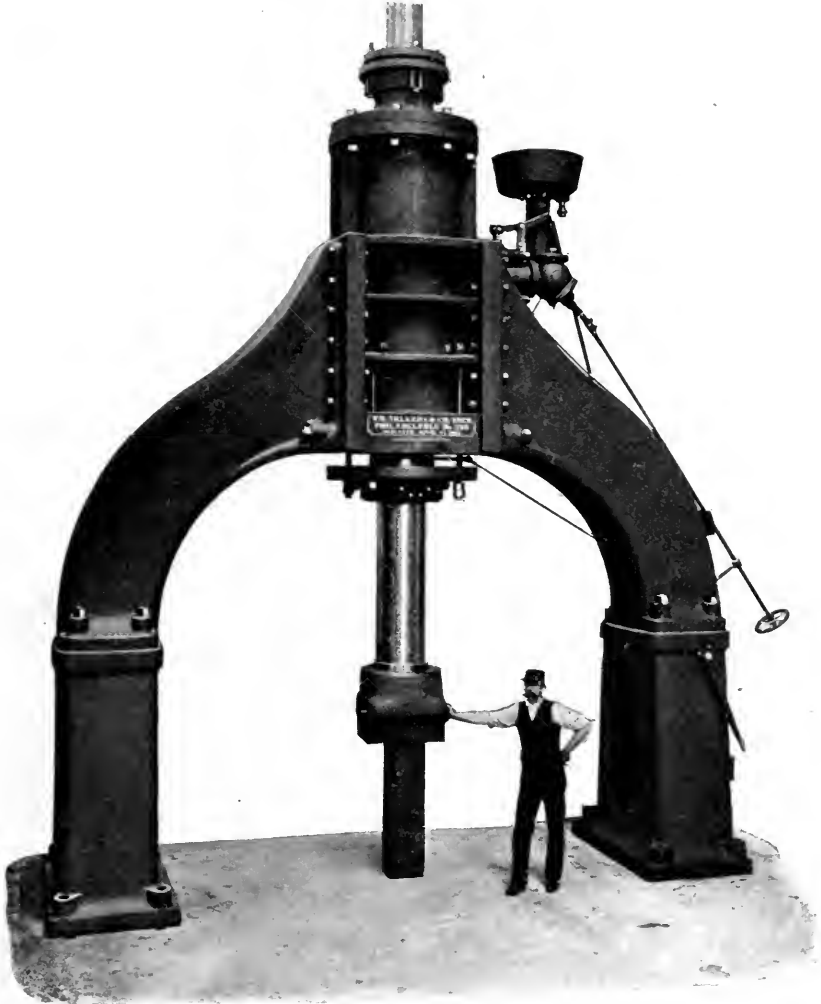

7 TON HAND-ACTING STEAM HAMMER.

33" cylinder, 5 ft. 10" stroke, width between frames 13 ft. Anvil and bed plate not shown. Takes steam above and below piston. Balanced piston valve and patent exhaust arrangement. Box uprights in two pieces.

Riveting Machines.

IN various editions of our treatise on machine tools, we considered it wise to present very fully the arguments which, in our judgment, demonstrated the superiority of rivets driven by pressure over those driven by impact ; but our view has been so fully sustained by general experience, and the superiority of the pressure-driven rivet is so universally acknowledged, that it does not seem necessary at this time to repeat the arguments formerly advanced, or to define our position on a question no longer in dispute. We desire, however, to point out the distinction which exists between driving a rivet by pressure only, and forming the head on such a rivet by a succession of blows applied either by a hand or a power hammer. In one case the rivet is squeezed into shape and in the other it is hammered into the form required. In the squeezed rivet, the shank is upset so as to fill the hole completely before the head is formed, and the plates are brought in close contact ; but in hammering, either by hand or power, the head is formed without necessarily upsetting the shank throughout its length ; the rivet is almost certain to be loose in some part of the hole, especially if the punching does not match exactly, and the plates are not clamped together with the same solidity which is attained in pressure driving. *A properly designed steam riveter will produce exactly the same quality of work as that made by the hydraulic riveter, it being only necessary to enlarge the cylinder in proportion to the lower pressure of fluid which is used, and to so proportion the valve and steam pipes that the movement of the ram will not be too quick.*

In regard to the amount of pressure required for riveting, there seems to be a considerable difference of opinion, resulting from differences of requirements and of practice. The character of the work to be done, the size and form of the rivet-heads, and the temperature of the rivets used, all affect the amount of power required. Where the work requires to be steam-tight, more pressure is necessary than in bridge or girder work. Some experiments recently tried seemed to demonstrate that for boiler-work with rivets having very large heads, eighty tons per square inch of rivet section is amply sufficient to produce tight work, and an increase of pressure above this point was found to be injurious, and as much to be *avoided as too little pressure.*

Our stationary riveters are usually built with separate cylinders, arranged so that they may be converted from steam to hydraulic or the reverse. They are made of as few parts as possible, and all unnecessary complication is avoided. The greatest care is taken in the selection and testing of material, and extensive use is made of steel castings, which are made to our specifications and carefully annealed. *Our usual sizes of stationary riveters vary from five feet to ten feet in gap, by differences of one foot ;* but our patterns are adapted for a variety of proportions, and we can meet almost any requirements as to depth or width of space between uprights. *In our hydraulic riveters, all packings are arranged for easy and quick replacement.*

PLATE NO. 178.

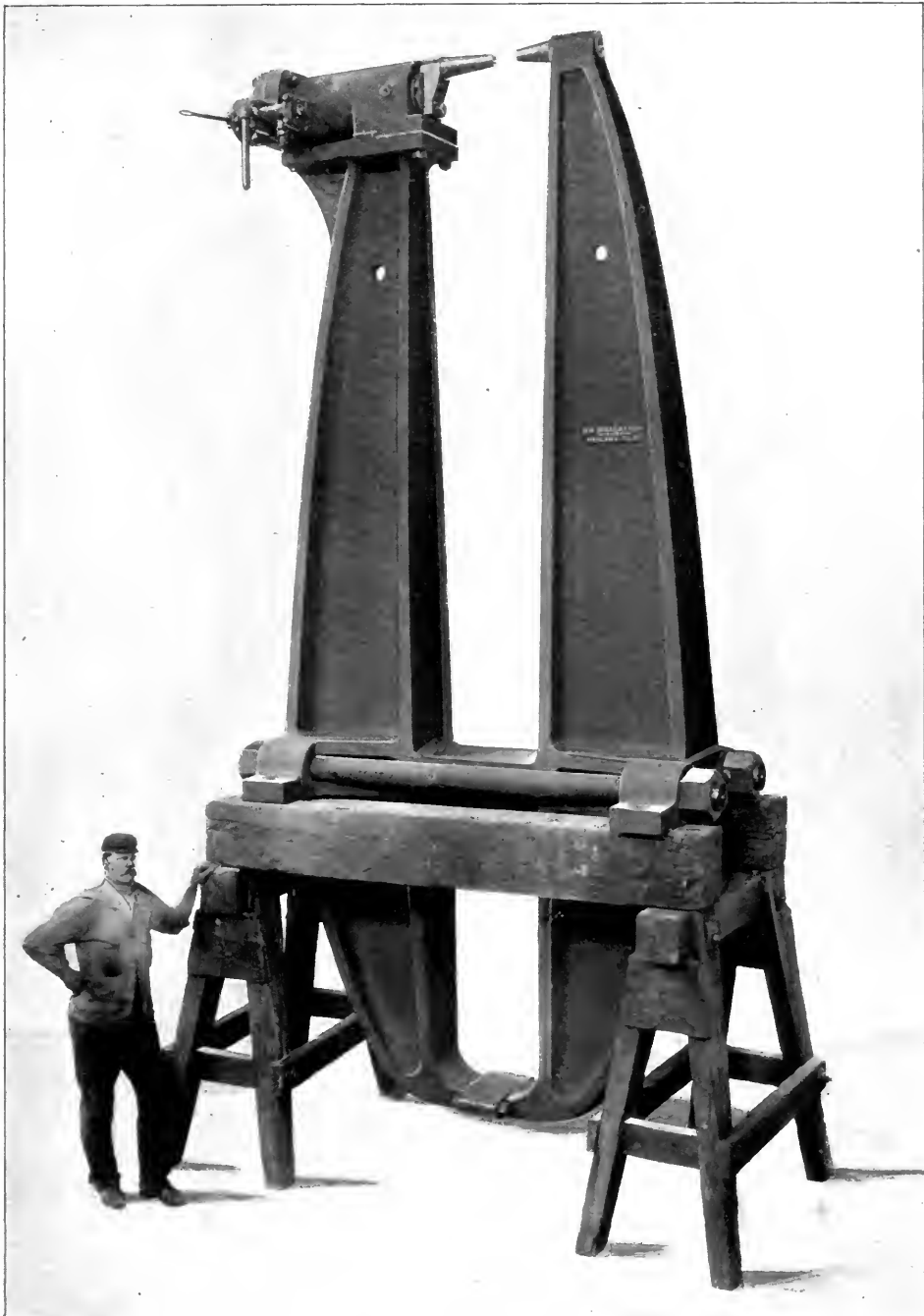

10 FT. HYDRAULIC RIVETING MACHINE.

Steel stakes, detachable cylinder and improved balanced hydraulic valve.
Made with one or three pressures.

PLATE NO. 179.



11 FT. HYDRAULIC RIVETER.

Steel stakes, balanced piston valve. All packings easily accessible.

PLATE No. 180.

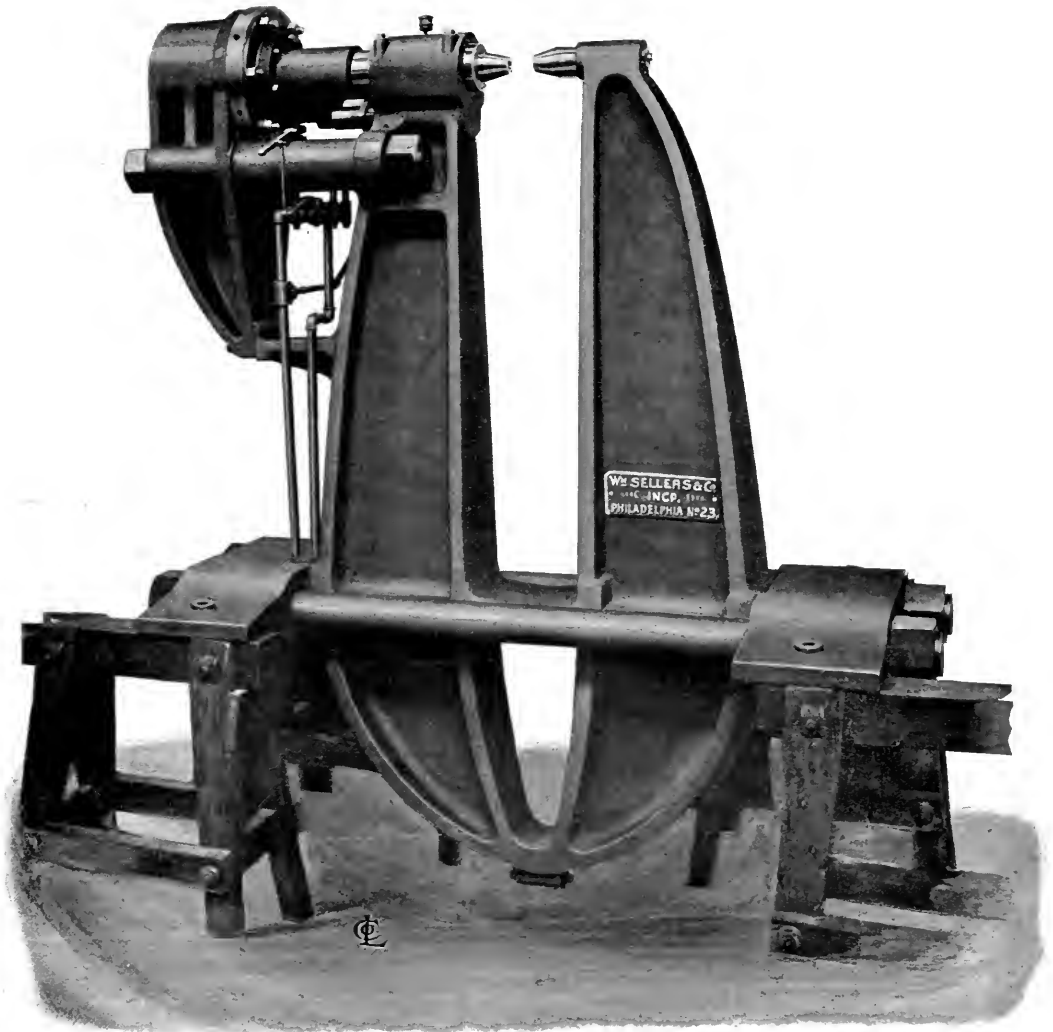

HYDRAULIC RIVETING MACHINE.

7 FEET GAP, 100 TONS PRESSURE ON DIES.

Balanced piston valve. All packings easily replaced. Plunger and "pull back" have stuffing boxes for flax packing.

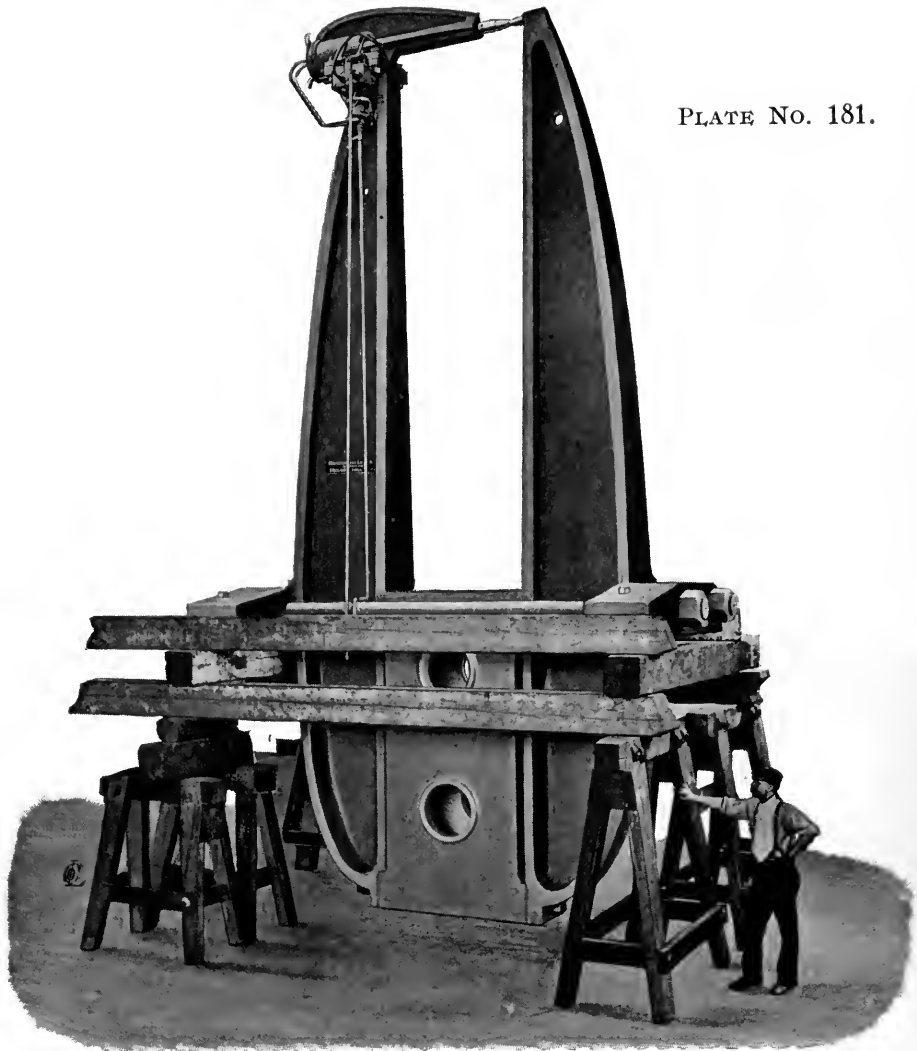

PLATE NO. 181.

HYDRAULIC RIVETING MACHINE.

17½ FEET OVERREACH ; STROKE, 5¾".

Pressure on dies adjustable for either 25, 50, or 75 tons. For riveting locomotive boilers without reversing them. Wide gap and long die plunger to clear fire boxes. (Vanclain's Patent.)

PLATE No. 182.

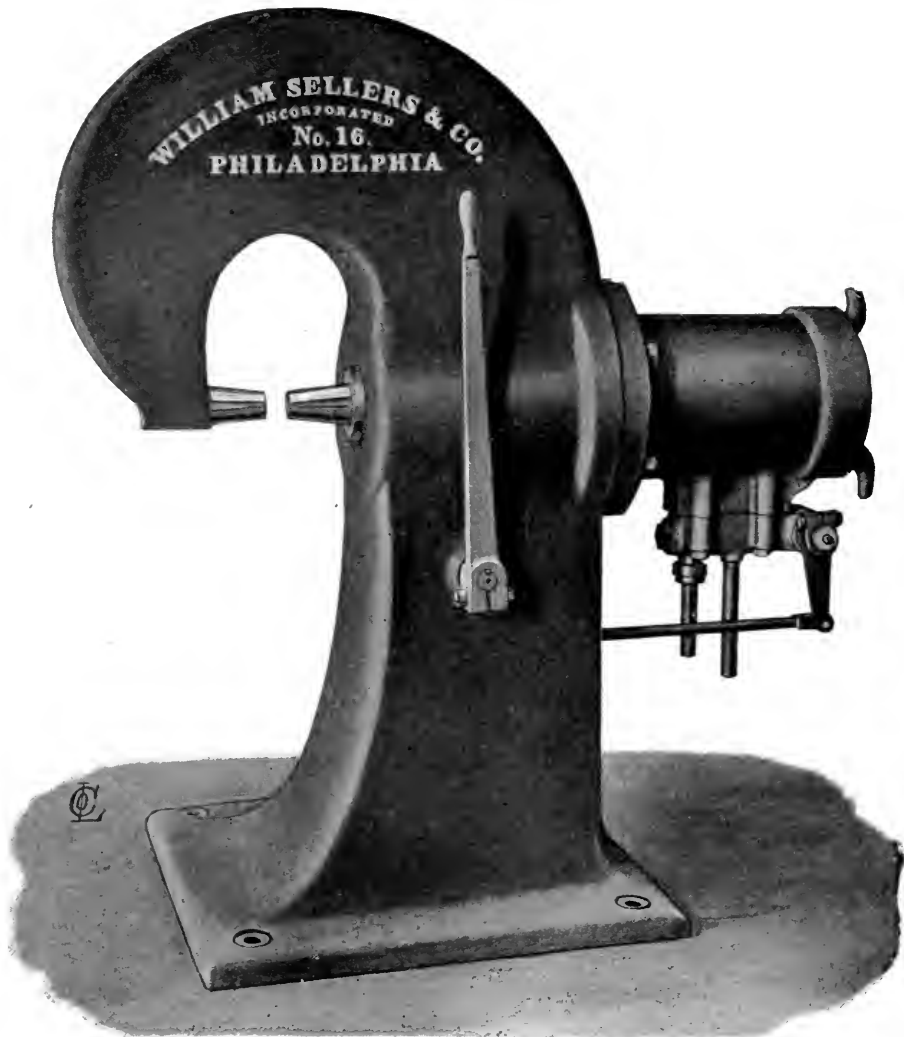

HYDRAULIC RIVETING MACHINE.

OVERREACH, 11"; GAP, 10" WIDE; STROKE, 5".

Originally built for work on iron car trucks. Packings easily accessible.
Construction simple and efficient.

PLATE No. 183.

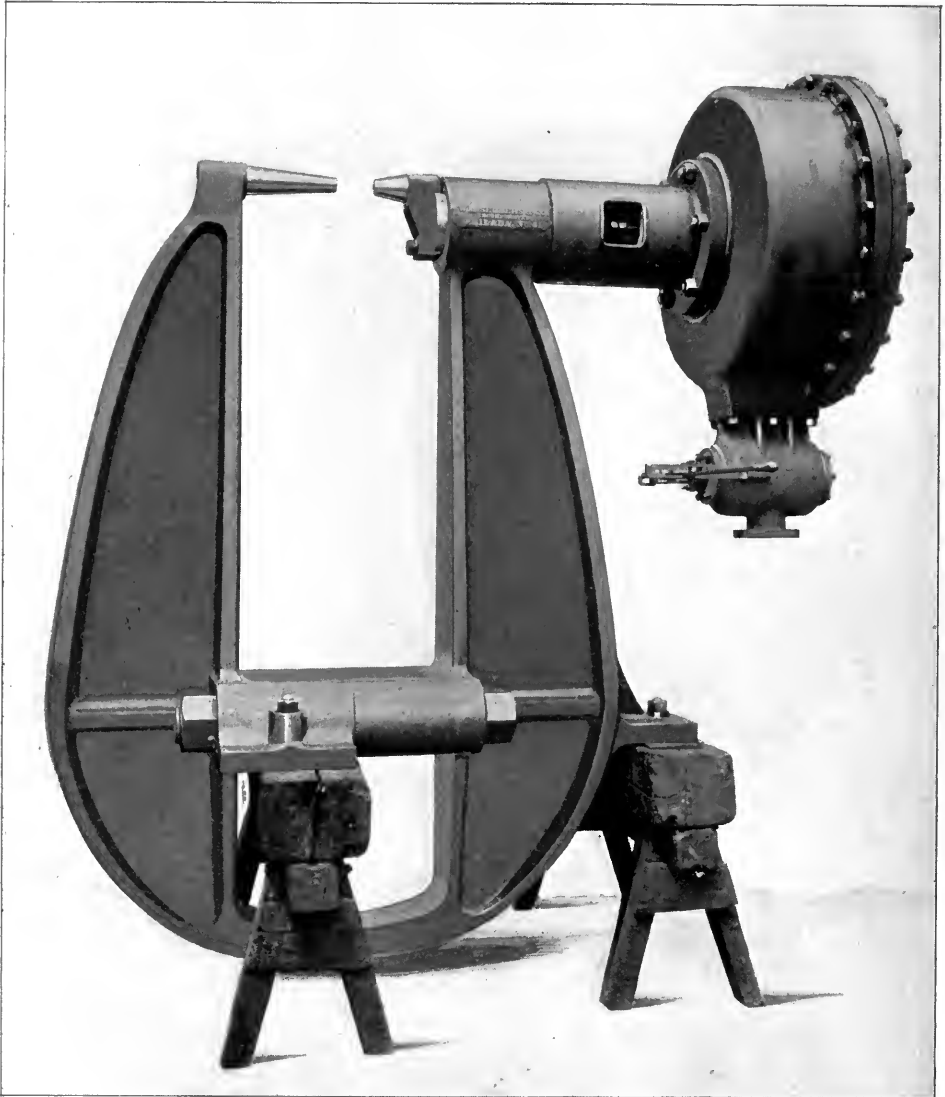

5-FT. STEAM RIVETING MACHINE—WITH EXTRA WIDE GAP.

The steam chest is provided with a cylindrical piston-valve, perfectly balanced and packed with steel rings. A by-pass through the valve permits the steam used for making a stroke to pass to the other side of the piston, and by expanding, draw back the die ready for the next stroke. Or, if it be desired to admit live steam for this purpose, a movement of the hand-lever beyond the ordinary end-stop admits the steam required to retract the piston. This is only necessary when the cylinder is cold, as in first starting.

PLATE No. 184.

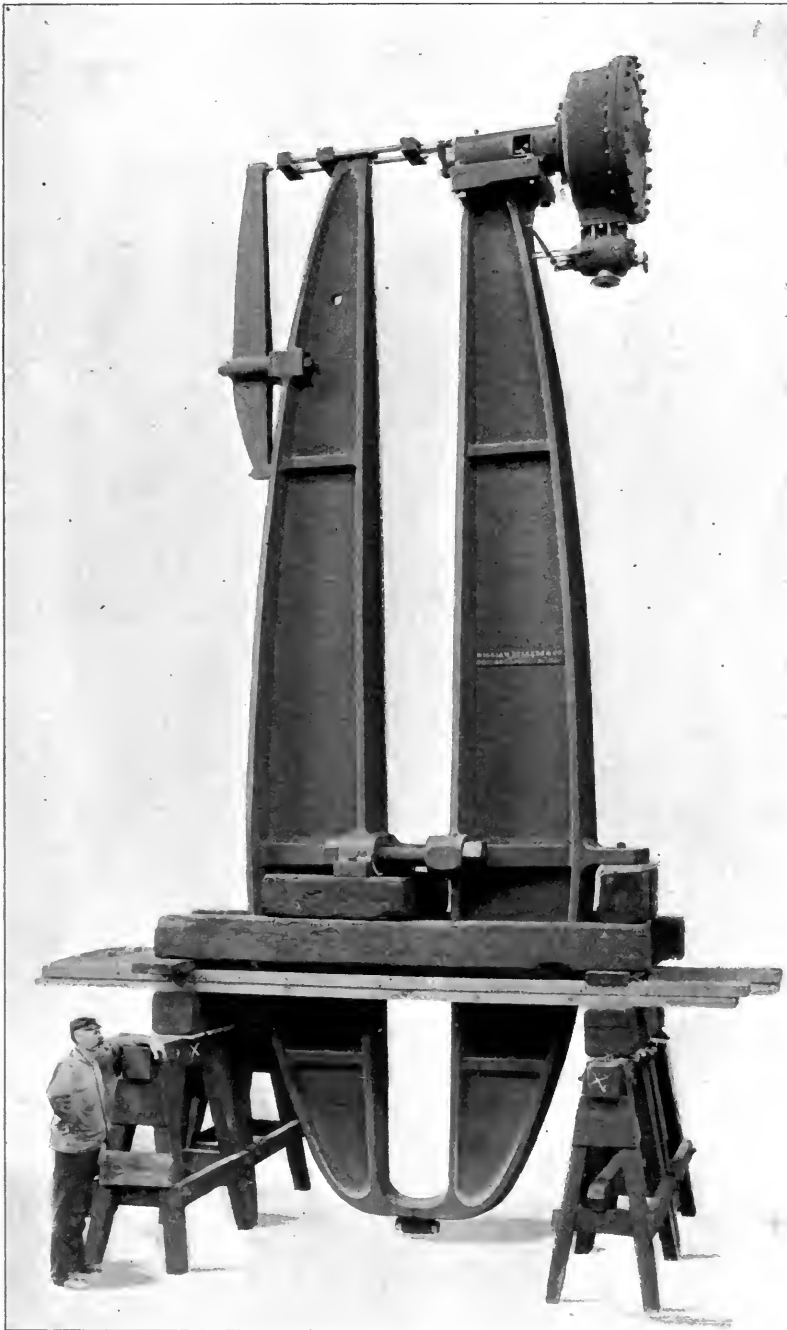

16-FT. STEAM RIVETING MACHINE
WITH AUXILLIARY STAKE FOR SMALL FLUES.
36" steam cylinder and improved balanced piston valve. *Auxilliary stake,*
for small flues, extra.

Portable Riveting Machines.

THE hydraulic system is particularly applicable to portable riveting machines, and a number of these have been made of various designs, and for many special purposes; they are either "direct-acting" or constructed with some form of jointed levers by which the dies are more conveniently arranged for working in contracted places. The machines illustrated in the accompanying plates are of both types, and show only a few of the many different forms which we make. The "overreach," the width of the gap and form of suspension being varied to suit the especial requirements of the work for which they are intended; while the size and strength of parts are fixed by the total pressure required, and the water pressure per square inch which is to be used.

Various arrangements are provided for suspending these machines and for bringing the high-pressure water from the accumulator. We prefer for the pressure system jointed pipes, such as are indicated in the plates, which are packed with simple leather rings, and are easily kept tight. For the exhaust, a rubber hose between points of attachment furnishes the necessary flexibility. We also make plain direct-acting portable riveting machines, especially designed for plate-girder work.

All of our portable riveters operate by pressure only, not by percussion, and form the rivet head in one movement. We also make portable riveters to operate by compressed air for use where there is no hydraulic supply. These machines, while somewhat more cumbersome than those operated by high pressure water, are very useful in many locations; especially as no exhaust pipes are required, and there is no danger from frost.

PLATE No. 185.

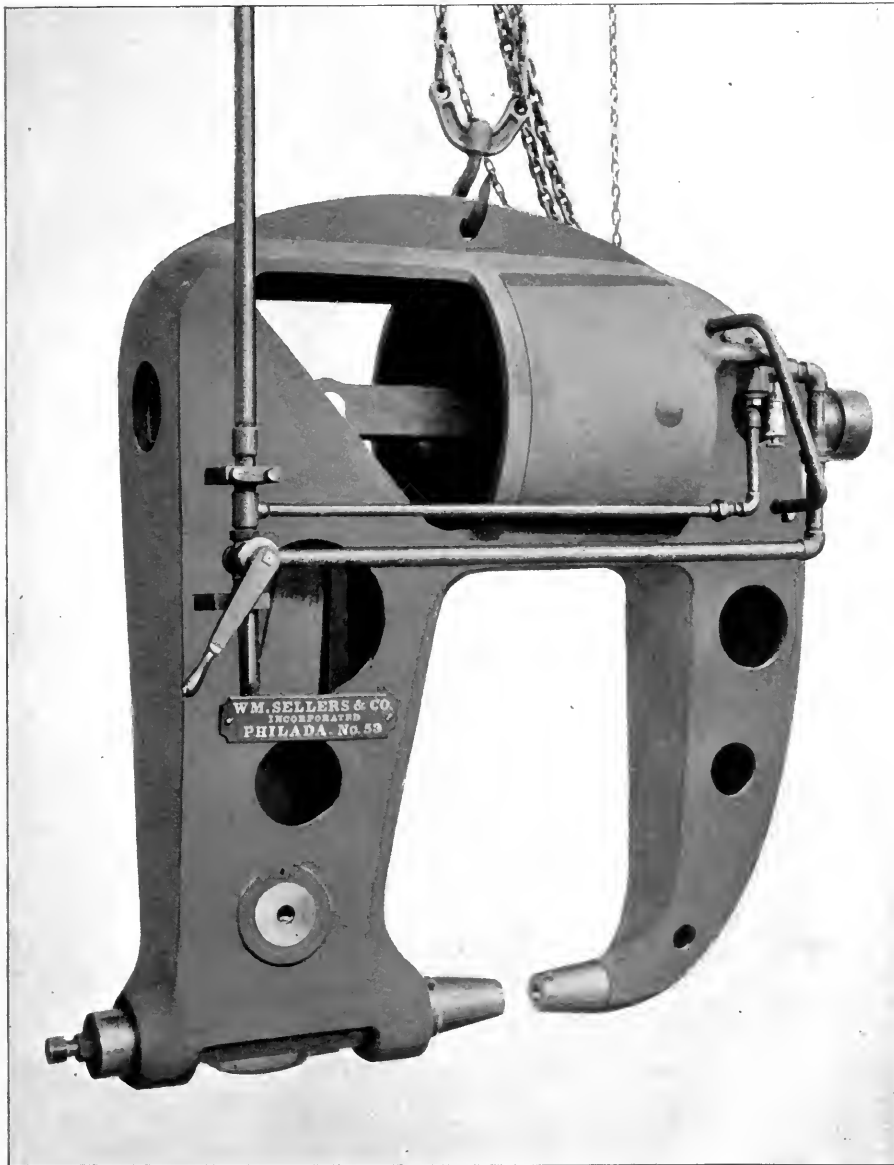

PORTABLE PNEUMATIC RIVETER.

The pressure in the cylinder is multiplied by steel lever in one leg. Over-reach, 31". Total pressure on dies with 80 pounds air, 40 tons. Especially adapted for locomotive domes. *Made also of different sizes and pressures.*

PLATE NO. 186.



DIRECT ACTING PORTABLE HYDRAULIC RIVETER.

WITH SWIVEL, HANGING BAIL.

Dies may be used vertically or horizontally, and the frame rotates to suit the work. Swivel pipe connections for pressure hose for exhaust water.

PLATE No. 187.



DIRECT ACTING PORTABLE HYDRAULIC RIVETER.

WITH SWIVEL HANGING BAIL.

Same type as machine in Plate No. 186, in a different position. Made of various sizes and pressures. Made also with plain suspension with dies vertical or horizontal, but without swivel bearing.

PLATE No. 188.

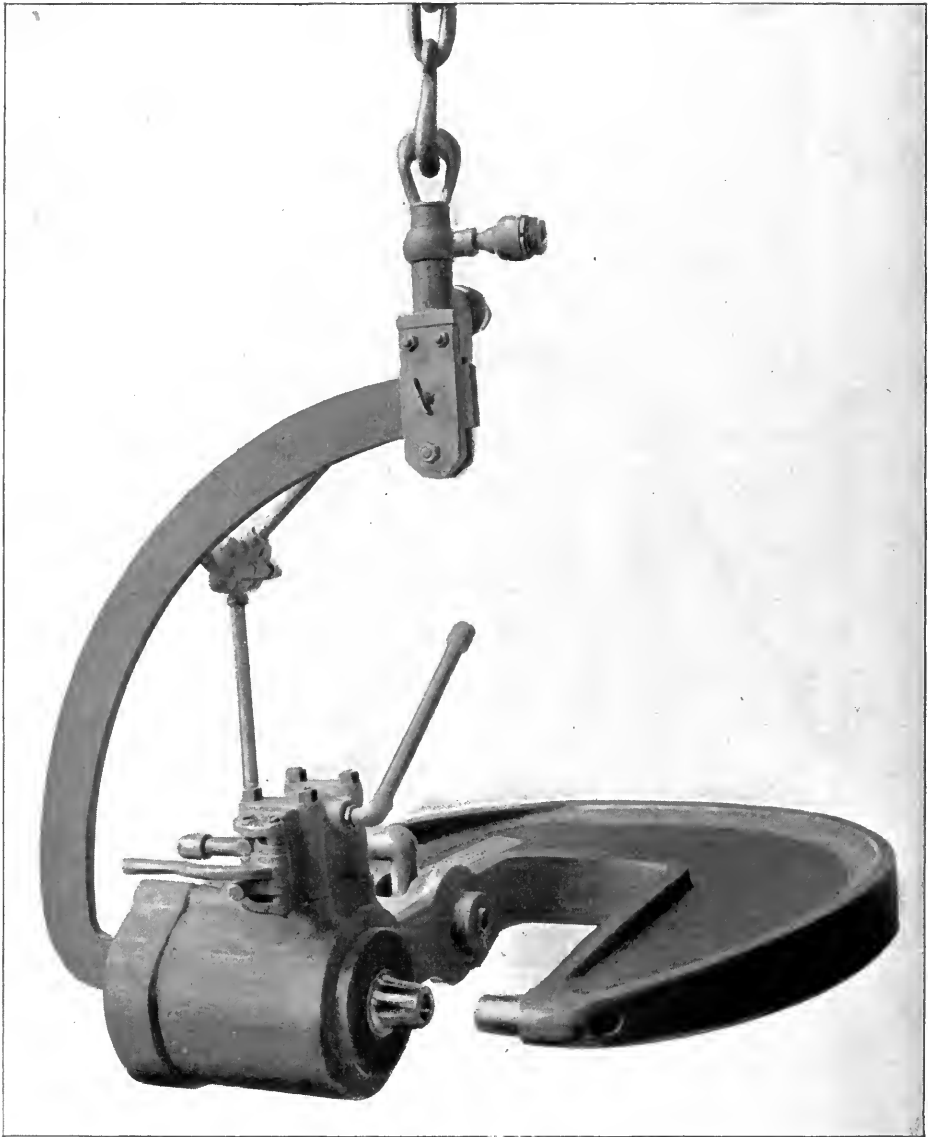

DIRECT-ACTING PORTABLE HYDRAULIC RIVETER.
WITH SWIVEL HANGING BAIL.

Dies may be used vertically or horizontally, and the frame rotates to suit the work. Swivel pipe connections for pressure, and hose for exhaust water.

PLATE No. 189.

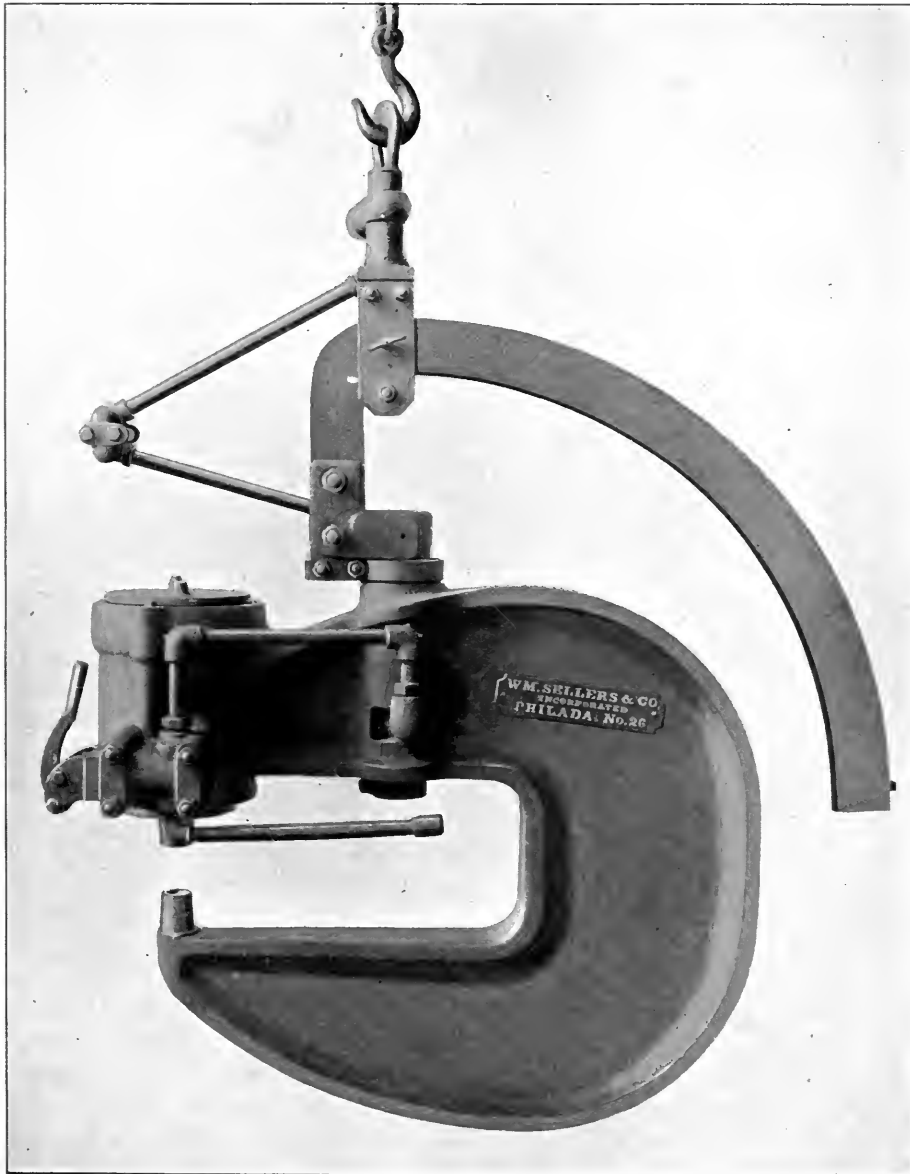

DIRECT-ACTING PORTABLE HYDRAULIC RIVETER.
WITH SWIVEL HANGING BAIL.

Same type as machine in Plate No. 188 in a different position. Made of various sizes and pressures. Made also with plain suspension, dies vertical or horizontal, but without swivel bearing.

Hydraulic Accumulator.

AN important factor of the hydraulic system is the accumulator, by which the pressure used is determined, and which should also furnish storage capacity enough to meet any sudden demand upon it. In its cheapest form it consists of a tank carrying iron ore or other heavy material, and suspended from a plunger moving in a vertical cylinder. The tank is sometimes replaced with cast-iron weights, so arranged that they may be removed in part to reduce the pressure of the system. In our patent accumulator the operation of adding or subtracting weights is readily accomplished, the weights being suspended upon cross-pins in vertical flat bars. The spacing of the pin-holes is such that upon lowering the accumulator the lowest weight is first lifted from its pins by striking the supports on the base-plate, the wood-bumper being removed to permit this, and the others follow in succession. As many weights as desired may be removed by pulling out the pins. A direct-acting steam pressure pump is usually employed in connection with the accumulator, controlled by a valve which is moved by the accumulator, so that the fall of the accumulator starts the pump, which is stopped again by the accumulator when it reaches its highest position.

For portable work we have a special form of belt-driven pump combined with accumulator (Plate No. 190). The pump may be driven directly from the line-shaft, and is stopped and started by the belt-tightener indicated. The accumulator is carried upon the same bed-plate, and is provided with four removable weights. When the accumulator has reached its highest position, it trips a special valve attached to the side of the upright and permits the water delivered by the pump to flow directly into a tank in the top of the upright, whence it finds its way through a sponge filter to a reservoir in the base of the tank. When water is used, the accumulator falls, the deflecting-valve is closed, and the pump delivers into the cylinder of the accumulator. These portable accumulators may be placed close to the riveters employing the pressure, and long lines of pipes for conveying the pressure and exhaust water may be avoided, and the exhaust led directly back into the tank in the upper part of the upright.

PLATE No. 190.

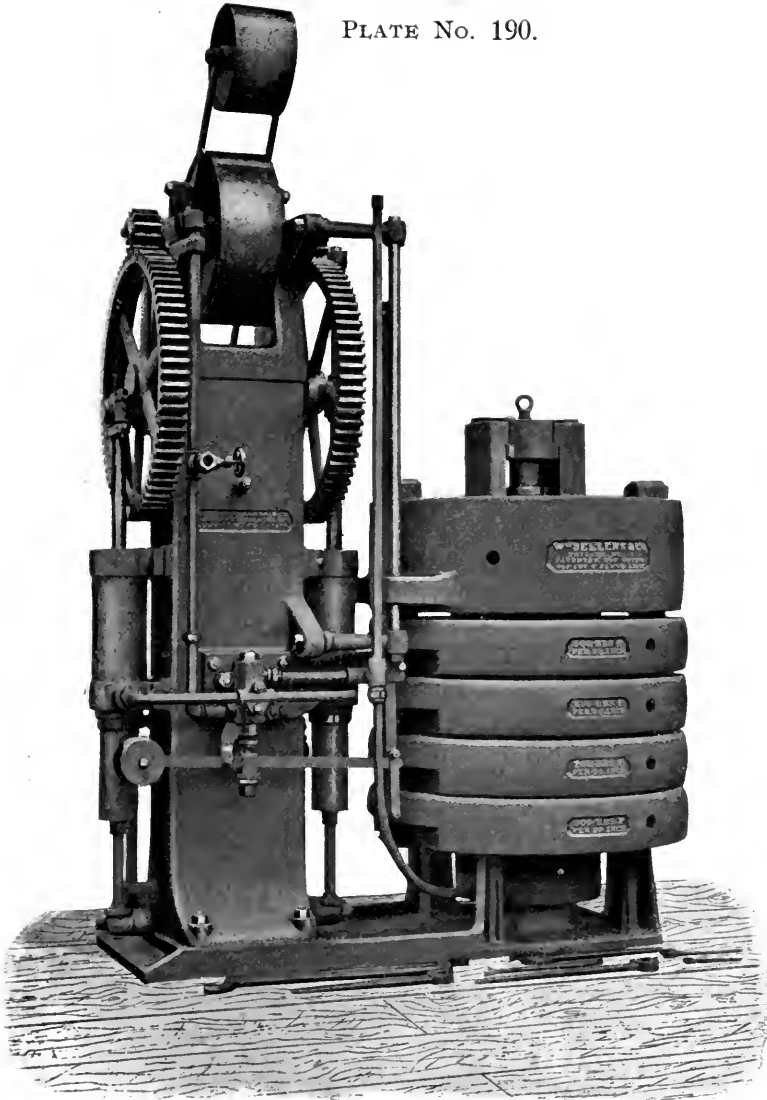

PATENT HYDRAULIC ACCUMULATOR AND PUMP.

Weights suspended so as to be readily released for adjusting pressure. Double-acting high-pressure pump carried on upright which forms tank, and is provided with sponge filter to remove all gritty matter before water enters the pump. Filter and tanks accessible by man-hole in side of upright. Improved relief-valve stopping flow of water to accumulator when it is full, but permitting the pumps to run full of water ready for action, but freed from pressure. Pumps readily accessible for changing packings.

PLATE No. 191.

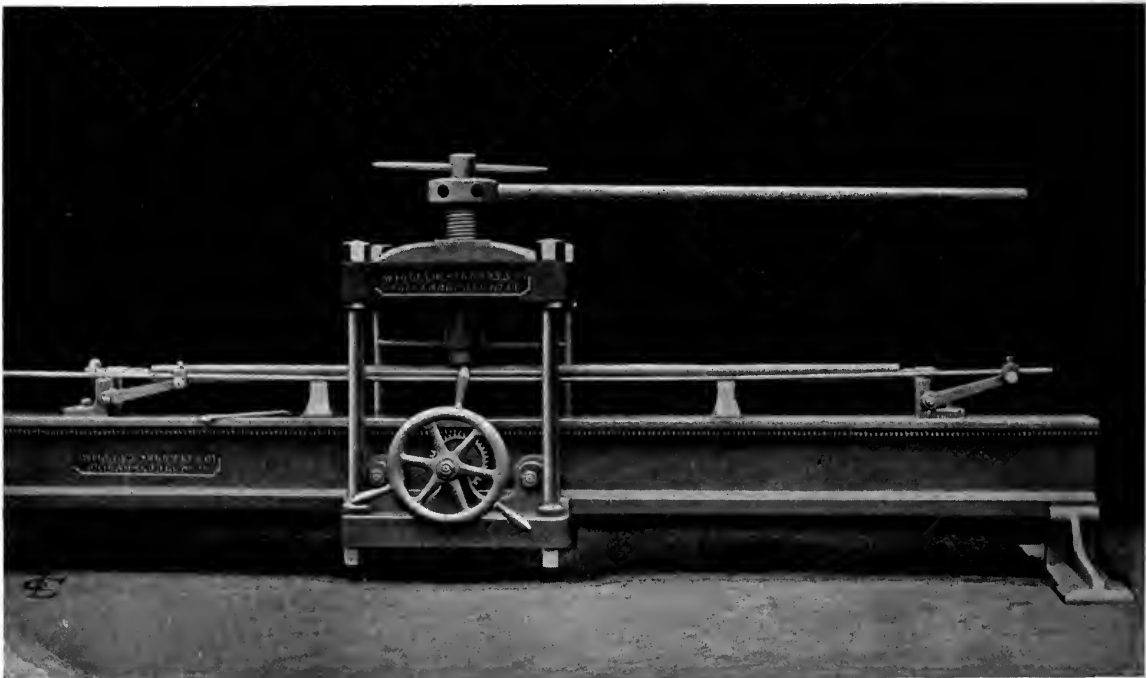

HAND STRAIGHTENING MACHINE.—FOR SHAFTS.

Bed 20 ft. long, with bending blocks for shafts up to and including 6" diameter. Screw press mounted upon rollers running upon planed track on lower flange of the bed. Screw press with pinion gearing into rack on the bed for rapid traverse back and forth. Shaft carried upon centers arranged to elevate and depress simultaneously. Capable of bending 6" shaft cold.

PLATE No. 192.

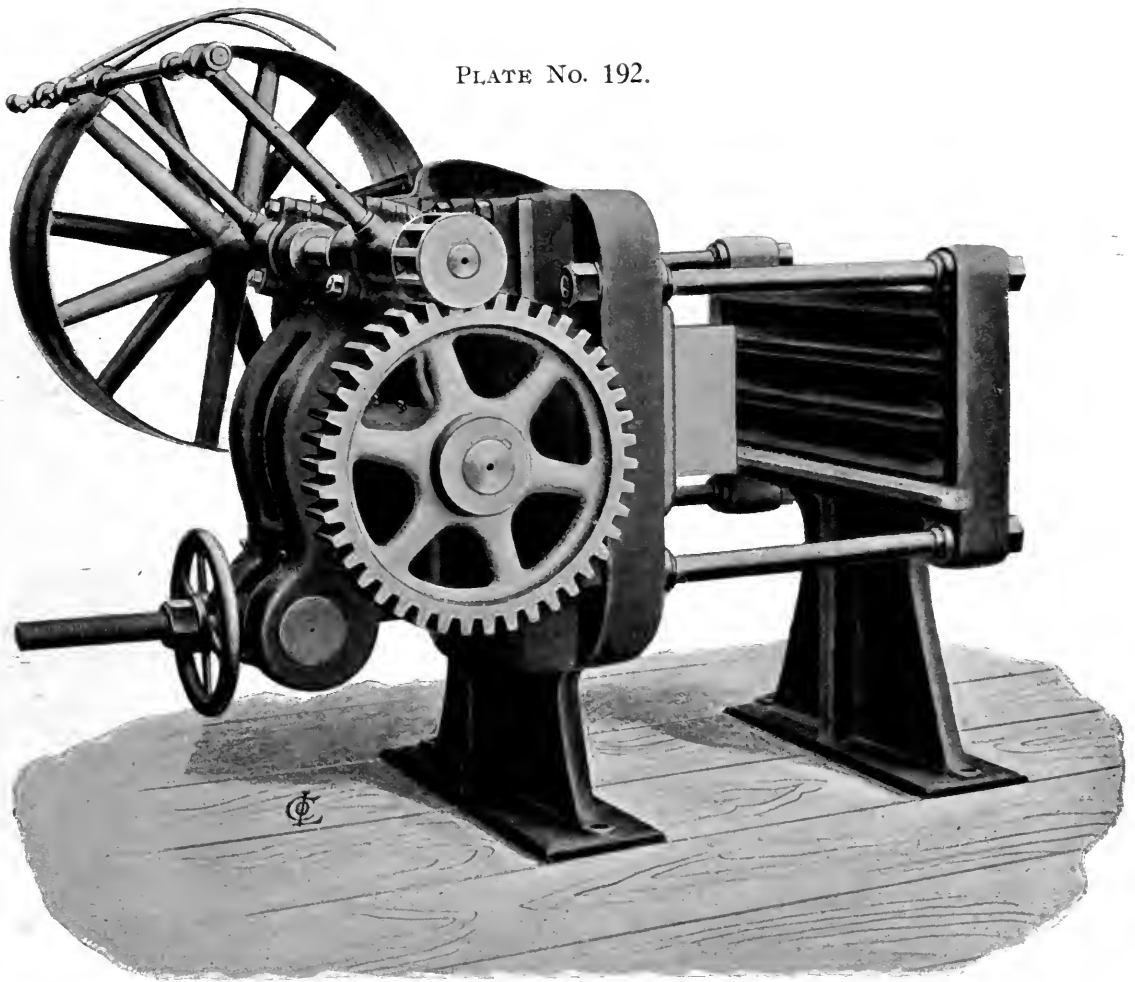

POWER STRAIGHTENING AND BENDING MACHINE.

FOR LIGHT BEAMS, ETC.

Bending plunger working horizontally. Operated by powerful crank with uniform length of stroke. Position of end of plunger adjustable. May be used for bars and other rolled shapes. Abutments adjustable along end platen. Maximum opening, 15". Fast and loose pulleys on machine, 36" diameter, 7" face. 150 revolutions per minute. Same machine arranged to operate by hand when required.

PLATE NO. 193.

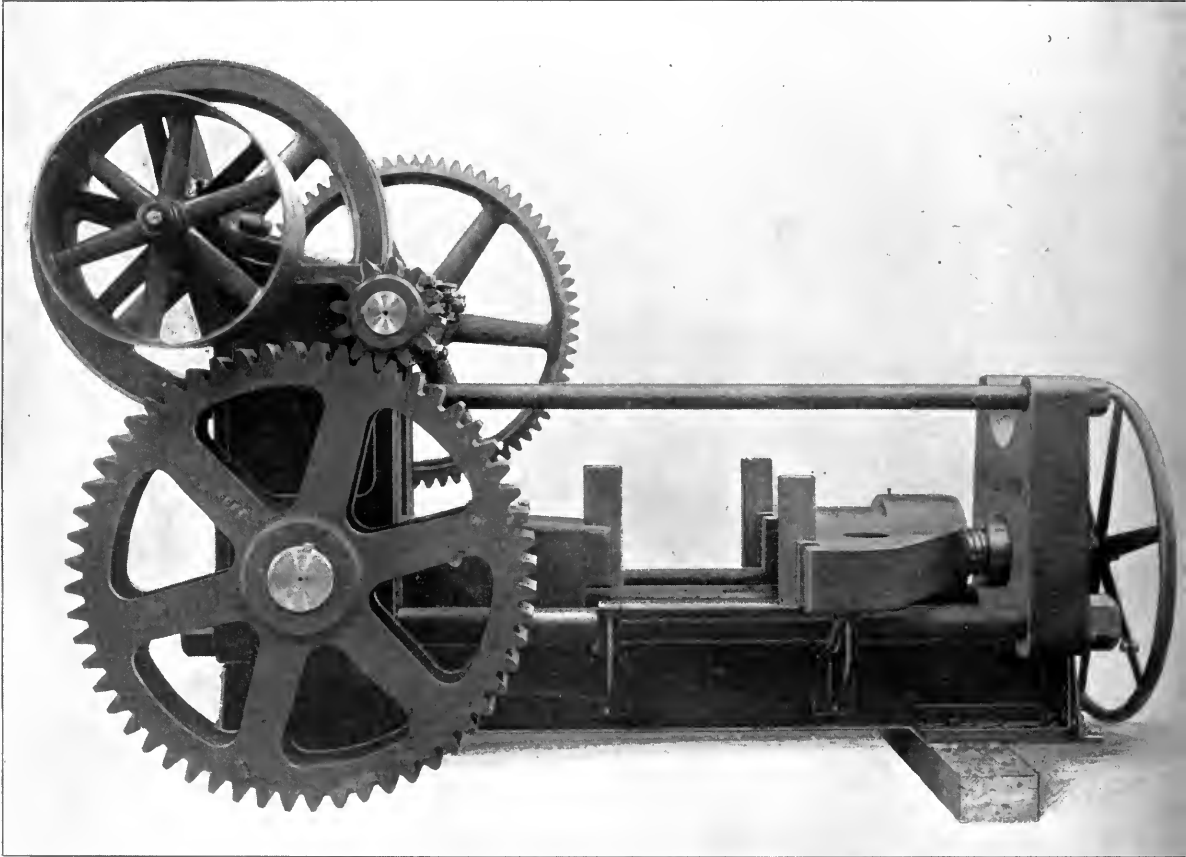

POWER STRAIGHTENING AND BENDING MACHINE.

FOR BEAMS UP TO 20" DEEP.

Steel slide with removable shoes, adjustable by hand wheel and screw to suit work. Stroke of head, 2". Especially designed for deck beams and other ship details. Very powerful and handy machine. Fast and loose pulleys 30" diameter for 7" belt, speed 420 rotations per minute.

PLATE No. 194.

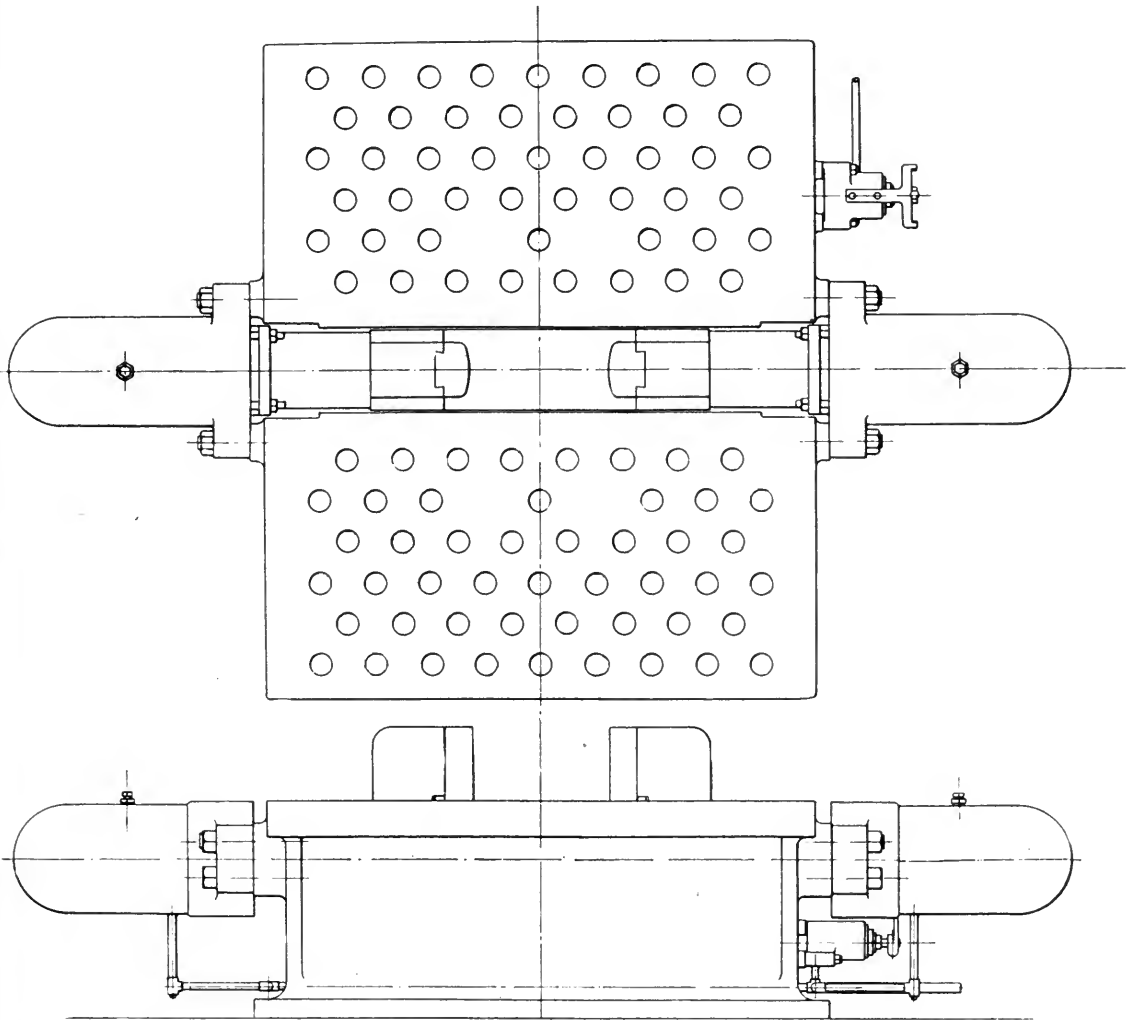

HYDRAULIC ANGLE-SETTING MACHINE.

Slide operated by two hydraulic cylinders controlled by special valve, giving perfect control of movement of plungers. Operated in both directions. Heavy pins in top plate placed to suit work. Table 6 ft. by 5 ft. Will bend or straighten beams, angles and pipes.

Bending Rolls.

WE illustrate in the following plates a number of bending rolls of various designs and dimensions, adapted for different requirements and different methods of driving. There are hand and power machines for boiler, tank and ship work, with three and four rolls and variously arranged details. We do not illustrate, but are prepared to build the ordinary type of machine with three rolls arranged pyramidally, the lower ones only being geared and the top or tilting roll driven by the action of the plate. This is a relatively cheap form of machine, it is simple in construction and serviceable, but the roll gears must be small to clear each other, and the power of the driving arrangement is thus limited by the strength of mere pinions but little larger than the rolls themselves, and only the friction of the lower rolls is available to carry the plate through. For this reason difficulty is experienced in causing plates to enter, and the clumsy expedient of grooving one of the lower rolls to catch the plate and drag it in has frequently been resorted to, and after the plate has been successfully entered, the limited power available in the gearing or in friction on the plate makes it necessary to proceed with the work of bending by slow and easy stages.

For this and other reasons, we prefer the construction used in our patent rolls (Plates Nos. 199 and 200). In these machines we increase the power by driving all of the rolls, adding a large wheel to the top roll, and augmenting the traction to such an extent that plates can be easily entered and carried through to any desired curvature at a single pass. In this arrangement the top roll, to which abundant power can be transmitted, is the main driver, while the lower rolls, which act in a secondary manner, receive power through a lost-motion clutch, so that whenever their assistance in driving is not required they may be carried ahead by the plate. The rolls are all driven at the same peripheral speed and all act together in entering a plate; but, if the top roll has sufficient traction to do the work of bending, the lost-motion clutch referred to avoids the calendering due to the difference between the outside and the inside circumference of the sheet, and saves the loss in friction which would otherwise occur. Should the top roll slip, however, the bottom rolls are always in readiness to assist in driving and carrying the plate through. Unlike other machines for the same purpose, the top roll is fixed at one end in a horizontal position, while the lower rolls are adjustable by power. This adjustment can be made at either end independently, or at both ends together, and against the full resistance of a plate between the rolls. The lower roll bearings are mounted on cross-pins to insure a perfect distribution of pressure under these conditions, and the main bearings for the top roll are mounted in the same way, so that the natural spring of the roll in service will not impair the surface exposed to pressure. These rolls are arranged in the usual pyramidal form, and the pressure required for bending is carried directly between the top and bottom rolls by heavy adjusting screws, on which all of the rolls are supported when in action. These screws are attached to the bearing yokes on the top roll, but for the removal of flues, provision is made to revolve the outer one by power and unscrew it at once from its yoke, leaving the top roll supported at one end and without any obstruction at the free end. When the flue is withdrawn the screw may be connected again by power, putting the rolls in readiness to repeat their work.

These rolls may be driven by straight and crossed belts from a single countershaft, and controlled by friction clutches on the machine, or, by using a reversing engine or electric motor, the belts may be dispensed with, the same machine being easily adapted to any mode of driving which may be preferred.

PLATE No. 195.

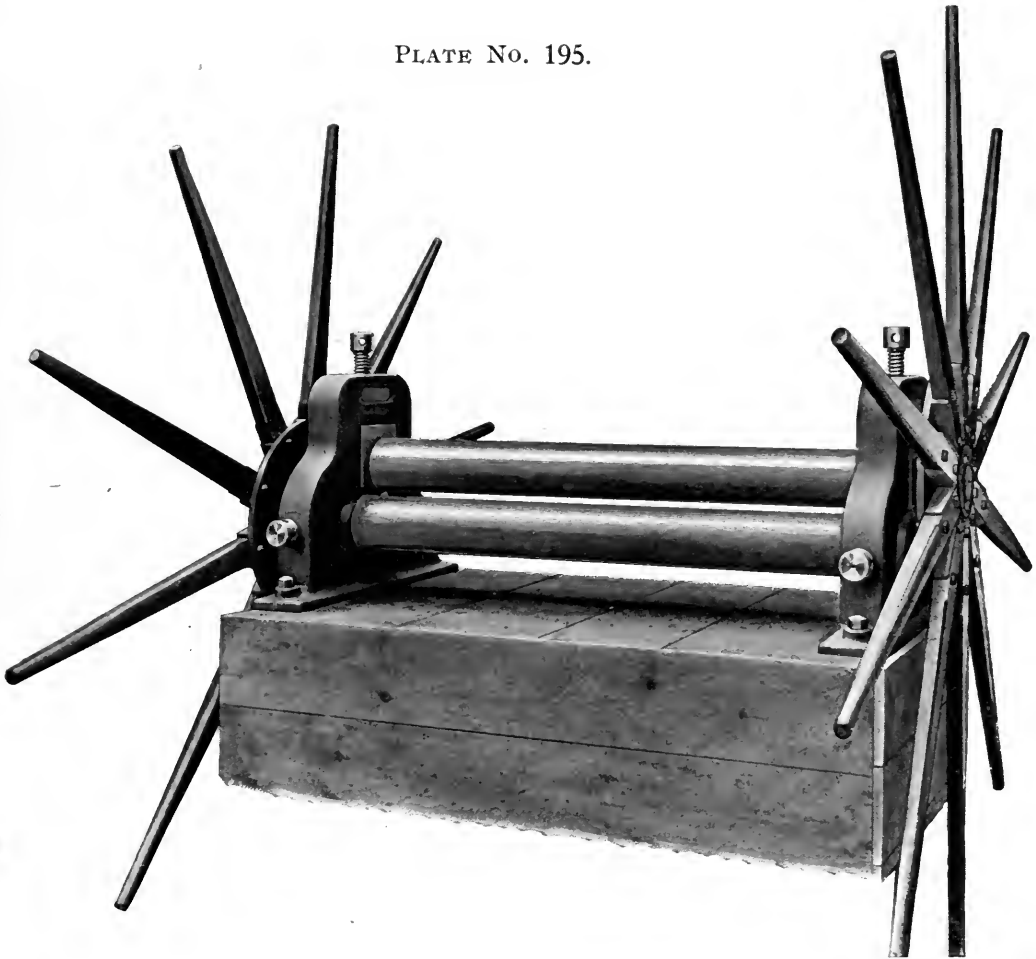

8" HAND BENDING ROLLS.—FOR LIGHT PLATES.

Used for tanks and light boilers. Top roll adjustable and self-supporting. Side rolls adjustable by screws. Arranged to bolt to foundation. Pits required in floor for the operating spiders. Made 6 ft. 1" and 8 ft. 1" between housings, with 8" and 9" rolls respectively. Strong and substantial machine. To remove flues, top roll may be partly withdrawn.

PLATE No. 196.

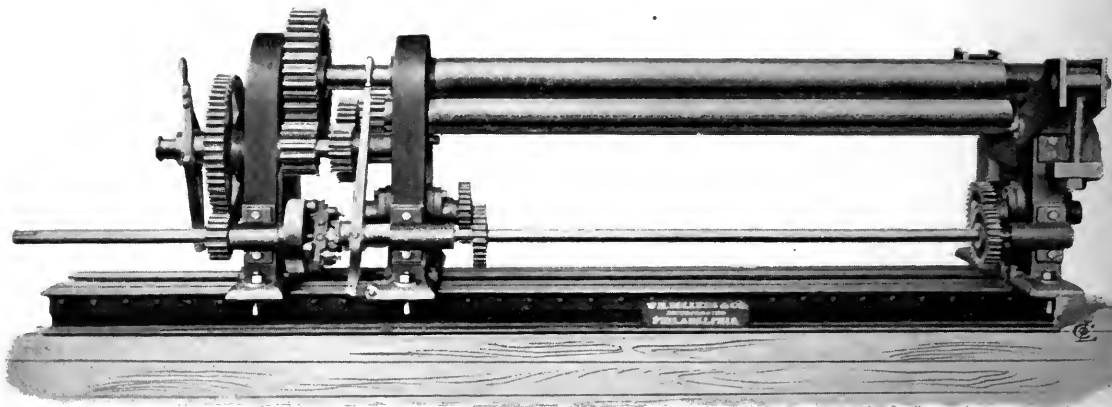
**6" POWER BENDING ROLLS.—FOR LIGHT PLATES.**

Top roll, 6" diameter ; side rolls, 5" diameter ; all forged steel. Tumbler bearing permits work rolled to a full circle to be readily removed. Housings attached to beams and extended to carry motor for driving rolls. Rolls adjustable by power through friction clutches. Arranged to drive by fast and loose pulleys when required.

PLATE No. 197.

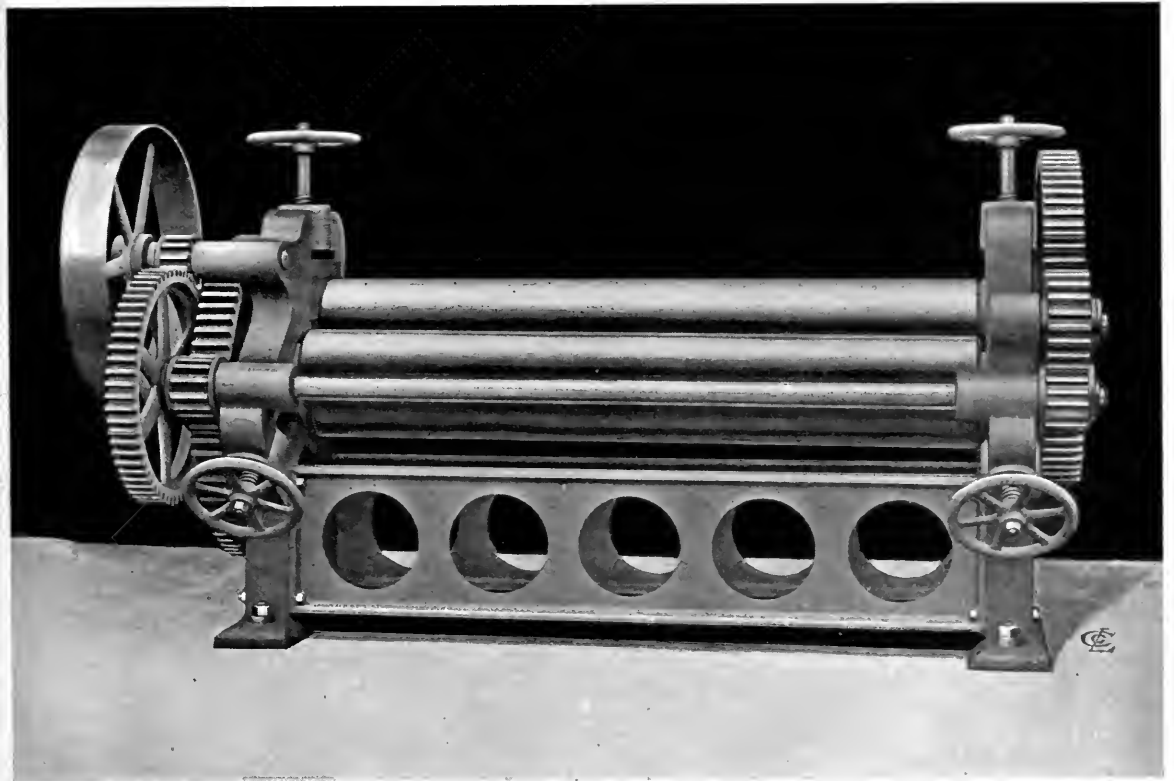

8" POWER BENDING ROLLS.

Arranged with two pinching rolls in same vertical plane, and bending roll moved at an angle to same. Pinching rolls geared at opposite ends. Top roll removable through housings to permit work to be removed. Rolls 8" and 9" diameter, 6 ft. long. Driven by open and cross belts on countershaft. Countershaft pulleys, 26" diameter for 3" belt. Speed, 180 revolutions per minute. Bending rolls adjustable by hand.

PLATE NO. 198.

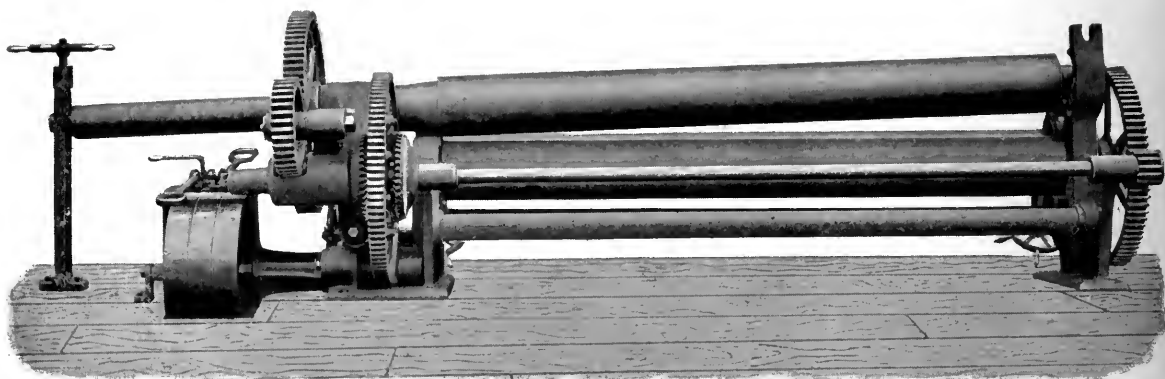

12" POWER BENDING ROLLS.—FOR PLATES 10 FEET WIDE.

Top roll tilting. Pinching rolls, 12" diameter, in same vertical plane. Bending roll 10" diameter, arranged at angle to same. Pinching rolls geared at opposite ends with large wheels, and power transmitted through equalizing gearing to prevent calendering action on the curving plates. Top roll arranged to tilt for ready removal of plates rolled to full circle. Improved belt-shifting device for operating open and cross belts from line-shaft. Pulleys, 30" diameter for 4" belt. Should make 180 revolutions per minute. Bending roll adjustable by hand. The equalizing gearing is an important feature of this machine, as it enables both rolls to be driven with less power than would be required if one had to slip on the plate. This is a simple and efficient machine, well adapted for lighter classes of work, especially where bending close to the edge of the sheet is an object.

PLATE No. 199.

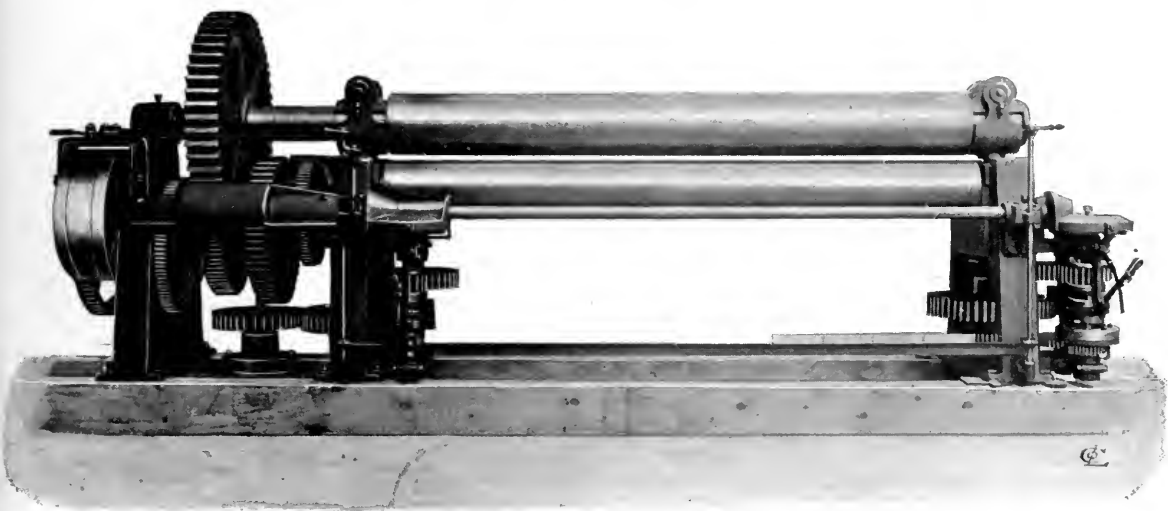

16" PATENT PLATE BENDING MACHINE.

Top rolls, 16" diameter ; bottom rolls, 13"; to bend $\frac{3}{4}$ " plate 12 ft. wide to circle of 64" in one pass. *All three of the rolls are driven.* Driving the lower rolls insures starting of the plate, while the main driving is through the top roll. Our "lost-motion clutch" enables the plate to control the speed of the lower rolls without straining of gears. The rolls all act together, causing the plate to enter readily and to keep moving at all times. The bottom rolls do not slide on the plate or retard its progress, but are always ready to help it along if the traction of the top roll is insufficient. The top roll is fixed in height, and is provided with two bearings at one end, capable of sustaining it when the outboard bearing is unsupported. The lower rolls are adjustable vertically by power at either end independently, or both ends together, against the full resistance of the plate. To remove circular work, the screw supporting the outer bearing of the top roll is run down by power, leaving the roll supported at one end and free from any obstruction to the removal of the plate.

PLATE NO. 200.

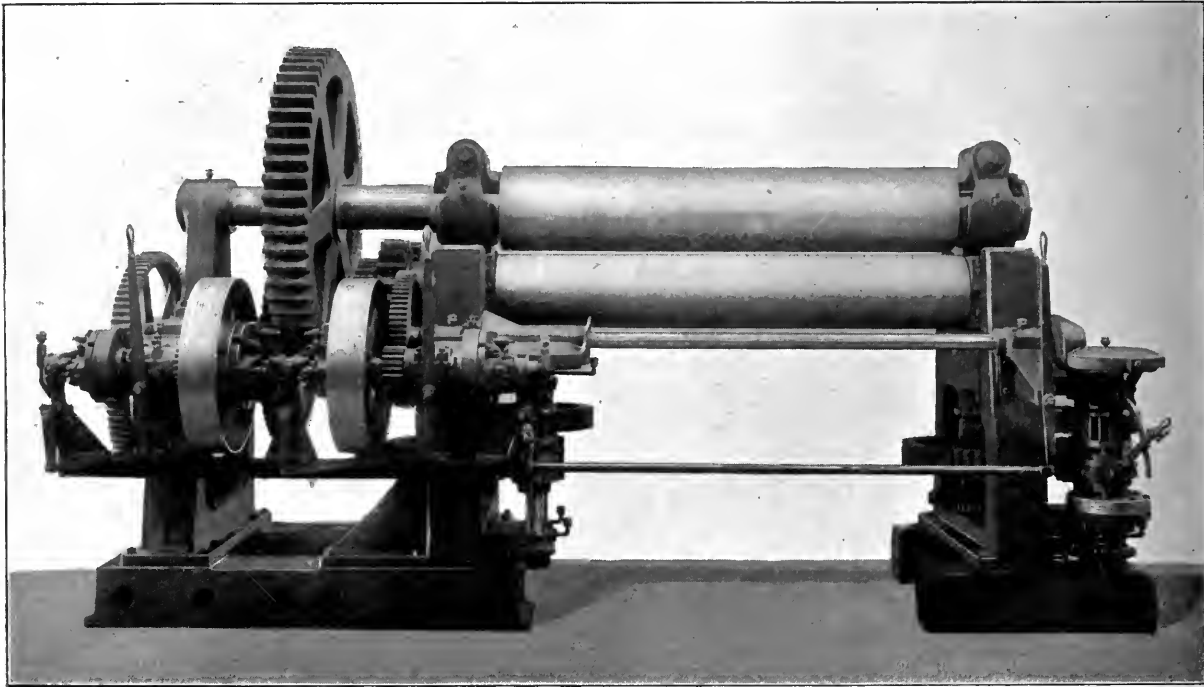

17" PATENT PLATE BENDING MACHINE.

To bend $1\frac{1}{2}$ " steel plates 7 ft. wide, to 48" radius at one pass. Arranged for the removal of work bent to the full circle. Top roll 17" diameter, lower rolls 14 $\frac{1}{2}$ " diameter. All of forged steel. Distance between housings, 7 ft. 6". Operated by reversing clutches from counter or line-shaft. All movements of adjustment by power, operated by hand levers. Special features same as 16" machine, Plate No. 199. Made in various lengths to suit.

PLATE No. 201.

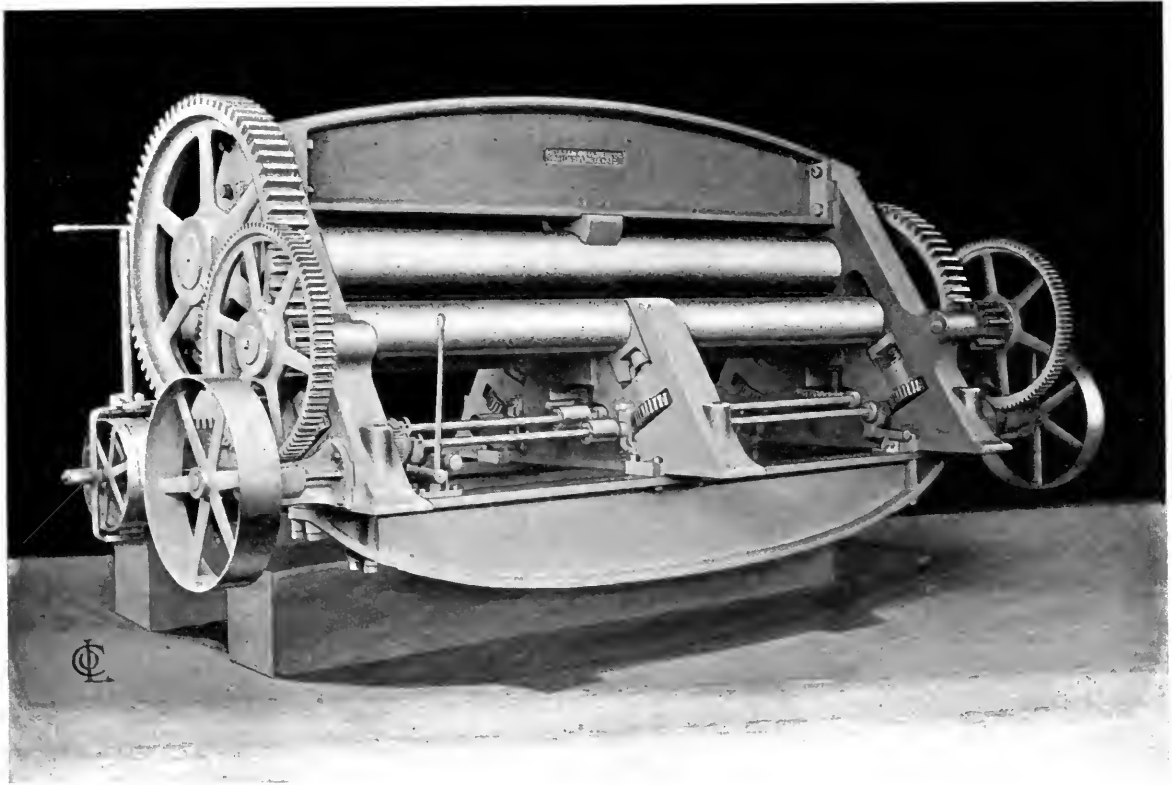

16" SHIP-PLATE ROLLS.—14 FEET BETWEEN HOUSINGS.

This machine has four cast-iron rolls, two pinching rolls 16" diameter, and two bending rolls of 12" diameter, with centre supports, making the machine unusually stiff and strong. The pinching rolls are driven from independent trains of gearing by pulleys at each end from a reversible countershaft, and all of the three lower rolls are adjustable by power; any bearing can be manipulated independently of the rest, or all bearings can be moved simultaneously. This machine is especially useful in bending warped surfaces such as are required in ship-building and similar work. It may also be used to straighten plates, curved or buckled.

PLATE NO. 202.

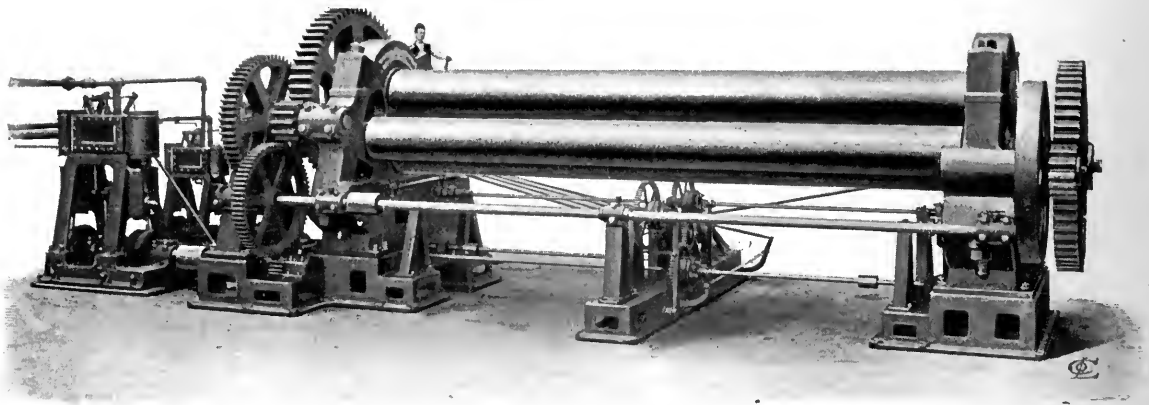

24" SHIP-PLATE ROLLS.—22 FEET 6" BETWEEN HOUSINGS.

This machine represents a late and approved design for ship-plate bending rolls. Special attention has been given to accessibility of parts, and, when possible, bearings have been capped for ease in assembling the various parts, and for ready examination and repairs in case of carelessness in oiling, accumulation of scale and dirt. The pinching rolls are 24" diameter, and the side rolls 20" diameter, all of forged steel. The gearing is very heavy, and provision is made in the driving arrangement to avoid calendering when the traction of the top roll is sufficient to carry the plate. The machine is driven by two reversing engines, one of which turns the rolls while the other is used to adjust them. The pinching rolls will take in plates 2" or less in thickness and side rolls have an adjustment of 18". By means of cut-off clutches either end of a roll may be adjusted independently, or both ends of all the rolls may be moved together when desired.

PLATE No. 203.

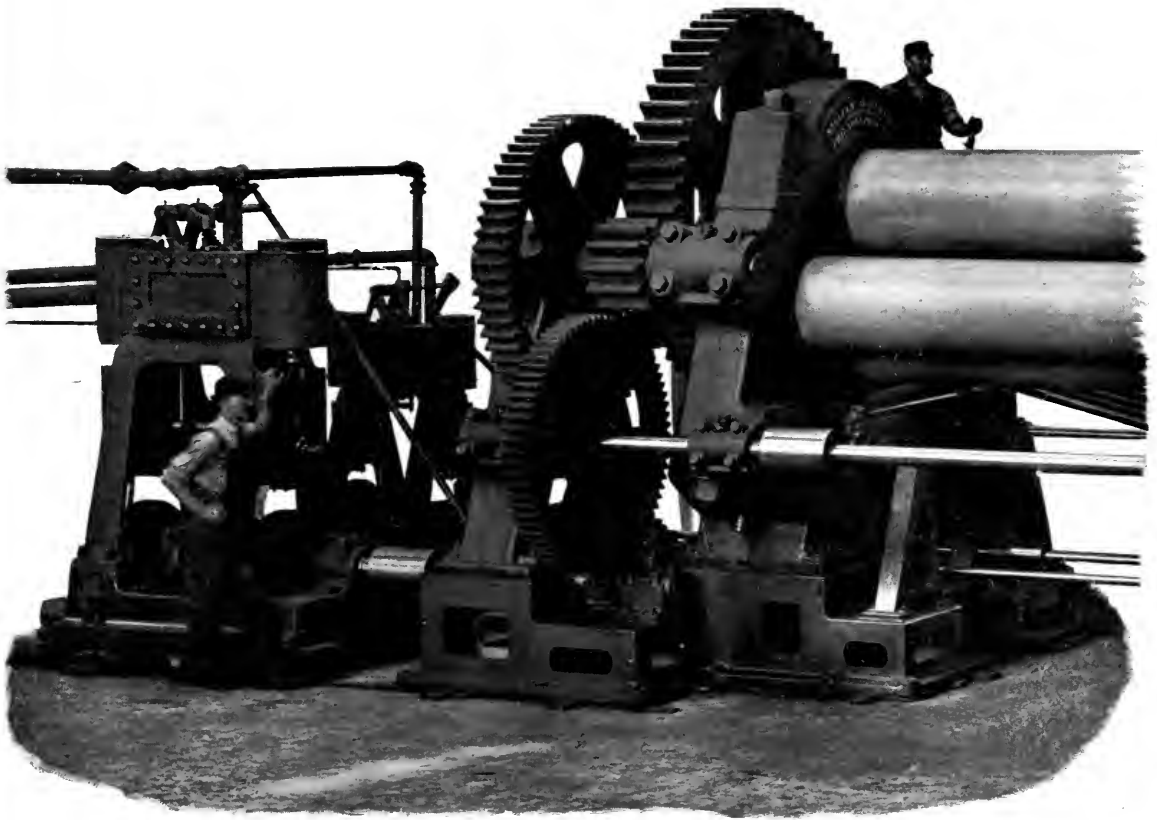

24" PLATE BENDING ROLLS.—22 FEET 6" BETWEEN HOUSINGS.

Top and bottom rolls, 24" diameter; side or bending rolls, 20". Independent engines for driving rolls and adjusting them to height. Ends of rolls adjustable simultaneously or separately, as required for the work. May be arranged to drive by electric motor. See specification on opposite page.

PLATE No 204.

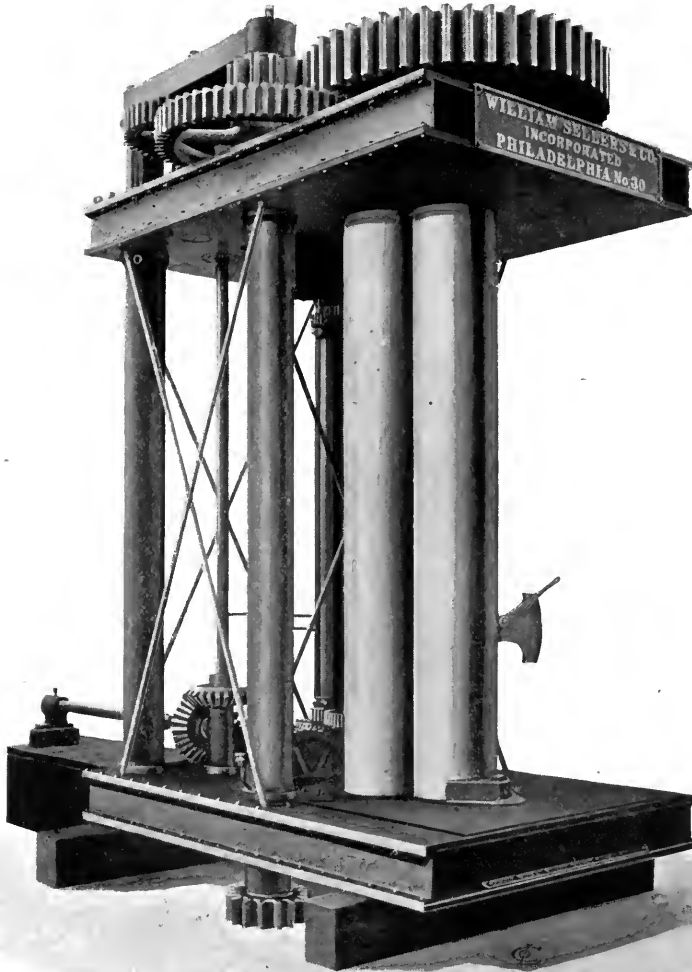

VERTICAL BENDING ROLLS.

Centre roll, 18" diameter; side rolls, 15" diameter. All forged steel. Distance between housings, 10 ft. 4". Housings of steel plates and beams. Capacity, 1½" steel plate, 10 ft. wide. Centre roll removable to take out work. Independent engines for driving and setting the rolls, or one engine may be used for both purposes. Can be arranged to drive by electric motor. Very useful form of machine for heavy plate since it rests upon its lower edge and does not require to be supported by crane. Principal wheels all above top housing and out of the way. 1¼" floor plate on lower housing protected by shield which may be easily replaced when worn.

PLATE No. 205.

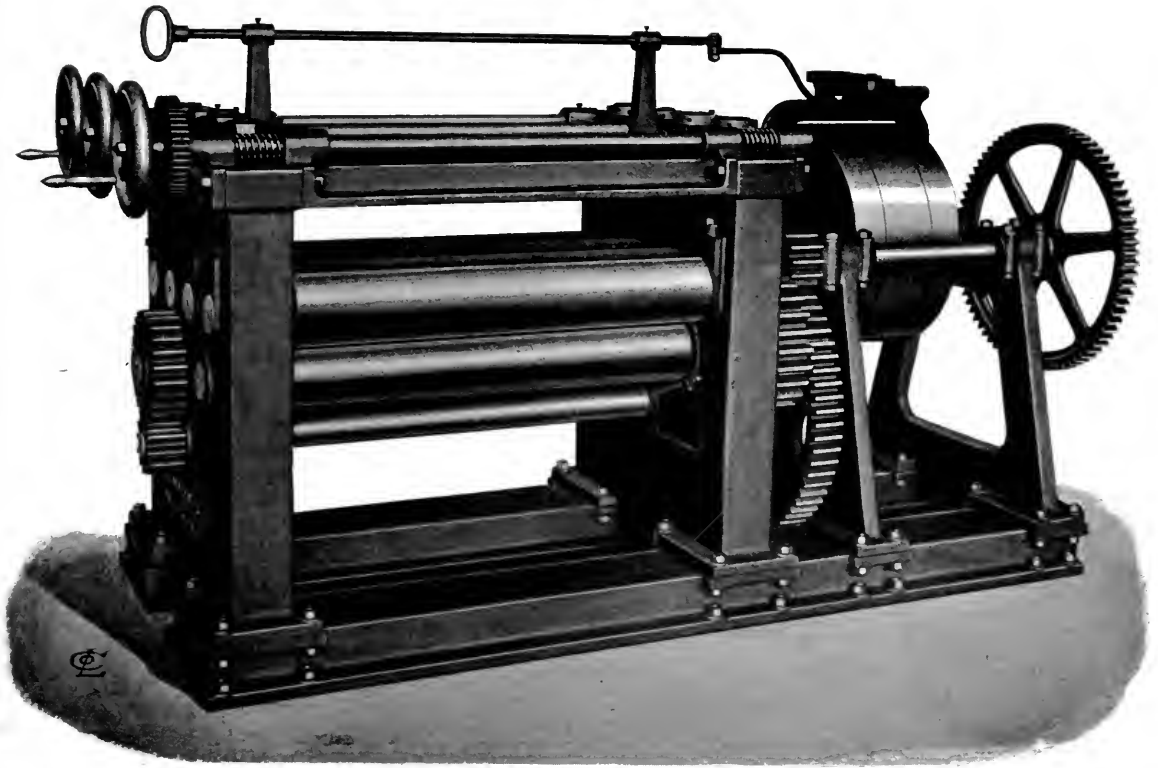

STRAIGHTENING ROLLS FOR PLATES

Seven 6" forged steel rolls, 38" long. Three lower rolls driven directly by large wheels from same shaft, a much better and more desirable arrangement than the usual train of small pinions with idle wheels. Outer rolls adjusted by separate hand wheels, two inner rolls together or by changing connections all four rolls may be moved in unison. Open and cross belts for reversing. Fast and loose pulleys on countershaft, 18" diameter, 7" face, 280 revolutions per minute.

Forcing Machines or Presses for Shafts, Mandrels, Wheels, etc.

NO progressive modern machine shop is without convenient appliances for forcing mandrels into work to be turned, or pressing wheels and other tight-fitting parts upon their shafts. All mandrels that are too large to be conveniently driven by a lead or copper hand-hammer require some form of forcing press, screw or hydraulic, and the practice of sledging mandrels to place is, or ought to be, prohibited in every good shop. The machine used for the purpose will depend on the size and character of the work and the amount of work that is to be done. For ordinary lathe work up to 20" diameter, the mandrel presses illustrated in Plate No. 207 will answer an admirable purpose. For larger work, up to say four feet in diameter, the type of machine illustrated on the succeeding page, Plate No. 208, will meet a large variety of cases. These machines are placed in convenient positions in the machine shop, regard being had to their accessibility by all the workmen likely to use them. Each group of lathes, for example, should have conveniently placed a suitable mandrel press covering the entire range of work for which the lathes are competent. For miscellaneous work of large size, and for work done away from the shop, the portable hand-forcing machine in Plate No. 206 is a very convenient tool. Where there is much work of this kind to be done, a power wheel-press of suitable size becomes a necessity. (See Plates Nos. 209-211).

PLATE No. 206.

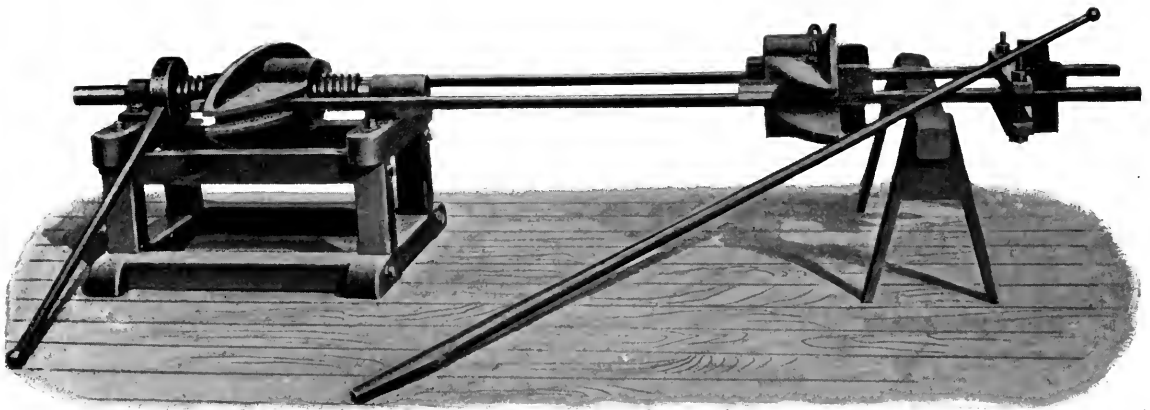

HAND FORCING MACHINE.

FOR PULLEYS, WHEELS, ENGINE CRANKS, ETC.

5 $\frac{1}{4}$ " screw, thread 26" long, mounted in bearings on convenient wooden frame. End thrust of screw taken upon steel step bearing. Crosshead, about 4 feet long, with slots for tension bars, carried upon screw. Outer crosshead same size, made in halves for convenience. Machine complete with crossheads, one pair of clamps 26" long, one set of tension rods 7 feet long, one set 19 feet long, one set of keys, one forged hand lever 5 feet long and one 9 feet long. A convenient machine for heavy miscellaneous work. Its portability is an important feature and enables the machine to be used in a variety of locations.

PLATE NO. 207.

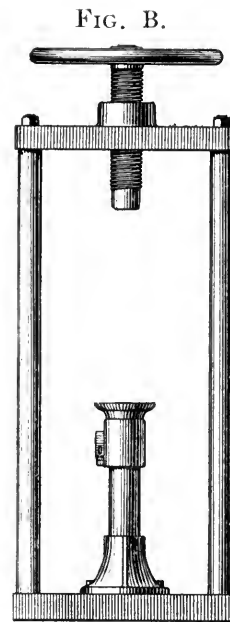

HYDRAULIC MANDREL PRESSES.

Having screw adjustment for length of mandrel. Fig. A, $10\frac{1}{4}$ " between tension bars ; 2" screw, 4 ft. 6" under crosshead, 4-ton jack. Fig. B, 21" between tension bars ; 5 ft. under crosshead, 4" screw, 10-ton jack.

PLATE No. 208.

**36" MANDREL PRESS.**

Distance between bars, 36"; section of bars, 3" square. Greatest height from base to underside of counterweighted crosshead, 7 ft. 3". May be used with 10-ton or 20-ton jack. Complete with counterweights, sheaves, keys, wire rope, and jack. A very handy and complete machine for the purpose, occupying but little floor room and covering a great variety of work. We also make a similar machine 50" between uprights, for 30-ton jack.

Hydrostatic Wheel Presses.

WE were the patentees of what has since become the usual form of hydrostatic wheel-press, that is, the machine having a movable abutment, adjustable along the tension bars, hollowed out in the centre to permit the shaft or axle to pass into the line of pressure. We also patented the hinged blocking piece carried upon the end of the plunger; and, later, we patented a method of lining the cylinder with copper without joint or possibility of leak; which we have found greatly increases the durability of the wheel-press.

We use in all of our wheel-presses double-acting pumps, producing a smooth and approximately uniform motion. The pump is sufficiently large to move the plunger at a reasonable rate of speed; and does not require that attention from the operator which is involved in the use of two single acting pumps of different capacities. The safety-valve is locked to prevent tampering, and the overflow is discharged into the oil tank on the side of the upright, from which it is again drawn to the pump when required. There are no openings through the side walls of the main cylinder, the oil being forced through a centre-block in the back end. When the machine is running, the oil raised by the pump passes back through an overflow passage to the tank until this passage is closed by the hand-wheel, when delivery takes place into the cylinder. Movement of the hand-wheel in the opposite direction opens the valve, permits the cylinder to exhaust and the plunger to be retracted, all without stopping the pump.

Our wheel-presses are rated by the size, measured on the tread, of the largest flanged wheel which they will take. They are thus: 36", 42", 54", 72", 84". The actual distance between the tension bars in each case is at least 4" greater than the nominal size. We make a line of these machines up to 72", with a maximum pressure of 150 tons on the plunger; another set from 54" to 84" inclusive, with a maximum pressure of 200 tons. We are also prepared to build machines of larger capacity and greater pressure.

LIST OF SIZES.

	Distance between tension bars.	Diameter of Ram.	Stroke.	Maximum Power
For 36 inch wheels.	40 inches.	9 inches.	18 inches	150 tons.
" 42 " "	46 " "	9 " "	18 " "	150 " "
" 54 " "	58 " "	9 " "	24 " "	150 " "
" 72 " "	76 " "	9 " "	24 " "	150 " "
" 54 " "	58 " "	10 $\frac{1}{2}$ " "	24 " "	200 " "
" 72 " "	76 " "	10 $\frac{3}{8}$ " "	24 " "	200 " "
" 84 " "	88 " "	10 $\frac{1}{2}$ " "	24 " "	200 " "
" 72 " "	76 " "	12 $\frac{3}{8}$ " "	24 " "	300 " "
" 84 " "	88 " "	12 $\frac{3}{8}$ " "	24 " "	300 " "
" 90 " "	94 " "	12 $\frac{3}{8}$ " "	24 " "	300 " "

As usually built, the machine is intended to stand at a right angle with the line shafting, but we also build them with pulleys for a parallel position or with an electric motor attached directly to the principal upright.

PLATE No. 209.

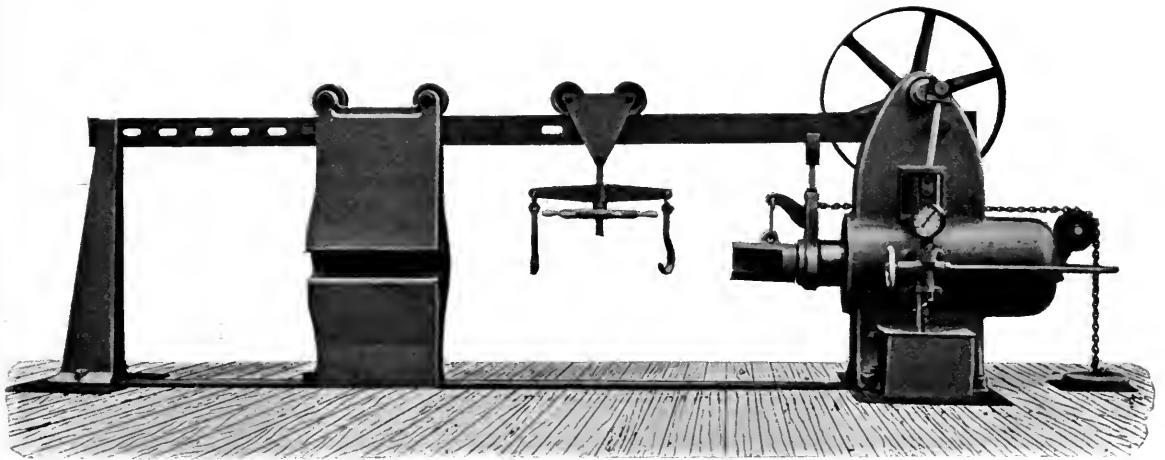

42" HYDROSTATIC WHEEL-PRESS.—150 TONS CAPACITY.

Distance between tension bars, 3 ft. 10"; capable of putting two wheels on axle at the same time. Cylinder lined with copper in improved manner. Double-acting bronze pump, arranged with pressure gauge and stop-valve and improved safety-valve to prevent overloading. Hooks and elevating screws for wheels and axles, travelling on tension bar. Resistance beam or post carried upon wheels on the tension bar, movable to any position, thus acting equally well for pulling off and pushing on. Complete with countershaft, pressure blocks, and full set of wrenches.

PLATE NO. 210.

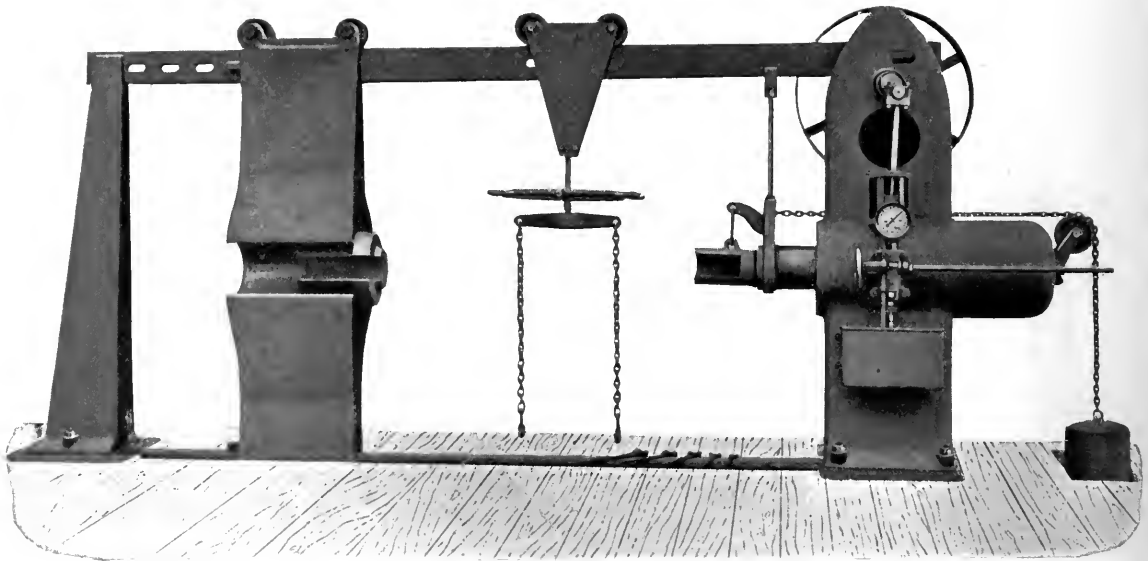

72" HYDROSTATIC WHEEL PRESS.—150 TONS CAPACITY.

Distance between tension bars, 6 ft. 4"; capable of putting two driving wheels on axle at the same time. Cylinder lined with copper in improved manner. Double-acting bronze pump, arranged with pressure gauge and stop-valve and improved safety-valve to prevent overloading. Chain-slings and elevating screws for wheels and axles, travelling on top tension bar. Resistance beam or post carried upon wheels on tension bar, movable to any position, thus acting equally well for pulling off and pushing on. Complete with countershaft, pressure blocks, and full set of wrenches. Made also for 200 tons pressure.

PLATE No. 211.

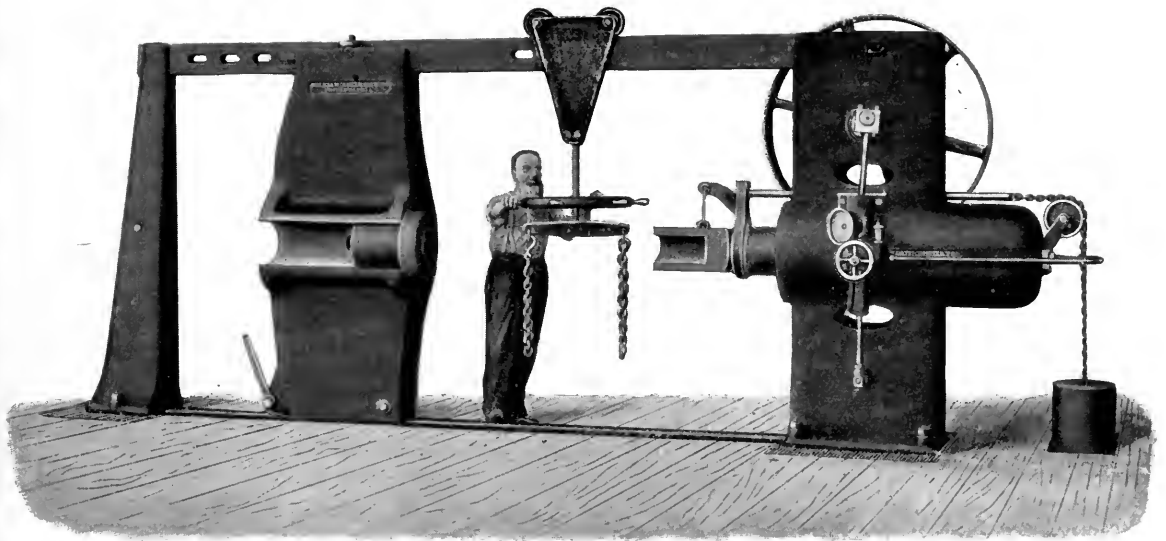

84" HYDROSTATIC WHEEL-PRESS.—200 TONS PRESSURE.

Distance between tension bars, 7 ft. 4"; capable of putting two driving wheels on axle at the same time. Cylinder lined with copper in improved manner. Double-acting bronze pump, arranged with pressure gauge and stop-valve and improved safety-valve to prevent overloading. Chain-slings and elevating screws for wheels and axles, travelling on top tension bar. Resistance beam or post, carried upon wheels on the tension bar, movable to any position, thus acting equally well for pulling off and pushing on. Complete with countershaft, pressure blocks, and full set of wrenches. Made also for 300 tons pressure.

Hydraulic Medal Press.

THE machine illustrated on the opposite page was designed and built for the U. S. Mint at Philadelphia, to stamp medals of various sizes, using any desired pressure up to 2,000,000 pounds upon the dies. It consists of two semicircular heads, separated by strong columns and united by heavy steel bands, between which is a cross-head operated by a large steel cylinder in the upper head and small return cylinders in the lower head. Power is supplied by a direct acting plunger pump, which maintains a constant flow of oil, to be deflected as desired from an idle circulation through a supply tank overhead into the large or small cylinders. The movement of the coining-head is controlled by a lever conveniently located on the side of the machine. In its middle position the head remains stationary, and as the lever is moved up or down the coining-head follows in the direction indicated by the lever movement. The pressure applied is determined by an adjustable safety-valve. This is easily and quickly adjusted, the pressure being regulated to suit the strength of the hardened steel dies used. Although the pressures employed are very great, the power required to run the press is quite small, and a rapid movement of the coining-head in both directions, toward and from its work, is accomplished by automatically putting the large coining cylinder in direct communication with the supply tank. This communication is established by a large valve on top, which automatically closes again as soon as the coining-head is arrested by the work, after which the movement continues slowly under pump pressure, allowing time for the metal to flow between the dies ; the head is made to move at the rate of an inch a minute under pressure, and three feet a minute toward and from its work. As the movement under pressure is very short, the operation of coining is rapid and applicable to a variety of work, such as punching and stripping, for which it is also used. Such a press may be used to supersede the drop or the fly-press for many operations.

PLATE No. 212.



HYDRAULIC MEDAL PRESS.—2,000,000 POUNDS PRESSURE.

Hoisting Machines.

WE make three sizes of worm hoisting machines for freight elevators, all of the same general type; they are strong, simple, and efficient. The worm-wheels and worms are made from iron patterns, and the latter are so moulded that the thread is without "parting" marks. The worms in all cases run immersed in oil, which is prevented from escaping at the end of the worm-box by a suitable packing. The thrust of the worm is taken upon hard steel steps, well lubricated.

These machines have our improved interlocked belt shifter, carried upon an adjustable frame, which may be set to suit the angle of the driving-belts. When both belts are off, a brake is automatically applied and remains on the driving-pulley until one of the belts is shifted. These machines are provided with an automatic adjustable stopping device, which causes the hoisting cage to stop at top and bottom of hoistway, regardless of whether or not the shifting-rod is moved; that is, the machine stops when the drum has made the desired number of rotations. This arrangement is certain in its action, and is a valuable addition to the ordinary stops on the shifting-rod.

WORM HOISTING MACHINES.

Nominal Rating.	Diameter of Worm-Wheel.	Usual Diameter of Drum.	Diameter of Pulleys.	Usual Speed, Revs. per Minute.
1000 lbs.	10"	14"	16"	212
2000 "	18"	18"	24"	275
4000 "	30"	36"	30"	225

Other drums can be furnished in each case when required.

We make cages or platforms for elevators to order, as well as all the iron-work for the guides, etc., and are prepared to supply safety catches, operated by spring or counterweights, as well as the "Tatham and Britton" safety arrangement, in which a pendulum suspended below the car vibrates in grooves in the guide-irons. In this device, as long as the proper speed is maintained, the pen-

PLATE NO. 213.

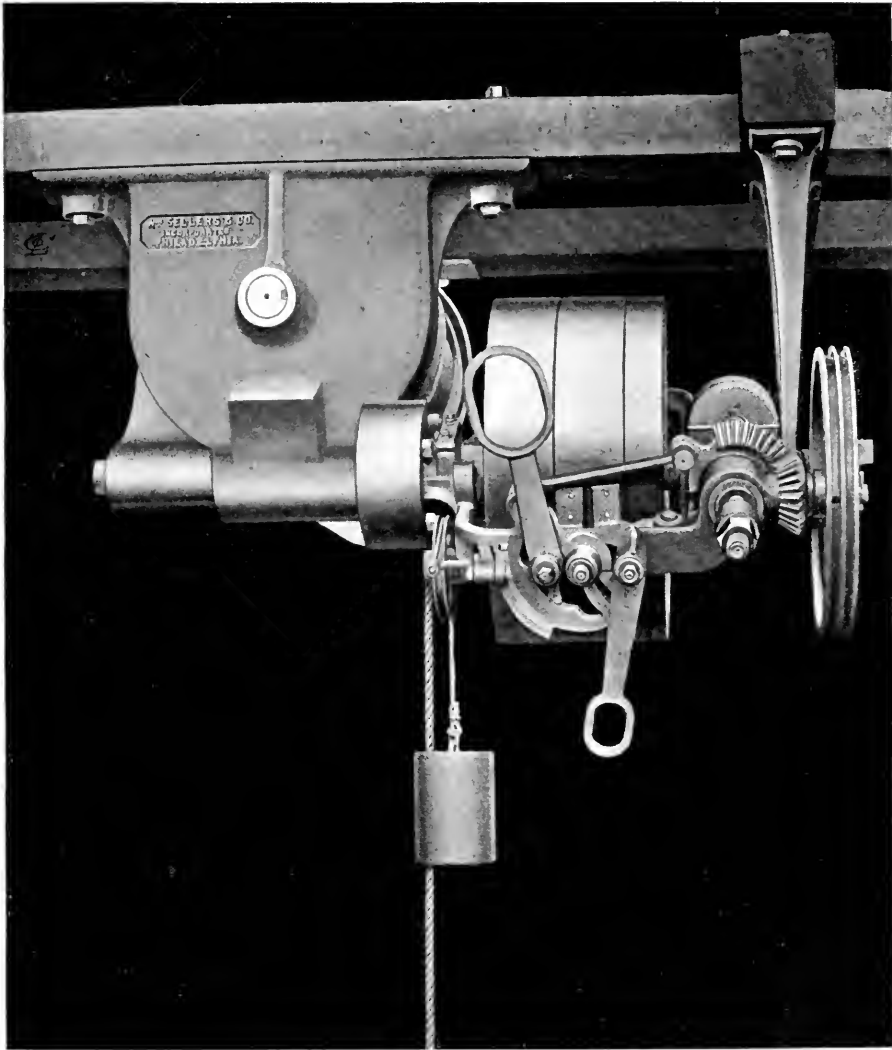

2000-LB. WORM HOISTING MACHINE.

Worm-wheel, 18" diameter. 24" pulleys, 4" belt to hoist; 2" belt to lower. Complete with 18" drum, and grooved for wire rope; belt shifter; automatic brake; automatic stop-motion; counterweight for brake, and outboard supports for drum-shaft and pulley-frame.

dulum vibrates freely, but should the motion of the cage be unduly accelerated, the pendulum at once jams and throws into operation a pair of toothed clutches which lock the cage absolutely and prevent further movement until the car is raised to disengage them. This is an absolutely certain safety device, and provides not only against accident from breakage of the rope, but from the running away of the hoist, due to any other cause.

SPUR-GEARED HOISTING MACHINES.

We show in Plate No. 214 a spur-gear hoisting machine, driven by open and cross-belts through our improved friction clutches, in which the load is sustained by our improved self-acting retaining device. This machine has a 36" drum, turned and grooved for 1" wire rope. It is provided with an automatic brake and automatic stop-motion, similar to that used on our worm-gear machines. It may be readily used to hoist the full load at least 60 feet a minute. It is a strong and substantial machine, arranged to bolt upon the floor or upon a foundation at base of elevator shaft. This machine is also used for a riveter hoist, as shown in Plate No. 215. For this purpose a chain drum is substituted for the wire rope drum, and the automatic brake and stop-motion are omitted, a suitable hand-lever being provided for operating the clutches. This machine is admirably adapted for the purpose, as it can be controlled with the utmost nicety, so that the hoist may be stopped at exactly the point required for driving the rivet. This machine is used for loads up to fifteen tons on four parts of chain.

PLATE NO. 214.

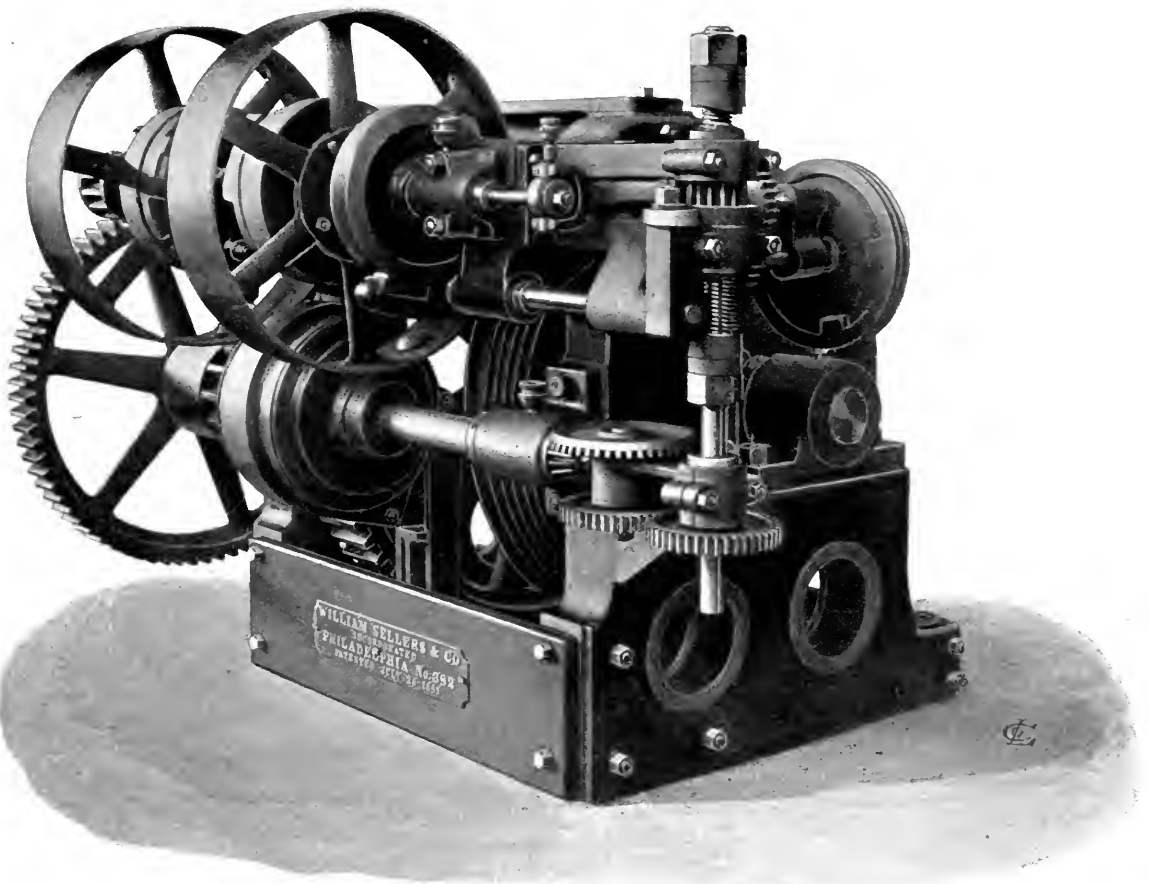

5000 L.B. SPUR GEARED HOISTING MACHINE.

WITH PATENT FRICTIONAL, RETAINING CLUTCH.

36" drum, turned and grooved for 1" wire rope. Pulleys 24" diameter, 5½" face. Should make 250 revolutions per minute, to hoist at a rate of 62 feet.

PLATE No. 215.

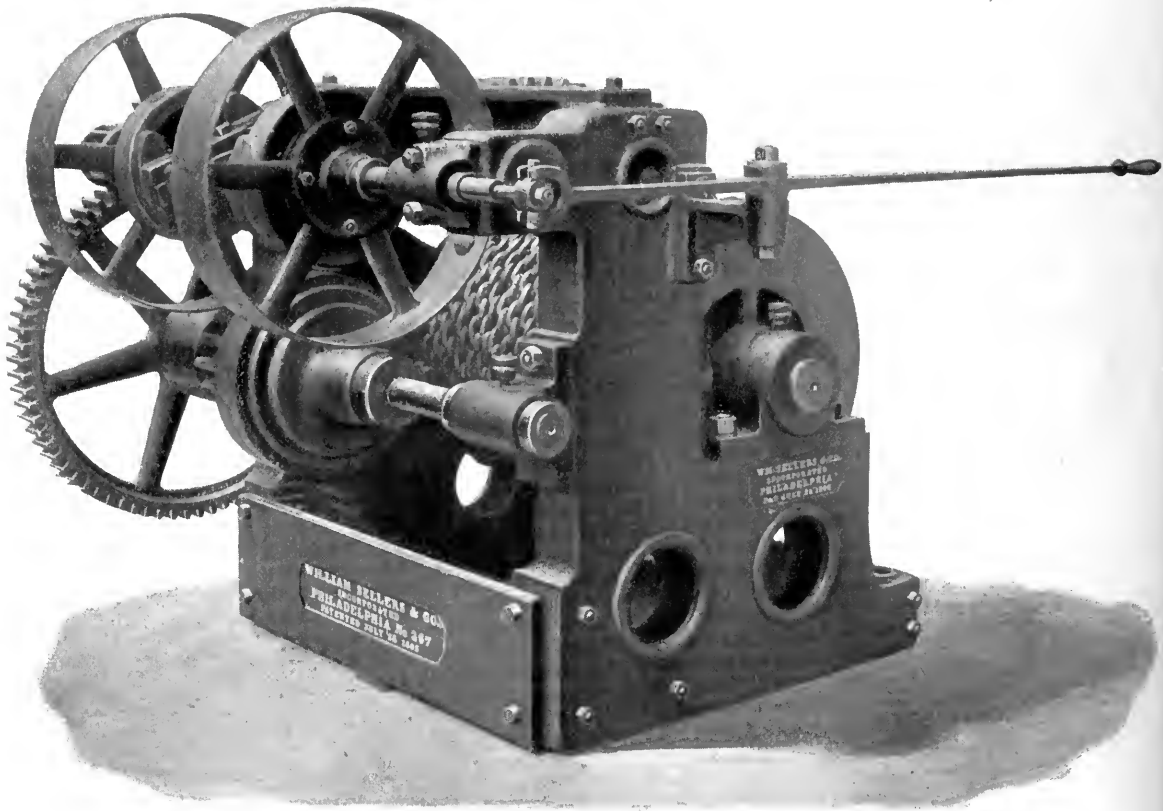

SPUR-GEARED HOISTING CRAB.

SPECIAL DESIGN FOR USE WITH OVERHEAD HOIST FOR RIVETING MACHINES.

24" by 4½" pulleys. Should make 300 revolutions per minute. Drum, 18" diameter. Load sustained by patent frictional retaining device.

PLATE No. 216.

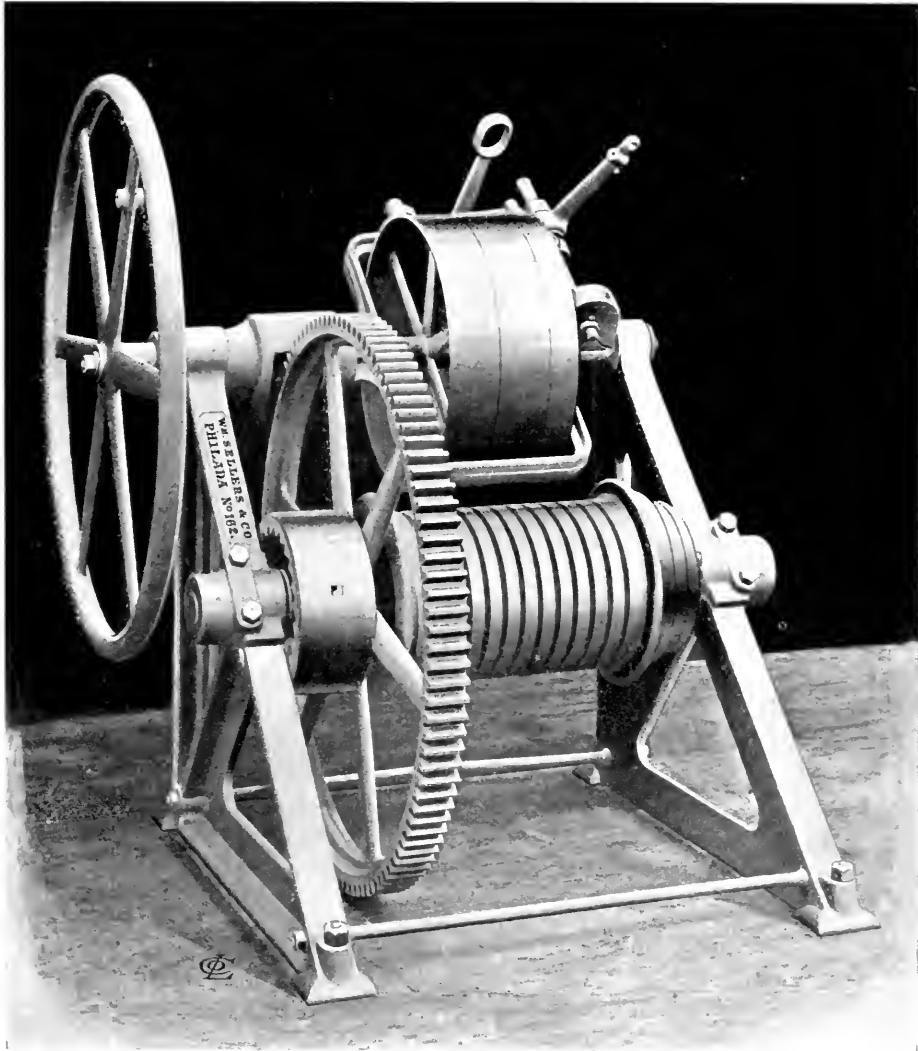

SPUR-GEARED HOISTING CRAB.—WITH WESTON RETAINING CLUTCH.

This machine was designed for use with light overhead hoist for riveting machines, up to five tons capacity. It is driven by open and cross belts. Is provided with a hand adjustment through 4 ft. hand-wheel, enabling fine adjustments to be readily made. The pulleys are 24" diameter. Made also to work by hand only.

Cranes.

UNTIL a recent period, very little attention was paid in this country to the improvement of cranes for heavy work. Any appliance that would lift the required load was considered by most people good enough, and economy of labor and time was neglected. In fact, our manufacturers were often as much behind their foreign competitors in facilities for lifting large machinery as our railroads and steamship terminals are now behind those of other civilized countries in appliances for rapidly handling the heaviest kinds of freight. New economic conditions, closer competition, and, above all, the remarkable improvements recently accomplished in cranes themselves, have produced an entire change of practice, and every progressive foundry and machine shop in the country has been improving its cranes, while an efficient system of handling its plant and product is now recognized as of prime importance in the arrangement of every new enterprise projected. In this mechanical revolution we were pioneers. We early recognized the necessity of more rapid power cranes, and were the first to produce power travelling cranes approximating in speed the fastest of the modern electric cranes. We have since built a large number of cranes of a great variety of types, and we do not hesitate to say that our cranes have proved eminently successful and satisfactory to our customers.

We attribute our success chiefly to our careful designing and thoroughly good workmanship. Realizing the vital importance of the crane and the amount of responsibility put upon it, we have allowed no detail in its mechanism to be neglected, and have calculated with care the strength of every part, allowing invariably a large factor of safety. In fact, our cranes are always designed to carry the full rated load for continuous working. Great care is taken to make all parts accessible for examination, to provide ample bearing surfaces, and the best facilities for lubrication. We avoid the use of worm-wheels, and as far as possible of bevels and very small spur-wheels. We reduce the chain friction to a minimum, and neglect no detail calculated to increase the efficiency of the operating mechanism. In all these respects we solicit examination and a comparison with competing cranes of the same rated capacity.

We pay particular attention to the hooks of our cranes, which are carefully designed, of correct mathematical proportions, and made of the best iron, forged and bent to shape. They are not steel castings. Our hooks are suspended upon ball-and-socket swivels, and in the larger sizes are provided in addition with anti-friction ball bearings for easy rotation.

In general, we claim for our crane machinery that it is simple and accessible, efficient, and strong; and for our clutches and the method of operating them, that we are able to put any motion into action without shock, to stop and start the load without risk of injury to it, and to make small movements with ease and certainty.

We have drawings and patterns for a great variety of cranes not illustrated in these pages, and are always prepared to consider cranes for special purposes.

PLATE No. 217.

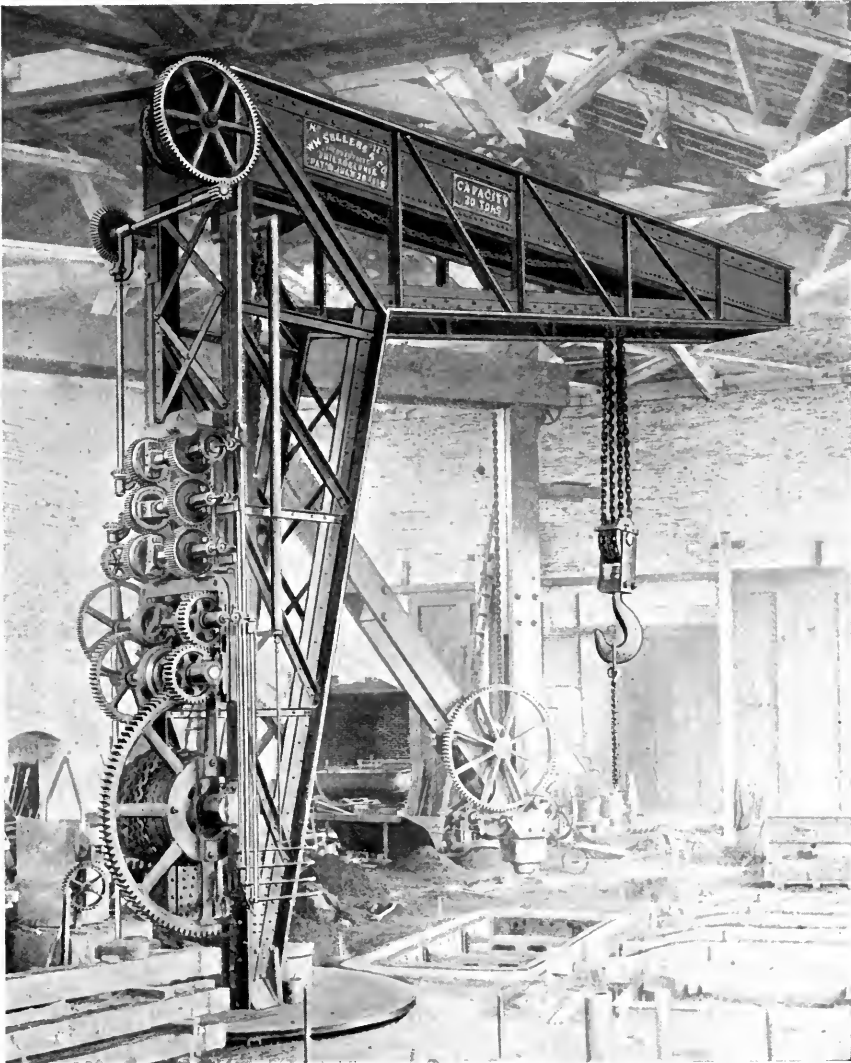

30-TON STEAM JIB-CRANE.

IN FOUNDRY OF THE J. MORTON POOLE CO., WILMINGTON, DEL.

Height of post, 26 ft.; effective radius of hook, 23 ft. All movements by power. Driven by independent 8" by 8" engines, bolted to frame carrying machinery, receiving steam through upper pintle and discharging exhaust through step in foundation plate.

Swing-Cranes.

CRANES may be divided broadly into two general classes ; the first, including the swing or jib-cranes, derricks, etc.; and the second, the various types of bridge-cranes, gantries, and overhead travelling cranes. Until recently overhead travelling cranes, even when driven by power, were slow in action, and capable therefore of a very limited amount of work. In establishments requiring much lifting, the travelling cranes were supplemented by numerous jib-cranes, situated at points where frequent hoisting was most required. By greatly increasing the speed of travelling cranes—and in this effort we believe ourselves to have taken the initiative—the conditions have been greatly modified, and one efficient travelling crane will now do the work which formerly required a number of cranes. For general purposes, especially where a large area of floor surface is to be covered, the travelling crane is usually the better form ; but there are many special purposes and many locations which require some form of swing-crane. In developing the travelling crane, therefore, we have at the same time improved the jib-crane type. In fact, the development of the two forms has proceeded side by side, and the contrast between the high-speed travelling crane of to-day and the old wooden hand traveller made by us forty years ago, is no more marked than is the difference between the wooden swing cranes of those days and their modern successors with power driving-gear and iron frames.

The usual framing for the wooden jib-crane consisted of a post, a jib, and a diagonal strut from the base of the post to a point near the centre of the jib, and the earlier iron cranes followed closely the same form of construction ; rolled beams took the place of the wooden ones, and the method of joining them was modified ; but the general form remained the same. As the post and jib were each composed of two beams, united only at their ends and of little value laterally, it was difficult to make such cranes strong enough without the use of an excessive amount of material. We early discovered that this form of frame was not adapted for quick-acting power cranes, and introduced the improved type of frame, shown in the accompanying illustrations, which combines lightness and strength in a marked degree. In this form the trolley or carriage travels within the jib, which is cross-braced from side to side above the carriage. The post in the same manner is cross-braced and latticed on all four sides, while at the top and bottom of the post wide plates are used to thoroughly unite the parts of the frame. Cranes can be built in this form of great torsional strength, and able to stand the strain produced by rapid rotation of the loaded crane and its sudden stoppage, while the omission of the separate strut permits work to be moved much nearer to the axis of rotation than is possible with the old form of construction.

Jib-cranes may be supported on the top by bearings attached to the roof-girders or by struts from walls or columns, or they may be made to embrace columns which support the upper floor of a building, as in Plate No. 221, or the

PLATE No. 218.

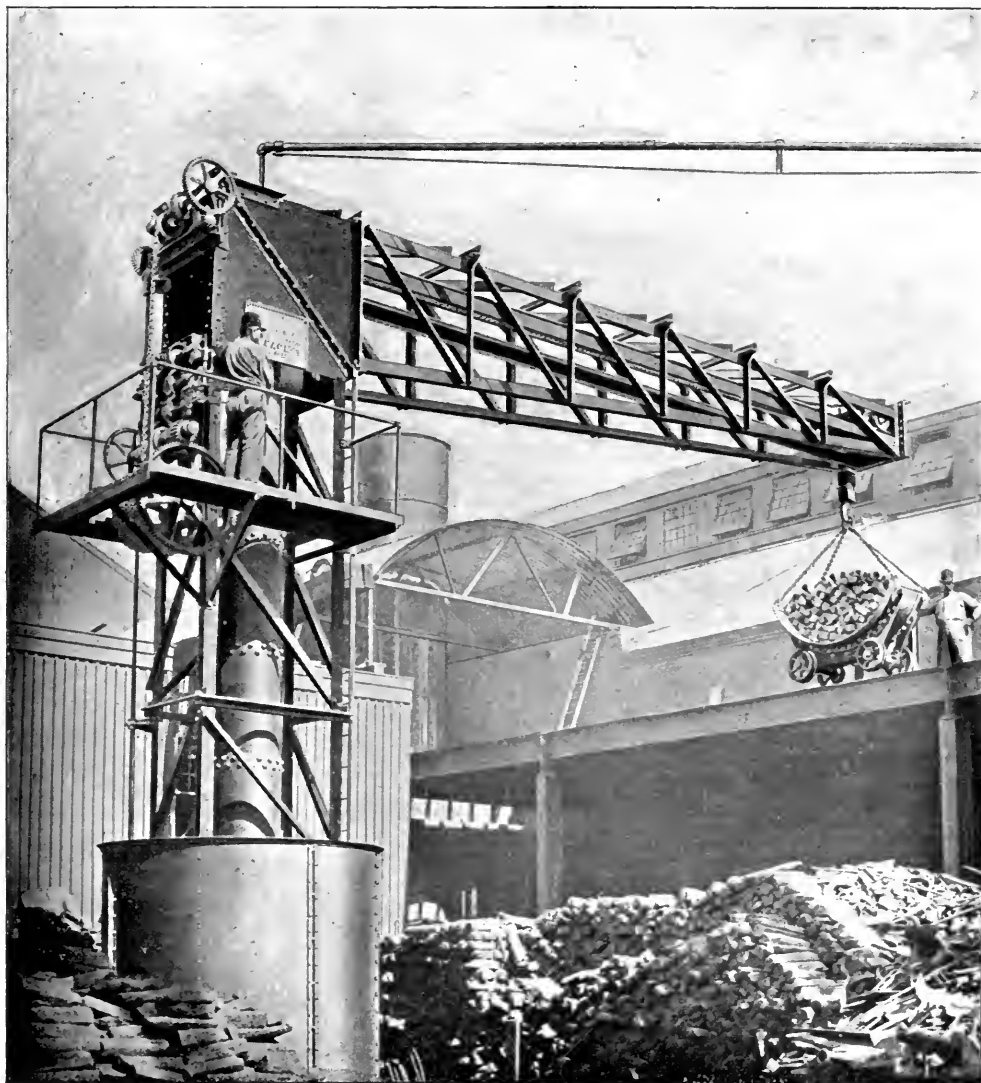

5-TON STEAM PILLAR JIB-CRANE.

Carried upon riveted steel pillar, bolted to foundation, driven by independent steam engine, and receiving steam from stationary boiler through top pintle bearing. Post of crane protected by cylindrical guard. Operating platform elevated. Maximum height of hook, 25 feet. Effective radius of the hook, 30 feet.

Swing Cranes—*Continued.*

column may be a pillar, like that of the crane shown in Plate No. 218, secured to a sufficient foundation and requiring no support from roof or wall; or the pillar may be bolted to the platform of a car of sufficient weight and size for use in various locations. Besides the jib-cranes described, in which the carriage supporting the load is arranged to travel radially along the jib, there are a number of swing-cranes having a fixed radius of action or a limited variation, by raising or lowering the end of the frame, which, vibrating about an axis near the centre of rotation, will move the load in and out through a limited distance. Such cranes are shown in Plates No. 222 and No. 225.

There is still some demand for cranes operated by hand only, and for swing-cranes of this kind we usually provide a crank-motion for the hoisting train, while the travel of the carriage is produced by a hand-chain operating the traversing gearing. Such a crane is shown in Plate No. 223.

Jib-cranes—not including those operated by direct-acting air or water cylinders—may be driven in various ways; by independent steam-engines attached to the crane, by power obtained from the line shafting, by one or more electric motors, etc. We use essentially the same machinery in all these cases, making only such changes as are required for the application of the particular motive power required. The drum is usually arranged to carry all of the chain in one course without overlapping, and the load is held in any position by our patent automatic sustaining clutch, so that it is impossible for it to overhaul or run down; and the load must be lowered by power. In special cases, when it is required to lower by brake, we make a suitable arrangement for the purpose. The mechanism we use in our cranes, while compact and neat in appearance, is carefully designed to facilitate examination and repairs, and careful attention is paid to proper lubrication of every part. We have paid great attention to the elimination of unnecessary chain friction, and design our carriages to avoid the twisting tendency which is so objectionable in many jib-cranes.

Very little modification is required to apply power of any kind to cranes of this type. If it be desired to drive from line shafting, we usually put a vertical shaft through the upper pintle, connected by bevels with the operating mechanism at its lower end, and provided at its upper end either with bevel wheels operated by horizontal countershaft, or with a pulley driven directly from the line. When driven by independent engines, they are secured to the housings which carry the operating clutches; steam is supplied through a stuffing-box in the top pintle, and the exhaust passes through a similar stuffing-box in the lower step.

PLATE No. 219.

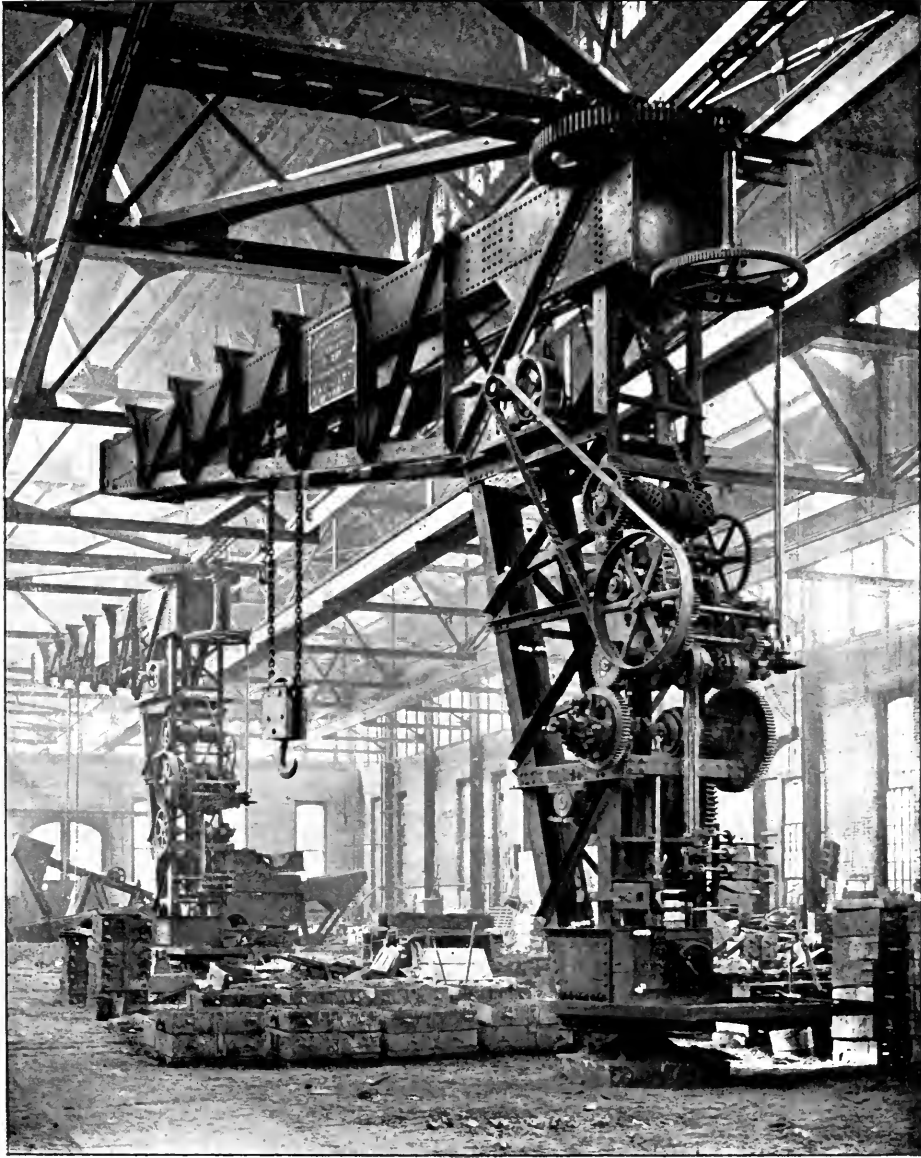

10-TON ELECTRIC JIB-CRANE.

IN FOUNDRY OF THE BALDWIN LOCOMOTIVE WORKS.

With two hoisting speeds. Effective radius of jib, 30 feet. Operated by single constant speed motor. Arranged to lower by power or brake, as may be required.

PLATE No. 220.

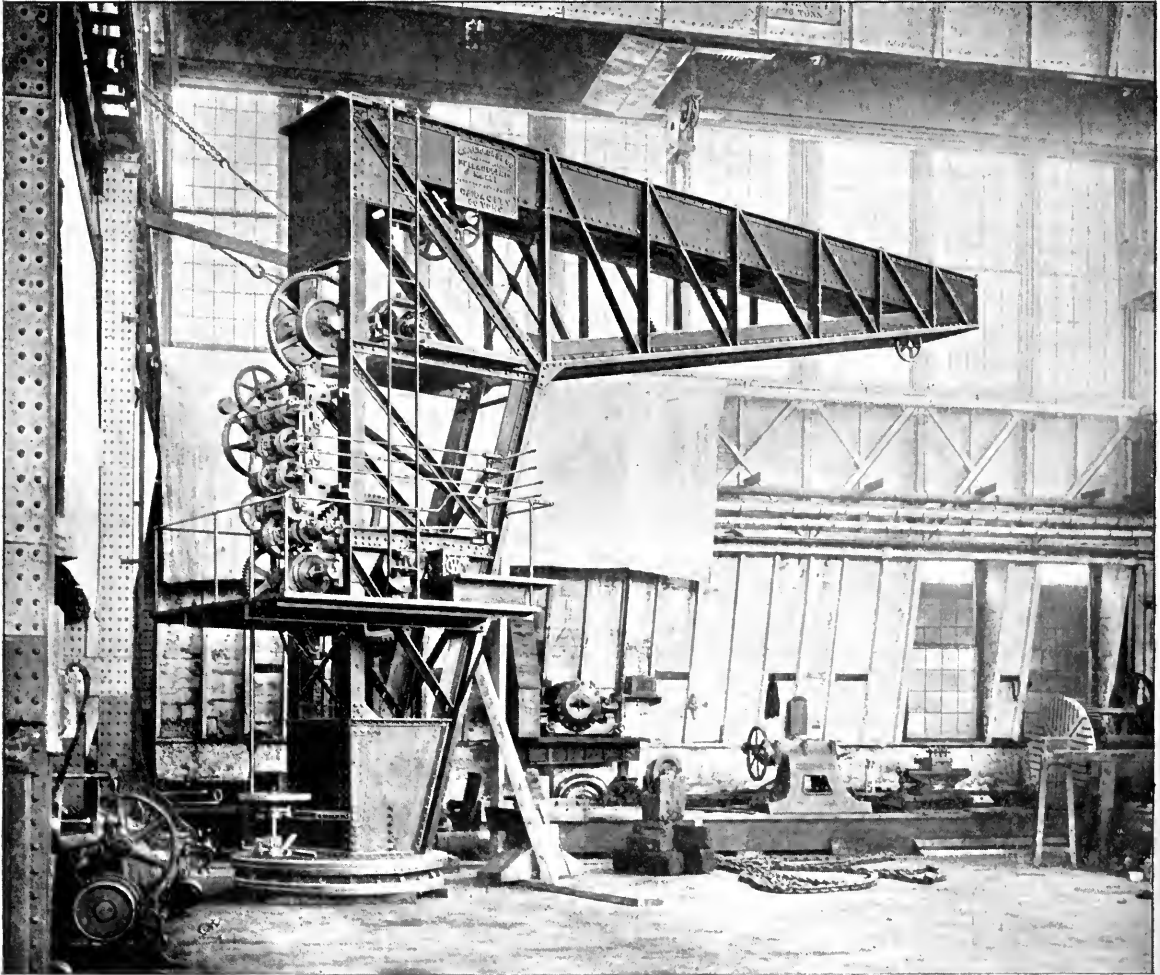

20-TON ELECTRIC JIB-CRANE.

Effective radius of hook, 31 ft. 9". Post, 28 ft. high. Has elevated platform for operator and turning gear at base of post. Driven by 15 horse-power shunt wound electric motor. Two hoisting speeds. This type made in larger sizes as required.

PLATE NO. 221.

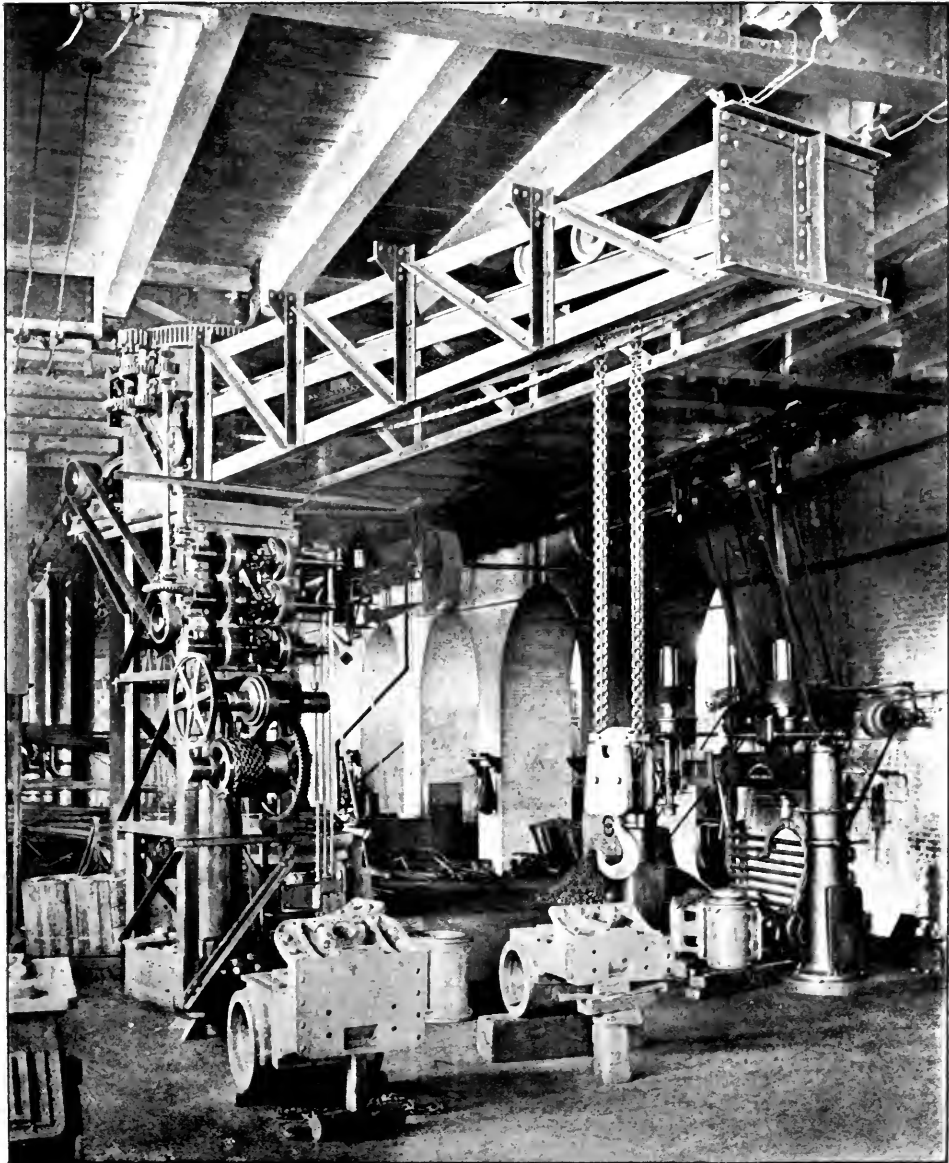

6-TON ELECTRIC COLUMN JIB-CRANE.

IN CYLINDER SHOP, BALDWIN LOCOMOTIVE WORKS.

Crane surrounding iron column used for supporting upper part of building. Height, 18 feet. Radius of jib, 20 feet. Driven by single motor.

PLATE NO. 222.

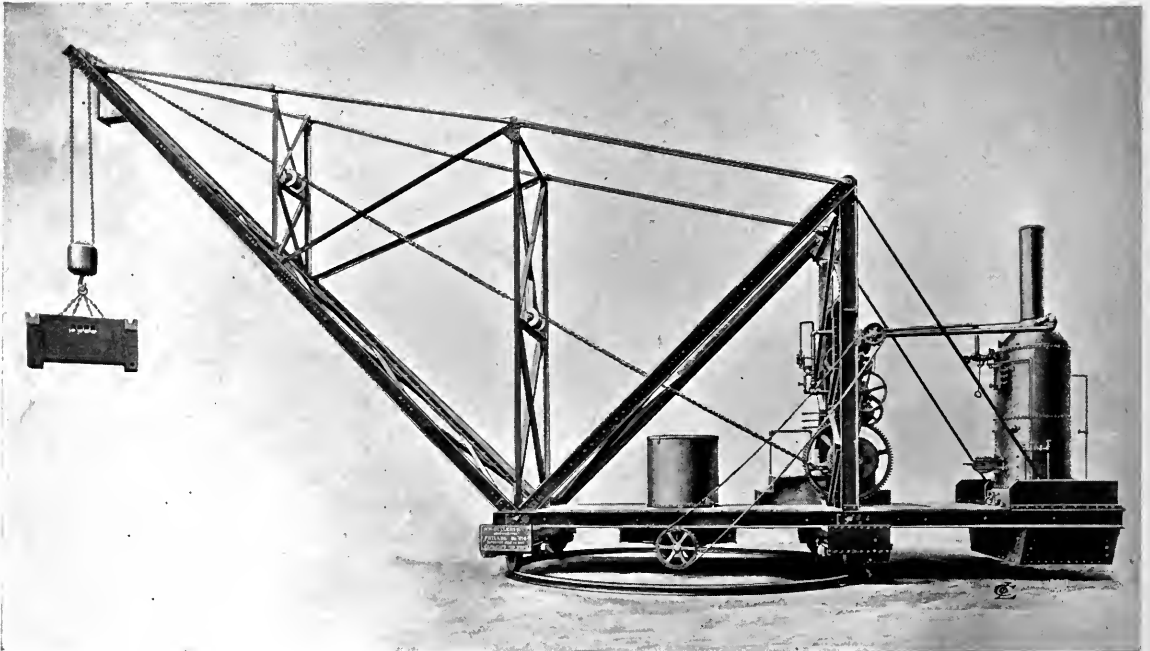

10-TON SWING-CRANE.—WITH FIXED RADIUS OF ACTION.

Centre of rotation to centre of hook, 40 feet. Maximum hoist, 40 feet. Crane frame and machinery carried upon rotating platform, which also supports water-tank, boilers, and counterweight. A useful crane for wharf purposes. Is carried on circular track 20 feet in diameter. Requires no masonry foundation. Is quick and handy. Made also in larger sizes.

PLATE NO. 223.

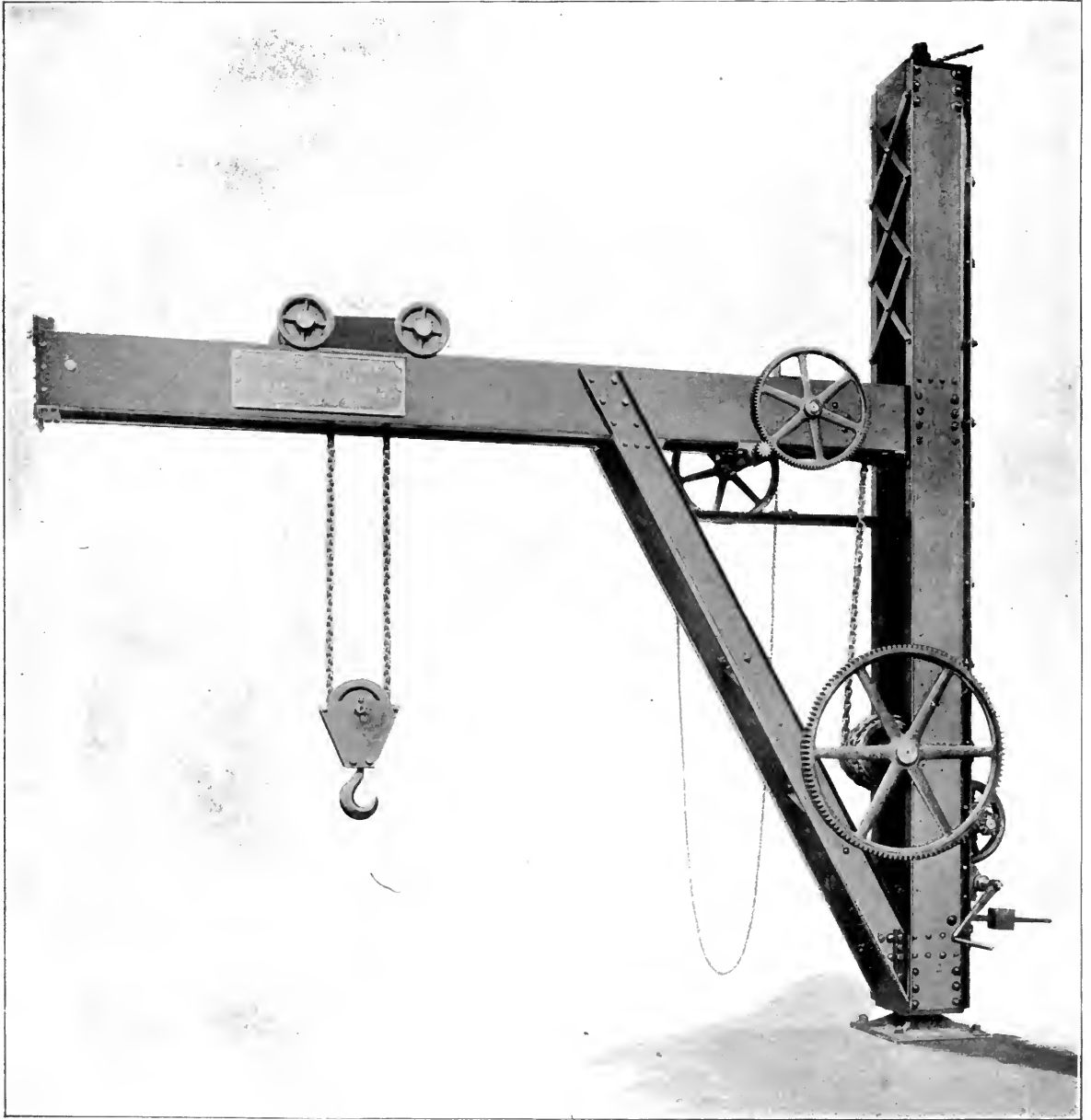

6-TON IRON HAND-POWER JIB-CRANE.

With double cranks and self-acting brake holding load at all times without attention from operator; must be lifted off to lower. Two hoisting speeds. Simple and efficient. Made also in other sizes.

PLATE NO. 224.

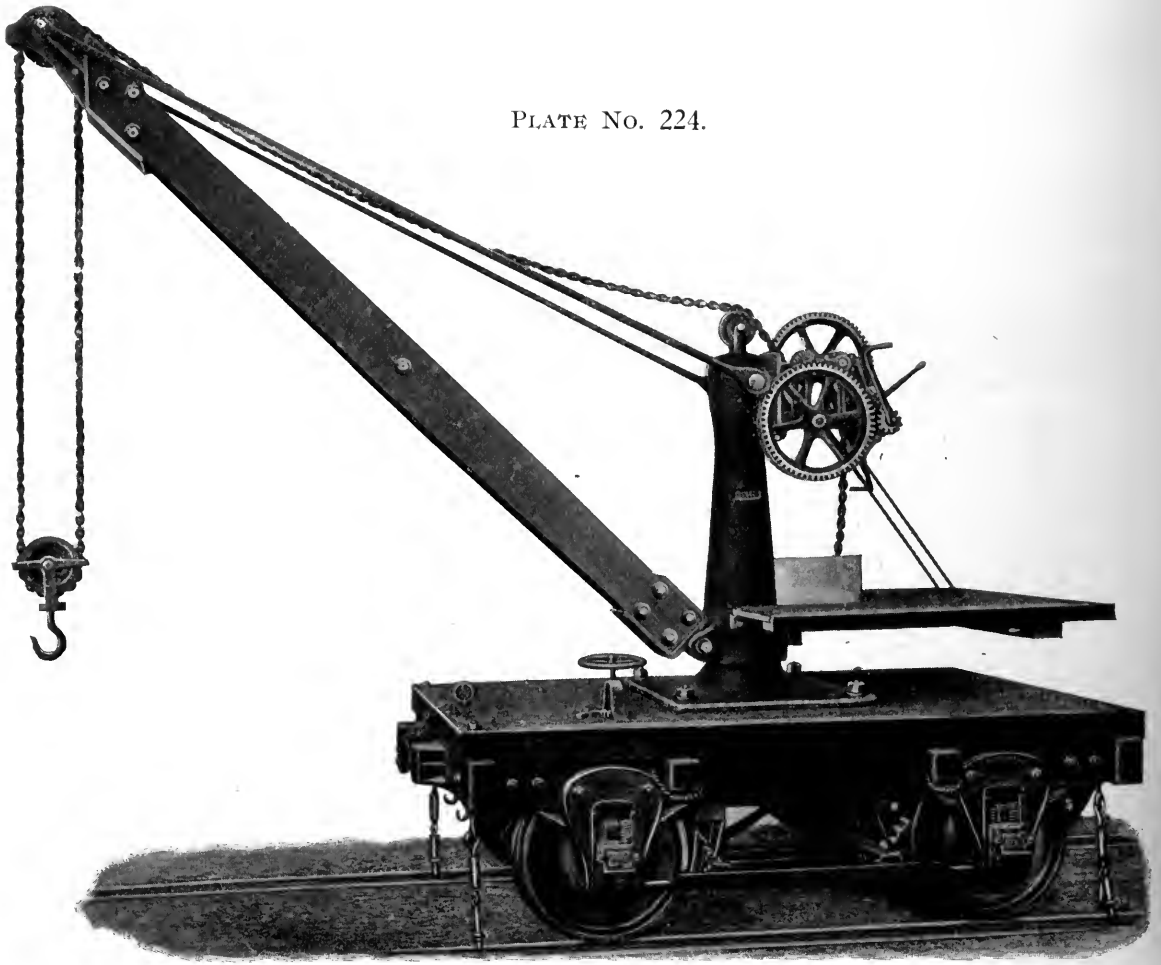

5-TON CAR CRANE.

With cast-iron post mounted on railroad car, for any required gauge of track. Gearing for fast and slow motions. Strap-brake on large gear-wheel. Provided with clamps and bracket for securing car when hoisting. Usual radius of hook, 12 feet. Made with wood or iron jib, as required. Simple, quick, and efficient.

PLATE No. 225.

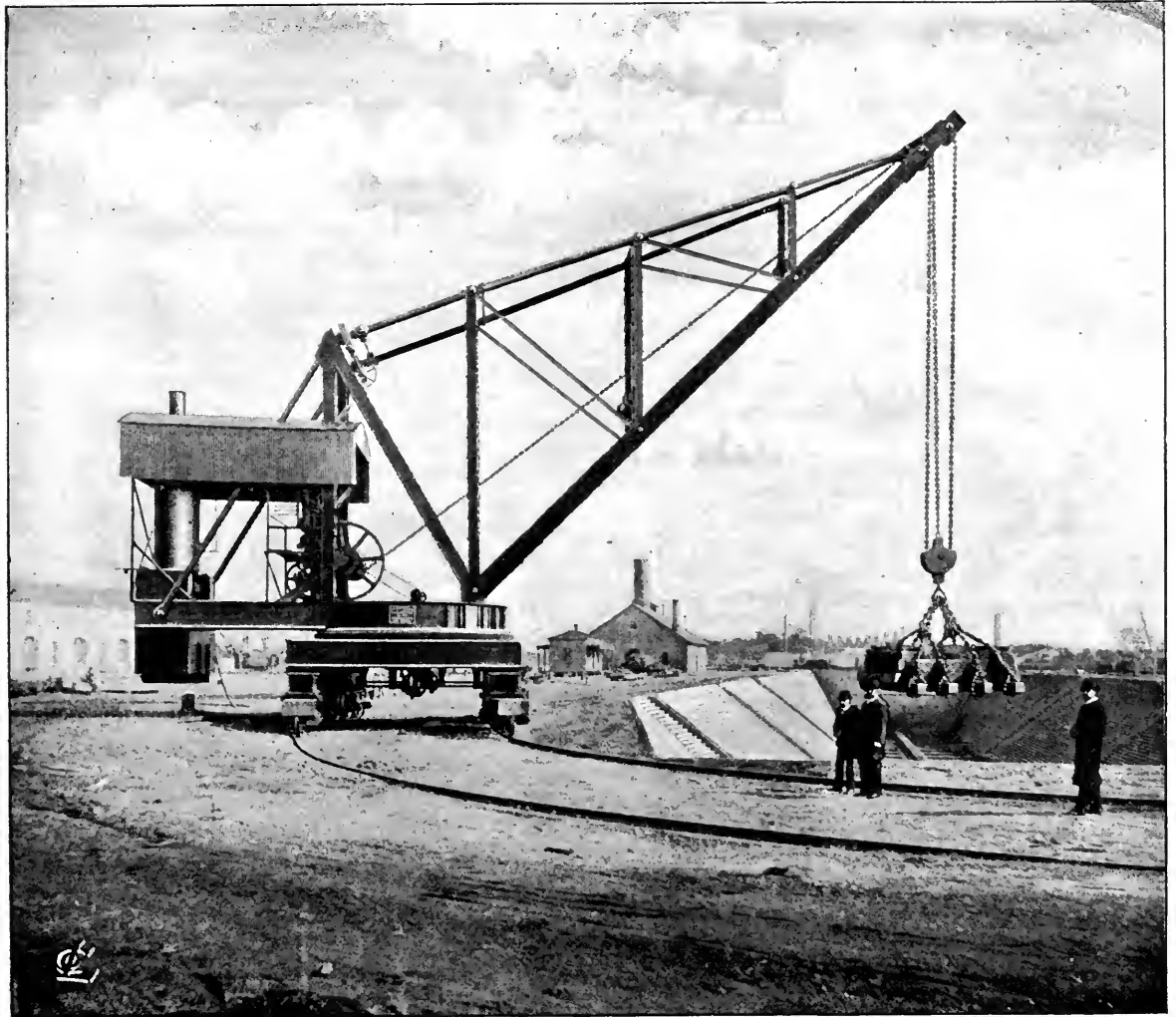

40-TON LOCOMOTIVE CAR CRANE.

IN PLACE ALONGSIDE OF DRY-DOCK, PORTSMOUTH NAVY YARD, VA.

Capacity of hoist, 90,000 pounds at 55 feet radius of hook; 64,000 pounds at 70 feet radius. Highest position of hook above rails, 56 feet. Gauge of track, 18 feet. Trucks arranged to equalize load on wheels and permit crane to travel around curves of 66 feet radius. The drum is centred to the car by a heavy steel pin, and the weight is taken upon steel rollers running in turned steel tracks. The jib is pivoted close to the platform, and is arranged to vibrate so as to change the radius of the hook from 56 feet to 70 feet. The load is carried by three parts of $1\frac{3}{8}$ " chain, which is wound on a large drum; the hoisting train being provided with our improved sustaining clutch, and operated through friction clutches from a pair of engines with cylinders 10" diameter and 12" stroke. The engines run without reversing, and the various movements are operated through suitable gearing and friction clutches. The crane is fully counterbalanced, and is therefore able to pick up its load and travel with it to any desired point. As shown in the plate, the jib is reduced to its shortest overreach, and the crane is loaded with the full test load of forty gross tons. The car is supported upon sixteen double flanged wheels driven through our patent equalizing gearing. Duplicate cranes have also been supplied to the U. S. Navy Department for other locations.

Hydraulic Cranes.

THERE are many locations where cranes are most conveniently operated by water under pressure or by compressed air, especially where the cranes are simple in construction and designed for one or two movements only. Direct-acting hoists are the simplest and most efficient, and where establishments are already provided with hydraulic accumulator and pumps or with a compressed air plant, such machines can be introduced to great advantage. We have built a number of various types for many special purposes, and are prepared to submit prices and designs for hydraulic cranes of all kinds. We illustrate on the opposite page a simple form of hydraulic pillar crane particularly adapted for certain classes of foundry work, or for putting work on machine tools, since the arrangement of levers is such that the operator can control the movement of the hoist while standing at the load. The cylinder is brass-lined and is double-acting, and a heavy counterweight is not required to overhaul the load.

The crane may be bolted directly to floor or foundation, and no portion extends below the floor line excepting the pipe connections. The capacity of the crane in Plate No. 226 is 2240 pounds. Radius of hook, 9 ft. 6". Height of hook in highest position above floor, 8 ft. Actual lift, 7 ft. We also manufacture a similar crane of 4000 pounds capacity, with a hook radius 9 ft. 8", and a similar stroke of 7 ft. 8". These machines are part of a series of special hydraulic machines that we designed for the equipment of the wheel foundry of the Pennsylvania Railroad Company at Altoona, Pa.; the equipment included, also, hydraulic ladle tilting machinery, iron breakers, pitting crane, platform elevators, etc.

PLATE NO. 226.



1-TON HYDRAULIC PILLAR CRANE.

(For description, see page 274.)

PLATE NO. 227.



VIEW IN CAR-WHEEL FOUNDRY OF PENNSYLVANIA RAILROAD, SHOWING
HYDRAULIC MOULDING CRANES AND LADLE-TILTING DEVICE.

PLATE NO. 228.

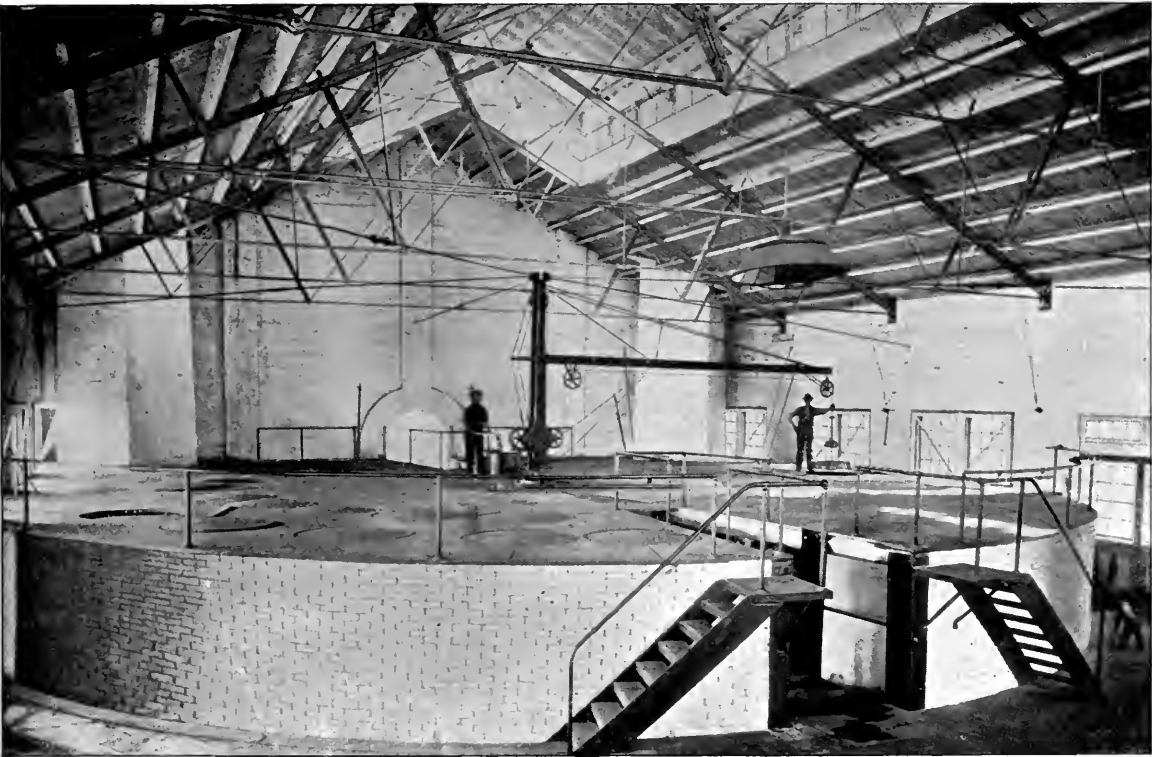

HYDRAULIC CRANE.—FOR THE ANNEALING FURNACE OF THE WHEEL

FOUNDRY OF THE PENNSYLVANIA RAILROAD.

Rotates and hoists by power. Automatic hooks for holding the wheels.

Travelling Cranes.

IT has become general practice to designate by the name *travelling crane* that type which consists of a bridge mounted upon wheels, supported upon an elevated track and having two motions in a horizontal plane, namely: a longitudinal motion along the runway rails, and a transverse motion within or upon the bridge itself. Such cranes were early employed, first operated by hand only, then by independent steam-engines, and to a large extent by a rope, and later by a square shaft supported on movable bearings along the runway. Until within a few years all such cranes were very slow in action, and, as far as we know, the first cranes approximating in speed of bridge travel the practice of to-day, were built by ourselves. We were led to consider the subject from the fact that we could not get from the then leading makers, travelling cranes approaching in speed the velocity which we considered essential for our own business. The speeds which we produced were considered phenomenal, and by our competitors were condemned as useless. We were interested, however, to observe that, as soon as they learned how to build rapid running cranes, they changed their views as to the utility of quick speeds. Our earlier power-travelling cranes were usually driven by square shafting, and for this purpose we invented a movable bearing, provided with a cap, which, being locked in place, enabled us to drive the shaft at a velocity not practicable while the shaft was carried in open bearings, as had previously been the practice, and at the same time the cap protected the bearing from dirt; more than this, the movement of our square shaft-bearings is so correct, and they are so well supported, that we were enabled to increase the length of the bearing, and by thus reducing the pressure per square inch, increase the durability of the shaft and bearing. A crane driven in this way is shown in Plate No. 239, and we have many other examples of such cranes which have been running successfully for years. The electric motor, however, furnishes by far the most convenient means yet devised of communicating power from a stationary source to the operating mechanism of a crane. There are two methods of thus employing the electric motor. The first, which was the earlier application, merely substitutes for the square shaft, rope, or other prime mover, an electric motor carried upon the crane itself. The distribution of the power to the various parts of the machinery, the stopping and starting of the different movements, are effected by mechanical means. In the other type, called for convenience the "all electric," a motor is provided for each movement which it is desired to make; thus, there is one for travelling the bridge and another for hoisting the load, while a third is required for traversing the carriage. In this type of crane the various movements are controlled by stopping, starting, or reversing the motors governing these movements, and changes of speed are commonly produced by changing the speed of the motor by Rheostat or otherwise.

There is a popular idea that this second type of crane, the "all electric,"

PLATE No. 229.

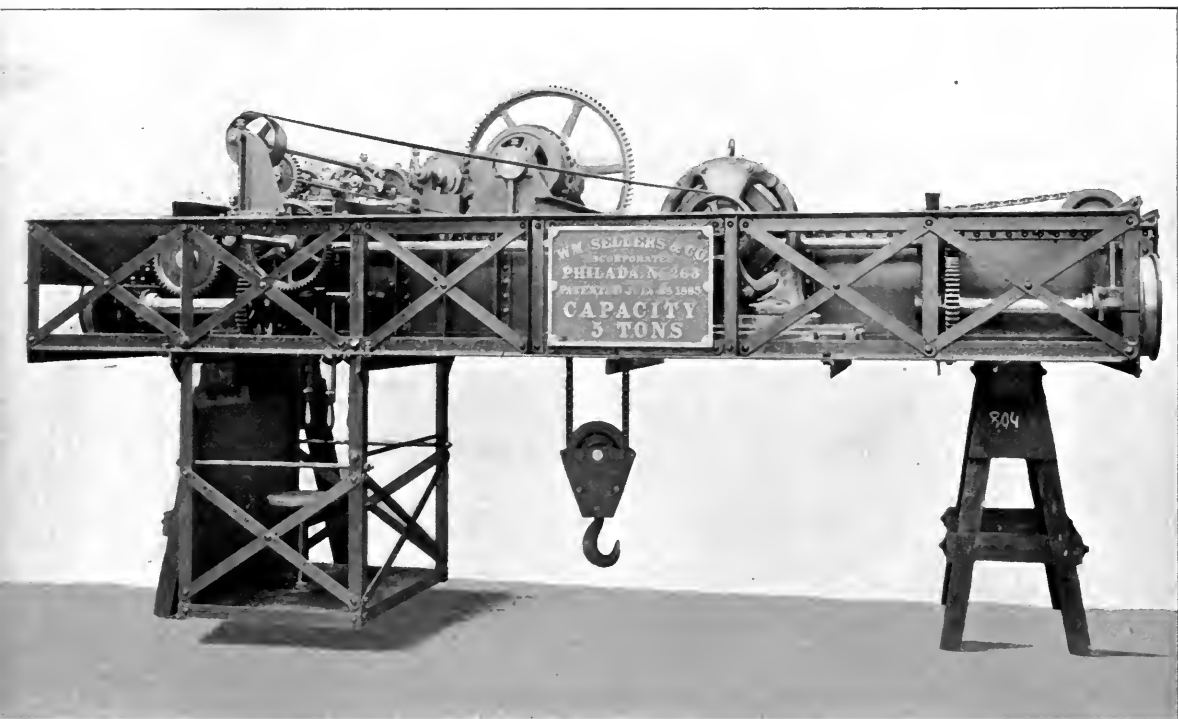

5-TON TRAVELLING CRANE.

Driven by single constant speed motor. Hoisting drum and operating clutches on top of bridge (may be arranged to one side if less head room is available). Carriage traversed by endless chain and sprocket wheels. Hook will go within 18" of runway rails. A convenient type for low ceilings and short spans.

Travelling Cranes—*Continued.*

dispenses with much machinery necessary for the former type ; but, in point of fact, it is only the machinery of transmission and the clutches which can be avoided. The reduction of gearing necessary between the motor and the work remains practically the same, while for the mechanical parts omitted, electrical equivalents are introduced, and with them a certain amount of mystery which is beyond the ken of the untrained mechanic. In the latter type, the motor, the machinery, and the load are put in motion at the same time, requiring a very large amount of power at the moment of starting, and an appreciable interval of time to get up the normal velocity ; while in the single motor crane the motor and a portion of the machinery are running at speed before the work is added. The inertia of these moving parts acts as a fly-wheel to assist in overcoming the resistance of the load when the latter is applied ; as a consequence, the properly constructed single motor crane is quicker in starting, and can handle more work in a given time than a crane of the "all electric" type, while it is possible to make small movements of the bridge and trolley with greater accuracy and certainty.

An important feature in our travelling cranes, and one to which we invite particular attention, is the form of bridge which we *generally* use. It will be noticed that this consists of two plate girders of uniform depth, connected together by cross and diagonal bracing on the top flanges, and carrying on their contiguous faces near the lower flange, the rails upon which the carriage travels. These girders are carried from the supporting rail on the runways, clearing them by an

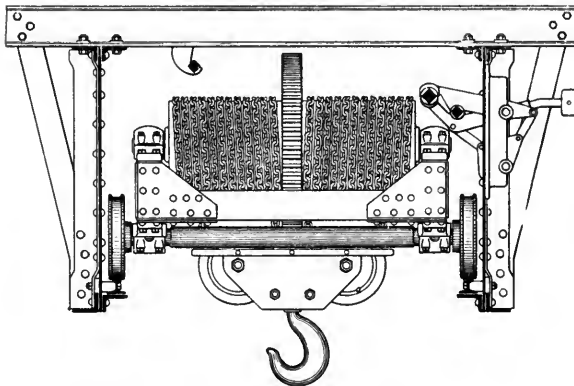

SECTION THROUGH BRIDGE WITH TROLLEY
IN POSITION.

inch or two where the carrying wheels are supported in bearings attached to wing-plates on the outsides of the girders. The trolley running within the bridge and close to its lower edge, the load is supported upon the tension side of the beam ; the centre of gravity of the entire mass is brought as near as possible to the point of support, and the bracing which ties the two girders together insures a lateral stiffness which is amply

sufficient to resist the transverse action produced by sudden stopping or starting of the heavily loaded bridge. That this action is not insignificant in a quick crane is now generally recognized, and those makers of travelling cranes who carry the trolley upon the upper flanges of the girders have been forced to meet this over-setting tendency by widening the flanges of their girders, by making box-girders

PLATE NO. 230.



5-TON TRAVELLING GANTRY CRANE.

IN SHIPYARD OF THE HARLAN & HOLLINGSWORTH CO., WILMINGTON, DEL.

Is mounted on high trestle and spans ship-ways. Distance between rails, 51 ft. Height of bridge above the ground, 70 ft. Driven by three variable speed motors.

Travelling Cranes—*Continued.*

instead of plain plate-girders, or by introducing external horizontal trusses, in either case increasing the weight of the bridge beyond that which is necessary to support the vertical loads. In very long spans this increase of bridge weight is a serious matter, involving, as it does, not only increased first cost of bridge, but constant expense in moving useless material back and forth.

We think it is obvious that our usual construction presents clearly the advantages we have enumerated, and this becomes more evident as the span is increased. We have, for example, built travelling cranes with a span as long as 134 feet between carrying rails, and to obtain in single girders the lateral stiffness, which we secured by our system of top bracing, would be almost impracticable with any reasonable increase of weight. Fancy a long railroad bridge span without lateral connections between the trusses!

The objection usually urged against the internal trolley is that the load is carried to one side of the web of the girder, thus tending to deflect the latter from a vertical plane. This tendency undoubtedly exists, but, owing to the small amount of the eccentricity, it is relatively insignificant, and is easily resisted. The deep cross-braces on top of the bridge are extended beyond the girders and connected by diagonal struts with the lower flanges of the girders. The tendency to spread is thus converted into a tendency to bend the cross-braces, and there is no difficulty in providing ample strength in these members to resist the bending moment; nor is there anything revolutionary or contrary to good practice in this construction. The strain is identical with that produced in the vertical drill-press, the slotter, punching and shearing machines, and the riveter; and in these it is easily met by properly proportioning the frame of the machine; although, in the machines cited, the whole load acts to spread the frame, while in our cranes the horizontal component is but a small fraction of the load. It is sometimes alleged that the trolley, being enclosed within the bridge, is not so easy to get at as though it were on top. This is to some extent true; but on the other hand, besides the advantages already enumerated, we may add, that the cross-bracing affords an attachment for a hoisting tackle, if it be desired to remove the trolley or any portion of it; while with the external trolley, a separate structure must be erected for this purpose, unless the roof of the building can be relied upon to stand the load, which is not usually the case. We are not restricted however to the internal trolley, and build many cranes of the deck or outside trolley type and are prepared to modify our constructions as required by the given conditions or to meet the preference of purchasers.

There are two general arrangements of machinery employed in our travelling cranes; these form two distinct types or styles. In the first, the trolley contains the hoisting mechanism and drums. In the other, the drum and hoisting machinery are attached to the bridge at some fixed point, and the chain or wire rope is led around suitable sheaves and through the trolley or carriage; this is exactly the arrangement of hoisting machinery which is used in jib-cranes. The

PLATE No. 231.

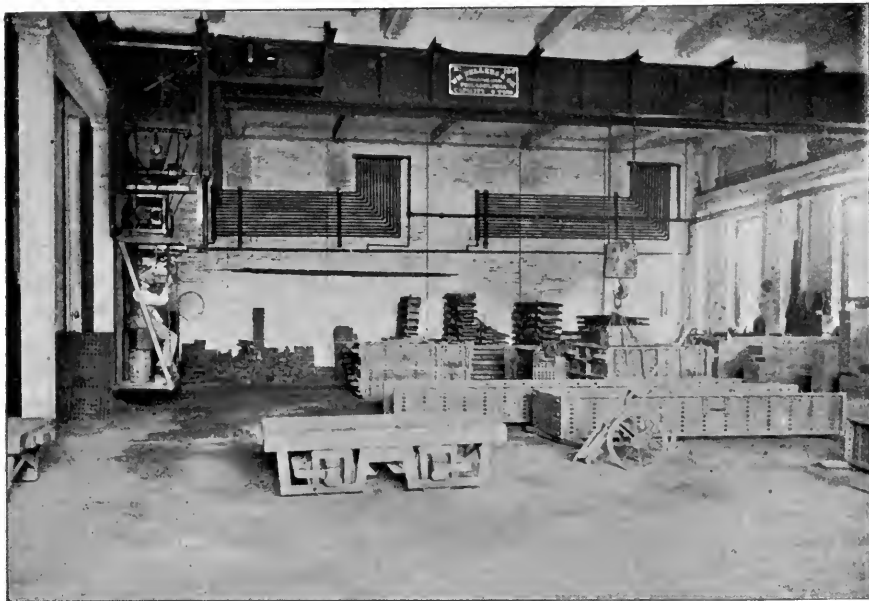

6-TON TRAVELLING CRANE.

IN FLASK SHOP, WORKS OF WM. SELLERS & Co., INCORPORATED.

43 feet span. With hoisting drum fixed at one end of the bridge. All movements by electric motors. This is a special crane designed for occasional use. No regular attendant is required; can be operated by any workman in the shop. Operator stands on a hanging platform, which is accessible from the floor.

Travelling Cranes—Continued.

first type requires usually a larger and deeper bridge, but the movement of the hook is steady, and is free from any irregularity of motion such as may be produced by the sagging of the chains in the "fixed drum" or jib-crane type. This irregularity is insignificant in short cranes, and for many purposes the fixed drum-cranes are perfectly satisfactory, and as they occupy very little head-room, are adapted for old shops and other locations where vertical height is limited. Both types of our cranes *hoist the load in a vertical line without lateral movement and without twisting.* This is an important matter, especially for foundry work.

Travelling cranes are usually moved along the runway by the traction of the supporting wheels only; but in many cases we supply spur-wheels at the ends of the bridge, engaging with cast racks attached to the rails on the runways. While not usually absolutely necessary, the racks afford a certain means of squaring the bridge and preventing any accidental derangement of its position, and they give a more positive control of the bridge movement than can be obtained by friction of the wheels on the rails. The rails for travelling cranes should be provided with efficient end-chocks or bumpers, for preventing the bridge from running beyond the proper point. Those built by us are arranged to bring the crane gradually to a stop without shock, and yet always maintain their proper alignment.

PLATE NO. 232.

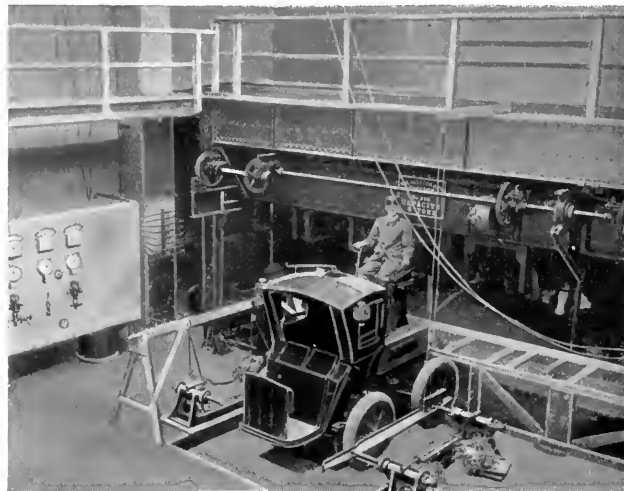

8-TON TRAVELLING CRANE.—FOR HANDLING STORAGE BATTERIES IN THE POWER HOUSE OF THE ELECTRIC VEHICLE CO., NEW YORK.

PLATE NO. 233.

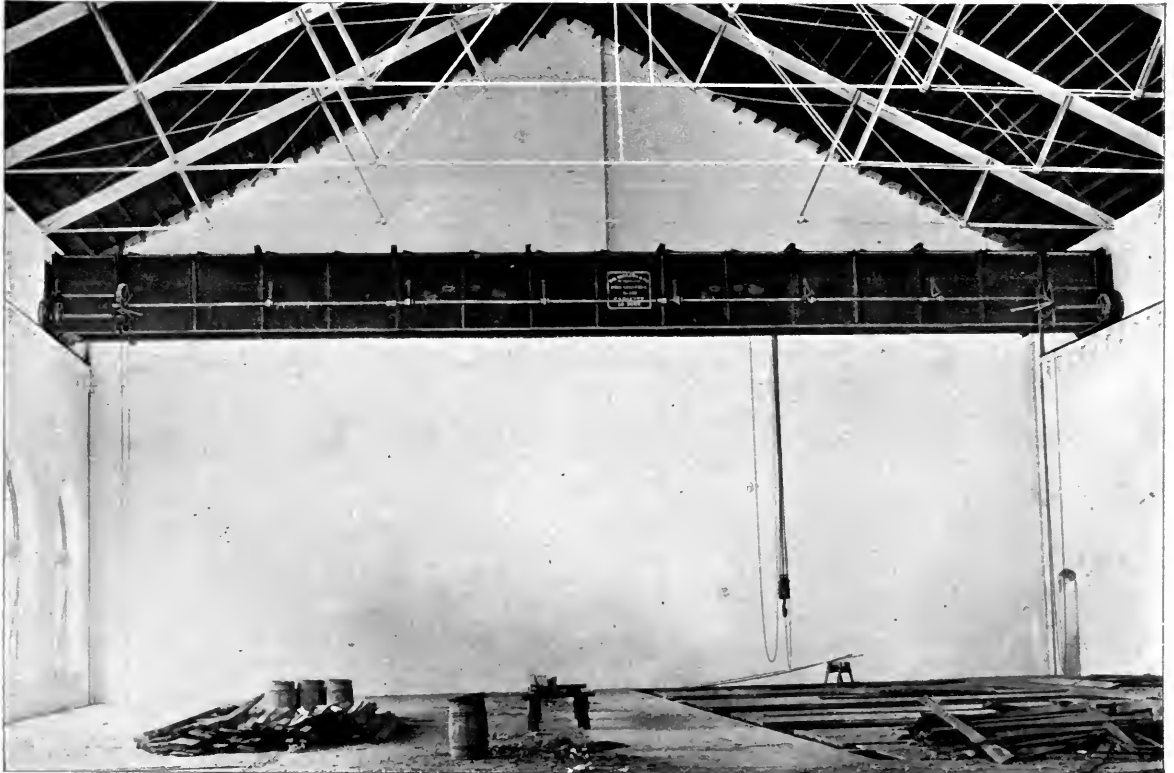

10-TON HAND-POWER TRAVELLING CRANE.

Span, 80 ft. Hoist, 22 ft. Operated by hand chains from floor. Retaining device to prevent load from running down. Spur geared throughout. With or without motor for traversing bridge.

PLATE NO. 234.

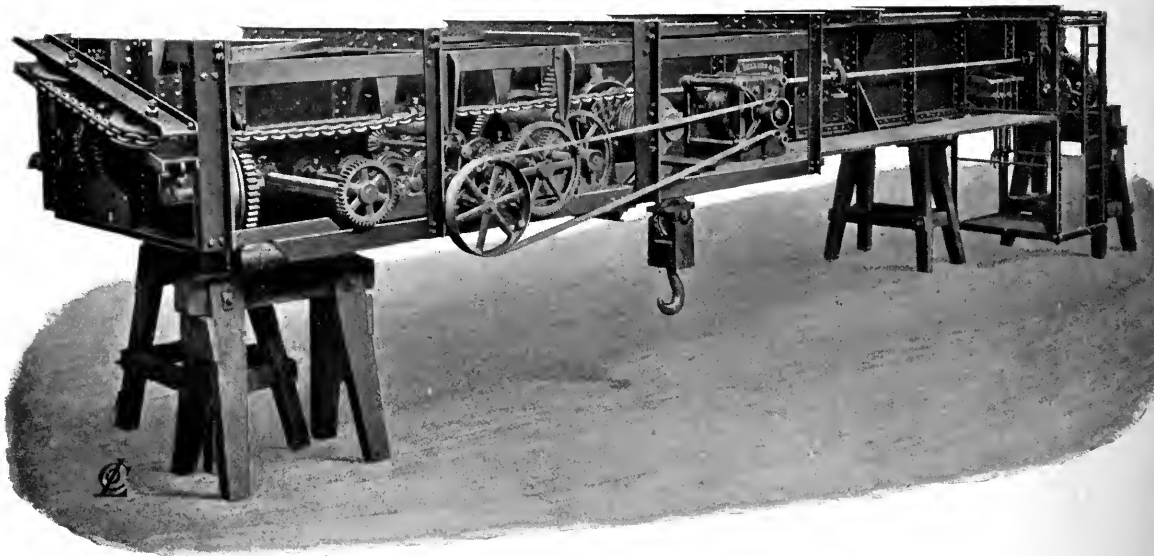

10-TON ELECTRIC TRAVELLING CRANE.

Fixed drum type. Operated by a single constant speed shunt wound no reversing motor. Span 33 ft. Requires but little head room and works close to rails.

PLATE No. 235.

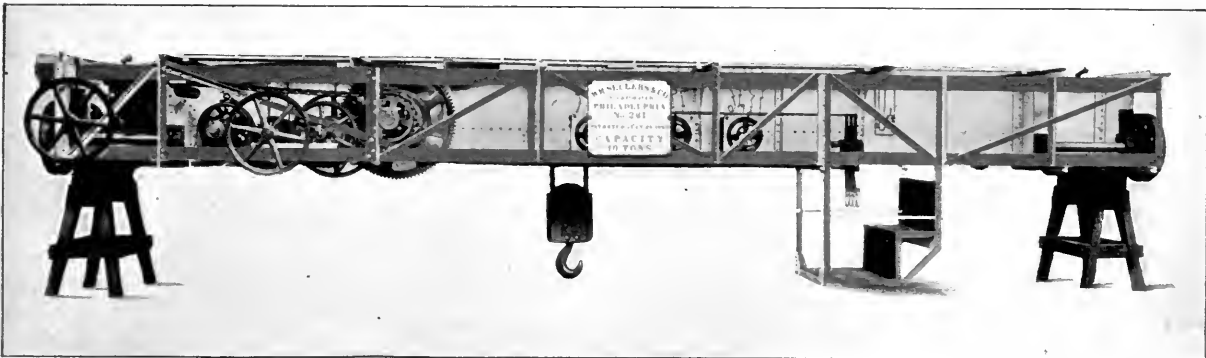

10-TON TRAVELLING CRANE.

Span, 37 ft. Height over rails, 23". Fixed hoisting drum and machinery carried to one side of main girders. Three operating motors of variable speed. Hoists full load 5 ft. per minute. Anti-friction hook bearing.

PLATE No. 236.

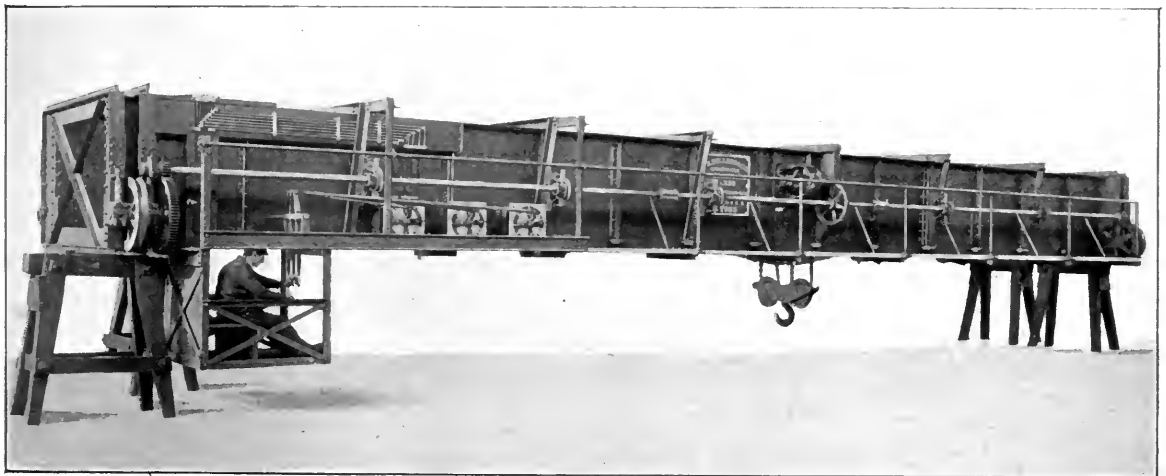

10-TON TRAVELLING CRANE.

54 ft. span. Hoisting machinery on trolley travelling within the bridge. Very shallow cage to suit low shop. Anti-friction hook. Three motors of variable speed. Foot board and hand-rail along one side to give access to bearings and bridge motor.

PLATE NO. 237.

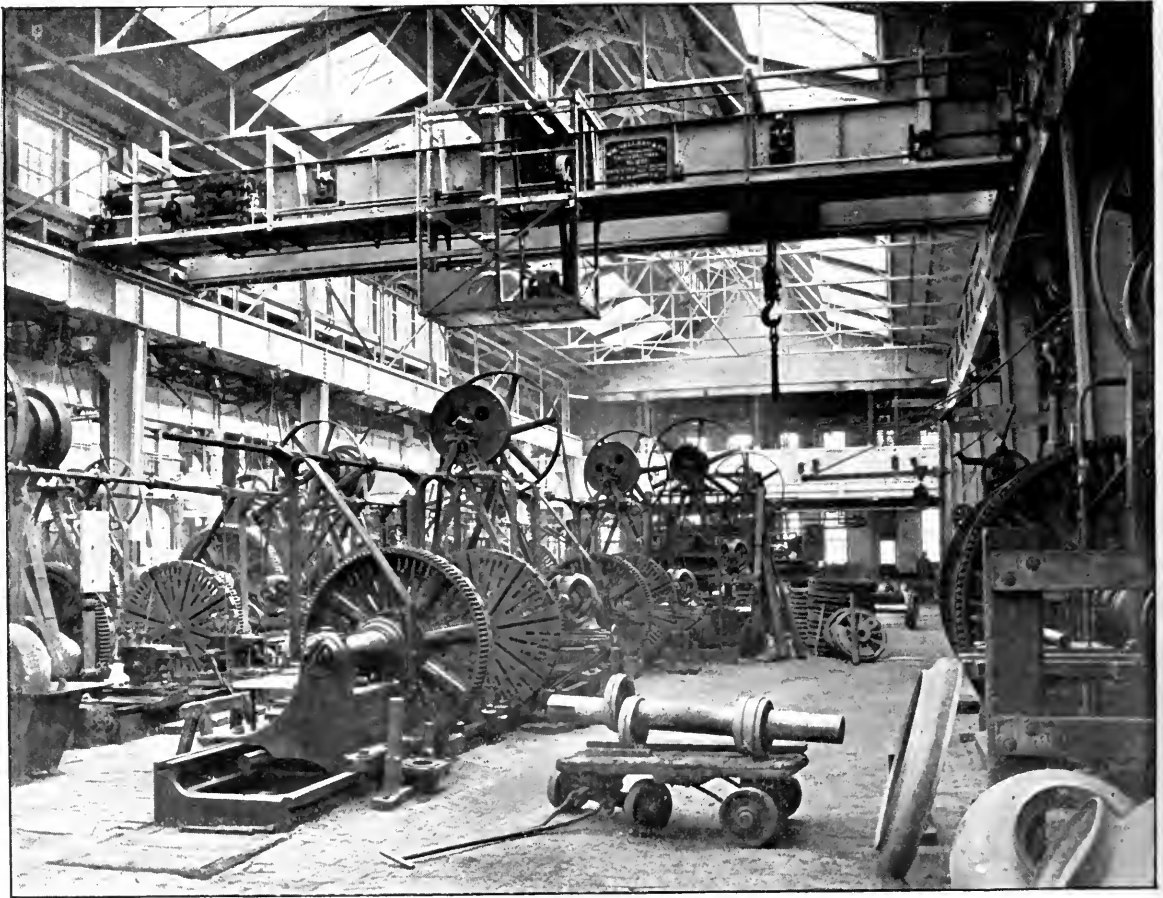

10-TON TRAVELLING CRANE.

IN WHEEL-SHOP, BALDWIN LOCOMOTIVE WORKS.

Driven by single motor and operated from hanging platform in the centre. Span, 48 feet. Hoisting speeds, 5, 10, 20 and 40 feet per minute. Very quick and handy crane. Foot board gives easy access to machinery on side of bridge.

PLATE No. 238

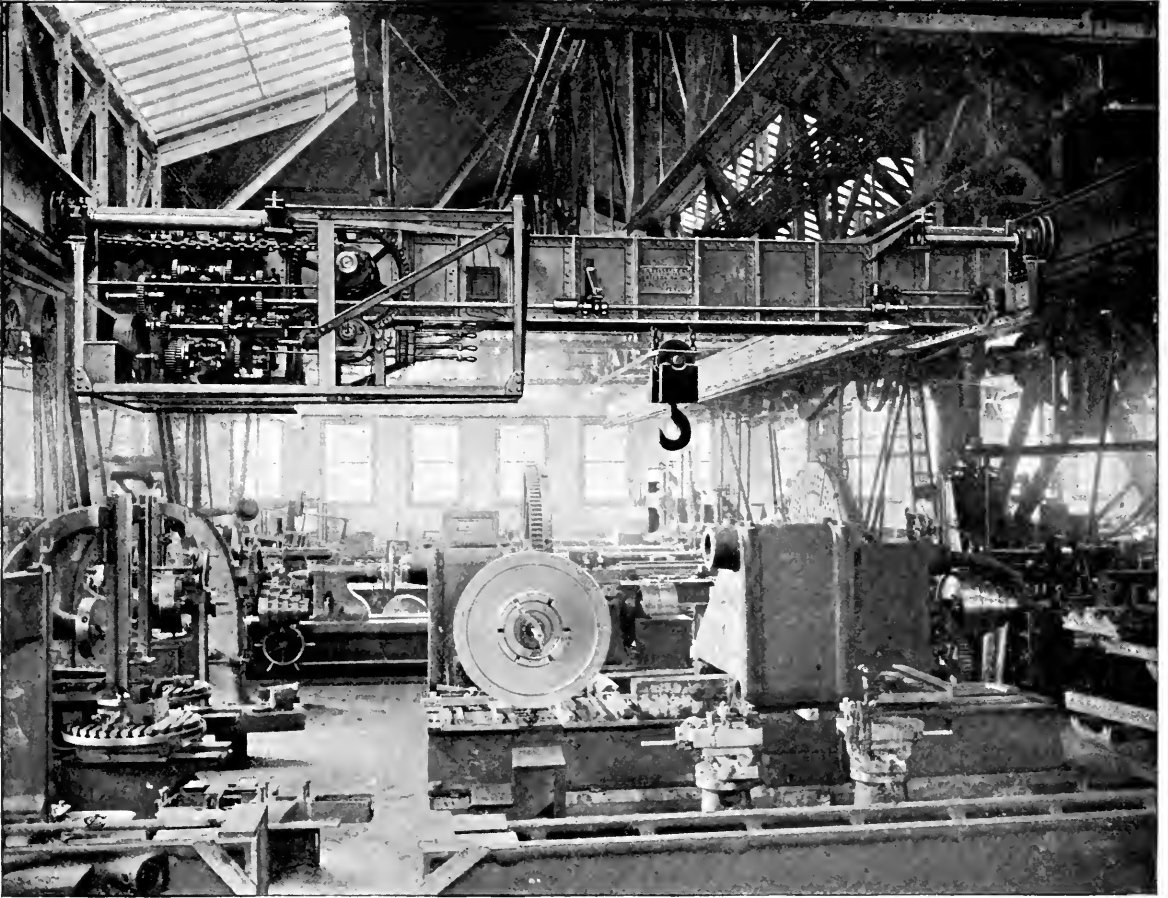

15-TON ELECTRIC TRAVELLING CRANE.

IN MACHINE-SHOP OF WM. SELLERS & CO., INCORPORATED.

32 ft. span. Fixed drum, single motor type. Runs on track supported wholly from roof. Head room available was very limited, and the bridge girders are only 33" deep.

PLATE NO. 239.



15-TON POWER TRAVELLING CRANE.

IN THE ERECTING-SHOP OF THE GEO. F. BLAKE MFG. CO.

41 ft. span. Runway 330 ft. long. As shown it was driven by a square shaft carried in our patent bearings. After many years of successful service a single electric motor was attached to the crane and the square shaft removed.

PLATE No. 240.

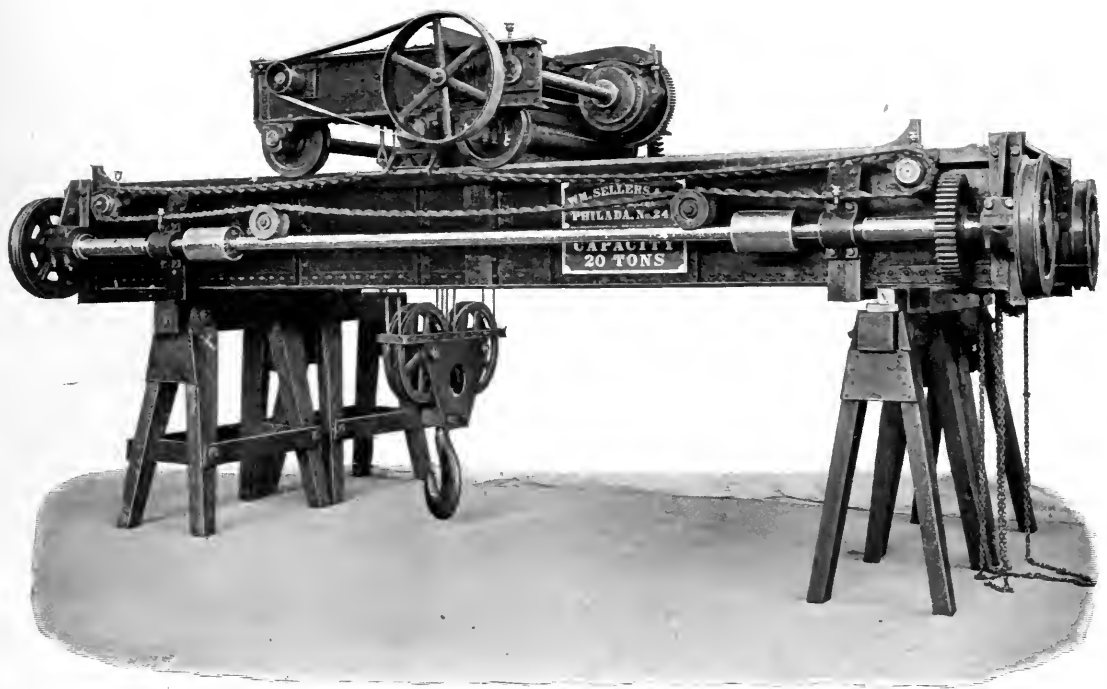

20-TON TRAVELLING CRANE.—FOR USE OVER A RIVETING MACHINE.

Hoist operated by electric motor controlled at the riveter. Cross and longitudinal travel by hand chains worked from the floor. Very high lift for long boilers. Span about 20 ft. Load carried by six parts of steel wire rope, automatic electric and mechanical brakes.

PLATE NO. 241.

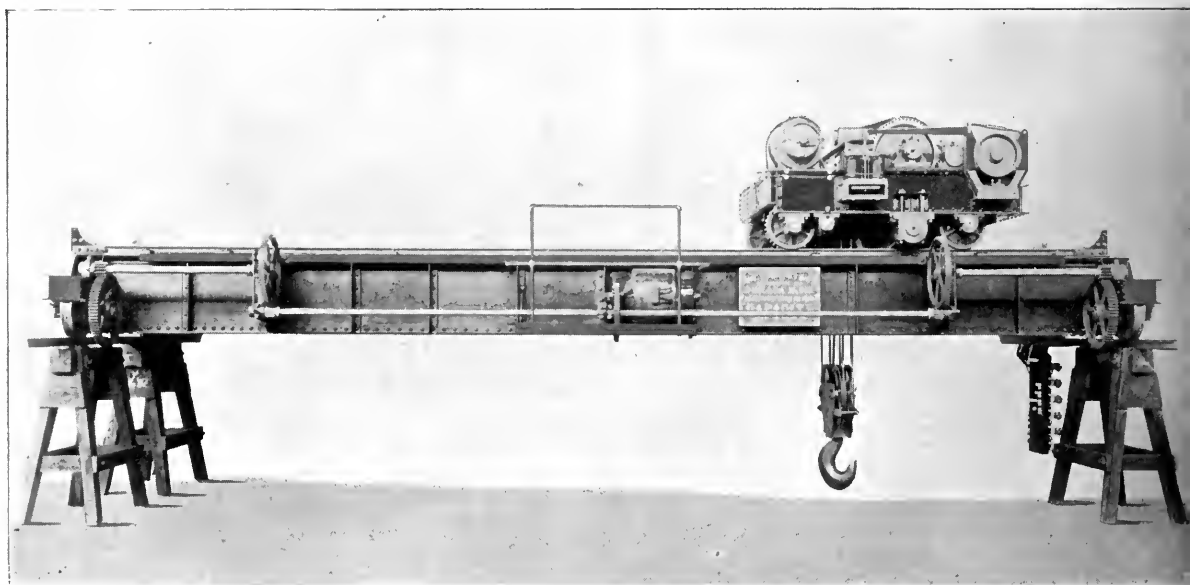

20-TON TRAVELLING CRANE.—FOR RIVETER TOWER.

30 ft. span. 40 ft. lift. Hoist, trolley and bridge travel by separate motors. Hook carried by six parts of steel wire rope. Movements operated by controllers situated at riveter. No operator on crane itself. Automatic mechanical and electric brakes. Used for handling long boilers over stationary riveter. Requires no special operator.

PLATE No. 242.

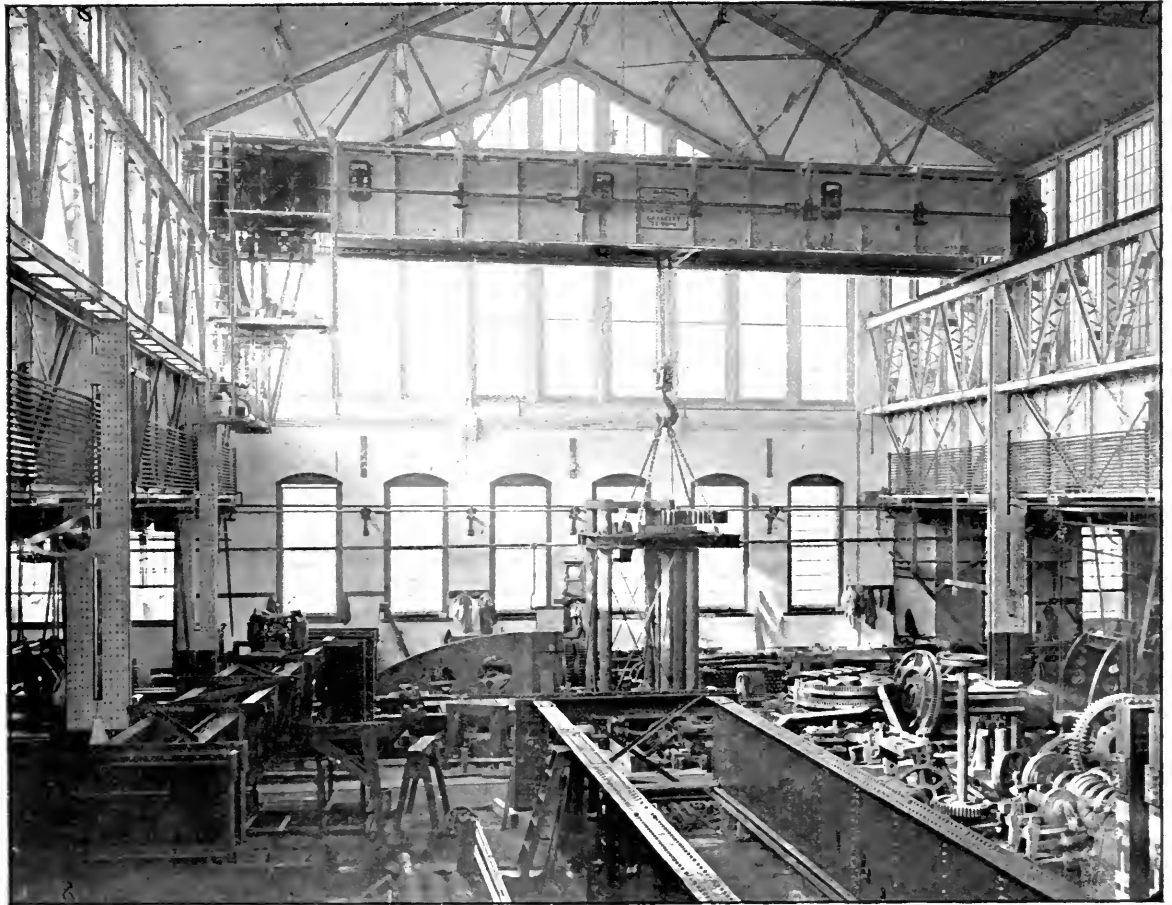

30-TON TRAVELLING CRANE.

IN EAST ERECTING SHOP, WM. SELLERS & Co., INCORPORATED.

56 feet span. Operated by single electric motor through our improved clutch machinery. Power transmitted to trolley by square shafts within the bridge. Bridge driven and kept in line by racks or runways.

PLATE No. 243.



40-TON ELECTRIC TRAVELLING CRANE.

IN THE SORMOVO WORKS, NIZHNI NOVGOROD, RUSSIA.

Span, 62 ft. The illustration shows a small locomotive hanging in the air, one end being supported by a suitable frame and the other by a chain sling.

PLATE NO. 244.

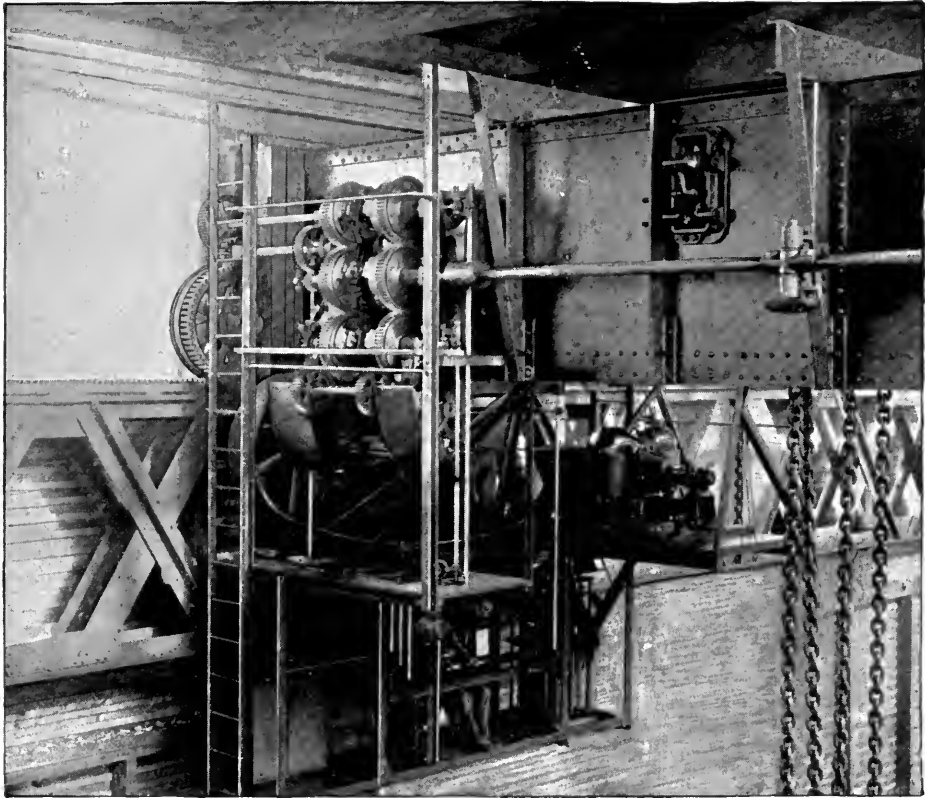

50-TON TRAVELLING CRANE.

IN THE ERECTING SHOP OF THE SOUTHWARK FOUNDRY AND MACHINE CO.

Operated by single 50 horse-power electric motor. The illustration shows arrangement of clutches and operating machinery on outside of bridge. It also indicates the cage and motor platform. Span, 50 ft. Lift, 40 ft.

PLATE No. 245.

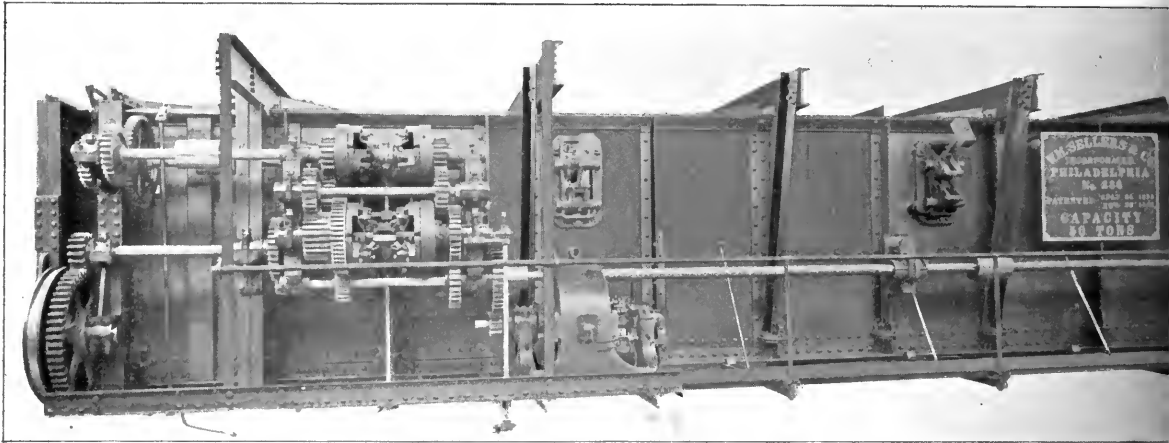

50-TON TRAVELLING CRANE.—SINGLE MOTOR TYPE.

Shows end of bridge with motor and operating machinery in place. Power is transmitted to the trolley by square shafts supported in our patent "tumbler bearings," steel tired bridge wheels are 37" diameter. Hanging cage for operator not shown.

PLATE No. 246.

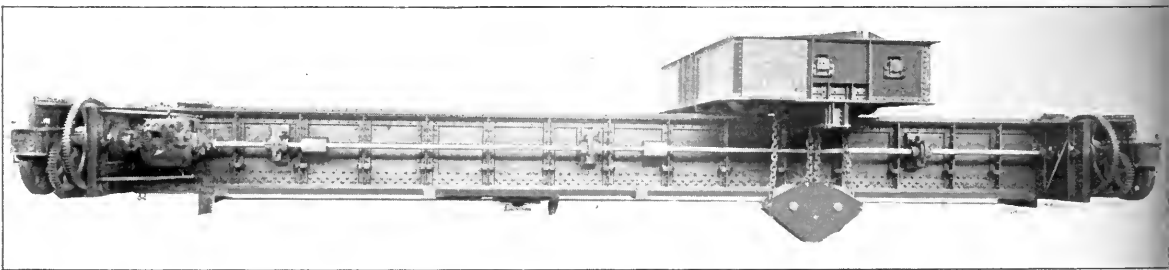

75-TON TRAVELLING LADLE-CRANE.

Welman type. Two trolleys, one on upper deck of bridge with two blocks for ladle hangers, and a 20-ton trolley running within the bridge for tipping ladle and handling light loads. Driven by seven reversing motors.

PLATE No. 247.

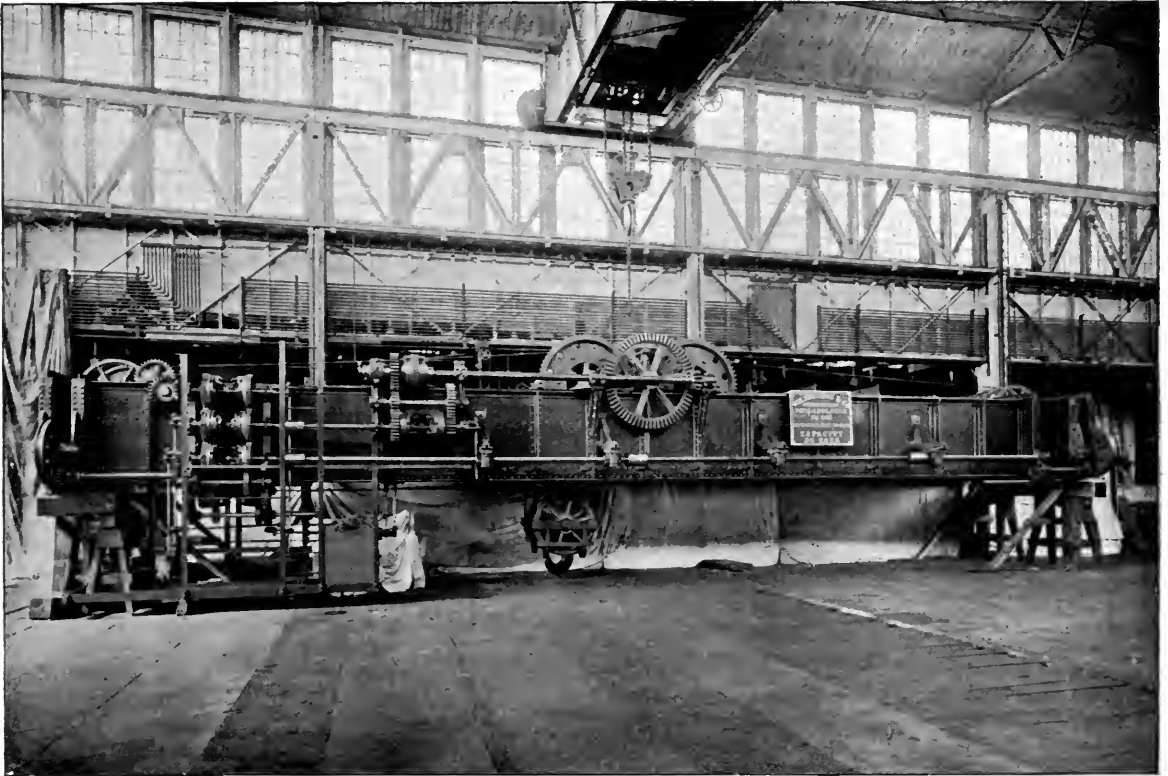

50-TON ELECTRIC TRAVELLING CRANE.

Fixed drum type. Span, 60 ft. Hoist, 164 ft. Two drums are used fixed in centre of bridge and the massive hook is carried by eight parts of $1\frac{1}{8}$ " steel wire rope. A single motor operates all movements through suitable clutches and mechanism. This is a special crane of great length of hoist, built for the Power House of the Niagara Falls Power Co. This crane is also shown in Plate No. 248.

PLATE No. 248.

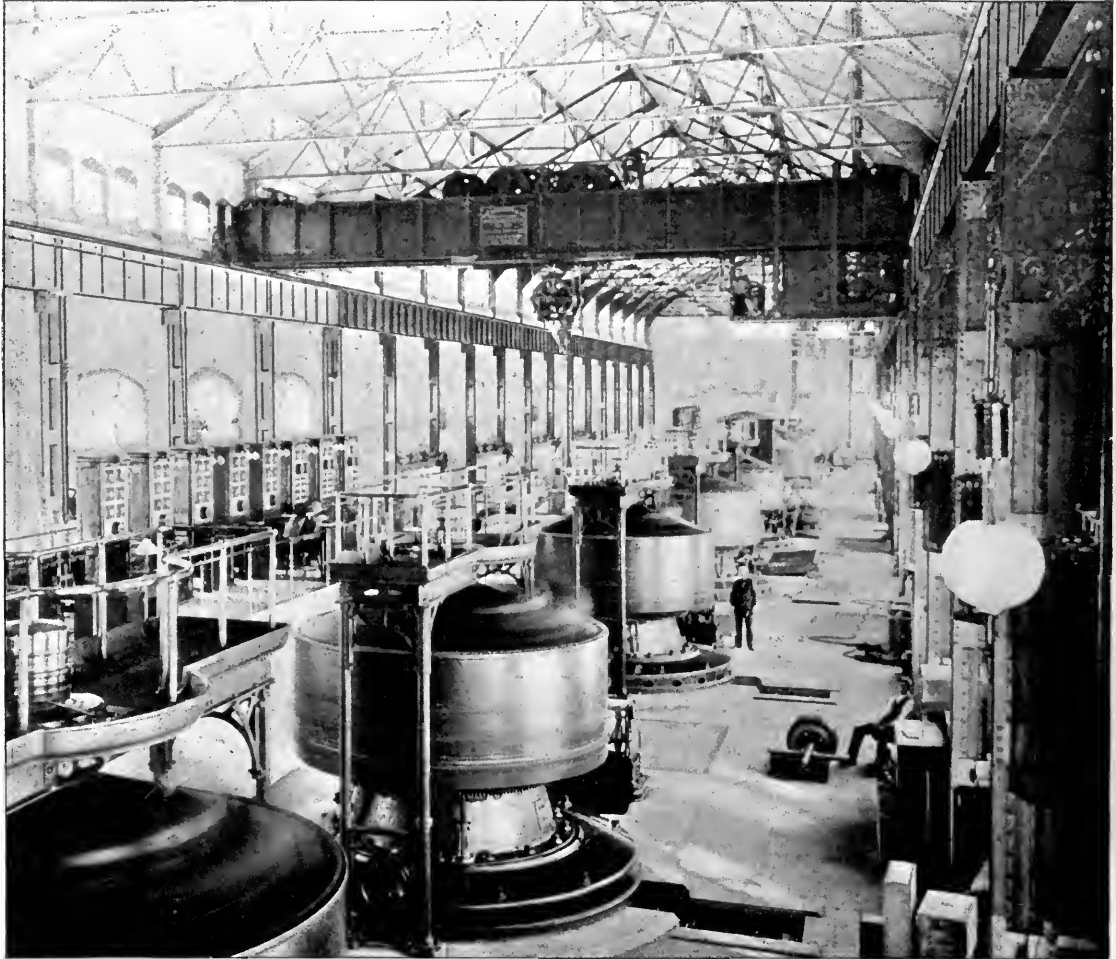

50-TON TRAVELLING CRANE.

IN POWER HOUSE OF NIAGARA FALLS POWER CO.

This is the crane shown in Plate No. 247. It was used to install all of the 5000 horse-power generators with their wheels and machinery. Is driven by a single constant speed 40 horse-power motor, direct current. The trolley carries a very quick 5-ton hoist, lifting light loads at 100 ft. per minute.

PLATE No. 249.

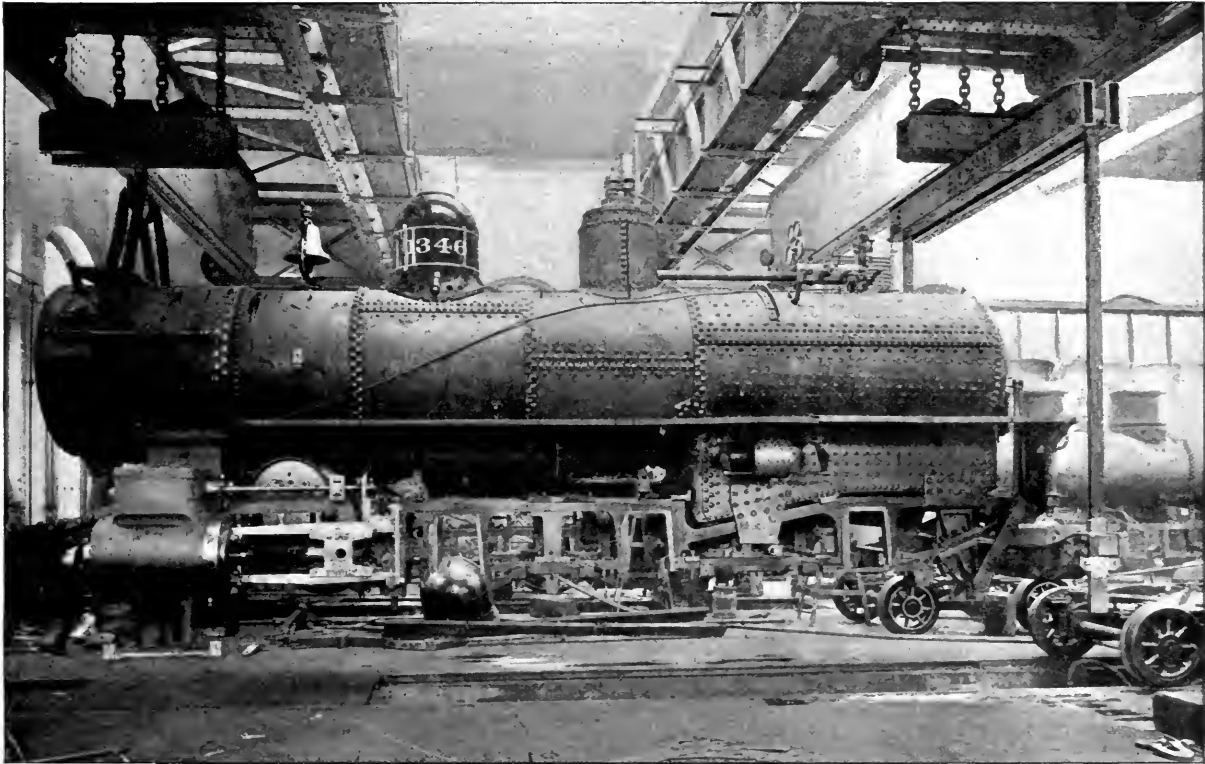

50-TON ELECTRIC TRAVELLING CRANES.

IN THE MT. CLARE SHOPS OF THE BALTIMORE & OHIO RAILROAD CO.

As shown, these cranes are lifting a large locomotive boiler with cylinders and frames attached. The lifting frame at the rear end is readily exchanged for a hook for ordinary work. The span is 69 ft. and the runway is 382 ft. long.

PLATE NO. 250.



100-TON ELECTRIC TRAVELLING CRANE.

IN THE ERECTING SHOP OF THE BALDWIN LOCOMOTIVE WORKS.

Span, 75 ft. 4" There are two such cranes on separate runways each having two independent trolleys operated from constant motors. Upon the same runways are two cranes of the same type, each having two 25-ton trolleys.

PLATE No. 251.

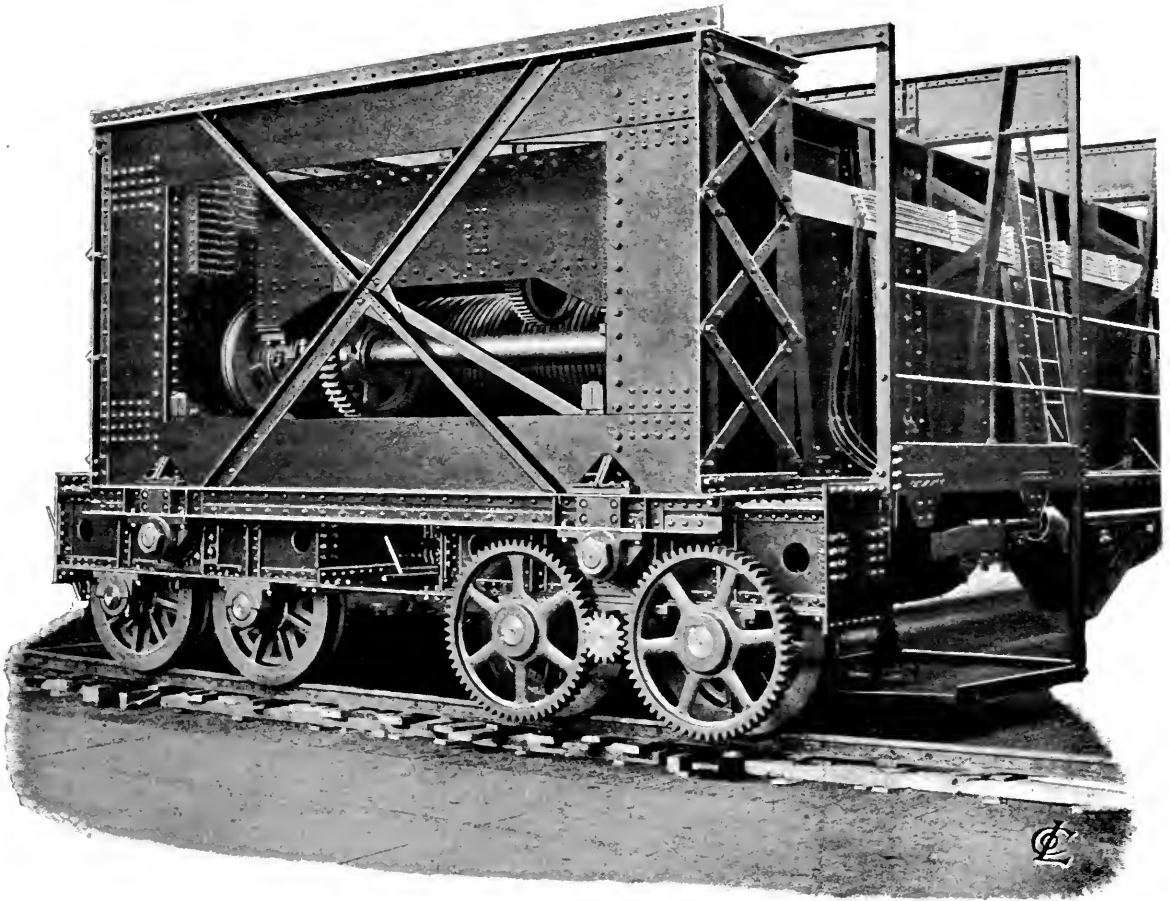

150-TON ELECTRIC TRAVELLING CRANE.

BUILT FOR THE HOMESTEAD WORKS OF THE CARNEGIE STEEL CO., LTD.

50 feet span, provided with two trolleys, 75 gross tons each, with 30 feet clear lift. Bridge carried upon eight 37" wheels arranged in pairs, supported in equalizing trucks connected to the bridge by large fulcrum pins and steel bearings. Two of the wheels at each end are driven. The load of 75 tons is carried upon six parts of $1\frac{3}{8}$ " chain, arranged so that the lift is vertical, and there is no tendency to lateral movement or to twisting of the load. The hoisting motors and those for the bridge travel are controlled by the "series-multiple" system. The lower frame of the trolley is plated underneath to protect it from the heat of the large masses of hot metal over which it is used.

PLATE No. 252.



CENTRIFUGAL SAND-MIXING MACHINE.

EXPEDITIOUS. EFFECTIVE. ECONOMICAL.

For disintegrating lumpy sand and mixing all kinds of moulding and core-sand quickly and economically. Will handle the sand as fast as two men can shovel it in. It consists of a rapidly revolving table, having on its upper surface a number of prongs projecting upward. The sand is fed through the hopper and thrown by centrifugal force from prong to prong, and out against the cover from which it emerges in a fine shower free from lumps and thoroughly mixed. Hopper is hinged for convenience of cleaning the prongs and removing the stones, nails, etc., which do not pass between them.

Railway Turn-Tables.

GREAT changes have taken place in the size and weight of locomotives since we first began (over forty years ago) the manufacture of cast-iron railway turn-tables. To meet these changing conditions, we have from time to time remodelled our patterns and added larger sizes to our list; and, having adopted a specially strong mixture of iron, we are able to furnish cast-iron turn-tables adapted for the heaviest locomotives in use. It happens that in many locations our early tables have been retained in service, although the engines they are expected to carry have doubled and trebled in weight. As a consequence, breakages have resulted, not through any inherent defect in the cast-iron tables, but

FIG. 1.

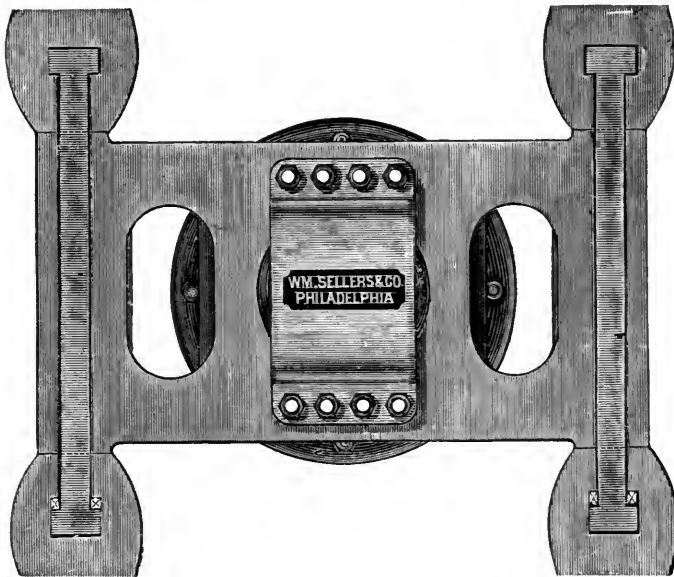

simply because those particular tables were greatly overloaded. Indeed, it is a remarkable fact, and one which speaks well for the materials used, that they have stood at all under the loads given them. Cast-iron tables can be made to carry any required weight, but they must be made deeper and heavier as the load is increased.

Cast-iron tables, properly designed, have many advantages, in convenience of shipment, in ease of repairing, in stiffness, etc., which make them generally popular.

Our large turn-tables, though differing in the dimensions of the various parts, are essentially of the same design. They are simple in construction, easily erected, very durable when not abused, and turn with the greatest ease. The

table, in general, consists of four cast-iron arms, firmly bolted and secured to a cast-iron centre-box of requisite width and strength. This centre-box surrounds

FIG. 2.

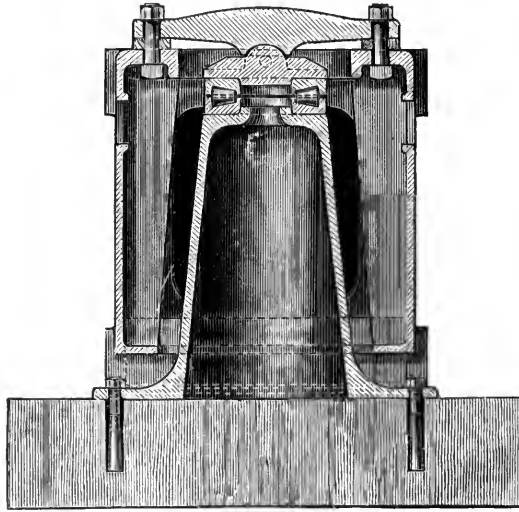

and is suspended from the pivot upon which the table turns; the outer ends of the arms are connected by transverse beams or "cross-girts" which carry the

FIG. 3.

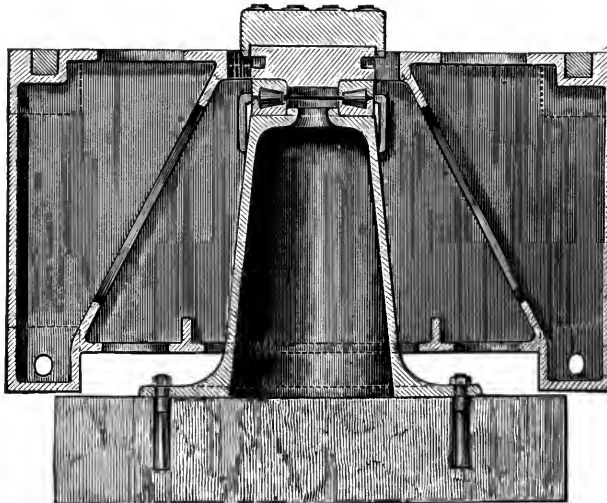

wheels that bear on the circular track and take the tip of the table when the load is not balanced. The pivot centre itself consists of a conical post with a broad base, for bolting securely to a large capstone upon a suitable foundation.

This conical post is nearly as deep as the centre-box itself, and terminates on its upper part on a flat surface upon which rests a set of steel plates with hard steel conical rollers. Upon the top plate is balanced a casting which carries a semi-cylindrical projection upon its upper surface, that fits into a corresponding concavity in the rectangular steel top-cap and thus forms a hinge which will permit the table to vibrate longitudinally to balance the weight of the engine, but will effectually prevent it from tipping sidewise.

FIG. 4.

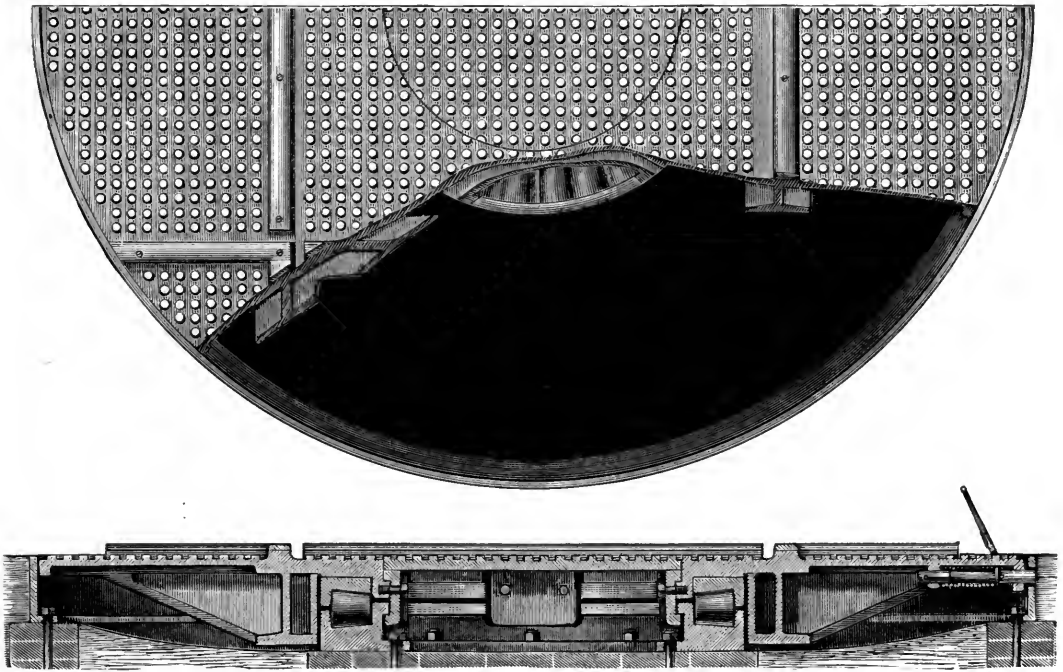

The centre-box is suspended from the top cap by eight bolts, thus throwing the entire weight of the table and balanced load directly upon the pivot centre (Fig. 2). A layer of wood packing is interposed between the top cap, arm, and the centre-box, which may be varied in thickness to adjust the height of the table to the point required. Upon the arms, and notched over them, transverse cross-ties are laid, and the rails are in turn spiked to these ties. The turn-table pit should be built with a proper retaining wall of brick or stone, surmounted by a suitable curb. The pit is deepest in the centre and grows shallower towards the circumference where it meets the circular track. This track should be carefully levelled and should rest on well laid sills. The distance from the top of the curb to the circular track is so slight that the pit may be crossed by stepping down into it, and, since the plates and rolls are situated so near the track level, no injury

to the table will result from even a large amount of water in the pit ; although the water will, of course, interfere with the motion of the table by its resistance. Where the nature of the soil requires it, it is best to underdrain the turn-table pit.

When our turn-tables are properly set up and the load nearly balanced, they may be turned with the greatest ease. One man can turn the heaviest engine. On a trial at our works, it was found that one and one-half pounds applied to the end of one arm of a turn-table weighing 24,000 lbs. was sufficient to

FIG. 5.

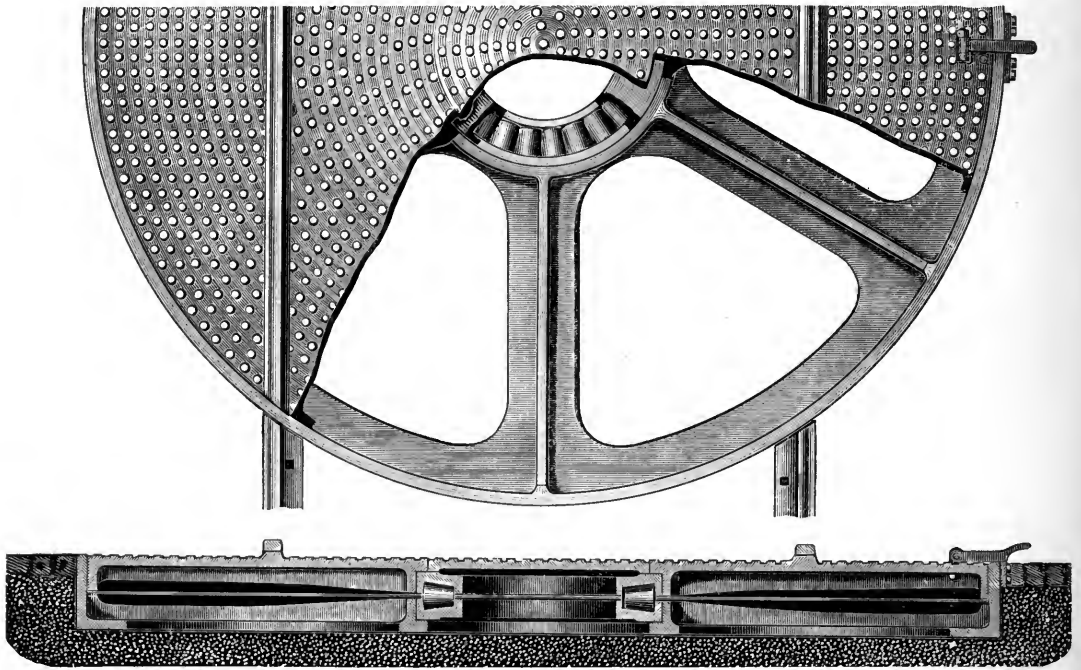

put it in motion from a state of rest. All turn-tables that we build are erected in our works, carefully fitted and properly marked for assembling, so that our customers will have no fitting to do except trimming the wooden packing so as to bring the table to the proper level. This is a simple matter.

SMALL TURN-TABLES.

For service where the loads to be turned are all comparatively short, we make a special form of table that entirely covers its pit. It is quite shallow, turns with great ease, and is very durable. Such tables are used for Street Railways, for Mines, Manufactories, and Warehouses, and we build various types and sizes adapted to various requirements. Fig. 4 shows our heavy pattern, 9 ft. 4" Turn-table, which is sufficiently strong to carry the heaviest car that can be placed

upon it. It will carry the passing load of locomotives, although too short to be used for turning any but very small ones. It is useful for machine shops and other manufactories doing a heavy class of work, and also for mine cars and locomotives. Fig. 5 shows a type of lighter table, such as are used for street railways and for ordinary factory purposes where the loads passing over them are not heavier than they are required to turn. These, too, are made of various diameters and greater or less strength according to requirements. This form of table requires very shallow excavation, measuring only 9" from the base to the top of the floor plate. A still shallower and lighter table for diameters up to say 6 feet is shown

FIG. 6.

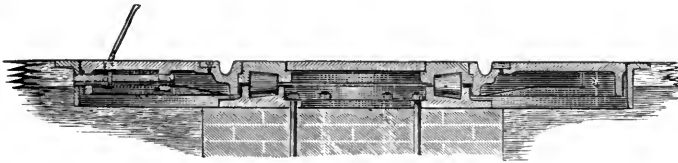

in Fig. 6. This is extremely shallow, in fact, measures only 6 inches from base to top of floor-plate. All of these tables are usually made with roughened iron tops, but when required they may be covered with planking to correspond with shop floors. The rails may be elevated above the general surface, as in Figs. 4 and 5, or depressed, as in Fig. 6, when it is desired to run trucks or barrows over the track. They are arranged with latches, which may be either of the spring form operated by lever or key, as in Figs. 4 and 6, or it may be a heavy drop-latch fitting into notched plates attached to the curb as in Fig. 5.

These tables are all set up before they leave our works, and are ready to put in service without any fitting on the part of the purchaser.

PLATE No. 253.



LOCOMOTIVE AND TENDER ON TURN-TABLE.

Hydraulic Testing-Machines.

SYSTEM OF A. H. EMERY, C.E.

THE accurate testing of iron, steel, and other metals used in constructive work presents a problem of great importance to which engineers have at all times devoted much attention, and the modern increased use of steel and iron in the largest structures renders it necessary not only that the metal work shall safely bear its load, but that it shall not unnecessarily add to it. The problem, therefore, is to adjust with certainty a safe margin of strength with a minimum of weight (and, incidentally, of cost), and this can only be determined by experimental tests upon full-sized sections of the materials used in such construction.

Heretofore, the principal method has been by machines designed to test comparatively small sample pieces under such conditions that the breaking strength of the test-piece was measured by the machine, and from the data thus obtained the supposed strength per square inch of full-sized bridge members and other constructive material was determined on paper by calculation. A feature common to all such machines heretofore in use is, in principle, the common steel-yard balance, supported by "knife-edges." While this is satisfactory for small work, it has proved inadequate for the modern requirements of testing a completed piece, such as a column, or an eye-bar forming a tension member of a bridge, by reason of the bending of the support under heavy pressure; also, the injury to the knife-edges if sharp, and, if blunted, the introduction of friction, all of which render the calculation required to measure the strain unreliable.

The "ideal" testing-machine would be one working without friction, capable of engaging all sizes and weights, measuring and registering with accuracy, easily and quickly operated, and practically indestructible by any use for which it was designed;

Impossible as such a combination may appear to a technical engineer, it is not too much to say that these conditions have been fulfilled; and it is the purpose of this paper to describe briefly the wholly original marvellous machine devised a number of years ago by Mr. A. H. Emery, C.E., and recently improved by us in its mechanical details.

The original machine of this type, constructed for the United States Government, has been in actual service at the arsenal at Watertown, near Boston, for many years, and other similar machines more recently built have served to confirm the soundness of the principles involved.

One of the "proof" experiments by the United States Government Board was the breaking in tension of a forged iron link, five inches in diameter between the eyes, at a strain of 722,800 pounds, and immediately thereafter slowly straining a single horse-hair $\frac{1}{16000}$ of an inch in diameter which, after stretching thirty per cent., snapped under the recorded strain of sixteen ounces. Masses of metal were subjected to pressures of one million pounds in compression alternately

with eggs and nut-shells, and in all cases the machine operated with equal accuracy.

About twelve years ago we acquired the exclusive right to build the Emery testing-machine under the numerous patents, and have since that time devoted much study to the subject, with a view of improving and simplifying its mechanism, reducing its cost, and increasing the facility of its operation, in order that we might be enabled to supply, at a comparatively moderate expense, testing-machines adapted to the requirements of bridge constructors and other manufacturers, as well as technical schools and colleges, etc. It was found that extensive alterations in mechanical details were needed before such improved machines could be economically produced, and the machines illustrated herewith present the latest forms, combining the essential features of the original invention with the added mechanical improvements.

DETAILED DESCRIPTION.

The essential peculiarity of the Emery testing-machine is the method by which the stress produced upon the piece tested is conveyed to the scale and accurately weighed by mechanism that is entirely frictionless, and hence responds to the same increment of load regardless of the amount of strain upon the specimen. This result is accomplished by receiving the load upon a flat closed cylinder called the "hydraulic support." The general scheme is indicated in Fig. 1, which shows merely the relation of the parts, no attention being paid to proportion.

The depth of the hydraulic support cylinder *A*, is exceedingly small, the end is closed to prevent the escape of the contained fluid by a thin sheet of metal, *b*, upon which rests a piston, *c*, considerably smaller than the internal diameter of the cylinder; this piston is secured to the cylinder by thin flexible fixing plates, *d d*, which permit a very small movement in the direction of the axis of the cylinder while rigidly securing it against any lateral movement; this longitudinal movement of the piston from no load to full load is not more than .003 inch, and as there is no hydraulic packing and no sliding, there is no friction beyond that of the fluid; this hydraulic chamber is connected by a pipe, *e*, with a smaller but similar chamber, *B*, placed in the scale; the piston *c'*, of this latter chamber acts through the block *H* against the first lever *C* of the scale, which thus receives a fraction of the load upon the piston *c* determined by the relation between the areas of the two hydraulic cylinders *A* and *B*.

The scale-body is a rigid cast-iron frame carrying the steel scale levers, all the supports and connections of which are thin flexible plates of steel firmly secured to the levers and their supports, and having a sufficient exposure between their fixed ends, that the amount of bending due to the movement of the levers shall be well within the elastic limit of the material. The long arm of the lever *C* is coupled by the bar *D* with the short arm of the poise-frame lever *E*: the long arm of this lever carries all the standard weights of the scale, and the method of

PLATE No. 254.

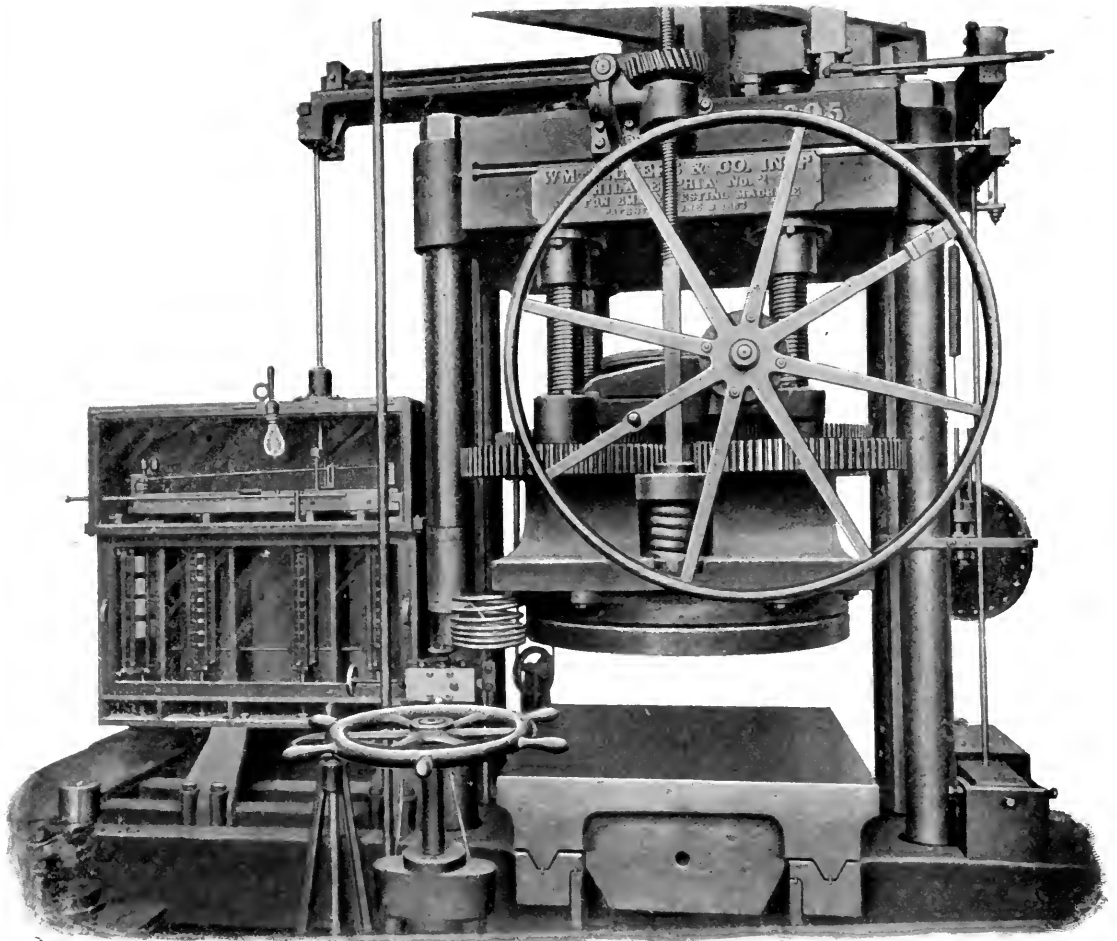

HYDRAULIC-SUPPORT TESTING-MACHINE.

MAXIMUM CAPACITY, 500,000 LBS.

Ratio from main weighing-platen to point of indicator needle in scale-case, 300,000 : 1. Used for calibrating the hydraulic supports of all new testing machines, and adjusting the poise weights with great precision. Extremely sensitive, 200 grains on main platform will put in motion 20,000 lbs. of levers and platforms, and deflect scale needle. No reduction of sensitiveness when fully loaded.

putting them on or taking them off, without handling, is peculiar to the Emery system. Suspended from this lever, *E*, at suitable intervals by thin fulcrum plates, are "poise-frames," *N*, consisting of an upper cross-head, *S*, and a lower cross-head, *T*, united by three vertical bars disposed at equal intervals about the cross-heads.

FIG. 1.

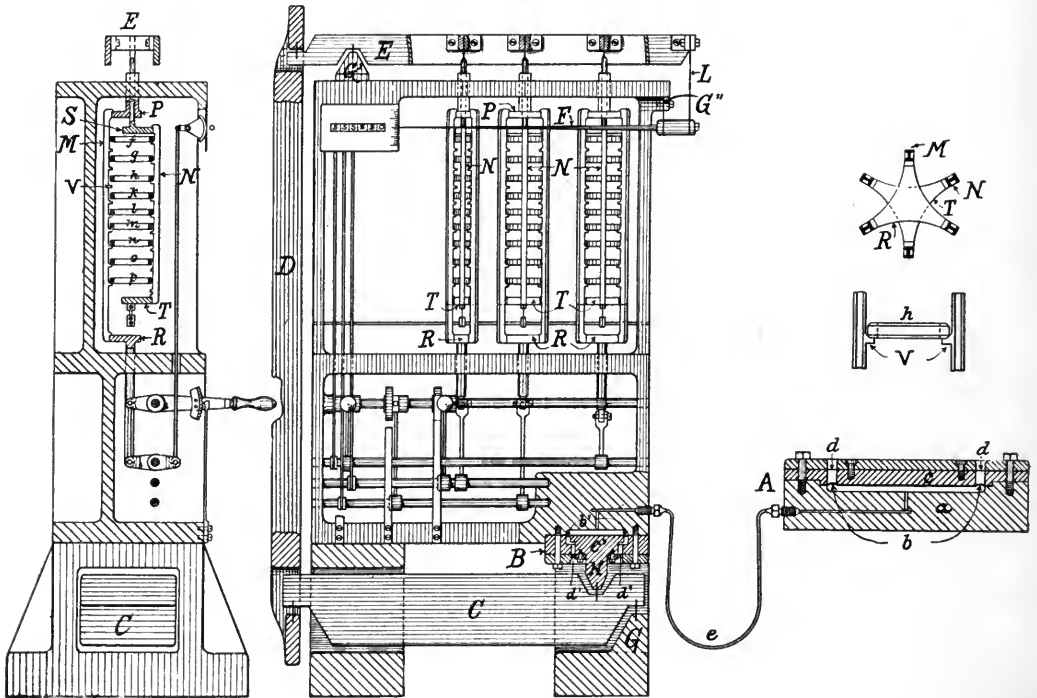

These bars are provided on their inner faces with short projecting brackets, *V*, having a horizontal surface and a bevelled surface corresponding with similar surfaces formed on the weights *h*, which are short cylinders or rings with bevelled edges; the weights are carried by the flat surfaces and centred by the bevelled surfaces. A "weight-frame," *M*, for carrying the weights when not in use, of similar construction, has its three vertical bracketed bars alternating with the bars of the poise-frame; this weight-frame is guided, and is raised and lowered in a vertical line without touching the poise-frame, by a rock shaft and a hand-lever coupled to the rod projecting from the cross-head *R*. The brackets on the weight-frame bars are differently spaced from those on the poise-frame, and when the weight-frame is at the top of its stroke, it carries all of the weights clear of the poise-frame; a small movement downwards transfers one weight to the poise-frame, the bevelled surfaces on the brackets centring the weight if it becomes displaced sideways by a too sudden movement. A further movement transfers an-

PLATE No. 255.

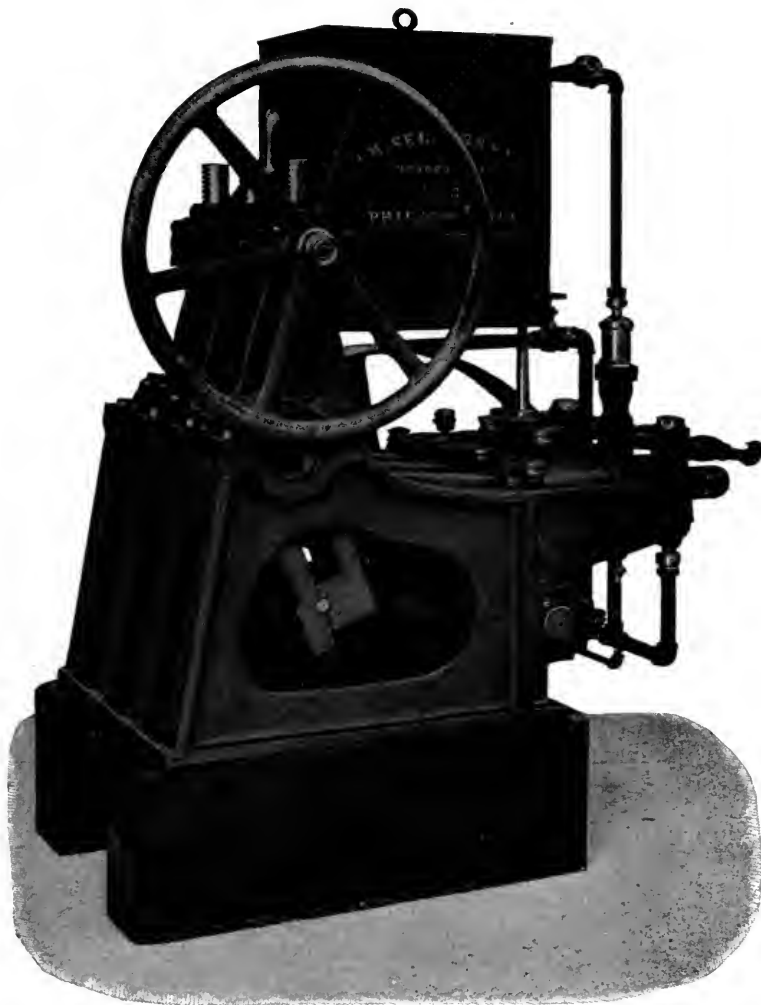

PUMP FOR HYDRAULIC TESTING MACHINES.

WITH ADJUSTABLE STROKE.

Maximum stroke of plungers, 5". Maximum discharge, 1178 cubic inches per minute. Crank-shaft, 100 revolutions per minute. Stroke adjustable by hand wheel to suit speed of movement desired. Has three single acting plungers, safety valve and tank.

other, and so on ; that is, the movement of the weight-frame in either direction transfers the weights singly and successively from one frame to the other ; the weights *f* and *g* are shown carried by the poise-frame, *j* and *k* by the weight-frame, while *h* is being transferred from one to the other.

The operating hand-lever is provided with a notched segment, into which a click-spring plays so that the operator feels when he has moved the lever the right distance to transfer a weight to or from the poise-frame without having to watch the indicator as formerly, and the arrangement of the six bars surrounds the weights by a cage that effectually prevents any displacement and consequent interruption of the test, as sometimes occurred when the weights rested on simple shelves secured only by short-pointed pins. There is hence no necessity for opening the glass case that encloses this part of the scale, and the weights are never exposed to any risk of alteration. The weights in the first poise-frame have a value of 100 pounds, the next frame carries weights of a value of ten times as much, or 1000 pounds, the next 10,000 pounds, and so on, and the readings are summed up by a series of segments connected to the several operating shafts and provided with figures denoting the number of weights on each poise-frame. A horizontal slot in a vertical plate near the upper left-hand corner of the scale is so placed that the reading of the figures shown through this slot denotes the number of pounds pressure applied to the specimen.

The final lever of the scale is an indicator needle, *F*, which has a movement at its point of $1\frac{3}{4}$ " to 2", and this movement, calculated from the mechanical ratios of the hydraulic chambers and of the levers in the scale, is not less than 300,000 times the movement of the piston *c* in the first hydraulic chamber, and may on large machines be 6,000,000 times as much. The transfer of fluid from one chamber to the other is almost imperceptible, and while it takes force to move the metal sheets and to bend the steel fulcrums, yet this force is all returned as the various parts resume their position of equilibrium, the needle returning to the same zero point after being disturbed in either direction.

The weighing-head (Fig. 2) consists of two circular or annular beams, 65 and 69, firmly secured together by bolts placed around their periphery and by the straining screws which pass through both beams and clamp them by a shoulder and nut. This head and the straining-head fit easily upon the bed which maintains the axes of the two heads in the same straight line. A draw-bar, 70, is secured in the axis of these beams by two thin annular steel plates, 72 ; these plates hold the draw-bar securely in line with the axis of the machine, while permitting a free motion to a limited extent in the direction of the axis. The projecting end of the draw-bar is provided with a screw-thread by which the compression platform or the tension holder is secured to it. The draw-bar is enlarged in the middle, and against each of the two shoulders thus formed is secured a thin annular steel plate, 73 ; these plates are for the purpose of carrying and centring the hydraulic support, which is made annular, instead of circular, as shown in Fig. 1. The hydraulic support is maintained in fixed relation with the draw-bar

PLATE NO. 256.

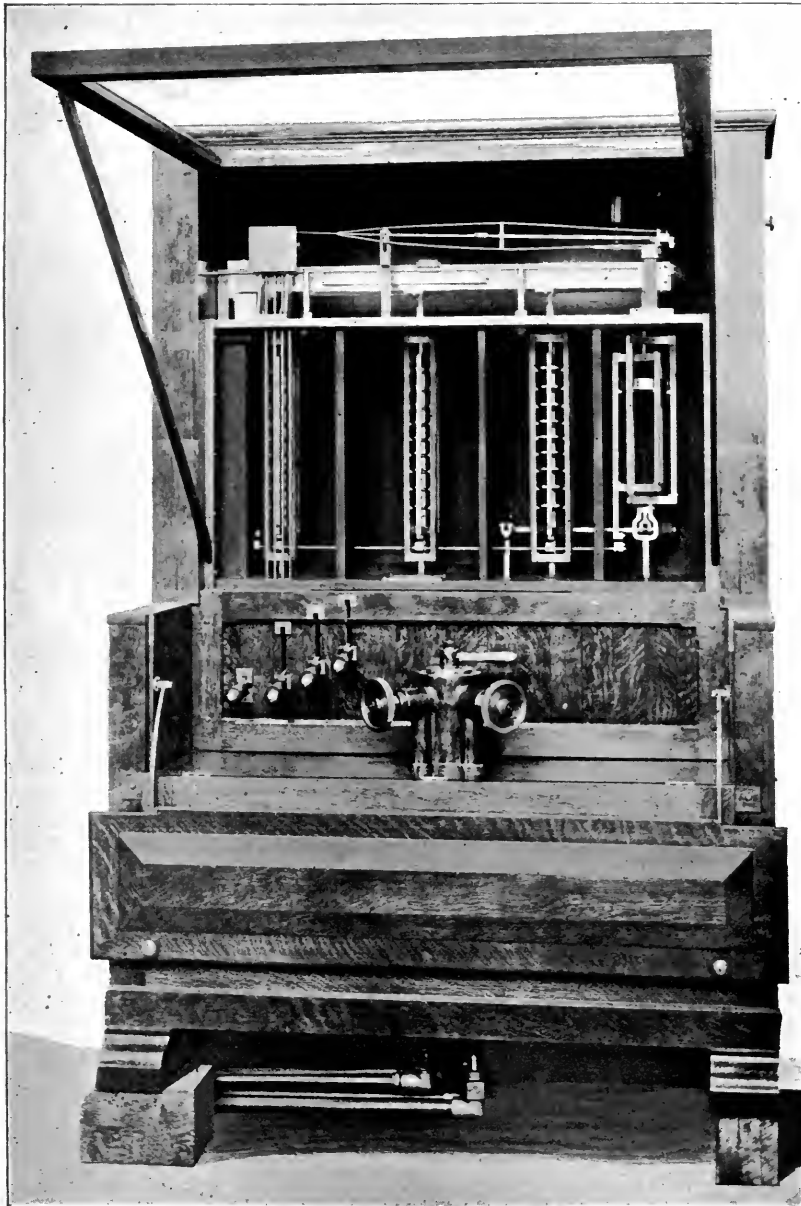

HYDRAULIC SCALE FOR EMERY TESTING MACHINES.

Showing hand levers for adding weights and valves for controlling movement of testing machine. All poise weights handled without opening case.

laterally, while it is left free to move relatively to it in the direction of its axis through the small distance required. On each side of the hydraulic support, steel collars, 71, are screwed and secured to the draw-bar; these collars are provided on the periphery with a series of ribs (Fig. 4) parallel with the axis of the draw-bar, and which lie between without touching, similar ribs projecting from the interior surface of the annular beams. The ends of all these ribs on the two beams and the collars are accurately faced to true planes at right angles to the axis of the draw-bar, and the distance between the two extreme faces of the hydraulic support is made slightly less than the distance between those two planes. Movement of the draw-bar in either direction carries the hydraulic support against the ends of the ribs in one annular beam, brings the ends of the ribs on one of the collars on the bar against the opposite side of the hydraulic support, and produces

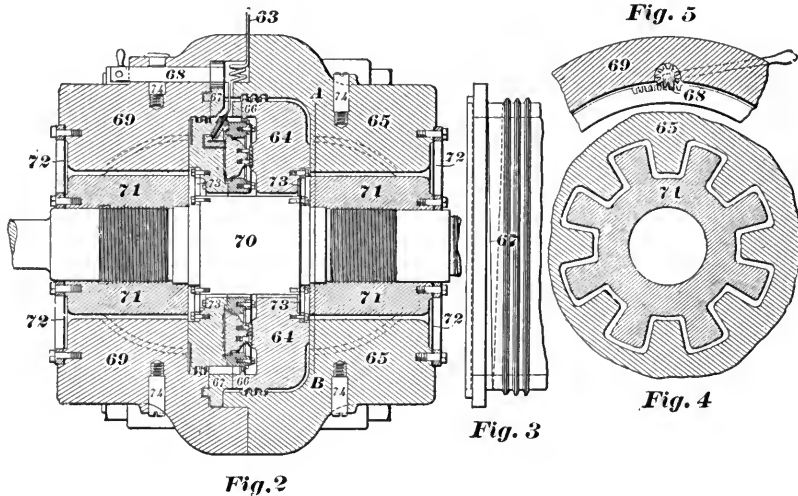

pressure on the contained liquid which is transmitted through the pipe, 63, to the small hydraulic chamber in the scale.

In order to prevent the shock of recoil, resulting from the rupture of a large specimen of high steel, from doing injury to the thin brass plates in the hydraulic support, the abutting piece, 64, of the support, which rests against the ribs in the annular beam, 65, when strains of tension are applied, is made larger in diameter than the hydraulic support proper, and is provided with a spiral or screw face, 66, which engages with a corresponding screw-face formed on a rotatable ring, 67, fitting in the other annular beam, 69. After the initial load has been applied, this ring is rotated by the pinion-shaft, 68, to bring the screw-faces in contact, see Fig. 3, and the abutting piece, 64, is thus clamped firmly to the annular beam against which it rests. When the specimen breaks, its first blow is delivered through the draw-bar and ribbed collar to this abutting piece, 64, which transmits it through the ring, 67, to the rear annular beam, 69, and as

PLATE No. 257.

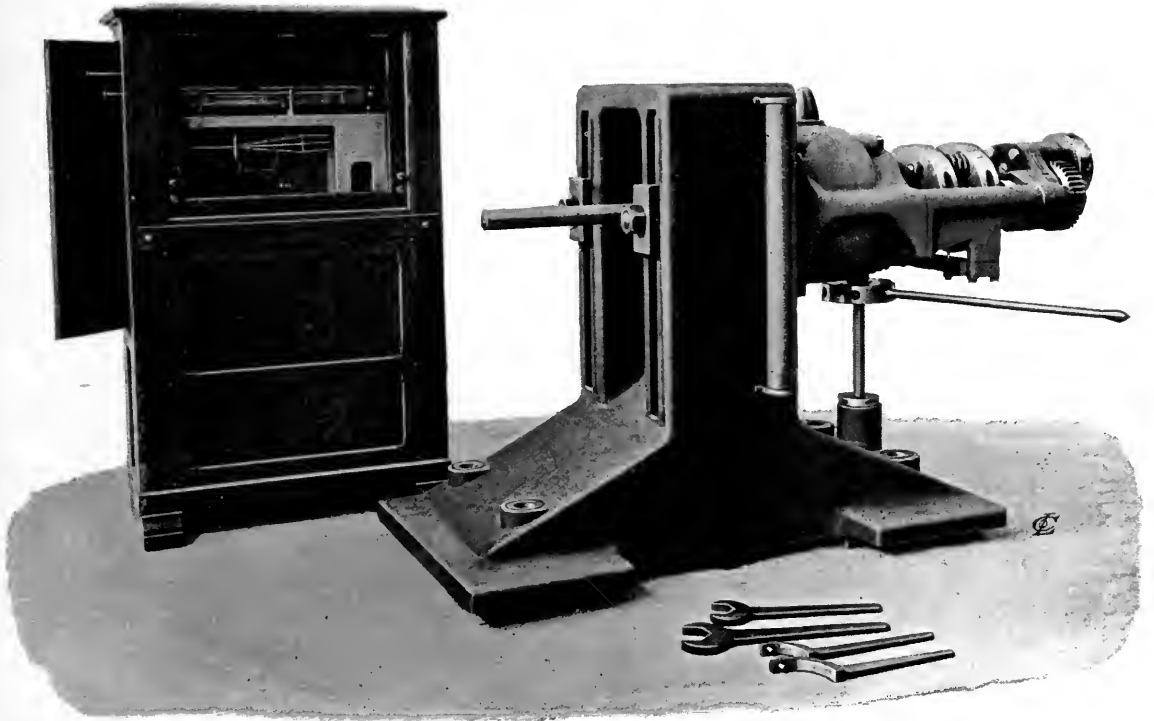

30,000-LB. DYNAMOMETER AND SCALE-CASE.

FOR WEIGHING TRACTIVE FORCE OF LOCOMOTIVES.

Centre of draw-bar adjustable from 28" above foundation to 46".

these beams, 65 and 69, are rigidly united, the blow is absorbed by the total mass of these two beams. The hydraulic support is thus thoroughly protected, and these machines can be used regularly for breaking high steel specimens up to the full capacity of the machine without any risk of injury.

The weighing-head is returned to its place on the bed after movement due to recoil by a set of spiral springs locked up in boxes secured to the bed; these springs are strong enough to move the head, and their resistance diminishes greatly the movement due to recoil, while the friction of the head upon the bed rapidly wipes out the oscillations. The annular beams bolted together, as described, constitute one built-up beam to resist the bending due to the pressure on the draw-bar midway between the straining screws. The hydraulic support is thus inclosed in a rigid mass of cast-iron and effectually protected against injury from violence or from being gummed up by oil from the straining cylinder, as has occurred with the upright machines, and the frictionless movement of this support under all conditions of service is thus insured.

Two straining screws, 77, are provided (Figs. 6, 7, and 8), fixed firmly to the weighing-head and passing freely through bearings, 88, formed on each end of the straining-head, 87; a revolving nut, 89, provided with gear-teeth on its periphery, is placed on each straining screw between the two bearings, 88, formed on the sides of the straining-head; these nuts are revolved by the wide face pinions, 90, driven through the bevel-wheels, 92 and 93, by a balancing train of gearing consisting of a gear-wheel, 96, carrying two balancing bevel pinions (see Fig. 8), meshing with two bevel-wheels, one on each side of the first gear-wheel, 96, so that power applied to the gear, 96, is by means of the balancing pinions divided equally between the two bevel-wheels, and thus imparts equal pressure to the revolving nuts, 89, on the straining screws. This arrangement does away with the necessity heretofore existing of having the straining screws of exactly similar pitch throughout their length. With this construction the screws could be of different pitches, the alignment of the heads being secured by the fit of the screws in their bearings and of the heads on the wrought-iron bed or shear; by driving this train of gearing either by hand or by power, the straining-head is moved back and forth upon the bed to accommodate the varying lengths of specimens; when the head is adjusted to place, the nuts form the abutments upon the screws to resist the movement of the cylinder for strains of compression or extension. The nuts, 89, do not fit snugly endwise as heretofore, but a space of several inches is left between the ends of the nuts, 89, and the faces of the bearings, 88 (see Fig. 6). This provides for the shock of recoil when breaking a long and large specimen, the sudden release of the straining screws from their load when the specimen breaks, together with the force resulting from the sudden contraction of that end of the specimen attached to the straining-head, merely give the head a push along the bed, and it slides freely until its momentum is absorbed by its own friction, the space between the revolving nuts

PLATE NO. 258.

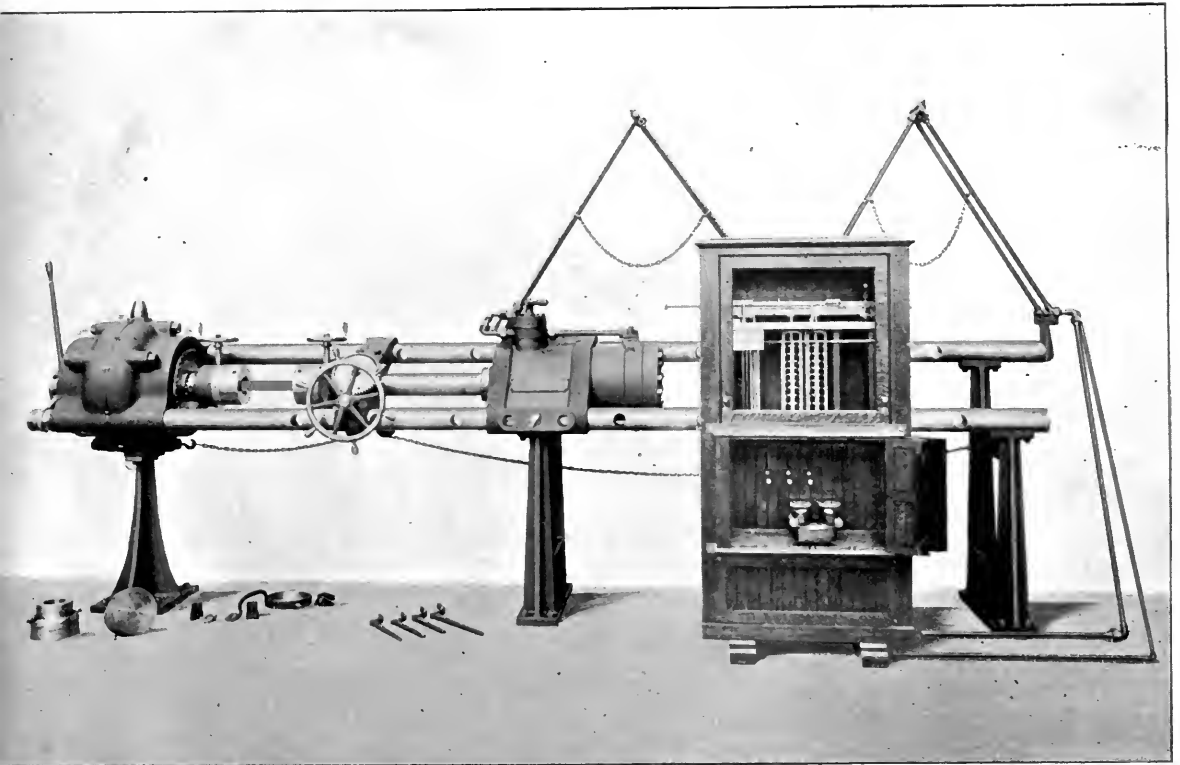

100,000-LB. TESTING MACHINE.

Capable of testing specimens 12 ft. long in compression, and 8 ft. 4" long in tension. Maximum stroke of piston in straining-head, 24". Hydraulic scale shown in position. Tension holders and specimen in place. The compression platforms are on the floor.

and the bearings allowing ample room for this travel even when the heads are thoroughly lubricated. This head is thus entirely cut off from the rapid vibrations of the straining screws, and the necessity of making the nuts an exceedingly good fit to both screw and head is entirely avoided.

The straining-head is provided with a piston packed to receive fluid pressure in either direction, and the piston-rod passing through a packed bearing in one end is provided with a screw-thread, similar to that on the draw-bar, to receive the various holders. The fluid is supplied to this straining cylinder through two systems of jointed pipes, which are connected through the valves at the scale-case with the pressure pump and the tank respectively, so that each pipe

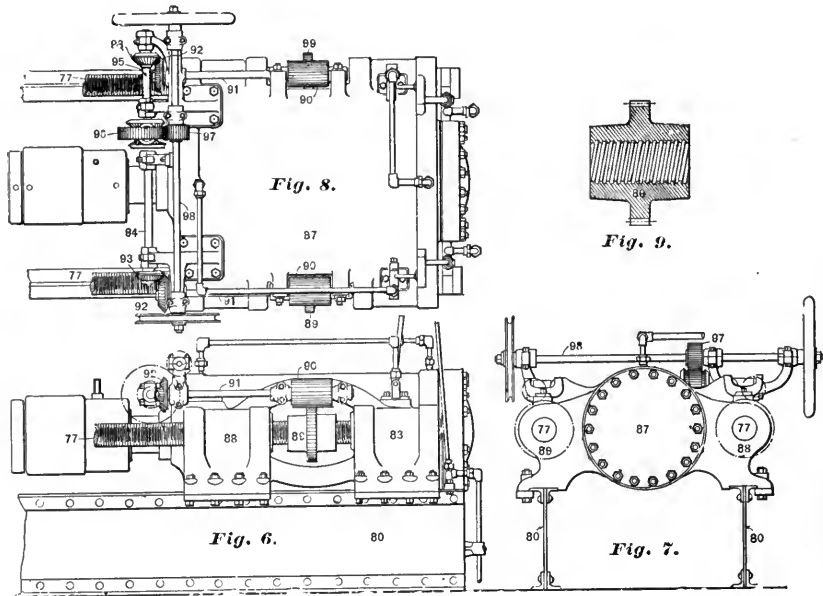

acts either as a pressure pipe or an exhaust pipe, depending upon the direction in which the strain is to be exerted upon the specimen.

The Emery testing-machines are now made horizontal instead of vertical; in the first place to make all sizes of machines of one type, and in the second place to get certain advantages in overcoming the shocks of recoil. In all but the very smallest size of machines, the weighing-head and the hydraulic cylinder or straining-head are carried and aligned by the top surface of a wrought-iron bed, as shown in the view of a 200,000-pound testing-machine, Plate No. 259, the straining-head on the right hand and the weighing-head on the left, back of which stands the scale, and to its right is the pump; in the foreground are the parts of the tension holders.

PLATE NO. 259.

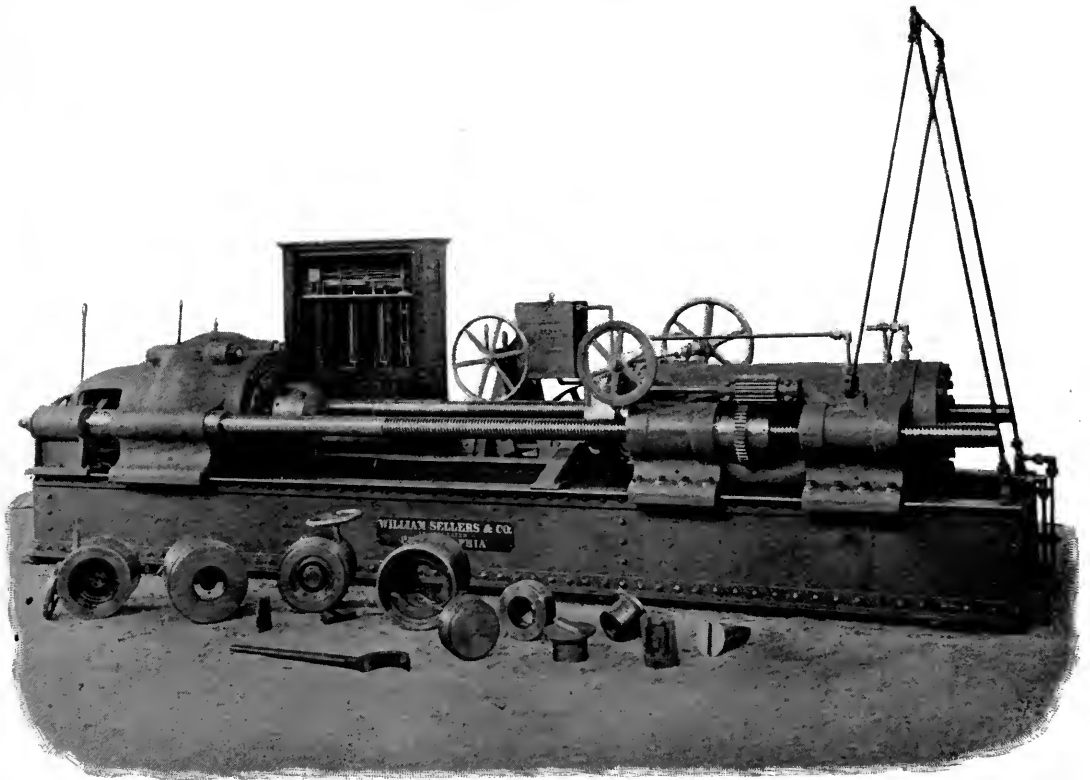

200,000-LB. TESTING MACHINE.

Capable of testing specimens 7 ft. 9" long in compression and 5 ft. 5" long in tension. Maximum stroke of piston, 3 ft. 6". Maximum travel of piston with pumps at maximum delivery, $4\frac{1}{2}$ " per minute.

PLATE No. 260.

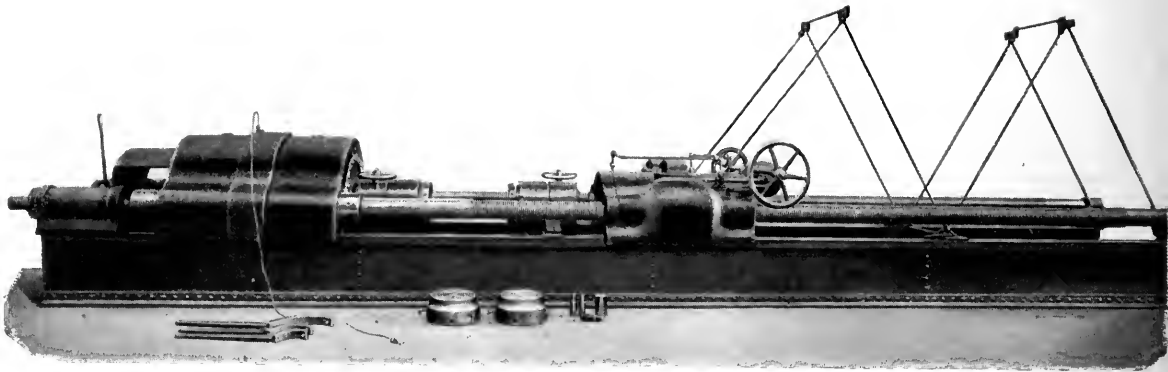

300,000-LB. TESTING MACHINE.

Capable of testing specimens 18 ft. long in compression and 13 ft. long in tension. Maximum stroke of piston, 3 ft. 6". Maximum travel of piston with pumps at maximum delivery, $4\frac{1}{2}$ " per minute.

Shafting.

SHAFTHING—so called—is a comprehensive term, firmly established by usage, and includes all the various appliances for the mechanical transmission of power. It is the intermediate agent through and by which the power of any establishment is conveyed from the source where generated to the various machines which are to receive motion.

The machinery of all manufacturing establishments can be properly divided into three main or fundamental parts,—viz., first, the source of power, whether it be steam, with its boilers and engines; water, with its wheels; or electricity, with its generators and motors; second, the shafting, which carries the power and distributes it in quantity and kind wherever required; and, third, the manufacturing machinery, which is the producing element, which is kept in motion by means of the prime mover and the shafting.

It is clearly to be seen that the best results in manufacturing cannot be secured without equal intelligence and judgment in the selection of all of the above, so proportioned and arranged that each may satisfactorily perform its part in perfect harmony with the others. The design and arrangement of shafting for power transmission is a subject worthy of more consideration than is generally awarded it. In fact, it cannot be wisely treated as in any way secondary to any other unit in the sum total of any manufacturing plant. In a large factory, the shafting, with its couplings, pulleys, belt carriers, and other similar adjuncts, considered as a machine to transmit motion, is frequently the largest in the establishment; hence, every consideration of economy requires that it should do its allotted work with the least possible loss of power in the transmission. It calls for economy in first cost and economy in use. The generation of power to be expended in operating machinery to do work costs something; it may cost much money in fuel consumed, or it may cost something in energy expended, the expense in most cases being in proportion to the amount of power generated and absorbed either in the direct operation of the machinery, or in the friction due to the transmission. In any case, the more perfectly the whole power is distributed to the operating machinery the more profitable will be its use.

To obtain the high speed found advantageous in mill practice, and at the same time reduce the friction load to such a minimum as will give the highest degree of economy in running, it is necessary that great care be used in the selection and disposition of the various materials used. The shafts must be straight, truly cylindrical, properly proportioned for the work to be done, and made of carefully selected materials, having such chemical and physical properties as will best resist the torsional and deflecting strains to which they are to be subjected. They must be united by couplings that hold them firmly, and be provided with self-adjusting

bearings that will maintain them in true line. All of the work should be so designed that it may be readily attached or detached, and a standard as to sizes should be adopted, so that the various parts may always be interchangeable.

These results, together with good judgment in the arrangement of the work, so that the best effects may be produced, with the least expense as to outlay and the cost of running, can only result from long and extensive experience.

It is important to state, however, that no matter how thorough a system of shafting is adopted, its arrangement, proportions, disposition of parts, and general adaptation to its special purposes, should all be carefully studied and determined upon by one who is an expert in such matters before the mill or factory building is designed. Too frequently this important matter is left without consideration until after the building is erected, and then the shafting must be arranged to suit controlling conditions, with results, both as to cost and efficiency, that are far from satisfactory.

No one not familiar with this business—as conducted upon an extensive scale—can have any idea as to the number and variety of its details. In addition to the every-day demands in the line of general practice, there continually arise cases of a peculiar kind, requiring hitherto unused expedients which can only be designed and applied by those having had long and successful experience in this line, and the demands of the day are so great, so varied, and so constantly increasing, that no establishment can properly meet them unless it has appliances and resources that are practically without limit.

Our extensive plant is the outgrowth of an experience in the front rank of over fifty years, during which time our products have found a market among the most exacting customers in almost every civilized country upon the face of the earth. At the beginning of this period the art of making shafting was in a very crude state, and the products of to-day are to be compared with those of that time much as daylight is to darkness. We do not hesitate to state, with justifiable pride, that most of the prominent improvements in this line originated with us, and have since been extensively copied by other manufacturers. This is notably the case with the "swivel" or "ball-and-socket" bearings, which are now almost universal in their use, and with the "cone-vice" compression couplings, which since the expiration of our patents have been extensively made by a number of others, both in this country and in Europe.

We were the first to introduce a scale of fixed prices for each separate article, by which the purchaser is enabled to know in advance the exact cost of his work,—a foreknowledge which cannot be possessed by those who purchase "by the pound." We claim that our customers not only make a direct saving in first cost over those who purchase in any other way, but that the advantages are continuous, in that they secure a well-designed and easy-running system, which is constructed with as little expenditure of material as is consistent with absolute strength.

PLATE NO 261.

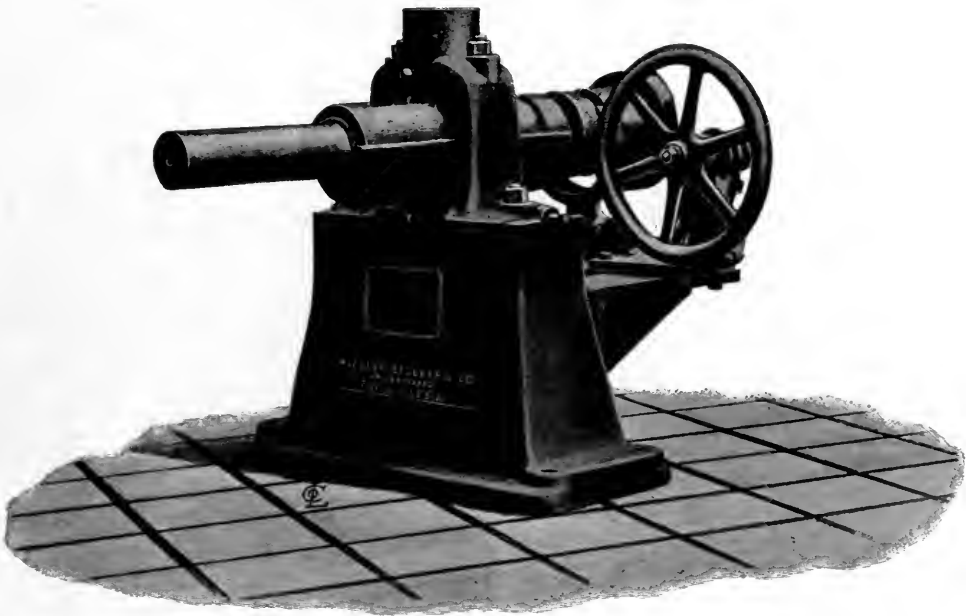

PEDESTAL BEARING.—WITH SELF-OILING BOX AND FLOOR STAND.

This form of bearing and stand is especially designed for use in electric plants, or where the shafting and the machinery to be driven are on the same floor. As shown in the plate, the floor stand has attached our hand-wheel and worm shifting device, which is applicable alike to tooth and friction clutches.

We publish for distribution a Shafting Price-List, illustrating our standard articles of manufacture, and giving price for each item. This book also contains tables for use in the laying out and proportioning of shafts, together with general dimensions of bearings, etc. All the prices given in this book are subject to discount, the rate of which will be furnished upon application.

We keep in stock a large assortment of the standard articles in this line, such as Shafts, Couplings, Hangers, various forms of Carriers, etc., which can be delivered promptly upon receipt of order, and our plant is so extensive that we can promptly make to order such articles as are not in stock.

Our shafts are made of stock carefully selected, and known to possess properties best suited for the purpose.

They are finished with care to standard ring gauge. All key seats, unless otherwise ordered, are cut to standard sizes, and the shafts are subsequently restraightened as a final process before boxing or delivery. Our standard sizes are one-sixteenth of an inch less in diameter than the nominal sizes; thus, what we call a 3-inch standard shaft is in reality $2\frac{15}{16}$ inches in diameter. This difference is due to the allowance for turning, although we can furnish shafts of full nominal sizes when so ordered. For large sizes and for heavy duties we make special shafts of forged iron or steel.

Our hangers are of the "double-braced," "ball-and-socket" variety, so designed as to resist with equal efficiency strains exerted in any direction, and having vertical adjustment by means of the "plungers," which are the "sockets" carrying the "ball" on the journal box or bearing. This "ball" is a sphere, having its centre co-incident with the centre of the box. A bearing when made in this way can adjust itself to any deflection or settlement of the shaft with equal facility in any direction, and thus distribute its load equally over its entire surface. This is, in fact, the only correct form of swivel box, and is usually made by us, with a length equal to four times the diameter of the shaft. We manufacture numerous modifications of this form of hanger, many of which will be better understood by reference to the shafting price-list before mentioned, where they are illustrated and described.



The question of properly lubricating the bearings is one of great importance, and the various methods and materials used for this purpose are almost without limit. To meet a very diversified range of requirements, we make—with certain modifications—two standard forms of boxes or bearings for our hangers. First, the ordinary box, so arranged that it can be oiled by hand, or can have attached any of the well-known forms of drop feeders. Each of these boxes is made with two small grease reservoirs or cups on its upper surface, and these can be filled with grease, or can have attached tubes for "candle" lubricators, which are

PLATE NO. 262.

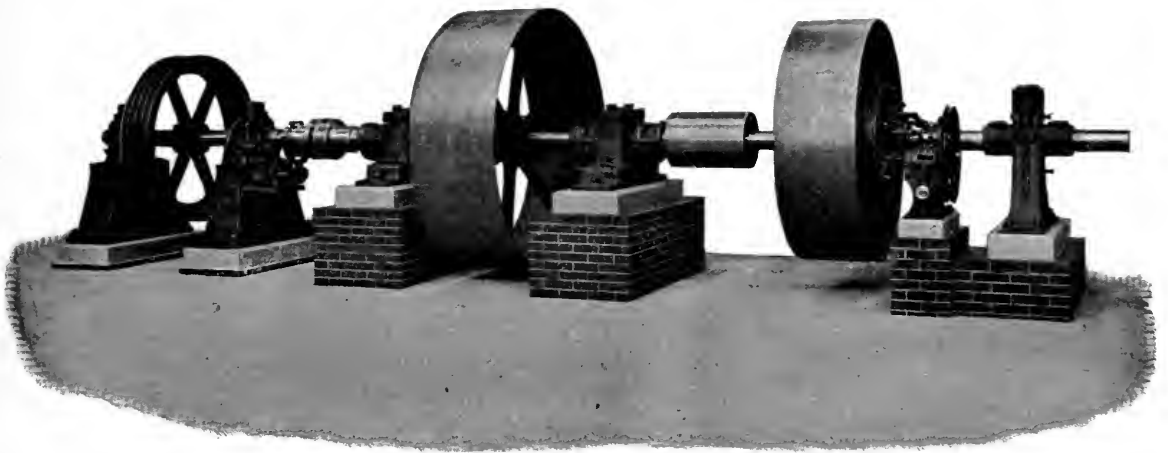

LINE OF SHAFTING.

This plate illustrates various types of bearings, pulleys, clutches, etc., such as are used for heavy jack-shafts or for main driving lines in Electric Light Stations.

now quite extensively used. In this way we meet the ordinary requirements for oil or grease lubrication.

Our second form of box is of the "ring" or "chain" self-oiling type. This is a neat and efficient adaptation of a method of oiling already in use for other purposes, and at the same time preserving the integrity of the ball-and-socket box. Each box has attached to it an oil reservoir or chamber extending its entire length, and having free communication between the two ends. Supported upon the shaft journal there are two rings or chains which hang into the bath of oil below, and which revolve with the shaft whenever it is in motion. With these rings or chains a copious supply of oil is carried to the journal at all times, and a complete lubrication is constantly maintained. A single charging of oil should keep the box in good running condition for several months without renewing. Our ordinary box or bearing for hangers is made of iron, bored accurately to size, so as to distribute the journal load over its entire length. Our long experience has demonstrated that for ordinary use cast-iron used in this way is superior to other metals as a material for boxes. We make to order, however, boxes babbitt lined, or of bronze.

COUPLINGS.

Our standard coupling is the double "cone-vise" coupling, universally known and commonly spoken of as the "Sellers Coupling." Its very extensive use has made it such a familiar object that anything more than a general description is unnecessary. This coupling consists of three (3) principal parts, viz., one outer "shell" and two "cones," the latter of which are drawn together within the former by means of three bolts. The construction is such that the cones compress with equal force upon both of the shafts to be coupled, holding them in absolute "line" with each other, whether the two are turned to the same finished diameter or not. They can readily be attached or removed without the use of any but the most simple appliances. Shafts of different sizes can be connected by this coupling, either by reducing the end of the larger shaft to the diameter of the smaller one, and using a coupling of this size, or by the better practice of using a coupling of the proper size for the large shaft, and having one of its cones bored to suit the small one. Each standard coupling has a strength greater than that of the shaft to be driven, and, under ordinary conditions, has a durability co-equal with that of the shaft itself. One particular feature of the cone-vise coupling is its combination of simple parts, any one of which can be replaced by a new one in case of breakage or excessive wear, and the coupling thus restored at a small cost to its original condition of usefulness and reliability.

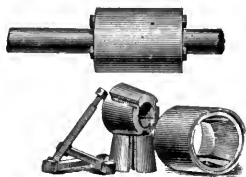

PULLEYS.

A review of the history of pulley making recalls the time when the substi-

PLATE NO. 263.

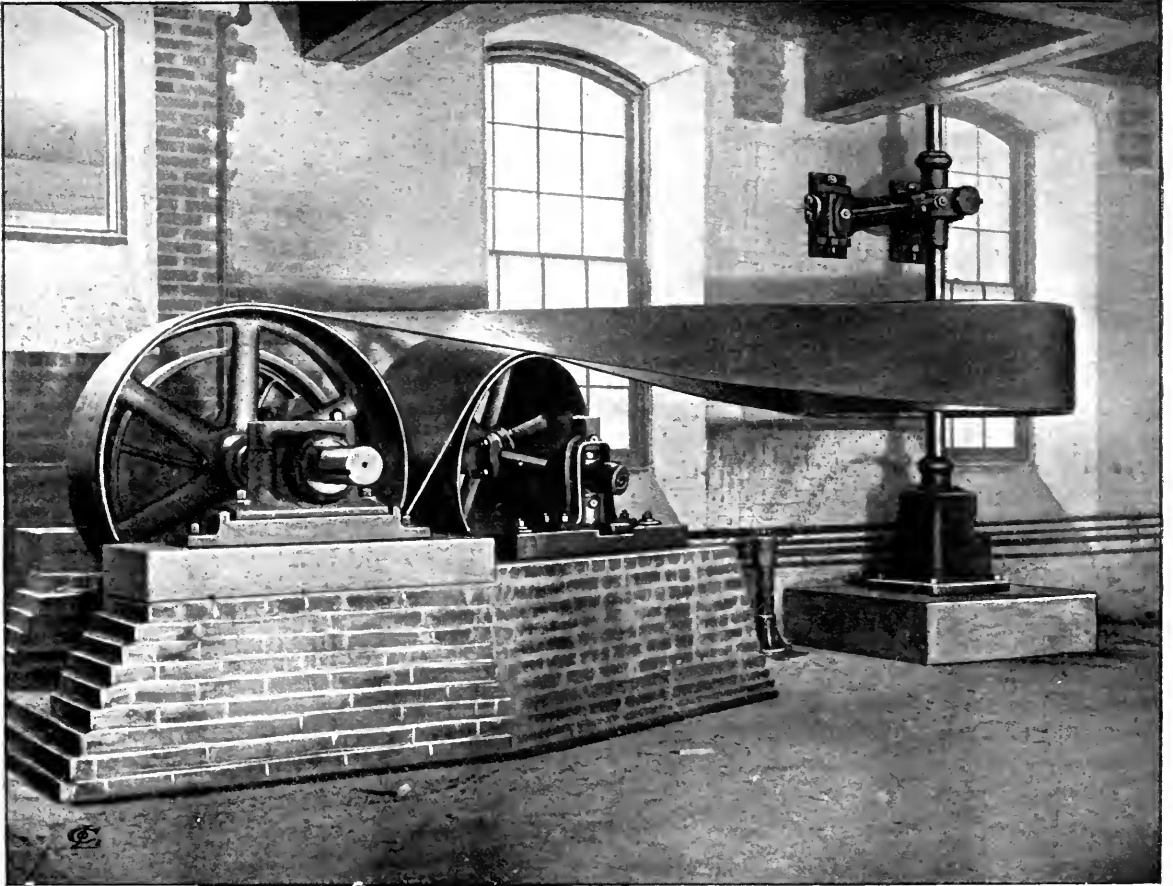

VERTICAL SHAFT.—WITH STEP AND DRIVING PULLEYS.

This plate shows the method of conveying power from a horizontal to a vertical shaft by means of a belt, and one carrier so adjusted as to distribute the pulling strain through the entire width of the belt. In this way power may be distributed through each story of a building without belts running through the floors. The shaft, coming from an adjoining building, is 5" in diameter, with driving-pulley 48" in diameter, and conveys 150 horse-power through a 20-inch double belt to the vertical shaft, which makes 200 revolutions per minute.

tution of iron for wood as a material for pulleys, and the capacity to do so skillfully and inexpensively, was justly considered as one of the great strides in the art. A properly proportioned and correctly finished iron pulley has, accidents excepted, a life of reliable usefulness that is practically without limit. No other

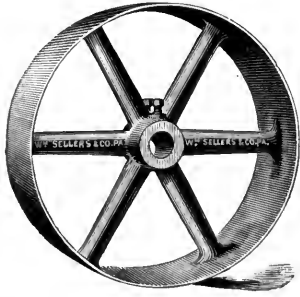

material has the same capacity for resisting wear, and is so little affected by changes in atmospheric conditions, and no other pulley is so graceful in appearance and action, and presents in revolving so small a surface to the resistance of the atmosphere.

Most of our pulleys are machine moulded, all are made with straight tapering arms, are properly proportioned, and in every way have an abundant and well distributed strength, without having any superfluous material to add to the necessary weight that is kept in motion at the expense of power. They are all bored to fit accurately to their carrying shafts, are made for either "single" or "double" belts, turned either "straight" or "high" on the face, as their service may require, and are balanced carefully, with a special reference to the speed at which they are to be run. Wherever the conditions are peculiar, as is frequently the case, we make the pulleys with special reference to these conditions. Our patterns and general facilities for pulley making cover an extensive range as to sizes, and include everything that is in the line of the best practice.

Friction pulleys are now quite extensively used for many purposes, and have a position in the line of power transmission which is exceedingly important, and will undoubtedly be lasting. The same may be said of friction clutches when used as cut-off couplings. By the use of these, machinery or shafting may be instantly started or stopped, and further, certain parts of the machinery may be engaged or disengaged without in any way interfering with the continuous running of other parts. The increasing recognition of the advantages in the use of frictions among users of machinery of all kinds has led to a demand which is constantly growing. We are prepared to furnish either friction pulleys or friction cut-off couplings of all sizes, suitable for all speeds, and adapted for any conditions of service, and we will be pleased to correspond at any time with any one contemplating purchasing.

The subject of pulleys would be incomplete without special reference to those used in the transmission of power by means of ropes as a substitute for belts. This practice, but recently introduced in this country, has become firmly established, and, under certain conditions, possesses advantages which are worthy of recognition. There are two principal methods of rope transmission; first, by means of several ropes running side by side in properly shaped grooves upon the faces of the pulleys, and having a combined capacity equal to the amount of power to be transmitted; and second, by means of one rope, having several turns (or wraps) in the grooves of the two wheels of sufficient number to convey the power

PLATE NO. 264.

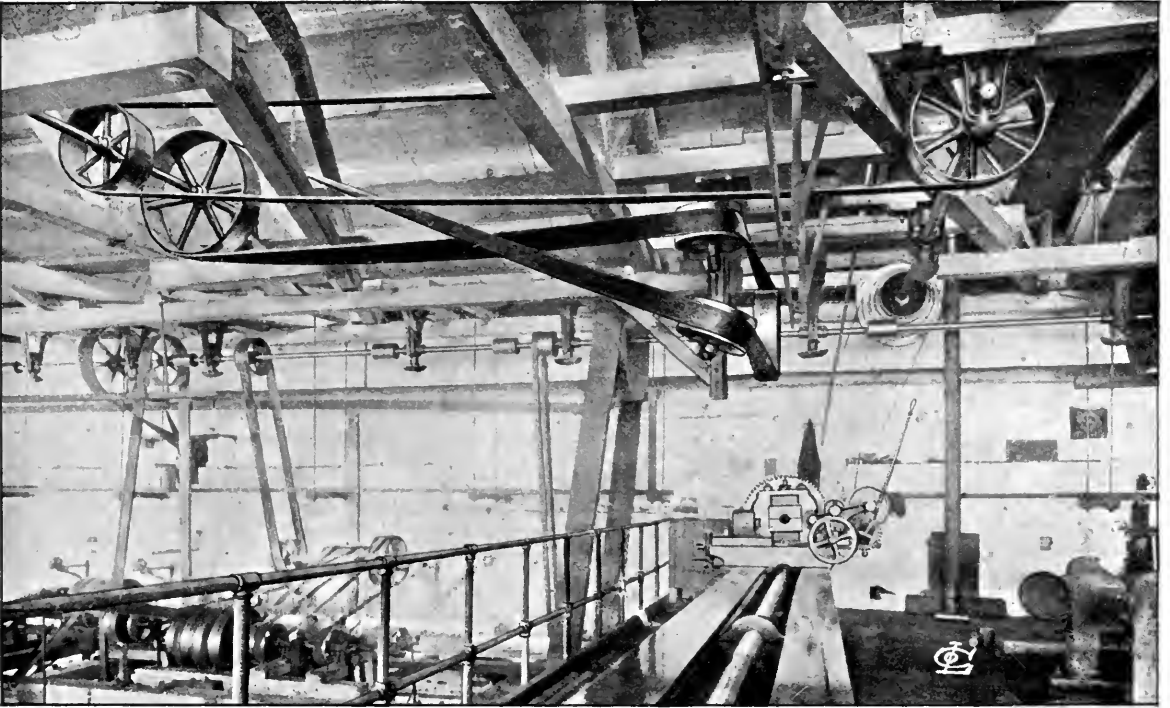

ANGULAR BELT DRIVE.

A method of connecting by belt two shafts that are at right angles and not in the same plane. In this instance the belt is "crossed," and is carried upon one of our adjustable *Mule Pulley Stands*.

required, and having its tension regulated and the travel of the rope returned to its starting groove in one of the wheels, by means of a "sheave" wheel with single groove, on a traveller or tightener, commonly called a "tension carriage."

Both of these systems have their special advocates, both have merits, and each has superior advantages under certain conditions. In the application of either method, it is important that the mechanical devices employed should be

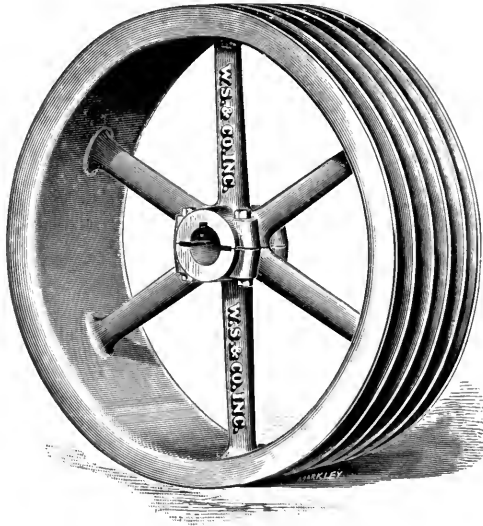

the best of their kind. The transmission wheels should be of *iron*, and have turned grooves of sizes and shapes that have been proved by long experience to be best for the purpose. They should be properly balanced, the various grooves should be so accurately turned to the same pitch diameter, that all of the ropes, or the various wraps of the same rope, may travel at the same velocity, and they should be so fitted and attached to the shaft that the grooves will "run true" and without vibration.

We can furnish to order transmission wheels with varieties as to pitch diameter, size, number, and shape of grooves, that will meet the broadest requirements for the best methods of rope driving. We have also designs and patterns for various forms of "tension carriages," rope carriers, etc., and are prepared to adapt to either usual or special conditions any standard or exceptional requirements in this line.

We will gladly render to any of our customers such engineering assistance as will enable them to secure a well-designed system of *Rope Transmission* which will insure a maximum of efficiency at a minimum of cost.

The limits of space restrict us here to a general and somewhat superficial mention of the articles manufactured by us under the comprehensive head of *Shafting*. It is scarcely necessary to say, therefore, that we have been compelled to omit various other and equally important items which we manufacture for power transmission. In fact, our regular output includes an extensive variety as to gearing, tighteners of various forms, carriers, mules, etc., many of which are standard and meet every-day requirements, whilst others have been designed to do service under special and peculiar conditions. We are fully equipped with all modern facilities for furnishing promptly and in any quantity all of the latest and most approved appliances for the mechanical transmission of power.

Our *Engineering Corps* is an important feature in this department, and is

PLATE No. 265.

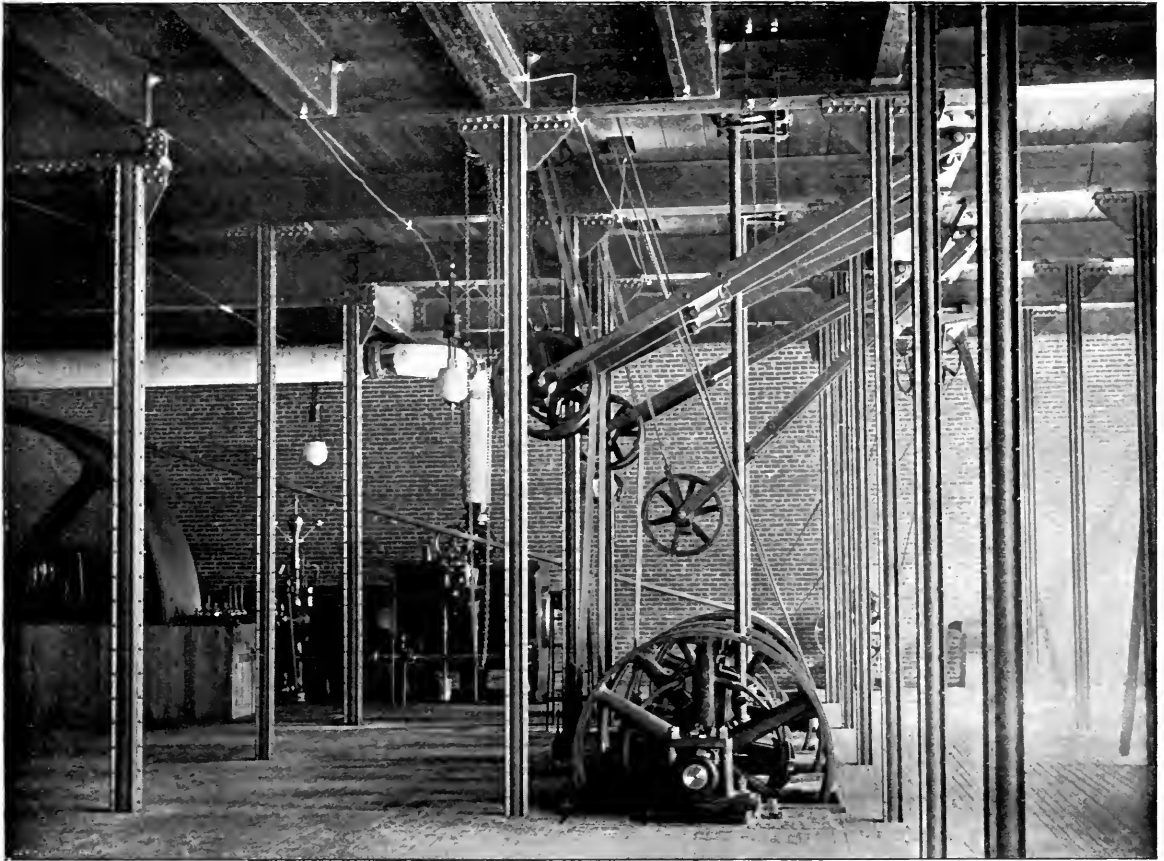

A LINE SHAFT IN THE STATION OF THE NORTHERN ELECTRIC LIGHT AND
POWER CO. OF PHILADELPHIA.

The dynamos on the floor above are driven from this shaft by nearly vertical belts, to which tension is given by means of belt-tighteners that are raised and lowered by chain-blocks.

well equipped for arranging general Shafting details in accordance with the best practice of the times.

Many of our customers find it greatly to their advantage to consult us as to the arrangement and proportions of their work, as they thus secure the best mechanical efficiency, and frequently at an important reduction both in first cost, and in expense of maintenance.

In our *Millwrighting Department* we keep employed a number of skilled millwrights, whose extensive and varied experience make them masters of the general details of their trade. We are prepared to do constructive millwright work of all kinds, though the special feature of this department is the careful, accurate, and judicious erecting in place of the shafting made by us.

The proper and skilful erection of work goes hand-in-hand with its accuracy of design and construction ; and no matter how perfect may be the design, and how well adapted to the purposes may be the various parts, they cannot yield their best efficiency unless they are judiciously erected and adjusted.

PLATE NO. 266.

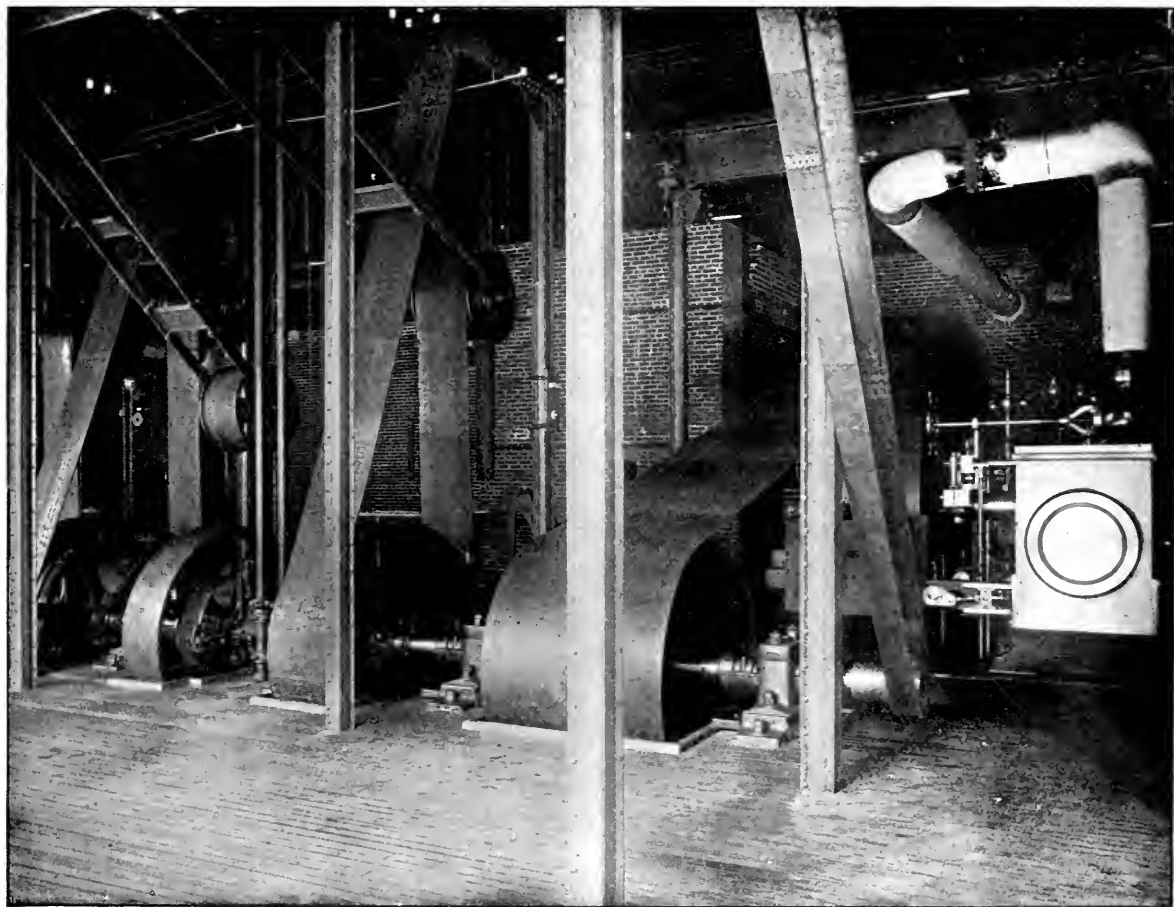

END VIEW OF THE LINE SHAFT SHOWN IN PLATE NO. 265.

Illustrating distinctly the clutches and shifting devices by means of which the operator on the second floor is enabled to control the action of the clutches on the floor below.

PLATE No. 267.

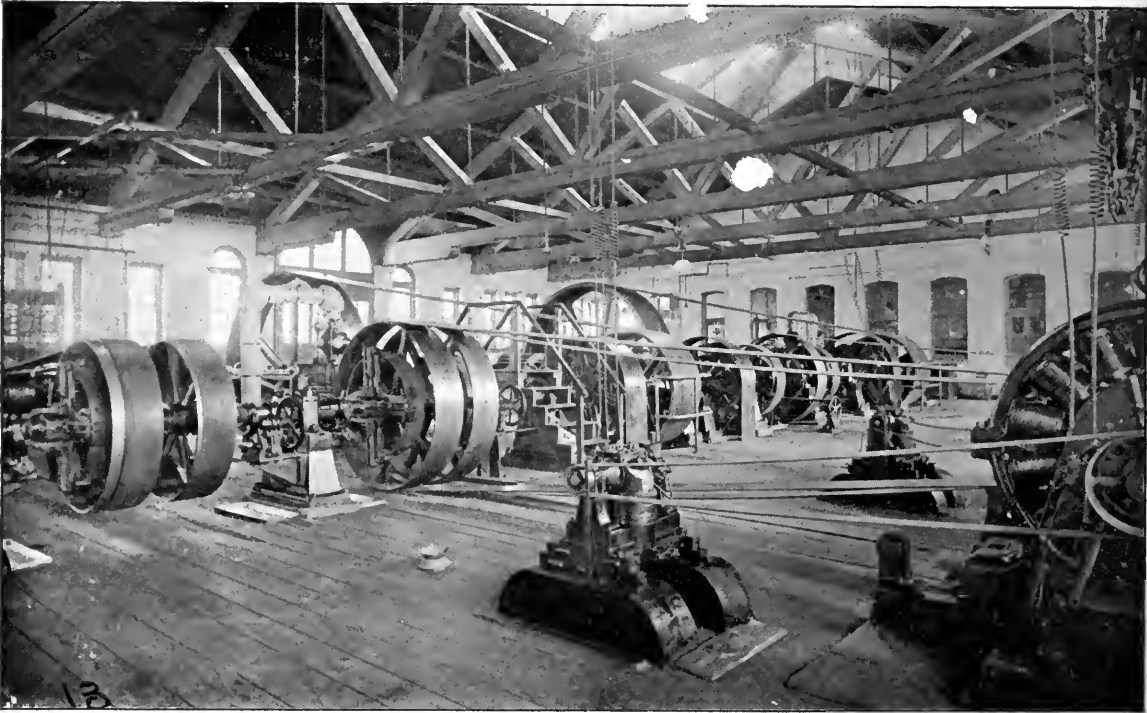

LINE SHAFT IN THE STATION OF THE WEST-END ELECTRIC CO. OF
PHILADELPHIA.

This is, in fact, three separate lines, each having an independent engine, but all so arranged that by means of friction cut-off couplings the three lines can be connected into one, and driven by either of the engines. It will be noticed that these lines are supported and their clutches operated by the pedestal-bearing, floor-stand, and shifting device more fully shown in Plate No. 261, on page 325.

PLATE NO. 268.

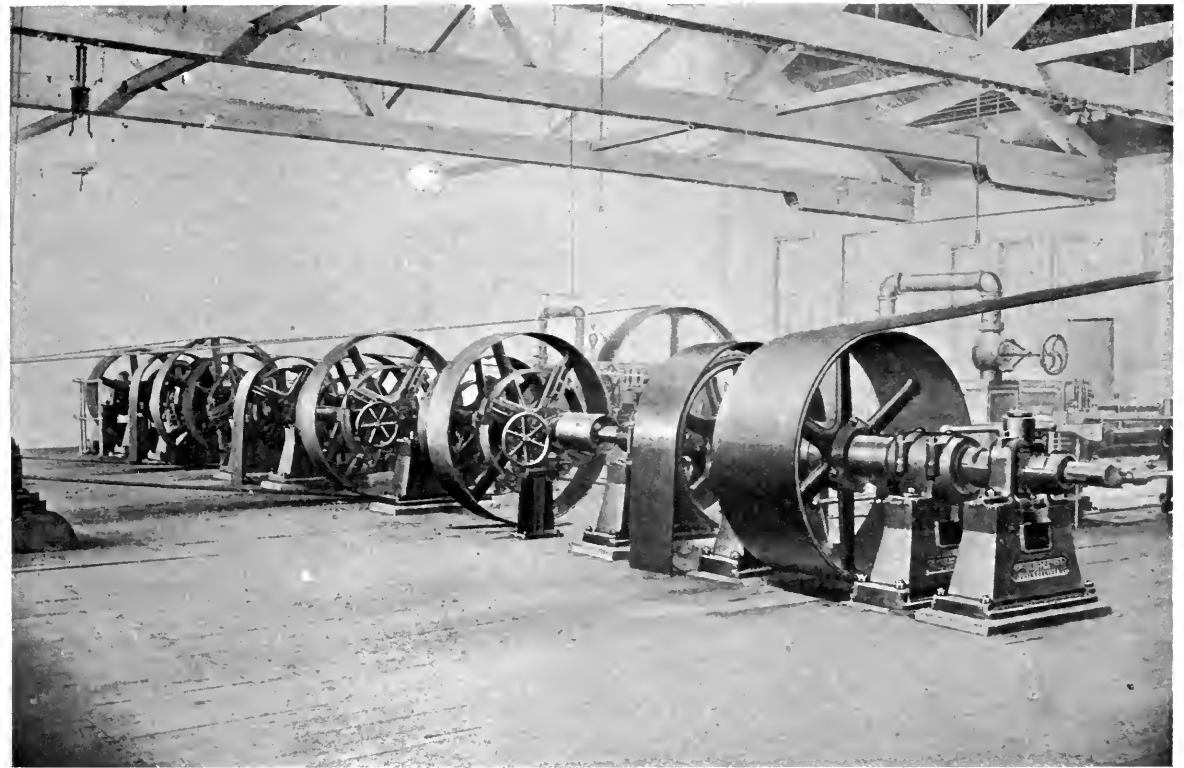

END VIEW OF LINE SHAFT SHOWN ON OPPOSITE PAGE.

The special feature in this view is the mounting of the receiving pulley on a "sleeve" or "quill," which is entirely independent of and apart from the line shaft which runs through it. The two are connected or disconnected by a friction cut-off coupling, so that either can be in motion while the other is at rest, and neither will be exerting any wearing strain upon the other.

Injectors.

IN 1860, the exclusive rights for the manufacture of the Giffard Injector in this country were obtained by our House, and constructive changes were introduced to increase its durability and efficiency and to adapt it to American practice. The most radical of these changes was due to the invention, by William Sellers, of the self-adjusting combining tube. This improvement was the chief feature of our Injector of 1865, which passed through a number of subsequent modifications, and found its final development in our self-adjusting Injector of 1876. The description of this injector in the following pages is fully justified by its extensive use in this and in foreign countries.

In the year 1887 an entirely different form was introduced. Differing essentially in its construction, and containing only fixed nozzles, this injector was designed so as to automatically adjust its water supply to suit any variation of the steam pressure, and, in addition, to re-start automatically after a temporary interruption of the steam or water supply. This instrument has been recently still further improved and is applicable to a wide range of service; it has been adopted by, or is in use upon, most of the leading railroads of this country and upon many of those abroad.

These two patterns of injectors are specially adapted for locomotive service, or to be used in connection with boilers carrying very high steam, or where the pressure is variable. By their use the watchful care on the part of the attendant is reduced to the minimum, and his time and attention can be given to other duties. For stationary boilers, steam tugs, traction or logging engines, a simpler and cheaper form answers equally well, and for such boilers we have designed and recommend our Re-starting Injector.

All our different styles of injectors and valves are manufactured in large quantities, and each part is fitted to and tested by special gauges, insuring accuracy of dimensions and perfect interchangeability of parts, permitting repairs to be made without the necessity of the return of the injector to our works. The size number of each injector is cast in raised figures upon a conspicuous part of the body, and this figure always corresponds to the exact diameter of the smallest orifice of the delivery tube, expressed in millimeters; for instance, the diameter of the delivery tube of a No. 6 Injector of 1876 is 6 millimetres; and of a No. 10½ Injector of 1887, 10½ millimeters; (a millimetre is equal to 0.03937"). Each injector is composed of the simplest form of tube and casing that will produce the desired results, combining the fewest possible movements to start and operate, with high efficiency and small consumption of steam; facility of repair is also well considered, and although beauty of design and finish of parts are not essential to the actual working of the injector, yet they instinctively suggest greater care upon the part of the operator, and therefore tend indirectly to prolong the life of the instrument.

PLATE NO. 269.

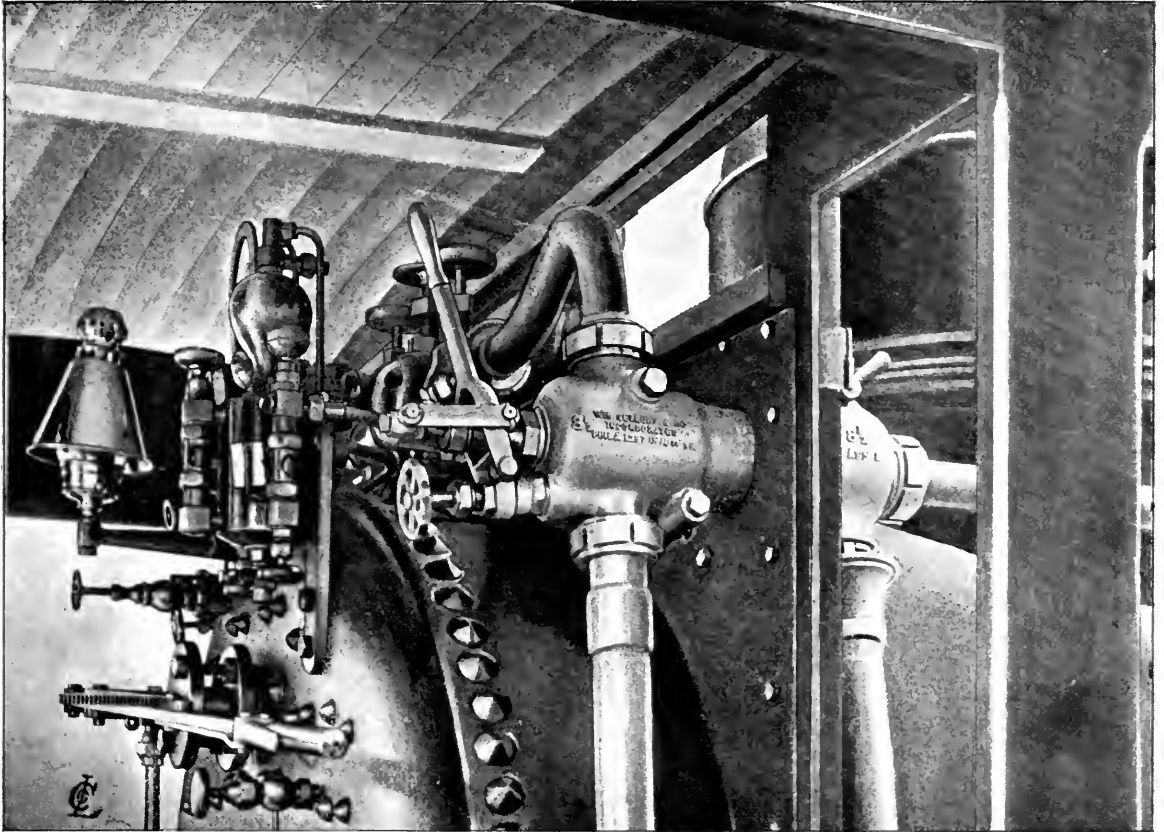

VIEW OF LOCOMOTIVE CAB.

Showing the method of attaching the Self-Acting Injector of 1887. The door of the cab has been removed to show the waste-pipe, the frame fits neatly around the injector body, the steam and feed pipes are inside and protected, and the starting lever and the regulating valve are within easy reach of the engineer.

The following pages contain all necessary information regarding the principal kinds of injectors which we manufacture. As each instrument is thoroughly tested upon our own boilers before leaving our works, the accuracy of the tables of capacity can be depended upon.

THE IMPROVED SELF-ACTING INJECTOR OF 1887.

The simplicity of construction of this injector, and the ease with which it can be started and regulated and the certainty of its action, render its use upon locomotives specially advantageous. It is made with several styles of bodies in order to adapt it to the requirements of all railroads. The form in which it was first manufactured is designated as Class L. Its threaded branches for pipe connections and the stay-bolt holes are placed in the same relative positions as those of the 1876 injector, so that injectors of the same size are interchangeable.

Class M, Improved, Plate No. 271, is of special construction, both in the size and the position of the branches; the capacity and method of handling are the same as that of Class N, Improved, and the same parts, with the exception of the body, are used in its construction. It is interchangeable with injectors of other manufacture, such as the Monitor, Ohio, etc.

Class N, Improved, Plate No. 270, is interchangeable with our Injector of 1876; the waste-pipe is a hollow casting or sleeve, which slides over the lower end of the body and is held in place by a jam-nut; it is made removable, so that the body may be placed through a circular hole in the cab-frame of the same diameter as the outside of the body, and is shown in the position it usually occupies in the cab in Plate No. 269. The connections are Pennsylvania Railroad standard.

For places in which the water supply does not have to be lifted, we provide Class N. L., shown in Plate No. 272. Its position upon the locomotive is under the foot-board, and it is so constructed that the overflow valve can be placed on either side of the injector, which is thus either right or left hand. Although the form of these bodies differ, the same tubes are used, and all have the same special features, which may be enumerated as follows:

- a.* Automatic adjustment of feed to suit all variations of steam pressure.
- b.* Automatic re-starting.
- c.* Wide range of capacities.
- d.* High admissible temperature of the feed-water.
- e.* Small expenditure of steam.

A sectional view of a Class N injector, on page 341, shows the constructive features which are common to all. Steam from the boiler is admitted to the lifting steam-nozzle by drawing the starting-lever back a short distance, and when water appears at the overflow it is pulled all the way open; this withdraws the central plug and allows the steam to discharge through the forcing steam-nozzle against the mass of water within the combining tube, forcing it with increased velocity and reducing cross section into and through the delivery tube to the

feed pipe ; there is always a strong suction in the supply pipe, even when the steam-valve is wide open, so that the usual operation of starting is drawing the lever backward with a continuous, steady motion. The minimum is obtained by throttling the water-valve only ; at a steam pressure of 120 pounds, the amount of water delivered can be reduced to 36 per cent. of the maximum, and to 42 per cent. of the maximum at 180 lbs. steam, while the range is still greater at lower boiler pressures ; although it is always more advantageous to use cold feed-water, as it enhances the certainty of action of all forms of injectors and increases the capacity, it is possible to feed a boiler at 120 pounds of steam with this injector when the temperature of the supply is 120 degrees Fahrenheit without interfering with the automatic action ; if the waste-valve is closed by means of the small lever over the waste-valve, the temperature may be raised to 136 degrees before the injector refuses to operate.

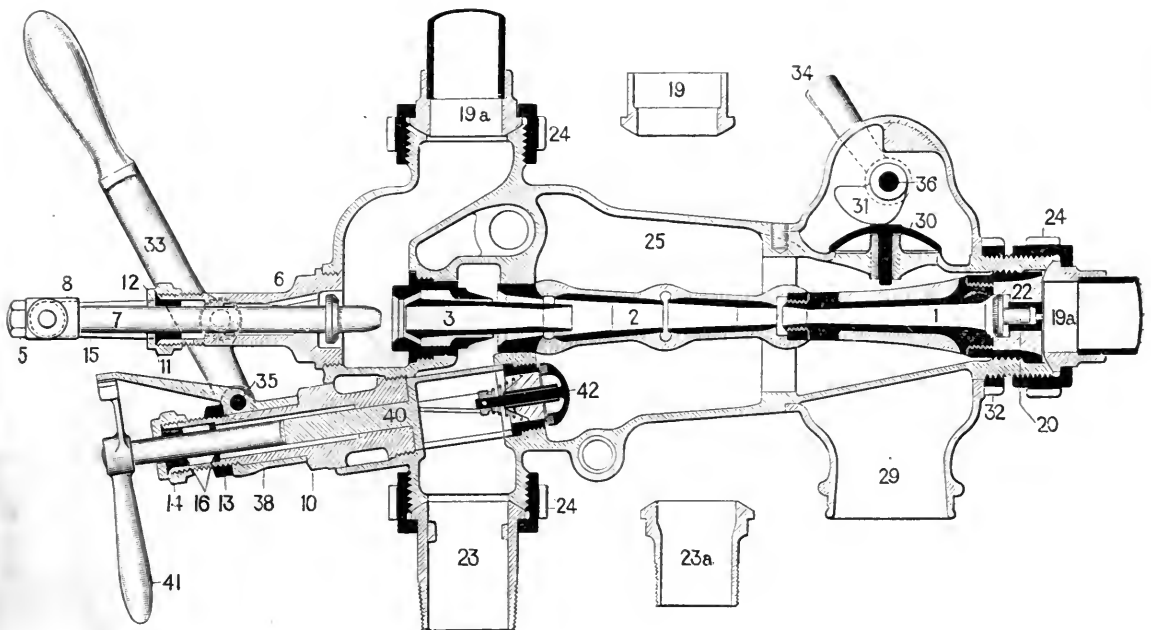

When it is especially desired to use supply water at a high temperature, a new form of this injector (Class K.) can be supplied, for which the limiting temperature is 145 degrees at 120 pounds of steam, and 140 degrees at 180 pounds pressure. The capacity of these injectors is given in the following table, which is based upon recent improvements that have largely increased the delivery at 180 and 200 pounds steam pressure.

TABLE I.

SIZE No.	CAPACITY PER HOUR. LIFTING 5 FEET.						DIMENSIONS OF PIPES. CLASSES L, N; N, L.				
	STEAM PRESSURE 60 LBS.		STEAM PRESSURE 120 LBS.		STEAM PRESSURE 180 LBS.		STEAM AND DELIVERY.		WATER SUPPLY		OVERFLOW.
	Cubic Feet.	Gallons.	Cubic Feet.	Gallons.	Cubic Feet.	Gallons.	Iron. Inside.	Copper. Outside.	Iron. Inside.	Copper. Outside.	Iron. Inside.
4 $\frac{3}{10}$	55	412	71	532	69	517	1''	1 $\frac{1}{4}$ ''	1''	1 $\frac{1}{4}$ ''	1''
5 $\frac{1}{10}$	89	667	121	907	131	982	1 $\frac{1}{4}$ ''	1 $\frac{1}{2}$ ''	1 $\frac{1}{2}$ ''	1 $\frac{3}{4}$ ''	1 $\frac{1}{2}$ ''
6 $\frac{1}{2}$	129	967	175	1312	190	1425	1 $\frac{1}{4}$ ''	1 $\frac{1}{2}$ ''	1 $\frac{1}{2}$ ''	1 $\frac{3}{4}$ ''	1 $\frac{1}{2}$ ''
7 $\frac{1}{2}$	172	1290	233	1747	253	1897	1 $\frac{1}{4}$ ''	1 $\frac{1}{2}$ ''	1 $\frac{1}{2}$ ''	1 $\frac{3}{4}$ ''	1 $\frac{1}{2}$ ''
8 $\frac{1}{2}$	221	1657	300	2250	326	2445	2''	2''	2''	2 $\frac{1}{4}$ ''	2''
9 $\frac{1}{2}$	277	2077	374	2805	407	3052	2''	2''	2''	2 $\frac{1}{4}$ ''	2''
10 $\frac{1}{2}$	338	2535	457	3427	497	3727	2''	2 $\frac{1}{4}$ ''	2''	2 $\frac{1}{4}$ ''	2 $\frac{1}{2}$ ''
11 $\frac{1}{2}$	405	3037	549	4117	596	4470	2 $\frac{1}{2}$ ''	2 $\frac{3}{4}$ ''	2 $\frac{1}{2}$ ''	2 $\frac{3}{4}$ ''	3''

THE INJECTOR OF 1876.

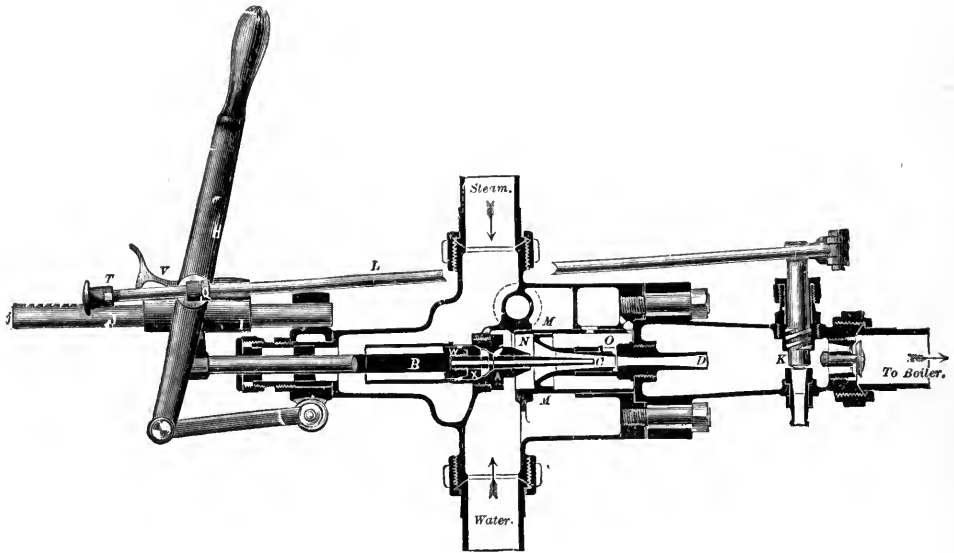

The principle of the movable combining tube of the injector of 1876 depends upon the change in the internal condition of the jet at the mouth of the delivery tube, whenever there is a deviation from the correct proportions of water to steam. By means of an overflow space at the lower end of the combining tube, communication is established between the jet and the piston of the combining tube; an excess of water supply will cause an overflow from the jet at this point, forcing the combining tube toward the steam-nozzle, and reducing the area for the inflow of water until the normal condition of the jet is re-established.

A deficiency of water causes a reversal of this action and a downward movement of the tube until the correct proportions again obtain. By this means the maximum efficiency of the steam jet can be obtained under varying conditions; the capacity of the injector increases as the steam pressure rises, and the temperature of the water delivered to the boiler upon the minimum is almost precisely the same as that of the maximum; the former capacity is obtained by reducing the steam discharge by inserting a taper-spindle in the steam-nozzle.

Referring to the sectional view on page 342, H is the starting-lever, which is drawn back a short distance until the resistance of the main steam-valve X is felt; this movement admits steam to the hollow spindle C, which discharges through the delivery tube D, and produces a partial vacuum in the suction-pipe. When water appears at the overflow, the starting-lever is drawn all the way back, striking against the nut T, and closing the waste-valve K by means of the connecting-rod, forcing the water to enter the boiler. The regulation of the capacity is effected by adjusting the position of the lever by means of the steel latch V on the guide-rod J; this alters the area of steam discharge by changing the distance of insertion of the taper steam-spindle, and any variation of the weight of steam discharged induces an automatic movement of the combining tube, which preserves the correct ratio between the weights of the water and the steam. An air-chamber, cored in the body, is connected with the column of water in the suction-pipe, so that all shocks or jars will be reduced by the elasticity of the enclosed air and lessen the danger of breaking the jet.

The position and sizes of the threaded branches of the injector of 1876 have been adopted by the Pennsylvania Railroad as the standard; all sizes are interchangeable with corresponding sizes of our Class L and Class N of the 1887 pattern. This injector is very conveniently arranged for operating, as it is started, regulated, and stopped by means of a single lever, requiring no hand adjustment for any variation of the pressure of steam, height of lift, or temperature of the feed water. The ratio of the minimum capacity to the maximum is 50 per cent., and the feed temperature may be raised to 130 degrees before the jet breaks. A list of capacities at 120 pounds steam pressure is given below.

TABLE II.

SIZE No.	CAPACITY PER HOUR.		DIAMETERS OF PIPES.			
	STEAM PRESSURE, 120 LBS.		STEAM AND DELIVERY.		WATER SUPPLY.	
	Cubic Feet.	Gallons.	Iron. Inside.	Copper. Outside.	Iron. Inside.	Copper. Outside.
3	38	285	$\frac{3}{4}$ "	1"	$\frac{3}{4}$ "	1"
4	72	540	1"	1 $\frac{1}{2}$ "	1"	1 $\frac{1}{2}$ "
5	112	840	1 $\frac{1}{4}$ "	1 $\frac{3}{4}$ "	1 $\frac{1}{2}$ "	1 $\frac{3}{4}$ "
6	162	1215	1 $\frac{1}{2}$ "	1 $\frac{3}{4}$ "	1 $\frac{1}{2}$ "	1 $\frac{3}{4}$ "
7	220	1650	1 $\frac{3}{4}$ "	1 $\frac{3}{4}$ "	1 $\frac{1}{2}$ "	1 $\frac{3}{4}$ "
8	290	2175	2"	2"	2"	2 $\frac{1}{4}$ "
9	365	2737	2"	2"	2"	2 $\frac{1}{2}$ "
10	453	3397	2"	2"	2"	2 $\frac{1}{2}$ "

PLATE No. 270.

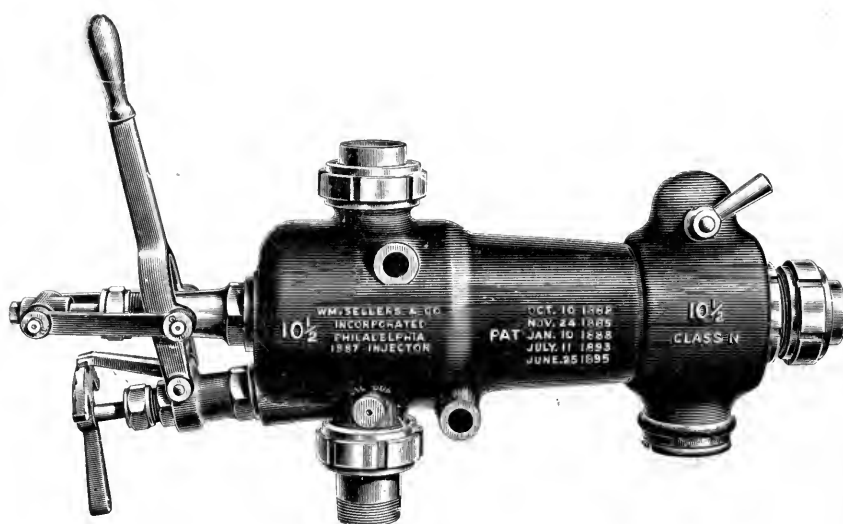

THE SELF-ACTING INJECTOR OF 1887, CLASS N, IMPROVED.

Automatically adjusts the water supply to suit all changes in the steam pressure without wasting at the overflow. Re-starts automatically. Lifts promptly and feeds steadily with hot suction-pipe. Pennsylvania Railroad standard connections. Capacities given in Table I., page 342.

PLATE No. 271.



THE SELF-ACTING INJECTOR OF 1887, CLASS M, IMPROVED.

Automatically adjusts the water supply to suit all changes in the steam pressure without wasting at the overflow. Re-starts automatically. Lifts promptly and feeds steadily with hot suction pipe. Interchangeable with "Monitor" and other patterns of Injectors. For capacity, see Table I., page 342.

PLATE No. 272.

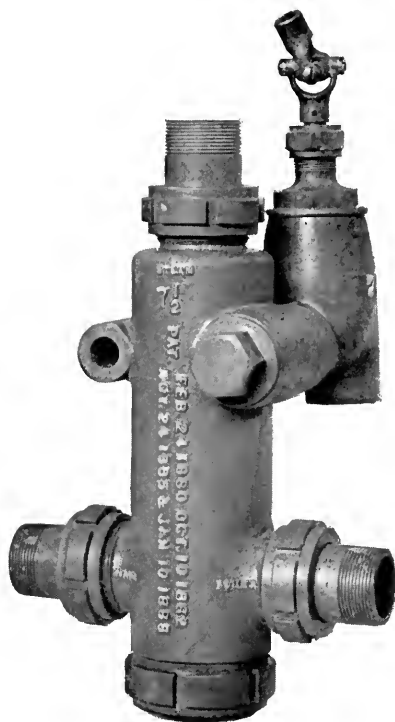

INJECTOR OF 1887, CLASS N, L.

Designed to be used under slight head of water ; other characteristics are the same as those of Classes L, M, and N. Automatic and self-adjusting ; capacity given in Table I.

PLATE No. 273.

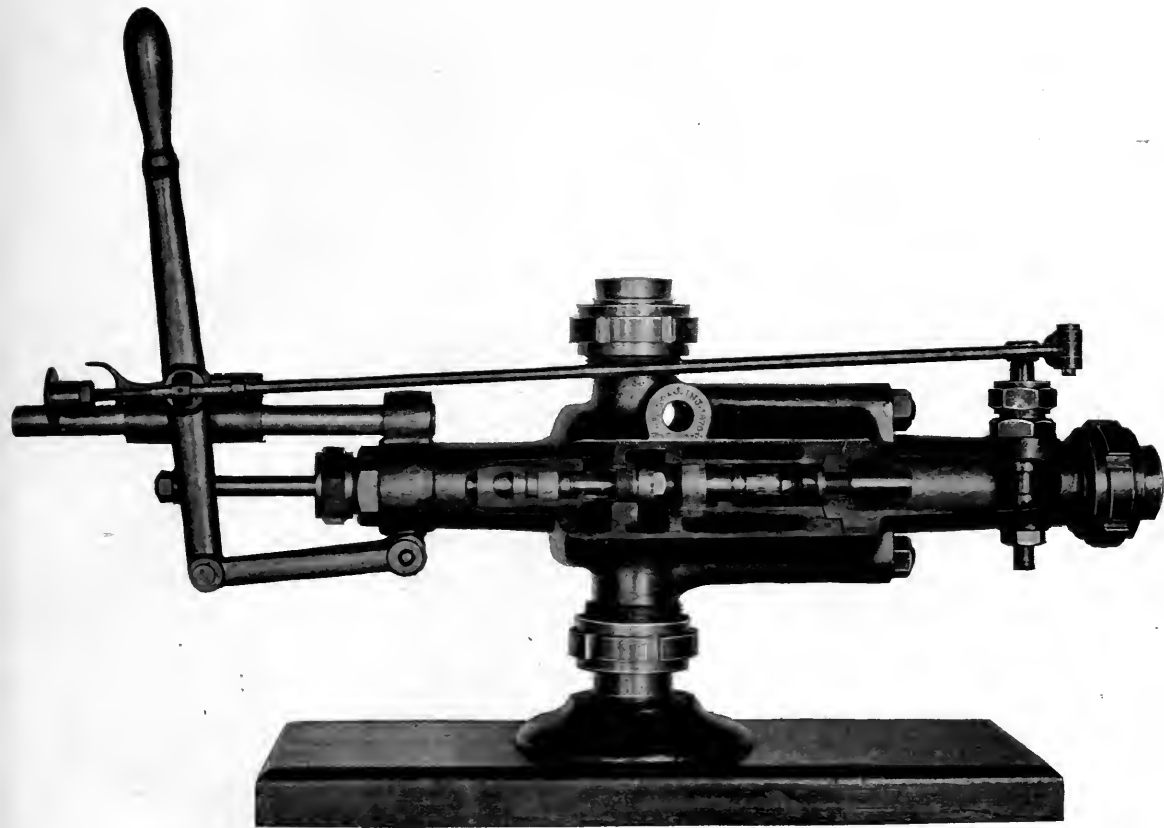

SELF-ADJUSTING INJECTOR OF 1876.

Part sectional view. Injector is operated entirely by one lever. Self-adjusting throughout widest ranges of steam pressures. Pennsylvania standard. Capacities given in Table II., page 343.

Sellers' Restarting Injector.

SCREWED OR FLANGED CONNECTIONS.

OUTSIDE views of the screwed and flanged Sellers' Restarting Injector are shown. The branches or flanges for steam, water supply and feed are conveniently arranged, so that all the pipes may be placed close against the boiler wall. The overflow is directly under the water branch and can be provided with a drip funnel and discharge pipe, without bending or springing the other pipe connections. The steam nozzle and delivery tubes are screwed into the body, and do not depend upon the pressure of the steam or of the delivery to hold them in place, so that there is no danger of leakage at these important shoulders. The body and tubes are constructed of the best bronze and are designed to give the longest service with the least amount of attention and repair.

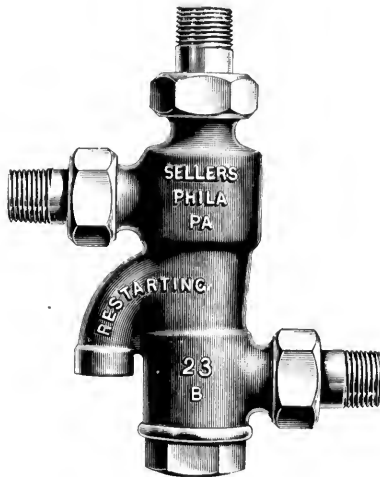

SCREWED CONNECTION.

The Injector is simply constructed, and contains but few parts. It is automatic in its action, restarting instantly after a temporary interruption of the steam or water supply. It raises the water promptly on long lifts, with hot or cold pipes, and gives a good range of capacities.

The Injector is simply constructed, and contains but few parts. It is automatic in its action, restarting instantly after a temporary interruption of the steam or water supply. It raises the water promptly on long lifts, with hot or cold pipes, and gives a good range of capacities.

A sectional view is given on page 349. Steam enters at the top and passing through the steam nozzle, No. 3, discharges through the draft tube, No. 11, into the overflow chamber and thence to the air, lifting the water to the injector. The partial vacuum caused by the condensation of the steam within the combining tube raises bushing No. 5 up against the draft tube and holds the lower bushing, No. 6, against the delivery tube, thus preventing the admission of air.

Upon removing the cap at the lower end of the body, the end of the delivery tube will be seen projecting below the lower face of the body; a monkey wrench may be used to unscrew this tube, drawing out the tubes and the overflow bushings at the same time.

The size numbers of these injectors are based upon the diameter of the delivery tube expressed in the tenths of millimeters; No. 16, for instance, is $\frac{1}{16}$ millimeters in diameter. The pattern



FLANGED.

or series, is indicated by one or more letters; thus, A, or C, or AB. Always give all the figures and letters cast on the body when ordering parts for repair.

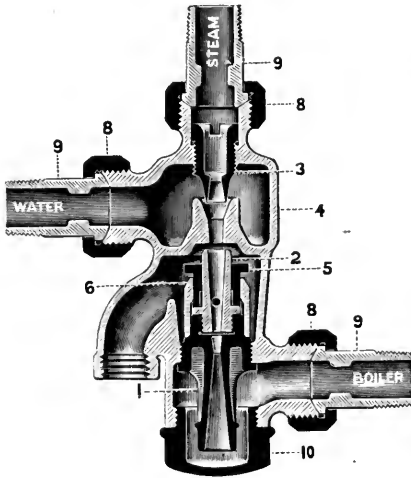

Size of Pipe Connections, Capacities and Horse Power.

Size Number.	Size of Pipes. Steam, Water and Delivery.	Capacity, Gallons per Hour. 80 lbs. Steam. 5 feet lift.		Horse Power, Medium Pressure Throttling Engine.
		Maximum.	Minimum.	
16	3"	56	35	2 to 6
20	3"	95	56	6 to 10
23	3"	127	64	10 to 15
27	3"	176	86	15 to 20
33	3"	263	130	20 to 30
40	3"	386	165	30 to 45
45	1"	488	204	45 to 65
50	1"	603	253	65 to 90
57	1 1/2"	784	329	80 to 120
64	1 1/2"	988	395	100 to 140
75	1 1/2"	1350	594	140 to 175
86	1 1/2"	1773	780	175 to 240
98	2"	2300	1010	240 to 300
110	2"	2900	1276	300 to 400
120	2"	3450	1520	400 to 950

FOR STATIONARY, PORTABLE,
TRACTION, MARINE BOILERS, ETC.



I N D E X .

	PAGE		PAGE
Accumulator, hydraulic,	228, 229	Carrier pulleys,	329
Angle belt-drive,	329-331	Centre heads for shapers,	144
Angle bending machines, 231-233		Channel-bar punch,	187-191, 195
belt driven,	231, 232	Chasing lathe,	100
hydraulic,	233	Cold saw,	130
Awards,	4	Cotter drill,	42
Axle lathes,	106, 107	Couplings for shafting,	328
Baldwin Locomotive Works,		Crab hoist,	260, 261
cranes,	265, 267, 269, 288, 300	Cranes,	262-301
Beam-bending machines,	231-233	car,	272, 273
multiple punches,	187-191	gantry,	281
straightening machines,	231-233	hydraulic,	274-277
Bearings, pedestal,	325	jib,	263-277
quill,	337	locomotive,	273
self oiling,	326	swing,	263-279
step,	329	travelling,	278-301
Bending rolls,	234-245	Cylinder boring machines,	
Bending machines for beams, 231-233		56-60, 62-65	
for pipe,	283	Dies for bolt cutters,	6, 8
Boiler drills,	30-33	Diplomas,	4
Bolt cutters,	6-11	Double traverse drill,	24, 25
Boring bars,	65	Drill grinding machine,	118-120
Boring bench,	98-99	pointing attachment,	118, 119
Boring machines,	44-69	Drilling machines,	12-55
car wheels,	66-69	boiler shells,	30-33
cylinders,	56-60, 62-65	connecting rods,	24, 25
floor,	50-55	cotter,	42
horizontal,	44-63	coupling marine,	48
pulleys,	66	eye-bars,	24, 25
quartering,	49	horizontal,	44-55
Boring and turning mills,	70-79	multiple,	26-33
5 feet,	70, 76	rail,	18-23
6 feet,	74	radial,	36-41
7 feet,	71, 75, 77	traverse,	42-43
8 feet,	72	universal,	34, 35
10 feet,	73	vertical,	12-17
12 feet,	78, 79	wheel,	29, 49
for steel tires,	74, 77	Drill presses, vertical,	12-43
with sliding upright,	73, 79	Drills, correct shape,	118
Cages, hoisting,	256	Dynamometer, traction,	317
Cannon, turning and boring,	98-99	Electric cranes,	262-301
Car cranes,	272-273	Emery, A. H. testing machines, 309-322	
Car wheels, boring machine,	60-69	Eye-bar drilling machine,	24, 25
lathe,	101	Facing machine, pipe flanges,	61
presses,	250-253	Fish-plate punches,	192, 193

	PAGE		PAGE
Flange facing machine,	61	Lathes, 60",	90, 91
Forcing machine, hand,	246, 249	72",	92, 96, 97
Gag-block for punches,	178	96",	98, 99
Gap-lathe,	94-98	122",	98
Gear-cutter,	131	axle,	106, 107
Giffard, H. J., injector,	338	chasing,	100
Grinding machine, drill,	118-120	gap,	94, 95, 96, 98
tool,	121-129	gun,	98, 99
Grindstone box,	117	roll,	91
Guns, 16" lathe,	98, 99	pulley,	104, 105
Hammers, steam,	204-213	turret,	100, 108
single upright,	205-211	wheel,	101, 109-116
double upright,	212, 213	rock shaft,	102, 103
table of sizes,	208	Lubrication of shafting,	326, 328
Hand forcing machine,	246, 247	Mandrel presses,	248, 249
Hanger-boxes,	326-328	Medals awarded,	4
Hanger for shafting,	326	Medal press,	254, 255
Hobs for bolt cutters,	8	Milling machines,	131-137
Hoisting attachments, wheel boring,		gear cutting,	131
67-69		horizontal,	132-135
for wheel lathe,	112-115	for test specimens,	134-136
Hoisting cages,	256	vertical,	136, 137
crabs,	260, 261	Millwrighting,	334
machines,	256-261	Mint, U. S. press for,	254, 255
Hydraulic, bending machines,	233	Mixing machine for sand,	302
cranes,	274-277	Pedestal bearings,	325
presses,	233, 250-255	Pennsylvania R. R. cranes	274-277
testing machine,	309-322	injector connections,	343, 344
I-beams, punches,	187-191	Pillar cranes, hydraulic,	274, 275
Injectors,	338-349	steam,	265
capacity,	342, 343-349	Planing machines,	156-177
history of,	338	shifting belt,	156-163
interchangeability of parts,	338-340	spiral geared,	164-169
method of attaching,	339	for connecting rods,	170
not affected by jars,	343	for frames,	171
small expenditure of steam,	340-343	for plates,	175-177
temperature of feed-water,	341	for rails,	172
tested before shipment,	340, 341	for switches,	172
wide range,	340-343	table of sizes,	158
Injectors of 1876,	342-344, 347	Planing machines, rotary	138, 139
1887,	339-342, 344-326	Plate girder punches,	188-191
restarting,	348, 349	Plate planers,	175-177
Lathes,	80-116	Presses, hand-forcing,	246-249
12",	81	hydraulic bending,	233
16",	83	mandrel,	248, 249
20",	85, 94, 95, 100	medal,	254, 255
25",	86	wheel,	250-253
36",	87	table of sizes,	250
36", rock shaft,	102, 103	Pulleys,	328-332
42",	88	boring machines,	66
48",	89	carrier,	329

	PAGE
Pulleys, friction,	330
lathe,	104, 105
rope,	332
Pump, accumulator,	228, 229
testing machine,	313
wheel press,	250
Punching machines,	178-195
combined,	180, 181
crank,	179-181
horizontal,	194, 195
lever,	182-195
multiple,	187-191
spacing,	182, 188, 191
splice plate,	192, 193
Punching and shearing machines,	178-203
Quartering attachment for lathes,	110-115
Quartering machine,	49
Quarter twist belt,	329
Quill bearing,	336, 337
Radial drilling machines,	36-41
Rail drilling machines,	13-23
Railway turntables,	303-308
Riveting machines,	214-227
hydraulic,	215-219
portable,	222-227
pneumatic,	222, 223
steam,	214, 220, 221
Rolls, bending,	234-245
for boiler work,	234, 236-245
for ship plates,	241-243
hand,	235
vertical	244
straightening,	245
Roll turning lathe,	91
Rope transmission,	330-332
Rotary Planer,	138, 139
Sand-mixing machine,	302
Saw, cold,	130
Scale for hydraulic testing machine,	312-315
Screwing machines,	6-11
Screw threads,	8
Setting machine, for angles,	232, 233
Shafting,	323-337
couplings,	328
friction clutches for,	330
history of development of manufacture,	324
lubrication of,	326-328

	PAGE
Shafting, millwrighting department,	334
price-list,	326, 337
quill-bearing,	336, 337
rope transmission,	330-332
scale of prices for each article,	324
skillful erection,	334
standard articles kept in stock,	326
and nominal sizes of shafts,	326
tables for laying out and proportioning,	326
vertical,	329
Shafts, hand-forcing machine for,	246, 247
straightening machine for,	231
Shaping machines,	140-147
centre heads,	144
cylinder,	145
double,	142, 143
driving box,	146, 147
planing and slotting,	174
Shearing machines,	196-203
crank,	196
lever,	197
for angles,	202, 203
for bars,	198-200
for plates,	201
Sheaves for rope transmission,	332
Ship plates, bending rolls,	241-243
Slabbing machine,	134, 135
Slotting machines,	148-155
30" to 72",	148-152
for locomotive frames,	154, 155
for locomotive links,	153
for locomotive cylinder ports,	153
for plates,	153
Spacing carriage for punch,	190, 191
table for punch,	182, 188, 189
Splice-plate, punch,	192, 193
Steam hammers,	204-213
Straightening and bending machines for angles,	231-233
for beams,	232
for shafts,	231-233
Straightening and bending rolls,	245
Testing machines, hydraulic,	309-322
absence of knife-edges and friction,	309
pump,	313
scale,	312-315
support,	310, 311, 312

	PAGE		PAGE
Testing machines,		Turntables, railway,	303-308
weighing-head,	316	shop,	305-307
Test Specimens, milling		Universal drill,	34,35
machines for,	134-136	Wheel, car, boring machine,	66-69
Tires, steel, boring and turning,	74-77	lathe,	101, 109-116
Tool grinding machine,	121-129	drill,	29, 49
Tools, cutting, shapes,	127,128,129	Wheel press, hand,	246-249
Traverse drill,	42,43	hydrostatic,	250-253
Turning and boring mills,	70-79	Whitworth, screw thread,	8

13
 —
 871



**PLEASE DO NOT REMOVE
CARDS OR SLIPS FROM THIS POCKET**

UNIVERSITY OF TORONTO LIBRARY

TJ
1190
S46
1899

ENGIN.

