

UC-NRLF

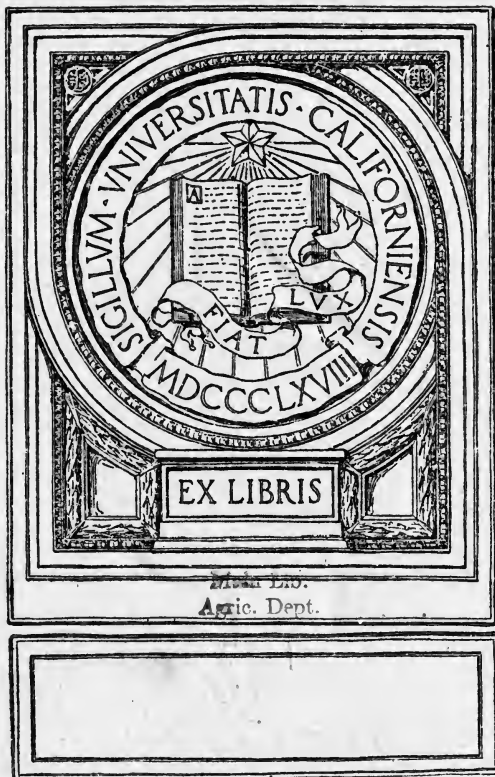

8 3 071 489





EX LIBRIS

MDCCLXVIII.
Agric. Dept.

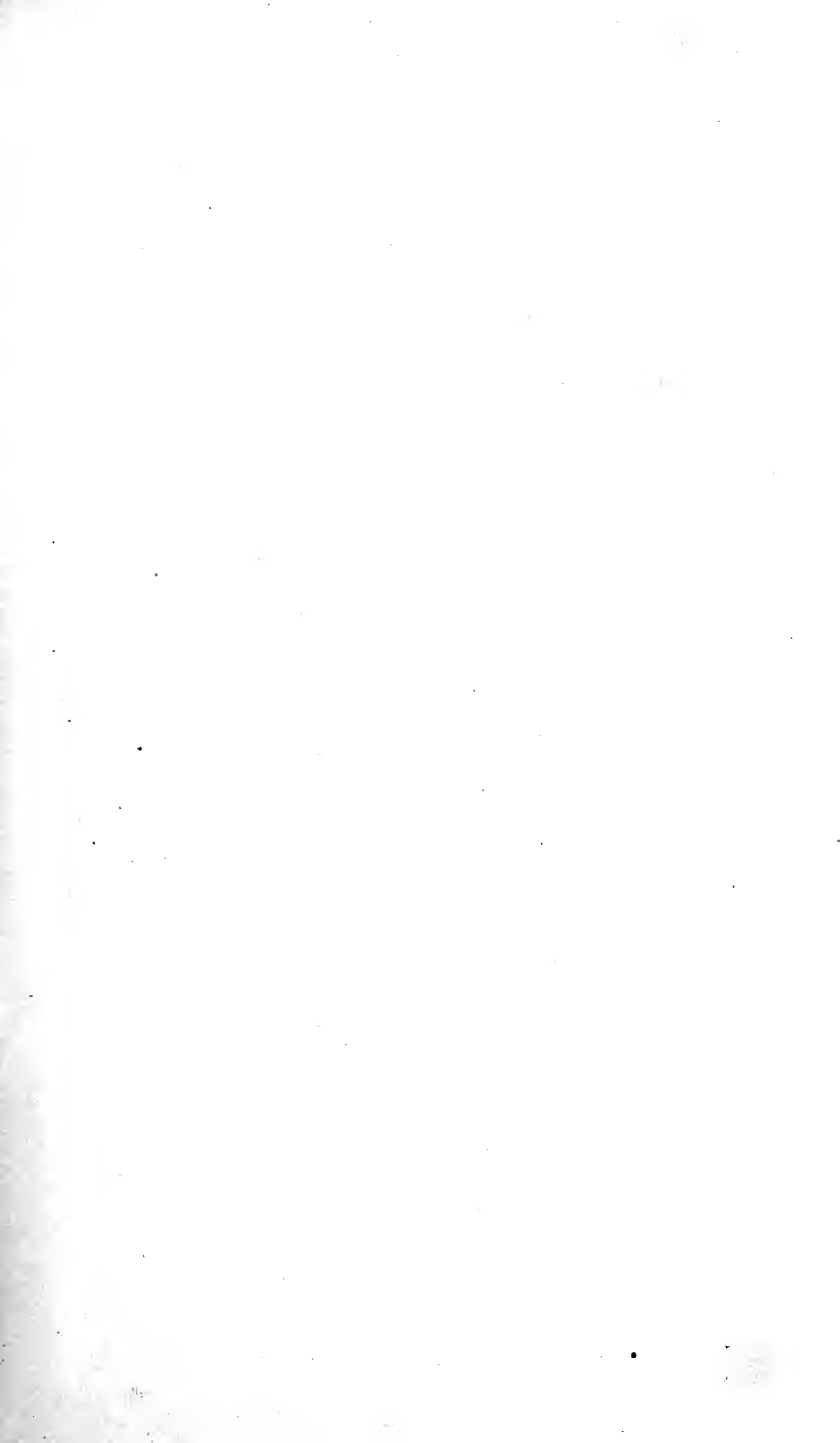

Digitized by the Internet Archive
in 2007 with funding from
Microsoft Corporation

United States Department of Agriculture,

BUREAU OF CHEMISTRY—Circular No. 69.

H. W. WILEY, Chief of Bureau.



IMPROVEMENTS IN THE KNORR FAT EXTRACTION APPARATUS.¹

By H. L. WALTER and C. E. GOODRICH, *Assistant Chemists, Miscellaneous Division.*

The common form of Knorr extraction apparatus presents a few difficulties in manipulation, some of which the authors have effectively overcome. These difficulties are:

(1) In many cases the ether which condenses in the lower part of the condenser can not return freely to the flask because the extraction tube fits too snugly in the mouth of the flask. In this case all the ether soon collects in the space *C*, figure 1, and the flask becomes dry.

(2) There is a tendency for many of the samples, together with layers of the asbestos felt, to push upward in the tube by the expansion of air and ether vapor which they inclose.

(3) When a sample is very fluffy, as alfalfas, for example, the ether runs through so rapidly that it fails to reach all parts of the sample, and consequently gives a poor extraction.

(4) The form of extraction tube ordinarily employed has several disadvantages which will be discussed later.

The first of these difficulties was overcome as follows: A glance at figure 1 will show that the escape of ether vapor from the flask of the Knorr extraction apparatus is accomplished by supporting the tube *A* upon the flask by means of three glass projections *D* on the lower part of the tube, which raise it somewhat above the rim of the flask. This is easily accomplished, even though only a small space is left between the

flask and the tube, but those who have used the tube to any extent know that considerable ether condenses in the lower part of the condenser and soon fills the space *C* above the mercury seal. After enough has condensed to reach the top of the flask, the ether begins to flow back into it. To take care of this return flow is very difficult, and in many cases impossible, without using some other means to support the extraction tube.

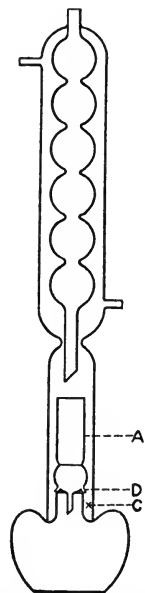

FIG. 1.—Old form of Knorr extraction apparatus.

¹To insure the free use of this invention to the public, letters patent have been applied for.

Two holes in the neck of the flask effectually overcame the trouble, besides making possible other valuable improvements in the apparatus. Figure 2 shows the flask with the holes. It will be noticed that the amount of ether collected in the space *C* when the flask with this modification is used is much less, making a saving of about 10 cc in each extraction.

The holes are about one-fourth of an inch in diameter and are placed opposite each other at a distance approximately one-fourth of an inch above the upper mercury line or above the line of the trough.

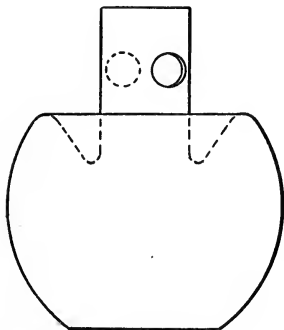

FIG. 2.—Modified form of flask.

The second and third difficulties were overcome by means of a simple spring shown in figures 3 and 4, a description of the spring and its uses being given in the following paragraphs.

It is well known to all who have used the Knorr ether extraction apparatus that the sample and sometimes layers of asbestos are pushed up toward the top of the tube by the expansion of the air and ether vapor which they inclose. Not only is there danger of losing in this way the sample for the crude fiber determination, but there is a chance of foreign substances reaching the interior of the fat flask, and the cushion formed of air, ether vapor, or both, materially checks the ether and extract on their way to the flask. This, as one can readily see, prevents thorough extraction, even though the sample be not pushed over the top of the extraction tube.

The remedy hitherto employed consists in striking gently the portion of the condenser surrounding the tube, at the same time holding the flask to prevent breaking. As a rule this serves

to break up the cushion of air, but it is often necessary to remove the tube from the condenser and push down the sample with a stirring rod. Every time a tube is taken from the condenser there is danger of mercury getting into the fat flask, despite the best precautions.

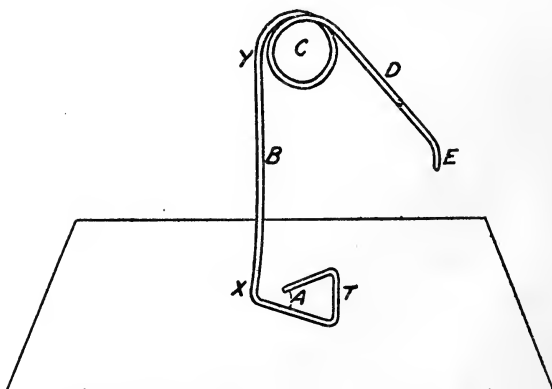

FIG. 3.—Perspective drawing of spring.

Even after the sample has been restored to its proper place in the tube by either of the foregoing methods, the cushion of vapor is likely to form again, requiring a repetition of the procedure just described.

A simple spring was, therefore, designed to avoid this unnecessary care and loss of time. It is made of No. 19 spring brass wire, and is of the form shown in the perspective drawing, figure 3. The parts consist of the upright *B*, at the lower end of which is formed the open equilateral triangle *T*. At the top of *B* the wire is bent into a single coil *C* and extended in the portion *D*, the end of which is bent at *E* to facilitate inserting it in the tube. A slight double curve should be given to *B*, as illustrated in the drawings, so that the points *X* and *Y* shall be in contact with the sides of the tube, thereby holding the apparatus in a vertical position.

The plane of the triangle *T* should be perpendicular to *B*. The length of its sides will vary according to the inside diameter of the extraction tube and should

be such as will allow a slight amount of play. The plane in which *B* and *D* lie must bisect the angle *A* to insure an upright position of the apparatus in the tube.

To use this apparatus proceed as follows:

Drop a perforated platinum (or nickel) disk on top of the sample so that it will lie in a horizontal position. Press *B* and *D* between the thumb and forefinger and push the spring down into the tube until *T* presses firmly against the disk; in fact it does no harm to compress the sample slightly. The complete combination is shown in figure 4, *O* being the sample and *P* the disk. *D* presses firmly against the side of the tube, thereby holding the apparatus securely in place at any height.

B should have a length of about 50 mm, and *D* 40 mm, the loop *C* being 15 mm in diameter. It is not necessary to use exactly these dimensions, but care should be taken to have *C* below the top of the

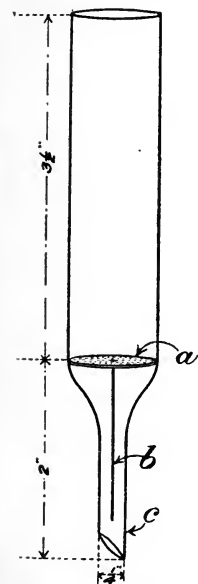

FIG. 5.—New form of extraction tube. *a*, Perforated disk; *b*, Wire riveted to disk; *c*, Size $\frac{1}{4}$ inch.

extraction tube, otherwise the ether in falling from the condenser may strike the wire and be scattered over the side of the tube.

With flasks modified as described it is possible to use the form of tube shown in figure 5. The advantages of this tube over the old form are many. (1) The initial cost is much less, since for most solvents

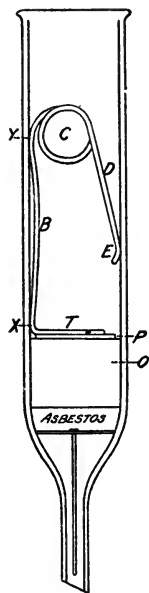

FIG. 4.—Spring in position in tube.

used the disks and wire may be of nickel instead of platinum. A few platinum disks may be kept on hand and used when the nature of the solvent requires it. (2) The sample after being extracted with ether can be much more readily transferred to the crude fiber flask by merely using a glass tube small enough to enter the constricted portion of the extraction tube easily, and pushing out the disk, asbestos mat, and sample. The wire attached to the disk should enter the small glass tube. In most cases this operation takes the sample out clean, but it is very easy to wash out any particles that may adhere to the sides. (3) Many tubes of the old form were defective and not able to stand the vacuum pressure, the disk being drawn into the bulb. Another source of loss was the breakage caused by heating to dry the asbestos felt, a large percentage of tubes developing cracks from the strains due to the projections *D* (fig. 1). The tubes here described, when broken, can be replaced for a few cents and the disks will last for years.

The price of the old tubes is about \$1.30 each, while the new form, with the disk, will cost probably about 10 cents. These modified flasks and tubes have been used in this laboratory for some time and have proved much more satisfactory than the regular form.

Approved:

JAMES WILSON,

Secretary of Agriculture.

[Cir. 69]

○

**RETURN
TO →**

MAIN CIRCULATION

ALL BOOKS ARE SUBJECT TO RECALL
RENEW BOOKS BY CALLING **642-3405**

DUE AS STAMPED BELOW

FEB 01 1996

JAN 23 2005

RECEIVED

NOV 02 1995

CIRCULATION DEPT.

UNIVERSITY OF CALIFORNIA, BERKELEY
BERKELEY, CA 94720

FORM NO. DD6

YC 69407

U. C. BERKELEY LIBRARIES



C051402935

001 67 102



