

ARCHIVES OF NEUROLOGY AND PSYCHIATRY

EDITORIAL BOARD

TRACY J. PUTNAM, Chief Editor

710 West One Hundred and Sixty-Eighth Street, New York 32

LOUIS CASAMAJOR, New York

CHARLES D. ARING, Cincinnati

STANLEY COBB, Boston

ADOLF MEYER, Baltimore

JOHN WHITEHORN, Baltimore

BERNARD J. ALPERS, Philadelphia

PERCIVAL BAILEY, Chicago

WILDER PENFIELD, Contributing Member, Montreal

VOLUME 57
1947

PUBLISHERS
AMERICAN MEDICAL ASSOCIATION
CHICAGO, ILL.

CONTENTS OF VOLUME 57

JANUARY 1947. NUMBER 1

	PAGE
Results of Treatment of Multiple Sclerosis with Dicoumarin. Tracy J. Putnam, M.D.; Ludwig V. Chiavacci, M.D.; Hans Hoff, M.D., and Hyman G. Weitzen, M.D., New York.....	1
Cerebral Blast Syndrome in Combat Soldiers. Lieutenant Colonel Howard D. Fabing, Medical Corps, Army of the United States.....	14
Mechanism of Motion Sickness. Guy Morton, M.D.; Andre Cipriani, M.D., and Donald McEachern, M.D., Montreal, Canada.....	58
The Electroencephalogram and Personality Organization in the Obsessive-Compulsive Reactions. Fred V. Rockwell, M.D., and Donald J. Simons, M.D., New York.....	71
Effects of Pitressin Hydration on the Electroencephalogram: Paroxysmal Slow Activity in Nonepileptic Patients with Previous Drug Addiction. Abraham Wikler, M.D., Lexington, Ky.....	78
Objective Method for Distinguishing Sleep from the Hypnotic Trance. John B. Dynes, M.D., Boston.....	84
Circulation of the Brain and Face: Determinations of Oxygen and Sugar in Arterial and in Internal and External Jugular Venous Blood. Julius Loman, M.D., and Abraham Myerson, M.D., Boston.....	94
Abnormally Large Birth Weights of Psychiatric Patients. Herbert Barry Jr., M.D., Ph.D., Boston.....	98
Obituaries:	
Charles Lewis Allen, M.D.....	102
Dr. C. U. Ariëns Kappers.....	104
Abstracts from Current Literature.....	106
Society Transactions:	
New York Neurological Society and New York Academy of Medicine, Section of Neurology and Psychiatry and Section of Pediatrics.....	118
Philadelphia Psychiatric Society.....	125
Philadelphia Neurological Society.....	128
News and Comment.....	134
Book Reviews.....	135

FEBRUARY 1947. NUMBER 2

Volume Flow of Blood Through the Human Brain. Frederic A. Gibbs, M.D.; Harry Maxwell, M.D., and E. L. Gibbs, with the Technical Assistance of Ruth Hurwitz, Chicago.....	137
Relation of Acute Mucosal Hemorrhages and Ulcers of Gastrointestinal Tract to Intracranial Lesions. George S. Strassmann, M.D., Waltham, Mass....	145
Abreaction in the Military Setting. Major Harold Rosen and Captain Henry J. Myers, Medical Corps, Army of the United States.....	161
Neurogenic Arthropathy (Charcot Joint) Associated with Diabetic Neuropathy: Report of Two Cases. Major D. Bernard Foster, Medical Corps, Army of the United States, and R. C. Bassett, M.D., Ann Arbor, Mich.....	173

FEBRUARY—Continued

	PAGE
Metastases of Uterine Carcinoma to the Central Nervous System: A Clinicopathologic Study. Theodore Lipin, M.D., and Charles Davison, M.D., New York.....	186
Schistosomiasis of the Brain Due to <i>Schistosoma Japonicum</i> : Report of a Case. Captain Charles Wesley Watson, Lieutenant Colonel Francis Murphey and Major Samuel C. Little, Medical Corps, Army of the United States..	199
Electroencephalogram in the Pitressin Hydration Test for Epilepsy. Captain Julius S. Blier and Captain Frederick C. Redlich, Medical Corps, Army of the United States.....	211
Abdominal Rigidity: A Symptom of Concussion of the Spinal Cord. Major Kenneth H. Abbott, Medical Corps, Army of the United States.....	220
Obituaries:	
Walter DeWitt Shelden, M.D.....	228
Nikolai Nilovich Burdenko, M.D.....	231
Christopher Charles Beling, M.D.....	233
News and Comment.....	234
Abstracts from Current Literature.....	238
Society Transactions:	
New York Neurological Society and New York Academy of Medicine, Section of Neurology and Psychiatry.....	255
New York Neurological Society.....	263
Book Reviews.....	275

MARCH 1947. NUMBER 3

Headache: The Teeth as a Source of Headache and Other Pain. Schuyler Robertson, M.D.; Helen Goodell, B.S., and Harold G. Wolff, M.D., New York	277
Central Course of Afferent Fibers for Pain in Facial, Glossopharyngeal and Vagus Nerves: Clinical Observations. Alf Brodal, M.D., Oslo, Norway..	292
Meningeal Reaction with Abscess of the Brain. Bernard J. Alpers, M.D., and Francis M. Forster, M.D., Philadelphia.....	307
Measurements of Pain Sensitivity in Patients with Psychoneurosis. William P. Chapman, M.D.; Jacob E. Finesinger, M.D.; Chester M. Jones, M.D., and Stanley Cobb, M.D., with the Assistance of George Chesley, M.D., and Benjamin L. Landing, A.B., Boston.....	321
Incidence of Combat Fatigue. Commander Philip Solomon (MC), U.S.N.R..	332
Paramyoclonus Multiplex (Friedreich): A Clinicotherapeutic Study. Arthur A. Morris, M.D., Memphis, Tenn.....	342
Retinal Periphlebitis Associated with Paraplegia. B. P. Silfverskiöld, M.D., Stockholm, Sweden.....	351
Congenital Facial Paralysis. J. P. Murphy, M.D., and W. J. German, M.D., New Haven, Conn.....	358
Cogwheel Phenomenon of the Eyes: Its Clinical Significance. Nathan Savitsky, M.D., New York, and N. W. Winkelman, M.D., Philadelphia.....	362
Localized Nontraumatic Neuropathy in Military Personnel. Edwin A. Weinstein, M.D., New York.....	369
News and Comment.....	377

MARCH—Continued

Correspondence :	PAGE
Methods of Frequency Analysis of the Electroencephalogram. George L. Engel, M.D., Rochester, N. Y., and Hudson Hoagland, Ph.D., Sc.D., Shrewsbury, Mass.....	379
Abstracts from Current Literature.....	384
Book Reviews.....	396

APRIL 1947. NUMBER 4

Cerebral Anoxia from High Altitude Asphyxiation: A Clinicopathologic Study of Two Fatal Cases with Unusually Long Survival and a Clinical Report of a Nonfatal Case. Leonard A. Titrud, M.D., Minneapolis, and Lieutenant Colonel Webb Haymaker, Medical Corps, Army of the United States....	397
Cerebellar Medulloblastoma in Adults. Eugene B. Spitz, M.D.; Henry A. Shenkin, M.D., and Francis C. Grant, M.D., Philadelphia.....	417
Static Tremor with Hemiplegia: Report of a Case; Development, Progression for Seven Years and Postmortem Histologic Observations. Fred A. Mettler, M.D., Ph.D.; Leo M. Davidoff, M.D., and Richard Grimes, M.D., New York.....	423
Japanese B Encephalitis: Clinical Observations in an Outbreak on Okinawa Shima. Commander Leon Lewis (MC), U.S.N.R.; Lieutenant Colonel Harvey G. Taylor, Medical Corps, Army of the United States, and Lieutenant Milton B. Sorem (MC), Lieutenant John W. Norcross (MC) and Lieutenant Commander Victor H. Kindsvatter, H(S), U.S.N.R.....	430
Incidence of Anisocoria and Difference in Size of Palpebral Fissures in Five Hundred Normal Subjects. Bernard C. Meyer, M.D., New York.....	464
Relation of Mental Imagery to Hallucinations. Philip F. Durham Seitz, M.D., and Hans B. Molholm, M.D., St. Louis.....	469
Case Reports:	
Medulloblastoma of the Cerebellum, with Survival for Seventeen Years. Wilder Penfield, M.D., F.R.S., and William Feindel, M.D., Toronto, Canada	481
News and Comment.....	485
Abstracts from Current Literature.....	486
Society Transactions:	
New York Neurological Society and New York Academy of Medicine, Section of Neurology and Psychiatry.....	499
Philadelphia Psychiatric Society.....	513
Book Reviews.....	519

MAY 1947. NUMBER 5

Relation Between Electroencephalographic and Histologic Changes Following the Application of Graded Force to the Cortex. Frederic T. Zimmerman, M.D., and Tracy J. Putnam, M.D., New York.....	521
Malignant Chordoma of the Lumbar Region: Report of a Case with Autopsy; Comment on Unusual Metastases to the Brain, Lungs, Pancreas, Sacrum and Axillary and Iliac Lymph Nodes. Arthur A. Morris, M.D., and R. Rabinovitch, M.D., Montreal, Canada.....	547
Histopathologic Changes Associated with Human Poliomyelitis. I. Mark Scheinker, M.D., Cincinnati.....	565

MAY—Continued

	PAGE
Physiology of Botulinus Toxin. Lieutenant Arthur C. Guyton (MC), U.S.N.R., and Captain Marshall A. MacDonald, Medical Corps, Army of the United States	578
Meningeal Gliomatosis: A Study of Forty-Two Cases. Frank E. Polmeyer, M.D., and James W. Kernohan, M.D., Rochester, Minn.....	593
Educability of a "Deteriorated" Epileptic Patient. Doris Twitchell-Allen, Ph.D., Cincinnati.....	617
Case Reports:	
Concussion of the Spinal Cord: Report of a Case with Radiculoneuritic Manifestations. Paul Chodoff, M.D., Washington, D. C.....	623
An Electroencephalographic Study of Helen Keller. William C. Still, New Orleans.....	629
Abstracts from Current Literature.....	633
Society Transactions:	
Philadelphia Neurological Society.....	646
Book Reviews.....	659
News and Comment.....	660

JUNE 1947. NUMBER 6

Loss of Axis-Cylinders in Sclerotic Plaques and Similar Lesions. Tracy J. Putnam, M.D., Los Angeles, and Leo Alexander, M.D., Boston.....	661
Topographic Distribution of Lesions in Central Nervous System in Japanese B Encephalitis: Nature of the Lesions, with Report of a Case on Okinawa. Lieutenant Colonel Webb Haymaker, Medical Corps, Army of the United States, and Albert B. Sabin, M.D., Cincinnati.....	673
Electrocerebral Shock Therapy: A Reconsideration of Former Contraindications. Matthew T. Moore, M.D., Philadelphia.....	693
Electroencephalographic Study of Electric Shock Therapy: Psychotic Patients Treated in a United States Naval Hospital. John D. Moriarty, M.D., Los Angeles, and John C. Siemens, M.D., Larkspur, Calif.....	712
Electroencephalographic Studies Following Electric Shock Therapy: Observations on Fifty-One Patients Treated with Unidirectional Current. André A. Weil, M.D., Cleveland, and Willard C. Brinegar, M.D., Concord, N. H.	719
Special Articles:	
Orientation to Forensic Psychiatry. Henry A. Davidson, M.D., Newark, N. J.....	730
Abstracts from Current Literature.....	756
Society Transactions:	
Boston Society of Psychiatry and Neurology.....	767
Illinois Psychiatric Society.....	777
News and Comment.....	779
Book Reviews.....	780
General Index.....	781

RESULTS OF TREATMENT OF MULTIPLE SCLEROSIS WITH DICOUMARIN

TRACY J. PUTNAM, M.D.

LUDWIG V. CHIAVACCI, M.D.

HANS HOFF, M.D.

AND

HYMAN G. WEITZEN, M.D.

NEW YORK

ETIOLOGY OF MULTIPLE SCLEROSIS

EVIDENCE has been accumulating over recent years which indicates that vascular destruction, or, more specifically, probably a thrombosis of venules, is an essential link in the chain of causation of multiple sclerosis and the related "encephalomyelitides."¹ This evidence may be summarized as follows:

1. Histologic pictures indistinguishable from the lesions of "encephalomyelitis" in the acute stage, and of multiple sclerosis when sufficient time has elapsed to permit gliosis to take place, have been produced experimentally in animals by the retrograde obstruction of cerebral venules² and by the intravenous injection of various coagulants, especially organ extracts.³

2. Similar lesions are also often seen in pathologic material of human origin, following spontaneous thrombosis of veins of a certain size from any cause, or compression of a pial vein by a tumor.⁴

From the Department of Neurology, Columbia University College of Physicians and Surgeons, and the Neurological Institute of New York.

1. (a) Putnam, T. J.; McKenna, J. B., and Morrison, L. R.: Studies in Multiple Sclerosis: I. The Histogenesis of Experimental Sclerotic Plaques and Their Relation to Multiple Sclerosis, *J. A. M. A.* **97**:1591-1595 (Nov. 28) 1931.

(b) Putnam, T. J.: The Pathogenesis of Multiple Sclerosis: A Possible Vascular Factor, *New England J. Med.* **209**:786-790 (Oct. 19) 1933; (c) Evidences of Vascular Occlusion in Multiple Sclerosis and "Encephalomyelitis," *Arch. Neurol. & Psychiat.* **37**:1298-1321 (June) 1937; (d) Lesions of "Encephalomyelitis" and Multiple Sclerosis: Venous Thrombosis as the Primary Alteration, *J. A. M. A.* **108**:1467-1480 (May 1) 1937.

2. Putnam, T. J.: Studies in Multiple Sclerosis: IV. "Encephalitis" and Sclerotic Plaques Produced by Venular Obstruction, *Arch. Neurol. & Psychiat.* **33**:929-940 (May) 1936.

3. Hoefler, P. F. A.; Putnam, T. J., and Gray, M. G.: Experimental "Encephalitis" Produced by Intravenous Injection of Various Coagulants, *Arch. Neurol. & Psychiat.* **39**:799-812 (April) 1938.

(Footnotes continued on next page)

3. Thrombi, usually in venules and veins, have been observed in a large proportion of cases of acute "encephalomyelitis," and of the more acute lesions of multiple sclerosis, by various authors over the past half-century.⁵ A recent survey disclosed that fresh thrombi were observed adjacent to fresh foci in 9 out of 17 cases of multiple sclerosis examined.^{1c} Dow and Berglund⁶ reported similar data. They observed thrombi in 9 of 60 lesions examined, usually adjacent to the more acute plaques. They chose to ignore the other types of evidence here presented, in concluding that the thrombi were the results of the parenchymal degeneration.

In 3 out of 5 cases of multiple sclerosis in which other organs of the body were available for study, thrombi were observed in them. In all 3 cases a recent exacerbation had occurred.^{1c} Changes in the vascular architecture suggestive of the sequelae of an old obstruction are almost always demonstrable.⁷

Thrombosis of cerebral venules is almost regularly observed in cases of acute "encephalomyelitis"—of the postinfectious type, for example.⁸ It occurs also with the experimental "encephalitis" provoked in monkeys by repeated injections of brain extract.⁹

4. The list of exogenous factors which tend to increase the coagulability of the blood and to produce thrombophlebitis—infection, trauma, pregnancy and chilling—as usually given (for example, by Howell¹⁰) corresponds closely with the list of exogenous factors which appear to precipitate the onset or exacerbations of multiple sclerosis (as listed, for example, by von Hoesslin¹¹).

4. Putnam, T. J., and Alexander, L.: Tissue Damage Resulting from Disease of Cerebral Blood Vessels, *A. Research Nerv. & Ment. Dis., Proc.* (1937) **18**:544-567, 1938.

5. Ribbert, H.: Ueber multiple Sklerose des Gehirns und Rückenmarks, *Virchows Arch. f. path. Anat.* **90**:243-260, 1882. Borst: Die multiple Sklerose des Zentralnervensystems, *Ergebn. d. allg. Path. u. path. Anat.* **9**:67-187, 1903-1904. Williamson, R. T.: The Early Pathological Changes in Disseminated Sclerosis, *M. Chron., Manchester* **19**:373-379, 1894.

6. Dow, R. S., and Berglund, G.: Vascular Pattern of Lesions of Multiple Sclerosis, *Arch. Neurol. & Psychiat.* **47**:1-18 (Jan.) 1942.

7. Putnam, T. J., and Adler, A.: Vascular Architecture of the Lesions of Multiple Sclerosis, *Arch. Neurol. & Psychiat.* **38**:1-15 (July) 1937.

8. Putnam, T. J., and Alexander, L.: Disseminated Encephalomyelitis, *Arch. Neurol. & Psychiat.* **41**:1087-1110 (June) 1939.

9. Rivers, T., and Schwentker, F. F.: Encephalomyelitis Accompanied by Myelin Destruction Experimentally Produced in Monkeys, *J. Exper. Med.* **61**:689-702 (May) 1935.

10. Howell, W. H.: A Textbook of Physiology, Philadelphia, W. B. Saunders Company, 1933.

11. von Hoesslin, R.: Ueber multiple Sklerose: Exogene Aetiologie, Pathogenese und Verlauf, Munich, J. F. Lehmanns Verlag, 1934.

5. The clotting mechanism can be shown to be abnormally labile in cases of multiple sclerosis (Simon and Solomon,¹² Simon¹³). Obstructive changes have been observed in the retinal vessels, some of which might be interpreted as thrombotic (Rucker,¹⁴ Franklin and Brickner¹⁵). Abnormalities can be observed in the capillaries of the nail bed in a majority of cases of multiple sclerosis (Gomirato,¹⁶ Chiavacci and Putnam¹⁷).

THEORETIC BASIS FOR USE OF AN ANTICOAGULANT IN TREATMENT OF
MULTIPLE SCLEROSIS

If the venous thrombosis often observed in cases of recent onset is the cause of the fresh lesion, and if thrombi occur in many parts of the body, without obvious local predisposing factors, it would seem reasonable to seek the next prior cause in some abnormality of the clotting mechanism of the blood.

The nature of the abnormality of the blood producing the thrombosis is obscure. Except for the lability of the clotting mechanism described by Simon and Solomon,¹² no disorder of the blood plasma has been demonstrated in cases of multiple sclerosis (nor has any been found in this investigation). There is some evidence which suggests that the tendency to thrombosis may in some sense be allergic (Putnam,¹⁴ Finley,¹⁸ Ferraro¹⁹). Patches of demyelination, with "inflammatory" infiltrations in the acute stages, may be produced by injection of minute doses of tetanus toxin (Claude²⁰; Putnam, McKenna and Morrison^{1a}),

12. Simon, B., and Solomon, P.: Multiple Sclerosis: Effect of Typhoid Vaccine and of Epinephrine on Coagulation of Blood, *Arch. Neurol. & Psychiat.* **34**:1286-1291 (Dec.) 1935.

13. Simon, B.: Blood Coagulation in Disseminated Sclerosis and Other Diseases of Brain Stem and Cord, *Arch. Neurol. & Psychiat.* **48**:509-517 (Oct.) 1942.

14. Rucker, C. W.: Sheathing of Retinal Vessels in Multiple Sclerosis, *Proc. Staff Meet., Mayo Clin.* **19**:176-178 (April 5) 1944.

15. Brickner, R. M., and Franklin, C. R.: Visible Retinal Arteriolar Spasm Associated with Multiple Sclerosis: Preliminary Report, *Arch. Neurol. & Psychiat.* **51**:573-574 (June) 1944.

16. Gomirato, G.: Alterazioni dei capillari in malati di sclerosi multipla e loro significato, *Riv. di pat. nerv.* **53**:148-156 (Jan.-Feb.) 1939.

17. Chiavacci, L. V., and Putnam, T. J.: Capillaroscopic Observations in Cases of Multiple Sclerosis, to be published.

18. Finley, K.: Perivenous Changes in Acute Encephalitis Associated with Vaccination, Variola and Measles, *Arch. Neurol. & Psychiat.* **37**:504-514 (March) 1937.

19. Ferraro, A.: Pathology of Demyelinating Diseases as an Allergic Reaction of the Brain, *Arch. Neurol. & Psychiat.* **52**:443-483 (Dec.) 1944.

20. Claude, H.: Myélite expérimentale subaiguë par intoxication tétanique. *Arch. de physiol. norm. et path.* **29**:843-847, 1897.

by remote infection with *Aspergillus fumigatus* (Ceni and Besta²¹) and by repeated injection of organ extracts (Rivers and Schwentker,⁹ Ferraro and Jervis²²), as well as by single doses of coagulants. Cases in which an acute "encephalomyelitis" or an acute outburst or relapse of multiple sclerosis has followed an acute infection or the injection of protein material are of course common.

If the thrombosis is allergic in origin, it seems unnecessary to suppose that the tissue reaction is due to a local sensitivity, as lesions displaying an extreme "inflammatory" reaction may be produced by bland obstruction of veins or by a single injection of lung extract.³ In any case, it would seem reasonable to suppose that the formation of local lesions might be prevented by decreasing the coagulability of the blood, as has been done in the case of experimental "encephalomyelitis" produced by intravenous injection of coagulants.³

LIMITATIONS OF ALL FORMS OF TREATMENT

In contemplating any form of treatment for multiple sclerosis, one point needs repeated emphasis.²³ Irrespective of theories of pathogenesis, neuropathologists are now well agreed that each sclerotic plaque goes through an acute stage, when the damage is at its height. The lesion is edematous and congested; the myelin is in the early stages of breakdown, and the surviving axis-cylinders show degenerative changes, suggesting impairment of function. At a later stage, the edema subsides; the debris is cleared away, and the axis-cylinders regain a much more normal appearance—all without special treatment. There is every reason to believe that the degree of recovery is fixed at the time the lesion is formed and that the surviving axis-cylinders will regain their function, at least to some extent. Further, it seems idle to hope that any form of treatment will induce regrowth of axis-cylinders once destroyed.

The clinical corollary of these fundamental pathologic facts is clear. It can scarcely be hoped that any form of treatment (beyond ordinary good hygiene) will materially improve the predetermined course of existing symptoms. The only substantial prospect of gain from specific treatment must be in the direction of protection against fresh relapses.

CHOICE OF AN ANTICOAGULANT FOR USE IN TREATMENT

With the apparent nature of the disease and the presumptive limitations of treatment in mind, the next problem would seem to be the choice

21. Ceni, C., and Besta, C.: *Sclerosi in placche sperimentale da tossici aspergillari*, Riv. sper. di freniat. **31**:125-135, 1905.

22. Ferraro, A., and Jervis, G. A.: *Experimental Disseminated Encephalopathy in Monkey*, Arch. Neurol. & Psychiat. **43**:195-205 (Feb.) 1940.

23. Putnam, T. J.: *The Criteria of Effective Treatment in Multiple Sclerosis*, J. A. M. A. **112**:2488-2491 (June 17) 1939.

of an anticoagulant. The properties of heparin and hirudin disqualify them from continuous use with a chronic disease. Cysteine has a feeble anticoagulant power and has seemed to have a corresponding tendency to prevent relapses in cases of multiple sclerosis.²⁴ A careful search was made through the literature for other anticoagulants (in 1937-1939) and none more suitable was found. The announcement of the discovery of dicoumarin (3,3'-methylene-bis-[4-hydroxycoumarin]) in 1941 appeared to furnish a possible solution of the problem.

Shortly after dicoumarin was released for clinical study its administration was begun in suitable cases (May 1942). Its use had to be discontinued for various reasons in some of the original cases, and others have been added at intervals. The drug has been administered in a total of 74 cases for periods up to forty-seven months. For the purposes of this paper, all the cases in which treatment has lasted less than six months, and all those in which the patient has not cooperated satisfactorily, will be disregarded. This leaves us with 43 cases for further analysis.

At the meeting of the American Neurological Association in May 1944,²⁵ Reese presented the results of treatment with dicoumarin, over a period of six months, in a series of 28 cases. His results will be more closely analyzed later ("Comment").

METHOD

In starting the clinical use of dicoumarin,²⁶ we were guided chiefly by the experience of Prandoni and Wright.²⁷ Patients were first hospitalized for a period of two weeks, and their blood prothrombin level was determined before and after the administration of dicoumarin. Hepatic and renal function tests were done, as well as complete blood studies of elements involved in the clotting mechanism. During the first fifteen months of this study, doses of 300 mg. of dicoumarin were given to patients daily for three days, followed by daily doses of 100 to 200 mg. Because of the high incidence of spontaneous hemorrhages in our early experience, it soon became apparent that the drug must be administered with more caution and in smaller doses. Consequently, during the ensuing years, while patients were hospitalized, they were given 150 mg. of dicoumarin for three days, the average daily dose thereafter being in the range of 50 to 100 mg. After discharge from the hospital the patients were given a maintenance dose of dicoumarin, which would be changed at any time, depending on the blood prothrombin level, which was determined at intervals of one to two weeks. Patients

24. Putnam, T. J., and Hoefler, P. F. A.: Cysteine Hydrochloride as an Anti-coagulant for Clinical Use, *J. A. M. A.* **198**:502-509 (Oct.) 1939.

25. Reese, H. H.: Multiple Sclerosis and Dicumarol Therapy, *Tr. Am. Neurol. A.* **70**:78-84, 1944.

26. The dicoumarin was supplied by the Lederle Laboratories, Inc., during the period covered by this study; at present it is being supplied by E. R. Squibb & Sons.

27. Prandoni, A., and Wright, I.: Anti-Coagulants: Heparin and the Dicoumarin—3,3' Methylene-Bis-(4-Hydroxycoumarin), *Bull. New York Acad. Med.* **18**:433-458 (July) 1942.

returned to the hospital at these intervals, at which time venous blood was drawn and subsequent changes in dosage of the medicament made, depending on the prothrombin level. We have found it convenient to have two mornings each week set aside for the drawing of bloods and laboratory work. We have found that the average daily dose required to maintain an adequate prothrombin level in patients receiving this drug over a prolonged period of time is in the vicinity of 50 to 100 mg. On this dosage hemorrhages are rare, but there is still some doubt whether such doses have served to maintain the prothrombin level as adequately as have the higher doses which we were accustomed to give early in the course of this study.

During the first eighteen months of this study, the blood prothrombin time was determined by the viper venom method of Russell,²⁸ using snake venom as a thromboplastin. The normal values with this method were 20 ± 3 seconds. Since then we have used the modification of the Link method proposed by Shapiro and associates for determining prothrombin time and find it to be more satisfactory, because of the constancy of results. In this method a specially prepared lung extract is used as thromboplastin,²⁹ and both whole plasma and plasma in the dilution of 1 : 8 is tested. The normal prothrombin times obtained by this method are 18 ± 3 seconds for undiluted plasma and 40 ± 10 seconds for the diluted sample of plasma. The average values obtained in cases of multiple sclerosis approximate the normal averages.

At present we attempt to elevate and maintain the prothrombin time to the vicinity of thirty seconds for the undiluted and ninety seconds for the diluted specimen by the administration of the appropriate doses of dicoumarin. Any sudden, disproportionate rise in the prothrombin time of the undiluted specimen portends an impending hemorrhage, as Shapiro and associates³⁰ have pointed out. Such an occurrence should lead to a marked reduction in dosage, or even withdrawal of the drug, for about four days, or until the time when a fall in prothrombin time permits further administration of the drug. Patients are cautioned about the use of salicylates in large doses while they are receiving dicoumarin because of the apparent tendency of the former series of drugs to elevate further the prothrombin time.³¹

RESULTS

The plan of evaluating our treatment was to determine the effectiveness of the daily administration of dicoumarin, in doses sufficient to elevate the prothrombin time of the blood to the desired levels, in preventing acute exacerbations or the appearance of new symptoms in a series of known cases of multiple sclerosis. Cases were chosen at random.

28. Russell, H. K., and Page, R. C.: Prothrombin Estimation Using Russell Viper Venom: Simple Modification of Quick's Method, *J. Lab. & Clin. Med.* **26**:1366-1370 (May) 1941. Fullerton, H. W.: Estimation of Prothrombin: Simplified Method, *Lancet* **2**:195-196 (Aug. 17) 1940.

29. Purchased from the Maltine Company, 745 Fifth Avenue, New York.

30. Shapiro, S.; Sherwin, B.; Redish, M., and Campbell, H. A.: Prothrombin Estimation: Procedure and Clinical Interpretations, *Proc. Soc. Exper. Biol. & Med.* **50**:85-89 (May) 1942.

31. Fashena, G. J., and Walker, J. N.: Salicylate Intoxication: Studies on Effects of Sodium Salicylate on Prothrombin Time and Alkali Reserve, *Am. J. Dis. Child.* **68**:369-375 (Dec.) 1944.

We were limited in our choice only by the place of residence of the patient, which might make it impossible for him to return to the hospital at stated intervals for determinations of the prothrombin time.

It has already been pointed out that treatment was given in a total of 74 cases of multiple sclerosis, but that only 43 are included in this study, since in the remaining 31 cases continuous treatment for six or more months was not carried out. Experience soon showed that the effectiveness of the treatment depended in large part on the clinical type of the disease and that the cases fell naturally into two groups, which we have designated as follows:

Group A: Cases characterized by the appearance of recurrent, acute sharply limited attacks and remissions.

Group B: Cases in which chronic or persistent progression of symptoms occurred without well defined acute outbreaks of symptoms or periods of remission. The duration of symptoms in this group far exceeded that of the previous group. Disabling paraplegia was a common symptom.

In group A, the group with remissions, there were 27 cases. In 23 of these 27 cases the disease remained static during the period of treatment without the occurrence of any acute, fresh attacks, such as had occurred prior to the onset of treatment. In 2 cases slight functional improvement occurred during the course of treatment. Relapses occurred in 4 cases. In 2 of these 4 remaining cases it was impossible to adjust the prothrombin time to an adequate level even with large doses of dicoumarin, and relapses continued as before. In the other 2 cases, treatment was discontinued or greatly reduced for periods of several months, during which time acute symptoms appeared in both cases, with further functional impairment.

In group B, the group with slowly progressive disease, without well defined exacerbations and remissions, there were 16 cases. Of these treatment seems to have been without influence in 9 cases, the disease progressing at a rate similar to that prior to the treatment with dicoumarin. No observable change could be detected in the condition in the remaining 7 cases of this group during treatment. The condition in these cases was practically static during treatment, as it had been before. In some of the cases in this group, as in many cases of paraplegia of various origin, fluctuations in functional ability occurred from time to time. These episodes were not considered as exacerbations of the disease process, since they were not permanent or accompanied by evidences of new lesions.

These statistics may be stated in another manner. The aggregate number of months, with interruptions subtracted, during which all the 43 patients received adequate treatment was seven hundred and eighty-eight, or approximately sixty-six patient years. During this time no

relapses occurred. The records of these same patients show that they had had symptoms for an aggregate of two hundred and twenty patient years. Including the onset, there had been 94 definite fresh outbreaks in this group of patients, or an average of 0.6 per patient-year before treatment was begun.

Illustrative cases falling into one or the other of these two groups deserve a more detailed description. The following cases fall in group A.

REPORT OF CASES

D. R., a 30 year old woman, had four discrete bouts of paresthesias, impaired hearing, diplopia and difficulty with gait from August 1941 to January 1944, with no residual impairment of function. During these attacks she was confined to bed. Treatment with dicoumarin was started in January 1944, since which time there have been no acute attacks. There is no functional impairment, and the patient is able to go ice skating. There are persistent inequality and overactivity of tendon reflexes, without any other residual signs.

H. W., a 42 year old woman, had an attack of disseminated sclerosis in April 1944, with paresthesias, diplopia, impairment of vision, hemiparesis and coarse intention tremor. Treatment with dicoumarin was started in July 1944, at which time a complete spontaneous remission occurred. Treatment has been continued uninterruptedly until the present time, and there has been no recurrence of symptoms. Examination shows only a mild intention tremor on the left side.

P. R., a 27 year old woman, had left hemiparesis in 1939, lasting three months, and a relapse in 1943, with signs referable to the pyramidal tract, cerebellum and dorsal column in both lower limbs, associated with marked difficulty in walking. The latter symptoms cleared gradually over a period of months, and treatment with dicoumarin was started in August 1943, since which time she has shown no subjective evidence of relapse. Examination shows persistent signs of involvement of the dorsal column in both lower limbs. Subjectively the patient is completely free of symptoms.

A. S., a 16 year old girl, had an acute attack in February 1942 involving the spinal cord and bulb, with impairment of vision and mild papillitis. She had to be placed in a respirator, and tidal drainage of the bladder was instituted. The disease was progressive over a period of three weeks and treatment with dicoumarin was then started. Progression of symptoms stopped at once. Within a period of weeks she made an excellent spontaneous functional recovery. In June 1944 administration of dicoumarin was discontinued because of an intercurrent illness, and on resumption of treatment she was given smaller doses of the drug, with which her prothrombin time was barely elevated to twenty seconds. In August 1944, at this level, she had a relapse, with marked difficulty with gait. Over a period of several months, this cleared as the dose of dicoumarin was increased. There have been no relapses since.

V. B., a 23 year old woman, had an attack of vertigo, nausea and vomiting in June 1944, which cleared spontaneously in one month. In January 1945 she had left hemiparesis, left homonymous hemianopsia, diplopia and impairment of vision, which cleared completely over a period of two months. In June 1945 she had a recurrence of the hemiparesis. Administration of dicoumarin was started; her symptoms cleared completely, and she has been free of relapses since that time, while receiving dicoumarin. There is no impairment of function subjectively; she is able to carry out her work as a typist without any difficulty. Examination reveals.

temporal pallor of one optic disk, overactivity of the tendon reflexes on the left and mild cerebellar signs in the left upper limb. Subjectively she is completely well.

S. S., a 28 year old housewife, had had four relapses since the onset of her disease with recurrent hemiplegia and ocular and vesical disturbance. There was residual difficulty with gait and vision. In January 1943 treatment was started with large doses of dicoumarin, and bleeding from the urinary tract developed, which was controlled by repeated transfusions of whole blood. Treatment was omitted for two weeks but was started again and continued until June 1944, when it was interrupted because the patient decided to go on a trip to Florida. During that time a relapse occurred, with marked ataxia and difficulty with gait. Treatment was resumed soon thereafter, and up to the present time her condition has not improved. She has had no further relapses, however.

R. T., a woman of 33, had recurrent attacks for three and a half years, with residual spasticity, but was able to walk with some difficulty and was otherwise well. Treatment was started early in 1944. After receiving dicoumarin for six months, without incident, she left for the Southwest and stopped treatment for two months. During this period she had a relapse; on returning she showed complete paraplegia and bilateral intention tremor and suffered from root pains and paresthesias. She has been confined to a wheel chair since, despite resumption of treatment with dicoumarin combined with a course of infusions of histamine but has had no further acute outbreaks.

In the following case the disease was of the chronic progressive type in which there was no apparent benefit from treatment.

W. B., a man of 38, had had only minor remissions during the eight years since the onset of the disease and prior to the beginning of treatment. His cerebellar symptoms were pronounced, with difficulty in walking, tremor of the head and upper limbs and difficulty with speech and deglutition. Early in 1943 treatment with dicoumarin was started. He had no remissions, and treatment did not seem to influence the course of his disease, his symptoms becoming progressively and slowly more marked. He had two series of histamine infusions, without any benefit. At present he is bedridden and almost totally incapacitated. On examination he shows signs of pronounced involvement of the cerebellum and the pyramidal tracts. Ocular signs are also present.

In another case with a progressive course an unusually high tolerance for dicoumarin was shown.

E. C., a 32 year old woman, was started on treatment with dicoumarin during her first admission to the Neurological Institute, in May 1942. Her symptoms began in 1939 with paresthesias, difficulty with gait and ocular and vesical disturbances. Examination revealed weakness and spasticity in both lower limbs with signs of involvement of the pyramidal tracts and posterior columns. There were bilateral atrophy of the optic nerve and nystagmus. After treatment with dicoumarin was started, it was found that the patient was able to tolerate usually high daily doses of the drug, as much as 150 to 200 mg. daily, without ever reaching the desired levels of prothrombin time or having a hemorrhagic episode. Hematologic studies and hepatic and renal function tests were all within the normal range. During the ensuing years she became slowly and progressively worse. She is now barely able to walk with assistance and has severe visual disturbance, so that she has difficulty in recognizing people. There is pronounced impairment of speech. Treatment with dicoumarin is being continued.

CLINICAL OBSERVATIONS ON EFFECTS OF PROLONGED ADMINISTRATION
OF DICOUMARIN

Inasmuch as this is the first study of prolonged administration of dicoumarin some observations on the clinical effects of the drug so administered seem pertinent. During the course of treatment it is not unusual for prominence and enlargement of the superficial veins of the limbs to appear. Subcutaneous extravasations of blood with subsequent discoloration appear rather frequently, often as a result of trauma, which is likely to be unnoticed by the patient. This is no indication for discontinuing treatment and may be seen in patients whose prothrombin time is moderately elevated, to desirable levels. Bleeding from the gums and nasal mucosa, widely scattered showers of subcutaneous hemorrhages and subconjunctival extravasations of blood usually indicate elevation of the prothrombin time to dangerous levels, which may soon be followed by bleeding from the urinary tract if a drastic reduction in the dose is not carried out. Colicky pain in the loins with tenderness in the costovertebral angle uniformly indicates bleeding in the urinary tract, which is followed after a latent interval of twenty-four to forty-eight hours by grossly bloody urine. With such an experience, administration of the drug is curtailed and the patient hospitalized. Hematuria is controlled by from one to five transfusions of 500 cc. of whole fresh blood. During the early period of this study, when larger doses of dicoumarin were being used, 9 of a total of 17 cases were complicated by severe hematuria. Thereafter, there were only 4 more cases with such a complication, that is, a total of 13 cases. Abnormal urinary findings usually clear completely in about ten days after gross hematuria has ceased, with no residual impairment of renal function. We usually allow an interval of six to eight weeks after an episode of hematuria before starting treatment again. Large doses of vitamin K are given intravenously in conjunction with blood transfusions, to control hemorrhage, though we are unable to state how effective this measure is, since vitamin K was given routinely in all cases of hematuria. No other sites of hemorrhage occurred in this series of cases. There were no fatalities and no instances of allergic or other toxic effects from this drug.

The response of the blood prothrombin time to the administration of dicoumarin over a prolonged period differs in different persons. In some patients despite large doses of dicoumarin, an adequate prothrombin time could not be maintained. There were 2 such patients, and treatment did not give them protection.

COMMENT

There are few data in the literature concerning the incidence of relapses in cases of untreated multiple sclerosis. Von Hoesslin¹¹ gave

the following information, based on his own study of the records of a group of unselected cases:

Among 516 cases, shorter or longer remissions were observed in 92, that is, in over 17 per cent. This includes not a few instances in which several remissions of long duration occurred. . . . In all cases in which I speak of a remission of a certain length, the remission was, of course, terminated by the beginning of a new outbreak. In 17 cases the remissions lasted three months to two years (often occurring repeatedly); in 10 cases, three to four years; in 10 cases, five to six years, in 16 cases, seven to ten years, and in 3 cases, eleven to twelve years. In 1 case in which the disease was of twenty-seven years' duration, 4 remissions occurred, 2 lasting four years and 2 five years. In a case in which the disease was of sixteen years' duration, 4 remissions occurred, of two, three, four and five years, respectively. In another case, remissions of eight years' duration occurred twice. Examples of especially long remissions are 4 of nineteen years' duration, 2 of sixteen and seventeen years, 3 of eighteen to twenty-one years, 2 of twenty-five years and 1 of forty-three years.

These figures are difficult to treat statistically, but it is obvious that no conclusion can be drawn from short series of cases observed over short periods. Moreover, in speaking of "remissions," von Hoesslin evidently means apparently complete restoration to health, not merely a period without exacerbation.

The only comparable series treated with dicoumarin is that of Reese,²⁵ reported at a meeting of the American Neurologic Association in May 1944. He treated 28 patients for periods up to six months. He reported subjective improvement in all his patients but saw no objective improvement. He found a rather marked fluctuation of the prothrombin level, perhaps because the dosage of dicoumarin was based on the patient's body weight rather than on the response. Some relapses occurred, but, to judge from the charts shown at the meeting, only during periods when the prothrombin time fell close to normal limits. On the whole, he apparently felt that the results of treatment were not sufficiently good to justify its continuance.

We have also observed subjective, and even objective, improvement in our cases but have been inclined to ascribe it to the normal healing process which clearly takes place in any lesion of the nervous system which damages, without destroying, nerve structures. Obviously, the maximum of restitution is obtained only when the general bodily condition is good (that is, in the absence of infection or malnutrition), and healing may be nullified by the extension of the pathologic process. If treatment with dicoumarin helps limit the spread of the damage, it may perhaps be said to permit recovery, rather than to produce it.

As far as we have been able to learn, no other forms of treatment have been statistically evaluated from the point of view of preventing the progress of the disease. Conclusions based on symptomatic improve-

ment following one or another form of treatment appear to be unreliable²³

It is of interest that in 9 patients with advanced disease of the slowly progressive type, all of whom had paraplegia, gradual deterioration of the patient was not prevented. It has been pointed out³² that paraplegia is one of the symptoms which carries the worst prognosis in cases of the untreated disease. In old, large, intense lesions of multiple sclerosis some mesodermal scarring occurs.¹⁶ It is possible that the slow downward course in such cases is dependent on secondary mesodermal fibrosis, rather than on an increase in the area of circulation impaired by progressive thrombosis.

TECHNIC OF TREATMENT

Much remains to be learned about the use of dicoumarin over long periods of time. The following points regarding its use have seemed important in our experience:

1. The patient, his family and the physician in touch with the case should be instructed in the purpose, method and dangers of the treatment (much as in the insulin treatment of diabetes). It should be constantly pointed out to all concerned that the treatment cannot be expected to produce improvement of symptoms, but merely to afford protection against serious future outbreaks. The danger of hemorrhage, and the steps to be taken should it occur, should be particularly emphasized. The patient should understand that the treatment confers protection only while it is used and that it will probably have to be continued the rest of his life.

2. Before starting the treatment, the physician in charge should assure himself that reliable determinations of the prothrombin time can be secured as often as necessary. We have found the method of Shapiro and associates the most reliable for the prothrombin time, and we use a specially prepared lung extract as thromboplastin. In this method, the clotting time of plasma diluted 1:12.5 is determined, as well as that of undiluted plasma.

The prothrombin time is determined before treatment is begun, twice the first week, weekly for the next month, then every two or three weeks. The dosage of dicoumarin is regulated to stabilize the prothrombin time of the undiluted plasma at about thirty seconds. If the clotting time of whole plasma rises to forty seconds, or that of diluted plasma to more than one hundred and twenty seconds, the dose should be omitted for at least four days and then begun at a lower level.

32. Putnam, T. J.: The Diagnosis of Multiple Sclerosis and the Outlook for Treatment, *M. Clin. North America* **21**:577-593 (March) 1937.

3. The usual initial dose is 150 mg. This is immediately cut down to 50 mg. daily until a proper prothrombin time is reached. Fifty milligrams can then be given every other day, until the prothrombin time drops below thirty seconds, when the dose is increased again.

4. If hematuria occurs, administration of dicoumarin should at once be stopped and the patient put to bed. A transfusion should be given within twenty-four hours. In stubborn cases repeated transfusions, as many as five, have been found necessary. Administration of vitamin K, even intravenously, has not seemed to be of benefit.

SUMMARY

The evidence that sclerotic plaques arise as a result of venular thrombosis is reviewed.

The results of treatment of 43 patients with multiple sclerosis with dicoumarin (3,3'-methylene-bis-[4-hydroxycoumarin]) for periods varying from six months to four years is reported.

Doses of dicoumarin sufficient to raise the prothrombin time to thirty seconds continuously were administered, with constant laboratory control.

Twenty-five patients suffering from a remittent form of the disease were adequately treated without interruption for a total period of approximately sixty-one patient years. In this group no fresh symptoms or obvious acute outbreaks occurred. Most of the 16 patients with chronic progressive disease continued in their downward course.

The treatment of 2 patients was interrupted for one reason or another. The patients were free from new symptoms while taking treatment, but both had acute relapses when it was discontinued. In 2 patients large doses of dicoumarin failed to produce the expected increase in prothrombin time, and relapses occurred.

710 West One Hundred and Sixty-Eighth Street.

CEREBRAL BLAST SYNDROME IN COMBAT SOLDIERS

LIEUTENANT COLONEL HOWARD D. FABING *

MEDICAL CORPS, ARMY OF THE UNITED STATES

IN NOVEMBER 1944, arrangements were made with the surgeons of the First and Ninth United States Armies to send patients with blast injury to a designated general hospital specializing in neuropsychiatry in the Advance Section, Communications Zone, European Theater of Operations. It was hoped that a concentration of this clinical material might lead to a better understanding of the problem of blast injury. As a consequence, all patients with conditions diagnosed as blast injury, concussion, concussion neurosis, and the like, anywhere in forward echelons, as well as those with disturbances thought to warrant such a diagnosis by the admission section of this hospital, were examined.

Approximately 130 such patients were seen in November and December 1944, but clinical data on these cases were lost during the Battle of the Belgian Bulge, when the hospital had to be abandoned because of enemy action. Operations were resumed in January 1945, and this report deals with 80 patients representing consecutive admissions who were seen in subsequent months, up to the German capitulation, May 8, 1945. Patients in the second series came from combat elements engaged in the Roer-Rhine offensive, the Remagen bridgehead and the Battle of Western Germany.

METHOD OF STUDY

At the outset, it was decided that the entire subject of blast injury was so controversial that there was no guide to follow. All the pertinent facts in each case were tabulated, and careful examination was carried out in an attempt to answer the following questions: (a) Does a

* Dr. Fabing has returned to civilian status.

Capt. Bill H. Williams, M.C., assisted in selecting the cases for this study; Major Douglas Kelley, M.C., gave ether hypnosis in some cases, and Capt. Oscar Legault, M.C., contributed his observations on verbal hypnosis.

Capt. William P. Kelleghan, M.A.C., chief of the rehabilitation section of the general hospital, made a careful appraisal of the patients during their stay under him. Major Morris Kleinerman, M.C., recorded his estimates of these patients at the time of their discharge from the hospital.

Tec. 5 Rommie W. Tyndall, wardmaster in charge of these patients, aided in the abreaction technic, and Pfc. Albert B. Siewers devoted many months to the recording and summarizing of the data.

blast injury syndrome exist? (b) What are its clinical manifestations? (c) Is there any evidence of organic damage to the brain on clinical or laboratory examination? (d) What therapy appears efficacious? (e) What is the pathogenesis of blast injury?

THE BLAST SYNDROME

It was soon determined that a group of patients could easily be separated from the larger classifications of soldiers with acute combat exhaustion. These men gave a history of having been subjected to a nearby explosion, of being rendered unconscious by it and of having intractable headache, tinnitus and varying anxiety symptoms as a result. As a group they were tense, quiet, extremely noise-sensitive soldiers who were in constant search of relief from headache. They comprised 7.9 per cent of the total neuropsychiatric admissions for the entire period. During the first half of this series of campaigns, until the Remagen bridgehead was established, enemy opposition was definitely more effective than it was after that time. This is reflected in the fact that patients with blast injury comprised 11.8 per cent of all neuropsychiatric casualties from Jan. 27 to March 15, 1945, while they comprised only 5.1 per cent in the slightly longer period from March 15 to May 8, 1945. From this it may be deduced that the size of the problem of the blast syndrome varies with the tactical situation and is in all likelihood an index of the effectiveness of the enemy's artillery.

In the majority of instances there was agreement on the diagnosis by the various medical officers who had seen the patient in the evacuation chain. When the diagnosis of the blast syndrome (variously labeled blast injury, blast concussion and W. I. A. shell blast) was made by the battalion surgeon, it was seldom changed by other medical officers. In only 30 per cent was the diagnosis of blast injury made for the first time at this hospital.

Blast injury appeared to be oblivious of rank. The majority of the patients were privates, but so are the majority of men who fight. A large number of the patients studied were infantrymen, and in figure 1 *A* are compared the distribution according to rank of 80 patients with that of an equal number of riflemen. Although this affords only an approximation of the distribution of the normal combat population according to rank since other types of units have somewhat different tables of organization, it illustrates that blast injury occurs in all ranks and in proportions consistent with their approximate distributions. Officers were not included in this series, but they appear to suffer blast injury in accordance with their number, as do enlisted men and noncommissioned officers.

Blast injury does not occur especially among new replacement troops or in soldiers with long battle experience. Figure 1 *B* shows an even spread according to length of combat service, with a relatively large number of cases in troops with three to four months of combat experience. It was my impression that the average soldier on this front had been in combat about that long and that it was logical to expect a slightly higher incidence among men with that amount of combat duty.

The patients were examined a variable number of days after the blast experience. The shortest interval after blast was forty-five hours. For the most part they were seen within a fortnight of exposure to

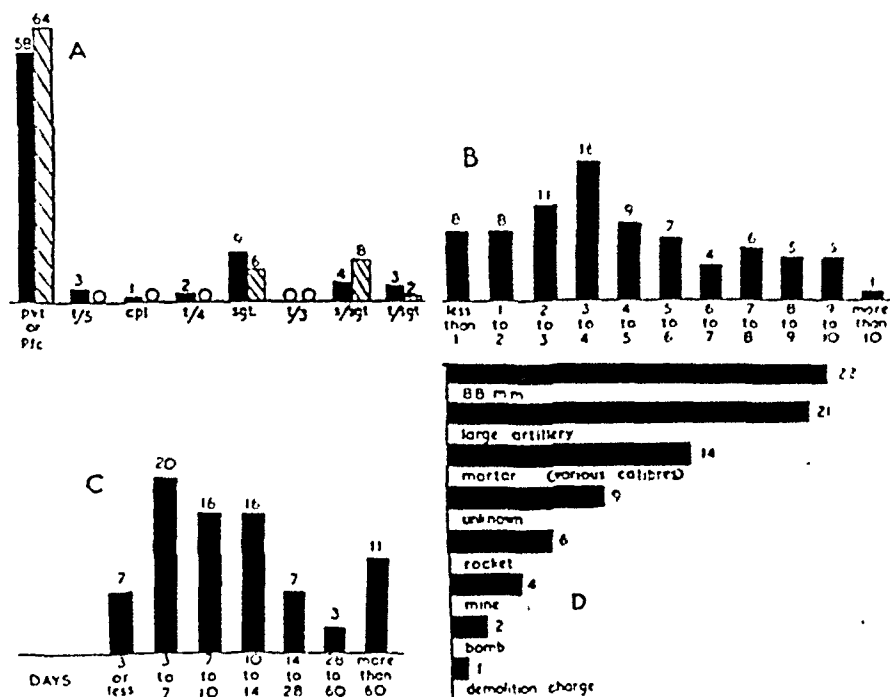

Fig. 1.—(A) Distribution according to rank of 80 patients with blast injuries (black rectangles) and that of an equal number of riflemen (hatchure). Distribution of patients with blast injury according to (B) number of months of combat, (C) time elapsed between blast and examination and (D) type of explosion.

blast. A small number had been blasted several months previously and were evacuated when symptoms became marked in subsequent action (fig. 1 *C*).

There seemed to be no specificity about the type of explosion causing blast injury. Some of the patients were at a loss to tell what the agent might have been. Eighty-eight millimeter shells were most frequently implicated; large artillery shells, next, and mortars, mines, bombs, etc., least often (fig. 1 *D*).

Each patient was questioned concerning the blast effect of one as compared with that of many shells. Approximately two thirds of

the men stated that "they were dropping stuff all around me, and one of them finally knocked me out." In the majority of the cases of multiple explosion, however, the soldier was able to recall a specific shell which finally rendered him unconscious.

CLINICAL MANIFESTATIONS

The unconsciousness caused by blast was studied with care. It is well known that there is often a long period of retrograde amnesia in cases of head injury, and my colleagues and I were interested in determining whether this was also true of patients with blast injury. Careful inquiry disclosed that it was not. About one fifth of the patients received blast injury from explosions which gave no warning noise (small mortar shells, mines, grenades), but of the remainder approximately three fourths recalled the whine of the oncoming shell. A smaller number recalled the visual component of the explosion—the flash—but it must be remembered that many soldiers are down in the bottom of holes with faces buried and eyes shut when shells explode nearby, and if such were not the case a larger number would probably see the flash. On the contrary, it is the rule that the sound of the explosion is never heard. This is in agreement with the oft-made assertion that "you never hear the one that hits you." It appears, then, that retrograde amnesia is confined to the sound of the explosion itself in cases of blast injury (fig. 2 *A*).

The period of anterograde unconsciousness was extremely variable. Some soldiers were unconscious for only a minute or two, according to their reckoning, but this was not usually the case. Many were unable to put an exact time limit on this period, and some of our figures are approximations. The majority recovered consciousness in aid stations or hospitals. A small number had small islands of lucidity during the period of unconsciousness. Return to consciousness was abrupt and definite in some cases, while in others there was a period of what might be described as groping for consciousness. If an average of these data is computed, a period of anterograde unconsciousness of four hours emerges. An average is not so instructive as a median, however, since the few cases of abnormally long unconsciousness prejudice the average to a high figure. The median of one hour gives a better picture of the period of anterograde unconsciousness in blast injury (fig. 2 *B*).

In a further inquiry into the unconsciousness produced by blast, it was often found that the patient regained his wits at some little distance from the place where the explosion took place. This was even the case when he found himself alone, when nobody had assisted him away from the place of the explosion. An inquiry was made into the patient's behavior during his amnesia, as told to him by his buddies, by the medical corps-

man who assisted him or by others. Data obtained in this way are extremely inaccurate, as further studies showed, but they led us to the conclusion that blast injury seldom produced motor inertia, i. e., coma, during the unconsciousness which followed it (fig. 3 A).

One of the great prejudices about the blast syndrome among medical officers in the field is the headache it produces. Before this study

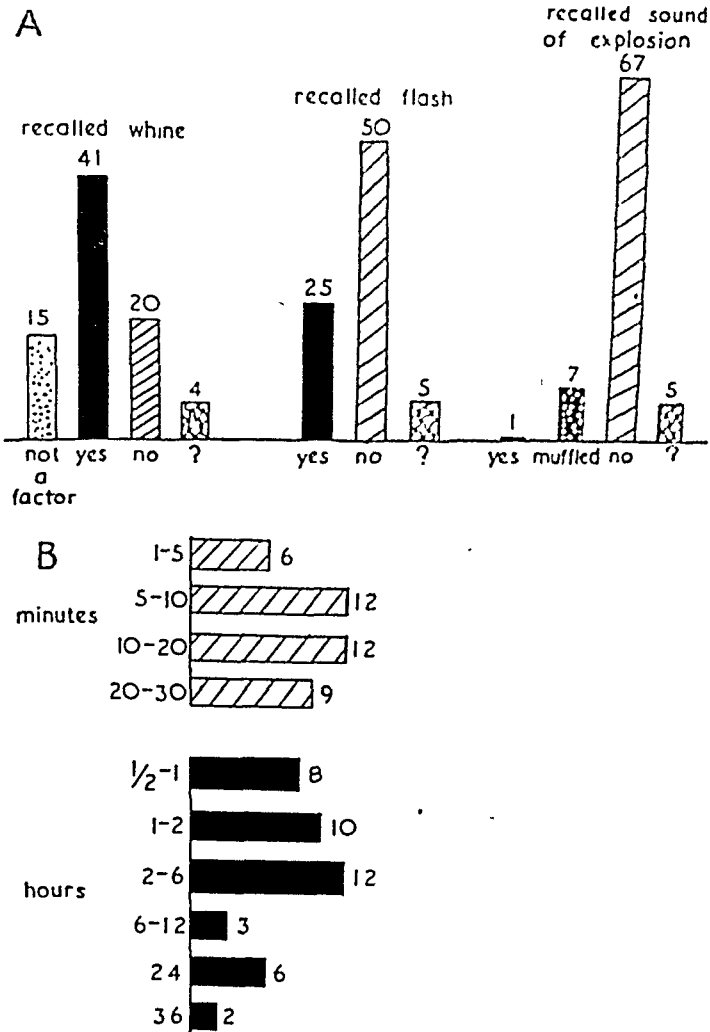

Fig. 2.—A, extent of retrograde amnesia; B, range of periods of anterograde unconsciousness, with an average of four hours and a median of one hour.

began, we were privy to many dogmatic statements on this subject made by colleagues during informal discussions. One officer asserted that the headache was always occipital; another, that it was always pounding; another, that it was bandlike, and so on. As a consequence, we determined to inquire into this symptom as thoroughly as possible. The results were anything but uniform. As for position, we found that the headache could be anywhere, that it was usually bilateral but could

be unilateral. Frontal and temporal headaches predominated, while others were a combination of many sites. Some were occipital, extending into the neck and shoulders. A few were generalized. No hemicrania of the classic migraine type was encountered (fig. 3 B).

The quality of the headache was no more specific than its location. About half were described as dull, while others were pounding or sharp, or shooting, and the occasional one was bursting in character. About half of the patients complained that they were never free of

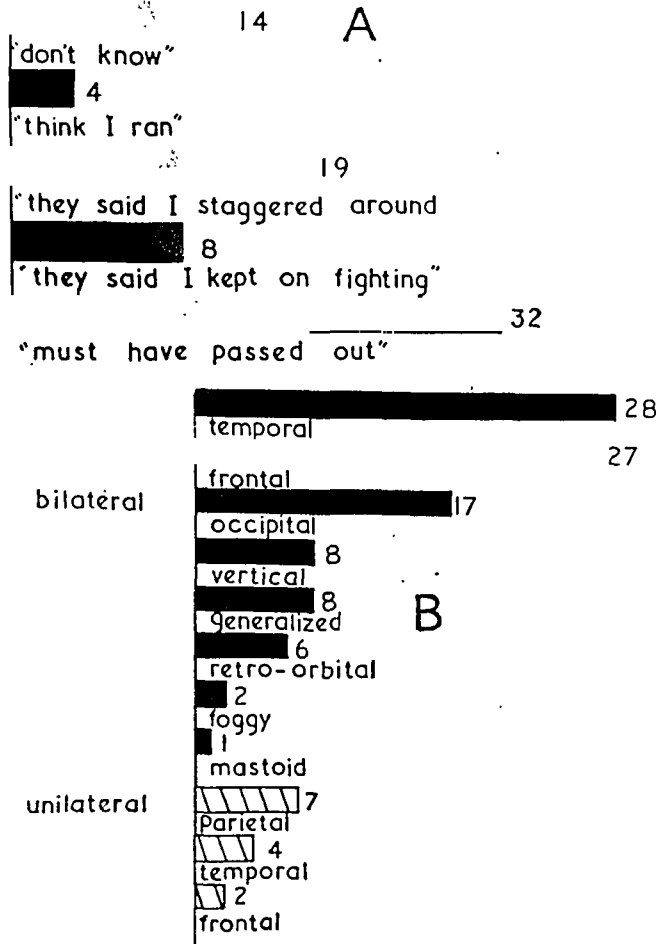

Fig. 3.—A, behavior during amnesia, based on the patient's statement on admission; B, types and location of headache.

headache, while the other half described their headache as intermittent. Of the continuous headaches, some were phasic in that they varied in intensity from hour to hour.

In summary, the headache in blast injury can only be described as a nonspecific, intractable one, varying in position, quality and persistence from case to case.

Tinnitus was an almost universal complaint in the cases of blast injury studied. In some cases it lasted only a matter of hours after the incident; in a few it was chronic and prolonged (fig. 4 A). The tinnitus was bilateral in more than one-half the cases and confined to one ear in

the others. In some cases of bilateral tinnitus one ear stopped ringing before the other.

Tinnitus was not the intractable symptom that headache was in these patients, although a paratrooper who was blasted at Nijmegen, Netherlands in October 1944 still complained of tinnitus the following March. About one third of the patients stated that their ears had stopped ringing by the time they were examined by us (fig. 4B).

The anxiety symptoms of which these patients complained were of the kind met with in other neuroses of combat.¹ There were significant

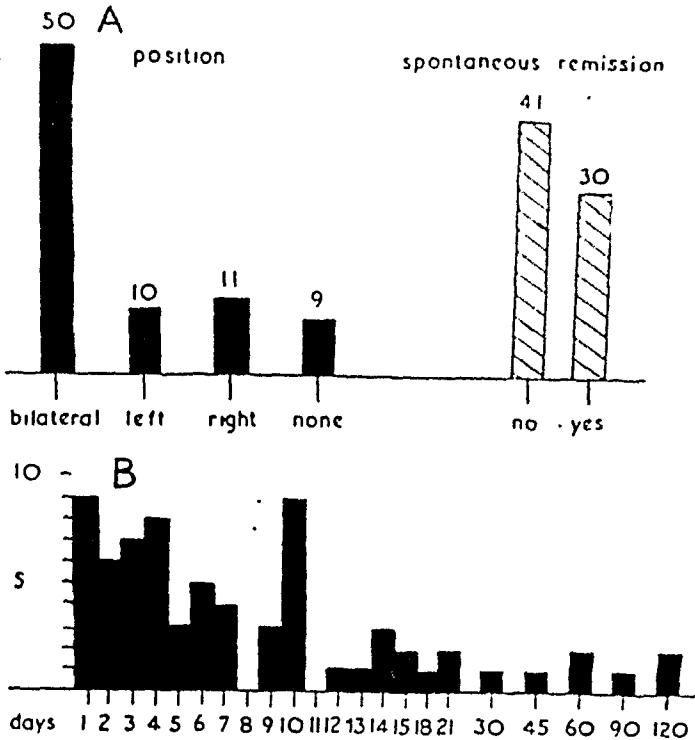

Fig. 4.—A, type and laterality of tinnitus; B, duration of tinnitus.

differences, however. The sensitivity to noise of which they complained was pitifully acute. One evening a recently admitted patient asked

1. Sargent, W., and Slater, E.: Acute War Neuroses, *Lancet* 2:1 (July 6) 1940. James, G. W. B.: *Psychiatric Casualties: Hints to Medical Officers in the Middle East Forces, G. H. Q., M. E. F. (British)*, revised edition, London, His Majesty's Stationery Office, September 1942. Love, H. R.: *Neurotic Casualties in the Field*, *M. J. Australia* 2:137 (Aug. 22) 1942. *Early Recognition and Treatment of Neuropsychiatric Casualties in the Combat Zone*, Circular Letter no. 176, War Département, *J. A. M. A.* 123:705 (Nov. 13) 1943. Raines, G., and Kolb, L. C.: *Combat Fatigue and War Neurosis*, *U. S. Nav. M. Bull.* 41:923 (Sept.) 1943. Zelig, M. A.: *War Neurosis: Psychiatric Experiences and Management on a Pacific Island*, *War Med.* 6:166-172 (Sept.) 1944. Kubie, L. S.: *Manual of Emergency Treatment for Acute War Neuroses*, *ibid.* 4:582 (Dec.) 1943.

permission to attend a U. S. O. show at the hospital. In a few minutes he was back in the ward; when asked why he had not remained for the show, he said that he took one look at the bass drum and realized that he would never be able to endure its cacophony. Slamming doors, rolling food carts, messhall noises, radios and even animated conversations brought complaints. Airplanes overhead, especially buzz bombs in their flight, brought to these patients a mixture of terror and anguish which beggars description. In a goodly number this was accompanied with motor startle patterns. Vertigo, not of a patterned kind, such as is seen in Ménière's disease and other aural disturbances, but a floaty dizziness, was a widespread complaint. Severe battle dreams seemed to occur as frequently in this group as in the rest of the patients with acute combat neuroses. A subjective feeling of tremulousness,

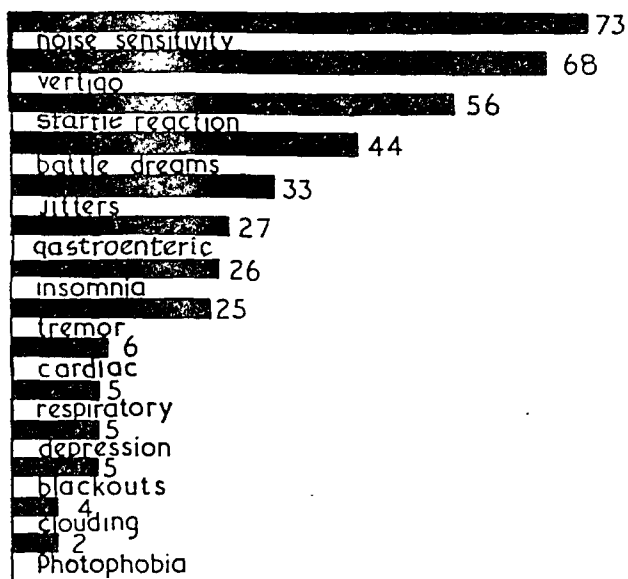

Fig. 5.—Distribution of anxiety symptoms.

of which the vernacular word “jitters” seems to be the most descriptive, was frequent. A fast, fine tremor of the hands, sometimes of the lips and legs, similar to that met in cases of hyperthyroidism, was also frequent. Gastric disturbances led the list of visceral dysfunctions. Although the complaint of clouding of the sensorium was not often voiced, it was obvious that it occurred frequently. These patients did not read, follow radio news, play cards and behave generally like a group of soldiers in a ward of an Army hospital. They wandered alone, lay on their cots or just talked a bit to the man in the next cot. The pall of apathy met in a ward of schizophrenic patients was not present, to be sure; yet normal animation was missing (fig. 5).

A kind of generalized muscular soreness was found in about one-half these patients. By the time they reached this hospital the complaint was no longer present, but they said that it was often severe for one or

two days. They described it vividly—it was like being whipped with a rubber hose or like receiving a thorough beating with a rifle butt.

Evidence of spontaneous hemorrhage has often been regarded as a frequent accompaniment of the blast syndrome. Some observers even feel that the diagnosis cannot be made in the absence of such bleeding. In our series this criterion did not hold. Nosebleed occurred in 25 per cent and bleeding from the mouth in 10 per cent. Bleeding from the mouth may have been from the lungs or from the upper respiratory tract, but roentgenologic evidence of diffuse pulmonary hemorrhage was not found. Bleeding from the ears was reported in 3 cases; ear drums were ruptured in 2 other cases. No hemorrhage or fissures were seen in the skin, or no petechiae in the eyegrounds, in this group. It is our conclusion, then, that evidence of spontaneous bleeding is the exception, rather than the rule, in cases of the blast syndrome.

Approximately 20 per cent of our patients showed evidence of other injury, such as minor lacerating wounds from shrapnel, abrasions, contusions and burns, acquired at the time of blast. It is probable that a large number of patients who are blasted receive severe wounds at the same time and are evacuated via surgical channels. We have seen such patients after successful treatment of wounds, and some are included in this series. The symptoms of headache and anxiety persist, and in some cases chronic tinnitus remains. It is impossible to estimate how many cases of such complications exist, but it appears certain that they do. The statement that the actually wounded do not have neuropsychiatric complaints has proved a false one in this theater, and this is especially true of soldiers who have suffered blast injury.

CLINICAL AND LABORATORY EVIDENCE OF ORGANIC DAMAGE TO THE BRAIN IN BLAST INJURY

Clinical neurologic examination was carried out on all these patients. Not one showed any evidence of focal damage to the central nervous system: No disorders of the cranial nerves, no motor disturbances, no pathologic reflexes, no sensory deficits and no cerebellar or extrapyramidal signs could be elicited. This was not true of signs of "functional" lesions. Three patients had a stammer; 1, a hysterical titubation of the head; 1, a pseudoparkinsonian tremor of the hands; 1, a wide-based, disorganized gait, without evidence of disease of the cerebellum or the posterior column; 1, a hysterical ankylosis of the left knee, and 1, fleeting right hemiparesis without orthodox neurologic signs, which cleared spontaneously five days after the blast. Clinical neurologic examination, then, was not productive of abnormal signs, except those of a type met with in patients with conversion hysteria.

An electroencephalograph was not available to us, and, unfortunately, I am unable to add the results of the test to these data.

Lumbar puncture was done in every case with the use of local anesthesia and with the patient in the horizontal position. A 20 gage needle and a water manometer were used. In all cases the spinal fluid pressure fell within the normal span of 70 and 180 mm. of water as defined by Merritt and Fremont-Smith² (fig. 6 A). The white blood cell count was also within the normal range as defined by the aforementioned authors (fig. 6 B).

Counts of red cells were made without centrifugation and without treating the fluid otherwise (fig. 6 C). Two fluids were clear but contained 38 and 60 red cells per cubic millimeter, respectively. In another, containing 13 red cells per cubic millimeter, the bleeding was

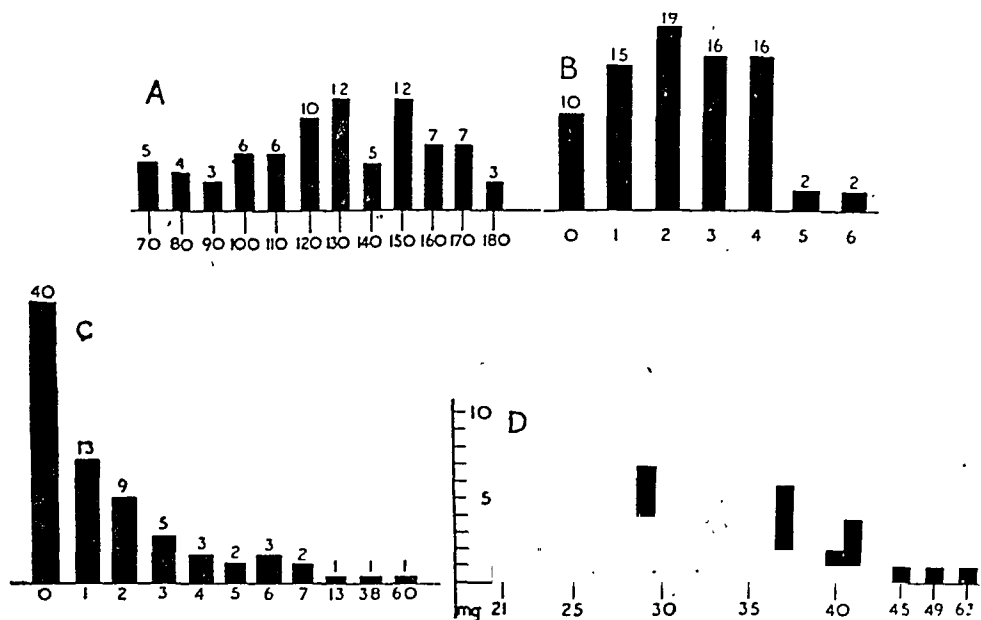

Fig. 6.—Results of study of cerebrospinal fluid. A, pressure; B, white cell count per cubic millimeter; C, red cell count per cubic millimeter, and D, protein content per hundred cubic centimeters.

obviously the result of a traumatic tap, as noted at the time of puncture. The rest of the fluids may be considered to have been free from blood.

In order to rule out the possibility that bleeding might have taken place prior to examination and that the red blood cells had been laked or dissolved at the time the puncture was performed, each specimen was subjected to a benzidine test. No free hemoglobin was found in any specimen except in 2 with the abnormally high red cell counts. The failure of this sensitive test to show evidence of free hemoglobin in the fluids was further evidence against bleeding within the central nervous system in these cases.

2. Merritt, H., and Fremont-Smith, F.: The Cerebrospinal Fluid, Philadelphia, W. B. Saunders Company, 1937.

The protein content of all specimens was determined by the method of Johnson and Gibson.³ It was found to be within the normal span of 20 to 45 mg. per hundred cubic centimeters in all but 2 specimens, those with the abnormal red cell counts. The specimen containing 38 red cells per cubic millimeter had 49 mg. of protein, and that containing 60 red cells had 62 mg. of protein, per hundred cubic centimeters (fig. 6D).

Colloidal gold was not available to us, but the mastic test was carried out on all specimens of spinal fluid. The curves were normal throughout the series.

SUMMARY OF CLINICAL AND LABORATORY DATA: TENTATIVE
DEFINITION OF BLAST SYNDROME

An appreciable group of combat soldiers become casualties as a result of nearby explosions. Blast injuries occurred among all ranks and in new replacements as well as in combat-wise troops. The type of explosive agent is not specific, varying from large caliber artillery shells to grenades. Some soldiers become casualties after a single explosion nearby, while others succumb during a barrage. The explosion produces a rather specific kind of unconsciousness, characterized by a retrograde amnesia for the sound of the explosion and an anterograde period of unconsciousness which is extremely variable, but which may be said to last an hour in the usual case. During the period of unconsciousness the patient is seldom comatose but usually carries out some motor activity, according to report. On regaining consciousness he complains of intractable headache, which may be almost anywhere in his head, may be constant or phasic or intermittent and may have any quality, such as dull, sharp or pounding. He complains of tinnitus as well, but this tends to disappear in a matter of days except in the unusual case. In addition, he complains of any of a number of symptoms of anxiety, chief among which are sensitivity to noise, vertigo, startle, "jitters," battle dreams and gastric disturbances. Almost half of these patients complain of a generalized somatic soreness for a day or two after blast. They show no evidence of focal damage to the central nervous system on neurologic examination. Few of them show evidence of bleeding from any of the orifices. The spinal fluid pressure is not increased, and except in rare instances bleeding does not occur into the spinal fluid. The fluid has no increase in white blood cells, and the protein content is normal except in the rare case in which bleeding has occurred.

From these data, a tentative definition of the disorder can be constructed as follows: The blast injury syndrome is that morbid condition

3. Johnson, G. W., and Gibson, R. B.: The Determination of Blood Plasma and Spinal Fluid Proteins, *Am. J. Clin. Path.* (Tech. Supp.) 8:22 (Jan.) 1938.

which results from the nearby explosion of one or more shells and causes the following tetrad of symptoms: (1) unconsciousness, with retrograde amnesia for the sound of the explosion and of varying anterograde duration, but persisting an hour in the usual case; (2) protracted, nonspecific headache; (3) tinnitus, which usually does not persist, and (4) diffuse anxiety symptoms.

CRITICISM OF THE FORMULATION

This definition of the blast syndrome, based on our data, gives rise to a series of questions. Is this series of cases a highly selected one? Are the patients with more serious blast injury evacuated through surgical channels and therefore not included in a series such as this? Does visceral damage occur in blast injury? In what way does blast kill the patient? Are cerebral changes present which are too subtle to be found by the methods used in this investigation? Do petechial hemorrhages occur in the brain substance, as has often been stated?

For answer to the first of these questions it is best to turn to experience in the field. In discussions with officers and noncommissioned officers of the line; with medical officers in battalions, in collecting and clearing companies and in Army exhaustion centers, and with divisional psychiatrists, the sum of impressions gained is that the foregoing description of blast injury is a valid one. Personal observations in divisional areas, together with experience during the Battle of the Belgian Bulge, in December 1944, confirm it as well. In the period last mentioned our hospital became an almost front line installation, owing to the tactical situation. Three thousand casualties passed through our hands in four days. The many cases of blast injury seen at that time conformed to the criteria defined here. Patients with blast injury who are also wounded are evacuated through surgical channels necessarily, but their symptoms of blast injury are identical with those of unwounded men.

Visceral damage occurring as a result of blast was studied by Hooker⁴ in 1924, and in the early years of the present war a number of reports by British investigators were made. Pulmonary lesions are most common and vary from scattered areas of interstitial bleeding to massive hemorrhage involving large portions of the lung.⁵ A series

4. Hooker, D. R.: Physiologic Effects of Air Concussion, *Am. J. Physiol.* **67**:219 (July) 1924.

5. (a) Hadfield, G., and others: Blast from High Explosive; Preliminary Report on Ten Fatal Cases, with an Identification and Estimation of Carboxyhemoglobin in Formol-Fixed Material, *Lancet* **2**:478 (Oct. 19) 1940. (b) Falla, S. T.: Effect of Explosion-Blast on Lungs, *Brit. M. J.* **2**:255 (Aug. 24) 1940. (c) Osborn, R. G.: Pulmonary Concussion ("Blast"), *ibid.* **1**:506 (April 5) 1941.

of experiments by Zuckerman⁶ give evidence that these pulmonary lesions are brought about by the direct force of the positive pressure wave of the blast on the thoracic wall rather than by tracheal transmission. Roentgenologic evidence of blast injury to the lung has been presented.⁷ Hemoperitoneum with rupture of abdominal viscera, hemopericardium, mediastinal hemorrhage and hematuria have been described. It appears that abdominal lesions are more frequent with immersion blast than with air blast.⁸ These lesions were not seen in our patients, although 2 of them gave histories of coughing up bloody sputum, apparently pulmonary in origin. No roentgenologic confirmation of pulmonary hemorrhage was found in our cases. It is probable that patients with frank visceral lesions due to blast are in the minority and that they would not be evacuated through neuropsychiatric channels.

Blast injury undoubtedly kills combat soldiers on occasion. The average battalion surgeon who has had continuous duty in the battles of France, Belgium and Germany can usually recall 1 or 2 cases of death following blast without external evidence of trauma. Srodes,⁹ psychiatrist of the First United States Army, was unable to obtain any

(d) Hadfield, G., and Christie, R. V.: A Case of Pulmonary Concussion ("Blast") Due to High Explosive, *ibid.* **1**:77 (Jan. 18) 1941. (e) O'Reilly, J. N., and Gloyne, S. R.: Blast Injury of Lungs, *Lancet* **2**:423 (Oct. 11) 1941. (f) Rose, T. F.: Lung Blast, *M. J. Australia* **1**:784 (June 28) 1941. (g) Palma, J., and Enright, W. M.: Blast Injury (Concussion) of Lungs, *U. S. Nav. M. Bull.* **40**:963 (Oct.) 1942. (h) King, J. D.: Concussion of Lung, *Surgery* **12**:415 (Sept.) 1942. (i) Booth, F. J.: Cases of Lung Injury Following Exposure to Blast and Nitrous Fumes, *Australian & New Zealand J. Surg.* **12**:72 (July 1942). (j) Tunbridge, R. E.: Cause, Effect and Treatment of Air Blast Injuries, *War Med.* **7**:3 (Jan.) 1945. (k) Brubaker, R. E.: Air Blast Injury, *Bull. U. S. Army M. Dept.*, April 1945, no. 87, p. 110.

6. Zuckerman, S.: (a) Experimental Study of Blast Injuries to Lungs, *Lancet* **2**:219 (Aug. 24) 1940; (b) in Discussion on Problems of Blast Injuries, *Proc. Roy. Soc. Med.* **34**:171 (Jan.) 1941.

7. Thomas, A. R.: "Blast Chest": Radiologic Aspect of Pulmonary Changes Following Exposure to High Pressure Waves, *Brit. J. Radiol.* **14**:403 (Dec.) 1941.

8. Williams, E. R. P.: Blast Effects in Warfare, *Brit. J. Surg.* **30**:38 (July) 1942. Travers, L. G.: Multiple Injuries Resulting from Bomb Explosion, *Australian & New Zealand J. Surg.* **12**:74 (July) 1942. Wakeley, C. P. G.: Blast Injuries, *Glasgow M. J.* **139**:91 (April) 1943. Wilson, J. V., and Tunbridge, R. E.: Pathological Findings in a Series of Blast Injuries, *Lancet* **1**:257 (Feb. 27) 1943. Fulton, J. F.: Blast and Concussion in Present War, *New England J. Med.* **226**:1 (Jan. 1) 1942. Cameron, G. R.; Short, R. H. D., and Wakeley, C. P. G.: Pathological Changes Produced in Animals by Depth Charges, *Brit. J. Surg.* **30**:49 (July) 1942. Yaguda, A.: Pathology of Immersion Blast Injury, *U. S. Nav. M. Bull.* **44**:232 (Feb.) 1945. Theis, F. V.: Atmospheric and Immersion Blast Injuries, *War Med.* **4**:262 (Sept.) 1943.

9. Srodes, W.: Personal communication to the author.

valid autopsy material. Krohn, Whitteridge and Zuckerman¹⁰ summarized this problem in experimental studies as follows:

There are a number of ways of being killed by blast, of which total disintegration of the body is the extreme case met with very close to an explosion. Those animals which are immediately killed without external injury presumably die from that undefined entity known as "primary shock" resulting from extensive visceral lesions. Some animals in this group have the trachea and main bronchi completely blocked by solid blood-clot. Whatever other factors may have contributed to their deaths, further air-entry would have been impossible. Most animals which have died more than a short interval after exposure usually had blood-stained froth in their mouth and nose and have died of pulmonary œdema. Others die because of continued hæmorrhage due to damage to an abdominal organ. Hæmorrhage into the ventricles of the brain has occasionally been observed in rabbits but not in other species. The other changes that have been observed in the nervous system are so slight that they can hardly be regarded as fatal. No direct fatal interference with cardiac function has been observed.

There seems to be little evidence to support the view that death following blast is due to cerebral lesions. A solitary human case was reported by Ascroft¹¹ in which he observed a curious lilac pink appearance of two areas of the cortex, which proved microscopically to contain widespread capillary hemorrhage. Stewart, Russel and Cone¹² described changes in the brain of a pheasant which died in the vicinity of a bomb crater. On the other hand, Hadfield^{5a} was unable to find any overt lesions of the brain in 10 autopsies, and in a later report,¹³ on 30 cases, he did not mention pathologic changes in the brain. O'Reilly and Gloyne^{5e} also observed no cerebral lesion. Zuckerman^{6b} subjected monkeys to fatal blast pressures of 110 pounds per square inch (7.7 Kg. per cubic centimeter) and was unable to find changes in the cortex, midbrain, pons or medulla in any of the animals. The conclusion¹⁴ that a shell blast sufficiently serious to damage the brain would prove fatal because of pulmonary or abdominal trauma appears to be a valid one.

Evidence of damage to the central nervous system in cases of nonfatal injury is equally meager. Garai¹⁵ reported a case in which there were

10. Krohn, P. L.; Whitteridge, D., and Zuckerman, S.: Physiologic Effects of Blast, *Lancet* **1**:252 (Feb. 28) 1942.

11. Ascroft, P. B.: Blast Injury of Lungs, with Curious Lesion of Cerebrum, *Lancet* **1**:234 (Feb. 20) 1943.

12. Stewart, O. W.; Russel, C. K., and Cone, W. V.: Injury to Central Nervous System by Blast: Observations on the Pheasant, *Lancet* **1**:172 (Feb. 8) 1941.

13. Hadfield, G., in Symposium on Problem of Blast Injuries, *Lancet* **1**:110 (Jan. 25) 1941.

14. Further Experimental Studies of Blast Injuries, editorial, *J. A. M. A.* **121**:1220 (April 10) 1943.

15. Garai, O.: Blast Injury: Non-Fatal Case with Neurological Signs, *Lancet* **1**:788 (June 17) 1944.

impaired pupillary reaction on the right and a transient extensor plantar response on the left. Abbott, Due and Nosik¹⁶ observed subdural hematoma in 2 victims of blast injury and "subdural effusions" in 8 others at operation.

It is quite possible, as Mott¹⁷ suspected, that subtle changes may occur in the nervous system following blast which cannot be discovered by crude methods of clinical and laboratory examination, such as those used in this study. The absence of an electroencephalographic record in these cases is regrettable, but we suspect that nonspecific brain wave patterns would be found, as was apparently the case in British studies on human subjects.¹⁸ Furthermore, Krohn and his associates¹⁹ obtained electrocorticograms from monkeys and cats (under light pentobarbital anesthesia) subjected to blast. In some they found no electroencephalographic changes whatever, even though the animal died as a result of the blast. In others there was a suppression of cortical activity for a period up to seven minutes after blast. No late electroencephalographic changes were found when observations were made several hours after blast. The authors concluded that the occasional transient changes observed could be related to cortical anoxemia resulting from general circulatory changes following the blast.

As for the claim that petechial hemorrhages occur in cases of blast injury, we have been forced to reject it. We are left with 2 cases out of 80 in which even minute amounts of blood and increased protein were present in the cerebrospinal fluid. This incidence of bleeding is too small to be taken seriously as evidence of multiple petechial hemorrhages in the brain. Nor is the argument tenable that such hemorrhages may be present but may not make themselves evident in the fluid: The cerebrospinal fluid is in too close approximation to all the brain substance to permit such an assumption. If such hemorrhages occurred with any consistency in cases of blast injury, they would be evident more often in the cerebrospinal fluid in the early stages.

In summary, in the series of cases in this study there appears to be no serious visceral pathology. The lack of evidence of cerebral damage appears to be consistent with the results of other studies, and it may be inferred that this series is representative of the cerebral type of blast injury. Klemm,¹⁹ in a study of 36 patients seen ten to twenty days after blast injury, and Anderson²⁰ described similar syndromes.

16. Abbott, W. D.; Due, F. O., and Nosik, W. A.: Subdural Hematoma and Effusions as Result of Blast Injuries, *J. A. M. A.* **121**:664 (Feb. 27); 739 (March 6) 1943.

17. Mott, F. W.: Lettsonian Lectures, *Lancet* **1**:331 (Feb. 12); 441 (Feb. 26); 545 (March 11) 1916.

18. Williams, D.: Personal communication to the author.

THERAPEUTIC TRIALS

The therapeutic effect of lumbar puncture in cases of blast injury proved to be nil. Analgesics, such as acetylsalicylic acid and codeine, brought only temporary relief, and then only occasionally. Sedation was of temporary benefit. Continuous narcosis therapy was not of value. Modified insulin therapy, as described by Sargant and Slater,²¹ failed to help these patients. The logic of desperation, and an almost mystical belief in what the drug can accomplish on occasion, even led us to try potassium iodide in some of our cases, but it was ineffective.

We stumbled on a new approach to therapy during an inquiry into the nature of the unconsciousness in these patients. Since all other methods had failed to disclose evidence of organic damage to the brain, we felt that a study of the period of unconsciousness following blast might shed further light on this question. We proceeded on the assumption that the patient would not be able to recover his memory for the period of unconsciousness if his brain was organically damaged by the blast but that he would be able to do so if there was no such damage. Consequently, chemical hypnosis was performed in a few of our early cases by Capt. David Turnoff, M. C. Sodium pentothal²² was used. He found that in this drug-induced state of semisleep the patients were able to relive the experience vividly and to recall the events in an accurate manner. Thus, it was proved that the loss of memory was of recoverable type, similar to that seen in hysterical amnesia, as Denny-Brown reported.²³ It was noted further that some of these patients reported a dramatic and gratifying relief of headache, tinnitus and anxiety after this procedure.

With the assistance of Major Douglas Kelley, M.C., it was demonstrated that this recovery of amnesia with consequent therapeutic effect could also be brought about by use of ether by inhalation, after the technic of Palmer,²⁴ as well as with sodium pentothal.

19. Klemm, R. A.: Atmospheric Blast Concussion: Medical Aspects, U. S. Nav. M. Bull. **44**:1228 (June) 1945.

20. Anderson, E. W.: Psychiatric Syndromes Following Blast, J. Ment. Sc. **88**:328 (April) 1942.

21. Sargant, W., and Slater, E.: An Introduction to Physical Methods of Treatment in Psychiatry, Edinburgh, E. & S. Livingstone, 1944.

22. (a) Horsley, J. S.: Narco-Analysis, London, Oxford University Press, 1943. (b) Grinker, R. R., and Spiegel, J. P.: War Neuroses in North Africa, New York, Josiah Macy Foundation, 1943. (c) Brenman, M., and Gill, M. M.: Hypnotherapy, *ibid.*, 1944.

23. Denny-Brown, D.: "Shell Shock" and Effect of High Explosives, J. Lab. & Clin. Med. **28**:509 (Jan.) 1943.

24. Palmer, H.: Personal communication to the author. In June 1944 Major Palmer demonstrated chemical hypnosis with ether to the staff of the general hospital where this study was made.

The early promise shown by these therapies led us into a more careful study of them. Too often the technic failed, but the occasional gratifying success was stimulating. For a while we felt that best results were obtained by producing strong emotional abreaction under the action of the drugs, with the patient struggling and shouting to extricate himself from the situation. At another time we believed that the essential element in therapeutic success was the production of tears, and we used every possible method to make the patient cry during the therapeutic session, as Palmer had advocated. Follow-up study, however, showed that best results were obtained when the patient recalled the amnesic period in all its details while under the drugs and when this became integrated into consciousness after the treatment.

Since many of the sessions were long, requiring repeated questioning for details when the patient was under the drug, ether was abandoned in favor of sodium pentothal. We found that it was more difficult for the patient to talk with a mask over his face and that the proper level of chemical hypnosis was more difficult to maintain with the inhalant than with the intravenously injected barbiturate.

After selecting sodium pentothal, administered intravenously, as our drug of choice, we continued to encounter difficulties. Often the patient was able to give a clear account of his amnesic period while under the drug, but after he returned to the ward from the treatment room he fell asleep, and on wakening he had no recall whatever for the details of his amnesia. We began to keep careful notes on the material uncovered during the treatment session, and these were read back to the patient after he was fully awake. Too often he would listen attentively, then shake his head ruefully, saying, "If you say so, it must be true; but I don't remember a bit of it." In such cases no therapeutic benefit was obtained.

Our next attempt was to induce the state of chemical hypnosis; get the patient to recite the events of the amnesia; then, by simulating battle noises, the shouts of his comrades and all the dramatic situation, have him relive the episode subjectively in its entirety. This abreaction technic produced more good results, but too many patients continued to fail to recall the amnesic events after full return to consciousness.

The next attempt was to have a corpsman stay with the patient for two or three hours after the treatment, keeping him awake and going over and over the amnesic material. This technic was abandoned because of the lack of an adequate resourceful personnel and because the patient was often so noisy and active during the period that he kept the entire ward in an upset state and required the assistance of more corpsmen than were available to restrain him. It was feared, also, that patients might injure themselves or the corpsman in attendance during these

periods. Because of these practical considerations this technic was abandoned.

Our next innovation proved to be a successful one. We decided that if the patient could be wakened immediately after recovering his amnesia he might be able to integrate it into consciousness. We turned to the analeptic drugs for this purpose. Those we had available were nikethamide^{24a} and metrazol. The rapid injection of 10 cc. of nikethamide or 5 cc. of metrazol wakened these patients immediately, and a quick review of the amnesic events then led almost invariably to complete integration of the amnesia into consciousness. Of the two analeptic drugs nikethamide proved to be the better, and it came to be adopted routinely.

THERAPEUTIC PROCEDURE ULTIMATELY ADOPTED

The technic of chemical hypnosis—or narcotic hypnosis, or narcohypnosis, or narcoanalysis, or narcosynthesis, or chemical abreaction, or ventilation, to list its many synonyms—is a lengthy procedure in cases of blast injury. Although we were pressed for time, we found that one to two hours was required to do the work correctly. In a small number of cases we were required to repeat the procedure a second or a third time, but the number of successes after a single treatment rose as our skill increased. The technic has been described by others in the treatment of various psychoneuroses. Because of the peculiar difficulties encountered in the use of this therapy in cases of blast injury, it is well to describe our variations in technic in detail.

Preparation of the Patient.—Premedication with 1/150 grain (0.4 mg.) of atropine is given hypodermically, and the patient is placed on a well built, padded table. The procedure is explained to him as an attempt to recover memory for the period of unconsciousness following the blast experience. The soldier is questioned about the events immediately preceding the blast. He is asked what he was doing at the time, the names of those near him, the tactical situation, and so on. He is also questioned about his situation and circumstances when consciousness returned fully, so that an exact end point of the amnesia is known.

Induction.—A 2 per cent solution of sodium pentothal in a 30 or 50 cc. syringe is then injected in an arm vein while the soldier counts backward from 100. The rate of injection varies as it does in surgical anesthesia, but in the usual case the patient begins to slow up or become confused in his counting after the injection of 10 to 15 cc. The injection is continued until light sleep is induced. The patient is permitted to sleep a minute or two, and then, by shaking his head or slapping his face, he is awakened. This level of profound drowsiness on the brink of sleep is the proper one, and enough pentothal is injected from time to time to maintain this optimum partial sleep state.

Probing Technic.—The patient is quiet and relaxed. His speech is thick and ataxic. His eyes, if they remain open, do not converge. He is told that he is to talk about the blast experience. In actual words the conversation goes something like this:

24a. Commonly known as Coramine.

"Jones, wake up and talk to me. We are going to talk about that time your squad was moving across the field to take that little village outside Cologne; remember? It was a gray day, shortly after noon; you had just had your chow. The sun was trying to come out between the clouds. Sergeant Smith was in the lead; then came Brown, and you followed with a B.A.R.; remember?"

Any of a number of responses may take place. A goodly number of patients will pick up the story and carry on. Another soldier may tend to ramble, wanting to talk of his intense admiration, or his equally intense dislike, for Sergeant Smith. Another may want to talk about his fine comrade Brown and the wonderful time they had on a twenty-four hour pass together in Liege. Another may want to describe the terrain and the tactical situation with the thoroughness of a Douglas Southall Freeman. These excursions into other matters must be discouraged if they are not germane to the narrative, and the patient must be urged along the line of productive inquiry. He begins to talk, usually in the earthy idiom of the soldier. He tells of shells coming in, of flattening on the ground.

"What is the first thing you remember after that?" he is asked.

"I don't remember anything! I was out like a light until I came 'to' near an aid station," he may say.

In other cases, without further prodding, he may begin to unfold an orderly, chronologic, well worded recapitulation of the entire period of amnesia. There are no two cases alike, and one cannot predict beforehand the amount of difficulty which may be encountered. In this regard the procedure is the same sort of an adventure as a laparotomy: the surgeon never knows quite how much difficulty he is going to encounter when he opens the peritoneum.

If the patient does not begin to recall the amnesia, a technic something like this is followed:

"No, you were not really 'out'; you were just stunned. You can see it all now. Everything is clearer to you. What is the first thing you remember after the shell went off? Where was Sergeant Smith? What happened to Brown? Think! Tell me!"

Sometimes easily, sometimes after great difficulty, a surprised exclamation follows, and the verbal picture begins to unfold:

"Oh yeah! Now I remember. Brown was hit. He was yelling for the medics. He was yelling for me, too. I tried to crawl, but my legs wouldn't work. My goddam legs! I was paralyzed! My head was splitting, and I couldn't hardly hear. I was shaking like a leaf. Christ, it was awful."

He is urged to continue with the story, which may reveal that Sergeant Smith crawled back to Brown, then herded both men into a ditch to avoid further injury; that Brown had an arm wound; that Sergeant Smith bandaged his wound and gave him some sulfonamide pills, while he, Jones, lay there shivering and shaking, feeling that his head would burst. Then the story may go on to tell how more shells came in, how they all prayed, how he was unable to hold the cigaret he was given, how he became frantic with the continued shelling, how he tried to get out of the ditch, how the others had to sit on him until the shelling slackened, how the "medic" came up and how he walked and stumbled between Brown and the "medic" to the rear, where they were put on a jeep and how he finally regained consciousness as they were riding to the aid station.

The tale is often more complex and more harrowing than that just related. It is advisable to have three or four corpsmen standing by during this recital, because the patient may try to leap off the table. At any point there may be a block in the narration, and it may become necessary to ask many questions in order to

get beyond an episode for which there may be a more profound amnesia. By constant insistence and reiteration, the memory is recovered for the entire period, step by step.

Review.—We have found it profitable at this point to recapitulate the entire narrative for the patient. Notes kept during the period of probing are consulted if necessary. The soldier is told:

"Now you have told me everything that happened to you after you were blown up by that shell. I am going to tell it back to you, and I want you to interrupt me and correct me on any point that may be wrong."

The story is then reviewed for the patient, and in this way it is checked accurately and enriched in detail. At the end of this review, the needle is withdrawn, and the patient is told to go to sleep.

Abreaction.—The corpsmen now range themselves strategically around the table, holding the patient in light restraint. He is told rather excitedly, "You're back up there now, you and Brown and Sergeant Smith and the rest of the squad. You're starting across the field. The 88's are coming in! Hear them? Hit the dirt!" At that point the sound of 88 mm. shells is simulated. The patient becomes extremely agitated and tries to leave the table. A corpsman plays the role of Brown, begins to cry that he is hit, begins to call for Jones, the "medics." Another plays the part of Sergeant Smith, orders the patient into a ditch. The patient is then seized with a violent shaking. In this manner the whole amnesia is quickly reviewed scene by scene, with the patient reliving the entire experience subjectively and with dramatic intensity. By employing appropriate sounds and words, the patient is quickly changed from a quiet, objective story teller to a frightened, desperate soldier, reliving the episode with the hard reality of the original experience. At the end of this abreaction, as it has been called, the patient is often exhausted.

Waking.—Another venipuncture is done quickly, and the sound of shells is mimicked once more. Simultaneously, as the soldier struggles to get away from the shells, 10 cc. of nikethamide is injected quickly. Within about a minute his face begins to flush, he sits up, and in about 80 per cent of cases he begins to sneeze violently. The sneezing lasts thirty to sixty seconds, and then the patient looks around, often scratches the skin of his chest and shoulders, rubs his eyes and head, recognizes his surroundings and is fully awake.

Recapitulation.—The soldier is told that while he was asleep he related his entire amnesic experience, and now that he is awake he will be able to recall everything. With very little prodding, and a suggestion here and there, he unfolds the whole episode again, often more rationally and in more detail than when under the drug. Many patients are amazed at the vividness of their recall as the narrative races on. When he has finished his recital, he is led back to his bed by one of the corpsmen who has been present throughout the procedure, and they talk over the experience as soldier to soldier, usually with much smoking of cigarets. Later in the day the patient is instructed to write out the entire episode on paper. He is encouraged to make it as lengthy and as detailed as he chooses. By his committing the experience to writing, its conscious recall is strengthened.

After-Care.—Many patients do not sleep well on the night after treatment. On the next morning or on the second morning most patients report great improvement in symptoms. They speak of relief of headache; they appear more buoyant, and the anxious facies has changed to a more placid one. They often use this phrase, "My head is clear now," instead of saying that the headache has abated.

This has been told to us so often that we suspect that the complaint originally was an intellectual and emotional torpor rather than a true pain in the head and that the generic word "headache" was used to describe it because of limitations of vocabulary.

The events of the amnesia are then discussed with the patient. About 1 in 4 has an adverse emotional reaction to the material uncovered. The noncommissioned officer often has a guilt reaction to the situation: He has failed in his duty to his squad. The soldier who struck his good friend during a panic reaction is deeply chagrined. The sensitive man who shot a sniper who turned out to be a woman may be so upset that he is advised to discuss this breach of ethics with the chaplain. The rifleman who has been tormented with distorted dreams is made to understand that they stem from a real situation which occurred after his blast. The occasional soldier who had the delusion that he was captured by the enemy, and tried to shoot his comrades and run away from them, is deeply shocked to realize that such a paranoid distortion of the thinking process could occur in him. The patient who has to live with the memory that his buddy who was in a hole with him was decapitated by the same shell that made him unconscious is in need of help. A desperate domestic situation which is interwoven with the deep anxiety following blast, and which reveals itself during the treatment session, must be discussed fully. Grinker and Spiegel^{22b} have called this process narcosynthesis. In some cases a series of interviews is necessary to bring the patient to adopt a healthy mature attitude toward such emotion-laden material, but this is not the rule. Most combat soldiers are realists, and they have learned to handle psychic trauma. Sympathetic handling, an attitude of naked frankness and the insistence that this is one more thing he will have to learn to live with in order to preserve his emotional health usually suffice.

The individual nature of this therapy has precluded the use of any kind of group psychotherapy with these patients. A subtle but effective group psychotherapy is constantly at work, however. These patients are kept in a ward together. The newly treated patient gravitates toward others who have been treated in a similar fashion, and the dilution of his experience with that of the group has a salutary effect.

Adjunctive Therapies.—An appreciable number of these patients are deteriorated physically and have a more or less chronic gastrointestinal dysfunction. Such patients are then given a period of modified insulin therapy (Sargant) in other wards until they have regained normal weight and digestive habits. Others with mild depressive reactions are given amphetamine for a variable number of days. Those not requiring such therapy, or any other medical or surgical attention, are moved to the rehabilitation section as soon as it is evident that they have improved. This may be done as early as forty-eight hours after treatment. There they receive a two weeks program of physical and military training and then appear before the disposition section.

EVALUATION OF THERAPEUTIC PROCEDURE

How true are these narratives which unfold themselves under chemical hypnosis? It is not possible to answer this question accurately. We have had occasion to check the stories of 3 out of 80 of the patients. Other patients in the hospital who were in the same squad and were evacuated with the blast casualties have checked over the patient's

narrative with us. In each instance they have corroborated his statements. This may not prove to be the case universally, but it is our opinion that it makes little difference. Whether something occurred this way or that way is not so important as the patient's belief in its reality. For example, a frequent distortion of belief on the part of the combat soldier is that a wounded comrade is dead, and in that instance it is the belief rather than the fact which has emotional and intellectual importance for him. We have accepted this solipsismal approach pragmatically, and we do not haggle over the question of the veracity of experiences told us under pentothal narcosis.

The company grade officer and the noncommissioned officer of the line know far more about the acute manifestations of the blast syndrome than any one else. Their descriptions of the behavior of blasted soldiers give support to the notion that what we hear and see relived under chemical hypnosis is close to the original experience in most cases. It is seldom that a man is rendered comatose by nearby shell blast. In any event, it is an unusual kind of coma when it does occur. It is treated by shaking, prodding or even kicking the soldier, after which he wakens suddenly. They tell us that at that point the patient may become acutely "wild" and attempt to run away or attack his friends. Much more often the blasted soldier hits the ground, begins to shake violently and even yells or cries. Often he crawls, unable to walk. A few assume catatonic postures. Another few go immediately into panic behavior. In the usual case other soldiers get hold of the casualty, get him to cover and continue to shake and slap him. At this point a cigaret is usually introduced. While he attempts to smoke, they talk to him and try to "bring him around." If he has not regained his composure in the time it takes to smoke a cigaret (five minutes), he is usually evacuated to the rear. One group of platoon leaders in an infantry division of large experience estimated for us that less than 5 per cent are comatose initially, about 5 per cent are in acute panic initially, less than 5 per cent "freeze" in catatonic attitudes and the remainder shake violently, with varying degrees of crying, shouting or jargon speech. From that point just about any form of dissociative behavior may occur until consciousness returns. This is consistent with the stories we hear under chemical hypnosis, and therefore we have come to believe that, in general, the patient is describing and reliving actual experience under the drug in cases of blast injury.

In occasional cases the conscious recall of the amnesic material is pathologically vivid and remains so for some days. The soldier can think of nothing else, can talk of nothing else and is unable to divert himself from it. When this is present, headache and anxiety persist, and sleep is poor. The longest time we have seen this condition last is five days, and then the episode began to lose its pervading intensity

and the patient's symptoms abated. One soldier described this state as follows:

"It's like I am in a theater and this picture is being shown over and over on the screen. I try to get away from it, but everywhere I go the picture goes with me."

Another patient wrote out his subjective reaction to this phenomenon. He said that it was stamped in his mind, that it prevented him from reading, writing or going to entertainments and even distracted him while eating, thus robbing him of appetite. He met a soldier from his home town, an old friend who was a member of the hospital detachment. He could not talk of the pleasant gossip of home with this friend but felt impelled to describe the amnesic material over and over, although his friend urged him to get the thing off his mind. We have found that it is best to wait for such abnormally vivid recall to abate naturally, rather than to try to interfere with psychotherapeutic or chemotherapeutic measures, since it always does so of its own accord within a matter of days.

There is no direct correlation between the length of time elapsed between blast and treatment and the ease with which memory is recalled. We got the impression that certain advantages were derived from early treatment, but that this was not consistently the case. When the patient is seen and treated early, he is able to recall the events before and after blast more clearly, thus facilitating treatment. Symptoms existing for long periods become deeply rooted and change the soldier's outlook and habits. The factor of secondary gain from neurotic symptoms is larger in chronic cases on the whole. On the other hand, we have seen striking relief of symptoms in cases of long duration, so that no rigid rule seems to apply. The lesson to be learned from this observation is that it is worth while to attempt treatment however long symptoms have persisted. One of our most gratifying results occurred in a soldier who had blast injury at Anzio in February 1944 and who was treated in May 1945.

Because so few patients had evidence of intracranial bleeding, and because they seemed to have the same symptoms as the rest of the patients with blast injury, chemical hypnosis was carried out on them exactly as it was in the entire group. In each of the 2 patients with hemorrhage a good therapeutic result occurred, and these patients were discharged to duty. The manner of response of these patients to therapy led us to the conclusion that bleeding into the central nervous system was not of primary importance but was a secondary matter—that the bleeding which occurred was not a phenomenon of etiologic importance but that it was an epiphenomenon in the course of blast injury.

It is probable that verbal hypnosis can be substituted for chemical hypnosis as a therapeutic technic in selected cases of blast injury. We are indebted to Capt. Oscar Legault, M.C., for preliminary observations on this method. In 2 cases he was successful in recovering and resynthesizing postblast amnesic material, and in 2 cases he reported failure with the use of classic hypnotic technic. He deliberately chose cases which appeared difficult, and it is probable that in a larger series the technic would prove more effective.

During our therapeutic investigations, we varied the technic occasionally for purposes of study. In some cases we avoided the review of the amnesic material while the patient was under pentothal hypnosis; in others we avoided the immediate recapitulation after recovery of consciousness. In some instances the patient was not required to write out the amnesic material. In another group the abreaction phase of therapy was deliberately omitted. We found that we were able to achieve successful results with all these variations, including the avoidance of abreaction. Any variation, however, which produced an inadequate recovery of memory for the amnesic material left the patient without therapeutic benefit. From these observations, we concluded that the least common denominator of therapy, the *sine qua non* of therapeutic effectiveness, was the recovery and emotional resynthesis of memory for the amnesic material. As long as that remains the therapeutic aim, wide latitude in devices to bring it about seems permissible.

A last point worthy of comment is the question of the recovery of memory for the sound of the explosion. It will be remembered that the patient has a retrograde amnesia of short duration and that the one thing he consistently fails to remember is the sound of the explosion itself. This is never recalled when he is under the drug either, even after direct accurate questioning. It is possible to suggest that the patient heard the explosion, but if this is not done he will maintain his original opinion that he did not hear it. One is driven to the conclusion that this sound never registers itself in consciousness in these patients.

THERAPEUTIC RESULTS

There is one symptom which is never entirely alleviated by any of the technics of chemical hypnosis we have employed—the complaint of sensitivity to noise. The auditory mechanism remains pathologically alert in these patients, and loud noise is capable of producing transient headache in almost all cases. At the time most of them leave the hospital, two or three weeks after treatment, this complaint is much less acute but is seldom completely obliterated. We were forced to excuse these patients from practice on the rifle range at the rehabilitation camp

because so many of them complained of the effect of the noise of gunfire. Some who volunteered to go to the range found that it caused a recrudescence of headache which they had not expected to occur. As a consequence of this sensitivity to noise, we have not sent these patients to combat duty because we felt that the noise of battle would be intolerable to them. With the exception of 2 patients who insisted on returning to combat after assuring us that they were no longer sensitive to noise, we have placed all others going to duty on limited noncombat status in the European Theater.

With the ether technic, about half the patients experienced therapeutic benefit from the recovery of amnesia, and these patients were sent to duty. Two were evacuated to the Zone of the Interior. One was mentally deficient, and the other appeared to have petit mal seizures which antedated the blast. Those who did not respond were treated with sodium pentothal (table).

Therapeutic Results of Chemical Hypnosis in Patients with Blast Injury

	Technic		
	Ether	Pentothal	Pentothal-Nikethamide
Patients treated.....	21	15	58
Therapeutic successes.....	10	10	53
Patients returned to duty.....	10	10	53
Patients retained for further treatment.....	9	5	..
Patients evacuated to Zone of Interior.....	2	..	2
Patients held in hospital.....	3

With the pentothal technic, two thirds of a small series were able to recover from their amnesia and were sent to duty. The remainder were treated with pentothal and nikethamide (table).

The majority of the patients were finally treated with the pentothal-nikethamide method. Of 58 patients so treated, 53 returned to duty. Two patients were evacuated to the Zone of the Interior as therapeutic failures. Both were patients who had complained of headache for many years prior to blast injury, and both gave histories of chronic psychoneurotic behavior. Three more patients were retained in hospital, complaining of chronic headache, sensitivity to noise and vertigo. It appeared that they would not be returned to duty and would have to be evacuated as well (table).

No follow-up studies are available on the patients treated. They went from hospital to reenforcement depots and from there to limited assignment duties. None have returned here, but it is not certain that they were not rehospitalized elsewhere after discharge. The assignment of these patients to duty was the decision of Major Morris Kleinerman, M.C., Chief of the Disposition Section. He was asked to make a short

comment on each patient at the time of discharge. He found that many were still somewhat sensitive to noise, that some complained of occasional headache and that others were somewhat tense and anxious at the time of discharge; but in no case were these complaints regarded as incapacitating, and it was felt that the patients would continue to maintain their therapeutic improvement.

SUSCEPTIBILITY TO BLAST INJURY

Not all soldiers appear to be equally susceptible to the damaging effects of nearby explosions. Two soldiers may be side by side, and a shell may explode directly in front of them. One may exhibit the blast injury syndrome; the other may go right on without any untoward effects. This has often been explained by the capricious manner and direction of spread of the blast wave, and this consideration cannot be underestimated. On the other hand, the nervous system of the recipient of the blast wave must not be ignored. To explain this is not easy, and we can offer no conclusive data. To say that all soldiers who become blast victims are chronically neurotic and emotionally unstable does not fit the facts. Longitudinal histories and previous battle performances of our patients do not bear this out. Most of the patients are well integrated persons. Approximately 10 per cent of the series gave a history of previous neurotic instability, and these soldiers appeared to experience blast injury relatively early in their combat career. In the larger group fatigue appears to play a role. Line officers report that when a man has gone for days without proper sleep or food he is more susceptible to blast injury than when he is fresh and properly nourished. In others the blast syndrome seems never to develop.

One officer of the line estimated that if ten soldiers were placed in a circle in an open field and a shell were exploded in their center, one or two would suffer blast injury and the others would escape. Barrow, and Rhoads²⁵ reported an occurrence similar to this. Two hundred persons were standing together when a large blast occurred. Less than 20 per cent had periods of unconsciousness as a result. We have no data on this subject; but, if we accept the impressions of observers in combat, there seem to be persons who are obviously neurotic and predisposed to blast, those who are apparently stable but susceptible to blast, those whose susceptibility is increased by the fatigue of combat and its consequent tensions and those who are apparently immune to this disorder. Blast injury appears to be similar to sequelae of head injury in this regard.

25. Barrow, D. W., and Rhoads, H. T.: Blast Concussion Injury, *J. A. M. A.* 125:900 (July 29) 1944.

RELATION OF BLAST INJURY TO POST-TRAUMATIC COMPLAINTS
OF HEAD INJURY

Throughout this inquiry the relation between the blast syndrome and the syndrome of the chronic post-traumatic complaints of patients who have received a direct injury to the head has been considered. A small number of patients reported that they were struck on the head by bricks or rubble at the time of the blast, and for these patients the therapy appeared as efficacious as for the much larger number who had escaped a direct blow to the head. One case in particular brought the problem into clear relief.

A rifleman aged 29 had suffered a blast injury near Mortain, France, on Aug. 12, 1944. This was followed by amnesia of twenty minutes' duration and the usual sequelae. He was evacuated to a hospital in England. On September 10, he was sitting on the hospital lawn reading a book, when he was struck on the left side of the head by a croquet ball driven by another patient. He was rendered unconscious by the blow and came to his senses about a half-hour later, while roentgenograms of his head were being made. After the second traumatic episode his symptoms were aggravated. He complained of constant dull frontal headache, vertigo of floating type, sensitivity to noise, jitteriness, insomnia and inability to concentrate. He remained in the hospital until December 1944 and was then assigned to a reenforcement depot. He remained in the replacement system for the next three months, moving from depot to depot, and continued to voice his complaints, for which he was finally rehospitalized.

On March 22, 1945 he was treated by chemical hypnosis with the pentothal nikethamide technic. It was possible to recover the amnesic material for both the blast experience and the blow to the head. Under pentothal hypnosis he was able to tell of being blown halfway out of a foxhole by the blast. He lay on his face, shaking violently. Then he heard the soldier in the next foxhole calling for the "medics." He crawled into the wounded man's hole, found him to have an abdominal wound and, as soon as he was able crawled and staggered to the rear. He rested in a clump of trees for a moment, then found his way to a road. There he met a major, who wanted to know what he was doing. The major ordered him to proceed down the road to the nearest aid station. Along the way he met an ambulance and told its occupants about his wounded comrade. He came to consciousness shortly thereafter, as he was walking toward the aid station.

He was then asked to describe the second episode. He said that the blow from the croquet ball knocked him to the ground and that the soldier who drove the ball ran to him and tried to apologize. The ward nurse ran out of the door, upbraided the offender and called for a corpsman to help her. The patient was lifted by the soldier and assisted to the ward, walking between the nurse and the corpsman. He was placed on his bed and the ward officer was called. The latter examined the patient, filled out a requisition for roentgenograms of the skull and told the ward man to take the patient to the department of roentgenology. He was lifted on to a wheel litter and was rolled about 200 yards (180 meters) along walkways to the roentgenology building and placed on a table. He woke up while pictures were being taken. The patient reported amelioration of all his symptoms after this amnesic material was recovered in consciousness, and he was returned to duty.

Another soldier, who had received a blow to the side of the head from the knee of a base runner during a game of baseball at Fort Meade, Md., nine months previously, was treated in a similar way. Under chemical hypnosis he was able to picture all the details of being carried off the field to the dispensary and of waking while a small supraorbital laceration was being treated. He made a good recovery and was deliberately kept in the rehabilitation section for sixty days, where he worked as a cook, so that his progress might be followed. During that time he did not complain of headache or vertigo. These symptoms had been so persistent prior to treatment that he had become a chronic visitor on sick call and had been rehospitalized on two occasions for study.

Another patient with head injury, an infantry man aged 23, was riding in a jeep east of Paris in August 1944 under blackout conditions on a dark night. The next thing he knew was that he was in a hospital, with his head bandaged. He had a large laceration of the left side of his forehead, and he surmised that the vehicle had been shelled. He was left with chronic persistent bitemporal headache, vertigo and insomnia. He was kept in hospital for ninety days and was then placed on limited duty as a welder in an ordnance unit. He was happy in this work, because welding had been his premilitary occupation. His headache failed to improve, however, and he was rehospitalized. By means of chemical hypnosis, it was found that his vehicle was not shelled but that it had a head-on collision with another jeep in the blackout. The vehicle turned over, and the patient was pinned underneath. The other soldiers lifted the jeep and dragged him out from under it. They carried him to the shoulder of the road, and 2 medical soldiers from the other vehicle bandaged his head. An ambulance was called by radio (the radio in the jeep was still in operation after the accident), and it came along about twenty minutes later. He was removed to the hospital and returned to consciousness shortly thereafter. After the recovery of this amnesic material in consciousness he had complete cessation of headache and other symptoms and was returned to his unit.

Our experience with treating post-traumatic complaints of head injury by chemical hypnosis with the pentothal nikethamide technic is limited to a small number of cases at this time. Capt. David Turnoff, M.C., has had therapeutic success in another small number of cases with this method. There have been a number of failures as well. It is our opinion that the failures occur especially in those cases in which there are painful scars in the scalp, bony defects in the skull, evidence of widespread cerebral damage, and the like. More work will be necessary to confirm these observations, but preliminary studies suggest that this technic may develop into a useful therapeutic tool in the large problem of treatment of the chronic sequelae to head injury of headache, vertigo and symptoms of tension.

SUMMARY

A study of 80 consecutive cases of blast injury in combat soldiers was carried out. It was found that the disorder occurs among men of all ranks, in new troops as well as in veterans of combat. All types of explosive agents can cause the disorder. Some soldiers become blast victims after a single nearby explosion; others succumb as the result

of the cumulative effect of a barrage. The unconsciousness produced by blast is characterized by a retrograde amnesia for the sound of the explosion and by a period of anterograde unconsciousness of variable length, but lasting an hour in the usual case. The unconsciousness is seldom characterized by coma, but, rather is marked by dissociated, aimless behavior. On return of consciousness, the patient complains of protracted headache which is nonspecific in position and quality and which may be constant or intermittent. In addition, he complains of tinnitus, which is usually nonpersistent, and of diffuse anxiety symptoms. About one-half the patients complain of a generalized somatic soreness for a day or two after blast injury. They show no evidence of focal damage to the central nervous system on neurologic examination, and few have bleeding from any of the orifices. Study of the spinal fluid shows normal pressure and normal cellular and protein contents. Bleeding into the fluid is extremely rare (2.5 per cent).

A successful method of therapy was discovered during an inquiry into the nature of the unconsciousness of these patients. It was found that memory for the unconscious period could be recalled under chemical hypnosis and it was therefore an amnesia of the type seen in hysteria. Furthermore, it was noted that there was dramatic relief of symptoms in cases in which there was good conscious recall for the amnesic material.

Clinical experimentation with the technic of chemical hypnosis led to a modification which proved successful in bringing about recovery of postblast amnesic material. The method employs intravenous injection of sodium pentothal to produce chemical hypnosis and exploration of the amnesic material, followed by rapid wakening with intravenous injection of nikethamide. The technic is described in detail. It proved of therapeutic value in more than 90 per cent of patients.

The problem of individual susceptibility to blast injury is raised. The relation between blast injury and head injury is pointed out, and it is demonstrated that the pentothal-nikethamide technic can be employed successfully in some cases of the chronic sequelae of head injury, as well as in cases of blast injury.

REPORT OF CASES

The following cases are illustrative of various aspects of blast injury. Proper names have been altered throughout; otherwise no changes have been made in factual data.

The first case is a typical one and is described in detail. An attempt has been made to put down the actual dialogue employed during treatment, although we were unable to record it verbatim.

CASE 1.—V. P., technical sergeant in a rifle platoon, aged 24, entered the hospital May 4, 1945, complaining of headache, "jitters" and lack of "pep." The patient had been in combat for four months, when he was "knocked out" for two hours by the effect of shell blast, on March 13, 1945. He returned to

consciousness while walking down a street in the company of one of his squad sergeants. He had severe pounding frontal headache and tinnitus and felt "flighty" and excited. His hands were trembling, and every muscle in his body felt as though it had been mashed. He was kept in the divisional area for two weeks and then went back to duty on his own insistence, even though his headache and tremulousness had not abated. He found that he fatigued easily and that the noise of artillery, friendly or enemy, was almost unendurable because it caused his head to hurt violently and produced increased tremor. After three days in the line he was evacuated.

He spent one month in other hospitals. He was given rest and symptomatic treatment, but his headache and tremulousness continued. His chief concern was his anxiety reaction. He spoke of it as something he had never experienced before and said that he was "getting mighty disgusted" with himself, "feeling so shaky inside all the time." His tinnitus was not entirely gone. He said that he experienced ringing in both ears for a few minutes several times a day. He was concerned about his abnormal sense of fatigue. He had left school in the fifth grade because he had to earn a living, and therefore he had never developed the habit of reading anything but newspapers. He complained now that he could not concentrate enough even to read a paragraph of the Army newspaper. He was not actually depressed and assured himself that he would "snap out of it," but he was apathetic and kept to himself.

Physical examination revealed nothing abnormal except for tremor of the outstretched hands. His blood pressure was 140 systolic and 80 diastolic and his pulse rate 112. Neurologic examination elicited nothing of significance. Lumbar puncture released an entirely normal fluid, under 160 mm. of pressure.

On May 10, 1945, after premedication with atropine, light sleep was induced with intravenous injection of 18 cc. of 2 per cent pentothal sodium. He was awakened by slapping his face and was asked to begin to talk about his blast experience. He was reminded that it had occurred late in the afternoon on a sunny day, when his platoon was attempting to take a hill beyond a sanatorium near Remagen, Germany. He rubbed his forehead and began to talk.

"Yes, that was a hot spot. There was a lot of shelling. Mortars and 88's all mixed up. There must have been a half million of them. They were killing my men. I was waiting for orders to move on or do something. There was a lot of shallow trenches on that hill—I guess the Jerries dug them. They were no damn good—too shallow. I yelled to the men to take the best cover they could, to flatten out in those damn shallow trenches. I crawled along from trench to trench, seeing how the men were, and I snuggled into a hole then myself. That was a hot spot, that hill!" At that, the patient removed his hand from his forehead and lay limp on the table. No more speech came from him.

"What happened next, Sergeant? What did you do then? What went on when you were in that hole?"

There was a pause, and the patient seemed to be asleep. He was slapped slightly on the face and was asked the same questions; at the same time he was exhorted to think and was assured that it was clearer now, that he could remember better.

He began. "One of those things must have hit almost in my hip pocket. I was dizzy. I moved to the next hole. I was dizzy. Then I heard Sergeant Wise yelling over to me, 'What happened to you?' I heard him calling over, calling out my name, but I couldn't answer. Then after a bit he came over and said, 'Sergeant, what's wrong?' and I could answer him then. I said, 'Nothing, I'm good as new.' I tried to get out of the hole, but I couldn't. He had to help

me. You know, that's a funny thing. I was weak as a kitten." At that the patient stopped talking and shook his head, apparently ruminating over his profound weakness at that moment.

"What happened next, after Sergeant Wise helped you out of that hole?"

After a short pause he replied, "He told me about Lieutenant Anders."

"What about Lieutenant Anders?" he was asked.

"Sergeant Wise told me that he was wounded in the leg," he said.

"What then?" I asked.

"I didn't know what to say to that. We all liked Lieutenant Anders. So I got up and . . ." At this point the patient laughed. "And do you know what I did? I walked smack into a tree. I don't know why, for I could see the tree, but I guess I didn't have much sense then. . . . And, do you know, I got mad at that tree. I hit it with my fist. Isn't that the silliest damned thing?"

"What happened next, Sergeant?"

"Well, Sergeant Buck came along about then and asked me what was wrong, and I said nothing was. He said, 'You'll have to come with me,' and I said, 'Where do you mean?' and he said, 'Just come with me'; so he took me by one side and the platoon runner got me by the other side, and they began to walk me down the hill, the same way as we came up, along a path. My head felt like hell, and I was dizzy and my ears were ringing, but I didn't want them to hold me; so I shook them off me and said I'd walk by myself." There was a pause.

"And then what happened while you were going down the hill?" he was asked.

"Four of my boys were dead along that path. I looked at them. I got a lump in my throat. The clothes of one of them were still smoking. I had to step right over one of them to get down the path."

"Yes?"

"And then they began throwing 88's in. They were coming in fast, right on the path. I started to run, and I ran and ran. And then I heard Sergeant Buck behind me saying, 'Sergeant, you don't want to go that way,' and so I came back to Buck and the runner, and they held on to me, and we went down the path. We saw some men from another outfit digging in along the path. Buck said, 'Don't you guys take any chances. It's really rough up there,' and then we got down on to a road."

"Yes?"

"We didn't know which way to go, but Buck said to go to the left; so we were going along this road when a bunch of rockets started coming in. Rockets make the damndest noise! The other two hit the ditch alongside the road, but I didn't seem to be able to use my sense; so I just looked at them. Buck jumped out of the ditch and snatched me down. I told him not to throw me around that way. He told me he was doing it for my own good, and he said, 'Goddamit, why don't you snap out of it?' I guess he was pretty mad at me acting like that." There was a pause.

"What happened next, Sergeant, after the rockets went over?" I asked.

"Well, we got up, and a fellow came along in a jeep. Buck asked him where the aid station was, and he said he didn't know. I said, 'You look to me like a guy who doesn't know a goddam thing,' and I wanted to smack him, but Buck wouldn't let me.

"Yes?"

"Well, we walked along the road, and Buck made me hug a stone wall—wouldn't let me walk out in the middle of the road."

"What happened then?"

"Well, we walked along this wall, and we heard a lot of artillery going over. It made me sick, and I threw up. Then we came to a house and we went inside."

"What did you do in the house?"

"Well, there was a blonde standing near the door—pretty good-looking babe—but I didn't pay any attention to her. She sort of stood in our way; so I took my gloves that I had in my hand and slapped her across the backside and told her to get moving." At this the patient laughed.

"And then what, Sergeant?"

"Buck led me into another room and told me to lie down on a bed. It was a fine, soft bed with sheets and everything. Boy! That bed felt fine! He told me to rest there while he hunted up the aid station." There was a pause.

"What did you do then, Sergeant?"

"I must have dozed off to sleep, because the next thing I knew some one was shaking me by the shoulders and it was Buck, and he told me to get up and get going, because he had found the aid station. So I got up and walked out of the house with him, and as we were going up the street toward the station I came to my senses."

"How did you feel?"

"I felt like hell. My head hurt, my ears were ringing, and I felt shaky all over. I asked Buck what it was all about, and he told me that a shell had knocked me groggy, and we kept on up the street to the aid station—it wasn't far—and he turned me in to the medics."

Then he was told: "Now you have told me just what happened after the shell hit near you, and I'm going to tell it back to you, and you correct me if I'm wrong." This was followed by a relatively rapid retelling of the foregoing events. When the episode of the tree was described, he said, "Can you imagine that! Trying to knock a tree down with my fist!" When the episode of seeing the four dead men was described, he turned his head into the pillow and said, "Awful!" When I mentioned the episode of his wanting to strike the jeep driver because he didn't know the whereabouts of the aid station, he said, "Yes, that's right. I wanted to hit that guy. That poor devil probably didn't know what to make of me. I remember the surprised look on his face." When the episode of finding the German girl in the doorway was described, he interrupted to say, "Can't fraternize with them, can't fraternize! I won't let any of my men fool with the Jerries. And I don't, either. So I smacked her—didn't hit her hard; it was sort of playful like—and told her to get moving."

At the end of the verbal review the patient was told to go to sleep. The needle was withdrawn. Twenty-seven cubic centimeters of pentothal sodium had been given. He assumed a relaxed position on the table, as though sleeping quietly. The corpsmen, two on each side of the table, placed their hands in readiness to restrain motions of the patient's extremities; and then in an excited, hoarse whisper he was told, "You're back up on the hill, Sergeant! Trenches are too shallow! Tell the men to find cover! Listen to the 88's!"

At that the corpsmen began to whistle, simulating the whine of oncoming shells. A tin can, filled with broken glass, was kicked vigorously to simulate the sounds of shell explosions. The patient tried to leave the table in one convulsive leap but was restrained. He began to bark out orders: "Mac, get down! Chris, hey, Chris, crawl to your left! They've spotted us! Down, all of you, down!" He continued to struggle, to attempt to crawl, to shout orders. The sound of shelling was continued. Then an excessively loud sound was made. A corpsman called, saying, "What happened to you? This is Wise; what's

wrong?" The patient lay limp on the table. Then he was grasped by the shoulders and lifted up. "How are you feeling, Sarge? What's wrong?" He replied, "Nothing, nothing; I'm all right, good as new."

"Did you hear about Lieutenant Anders?" he was asked.

"No, what happened?"

"He got it."

"Bad? Where? Where is he?" he asked wildly.

"No, they said it wasn't too bad. The medics got him, and he's gone back."

"That's a damned shame," he said; "they don't make guys like that very often. I hope he makes out all right."

There was a pause, and then he was told quickly, "Tree! What are you doing, bumping into the tree?"

The patient tried to swing his right fist but was restrained. "This is Buck, Sarge. You'll have to come with me," he was told firmly.

"Where? Where to, Buck? Where are we going?" he asked.

"Just come along with me, this way," was the reply, and he was grasped by both arms, in a simulated pulling fashion. "Come on, down the hill here."

"This is the way we came up, ain't it, Buck?" he asked.

In this fashion, the entire amnesic period was relived subjectively, scene by scene, with dialogue and sound effects created as the action proceeded. Corpsmen quickly develop an appropriate sense of theater for these abreactions and interject questions, answers and expletives to fit the occasion. Using these techniques, the patient was made to relive the passing of the dead bodies, the final descent to the road, the shelling, the episode of the jeep, the entrance into the house, the stretching out on the soft, clean bed, the shaking awake and the walk to the aid station.

Nikethamide was then injected quickly into an arm vein; 10 cc. was given as rapidly as possible. Within thirty seconds the patient's face was noted to flush, and he began to rub his scalp and eyes. He sat up, coughed a few times and then began to sneeze violently. The sneezing continued for almost a minute. Then he looked around the room, recognized a corpsman, smiled and said, "Hi, fella."

He was asked whether he knew where he was and was asked to identify those in the room. Within a minute he did this accurately, and it became evident that he was fully conscious and properly oriented. He was then told that he had had a treatment, that he had been describing the events which occurred after his blast experience, and he was asked to recall them for us.

Some scratching of the scalp and chest went on, and then patient said, "I remember trying to knock a tree down with my fists."

"That's right," he was told, "and many other things as well. Start at the beginning, and tell us all about it."

"Well, we were up on this hill beyond the sanatorium," he began, and then he gave a detailed account of the entire amnesic episode. The story came out in full detail, and the patient stopped during his account now and then to reveal his amazement at the extent of his ability to "see all this now, just like it happened."

At the end of this recital he dressed himself and walked back into the ward with one of the corpsmen. He was told to go over the story once again with the corpsman. This was done, and then the patient was instructed to write the story out on paper later in the afternoon just as though he were writing a letter to some one describing the episode in detail. He was advised to write as many pages as were necessary to make a full account. Because in this particular

instance the patient had had minimal educational advantages and was not in the habit of committing himself on paper, the written review was short and superficial.

On the morning after treatment the patient reported that he had not slept well, that he had ruminated over the amnesic material long into the night. Despite this, he said that his headache was much better and that he felt less fatigued. He was particularly gratified to find that his uncomfortable feeling of inward tremulousness was much improved.

The content of amnesic material was reviewed, and care was taken to note the patient's reaction to it. He stated that he must have looked "very goofy" to those about him during his amnesia but that he wasn't really ashamed of himself because he had seen other men act just that way after shell blast, and that he was probably no different than anybody else. The episode of wanting to hit the tree with his fists provoked a measure of astonishment but served to reveal to him the extent of his behavior disorder. The recall of memory for seeing four of his men killed was painful, but he summed it up by saying that it was some more death he had to look at: He had seen it before in battle; it was never easy to contemplate, but a soldier had to become hardened to death or go completely to pieces. He blushed when he talked about the way he had slapped the German girl, but he saw the humor in it and laughed about it. He had no real feeling of guilt about abandoning his platoon, but he did have genuine regret about it. He was sorry that he was no longer with his unit, but he concluded that he had done as much as he could, that he had tried to stay there and do his part as long as possible. It was felt that this was a healthy emotional reaction to the amnesic material, and the patient was advised to spend the day as he saw fit.

On the next morning he reported that he had slept soundly, that his headache was gone and that he no longer had the "jitters." He volunteered that he was beginning to feel like his former self. He was kept in the ward for two more days. He reported that loud noises made him jump and caused a shooting pain to go through his head. This was true especially of noises such as slamming doors and the clanging of metal stove lids. He complained of the noise of the mess hall, saying that it upset his appetite. On one occasion the mess hall was so noisy that he made himself some sandwiches and took them outside to eat them. He said that his tinnitus was completely gone.

On the fourth day after treatment he was transferred to the rehabilitation camp. While he was there, he participated in all the activities except firing on the rifle range. He found this too noisy even when he was 500 yards (460 meters) away from it. He did not attend sick call during his two weeks' stay there, and he reported no headache or other complaints during the rehabilitation period. When he appeared before the disposition section, he stated that he felt entirely well except for his sensitiveness to noise and the transient headache caused by loud noises. The diagnosis was "psychoneurosis, mixed type, secondary to shell blast March 13, 1945, in Germany, line of duty *yes*," and he was sent to a reinforcement depot with recommendation for assignment to limited duty.

The following case is an uncomplicated one and may be regarded as typical of many of the cases of blast injury in this series. It illustrates the manner in which a normally articulate soldier puts his amnesic material in writing after treatment.

CASE 2.—W. E. F., private first class, rifleman, aged 20, was admitted to the hospital April 27, 1945, complaining of headache, nervousness and dizzy spells. The patient was in combat from June 12 to July 13, 1944, when he was evacuated

because of shrapnel wounds in his right leg. On Jan. 3, 1945 he returned to combat. On March 24 a shell hit near the patient as he was standing on the bank of the Rhine waiting to board a boat for the crossing. He stated that he saw a bright flash, was rendered unconscious for approximately two hours and came to his senses in a British command post. He was shaky and complained of sharp headache in the right parietal region and bilateral tinnitus. He was taken to an American battalion aid station and was ultimately sent to this hospital.

On admission, his complaints were those of intermittent and sharp headache in the right parietal area, sensitivity to noise, startle reaction, epigastric distress, insomnia and recurrent battle dreams. Sudden attacks of dizziness of the floating type, lasting approximately one minute, occurred repeatedly throughout the day. They seemed worse on sudden change of position of the head. His tinnitus abated spontaneously the second day after his blast injury. General physical and neurologic examinations revealed nothing of significance except for a large scar on the inner aspect of the right knee, the result of his earlier wound. Lumbar puncture released an entirely normal fluid, under 180 mm. of pressure.

On May 3, 1945 the patient was treated by chemical hypnosis. After pre-medication with atropine, $\frac{1}{150}$ grain (0.4 mg.) given hypodermically, a 2 per cent solution of pentothal sodium was introduced intravenously. He fell into light sleep after the administration of 15 cc. Two minutes later he was slapped lightly on the face and was instructed to talk about the morning when he was knocked out by shell blast on the bank of the Rhine. With very little prodding, the story came out in a logical chronologic fashion. After he had told of the episode, it was reviewed for him. The needle was then withdrawn. Twenty-three cubic centimeters had been injected. The patient was told to go to sleep, and he closed his eyes and relaxed completely on the table.

Then he was told excitedly, "There comes the L. C. V. P. [boat] over the river to get us! See it?" Then followed a loud whistle and a banging sound made by a corpsman kicking a tin can full of broken glass. The patient tried to leap from the table. As more shells were simulated, he struggled to leave the table. In rapid succession he tried to jump into a foxhole and to run away. He was asked in a British voice, "Where are you going, Yank?" and he replied, "I dunno! Where am I?" He was then told to lie down, and he struggled, saying, "Let me go! I want to go back to the outfit!" He was told that he was too shaken up to return, that he had better get some rest. After some argument, he agreed and lay still. Then he was shaken by the shoulder and asked whether he wanted some breakfast. He replied in the affirmative and went through the motions of eating. Then he remarked, "What is this I'm drinking, tea? What a hell of a drink for breakfast! But that's what a guy gets for fooling around with you Limeys." He was told that he had better go to an aid station. He asked where it was. He was told, "Over there, that big building on the left." Then he mumbled his thanks for the breakfast.

At that point, 10 cc. of nikethamide was injected quickly into an arm vein. He flushed, coughed, rubbed his face and sat up. Then he sneezed repeatedly for one minute. At the end of that time he was fully awake and was able to recall all the events of his amnesia. He was returned to the ward, where he was told to repeat the content of his amnesia to a corpsman and then to write it out. His written account is as follows:

"Approximately at 11 p. m., March 23, we started for the Rhine, which resulted in an all-night hike, that is, until 3 a. m. We were put in buildings which were approximately two blocks from the Rhine, awaiting H hour.

"The order was received to move out immediately. We put our equipment on and started for the Rhine. The fellow behind me was lagging a little too far behind; so I hollered and told him to close it up. We arrived at the edge of the river and had to wait until the L. C. V. P. returned from the opposite shore. While we were waiting, Jerry was throwing some 240's [artillery]. Most of it went into town. All of a sudden I saw a large flash between the boat and me. Immediately I was lying in the prone position.

"After the explosions I got on my feet and started to run up the hill to a slit trench that I had noticed on the way to the River. While I was running up the hill, I heard a couple of the boys hollering for the medics. I reached the slit trench, and I lay there for awhile. The shells were still going over. Then one exploded fairly close to the slit trench, and it lifted me into the air. I took off and ran back to the town. I found a house that the English soldiers were using as an outpost. I went in the cellar, and the lieutenant made me lie down and sleep for awhile. It was still dark when this took place.

"The next thing I knew one of the fellows was shaking me to have breakfast. We had eggs, bacon, grape jam, bread, butter and tea. After I finished eating, I started to gather my equipment, and the sergeant (I believe) asked me where I was going, and I told him I was going to try and find my company. He suggested my going to the aid station. I went to the aid station and was evacuated from there to the evacuation hospital."

The patient slept well the first night after his treatment and did not dream. The next day he was much improved, saying that his headache was practically gone and that he had no dizziness. The amnesic material was reviewed, and the patient was pleasantly surprised at his ability to recall the material. He had no untoward emotional reaction to it. He concluded that he had acted like other soldiers he had seen after blast injury. He said, "I guess I just went goofy like a lot of other guys do when shells knock them out." He remained in the ward three more days, during which time he continued to be free from symptoms except that loud noises made him flinch and gave him a slight pain in the right side of his head. He was sent to the rehabilitation camp, where he spent two weeks and then was dismissed to limited assignment duty.

Case 3 is illustrative of the reaction of a somewhat obsessively conscientious soldier to blast injury. In this case the treatment session was abnormally long because the soldier insisted on giving a carefully detailed account of the amnesic material. It also illustrates how post-blast amnesic material can be emotionally traumatic when it is recovered in consciousness.

CASE 3.—E. P., private first class, a machine gunner, aged 24, was admitted to the hospital Feb. 10, 1945, because of laryngitis and headache. His laryngitis improved rapidly, but his headache persisted. He stated that the pain in his head began after a blast injury on Dec. 17, 1944, near Krinkelt, Germany, at the beginning of the Battle of the Belgian Bulge. He had been rendered unconscious for an hour or more by the blast, and this was followed by a constant dull occipital headache, extending into the parietes. Any loud noise caused a sharp, shooting pain throughout his head. In addition, he felt jittery, lost his appetite and complained of precordial heaviness, effort dyspnea and battle dreams. Despite these complaints, he continued in action until Jan. 27, 1945, in the counter offensive in the Ardennes. He was evacuated because of an acute infection of the upper

respiratory tract with fever and laryngitis. He was transferred from the ear, eye, nose and throat service when his laryngitis had subsided.

He stated that his unit, which had been in combat three months, had been on a forced march most of the night prior to his blast experience and that he was hungry, cold and extremely tired. He was awakened at daybreak the next morning, and shortly thereafter he was rendered unconscious by shell blast. It was his surmise that he was comatose for the next hour. When he recovered consciousness, he was sitting in an abandoned anti-aircraft-gun pit with some of his comrades. The Battle of the Ardennes continued at a heavy pace for several weeks after that, and he remained with his unit despite his complaints of headache, transient tinnitus and vertigo, loss of appetite, cardiorespiratory disorder and frequent dreams. He felt that if he kept going he would be able to "shake off" these complaints. It was his opinion, however, that he was about to turn himself in for medical aid because of his severe headache when the infection of the respiratory tract developed. So many casualties had occurred among older men that he felt obligated to remain on duty as long as possible to help the new reinforcements who were coming into the unit.

General physical and neurologic examinations revealed nothing abnormal. He was 12 pounds (5.4 Kg.) under his normal weight. He was quiet and cooperative but somewhat seclusive in his habits. He avoided all loud noises because they caused shooting pains in his head and had managed to move to a bed as far as possible from the ward radio. Lumbar puncture released clear fluid, which was under a pressure of 140 mm. and contained no red cells, 3 white cells per cubic millimeter and 34 mg. of protein per hundred cubic centimeters.

An attempt was made to treat him by chemical hypnosis, using ether by inhalation, but this was unsuccessful. A series of attempts to induce hypnosis by verbal means was equally ineffective. On March 24, 1945, chemical hypnosis was induced with intravenous injection of sodium pentothal. The patient went into light sleep after the injection of 18 cc. Two minutes later he was slapped on the face and told to describe his blast experience. He elected to begin his recital with an account of the long march which preceded the blast experience. All attempts to hasten him toward the blast experience and subsequent events were countered with, "Wait, wait; don't rush me. . . . I'll tell you all about it." Because he was a meticulous person, somewhat obsessive in his behavior, it was deemed best to let him tell the story in his own way. He described every change in contour of the terrain in greatest detail, named the type and age of every timber stand he walked through and gave a detailed account of every scrap of conversation he engaged in during the entire period. Slowly, carefully, accurately, the entire march, the final assuming of positions and the digging in were described. Then came a detailed account of dawn, the blast experience and his unit being cut to pieces by enemy artillery. The patient ministered to his wounded comrades and made repeated trips to the aid station with casualties. He had been amnesic for all this prior to treatment. Almost two hours were spent in the telling of these experiences. Then the material was reviewed quickly, and the needle was withdrawn. Thirty-eight cubic centimeters of pentothal sodium had been used. By employment of appropriate sounds and shouts the experience was reenacted in abreaction, but this was not unusually dramatic in this case. Then 10 cc. of nikethamide was injected intravenously. The patient sneezed once or twice, rubbed his eyes and was awake. He was able to give a full account of the amnesic material immediately. He spent the next two days writing out the experience.

Some of the preliminary material is omitted, but the following is the main body of his written account:

"The next couple of hours were not very eventful, as we marched along the edge of a wooded area opposite Krinkelt. There was a considerable amount of machine gun fire to our left. About an hour after darkness had settled, we met 395, where we learned that the message we had accepted was a phoney. So we turned back, retracing our same route. Artillery shells were constantly whizzing overhead. Krinkelt was in flames as we came around it. An ammo dump was hit, and flares flew in all directions and all colors, making our progress more difficult to keep from being observed. We finally got back to our old positions. We started to dig in, but we were so thick that we were moved up to the positions we had started to dig the previous morning on the hill. Instead of a section, our whole platoon took the hill.

"We were so all in and hungry that we didn't dig but used the shallow holes until daylight. I took the second watch that night. While on guard I saw a big burst up ahead of us. Nothing else followed; so no more thought was given it. Chris and I were holed up together; so he followed me on guard. I took a nap over a gas cape laid in the bottom of the hole to keep from getting more wet than we were.

"At the first indication of daylight we were all awakened by Parks.

"Chris left the hole, and I told him to hurry because we had a lot of digging to do. Right after he left, two shells came close, and I flattened out in the shallow hole. Then, ka-flooiie! Everything went black. I just don't know how to describe a sensation of this type. The next thing I recall is crawling out of the debris piled over and around me. What a mess! What a sight! I found Ealing lying on his back. His left arm was off at the shoulder, but I wasn't quite aware of it at the moment. He was ghastly looking. I found a bloody canteen and washed and filled it in the stream. I raised his head enough for him to take his wound tablets. I covered him with blankets that I picked up. Shrapnel had torn the packs up so bad that the blankets were easily pulled from the pack.

"As I gathered up blankets, I came on Phillips being held in a sitting position by Nugent. I put a blanket around Phillips and lit up a smoke for him.

"McQuay lay nearby with the top of his head blown off. Damn unpleasant talking material. Nugent kept Phillips ignorant of McQuay's condition.

"I bumped into Tilney, and he mentioned Parks being up on the hill. Our aid man from the third platoon patched up the two big holes in Park's back. Poor devil was in helluva pain. I picked up a bayonet somewhere and cut a couple of poles for a litter. We gently put Parks on the litter and carried him to the aid station. I told the aid man to visit Ealing.

"I made a second trip to the hill. I learned that Stricker was somewhere up on the hill, too. We searched all over for him and spotted him in a crater. He was wounded in the leg and already had been patched up. There was a box of morphine Syrettes lying near him. Tilney pocketed them. Windy was up there with us. We finally eased Strick on a litter that I managed to acquire from some bozo that had no use for it. We got our man to the aid station. I managed to stumble all over the creek. The other boys kept dry, but I got wetter than all get out. I saw Berry at the aid station. He told me he was all through with the war. Chris brought him in; I don't how or when. I sat against a tree to rest up. Felt too weak. I didn't think I could go any more. But I simply had to go up again. Went up again. Saw some fellows carrying somebody in on a litter. One of the carriers felt weak; so I gave them a lift. Damn, I had

to hold that handle with both hands. Got this fellow in okay, too. Sat down again, to rest up a bit.

"Met Jones at the aid station. We went up to gather what was left of our guns. There were three of us going up. Can't recall who the third fellow might be. He was just a short way ahead of us. We picked up all the junk we could carry. I also picked up a smashed rifle. Only one of the guns was any good, and that was for only about 500 rounds. We piled the junk on the road above the aid station.

"A case of rations was brought down. We devoured that in no time flat. We were all hungry, after not eating for so long. I got my back taped by an aid man after having a bite. Our troops were in changing mortar fire with the Jerry; so we hopped into an abandoned anti-aircraft-gun pit. There was a helluva lot of gunfire and machine gun fire to our left and front.

"From here on the trend of things I can easily recall. So I don't think it's necessary to write it down. It was all more or less being shelled."

The recall of this material was extremely painful to the patient. The sudden catastrophic loss of these friends despite his every effort to assist them was hard to contemplate. Another episode was so painful that he failed to write it down. His closest friend was killed that morning. As he was walking up the hill for the last time to salvage what material he could with Jones and the other man, they met a litter squad coming down. The face of the casualty was covered with blankets. The patient asked, "Who've you got there?" The reply was, "Downs. . . Do you want to see him?" The patient answered in the negative, saying that he had no desire to look at his best friend in death.

It is interesting that the patient heard of these wounds and deaths among his comrades during the next weeks that he remained with the unit, but he was never able to recover his memory for the part he had played on the morning of the catastrophe until after treatment. He found that it was convenient to walk away when conversation turned to these comrades, because it made his head worse, gave him a feeling of nausea and caused precordial pain when he heard about them.

After treatment the patient had mixed feelings of relief for the restoration of his amnesia and grief for the loss of his friends. He slept poorly that night, and the next day he was quiet but obviously upset. He was told that he had best write it all down, that he would have to learn to live with this knowledge. For the next few days he was encouraged to speak freely about these friends. He continued to have headache, although it was not so severe as it had been before treatment. On the fourth post-treatment day he spent a long time talking about Downs, telling many anecdotes about him. That night he slept better and seemed to be reconciled to the emotional trauma of the experience after that. Because he was underweight, he was transferred to another ward, given a course of modified insulin therapy, which permitted him to regain his lost weight, and then was transferred to the rehabilitation section. He was discharged to limited duty. At the time of discharge he regarded himself as much improved. He complained of occasional mild headaches when he was around loud noises.

Case 4 illustrates how the pentothal-nikethamide technic was successful after chemical hypnosis with both ether and pentothal had failed. This patient was probably one of the most anxious in the series, and the relief of his symptoms after successful treatment was a pleasure to observe.

CASE 4.—T. M., private first class, a tank driver aged 29, entered the hospital March 6, 1945, with a diagnosis of blast concussion, sustained Feb. 28, 1945 in a small village near the Roer River in the Rhineland. He complained of a constant dull headache, which extended across the top of his head from both temporal areas. He had had intermittent tinnitus for six days in both ears, as well as a floaty dizziness. He was extremely sensitive to noise and was severely startled by sudden noises, and he had a pronounced tremor of the outstretched hands. His lips were tremulous, and a tremor was evident in his voice. He complained of feeling inwardly "jittery" at all times, and he had difficulty in going to sleep. He dreaded the night because of his vivid recurrent combat dreams, in which he awakened in terror, drenched in sweat. In the ward he was restless and seclusive. He wore a constant expression of fear and said that he felt frightened all the time. He had always regarded himself as a stable person and had little occasion to consult doctors in the past. He had been in combat for four months and had been wounded by shrapnel in the chest and neck on a previous occasion.

His history revealed that he had parked his tank, gone into a house and was preparing for bed when large artillery shells began to crash all around him. He remembered one striking the house, and he surmised that it must have landed directly in the room where he and his comrades were. The next thing he remembered clearly was of being carried out of a battalion aid station on a litter and of being transported to the rear on a "weasel," a small tracked vehicle.

General physical and neurologic examinations revealed nothing abnormal except for somewhat dilated pupils, an appearance suggestive of exophthalmos, tremor of the hands and lips, hyperhidrosis, a pulse rate of 108 and sighing respirations. Lumbar puncture released a clear fluid under 150 mm. of pressure, which contained no red cells, 2 white cells per cubic millimeter and 31 mg. of protein per hundred cubic centimeters.

On March 6, 1945 he was treated by chemical hypnosis, using ether by inhalation. He became excited, repeating "Siler, Siler, come on; let's get out of here! This place is on fire; we'll burn up!" It was impossible to control him properly to carry out a systematic inquiry into his amnesia, and the treatment was abandoned. Afterward he was extremely agitated, saying that he remembered the house being on fire and recalled wandering from room to room, holding Siler by the hand, looking for an exit. Another soldier, Baldy, would not permit them to go out through the kitchen door because there were snipers outside on that side of the house.

The patient could not recall any more of his experience during the next two days, and his condition of acute anxiety and restlessness, with severe headache, continued. On March 8 he was treated a second time, using sodium pentothal. A more connected story was given. He told of parking his tank, going into the house, cooking supper and going into a bedroom with Siler and Moneta, two members of the crew of his tank. He remembered a blinding flash, then saw bricks and rubble tumbling all about him. The air was so full of brick dust that he could not see, and he remembered his mouth being so filled with dust that he could not spit. He groped around and found Siler lying on a bed, blood covering his forehead. He grasped the wounded man by the wrist and jerked him to his feet. He called for Moneta, but received no reply and could not locate him with his hands. Holding tight to Siler, he started for the kitchen door, but Baldwin, who had been standing guard, told him that snipers were out in the rear, that he should leave by the front. By that time fire had broken out, and the house was filling with smoke. He worked his way to the front, still holding to Siler's wrist,

kicked out a window and found himself on the road. Siler complained that the patient was hurting him with the viselike grip on his wrist, but he would not let go. They moved up the road, walking along a stone wall. As more shells came in, they crouched between the wall and an abandoned tank. When the shelling slackened, they walked along about 300 yards (275 meters) to the left, where they found a medical soldier in a doorway. He tried to take Siler away from the patient, but he would not let go of the man's wrist until he got him to a doctor. The doctor took them inside and convinced the patient that they were in an aid station and that Siler would be taken care of; the patient then released his grip and allowed Siler to be taken from him. Another medical soldier came by and noticed the patient wandering about aimlessly, shaking from head to foot. He put him on a litter in the hallway and piled blankets on him, but he continued to shake violently. As he lay there in the dark, somebody stumbled into him and kicked him in the head. He swore and tried to get up to fight the man who kicked him but did not have the strength to stand. Then two corpsmen came by, put a tag on him and carried him outside to a "weasel." When the motor of the vehicle was started, the patient returned to consciousness.

The material was reviewed; and then, with appropriate sound effects, the patient underwent a violent abreaction in reliving the amnesic material. This treatment was carried out before we had begun to use nikethamide, and the patient was removed to the ward at the end of his abreaction. There he continued to relive the amnesic episode and tried to break the window near his bed. Four men were required to hold him down, and because he continued to struggle and snout it became necessary to restrain him and to quiet him with paraldehyde.

Later that day he became calm but remained tense and frightened. His headache had not improved, and he was extremely restless during the night which followed. On the next day he was unable to recount the amnesic experience in any detail, even after notes taken during the treatment had been read to him carefully. He remembered wandering through the house and recalled that he dared not let go of Siler's wrist; but little else was clear to him. In the next days the amnesic material was reviewed for him repeatedly, but he was unable to recall it properly. He pounded his forehead and said, "I can't get it! I can't see it like it was, except a bit here and there." His symptoms of headache and acute anxiety persisted, and tormenting dreams continued to disrupt his sleep.

On March 20 he was treated a second time by chemical hypnosis induced with sodium pentothal. His account was similar to the former one, and a few details were added. After the recital of his amnesic experience, it was reviewed for him. Then, with the use of sound effects, he underwent an active abreaction once more. Then 10 cc. of nikethamide was given intravenously. He reddened, coughed and sneezed for thirty seconds. Then he was fully awake. He was asked to recount the amnesic experience immediately. He looked up; a pleasant smile of discovery crossed his face, and he said, "Now, now I can see it, just like it happened." He raced through the narrative, stopping at intervals to remark that the whole picture was clear in his mind. He was buoyant about his memory recall, after almost two weeks of struggling to accomplish it after the previous treatment. His sleep that night was better, and the next day he volunteered the information that his head was "clear," that it no longer had the dull heavy ache of which he had complained before. During the next few days he continued to improve, and he showed himself to be a person of good humor and affability, traits that he had not shown before. He expressed relief that his frightened feeling was

gone, that he now slept well and that he was no longer bothered by weird, mixed-up dreams.

He was transferred to the surgical service for the removal of a piece of shrapnel under the skin of the right side of his jaw, which had given him discomfort while shaving, and then was transferred to the rehabilitation section. There he was placed on duty as a cook, and in a two month period of observation there he was without complaints and had no occasion to report at sick call.

Case 5 is included to demonstrate the relatively rare but striking phenomenon of pathologically vivid recall of amnesic material. This patient recalled the events of his postblast amnesia so vividly after chemical hypnosis that for almost four days after treatment the episode seemed to flood his entire consciousness. It was not until the recalled memories had lost their excessive vividness that the patient began to improve.

CASE 5.—A. B., sergeant, assistant squad leader of a rifle squad, aged 25, entered the hospital March 1, 1945, with a diagnosis of blast injury, sustained Feb. 23, 1945, near the Roer River in Germany

On admission the patient complained of a severe frontal headache, which was constant, but which varied in intensity and in quality from dull to sharp to pounding. He held his head cupped in his hands and said that he had never experienced anything so intense. He complained of bilateral tinnitus as well but said that it was not constant like the headache. Any movement of his head produced a floaty dizziness. All noises caused him to wince with pain, and he jerked in a startle reaction to them. He complained of a tremor of the hands and of feeling excessively fatigued. He said that his eyes felt weak and sore, and he avoided bright light. His sleep was interrupted by battle dreams, in which he saw every one around him wounded and heard their cries for help. He spent most of the day on his bed and was completely apathetic toward everything about him. This behavior appeared to be inconsistent with his past performance. He had been a college student, hoped to become a teacher of music and was interested in dramatics. He admitted that he was not himself: When he was well he was a gregarious person and an avid reader.

He stated that his unit had crossed the Roer River during the early hours of Feb. 23, 1945, before daylight and had dug in on the far side. The Germans counterattacked with tanks and infantry and were met with rifle fire and grenades. American artillery fire was called for in support and began to fall among the advancing Germans. Then shells began to rain down all around the patient. He heard the cries of wounded men and managed to drag two members of his squad into his hole. One was wounded in the leg, the other, in the chest. One of the men asked him to pray for them, and he began to do so, when he heard a loud whiz and saw a blinding flash and then lost consciousness. The next thing he remembered was lying on a pile of straw in a cellar on the far bank of the river. It was fully light, and the patient estimated that he had been unconscious for approximately two hours.

General physical and neurologic examinations revealed nothing significant except for multiple abrasions about the face and tremor of the outstretched hands. Speech was slow; mood was flattened, and his face wore an expression of tension and pain. Lumbar puncture released clear fluid under 110 mm. of pressure, con-

taining, no red cells, 4 white cells per cubic millimeter and 31 mg. of protein per hundred cubic centimeters.

On March 4, 1945 light sleep was induced with 14 cc. of sodium pentothal injected intravenously after premedication with atropine. Within a minute the patient was able to respond to his name. He was told to begin to talk about the assault crossing of the Roer River during the night of February 23. In a slow, careful manner he began to describe the events of those hours. When he talked about seeing enemy tanks and infantrymen approaching his hole, he struggled violently to get off the table and required the manual restraint of four attendants. He continued to tell his story, but every new event made him struggle for freedom. It was necessary to inject sufficient pentothal to keep him in a deeply drowsy state in order to prevent his struggles. He fell off to sleep again, and it was necessary to wait about three to four minutes before he was sufficiently roused to continue his story. Then he told of an incessant barrage of shells and of hearing one of his squad members, Green, calling for help. He stuck his head out of his hole and saw that Green was lying to his right. He wiggled out of the hole, grasped Green by the left foot and dragged him down into the hole. Then he heard Nolan shouting to his left. He called to Nolan to crawl his way, as he went out to meet him. The second man was assisted into the hole. Green was crying, asking that prayers be said for him. Nolan and the patient managed to dress Nolan's leg wound and to prop Green up in the sitting position. He had a chest wound and was having difficulty in breathing. Then, in the midst of the barrage, both men asked the patient to pray. He was known as a sincerely religious person and had led the unit in prayer on previous occasions. He began to pray, when he heard a loud whizzing noise close by and then saw a blinding flash. In his own words, as he wrote it later, he said:

"I don't know how long we remained in prayer, but I remember a real close whiz as it was coming in and then a big flash. Then I saw that this shell had landed on the edge of the foxhole. Everything was so quiet all up and down the battle front, it seemed as though the whole world was at peace with God and man. The barrage had stopped suddenly. I called the name of the boy who was wounded the worst; but no answer. It was dark in the hole; so I felt for him and found him almost covered with dirt. I pulled him out and shook him to try and bring him to. I started to place my hand on his head to try to arouse him. His head was gone, and when I felt the blood and flesh I think I went out again."

He was roused by Nolan's voice. The other man was unable to move because of his leg wound. The patient crawled out of the hole and staggered about 50 feet (15 meters) to his left to a pillbox which was being used as his platoon command post. At the entrance to the pillbox he met a soldier by the name of Brown and tried to tell him about Nolan, but he was shaking so badly that he could not talk. Brown took him inside and had the patient lie down on a pile of rags and threw a blanket over him. Shortly thereafter an amphibious vehicle, a "duck," came by the pillbox, and the patient was loaded on the vehicle and carried back to a concentration point, where a group of prisoners were herded together. He was told by the driver that he could go no farther, and the patient was advised to follow the prisoners back to the river.

He found walking difficult and was unable to keep up with the file of prisoners, but he managed to keep them in sight as he staggered along. He finally reached the river, where a treadway bridge had been thrown across. Just then a barrage of enemy shells, intent on knocking out the bridge, began to fall near the patient. He rolled into a ditch, then got up and staggered across the bridge when the

shelling had abated. On the far side he wandered aimlessly up a hill into a village, where a medical soldier found him and took him to a battalion aid station. He recovered consciousness in the cellar of the aid station as he was being given a cup of coffee. He estimated that he had walked and stumbled about 4 miles (6.5 kilometers) in his amnesia.

The amnesic material was reviewed for him, and he continued to struggle to leave the table as each event was mentioned. Then the needle was withdrawn. Twenty-eight cubic centimeters of pentothal sodium had been administered. When the sound of shells was simulated by whistling and appropriate noises, the patient became so frenzied that it was almost impossible to hold him. At the suggestion that he pray, he broke into eloquent supplication, with tears streaming down his face. During the remainder of this violent abreaction he continued to cry copiously, calling on God to help his stricken comrades.

At the end of his abreaction the patient was physically exhausted and drenched in sweat and continued to pray through his tears. We had not hit on the nikethamide technic at that time, and he was permitted to remain in the treatment room for the next hour with two corpsmen. He cried and prayed for twenty to thirty minutes; he then realized his surroundings and rested more comfortably.

Later that day he was visibly upset and said that his headache was severe. That night his sleep was poor because he kept reliving the amnesic episode over and over again. For the next three days he could think of hardly anything else. He tried to play checkers, a game which he liked, but could not concentrate on it. He attempted to go to the cinema at the post on two occasions but abandoned it because he could not interest himself in the picture. He wrote two long letters, one to his mother and one to his sweetheart, describing the amnesic episode, apologizing for the gruesome subject, but saying that he could think of nothing else and felt impelled to write about it. The letters were withheld from mailing, and later the patient was happy that they had not been forwarded. Other patients on the ward avoided him because his only topic of conversation was the amnesic episode.

On the fourth day he seemed brighter and no longer held his head in his hands. He said that he was no longer troubled by the constant "picture" of his amnesia, and he managed to spend part of the day reading a novel. That night he slept better; and on the next day he reported that his head felt better, he no longer felt his excessive fatigue and the heavy feeling in the precordium had lifted. He had concluded that the events which occurred at the time of his blast injury were the will of God, and he was reconciled to it, although the decapitation of Green would always be hard to contemplate. His progress after that was rapid, and on the eighth post-treatment day he was transferred to the rehabilitation section.

There he was found to be an excellent noncommissioned officer, and he was retained as a member of the staff. During the two and a half months (at the time of writing) he has worked in that capacity he has been free of complaints, has won himself the high regard of his officers and has had no occasion to report at sick call.

MECHANISM OF MOTION SICKNESS

GUY MORTON, M.D.

ANDRE CIPRIANI, M.D.

AND

DONALD McEACHERN, M.D.

MONTREAL, CANADA

SEASICKNESS is a serious inconvenience to many people in times of peace. In times of war, however, motion sickness in its various forms may be a very real threat to the success of operations in the air and on the sea. Army personnel are apt to be affected in very large numbers, when airborne or in landing craft, since they have little opportunity to become acclimatized, as does the sailor or the airman.

The literature on motion sickness up to 1942 has been reviewed elsewhere.¹ Since that time a large amount of important work has been done, but publication has been in restricted reports. It is hoped that various workers will soon write up their results for open publication.

The present paper is a summary of studies carried out during the recent war by a group of workers in Montreal of which we were a part. These experiments on the mechanism of motion sickness were made at an early stage of the investigation in the hope that they might give a lead to specific therapy. Later, through urgency, all our attention was devoted to therapeutic experiments. It is probable, however, that if worth while advances are to be made in therapy more must be known of the fundamental mechanism of motion sickness.

MATERIALS AND METHODS

Many hundreds of human volunteers were subjected to various types of motion. The majority were naval ratings from H.M.C.S. Montreal, but University students and members of the staff of the Montreal Neurological Institute also volunteered.

The device first used was designed to reproduce the wayward movements of a ship at sea. This was called the "Roll-Pitch Rocker," or, more commonly, the

From the Department of Neurology and Neurosurgery, McGill University, and the Montreal Neurological Institute.

This work was supported by a grant from the Subcommittee on Seasickness of the Associate Committee on Naval Medical Research, National Research Council of Canada, Ottawa, Ontario, Canada.

1. (a) McEachern, D.; Morton, G., and Lehman, P.: Seasickness and Other Forms of Motion Sickness, *War Med.* 2:410 (May) 1942. (b) McNally, W. J., and Stuart, E. A.: Physiology of the Labyrinth Reviewed in Relation to Seasickness and Other Forms of Motion Sickness, *ibid.* 2:683 (Sept.) 1942.

“S.S. Mal-de-Mer,” and was installed in the squash court of the Montreal Neurological Institute. It consisted of a giant rocker which rolled from side to side. On this was a counter-weighted seesaw, at one end of which the subject was seated. The seesaw moved up and down like a ship pitching. The device² is pictured in figure 1. The two motions (roll and pitch) could be obtained separately or in unison, and either one, at various speeds. The up and down motion was through 12 feet (3.6 meters), and the roll, through 26.5 degrees. This machine reproduced in a very realistic way the movements of a ship.³

At a later date, when large numbers of men were to be tested, two simple swings were constructed, as shown in figure 2. These had a maximum radius of 14 feet (4.2 meters), a period of 15 complete cycles per minute and a total arc of 90 degrees. An electromechanical drive for these swings was designed to permit their automatic operation.⁴ Similar hand-operated swings were used for animals, the cage being placed at the end of the pendulum.

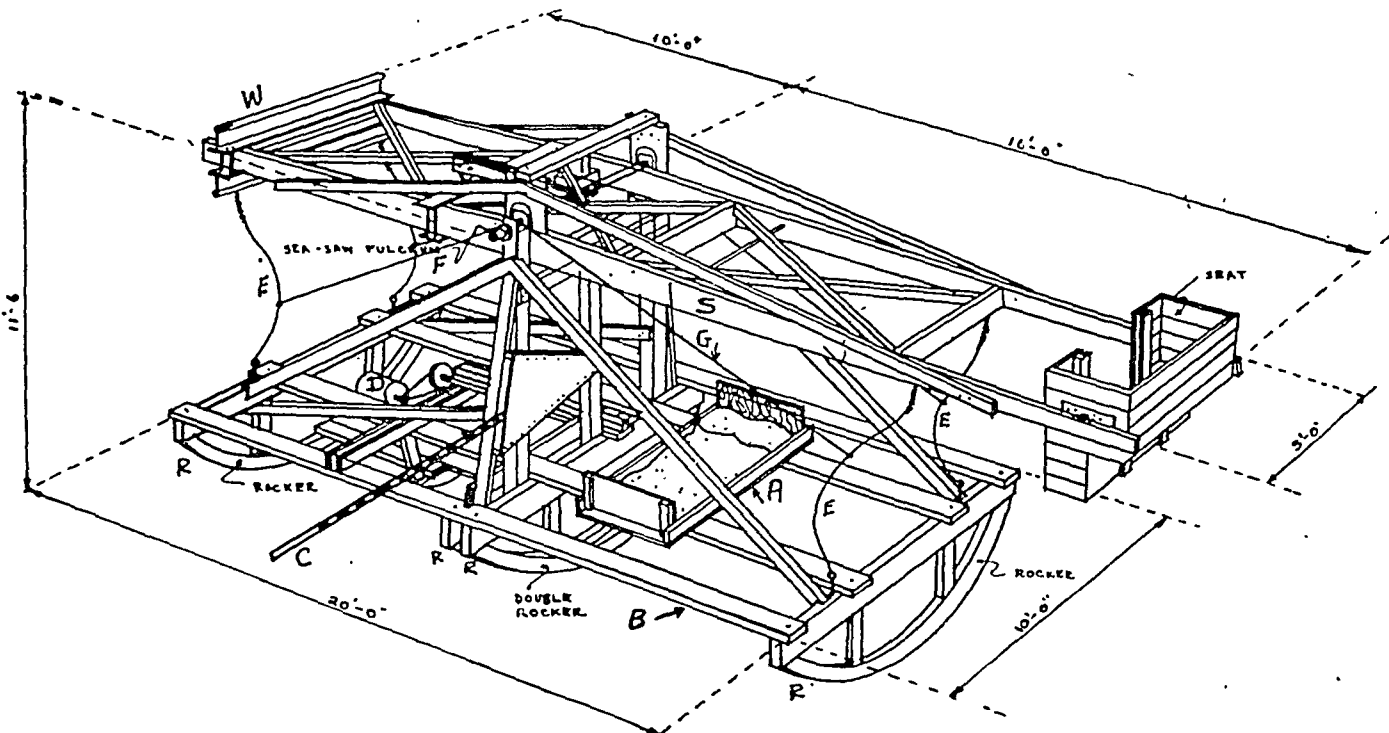

Fig. 1.—Sketch of the motion sickness machine used at the Montreal Neurological Institute. Here, *B* indicates base of machine (some of the longitudinal bracing of the machine has been omitted); *R*, rockers (restraining cables attached to the end rockers are not shown); *C*, connecting rod for rocking motion drive (drive is not shown); *F*, seesaw fulcrum; *S*, seesaw beam, showing manner of bracing; *W*, counterweights; *D*, seesaw drive; *A*, bed fixed to base; *E*, damping springs and cables, and *G*, rope which keeps damping spring cable from catching the woodwork.

2. Factors of acceleration built into this machine were based on experience which we gained on so-called pleasure devices at Belmont Amusement Park, near Montreal.

3. Cipriani, A., and McEachern, D.: Montreal Motion Sickness Machine, in Proceedings of the Conference on Motion Sickness, National Research Council of Canada, Report no. C 615, Aug. 28, 1942.

OBSERVATIONS

Symptoms.—It is not necessary to describe the symptoms of motion sickness. It may be of interest, however, to note their incidence as observed in 175 Naval ratings and 42 miscellaneous subjects who were exposed to motion on the large machine.

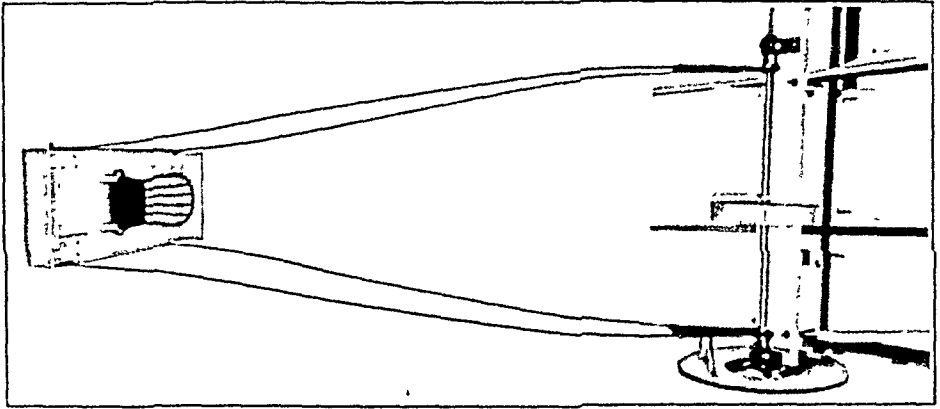

Fig. 2.—Simple swing.

Effective Types of Motion.—There was a curious variability in the incidence of motion sickness, dependent on relatively minor changes in the type of motion. This matter is still beclouded, but certain facts emerged from our work. In table 2 will be seen the incidence of sickness with different types of motion on the roll-pitch rocker.

TABLE 1.—Incidence of Symptoms Produced by Large Machine

	175 Ratings, %	42 Miscellaneous Subjects, %
Epi-gastric awareness.....	48	60
Pallor.....	47	43
Malaise.....	42	45
Nausea.....	48	57
Vomiting.....	30	33
Sleepiness.....	10	14
Yawning.....	18	28
Headache.....	17	21
Sweating.....	17	21
Abdominal cramps.....	2	7
Salivation.....	2	21

It will be seen that the pitching motion was as effective by itself in producing illness as was the combined pitch and roll. Furthermore,

4. Cipriani, A.: A Mechanical Drive for the Simple Swing Used in the Study of Motion Sickness, in Proceedings of the Fourth Meeting of the Subcommittee on Seasickness, National Research Council of Canada, Report no. C 2245, Nov. 27, 1942.

for each increase in the number of pitching motions per minute there was an increased incidence of sickness, at least up to a certain point.

Further evidence that pure up and down motion is effective was obtained in a small number of subjects exposed to the up and down motion of an express elevator in the Sun Life Building, Montreal. The elevator moved through a distance of about 5 meters, and the accelera-

TABLE 2.—Incidence of Sickness with Different Types of Motion

Group	Number of Subjects	Motion, Cycles per Min.		Vomiting		Illness	
		Seesaw	Rocking	No.	%	No.	%
1	10	5-5½	6½-8	1	10	1	10
2	15	7½	0	6	40	8	53
3	6	7½-8	.5	2	33	3	50
4	186	8-11½	6½	68	37	115	62

tion level was approximately 0.275 g. The maximum speed was approximately 4 meters per second. Four out of 5 subjects tested became sick in a period of ten to thirty minutes.

Accelerometer records taken during the pitching motion of the roll-pitch rocker and the measured values of radial acceleration for the simple swing used by us are shown in figure 3. Mathematical analysis of the forces encountered on the simple swing would indicate that radial acceleration in the long axis of the body with the subject sitting upright

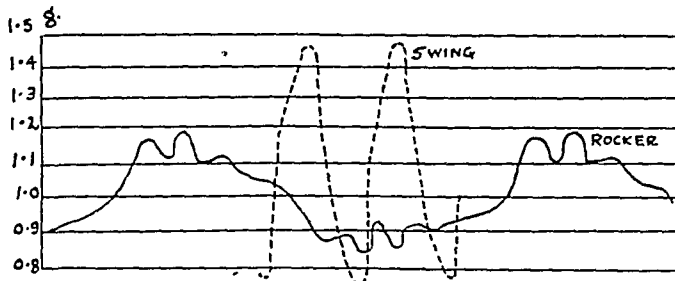

Fig. 3.—Accelerometer readings taken on the pitch-roll rocker and the standard swing. The period of the rocker due to pitch was 8 cycles per minute; the period of the swing, 15 cycles per minute.

is one of the principal vestibular stimuli encountered in the simple swing.⁵ In attempting to determine the various positions and forces most productive of motion sickness, it is essential that the position of the subject's head be fixed, and in our later experiments the head was always confined by a specially designed head rest.⁶

5. Cipriani, A.: An Analysis of the Forces Encountered on the Simple Swing Used in the Study of Motion Sickness, in Proceedings of the Fourth Meeting of the Subcommittee on Seasickness, National Research Council of Canada, Report no. C 2246, Nov. 27, 1942.

The time necessary to produce sickness varies with different subjects, but in our later work it became the rule to make runs of only thirty minutes, since few subjects became ill after this time even if the run was continued to sixty minutes.

Susceptibility to Motion and History of Motion Sickness.—The relation between past history of motion sickness on ship, plane or train and susceptibility to motion on the machine is shown graphically in figure 4. This study was made in collaboration with Surg. Lieut. William Fields. The data may be analyzed as follows:

Number of Subjects	History	Severe Symptoms Within 30 Min. on Machine	
		Number	Per Cent
26	Resistant.....	1	3.9
108	Unknown.....	34	31.5
41	Susceptible.....	28	68.3

It will be seen that there is good correlation between past history of susceptibility and results on the machine.

Acclimatization.—Efforts were made to avoid acclimatization in subjects used more than once by requiring an interval of at least one week between two successive exposures to motion. In 1 very susceptible subject, an airman who had been grounded because of recurring air sickness, an attempt was made to produce acclimatization by repeated daily exposure to motion for twenty-three successive days.⁷ Some tolerance was built up, but this was not very striking. The degree of adaptation produced in this subject by many repeated exposures was not sufficient to enable him to resume his former duties as air observer.

History of Susceptibility in Relation to Instability in the Electroencephalogram.—In view of a suggestion that persons subject to motion sickness showed a certain instability in the electroencephalogram, it was decided to question 87 McGill medical students on whom electroencephalograms had already been taken. The records and history of susceptibility to motion sickness were reviewed by Dr. H. H. Jasper, who found no correlation.⁸

Vestibular Responses in Caloric Test in Relation to Motion Sickness.—In order to test the correlation between caloric vestibular responses and susceptibility to motion on the machine, 31 volunteers were tested

6. Fields, W. S., and Cipriani, A.: Adjustable Head Rest for Swing, Proceedings of the Sixth Meeting of the Subcommittee on Seasickness, National Research Council of Canada, Report no. C 4032, March 24, 1943.

7. Morton, G., and McEachern, D.: Experimental Studies on a Susceptible Individual, in Proceedings of the Conference on Motion Sickness, National Research Council of Canada, Report no. C 750, Aug. 28, 1942.

8. Jasper, H. H., and Morton, G.: Electroencephalography in Relation to Motion Sickness in Volunteers, in Proceedings of the Conference on Motion Sickness, National Research Council of Canada, Report no. C 745, Aug. 28, 1942.

by Dr. W. J. McNally and Dr. E. A. Stuart. Three cubic centimeters of ice water was used as stimulus, and the time of onset of nystagmus and past pointing and the patient's subjective complaints were recorded. Twenty-five of the subjects were given a test on the machine, but no correlation could be found between their vestibular responses and their liability to motion sickness. Of the 7 patients who showed the most active responses to the caloric test, 2 vomited when on the machine, 2 complained of minor symptoms and 3 were unaffected by motion.⁹

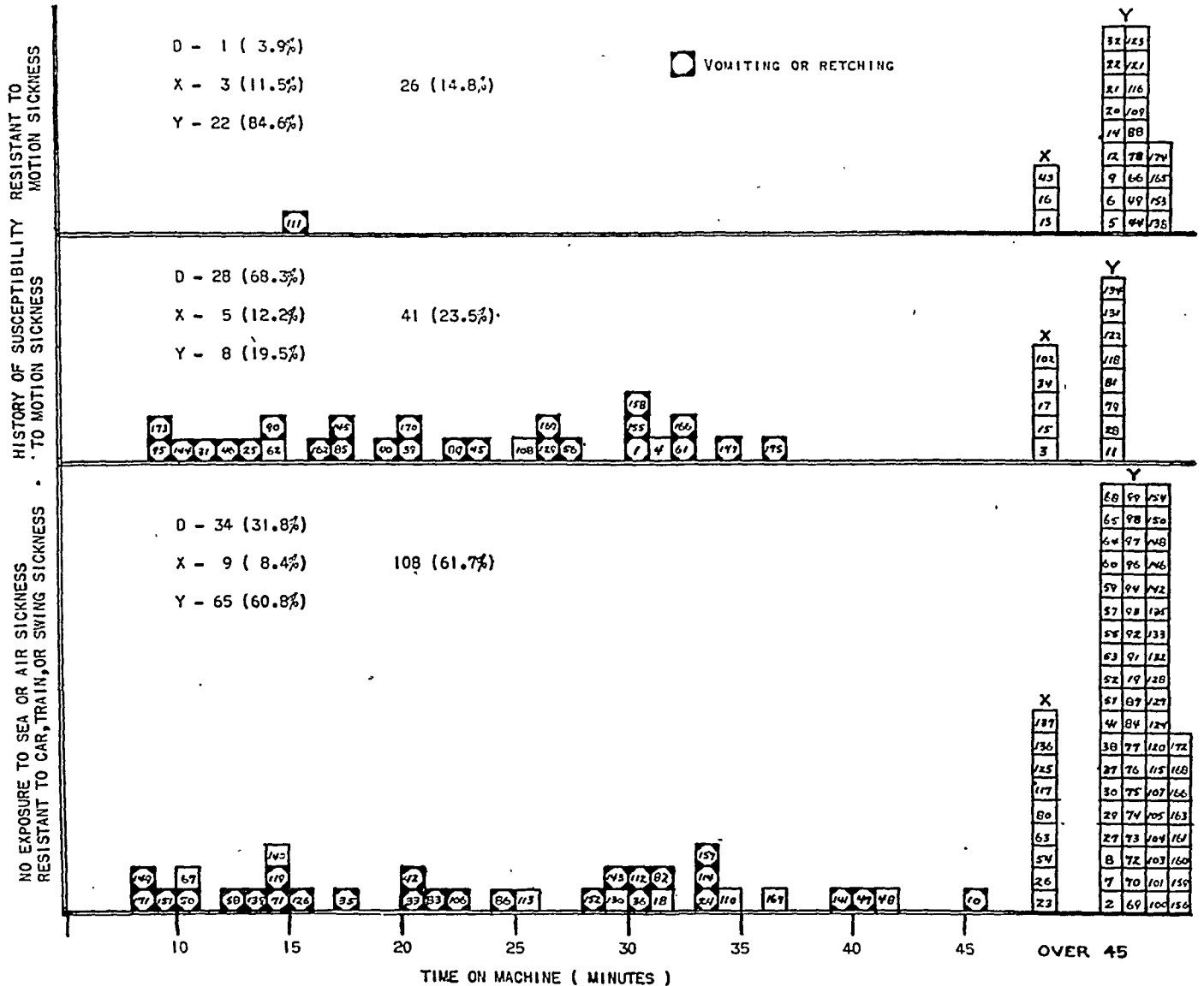

Fig. 4.—Graph showing relation between susceptibility to motion on the machine and a history of motion sickness for 175 Naval ratings. *D* indicates that motion was discontinued (63 of the 175 men, or 36 per cent); *X*, that symptoms of illness occurred at cessation of motion (17, or 10 per cent), and *Y*, that illness did not occur as a result of the experiment (95, or 54 per cent).

9. Morton, G.; McNally, W. J., and Stuart, E. A.: Caloric Vestibular Tests in Relation to Susceptibility to Motion Sickness, in Proceedings of the Conference on Motion Sickness, National Research Council of Canada, Report no. C 743, Aug. 28, 1942.

Physiologic Observations During Motion.—By ingenious methods of recording, it was possible to take an electrocardiogram, an electroencephalogram and records of the respiratory excursion and the blood pressure on some of the subjects before, during and after motion.

Electrocardiogram: From one lead records were obtained on an ink-writing oscillograph from 23 subjects, in 13 of whom sickness occurred. There was no constant change in the heart rate or the configuration of waves as a result of motion. In 12 subjects in whom sickness occurred the average change in heart rate was +6; in 10 patients without sickness it was -6.

Respiratory Rate and Rhythm: These were recorded on 22 subjects by means of a respiratory belt connected to a rubber tambour and an ink-writer. Except for a slight reduction in respiratory rate in most cases and the rather frequent presence of large sighs, there was little change. Yawning and sighing are rather common premonitory symptoms of motion sickness. In 1 subject tetany developed from hyperventilation. His respiratory rate rose from 13 to 34 and his heart rate from 96 to 148, per minute.

Electroencephalograms: Records were taken from 23 subjects, using one central lead and one lead attached to the ear lobe. No consistent abnormality was found in subjects who experienced motion sickness. The usual finding was a damping of the alpha waves early in the experiment, both in subjects who became motion sick and in those who did not. This was attributed to a moderate degree of initial apprehension on the part of the subject. These records were reviewed by Dr. H. H. Jasper.

Blood Pressure: Records of blood pressure were obtained from 4 subjects by means of a microphone placed over the brachial artery and connected to ear phones in the observation gallery. Readings were made before, during and after motion. No significant abnormality was found.

Details of the physiologic observations described will be found in the original report.¹⁰

Blood Chemistry.—Determinations of the sugar, calcium, phosphorus, sodium and potassium contents of the blood were made before and after motion on 13 subjects.¹¹ The results are given in table 3. Three of these subjects vomited, 5 had illness without vomiting and 5 were unaffected. One significant change was an increase in blood sugar,

10. Cipriani, A., and Morton, G.: Studies of Blood Pressure, Electrocardiograms and Respiratory Tracings in Volunteers, in Proceedings of the Conference on Motion Sickness, National Research Council of Canada, Report no. C744, Aug. 28, 1942.

11. Fields, W. S.; Meakins, J. C., and McEachern, D.: Blood Chemistry Studies in Motion Sickness, in Proceedings of the Conference on Motion Sickness, National Research Council of Canada, Report no. C740, Aug. 28, 1942.

TABLE 3.—*Chemical Constituents of Venous Blood of Thirteen Human Subjects Before and After Motion*

Subject No.	Reaction	Serum, Mg./100 Cc.														
		Blood, Mg./100 Cc.		Phosphorus		Sodium		Potassium								
		Before	After	Dif- ference	Before	After	Dif- ference	Before	After	Dif- ference						
1	Illness and vomiting	107	107	0	10.5	11.2	+0.7	3.26	3.03	-0.23	336	337	+ 1	16.3	16.45	+0.15
2	Illness and vomiting	87	128	+41	12.5	12.5	0	4.75	4.23	-0.52	14.90	14.25	-0.65
3	Illness and vomiting	100	152	+52	2.98	2.93	-0.05
	Average.....	98	129	+31	11.5	11.9	+0.4	3.66	3.40	-0.26	15.6	15.35	-0.25
4	Illness.....	83	106	+23	11.0	10.6	-0.4	3.83	3.40	-0.43	336	339	+ 3	13.5	15.55	+2.05
5	Illness.....	99	110	+11	11.0	10.6	-0.4	4.61	4.23	-0.38	16.15	15.21	-0.94
6	Illness.....	89	114	+25	10.4	10.4	0	339	343	+ 4	15.60	15.05	-0.55
7	Illness.....	90	142	+52	11.6	11.8	+0.2	3.83	3.70	-0.13	357	346	-11	15.95	16.60	+0.65
8	Illness.....	111	125	+14	3.70	3.76	+0.06
	Average.....	94	114	+25	11.0	10.9	-0.1	3.99	3.77	-0.22	344	339	- 5	15.3	15.6	+0.30
9	None.....	100	126	+26	12.3	12.3	0	4.50	3.37	-1.13	329	333	+ 4	15.45	16.16	+0.71
10	None.....	11.1	11.2	+0.1	3.95	3.40	-0.55	337	335	- 2	15.25	16.20	+0.95
11	None.....	108	110	+ 2	2.62	2.51	-0.11
12	None.....	85	87	+ 2	3.95	3.83	-0.12
13	None.....	117	101	-16	2.93	2.72	-0.21
	Average.....	102	106	+ 4	11.7	11.8	+0.1	3.59	3.17	-0.42	333	334	+ 1	15.35	16.18	+0.83
	Total average....	98	117	+19	11.3	11.3	0	3.74	3.42	-0.32	339	339	0	15.39	15.68	+0.29

which occurred in 11 of the 13 subjects whether illness was present or not and which ranged from 2 to 52 mg. per hundred cubic centimeters. There was also a reduction of blood phosphorus in 11 of the 13 subjects, ranging from 0.05 to 1.13 mg. per hundred cubic centimeters. No significant changes occurred in the other bases. The reason for these alterations in the sugar and phosphorus levels of the blood are not clear. It is possible that they result from the release of epinephrine, due either to the motion or to apprehension.

An attempt was made to study blood gases in the human subject, but this had to be abandoned because of difficulty in obtaining arterial blood immediately after motion. The experiments were therefore performed on dogs, using a simple pendulum swing.¹² Specimens of arterial blood were taken from each animal immediately before and after motion,

TABLE 4.—*Values for Blood Gases in Blood of Dogs Subjected to Pendulum Motion*

Dog No.	Comment	Period of Motion, Min.	Carbon Dioxide Content, Vol. %		Oxygen Content, Vol. %		Oxygen Capacity, Vol. %		Oxygen Saturation, Vol. %	
			Before	After	Before	After	Before	After	Before	After
			1	Vomiting.....	6	31.1	25.4	21.7	17.8	21.01
2	Vomiting.....	17	40.3	42.2	15.8	18.0	16.9	20.3	93.5	83.7
3	Vomiting.....	10	39.5	36.7	17.7	18.9	18.8	20.3	94.1	93.1
4	Vomiting.....	5½	36.15	31.05	17.01	18.45	18.2	18.82	93.4	98.0
5	Vomiting.....	6	26.8	35.6	16.45	17.3	18.2	19.2	99.4	90.1
6	Illness but no vomiting.....	20	32.8	31.2	17.6	19.0	18.8	19.0	93.6	100
7	No vomiting.....	30	34.2	34.1	18.2	18.9	20.9	21.5	87.1	88.2
8	No vomiting.....	35	30.4	29.3	19.65	20.6	20.9	23.4	94.0	88.0
9	Labyrinthectomy; no vomiting.....	30	35.5	42.1	17.0	15.0	17.8	17.8	95.5	84.8
10	Labyrinthectomy; no vomiting.....	30	41.8	45.5	20.8	19.4	21.5	21.5	97.0	90.5
11	Labyrinthectomy; no illness	60	41.05	43.45	16.92	16.86	17.15	18.3	98.7	92.1
12	Labyrinthectomy; no illness	60	41.87	37.2	17.09	18.06	18.18	18.18	94.0	99.3
13	Control.....	..	32.55	33.7	15.91	15.60	16.5	17.55	96.5	89.3
14	Control.....	..	32.85	32.07	16.35	16.75	17.77	17.77	92.0	94.2
15	Control.....	..	40.32	39.1	16.8	16.72	17.97	19.02	93.5	87.9

by puncture of either the femoral artery or the left ventricle of the heart. The pre-motion specimens were taken within sixty seconds of the commencement of motion, and the post-motion specimens, within sixty seconds of cessation of motion. Samples were collected under oil in the usual way, and estimations made of the carbon dioxide content, the oxygen content, the oxygen capacity and the oxygen saturation. The animals were divided into three groups. Group A (6 dogs) included those which vomited or were ill as a result of motion; group B (6 dogs), those which showed no evidence of motion sickness; group C (3 dogs), those which were subjected to the experimental procedure except that

12. Meakins, J. C.; Morton, G., and McEachern, D.: Studies of Blood Gases in Animals, in Proceedings of the Conference on Motion Sickness, National Research Council of Canada, Report no. C 747, Aug. 28, 1942.

they were placed in the motionless swing for thirty minutes. The results are shown in table 4. There were no significant changes in the blood gases of these animals in a series of 15 experiments.

Changes in Cerebrospinal Fluid Pressure During Motion.—Observations were made on 1 human subject during repeated up and down motion of an express elevator moving through a distance of about 5 meters at a maximum speed of 4 meters per second. The subject was in an upright position. Pressures were measured with an isometric manometer attached to a needle placed in the subarachnoid space in the lumbar region. Recording was done by means of motion picture photography, so that the film simultaneously showed (1) oscillation of cerebrospinal fluid pressure, (2) acceleration and deceleration of the elevator, recorded by an accelerometer and (3) time, recorded by a stop watch.

At times when the elevator was reversing direction there were changes in cerebrospinal fluid pressure amounting to 70 to 85 mm. of water. Maximum pressures, of 460 mm. of water, were recorded at the point at which the elevator stopped descending; minimum pressure readings, of 375 mm. water, were recorded when the elevator stopped ascending. The acceleration was approximately 0.275 g.

Animal Experiments.—An attempt was made to produce motion sickness in animals by means of a simple swing.¹³ Cats were found to be unsuitable. In 14 experiments on 6 animals, vomiting occurred in only 3 instances. Two experiments were carried out on 2 monkeys, but no vomiting occurred. In 35 experiments on 20 dogs, vomiting occurred in 26 instances (74 per cent) and no vomiting in 9 instances (26 per cent). Dogs were therefore used in future experiments.

Effect of Labyrinthectomy on Susceptibility in Animals.—Bilateral labyrinthectomy was carried out by Dr. W. J. McNally and Dr. E. A. Stuart on 4 dogs, each of which had previously been found to vomit on several occasions on the swing.¹⁴ Before operation the 4 dogs were subjected to a total of 10 swing experiments and vomiting occurred each time. After operation the 4 dogs were subjected to the same motion on 11 occasions and in no instance did vomiting occur. As an additional check, the 4 animals were subjected to the motion of the express elevator in the Sun Life Building for thirty minutes, over a distance of 5 meters with a maximum speed of approximately 4 meters per second. A normal dog, known to be susceptible on the swing,

13. Morton, G.: Susceptibility of Animals to Induced Motion Sickness, in Proceedings of the Conference on Motion Sickness, National Research Council of Canada, Report no. C 746, Aug. 28, 1942.

14. McNally, W. J.; Stuart, E. A., and Morton, G.: Effect of Labyrinthectomy on Motion Sickness in Animals, in Proceedings of the Conference on Motion Sickness, National Research Council of Canada, Report no. C 748, Aug. 28, 1942.

was in the elevator at the same time. The 4 labyrinthectomized animals were entirely unaffected, whereas the normal dog became apathetic, remained quietly in the corner and showed marked hypersalivation. Bilateral labyrinthectomy therefore caused each of 4 susceptible dogs to become nonsusceptible to motion sickness.

COMMENT

Many different mechanisms have been blamed for motion sickness. These include visual and kinesthetic incoordination, psychologic factors, movement of heavy viscera, chemical influences, vascular instability, carotid sinus reflexes and labyrinthine stimulation. In the 1942 review¹⁵ the following caution was given:

. . . Present knowledge of the prostrating symptoms which follow stimulation of the semicircular canals and the dramatic phenomena of Ménière's syndrome have resulted in a general assumption that motion sickness is primarily due to disturbed vestibular function. Although more of the present evidence favors this hypothesis than any other, it is essential that other possible mechanisms be not disregarded until more facts are available. It should be remembered that much of the evidence which tends to incriminate the vestibular apparatus has been obtained by direct stimulation of the labyrinths and not by reproduction of the bodily movements which ordinarily cause motion sickness. Vestibular irritation may not be motion sickness despite the similarity of symptoms.

Work done during the past three years has absolved some of these factors, although they may undoubtedly play a conditioning role. No attempt will be made here to refer to all the wartime work. Much has not yet received open publication.

Incoordination of visual and kinesthetic sensations probably plays a minor role. R. C. A. F. workers¹⁵ showed that ". . . motion sickness is primarily a labyrinthine disturbance which tends to be suppressed or compensated by visual orientation." Certainly, no amount of visual orientation can prevent sickness in susceptible people if they are exposed to the proper type of motion. It is of interest in this respect that Dr. H. H. Jasper and Surg. Lieut. William Fields took moving pictures from the subject's seat in a moving swing. This was shown for over thirty minutes to a group of students seated in a classroom. It did not produce sickness.

Our studies have revealed no chemical changes in the blood which would be likely to play a part in the mechanism of motion sickness. It seems more probable that a humoral transmitter, such as acetyl-

15. Manning, G. W., and Stewart, W. G.: The Effect of Position on the Incidence of Swing Sickness, in Proceedings of the Conference on Motion Sickness, Co-ordinating Committee for Medical Research, National Research Council of Canada, June 16, 1943.

choline, might appear in the blood in excess, but Babkin and Dworkin¹⁶ were unable to demonstrate this in animals.

Mainland¹⁷ showed that there could be a shift of up to 5 cm. in the position of the heavy viscera as a result of tipping. No correlation was found, however, between lability of the organs and susceptibility to motion sickness. The final proof that this factor is of no importance lies in the swing experiments¹⁵ carried out by the Royal Canadian Air Force. Here the highest incidence of sickness (90 per cent) occurred when men were swung with the body in the horizontal position and the head placed to give maximal stimulation of the utricles.¹⁸ There would in this position be practically no acceleratory force acting on the viscera in a cephalocaudad direction.

These facts minimize the importance of vascular instability or carotid sinus pressor reflexes. Indeed, our own experiments have shown that there is little or no gross disturbance of vascular or respiratory reflexes even if sickness occurs.

There has been a tendency to attribute motion sickness entirely to psychogenic causes. This is quite unwarranted and entirely against the facts. Motion sickness can be produced in practically every one if the right type of motion and proper position of the head are used. It can be produced in animals, but not after the labyrinths are removed. In any large group of men the incidence varies from 0 to 90 per cent, depending on position of the head. In our experiments the young Naval ratings were eager to try the "sickness test." They approached it with bravado, interest or unconcern. There is no question that psychologic factors can play an important conditioning role which may tip the balance, but that is common to most human reactions.

SUMMARY

Motion sickness was produced in human subjects by means of a machine designed to reproduce the wayward movements of a ship at sea. Simple pendulum swings were also effective, although some persons susceptible to one motion did not succumb to the other. Vertical acceleration and deceleration in the long axis of the body with head erect appeared to be the most important element in the production of motion sickness. An increase in the frequency of oscillation resulted in a higher incidence of sickness within the limits of the experiment.

16. Babkin, B. P., and Dworkin, S.: Unpublished report, First Meeting of Subcommittee on Seasickness, National Research Council of Canada, Jan. 27, 1942.

17. Mainland, D.: Unpublished report, First Meeting of the Subcommittee on Seasickness, National Research Council of Canada, Jan. 27, 1942.

18. Howlett, J. G., and Brett, J. R.: A Speculation on the Mechanism of Utricular Response to Stimulation in Motion Sickness, in Proceedings of the Conference on Motion Sickness, Co-ordinating Committee for Medical Research, National Research Council of Canada, Report no. C2509, June 16, 1943.

There was a definite correlation between history of motion sickness and susceptibility on the machines. Vestibular responses to the caloric test were no guide to a subject's susceptibility to motion, nor was instability of the electroencephalogram.

Electrocardiograms, electroencephalograms and records of blood pressure taken before, during and after motion showed no important abnormality. There were a slight slowing of respiratory rhythm during motion and a rather frequent tendency to yawning or long sighs. Tetany due to hyperventilation was observed in 1 instance.

Determinations of the sugar, phosphorus and other bases in the blood in human subjects showed a moderate increase in sugar and a reduction of phosphorus as a result of motion. These changes occurred whether or not the subject became sick. They were attributed possibly to the liberation of epinephrine, due to motion or apprehension.

Studies of gases in the arterial blood of animals showed no significant change as a result of motion. Changes of cerebrospinal fluid pressure were measured in 1 volunteer in the sitting posture while exposed to motion capable of producing sickness. There was a variation of about 70 to 85 mm. of water with each change of direction of motion.

Dogs were found to be suitable for the study of motion sickness. Cats and monkeys were not. Bilateral labyrinthectomy abolished motion sickness in dogs which had previously been highly susceptible.

It is probable that the most important factor in motion sickness in man is stimulation of the utricles by linear accelerations in the vertical plane of the head.

Montreal Neurological Institute.

THE ELECTROENCEPHALOGRAM AND PERSONALITY ORGANIZATION IN THE OBSESSIVE- COMPULSIVE REACTIONS

FRED V. ROCKWELL, M.D.

AND

DONALD J. SIMONS, M.D.

NEW YORK

IT HAS been observed by Pacella and others¹ that a relatively high percentage of patients with obsessive-compulsive reactions have abnormal electroencephalograms. The present study was made to determine the factors responsible for the presence or absence of abnormal electroencephalographic findings in this group of patients. A promising lead was available in the paper of Simons and Diethelm,² in which it was reported that abnormal electroencephalograms were common in certain groups of psychopathic personalities. On the basis of these findings, a study of the obsessive-compulsive reactions from the standpoint of underlying personality organization seemed indicated.

PRESENT INVESTIGATION

The case material for the present study consisted of 24 patients between the ages of 13 and 45 years, all of whom showed well marked obsessive-compulsive symptoms. Many varieties of compulsive actions were encountered, including compulsive washing, cleaning, dressing and toilet rituals, repetition of words, counting, touching and looking. Obsessive phenomena included religious scruples with repeated examination of conscience, obsessive fears and doubts, obsessive thoughts of a sexual or an aggressive nature and various obsessive impulses, e. g., to imitate or to repeat the actions of other people. All the patients showed manifest symptom formation, and none was included merely because of so-called compulsive or obsessional character traits. None of the patients showed any evidence of gross structural disease of the nervous system. All were studied in detail as inpatients at the Payne Whitney Psychiatric Clinic of the New York Hospital, and all had one or more satisfactory electroencephalograms. These 24 patients fell into three groups.

This study was supported by the Barbara Henry Research Fund.

From the New York Hospital and the Department of Psychiatry, Cornell University Medical College.

1. Pacella, B. L.; Polatin, P., and Nagler, S. H.: Clinical and Electroencephalographic Studies in Obsessive-Compulsive States, *Am. J. Psychiat.* **100**:830-838 (May) 1944.

2. Simons, D. J., and Diethelm, O.: Electroencephalographic Studies in Psychopathic Personalities, *Arch. Neurol. & Psychiat.* **55**:619-626 (June) 1946.

Group 1.—This group includes the patients who could be considered to have stable and well organized personalities. A patient was considered to have a well organized personality when it could be demonstrated that his attitude toward life and his judgment corresponded to his chronologic age; that he had been able to achieve an average degree of harmony among various strivings, with integration of emotional and intellectual resources, and that he was able to utilize past experiences and to adjust imagination and anticipation to reality. In their illness, these patients showed either uncomplicated obsessive-compulsive neuroses or various mixtures of obsessive-compulsive and affective features. None showed any signs of a disorganizing illness. In this group were 11 patients, 9 of whom had electroencephalograms which were normal according to the criteria of Gibbs, Gibbs and Lenox.³

From the standpoint of symptoms and stability of personality organization, the tenth patient did not differ from the 9 who had entirely normal electroencephalograms. Unlike the others, this patient received a course of fifty-five subcoma insulin treatments, which were administered to alleviate severe tension and anxiety. Immediately after the conclusion of this treatment, an electroencephalogram was found to contain an excessive amount of low voltage fast activity, being otherwise normal. A second record, taken three months later, was entirely normal. It was felt that, for the purposes of this study, the patient belonged essentially in the category of the first 9 patients of this group.

The eleventh patient, like the first 10, was a well organized person, whose leading symptoms were depression, obsessions and compulsions. Unlike the others of group 1, this patient experienced occasional half-hour periods during which her environment appeared unreal and somewhat distorted. Her first electroencephalogram was taken June 12, 1945, at a time when obsessive thinking was pronounced. This record was abnormal because of the presence of excessive quantities of 3 to 5 per second waves in the frontal and parietal leads. Dextrose was administered orally before this test, and the response to hyperventilation was normal. A second electroencephalogram was made on October 19, at a time when she was free from all obsessive-compulsive symptoms but was experiencing the feelings of unreality before mentioned. This second record contained an excessive quantity of 5 to 7 per second waves and, in addition, showed an abnormal response to hyperventilation. Dextrose was not administered before this test. In order to evaluate the relationship between the administration of dextrose and the abnormal response to hyperventilation, the following experiment was performed on November 16. An electroencephalogram was taken with

3. Gibbs, F. A.; Gibbs, E. L., and Lennox, W. G.: Electroencephalographic Classification of Epileptic Patients and Control Subjects, *Arch. Neurol. & Psychiat.* **50**:111-128 (Aug.) 1943.

the patient fasting. The response to hyperventilation consisted of a big build-up of 5 to 7 per second activity of high amplitude, beginning at the end of the first minute and developing into 2 to 3 per second activity during the second minute. This duplicated the patterns obtained during the test run without dextrose taken on October 19. After the patient was tested while fasting (November 16), she was given orally 250 cc. of 50 per cent dextrose and retested fifteen minutes later. This time hyperventilation elicited 5 per second activity of average amplitude during the second minute. Toward the end of the second minute there were outbursts of 5 to 7 per second activity of high amplitude. These outbursts became more pronounced during the third minute, during which some 2 to 3 per second waves appeared; but 5 per second waves predominated. This response was considered comparable to that obtained in the first test with administration of dextrose, on June 12. The experiment was considered evidence that dextrose protected this patient against the appearance of electroencephalographic abnormalities educible with overbreathing.

Group 2.—The patients in this group also showed well marked obsessive-compulsive symptoms with varying admixtures of affective features. None showed any signs of a schizophrenic illness. Unlike group 1, all these patients showed disturbances in the organization of personality to the extent that they were classed as psychopathic personalities. The pathologic manifestations which led to classifying these patients as psychopathic could not be explained by the existence of any of the well defined types of psychoneurosis or psychosis but had to be considered as representing a fundamental psychopathologic disorder of the personality. In this group there were 10 patients, all of whom had abnormal electroencephalograms.

The concept of psychopathic personality as used in this paper needs elaboration. The functions of the personality may be considered pathologic when there is a disturbance in the organization of the personality or when personality features are exaggerated or underdeveloped. Considered from this point of view, psychopathic personalities may be classified according to the leading disturbances in personality functions. In disorders of personality organization, late or insufficient maturing may be the essential factor, as seen in the immature psychopathic type. In another type, i. e., the loosely organized psychopathic personality, the functions relating to the synthesis of the personality are disturbed. In both types one finds a lack of need and ability for the spontaneous adjustment of contradictory strivings and actions. With immaturity, which may be observed in adolescents, as well as adults, the person's attitude to life and his judgment in general do not correspond to his intelligence and chronologic age. Certain poorly organized personalities may show,

as one symptom, a rigidity along certain lines. Some psychopathic personalities have a basic, but usually unrecognized, intellectual disorder. In this type one finds vagueness of thinking caused by poor concept formation. Such vagueness may be seen in the setting of normal or superior intelligence. This type of psychopathic personality shows an increase in the thinking disorder under the influence of intense emotions. This phenomenon, in the past, has led psychiatrists to assume mistakenly that they were dealing with an early schizophrenic development when, for example, they encountered such a psychopathic personality, with obsessive-compulsive symptoms, marked anxiety and vagueness of thinking with poor concept formation. This type of intellectual disorder is often associated with general inadequacy of personality. Another type of psychopathic personality is characterized by low ethical and moral standards, with resulting social difficulties. Persons of this type exhibit irresponsibility of behavior with disregard of consequences, lack of persistence of emotional relationships and lack of emotional depth. Inability to profit from experience leads to repeated misdemeanors, such as stealing, lying, truancy and irresponsibility with regard to social and financial obligations.

Many other functions of personality may be disturbed in psychopathic persons, but the patients in group 2 of this study all showed an underlying psychopathic disorder of personality, characterized by one or more of the features discussed here, *viz.*, loose organization of personality, immaturity, low ethical standards and general inadequacy with vague thinking. Simons and Diethelm,² in their study of psychopathic personalities, found that electroencephalographic abnormalities were confined to three types of psychopathic personalities, which they characterized as follows: (1) low ethical and moral standards; (2) loose organization of personality and (3) vague thinking and general inadequacy of personality. Thus, it can be seen that the types of psychopathic personality found in group 2 of the present study correspond closely to those found by Simons and Diethelm to be associated with abnormal electroencephalographic findings.

In their electroencephalograms, all the patients in group 2 showed slow waves of average or low amplitude, with frequencies of 3 to 5 or 5 to 7 per second. Two of the 10 records were considered borderline because of insufficient amounts of such slow waves. Two records had paroxysmal features. One of these had outbursts of 6 per second waves of high amplitude, while the other had outbursts of 5 per second waves of low voltage. Neither of the 2 patients with records showing paroxysmal features had any psychopathy that might be considered related to epilepsy.

Group 3.—This group includes 3 patients, all of whom showed well marked obsessive-compulsive symptoms but none of whom fell clearly into the categories of group 1 or group 2.

The first of these 3 patients, a woman aged 22, had a disorganizing illness of four years' duration, with definite schizophrenic symptoms, as well as obsessive thoughts and compulsive activity. The classification of her electroencephalogram was open to question because of drowsiness, but the pattern was probably normal.

The second patient, a 13 year old boy, had had a severe compulsion neurosis since the age of 3 years. His electroencephalogram was classified as abnormal because of the presence of 3 to 5 per second waves and a pathologic response to hyperventilation. It is known that the manifestations of disturbed personality organization may not make their appearance as early as the age of 13. Hence it was not possible to reach any final conclusion in regard to the underlying personality organization of this patient.

The third patient, a 16 year old youth, for six years had experienced a tic, characterized by head jerking with grunting. For three years before admission he had indulged in a compulsive ritual at bedtime, turning his pillow so that the open end was against the wall, with the idea that in some magic way this would make things go well the next day. His electroencephalogram was abnormal because of the presence of excessive quantities of 5 to 7 per second waves. The status of the personality organization could not be settled conclusively, and the presence of the severe tic introduced a complicating factor which made it impossible to evaluate etiologically the observed electroencephalographic abnormalities.

COMMENT AND CONCLUSIONS

The number of patients in this series was relatively small, but since each was thoroughly studied for an adequate period it is felt that certain tentative conclusions may be drawn.

1. Pathologic findings were present in the electroencephalograms of 13 out of 24 patients who presented obsessive-compulsive symptoms. There did not appear to be a connection between any special type of compulsive psychopathic disorder and the abnormal electroencephalographic findings. There was, however, a high degree of correlation between disturbances of the underlying personality organization and electroencephalographic abnormalities. All the patients with clearcut disturbances of personality organization, i. e., with psychopathic personalities, had abnormal electroencephalograms. Ten of the 11 patients who were considered to be well organized persons had normal electroencephalograms.

2. Abnormal electroencephalograms, which were found in all the patients with disturbances of personality organization, were characterized by the presence of excessive quantities of slow waves (3 to 7 per second). The consistent finding of slow activity in this series suggests that we

are dealing with the same type of neurophysiologic disturbance observed by Simons and Diethelm,² who, in their study of psychopathic personalities, reported:

The majority of abnormal records were those containing sufficient 5 to 7 a second activity of low average amplitude in the frontal and parietal leads to be considered beyond the limits of normal.

3. If the conclusions drawn from these observations are valid, certain therapeutic implications follow. Any patient who shows electroencephalographic abnormalities of the type presented by these poorly organized psychopathic patients must be suspected at least of having a deficiency in the synthesizing functions of his personality: This point should be investigated further, utilizing both clinical observation and anamnestic data from outside sources whenever possible. In the treatment of a psychopathic patient with obsessive-compulsive symptoms, it has been our experience that more or less passive analytic technics will result in the disappearance of the obsessive-compulsive phenomena, but there remain the manifestations of psychopathic personality, which must be approached with a more active, synthesizing type of treatment. The electroencephalogram is a useful tool in giving an early lead to the presence of disturbances of personality organization, for these disturbances are not always obvious during early contacts with the patient.

4. The present study gives evidence that certain types of psychopathic personality, described by Simons and Diethelm,² are associated with electroencephalographic abnormalities, whether these disturbances of personality organization appear as the leading clinical features or occur in cases in which obsessive-compulsive symptoms dominate the clinical picture.

Recognition that a considerable number of patients with obsessive-compulsive symptoms are psychopathic is not new. Meige and Feindel⁴ in their monograph, published in 1907, cited the views of a number of earlier French psychiatrists in regard to the personality makeup of patients with tics, obsessions, compulsions and phobias. Charcot (1888) remarked on the presence of certain signs or psychic stigmas of degeneration, or instability, as he preferred to say. Ballet called these patients "superior degenerates," or "unstable," and remarked on the inequality of their mental development, stating that "brilliance of memory or conversational gifts may be counteracted by absolute lack of judgment; solidity of intellect may be neutralized by more or less complete absence of moral sense." Itard (1825) noted "mental infantilism, evidenced by inconsequence of ideas and fickleness of mind, reminiscent of early youth and unaltered with the attainment of years

4. Meige, H., and Feindel, E.: *Tics and Their Treatment*, translated and edited by S. A. K. Wilson, London, Sidney Appleton, 1907.

of discretion." Magnan said of these "superior degenerates" that "clinical observation reveals functional disorders so distinct and so invariable that it is impossible that they should not be the outcome of some pathologic modification of the organism." It seems fitting to conclude with the comment that our observations on neurophysiologic disturbances in a group of psychopathic patients with obsessive-compulsive symptoms merely confirm the statement made by Magnan in the latter part of the nineteenth century.

Payne Whitney Psychiatric Clinic, New York Hospital.

EFFECTS OF PITRESSIN HYDRATION ON THE ELECTROENCEPHALOGRAM

Paroxysmal Slow Activity in Nonepileptic Patients with Previous Drug Addiction

ABRAHAM WIKLER, M.D.

Surgeon (R), United States Public Health Service
LEXINGTON, KY.

ALTHOUGH hydration by forcing of fluids and the use of pitressin has long been employed to precipitate epileptic seizures for diagnostic purposes in persons suspected of having idiopathic epilepsy,¹ no study has been made of the electroencephalographic changes produced by this procedure, either in normal or in epileptic subjects. A single injection of pitressin has been reported to have no effect on the electroencephalogram,² but no data have been found on the effects of water intoxication except for the statement by Allen³ that some experiments of this type on dogs had been attempted.

The present study was undertaken in an attempt to solve a clinical problem. A patient at the United States Public Health Service Hospital was referred for electroencephalographic study because he exhibited periodic episodes of antisocial behavior. A diagnosis of psychopathic personality had been made, but it was desired to rule out epilepsy. A routine electroencephalogram was essentially normal. A pitressin hydration test was then made with a view to provoking a fit, antisocial behavior or "epileptiform" changes in the electroencephalogram. Neither a fit nor antisocial behavior occurred during this procedure, but paroxysmal slow activity did appear in the electroencephalogram. This was difficult to interpret because of the lack of control data in the literature, and therefore further investigations were made.

MATERIALS AND METHODS

The subjects for these experiments were 14 male patients at the United States Public Health Service Hospital who were undergoing treatment for addiction

From the United States Public Health Service Hospital.

1. McQuarrie, I., and Peeler, D. B.: The Effects of Sustained Pituitary anti-diuresis and Forced Water Drinking in Epileptic Children: A Diagnostic and Etiologic Study, *J. Clin. Investigation* **10**:915, 1931. Hilger, D. W.; Mueller, A. R., and Freed, A. E.: The Pitressin Hydration Test in the Diagnosis of Idiopathic Epilepsy, *Mil. Surgeon* **91**:309, 1942.

2. Gibbs, F. A.; Gibbs, E. L., and Lennox, W. G.: Effect on the Electroencephalogram of Certain Drugs Which Influence Nervous Activity, *Arch. Int. Med.* **60**:154 (July) 1937.

3. Allen, F. F.: Spontaneous and Induced Epileptiform Attacks in Dogs, in Relation to Fluid Balance and Kidney Function, *Am. J. Psychiat.* **102**:67, 1945.

to opiates while serving sentences for violation of the Harrison Narcotic Act and who volunteered for this test. All these subjects had been in the institution six months or more and had not used opiates habitually for at least that length of time. Their ages varied from 32 to 46, with an average of 37.1. None gave a history of epilepsy, and in no case had a seizure been recorded since the patient's admission to the institution. All were in good health. For 7 patients a diagnosis of psychopathic personality was made on admission.

Electroencephalograms were made before and after pitressin hydration. Silver-silver chloride cup electrodes were applied to the scalp, and bipolar recordings were made from the frontal, precentral, parietal and occipital regions. The electroencephalograph was a four channel, capacity-coupled, amplifier and oscillographic apparatus with photographic recording on bromide paper. During the recording the patient lay quietly on a comfortable bed in an electrically shielded, sound-proofed, air-cooled room. An observer was always present to note movement and to make sure the patient was not asleep. Records were taken before, during and after hyperventilation.

Each record was analyzed as follows: A representative thirty second sample was selected, and all waves over 5 microvolts in amplitude were measured and counted. Paroxysmal activity was not included in the strip. The mean alpha frequency was calculated by averaging all frequencies from 8 to 13 per second, and the percentage of alpha activity was determined by calculating the time occupied by such frequencies during a thirty second recording. A frequency spectrum was then plotted. The limits of individual variation from day to day were determined on several records, and, with this method of analysis, the variation in alpha frequency was found to be not more than 0.5 cycle per second, and that in percentage of alpha activity, 12 per cent.

The method of hydration varied to a considerable extent because of differences in the ability of the subjects to tolerate this procedure. In the first few experiments, pitressin was injected hypodermically every hour for seven hours (in doses of 0.3, 0.4, 0.5, 0.5, 0.5, 0.5, 0.5 cc.), and the patient drank 500 cc. of water every hour for eleven hours. Some patients were able to tolerate this, but others suffered from vomiting and abdominal cramps. The procedure was then altered by giving smaller doses of pitressin hourly for eight hours (0.2, 0.3, 0.3, 0.3, 0.3, 0.3, 0.3, 0.3 cc.) and administering 1,000 cc. of 5 per cent dextrose in distilled water intravenously every two hours until a total of 5,000 cc. had been given during the eight hour test period. Some minor modifications were made in the dosage in individual cases.

The patients were admitted to the research ward in the morning, and preliminary physical examinations and records of pulse, temperature, blood pressure, respiration and weight were made. An electroencephalogram was made in the afternoon. Pitressin hydration was begun early the next morning, and the patient was weighed at frequent intervals. Another electroencephalogram was made the same afternoon, after maximum hydration had been achieved. The patients were closely observed, and records of blood pressure, pulse, respiration and temperature were made every four hours during the period of hydration. A regular diet was prescribed, but coffee, tea and soup were excluded.

RESULTS

Clinical Observations.—Some of the patients were fairly comfortable during these procedures, but most of them had some degree of discomfort, chiefly nausea, abdominal cramps and occasional vomiting.

Considerable puffiness of the face appeared in a few patients. In none did alarming reactions of circulatory nature appear, and there were no significant changes in pulse rate or blood pressure. No epileptic seizures of any kind were precipitated. It was found that the smaller doses of pitressin (0.3 cc.) were just as effective in inhibiting diuresis as larger amounts and produced less discomfort. On the morning following pitressin hydration voluminous diuresis took place, and the patient's weight returned rapidly to or slightly below the control level.

Electroencephalographic Observations.—The data are summarized in the table. The average gain in weight at the end of hydration was

Effects of Pitressin Hydration on the Electroencephalogram

Sub- ject No.	Total Pitres- sin, Cc.	Per Cent Gain in Body Weight	Alpha Frequency			Alpha Percentage			Comment
			Before	After	Differ- ence	Before	After	Differ- ence	
1	3.4	5.3	9.9	10.1	+0.2	71.0	73.7	+ 2.7	Shift to slow side and paroxysmal delta activity after hydration
2	3.4	5.0	10.2	9.8	-0.4	83.5	82.1	- 1.4	
3	3.2	4.5	11.1	10.6	-0.5	47.3	40.0	- 7.3	
4	3.2	2.7	10.7	10.5	-0.2	42.3	63.3	+21.0	Shift to slow side after hydration
5	3.0	2.6	11.5	10.9	-0.6	42.7	42.2	- 0.5	
6	3.0	5.1	11.6	11.4	-0.2	57.4	67.8	+10.4	Shift to slow side and paroxysmal delta activity after hydration
7	3.2	1.8	9.9	10.0	+0.1	57.1	60.6	+ 3.7	
8	2.6	3.2	10.3	10.0	-0.3	76.2	67.7	- 8.5	Shift to slow side after hydration
9	2.5	7.3	10.3	9.7	-0.6	74.3	59.0	-15.4	Shift to slow side and paroxysmal delta activity after hydration
10	1.3	4.3	11.5	11.5	0.0	22.6	22.0	+ 0.6	Paroxysmal delta activity after hydration
11	1.3	5.3	11.1	10.5	-0.6	42.9	63.9	+21.0	Shift to slow side and paroxysmal delta activity after hydration
12	1.3	4.4	10.9	10.7	-0.2	63.3	41.2	-22.1	Paroxysmal delta activity after hydration
13	1.7	5.3	10.4	10.4	0.0	67.0	61.2	- 5.8	
14	1.0	3.9	11.1	10.6	-0.5	60.8	46.9	-13.9	Shift to slow side and paroxysmal delta activity after hydration

3 Kg., or 4.1 per cent of body weight. In 3 of the subjects the mean alpha frequency was lowered 0.6 cycle per second, but in the remainder the changes in alpha frequency, although mostly in the direction of slowing, were within the range of daily variation. In half the patients the frequency spectrum showed a definite shift toward the slow side (fig. 1). In the remainder no definite shift could be observed. In no case was there an unequivocal shift toward the fast side of the spectrum.

The most striking change, however, was the appearance of bursts of slow activity (6 cycles per second) of moderately high amplitude in 7 of the 14 records after hydration (fig. 2). All but 1 of the control records were essentially normal and contained no paroxysmal slow activity, either before or after hyperventilation. In the one record

a scant amount of paroxysmal 6 per second rhythm was present, and this activity was greatly increased after hydration. In those records which showed paroxysmal 6 per second rhythms, such activity appeared in short bursts of 8 to 15 waves two to six times during the entire run, which was usually about three or four minutes. The incidence of paroxysmal slow activity was not entirely the same as that of shift in the frequency spectrum to the slow side. In 2 records there was a shift but no paroxysmal slow activity, and in 2 the latter was present but there was no shift in the spectrum. There was no correlation between the incidence of paroxysmal slow activity and the degree of hydration or the total amount of pitressin injected. Nor was there a correlation between the admission diagnosis of psychopathic personality and shift in frequency spectrum or incidence of slow activity. Such changes in the electroencephalogram after pitressin hydration were present in 50 per cent of patients with diagnoses of psychopathic personality and in 50 per cent of the others. Consciousness was not grossly disturbed

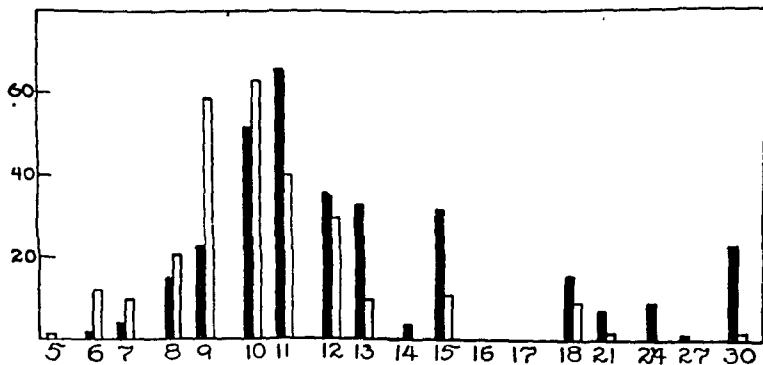

Fig. 1 (case 1).—Effects of pitressin hydration on the frequency spectrum of the electroencephalogram. The solid bars indicate values before, and the outline bars values after, pitressin hydration. On the abscissa are plotted frequencies in terms of cycles per second; on the ordinate, the number of such frequencies in a thirty second record. Note the shift to the slow side after hydration.

during the electroencephalographic recording so far as could be determined by the observer in the electroencephalographic chamber.

COMMENT

Although none of the patients gave a history or showed clinical evidence of epilepsy, the electroencephalograms obtained on half the subjects after pitressin hydration could be termed "epileptoid" because of the presence of paroxysmal slow activity. Furthermore, it is noted that this change occurred in only half the subjects and was independent of the degree of hydration. This suggests that the appearance of "epileptoid" changes in the electroencephalogram depends on individual susceptibility. It should be emphasized here that the persons subjected to this test were not truly representative of a "normal" group, since all

had previously been drug addicts and recent studies at this institution have shown that the great majority of the drug addicts fall into either the psychopathic or the psychoneurotic group.⁴

The findings provide a partial answer to the clinical problem which gave rise to this study. It is evident that the appearance of paroxysmal slow activity in the electroencephalogram after pitressin hydration cannot be considered indicative of epilepsy in the clinical sense of the

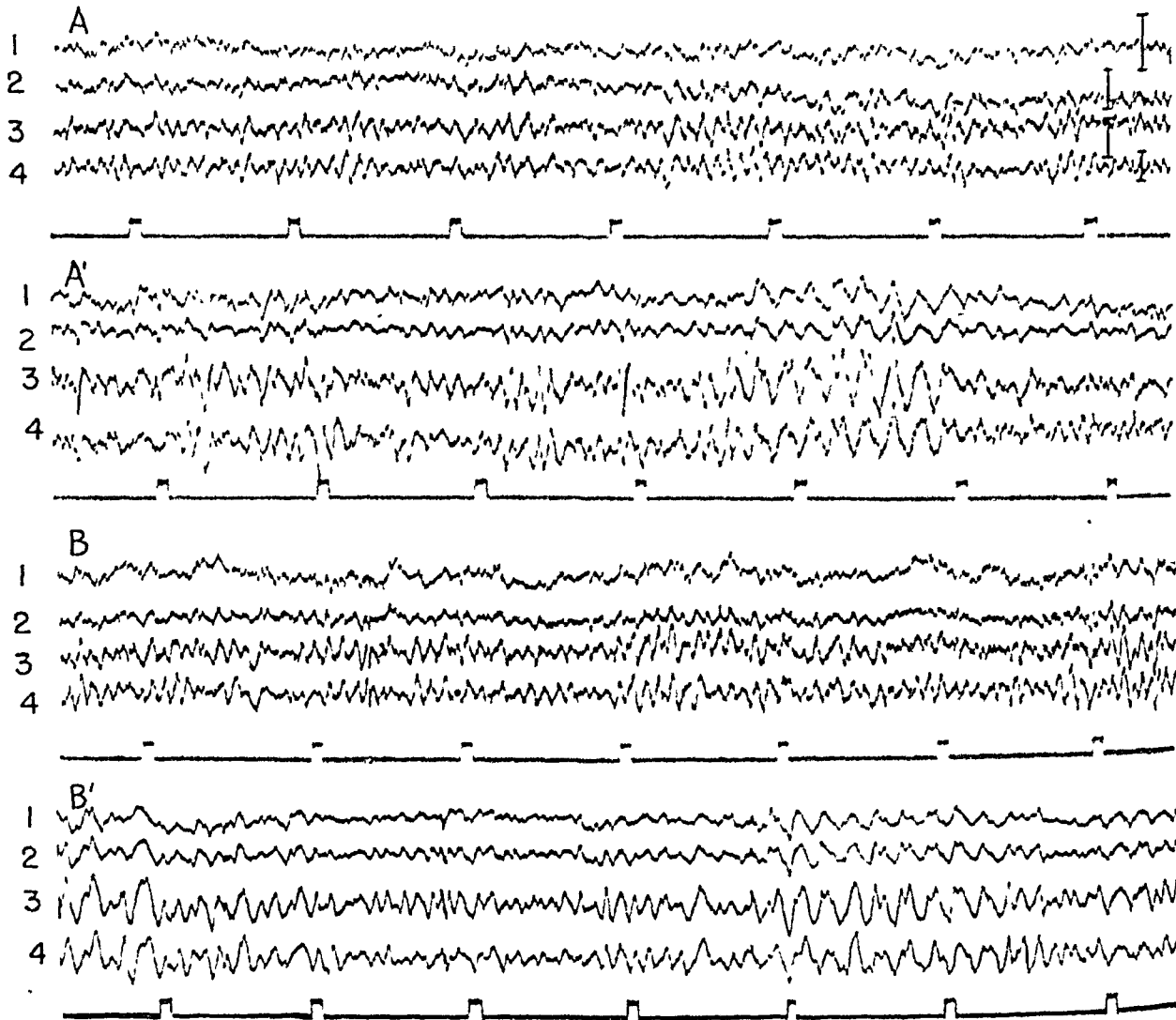

Fig. 2 (case 6).—Effects of pitressin hydration on the electroencephalogram (bipolar recording from the frontal (1), precentral (2), parietal (3) and occipital (4) leads; calibration 50 microvolts; time in seconds). *A* and *B* are control records made before and after hyperventilation, respectively; *A'* and *B'*, records obtained before and after hyperventilation after pitressin hydration. Note the paroxysmal 6 per second activity after hydration.

4. Aldrich, C. K., and Ruble, D. C.: Studies on the Personalities of Drug Addicts, to be published.

term. However, it does suggest the possibility that the physiologic mechanism which underlies the production of clinical seizures by this method is also operant in certain susceptible nonepileptic persons and that, essentially, quantitative threshold differences determine whether or not, in any given case, clinical seizures will be precipitated. It would be illuminating, in this connection, to compare the group observed in this investigation with "normal" subjects and with persons known to have epilepsy with special reference to the incidence of paroxysmal slow activity in the electroencephalogram after pitressin hydration. However, such studies have not yet been made.

SUMMARY AND CONCLUSIONS

The electroencephalograms of 14 nonepileptic men with previous drug addiction were studied before and after pitressin hydration. No clinical seizures were induced by this procedure.

The alpha frequency showed a tendency to slowing after hydration, but in only 3 instances was the degree of change greater than that which could be expected from day to day variation. There was no significant change in the percentage of alpha activity.

In half the records there was shift to the slow side of the frequency spectrum.

In half the records paroxysmal slow activity of moderately high amplitude appeared after hydration.

There was some correlation between the appearance of paroxysmal slow activity and the shift of the frequency spectrum to the slow side, but no correlation with the degree of hydration or the amount of pitressin administered.

The possible significance of these observations in their relation to idiopathic epilepsy is discussed.

United States Public Health Service Hospital.

OBJECTIVE METHOD FOR DISTINGUISHING SLEEP FROM THE HYPNOTIC TRANCE

JOHN B. DYNES, M.D.
BOSTON

ALTHOUGH most persons spend approximately one third of their lives sleeping, and although considerable time and study have been expended in the elucidation of this phenomenon, little is known about it. It is recognized that certain phenomena occur during sleep¹: There is a generalized muscular relaxation which roughly parallels the depths of sleep; the temperature of the body falls; tendon reflexes tend to diminish and may disappear; breathing becomes periodic, and there is a slight acidosis, with increase of carbon dioxide in the blood. Contrary to earlier theories regarding the blood supply of the brain in the sleeping state, it is now fairly well established that there is no anemia of the brain during sleep. However, until the advent of the electroencephalograph there was no instrument or objective measuring device which would indicate the sleeping state with any degree of certainty. The characteristic changes which occur in the electroencephalograms of sleeping persons have been well demonstrated in the work of Davis² and Loomis³ and their associates. Figure 1⁴ illustrates the electroencephalographic patterns occurring at each of the various levels of sleep. Lines 1 and 12 of this tracing illustrate the electroencephalographic tracings in the normal waking state, and lines 2 to 11, inclusive, those at the various levels of sleep. Line 2 shows the pattern during very light sleep, with general low voltage and flattening of the tracing. Line 5 is typical of deep sleep, with the appearance of high voltage, slow waves. Although it must be confessed that the nature of sleep is

From the Department of Neuropsychiatry, Lahey Clinic.

1. Kleitman, N.: *Sleep and Wakefulness as Alternate Phases in the Cycle of Existence*, Chicago, University of Chicago Press, 1939.

2. Davis, H.; Davis, P. A.; Loomis, A.; Harvey, E. N., and Hobart, G.: *Human Brain Potentials During the Onset of Sleep*, *J. Neurophysiol.* **1**:24-38, 1938. Davis, P. A.: *Effects of Sound Stimulation on the Waking Human Brain*, *ibid.* **1**:494-499, 1939.

3. Loomis, A. L.; Harvey, E. N., and Hobart, G. A.: *Disturbance-Patterns in Sleep*, *J. Neurophysiol.* **1**:413-430, 1938.

4. Dynes, J. B.: *Narcolepsy and Cataplexy*, *Lahey Clin. Bull.* **2**:83-90, 1941.

poorly understood, at the same time, with an objective measure of the phenomena of sleep, such as that offered by the electroencephalogram, there is hope of further elucidating the fundamental nature of sleep and, also, of distinguishing certain other conditions from sleep. This

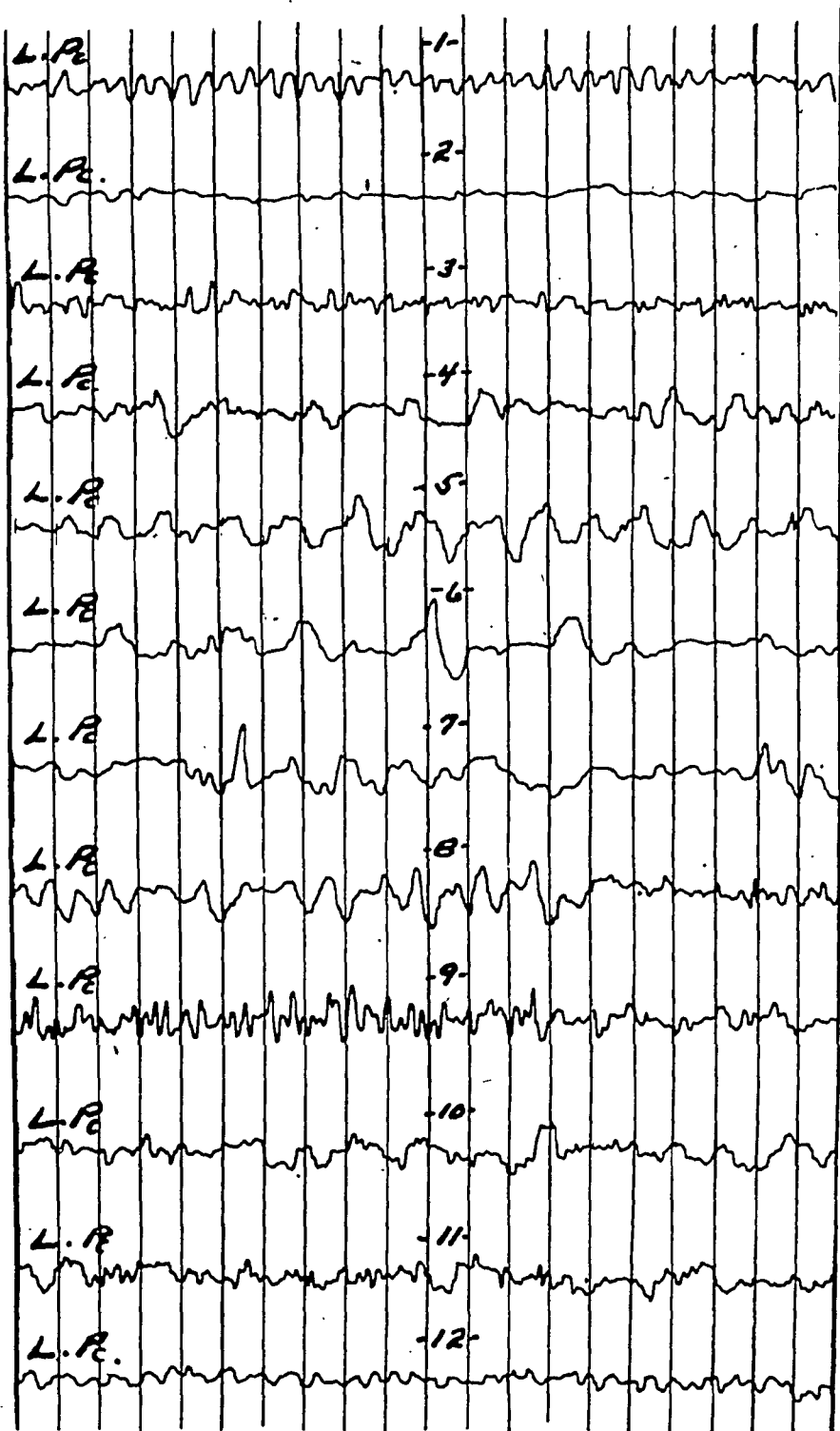

Fig. 1.—Electroencephalograms taken during the normal waking state (lines 1 and 12) and various levels of normal sleep (lines 2 to 11, inclusive). Line 2 shows very light sleep, and line 5, deep sleep.

paper deals primarily with the objective evidence, as recorded by the electroencephalograph, in the distinction between sleep and the hypnotic trance.

Hypnosis and sleep have been considered by many investigators as related states, and the similarity between these two states has been mentioned in all previous neurophysiologic studies and theories relating to this subject. Hypnosis has been spoken of as "an artificial sleep," or as "a sleep-like state." Few hypnotists induce a trance without referring to sleep directly or indirectly. Pavlov⁵ expressed the belief

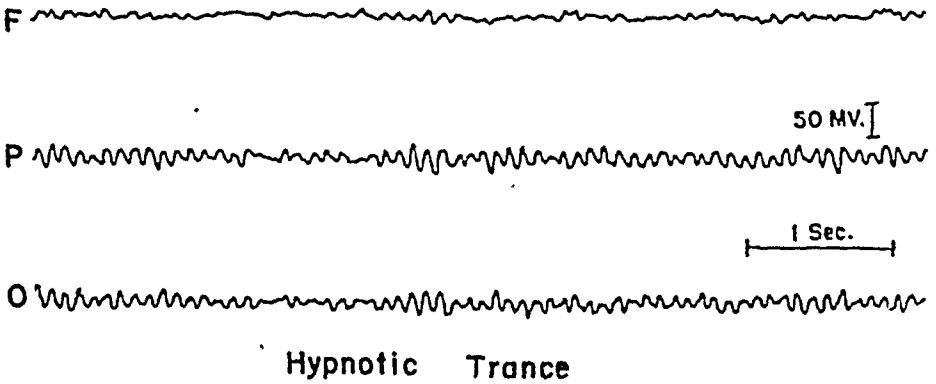
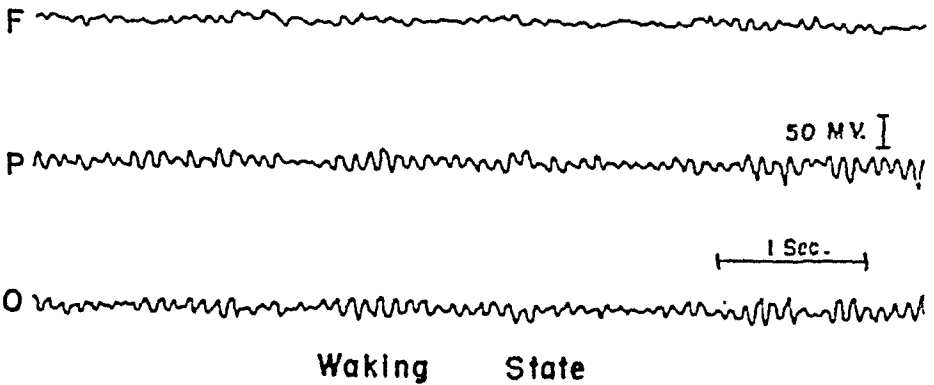

Fig. 2.—Electroencephalograms taken during the waking state and during a hypnotic trance.

that sleep and hypnosis were related and postulated a state of inhibition of the brain which influenced motor activity primarily. Schilder and Kauders⁶ stated that the altered state of consciousness in hypnosis is

5. Pavlov, I. P.: Inhibition, Hypnosis and Sleep, *Brit. M. J.* 2:256-257, 1923.

6. Schilder, P., and Kauders, O.: Hypnosis, translated by S. Rothenberg. *Nervous and Mental Disease Monograph Series no. 46*, New York, Nervous and Mental Disease Publishing Company, 1927, p. 118.

in some way related to stimulation of the so-called sleep center in the region of the hypothalamus and the third ventricle. Kubie and Margolin⁷ expressed the opinion that the induction of hypnosis is a condition of partial sleep and that the monotony of sensory stimulation and the immobility of the subject are the chief factors in bringing about the hypnotic trance. Salter,⁸ in his theory, stated that hypnosis is a type of conditioned reflex and inferred that hypnosis is a variant of sleep.

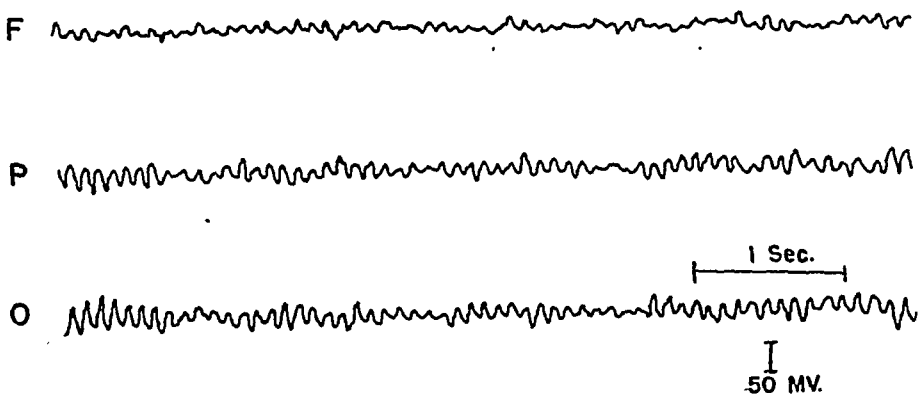
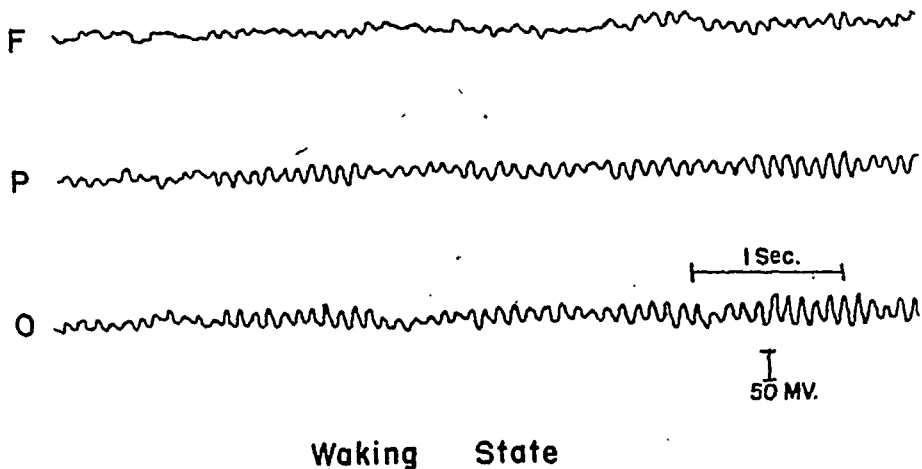

Fig. 3.—Electroencephalograms taken during the waking state and during a hypnotic trance.

Although the electroencephalogram does give an objective measure or indicator of the phenomenon of sleep, there as yet exists no objective measure or indicator of the hypnotic trance. It is true that there have

7. Kubie, L. S., and Margolin, S.: The Process of Hypnotism and the Nature of the Hypnotic State, *Am. J. Psychiat.* **100**:611-622, 1944.

8. Salter, A.: *What Is Hypnosis: Studies in Auto and Hetero Conditioning*. New York, Richard R. Smith, 1944.

been those who claimed that a hypnotic trance might be induced without reference to sleep⁹; it is also true that the so-called production of hypnotic phenomena has been observed in the waking state. The great variety of sensory and motor phenomena observed in association with conversion hysteria in the "waking state" may also be reproduced in a hypnotic trance. However, no one had presented any good objective evidence that the phenomena of sleep and the phenomena of the hypnotic trance were of a different order until Loomis,¹⁰ in 1936, reported a

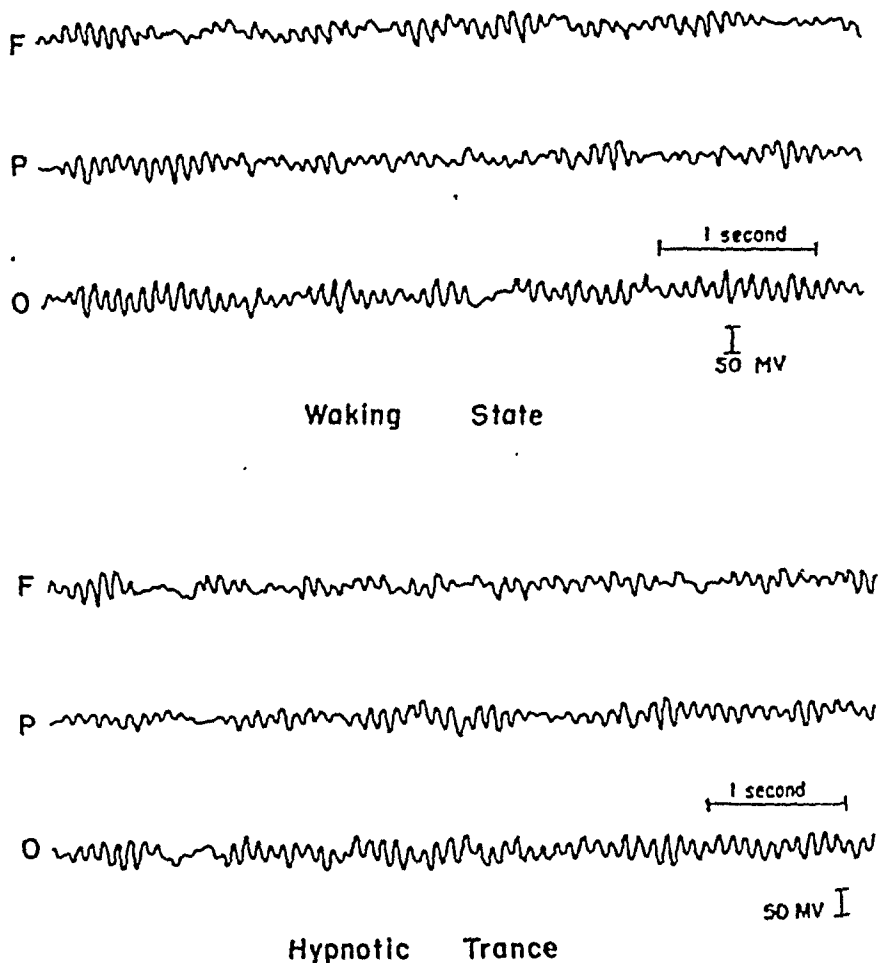

Fig. 4.—Electroencephalograms taken during the waking state and during a hypnotic trance.

single instance in which the electroencephalogram of a patient in the hypnotic trance showed no fundamental change from the electro-

9. Wells, W. R.: Experiments in Waking Hypnosis for Instructional Purposes, *J. Abnorm. & Social Psychol.* **18**:389-404, 1924.

10. Loomis, A. L.; Harvey, E. N., and Hobart, G.: Brain Potentials During Hypnosis, *Science* **83**:239-241, 1936.

encephalogram taken during the so-called waking state. No electroencephalographic tracings were presented, and no one, to my knowledge, has confirmed or substantiated this report. Brenman and Gill,¹¹ in their recent review of hypnotherapy, concluded that the use of cortical electrical activity as a criterion has yielded contradictory results and cited the work of Loomis and associates¹⁰ and Lundholm and Löwenbach.¹² A review of the article by the latter authors does show a

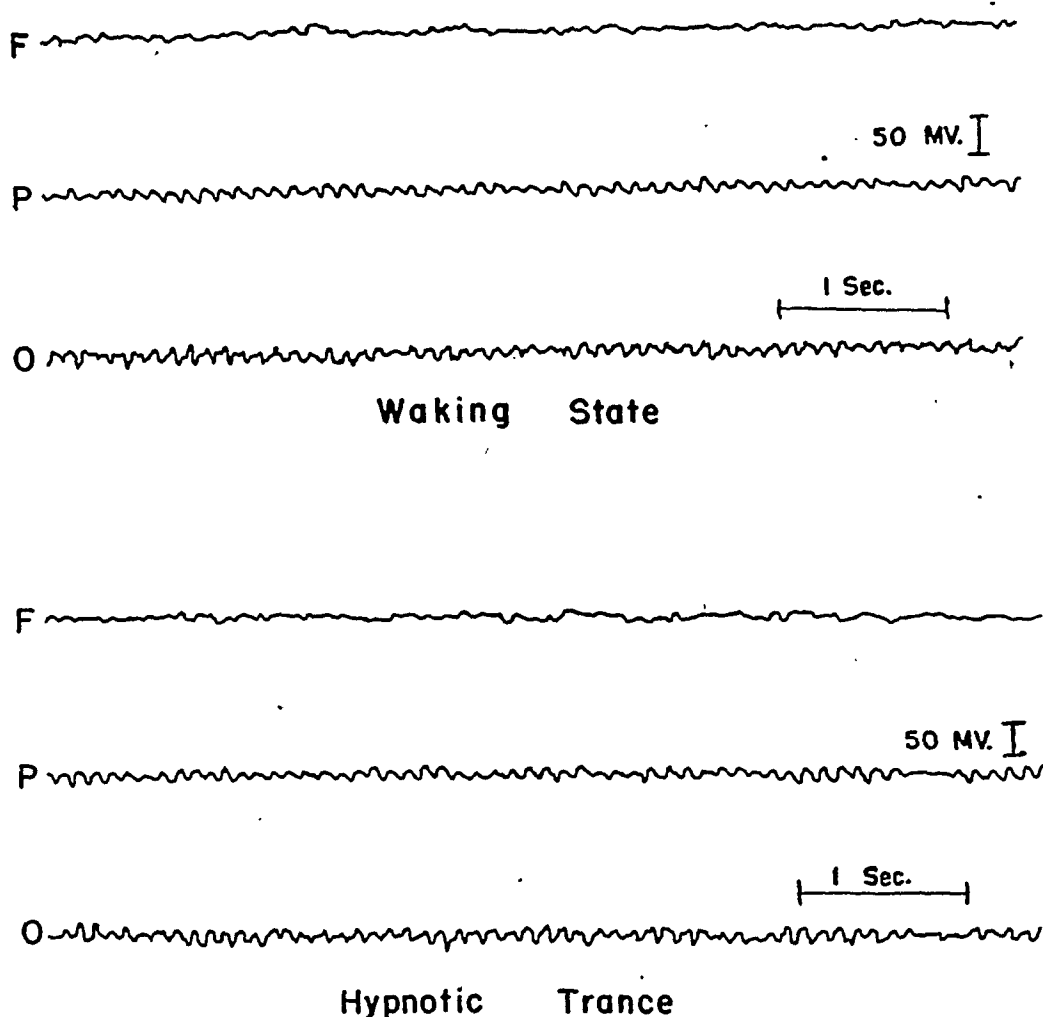

Fig. 5.—Electroencephalograms taken during the waking state and during a hypnotic trance.

failure to confirm by means of the electroencephalogram certain phenomena of the hypnotic trance, but there was no disagreement with the earlier report by Loomis that no difference exists between the

11. Brenman, M., and Gill, M. M.: *Hypnotherapy, Review Series*, New York, Josiah Macy Foundation, 1944, vol. 2, no. 3.

12. Lundholm, H., and Löwenbach, H., Jr.: *Hypnosis and the Alpha Activity of the Electroencephalogram*, *Character & Person.* **11**:145-149, 1942.

electroencephalographic tracing of the waking person and that of a person in an hypnotic trance, as Lundholm and Löwenbach did not call attention to this important observation.

The accompanying electroencephalographic tracings (figs. 2, 3, 4, 5 and 6), recorded on 5 different patients, illustrate the waking state and the hypnotic trance in each subject. The apparatus used was a three channel, Grass electroencephalograph, with leads taken from the frontal,

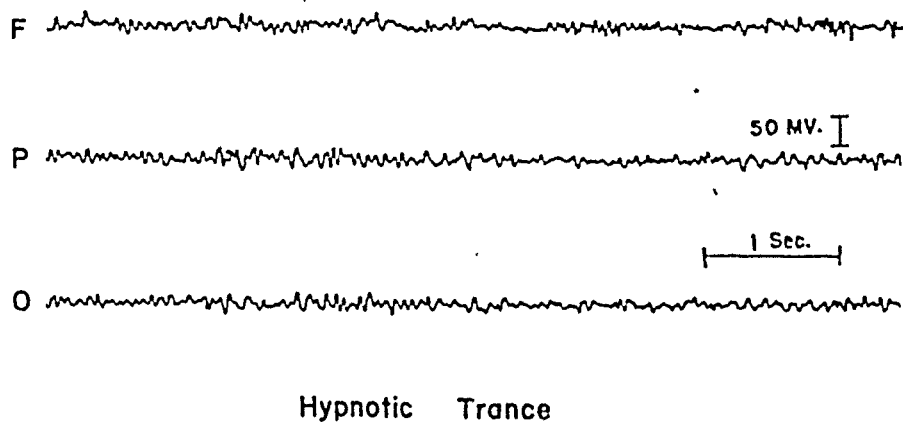
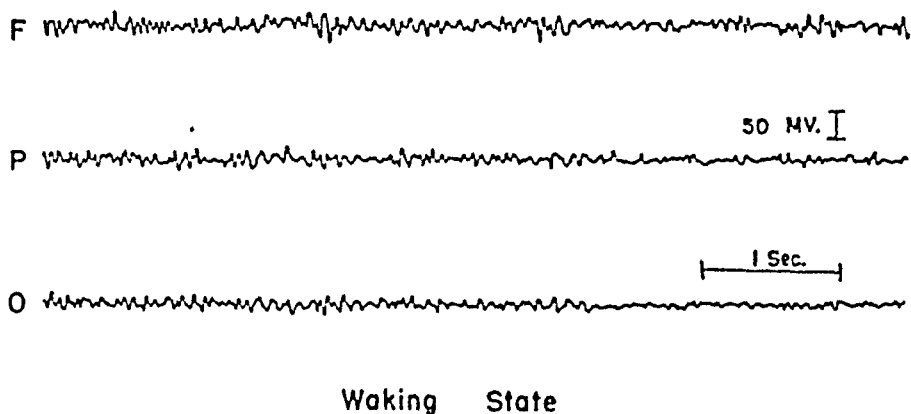

Fig. 6.—Electroencephalograms taken during the waking state and during a hypnotic trance.

parietal and occipital regions. Each subject was capable of being placed in a deep hypnotic trance. The criteria used to indicate a deep trance were complete amnesia for events happening in the hypnotic trance, anesthesia to painful stimuli and the ability to carry out posthypnotic suggestions. One patient had been hypnotized repeatedly and had been conditioned so that he would pass into a trance more or less instan-

taneously on the giving of a signal. The signal in this particular instance was the snapping of the hypnotist's fingers. Figure 7 illustrates two electroencephalographic tracings taken at times when an instantaneous trance was induced. There is no indication that cortical electrical activity, as shown in the electroencephalogram, was altered, either at the time of induction of the trance or later, when the patient was in a deep trance. There is no evidence that the cortical electrical activity as recorded by the electroencephalogram during the hypnotic

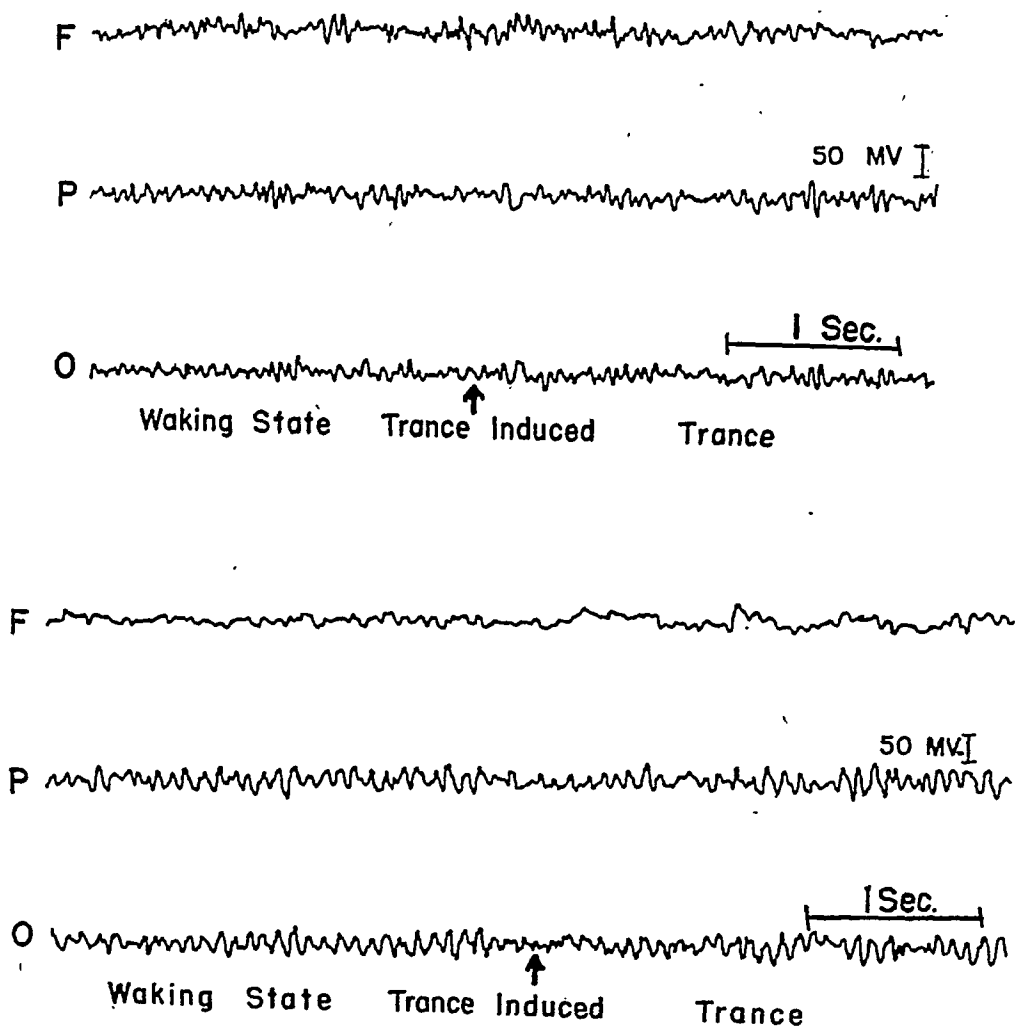

Fig. 7.—Electroencephalogram taken at the time an instantaneous hypnotic state was induced.

trance resembled the cortical electrical activity as seen in a sleeping person (figs. 1 and 8). Figure 8 illustrates the electroencephalograms taken in the waking state, the hypnotic trance and a light sleeping state in the same patient. It is apparent that the sleeping state, as seen in figures 1 and 8, gives rise to an entirely different type of electrical activity than does either the waking state or the hypnotic trance.

SUMMARY

It appears from these electroencephalographic tracings that there was no distinctive difference between the cortical electrical activity at the time the hypnotic trance was induced, or during the established hypnotic trance, and that of the normal waking state, and, further, that

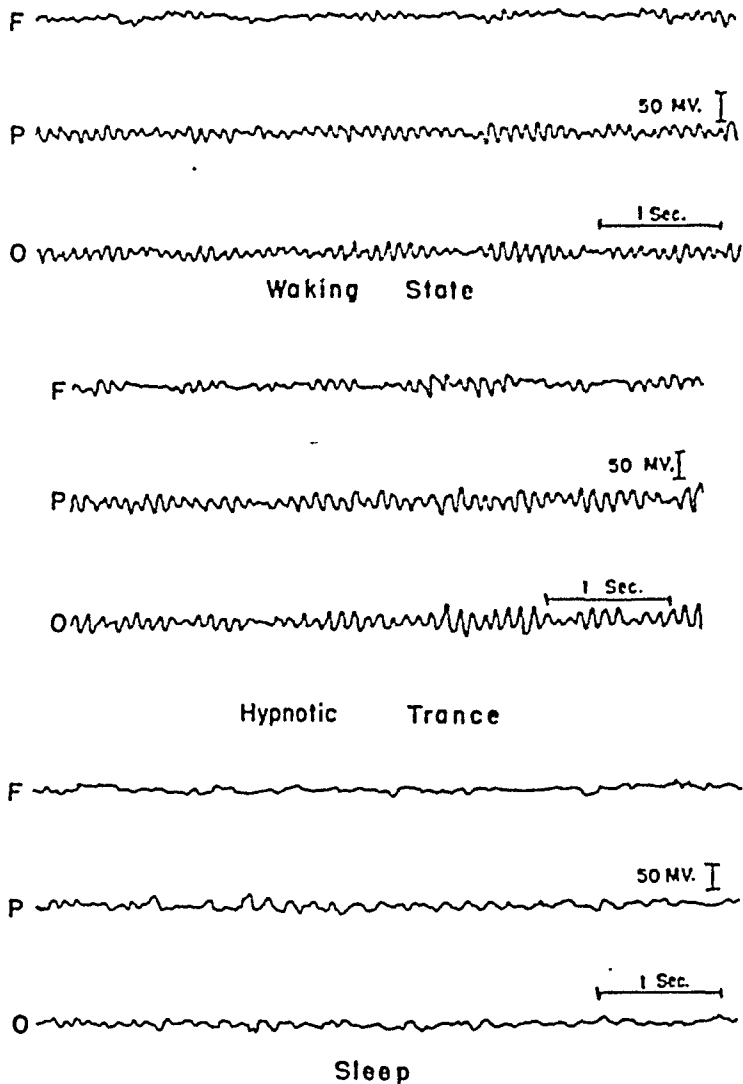

Fig. 8.—Electroencephalograms taken during the waking state, a hypnotic trance and a light sleeping state.

the cortical electrical activity recorded from the brain of a person in a hypnotic trance shows no resemblance to the electroencephalographic tracings taken from the brain of a sleeping person. The objective evidence presented here confirms the opinions of investigators who have claimed that hypnosis is not a sleep variant. Just what hypnosis is has

not been determined objectively, although it can be said that there is no definite difference between the cortical electrical activity, as recorded electroencephalographically, of a person in a deep hypnotic trance and that of the same person in the normal waking state.

605 Commonwealth Avenue.

CIRCULATION OF THE BRAIN AND FACE

Determinations of Oxygen and Sugar in Arterial and in Internal
and External Jugular Venous Blood

JULIUS LOMAN, M.D.
AND
ABRAHAM MYERSON, M.D.
BOSTON

THE VESSELS of the brain are much more resistant to changes in caliber than vessels elsewhere in the body. Forbes and Cobb¹ observed that when the cervical sympathetic nerve is stimulated, arteries in the skin constrict ten times as much as those in the pia. Pool, Nason and Forbes² found that the vessels of the dura are almost eight times as active as the arteries of the pia. Schmidt and Hendrix³ observed that the vessels of the parietal cortex are much less responsive to vaso-motor drugs than the vessels of the tongue and of the mylohyoid muscle. Of all the cerebral vasodilators, carbon dioxide is the most consistently effective.⁴ Vasodilators, such as histamine, acetylcholine and acetyl-beta-methylcholine, which have a pronounced dilating action on the extracranial vessels, are either comparatively ineffective or irregular in their influence on the intracranial vessels.⁵ Nicotinic acid, another strong extracranial vasodilator, has a comparatively mild effect on the intracranial circulation.⁵

The purpose of the present study was to compare the oxygen and sugar contents of the arterial and internal and external jugular venous blood as an indirect index of the blood flow in the brain and face.

From the Division of Psychiatric Research, Boston State Hospital.

This study was aided by a grant from the Commonwealth of Massachusetts.

1. Forbes, H. S., and Cobb, S.: Vasomotor Control of Cerebral Vessels, *A. Research Nerv. & Ment. Dis., Proc.* (1937) **18**:201, 1938.

2. Pool, J. L.; Nason, G. I., and Forbes, H. S.: Cerebral Circulation: XXXIII. The Effect of Nerve Stimulation and Various Drugs on the Vessels of the Dura Mater, *Arch. Neurol. & Psychiat.* **32**:1202 (Dec.) 1934.

3. Schmidt, C. F., and Hendrix, J. P.: The Action of Chemical Substances on Cerebral Blood-Vessels, *A. Research Nerv. & Ment. Dis., Proc.* (1937) **18**:229, 1938.

4. Wolff, H. G., and Lennox, W. G.: Cerebral Circulation: XII. The Effect on the Pial Vessels of Variations in the Oxygen and Carbon Dioxide Content of the Blood, *Arch. Neurol. & Psychiat.* **23**:1097 (June) 1930. Schmidt and Hendrix.³

5. Loman, J.; Rinkel, M., and Myerson, A.: The Intracranial and Peripheral Vascular Effects of Nicotinic Acid, *Am. J. M. Sc.* **202**:211, 1941.

MATERIAL AND METHODS

Quiet, cooperative patients with dementia precox were the subjects of the study. They lay quietly for one-half hour before the experiments were begun. Blood was withdrawn simultaneously from the brachial artery and the internal and external jugular veins. The external jugular vein is fairly readily entered as it courses across the sternocleidomastoid muscle. This vein is made to stand out conspicuously in most cases by compressing the structures above the clavicle. A long-beveled,

TABLE 1.—*Oxygen Content of the Arterial and of External and Internal Jugular Venous Blood of Forty-Two Subjects with Dementia Precox*

Patient	Oxygen Content, Vol. %			Differences in Oxygen Content, Vol. %	
	Arterial Blood	External Jugular Venous Blood	Internal Jugular Venous Blood	Arterial- External Jugular Venous Blood	Arterial- Internal Jugular Venous Blood
J. C.....	20.3	17.8	10.7	2.5	9.6
W. D.....	16.9	14.5	12.8	2.4	4.1
C. O.....	15.7	13.8	9.2	1.9	6.5
B. O.....	14.2	12.6	7.2	1.6	7.0
F. K.....	15.7	11.2	10.5	4.5	5.2
P. S.....	18.4	14.6	13.9	3.8	4.5
R. M.....	17.5	16.5	10.6	1.0	6.9
F. F.....	17.7	16.7	11.0	1.0	5.7
W. M.....	15.3	14.3	9.6	1.0	5.7
W. B.....	15.6	15.2	11.2	0.4	4.4
T. M.....	14.3	12.9	9.3	1.4	5.0
L. H.....	18.7	17.5	12.9	1.2	5.8
J. S.....	17.7	15.3	12.2	2.4	5.5
P. G.....	19.0	18.1	11.3	0.9	7.7
G. L.....	18.0	15.5	11.2	2.5	6.8
E. L.....	20.4	17.8	11.4	2.6	9.0
C. S.....	17.4	16.4	11.7	1.0	5.7
A. K.....	16.7	15.0	13.3	1.7	3.4
E. L.....	20.0	16.9	11.9	3.1	8.1
C. S.....	16.9	15.2	12.9	1.7	7.0
A. K.....	16.5	13.9	11.0	2.6	4.5
H. B.....	17.2	15.5	9.5	1.7	7.7
J. S.....	18.5	16.7	13.1	0.8	5.4
J. C.....	17.1	15.9	9.0	1.2	8.1
W. D.....	14.3	12.9	4.1	1.4	10.2
E. L.....	19.5	16.6	11.9	2.9	7.6
W. L.....	19.5	18.3	11.9	1.2	7.6
W. D.....	13.1	10.9	6.0	2.2	7.1
H. B.....	17.1	13.0	10.3	4.1	6.8
J. C.....	17.2	14.3	9.8	2.9	7.4
W. M.....	18.1	15.4	11.0	2.7	7.1
P. S.....	18.5	13.7	11.5	4.8	7.0
F. F.....	18.0	16.6	10.4	1.4	7.6
W. B.....	17.2	14.8	11.0	2.4	6.2
W. L.....	16.7	16.0	9.5	0.7	7.2
W. M.....	17.6	16.1	8.4	1.5	9.2
F. B.....	17.5	16.3	11.2	1.2	6.3
H. L.....	19.6	16.7	11.1	2.9	8.5
G. L.....	16.8	16.4	13.9	0.4	2.9
J. S.....	18.5	17.6	10.8	0.9	7.7
W. M.....	15.7	14.0	10.5	1.7	5.2
J. D.....	17.5	16.3	12.0	1.2	5.5
Average.....	17.3	15.4	10.8	1.9	6.6

very sharp needle facilitates the puncture of the external jugular vein, since the vessel tends to collapse readily. The oxygen determinations were carried out by the Van Slyke method and the sugar determinations by the Folin-Wu method.

RESULTS

Table 1 shows the oxygen contents of the brachial artery and the internal and external jugular veins for 42 patients. The values for the

internal jugular vein were found to be very close to those observed by Gibbs, Lennox, Nims and Gibbs,⁶ who compared the various chemical constituents of this vessel in 50 normal subjects. In most instances the blood withdrawn from the external jugular vein had the appearance of arterial blood. Its color was readily explained by its high oxygen content, a value which was usually much closer to that of the arterial blood than to that of the internal jugular venous blood. The differences in oxygen content between the arterial and the external jugular venous blood varied from 0.4 to 4.8 volumes per cent, with an average difference of 1.9 volumes per cent, in contrast to the differences between the arterial and the internal jugular venous blood, which varied from 2.9 to 10.2 volumes per cent, with an average difference

TABLE 2.—Oxygen and Sugar Contents of Arterial and of External and Internal Jugular Venous Blood*

Patient	Oxygen Content, Vol. %					Sugar Content, Mg./100 Cc. Blood				
	A.	E. J.	I. J.	A.-E. J.	A.-I. J.	A.	E. J.	I. J.	A.-E. J.	A.-I. J.
W. D.	13.1	10.0	6.0	2.2	7.1	93	16	85	0	10
H. B.	17.1	13.0	10.3	4.1	6.8	93	95	85	0	12
F. F.	18.0	16.0	10.4	1.4	7.6	101	99	87	2	14
W. B.	17.2	14.8	11.0	2.4	6.2	85	86	79	+1	6
W. L.	16.7	16.0	9.5	0.7	7.2	97	89	79	8	18
W. M.	17.6	16.1	8.4	1.5	9.2	100	97	92	3	8
G. L.	16.8	16.4	13.0	0.4	2.0	89	86	81	0	5
J. S.	18.5	17.6	10.8	0.9	7.7	81	80	72	1	9
W. M.	15.7	14.0	10.5	1.7	5.2	100	95	89	5	11
E. L.	17.5	13.2	4.3	...	79	79	70	0	9
Average	16.8	14.0	9.1	2.0	6.0	92	91	82	2	11

* In this table, A. indicates arterial blood; E. J., external jugular venous blood; I. J., internal jugular venous blood; A.-E. J., arterial-external jugular venous difference, and A.-I. J., arterial-internal jugular venous difference.

of 6.6 volumes per cent. There was found to be no correlation between the color (redness or paleness) of the face and the percentage of oxygen uptake by the face.

In another group, of 10 subjects, the differences in sugar and oxygen content between the arterial and the external jugular venous blood and the arterial and the internal jugular venous blood were compared. As with the differences in oxygen content, only a relatively small amount of sugar was removed from the arterial blood as it passed through the face as compared with the amount that was removed from the arterial blood as it passed through the brain (table 2).

COMMENT

Approximately three times as much oxygen disappears from the blood in its passage through the brain as from the blood in its passage

6. Gibbs, E. L.; Lennox, W. G.; Nims, L. F., and Gibbs, F. A.: Arterial and Cerebral Venous Blood: Arterial-Venous Differences in Man, *J. Biol. Chem.* **144**: 325, 1942.

through the face. An insufficient number of cases were studied for comparison of the arterial-venous differences in sugar content between the two organs, although very marked differences also occur with reference to this metabolite. The low uptake of oxygen by the face and scalp can be explained either by the low metabolic requirements of these tissues or by a rapid blood flow through these organs. Certain observations appear to favor the latter explanation: The circulation of the face reflects very sensitively changes in the emotional state. The facial vessels react more quickly and actively to such drugs as histamine, acetylcholine and nicotinic acid than the vessels in other parts of the body. The face, too, plays a very active role in the dissipation of heat. These vascular phenomena suggest that the blood vessels of the face contain many more arteriovenous shunts or are more widely open than are vessels elsewhere in the body, such as those in the fingers and hand. In the latter parts, the venous blood contains a much smaller percentage of oxygen than the external jugular venous blood. However, under conditions of vasodilatation, such as obtains after the intrabrachial administration of nicotinic acid, the venous blood of the hand and arm resembles in its oxygen content the blood of the external jugular vein. By contrast, the oxygen content of the internal jugular vein changes but slightly after the injection of nicotinic acid into the internal carotid artery.⁵ Thus, the circulation of the face under conditions of rest may be compared with the circulation in the arm under conditions of strong vasodilatation.

SUMMARY

The oxygen and sugar contents of the arterial and the internal and external jugular venous blood were determined in a group of subjects with dementia precox.

The oxygen concentration of the external jugular venous blood is much higher than that of the internal jugular venous blood. Because of its relatively high oxygen content, the external jugular venous blood usually has the gross appearance of arterial blood. Approximately three times the amount of oxygen is removed from the blood as it passes through the brain as is removed from the blood as it passes through the face. A similar statement may be made with reference to the sugar uptake of the two organs. These data may be explained either by differences in metabolic requirements of the brain and the face or by differences in the circulation of the two organs. Certain observations favor the latter explanation.

483 Beacon Street.

171 Bay State Road.

ABNORMALLY LARGE BIRTH WEIGHTS OF PSYCHIATRIC PATIENTS

HERBERT BARRY Jr., M.D., Ph.D.
BOSTON

ALTHOUGH numerous factors have been studied in relation to psychiatric disease, the patient's weight at time of birth seems to have received little attention. This is not surprising in view of the many years which elapse between birth and onset of a psychosis. Nevertheless, pathologists have noted that premature infants are susceptible to intracranial hemorrhage or anoxia during parturition. It is also well known that abnormally large babies are apt to have difficult deliveries. There is thus at least a theoretic justification for investigating the birth weights of a series of psychotic patients and comparing these weights with those for the normal population. The only psychiatric study of this type appears to be that of Benda,¹ who found that most patients with mongolism weighed 9 pounds (4,000 Gm.) or over at time of birth.

A number of authors have compiled statistics on average weights at birth for unselected maternity cases which indicate that large babies (weighing over 4,000 Gm.) do not constitute much more than 5 per cent of all births.

METHOD AND RESULTS

Data were obtained from the anamneses of 750 patients who had been admitted for the first time to Greystone Park, N. J., and 225 patients from the psychiatric ward of the Massachusetts General Hospital, and all information on weights at birth was tabulated. The group from Greystone Park were young psychotic patients, similar to a group described previously² except that they had all been admitted for the first time between 1937 and 1945. The 225 patients from the Massachusetts General Hospital were mostly psychoneurotic, with some patients with psychosomatic disturbances, and had been admitted during the years 1942 to 1945, inclusive. Anamneses at the Massachusetts General Hospital were secured by a physician and those at Greystone Park by a psychiatric social service worker. Weights at birth were usually given to the nearest $\frac{1}{2}$ pound (226 Gm.) for the psychotic patients, though some were given to the nearest ounce (28 Gm.). Some

From the Department of Neurology and Psychiatry of the Harvard Medical School, and the Department of Psychiatry of the Massachusetts General Hospital.

1. Benda, C.: *Mongolism and Cretinism*, New York, Grune & Stratton, Inc., 1946.

2. Barry, H., Jr.: *Incidence of Advanced Maternal Age in Mothers of One Thousand State Hospital Patients*, *Arch. Neurol. & Psychiat.* **54**:186-191 (Sept.) 1945.

were approximations, such as "6 or 7 pounds," or "8 or 9 pounds." In these instances the lowest weight mentioned was used in the tabulation. In a number of protocols the patient was merely described at birth as "heavy," "average" or "small." These were tabulated separately, and the total number of patients are presented for each of these categories (table).

In many instances no data on weights at birth were obtainable. This was in large part due to the great lapse of time between the birth of the patient and his subsequent commitment. In general, the older the patient, the more difficult it becomes to secure information concerning his birth. Thus, at Greystone Park the percentage of patients for whom birth weights were obtained decreased from 75 per cent (for patients under 25) to 33 per cent (for patients over 30). A similar trend was found at the Massachusetts General Hospital, the figures ranging from 48 per cent, for patients under 20, to 3 per cent, for patients over 40. When the figures were analyzed according to source of information, it was found that 55 per cent of the records from the Massachusetts General Hospital for which the mother was informant contained data regarding the weight at birth, while only 13 per cent of the records with informants other than the patient's mother had data concerning weight at birth. The percentage of records with data on weight at birth is somewhat larger for psychotic patients at Greystone Park, since the closest relative is routinely asked to appear for an interview; this procedure, of course, could not be insisted on to the same extent with the psychoneurotic patients who were treated at the Massachusetts General Hospital.

In order to avoid too large a percentage of patients whose birth weights were unknown, which might make values ambiguous, only patients under 30 years of age were included in the final tabulation of birth weights of patients at Greystone Park. There were 462 such patients. Of these, data were not available for 154; of the remaining 308, 30 per cent either were described as heavier than average or stated specifically that they weighed 9 pounds or over at birth (table).

Weight stated in pounds	No. of Patients
9 or over.....	76
6 to 8.....	163
Under 6.....	21
Total.....	260
9 lb. or over, 29.2%	
Weight described	
"Heavy".....	15
"Average".....	28
"Light".....	5
Total.....	48
"Heavy," 31.1%	
No information.....	154
Total number of patients (aged 30 or under).....	462

If all the patients whose weight at birth was unknown were babies of average or less than average weight (an unlikely supposition), at least 20 per cent of the patients under 30 were reported as having been large babies. This is at least four times the expected incidence of overweight babies as reported by other investigators,³ who have

3. (a) Von Reuss, A. R.: Diseases of the Newborn, New York, William Wood & Co., 1921, pp. 1-2. (b) Anderson, N. A.; Brown, E. W., and Lyon, R. A.: Causes of Prematurity: Comparison of Maternal Histories of Premature and of Full Term Infants, *Am. J. Dis. Child.* 61:72-87 (Jan.) 1941.

recorded percentages ranging from 2.9 to 5.1 of unselected patients as weighing over 9 pounds (4,000 Gm.) at birth.

Birth weights of psychoneurotic patients at the Massachusetts General Hospital showed a similar distribution. Of the 61 patients whose anamneses were furnished by the mother, data concerning weight at birth were available for 34 (56 per cent). Nine patients weighed 9 pounds or over at birth. Thus, 26 per cent of the patients for whom birth weights were given, or 15 per cent of all patients on whom the mother acted as informant, were large babies. While the number of patients is small, the percentages are substantially similar to those noted for psychotic patients. By contrast, in a series of 12,000 consecutive deliveries from the obstetric service of the Boston City Hospital, it was found that the percentage of babies over 9 pounds showed some variation from year to year, with a maximum of 6.5 per cent in 1937 and a minimum of 5.3 per cent in 1939. These data were made available through the courtesy of Dr. Frederick L. Good.

COMMENT

Since the data on weights at birth are based on reports made many years previously, there are obviously many possibilities of inaccuracy or error. However, in a large series of patients such inaccuracies should tend to cancel each other unless there is a consistent bias which would lead a number of informants to exaggerate or distort their reports in the same direction. That there might be a tendency to exaggerate birth weights cannot be denied. Actually, the substantial number of patients (6 per cent) who are reported as weighing 12 pounds or over at birth might be considered presumptive evidence of such exaggeration. For this reason, the results must be considered as tentative until they can be confirmed by checking the informant's statements against hospital records or by obtaining other objective verification. At the same time, the reported incidence of overweight babies is so striking that it seemed desirable to publish preliminary figures.

Pending confirmation, any extended discussion of theoretic implications may appear premature. For the same reason, a more detailed report on diagnoses and relationship to other factors which have been supposed to be related to birth weight, such as maternal age,⁴ diabetes,⁵ and other conditions⁶ will be deferred. However, it should be stated that

4. Curtis, A. H.: *Obstetrics and Gynecology*, Philadelphia, W. B. Saunders Company, 1933, vol. 2, p. 137.

5. Miller, H. C.: The Effect of the Prediabetic State on the Survival of the Foetus and the Birth Weight of the Newborn Infant, *New England J. Med.* **233**: 376-378 (Sept. 27) 1945.

6. Goldstein, H.: The Relation of Order of Birth to Other Birth Factors, *Child Development* **9**:127-147 (March) 1938.

in this series the male patients on the average were heavier at birth than the female patients. The differences observed are consistent with those which have been reported by previous investigators for normal persons and support the belief that these reported birth weights have some relation to actual birth weights.

A point concerning methodology may be briefly emphasized. Attempts to obtain birth weights of older patients are likely to be unsatisfactory, and the percentage of patients whose birth weights are unknown may be so high as to result in abandonment of any investigation; however, birth weights may be secured for young patients (16 to 25 years of age) in a high percentage of cases, especially if the mother is available as informant. If attention were focused on younger patients (under 25), it might be possible to evaluate more precisely whether birth weight or other events connected with birth and infancy have any significance as predisposing factors in psychiatric disease.

CONCLUSIONS

Twenty per cent of a series of psychiatric patients for whom data were obtainable were reported to have been large babies or to have weighed 9 pounds (4,000 Gm.) or over at birth.

The difficulty of securing data on weights at birth can be minimized by limiting investigation to patients who are under 25 years of age.

Massachusetts General Hospital.

Obituaries

CHARLES LEWIS ALLEN, M.D.

1860-1946

On May 28, 1946, Dr. Charles Lewis Allen, one of the pioneers of Western psychiatry, passed to his rest after a lingering illness. His mind remained young and receptive until a cerebral vascular accident left him aphasic and physically helpless.

Dr. Allen was born on Sept. 24, 1860, at Charleston, S. C. He was the youngest of six children, the eldest of whom lost his life in the War between the States. Lewis attended private schools in Charleston until, in his teens, he entered the military academy in Charlotte, N. C.

For his higher education he went to the University of Virginia in 1879, and there in 1882 he took the degree of Bachelor of Science. At first he had decided to be a chemist, but he later conceived the desire to study medicine, taking up his medical studies at the University of Maryland, which granted him a degree in 1887.

In 1888, immediately after his marriage to Miss Ellen Augusta O'Connor, of Charleston, he and his bride went to Europe, where he took up postgraduate studies in Vienna, Berlin and Paris and continued these on a second trip abroad, in 1895. While in Paris, he came under the influence of the great Charcot, whose personality and accomplishments were a great inspiration to him and led him to seek a career in neurology and psychiatry.

After focusing his interest in the field of neuropsychiatry, he worked as clinical assistant in neurology at the Vanderbilt Clinic, Medical Department of Columbia University (1890-1892), and later as assistant physician and pathologist at the New Jersey State Hospital, at Trenton (1899-1906). He was chief of the neurologic clinic, Los Angeles Medical Department, University of California (1908-1913). For many years he was associated with the psychopathic department of the Los Angeles County Hospital, holding the following positions: physician for nervous and mental diseases (1910-1941), physician in charge of the Los Angeles County Psychopathic Hospital (1914-1919) and member of the Insanity Commission (1909-1941).

From his father he inherited his love for teaching, and during all his long and varied life he lectured and taught in his chosen field. He was instructor in medicine at the New York Polyclinic Medical School and Hospital (1890-1892); clinical professor of neurology, Georgetown

University School of Medicine, Washington, D. C. (1897-1899), and assistant professor of neurology, Los Angeles Medical Department, University of California (1910-1913). From 1915 to 1941 he was clinical professor of neurology and psychiatry, College of Medical Evangelists, Los Angeles.

During World War I, since he was beyond the age for active military service, he enlisted as a contract physician and worked as psychiatrist in the mustering office at Camp Lewis, American Lake, Wash. After the armistice he served as neuropsychiatrist for the United States Veterans Bureau from 1919 until his retirement from practice.

He was author of a number of contributions in neurology and psychiatry. In addition, he wrote a number of articles on neurologic and psychiatric subjects in Albert H. Buck's "Reference Handbook of the Medical Sciences" (New York, W. Wood & Co., 1913-1923). He also translated from the German Bing's "Textbook of Nervous Diseases" (New York, Rebman Company, 1915).

For years he was an active member of the American Medical Association, the American Psychiatric Association and the Association for the Study of Internal Secretions, and he was founder of the Los Angeles Society of Neurology and Psychiatry. For a number of years he belonged to a local group known as the Psychopathic Association, the object of which was to improve conditions in the care and general treatment of the insane, particularly by means of improved laws in the State of California. His name for many years has been on the editorial staff of the *Journal of Nervous and Mental Disease*.

In his long and active career, Dr. Allen exemplified the real spirit of the profession of medicine by his kind consideration for his patients, his active interest in medical progress and his high standards of ethical practice. He will be missed by those who came to know him.

DR. C. U. ARIENS KAPPERS

1877-1946

On Sunday afternoon, July 28, 1946, C. U. Ariëns Kappers was found dead in the lovely garden of his home in Amsterdam. He was the director of the Central Institute for Brain Research and had been professor of comparative anatomy at the University of Amsterdam since 1928. His death marks the passing of a great Netherland scientist.

In his youth he worked in the laboratory of Edinger, in Frankfort on the Main, where he studied the relationship of the nuclei of the central nervous system. It was there that he conceived the idea that led him to the famous theory of neurobiotaxis. It appeared to him that there were differences in the location of nuclei in the various species of animals. He explained this movement of the nuclei by a process of "tropism," or "taxis," which was caused by stimuli flowing toward the nuclei. As the stimuli increase in number and strength, the nerve cells move in the direction of the stimuli, just as, for example, many organisms are drawn toward light. When he began his work in the Central Institute for Brain Research in 1909, he had the opportunity to elaborate on the theory of neurobiotaxis, and, with the help of several associates, he established his theory so well that by now it is generally accepted as one of the laws determining the construction of the central nervous system.

Ariëns Kappers gathered a quantity of material which was so well treated technically that his collection became a treasury from which many scientists could enrich their knowledge.

He gave great impetus to comparative neurology, trying always to find the connection between form and function, bringing light in many fields which were dark before and opening vistas no one had known existed. The results of his work were published in many papers and collected in two great textbooks: "Die vergleichende Anatomie des Nervensystems der Wirbeltiere und des Menschen" (Haarlem, de Erven F. Bohn, 1920 and 1921) and "The Comparative Anatomy of the Nervous System of Vertebrates, Including Man" (together with G. C. Huber and Elizabeth C. Crosby) (New York, The Macmillan Company, 1936).

Ariëns Kappers' work was not limited to anatomy. He also contributed to anthropology, in which he became interested because of his experiences in China and, especially, in Beirut, Syria, where he worked as a visiting professor.

He was offered a professorship at Yale University in 1928 but declined in favor of a similar position at the University of Amsterdam.

Ariëns Kappers had a universal mind, was interested in philosophic and religious problems and benefited many by publishing his ideas in these fields. Although many scientific honors were conferred on him, he remained the same: the quiet worker in his laboratory who, day after day, studied nature in its various aspects; who saw more than the plain objects, and who always remained susceptible to feelings of wonder, which is the first step toward discovery. From his rich mind he gave much to his friends, who will never forget him.

Translated from *Nederlandsch tijdschrift voor geneeskunde* (Aug. 10, 1946).

Abstracts from Current Literature

EDITED BY DR. BERNARD J. ALPERS

Anatomy and Embryology

BASILAR IMPRESSION: THE POSITION OF THE NORMAL ODONTOID. W. W. SAUNDERS, *Radiology* **41:589** (Dec.) 1943.

Saunders examined 100 "normal" lateral roentgenograms of the skull and attempted to correlate statistically the relation of the tip of the odontoid to the "Chamberlain line." The latter runs from the posterior margin of the hard palate to the dorsal margin of the foramen magnum. Normally, the odontoid tip is assumed to fall below this hypothetical line.

While in the 100 "normal" skulls the arithmetical mean position of the odontoid tip was 1 mm. below the line, in 35 skulls it was above the line. In 1 case it was 8 mm., and in another 7 mm., above this hypothetical line. Statistically, it was calculated that normally in 1 of 5 skulls the odontoid tip will lie more than 2 mm. above; in 1 of 19 skulls, more than 5 mm. above; in 1 of 64 skulls, more than 7 mm. above, and in 1 of 800 skulls, more than 10 mm. above.

TEFLICK, Philadelphia.

Physiology and Biochemistry

EXPERIMENTAL STUDY OF THE RELATION BETWEEN PRESSURE OF THE RETINAL ARTERIES AND INTRACRANIAL PRESSURE. S. OBRADOR ALCALDE and M. RIVAS CHERIF, *Bol. Lab. de estud. med. y biol.* **2:27** (Jan.-Feb.) 1943.

Eight dogs were used for the experiments. They were anesthetized with pentobarbital sodium. The lids were excised to facilitate observation. Retinal arterial pressure was measured by Baillart's retinal dynamometer. The diastolic pressure was determined at the point when retinal arterial pulsations appeared and the systolic pressure when they disappeared as the pressure continued to be increased. Intracranial pressure was increased by connecting the cisterna magna with a bottle containing isotonic solution of sodium chloride under pressure. The pressure was at first elevated to 20 to 30 cm. of water for five to ten minutes. Two or three readings of retinal pressure were then made. The pressure was then raised to higher levels, up to 80 cm. of water, with repetition of the retinal pressure readings. The systemic blood pressure was recorded at the same time in the femoral artery. In about half of the experiments, there was a progressive rise in retinal diastolic and systolic pressure as the intracranial pressure increased. In the other half, there was some increase in retinal pressure with little change in the systolic as compared with the diastolic retinal pressure. In the second series of experiments, no increase in retinal pressure was noted, in spite of continued increase in intracranial pressure. No increase in systemic pressure was found even when the intracranial pressure reached 80 cm. of water. The retinal pressure is not constantly elevated in cases of intracranial hypertension accompanying brain tumor, for the rise is not so rapid as in experimental conditions, time being allowed for the operation of compensatory mechanisms.

SAVITSKY, New York.

EXPERIMENTAL INVESTIGATIONS ON CAUSES OF CENTROGENIC HYPERTENSION ASSOCIATED WITH INTRACRANIAL INCREASE IN PRESSURE. H. BIERHAUS, *Arch. f. klin. Chir.* **203:257** (June 15) 1942.

Bierhaus states that intracranial traumatic hemorrhage causes changes in peripheral parts of the organism in addition to the local irritation. Effects on the

respiration and the circulation are of the greatest importance. The author studied these changes in dogs, utilizing the sphygmographic method of Frank and Broemser. The effect of trepanation and of increased intracranial pressure was thus determined. The centrogenic hypertension which develops subsequent to intracranial pressure is mild at first but later becomes more pronounced. This hypertension is caused by a great increase in the elastic resistance at the termination of the arterial system, while at the same time there is a decrease in the beat and minute volumes and in the pulse frequency. Thus, there is not only hypertension due to peripheral resistance but hypertension due to elastic resistance. Not only the vagus nerve but also the vasomotor center is irritated. In a second experiment, the action of various increases in pressure in the cranium was ascertained. A noticeable failure of the circulation was evident at the beginning of a third experiment, but after intramuscular injection of synephrin tartrate there was an increase in blood pressure. In subsequent experiments the vagus nerve was cut on both sides; then the vagus nerve and the sympathetic fibers were cut, and, finally, all nervous influences were eliminated. Studies were also made on the action of vasopressin, acetylcholine and epinephrine. The author concludes that in the presence of an intracranial increase in pressure there results not only an irritation of the sympathetic centers but also a flooding out of vasopressin into the blood stream. A peripheral resistance hypertension and an elasticity hypertension are produced in this manner.

J. A. M. A.

Diseases of the Spinal Cord

GUNSHOT WOUNDS OF THE MAXILLOFACIAL REGION WITH SPINAL COMPLICATIONS.

G. D. ARONOVICH, *Am. Rev. Soviet Med.* 1:344 (April) 1944.

Aronovich observed 12 patients with combined wounds of the maxillofacial region and injuries of the spinal cord. The diagnosis of this combination of lesions requires a careful history and examination. At times these are difficult to obtain because the patient may be in shock or may have difficulties of speech, phonation or respiration.

In the author's experience, the involvement of the spinal cord associated with maxillofacial wounds is often unrecognized during the various stages of evacuation of the wounded. Concussion or contusion of the spinal cord is rather characteristic, as is fracture of a cervical vertebra. In this series of patients complete recovery from the symptoms referable to the spinal cord was the rule, but a few had mild residual neurologic sequelae. Therapy ranged from surgical intervention to conservative orthopedic management, physical therapy and medical gymnastics.

GUTTMAN, Philadelphia.

NEUROPSYCHIATRIC COMPLICATIONS FOLLOWING SPINAL ANESTHESIA. H. EDWARD YASKIN and BERNARD J. ALPERS, *Ann. Int. Med.* 23:184 (Aug.) 1945.

Yaskin and Alpers report 6 cases in which neurologic and emotional disturbances developed after spinal anesthesia. They also mention a case of metastatic neoplasm of the spinal cord which was discovered after spinal anesthesia. In this case the anesthetic agent was suspected at first to have been the cause of the myelitic syndrome. In 4 cases the complications occurred immediately after the use of the anesthetic agent. The syndromes were of a myelitic or myeloradicular nature. Clinically, in all these cases of neuropsychiatric complications following spinal anesthesia little or no recovery was apparent after periods ranging from one to four years. The spinal fluid showed no characteristic abnormality. There was no pleocytosis or increase in total protein except in 1 case. In 2 of the reported cases the disturbance was in the nature of a conversion hysteria "paralysis" of the lower extremities. The conversion mechanism was conditioned by the patient's subjective experience with spinal anesthesia. The case of metastatic neoplasm

of the spinal cord, which came to light immediately after spinal anesthesia, was presented to illustrate the importance of keeping in mind the possibility of pre-existing neurologic disease when evaluating the role of spinal anesthesia in the causation of postoperative neurologic sequelae.

The authors state that many neurologic complications, of great diversity, immediate or remote, mild or severe, temporary or permanent, may follow spinal anesthesia. Serious complications in normal persons are apparently relatively infrequent, and in properly selected cases spinal anesthesia holds an important, and almost indispensable, place in the surgeon's armamentarium.

GUTTMAN, Philadelphia.

ACUTE SPINAL EPIDURAL ABSCESS AS A COMPLICATION OF LUMBAR PUNCTURE.
LEO RANGELL and FRANK GLASSMAN, *J. Nerv. & Ment. Dis.* 102:8 (July) 1945.

Rangell and Glassman report the occurrence of an acute epidural abscess following a diagnostic lumbar puncture in a 28 year old Negro soldier. Two or three days after the procedure the patient began to complain of severe pain in the lower part of the back, which radiated down along the posterior aspects of both lower extremities. The pain became more severe; elevation of temperature appeared, and eleven days after the puncture complete flaccid paraplegia suddenly developed. Examination revealed decided tenderness, spasm and edema of the paravertebral muscles in the lumbar region on the left side. Laminectomy was performed, and an extensive epidural abscess was evacuated. After this the patient showed marked improvement, although motor function had returned only partially six weeks later.

Although the importance of epidural abscess has been recognized since Dandy's study, in 1929, this is the first case reported as a complication of spinal puncture. The clinical picture of the condition is characteristic, being marked by the occurrence of root pains, followed by a latent period and then by evidence of compression of the cord. Fever, tachycardia and leukocytosis are present, and the finding of localized tenderness of the spine and edema and redness of the paravertebral muscles clinches the diagnosis. A diagnostic lumbar tap is probably contraindicated, owing to the danger of introducing infection into the subarachnoid space, with subsequent meningitis. The most usual site of involvement is the interscapular area, while the region of the cauda equina is next. The organism responsible for epidural abscess is almost always the staphylococcus, which seems to have a special affinity for the loose areolar tissue which makes up the epidural space. A surprising fact is the nonoccurrence of epidural abscess following lumbar puncture in cases of purulent meningitis. Neuropathologic studies have shown that the symptoms of the condition are attributable not only to direct compression of the cord but also to the secondary effects of venous and lymphatic obstruction. Treatment consists of the prompt and adequate surgical evacuation of pus, with open drainage favored by most authors.

CHODOFF, Langley Field, Va.

CORD BLADDER; RESTORATION OF FUNCTION BY TRANSURETHRAL OPERATION.
G. J. THOMPSON, *U. S. Nav. M. Bull.* 45:207 (Aug.) 1945.

Thompson says that paralysis is so extensive in the vast majority of cases of injury to the cord that urination is impossible and remains so for many months. The distended bladder must be emptied. In the early phase of the paralysis the bladder of a few of these patients can be emptied by manual pressure applied in the suprapubic region. As time goes on these few usually find that the bladder cannot be completely emptied. The majority of paralyzed patients require drainage of the bladder through a catheter placed suprapubically through a stab wound, through a boutonniere incision in the perineal portion of the urethra or through the penis. No matter where placed, the catheter must be irrigated regularly and

changed at regular intervals. After a lapse of weeks or months, when the catheter is removed, there develops in some of these patients what is loosely called an automatic bladder. They void at irregular intervals but are usually incontinent to some degree; hence a urinal must be worn. If the indwelling catheter can be dispensed with, the patient's condition improves rapidly. Some patients will have spontaneous recovery of function. Patients who are unable to urinate after maximum nerve recovery has taken place can regain voluntary control of bladder function as the result of a properly performed transurethral resection of the vesical neck. It is important to remove a substantial amount of tissue. The resection of a few pieces from the posterior half of the vesical neck usually accomplishes nothing; tissue must be excised from the entire circumference of the outlet. Only in this way can the resistance of the retention mechanism be diminished sufficiently so that an increase of pressure within the abdomen, accomplished by straining, will squeeze the bladder dry. The most gratifying feature is that between urinations the patient has perfect control. Depending on fluid intake, four or more hours may elapse between urinations. If fluids are restricted in the evening, the patient can sleep all night. The author presents the histories of 5 patients. Voluntary bladder function was restored in all cases by transurethral resection of the hypertrophied internal sphincter. Prior to operation these patients had suffered from urinary retention and dribbling overflow incontinence. Since operation they have been able to void at will; they empty the bladder completely and have good control.

J. A. M. A.

Peripheral and Cranial Nerves

NEURINOMA OF THE FACIAL NERVE. ROBERT M. BOGDASARIAN, Arch. Otolaryng. 40:291 (Oct.) 1944.

Bogdasarian reports a case of facial neurinoma occurring in a white man. The patient presented a history of diminishing auditory acuity of ten years' duration; progressive paralysis of the right side of the face of over five months' duration, becoming complete three days prior to his admission to the hospital, and slight pain in the right ear. He did not complain of vertigo or tinnitus but had a feeling of fulness in the ear. Examination revealed the drum membrane to be pinkish gray and bulging slightly in the posterior inferior quadrant. Taste sensation for all qualities was absent on the anterior two thirds of the right side of the tongue. There was no nystagmus. Hearing was poor in the right ear, and in the Weber test the sound was lateralized to the right. The left ear was normal. The audiogram for the right ear showed losses of from 40 to 50 decibels in all frequencies for hearing by air conduction, with normal hearing by bone conduction. After myringotomy a reddish mass was observed protruding through the posterior inferior quadrant of the drum membrane. Since bleeding was slight, a diagnosis of neurinoma was made and was confirmed by biopsy. The usual postauricular approach to the mastoid process was made, and a neoplastic mass was seen to fill the middle ear. It had eroded the bone of the middle fossa, so that the dura was visible. The tumor involved the horizontal portion of the facial nerve, and the growth was removed as completely as possible. Postoperative convalescence was uneventful, but no change resulted in the facial paralysis.

RYAN, Philadelphia.

MÉNIÈRE'S DISEASE IN A DEAF-MUTE. WALTER E. DANDY, Arch. Surg. 50:74 (Feb.) 1945.

Dandy reports the case of a deaf-mute man aged 22 with typical Ménière's disease. When the right eighth nerve was sectioned, a congenital anomaly of the petrous portion of the temporal bone and the porus acusticus was noted, and the auditory nerve was observed to be abnormally small. There is no reason to believe that Ménière's disease is more common in deaf-mutes than in the general popula-

tion, and therefore the combination of the two conditions in this case must be considered incidental. Congenital deaf-mutism is usually due to a defective or malformed labyrinth, whereas the cause of Ménière's syndrome lies in a congenital or acquired lesion of the auditory nerve.

LIST, Ann Arbor, Mich.

PERONEAL PALSY AS A COMPLICATION OF PARTURITION. ELEANOR MILLS, J. Obst. & Gynaec. Brit. Emp. 52:278 (June) 1945.

Mills reviews 7 cases of peroneal palsy, 3 from personal observation and 4 from hospital records. These cases show that peroneal palsy follows difficult deliveries which entail extraction by forceps. The paralysis is unilateral. It occurs on the side opposite the one occupied by the greatest diameter of the fetal skull in the majority of cases. The cause in most cases must be instrumentation. In the minority direct pressure of the fetal head may be the cause, though in these, too, instrumentation cannot be excluded. Pain and paresthesia, though transient and not severe, precede the paralysis. The paralysis affects the dorsiflexors and evertors of the ankle. The paralysis will usually clear up, and in those cases in which permanent damage is done the final paralysis is considerably less than the initial loss of function.

J. A. M. A.

FACIAL PALSY IN CLOSED HEAD INJURIES: THE PROGNOSIS. J. W. TURNER, Lancet 1:756 (June 10) 1944.

Turner discusses two types of post-traumatic facial palsy: that occurring at the time of injury and that of delayed onset. The second type developed two to eight days after the injury in the author's series of cases. There were 34 cases of this type (bilateral in 1 case), in 11 of which the paralysis was complete. In 19 cases the paralysis had cleared completely in three weeks; in 5 cases it took seven weeks to clear; in 1 case, twelve weeks, and in 5 cases, four months, though whether in all the last cases recovery took fully that much time is not known. In 1 other case there was partial recovery in six to eight months, and in 1 case, in which acute otitis media was a complication and the palsy developed five days after injury, no improvement appeared in six months. In 1 case the course was not followed. In the case of bilateral complete palsy recovery occurred in eight weeks.

Of the 36 cases of immediate palsy, the paralysis was complete in 19. In 9 of the 36 cases the palsy cleared in about three weeks, and in 15 cases recovery took six to eight weeks. In 3 cases recovery took three months, but in 6 others the patient did not start to regain normal movements until after this time, and then slow, incomplete recovery began. In 3 cases no improvement occurred in eighteen months to two years after injury; in 2 of these concomitant otitis media developed. The most troublesome feature of incomplete recovery was the presence of associated movements.

Turner believes that it is impossible to tell in the early stages whether a complete palsy will clear rapidly or not; but after three weeks if the faradic response is still obtainable the outlook is good for complete recovery. Deafness on the same side is a common accompaniment of the palsy, but there is no relation between the degree of deafness and the time of recovery. Turner also thinks it is probable that the petrous part of the temporal bone is always fractured in cases of traumatic palsy whether or not a fracture appears in the roentgenogram. The exact cause of the palsy is uncertain, but Turner suggests laceration or intraneural vascular accident as a cause of immediate paralysis and pressure on the nerve by blood as the cause of delayed palsy.

The treatment recommended is a wire splint hooked around the mouth and behind the ear to support the muscle. Massage upward and backward can be done by the patient himself. Individual movements of facial muscles can be practiced in front of the mirror. "Regular treatment with the galvanic current

is probably worth while, though experimental evidence of its value is still meager." The author feels that this series of cases provides no brief for surgical intervention for at least six months after injury; then exploration of the canal may be advisable.

McCARTER, Boston.

POLYNEURITIS FOLLOWING SULFANILAMIDE THERAPY. R. MÜLLER, *Acta med. Scandinav.* **121**:95 (May 14) 1945.

Müller reports 7 cases of polyneuritis following chemotherapy in 2 women and 5 men. The patients, who were admitted to the neurologic clinic of the Serafim Hospital in Stockholm, were between the ages of 3 and 56 years. Two of them were treated with dimethyldisulfanilamide (uleron), 1 with sulfanilamide, 2 with sulfathiazole, 1 with sulfanilamide, sulfapyridine and sulfathiazole and 1 with sulfapyridine. In the cases of polyneuritis caused by sulfanilamide, sulfapyridine and sulfathiazole the symptoms were more extensive and more pronounced than in cases in which dimethyldisulfanilamide or sulfamethylthiazole was the causative factor. In addition there was less motor disturbance than in polyneuritis caused by the latter drugs. The incidence of polyneuritis is probably greater after treatment with dimethyldisulfanilamide or sulfamethylthiazole than with the administration of other nonmethylated sulfanilamide compounds. The possibility that in some cases polyneuritis may result from purely toxic damage to the nerve tissues cannot be excluded. In general, an allergic reaction seems to be responsible for its occurrence, as polyneuritis may result from serum administration. Previous damage to the nervous system, achylia and thiamine deficiency may be predisposing factors which render the patient susceptible to polyneuritis. Muscular exertion may cause a latent polyneuritis to become manifest. To prevent the occurrence of polyneuritis, chemotherapy should be practiced for as short a period as possible. Intermittent administration of the drug should be avoided. Methylated preparations should not be employed. Patients who on the occasion of previous treatment presented signs of hypersensitivity, such as drug fever or exanthems, should be desensitized before repeating chemotherapy. Polyneuritis due to administration of sulfonamide compounds suggests that further chemotherapy should not be employed.

J. A. M. A.

Vegetative and Endocrine Systems

DERMATOMYOSITIS. B. V. JAGER and L. A. GROSSMAN, *Arch. Int. Med.* **73**:271 (April) 1944.

Jager and Grossman report the clinical and laboratory findings, including biopsy observations on muscle, in 9 adult patients, 7 men and 2 women, with dermatomyositis. The ages ranged from 32 to 61 years. The duration of illness prior to establishment of the diagnosis varied from five weeks to eight years. Every patient complained of muscular stiffness, and 8 of the 9 patients had muscular weakness and tenderness. Edema, which was chiefly in the periorbital region, was present in every patient at some stage of the illness. Dermal lesions, of various types, were present in 7 of 9 patients. Seven patients had lost from 10 to 100 pounds (4.5 to 45 Kg.) in weight. Six patients had muscular atrophy, and a similar number complained of dyspnea; but emphysema and cardiac failure may have produced this symptom. Five patients had bouts of elevated temperature at some time during the course of their illness. A history of Raynaud's disease was elicited from 4 patients, and 2 of these had sclerodermatous changes in the hands. One patient had diffuse scleroderma without a history of Raynaud's disease. Other, less common, findings were hoarseness, in 4 patients; cough; paresthesias; hepatomegaly; arthritic pains, and muscular cramps and muscular twitching, each in 3 patients. Dysphagia, diaphragmatic impairment and cardiac arrhythmia occurred in 2 patients, while 1 patient experienced diplopia.

The patients were studied extensively, and the only consistent abnormality found was spontaneous creatinuria. The reactions to overcooling, as shown by

studies of the cutaneous temperature, gave results typical of Raynaud's syndrome in the 4 patients with a history of this disturbance and in another patient without such a history. Biopsy specimens of skeletal muscles failed to reveal any lesion specific for dermatomyositis, but microscopic study showed abnormalities in all specimens.

Several unsuccessful attempts at therapeutic measures were reported. One patient obtained symptomatic relief from the oral administration of salicylates. Frequent hot baths, however, gave temporary symptomatic relief. Five of the 9 patients received 40 mg. of alpha tocopherol orally each day for one to several months, without obvious benefit. Fever therapy with typhoid vaccine seemed to have benefited 1 of 3 patients.

The authors concluded that "the variability of the manifestations in this series of cases was sufficient to arouse doubt as to whether 'dermatomyositis' is a single clinical entity. A similar view is obtained from reading previous reports of cases of this disorder. In addition to clinical, laboratory pathologic data, it may be necessary to follow the course of the illness for a prolonged period before the diagnosis may be established with certainty."

GUTTMAN, Philadelphia.

Treatment, Neurosurgery

SUCCESSFUL TREATMENT OF EXPERIMENTAL WESTERN EQUINE ENCEPHALOMYELITIS WITH HYPERIMMUNE RABBIT SERUM. J. ZICHIS and H. J. SHAUGHNESSY, *Am. J. Pub. Health* 35:815 (Aug.) 1945.

Fifty-five guinea pigs were treated with specific hyperimmune rabbit serum having a titer of 500 to 1,000 units when they became sick following intralingual injection of western equine encephalomyelitis virus. Of this number 67.3 per cent recovered. Of the 41 guinea pigs used as controls, 1 recovered spontaneously and 40 died. Serum therapy was less effective in rhesus monkeys, giving a recovery rate of 45.5 per cent, as against no recoveries in the control group. These animals were treated with serum at the onset of fever following intracerebral injection of the virus. With this method of injection the virus produces a fulminating type of the disease which is more difficult to treat. A western equine encephalomyelitis antiserum has been prepared by hyperimmunization of rabbits which is effective in treating the experimental disease even after the animals show evidence of involvement of the central nervous system. It is believed that the successful treatment of the disease in these experiments can be attributed to the use of adequate quantities of antiserum of high potency administered by a route which made the serum antibodies readily available to the animal.

J. A. M. A.

PENICILLIN TREATMENT OF NEUROSYPHILIS: A PRELIMINARY REPORT OF SEVENTY CASES FOLLOWED FROM FOUR TO TWELVE MONTHS. AUGUSTUS S. ROSE, LAURENCE D. TREVETT, JOSEPH A. HINDLE, CURTIS PROUT and HARRY C. SOLOMON, *Am. J. Syph., Gonorr. & Ven. Dis.* 29:487 (Sept.) 1945.

The data for this study were compiled from observations on 72 patients who had syphilis of the central nervous system. All the patients were followed from four to twelve months after therapy. One hundred and six patients were treated, and of this group 7 died. The observations on 34 patients are not included because the period of follow-up study was not four months. Penicillin was administered intramuscularly, in doses of 50,000 Oxford units per injection, for a total of sixty injections (3,000,000 Oxford units) to all the patients. The great majority were also given either malaria or fever cabinet therapy in approximately one-half the amount generally accepted as sufficient.

Clinically, it is estimated that of these 70 patients, the condition of 28 was improved, that of 37 was unchanged and that of 5 was made worse. The

greatest percentage of improvement was to be found among the 49 patients with a condition diagnosed as dementia paralytica. The most striking result, however, was shown in the 6 patients with primary optic nerve atrophy, 5 of whom may have had arrest of visual loss.

Examinations of the spinal fluid revealed an immediate response, consisting in an increase of cells and total protein in most of the previously untreated patients, followed by a general gradual reduction in the cell count and total protein content and, later, by a decrease in the Wassermann titer. Comparison of the clinical and the serologic results showed no definite correlation at this stage of observation.

From the data presented, it is believed that penicillin is an active and effective therapeutic agent for late neurosyphilis, but comparison with the serologic results in 30 patients treated by older methods indicates that there is no striking difference at this period of observation. Caution is advised in the interpretation of these results, and the authors state, "We believe that the time has not arrived for the distribution of penicillin for general use in the treatment of neurosyphilis."

GUTTMAN, Philadelphia.

THE PUBLIC HEALTH ASPECT OF MALARIA THERAPY OF NEUROSYPHILIS. WALTER L. BRUETSCH, *Am. J. Syph., Gonorr. & Ven. Dis.* **29**:494 (Sept.) 1945.

Bruetsch reviews the literature on the public health aspect of malarial therapy. From his survey he comes to the conclusion that the danger of disseminating malaria to the community is negligible. After a review of the cases of malaria which have been reported as having their origin through transmission from therapeutic malaria, he is left with the impression that definite proof of this assertion is lacking in almost all instances. The theory that maintenance of malaria in the human host for prolonged periods by direct blood inoculation leads to "asexualization of the plasmodium" is not shared by most malariologists. Unfavorable ecologic requirements explain why accidental transmission through therapeutic malaria practically never occurs.

GUTTMAN, Philadelphia.

HIGH FREQUENCY ELECTRIC CURRENT IN THE TREATMENT OF ALCOHOLIC HALLUCINOSIS. K. Y. GRUENBERG, *Am. Rev. Soviet Med.* **1**:544 (Aug.) 1944.

Gruenberg reports the histories of 3 patients with "alcoholic hallucinosis" who were successfully treated with high frequency electric current. He believes that so-called alcoholic hallucinosis occurs in the hang-over period, chiefly because of vasoconstriction of the cerebral blood vessels. "High frequency electric current . . . produces a selective vasoparalytic effect, i. e., it counteracts the pathogenic mechanism which forms the basis of the hallucinosis. It is suggested, however, that this is not the only therapeutic mechanism of action of high frequency current in alcoholic hallucinosis just as ischemia is not the only pathogenic factor. It is wholly possible that the positive therapeutic effect obtained by use of high frequency current depends on a number of other factors which contribute to the specific effect on the central nervous system.

GUTTMAN, Philadelphia.

ELECTROCONVULSIVE SHOCK THERAPY AND CARDIOVASCULAR DISEASE. VERNON L. EVANS, *Ann. Int. Med.* **22**:692 (May) 1945.

Evans reports his observations on a series of 750 patients given electroshock therapy. Among this number were 38 patients with known cardiovascular disease, of whom 19 had presumptive to positive evidence of disease of the coronary arteries. Five of the patients had definite histories of previous occlusions of the coronary arteries. Five patients who had auricular fibrillation were treated during the presence of this abnormality. Nine patients with hypertension were also included in this group. They all had a systolic blood pressure over 200 mm. of mercury.

In one of the patients who had auricular fibrillation and was given electroshock therapy a fever and thoracic rales suddenly developed two days after the last treat-

ment. She then felt pain in the chest, and seven days after the last treatment the patient suddenly became dyspneic and cyanotic, went into shock and died in an hour. A pulmonary embolus was suspected but not proved. Necropsy was not done. This is the only mortality among the patients with known cardiovascular disease.

Evans concludes that electroshock therapy can be given with remarkably little danger in cases of serious organic disease of the cardiovascular system. In this series of 750 patients receiving electroshock therapy, 38 had positive evidence of previous damage to the cardiovascular system. With 1 exception, all the patients survived the electroshock treatment, with remarkably few ill effects and complications. Nearly all the patients treated were suffering from severe mental illnesses, which might well have terminated fatally from undernutrition or suicide if shock treatment had not been used.

GUTTMAN, Philadelphia.

PICROTOXIN IN BARBITURATE POISONING. D. L. BURDICK and E. A. ROVENSTINE, *Ann. Int. Med.* 22:819 (June) 1945.

Burdick and Rovenstine report observations on 4 patients who suffered from the effects of barbiturate intoxication. The cases are presented to illustrate the effects of neglected, inadequate, delayed and more immediate treatment. The suggested therapeutic regimen outlined is as follows: an adequate airway, artificial respiration, adequate administration of oxygen, gastric lavage, intravenous fluid therapy, chemotherapy when there is evidence of infection, maintenance of diuresis, good nursing care and, of course, analeptic therapy.

Analeptic therapy should be conservative if the reflexes are active and motor activity is present. Vigorous treatment is for the deeply depressed patient. To such patients picrotoxin may be given in 0.001 to 0.003 Gm. doses intravenously or in 0.003 to 0.006 Gm. doses intramuscularly every fifteen minutes until the desired response is attained. This fractional method is not so effective as the continuous intravenous procedure, which is equally safe if employed with proper caution. The drug is administered at the rate of 0.001 to 0.002 Gm. per minute until the corneal, swallowing or other reflexes appear or until slight twitchings of the facial muscles occur. If the drug is given beyond this point, convulsions may result. These are usually mild and gradually subside as the stimulant is destroyed. Should they be severe, or should milder ones persist, intravenous injection of a barbiturate, such as sodium pentothal, is given slowly to the point of control. Once signs of reflex and motor activity return, picrotoxin is continued intramuscularly in maintenance doses of 0.003 to 0.006 Gm. every fifteen to thirty minutes as indicated. Should regression develop, the same dose is given intravenously until the desired plane of activity is reestablished. In each case treatment must be individual and the drug continued until active reflexes and involuntary movements are maintained.

Since the action of picrotoxin may be delayed as much as ten minutes, caution is to be exercised in its administration. Furthermore, the impression has been gained that the initial response to picrotoxin following depression from the longer-acting barbiturates is slower than is the case with the shorter-acting ones; hence, the analeptic should be given in smaller amounts if its accumulation, with a resultant sudden and severe stimulation, is to be avoided. Convulsions, if they occur, usually are followed by a degree of depression deeper than that existing before their onset.

The amount of picrotoxin necessary to establish the desired plane of activity is unpredictable. The wide variation in dosage seemingly bears little relation to the quantity of barbiturate taken. Although 0.02 Gm. of picrotoxin is dangerously toxic to a normal adult, doses ranging from 1.079 to 2.296 Gm. have been employed for patients poisoned by barbituric acid derivatives.

Burdick and Rovenstine state that early and adequate analeptic therapy with microtoxin may prevent death, obviate a prolonged illness and result in a complete, or more nearly complete, recovery. Each case must be judged by the condition of the patient when admitted to the hospital and managed according to the response shown toward undelayed treatment. If this is prompt, the more expensive and time-consuming measures should not be necessary. GUTTMAN, Philadelphia.

MENINGOCOCCIC MENINGITIS TREATED WITH SULFADIAZINE AND SULFAMERAZINE: A THREE YEAR STUDY. LEWIS K. SWEET, EDITH DUMOFF-STANLEY and HARRY F. DOWLING, *Ann. Int. Med.* **23**:338 (Sept.) 1945.

Data are presented in an attempt to evaluate the results of treatment in 207 patients with meningococcic meningitis.

The patients were treated either with sulfadiazine or sulfamerazine as the principal therapeutic agent. The gross mortality was 10.1 per cent. There was no significant difference in the fatality rate in patients treated with the two drugs. Fewer patients were seen in 1944 than in 1943, and the illness was less severe. The etiologic diagnosis was established immediately from direct examination of the cerebrospinal fluid in 188 (90.8 per cent) of the group of 207 patients.

The factors of the greatest prognostic significance at the time of the patient's admission were the presence or absence of the coma-delirium state and the age of the patient. For patients who were delirious or in coma, the presence of numerous micro-organisms in, or the virtual absence of dextrose from, the initial specimen of cerebrospinal fluid added to the gravity of the prognosis.

There was no relationship between the concentration of the sulfonamide compound in the blood and the outcome of the meningitis. Massive doses of the sulfonamide drugs are not necessary for most patients with meningococcic meningitis. Those patients who are obviously more ill require more vigorous treatment.

GUTTMAN, Philadelphia.

BLOCKING OF THE MIDDLE CERVICAL AND STELLATE GANGLIONS WITH DESCENDING INFILTRATION ANESTHESIA: TECHNIC, ACCIDENTS AND THERAPEUTIC INDICATIONS. A. DE SOUSA PEREIRA, *Arch. Surg.* **50**:152 (March) 1945.

Numerous methods have been devised to block the stellate ganglion with local anesthesia, but most of them possess no accurate bony points of reference for the insertion of the needle and they frequently lead to disagreeable, or even dangerous, accidents by injury to the pleura, lung, subclavian or vertebral artery or brachial plexus.

On the basis of anatomic studies, the author has worked out a safe and satisfactory technic for anesthetization of both the middle cervical and the stellate ganglions. The middle cervical ganglion is situated in front of the transverse process of the sixth cervical vertebra; the intermediate ganglion (superoexternal portion of the stellate ganglion) lies in front of the transverse process of the seventh cervical vertebra. Complete sympathetic block is usually obtained with anterolateral injection against the transverse process of the sixth cervical vertebra. With the patient in the upright position, the anesthetic diffuses downward in the prevertebral tissue and thus produces a block of the stellate ganglion. If the stellate ganglion is not sufficiently anesthetized, a second injection is made at the transverse process of the seventh cervical vertebra. No serious complications or accidents have been observed with this method.

The author has successfully employed his technic in the following conditions: angina pectoris, cerebral vasospasm, organic vascular disease of the upper extremity, Raynaud's disease, causalgia and painful edema of the arm following radical mastectomy.

LIST, Ann Arbor, Mich.

TREATMENT OF EPILEPTIC PATIENTS WITH A COMBINATION OF 3-METHYL 5, 5 PHENYLETHYL-HYDANTOIN AND PHENOBARBITAL. ANTHONY E. LOSCALZO, *J. Nerv. & Ment. Dis.* **101:537** (June) 1945.

Loscalzo reports the use of a new hydantoin derivative, 3-methyl-5, 5-phenylethyl-hydantoin, in combination with phenobarbital in 17 cases of epilepsy of unknown origin. Each tablet contained 0.02 Gm. of phenobarbital and 0.1 Gm. of the hydantoin derivative. Of the 17 cases, 15 were of the so-called idiopathic type, while the remaining 2 were probably on an organic basis. One to 6 tablets were taken by each patient daily, the average dose being 3 tablets daily. In 12 cases a notable reduction occurred in frequency of attacks, and the total number of attacks was reduced by approximately 60 per cent. An improved mental and emotional status was noted consistently. The incidence of side effects as compared with that for sodium diphenylhydantoin was strikingly low, there being only 2 instances of gum hyperplasia and no ataxia, vomiting, dizziness or diplopia.

CHODOFF, Langley Field, Va.

ELECTROSHOCK THERAPY. SAMUEL RAMIREZ MORENO, *Rev. mex. de psiquiat.* **10:3** (Jan. 1) 1944.

The author reports experiences with electroshock therapy of 87 patients, 48 men and 39 women. The course of treatment was completed for 81 patients. The maximum age was 60 and the minimum 8, with an average of 30.9 years, 28 for the men and 34.5 for the women. A total of 1,191 treatments were given, in 701 of which grand mal seizures and in 490 petit mal seizures, were induced. Petit mal seizures were much more frequent in men than in women. The maximum number of treatments given to a patient was 31. The largest number of grand mal seizures in any patient was 27. The male patients were given an average of 12.9 treatments and the female patients 14.3 treatments. There were 40 complete remissions among 81 patients, 22 in men and 18 in women. There were 30 partial remissions, 15 in men and 15 in women. There was no improvement at all in 11 patients. Three patients had a recurrence after completion of treatment. Many of the patients could not be followed. Sixteen patients (9 men and 7 women) were treated inadequately, for various reasons. The only accidents during treatment were 3 cases of prolonged apnea and 1 case of dislocation of the mandible; in a few instances there were mild injuries to the lips. Among 54 schizophrenic patients there were 24 complete remissions (44 per cent), 41 partial remissions (30 per cent) and 9 failures (17 per cent). Among 14 patients with stupor syndromes (*síndromes confusionales*) 11 had complete remissions and 3 incomplete remissions. Of 6 patients with manic-depressive psychosis, 3 had complete remissions and 3 partial remissions. In 23 patients with an illness of less than six months' duration, there were 15 complete and 8 partial remissions; in 9 patients with an illness of six to twelve months' duration, there were 7 complete remissions, 1 partial remission and 1 failure. In 20 patients with a history of one to three years' illness, there were 7 complete remissions, 9 partial remissions and 4 failures. In 23 patients with an illness of more than three years' duration, there were only 7 complete remissions, 10 partial remissions and 6 failures. For 6 in the series of 81 patients the duration of illness was unknown. In 65 patients of this series insulin hypoglycemia was induced in addition to the electroshock therapy. This unquestionably contributed to the favorable results. Metrazol was also given to 4 and malarial therapy to 3. Curare was used for only 6 patients.

SAVITSKY, New York.

ELECTROSHOCK THERAPY: TECHNIC AND INDICATIONS. ARTURO VIVADO and CARLOS NUNEZ SAAVEDRA, *Rev. de psiquiat. y disc. conexas* **9:7**, 1944.

The authors report on 1,116 treatments given to 75 patients in a hospital in Chile. The first patient was treated in June 1943. The average current was

120 volts, given for 0.1 second, the voltage varying from 60 to 150 and the time from 0.1 to 4 seconds. Two patients with cardiac lesions withstood the therapy well. The seizures were considered to be more severe than those induced with metrazol. There were no fractures. Pain in the region of the right shoulder was reported a few times; there were readily reducible dislocations of the jaw in 2 instances. Of the patients with acute schizophrenia 76 per cent recovered, and of those with the chronic form 22 per cent. All 6 patients with simple schizophrenia failed to respond. Four of 5 patients with acute catatonia recovered; 3 with hebephrenia who were ill less than seven months recovered completely, but only 2 of the patients with chronic hebephrenia responded. Only 2 of 15 patients with chronic paranoid schizophrenia showed improvement, and the condition of 3 of 6 patients with the acute form cleared up. Of the patients with manic-depressive psychoses 87 per cent improved. The best results were obtained with the involuntional psychoses (100 per cent recovery). More treatments were necessary for schizophrenia than for manic-depressive psychosis.

SAVITSKY, New York.

Muscular System

DYSTROPHIA MYOTONICA (STEINERT'S DISEASE): IMPORTANCE OF CATARACT AND DISTURBANCES OF METABOLISM; THERAPEUTIC EFFECT OF VITAMIN E.
A. FRANCESCHETTI and R. S. MACH, *Helvet. med. acta* **11:887**, 1944.

Franceschetti and Mach describe 3 personally observed cases of dystrophia myotonica and stress the importance of cataract in the differential diagnosis. In the atypical forms of Steinert's disease only the presence of a cataract permits a definite diagnosis. The biomicroscopic examination of the crystalline lens is indispensable for the differentiation of myotonic dystrophy from other myopathies, particularly from congenital myotonia. The appearance of creatinuria after an aminoacetic acid tolerance test is of great diagnostic value in that in cases of progressive muscular atrophy, congenital myotonia, myasthenia gravis and the muscular atrophies of the Charcot-Marie type creatinuria nearly always appears after the test but neither spontaneous nor induced creatinuria is necessarily present in myotonic dystrophy. The authors observed the favorable effect of vitamin E in a case of myotonic dystrophy, as well as in a case of idiopathic muscular dystrophy (Erb's disease). The therapeutic effect of vitamin E on the muscular function is accompanied by improvement in the creatine metabolism. Myotonic dystrophy has a special place in that some of its symptoms indicate a lesion of endocrine glands, while others indicate a nervous origin. It is possible that both these factors are involved.

J. A. M. A.

Society Transactions

NEW YORK NEUROLOGICAL SOCIETY AND NEW YORK ACADEMY OF MEDICINE, SECTION OF NEUROLOGY AND PSYCHIATRY AND SECTION OF PEDIATRICS

Lawrence S. Kubie, M.D., *Chairman, Section of Neurology and Psychiatry,
Presiding*

Joint Meeting, Jan. 8, 1946

Relation Between Maturation and Acculturation. DR. ARNOLD GESELL, New Haven, Conn. (by invitation).

The individual comes into his racial inheritance through processes of maturation. He comes into his social inheritance through processes of acculturation. These two sets of processes operate and interact in such conjunction that it is impossible to separate the two components. Racial man is extremely ancient. Cultural man is extremely recent. The processes of maturation in the individual perpetuate the evolutionary past and mediate the evolving future. Maturation is the net sum of the gene effects, operating in a self-limited life cycle.

The embryology of behavior can be envisaged in terms of posture and postural sets. All vertebrates strike attitudes. The morphogenesis of the tonic neck reflex in man illustrates the mechanism of maturation. At an early fetal age (11½ weeks) the characteristic habitus of the fetus is symmetric. The fetus manifests a bilaterally balanced attitude, in which the hands may simultaneously approximate toward the midline. This is called the symmetrotic reflex, which in time gives way to an asymmetric habitus. I have identified and photographed a well defined tonic neck reflex in a prematurely born infant at the fetal age of 28 weeks. This reflex holds strong sway during the first eight weeks after normal, full term birth; at the age of 12 weeks it is less conspicuous; at 16 weeks it is in transition, and at 20 weeks it is in eclipse, for the head is then held predominantly in the midposition. In another two months the symmetric bilaterality, in turn, gives way to new unilateral patterns: one-handed reaching; one-handed manipulation and hand to hand transfer, and, ultimately, to well defined dextrality or sinistrality. Here is a clear example of almost periodic, interweaving maturation, now of symmetric and then of asymmetric behavior forms, with corresponding shifts in sensorimotor attitudes—a reciprocal, spiral-like interweaving, which prevails at all levels of the growth cycle and which may well have implications for the comparative study of varying cultures.

The tonic neck reflex and related postural sets have left their impress on many of the tools of man and on the manner in which he wields them. Note how unidexterity and asymmetric stances figure in the use of spear, harpoon, shovel, rifle, fencing foil, violin and golf stick.

It is interesting to learn that *Sinanthropus pekinensis*, as early as the second glacial age, a few hundred thousand years ago, was mastering the vertical and the horizontal movements of his even then archaic motor system. He flaked boulders into heavy chopping tools and into finer scrapers; and the manner of his flaking suggests that he was right handed and perhaps, by the same token, vocally articulate.

Monozygotic twins also exemplify mechanisms of maturation. Using the method of co-twin control, we have investigated the growth careers of twins T and C over a period of seventeen years, from early infancy to adolescence. Twin T was subjected to hundreds of hours of specialized training designed to improve her motor coordinations in stair climbing, her prehension and manipulation, her constructiveness in cube play, her vocabulary and other associated behavior attain-

ments. There is no evidence that these specialized experiences have added either a cubit to her mental stature or a basic component to her individuality. To this day, the twins remain remarkably, almost indistinguishably, alike. Training cannot readily transcend maturation. The growth careers of the twins have been strikingly parallel.

Certain disparities, however, in the behavior traits of twins T and C have great significance, because we were unable to trace these disparities to any cultural or psychogenic factors or to the influences of differential training.

Subtle, but deep-seated, differences in sensorimotor attitudes finally express themselves in attentional characteristics. The following double column sums up basic differences in the behavior equipment of twins T and C, adapted from Gesell and Thompson (Twins T and C from Infancy to Adolescence: A Biogenetic Study of Individual Differences by the Method of Co-Twin Control, *Gen. Psychol. Monogr.* 24:3-121, 1941).

Attentional Characteristics of Twins T and C

	Twin T	Twin C
Initial pick-up	Prompt	Deliberate
Fixation	Intense	Relaxed
Focalization	Sharp	Diffuse
	Decisive	Roving
	Discrete	Confluent
	Delimited	Sensitive to context
Other characteristics.....	Selective for details	Comprehensive
	Specifically alert	Generally alert
	Adaptive exploitation	Personal-social elaboration
	Less social initiative	More social initiative

We do not wish to imply that the culture does not imprint its stamp through its molding apparatus. But, once more, the primary role of maturation must be noted. When human behavior is organized in a cultural milieu, there is almost an infinitude of available environments; the organism selects from this infinitude in much the same way that a living cell may or may not select potassium from a fluid medium. The structure of the organism, whether conceived in terms of bioelectric potentials or particles of stereochemistry, is attuned to what it selects and averse to what it rejects. This accounts for the primary molding power of innate sensorimotor attitudes and of the psychomotor attitudes which they induce.

Cultural Patterning of Maturation in Selected Primitive Societies. DR. MARGARET MEAD (by invitation).

Moving pictures of the Balinese and of the Iatmul tribe in New Guinea were shown contrasting the methods of handling, bathing, feeding and carrying of very young children. Material from other primitive cultures supports the hypothesis that handling the child as a limp part of the mother's body, so that it learns to move as she moves and when she moves, is congruent with a passive type of behavior, while handling the child as if it had a separate will of its own, and giving it an opportunity to assume states of tension separate from and contrasting with those of the maternal body, is associated with more assertive types of behavior. In later life the Balinese tend to use only such parts of their bodies as are relevant, fitting plastically into an action context, while the Iatmul, especially the males, tend to mobilize their whole bodies, even for small acts. The partial bodily involvement of the Balinese is accompanied by a lack of "attention" to the task in hand, while the Iatmul must mobilize his full interest if he is to do any piece of work. While it is improbable that any single item of child rearing can be credited with causality, the whole array of items can be seen as a means of communication between parent and child, within which the child establishes—through deuterolearning—an expectation about the nature of the world and a habit of responding to it. Analysis of the details in two contrasting systems such as these should provide a framework for the identification of significant cultural *units* of behavior, supplementing Dr. Gesell's analysis of maturation patterns.

Environment Vs. Race—Environment as an Etiologic Factor in Psychiatric Disturbances in Infancy. DR. RENÉ A. SPITZ (by invitation) and DR. KATHE M. WOLF (by invitation).

An experimental approach to the question whether racial differences exert an influence on development—mental, social and otherwise—was attempted. With the purpose of excluding variables usually encountered in such investigations, the sample was limited to a nursery in which Negro and white babies were reared together under identical conditions. Eighty-seven Negro and 178 white babies were observed from birth to the end of the first year. The developmental quotients of these infants were established at monthly intervals, as well as the quotients for six different sectors of the personality, namely, perception, body mastery, social behavior, learning, handling of material and intelligence. A comparison of the averages of the developmental quotients for the white children with those for the Negro children in the single months resulted in curves with insignificant differences except for the eleventh and twelfth months, in which the Negro children showed a relative retardation of about 10 per cent as compared with the white children.

A comparison of the average quotients of the white and the Negro children in the six different sectors of personality at monthly levels showed that the variations observed in the Negro children (better than average body mastery, slightly poorer than average development in the other sectors) simply exaggerated the same findings for the white children in this nursery. A scrutiny of the environmental factors disclosed a negative selection operating to the detriment of the Negro children admitted. These variations, therefore, could be attributed to the influence of environmental factors. This makes it probable that, if not the whole, at least a large part of the difference between the developmental quotients of white and Negro children encountered in this sample was attributable to environmental influences.

In a second experiment, this group of children belonging to mixed races was compared with a group of 61 children also belonging to mixed races. In the case of the latter, however, a completely different environment was selected. The first group was reared by their mothers in a nursery; the new group was also reared in a nursery, but without mothers, in conditions of emotional starvation. Although the developmental quotients for the two groups were approximately equal during the first three months, the difference in the average developmental quotients between the first and the second group at the end of the first year was startling, amounting to nearly 30 per cent, placing the children of the second group at the level of high grade morons. By the end of eighteen months this difference had increased to over 50 per cent, placing the children of the second environment in the category of imbeciles.

Conclusion: The consequences of racial difference on development, both of a physical and of a mental nature, appear to be insignificant in the course of the first year of life. The consequences of environmental differences in the same period, when they are of an emotional nature, are extremely far reaching.

DISCUSSION ON PAPERS BY DRs. GESELL, MEAD AND SPITZ AND WOLF

DR. GREGORY BATESON (by invitation): From all these papers there is an important lesson for anthropology. I shall state this as it appears to me as an anthropologist and then consider what its bearing will be in the fields of psychiatry and pediatrics. For the last fifteen years we anthropologists have been trying to demonstrate and analyze the uniformities and homogeneities of the cultural matrix in which the child grows up and in which the adult lives, and we are now able to demonstrate this factor fairly well in the simpler, nonoccidental cultures. We hesitate on the word "homogeneity" when faced with such heterogeneity as exists in New York city, but in part we get out of the difficulty by saying that the fact of heterogeneity is an element which affects every person in his environment. Every baby in New York is born of parents who know

that other parents down the street are bringing up their babies in a way very different from theirs.

For a long time we were inclined to suggest that the individual is in some sense standardized by the cultural matrix in which he lives. I think the next step is to discard the notion of the standardization of the individual in terms of his culture and ask what types of persons will be differentiated and made more deviant by any particular cultural matrix.

With respect to Dr. Gesell's suggestion: If a culture insists on teaching a given item or habit at a given stage, that culture will sort out and push into deviant character formation any child whose growth deviates from the local norm in its sequence or duration. The deviant child will be compelled to learn things at a difficult period while a majority of children are learning them at an easy period, or vice versa. Similarly, with the twins T and C: Scientists are familiar with the sorting of optical isomers by bringing them against other optically active substances. The two optical isomers can be separated by setting up a chemical reaction in which the mixed isomers react with another optically active material. Something of the same sort has probably happened to the twins, one evidently left handed and the other right handed. They were probably handled by predominantly right handed people, and this experience must necessarily have had a different and special quality for the left handed twin. The difference between these twins was essentially a matter of certainty and precision and care in movement and locomotion, such as might well be caused by differential muscular experience.

An entirely new facet on the cultural matrixes will be available when a given culture can be described in terms of the deviants which that culture creates in a genetically mixed population.

DR. MARIANNE KRIS: I speak as a clinician, and thus as one who relies on impressions gained outside the experimental situation. I am greatly impressed by the exactitude and by the stimulating nature of the data presented in all three papers. Two of these papers refer to a context familiar in a way: The reports of Dr. Mead and Dr. Spitz deal with the unit with which we clinicians are concerned in our daily work: that of child and mother.

During the last few years we have come to appreciate ever more the closeness of this relation. I should like to remind you of Dr. Ribble's and Dr. Fries's recent contributions. My own material consists of persons of lower and upper middle class homes, who turn to the analytically trained psychiatrist, directly or through the social agencies, for prophylactic guidance in child rearing or for advice when disturbances have set in. From this material it is evident that the closeness of mother and child outlasts the early phases of development discussed in these papers. It is not limited to the first and second years of life but lasts, with normal and abnormal children, sometimes well into the period of latency. This closeness becomes more apparent with the appearance of disturbances or in critical phases of the child's life. Let it not be forgotten that no child in present day civilization grows up "smoothly"; normalcy is not a linear development but is full of tempestuous ups and downs. For instance, a child of 7 still reflects the mother's starvation fantasy in its refusal to eat; the child will eat when away from the mother, even just for mealtime. A child of 5 cannot tolerate the separation from the mother and apparently does not want any contact with other children, in order to stay with her. In reality, it is the mother who keeps the child for herself; and while she urges the child consciously, verbally, to play with others, the child in clinging to the mother, reacts in tune with the mother's separation anxiety; this could be observed in the consultation room and was evidenced by the fact that when the child went out to the park with the maid he could readily associate with playmates. A little girl in her second year of life is well adjusted, active and independent and behaves appropriately to her age when she is with her mother. But the nurse, who since the child's birth has taken her over for several hours daily, loves babies only. Whenever the child is

with the nurse, she acts more passively, more dependently, like a baby. These superficial examples illustrate that child behavior can be directly patterned by the personalities of mother and mother substitute. What in these cases appears as a transient influence on behavior, bound up with the presence of the mother or nurse soon gains permanent influence in these and other areas of child rearing. Through lasting identification with the primary objects the process of acculturation takes place.

In clinical observation the pink and the blue are constantly mixed. Nature and culture ordinarily appear as one.

The exactitude and the wealth of Dr. Gesell's data have always been impressive to me so far as the development of bodily functions is concerned. But in regard to social and emotional development one is faced with a greater complexity. Where processes of growth affect interpersonal relationships, of whatever kind, social learning plays its part. Those of Yerkes' chimpanzees who never lived in a group and never saw a cub being trained were inapt as mothers; those who had lived with the group and had seen cubs being reared knew their duties as mothers well.

Dr. Mead's material throws ample light on these points. The few examples she showed are fascinating even to those who have no complete picture of Balinese or Iatmul culture. May I point to a detail of the material (in order to elicit a reaction from Dr. Mead in the discussion)? Dr. Mead reports that the Balinese eat snacks freely and drink freely but are embarrassed and hide their faces from each other when eating solid food. "They are embarrassed," said Dr. Mead once, "as when they defecate." In the admirable moving picture, we saw that pre-chewed solid food is forced on them in infancy. Such gestures as the mother makes may well be experienced by the child as coercion of some kind. It may be remembered that coercion also usually plays a part in toilet training. Might it not be that the Balinese child reacts to the coercive handling? Coercion might indicate a forbidding attitude of the parents, and thus in the Balinese the act of eating solid food may have become associated with something forbidden, embarrassing; of course, this need not be the only, nor even the main, source of the embarrassment.

My question to Dr. Spitz is linked with a similar problem. In his conclusive presentation he stated that the Negro babies were more advanced in body control than the white ones. He traced this to the difference in the behavior of the Negro and the white mothers in the institution. In the nursery which I once had the privilege of visiting with Dr. Spitz, all the babies seemed to be restricted to their cots. No crawling, creeping or walking was permitted, except within the cot itself. Might not this restriction be more severe when it affects babies more advanced in motor development? Might it not influence, in turn, their social development in the second half of their first year and thus partly account for its relative retardation?

May I conclude with a suggestion? One has much to learn from the methods of systematic observation, of which such impressive examples have been presented here. Anthropologic field work in occidental culture, integrating the approaches which are seen to be at work, might in the future permit the formulation of hypotheses on more exact data than those on which they have usually been derived.

DR. HEINZ HARTMANN, Canajoharie, N. Y.: If a psychoanalyst is asked to take part in a discussion on maturation and acculturation, or development, I suppose he should state specifically what the analytic approach can contribute to a solution of the problems involved. This I cannot possibly do here, but I shall try to say something in the time allotted me.

There is, to begin with, the attempt to determine the phases and situations that can be considered crucial in human development. Take, for example, Dr. Spitz's significant comparative study of white and Negro infants. Dr. Spitz avoided a probably wrong conclusion (predominance of racial characters) and found a probably right one by introducing a hypothesis derived from clinical

analytic experience, and based on a genetic point of view: the hypothesis that a great variety of developmental characters in the child (such as body mastery and handling of materials) can in part be traced to his emotional relationship with his mother or her substitute. The same hypothesis is applicable to Dr. Mead's interesting work on the handling of children in various primitive cultures. One may say that the developmental importance of many childhood situations, typical and atypical, has been ascertained by the retrospective method of analysis, even in cases in which it could not be traced by the direct observation of the child, for reasons I shall not discuss here. Think, for example, of the vicissitudes of the child's oral needs, of the role of frustrations in the period of toilet training, of growth and development at the phallic level and of aggression.

Another characteristic of the analytic approach is the pursuit, to as great extent as is possible, of continuous developmental trends under specific and controlled conditions. A great number of childhood situations of incisive significance for the formation of the adult personality have—if I may borrow a term from genetics—a low "probability of manifestation." A girl at the age of 3 may have wished that her pregnant mother would die in giving birth to the sibling. At the age of 25, being pregnant, the woman may develop fears of dying during childbirth or feeding disturbance. The early childhood wish or situation will have been repressed. No nonanalytic method will be able to unearth it or to disclose its vicissitudes in the period between. The retrospective method of analysis, however, enables one to gain an understanding of the continuity of the development. In order to define correctly the respective significances of maturation and environment, the inclusion of such latent factors is necessary—at least in certain sectors of human development.

Another approach has been presented by Dr. Gesell with great lucidity. His co-twin control method is perhaps the most exact one available in this field, though its applicability is unfortunately limited. The same also holds true to a certain extent for the comparative study of monozygotic twins in general. If an analyst could get hold of analogous material in an analogous setup, his selection of variables would probably be different. Briefly to characterize the differences in approach, both being necessary, of course, I should say that in Dr. Gesell's research one has the study per se of what are called ego mechanisms; in the other approach, analysis, the investigations center around the child's needs. Rather than subject one of the twins to special training in prehension or manipulation, for example, the analyst would (without going so far as Patagonia) change the emotional environment, or the duration of the nursing period, or the attitude toward sexual play, or aggression, of one twin; he would expect—rightly or wrongly, a matter to be tested—differences in the later behavior of the twins to be noticeable.

What Dr. Gesell has said about gradients of growth partly conforms in a rather striking way to analytic findings. I am thinking of his comments on shame, on the ambivalent attitudes toward commands, on obedience to rules, on doubt, in what is called the latency period. In some instances the analyst could probably explain typical sequences or trace individual deviations from the gradients (such as those in the myth of Santa Claus). He might also be able, in certain cases, to evaluate the prospective importance of these deviations and eventually to check his prognosis, as Dr. Spitz did in a paper which he recently published, though he would not expect a simple correlation between any one such factor and the later behavior of the subject. (Dr. Mead is quite right in what she has said against any single causative factor.) He has become used to the fact that in most cases a rather complicated analysis of a great variety of factors is necessary.

The gradients of growth indicate not only average maturation but also average environment. So do the typical phases of growth which psychoanalysis describes. It is true that Freud discovered a category of environmental factors the influence of which on development had not been previously understood. The concept of the libidinal phase, for instance, is defined not only by these factors but by the process of maturation. An experience which may be meaningless for a child

of 2 may be traumatic for the same child at the age of 3. There is a specific vulnerability to specific experience at each level of development. Crucial situations which have influence on the child's development may be chiefly related to maturation or to environment; as a matter of fact, in the typical phases of conflict, as they are called, maturational changes and typical, decisive environmental influences largely coincide.

Though maturation is based on constitutional factors, its actual course is not necessarily rigidly defined in this way. As in the case with other factors in the anlage, a certain plasticity in its manifestation has to be accounted for. The investigation of the factors that may hasten or retard it is, in analysis, of special interest. Of equal interest are the steps by which the potentialities of the anlage become actualized.

Except by the twin methods, one cannot study maturation as an isolated factor and environment as an isolated factor and then put the two together. Also, as a rule, cultural patterns have to be broken down into specific and psychologically significant elements before they can be correlated with the problems of growth, as Dr. Mead of course knows better than I. On the other hand, the developmental implications of the growth patterns have to be clarified before their possible cultural importance can be evaluated. If, however, one makes a comparative study of childhood histories, based on the analysis of hundreds of concrete situations and over long periods of time, and if these data are elaborated with respect to both maturation and cultural patterns, one should gradually acquire relatively clear insight into a variety of actual relations between these factors. It is then evident that, as Dr. Gesell said, a selection of cultural environments can often be traced to factors of maturation, but a selection takes place also in the other direction; that is, individual tendencies are strengthened, repressed and displaced in accordance with cultural patterns.

I have tried to indicate some points at which analysis could contribute, or actually has contributed, to solving the problems discussed by these three stimulating papers. Today there is a considerable sphere of agreement as to some main features of human development. As to other features, there is an interesting correlation between the emphasis on various factors and the different methods of study. In the study of a particular phase of growth, for method, one method will make facts apparent or give them importance, while the other leaves them in the dark or lets them seem unimportant, and vice versa. This merely emphasizes in other words what Dr. Gesell said in the beginning: that at the present stage of factual and methodologic insight, given the incompleteness of any single approach to the problem, the conjunctive contributions of all of them, and their mutual checking, are necessary.

DR. ARNOLD GEsELL, New Haven, Conn.: I wish to express my appreciation of the comments made and of the illumination that has come from these related fields of study. In this work one is dealing with facts and with panels; there is no one method of investigation, but there is the integrity of the individual. Perhaps the various investigators can meet on common ground in some integrating psychosomatic concept which recognizes that morphology is the fundamental problem of behavior.

DR. RENÉ A. SPITZ: I wish to thank the discussers for their illuminating and stimulating comments. In connection with Dr. Bateson's problem of the types of persons who will be made more deviant by a given condition, he will have to take into consideration, on the one hand, a concept introduced by Dr. Gesell, that of maturation, and its relationship, on the other hand, to that of certain environmental factors becoming effective. To give him the simplest description of this relationship, and the most brutal one: Separation from the mother, about which I have said little here, and which I intend to present in more detail, can be completely and irreversibly destructive if it happens during the first year; it can be reversible if it happens during the second year. This is a problem of maturation, though I should call it maturation not of the bodily

type but of the "ego maturation" type. In this connection, I want to answer Dr. Kris's question also. The baby's restriction to the cot is a problem which I had intended to discuss, but the shortness of the time did not permit. It is true that these children are restricted to the crib during the first year; the curious fact is that their bodily development is not hampered by this restriction; if anything, it is better than average because they climb in a manner in which children in the first year cannot climb. The restriction seems actually to present a stimulus. However, it probably has a certain influence in the sphere of intellectual development; whether it is an influence in social development is a question which certain investigations which I am now conducting will clarify.

PHILADELPHIA PSYCHIATRIC SOCIETY

Samuel B. Hadden, M.D., *President, in the Chair*

Regular Meeting, March 8, 1946

Psychiatric Characteristics of Patients with Venereal Disease. DR. MORRIS W. BRODY.

While in the military service, I was afforded an opportunity to make a psychiatric study among men who had contracted venereal disease. Part 1 of this paper concerned a questionnaire submitted to these men. As a basis for comparison, a similar study was conducted on men in the medical and surgical wards of a general hospital and on a third group of men hospitalized because of psychoneurosis.

The man with venereal disease has certain characteristics which distinguish him from members of the other groups. He is more often colored; he is of average intelligence; he is younger, and he is more often single. He is more unrestrained, is readier to take chances and is more easily influenced. He drinks a little more as a civilian and has been arrested more frequently. He does not adjust so well to Army life, receiving more courts-martial and company punishments. He is chiefly distinguished by being more lascivious than the average person. He begins his sexual life earlier as a civilian, indulges more frequently in illicit sexual relations and more often visits professional prostitutes. As a soldier overseas, he resumed his heterosexual experiences sooner and indulged more frequently. Sexual intercourse is a more important factor in his life, and he shows less choice regarding the women with whom he cohabits. He less often selects the women, but, because of his libidinous ways, he is readily solicited by them. After he has contracted venereal disease he is not deterred from exposure to fresh infection. The psychoneurotic patient, on the other hand, is most inhibited in his behavior. There is a more striking difference in behavior between the colored control group and the colored venereal group than is shown between the corresponding white groups.

Part 2 of the paper dealt with the reasons that men expose themselves to the risk of contracting venereal disease. In part 3, the relation of mental sickness and the patient with venereal disease was discussed. Part 4 dealt with (1) the teaching program in the Army regarding the control of venereal disease, and (2) suggestions regarding the control of venereal disease.

DISCUSSION

DR. CALVIN DRAYER: I was present at the previous presentation of Dr. Brody's paper, in Naples. It is quite true that some of the points he discussed brought forth considerable protest. Nevertheless, the investigation has been carefully conducted and throws light on a delicate subject, which is by no means a problem in the Army only. It has been brought into prominence by the military authorities, as Dr. Brody has described. Briefly, the important point which Dr. Brody made

is that one is concerned not so much with abnormal persons as with abnormal situations. In that respect, of course, the problem of venereal disease is somewhat similar to the more widely discussed problem of combat reactions, in which a highly abnormal situation is involved. In both these problems one is faced with what to do about it. Dr. Brody, unfortunately, did not discuss some of his recommendations in reading the paper. I say unfortunately, for they are, I think, sound, and I should like to discuss some of the basic elements in them. They may be classified as positive and negative measures. The recommendation he made not only includes the elements of patriotism but appeals to men's loyalty to the home situation. The negative, or restrictive, measures include the clean-up campaigns. As psychiatrists, we tried to maintain our loyalty to psychiatric concepts, but I think we were all enlightened by finding that many of the restrictions worked which we would have regarded theoretically as too severe. Unless some real obstacles are set up, the positive effort is not going to work very well. An illustration of this was the experience in the early part of the Italian campaign. General Clark, who was much concerned about the problem, issued a number of severe directives. We all wondered what the result would be, since there were serious threats to morale at that stage of the campaign. A little later we captured a directive from Kesselring to the German troops, which was practically a duplicate of General Clark's. There was no question that the Germans had reasonably good morale at the time. In other words, a positive appeal certainly had its place, but setting up of restrictions could not be avoided. One cannot overcome completely a person's needs and normal drives by superimposing ideologies even as strong as those of the Nazis, and effective restrictions ultimately paid dividends in the form of lowered rates of venereal disease.

The situation in which the patients whom Dr. Brody studied became infected was unusual in many ways. Venery has a long, and one might almost say an honorable, tradition in the area about Naples. Hannibal wintered his troops there, and the Romans sent women down who succeeded very well in their mission of demoralization. Syphilis was first recognized there in the fifteenth century. I have heard it said that the gonococci there were fully 50 per cent larger than in any other part of the world! We had the opportunity to observe very normal men exposed to very abnormal pressures.

To come back to the original point, we soon found that until restrictions could be established the rates of venereal disease were not reduced. It was a temporary situation, and resort to restrictive measures was certainly the way to handle it in Naples.

DR. LEONARD H. TABOROFF, New York: I was interested in the paper because of my experience as temporary venereal disease control officer with an American Infantry Division. My tenure was short and immediately followed the invasion of Cebu, P. I., in April 1945. My colleagues and I thought our rate was very high when it reached 55 per 1,000 per annum. The rate on Guadalcanal and Bougainville had been zero for two and one-half years. The base and the headquarters troops had a much higher rate than the combat infantry. I could not make a statistical study at the time, but in talking with the men I obtained an impression quite similar to Dr. Brody's statistical findings.

DR. O. S. ENGLISH: A paper like this makes one wonder how more can be done to prevent the high incidence of venereal disease. I was interested in Dr. Brody's opinion that the best campaign is to try to inculcate into the men an attitude of total restraint. It seems like a great undertaking and one wonders whether such a plan could be carried out successfully. It could, of course, be done more successfully if every one were behind it; but people are divided on their opinion as to the need for sexual expression. Those expressing themselves against sexual indulgence are secretly for it, and those speaking of liberality are really not ignoring the value of restraint. The solution would have to be one of more intensive work on the two extremes. Either more campaigning should be done for abstinence, or the need for sexual outlet should be accepted and some means for

control of venereal disease set up. The hardest thing for people to think about is the need for sexual outlet. The figures show that even in peacetime the figures for extramarital and premarital intercourse increase with each decade. If this is true in peacetime, it is certain that the rate will be much higher in war, as the man then feels more justified in indulging himself in sexual gratification. I wonder whether it is possible to get to the point where the spread of venereal disease can be controlled; I wonder, also, whether it is possible to help the venereal program by a program of abstinence.

DR. JOSEPH M. FOLEY, Boston: Another method of control to keep down the rate of venereal disease was tried. A circle of military police would be drawn around an area that was involved in the industry, so that anybody coming out of that area was required to submit to prophylactic treatment. This caused great difficulty, since innocent parties were frequently apprehended. While serving with the Army, I was in close proximity to a group of 500 Navy men for one and one-half years. During this time only 4 cases of venereal disease developed in this group, even though lectures on venereal disease were never given. A disturbing thing about the venereal disease lectures in the Army is that the same points are constantly repeated and the lectures all follow the same pattern.

DR. SAMUEL B. HADDEN: Has Dr. Brody noticed any correlation in the rise and decline of the incidence of venereal disease with the visits of the U. S. O. shows?

DR. MORRIS W. BRODY: That is an interesting question. I do not know the effects of variety shows on the rate of venereal disease. However, the venereal disease control officer in Naples had the idea of getting together a group of beautiful Italian prostitutes, dressing them in lovely clothes and presenting them in a short variety show to groups of soldiers. After the show the soldiers were told not to be fooled by appearances, since all these beautiful women had venereal disease. The soldiers, however, were not impressed and sought dates with these infected women. The soldiers, furthermore, showed real hostility toward the venereal disease control officer, who they thought was fooling them and treating the girls in an ungentlemanly manner. The soldiers, on the other hand, were impressed and easily fooled when a man blinded by cataracts and badly crippled with rheumatism was presented to them to illustrate the last stages of syphilis.

Physiologic Pathology of Schizophrenia and Manic-Depressive Psychosis.

DR. SEYMOUR DEWITT LUDLUM.

Various psychologic modalities were plotted as physiologic gradients in a number of cases of schizophrenia. The graph taken during the illness was contrasted with the graph on recovery, thus emphasizing the physiologic change which accompanies the return of normal mental functions. Evidence was presented to the effect that the physiologic gradient of the recovered schizophrenic patient is almost identical with that of the normal type of the "immature" personality, frequently referred to as the constitutional psychopathic inferior personality.

Subsequently, the physiologic findings for the manic-depressive psychosis were presented by the same method of analysis. The physiologic symptoms are those of regression, a falling back into the physiologic gradient of the "immature," or the "constitutional inferior," personality, in which there is a lowered physiologic state which cannot produce orderly psychomotor responses.

As proof of the reversibility of physiologic symptoms, the graphs for recovered patients following insulin and electroshock treatment were presented.

It does not matter what etiologic emphasis is held—whether psychic or somatic—the mechanism remains the same and operates in the same manner. Compensation in relation to cardiac function is a term that means balancing of the forces—equilibrium. The functioning of the brain lends itself to similar concepts.

DISCUSSION

DR. SAMUEL B. HADDEN: Dr. Ludlum's exhaustive studies over many years have made a valuable contribution to psychiatry. All are familiar with efforts in the past to classify patients with mental illness according to their physical build and other physical characteristics. Dr. Ludlum points out a disturbance in physical chemistry associated with mental illness, and this observation may well be an initial step in the eventual alteration of body chemistry, with final restoration of normal mental function. Already, this type of study of the blood has been of practical value to manufacturers of biologic products. Through studies of the blood, such as Dr. Ludlum presents here, the ability of a horse to form antitoxic substances may be determined. I feel that eventually Dr. Ludlum's observations and studies will be integrated into a more complete understanding and treatment of the mentally ill.

DR. O. S. ENGLISH: I have always been interested in Dr. Ludlum's work. It seems to me that there is something here that should be checked psychologically in much the same way as Dr. S. J. Beck has done in a series of Rorschach tests on patients before they are given prolonged psychiatric treatment and repeated after-treatments. Also, his findings deserve correlative psychologic study, in the manner of Benedek and Rubinstein, who studied psychologic, emotional curves of patients independently of those investigators who are doing physiologic work on activity of the ovarian hormone. I feel that if these patients were studied over a long period the physiologic changes would show a sensitivity which could be correlated with the emotional state.

Some people assume that the manic-depressive temperament cannot be changed; others say that it can. The same is true of schizophrenia. I believe changes can be brought about through intensive psychotherapy which may prevent future attacks. These changes would probably bring about alterations in the chemistry and physiology of the body.

Dr. Ludlum has assured me that he would be interested in cooperating with any one who would care to carry out such a study with him. I wish I could arrange to do it myself, as correlations between psychologic and physiologic activity in mental disease are much to be desired.

DR. SEYMOUR D. LUDLUM: There are laboratories in which regular studies are carried out on the ability of horses to form antibodies. Some are nonreactors and cannot make diphtheria antibodies; others make too many. I want to make it quite clear that I do not think that these physiologic abnormalities are the cause of insanity. They are the soil in which curious mental reactions grow. Stress and strain can produce those changes just as well as infection.

 PHILADELPHIA NEUROLOGICAL SOCIETY

Robert A. Groff, M.D., *Presiding*

Regular Meeting, March 22, 1946

The Meningeal Reaction Associated with Abscess of the Brain.

DR. BERNARD J. ALPERS and DR. FRANCIS M. FORSTER.

This article will be published in full in a future issue of the ARCHIVES.

A Case for Diagnosis. DR. HELENA RIGGS and DR. CHARLES RUPP JR.

A white boy aged 11 years complained of backache and stiff neck, of three months' duration. Two weeks before admission to another hospital he fainted and complained of loss of feeling in his right arm. Within two days there developed weakness of all extremities and difficulty in talking and swallowing. The general

physical examination showed no significant abnormalities. Neurologic examination revealed a diminished corneal reflex on the right side; horizontal nystagmus; weakness of the palate, tongue and trapezius muscle on the right side, and nasal speech. The right arm was paralyzed, and the left shoulder was weak. The abdominal reflexes were absent; the knee and ankle jerks were diminished, and the plantar responses were normal. There was nuchal rigidity, and position sense was lost in the right leg. The spinal fluid showed 1 cell per cubic millimeter and a total protein of 2,040 mg. per hundred cubic centimeters. The rest of the examination of the spinal fluid revealed nothing abnormal. After eleven days he was transferred to the Philadelphia General Hospital, where the previous neurologic findings were confirmed. In addition, there were found papilledema of 1 D. in both eyes, weakness of all extremities and a bilateral Babinski sign. A roentgenogram of the skull showed no abnormalities, and three examinations of the spinal fluid revealed grossly bloody fluid. The course was afebrile but was characterized by several attacks of weakness, lethargy and cyanosis. The papilledema increased to 4 D.; difficulty in urination developed, and respirations suddenly ceased as preparations for a craniotomy were being made.

DISCUSSION

DR. SHERMAN F. GILPIN JR.: I may have seen this patient unofficially. Certainly, the case presented a diffuse picture in that there were evidences of choked disk, weakness in all four extremities and absence of tendon reflexes in the lower extremities. He had some sensory changes. There was a great increase of protein in the spinal fluid. The Guillain-Barre syndrome covers the picture as well as any other. Cases are described in which there is edema of the disk, and the condition is called Devic's disease, or neuroencephalomyelitis optica. I do not think of any better diagnosis than that. Many believe that this group of diseases is quite variable in the extent of the involvement. The condition is thought by many to be of virus origin. Perhaps confined to the roots at times, at other times it includes the peripheral nerves, and I feel quite certain it also involves the central nervous system in some cases.

DR. BERNARD J. ALPERS: I believe that the condition started with involvement of the cervical portion of the cord or of the medullary region, and I visualize a bilateral lesion in both the cervical and the medullary region. With a protein content of 2,040 mg. per hundred cubic centimeters, I should make a diagnosis of tumor of the posterior fossa which was projecting through the foramen magnum; or, if the blood in the spinal fluid means what it is supposed to, the patient might even have an aneurysm in that region.

DR. JAMES J. RYAN: I should like to take a chance on the diagnosis of a multiple vascular neoplastic process. I believe that the early picture might well point to a lesion in the high cervical region of the cord or the lower part of the medulla, and there is reason to believe that the vestibular apparatus was later involved, as well as the cortex of the brain. The picture then shows unmistakable evidence of gradually increasing intracranial pressure. I wonder whether the early evidence of a high protein content of the spinal fluid and the later grossly bloody fluid are not indicative of a vascular neoplasm in the first place, with the possibility of leakage later. I should be in favor of the diagnosis of multiple hemangioma or multiple hemangioblastoma.

DR. MATTHEW T. MOORE: Dr. Ryan has indicated several of the considerations which have come to mind. In 2 other cases the history was somewhat similar. One was that of a woman aged 28, married, who presented the symptoms of choked disk and headache and then signs of bulbar involvement. There was xanthochromic spinal fluid, with an extremely high protein content. She subsequently had an acute episode with bloody spinal fluid, and operation revealed a hemangioblastoma of the cerebellum.

The other case was that of a youngster aged 8 who presented bulbar symptoms over a period of almost a month and suddenly had vomiting, stupor and choked disk. The intracranial pressure was increased. The spinal fluid was xanthochromic

and then frankly bloody. Autopsy revealed an angiomatous lesion involving the ventral surface of the medulla. I should venture the diagnosis of one of the following lesions: (1) cerebellar hemangioblastoma, (2) tumor apoplexy or (3) rhexis of a hemangioma at the ventral surface of the medulla.

DR. FRANCIS M. FORSTER: So long as vascular lesions are under discussion, arteriovenous aneurysm should be considered. In a recent review, Worster-Drought described lesions extending along the brain stem from the posterior into the anterior fossa. Recently, my associates and I saw a hemangioma which lay outside the brain stem proper and extended from the middle into the posterior fossa. These lesions should be included in the consideration of vascular neoplasms for the sake of completeness, but they are so rare as to be curiosities.

DR. FRANCIS C. GRANT: I believe that the patient had a mass lesion in the posterior fossa, either an aneurysm or a tumor.

DR. HELENA RIGGS: Autopsy revealed that the entire medulla and the upper cervical portion of the cord were replaced by tumor tissue. There were both old and recent hemorrhages into the tumor. Histologically, the tumor appeared to be composed of immature cells resembling polar spongioblasts, with astrocytes predominating in some areas. There were deposits of calcium within the tumor, and the intrinsic vessels showed endothelial hyperplasia to the point of obliteration of the lumen.

In an earlier similar case autopsy had been performed. A white boy aged 11 complained of headache and projectile vomiting of one year's duration. On admission to the Philadelphia General Hospital, he showed slight choking of both disks, lateral nystagmus, pronounced dysarthria, atrophy of the right side of the tongue and inconstant weakness of the external rectus muscle bilaterally. He could barely stand and tended to fall to the left. His gait was ataxic. The tendon reflexes were diminished, but no pathologic reflexes were obtained. No sensory loss could be demonstrated. Examination of the spinal fluid revealed a pressure of 400 mm. of water. The child died three weeks after admission, during a sub-occipital craniotomy.

Autopsy revealed gross lesions similar to those in the present case. Histologic examination showed that the tumor was composed of large fiber-forming astrocytes with voluminous cell bodies. Deposition of calcium and proliferation of vascular endothelial cells were also present.

Recent Advances in Treatment of Epilepsy, with Particular Emphasis on Use of Tridione. DR. H. HOUSTON MERRITT, New York (by invitation).

Research in epilepsy in the first two and one-half decades of this century was mainly directed toward the discovery of the cause of the disease. All means available to medical science were used to study patients afflicted with seizures, with the hope of finding some deviation from normal which would explain the seizures. These studies contributed greatly to knowledge of the disease but, with few exceptions, gave no new approach to therapy. In 1936 Dr. Tracy J. Putnam and I began a different approach to the problem. Using a new method of inducing convulsive seizures in animals, we made a systematic search for new anticonvulsant agents. This search had two aims: to discover a more efficient chemical for the prevention of convulsive seizures in man and to determine whether there is any constant structural configuration in the more effective anticonvulsant compounds. From the latter, it might then be possible to draw indirect conclusions regarding the cause of seizures.

We have to date tested over five hundred chemical compounds, and approximately seventy-five of these are capable of raising the convulsive threshold in animals to electrical stimulation to a significant degree. While most of these compounds have some similarity in their structural formula, no constant arrangement

of molecules has as yet been discerned. The effective anticonvulsants include derivatives of such various compounds as the phenyl ketones, the phenyl sulfones and sulfoxides, the barbiturates, the hydantoins, the benzoxazoles and the oxazolidinediones. The study is still in progress, and it is hoped that the results will throw further light on the problem.

Some of the compounds which were found to raise the convulsive threshold in animals have been used in the treatment of epilepsy in human beings. The best results have been obtained with diphenylhydantoin sodium, which was first reported in 1938. The good results which were reported with this drug have been confirmed by numerous investigators and have stimulated the search for other, and more effective, drugs. One of the compounds which has been introduced in the past few months is Tridione (3,5,5-trimethyloxazolidine-2,4-dione). The anticonvulsant activity of this drug in animals was first reported by Everett and Richards (*J. Pharmacol. & Exper. Therap.* 81:402 [Aug.] 1944), and results of its use in human beings have been reported by Lennox, Thorne and De Jong. Experience with this drug has been limited, because its use has been restricted to several investigative clinics and only a few days ago was placed on the open market. The results reported to date indicate that its value is limited to the control of petit mal seizures. In our experience it has no value in the treatment of grand mal seizures, but our results in the limited trial that we have given it are in agreement with those of Lennox (*The Petit Mal Epilepsies, J. A. M. A.* 129:1069 [Dec. 15] 1945) and indicate that it is the most efficient means of controlling petit mal seizures that has been discovered to date. We have not been able to confirm the statement of De Jong that Tridione is effective in controlling psychic equivalent or psychomotor seizures. A word of caution is necessary in regard to the use of Tridione. Patients who have both grand and petit mal seizures and are under treatment with an anticonvulsant drug, such as phenobarbital or diphenylhydantoin sodium, should continue to take that drug if Tridione is to be given, in order to prevent the occurrence of status epilepticus.

Representative case histories are presented here to illustrate the effect of Tridione.

CASE 1.—M. A. G., an 8 year old girl, had been subject to petit mal seizures since the age of 8 months. For the past several years the attacks had occurred at the rate of about thirty per day. The patient was mentally and physically normal. The electroencephalogram showed frequent bursts of 3 per second spike and dome waves, characteristic of petit mal epilepsy, and an attack could be precipitated regularly by a brief period of overventilation. Treatment with phenobarbital, 0.1 Gm. daily, and diphenylhydantoin sodium, 0.25 Gm. daily, or with Mebaral (n-methylethylphenylbarbituric acid), 0.2 Gm. daily, and glutamic acid, 4 Gm. daily, had no effect on the frequency of the seizures. Treatment with Tridione in a dose of 0.6 Gm. per day was started on Sept. 6, 1945, and there was a slight decrease in the frequency of the attacks. The dose of Tridione was increased to 0.9 Gm. daily on September 18, and the attacks were reduced to about one-half their former frequency. The child had an attack of grip in December 1945, and the drug was not given during the few days of the illness. There was an immediate recurrence of the attacks to their former frequency of thirty a day. The frequency was reduced to three or four attacks daily by administration of 0.9 Gm. of Tridione, and on Feb. 1, 1946 the dose of the drug was increased to 1.2 Gm. a day. There was an immediate cessation of attack, which had not recurred at the date of the last report, March 20, 1946.

CASE 2.—I. S., a boy aged 10, had one grand mal attack at the age of 4 years and three similar seizures in the year preceding our examination. Petit mal attacks had started at the age of 8, and for the last year they had occurred at the rate of twenty-five to fifty a day. The patient was mentally and physically normal. The electroencephalogram showed bursts of typical dome and spike waves with a frequency of 3 per second. Treatment with phenobarbital and glutamic acid or with Mebaral did not influence the frequency of the petit mal seizures. Treatment

with Tridione, 0.6 Gm., and Mebaral, 0.2 Gm., was started on Nov. 2, 1945. With this treatment, the petit mal attacks decreased to four or five a day, and the patient had a grand mal seizure on December 27. The treatment was changed to phenobarbital, 0.1 Gm., and Tridione, 0.9 Gm. The petit mal attacks were decreased to one in several days. The daily dose of Tridione was further increased to 1.2 Gm. on Jan. 26, 1946. No petit mal attacks had been noted up to the time of the patient's last report, on March 20, 1946.

CASE 3.—S. M., a 3½ year old girl, began at the age of 18 months to have attacks of "staring," lasting a few seconds. Grand mal seizures started at the age of 2 years. An electroencephalogram taken at this time at another hospital was read as diagnostic of petit mal epilepsy. The patient had been treated with phenobarbital, in doses varying from 0.03 to 0.25 Gm. daily, and glutamic acid, 13 Gm. daily, without any decrease in the number of attacks. When first seen by me, in July 1945, the child was mentally retarded. She talked very little and responded poorly to questions. She did not play with toys and was difficult to manage. She was extremely overactive, continuously climbing over the furniture in the home. At this time the attacks were occurring at the rate of five or six a day and were of the minor grand mal type. Treatment with diphenylhydantoin sodium, 0.2 Gm. a day, and phenobarbital, 0.1 Gm. a day, resulted in immediate cessation of the grand mal attacks and remarkable improvement in the child's behavior, but the patient began to have one or two minor attacks daily. In these attacks she would stare blankly and make a few movements of the head and arms. The entire attack lasted only a few seconds. Tridione was added to the previous medication, and the dose was gradually increased to 1.2 Gm. per day. The minor attacks have continued to occur at the rate of about two a day.

DISCUSSION

DR. H. T. WYCIS: I should like to ask Dr. Merritt whether he has had any experience with Tridione in the control of status epilepticus and whether he has any explanation of why in some cases the petit mal seizures cease on discontinuing the drug.

DR. MILTON K. MEYERS: I should like to ask the speaker whether he distinguishes between petit mal attacks in children and pyknolepsy. In the first case there were no grand mal seizures; yet there were at least thirty, and perhaps fifty, attacks a day of what seemed to be petit mal, and the child did well in school. The child with pyknolepsy, on the other hand, frequently has gradual relief from his seizures without any medication at all. I should like to know whether there is any difference in the electroencephalogram of pyknolepsy and that of petit mal and whether the first case which Dr. Merritt reported might not have been one of pyknolepsy.

DR. CHARLES RUPP JR.: If a patient is already receiving phenobarbital and is then given Tridione, should the phenobarbital be discontinued altogether, or should it continue to be given in conjunction with Tridione?

DR. H. HOUSTON MERRITT: In answer to Dr. Meyer's question, Mebaral is the 3-methyl derivative of phenobarbital. It is reputed to be less sedative than phenobarbital, but in our experience the results with the use of Mebaral have not differed from those with administration of phenobarbital.

Dr. Wycis asks about the use of Tridione for status epilepticus. Unfortunately, we have no information on this subject since we have not had the chance to use it with any patient in this state. Dr. Richards, who synthesized the compound, tells me it has been effective in several cases of status epilepticus.

Our experience would indicate that Tridione, when it is effective, only prevents the petit mal attacks and does not cure the underlying physiologic disturbance. The attacks have always returned in our patients when the medication was withdrawn.

In reply to Dr. Rupp's question regarding the use of other anticonvulsant medications with Tridione: If the patient has only petit mal seizures, it is safe

to discontinue previous forms of medication and use Tridione alone; but if the patient has grand mal as well as petit mal attacks, he should continue to receive whatever anticonvulsant medicine he has been given, in addition to the Tridione.

DR. FRANCIS M. FORSTER: I should like to ask Dr. Merritt whether he did not mean the status epilepticus of petit mal when he said that Tridione had been used successfully.

DR. H. HOUSTON MERRITT: No. Dr. Richards says that Tridione has been used to control status epilepticus of the grand mal type.

News and Comment

POSTGRADUATE COURSES OFFERED AT UNIVERSITY OF CALIFORNIA MEDICAL CENTER

The University of California Medical School, with the cooperative administration of University Extension, University of California, will shortly announce a program of postgraduate instruction to be offered at the Medical Center, San Francisco. A variety of courses will be given which will encompass the fields of internal medicine, general surgery, obstetrics and gynecology, otorhinolaryngology, ophthalmology, psychiatry and the basic sciences, as well as a course specially designed to meet the needs of general practitioners.

Fees for all these courses will be covered by the provisions of the G. I. Bill of Rights.

For further information with regard to these various programs of postgraduate instruction, kindly communicate with Stacy R. Mettier, M.D., Head of Postgraduate Instruction, Medical Extension, University of California Medical Center, San Francisco 22.

COURSE IN NEUROLOGY AND PSYCHIATRY, ILLINOIS NEUROPSYCHIATRIC INSTITUTE

The Illinois Neuropsychiatric Institute announces that its second three months' course in neurology and psychiatry will start on Monday, Feb. 24, 1947. This course is part of the regular basic training program for residents and fellows in the departments of psychiatry and neurology and neurologic surgery of the University of Illinois College of Medicine, and a limited number of qualified outside students will be accepted. The subjects included are: neuroanatomy; neuropathology and neuroroentgenology; electroencephalography; psychobiology, psychopathology and history of psychiatry, and psychoanalysis.

For information write to: Dr. Ben W. Lichtenstein, Illinois Neuropsychiatric Institute, 912 South Wood Street, Chicago 12.

Book Reviews

Psychoanalytic Therapy: Principles and Application. By Franz Alexander, M.D., and Thomas M. French, M.D., and associates. Price, \$5. Pp. 353. New York: The Ronald Press Co., 1946.

For the past few years, members of the Institute for Psychoanalysis, Chicago, have individually reported material dealing with modifications of psychoanalytic therapy. In this book, Dr. Alexander and Dr. French, in collaboration with various members of the institute, present their findings. The material is discussed under two main headings. Part 1 deals with principles of psychoanalytic therapy and part 2 with the application of these principles. In the second part, case material is presented to illustrate the postulates of the authors. A greater flexibility in psychoanalytic therapy is the principal thesis of this book. The authors feel that many variations in technic not only may but should be adopted in certain situations. For instance, frequency of visits, which has usually been accepted as four to six times a week, may, according to these authors, at times be cut down as a therapeutic maneuver. The authors feel that frequency of interviews is in no way the determining factor of the depth of treatment. Cases are presented in which depth therapy is illustrated in patients who have been seen for relatively short periods.

The authors postulate that the transference relationship, as the dynamic aspect in the curative process, should be actively utilized by the analyst. This should be done not only through interpretation of the transference relationship but through actual intervention or playing down by the analyst. This can provide the patient with situations in which he will undergo new emotional experiences—"re-experiencing the old, unsettled conflict, but with a new ending, is the secret of every penetrating therapeutic result."

Ever since psychoanalysis has been established as a definite therapeutic procedure, attempts have been made to achieve the same results through short cuts. Some of these attempts have been rather disastrous and have done nothing more than dilute psychoanalysis. Other attempts have resulted in valuable contributions, which have been included in general psychotherapeutic and special psychoanalytic procedure.

In their contribution, the authors have widened their concept of psychoanalytic treatment. "Every therapy which increases the integrative functions of the ego (through re-exposing the patient under more favorable conditions to those conflicts which have before been met with neurotic defense mechanisms) should be called psychoanalytic, no matter whether its duration is for one or two interviews, for several weeks or months or for several years." Many analysts, of course, will take issue with this definition and feel that the authors in the main are applying psychoanalytic principles to psychotherapy and calling it psychoanalysis. Others, depending on their orientation, will agree with the authors.

One has the feeling that the authors set out with the objective of helping the patient, the means being secondary. Psychotherapeutic reports are most difficult to evaluate. So many variabilities enter into play, and the difficulties of adequate control make this field of psychiatry a most difficult one to evaluate scientifically. It will probably require many, many more years of work and study and more research than has been presented in this book to prove the authors' point one way or the other. Until then, depending on the psychotherapist's orientation, this book may be considered a start in the right direction or another of the experimental psychoanalytic deviations which have marked the tempestuous course of the development of psychoanalysis. The book is recommended.

Psychodrama. By J. L. Moreno, M.D. Volume 1. Price, \$6. Pp. 424. New York: Beacon House, Inc., 1946.

This is volume 1 of a series of three volumes on psychodrama written by the creator of the art, Dr. J. L. Moreno. The other two volumes are in the process of publication. It is the first organized compilation of facts, figures, diagrams and theories explaining the basis for this form of therapeutics. Those who have seen Dr. Moreno in action wonder how he was capable of boiling down his explanation of psychodrama to three volumes. He has so much to say that, by his own admission, three volumes is but a compromise. If one considers the innumerable ramifications of his theory and practice, one can understand the enormousness of the task.

It is the function of psychodrama to record on a stage the drama of the patient's life in all its normal, neurotic or psychotic interrelations. Psychodrama, in contradistinction to the verbiage of psychoanalysis, uses the drama itself, with all its intrinsic settings, aids and other people (alter egos, directors and accessories). The patient acts out his neurosis, his delusions, his loves and hates, and hostilities, and even his hallucinations. Just what this does to the patient's problems is not clear. Catharsis is a very old mechanism and has been used in every form of psychiatric aid. Yet today one shies away from empiric psychiatry. The present day psychiatrist is interested in dynamics, and the author, in spite of criticism of the psychoanalytic method, does not lend enough scientific data to put him on solid ground.

There is no question in the mind of this reviewer that there is a functional niche in therapeutic psychiatry for psychodrama, but it is suspected that Dr. Moreno seeks more than a niche. His volume is a most ambitious piece of literature, in which he professes to have "the answer." One doubts it.

Laying a great deal of emphasis on "the spontaneity factor," he writes about it as though spontaneity could be found in the chromosomes and genes. He actually says so. Skepticism is a mild reaction to the speculation which he attempts to dress up as a science.

To psychiatrists familiar with psychodrama and to those who have used psychodrama as "another instrument" of psychotherapy, the formulations of this volume may be meaningful. However, I should hesitate to recommend this volume to those who are but vaguely familiar with the theory and practice of psychodrama. The formulations are too speculative and vague. Some of the author's statements are so foreign to the scientific way of thinking that they are actually incomprehensible. This book is recommended to Moreno's disciples.

VOLUME FLOW OF BLOOD THROUGH THE HUMAN BRAIN

FREDERIC A. GIBBS, M.D.

HARRY MAXWELL, M.D.

AND

E. L. GIBBS

With the technical assistance of Ruth Hurwitz

CHICAGO

VALID quantitative data on the volume flow of blood through the human brain are of crucial importance for the solution of a variety of clinical and theoretic problems. The poverty of such data has been due chiefly to a lack of suitable technics. The thermoelectric flow recorder devised by one of us (F. A. G.)¹ does not yield qualitative data unless calibrated in situ, and this has not been done in man. Ferris² has employed a method by which the bone-supported dural coverings of the brain and spinal cord are used as a plethysmograph. A trochar is inserted into the lumbar sac, and with an inflatable cuff the veins of the neck are compressed. The cerebral blood flow is estimated from the rate of displacement of spinal fluid. Kety and Schmidt³ have recently described a method based on the principle that the rate at which the brain comes into equilibrium with the concentration of a physiologically inert and freely diffusible substance is a function of the cerebral blood flow; this rate is determined by plotting against time the difference in concentration of the substance in the arterial and the cerebral venous blood. Comments on the methods of Ferris and of Kety and Schmidt and comparison of their results with those of the present study will be found in the succeeding paragraphs.

METHOD

By injecting at constant rate a physiologically inert, nondiffusible substance into a major cerebral artery and then determining the concentration of that substance in a major cerebral venous channel, it is possible to estimate the

From the Departments of Psychiatry and Neurology and Neurosurgery, University of Illinois College of Medicine and the Illinois Neuropsychiatric Institute.

1. Gibbs, F. A.: A Thermoelectric Blood Flow Recorder in the Form of a Needle, *Proc. Soc. Exper. Biol. & Med.* **31**:141-146, 1933.

2. Ferris, E. B.: Objective Measurement of Relative Intracranial Blood Flow in Man, *Arch. Neurol. & Psychiat.* **46**:377-401 (Sept.) 1941.

3. Kety, S. S., and Schmidt, C. F.: The Determination of Cerebral Blood Flow in Man by the Use of Nitrous Oxide in Low Concentrations, *Am. J. Physiol.* **143**:53-66, 1945.

volume flow of blood through the brain (F. A. G.). If mixing is complete, the ratio of the concentration of the injected substance to its concentration in the sample of blood from the major venous channel will be inversely proportional to the ratio of the rate of injection to the rate of blood flow; i. e., the dilution factor times the rate of injection equals the minute-volume flow of blood through the brain. However, when the period of injection has continued beyond the circulation time, some of the injected substance will reach the general arterial stream, and this will require that the concentration of the substance in the general arterial stream be subtracted from the concentration in the cerebral venous sample.

The substance chosen for injection in the present study was Evans blue (T-1824). It was injected into the right internal carotid artery by means of a constant speed injection apparatus of the type described by Koehler.⁴ The original plan had been to inject the dye and withdraw samples through indwelling needles inserted through the previously unbroken skin, but it was decided that for preliminary studies it would be wiser to cut down on the great vessels of the neck, thus guarding against possible extravasation of the dye or failure because of inability to puncture the correct vessels.

MATERIAL

Since an open operation was decided on, only special types of patients could be used. The first 2 had inoperable gliomas; the third was a psychopathic patient who craved operation; the fourth was a patient with convulsions and right hemiplegia; the fifth had severe unilateral paralysis agitans, and the sixth had advanced progressive muscular atrophy without any known intracranial pathologic condition. The seventh patient had alcoholic encephalitis. Probably because of the dramatic value of the surgical procedure, the increased attention from physicians and the greater nursing care, all patients reported that they felt better after the operation.

OPERATIVE PROCEDURE

With local anesthesia, the bifurcation of the right common carotid artery and the right internal jugular vein with its local branches was exposed. A large ureteral catheter was then introduced through a branch of the jugular vein up to the level of the jugular bulb. A no. 22 intravenous needle, through which the dye was injected, was then introduced into the lumen of the internal carotid artery.

When the volume of cerebral blood flow was measured directly, both sides were exposed and a heavy loop of black silk was placed high in the neck around the left internal jugular vein. The ends of the silk loop were threaded through a large silk-woven catheter, so that the blood flow through the left internal jugular vein could be stopped by placing tension on the silk loop. On the right side a large rubber cannula was inserted into the right internal jugular vein after all the local branches had been ligated and divided. Thus, the cerebral venous return could be entirely deflected through the right internal jugular vein during temporary occlusion of the left internal jugular vein.

INJECTION AND SAMPLING

The syringe on the constant speed injector was filled with an 0.2 per cent solution of Evans blue. The motor was then started, providing a flow

4. Koehler, A. E.: A Simplified Apparatus for Constant Rate Injections, *J. Lab. & Clin. Med.* **26**:383-385, 1940.

of 1 cc. per minute of the dye solution into the internal carotid artery. After allowing at least two minutes for equilibrium to be established between the dye stream and the blood stream, a 10 cc. sample was drawn from the catheterized jugular bulb; this sample was discarded and a second 10 cc. sample drawn, which was retained. Simultaneously with drawing of the second sample from the jugular bulb, a 10 cc. sample was drawn from the left femoral artery. Thereafter, heparin was injected into the jugular catheter to prevent clotting, and a stylet was inserted into the femoral needle for the same purpose. This sampling procedure was repeated whenever an estimate of cerebral blood flow was desired.

The concentration of dye in the arterial and the venous samples was determined by photoelectric colorimetry. Six cubic centimeter samples of blood were centrifuged, and the concentration of the dye in the plasma was determined. If hemolysis was present, a correction was applied by using a formula provided by Gibson and Evelyn.⁵ The ratio of plasma to cells was determined with the hematocrit, and the amount of dye in the whole blood was calculated from another of Gibson's formulas.⁵ The minute volume flow of blood through the brain was determined as follows:

$$\frac{\text{Concentration of dye injected}}{\text{Concentration of dye in internal jugular vein} - \text{concentration of dye in artery}} \times \text{cc. dye injected per min.} = \text{blood flow (cc./min.)}$$

The oxygen and carbon dioxide contents of all samples of blood were determined by the Van Slyke manometric method,⁶ and sugar values, by the Nelson adaptation of the Somogyi method.⁷ Arteriovenous differences for oxygen, sugar and carbon dioxide multiplied by minute volume flow gave values for the oxygen and sugar consumption of the brain and its production of carbon dioxide. Attempts were made to alter the cerebral blood flow by having the patient hyperventilate and by adding 5 or 10 per cent carbon dioxide to the respired air.

SOURCES OF ERROR

The chief source of error is failure of the dye to mix completely with the total cerebral venous blood. If part of the dye reaches a channel that by-passes the internal jugular veins, the concentration in the internal jugular vein will be too low and the calculated flow will be erroneously high. If the stream in the right internal carotid artery leads into relatively isolated venous channels, where it is unmixed with blood from all other cerebral arteries, and the dye is thus carried in high concentration to the right internal jugular vein, an erroneously low value for cerebral blood flow will be obtained.

It is customary, when expressing the results of *in vitro* studies with the Warburg apparatus, to give the oxygen consumption in terms of cubic centimeters of oxygen per gram (or 100 Gm.) of dry brain. A distinction also is made between the oxygen consumption of gray matter and that of white matter.

5. Gibson, J. R., Jr., and Evelyn, K. A.: Clinical Studies of Blood Volume: IV. Adaptation of Method to Photoelectric Microcolorimeter, *J. Clin. Investigation* **17**:153-158, 1938.

6. Van Slyke, D. D., and Neill, J. M.: The Determination of Gases in Blood and Other Solutions by Vacuum Extraction and Manometric Measurement, *J. Biol. Chem.* **61**:523-573, 1924.

7. Nelson, N.: A Photometric Adaptation of the Somogyi Method for the Determination of Glucose, *J. Biol. Chem.* **153**:375-380, 1944.

Such precision is difficult, if not impossible, to obtain in vivo. In the present study no information is available as to the weight of the brain, nor is it known what part of the flow from the cerebellum and the hindbrain is included.

It must be realized that as flow increases arteriovenous differences of oxygen content and of dye concentration both approach zero and both become relatively insensitive indicators of flow. Consequently, an over-all percentage accuracy would be meaningless, and the same holds for the needle flow recorder.¹ A quantitative check against direct volumetric determinations was carried out in 1 case; this is referred to in the next section.

Two of the patients had large intracranial tumors which might have been expected to alter cerebral blood flow. The patient with seizures and hemiplegia must have had some cerebral atrophy. Only 2 of the patients (cases 3 and 6, in table 2) can be presumed to have had normal brains.

RESULTS

Table 1 shows the values for three direct volumetric determinations of cerebral blood flow in 1 case, together with the values obtained

TABLE 1.—Data for Cerebral Blood Flow by Direct Volumetric and Dye Injection Methods and Arteriovenous Differences in Oxygen, Carbon Dioxide and Glucose

Procedure	Cerebral Blood Flow		Arteriovenous Differences		
	Direct Volumetric Method, Cc./Min.	Dye Injection Method, Cc./Min.	Oxygen, Vol. %	Carbon Dioxide, Vol. %	Glucose, Mg./100 Cc.
Room air.....	370	378	7.14	7.35	10
Low carbon dioxide.....	320	327	9.89	10.04	15
High carbon dioxide.....	348	401	5.79	5.51	11

with the dye injection technic, and also arteriovenous differences for oxygen, carbon dioxide and glucose. In two of these determinations the data for the dye injection method and the direct volumetric method agreed to within 3 per cent and the change in arteriovenous difference for oxygen was entirely consistent with the change in blood flow.

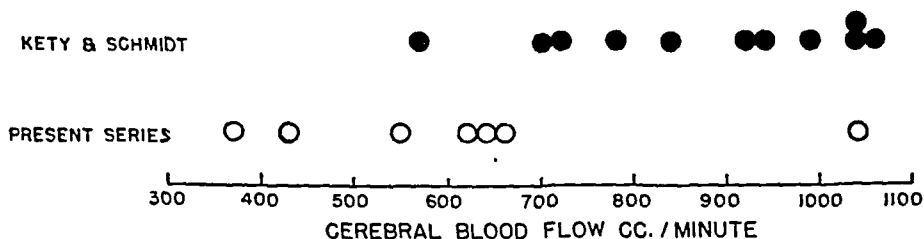

Fig. 1.—Distribution of values for minute blood flow through the brain in the present series of 7 cases and in the series reported by Kety and Schmidt.³

In the third, the dye injection method gave values for the cerebral blood flow in accord with the change in the arteriovenous difference for oxygen, but the volumetric determination of flow gave data at variance.

This discrepancy is believed to have been due to an error in technic, probably a failure to occlude completely the left internal jugular vein during the time that the flow from the right internal jugular vein was being collected.

The oxygen, carbon dioxide and sugar contents of the arterial and the internal jugular blood, the arteriovenous differences and the cerebral blood flow and oxygen consumption during rest, hyperventila-

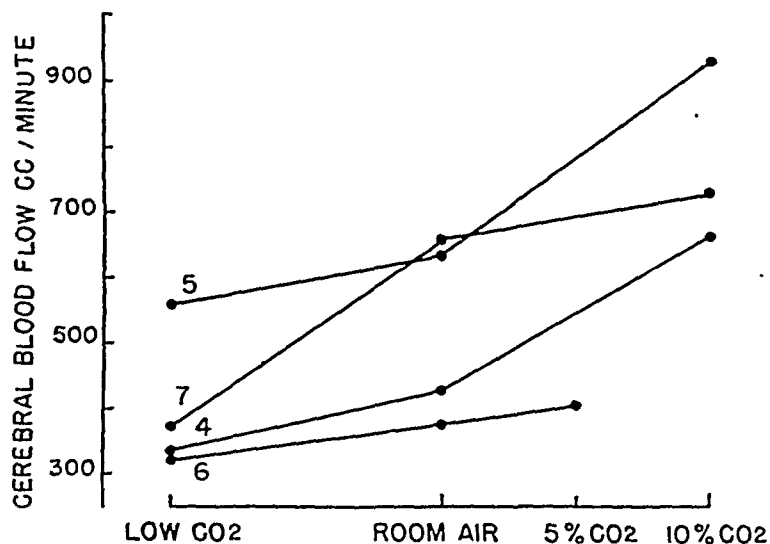

Fig. 2.—Changes in the cerebral blood flow occurring in 4 cases in which both higher and lower concentrations of carbon dioxide were breathed.

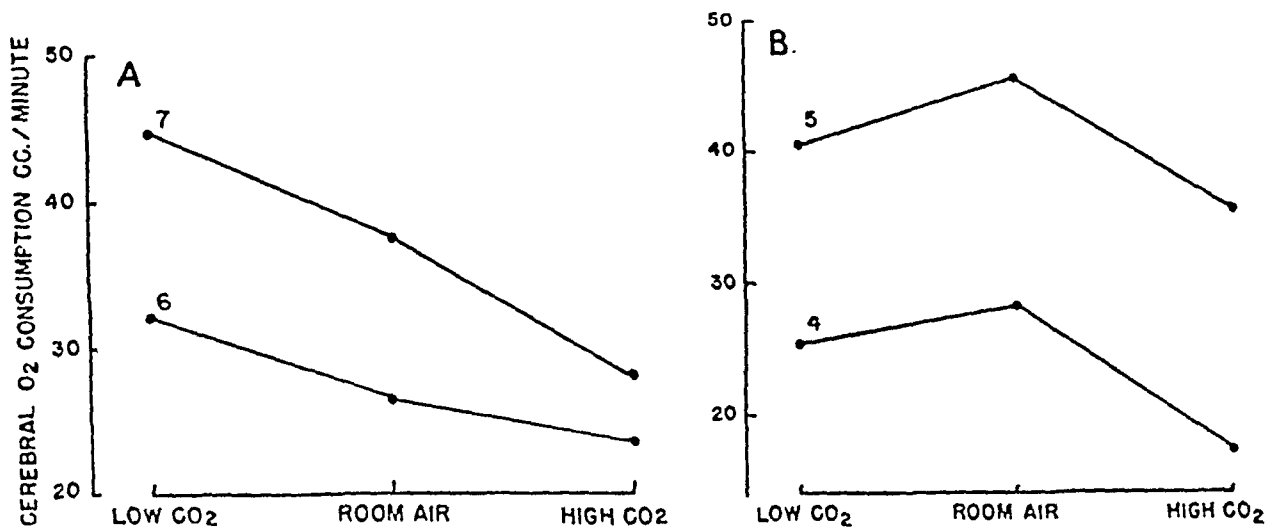

Fig. 3.—Changes in oxygen consumption with hyperventilation in the 4 cases values for which are shown in figure 3.

tion and breathing of high carbon dioxide mixtures are shown in table 2. Figure 1 shows the distribution of values for minute volume flow of blood through the brain as determined by us and the values reported for their cases by Kety and Schmidt.³

In all the present cases in which hyperventilation was employed, the cerebral blood flow decreased; in all cases in which carbon dioxide was

TABLE 2.—Data on Oxygen, Carbon Dioxide and Glucose Contents of Arterial and Internal Jugular Venous Blood and on Oxygen Consumption and Blood Flow of the Brain

Case No.	Procedure	Oxygen Content, Vol. %		Carbon Dioxide Content, Vol. %		Glucose, Mg./100 Cc.		Arteriovenous Difference		Oxygen Uptake, Cc./Min.		Blood Flow, Cc./Min.: Whole Brain	
		Arterial	Internal Jugular	Arterial	Internal Jugular	Arterial	Internal Jugular	Oxygen, Vol. %	Carbon Dioxide, Vol. %	Glucose, Mg./100 Cc.	Whole Brain		100 Gm. of Brain
1	Room air.....	19.50	11.98	48.62	55.97	138	125	7.58	7.35	13	41.5	2.9	548
	Low carbon dioxide.....
	High carbon dioxide.....	20.52	15.92	50.90	55.09	134	127	4.60	4.19	7	27.8	2.0	606
2	Room air.....	18.78	13.81	48.81	53.73	93	85	4.92	4.92	8	30.3	2.2	619
	Low carbon dioxide.....
	High carbon dioxide.....	19.87	18.73	57.30	58.47	90	87	1.14	1.17	3	14.9	1.1	1,304
3	Room air.....	21.90	15.72	44.48	50.80	142	134	6.18	6.32	8	64.4	4.6	1,039
	Low carbon dioxide.....	22.65	9.68	37.96	50.80	148	127	12.97	12.84	21	44.8	3.2	353
	High carbon dioxide.....
4	Room air.....	19.26	12.73	47.06	53.43	92	83	6.53	6.37	9	28.1	2.0	433
	Low carbon dioxide.....	19.32	11.77	38.35	48.93	92	81	7.55	10.58	11	25.6	1.8	337
	High carbon dioxide.....	19.72	17.14	51.85	53.93	91	86	2.58	2.08	5	17.3	1.2	666
5	Room air.....	19.68	12.55	43.43	50.45	111	100	7.13	7.02	11	45.5	3.3	641
	Low carbon dioxide.....	19.68	12.43	43.44	50.48	107	98	7.25	7.04	9	40.5	2.9	563
	High carbon dioxide.....	21.02	17.21	46.24	50.10	107	102	3.81	3.86	5	35.4	2.5	932
6	Room air.....	20.76	13.62	47.01	54.36	99	89	7.14	7.35	10	26.6	1.9	378
	Low carbon dioxide.....	22.19	12.30	44.22	54.26	103	88	9.89	10.04	15	32.2	2.3	327
	High carbon dioxide.....	22.67	16.88	49.14	54.65	104	93	5.79	5.51	11	23.8	1.7	401
7	Room air.....	20.20	14.52	41.21	46.69	140	133	5.68	5.48	7	37.8	2.7	662
	Low carbon dioxide.....	22.08	9.69	31.90	44.84	139	127	12.39	12.94	12	44.8	3.2	-370
	High carbon dioxide.....	23.08	19.50	44.71	46.83	143	136	3.58	2.12	7	28.0	2.0	732

breathed, the cerebral blood flow increased (table 2). The changes in cerebral blood flow that occurred in the 4 cases in which carbon dioxide was both lowered and raised are shown in figure 2.

Calculations of oxygen uptake based on cerebral blood flow and arteriovenous differences in oxygen indicate that the oxygen uptake was reduced in all cases in which carbon dioxide was increased (table 2). However, no such consistency was found with hyperventilation; in 3 cases the oxygen uptake was decreased, and in 2 it was increased (table 2). In figure 3 *A* and *B* are shown the changes in oxygen uptake in the 4 cases in which carbon dioxide was both lowered and raised.

COMMENT.

The values obtained for cerebral blood flow in the present study are approximately three times as great as those of Ferris.² They are in general lower than, but in fairly close accord with, the values reported by Kety and Schmidt.³ If the present values for cerebral blood flow are used for calculating oxygen consumption per gram of brain (assuming a brain weight of 1,400 Gm.), values are obtained having the same order of magnitude as the initial rate of oxygen consumption for brain *in vitro*.⁸ The results are also in general accord with the values for cerebral oxygen consumption obtained from *in vivo* studies on monkeys by Schmidt, Kety and Pennes.⁹

The present findings prove conclusively that lowering the carbon dioxide level of arterial blood causes a decrease in cerebral blood flow, and raising it causes an increase. This conclusion is supported by previous evidence based on the caliber of cerebral vessels¹⁰ and by qualitative changes in cerebral blood flow as measured either with a needle flow recorder¹ or by Ferris' spinal fluid displacement method.² They are also in accord with amperometric determinations of cerebral oxygen tension as reported by Roseman, Goodwin and McCulloch.¹¹

Lennox and 2 of us (F. A. G. and E. L. G.)¹² have shown that at normal oxygen levels, carbon dioxide is more effective than oxygen in altering cerebral arteriovenous differences. However, at low levels

8. Warburg, O.; Posener, K., and Negglein, E.: Ueber den Stoffwechsel der Carcinomzelle, *Biochem. Ztschr.* **152**:309-344, 1924.

9. Schmidt, C. F.; Kety, S. S., and Pennes, H. H.: The Gaseous Metabolism of the Brain of the Monkey, *Am. J. Physiol.* **143**:33-52, 1945.

10. Wolff, H. G., and Lennox, W. G.: Cerebral Circulation: XII. The Effect on Pial Vessels of Variations in the Oxygen and Carbon Dioxide Content of the Blood, *Arch. Neurol. & Psychiat.* **23**:1097-1120 (June) 1930.

11. Roseman, E.; Goodwin, C. W., and McCulloch, W. S.: Rapid Changes in Cerebral Oxygen Tension Induced by Altering the Oxygenation and Circulation of the Blood, *J. Neurophysiol.* **9**:33-40, 1946.

the situation is reversed: Carbon dioxide produces little change, and oxygen produces great changes. Under conditions of relative anoxia, therefore, a close relationship is found in the arteriovenous differences, the oxygen level and cerebral metabolism. In our opinion, homeostasis for oxygen is an emergency mechanism that does not appear until the oxygen supply to the brain is threatened. At normal oxygen levels the cerebral blood flow is regulated to give a homeostasis for carbon dioxide. The arterial oxygen content in many of the cases reported by Schmidt, Kety and Pennes⁹ suggests that they were working in a low oxygen zone, where carbon dioxide is ineffective as a determinant of cerebral blood flow and where the oxygen level and the oxygen requirement, and therefore the metabolism, are the predominant determinants.

Under the conditions of the present experiments, an increase in cerebral blood flow (produced with high carbon dioxide levels) was associated with a decrease in cerebral oxygen uptake. The antianoxic action of carbon dioxide has been recognized for a long time. It has been suspected that this action was due in part to a direct depressant action of carbon dioxide on cerebral oxygen uptake. The data obtained in the present study are in accord with such an assumption.

SUMMARY

By means of a dye injection method, which in 1 instance was checked against direct volumetric determinations, the cerebral blood flow of man was measured in 7 patients. The average resting flow for all subjects was 617 cc. per minute.

By hyperventilation it was possible to reduce the cerebral blood flow approximately one-half. By breathing 10 per cent carbon dioxide, it was possible to double the cerebral blood flow. Under the conditions of these experiments, the major changes which occur in arteriovenous differences of oxygen are the result of change in the cerebral blood flow. However, in all cases the oxygen uptake of the brain was reduced by high carbon dioxide concentrations; no consistent change in oxygen uptake occurred with hyperventilation.

University of Illinois School of Medicine.

12. Lennox, W. G.; Gibbs, F. A., and Gibbs, E. L.: The Relationship in Man of Cerebral Activity to Blood Flow and to Blood Constituents, *J. Neurol. & Psychiat.* **1**:210-225, 1938. Gibbs, F. A.; Gibbs, E. L., and Lennox, W. G.: The Value of Carbon Dioxide in Counteracting the Effects of Low Oxygen. *Aviation Med.* **14**:1-2, 1943.

RELATION OF ACUTE MUCOSAL HEMORRHAGES AND ULCERS OF GASTROINTESTINAL TRACT TO INTRACRANIAL LESIONS

GEORGE S. STRASSMANN, M.D.
WALTHAM, MASS.

CUSHING, in his Balfour Lecture,¹ stated that erosions and ulcers in the gastrointestinal tract are not infrequently seen in association with various cerebral lesions and after intracranial operations. He reviewed the literature covering this subject up to 1932. The generally accepted opinion is that these ulcers follow certain intracranial processes which cause a state of parasympathetic irritation or sympathetic paralysis of autonomic centers in the hypothalamus. A number of experimental studies were dedicated to this problem.² Mechanical or chemical stim-

From the Laboratory of the Metropolitan State Hospital.

1. Cushing, H.: Peptic Ulcer and the Interbrain (Balfour Lecture), *Surg., Gynec. & Obst.* **55**:1 (July) 1932.

2. Durante, L.: The Trophic Element in Origin of Gastric Ulcers, *Surg., Gynec. & Obst.* **22**:399, 1916. Gundelfinger, E.: Klinische und experimentelle Untersuchungen über den Einfluss des Nervensystems bei der Entstehung des runden Magengeschwürs, *Mitt. a. d. Grenzgeb. d. Med. u. Chir.* **30**:189, 1918. Berg, M.: Experimental Peptic Ulcer by Vasomotor Episodes (Pitressin Episodes) and Autonomic Disturbances, *Arch. Path.* **33**:636 (May) 1942. Beattie, J.: Relation of Tuber Cinereum to Gastric and Cardiac Functions, *Canad. M. A. J.* **26**:278 (March) 1932; Hypothalamic Mechanisms, *ibid.* **26**:400 (April) 1932. Burdenko, N., and Mogilnitzky, B. N.: Zur Pathogenese einiger Formen des runden Magengeschwürs, *Ztschr. f. d. ges. Neurol. u. Psychiat.* **103**:42, 1926. Mogilnitzky, B. N.: Zur Frage der Entstehungsweise und Ursache neurogener Formen des runden Magengeschwürs, *Virchows Arch. f. path. Anat.* **257**:109, 1925. Keller, A.: Ulceration of the Digestive Tract in the Dog Following Intracranial Procedures, *Arch. Path.* **21**:127 (Feb.) 1936. Keller A.; Hare, D., and D'Amour, C.: Ulceration in Digestive Tract Following Experimental Lesions in Brain-Stem, *Proc. Soc. Exper. Biol. & Med.* **30**:772 (March) 1933. Keller, A., and D'Amour, C.: Ulceration in the Digestive Tract of Dog Following Hypophysectomy, *Arch. Path.* **21**:185 (Feb.) 1936. Watts, J., and Fulton, J.: The Effect of Lesions of the Hypothalamus upon the Gastro-Intestinal Tract and Heart of Monkeys, *Ann. Surg.* **101**:363 (Jan.) 1935. Light, R. U.; Bishop, C. C., and Kendall, L. G.: The Production of Gastric Lesions in Rabbits by Injection of Small Amounts of Pilocarpine into the Cerebrospinal Fluid, *J. Pharmacol. & Exper. Therap.* **45**:227 (June) 1932. Hoff, E., and Sheehan, D.: Experimental Gastric Erosions Following Hypothalamic Lesions in Monkeys, *Am. J. Path.* **11**:789 (Sept.) 1935. Nedzel, A. J.: Experimental Production of Gastric Ulcers in Dogs by Inducing Vascular Spasm with Pitressin, *Am. J. Digest. Dis.* **10**:283 (Aug.) 1943; Experimental Gastric Ulcer (Pitressin Episodes), *Arch. Path.* **26**:988 (Nov.) 1938.

ulation of the hypothalamic region was frequently followed by hemorrhages or erosions of the gastrointestinal tract. Since Cushing's paper, the coincidence of cerebral lesions and acute peptic ulcers in man has been reported only occasionally.³ The purpose of the present paper is to elucidate as far as possible how frequently and under what conditions acute mucosal hemorrhages and erosions of the gastrointestinal tract may be observed with and without fatal intracranial lesions.

MATERIAL

Available for this study were the large autopsy material of the Office of the Chief Medical Examiner of New York City (Dr. Thomas A. Gonzales) during a two year period (about 1,200 cases) and 196 cases in which autopsy was performed occurring during a similar period in two state hospitals for mental disease. These 196 cases with autopsy were divided into five groups. Group 1 consisted of 59 cases in which no hemorrhages, erosions or softenings of the gastrointestinal tract were observed at autopsy. Group 2 consisted of 89 cases in which autopsy showed mucosal hemorrhages of the stomach or duodenum (or in other parts of the intestine) without gross evidence of effusion of blood into the gastrointestinal tract. Group 3 consisted of 24 cases in which the mucosal hemorrhages had produced gross bleeding into the lumen of the stomach and/or the intestine. Group 4 consisted of 14 cases in which acute hemorrhagic ulcerations of the upper gastrointestinal tract were observed at autopsy. Group 5 consisted of 10 cases in which autopsy revealed advanced gastromalacia. The ages of the 196 patients varied from 16 to 94 years, and the cases were distributed equally between the sexes. The psychosis and the terminal disease were of very different types in all five groups. In group 4 were included also 12 cases of acute gastroduodenal ulcer, and in group 5, 30 cases of nontraumatic perforation of the esophagus or stomach, observed at and collected from about 1,200 autopsies performed by the Office of the Chief Medical Examiner of New York City.

OBSERVATIONS

GROUP 1.—In 59 of 196 cases with autopsy (or 30.1 per cent) no mucosal hemorrhage of the gastrointestinal tract was observed. In this group only 3 cases of severe cerebrovascular lesions (thrombotic softenings) were encountered. The types of the psychosis and of the terminal illness varied widely in this group.

GROUP 2.—In 89 of 196 cases with autopsy (or 45.4 per cent) more or less numerous mucosal hemorrhages were observed in the stomach or duodenum, frequently associated with hemorrhages in other parts of the intestine. The hemorrhages varied from a few small echymoses in the fundus of the stomach to numerous linear hemorrhages involving large parts of the stomach and duodenum. The cause and mechanism of death in this group were also variable. There were 6 cases of a severe cerebral lesion in this group (2 of spontaneous cerebral hemorrhage, 2 of large cerebral thromboses, 1 of cerebral tumor [ependymoma] and

3. Masten, M., and Bunts, R. C.: Neurogenic Erosions and Perforations of the Stomach and Esophagus in Cerebral Lesions: Report of Six Cases, *Arch. Int. Med.* 54:916 (Dec.) 1934.

1 of cerebral abscess). The gross and microscopic pictures of the mucosal hemorrhages in the 6 cases were not different from those observed in cases without cerebral lesions.

Histologically, there were superficial necrosis, edema and extravasation of red cells into the mucosa. As a rule the mucosal and submucosal vessels in the hemorrhagic area were engorged with red cells.

GROUP 3.—In 24 of 196 cases (or 12.3 per cent) mucosal hemorrhages of the stomach or duodenum, with dark brownish fluid in the stomach and tarry stools, were observed at autopsy. Cases of bleeding from peptic ulcer, tumor or inflammatory processes of the gastrointestinal tract were excluded from this group. In 5 cases, however, local circulatory disturbances could have caused the bleeding into the stomach

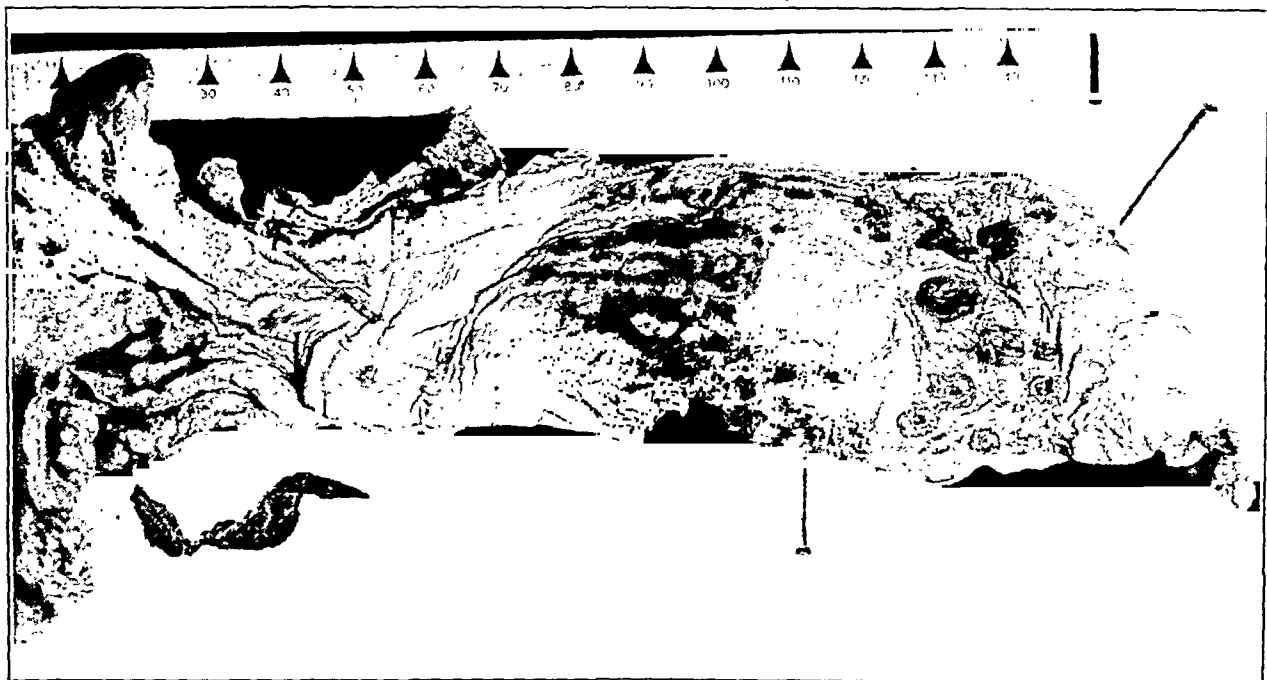

Fig. 1 (case 1).—Lower portions of the esophagus of a woman aged 78, who had a psychosis with cerebral arteriosclerosis. Multiple circular hemorrhagic ulcers, with blackish borders, and bleeding into the gastrointestinal tract were present.

or intestine. These were 2 cases of cirrhosis of the liver, 1 case of volvulus of the sigmoid and 2 cases of myocardial failure from hypertensive heart disease. In 9 out of 24 cases there were gross intracranial lesions; these were 3 cases of spontaneous cerebral hemorrhages, 2 cases of laceration of the brain associated with subdural and subarachnoid hemorrhages, 1 case of cerebral tumor (meningioma), 1 case of dementia paralytica, 1 case of Alzheimer disease and 1 case of sudden death in the catatonic state with cerebral edema. The microscopic picture in the hemorrhagic area differed only slightly from that seen in group 2. Necrosis, edema and effusion of red cells into the mucosa were, however, more extensive, and there was a cellular reaction, con-

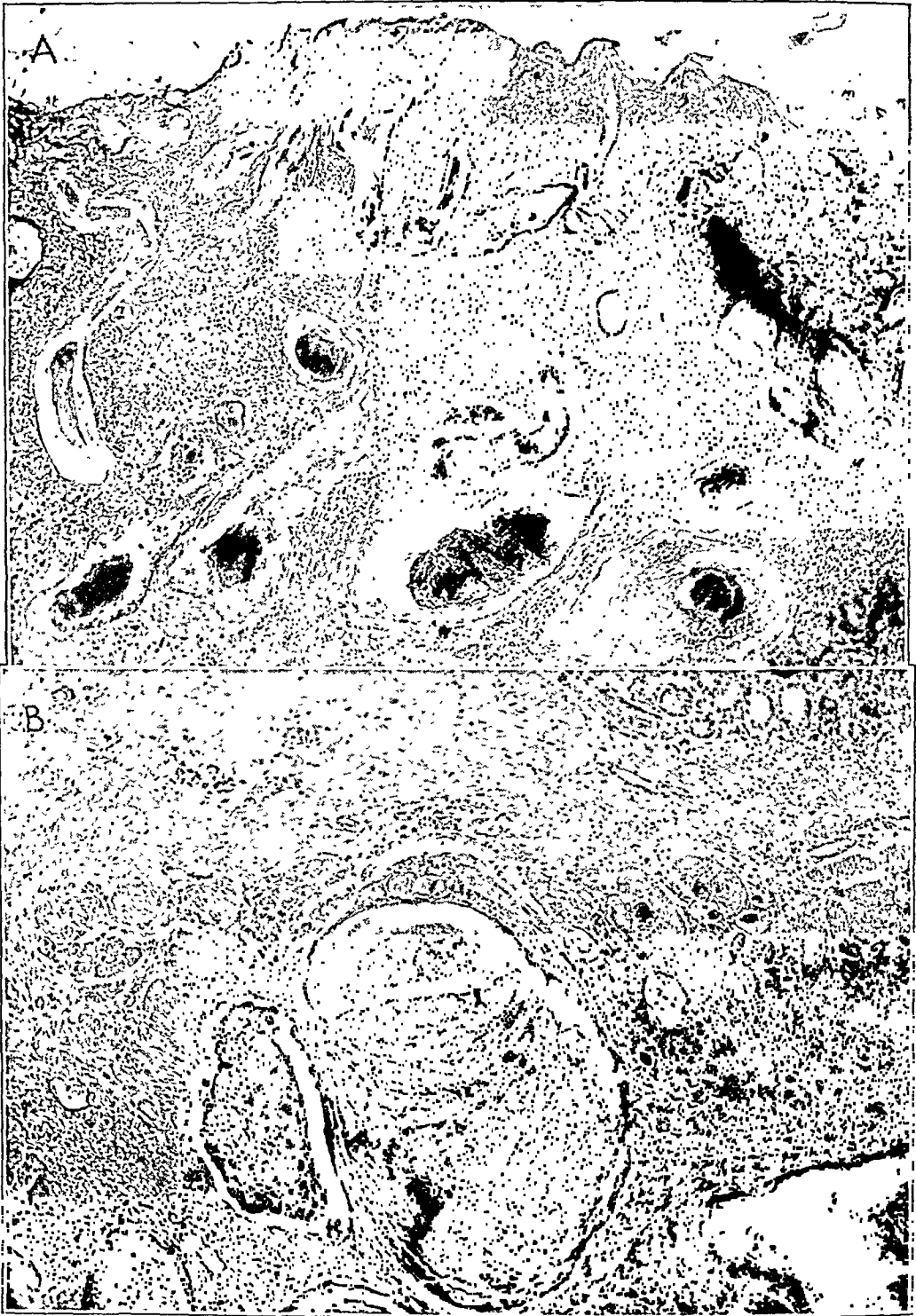
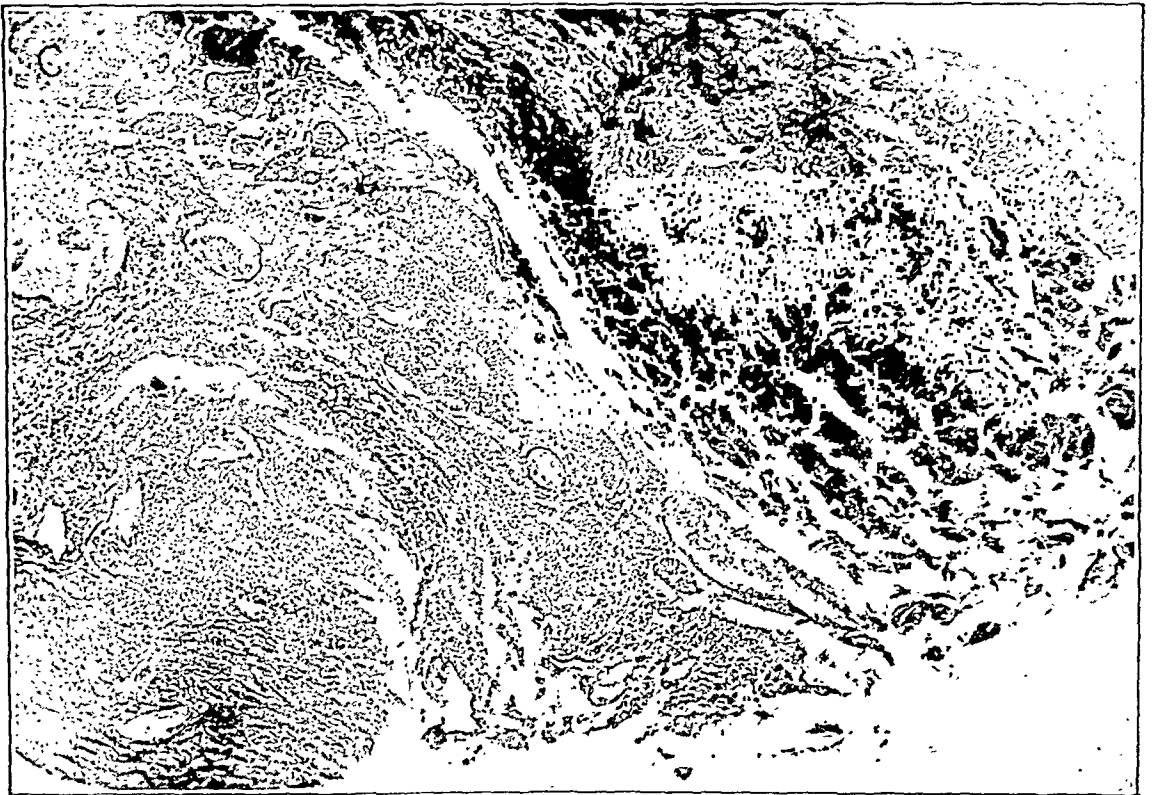

Fig. 2 (case 1).—*A*, area of esophageal ulcers, showing necrosis, edema, inflammatory reaction, engorged vessels and thrombi in mucosal and submucosal veins. Note diffuse blackish discoloration in the right corner due to hemorrhagic infiltration. Hematoxylin and eosin stain; $\times 45$.

B, portion of the same area as that in *A*, showing large thrombus in a submucosal vein surrounded by cellular infiltrates, consisting mostly of polymorphonuclear leukocytes. Hematoxylin and eosin stain; $\times 84$.

sisting in accumulations of polymorphonuclear leukocytes, which extended from the necrotic area of the mucosa into the submucosa. The mucosal and submucosal blood vessels were engorged with red cells.

GROUP 4.—In 14 of 196 cases (or 7.1 per cent) acute hemorrhagic ulcerations of the upper gastrointestinal tract were observed at autopsy. In 3⁴ of the 14 cases the ulcers were situated in the lower portion of the esophagus; in 5 cases, in the stomach (in the fundus near the cardia), and in 6 cases, in the upper portion of the duodenum. Of 12 additional cases of the same type observed at the Office of the Chief Medical Examiner of New York City, the ulcers were situated in the stomach



C, another part of the ulcer, showing edema, necrosis, cellular infiltration of the mucosa and submucosa and diffuse blackish discoloration of the superficial and deeper necrotic layers due to formation of hemosiderin (appearing black in the picture). Stain for hemosiderin; $\times 76$.

in 6 cases and in the duodenum in 6 cases. Tarry stool or brownish fluid in the stomach was found in all 26 cases.

Lower Portion of Esophagus.—Acute esophageal hemorrhagic ulcers were observed incidentally at the autopsy of 4⁴ elderly patients with arteriosclerotic psychosis. There had been no tube feeding, nor had operation been performed shortly before death.

CASE 1.—A woman aged 78, confused and disoriented, had been for three weeks prior to her death in the Danvers State Hospital. Autopsy revealed, besides advanced generalized and cerebral arteriosclerosis, multiple mucosal hemorrhages

4. Case 4 is classified with the cases of duodenal ulcers.

in the stomach and small and large intestine and numerous sharply demarcated, round ulcers of the lower portion of the esophagus. The necrotic areas were covered with blackish material; the edges of the ulcers had a brownish discoloration (fig. 1).

Microscopically, the esophagus in this area showed necrosis, edema, hemorrhages and accumulations of inflammatory cells, mostly polymorphonuclear leukocytes, in the mucosal and submucosal layers. Many thrombi were seen in the mucosal and submucosal veins. There was a strong reaction for hemosiderin in the superficial and deeper layers of the necrotic mucosa and submucosa, the whole necrotic area giving a dark blue reaction to the stain for iron. Weigert's fibrin stain revealed a number of gram-positive rods in the veins, which probably represented a postmortem artefact (fig. 2 *A, B* and *C*).

CASE 2.—A white man aged 88 had been for three months in the Metropolitan State Hospital; he was confused and deteriorated all the time. Autopsy revealed

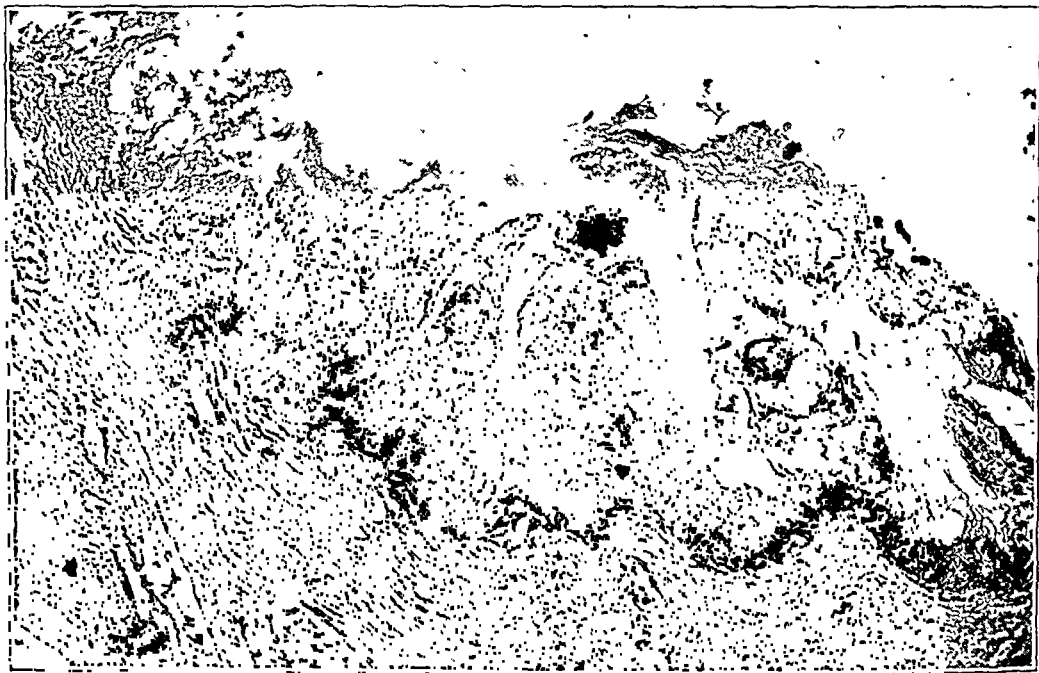

Fig. 3 (case 2).—Section of esophageal ulcer in a man aged 88 who had a psychosis, with cerebral arteriosclerosis, thrombotic softening of the right basal ganglia and confluent esophageal ulcers. The picture of necrosis, edema, cellular infiltrations and formation of hemosiderin (visible as dark bluish-stained areas) in the mucosa and submucosa is similar to that in case 1. Stain for hemosiderin; $\times 75$.

advanced generalized and cerebral arteriosclerosis, myocardial fibrosis, terminal endocarditis, softenings of the right basal ganglia and a number of confluent ulcerations of the lower part of the esophagus, which had a brownish discoloration. One of these areas measured 3 by 2 cm. The microscopic picture of the ulcerated area of the esophagus was similar to that seen in the first case. There were also necrosis, edema, diffuse hemorrhages and accumulations of inflammatory cells in the mucosa and submucosa and some thrombi in the mucosal veins. The reaction for hemosiderin was strongly positive, staining dark blue the whole inflamed, necrotic area of the mucosa. The stain for fibrin did not reveal any organisms (fig. 3).

CASE 3.—A woman aged 93 was confused and deteriorated during her stay in the hospital. Autopsy revealed, besides general and cerebral arteriosclerosis, a large aneurysm of the abdominal aorta filled with clotted blood and multiple hemorrhagic erosions in the lower portion of the esophagus and the stomach. The microscopic picture of the esophageal ulcerations was similar to the one described in the first 2 cases. There were necrosis, edema, hemorrhages and accumulations of inflammatory cells in the mucosa and submucosa, but the reaction for hemosiderin was negative.

CASE 4.—This case, that of a man aged 73, is reported in detail later because of the accompanying duodenal ulcers. Autopsy revealed multiple thrombotic softenings in the cortex and esophageal and duodenal ulcers. The ulcers of the esophagus showed necrosis, hemorrhages, intense inflammation and a strong,

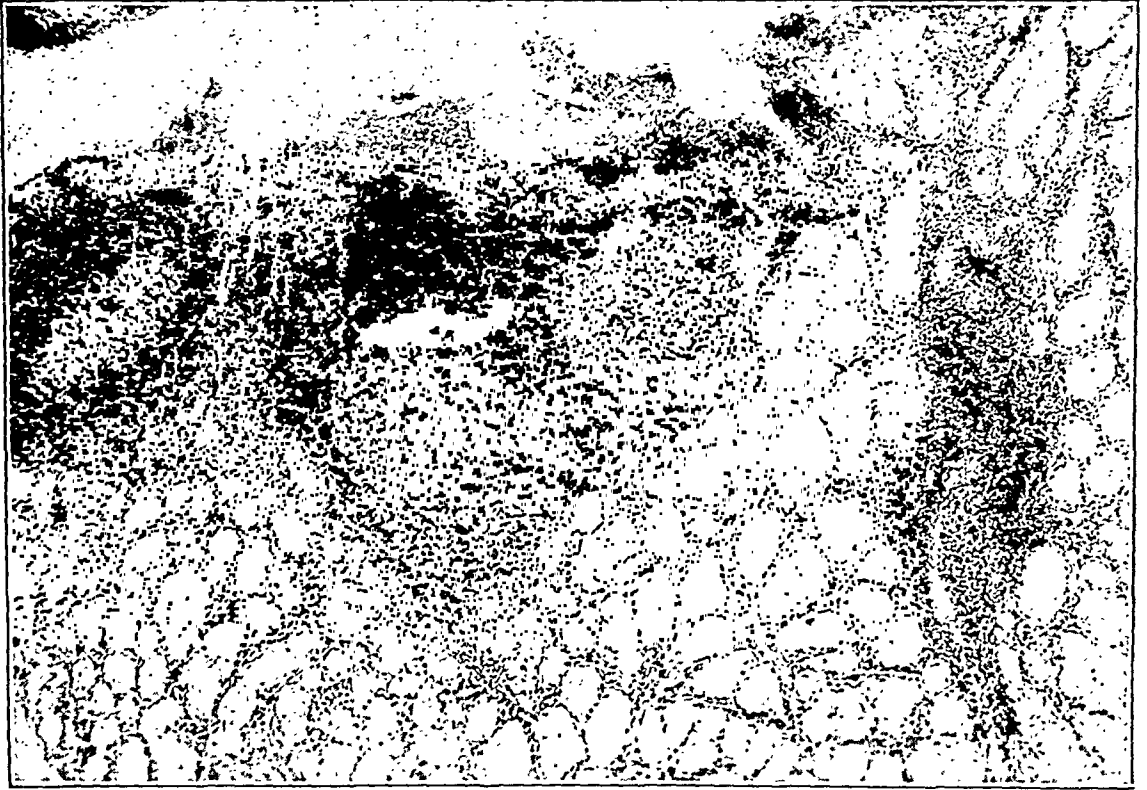

Fig. 4 (case 5).—Multiple acute hemorrhagic erosions of the stomach in a man aged 62 who had a psychosis with epilepsy. He fell forty-eight hours before death and sustained a fracture of the right middle fossa, with extradural hemorrhage over the right temporal lobe and subdural and subarachnoid hemorrhages over and contusions of the left temporal lobe. Necrosis, edema and intense cellular reaction extend from the mucosa into the submucosa. Hematoxylin and eosin stain; $\times 76$.

diffuse bluish stain for hemosiderin in the necrotic layers, similar to that seen in the first 2 cases.

Fundus of Stomach.—Acute hemorrhagic gastric ulcerations in the fundus were seen in 5 elderly patients, 4 of whom had been treated for arteriosclerotic psychoses and 1 for epilepsy.

CASE 5.—A man aged 62 fell during a convulsion, hit his head and remained unconscious for forty-eight hours, when he died. Autopsy revealed fractures of the right middle and anterior fossae, extradural hemorrhage over the right

hemisphere, subdural and subarachnoidal hemorrhage over the left hemisphere and contusions of the left temporal lobe, hemorrhages into the pulmonary tissue, general and cerebral arteriosclerosis, cirrhosis of the liver and hemorrhagic erosions in the fundus of the stomach. Microscopically, the eroded area showed edema, necrosis, hemorrhages and inflammatory reaction of the mucosa and submucosa (fig. 4).

Two of the 5 patients (cases 6 and 7) were diabetic with hypertensive heart disease and died in coma.

CASE 6.—A man aged 66 with diabetes had a severe heart attack one week before his death. Autopsy revealed generalized and cerebral arteriosclerosis; coronary occlusion; old and fresh myocardial infarctions; a hypertrophic heart,



Fig. 5 (case 6).—Multiple acute gastric erosions in a man aged 66 who had a psychosis with cerebral arteriosclerosis, thrombotic softening of the right basal ganglia, coronary occlusion and myocardial infarction of one week's duration. The necrosis, edema and cellular infiltration of the mucosa are more superficial than in case 5 (fig. 4). Hematoxylin and eosin stain; $\times 77$.

weighing 750 Gm.; softenings of the right basal ganglia, and a number of hemorrhagic ulcerations in the fundus of the stomach. The microscopic picture was similar to the one seen in the first case. The reaction for iron was negative (fig. 5).

CASE 7.—A man aged 77 with diabetes vomited blackish fluid before his death and died in coma. Autopsy revealed generalized and cerebral arteriosclerosis, hypertrophic heart, softenings of the right basal ganglia and numerous hemorrhagic ulcerations in the fundus of the stomach. The microscopic picture was not different from the one observed in the other cases, with necrosis, edema, hemorrhages and accumulations of inflammatory cells in the mucosa and submucosa.

CASE 8.—A woman aged 84 sustained a fracture of the hip two months prior to her death. She was confused and deteriorated and died in coma. Autopsy revealed advanced generalized and cerebral arteriosclerosis, softening of the right occipital lobe and a few hemorrhagic ulcerations in the stomach below the cardia. The microscopic picture of the ulcerated area was similar to the one seen in the other cases.

The fifth case should be considered separately because local pathologic changes could explain the occurrence of the gastric ulcerations.

CASE 9.—A man aged 78 collapsed one afternoon and died within twenty-four hours after the onset of the symptoms, which consisted in repeated vomiting and general weakness. Autopsy revealed, besides generalized and cerebral arteriosclerosis, acute dilatation of the stomach and the upper portion of the jejunum and an obstruction of the jejunum by old fibrous adhesions. There were multiple small ulcerations in the fundus of the stomach below the cardia.

Microscopically, there were necrosis, edema, diffuse hemorrhages and accumulations of inflammatory cells in the mucosa and submucosa. A few thrombi were seen in the mucosal veins. The reaction for hemosiderin was negative. The mucosa at one of the ulcers was covered by metaplastic squamous cell epithelium. Otherwise, the picture was not different from that in the other 4 cases.

In 4 out of 6 cases studied at the office of the Chief Medical Examiner of New York City, the acute hemorrhagic ulceration of the stomach followed skull fractures with subdural and subarachnoid hemorrhages and lacerations of the brain. In 1 case the ulcers were associated with a spontaneous cerebral hemorrhage, and in another case, with a subarachnoid hemorrhage. The ages of the 6 patients varied from 40 to 74 years; all the patients had been unconscious for more than twenty-four hours before death. Thus, acute gastric ulcerations were associated with the following cerebral lesions: cerebral lacerations, with traumatic subdural and subarachnoid hemorrhages, 5 cases; spontaneous cerebral hemorrhage, 1 case; subarachnoid hemorrhage, 1 case; cerebral arteriosclerosis and thrombosis, 3 cases; cerebral arteriosclerosis and acute intestinal obstruction, 1 case.

Duodenal Ulceration.—Twelve cases of acute hemorrhagic duodenal ulcerations were seen in association with the following cerebral lesions: traumatic cerebral lacerations with subdural and subarachnoid hemorrhages, 4 cases; cerebral thrombosis, 4 cases; acute purulent meningitis, 1 case; advanced cerebral arteriosclerosis, 2 cases; meningioma, 1 case. All the patients had been in a state of coma or unconsciousness for several hours or longer before death. Tarry stools were present in all cases. Ages of patients in state hospitals for mental diseases ranged from 16 to 93 years; the ages in the Medical Examiner's series, from 42 to 77 years. The duodenal ulcers were multiple, superficial, circular or linear and were situated in the first third of the duodenum. They were covered with a blackish material. No ulcer had perforated. The microscopic picture was similar in all cases. There were necrosis, edema, hemor-

rhages and accumulations of inflammatory cells through the mucosa and submucosa and thrombi in the mucosal veins. The blood in the vessels and the necrotic mucosa was often brownish. The reaction for hemosiderin was negative in all cases.

CASE 10.—The youngest patient in the series, a youth aged 16, died on the sixth day in the hospital, of pneumococcic meningitis. Autopsy revealed purulent exudate covering the whole surface and base of the brain, which was swollen (weight, 1,530 Gm.). There were also hemorrhagic, pneumonic areas in both lungs, an acute tumor of the spleen and multiple circular hemorrhagic ulcerations in the upper portion of the duodenum. The microscopic picture of the ulcer was that already described (fig. 6 *A* and *B*).

The other 5 patients in the present series had an arteriosclerotic psychosis, and 3 of them had been in coma because of cerebral thrombosis for several days before death.

CASE 11.—A woman aged 66 had been unconscious and paralyzed on the left side for five days. Autopsy revealed generalized and cerebral arteriosclerosis, a large thrombus in the abdominal aorta, thrombotic softening of the whole right hemisphere and multiple hemorrhagic ulcerations in the upper portion of the duodenum.

CASE 12.—A man aged 88 was admitted in a semicomatose condition to the hospital and died three days later. Autopsy revealed advanced general and cerebral arteriosclerosis with softenings of the right basal ganglia, which were probably three weeks old. There were multiple linear and circular hemorrhagic ulcerations in the upper part of the duodenum (fig. 7 *A* and *B*), with a microscopic picture in the region of ulceration similar to that in the other cases.

CASE 13.—A man aged 93 was for three months in the hospital, confused and disoriented all the time. Autopsy revealed generalized and cerebral arteriosclerosis, softening of the right basal ganglia, caseous tuberculosis of the lungs, multiple linear hemorrhagic ulcers in the upper portion of the duodenum, which grossly and histologically gave the same picture as that in all the other cases, namely, necrosis, edema, hemorrhages and intense inflammation of the mucosa and submucosa associated with thrombi in the mucosal veins.

CASE 14.—A white woman aged 66 had been confused and stuporous during the last days before her death. Autopsy revealed general and cerebral arteriosclerosis, a carcinoma of the uterus with metastases to the regional lymph nodes and numerous linear hemorrhagic ulcers in the upper portion of the duodenum.

CASE 4.—A man aged 73 was deteriorated and confused and in coma twenty-four hours prior to death. Autopsy revealed generalized and cerebral arteriosclerosis, multiple thrombotic softenings in various parts of the brain, adhesive pericarditis, terminal endocarditis and a few hemorrhagic circular ulcers in the upper portion of the duodenum and blackish discolored, confluent ulcers of the lower portion of the esophagus, the microscopic picture of which has been already described.

Microscopically, the ulcerated areas in the duodenum in the last 2 cases showed the same picture as was observed in the other cases.

In 4 out of 6 cases observed at the Office of the Chief Medical Examiner of New York City, the acute hemorrhagic duodenal ulcerations

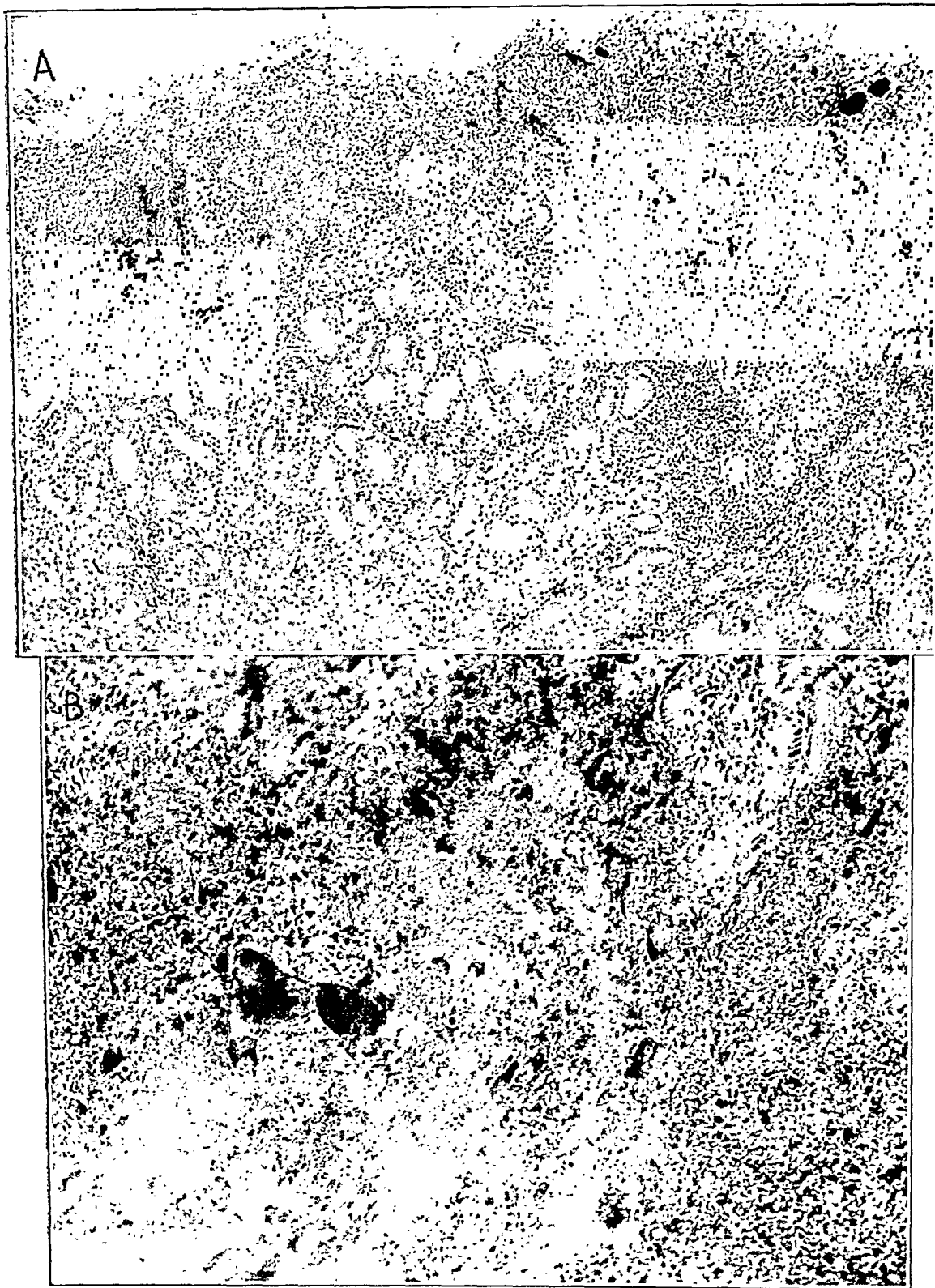

Fig. 6 (case 10).—*A*, section from the region of the duodenal ulcer in a youth aged 16, who had purulent pneumococcic meningitis and multiple circular hemorrhagic duodenal ulcers. Necrosis, edema, cellular infiltrations and thrombi in the mucosal and submucosal layers are visible. Hematoxylin and eosin stain; $\times 77$.

B, higher magnification ($\times 165$) of a portion of the same section as that in *A*, showing necrosis, edema, cellular infiltrations and thrombi in the veins of the mucosa and submucosa.

followed skull fractures with subdural and subarachnoid hemorrhages and cerebral lacerations. In 1 case they were associated with a thrombotic softening of the right hemisphere, and in another case with edema of the brain caused by meningioma. All 6 patients had been in coma from fourteen hours to four days prior to death. Thus, in the 26 cases

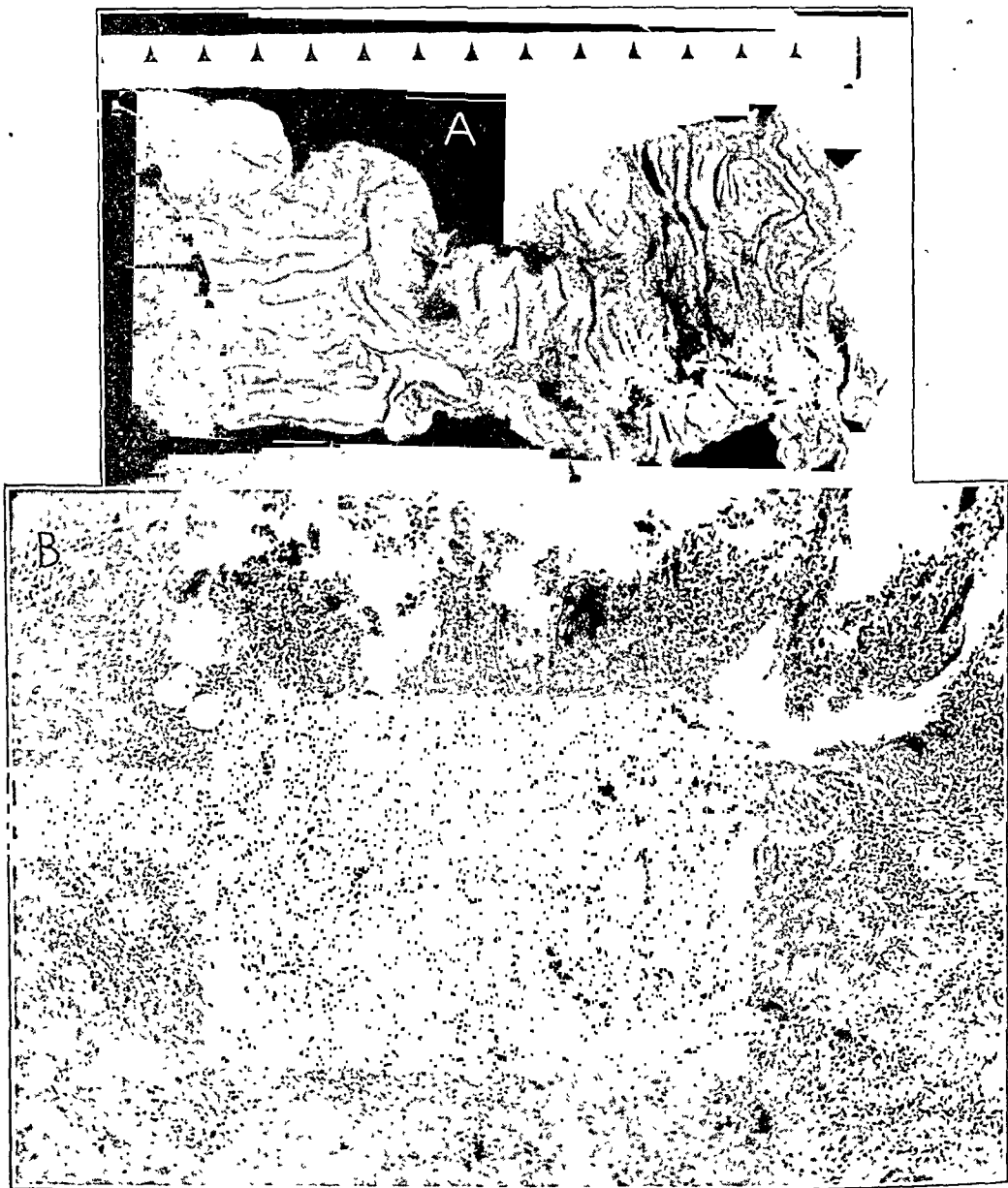

Fig. 7 (case 11).—*A*, duodenum with multiple terminal acute hemorrhagic ulcers, circular and linear, in a man aged 88, who had a psychosis with cerebral arteriosclerosis. Autopsy revealed thrombotic softening of the right basal ganglia of three weeks' duration.

B, region of the ulcer, showing intensive cellular infiltration, diffuse hemorrhages, necrosis and edema of the mucosa and submucosa. Hematoxylin and eosin stain; $\times 76$.

acute hemorrhagic ulcerations of the upper gastrointestinal tract were associated with the following cerebral lesions: cerebral arteriosclerosis, 4 cases; cerebral thrombosis, 9 cases; traumatic cerebral lacerations, with subdural and subarachnoid hemorrhages, 9 cases; cerebral spontaneous hemorrhage, 1 case; subarachnoid hemorrhage, 1 case; meningioma, 1 case; purulent meningitis, 1 case.

Dark brownish fluid and tarry stools were present in all 26 cases, but the diagnosis of ulceration had not been made during life. In the majority of the cases there were sclerosis, thickening and narrowing of the lumen of the arterioles of the esophagus, stomach or duodenum. The reaction for iron was negative in all but the 3 cases of esophageal ulcer, in which Gömöri's stain for hemosiderin gave the unusual picture of diffuse bluish staining of the necrotic area, especially of the vessel walls and the fibrous connective tissue of the submucosa.

GROUP 5.—In 10 out of 196 cases (or 5.1 per cent) autopsy showed advanced gastromalacia, although the wall of the stomach had not ruptured. The following lesions of the brain were observed: cerebral arteriosclerosis and thrombosis, 7 cases; multiple sclerosis, 1 case; Alzheimer disease, 1 case; edema of the brain in a catatonic state, 1 case. The stomach contained dark brownish fluid in all cases and microscopically showed necrosis, brownish discoloration, edema and some accumulations of inflammatory cells in the mucosa and submucosa. Sixty cases of advanced esophagomalacia and gastromalacia were collected from 1,200 autopsies observed at the Chief Medical Examiner's Office of New York City during a two year period. In 30 of these cases the esophagus or stomach had ruptured and brownish fluid was noted in the abdominal or the pleural cavity, which had digested the spleen, the diaphragm, the pleura or the lungs. In these 30 cases nontraumatic ruptures of the esophagus or stomach were associated with the following intracranial lesions: skull fractures, subdural and subarachnoid hemorrhages and lacerations of the brain, 15 cases; spontaneous subarachnoid hemorrhages, 3 cases; acute purulent meningitis, 3 cases; cerebral thrombosis, 1 case; meningioma, 1 case; cerebral abscess, 1 case; acute encephalitis, 1 case; fracture of the cervical portion of the spine with crushing of the cord, 1 case; barbiturate poisoning, 2 cases; septicemia after burns, 1 case, and emphysema with purulent bronchitis, 1 case, that of a man aged 76.

Thus, in 25 out of 30 cases traumatic or spontaneous severe intracranial lesions were observed. The case of crushing of the cord and the 2 cases of fatal barbiturate poisoning should be included with the cases of intracranial lesions. Therefore, in only 2 cases of rupture of the esophagus or stomach was no gross intracranial lesion apparent. The ages of the 30 patients at death varied from 20 to 76 years.

COMMENT

It has long been known that acute hemorrhagic erosions and softening of the upper gastrointestinal tract are occasionally seen in connection with cerebral lesions.⁵ Eleven such cases in man were reported by Cushing¹ and 8 similar cases were recently described by Masten and Bunts.³ Hemorrhagic ulcerations of the stomach and duodenum have been observed in animals after experimentally produced mechanical or chemical stimulation of autonomic centers or fibers² and after head injuries.⁶ Such stimulation causes spasm of gastrointestinal vessels, followed by ischemic necrosis of the mucosa, vasodilatation, edema and diapedetic hemorrhages. Small mucosal hemorrhages of the gastrointestinal tract were frequently seen in this autopsy material under varying conditions. They have no special significance and should be considered a terminal or agonal phenomenon. However, they have more importance if they lead to gross bleeding into the lumen of the stomach or intestine. In 24 of 196 cases with autopsy this gross bleeding was observed, and in 9 cases it was associated with intracranial lesions of various types. Hemorrhagic ulcerations were observed when the vascular disturbances were of a severer nature and had lasted for a longer period. The gross picture was that of multiple, superficial, circular or linear erosions covered with blackish material.

These erosions were situated in various areas of the lower portion of the esophagus, the fundus of the stomach or the upper part of the duodenum. No perforated ulcers were seen. In number, appearance, size and site of occurrence, the erosions differed from the picture usually given by peptic ulcers of the stomach and duodenum. Microscopically, all these ulcerations were characterized by necrosis, edema, hemorrhages, formation of venous thrombi and an intense cellular reaction (inflammation), extending from the mucosa through the submucosa. In the majority of cases the ulcerations had been formed apparently shortly before death, for the reaction for hemosiderin was negative in all but 3 cases of esophageal ulcer. In these 3 instances the stain for hemosiderin gave a diffuse bluish discoloration of the whole necrotic area of the mucosa and submucosa; vessel walls and connective tissue fibers became intensely blue with the Perles test. This picture was quite different from the one usually seen in hemorrhagic areas of other organs, and it has not been described in cases of esophageal ulcer reported by

5. Beneke, R.: Ueber die hämorrhagischen Erosionen des Magens (Stigmata ventriculi), *Verhandl. d. deutsch. path. Gesellsch.* **12**:284, 1908. Roessle, P. R.: Das runde Geschwür des Magens und Zwölffingerdarmes als "Zweite Krankheit," *Mitt. a. d. Grenzgeb. d. Med. u. Chir.* **25**:766, 1912. Ewalt, J. R.: Psychosomatic Problems, *J. A. M. A.* **126**:150 (Sept. 16) 1944. Cushing.¹

6. Tedeschi, C.: Gastric Mucosal Lesions in Rats Submitted to Head Trauma, *Proc. Soc. Exper. Biol. & Med.* **57**:268 (Nov.) 1944. Footnote 2.

other authors.⁷ As a rule, hemosiderin is always observed within histiocytes. The diffuse bluish coloring of the tissues with the hemosiderin stain cannot be considered an artefact, because it was seen with an intense inflammatory reaction only in these 3 cases of esophageal ulcer, which were fixed, cut and stained at different times. No reaction to prussian blue was obtained in any of the other cases.

The patients in whom ulcerations or softenings of the gastrointestinal tract were observed had been unconscious or in coma for hours or days before death. The ages of the patients ranged from 16 to 93 years, but patients over 60 years of age with arteriosclerotic changes in the gastrointestinal vessels provided most of the material. The importance of the arteriosclerotic factor in the occurrence of bleeding peptic ulcers was recently stressed by Wangensteen.⁸ Ulcerations of the esophagus, stomach and duodenum have been reported under a variety of primary conditions, after operations and in connection with shock.⁷ However, the present material proves that under various traumatic or spontaneous pathologic intracranial conditions hemorrhagic ulcerations and softenings of the gastrointestinal tract occur. They were seen after traumatic lacerations of the brain with subdural and subarachnoid hemorrhages, spontaneous subarachnoidal hemorrhages, spontaneous cerebral hemorrhages, cerebral thrombosis and arteriosclerosis, cerebral tumor, purulent meningitis, cerebral abscess, acute encephalitis and barbiturate poisoning. Gross lesions of the brain were absent in only 2 out of 30 cases of perforation of esophagus or stomach. There is no explaining why gastrointestinal ulcerations and softenings were not observed more often in connection with these intracranial lesions when the same

7. Pringle, J.; Stewart, L., and Teacher, J. H.: Digestion of the Esophagus as a Cause of Postoperative and Other Forms of Hematemesis, *J. Path. & Bact.* **24**:396 (Oct.) 1921. Bartels, E. C.: Acute Ulcerative Esophagitis: Pathologic and Clinical Study of Eighty-Two Cases Observed at Necropsy, *Arch. Path.* **20**:369 (Sept.) 1935. Butt, H., and Vinson, P.: Esophagitis: Anatomy and Physiology and Review of Literature, *Arch. Otolaryng.* **23**:391 (April) 1936. Bloch, L.: Acute Ulcerative Esophagitis, *Am. J. Digest. Dis.* **7**:407 (Oct.) 1940. Penner, A., and Bernheim, A.: Acute Postoperative Esophageal Gastric and Duodenal Ulcerations: Further Study of Pathologic Changes in Shock, *Arch. Path.* **28**:129 (Aug.) 1939; Acute Postoperative Enterocolitis: A Study on Pathologic Nature of Shock, *ibid.* **27**:966 (June) 1939. Dick, R. C., and Hurst, A.: Chronic Peptic Ulcer of the Esophagus and Its Association with Congenitally Short Esophagus and Diaphragmatic Hernia, *Quart. J. Med.* **11**:105 (April) 1942. Chamberlin, D. T.: Peptic Ulcer of the Esophagus, *Am. J. Digest. Dis.* **5**:725 (Jan.) 1939. Feldman, M.: Peptic Ulcer of the Lower Esophagus Associated with Esophageal Hiatus Hernia: Report of Two Cases, *Am. J. M. Sc.* **198**:165 (Aug.) 1939.

8. Wangensteen, O. H.: The Ulcer Problem: Etiology with Special Reference to Inter-Relationship Between Vascular and Acid-Peptic Digestive Factors: Characterization of Satisfactory Operation Which Will Protect Against Recurrent Ulcer (Listerian Oration), *Canad. M. A. J.* **53**:309 (Oct.) 1945.

pathologic conditions involving the brain or the meninges were seen in cases with and without ulcerations or softening of the gastrointestinal tract. It seems likely that autonomic centers and fibers can be stimulated under varying conditions—by direct pressure from hemorrhages or exudates or by disturbances of blood supply, thrombosis, anoxemia, edema or inflammation. Hemorrhagic ulcerations or softenings of the esophagus, stomach or duodenum followed such stimulation in several instances. The reason that none of these ulcerations or softenings had been diagnosed during life could be seen in the disturbed or comatose condition of the patients.

During the preparation of this paper, hemorrhagic, ulcerative esophagitis was observed in a patient aged 64 with Alzheimer disease; hemorrhagic acute terminal duodenal ulcers were seen in 3 patients with cerebral arteriosclerosis and multiple thrombotic softenings, and advanced gastromalacia was seen in several patients, in 1 of whom perforation of the stomach and digestion of the spleen, diaphragm and left lung, associated with spontaneous cerebral hemorrhage of two days' duration, were observed.

SUMMARY

In a large autopsy material, the coincidence of intracranial lesions with and their relationship to acute hemorrhagic ulcerations and softenings of the gastrointestinal tract were studied. Mucosal hemorrhages of the stomach, duodenum and other parts of the intestine were frequently encountered in routine autopsies; they were a terminal phenomenon occurring under a variety of conditions. More important were advanced stages of vascular disturbances involving the esophagus, stomach and duodenum, such as gross bleeding from mucosal hemorrhages, hemorrhagic ulcerations or softenings with perforations. These lesions were observed in association with various injuries and diseases of the meninges and brain. In cases of ulcer formation, microscopically, an intense inflammatory reaction, hemorrhages and venous thrombi were noted in and near the necrotic area. In cases of softening, the necrosis of the wall extended through all layers, and the inflammatory reaction was insignificant. It seems likely that autonomic centers had been stimulated in a variety of pathologic intracranial conditions and that the irritation had produced mucosal hemorrhages or ulcerations or softenings of the gastrointestinal tract or a combination of such lesions. In this paper, 26 cases of acute hemorrhagic ulcerations and 30 cases of softenings and perforations of the esophagus, stomach and duodenum are reported. In all but 2 cases the gastrointestinal lesions were associated with intracranial lesions of various natures. Hemosiderin was observed in 3 cases of esophageal ulcer, staining diffusely the necrotic area. In all other cases the reaction for hemosiderin was negative.

Metropolitan State Hospital.

ABREACTION IN THE MILITARY SETTING

MAJOR HAROLD ROSEN

AND

CAPTAIN HENRY J. MYERS

MEDICAL CORPS, ARMY OF THE UNITED STATES

IN THEIR epoch-making work on hysteria, Freud and Breuer first used the term "abreaction" to describe the intense reproduction, under hypnosis, of the original emotion accompanying the recollection of traumatic experience.¹ Recently, with the increased use of intravenously injected barbiturates in the treatment of war neuroses, the importance of abreaction as a therapeutic measure has been stressed. It is basic in narcosynthesis,² or narcoanalysis,³ and in hypnoanalysis.⁴ The purpose of this paper is not to review the literature dealing with the subject but, rather, to present a brief outline of our experiences with, and our conclusions about, the use of abreaction in the treatment of combat-precipitated neuroses in the only general hospital in the European Theater of Operations in which the total case load was continuously neuropsychiatric.

Abreactive therapy seemed especially valuable as an initial step in the treatment of acute battle reactions with pronounced amnesias, severe anxiety states, hallucinatory experiences, regressive phenomena, apparently psychotic episodes or severe conversion symptoms. In most cases, however, the abreacted material had to be utilized immediately. We have occasionally seen improvement when the patient was allowed to fall asleep at the end of a session, but in our experience such a procedure usually has no more curative value than a half-forgotten nightmare (cases 3 and 5). We have found it a *sine qua non* of abreaction with the barbiturates to keep the patient awake and to bring about immediate recall, in the waking state, of the material uncovered under narcosis. When intravenously injected barbiturates are used, the physician who is too busy to remain until the effects of the drug wear off can assign a corpsman or a nurse, or even another patient, to stay with the soldier

1. Hendrick, I.: Facts and Theories of Psychoanalysis, ed. 2, New York, Alfred A. Knopf, 1944.

2. Grinker, R. R., and Spiegel, J. P.: War Neurosis in North Africa—The Tunisian Campaign, New York, Josiah Macy Jr. Foundation, 1943.

3. Minski, L.: War Neuroses, *Am. J. Psychiat.* **101**:600, 1945.

4. Hadfield, J. A.: Treatment by Suggestion and Hypno-Analysis, in Miller, E.: *The Neuroses in War*, London, Macmillan and Company, Ltd., 1940, chap. 7.

who has abreacted, to walk and to talk with him and to keep him awake. Kubie⁵ stated:

. . . whatever the method used, whether it is hypnosis alone, hypnosis under narcosis or hypnagogic reveries with or without narcosis, the recovered material must be fully fused with its appropriate emotional content and with normal waking consciousness.

To us, the most important aspect of abreactive therapy, so called, consists in the ultimate aeration of conflict material on the conscious level. This is of prime importance when conversion symptoms are removed and underlying anxiety, with or without depression, comes to the fore. It is even more important when symptomatic recovery, partial or complete, is achieved after an abreaction or a series of abreactions. Valuable as emotional catharsis has proved itself to be, it must, nevertheless, be considered merely one stage in a therapy which has as its goal the reintegration of the total personality of the patient under treatment.⁶

Abreaction may be spontaneous, suggested under hypnosis or induced with drugs. Some patients abreact spontaneously. Months after leaving the line, they repeatedly hallucinate themselves back into menacing, terror-laden combat situations for which otherwise they seem completely amnesic. Sudden, unexpected noises, like the slamming of a door, can constitute the stimulus (case 1). Perhaps a mere drink or two of an alcoholic beverage may precipitate the abreaction. So may superficially innocuous discussions about combat (cases 2 and 3). Raines and Kolb⁷ stated that abreaction in their cases was obtained, on a conscious level for the most part, by individual psychotherapeutic sessions during which the patient was brought to relive his battle experience.

In our experience, however, conscious abreaction of this type cannot be affected quite so universally as these authors seem to believe. With most of the combat-precipitated psychiatric casualties seen at this installation, abreaction must be induced. Various pharmacologic agents have been recommended. In forward areas, the British used ether.³ Psychiatrists in the Red Army apparently also made use of this drug.⁸ Nitrous

5. Kubie, L. S.: Manual of Emergency Treatment for Acute War Neuroses, *War Med.* **4**:582 (Dec.) 1943.

6. (a) Kubie.⁵ (b) Grinker, R. R., and Spiegel, J. P.: Brief Psychotherapy in War Neuroses, *Psychosom. Med.* **6**:123, 1944. (c) Grinker, R. R.: Treatment of War Neuroses, *J. A. M. A.* **126**:142 (Sept. 16) 1944. (d) Grinker, R. R., and Spiegel, J. P.: War Neuroses in Flying Personnel Overseas and After Return to the U. S. A., *Am. J. Psychiat.* **101**:619, 1945.

7. Raines, G. N., and Kolb, L. C.: Treatment of Combat Induced Emotional Disorders in a General Hospital Within the Continental Limits, *Am. J. Psychiat.* **101**:331, 1944.

8. Zilboorg, G.: Some Aspects of Psychiatry in the U. S. S. R., *Am. Rev. Soviet Med.* **1**:562, 1944.

oxide has been tried.⁹ Scopolamine hydrobromide has been used in combination with morphine sulfate.⁵ Alcohol has at times been called the drug of choice,¹⁰ but with acute combat casualties its use is obviously contraindicated because of the danger of cerebral involvement. The barbiturates are now being administered, orally and intravenously, on a wide scale.¹¹

Nevertheless, suggestion hypnosis constitutes the simplest abreactive agent. We have seen few patients who could not be hypnotized at first trial within, at the most, a five minute period, provided that symptoms seemed of the type for which abreactive therapy was indicated as part of the treatment program. Ready suggestibility seems almost characteristic of such patients, whether they show psychotic-like pictures or not, and this is especially true of acute battle casualties with pronounced regressions. Technics are simple and can readily be learned, even without formal instruction.¹² On the other hand, it appears at times practically impossible to hypnotize soldiers hospitalized for medicolegal reasons by order of a court martial, and it seems almost as impossible to hypnotize patients completely out of contact because of severe and all-enveloping depressions, equally severe regressions or confusional states with extreme disorientation. For such patients, intravenous injection of a barbiturate is indicated, at least for the initial abreaction. With most patients, suggestion hypnosis can be utilized during subsequent sessions (case 4).

Abreaction under suggestion hypnosis, in our experience, cannot be distinguished clinically from the abreaction induced with pentothal or amytal.¹³ Lambert and Rees¹⁴ utilized both verbal hypnosis and narcosis induced by intravenous injection of barbiturates in 247 cases of hysteria and found no significant difference. Erickson¹⁰ urged more extensive utilization of hypnosis as a therapeutic procedure and stressed its

9. Rogerson, C. H.: Narcoanalysis with Nitrous Oxide, *Brit. M. J.* **1**:811, 1944.

10. Erickson, M. H.: Hypnotic Techniques for the Therapy of Acute Psychiatric Disturbances in War, *Am. J. Psychiat.* **101**:668, 1945.

11. Grinker and Spiegel.² Minski.³ Kubie.⁵ Grinker and Spiegel.^{6b, d}

12. Brenman, M., and Gill, M. M.: *Hypnotherapy*, New York, Macy Foundation Review Series, 1944, vol. 2, no. 3, chap. 3.

13. Two of our patients had abreacted first under amytal narcosis, then under suggestion hypnosis and, finally, under amytal narcosis again. On each occasion, the abreaction was apparently of the same intensity. Near the end of each abreaction, the patient was given the same posthypnotic (or, rather, postabreactive) suggestion, to be carried out twenty-four hours later. The suggestion was ignored after amytal narcosis, but not after hypnosis. For obvious reasons, however, no conclusions can be drawn from so isolated an experiment.

14. Lambert, C., and Rees, W. L.: *Intravenous Barbiturates in the Treatment of Hysteria*, *Brit. M. J.* **2**:70, 1944.

advantage over the use of narcotic drugs. It is interesting to note that psychiatrists now seem to be returning to the hypnotic therapy first used by Breuer and Freud.

With the United States Army in the European Theatre of Operations, intravenously injected barbiturates appear to have been the most commonly utilized abreactive agents. To a large extent, this seems to have been due to the significant work of Grinker and Spiegel.¹⁵ With cases of the type encountered in our wards, barbiturates were not often necessary. In soldiers who abreact on the mere injection of the drug, conflict material is probably so close to the surface that aeration can usually proceed on the conscious level. Acutely ill patients, especially those with pronounced amnesia, confusion, hallucinations and other superficially psychotic symptoms, can usually be hypnotized in less time than it takes to sterilize the skin, inject the drug and induce the abreaction. We believe, therefore, that intravenous injection of barbiturates is indicated under the following conditions: (*a*) when the patient is completely out of contact or when he is uncooperative for medicolegal or other reasons; (*b*) when suggestion hypnosis has already been unsuccessfully attempted, or (*c*) when the therapist lacks training in hypnotic technics or confidence in his ability to use them.

Grinker and Spiegel preferred pentothal as the abreactive agent because its effects wear off quickly, permitting continuance of psychotherapy immediately after the discussion of battle experiences.² So far as we can determine, it makes little difference whether amytal or pentothal is injected. Amytal occasionally works when pentothal is without effect, and vice versa. Occasionally, neither hypnosis nor intravenous injection of barbiturates is sufficient. In such cases, intravenous administration of drugs with superadded suggestion hypnosis may be efficacious. This should always be tried. However, failures occur. In 1 of our cases repeated injections of amytal and pentothal, in conjunction with as often repeated concurrent attempts at hypnosis, were completely unsuccessful. Again, occasional patients abreact but, despite strong suggestion, remain amnesic for both abreaction and events abreacted, and these patients often fail to show symptomatic improvement (case 5). In failures of this type, electric shock seems to effect a partial remission, as a result of which the patient becomes more accessible to other forms of psychotherapy. We believe, therefore, that electric convulsive therapy is of value for patients with psychotic or psychotic-like pictures which have not responded to abreactive therapy. Electric shock seems to be of aid, however, primarily in helping the patient repress his traumatic experiences, rather than aerate them. Abreaction successfully induced in 2 such patients after partial remis-

15. Grinker and Spiegel (footnotes 2 and 6 *b* and *d*) Grinker.^{6e}

sions had been effected seemed to reprecipitate the original symptoms (case 6); and, in our opinion, abreactive therapy either is contraindicated after electric shock or should be used with extreme caution, although this opinion may have little validity because of the small number of patients so studied.

There seem to be four other contraindications to the use of abreactive therapy in the military setting. Concisely, these may be stated as follows: 1. A number of combat-precipitated psychiatric casualties show anxiety and depression without bizarre coloration. Treatment of symptoms on a conscious level is much less dramatic, but symptomatic improvement is usually just as rapid and just as pronounced. If a sense of ignominy and frustration about enforced withdrawal from combat is superadded, repressive technics may at times be indicated.¹⁶ 2. Some patients show startle reactions so pronounced that at times they seem to be climbing up walls, hanging on rafters or cowering under chairs and bedding. Such patients are to all intents and purposes abreacting spontaneously. They require heavy sedation, at least for a few days, after which they become much more approachable. By this time, abreaction may no longer be indicated, although for some patients it seems invaluable. 3. We do not believe it necessary to clear up every amnesia. Amnesia may represent an attempt to repress and forget painful emotional experience. As a result, we feel justified in using abreactive technics in the treatment of such amnesia only when the patient himself consciously desires to remember, is disturbed by his failure to remember or shows by the overt symptoms of anxiety, depression and the like, that the process of repression is unsuccessful. 4. Finally, in our experience, abreactive therapy of the type possible in the military setting is of little value in the treatment of chronic neuroses or of vague hypochondriacal syndromes.

Our discussion up to this point has been concerned primarily with indications and contraindications to the use of abreaction as the first step in the treatment of severe combat-precipitated psychiatric casualties. Military physicians have at times utilized this particular therapeutic procedure, without deeper or adjuvant therapy, for the "cure" of hysterical paralyses and other conversion symptoms. Whether such therapy, so called, is of much importance in the absence of free-floating anxiety is a problem which warrants further investigation. We have seen too many failures, in men transferred to this installation from other hospitals or sent back to duty and almost immediately rehospitalized, to be impressed. A complete reorientation of the total personality seems in

16. Needles, W.: A Statistical Study of One Hundred Neuropsychiatric Casualties from the Normandy Campaign, *Am. J. Psychiat.* **102**:214, 1945.

order, not merely the removal of a symptom serving to mask deep underlying insecurity, anxiety and even potentially suicidal depression.

All authors¹⁷ have stressed the importance of concomitant psychotherapy.¹⁸ Grinker and Spiegel^{6b} stated:

The idea that narcosis therapy of any form of abreaction is all that is necessary for the treatment of the acute war neuroses is erroneous, as proven by the fact that if nothing else is done for the patient he relapses. . . . Psychotherapy must be instituted as soon as possible.

Heath and Sherman¹⁹ stated that they found narcosynthesis disappointing and that "it often causes the patient to go beyond the war experience, stirring up old neurotic conflicts which may merge with the war reaction, thereby adding to the danger of chronicity." This seems to us to ignore the fact that war neuroses do not arise *de novo*, but bear a fundamental relation to the previous personality and to old conflicts. This was clearly recognized and expressed by Grinker and Spiegel.^{6d}

The associations [under pentothal] clearly bring out the dynamic relationship between the new neurotic reaction and the old character neurosis or psychoneurotic pattern which are the real perpetrators of the vicious cycle of anxiety. We are unsatisfied now until the patient becomes aware with emotional insight of the relationship between his reaction to inter-personal problems in the combat squadron and his old patterns or until he gains insight into these ancient dynamic forces.

Parenthetically, we might add that we have failed to see the benefit from ergotamine claimed by Heath and Sherman.¹⁹

Abreaction is not only a therapeutic weapon but a diagnostic one as well. Whether or not it can be used indiscriminately to detect the malingerer, as some authors have apparently claimed, raises a problem which we should like to discuss in detail in another paper, especially in view of the fact that at times malingering itself may constitute a symptom. Abreaction, nevertheless, has a definite place in the investigation of certain types of medicolegal cases. Ludwig²⁰ expressed the belief that with intravenous injection of barbiturates the malingerer resists narcosis and is unproductive and negativistic, in contrast to the

17. Morris, D. P.: Intravenous Barbiturates: An Aid in the Diagnosis and Treatment of Conversion Hysteria and Malingering, *Mil. Surgeon* **96**:509, 1945. Grinker and Spiegel.² Minski.³ Hadfield.⁴ Grinker and Spiegel.^{6b} Grinker.^{6c} Raines and Kolb.⁷

18. Psychotherapy often involved definite reassurance that the patient would not be returned to combat duty,^{6b} and this was particularly true for the conversion states.

19. Heath, R. G., and Sherman, S. H.: The Use of Drugs in the Treatment of Traumatic War Neuroses, *Am. J. Psychiat.* **101**:355, 1944.

20. Ludwig, A. C.: Clinical Features and Diagnosis of Malingering in Military Personnel: Use of Barbiturate Narcosis as an Aid in Detection, *War Med.* **5**: 378 (June) 1944.

neurotic patient, who "opens up" and becomes productive. Morris¹⁷ agreed with Ludwig and cited several cases. These are unconvincing. On the evidence presented, we should certainly never call his case 3 one of malingering, and we feel doubtful about his case 5. Hartman's²¹ experience seems of value in connection with this problem of malingering. He dealt with all prisoners sent to this hospital, several of whom claimed amnesia for their alleged offense. When the patient was assured that the medical officer wished to help him with his legal difficulties and that of course he, the patient, wished to recover his memory, it was possible in every case to clear up the amnesia, provided the examiner was persistent enough and the drug was pushed to a deep enough level. At first, this frequently necessitated the use of large amounts of amytal or pentothal. Later, it was found that with a combination of verbal hypnosis and drug narcosis the same results could be obtained with much smaller amounts of the drug. It was of interest that in patients suspected of malingering the first productions were bizarre and disconnected. Then, often in a sudden burst, a clear, connected story was obtained. This work contradicts Ludwig's claim that malingerers are always nonproductive, and the results are probably due to differences in the technics used.

Abreaction can also often be used as a definite aid in the differentiation of mute, regressive psychotic-like reactions from actual psychoses. One patient produces a wealth of paranoid ideas, hallucinations, and the like, while another, with approximately the same clinical picture, hallucinates and relives the traumatic events which precipitated his symptoms. The prognosis is relatively good if the thought content, as determined by material released during abreaction, is concerned primarily with recent battle trauma (cases 1 to 5). With some patients, however, childhood or adolescent traumatic experience comes to the fore. For example, a catatonic-like patient who complained of pains in the shoulders and back, when abreacting began hallucinating his unexpectedly early return from elementary school, saw his mother in the midst of intercourse with a stranger on the living room floor, flung himself on his rival, felt his shoulder gripped and was hurled against the wall, bruising his back. This type of reaction is not uncommon and seems usually concerned with fantasied or actual sexual experience, not necessarily, as in this case, incestual. We believe that with such patients the fundamental mechanism is probably schizophrenic, rather than that of a major hysteria (case 7). For such patients, diagnostic abreaction is indicated, but abreactive therapy should be approached with infinite caution. It seems, in fact, contraindicated for most psychotic patients.

21. Hartman, J.: Unpublished data.

A few illustrative examples may be of value. Detailed case histories have been incorporated in various articles already published. This paper is concerned primarily with abreaction as such, and therefore no attempt will be made to present the detailed psychodynamics and developmental histories of the patients involved. All were in their middle twenties. All had had at least two months of combat. Several had been awarded medals for undoubted heroism. All were amnesic for the traumatic experiences which precipitated their symptoms. Unless otherwise stated, the precombat personalities were essentially stable. Therapy consisted primarily of ventilating conflict material on the conscious level. Within four to six weeks, sufficient insight was attained in each case, and enough of a psychologic reorientation effected, for us to describe the result as symptomatic recovery. All were transferred to the Zone of the Interior. For most, unfortunately, follow-up studies have not as yet been obtainable. The cases are summarized as follows:

CASE 1.—Spontaneous abreaction to noise. The patient was defecating by the side of a road when his tank was blown to smithereens and its crew killed. He immediately became amnesic for the whole incident and, as a result, was soon hospitalized, a jittery and tremulous patient with extreme sensitivity to noise, pronounced disturbance of sleep and terrifying combat nightmares. Treatment consisted of modified insulin and amytal narcosis. Within six weeks he was discharged to noncombat duty. While still hospitalized, he had had frequent "black-outs," as a result of which he had been specifically instructed to see no pictures except Mickey Mouse cartoons. Two days after his discharge to a replacement depot, his anxiety was pronounced enough to necessitate rehospitalization, and he was admitted to this installation. He seemed calm and well oriented; nevertheless, he was unable to remember what had happened. While we were taking his history, a door in the ward slammed shut. In an instant he was crouching in a corner of the room, his eyes widely dilated. His tank was again aflame! His comrades were being incinerated! Shells began falling round about! He started to shoot a sniper some distance away (and if he had actually had a gun, one of us would no longer be alive!). A plane swooped down, strafing the road! He rolled panic-stricken into a ditch, landed head first and lost consciousness. With this, the abreaction came to an end, eight or ten minutes after it had begun.

If this abreaction had occurred before the patient had been rehospitalized, it is possible that nearby property would have been damaged, persons hurt and medicolegal complications arisen. As it was, the patient knew only that another brief "black-out" had taken place. He was completely amnesic for both abreaction and incidents abreacted. Nevertheless, with material so close to the surface as this, aeration on the conscious level was indicated. Neither intravenous administration of barbiturates nor suggestion hypnosis was needed. He was therefore given three or four psychotherapeutic interviews a week during a four week period. The material became conscious; his previous patterns of behavior came to light; insight was attained, and a symptomatic recovery was effected.

CASE 2.—Spontaneous abreaction to discussion of combat by other patients. The patient, a private first class, after two and one-half months in the line was placed in noncombat service because of "combat exhaustion". He seemed unable to discharge even the mildest of duties with any acceptable degree of efficiency

and was therefore hospitalized, boarded and transferred to this installation for holding until his transfer to the states became effective. On his admission here, his affect seemed somewhat flat; he had difficulty in concentrating and complained of occasional combat nightmares. Aside from this, he seemed free from symptoms. Nevertheless, on the afternoon of his admission, when fellow patients began to reminisce about combat experience his eyes dilated, he began to tremble and he found himself back in combat again. This occurred three times during his first two days here, once on his fourth day in the hospital and once on his sixth. The stimulus was always the same. On each occasion his abreaction lasted three to five minutes. During his twelve days at this installation, he received seven hours of individual psychotherapy. His affect no longer seemed flat, and he stated that he no longer had difficulty in concentrating. So far as we could determine, he was free from symptoms at the time of his transfer to the Zone of the Interior.

CASE 3.—Spontaneous abreaction to discussion of combat by the patient himself. The patient was hospitalized for two and one-half months, after which he was discharged to noncombat duty only to be rehospitalized within a week. Two months later, or four and one-half months after his original breakdown, he was transferred to this installation, as a case of moderately severe anxiety with a pronounced startle reaction and complete amnesia for traumatic experiences immediately preceding his initial hospitalization. However, he had previously had four sessions of abreaction induced with pentothal and one induced with amytal. According to his statement, "I blew my top each time. The next day, the doc would tell me everything I said. That's how I know what happened. But I don't remember anything about it."

Free association was tried with this patient. Within five minutes he began describing his early combat experiences, and ten minutes later he was actually reliving them again. Abreaction was induced in this way on four successive days, and the abreacted material was discussed with him immediately after each session. The first two abreactions were characterized by amnesia for the events abreacted. The third was so pronounced that the very intensity of the emotional release "awakened" him, and abreacted material was recalled as though part of a nightmare. The fourth abreaction was remembered in detail. On the fifth attempt, this patient was able to discuss combat without hallucinating. Within a week, he seemed free from symptoms. For three weeks, however, he received three psychotherapeutic interviews a week, of from one-half to three quarters of an hour each. He was then transferred to the States, at the time of his discharge from this hospital, so far as we could determine, with a symptomatic recovery.

CASE 4.—Abreaction induced with barbiturates followed later by suggestion hypnosis. This patient's break had been precipitated in the Ardennes salient three months before he was transferred here as a catatonic type of dementia precox. During this period, he had apparently been almost motionless and completely mute. On occasion it would seem as though he were trying to speak, only to drool instead. His eyes usually seemed about to pop from his head. Occasionally he would play with toys like a 3 year old, and at such times his face would relax into a delightfully ingenuous childlike smile. Hypnosis was unsuccessfully attempted, and therefore abreaction was induced by intravenous administration of amytal. Strong suggestion was given toward the close of the session. Subsequent abreactions were induced with suggestion hypnosis. The patient incidentally had had a year of college psychology. When hypnotized, he stated in so many words that he was utilizing his symptoms as an escape from combat, that he had no desire to get well and that he wished we would let him alone. Nevertheless, despite

his rationalization about his symptoms, we can see no basis for considering the possibility of malingering.

The literature is replete with the case histories of patients successfully treated with abreaction. The following cases illustrate possibilities of failure of the type mentioned in the preceding discussion. For obvious reasons, brief developmental histories with some of the material released during the course of the abreaction are included as part of the illustrative material.

CASE 5.—Postabreactive amnesia for material abreacted. A 19 year old rifleman had stammered until the age of 5 and was afraid of high places but his past history was otherwise stable. After three and one-half months of continuous combat, he was hospitalized for three weeks because of a badly contused left knee, after which he was returned to duty, only to be rehospitalized five days later, stammering, tremulous and jittery. During the next six weeks his symptoms became progressively worse, and he was transferred to this installation. On his admission, his speech defect was no pronounced as to make him completely understandable. He therefore found it necessary to write whatever he wished us to know. His heart was racing, and he had severe pain in the chest. He was depressed by thoughts of dead comrades, was plagued by nightmares of Germans throwing dismembered limbs at him before he bayoneted his tormentors, and was agonized by severe headaches. Sleep was difficult and at times impossible. He showed extreme sensitivity to noise. General information and intelligence were unimpaired.

During the course of his first abreaction, he described a bombing raid in the past tense. Then, "after it was over, I started shaking. I couldn't talk so good. That was all. . . . After that, we started to move. We . . . we . . . I . . . I don't know what the hell we were doing there, but we waited. And a sniper took a pot shot at me. I got scared. We looked around—couldn't see no one. I saw another sniper. He took a pot shot at my buddy. He hit him! I shot him out of the tree. He had his hand on his right arm. He started hollering, 'Kamerad!' I said 'f—k him!' When he came up to me, I shot him 10 yards away. He didn't have a gun. . . . And I'm always trying to forget about it. He tried to shoot me. He killed my buddy. I couldn't save him. . . . And the f—king Germans were shooting machine guns at us. I saw a tracer coming right at me. I fell to the ground. . . . Get that bastard! Where's my gun? I got him! They're shelling! Stay in your hole, men! God dam them—that one was close. Down, men! Stay down! [Tears] He's killed! They've got him. He had a nice family back home. Two blocks away, we lived. Kill the bastards! . . . I'll shoot! I'll shoot them all! I've got that f—king son of a bitch! I bayoneted that other c.s. . . . I bayoneted him! I tried to forget him! I can't! I can't!" And this patient saw three and a half months of grueling infantry combat after this particular experience.

Soon after each abreaction, he would become amnesic for the events abreacted. The material was nevertheless discussed with him. By the time of his transfer to the Zone of the Interior, four weeks later, all but one of his symptoms had disappeared, but his stammer was still so pronounced as to make it impossible to understand anything he tried to say.

CASE 6.—Partial remission effected by electric shock, followed by abreaction-induced reprecipitation of original symptoms. The patient, a 19 year old private,

hated his father because the latter beat him and his mother. He had stammered until the age of 7, was enuretic and somnambulistic until he was 10 and frequently had ejaculatio precox. He had served through the African and Sicilian campaigns as a cannoneer. He was hospitalized with a moderate startle reaction. He was unable to eat or sleep, had hallucinations of the presence of dead comrades and was profoundly depressed and suicidal. After three electric shocks, he showed a partial remission. He was in contact, but the symptoms present on admission were reprecipitated when he underwent abreaction. Whether or not he would have had a relapse within a few days if abreaction had not been tried is impossible to state.

CASE 7.—Abreactive material not concerned primarily with combat experience. The patient was a 26 year old corporal whose background included a loveless marriage with a girl who two years later divorced him, a passionate love affair with another girl who became his mistress but refused to marry him because of differences in their respective religions, an intense ambition to become a writer and a legal education which he had not quite completed before his induction into the service. His break was precipitated during the collapse of the Ludendorf bridge. On admission, he was confused, wandered aimlessly about the ward, was constantly in a deep fog, seemed disoriented for time and place and was unable to remember his age or any details about his past life. Under suggestion hypnosis, he abreacted segments of his whole life in cross section, the individual events being tied together by the same emotional tone. A portion of the abreacted material follows. "He's up on the bridge. He's a human animal. I wish he were dead. I wish the bridge would cave in. . . . It's falling down! See what you did? See what happens to bad people? Can't torment me any more! See how you suffer? There's something the matter with my head. Whitie—he threw a rock at it. If he ever does that again, I'll hurt him. I won't have bad little boys coming into my kingdom. I won't let him climb and climb into the clouds with me. And you're a human animal, too. You say you won't marry me? You ought to be dead! I'll kill you! I'll kill you! I'll kill you all!"

We believe that in this case an underlying schizophrenic reaction type was asserting itself. The abreaction therefore can be considered a diagnostic one.

SUMMARY AND CONCLUSIONS

Some of the more recent literature dealing with abreaction is discussed and reviewed, and illustrative cases are reported. The following conclusions are reached as the result of our experience with patients in the only general hospital in the European Theatre of Operations in which the total case load was continuously neuropsychiatric.

1. With some patients, abreaction can be induced spontaneously. Many abreactive agents are available, among them sodium amytal, pentothal, ether and nitrous oxide. We believe that suggestion hypnosis is the method of choice because of the ease of administration and the simplicity of technic. Most acute psychiatric combat casualties can be hypnotized as readily and as quickly as the abreaction can be induced with intravenously injected barbiturates. It is therefore recommended that the latter method be used only when suggestion hypnosis is unsuccessful.

2. Abreactive therapy seems of importance primarily as an initial step in the treatment of acute battle reactions with amnesia, severe anxiety symptoms, hallucinations, regressive phenomena or major conversion symptoms. It is believed to be of value because of the sometimes amazingly rapid symptomatic recoveries which it helps to effect. Such therapy, despite its frequent superficially dramatic, and even melodramatic, results, must be considered merely as part of a long range psychotherapeutic program designed to meet the needs of the individual patients under treatment. Other forms of psychotherapy must be utilized in addition or the patient will relapse. This is true because of the underlying relation of present symptoms, old neurotic conflicts, personality development and general patterns of behavior. Nevertheless, the value of emotional catharsis per se should not be minimized.

3. In the military setting, abreaction is contraindicated for the continued treatment of psychotic patients, for certain types of patients with pronounced startle reactions, for chronically neurotic persons and patients with hypochondriacal syndromes and for patients for whom repressive technics are indicated.

4. Abreaction may also be utilized with some patients for the differential diagnosis of psychoses from psychotic-like and neurotic reactions. With the latter, abreactive thought content for the most part seems concerned primarily with recent combat experience. It may also be utilized, but warily, for the differential diagnosis of malingering, provided it be kept in mind that malingering often constitutes a symptom.

Phipps Psychiatric Clinic.
St. Elizabeth's Hospital.

NEUROGENIC ARTHROPATHY (CHARCOT JOINT) ASSOCIATED WITH DIABETIC NEUROPATHY

Report of Two Cases

MAJOR D. BERNARD FOSTER
MEDICAL CORPS, ARMY OF THE UNITED STATES

AND

R. C. BASSETT, M.D.
ANN ARBOR, MICH.

IT is a matter of general knowledge that tabes dorsalis or syringomyelia underlies most neuropathic joints; the mechanism by which these diseases predispose afflicted persons to the development of neurogenic arthropathy (Charcot joint) is still imperfectly understood. Disease processes which afflict areas of the nervous system other than those involved in tabes dorsalis or syringomyelia offer an approach to a better understanding of the genesis of such joint disorders; for this reason, and because of the scarcity of similar observations, the following cases of Charcot joint complicating the neuropathy of diabetes mellitus are presented.

REPORT OF CASES

CASE 1.—*History*.—W. E., a poolroom proprietor aged 23, was admitted to University Hospital because of swelling of the left foot, of five months' duration. His occupation required him to stand about ten hours a day, and for two or three months prior to onset of the swelling he had worn canvas shoes with thin rubber soles instead of his customary firm leather shoes but no specific trauma to the foot was recalled. The swelling increased with activity and subsided somewhat with elevation of the foot; there had been mild pain in the calf at the onset but none in the area of swelling. There was no redness, drainage, previous abrasion of the skin, fever or constitutional symptoms.

Polyuria, polydypsia, polyphagia, glycosuria, loss of weight and enuresis began at the age of 13 years; insulin and dietary therapy was instituted and closely supervised for the next three years, with relative freedom from symptoms. Less care was exercised in the management of his diabetes during the next four years, but no complications appeared except for numbness in the legs at the age of 20. When he was 21, acidosis without coma had developed, and the diet and insulin dosage were readjusted. At the age of 22 all use of insulin was discontinued for one month in order to try an oral therapy for diabetes; he lost 30 pounds (13.6 Kg.) in one month and again experienced acidosis but regained weight and strength after the institution of insulin therapy and a restricted diet.

For three years he had noted numbness of both legs below the knees, and for six months he had urinated only once or twice daily. Erections and ejacu-

From the Departments of Neurology and Surgery, Neurosurgery Section, University Hospital, and the University of Michigan Medical School, Ann Arbor, Mich.

lations were normal. He stated that he had been generally weak in both the upper and the lower extremities since the diabetes was first discovered, with less muscular strength than the average throughout his later development; but there had been no noticeable change in recent years except when he had acidosis.

There was no history of syphilis. His father, mother, sibling (1), wife and 4 month old daughter were living and in good health.

General and Neurologic Examination.—Punctate retinal hemorrhages were present bilaterally. The left forefoot showed moderate edema and induration over the midtarsal area, loss of the longitudinal arch and painless hypermotility, with slight crepitus on passive motion. The pulsations of the dorsalis pedis and posterior tibial arteries were easily palpable.

The cranial nerves were normal. There were mild diffuse weakness of the extremities, with generalized flabbiness and hypotonia, and focal diminution in muscular power in the dorsiflexors of the left ankle, apparently due to the local bony lesion. Fibrillations, focal atrophy and ataxia were absent. The biceps, triceps, patellar, hamstring and achilles reflexes were absent and the plantar reflex was diminished bilaterally. The abdominal and cremasteric reflexes were normal. Vibratory sensation was slightly diminished distally in the lower extremities; deep pain sensibility and the sense of position were well preserved. Superficial pain sensation was absent in a stocking fashion from 3 inches (7.5 cm.) above the malleoli distally and was diminished to 2 inches (5 cm.) below the patellas, the loss being slightly greater on the right than on the left. Temperature sensation was absent from 2 inches above the knee bilaterally and was diminished to the groins; tactile sensation was absent over the toes and was diminished to the knees. Sensation was normal over the saddle area, the trunk and the upper extremities. Tenderness of the muscles and nerve trunks was absent. Cystometric examination revealed an early atonic neurogenic bladder (first desire to void at 250 cc.; maximum intravesical pressure, 6 mm. of mercury; capacity, 800 cc.; doubtful temperature perception, and no residual urine). Sweating tests showed normal sweating over the abdomen and groin, diminished sweating over the thighs and absence of sweating from 1 inch (2.5 cm.) above the knees distally. Cutaneous temperature recordings were taken at constant room temperatures with the patient in the resting state, after use of nicotine, after immersion of the arms in hot and cold water and after spinal anesthesia used to give a complete sympathetic block. The resting temperature over the dorsum of the left foot consistently averaged from 2.25 to 2.75 degrees (C.), or 4.05 to 4.95 degrees (F.), higher than that over the right foot; after the use of nicotine the cutaneous temperature increased (normally decreases) over both feet. After spinal block the cutaneous temperature increased only 1.07 degree (C.), 1.92 degrees (F.), over the left foot and 1.37 degrees (C.), or 2.66 degrees (F.), over the right foot (average increase in normal persons from 5 to 9 degrees (C.), or 9 to 16.8 degrees (F.)). The distal reduction in temperature commonly present with peripheral vascular disease was not observed. The findings were interpreted as those of partial paralysis of the vasoconstrictor fibers to the lower extremities, the paresis being greater on the left than on the right.

Laboratory Examinations.—Glucose and acetone bodies were present in the urine on his admission to the hospital. The hemoglobin of the blood measured 15.6 Gm.; the red cell count was 5,200,000 and the white cell count 5,000, per cubic millimeter and the differential count was normal. Roentgenographic examination of the chest was normal, and the test with tuberculin gave a negative reaction. The sedimentation rate was normal. The dynamics of the cerebro-

spinal fluid were normal; the cellular content was 4 per cubic millimeter. The Pandy reaction was positive for globulin, and the total protein measured 74 mg. per hundred cubic centimeters. The colloidal gold curve was 0000000000, and the Kahn reactions of the blood and cerebrospinal fluid were negative. Roentgenograms of the spine revealed minimal spina bifida occulta of the first sacral segment; roentgenograms of the left foot (fig. 1) showed extensive disorganization of the tarsometatarsal joints. There was advanced destruction of the three

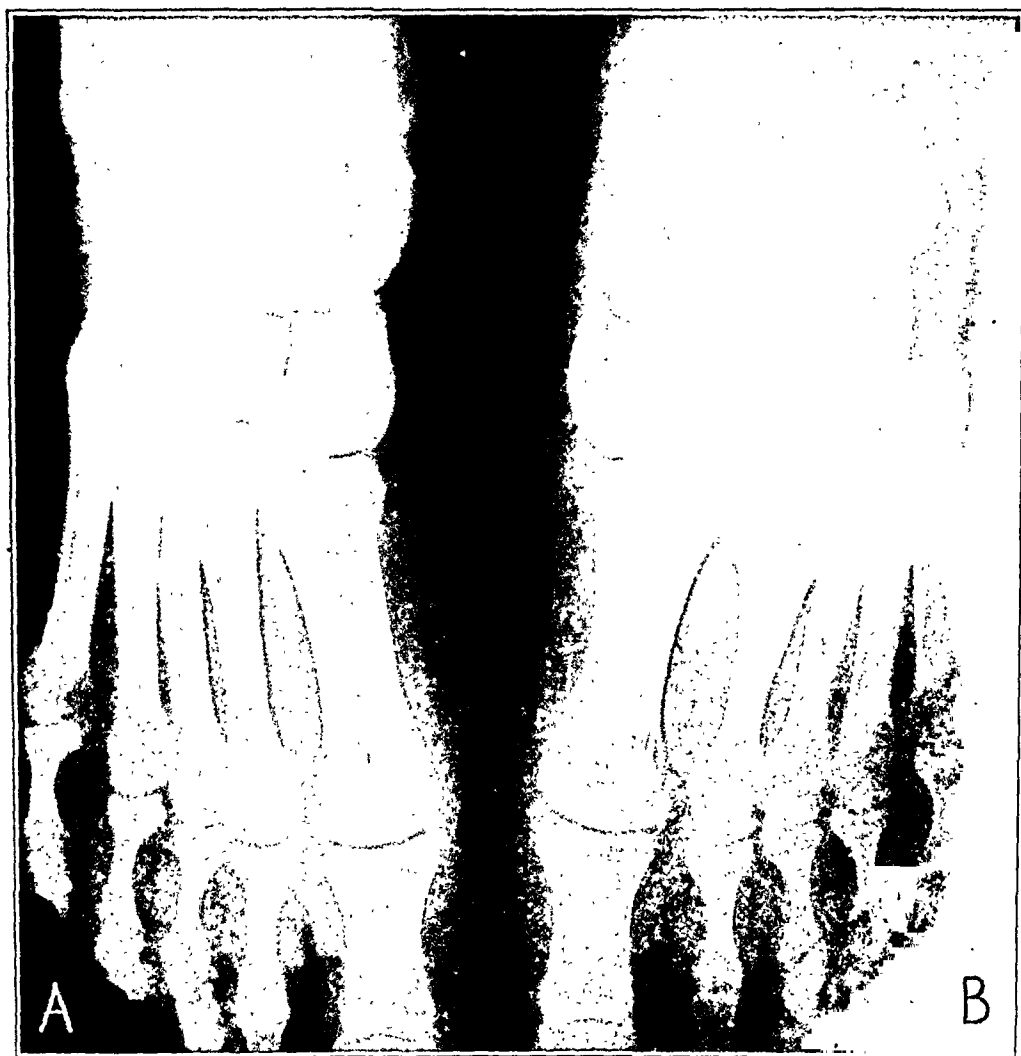

Fig. 1 (case 1).—*A*, normal right foot; *B*, neuropathic tarsal joint of the left foot, with medial displacement of the cuboid and navicular bones, destructive changes in the tarsal and metatarsal bones, loss of the joint surfaces and proliferative changes, best seen about the metatarsal heads of this projection.

cuneiform bones and their adjacent surfaces; the cuboid and navicular bones were displaced medially. The medial and distal surfaces of the cuboid bone, the distal surface of the navicular bone and the proximal ends of the second, third and fourth metatarsal bones were involved in the destructive process. Proliferative changes were present in the metatarsal heads, and there were numerous loose bodies about the area of disorganization. No change could be seen in roentgenograms made one month later.

Course.—On a diet furnishing 3,000 calories per day and containing 100 Gm. of protein and 200 Gm. of carbohydrate, the patient was rendered aglycosuric with 40 units of protamine zinc insulin and 65 units of regular insulin daily.

CASE 2.—History.—G. W., a farmer aged 29, single, was admitted to the University Hospital because of painless, progressive swelling and deformity of the left ankle, appearing without apparent precipitating cause two months prior to examination. He had continued to bear his weight on the foot until an ulcer developed over the lateral malleolus, five weeks after onset.

At the age of 12, after a six month period of polyuria, polydypsia, polyphagia and loss of weight, the patient passed into coma and a diagnosis of diabetes mellitus was made. For two years treatment with insulin and a high fat diet was carried out; then use of insulin was discontinued for four years, although the prescribed diet was followed. At the age of 18 a higher carbohydrate diet with insulin was prescribed, but periodic urinalyses usually showed some degree of glycosuria. At the age of 22, after a period of loss of weight, he was told by a physician that he was in acidosis. Shortly thereafter a minor abrasion of the anterior surface of the left leg led to a severe infection, requiring surgical drainage and six weeks of hospital treatment. Irregular amounts of insulin were used in the following two years, and an ulcer developed under the base of the right great toe. Large amounts of sugar were present in the blood and urine on admission to the hospital at this time, and ten weeks of hospital care was required to control the diabetes and to heal the ulcer. At the age of 27 the second toe of the left foot became infected and amputation was necessary. More care was taken with the diet and administration of insulin in the ensuing two years, but some degree of glycosuria persisted.

· Numbness and tingling in the hands and feet had been present about three years; cramps occurred frequently in the calves. He did about one-half an average farmer's duties per day because of weakness and ease of fatigue. He urinated but once or twice daily and had never had erections or ejaculations.

There was no history of syphilis; the father had died of cancer of the throat and the mother of diabetes. There were no siblings.

General and Neurologic Examination.—Linear and punctate retinal hemorrhages were present bilaterally. The liver descended 3 cm. below the costal margin on inspiration. The scars of surgical drainage were present over the anterior and lateral aspects of the middle third of the left tibia, and a clean, graulating ulcer was present over the inferior portion of the lateral malleolus. Induration and edema extended midway up the tibial surface of the left leg; there were painless hypermotility, crepitus on passive motion and pronounced medial displacement of the left ankle. The toe nails were brittle, and the skin over the legs was dry and scaling. The second toe on the left foot had been amputated (fig. 2). The pulsations of the dorsalis pedis and posterior tibial arteries were palpable.

The cranial nerves were normal. There were mild diffuse muscular atrophy, hypotonia and paresis of the upper and lower extremities bilaterally, with somewhat greater paresis of the extensor hallucis longus muscles. Voluntary motion of the left ankle was impaired because of the derangement of the joints. Fibrillations, focal atrophy and ataxia were absent. The biceps and patellar reflexes were weakly preserved bilaterally, and the abdominal reflexes were normal. The triceps, cremasteric, hamstring and achilles reflexes were absent, and the plantar reflexes were diminished. Vibratory sensation was diminished distally in the lower extremities; the sense of position was intact. Deep pain sensibility was

diminished in the achilles tendon, the hamstring tendons and the testis on both sides. Superficial pain sensibility was absent below the midcalf on the left, approximating a stocking type of sensory loss, and was diminished to about 3 inches below the inguinal ligament; it was absent from 1 inch above the malleoli distally of the right leg and was diminished to the level of the knee. Temperature sensation was impaired over a similar distribution, the loss likewise being greater on the left side than on the right. Tactile sensibility showed a minimal distal diminution below the malleoli bilaterally. There was no disturbance in sensation in the saddle area, the trunk or the upper extremities. Tenderness over the muscles and nerve trunks was absent. Cystometric examination showed an atonic neurogenic bladder (first desire to void at 400 cc.; maximum intravesical pressure, 4 mm. of mercury; capacity, 1,500 cc.; absence of temperature



Fig. 2 (case 2).—Edema and displacement of the left ankle, dry hyperkeratotic skin and ulcer over the lateral malleolus.

perception, and 80 cc. of residual urine). Sweating tests showed normal sweating responses over the thorax, abdomen and groin; slight diminution over the lower third of the lateral aspect of each thigh, and complete symmetric absence of sweating from 1 inch below the knees distally. The results of cutaneous temperature recordings were interpreted as those of almost complete symmetric paralysis of the vasoconstrictor fibers to the lower extremities. There was no local increase in heat over the afflicted joint; the disturbance was symmetric, and it was of greater magnitude than that in case 1. The characteristic cutaneous temperature readings of occlusive peripheral vascular disease was not found.

Laboratory Examinations.—In addition to glycosuria, urinalyses revealed a constant 2 plus reaction for albumin, without casts or red blood cells. The hemoglobin of the blood measured 12.4 Gm., and there were 8,600 white blood

cells per cubic millimeter. The sedimentation rate was normal. The Kahn reactions of the blood and the cerebrospinal fluid were negative. The dynamics of the cerebrospinal fluid were normal; the cells numbered 6 per cubic millimeter. The Pandy and Nonne-Apelt reactions for globulin were positive; the total protein content was 160 mg. per hundred cubic centimeters, and the colloidal gold curve was 0000000000. Roentgenograms of the gastrointestinal tract showed 15 per cent gastric retention at the end of five hours and impaired motility in the small



Fig. 3 (case 2).—Neuropathic left ankle joint, with medial displacement of the left ankle, destructive changes in the tibia, fibula and astragalus and loose calcium bodies surrounding the astragalus.

intestine. Roentgenograms of the spine, the pelvis and the right leg were normal. On the left side (fig. 3) there was severe disorganization of the ankle joint. The normal articulations of the astragalus with the tibia, fibula and os calcis had disappeared, with loose bodies above and about the remnants of the astragalus. The distal portion of the fibula had slipped downward from its articulation with the astragalus, and the ankle joint was displaced medially. The navicular bone,

os calcis and distal portions of the tibia and fibula showed loss of substance and fragmentation at their articulation with the astragalus.

Course.—On a diet furnishing 2,600 calories per day and containing 90 Gm. of protein and 200 Gm. of carbohydrate, the patient was rendered aglycosuric with 40 units of protamine zinc insulin and 30 units of regular insulin daily.

The foot was placed in a well padded shoe with a rigid caliper brace, and the diabetes was maintained under excellent control on the aforesaid regimen. He



Fig. 4 (case 2).—*A*, posterior tibial nerve, showing advanced perineural fibrosis, endoneural fibrosis and hyalinization of the endoneural arterioles at *a* and *a'*. Hematoxylin and eosin stain; $\times 70$; United States Army Medical Museum negative no 91819. *B*, higher magnification ($\times 230$) of a portion of the same section. United States Army Medical Museum negative no. 91814.

was reexamined at regular intervals; although the ulcer never showed any gross signs of infection, no healing occurred over a period of two years. There was no appreciable change in the neurologic status, and no striking changes appeared in serial roentgenograms of the ankle.

Twenty-five months after the patient was first seen, a guillotine amputation through the midcalf was performed, followed by plastic repair of the stump.

The wound healed uneventfully; a prosthesis was fitted, and the stump adjusted well to weight bearing. When the patient was last seen, the diabetes was under control with 90 units of insulin daily and a diet of 3,000 calories per day, containing 110 Gm. of protein and 200 Gm. of carbohydrate.

Pathologic Study.—Examination of the tissue removed by amputation showed severe degenerative changes in the peripheral nerves (fig. 4). There were striking reduction in the myelin sheaths and axis-cylinders, an increase in Schwann cells and advanced endoneural and perineural fibrosis; the smaller arterial branches within the nerve bundles had undergone varying degrees of hyaline degeneration. The arteries throughout the specimen showed mild to moderate hyalinization of their walls; one branch of the posterior tibial artery contained an old, well organized thrombus, which had recanalized. The malleolar ulcer had a base of

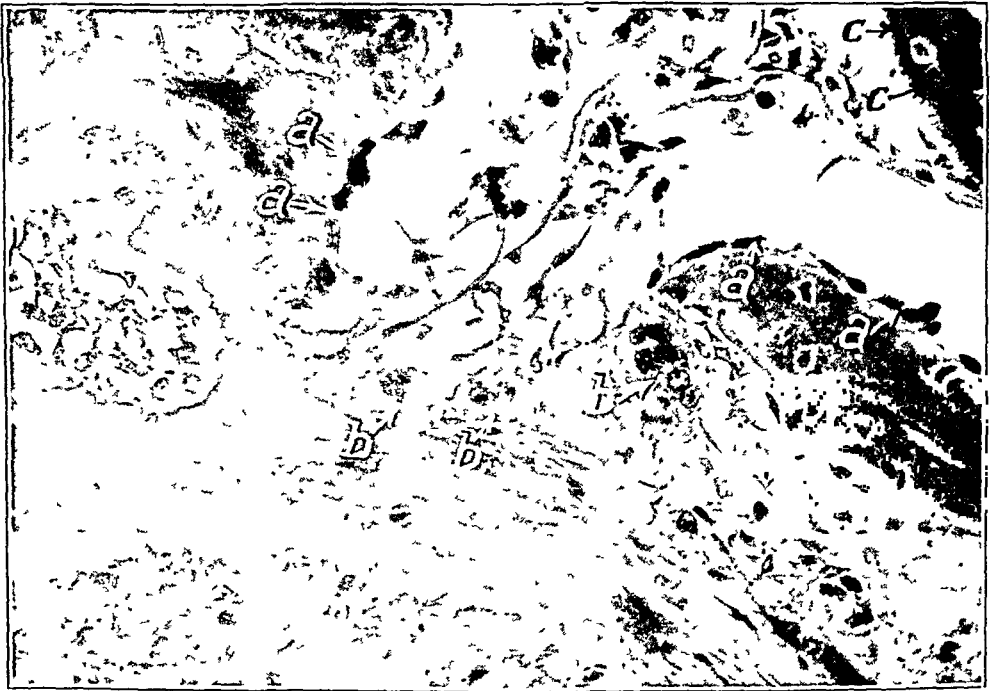

Fig. 5 (case 2).—Osteoblastic activity (a), adjacent to osteoclasts (b), and areas of bone resorption (c). Left astragalus; hematoxylin and eosin stain; $\times 500$; United States Army Medical Museum negative no. 91816.

vascular granulation tissue, and there was pronounced hyperplasia of the marginal stratified squamous epithelium. The bone marrow (fig. 5) was fibrotic; areas of vascular granulation tissue with lymphocytes and plasma cells replaced the bone marrow in some regions. Signs of new bone formation were evident in many areas, frequently adjacent to regions undergoing bone resorption.

COMMENT

Sensory disturbance, areflexia, predilection for the lower extremities, minimal or no muscular atrophy and paresis and minimal or no tenderness over the nerve trunks and muscles are the generally recognized features of chronic diabetic neuropathy¹ and were present in both these

cases. The presence of poorly regulated diabetes of ten and seventeen years' duration, respectively; the pattern of neurologic changes; the absence of historical, clinical or serologic evidence of syphilis, and the absence of distinctive signs of lumbosacral syringomyelia are compatible, we believe, with the diagnosis of chronic diabetic neuropathy complicated by Charcot joint; the pathologic changes of chronic neuropathy and neuropathic disease of bone corroborate the clinical diagnosis in case 2.

Within the limitations inherent in a clinical analysis, the lesions would appear to be predominantly extramedullary, with the major involvement in the posterior roots, the posterior root ganglia and the sensory components of the peripheral nerves and with relative sparing of the ventral roots and the motor fibers of the peripheral nerves. A high concentration of protein in the spinal fluid is characteristic of the Guillain-Barré type of radiculoneuritis, in which there are anatomic changes in the posterior roots and posterior root ganglia;² its presence in these cases is evidence of radicular localization. The localization of the lesions responsible for the disturbed function of the autonomic nervous system (decrease in gastrointestinal motility, decreased sweat secretion over the legs, disturbed vasomotor reactions in the legs, disturbance in vesical muscle tone) is less precise, but an extramedullary origin seems most probable. Dees and Langworthy³ produced atonic neurogenic bladders in animals by section of the posterior roots of the second, third and fourth sacral spinal nerves. Bayliss,⁴ Foerster⁵ and others⁶ showed that stimulation of the distal end of divided posterior roots causes peripheral vasodilatation. The sudomotor fibers concerned

1. Wilson, S. A. K.: *Neurology*, Baltimore, Williams & Wilkins Company, 1940, page 300. Woltman, H. W., and Wilder, R. M.: *Diabetes Mellitus: Pathologic Changes in the Spinal Cord and Peripheral Nerves*, *Arch. Int. Med.* **44**:576-603 (Oct.) 1929.

2. Löwenberg, K., and Foster, D. B.: *Polyradiculoneuritis with Albuminocytologic Dissociation: A Pathoanatomic Report of Three Cases*, *Arch. Neurol. & Psychiat.* **53**:185-190 (March) 1945.

3. Dees, J. E., and Langworthy, O. R.: *An Experimental Study of Bladder Disturbances Analogous to Those of Tabes Dorsalis*, *J. Urol.* **34**:359-371 (Nov.) 1935.

4. Bayliss, W. M.: *On the Origin from the Spinal Cord of the Vasodilator Fibers of the Hind-Limb, and on the Nature of These Fibers*, *J. Physiol.* **26**:173-209, 1901.

5. Foerster, O.: *Ueber die Vasodilatoren in den peripheren Nerven und hinteren Rückenmarkswurzeln beim Menschen*, *Deutsche Ztschr. f. Nervenhe.* **107**:41-56, 1928.

6. Zuckerman, S., and Ruch, T. C.: *Spinal Roots and Tracts in the Regulation of Skin Temperature*, *Am. J. Physiol.* **109**:116-117, 1934. Toennies, J. F.: *Conditioning of Afferent Impulses by Reflex Discharges over the Dorsal Roots*, *J. Neurophysiol.* **2**:515-525 (Nov.) 1939.

in thermoregulatory sweating are known to follow the peripheral course of sensory nerves;⁷ no constant change in sweating follows posterior rhizotomy.⁸

Evidence of disturbance of the autonomic nervous system associated with the neuropathic joints of syringomyelia was presented by Dreyfus and Zarachovitch,¹⁰ who found local arterial vasodilatation by oscillometric examination over the foot of a patient with syringomyelia who had multiple spontaneous fractures of the tarsal bones. Wartenberg¹¹ cited no specific cases but stated that elevation of the local temperature, rise in the arterial and venous blood pressures, increase in the oscillometric index, anomalies of sweat secretion and disturbances in the pilomotor reflex were found in the neighborhood of the neuropathic joints of tabes. Disturbances in the vasomotor reactions of the feet analogous to those in our patients were found in cases of peripheral neuritis by Wilkins and Kolb,¹² who used cutaneous temperature recordings in their investigation.

Charcot joint occurring with lesions of the peripheral nerves is of relatively infrequent occurrence as compared with its incidence in cases of tabes dorsalis and syringomyelia. The review of Shands¹³ contains references to a number of such cases and describes the appearance of a Charcot ankle joint following a traumatic-infectious neural lesion. The condition has been described in association with tumors of the peripheral nerves, traumatic avulsion of nerves, callus formation from fracture constricting nerves and the neuritides of lead and leprosy. Jordan¹⁴ mentioned the occurrence of a Charcot joint with diabetic neuropathy. Bailey and Root¹⁵ reported painless destruction of the

7. List, C. F., and Peet, M. M.: Sweat Secretion in Man: II. Anatomic Distribution of Disturbances in Sweating Associated with Lesions of Sympathetic Nervous System, *Arch. Neurol. & Psychiat.* **40**:27-43 (July) 1938.

8. List, C. F.: Personal communication to the authors.

9. Footnote deleted by the authors.

10. Dreyfus, G., and Zarachovitch: Gros orteil d'apparence syringomyélique avec fractures spontanées multiples du métatarse: Considérations physiopathologiques et thérapeutiques, *Bull. et mém. Soc. méd. d. hôp. de Paris* **53**:328-333 (March 8) 1937.

11. Wartenberg, R., in discussion on Haldeman, K. O., and Soto-Hall, R.: Neuropathic Joint Disease, *J. A. M. A.* **111**:2043-2044 (Nov. 26) 1938.

12. Wilkins, R. W., and Kolb, L. C.: Vasomotor Disturbances in Peripheral Neuritis, *Am. J. M. Sc.* **202**:216-221 (Aug.) 1941.

13. Shands, A. R., Jr.: Neuropathies of the Bones and Joints: Report of Case of Arthropathy of Ankle Due to Peripheral Nerve Lesion, *Arch. Surg.* **20**:614-636 (April) 1930.

14. Jordan, W. R.: Effect of Diabetes on the Nervous System, *South. M. J.* **36**:45-49 (Jan.) 1943.

15. Bailey, C. C., and Root, H. F.: Neuropathic Joint Lesions in Diabetes Mellitus, *J. Clin. Investigation* **21**:649 (Sept.) 1942.

joints of the tarsus in 14 patients with chronic, poorly controlled diabetes mellitus; they expressed the belief that the lesions of the joints were of a neuropathic type and were not dependent on syphilis, syringomyelia or deficient blood supply. The frequent coincidence of mal perforant and Charcot joint makes for a difficult differentiation from cutaneous infections of the feet with secondary osteomyelitis, and it is probable that neuropathic joints in the feet are associated with diabetic neuropathy more often than the scarcity of reports would lead one to believe.

None of the proposed theories of the pathogenesis of neuropathic joint has escaped criticism. The trophic theory of Charcot¹⁶ would find considerable support if neuropathic joints could be shown to occur with isolated lesions of the autonomic nervous system. Neuroarthropathies were not observed in a series of 30 patients in University Hospital who were subjected to lumbar ganglionectomy for peripheral vascular disease, and reports of such occurrences have not been found in the literature. The analogy in this series is not an ideal one because of the regeneration of sympathetic fibers following surgical extirpation and the coexisting vascular disease; but there was a precise anatomic localization of the nerve lesion, it was limited to the sympathetic nervous system and the patients were carefully observed for long periods, some for as long as fifteen years. Corbin and Hinsey¹⁷ failed to find any neuropathic changes in the bones or joints in cats under observation for three years following lumbar sympathectomy and section of the posterior roots. The presence of neuropathic joints in cases of non-syphilitic diseases excludes Virchow's explanation of syphilitic osteochondritis. A humoral mechanism to explain the increased susceptibility of denervated joints to trauma was proposed by Katsuki,¹⁸ who found that the parenteral administration of parathyroid extract or calcium chloride and the oral ingestion of sucrose facilitated the experimental production of Charcot joint in rabbits and dogs whose legs were traumatized after section of the posterior roots. Other corroborative evidence for this theory is so far lacking. Volkmann expressed the belief that repeated injuries to anesthetic joints were responsible for the development of Charcot joint; Turney,¹⁹ who alleged that leprosy was the

16. Charcot, J. M.: Sur quelques arthropathies qui paraissent d'épendre d'une lésion du cerveau ou de la moelle épinière, *Arch. de physiol. norm. et path.* **1**:161, 1868.

17. Corbin, K. B., and Hinsey, J. C.: Influence of the Nervous System on Bones and Joints, *Anat. Rec.* **75**:307-319 (Nov.) 1939.

18. Katsuki, S.: Beitrag zur experimentellen neuropathischen Arthropathie und zugleich zu deren Pathogenese, *Ztschr. f. klin. Med.* **130**:567-574, 1936.

19. Turney, H. G.: Neurotrophic Affections of Bones and Joints, in Allbutt, C., and Rolleston, H. D.: *System of Medicine*, New York, The Macmillan Company, 1910, vol. 7.

only disease of the peripheral nerves responsible for Charcot joints, explained their presence in that disease by the chronicity, the analgesia of the deep tissues and the unimpaired muscular power, factors also present in tabes and syringomyelia. Eloesser²⁰ stated:

Of three animals whose joints were subjected to operative trauma after having been previously rendered anesthetic by resection of posterior roots, all developed Charcot lesions. Trauma in a limb rendered anesthetic and analgesic experimentally leads to grotesque lesions of the bones and joints, which are in every way the counterparts of tabic fractures and arthropathies; trauma and lack of the warning sense of pain are the cause of most tabic bone and joint lesions.

Why the removal of the afferent impulses subserving the experience of pain and the trauma of normal weight bearing should produce such devastating lesions in the joints is not clear, although in recent years this "mechanical" theory has overshadowed the original Charcot theory of their genesis.

Since dysfunction of the autonomic nervous system appears to be associated with Charcot joint in those cases in which functional tests have been carried out, it seems premature to discard entirely the excellent clinical observations and deductions of Charcot because of his use of the term "trophic" and his inability to specify the anatomic pathway by which "trophic" functions were controlled. The factors common to most neuropathic joints are (1) trauma, from repeated small injuries, continued movement of a diseased limb or an isolated major trauma; (2) intact motor power to the afflicted joint; (3) impairment of afferent pain impulses; (4) diminution or absence of afferent proprioceptive impulses which normally inhibit hypermotility of joints; (5) chronicity of the underlying nervous disorder, and (6) metabolic disturbances, conditioned by hypotonic arteries and a defective temperature-regulating mechanism. A combination of these offers a more reasonable explanation for their development than either isolated metabolic or mechanical factors. This explanation, proposed in slightly different form by Wartenberg, is also in keeping with the pathoanatomic background of the disorders in which Charcot joint occurs, so far as they are known. In syringomyelia, cavitation with gliosis occur within the spinal cord in a location which permits interruption of visceral afferent and visceral efferent fibers in the intermediolateral cell column of the dorsal and lumbar portions of the cord, as well as interrupting the decussating fibers for pain and temperature of the ventral commissure. In tabes dorsalis and in the experimentally produced Charcot joint of Eloesser and Katsuki, the visceral afferent and vasomotor fibers of the posterior roots are interrupted, in addition to afferent somatic sensory stimuli.

20. Eloesser, L.: On the Nature of Neuropathic Affections of Joints, *Ann. Surg.* 66:201-208 (Aug.) 1917.

A complete and entirely satisfactory pathologic description of the dorsal root area in cases of diabetic neuropathy is not available, but both Schweiger²¹ and Williamson²² described degeneration of the intramedullary fibers of the posterior roots and sclerosis of the posterior columns secondary to extramedullary lesions and likened the changes to those of mild tabes dorsalis.

SUMMARY

Two cases of severe, poorly regulated diabetes mellitus of ten and seventeen years' duration, respectively, are described. They were characterized by signs of damage to the somatic and autonomic nervous systems in the region of neuropathic joints of the lower extremities. From their functional and pathoanatomic analogy to the Charcot joint of tabes and syringomyelia and to experimentally produced Charcot joint in animals, it is suggested that dysfunction of the autonomic nervous system is of significance in predisposing the skeletal system to an overreaction to trauma, with the corresponding development of Charcot joint.

University Hospital, Ann Arbor, Mich.

21. Schweiger, L.: Ueber die tabiformen Veränderungen der Hinterstränge beim Diabetes, *Arb. a. d. neurol. Inst. a. d. Wien. Univ.* **14**:391-405, 1908.

22. Williamson, R. T.: Changes in the Spinal Cord in Diabetes Mellitus, *Brit. M. J.* **1**:122, 1904.

METASTASES OF UTERINE CARCINOMA TO THE CENTRAL NERVOUS SYSTEM

A Clinicopathologic Study

THEODORE LIPIN, M.D.

AND

CHARLES DAVISON, M.D.

NEW YORK

METASTASES of carcinoma of the uterus to the central nervous system are infrequent. These metastases are often solitary and may occur in the absence of widespread metastatic disease. In cases of a single metastatic nodule in the brain without evidence of carcinomatosis, the advisability of neurosurgical intervention should be considered, for in selected cases life may be prolonged appreciably by operation.

Three cases of metastatic brain tumor from uterine cancer, in all of which the primary growth was adenocarcinoma of the fundus, were studied pathologically at the Montefiore Hospital in the past twenty years. Because of the infrequency of such cases, they are reported here.

REPORT OF CASES

CASE 1.—M. P., a housewife aged 46, entered this hospital in January 1928, with the complaints of convulsive seizures, some of which were right sided, weakness of the left side of the body, apathy, diplopia and headache. A carcinoma of the body of the uterus had been removed one year previously. The patient was right handed.

General physical examination revealed nothing significant except for tenderness over the right frontal region and over the lower part of the distended abdomen.

Abnormal findings on neurologic examination were mild nominal aphasia and acalculia, early bilateral papilledema, right homonymous upper quadrant visual field defects, weakness of right lateral gaze, inability to look upward, hemiparesis and hyperreflexia on the left side and a Babinski sign on the left.

Laboratory studies, which included roentgenographic examination of the skull, but not lumbar puncture, gave normal results.

After hospitalization, the patient became semistuporous; left hemiplegia developed, and she died suddenly on the twenty-third day of hospitalization.

Autopsy.—The diagnosis was: (1) status following hysterectomy for carcinoma of the uterus and (2) metastases of adenocarcinoma to the retroperitoneal lymph nodes and the brain.

From the Neuropathological Laboratory and Neuropsychiatric Division of the Montefiore Hospital, and the Neurological Department of Columbia University College of Physicians and Surgeons.

Gross examination of the brain revealed a solitary, hard, yellowish tumor of the left frontal lobe (fig. 1). The microscopic diagnosis was metastatic adenocarcinoma (fig. 2). The spinal cord was normal in gross and microscopic appearance.

Comment.—Signs and symptoms of a neoplasm in the left temporo-parietal region appeared one year after a hysterectomy for adenocarcinoma of the body of the uterus. The left hemiparesis was a false localizing sign and was probably due to compression of the right cerebral peduncle against the tentorium. Whether the patient's cerebral tumor was metastatic, rather than primary, could only be speculated on during life.



Fig. 1.—Circumscribed solitary metastatic nodule in the left hemisphere. Myelin sheath stain; $\times 1$.

This case illustrates that carcinoma of the uterus may give rise to a solitary metastasis to the brain in the absence of metastases to other organs.

CASE 2.—R. M., a woman aged 63, entered this hospital in October 1941, five years after panhysterectomy for adenocarcinoma of the body of the uterus (fig. 3). Her complaints on admission were loss of weight, cough with hemoptysis and enlarged supraclavicular lymph nodes.

General physical examination revealed nothing abnormal except for enlarged supraclavicular lymph nodes and signs of fluid in the right side of the chest. Neurologic examination showed a normal condition, but there was no record in the patient's chart that specific tests for cerebellar dysfunction had been made.

Laboratory data were noncontributory except for the roentgenologic confirmation of fluid in the right side of the chest.

The patient became progressively more dyspneic and died three months after admission. At no time did she have neurologic signs or symptoms.

Autopsy.—The diagnosis was: (1) status following hysterectomy and bilateral salpingo-oophorectomy for adenocarcinoma of the uterus; (2) metastases of adenocarcinoma to the lungs, pleura, lymph nodes, adrenal glands, kidneys, esophagus and brain, and (3) bilateral pleural effusion with bronchopneumonia and hemorrhagic infarct of the upper lobe of the right lung.

The brain on gross examination was normal except for a single, soft tumor, 3.5 by 1.75 cm. in size, involving the lobulus anterior and lobulus simplex of the

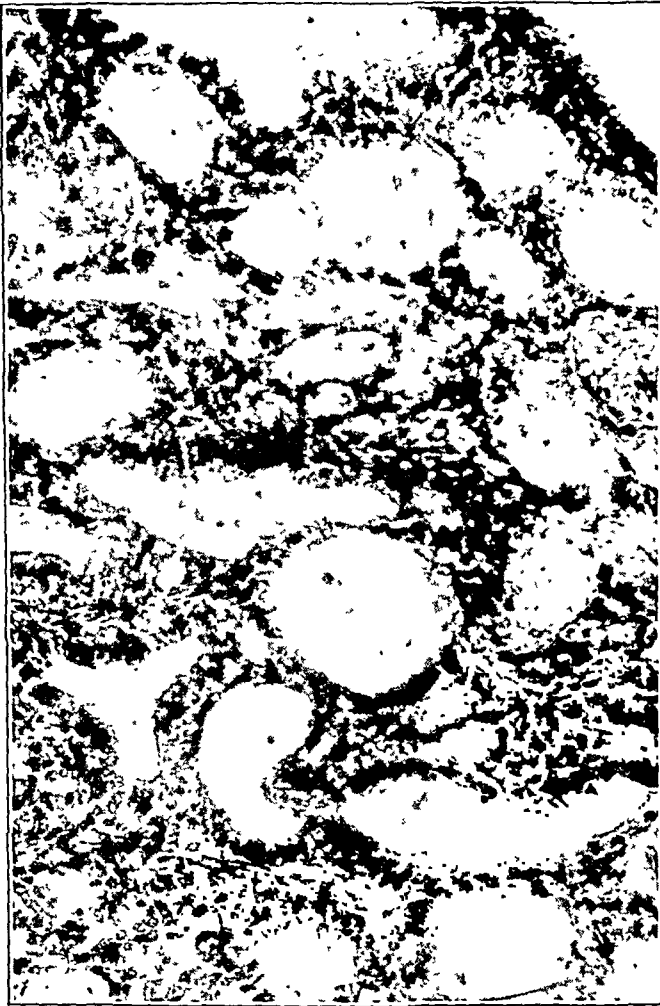

Fig. 2.—Adenocarcinomatous appearance of metastatic tumor of the central nervous system. Hematoxylin and eosin stain; $\times 100$.

right cerebellar hemisphere (fig. 4). Microscopically the tumor was a metastatic adenocarcinoma (fig. 5), of the same appearance as the primary uterine carcinoma.

Comment.—Evidence of carcinomatosis appeared five years after the patient had a hysterectomy for a uterine adenocarcinoma. Although there were multiple metastases to many organs, only a single metastatic nodule was observed in the brain.

CASE 3.—F. N., housewife aged 41, who had had a total hysterectomy for uterine adenocarcinoma five years previously, entered this hospital in April 1927 because of pain and weakness of the left lower extremity and loss of weight.

The abnormal findings on general physical examination were cachexia, enlarged cervical lymph nodes and moderate hepatomegaly.

On neurologic examination, the patient was found to be hyperemotional and slow in thought, with poor memory and judgment. Speech was slurred. The optic disks were pale; the tongue was deviated to the right, and there was right hemiparesis. Tendon reflexes were present and equal on the two sides except for a diminished



Fig. 3.—Primary adenocarcinoma of the body of the uterus. Hematoxylin and eosin stain; $\times 100$.

knee jerk and absent ankle jerk on the left side. Abdominal reflexes were absent on the right side. The plantar responses were normal. Cutaneous sensation was unimpaired.

Metastatic lesions in the fifth and sixth dorsal vertebrae, the left hip, and the left lung were seen in roentgenograms. Laboratory data were otherwise noncontributory. Lumbar puncture was not performed.

The patient became progressively weaker and died on the seventeenth day in the hospital.

Autopsy.—The diagnosis was: (1) status following hysterectomy for uterine carcinoma; (2) metastases of adenocarcinoma to the liver, right kidney, adrenal glands, right lung and brain; (3) gangrenous ulceration and perforation of the rectum, with terminal peritonitis.

Gross examination of the brain revealed a solitary tumor, measuring 1.5 cm., between the cerebral hemispheres, adherent to the tip of the left frontal lobe. Microscopically the tumor was a metastatic adenocarcinoma (fig. 6). The spinal cord was normal in gross and microscopic appearance.

Comment.—This case, like the preceding one, illustrates that a single metastasis to the central nervous system may occur in a patient

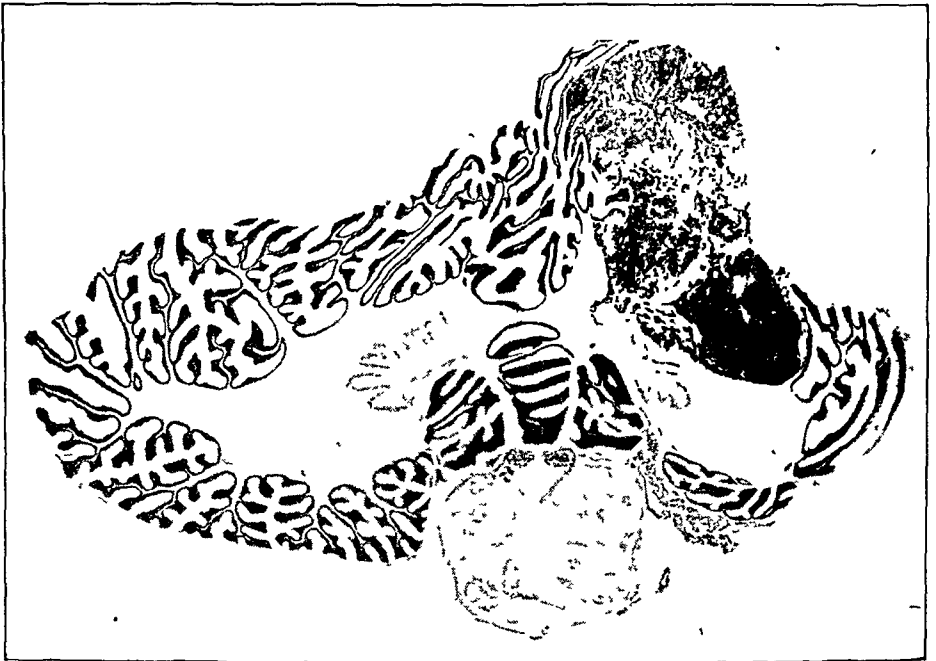

Fig. 4.—Circumscribed solitary metastatic nodule in the right cerebellar hemisphere. Cresyl violet stain; $\times 1$.

with carcinomatosis secondary to a malignant growth in the uterine fundus.

CASES FROM THE LITERATURE

Two cases of metastatic tumor of the brain from carcinoma of the uterus are summarized from the literature because they illustrate important points.

Hodge and Steelman¹ reported the case of a woman aged 47 who had an adenocarcinoma of the uterus removed sixteen months after the onset of abnormal vaginal bleeding. Four months before operation weakness of the right leg developed, and five months after operation the patient began to have jacksonian seizures,

1. Hodge, G. B., and Steelman, H. F.: Carcinoma of the Uterine Fundus with Metastasis to the Brain: Report of a Case, *Arch. Neurol. & Psychiat.* **53**:218-221 (March) 1945.

starting in the right foot. Neurologic examination revealed weakness and spasticity of the right lower extremity and hypoactive tendon reflexes on the right. There were no cranial nerve palsies or papilledema. Because the possibility of a primary cerebral tumor could not be excluded, craniotomy was performed, and a tumor, 4 cm. in diameter, located 2 cm. below the surface of the motor and sensory cortex on the left side was shelled out. The microscopic appearance of this tumor was identical with that of the uterine tumor. The patient lived for two years and at no time showed evidence of metastasis other than the one to the brain.

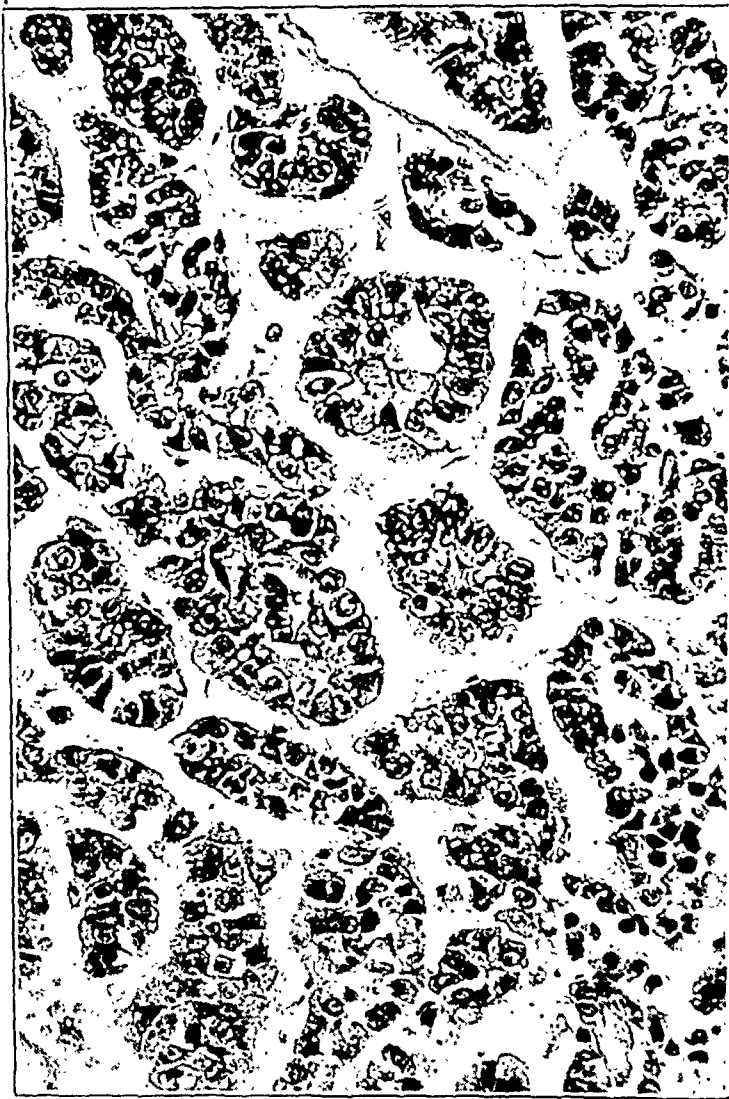

Fig. 5.—Metastatic tumor of the brain from an adenocarcinoma of the uterus. Compare this section with figure 3. Hematoxylin and eosin stain; $\times 100$.

Mitchell and Angrist² reported the case of a woman aged 28 with signs and symptoms of multiple sclerosis of three years' duration. At the time of her final admission to the hospital the patient's complaints were difficulty in walking, incontinence of urine and feces and personality change. Abnormal neurologic findings were bilateral temporal pallor of the optic disks; weakness of the right side of the

2. Mitchell, N., and Angrist, A.: Massive Metastasis to the Brain from Primary Uterine Carcinoma Complicating an Advanced Case of Multiple Sclerosis, *Am. J. Clin. Path.* **12**:232-238 (April) 1942.

face of central origin; right hemiparesis; intention tremor; hyperactive tendon reflexes, more pronounced on the right; absence of abdominal reflexes; bilateral Babinski sign, and impairment of vibration and position sense. The cerebrospinal fluid pressure was 80 mm. of water. Two weeks later the margins of the optic disks were noted to be hazy. The patient died shortly afterward, of bronchopneumonia. Autopsy revealed, in addition to signs of extensive multiple sclerosis, a single tumor, 4.5 by 5.5 cm., in the left parietal lobe. Microscopically the tumor was an adenocarcinoma. The uterus contained an anaplastic adenocarcinoma. No metastasis other than that to the brain was encountered.

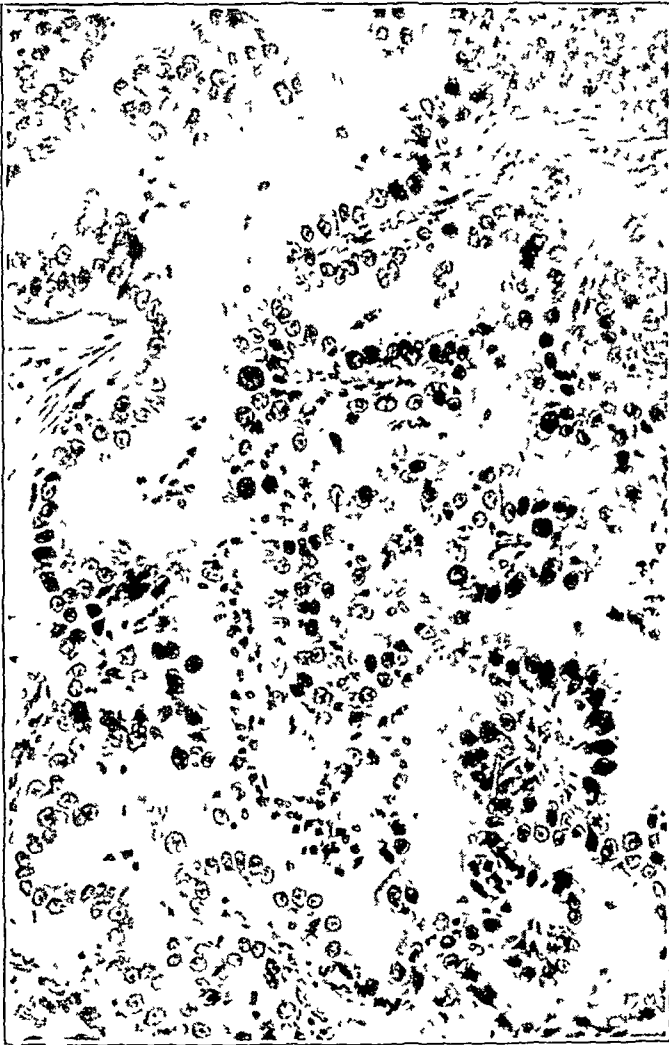

Fig. 6.—Metastatic adenocarcinoma from the brain. Hematoxylin and eosin stain; $\times 100$.

INCIDENCE OF METASTASES

The incidence of these metastases may be expressed in two ways: (a) the percentage of metastatic tumors of the central nervous system arising from carcinoma of the uterus, and (b) the percentage of carcinomas of the uterus metastasizing to the central nervous system. The two aspects will be considered separately.

The percentage of metastatic tumors of the central nervous system arising from carcinoma of the uterus lies between 1 and 3 per cent (table 1). Of the 128 pathologically verified metastatic tumors of the central nervous system studied at the Montefiore Hospital in the past twenty years, 16 were sarcomas, 5 hypernephromas and 107 carcinomas, 3 of which arose in the uterus. In table 2 the primary sites of these tumors are listed.

The percentage of carcinomas of the uterus metastasizing to the central nervous system is not known accurately, partly because several large surveys in the literature were based on cases which were not sub-

TABLE 1.—Percentage of Metastatic Tumors of the Central Nervous System Arising from Uterine Carcinoma

Series	No. of Cases of Metastatic Carcinoma to Central Nervous System	Cases with Primary Tumor in Uterus		Percentage
		Unverified Pathologically	Verified Pathologically	
Neustaedter, M.: Arch. Neurol. & Psychiat. 51: 423-425 (May) 1944.....	143	3	..	2
Montefiore Hospital	107	..	3	3
Hare, O. C., and Schwartz, G. A.: Arch. Int. Med. 64: 542-565 (Sept.) 1939.....	100	..	1	1
Dunlap ⁴	95	1	..	1
Elkington, J. S.: Proc. Roy. Soc. Med. 28: 1080-1096 (June) 1935.....	72	..	0	0
Globus, J. H., and Meltzer, T.: Arch. Neurol. & Psychiat. 48: 163-226 (Aug.) 1942.....	49	..	0	0
Meagher and Eisenhardt ¹⁰	44	..	0	0
Krasting ³	39	..	4	10
Grant ⁹	36	..	0	0
Pass, K. E.: Nervenarzt 11: 385-400 (Aug.) 1938...	32	1	..	3
Behrend, C. M., and Schiff, E.: Nervenarzt 11: 57-62 (Feb.) 1938.....	20	1	..	5
German ⁹	14	..	0	0
Globus, J. H., and Selinsky, H.: Arch. Neurol. & Psychiat. 17: 481-513 (April) 1927.....	9	..	0	0

ject to a complete pathologic study. The percentages range from 0.1 to 3.4 per cent (table 3). Whether or not the percentage of uterine carcinomas metastasizing to the central nervous system is less than the percentage of carcinomas of other organs metastasizing to the central nervous system along the same channels (presumably blood borne via the lungs or the vertebral veins) will not be known until statistics from series with complete autopsies are available in larger quantity. The statistics from Krasting's³ small series, which, oddly, contains no cases of metastasis from pulmonary carcinomas, is presented in table 4. It is the only study of the percentages of carcinomas of various organs metastasizing to the central nervous system that can be found in the literature of the past forty years.

Table 5 is an attempt to determine the index of frequency of metastasis from carcinomas of various organs to the central nervous

3. Krasting, K.: Beitrag zur Statistik und Kasuistik metastatischer Tumoren, besonders der Carcinommetastasen im Zentralnervensystem, Ztschr. f. Krebsforsch. 4:315-379, 1906.

system. The values in the table are the ratios of the following percentages:

$$\frac{\% \text{ of carcinomas of the central nervous system metastasizing from organ X}}{\% \text{ of carcinomas primary in organ X}}$$

The percentage of carcinomas of the central nervous system metastasizing from organ X is based on the Montefiore Hospital series (table 2)

TABLE 2.—*Primary Sites of Metastatic Tumors of the Brain: Montefiore Hospital Series*

Type	Primary Sites	No. of Cases with Full Autopsy	No. of Cases with Pathologic Study of Metastasis Only	Percentage of Total No. of Carcinomas
Carcinoma	Adrenal.....	1	..	0.9
	Antrum.....	1	..	0.9
	Breast.....	41	6	44.5
	Colon.....	2	..	1.9
	Gallbladder.....	1	..	0.9
	Liver.....	..	1	0.9
	Lung.....	37	4	38.8
	Nasopharynx.....	1	..	0.9
	Ovary.....	2	..	1.9
	Rectum.....	2	..	1.9
	Skin (scalp).....	1	..	0.9
	Sphenoidal sinus.....	2	..	1.9
	Thyroid.....	1	..	0.9
	Uterus.....	3	..	2.8
Unknown.....	1	
Hypernephroma	5
Sarcoma	Antrum.....	2
	Femur.....	1
	Pancreas.....	1
	Parotid.....	1
	Unknown.....	2	2	..
Lymphoblastoma	Unknown.....	3
Melanosarcoma	Ear.....	1
	Foot.....	1
	Unknown.....	..	2	..

TABLE 3.—*Percentage of Uterine Carcinomas Metastasizing to Central Nervous System*

Series	No. of Cases of Uterine Carcinoma	No. of Cases with Metastases to Central Nervous System	Percentage	Full Autopsy in All Cases
Willmsky, W. F.: Die Metastasen des Uteruscarcinoms in entfernten Organen, Thesis, Berlin, E. Ebering, 1904	1,122	3	0.3	No
Krasting ³	116	4	3.4	Yes
Glockner, cited by Offergeld ⁵	974	1	0.1	No
Müller, cited by Offergeld ⁵	65	1	1.5	No
Rau, W.: Ztschr. f. Krebsforsch. 18: 141-170, 1922	58	0	0.0	Yes

and the percentage of carcinomas primary in organ X is based on a collection of 3,350 cases of carcinoma with autopsy reported by other authors (table 6). The ratios so derived are generally of the same magnitude as those derived from Krasting's statistics, shown in table 4.

Table 5 suggests that carcinoma of the breast, lung, pharynx, thyroid, sinuses and adrenal gland may metastasize more frequently to the central nervous system than carcinoma of the uterus, whereas carcinomas of the stomach, urinary bladder, pancreas and probably esophagus may metastasize less frequently.

TABLE 4.—*Percentages of Carcinomas of Various Organs Metastasizing to Central Nervous System*
(Krasting's ³ Series, All with Complete Autopsy)

Site of Primary Carcinoma	No. of Cases	No. of Cases with Metastases to Central Nervous System	Percentage
Adrenal.....	3	1	33.3
Breast.....	53	10	18.9
Chorioepithelioma.....	2	2	100.0
Esophagus.....	74	4	5.4
Gallbladder.....	37	2	5.4
Maxilla (inferior).....	5	1	20.0
Maxilla (superior).....	4	1	25.0
Pharynx.....	8	2	25.0
Prostate.....	18	4	22.2
Rectum.....	44	1	2.3
Sigmoid.....	20	1	5.0
Thyroid.....	23	2	8.7
Uterus.....	116	4	3.4
Vagina.....	2	1	50.0
Vulva.....	4	2	50.0

TABLE 5.—*Index of Frequency of Metastases from Carcinomas of Various Organs to the Central Nervous System*

Organ	Ratio: $\frac{\text{Percentage carcinomas metastatic from organ X}}{\text{Percentage carcinomas primary in organ X}}$	Ratio from Krasting's Series (Table 4)
Adrenal.....	3	15
Biliary tract.....	0.2	3
Breast.....	10	10.
Esophagus.....	0	3
Intestine.....	0.3	2
Liver.....	0.8	0
Lung.....	12	0
Nasopharynx and sinuses.....	6	13
Ovary.....	1	0
Pancreas.....	0	0
Prostate.....	0	11
Skin.....	1	0
Stomach.....	0	0
Thyroid.....	3	4
Urinary bladder.....	0	0
Uterus.....	0.3	1

FREQUENCY OF SOLITARY METASTASIS TO THE CENTRAL NERVOUS SYSTEM

Metastatic tumors to the central nervous system are usually multiple. It is possible, however, that carcinomas in some organs may give rise to solitary metastasis to the central nervous system more frequently than those in other organs. The evidence, summarized in table 7, suggests that metastases from carcinomas of the uterus to the central nervous system are often solitary. In this series of 26 cases, 70 per cent had a

single metastasis to the nervous system. More statistics are needed to clarify this point. It is hoped that future statistical surveys will avoid such classifications as "carcinoma of the ovary and uterus" and "carcinoma of the genitourinary tract," which do not take into account the possibly different metastatic behavior of various tumors.

FREQUENCY OF METASTASIS TO THE CENTRAL NERVOUS
SYSTEM WITHOUT CARCINOMATOSIS

A pertinent neurosurgical consideration is whether carcinomas from certain organs may metastasize to the central nervous system in the absence of carcinomatosis. Dunlap⁴ generalized: "Metastasis in general

TABLE 6.—*Site of Primary Tumor in 3,350 Cases of Carcinoma with Autopsy**

Organ	No. of Cases	Percentages
Adrenal.....	1	0.03
Biliary tract.....	175	5.2
Breast.....	139	4.2
Esophagus.....	331	9.9
External genitals.....	43	1.3
Intestine.....	473	14.1
Kidney.....	33	1.0
Larynx.....	47	1.4
Liver.....	42	1.3
Lung.....	110	3.3
Mouth, lips and pharynx.....	97	2.9
Nose and sinuses.....	11	0.3
Ovary.....	65	1.9
Pancreas.....	95	2.8
Prostate.....	95	2.8
Skin.....	35	1.0
Stomach.....	1,044	31.2
Thyroid.....	10	0.3
Tongue.....	49	1.5
Urinary bladder.....	104	3.1
Uterus.....	351	10.5

* Figures represent the combined statistics of the following authors: DeVries, W. M.: *The Prevalence of Cancer, in Cancer Control, Chicago, The Surgical Publishing Company of Chicago, 1927, pp. 217-246.* Scholte, cited by DeVries. Bilz, cited by DeVries. Wells, H. G.: *Cancer Statistics as They Appear to a Pathologist, J. A. M. A. 88: 399-403 (Feb. 5) 1927.*

is widespread throughout the body in those cases in which there is cerebral metastasis." Statistics on this matter applying to carcinoma of the uterus seem to be nonexistent. In several of the 20 cases of metastases to the central nervous system from uterine carcinoma reported by Offergeld,⁵ autopsy showed absence of generalized carcinomatosis. This is true, also, of the cases reported by Hodge and Steelman and by Mitchell and Angrist and of case 1 reported here. It can be concluded,

4. Dunlap, H. F.: *Metastatic Malignant Tumors of the Brain, Ann. Int. Med. 5:1274-1288 (April) 1932.*

5. Offergeld, H.: *Ueber die Metastasierung des Uteruscarzinoms in das Zentralnervensystem und die höheren Sinnesorgane, Ztschr. f. Geburtsh. u. Gynäk. 63:1-36, 1908-1909.*

therefore, that carcinomas of the uterus metastasize to the central nervous system not infrequently in the absence of generalized metastatic disease. The role played by the vertebral veins in such metastasis is not clear.

THERAPY

The usefulness of neurosurgery in cases of metastatic tumors of the brain has been discussed in the literature. Grant⁶ stated that in cases of metastatic brain tumor “. . . neither radical nor palliative surgery is of any permanent avail.” His conclusion was based on a series of 47 cases of metastatic tumors of the central nervous system, in 25 of which operation was performed and in 22 of which it was not. The average length of life from the time of hospitalization to death was less than four months regardless of whether or not operation was performed. Grant's observations were in accord with those of Tooth.⁷ Oldberg,⁸ however, reported 3 cases of metastatic tumor of the central nervous system in which there was definite prolongation of life after neurosurgical intervention, just as in Hodge and Steelman's case. He sug-

TABLE 7.—Percentage of Solitary Metastatic Tumors of the Central Nervous System from Uterine Carcinoma

Source	No. of Cases of Uterine Metastases to Central Nervous System	No. of Cases with Metastases to Central Nervous System		
		One Metastasis	Two Metastases	Multiple Metastases
Offergeld ⁵	14	9	2	3
Krasting ³	4	2	1	1
Montefiore Hospital	3	3	0	0
Willmsky, W. F.: Die Metastasen des Uteruscarcinoms in entfernteren Organen, Thesis, Berlin, E. Ebering, 1904.....	3	2	0	1
Hodge and Steelman ¹	1	1	0	0
Mitchell and Angrist ²	1	1	0	0
Total number of cases.....	26	18	3	5
Percentage	100%	70%	11%	19%

gested that before operating for a suspected metastatic tumor of the brain one should check for clinical evidence of multiplicity of metastases to the central nervous system and for clinical evidence of metastases elsewhere, and prognosticate as to the course or recurrence of the primary focus. German⁹ stated:

The conclusion is drawn that operation is definitely indicated in patients with metastatic carcinoma of the brain if the metastasis is apparently solitary.

6. Grant, F. C.: Intracranial Malignant Metastases: Their Frequency and Value of Surgery in Their Treatment, *Ann. Surg.* **84**:635-646, (Nov.) 1926.

7. Tooth, H. T.: The Treatment of Tumors of the Brain and Indications for an Operation, *Tr. Internat. Cong. Med., London, sect. VII, Surg., 1913*, pp. 203-299.

8. Oldberg, E.: Surgical Consideration of Carcinomatous Metastases to the Brain, *J. A. M. A.* **101**:1458-1461 (Nov. 4) 1933.

9. German, W. J.: Carcinomatous Metastases to the Brain, *Ann. Surg.* **108**: 980-991 (Dec.) 1938.

Oldberg⁸ and Meagher and Eisenhardt¹⁰ reported a case of suspected metastatic brain tumor which at operation was found to be a primary brain tumor. A similar experience was encountered recently at this hospital in the case of a woman aged 54 with signs and symptoms of an expanding intracranial lesion. Ten years previously the patient had received roentgen therapy for a uterine carcinoma. Physical examination failed to reveal any sign of recurrence or metastasis of the cancer except for the probable existence of a cerebral metastasis. Because of the woman's poor physical condition and because the accepted diagnosis was metastatic tumor of the brain, craniotomy was not performed. The patient died, and at autopsy her death was attributed to the cerebral tumor—a large glioblastoma multiforme. There was no pathologic evidence of recurrence or metastasis of the uterine carcinoma to any part of the body.

Neurosurgical intervention is contraindicated in most cases of metastatic tumor of the brain secondary to the uterine carcinoma because of the frequent accompaniment of carcinomatosis. But when, as in case 1, there is no evidence of this complication and when signs suggest a solitary brain tumor, neurosurgical intervention may prolong life.

SUMMARY

Metastases from carcinoma of the uterus probably account for 1 to 3 per cent of all carcinomas of the central nervous system.

The percentage of uterine carcinomas metastasizing to the central nervous system varies from 0.1 to 3.4 per cent, according to different sources.

Carcinoma of the breast, lung, pharynx, sinuses, thyroid and adrenal gland may metastasize more frequently to the central nervous system than carcinoma of the uterus, whereas carcinoma of the stomach, urinary bladder, pancreas and esophagus may metastasize less frequently.

There is evidence that metastases to the central nervous system from uterine carcinoma are often solitary.

Uterine carcinoma may metastasize to the central nervous system in the absence of carcinomatosis.

In cases in which metastasis to the central nervous system from a carcinoma of the uterus is suspected, neurosurgical exploration is indicated only if there is no evidence of multiple metastases to the brain or spinal cord and no evidence of carcinomatosis.

11 East Thirty-Sixth Street.

Montefiore Hospital for Chronic Diseases.

10. Meagher, R., and Eisenhardt, L.: Intracranial Carcinomatous Metastases, with Note on Relation of Carcinoma and Tubercle, *Ann. Surg.* **93**:132-140 (Jan.) 1931

SCHISTOSOMIASIS OF THE BRAIN DUE TO SCHISTOSOMA JAPONICUM

Report of a Case

CAPTAIN CHARLES WESLEY WATSON

LIEUTENANT COLONEL FRANCIS MURPHEY

AND

MAJOR SAMUEL C. LITTLE

MEDICAL CORPS, ARMY OF THE UNITED STATES

THE DEPOSITION of ova in the central nervous system is a rare complication of the infection of man by the trematode *Schistosoma japonicum*. The demonstration of these ova in the cerebral tissue has been reported four times in the available literature,¹ and a fifth report is to be published.² Two reports originate in the Philippine literature and one in the British literature. Vitug, Cruz and Bautista^{1a} reported 2 cases of schistosomiasis involving the brain, 1 of which was presented with histologic evidence of ova-infected cerebral tissue. A favorable response to antimony was accepted as evidence for the diagnosis in the second case. These authors found two reports in the Philippine literature referring to schistosomiasis of the brain. Nieva³ described the case of a patient from Samar who experienced epilepsy, headaches and sensory changes. The ova of *S. japonicum* were found in the feces. The probable diagnosis of cerebral schistosomiasis was based on inference. Improvement followed injections of emetine hydrochloride and antimony and potassium tartrate U. S. P. Greenfield and Pritchard^{1c} reported 2 cases of schistosomiasis of the brain in which the ova were

From the Section of Neurology and Neurosurgery, O'Reilly General Hospital, Springfield, Mo.

1. (a) Vitug, W.; Cruz, J. R., and Bautista, L. D.: Schistosomiasis Involving the Brain: Two Case Reports, *J. Philippine Islands M. A.* **21**:291-298 (June) 1941. (b) Africa, C. M., and Cruz, J. Z.: Eggs of *Schistosoma Japonicum* in the Human Heart, in *Volumen Jubilare pro Sadao Yoshida*, Osaka, Japan, 1939, vol. 2, pp. 113-117; cited by Vitug, Cruz and Bautista.^{1a} (c) Greenfield, J. G., and Pritchard, B.: Cerebral Infection with *Schistosoma Japonicum*, *Brain* **60**:361-372 (Sept.) 1937. (d) Tfunada, T., and Shimamura, S., cited by Greenfield and Pritchard.^{1c}

2. Maltby, G. L., and Schmidt, J. R.: Schistosomiasis of the Cerebrum Simulating Brain Tumor, to be published.

3. Nieva, D. E.: Epileptiform Convulsions Probably Due to Schistosomiasis, *Bull. San Juan de Dios Hosp.*, 1935, vol. 9, no. 7; cited by Vitug, Cruz and Bautista.^{1a}

demonstrated histologically in the cerebral tissue of the left parietal and occipital regions. Tfunada and Shimamura,^{1d} in 1906, reported a case of cerebral involvement by *S. japonicum* with symptoms of convulsions, aphasia and hemiplegia. Autopsy revealed abnormal masses in the parietal lobe, the internal capsule and the optic thalamus on the left side. Histologic examination revealed ova of *S. japonicum*. Tillman,⁴ reporting experiences with soldiers on Leyte, recently described 7 cases of schistosomiasis in which there were symptoms of involvement of the central nervous system. Confusion, aphasia and hyperreflexia were noted. All the patients recovered. The diagnosis was made by inference. A patient with visceral schistosomiasis due to *S. japonicum* who exhibited convulsions, aphasia and evidence of increased intracranial pressure was subjected to craniotomy at England General Hospital. A biopsy of the mass removed from the left parietal region contained ova of *S. japonicum*.² A second patient with schistosomiasis due to *S. japonicum* observed at the same hospital had jacksonian convulsions and aphasia. A "mass of probable parasitic etiology" was detected in the left parietal lobe, in the postcentral region, but was not removed.⁵ Africa and Cruz,^{1b} in a report of the discovery of ova of *S. japonicum* in the human myocardium, mentioned that these ova were also observed in the brain. Clinical data were not given. Spiridon⁶ reported an outbreak of schistosomiasis due to *S. japonicum* among British sailors who had bathed in the Yangtze River; 3 men infected simultaneously exhibited well defined neurologic signs and symptoms, which improved notably after treatment with antimony compounds. Hoff and Shaby⁷ reported a case in which paraplegia and mental confusion were exhibited and air encephalograms revealed a mass in the lateral wall of the right ventricle. *S. japonicum* was observed in the stools. In the authoritative monograph on schistosomiasis by Faust and Meloney⁸ it is stated that symptoms of involvement of the central nervous system, such as jacksonian epilepsy, may occur. Edgar⁹ reported a case with convulsions and symptoms similar to those described by Greenfield and Pritchard.^{1c}

4. Tillman, A. J. B.: Cerebral Manifestations of Schistosomiasis Japonica, abstracted, Bull. U. S. Army M. Dept. **4**:492 (Nov.) 1945.

5. Chasoff, J.: Personal communication to the authors.

6. Spiridon, J. T.: Schistosomiasis Japonica: An Account of an Outbreak, J. Trop. Med. **39**:161-164 (July 15) 1936.

7. Hoff, H., and Shaby, J. A.: Nervous and Mental Manifestations of Bilharziasis and Their Treatment, Tr. Roy. Soc. Trop. Med. & Hyg. **33**:107-111 (June) 1939.

8. Faust, E. C., and Meloney, E. H.: Studies on *Schistosoma Japonica*, Monograph Series no. 3, Baltimore, American Journal of Hygiene, 1924.

9. Edgar, W. H., cited by Chalgren, W. S., and Baker, A. B.: Tropical Diseases: Involvement of the Nervous System, Arch. Path. **41**:66-117 (Jan.) 1946.

A tumor mass containing ova of *S. japonicum* was removed "from beneath the parietal bone."

Involvement of the central nervous system by the ova of related trematodes has been described.¹⁰ Müller and Stender^{10b} described a verified case of infection of the spinal cord by the ova of *Schistosoma mansoni*. Chung^{10d} reported a case of bilharziasis with neurologic signs. Spiridon⁶ stated that Mann, of the United States Naval Medical Service, recorded an outbreak of bilharziasis in which jacksonian epilepsy, hemiplegia and aberrations of personality resembling schizophrenia were mentioned. Khaw, of Peiping, China, in a communication to Spiridon,⁶ described a case of bilharziasis with neurologic signs. In few cases can autopsy be performed. Ferguson^{10c} reported that he had observed the ova of *Schistosoma haematobium* in the brain and the spinal cord.

REPORT OF CASE

History.—On Dec. 12, 1944, one and one-half weeks after the patient, an infantryman, landed on Leyte, Philippines, he swam in a river which was later condemned for swimming, laundry and drinking purposes. One and one-half weeks later he noted the onset of anorexia, the first symptom. Two weeks after exposure he experienced intermittent coughing and moderately severe, sharp pain in the right upper abdominal quadrant, which occurred in the morning and the evening and was accentuated after the ingestion of food. Three days after onset of the abdominal pain, or seventeen days after exposure, the patient had a regular intermittent fever, with diarrhea and vomiting. The temperature curve rose and fell over a period of one hour, at approximately 8:30 in the morning, reaching a maximum of 101 F.; and then returning to normal, it showed a gradual elevation during the early afternoon, reaching a maximum of 103 F. at approximately 8:30 p. m., and returning to normal one-half hour later. This type of fever was present daily without alteration or cessation until March 28, 1945, after which for six days the patient experienced a continuous fever of 102 F. throughout the day and night. On April 2 the patient was given eleven tablets of sulfadiazine and four tablets of acetylsalicylic acid at one time. There was cessation of the fever, with return to normal. There has been no fever since that time. The diarrhea, which began on December 29, was intermittent, without gross blood or mucus, and continued until the patient returned to the United States. The vomiting, which began December 29, was sudden in onset, violent but nonprojectile, and occurred as often as thirty times a day for a period of fifteen days, the vomitus consisting of green, bitter-tasting material and containing no gross blood or fecal contamination. One hundred and nine days after exposure the patient was hospitalized because of

10. (a) Spiridon.⁶ (b) Müller, H. H., and Stender, A.: Bilharziasis of the Spinal Cord Presenting the Picture of Myelitis Dorsolumbalis Transversa Completa, Arch. f. Schiffs- u. Tropen-Hyg. **34**:537-538 (Oct.) 1930. (c) Yamigawa, K.: The Etiology of Jacksonian Epilepsy, Virchows Arch. f. path. Anat. **119**:447-460, 1890. (d) Chung, H. L.: Certain Surgical Complications of Schistosomiasis Japonica, China M. J. **47**:1171-1180 (Nov.-Dec.) 1933; cited by Vitug, Cruz and Bautista.^{1a} (e) Ferguson, A. R., cited by Chalgren, W. S., and Baker, A. B.: Tropical Diseases: Involvement of the Nervous System, Arch. Path. **41**:66-117 (Jan.) 1946.

the fever, diarrhea and abdominal cramps. Examination of the stool on April 2 and April 6 revealed the presence of ova of *S. japonicum*. Beginning on April 8, ten intramuscular injections of emetine hydrochloride, containing 1 grain (0.065 Gm.) each, were administered. There was no other treatment with antimony preparations prior to admission to O'Reilly General Hospital.

Between April 6 and June 24, 1945, laboratory procedures were carried out as follows: Hematologic examination revealed 12,000 to 22,000 leukocytes per cubic millimeter, with persistent eosinophilia, the latter reaching 32 to 74 per cent. The hemoglobin measured 8.6 to 15 Gm. (a normal content followed the transfusion of 500 cc. of whole blood). Examination of the cerebrospinal fluid on May 24 revealed 3 lymphocytes per cubic millimeter, a normal colloidal gold curve, a negative Wassermann reaction and 30 mg. of protein per hundred cubic centimeters. Repeated examinations of the stool and urine showed nothing abnormal except for occult blood in the stool on two occasions. The blood sugar measured 78 mg. per hundred cubic centimeters.

In the same period, during which the patient passed through three hospital installations, he became progressively more emaciated and experienced daily cramping pain in the right upper abdominal quadrant, tenderness on abdominal pressure and recurrent seizures, which will be described later. Physical and neurologic examinations performed at each installation revealed a similar picture. Significant findings included emaciation; palpable liver, spleen and kidneys; abdominal tenderness, and distention of the superficial veins of the lower part of the abdomen.

The patient experienced ten seizures prior to his admission to O'Reilly General Hospital, on June 24. In general, the seizures were of grand mal and psychomotor equivalent types. The first seizure, which occurred on the one hundred and fifty-sixth day following exposure, which presumably was Dec. 12, 1944, was initiated by radiating headaches of great violence in the left prefrontal lesion; loss of consciousness followed, and there were postictal confusion and an amnesic type of aphasia. A second seizure was similar, but there was a jacksonian "march," beginning in the right leg and progressing to generalized clonic movement, without loss of consciousness. The patient had delayed mixed aphasia, amnesia for the episode, postictal headache on the left side, abdominal pain and vomiting. The fifth seizure was noteworthy for uncontrollable weeping and laughing without appropriate emotional disturbance. Urinary incontinence occurred on one occasion. Between June 15 and June 24 there were five seizures, of varying severity, but all were characterized by similar symptoms.

Phenobarbital was given irregularly after the seizures and in variable doses. Diphenylhydantoin sodium (0.2 Gm. daily) was given from the one hundred and sixty-seventh day following exposure, to the time of his admission to the general hospital.

Examination.—On arrival at the general hospital, on the one hundred and ninety-fourth day following exposure, the patient appeared undernourished, extremely emaciated but alert, pleasant and not acutely ill. The family history and the past personal history revealed nothing of significance. Routine physical examination showed "shotty" enlargement of the inguinal and epitrochlear lymph nodes. The abdominal viscera could not be palpated satisfactorily because of increased tension of the abdominal muscles, but it was determined by percussion that the edge of the liver extended 4 cm. below the right costal margin. Superficial veins over the lower part of the abdomen were moderately distended and collapsed

when the patient lay in the horizontal position, the blood appearing to drain downward.

Neurologic examination on his admission, including studies of gnosis, praxis and phasia, showed nothing abnormal except for a slight "rolling" gait (superficially resembling the cerebellar type) and slight confusion of laterality.

Between June 24 and July 5, laboratory procedures were carried out as follows: Hematologic examination revealed 5,750 leukocytes per cubic millimeter, with a normal differential count; 3,870,000 erythrocytes, 85 to 95 per cent hemoglobin; a hematocrit reading of 39 per cent, and a sedimentation rate of 19 mm. in one hour (diagonal curve, Crile method). The cerebrospinal fluid on June 28 showed a pressure of 130 mm. of fluid, normal dynamics, 1 lymphocyte per cubic millimeter, a total protein content of 100 mg. and a glucose content of 56.8 mg. per hundred cubic centimeters, a negative Wassermann reaction, a sterile culture and a colloidal gold curve of 5542100000. No eosinophils or ova were found in the centrifuged

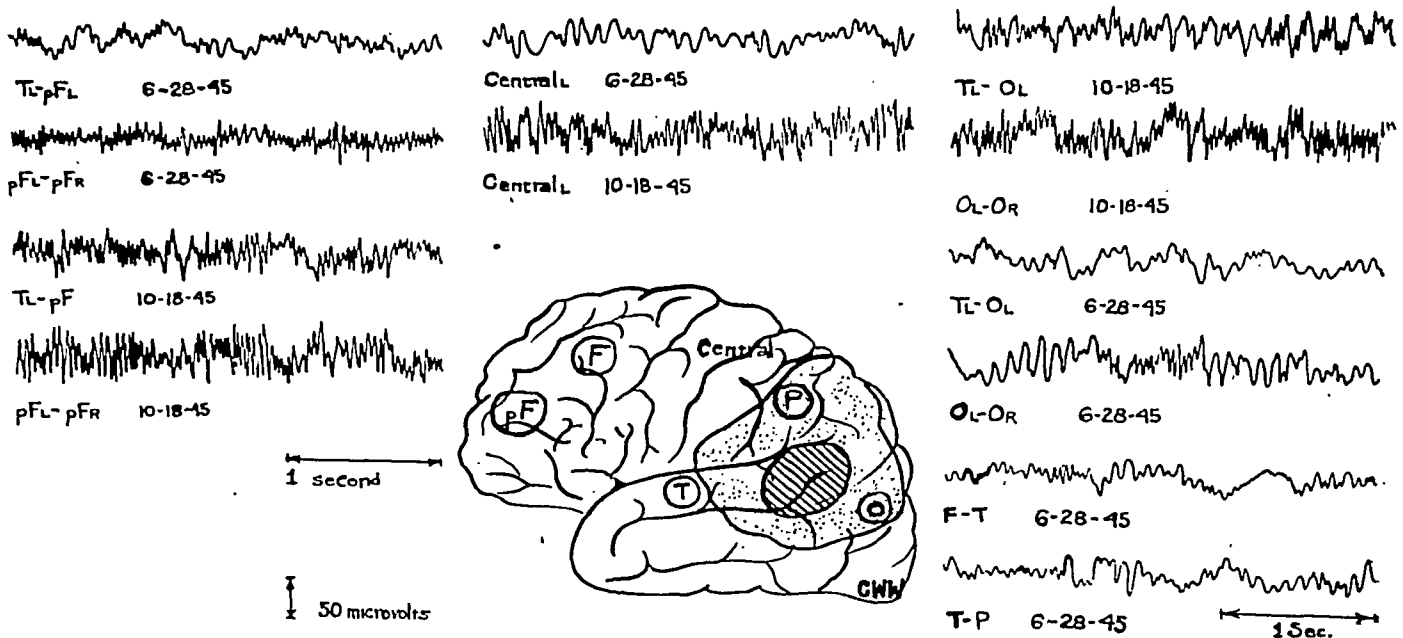

Fig. 1.—Composite chart showing electroencephalographic tracings in a case of schistosomiasis of the brain. All tracings were recorded under standard conditions. Technical data are indicated below the tracings. In this figure, *pF* means prefrontal; *F*, frontal; *central*, the rolandic fissure; *P*, parietal; *O*, occipital; *T*, temporal, and *r* and *l*, right and left. The appropriate date is recorded immediately beneath each tracing. The area of cross hatching indicates the preoperative localization of the lesion by electroencephalographic recording. The shaded area shows the area of "neighborhood signs," as indicated electroencephalographically. The slow activity with "phase reversal" which permitted preoperative localization is illustrated by the four tracings in the lower right corner of the figure. The two tracings in the upper right corner are to be compared with the two tracings immediately beneath. The progression of "epileptogenic activity" is notable. The rest of the tracings illustrate the progression of "epileptogenic activity" as recorded from the same areas on various occasions.

specimen of the cerebrospinal fluid. Urinalysis, biopsy of muscle and roentgenographic examination of the chest and the cervical portion of the spine revealed nothing abnormal. Repeated examinations of the stool, including concentration and egg-hatching technics for ova of trematodes, consistently revealed no parasites. The serum cephalin-cholesterol flocculation test gave a 1 plus reaction; the total serum protein measured 5.4 Gm., with 2.9 Gm. of albumin and 2.5 Gm. of globulin

(ratio of albumin to globulin, 1 : 1), and the icteric index was 4. Roentgenograms of the skull revealed a calcified pineal gland, which was displaced 1.2 cm. to the right and posteriorly.

The preoperative electroencephalogram (fig. 1) was abnormal, with localization of abnormally slow activity showing "phase reversal" in the region of the posterior third of the superior temporal gyrus, including the superior portion of the angular gyrus and the inferior portion of the supramarginal gyrus. There was definite generalized "epileptogenic activity." Electroencephalographic abnormalities, with graphic illustration of the progressive enhancement of epileptogenic activity, are shown in figure 1.

Preoperative Course.—From the time of admission, on June 24, to July 27, the patient experienced only five disorders of consciousness. Thereafter, despite frequent upward revisions of medication and the inclusion of phenobarbital, until he eventually was receiving 0.7 Gm. of diphenylhydantoin sodium and 0.3 Gm. of phenobarbital daily, he continued to have as many as six seizures daily, with

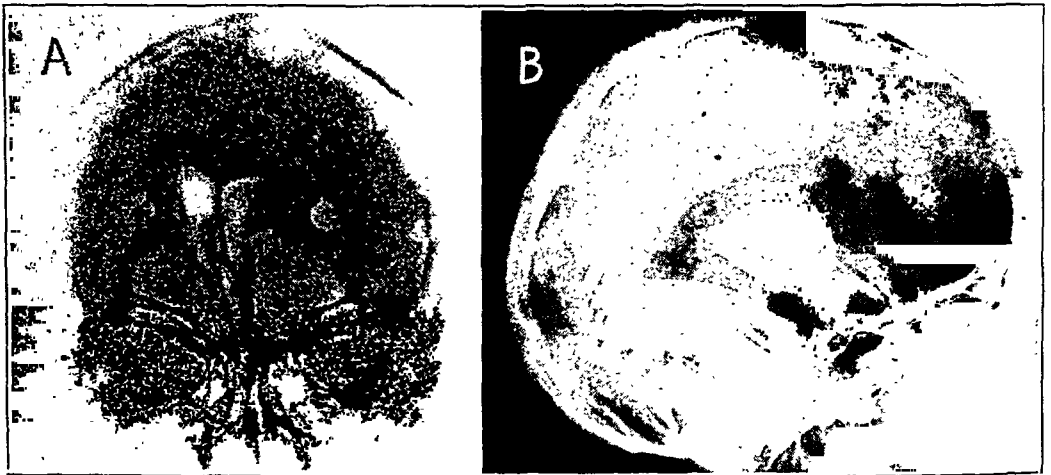

Fig. 2.—*A*, ventriculogram showing shift of the ventricular system to the right as a result of a space-occupying lesion of the left temporal region. *B*, ventriculogram showing displacement of the temporal horn of the left lateral ventricle and intracranial calcification. The excised granuloma contained calcium.

variable symptoms. Sometimes there was a prodrome of alexia associated with an amnesic type of aphasia which lasted five minutes and was followed by severe headache in the left temporal area. Some seizures began with micropsia and were followed by severe headaches in the left temporal regions. Some seizures began with micropsia and were followed by clonic movements of the right arm, spreading to the right leg and finally over the entire body. In this type, there was no loss of consciousness, tongue biting or incontinence of urine or feces, but immediately after the seizure uncontrollable copious weeping occurred. One attack was followed by a right homonymous field defect with macular sparing. A detailed examination twelve hours later revealed no evidence of visual impairment. Visual agnosia was absent.

Ventriculographic Study and Operation.—A pneumoencephalogram was attempted on July 2, but ventricular filling did not occur. On July 5 a ventriculographic study showed a large expanding lesion in the left parietotemporal region. Opacity, suggestive of abnormal intracranial calcification, was present in the

region of the posterior portion of the left temporal horn. One hour after the ventriculogram was taken an exploratory parietotemporal craniotomy was performed. The dura, when exposed, was seen to be tense and could be opened only after a spinal puncture had been made and the intracranial pressure reduced. An area of discoloration and induration, with multiple irregular, tiny white nodules, was observed in the posterior third of the superior temporal gyrus. At one point it invaded the dura. This area measured 2 cm. in diameter on the surface of the cortex and seemed to extend subcortically into the angular and supramarginal gyri. The entire mass was estimated to be 5 or 6 cm. in diameter. An incision was made into the mass, and the tissue had the gross appearance of a glioblastoma multiforme. A biopsy specimen was obtained, and frozen sections were made. A definite diagnosis could not be made from these sections, but the appearance was suggestive of an invasive glioma. Since complete resection of the mass would have resulted in a serious speech defect, it was not done. A large subtemporal decompression was made and the operation terminated.

Biopsy.—Examination of permanent sections (hemotoxylin and eosin stain) revealed numerous focal lesions, some near and some relatively distant from blood vessels and capillaries. The typical lesion consisted of a central area of necrosis with a concentric ring of packed leukocytes, predominantly eosinophils (fig. 3). There was extensive glial proliferation but no evidence of neoplasia. Within or near the center of many of the lesions there were doubly refractile, light brown paraboloid structures, measuring approximately 60 by 40 microns with polar flattening and a single rudimentary "hook." No foreign body giant cells were observed.

Treatment.—On July 8 a course of treatments with fuadin was begun. Fuadin contains 13.6 per cent trivalent antimony and is supplied in ampules containing a 6.4 per cent solution of the drug (approximately 0.06 mg. of fuadin in 1 cc. of solution). The fuadin solution is injected slowly into the muscle. The first three doses, of 1.5, 3.5 and 5 cc., were given on successive days. On the fifth day, and on subsequent alternate days, 5 cc. was given, until a total of sixteen doses had been administered (75 cc. of solution, containing 0.653 Gm. of antimony). The hemogram was determined every two days, and a complete urinalysis was done at the same time. Prior to the beginning of the therapy, and periodically during the course, an electrocardiogram was taken, the serum cephalin-cholesterol flocculation test was done and the icteric index was determined. There was no evidence of renal, hepatic or myocardial dysfunction during the period of therapy. Since the seventh postoperative day, the decompression has remained soft and pulsating.

Because of the failure to control the seizures with relatively large amounts of diphenylhydantoin and phenobarbital, and because there persisted a definite focus of cerebral damage, as evidenced by repeated electroencephalograms, a second craniotomy was performed on November 5. On exposure, the dura was observed to be quite soft, and there was no evidence of increased intracranial pressure. The dura was then opened, and the lesion which previously had been present was observed to have disappeared and to have been replaced by an area of scar tissue 1.5 cm. in diameter. Numerous white, hard lesions, 1 mm. in diameter were observed over the entire field. A ventricular needle inserted toward the posterior portion of the temporal horn entered the ventricle at a depth of 2 cm., indicating that the ventricle, which had formerly been compressed, was now greatly dilated. Further exploration with a ventricular needle revealed considerable subcortical scar

tissue for a distance of approximately 5 cm. posterior to the cortical lesion. It was immediately apparent that all the scar tissue could not be removed without producing a serious speech defect, but it was thought worth while to remove the

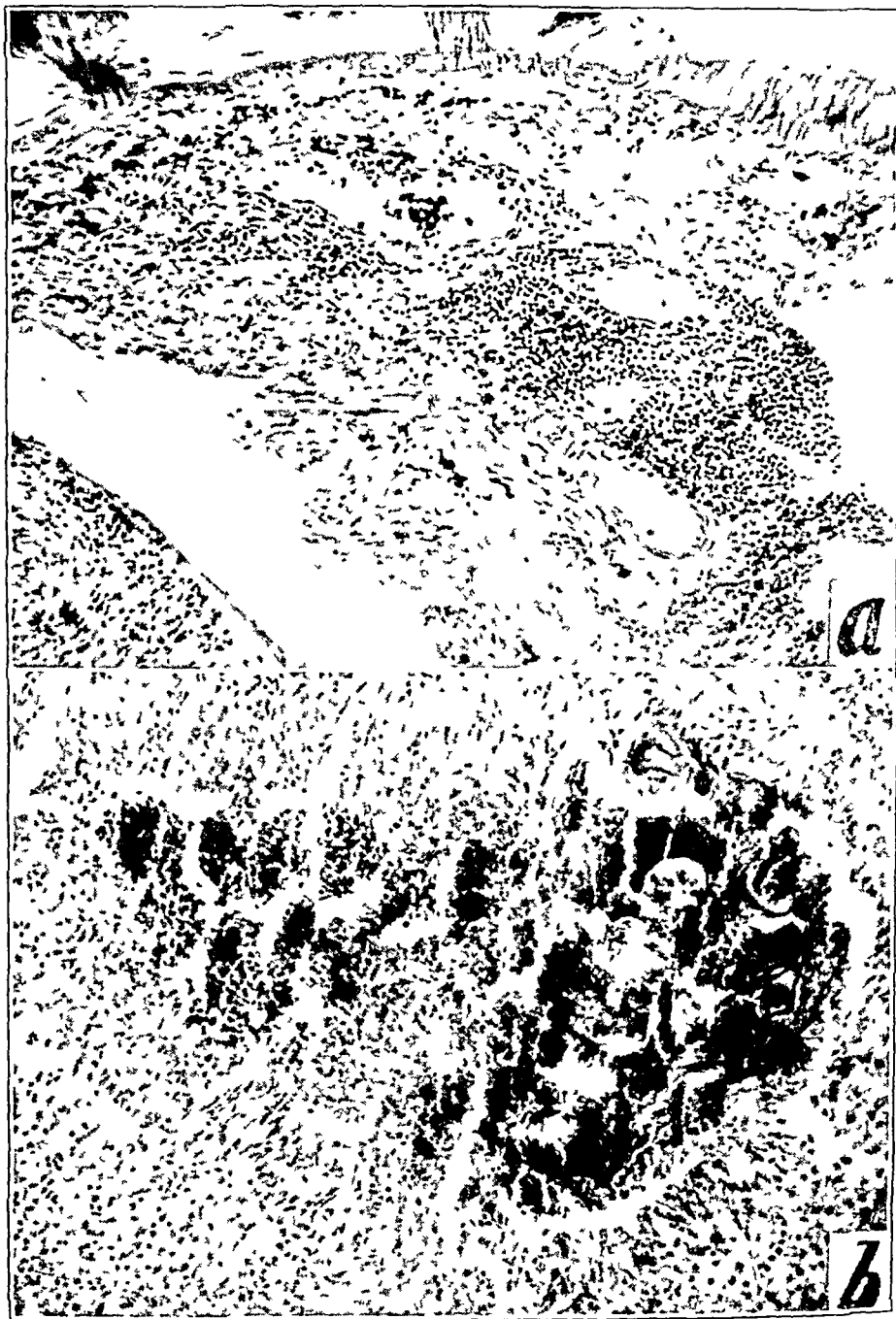

Figure 3, *A* and *B*.

superficial scar tissue which had replaced the granuloma visible at the first operation. The specimen measured approximately 15 by 1 by 0.5 cm. The patient had no untoward effect from the operation.

Attempts to hatch miracidia from the tissue obtained at biopsy were unsuccessful, but stained sections (hematoxylin and eosin) showed large numbers of ova of *S. japonicum*.

At the time of writing, it has been only four weeks since the operation, and it is obviously too early to justify our reaching any conclusions concerning the benefit of this procedure. However, it should be stated that the patient's general condition is much improved. Administration of phenobarbital has been discontinued, but in spite of this the seizures are less frequent and less severe.

COMMENT

The route of infection of the brain by the ova of *S. japonicum* remains obscure. The rarity of this complication is commonly explained by the existence of the vascular barriers of the lung and liver. Ordi-

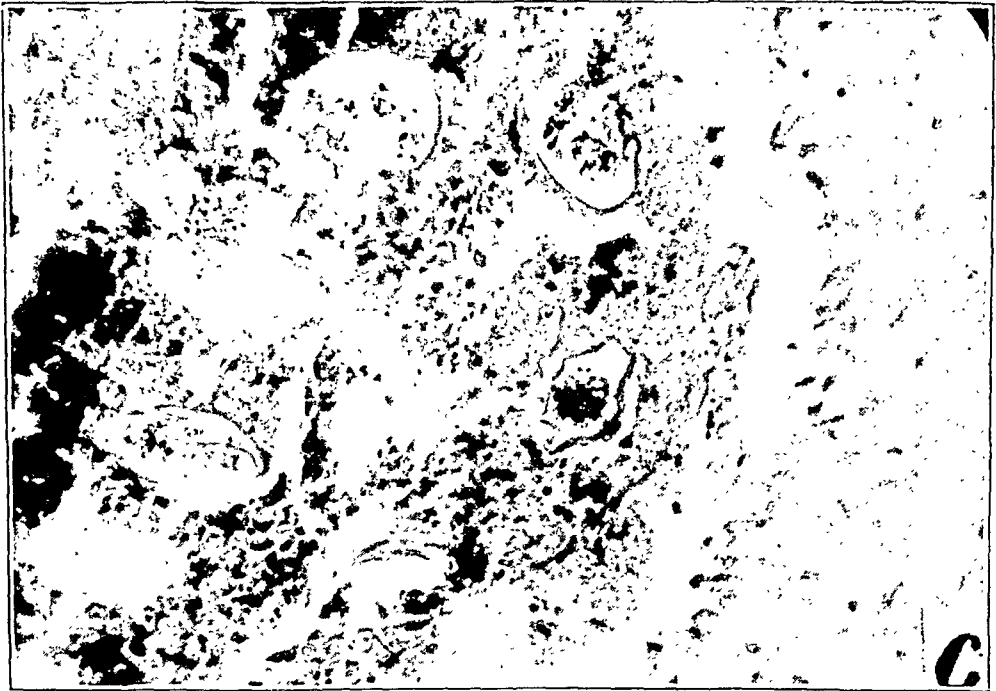

Fig. 3.—Photomicrographs showing (a) perivascular infiltration with round cells and eosinophils ($\times 140$), (b) the typical lesion or "pseudotubercle," with gliosis, necrosis, packed eosinophils and distorted ova of *Schistosoma japonicum* ($\times 140$) and (c) six distorted ova of *S. japonicum* embedded in packed, damaged eosinophils. ($\times 330$). The "hook" is visible on the ovum in the upper right corner of this photograph.

narly, the cercariae of the trematode infect man by penetrating the skin, after which, they travel to the liver by way of the blood and lymph channels. The cercariae develop into adults, which migrate to the venules of the small intestine, where ova are deposited. By passive penetration, the ova enter the lumen of the intestine and are excreted. The life cycle is completed by hatching of the ova in water, with the liberation of ciliated miracidia, which infect certain species of snail, the distribution of which determines the distribution of the disease. After

the intramolluscan phase of multiplication and development, the resultant cercariae emerge and swim about in search of a human host. Penetration of the skin begins the intramammalian phase of the cycle. Even assuming the presence of a cardiac anomaly which would allow the passage of the ova from the venous to the arterial circulation without the impediment of the pulmonary capillary bed, there is still the barrier of the hepatic portal system. Greenfield and Pritchard^{1c} noted the tendency of the ova to localize in the left cerebral hemisphere. This observation is confirmed by a review of the literature. They suggested that the adult worms lie in one of the cerebral venous sinuses, probably the lateral sinus, and migrate up the posterior anastomotic vein for the purpose of egg laying. There is yet no proof for such a hypothesis. Without the benefit of scientific explanation, the ova occasionally, nevertheless, arrive in the cerebral tissue. Faust and Meleney⁸ offered no solution for the problem.

The pathologic basis for the symptoms presented by this patient lay in the lesions produced by the presence of the ova. There was an inflammatory response, characterized mainly by necrosis and the presence of large numbers of eosinophils. Calcification was evident in both gross and microscopic specimens and may have been the cause of the cerebral irritation, which became progressively more pronounced, as evidenced by the electroencephalogram and the increased difficulty in controlling the seizures (figs. 1 and 2). The juxtaposition of numerous lesions may produce the signs and symptoms of cerebral tumor, as in this case. The electroencephalographic evidence of generalized epileptogenic activity in the case in point implied wide distribution of the lesions.

The diameter of the tumor at the time of operation was approximately 5 cm. This estimate is based on the observations on the cortical surface at operation and the degree of distortion of the ventricular system. Headache was relieved immediately after operative decompression.

Language dysfunction of the receptive type, with a premonitory marked fatigue phenomenon, was present at all times and became more pronounced. The idea content of written and spoken language was appreciated to a moderately impaired degree for approximately five minutes of narrative speech. The patient was then incapable of repeating the idea content. He said, "After five minutes of listening, I can hear the individual words and the sentences and understand them, but I can't get the idea they want to put over at all."

The patient was placed under treatment with a standard course of fuadin immediately after operation and confirmation of the preoperative diagnosis. Since there was no recurrence of the headaches of the type experienced prior to operation, it may be inferred that there was some

reduction of the tumor mass due to fuadin therapy, possibly on the basis of the reduction of inflammation around the ova.

Treatment of the seizures was by use of diphenylhydantoin sodium and phenobarbital. It is of interest that the phenomenon of weeping persisted after the disappearance of micropsia and episodic dysphasia, usually in the absence of overt motor movements. This improvement was of transient character, since the seizures became progressively worse.

There is little case material to serve as a standard for prognosis. Greenfield and Pritchard^{1c} stated:

The prognosis with regard to survival and cessation of convulsive seizures is good when operative removal of the tumour is followed by a course of antimony therapy.

Of the 2 patients at England General Hospital,² the one who was operated on was discharged with "very slight weakness of facial muscles and occasional slurring of speech." The other patient, who was subjected merely to probing, continued to show some aphasia. Convulsions were controlled with diphenylhydantoin sodium. Both patients received fuadin therapy after operation. Seven patients reported on by Tillman⁴ recovered. Some showed residual symptoms three months after exposure. Of the 2 patients with cerebral schistosomiasis reported by Vitug, Cruz and Bautista,^{1a} 1 died in a convulsive attack and the other, after two months of convalescence, recovered from hemiparesis and was discharged as "strong and walking." Spiridon⁶ reported on 12 patients with schistosomiasis, of whom 3 showed neurologic signs. A patient who had shown clouding of the sensorium, paresis of the arms and incontinence was given intravenous injections of sodium antimonyl tartrate and had no symptoms at the end of four weeks. A second patient, with coma, spastic quadriplegia and attacks of screaming at various times, who received similar treatment, was allowed to return home after seventeen weeks of convalescence. He had residual spastic hemiparesis. A third patient had flaccid hemiplegia, which showed improvement apparently prior to, as well as after, injections of fuadin.

Vitug, Cruz and Bautista^{1a} described lesions in the choroid plexus, as well as in the parenchyma. The pia was thickened. There were fibrosis and thickening of the vessel walls with "pseudotubercles," including giant cells. Gliosis was present. The pathologic picture described by Greenfield and Pritchard^{1c} was similar in most respects to that described in the present report. A much smaller proportion of eosinophils was observed in the lesions of their cases, however.

Faust,¹¹ paraphrasing Gonzales Martinez, merely stated that the egg has an "irritative action."

11. Faust, E. C.: Studies on Schistosomiasis *Mansoni* in Puerto Rico: I. The History of Schistosomiasis in Puerto Rico, Puerto Rico J. Pub. Health & Trop. Med. 9:154-161 (Dec.) 1933.

The earliest symptom of cerebral involvement by the ova is usually focal epileptic seizures,¹² and the left hemisphere is most frequently involved.¹²

SUMMARY

This report deals with a case of cerebral schistosomiasis, in which the ova were demonstrated in the cerebral tissue.

There was a definite history of exposure in water, later condemned for bathing, in a region in which the disease is endemic. The onset was typical, with vague constitutional symptoms, gastrointestinal disturbance, fever and eosinophilia. Ova of *S. japonicum* were found in the stool. Convulsive seizures and paroxysmal disturbances of consciousness developed. There were definite electroencephalographic changes indicative of a localized intracranial space-occupying lesion and of epilepsy. A ventriculogram confirmed the presence of a space-occupying lesion, and a granuloma in the predicted location was visualized at operation. Biopsy of specimens obtained on two separate occasions revealed ova of *S. japonicum*. The patient's clinical course and treatment are described.

River Cottage, Forest Street, Sherborn, Mass.
899 Madison Avenue, Memphis 3, Tenn.
2167 Highland Avenue, Birmingham 5, Ala.

12. Greenfield and Pritchard,^{1c} Tfunada and Shimamura,^{1d} Chasnoff,⁵ Maltby and Schmidt.²

ELECTROENCEPHALOGRAM IN THE PITRESSIN HYDRATION TEST FOR EPILEPSY

CAPTAIN JULIUS S. BLIER
AND
CAPTAIN FREDERICK C. REDLICH
MEDICAL CORPS, ARMY OF THE UNITED STATES

THE PROBLEM

IN A LARGE number of patients with alterations of consciousness and convulsive seizures there is difficulty in establishing the diagnosis of epilepsy because the seizures cannot be observed and the electroencephalogram is not sufficiently abnormal to warrant a probable diagnosis of paroxysmal disorder. The necessity of arriving at a diagnosis with reasonable certainty is particularly great in military neuropsychiatry. Army regulation requires confirmation of the history by a medical officer, who must witness a seizure or an abnormal electroencephalogram. Concerning such witnessing of a seizure, Roseman¹ pointed out how rarely a qualified observer has the opportunity to observe a convulsive seizure in the wards of a military hospital. As to the value of the electroencephalogram, Gibbs, Gibbs and Lennox² found that in a series of 730 adult epileptic patients the electroencephalogram gave little diagnostic aid in 47.1 per cent.

This problem is of long standing, and many techniques have been evolved to prove or disprove the diagnosis of epilepsy, the most useful of which is the pitressin hydration test developed by McQuarrie and Peeler.³ They showed that grand mal seizures can be induced within twelve to forty-eight hours in epileptic children by giving water while maintaining effective pituitary antidiuresis. Alteration of the colloids and electrolytes in the brain was considered the essential factor. Subsequent work by Jacobsen,⁴ also on children, and by Clegg and Thorpe,⁵

1. Roseman, E.: The Epileptic in the Army, *Am. J. Psychiat.* **101**:349-354 (Nov.) 1944.

2. Gibbs, F. A.; Gibbs, E. L., and Lennox, W. G.: Electroencephalographic Classification of Epileptic Patients and Control Subjects, *Arch. Neurol. & Psychiat.* **50**:111-128 (Aug.) 1943.

3. McQuarrie, I., and Peeler, D. B.: The Effects of Sustained Pituitary Antidiuresis and Forced Water Drinking in Epileptic Children: A Diagnostic and Etiologic Study, *J. Clin. Investigation* **10**:915-940 (Oct.) 1931.

4. Jacobsen, A. W.: The Pitressin Test in Epilepsy, *New York State J. Med.* **34**:506-509 (June 1) 1934.

5. Clegg, J. L., and Thorpe, F. T.: Induced Water Retention in Diagnosis of Idiopathic Epilepsy, *Lancet* **1**:1381-1382 (June 15) 1935.

Hilger, Mueller and Freed,⁶ Garland and associates;⁷ Blyth⁸ and others gave further support to the validity of the test. Garland and associates⁷ reviewed the literature to 1943 and found that various observers had reported 10 to 100 per cent efficacy for this test, with approximately 40 per cent positive results in series excluding children. He suggested studying the pitressin hydration test in conjunction with electroencephalography. Gibson⁹ combined the pitressin hydration test with hyperpnea and found a positive reaction in 75 per cent of epileptic patients. However, Clegg and Thorpe⁵ concluded that, although the pitressin hydration test is of definite value in arriving at a diagnosis of epilepsy in doubtful cases, no fit may be induced when the patient has seizures infrequently. Stone and Chor¹⁰ presented the divergent opinion that a high fluid intake with or without the addition of an antidiuretic did not produce an increase in the incidence of convulsions in their group of adult epileptic patients. Further, their biochemical studies led them to doubt the efficacy of the hydration technic. The work of several other observers, who also felt that the pitressin hydration test is of doubtful value, was cited. A review of the literature failed to reveal any study of the pitressin hydration test in conjunction with electroencephalography except possibly by Allen,¹¹ whose work on dogs was discontinued after one tracing was made.

In our material the pitressin hydration test was applied to patients with a reliable history of convulsive seizures whose electroencephalograms were normal. In this group, which consisted of relatively mildly affected subjects, seizures were induced infrequently. It was then decided to examine the electroencephalogram of these patients at the conclusion of the pitressin hydration test in an attempt to discover changes of possible diagnostic significance. Further, the electroencephalograms of 11 patients with a diagnosis of fainting and those of 10 controls were studied in similar circumstances. The electroencephalographic changes will be reported.

6. Hilger, D. W.; Mueller, A. R., and Freed, A. E.: The Pitressin Hydration Test in the Diagnosis of Idiopathic Epilepsy, *Mil. Surgeon* **91**:309-313 (Sept.) 1942.

7. Garland, H. G.; Dick, A. P., and Whitty, C. W. M.: Water-Pitressin Test in Diagnosis of Epilepsy, *Lancet* **2**:566-569 (Nov. 6) 1943.

8. Blyth, W.: The Pitressin Diagnosis of Idiopathic Epilepsy, *Brit. M. J.* **1**:100-102 (Jan. 23) 1943.

9. Gibson, P. L.: Pitressin Hyperpnea Test and Epilepsy, *J. Roy. Nav. M. Serv.* **23**:334-338 (Oct.) 1937.

10. Stone, T. T., and Chor, M.: Water Metabolism in Relation to Convulsions, *Arch. Neurol. & Psychiat.* **38**:798-817 (Oct.) 1937.

11. Allen, F. M.: Spontaneous and Induced Epileptiform Attacks in Dogs, in Relation to Fluid Balance and Kidney Function, *Am. J. Psychiat.* **102**:67-73 (July) 1945.

. MATERIAL

Patients with Convulsive Seizures (1 to 12, table 1).—All patients in this group were thought to have idiopathic epilepsy, grand mal type. Only patients with normal electroencephalograms were included. Some of the characteristic symptoms and electroencephalographic findings are indicated in table 1. Eleven patients reported generalized convulsive seizures, and all, loss of consciousness and amnesia. In 6 of the 12 patients seizures were observed by a medical officer. As in most patients seen in military hospitals, the average frequency of seizures was low.

Patients with Syncopal Attacks (13 to 23, table 2).—For patients 13 to 19 the diagnosis of hysterical fainting was made in accordance with the diagnostic criteria as outlined by Romano and Engel.¹² For patients 20, 21 and 22 the diagnosis was not certain, and there was some doubt as to whether these patients were epileptic. In the case of patient 23 it was felt that the old diagnostic term of hysteroepilepsy fitted the picture best, as the patient had a hysterical personality and seizures characterized by loss of consciousness without convulsions. All electroencephalograms prior to pitressin hydration in this group were normal.

Controls (24 to 33, table 3).—For 7 of these patients the diagnosis was mild post-traumatic encephalopathy manifested by headache; for 1, postmeningitic cephalalgia, and for 2, anxiety state. Here, too, the electroencephalograms taken prior to pitressin hydration were normal.

All patients were subjected to a complete physical and neurologic examination, with attention to sensitivity of the carotid sinus. Laboratory procedures included a blood count, examination of the urine, a Wassermann test and roentgenographic examination of the skull. The patients in groups 1 and 2 had, in addition, a lumbar puncture, with determination of pressure and study of the spinal fluid, and a carbohydrate tolerance test. All findings were noncontributory except in a negative sense.

METHOD

The Pitressin Hydration Test.—The technic described by Garland was considered to be simple, effective, safe and in conformity with the technics used by workers in similar studies and was therefore followed. A regular diet was given. The patients were kept in bed for the day of the test and twenty-four hours thereafter. Sideboards were used. The patient was weighed at 6:55 a. m. on the day of the test, after emptying the bladder, and then every three hours. The intake and output of fluids were charted. The blood pressure was determined every two hours. A pint (473 cc.) of water was given hourly for eleven hours, starting at 7:00 a. m. Pitressin was given hourly, starting at 10:00 a. m., according to the following dosage: 0.2, 0.3 and 0.4 cc., and then 0.5 cc. for four doses. The electroencephalogram was made at approximately 6 p. m. If a convulsion occurred, the test was stopped immediately and phenobarbital, 1½ grains (0.097 Gm.), administered.

Electroencephalographic Technic and Classification.—The electroencephalogram was determined by the standard technic.¹³ A Grass encephalograph was used.

12. Romano, J., and Engel, G. L.: Studies of Syncope: III. Differentiation Between Vasodepressor and Hysterical Fainting, *Psychosom. Med.* 7:3-15 (Jan.) 1945.

13. *Electroencephalography: Operative Technique and Interpretation*, United States War Department, Technical Bulletin (TB Med 74), Washington, D. C., Government Printing Office, July 27, 1944.

TABLE 1.—Effect on Electroencephalogram of Pitressin Hydration Test in Patients with Clinical Diagnosis of Epilepsy

Patient No.	Age	Seizures Reported	Seizures Observed	Frequency of Seizures	Onset of Seizures (Yr.)	Convulsions	Unconsciousness	Tongue Biting	Incontinence	Family History of Epilepsy	EEG Type *		Comment
											Before Hydration	After Pitressin Hydration	
1	22	Yes	Yes	Infrequent	10	Yes	Yes	Yes	Yes	+	N	F.2	Seizure 5 hr. after hydration; marked change persisted 1 week
2	21	Yes	Yes	2 in 9 yr.	11	Yes	Yes	Yes	No	+	L.V.F.	F.1	Slight change
3	23	Yes	Yes	Infrequent	10	Yes	Yes	Yes	No	—	N	F.1	Marked change; seizure 6 days after hydration
4	21	Yes	No	Infrequent	Early life	No	Yes	No	No	+	N	S.1	Slight change
5	19	Yes	No	Total 5	14	Yes	Yes	Yes	No	+	N	S.1	Slight change
6	25	Yes	Yes	4 in 4 mo.	24	Yes	Yes	Yes	Yes	—	N	S.1	Slight change
7	20	Yes	No	5 in 18 mo.	19	Yes	Yes	No	No	+	N	Psy.	Marked change
8	24	Yes	Yes	2 in 2 mo.	24	Yes	Yes	Yes	No	—	N	F.1	Slight change
9	25	Yes	Yes	Infrequent	16	Yes	Yes	Yes	No	—	N	F.1	Slight change
10	28	Yes	No	7 in 9 yr.	19	Yes	Yes	Yes	Yes	—	N	N	No change except 2 short 18-24 per sec. bursts
11	22	Yes	Yes	2 yr.	Childhood	Yes	Yes	Yes	Yes	+	N	N	No change
12	24	Yes	Yes	Infrequent	18	Yes	Yes	No	Yes	—	N	N	No change; seizure 6 hr. after hydration

* In this table, and in the accompanying tables, N indicates a normal electroencephalogram; F.1, slightly fast activity; F.2, very fast activity; L.V.F., low voltage fast activity; P.M., petit mal type, and S.1, slightly slow activity.

The electrical activity of the frontal, motor, temporal and occipital areas was recorded with monopolar leads. The classification of Gibbs, Gibbs and Lennox was followed. For our comparisons this classification, although based on subjective criteria, was deemed satisfactory; actually, more objective methods are cumbersome and do not yield more useful results. The classification as described by Gibbs, Gibbs and Lennox² includes the following categories:

A. Paroxysmal

1. Petit mal variant—P.M.V.
2. Petit mal type—P.M.
3. Psychomotor type—Psy.
4. Grand mal type—G.M.
5. Spikes—Sp.

B. Slow activity

1. Very slow—S.2
2. Slightly slow—S.1

C. Normal activity

1. From 8½ to 12 waves per second
2. Low voltage fast—L.V.F.

D. Fast activity

1. Slightly fast—F.1
2. Very fast—F.2

Records taken before and after pitressin hydration were compared primarily as to any change in frequency and character of the brain waves. Deviations were expressed in terms of the classification of Gibbs, Gibbs and Lennox.² Changes from normal to fast (F.1) or slow (S.1) frequencies were classified as "slight." Changes from normal to very fast (F.2), to very slow (S.2) or to paroxysmal (petit mal, petit mal variant, psychomotor, grand mal and spikes) dysrhythmias were counted as "marked."

OBSERVATIONS

It was found that the pitressin hydration test was in general well tolerated by the patients.

In the entire series convulsive seizures occurred as follows: In patient 1 a grand mal seizure occurred in the fifth hour of the test; in patient 12 six hours after termination of hydration, and in patient 3, six days (!) after hydration. All these patients were presumed to be epileptic. Side reactions were similar to those observed by previous workers and consisted of pallor, occasional abdominal cramps, occasional vomiting and occasional headache, none of which was severe enough to cause suspension of the procedure. The blood pressure did not vary significantly except in patient 24, in whom it rose from normal to 210 systolic and 110 diastolic in the eighth hour of the test, at which time the test was discontinued. This elevation was accompanied with headache and dizziness. Phenobarbital was administered, after which the blood pressure became normal in a short period. In the case of patient 16 the test was discontinued in the seventh hour for the sake of safety because at that time he suddenly sat up in bed and complained of queer feelings. There was no loss of consciousness. The blood pressure was normal. The electroencephalogram taken immediately was normal. It was felt that this was not an epileptic manifestation.

A positive water balance was uniformly obtained, as evidence by a diminution of urinary output as compared with the fluid intake and by a gain in weight (average 5.3 pounds [2.4 Kg.]).

In the group of patients with convulsive seizures (table 1), 3 of 11 patients showed pronounced changes in the electroencephalogram after

pitressin hydration; the record of patient 1, which was previously normal, showed very fast activity; the record of patient 3, which was normal, contained some petit mal waves after the test; and the record of patient 7 changed from a normal to a psychomotor pattern. For 6 patients the alterations were characterized as slight, as manifested by a change from a normal record before the test to one with fast frequencies for 3 patients and to one with slow frequencies for 3 patients. The record of patient 10 showed only a slight change, which consisted of two short bursts of 18 to 24 per second waves of medium voltage in an otherwise normal record. In the records of patients 11 and 12 no change was noted in spite of the fact that the latter had two grand mal seizures, witnessed by a nurse about five hours after the recording.

In the second group of patients, who had fainting attacks (table 2), no changes in the electroencephalogram were noted after hydration

TABLE 2.—*Effect on Electroencephalogram of Pitressin Hydration Test in Patients with Syncope*

Patient No.	Diagnosis	Type of EEG		Comment
		Before Pitressin Hydration Test *	After Pitressin Hydration Test	
13	Vasodepressor syncope	N (4)	N	No change
14	Hysterical syncope	N (4)	N	No change
15	Hysterical syncope	N (3)	N	No change
16	Hysterical syncope	N	N	No change; hydration suspended †
17	Hysterical syncope	N (2)	N	No change
18	Hysterical syncope	N (2)	N	No change
19	Hysterical syncope	N	N	No change
20	Psychopathic personality ? epilepsy	N (2)	N	No change
21	Hysterical syncope ? epilepsy	N	N	No change
22	Psychopathic personality ? epilepsy	N (2)	N	No change
23	? Hysteroepilepsy	N	F.1	Slight change

* Figures in parentheses refer to the number of records made.

† Bizarre behavior in the seventh hour of the test.

except for that of patient 23, in which there was a slight change. This patient was a 23 year old private first class who was hospitalized for nervousness accompanied with dizzy spells, black-outs and a sensation described as "electricity" in the cervical and occipital regions, all of three months' duration. There was no history of convulsions, incontinence or tongue biting. The soldier was amnesic for the period of unconsciousness. He gave the impression of a hysterical personality, with much anxiety. The family history was normal, and neurologic examination and laboratory tests revealed nothing significant. The diagnosis in this case remained obscure, since no definite psychogenic explanation could be found to account for his loss of consciousness on a hysterical basis.

In the group of control patients (table 3) no alteration in the electroencephalogram was noted after hydration except as follows:

Patient 24 showed a change in the record from low voltage fast to fast (F1) activity. In this patient the hydration was complicated by hypertension (210 systolic and 110 diastolic). Patient 31, for whom a diagnosis of postmeningitic cephalalgia was established, showed a slight change in that a few 12 to 14 per second and a few 7 to 8 per second brain waves were noted after hydration.

COMMENT

According to Gibbs, Gibbs and Lennox, the use of the electroencephalogram alone permitted confirmation of the diagnosis of epilepsy in only 39 per cent of cases (paroxysmal records). In 32 per cent records showing fast (F. 1) or slow (S. 1) activity gave only supporting evidence, and in 13 per cent of epileptic patients the electroencephalogram

TABLE 3.—*Effect on Electroencephalogram of Pitressin Hydration Test in Control Subjects*

Patient No.	Diagnosis	Type of EEG		Comment
		Before Pitressin Hydration Test	After Pitressin Hydration Test	
24	Post-traumatic encephalopathy	L.V.F.	F.1	Test suspended because of hypertension *
25	Post-traumatic encephalopathy	N	N	No change
26	Anxiety state	N	N	No change
27	Cephalalgia	N	N	No change
28	Post-traumatic encephalopathy	N	N	No change
29	Anxiety state	N (2 records)	N	No change
30	Post-traumatic encephalopathy	N	N	No change
31	Postmeningitic cephalalgia	N	? N	Very slight change †
32	Post-traumatic encephalopathy	N	N	No change
33	Post-traumatic encephalopathy	N	N	No change

* The blood pressure rose to 220 systolic and 110 diastolic in the eighth hour of the test.

† The change consisted in the appearance of a few 12 to 14 and 7 to 8 per second bursts.

was normal. Roseman¹ found that 21 per cent of his 364 patients had normal records. Of our 120 patients, the records of 39.2 per cent showed normal, borderline normal or low voltage fast activity. The records with fast (F. 1) and slow (S. 1) potentials comprised 18 per cent. Thus, the electroencephalogram alone gave little diagnostic aid in 57.2 per cent of our patients. The fact that the electroencephalogram tends to show fewer abnormalities in military epileptic patients, who by and large have a mild form of the disease and have previously been screened, had been observed by O'Leary.¹⁴ This consideration makes it even more desirable to find other objective technics in order to arrive at a diagnosis of epilepsy in patients whose electroencephalogram is not decisive. This consideration led us to use the pitressin hydration test in combination with electroencephalographic observation.

14. O'Leary, J.: Verbal communication to authors.

Pitressin hydration induces seizures in a variable percentage of epileptic patients, probably depending on the degree of hydration. This is attributed to the alteration of colloids and electrolytes in the tissues of the brain. The work of Fremont-Smith, Merritt and Lennox¹⁵ confirmed this hypothesis and showed that the mechanical theory is untenable, since the cerebrospinal fluid pressure after hydration was found to be only slightly increased and the cerebrospinal fluid pressures at the time of seizures were within normal limits.

The pitressin hydration technic is not without danger, particularly when a large dose of the drug is administered. Deaths have been reported in the literature in the older age groups. Young and otherwise vigorous adults seem to tolerate the procedure as outlined in this report without serious difficulty. More drastic hydration does not seem warranted. Careful selection of cases and caution are indicated.

Our electroencephalographic findings suggest that pitressin hydration causes a dysrhythmia in epileptic patients whose electroencephalograms were previously normal. We noted pronounced changes in the records of 3 and slight changes in the records of 6 of the 12 patients in the epileptic group. The 3 remaining patients showed no significant change. Such changes were shown by only 1 of 11 patients with fainting attacks, in group 2, and by 2 of 10 control subjects. This difference is even more striking when we consider that patient 23, in group 2, who showed slight changes, may well have been epileptic, and that in patient 24 hydration was complicated by an abrupt and severe elevation of the blood pressure. Patient 31, in the control group, who showed very slight changes, had recently recovered from meningococcic meningitis, with possible, though undetectable, cerebral change.

Our results at least seem to encourage a similar study on a larger group of patients. Tentatively, it may be said that cerebral hydration induces cerebral dysrhythmia in patients with epilepsy. In normal persons and in patients with fainting attacks (vasodepressor and hysterical syncope) few electroencephalographic changes were induced. A moderate and well tolerated degree of pitressin hydration seems to induce electroencephalographic changes more frequently than actual seizures in adult epileptic patients with a mild form of the disease, if one may judge from such a small number of cases. We believe that electroencephalographic observations before and after pitressin hydration add to the diagnostic significance of the test and aid in the differential diagnosis of the paroxysmal disorders and syncopes.

15. Fremont-Smith, F.; Merritt, H. H., and Lennox, W. G.: Relationship Between Water Balance, Spinal Fluid Pressure and Epileptic Convulsion, *J. Nerv. & Ment. Dis.* **76**:176-179 (Aug.) 1932.

SUMMARY

The pitressin hydration test in conjunction with electroencephalographic study was applied to 12 patients for whom a clinical diagnosis of epilepsy was made, 11 patients with psychogenic fainting and 10 control subjects. All patients had normal electroencephalograms prior to hydration.

Convulsive seizures occurred in the epileptic group as follows: in 1 patient during the test, in 1 shortly after the test and in 1 six days later.

The electroencephalograms of 9 of 12 patients of the epileptic group showed changes after pitressin hydration (3 patients had marked changes, and 6 patients, slight changes). In the group consisting of patients with psychogenic disturbance of consciousness slight changes occurred in the record of 1 of 11 patients. In the control group, 2 of 10 subjects showed slight changes. For 1 of these subjects a diagnosis of post-meningitic state was made. The other had a sharp rise in his blood pressure after hydration.

The findings are discussed; and, although the number of observed cases was small, the results are thought to be significant and of some value in differentiating epilepsy from hysterical and vasodepressor disturbances of consciousness.

140 Riverside Drive, New York.
333 Cedar Street, New Haven, Conn.

ABDOMINAL RIGIDITY

A Symptom of Concussion of the Spinal Cord

MAJOR KENNETH H. ABBOTT

MEDICAL CORPS, ARMY OF THE UNITED STATES

IT HAS been common practice to include all the injuries to the spinal cord arising out of indirect violence in the one term "spinal concussion." For the purpose of this paper, the more definite term "concussion of the spinal cord" seems better and will be used. It signifies the presence in the spinal cord of a physiologic state similar to that in the cerebrum when the term "cerebral concussion" is used. In concussion of the spinal cord a transitory functional, and perhaps structural, disturbance of the spinal cord is incurred consequent to indirect trauma to the cord. This definition emphasizes the functional reversibility of the injury to the cord and makes it evident that recovery occurs in a relatively short time, that is, from a few hours to a few days. The reports in the literature and my experience in World War II indicate that functional recovery should occur in less than two weeks, more likely within ten days. It is presumed that when loss of function persists longer than ten days the injury to the spinal cord is of a structural and more serious type or degree than concussion.

The greatly confused subject of "spinal concussion"¹ in general has been the topic of considerable controversy and speculation for at

Dr. Abbott has received his discharge from the service and is now located in Rochester, Minn.

1. Most writers include any type of injury to the spinal cord as a result of indirect trauma under the term "spinal concussion," "commotio spinalis" or *Rückenmarkerschütterung*, of the German writers. The papers of H. Obersteiner (Ueber Erschütterung des Rückenmarkes, *Med. Jahrb.*, 1879, pp. 531-562; abstracted, *Schmidt's Jahrb.* **186**:236-237, 1880), J. Lhermitte (*Étude de la commotion de la moelle*, *Rev. neurol.* **1**:210-239 [Feb.] 1932), G. B. Hassin (Concussion of the Spinal Cord: A Case with Clinical Picture of Amyotrophic Lateral Sclerosis, *Arch. Neurol. & Psychiat.* **10**:194-211 [Aug.] 1923), O. Marburg (Die traumatischen Erkrankungen des Gehirns und Rückenmarks: B. Die traumatischen Erkrankungen des Rückenmarks, in Bumke, O., and Foerster, O.: *Handbuch der Neurologie*, Berlin, Julius Springer, 1936, vol. 11, pp. 100-153), H. Claude and J. Lhermitte (*Étude clinique et anatomo-pathologique de la commotion médullaire directe par projectiles de guerre*, *Ann. de méd.* **2**:479-506, 1915) and C. Davison (General Pathological Considerations in Injuries of the Spinal Cord, in Brock, S.: *Injuries of the Skull, Brain and Spinal Cord: Neuro-Psychiatric, Surgical and Medico-Legal Aspects*, Baltimore, Williams & Wilkins Company, 1940, pp. 453-485), among innumerable others, all exemplify the broad and nonspecific use of these terms.

least two centuries, and little enlightenment has resulted. In the last century Erichsen² reviewed the subject thoroughly; and, like all other investigators of his time and many since, he confused many different types of traumatic lesions of the spinal cord with unrelated degenerative diseases, neuroses ("railway spine") and inflammatory processes. However, he suggested that a "molecular disturbance"³ in the spinal cord was the fundamental cause of the immediate loss of function and of other symptoms subsequent to trauma. Just what he meant by "molecular disturbances" is not clear, but he implied that minor intracellular (or fiber) structural changes took place in the neurons. If this interpretation of his meaning is correct, his hypothesis is not unlike present conceptions concerning the histologic and physiologic changes accompanying cerebral concussion.

Recent investigations have pointed toward a structural basis for the clinical symptoms of true concussion of the spinal cord. Groat and co-workers⁴ observed definite cellular changes in the spinal cords of cats which had been subjected to blows of the type that produce concussion. These cellular changes were characterized by chromatolysis involving principally the "interneurons of large and intermediate size of both dorsal and ventral grey columns." The long descending and ascending fiber tracts were also involved,⁵ as were the lower motor

2. Erichsen, J. E.: *On Concussion of the Spine, Nervous Shock, and Other Obscure Injuries of the Nervous System in Their Clinical and Medico-Legal Aspects*, revised ed., New York, Bermingham & Co., 1882, p. 93.

3. Hassin gave credit to Obersteiner for introducing the term "molecular" change as the essence of spinal concussion. However, it appears that Erichsen² (ed. 1, New York, William Wood & Company, 1875) published his book four years before Obersteiner's paper appeared (1879).

4. Groat, R. A.; Rambach, W. A., Jr., and Windle, W. F.: *Concussion of the Spinal Cord: An Experimental Study and Critique of the Use of the Term*, *Surg., Gynec. & Obst.* **81**:63-74 (July) 1945.

5. It is not intended in this paper to consider details of theories about commotio spinalis or the minutiae of its pathology. The results of the recent, and more accurately controlled, experimental work of Groat and his co-workers, however, seem more closely to coincide with the clinical aspect of concussion of the spinal cord than the results of any previously reported experimental or clinicopathologic study. These previous studies have been summarized by Groat and his associates⁴ and in the papers of W. G. Spiller (*A Critical Summary of Recent Literature on Concussion of the Spinal Cord with Some Original Observations*, *Am. J. M. Sc.* **118**:190-198 [Aug.] 1899), J. Lhermitte (*Étude de la commotion de la moelle*, *Rev. neurol.* **1**:210-239 [Feb.] 1932), G. B. Hassin (*Concussion of the Spinal Cord: A Case with Clinical Picture of Amyotrophic Lateral Sclerosis*, *Arch. Neurol. & Psychiat.* **10**:194-211 [Aug.] 1923), C. Davison (*General Pathological Considerations in Injuries of the Spinal Cord*, in Brock, S.: *Injuries of the Skull, Brain and Spinal Cord: Neuro-Psychiatric, Surgical and Medico-Legal Aspects*, Baltimore, Williams & Wilkins Company, 1940, pp. 453-485) and others.

neurons, but to a much less extent. These changes were proportional to the severity of the concussion. Edema also has been observed. In the light of the definition of concussion of the spinal cord given, it is unlikely that petechial hemorrhages and focal necrosis, as described by certain investigators, belong to the syndrome of concussion of the spinal cord. Changes similar to those produced by electrical phenomena accompanying cerebral concussion, namely, intense excitation, after-discharge and extinction, as described by Walker and associates,⁶ possibly may exist in the cord consequent to concussion. If concussion of the spinal cord can be explained on the same basis as cerebral concussion, it may be caused in part by a breakdown of the polarized cell membranes of many spinal neurons, thus discharging intercollated and other neurons.⁷

In war concussion of the spinal cord is common consequent to the striking of vertebral bodies or processes with a missile. In such injuries concussion of the spinal cord may occur even if the spinal column is not fractured. Perforation of the body of a vertebra frequently causes concussion or contusion of the cord. A blow or a fall on the back without fracture of the spinal column likewise may be the cause of concussion of the spinal cord. The damage inflicted on the cord by an indirect injury resulting from a blow or fall has been well described by Holmes,⁸ who saw many such injuries in World War I, and by many other authors. It varies from transitory loss of function without evidence of gross damage to complete transection of the cord.

Clinically the symptoms of concussion of the spinal cord vary greatly. Most commonly motor and sensory function at and below the site of concussion of the cord is lost temporarily. The intensity and duration of the paralysis vary, but it always lasts less than two weeks. Kislow,⁹ who had studied an unusually large number of spinal injuries in the Russian army, aptly pointed out that in cases of concussion of the spinal cord the site of the gunshot wound, the vertebral damage and the lesion of the cord do not have a direct relationship. Whether this absence of relationship is due to spinal shock (von Monakow's

6. Walker, A. E.; Kollros, J. J., and Case, T. J.: *The Physiological Basis of Concussion*, *J. Neurosurg.* **1**:103-116 (March) 1944.

7. Groat and his associates⁴ recognized this possibility but were unable to find experimental evidence to support this theory as applied to the spinal cord.

8. Holmes, G.: *The Goulstonian Lectures on Spinal Injuries of Warfare: I. The Pathology of Acute Spinal Injuries*, *Brit. M. J.* **2**:769-774 (Nov. 27) 1915; II. *The Clinical Symptoms of Gunshot Injuries of the Spine*, *ibid.* **2**:815-821 (Dec. 4) 1915; III. *The Sensory Disturbances in Spinal Injuries*, *ibid.* **2**:855-861 (Dec. 11) 1915.

9. Kislow, V. A.: *Clinical Peculiarities of War Wounds of the Spinal Cord*, abstracted, *Bull. War Med.* **4**:705 (Aug.) 1944.

“diaschisis”), as Kislow said, to violent changes in the circulation of spinal fluid, or to vascular stasis with ischemia is not certain. In Kislow's group of patients the motor paralysis was spastic in 35 per cent and flaccid in 65 per cent. He further stated that 97 per cent of the patients recovered in from two to thirteen days when the motor paralysis was not due to destruction of the cord. This suggests that this group suffered principally from true concussion of the cord. Sensory recovery, he noted, usually tarried behind motor recovery. Others have reported similar findings which emphasize that spasticity is a common clinical symptom of concussion of the spinal cord. It is also of interest that in cats with experimentally induced spinal concussion the hindlimbs were frequently extended in tonic spasm. Here, again, the symptoms were transitory; and if the symptoms were consequent to structural disturbances (chromatolysis and others), these cellular changes were probably reversible.

CLINICAL FINDINGS IN SEVEN CASES

In evacuation hospitals in the combat zone in the Southwest Pacific Theater of Operations, 7 out of more than 100 soldiers examined by me because of acute injuries to the spinal cord presented certain interesting symptoms of spinal concussion. These patients were seen from one to five hours after injury had occurred, and all of them had abdominal rigidity with mild to severe spasticity in extension of the lower extremities and varying degrees of sensory paralysis up to the level of the lesion. The injuries were all the result of bullet, shell or bomb fragment wounds of the back in the thoracic and lower cervical regions. Four patients presented roentgenographic evidence of fractures of the laminae or spinous processes without comminution or displacement of bone. Although the roentgenograms of the other 3 patients did not show any evidence, fractures may have been present, for stereoscopic views were not available. The spinal fluid of 5 patients was entirely normal, and that of 2 patients contained a few red blood cells. These 2 patients, who also had fractures, may be considered to have had contusion of the cord, although the clinical course of these men varied but little from that in the others.

All the patients gave a history of complete loss of motor and sensory function in the lower extremities and approximately the lower half of the trunk. This was present from a few minutes to four hours after injury and was followed by a gradual return of sensory function, usually accompanied with paresthesia. Coincident with the return of sensory function, all 7 patients complained of increasing abdominal pain with varying degrees of pain in the lower extremities. Because of this abdominal pain, nearly all the patients had been seen by general surgeons, who asked for neurosurgical consultation because of the lack

of evidence of penetrating abdominal wounds or of direct or indirect injury to the abdomen, pleura or lung.

The neurologic examination disclosed both sensory and motor deficits affecting the lower extremities and the trunk. The sensory changes varied from pronounced to mild; hypesthesia and, frequently, dysesthesia and paresthesia were prominent. The sensory changes usually extended irregularly to the lower or middle part of the thoracic region. Sensations of pain and temperature were much more severely impaired than sensations of touch and pressure. Postural sense was poor. Mild to severe motor paralysis of the lower extremities with varying degrees of spasticity in extension was present, although all the patients had experienced complete paralysis of the lower extremities immediately after the injury. The abdominal muscles were likewise spastic, actually rigid, and no one quadrant was affected more than others. Although the patients complained of abdominal pain, sometimes more severe on one side than on the other, localized tenderness was not demonstrable. The abdominal rigidity was not unlike that found with peritoneal irritation from various causes, but no rebound tenderness was present and other evidence of intra-abdominal disease or injury was lacking.

The cremasteric reflexes were sluggish or absent, while the superficial abdominal reflexes were not elicited except in 1 patient, and in this patient they were unequal on the two sides and sluggish. The abdominal muscle reflexes, examined in 2 patients, were bilaterally hyperactive. The state of the patellar and tendo achillis reflexes varied greatly, from absence (4 patients) to hyperactivity (1 patient); but when present they were unequal. These patients were not followed closely enough throughout the ensuing hours and days to warrant any conclusions as to the significance of these irregularities. The plantar responses were absent in 3, "normal" in 1 and "slightly positive" in 3. Rotation of the head failed to induce any change in the position or in the intensity of the spasticity of the lower extremities in any of these 7 patients.

In all these patients the symptoms were transitory. The motor paralysis (paralysis in extension or extensor spasms) and abdominal rigidity nearly or completely disappeared in from two to forty-eight hours. In no instance did abdominal rigidity persist longer than forty-eight hours. The motor weakness completely disappeared in forty-eight hours in 5 patients, while in the 2 patients who had blood in the cerebrospinal fluid the paralysis had improved notably in forty-eight hours. By the fourth day these 2 patients were able to walk without assistance, and neurologic examination disclosed only slight weakness and revealed that the tendon reflexes and plantar responses were within normal limits. These patients were then evacuated to hospitals farther back and could not be followed.

COMMENT

The problems of incomplete section of the spinal cord have been studied extensively, so that it may be stated that "paraplegia in extension is common in spinal lesions and bears evidence that the spinal cord has not been completely severed."¹⁰ Ranson, Muir and Zeiss,¹¹ in experiments in which cats were used, were able to reproduce the equivalent of paraplegia in extension by producing lesions involving the dorsal two thirds of the spinal cord. These experimental results suggest that integrity of the tracts in the anterior and anterolateral portions of the cord is necessary for paraplegia in extension to occur. Studies on decerebrate rigidity by Sherrington,¹² Magnus,¹³ Weed,¹² Keller¹² and others¹⁴ have thrown further light on the problem of paraplegia in extension caused by lesions of part of the cord. Their experiments suggest that decerebrate rigidity must depend on the interruption of extrapyramidal pathways. Fulton, Liddell and Rioch¹⁵ demonstrated that isolated destruction of the vestibular nuclei abolished rigidity in decerebrate preparations, thus indicating that integrity of the vestibular nuclei is necessary in the production of rigidity.

In attempting to explain the physiology of the syndrome of concussion of the spinal cord, it is necessary to eliminate what might be called "local causes" of the abdominal rigidity. Only 3 of the 7 patients had any type of wound of the abdomen, and these were minor and certainly would not be considered capable of producing generalized abdominal symptoms. Wounds of the pleura and lung, which are likewise known to produce abdominal rigidity, were also eliminated as possible etiologic factors. Blood as an irritant to the spinal roots was a possible cause of the abdominal rigidity in only 2 patients. The problem, therefore, appears to be one of determining what structures or tracts in the spinal cord were functionally interrupted. From the evidence presented by these 7 patients, it would appear that the concussion temporarily interrupted the extrapyramidal tracts in the cord (figure). It is also necessary to assume that the vestibular tracts were functionally intact.

10. Fulton, J. F.: *Physiology of the Nervous System*, ed. 2, New York, Oxford University Press, 1943, p. 140.

11. Ranson, S. W.; Muir, J. C., and Zeiss, F. R.: *Extensor Tonus After Spinal-Cord Lesions in the Cat*, *J. Comp. Neurol.* **54**:13-33 (Feb.) 1932.

12. Cited by Fulton,¹⁰ chap. 8, pp. 118-162.

13. Magnus, R., cited by Fulton,¹⁰ chap. 8, pp. 118-162.

14. Bazett, H. C., and Penfield, W. G.: *A Study of the Sherrington Decerebrate Animal in the Chronic as well as the Acute Condition*, *Brain* **45**:185-265 (Oct.) 1922.

15. Fulton, J. F.; Liddell, E. G. T., and Rioch, D. McK.: *The Influence of Experimental Lesions of the Spinal Cord upon the Knee-Jerk: I. Acute Lesions*, *Brain* **53**:311-326 (Oct.) 1930; *The Influence of Unilateral Destruction of the Vestibular Nuclei upon Posture and the Knee-Jerk*, *ibid.* **53**:327-343 (Oct.) 1930.

In addition to the extrapyramidal tracts, the pyramidal and spinothalamic tracts were interrupted functionally to various degrees. The symptom of abdominal rigidity was noted while these tracts were recovering, though severely involved. The posterior columns were also affected but to a less degree than the lateral spinothalamic tracts. Thus, a lesion of part of the spinal cord produced rigidity in extension of the lower extremities, sensory impairment and spasticity (rigidity) of the abdominal muscles; the last-named probably is another manifestation of extensor spasticity. Thus, below the level of the spinal lesion a condition exists which resembles a decerebrate state.

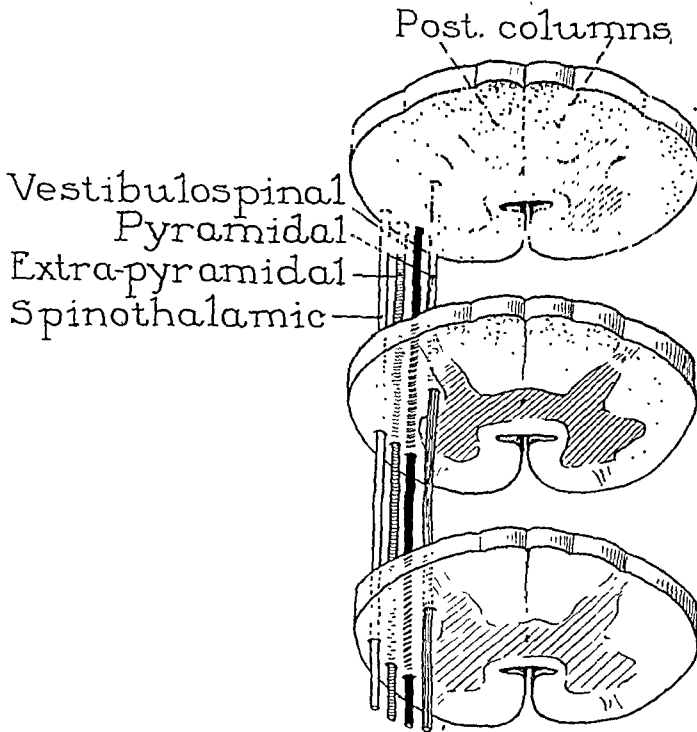

Schematic diagram of the tracts of the spinal cord partially or completely but temporarily interrupted consequent to concussion of the spinal cord. Spasticity in extension of the lower extremities and abdominal rigidity result.

SUMMARY

The term "concussion of the spinal cord" is limited in this paper to a transitory syndrome following indirect injury to the spinal cord. Seven cases are described in which the syndrome of transitory sensory paralysis of the lower extremities with involvement of the trunk into the thoracic region was accompanied by abdominal rigidity and paralysis in extension of the lower extremities. No clinical evidence of gross damage to the spinal cord was found in 5 cases, and in 2 a small quantity of blood was observed in the spinal fluid. All the patients recovered. It is considered that the symptoms referable to the lesion may be due to a so-called molecular disturbance and that the reversible

structural changes within the nerve cells and fibers, associated with probable changes in electrical conductivity and excitation, are not unlike those in cerebral concussion. A brief review of the physiology of the spinal cord in relation to paraplegia in extension suggests that the syndrome resembles that of the decerebrate state, for it is manifest below the level of the spinal injury and is due to involvement of the extrapyramidal pathways without interruption of the vestibulospinal tracts.

The Mayo Clinic, Rochester, Minn.

Obituaries

WALTER DE WITT SHELDEN, M.D.

1870-1946

It may be said that a good teacher or a good diagnostician never mistakes information for understanding or fancy for fact. Dr. Shelden did neither and was both. After his acknowledgment of the friendly greeting of his patient, Dr. Shelden was off to a good start when he called attention to an area of the patient's thorax and asked, "What do you see there?" We saw the patient breathe; we saw his heart beat; we saw a score of things, then carried away a lesson we never forgot: "It is a movement that you see, is it not?" That particular movement was a retraction of the chest wall caused by adhesive pericarditis. Nor did we forget the morning we spent with him simply in feeling pulses. The art of physical examination was at its best, and all that he could catch in the dragnet of the five senses left us spellbound and speechless. It was his slip of paper that lay on the autopsy table with the correct diagnosis, "Carcinoma of the stomach and congenital coarctation of the isthmus of the aorta," and his was the first diagnosis of pituitary tumor made in Minneapolis. Although thirty-five years have come and gone since then, his pupils at the University of Minnesota recall his clinics as though they had been held but yesterday, for in every master there is a touch of eternity.

"Sometimes," he said, "it's wrong to be right," and he never hesitated to admit that he did not know. Reflexes were never "completely absent," for what could be more absent than "absent"? He seldom carried a watch, and since his day began at the City Hospital it often ended there. His patients would leave his office and wait for him next day, perhaps not too patiently, but ready to forgive. Mrs. Plumpandfussy, with a private elevator in her house and a retinue of physicians, left him unruffled. "Sit down," he would say, "what do you want?" "I want to get well." "Why do you want to get well?"

His examinations were pursued with cool and infinite patience. Little wonder that he turned to neurology, where his gifts could find expression and application. In 1913, he accepted the invitation of the Mayo Clinic to establish a section on neurology, and, at the same time, he was appointed professor of neurology, Mayo Foundation, Graduate School, University of Minnesota.

Fifty years ago, extended training for the profession of medicine was not mandatory. Walter Shelden prepared himself thoroughly for his life's work. He entered medical school in possession of the degree of

bachelor of science, which he had been granted by the University of Wisconsin. In 1895, he received the degree of Doctor of Medicine from Rush Medical College. He served as an intern at Cook County Hospital, Chicago, for two years, and finally he spent two additional years in graduate training in Vienna.

He was a courageous leader and was not impressed by undeserved criticism. His ideas were orderly and well formulated, and he was never caught speaking *ore rotundo* or "on stilts." He resisted publication of any article that contributed nothing new or that was no improve-



WALTER DeWITT SHELDEN, M.D.

1870-1946

ment on what already had been said well. His undisputed standing as an internist, his penetrating knowledge of clinical neurology and his unpretentious and genial manner left an indelible yet tender memory in the minds and hearts of hundreds of graduate students whose good fortune had taken them through his door. He administered his section in the Mayo Clinic on the theory that the less you belabor a hoop, the more smoothly it will roll.

He was a member of the American Medical Association, the American Neurological Association, the American Psychiatric Association, the

Central Neuropsychiatric Association, the Minnesota Society of Neurology and Psychiatry, the Osler Medical Historical Society; the Alumni Association of the Mayo Foundation, Alpha Kappa Kappa, Alpha Omega Alpha and Sigma Xi.

Soon after I became his assistant, as we were walking home together, he spoke of things which made clear how close to his heart lay an abiding passion for justice, that true principle of humanity. Of progress and poverty, of philosophy and of religion, I was to hear much more. His numerous essays on these subjects were penetrating and subtle. Although written well, he could not be persuaded to have them published.

His deliberate movements and almost shambling gait led no casual observer to suspect a powerful physique capable of swift, smooth and well coordinated movement. As a student at the University of Wisconsin, he played on the baseball team, and he was also a member of the first football team of that university. Later, he took up golf, which he pursued with his usual thoroughness, expertness and good humor.

He was intolerant of the waste and destruction of natural resources that represented no effort of man to produce; and if he was immoderate in anything, it was in the affection he bore for a beautiful tree or a good piece of wood. The Country Club was his cathedral, and he helped build it with his own resources and with his own hands. On it, he planted thousands of trees, and now that he is gone it is becoming a monument of ever increasing beauty and value.

His admiration and respect for a good craftsman were profound, and he himself excelled in woodworking. His projects were planned with care; the execution of them was precise, and the product was always dignified, sturdy and lovely. His favorite wood was black walnut, and it must have loved him, too, since it responded to his efforts like a gem.

On the morning of Feb. 13, 1946, Dr. Sheldon did not awaken from his sleep. His passing was just as he and we wished that it might be. Left to survive him are his wife and two sons, both of whom are physicians. His wish that his ashes might rest on the golf course, under the wide and starry skies and the trees he loved so well, has been respected. As Wordsworth thought of his own life, so those who worked with Dr. Sheldon feel, "That there hath passed away a glory from the earth."

HENRY W. WOLTMAN, M.D.

NIKOLAI NILOVICH BURDENKO, M.D.

1881-1946

In 1939, when Germany marched on Poland and the dreadful news of war echoed around the world, Nikolai Nilovich Burdenko was on his way out of the U.S.S.R. with Mrs. Burdenko to visit the neurosurgical clinics of the United States. Bitterly disappointed, they returned to Moscow.

In 1943, when the German armies had been held 50 miles from the gates of that capital, Lieutenant General Burdenko had become Chief Surgeon of the Red Army. The other posts which he held at that time bore witness to his amazing vitality and capacity for leadership: president of the National Research Council, president of the Association of Russian Physicians, director of the Institute of Neurosurgery, professor of Surgery in the First Medical Institute of Moscow, Stalin Prize winner, Academician and honorary fellow in the Royal College of Surgeons of England and in the American College of Surgeons.

Burdenko received his medical education in Tartu (Dorpat) where he shortly became professor of surgical therapy. From there he went to Voronezh as professor of surgery and finally to Moscow, in 1929. Here he organized the Institute of Neurosurgery. Beginning in a small way, the institute grew rapidly until, at the end of fourteen years, it housed 150 beds and ample laboratories.

In the assembly room of this institute there hung three full-length paintings, of Sklifassofsky, surgeon; Ivan Pavlov, physiologist, and Harvey Cushing, neurosurgeon. These three men may be considered his heroes in the profession, for he labored throughout his life to excel in surgery, in science and in his chosen specialty of neurosurgery.

His ambitions, however, were not alone for himself. He was an enthusiastic extrovert, who strove to stimulate the members of his own profession. In this effort he was eminently successful, for he gathered about him a school of brilliant pupils, who continued loyal to him. Among them are the surgeon Yudin; the neurosurgeon Koreisha; Sarkisov, neuropathologist and medical liaison officer in London, and Lebedenko, neurosurgeon and liaison officer in Washington, D. C. The distinguished neurologist, Professor Rappaport, was his friend and constant companion from their early days in Tartu, and he eventually took charge of neurology in the new institute.

Burdenko was a short, stocky, quick-moving man. He preserved his tireless energy and ability to work far into the night even in his later years, when deafness came upon him more and more completely. In 1942 a cerebral embolus deprived him of speech. However, he regained the ability to read and write almost at once and, nothing

daunted, continued to discharge his numerous duties by reading reports and writing out his orders.

Within the year he was able to speak again, although with difficulty; and, maintaining his leadership, he continued to demand exacting discipline among his juniors and received from them unfailing allegiance. Lieutenant General Smirnov, the youthful Chief of Medical Services in the Red Army, stated that, despite his disabilities, the surgeon in chief never ceased to serve his country and the medical services effectively.

Professor Burdenko must be considered the founder of neurosurgery in Russia and a principal organizer of medical research and teaching during the rapid expansion of medical education that preceded the war. Although fate prevented him for making personal contact with foreign neurologists and neurosurgeons of his day, a contact which would have helped him with technical detail, he nevertheless established in Moscow a modern institute and taught correct basic principles of surgery and neurology.

During a luncheon given for the British-American-Canadian surgical mission in Moscow in 1943, General Burdenko hurried momentarily from the room and wrote out a toast which he brought back to the interpreter. It was as follows: "I ask you to fill your glasses and listen to the few words I have to say: Our friendship must be closer; this is only the beginning of it. To our friendship in science, in life and in the world."

The heroic labor of this neurosurgeon has ended, while the world is seeking a way of peace. Let medical men in every land and with one accord respond to his farewell toast—"To our friendship in science, in life and in the world." And let this be "only the beginning of it"!

WILDER PENFIELD, M.D.

CHRISTOPHER CHARLES BELING, M.D.

1873-1946

Dr. Christopher C. Beling was born in Colombo, Ceylon, on April 4, 1873, the son of a prominent lawyer of the colony. He was educated in private schools in Colombo and was graduated from Wesley College in 1891. In 1892 he entered the Ceylon Medical College and was graduated in 1897, having won a government prize.

For two years after his graduation he served in the government medical service as superintendent of the leper asylum and colonial surgeon of one of the provinces. He then went to Edinburgh for graduate work at the Royal College of Physicians and Surgeons there and was granted the degrees of L.R.C.P. and L.R.C.S. in 1900.

In June of that year he came to this country and was licensed to practice in New York state and started practice in New York city. As his interests were turning to neurology and psychiatry, he sought and obtained a position on the resident staff of the New Jersey State Hospital for the Insane at Greystone Park in 1901. There he served till 1907, when he entered private practice in Newark, N. J. This was his final move, for he remained in practice in Newark to the end.

Always he was interested in mental hygiene, and especially in boys. He founded the first juvenile clinic and bureau of mental hygiene in Newark, one of the first in the country, and was director of the bureau from 1919 to 1922. He was attending and consulting neurologist and psychiatrist to many hospitals in Newark and other parts of northern New Jersey.

Dr. Beling was a member of many medical organizations, including the Medical Society of New Jersey (judicial council, 1912-1946); the Morris County Medical Society (president, 1907), the New York Academy of Medicine, the New York Neurological Society and the New Jersey Neuropsychiatric Association (first president, 1933-1937). He was elected to membership in the American Psychiatric Association in 1904 and to the American Neurological Association in 1920.

Dr. Beling continued to be active in his practice until shortly before the end. In the summer of 1946 he went on his annual vacation to Mount Desert Island. He appeared well at this time, but in September cardiac decompensation set in, secondary to hypertension. He died quietly on Nov. 30, 1946. He is survived by his widow, a son, a daughter and a brother.

Dr. Beling was a gentle, modest sort of fellow. His interest in neurology and psychiatry was genuine and strong. Especially did he care for the psychiatric problems of youth, including delinquency, and he did much to arouse the interest of his community in these problems. Those of us who knew him best will miss him most.

LOUIS CASAMAJOR, M.D.

News and Comment

THE AMERICAN BOARD OF PSYCHIATRY AND NEUROLOGY, INC.

The following diplomates were certified in December 1946:

Psychiatry.—By Examination: * John Alden, San Francisco; C. Knight Aldrich, Madison, Wis.; Adam G. Allen, Coatesville, Pa.; Herman S. Alpert, Marcy, N. Y.; Charles L. Anderson, Worthington, Ohio; Sam Beanstock, Downey, Ill.; Nathan Beckenstein, Brooklyn; Robert Eugene Bennett, Trenton, N. J.; John A. Bianchi, Brooklyn; Viola Bernard, New York; Margaret V. Beyer, Sykesville, Md.; Albert J. Boner, Madison, Wis.; Ina Helene Boyd, San Antonio, Texas; George Clayton Branche, Tuskegee, Ala.; Norbert Bromberg, New York; Warren T. Brown, New Haven, Conn.; Charles Buckman, Queens Village, N. Y.; Samuel Burack, Chicago; Edward Morse Burn, Philadelphia; James A. Campbell, Thiells, N. Y.; Elmer E. Capellari, Pittsburgh; Vincent James Cassone, Danville, Pa.; Carmelo Chiarello, Brooklyn; Dominick F. Chirico, Brooklyn; John Chornyak, Chicago; William J. Clauser, Boston; Irwin Justus Cohen, New York; M. Michael Cohen, Brooklyn; Henry A. Davidson, Newark, N. J.; John Evan Davis, Trenton, N. J.; Vernam Terrell Davis Jr., Ellis Island, N. Y.; Amerigo Philip Dell Cort, Canandaigua, N. Y.; Edward E. DeLong, Lyons, N. J.; Victor William Eisenstein, New York; Harrison Force English, Trenton, N. J.; Harold Feldman, Rochester, N. Y.; Leon Ferber, Nashville, Tenn.; Howard B. Finkelhor, Pittsburgh; Ernest J. Fogel, Harrisburg, Pa.; Henry Morgenthau Fox, Boston; Jerome D. Frank, Washington, D. C.; Vincent L. Frankfurth, Northampton, Mass.; Joe Edward Freed, Columbia, S. C.; * Arnold P. Friedman, New York; James Bauer Funkhouser, Richmond, Va.; William Furst, Newark, N. J.; Wilbert M. Gansloser, St. Louis; Harry Gershman, Central Islip, N. Y.; Leonard Gilman, Washington, D. C.; Leon Ginsburg, Cedar Grove, N. J.; Stewart T. Ginsberg, Marion, Ind.; Bernard C. Glueck Jr., Ossining, N. Y.; Lionel Goitein, New York; Morton M. Golden, Brooklyn; Joseph L. Goldstein, Asheville, N. C.; Meyer E. Golob, New York; Samuel T. Gordy, Philadelphia; Louis N. Gould, Norwich, Conn.; Henry G. Grand, New York; Saul Greizman, Torrance, Pa.; S. Cyrus Grossman, Detroit; Peter B. Hagopian, Hathorne, Mass.; Solomon M. Haimes, Philadelphia; Louis Halle, Chillicothe, Ohio; Irving D. Harris, Chicago; Richard Lamar Harris, Los Angeles; William B. Hawkins, Lyons, N. J.; Harry Hoffman, Plainfield, N. J.; Charlton Gilmore Holland, Charlottesville, Va.; Joseph J. Hornisher, Fort Sam Houston, Texas; Elmer Leaman Horst, Coatesville, Pa.; Imre E. Horvath, Hines, Ill.; Ira L. Howell, Alamosa, Colo.; Charles B. Huber, Roanoke, Va.; William J. Hutchins, New York; Herbert W. Hyatt, American Lake, Wash.; Evelyn P. Ivey, Morristown, N. J.; Abraham I. Jackman, Chicago; Jack Reynolds Jarvis, Towson, Md.; Chester Earle Johnson Jr., Tuscaloosa, Ala.; Erich Kaufmann, Rochester, N. Y.; Frank Alfred Kay, Birmingham, Ala.; Francis W. Kelly, Hartford, Conn.; Cyril J. C. Kennedy, Kings Park, N. Y.; Walter S. Kern, Orangeburg, N. Y.; Robert Palmer Knight, Topeka, Kan.; Louis J. Kowalski, Philadelphia; Frederick H. Kramer, Philadelphia; Leonard Charles Lang, Buffalo, N. Y.; Gerald O. Laxson, Meade, S. D.; Martin Lazar, Ogdensburg, N. Y.; Harry Leaffer, Springfield, Mo.; Ann Hankins Leaman, Philadelphia; Louis Levinstim, New York; Lawrence A. Levitin, San Francisco; Erwin Levy, New York; Thomas Anthony Loftus, McLean, Va.; William H. Longley Jr., Greystone Park,

N. J.; Capt. Thomas W. McDaniel Jr., (MC), U.S.N., Fort Worth, Texas; Ivan A. McGuire, Detroit; Harry L. MacKinnon, Dayton, Ohio; William K. McKnight, Philadelphia; Rudolph S. Matthews, Columbia, S. C.; Albert N. Mayers, New York; Frank Mercurio, Coatesville, Pa.; John Charles Mergener, Los Angeles; Joseph S. Miller, New York; Burness Evans Moore, New Haven, Conn.; James A. Mosco, St. Louis; Lieut. Comdr. Charles S. Mullin Jr., U. S. N., Great Lakes, Ill.; Lloyd J. Nelson, Queens Village, N. Y.; Jack G. Oatman, Greystone Park, N. J.; William E. Olson, San Francisco; Arpad Pauncz, Lyons, N. J.; Frank Percy, Dallas, Texas; Rosco E. Petrone, American Lake, Wash.; Hugh M. Pierce, Rochester, N. Y.; Edward N. Pleasants, Marlboro, N. J.; Hyman Pleasure, Central Islip, N. Y.; Leopold A. Potkonski, Philadelphia; James H. Rankin, Los Angeles; E. Louis Reder, Brooklyn; Herbert Spencer Ripley, New York; William Rosenbloom, Downey, Ill.; Charles Russman, Middletown, Conn.; Robert Bruce Sampliner, Van Nuys, Calif.; Nathaniel Sandler, Detroit; Arnold A. Schillinger, Northport, N. Y.; Herbert T. Schmale, Ann Arbor, Mich.; Clarence M. Schrier, Kalamazoo, Mich.; Lee Goodrich Sewall, Lyons, N. J.; Albert M. Sherman, Weehawken, N. J.; Stephen C. Sitter, Milwaukee; Kenneth K. Slaght, Rochester, N. Y.; Alan Percival Smith Jr., Tuskegee, Ala.; Theodore P. Sohler, Hartford, Conn.; Curtis G. Southard, Fort Worth, Texas; Sidney L. Tamarin, Brooklyn; George Tarjan, Peoria, Ill.; James Sidney Tarwater, Tuscaloosa, Ala.; Abraham Tauber, Pontiac, Mich.; Christopher F. Terrence, Brooklyn; Harvey J. Tompkins, Arlington, Va.; Seymour D. Vestermark, Fort Worth, Texas; B. Frank Vogel, New York; Charlotte Frisch Walker, Ann Arbor, Mich.; David Royal Wall, St. Louis; Maurice C. Wander, Kings Park, N. Y.; Merna Mary Warne, Greystone Park, N. J.; Robert W. Webb, Washington, D. C.; Frederic Samuel Weil, New York; Jerome L. Weinberger, Boston; Joseph Weinreb, Elmsford, N. Y.; Samuel A. Weiss, Teaneck, N. J.; Max Weissman, New York; Paul Weitz, Lyons, N. J.; William Winick, Coatesville, Pa.; Robert Andrew Wise, Rochester, N. Y.; David Graham Wright, Providence, R. I.; Israel Zeltzman, Augusta, Maine.

Psychiatry.—On Record: George F. Asselin, Kankakee, Ill.; Marion Prentiss Bailey, Hines, Ill.; Victor H. Bean, Fort Lyon, Colo.; Carl A. L. Binger, New York; Smiley Blanton, New York; Parker G. Borden, Canandaigua, N. Y.; Harry H. Botts, Marion, Ind.; Walter Garfiels Bowers, Reading, Pa.; Thomas P. Brennan, White Plains, N. Y.; Robert Homer Bryant, Alexandria, La.; Charles Henry Burdick, Minneapolis; Walter Painter Burrier, Bedford, Mass.; Joy Ricketts Carriel, Elgin, Ill.; Olin B. Chamberlain, Charleston, S. C.; Marcus A. Curry, Greystone Park, N. J.; Howard Crosby Curtis, Wichita, Kan.; Charles F. Davis, St. Cloud, Minn.; William Drayton Jr., Philadelphia; Raymond C. Fagley, Newark, N. J.; John Blaize Ferran Jr., Binghamton, N. Y.; Floyd K. Foley, Lexington, Ky.; Joseph C. Fulmer, Coatesville, Pa.; William A. Gardner, Togus, Maine; James Alfred Gould, Denver; Thomas W. Hagerty, Camarillo, Calif.; Hans Hansen, Canandaigua, N. Y.; Clifford E. Harkey, North Little Rock, Ark.; John LeRoy Haskins, Portland, Ore.; Carl Johan Hedin, Bangor, Maine; Roger P. Hentz, Fort Custer, Mich.; Hiram G. Hubbell, Newark, N. J.; James Richard Hunter, Kankakee, Ill.; Kristine B. Johnstone, Imola, Calif.; Avonia Eads Kiser, Imola, Calif.; David Lionel Liberman, Wood, Wis.; Louis V. Lopez, Fort Lyon, Colo.; William F. Lorenz, Madison, Wis.; Floy E. Lyon, Terrell, Texas; Harriet S. McCarthy, Kankakee, Ill.; Frank S. Marnell, Santa Cruz, Calif.; Cecelia K. Morris, Cleveland; Arthur Harold Mountford, Sheridan, Wyo.; George William Morrow, Kankakee, Ill.; John Francis O'Brien, Bedford, Mass.; Alfred S. Oliver,

Imola, Calif.; James C. O'Neil, Burlington, Vt.; Victor Parkin, Los Angeles; William L. Patterson, Fergus Falls, Minn.; Guy Payne, Cedar Grove, N. J.; James Kenneth Pettit, Pass-a-Grille Beach, Fla.; James Stuart Plant, Newark, N. J.; Darley Garfield Plumb, Fort Lyon, Colo.; John A. Pringle, St. Cloud, Minn.; Margaret Antoinette Ribble, New York; William J. Riley, Indianapolis; Albert L. Roberts, Tuscaloosa, Ala.; Paul A. Royal, Lincoln, Neb.; Harry Rubin, Waco, Texas; Gettis Troy Sheffield, Gulfport, Miss.; Cecil B. Shrout, Chillicothe, Ohio; Dennis E. Singleton, Mendota, Wis.; Earl H. Snavely, Newark, N. J.; Arthur E. Soper, Kings Park, N. Y.; Edgar A. Stewart, Dayton, Ohio; John James Thompson, Danville, Ill.; William James Thompson, Pass-a-Grille, Fla.; Leo R. Tighe, Augusta, Ga.; Roland E. Toms, Northport, N. Y.; Letcher Evans Trent, Mendota, Wis.; James F. Vavasour, Greens Farms, Conn.; Willard H. Veeder, Sonyea, N. Y.; Raymond Farnham Wafer, Canandaigua, N. Y.; Guy H. Williams, Macedonia, Ohio; Leo Clement Woods, Knoxville, Iowa; Frederick L. Wright, Wingdale, N. Y.; Roy Carl Young, Covington, La.; Charles LeRoy Zimmerman, Danville, Pa.

Neurology.—By Examination: *Abraham H. Ascher, Brooklyn; *L. D. Borough, New Albany, Ind.; J. Robert Campbell, Tampa, Fla.; *Lewis J. Fielding, Los Angeles; *William A. Florio, Washington, D. C.; *Werner Hamburger, Utica, N. Y.; Frederick H. Hesser, Durham, N. C.; Daniel Solomon Jaffe, Washington, D. C.; *Emmett B. Litteral, San Francisco; *Harry B. Luke, West Brentwood, N. Y.; Clark H. Millikan, Iowa City; Veronica O'Brien, Valhalla, N. Y.; Fred Terry Rogers, Dallas, Texas; Ira Stanley Ross, Newark, N. J.; Dave Burnard Ruskin, Caro, Mich.; George A. Schumacher, Hastings-on-Hudson, N. Y.; *Herman Shlionsky, Montclair, N. J.; Jonathan M. Williams, Chicago; Emil Guenther Winkler, Long Island City, N. Y.; *Samuel A. Zeritsky, Philadelphia.

Neurology.—On Record: Mervyn Heller Hirschfeld, San Francisco; Harry Lee Parker, Rochester, Minn.; Alexander Hamilton Williamson, Pass-a-Grille, Fla.

Neurology and Psychiatry.—By Examination: Nicholas A. Bercel, Beverly Hills, Calif.; Sidney Cohen, New York; Albert J. Crevello, Philadelphia; Herbert J. Darmstadter, Philadelphia; Herbert Jackson De Shon, Boston; Robert L. Garrard, Providence, R. I.; Wilfrid M. Gill, Cleveland; Robert G. Heath, New York; Bruce Lynn Kendall, New York; Lincoln Lebeaux, Bogota, N. J.; Albert J. Lubin, San Francisco; Richard Sherman Lyman, Durham, N. C.; Theodore Meltzer, Brooklyn; Paul G. Myerson, Boston; Milton R. Sapirstein, New York; Morris Weinblatt, Toledo, Ohio; Avery D. Weisman, Boston; Hyman G. Weitzen, New York; Leon J. Whitsell, San Francisco.

Neurology and Psychiatry.—On Record: Glenn John Doolittle, Sonyea, N. Y.; Francis Argyle Ely, Des Moines, Iowa; Charles Englander, Newark, N. J.; Walter Arthur Jillson, San Francisco; Herman Josephy, Chicago; Pat Murphey, Little Rock, Ark.; Groves Blake Smith, Godfrey, Ill.; Henry Greene Smith, Cedar Grove, N. J.; Erwin W. Straus, Lexington, Ky.; Hillel Unterberg, St. Louis; Hans Wassing, Paterson, N. J.

AMERICAN BOARD OF PSYCHIATRY AND NEUROLOGY, INC.

The tentative dates and locations of the next examination for certification by the American Board of Psychiatry and Neurology, Inc., are May 16 and 17, 1947, in Philadelphia. Applications should be in the hands of the secretary, F. J. Braceland, M.D., 102 Second Avenue, S. W., Rochester, Minn., ninety days before the examination is scheduled. The last possible date for filing is March 1, 1947.

* The asterisk denotes complementary certification.

RESIDENCY IN NEUROPSYCHIATRY, SOUTHWESTERN MEDICAL FOUNDATION AND VETERANS ADMINISTRATION

The Southwestern Medical Foundation in cooperation with the Veterans Administration is offering a three year residency in neuropsychiatry. Two years of this is divided into eight month rotation periods between the Dallas area and the Veterans Administration hospitals at McKinney and Waco, Texas. The third year is elective, and investigative work is included. Approximately one-half the required time covers inpatient psychiatry. The other half is work in psychosomatic medicine and mental hygiene, including child guidance. The Dean's Committee consists of Dr. Guy Witt, Dr. P. C. Talkington and Dr. Don Morris, as secretary. For further information, write the secretary of the Dean's Subcommittee for Neuropsychiatry, Southwestern Medical College, 2211 Oak Lawn Avenue, Dallas 4, Texas.

NEW YORK SOCIETY OF NEUROSURGERY

The New York Society of Neurosurgery was recently organized. The organization is an outgrowth of a group of New York neurosurgeons who have met informally at regular intervals since 1939. The present membership consists of twenty-four neurosurgeons who practice in the metropolitan area. Dr. J. Lawrence Pool, of 195 Fort Washington Avenue, New York, is president. Dr. Sidney W. Gross, of 8 East Eighty-Third Street, New York, is secretary.

RESIDENCIES IN NEUROLOGY, VETERANS ADMINISTRATION

Two additional residency training programs in neurology for physicians in the Veterans Administration have been organized. The residencies, which will vary from one to three years, according to the physician's previous experience, are designed to prepare residents for certification in neurology by the American Board of Psychiatry and Neurology.

One training program will be conducted under the joint auspices of Boston University School of Medicine, Tufts College Medical School and Harvard Medical School. Residents will be stationed at the Veterans Administration Hospital at Framingham, Mass. (formerly the Army's Cushing General Hospital), which has special units for the study of epilepsy, aphasia, paraplegia and electroencephalography, and a complete diagnostic service in neurology. Applications should be sent to Dr. Harry C. Solomon, chairman, Dean's Subcommittee for Neuropsychiatry, Harvard Medical School, Boston.

The other training program will be conducted at Jefferson Medical College and Clinic, Philadelphia, under the auspices of the Dean's Committee of the Veterans Administration, Philadelphia. Dr. Bernard J. Alpers, professor of neurology at the Jefferson Medical College, will direct the program. Applications should be sent to Dr. Edward A. Strecker, chairman, Dean's Subcommittee for Neuropsychiatry, University of Pennsylvania School of Medicine, Philadelphia.

Other medical schools affiliated with the Veterans Administration for residency training in neurology where training programs are already under way are:

Medical School	Veterans Administration Hospitals and Clinics	Applications Received by
Cornell University Medical College		
Columbia University College of Physicians and Surgeons	Bronx, N. Y.	Dean Willard C. Rappleye, 630 W. 168th Street, New York
Northwestern University Medical School		
University of Illinois College of Medicine	Hines, Ill.	Dr. Lewis J. Pollock, Northwestern University Medical School, Chicago
University of Minnesota Medical School	Minneapolis	Dean Harold S. Diehl, University of Minnesota Medical School, Minne- apolis

Abstracts from Current Literature

EDITED BY DR. BERNARD J. ALPERS

Physiology and Biochemistry

EXPERIMENTAL NON-PARALYTIC POLIOMYELITIS: FREQUENCY, AND RANGE OF PATHOLOGICAL INVOLVEMENT. DAVID BODIAN and H. A. HOWE, Bull. Johns Hopkins Hosp. **76**:1 (Jan.) 1945.

Bodian and Howe inoculated 37 rhesus monkeys intracerebrally with material from pharyngeal swabs of patients with poliomyelitis. Nine of the animals became paralyzed, and 1 had a nonparalytic infection. Pathologic examination in all cases "showed typical infiltrative and neuronal lesions in the spinal cord, of moderate to severe intensity, and a characteristic distribution of lesions in the brain. The one case of non-paralytic infection showed a histopathological picture quite similar to that seen in the paralytic monkeys."

The occurrence of a nonparalytic infection in 1 of a total of 10 monkeys inoculated intracerebrally compares favorably with observations on monkeys inoculated intranasally with human and chimpanzee stools.

Histologic examination of the brains of 23 of the animals which did not become infected revealed scattered perivascular infiltrations in the pia mater in 16. These were interpreted as nonspecific reactions to the inoculation. Passage to 2 normal rhesus monkeys of a suspension of the cord of each of 7 of these animals gave a negative result.

The range of anatomic changes in monkeys with nonparalytic infections, as in those with paralytic infections, was wide. The distribution, within the limits imposed by resistant centers, varied from arrest of the pathologic process near the portal of entry to severe and extensive involvement of all susceptible centers in the brain and spinal cord. The authors suggest that this variability may be a factor in the degree of resistance to reinoculation. GUTTMAN, Philadelphia.

THE CHEMICAL DETERMINATION OF TOCOPHEROLS IN LIVER AND MUSCLE: TOCOPHEROL IN URINE AND FECES. L. R. HYNES and H. A. MATTILL, J. Biol. Chem. **149**:549, 1943.

Only one systematic study of the distribution of tocopherol in animal tissues seems to have been made, and this was accomplished by laborious biologic assay. Although direct evidence on the role of tocopherol in cellular metabolism is thus far confined to its action in muscle, its presence in other tissues, whether as functional or as stored material, calls for a reliable chemical method of assay. When the technic of Devlin and Mattill for the determination of tocopherol in muscle was applied to liver tissue, its shortcomings became immediately obvious. This paper describes the modifications by which that method appears to have been improved and made adequate for use with liver, urine and feces. The tocopherol content of rat and rabbit liver tissue from animals receiving diets high in tocopherol, commercial laboratory chow and vitamin E-deficient diets averaged 42.3, 22.1 and 22.6 (rat) and 86.8, 9.2 and 9.4 mg. per kilogram, respectively. Muscle tissue of the same animals averaged 11.9, 7.5 and 4.8 and 28.1, 8 and 5.7 mg. per kilogram, respectively. No tocopherol was found in the urine of rats with a high tocopherol intake, nor was evidence obtained for the presence of tocopherylquinone in liver or muscle or its excretion in the urine, although considerable tocopherol was found in the feces under those conditions. Evidence was obtained indicating

that not all the tocopherol is removed from tissues by simple extraction with organic solvents. The possible significance of these observations is indicated.

PAGE, Cleveland.

ELECTROMYOGRAPHIC STUDIES IN POLIOMYELITIS. PAUL M. KOHN, EDWARD M. ZUCKER and JOHN A. TOOMEY, *J. Nerv. & Ment. Dis.* **102:433** (Nov.) 1945.

Electromyographic studies of the muscles of victims of poliomyelitis have produced contradictory results. One group of investigators (Schwarz and Bouman, and Watkins, Brazier and Schwab) found evidence of spasticity in weakened and paretic muscles, as shown by a characteristic pattern of action currents, whereas Moldover found little or nothing to support the belief that spasm was present in either the paralyzed muscles or their antagonists. In view of these contradictory findings, Kohn, Zucker and Toomey tested with the electromyograph the muscles of 13 patients ranging in age from 7 to 33 years, 12 of whom had had acute attacks of poliomyelitis within eighty days of the examination. The muscles in question were tested at rest, when passively stretched and when voluntarily contracted. In general, potentials were recorded from the agonist and the antagonist muscle simultaneously, one or both of which showed clinical paresis. An analysis of the results indicated that most paretic or paralyzed muscles in cases of poliomyelitis do not show electromyographic evidence of spasm at rest. Only 20 per cent of the involved muscles tested showed continuous and sustained potential changes even when passively stretched. An interesting finding was evidence of disordered reciprocal innervation, as shown by the presence of potentials of unusually high amplitude in the antagonist muscles when the agonist (weak or paralyzed muscle) was actively contracted.

CHODOFF, Langley Field, Va.

STUDIES REGARDING GLUTAMINE AND AMMONIA IN THE CEREBROSPINAL FLUID OF PATIENTS WITH NERVOUS AND MENTAL DISEASES. MEYER M. HARRIS, *J. Nerv. & Ment. Dis.* **102:466** (Nov.) 1945.

It has been shown that there is an increased amount of ammonia in the spinal fluid of patients in status epilepticus. According to Riebeling, this is due to the diffusion of ammonia into the spinal fluid from deamination of adenylic acid in the brain. Another possible source of ammonia in the spinal fluid is through spontaneous hydrolysis of glutamine.

A group of 50 patients with various nervous and mental diseases were studied to determine the levels of free ammonia and glutamine in the spinal fluid. The elevation in the levels of ammonia found by previous investigators was not confirmed, and the author believes that such findings are the result of a technical error caused by failure to take into account the decomposition of glutamine into glutamic acid and ammonia.

The level of glutamine in the spinal fluid was found to be within normal limits in cases of cretinism, oligophrenia phenylpyruvica and mongolism. Although the level of glutamine in the blood drops notably during insulin hypoglycemia, there is no change in the level in the spinal fluid.

CHODOFF, Langley Field, Va.

INFLUENCE OF GALVANIC STIMULATION ON MUSCLE ATROPHY RESULTING FROM DENERVATION. E. C. S. JACKSON and H. J. SEDDON, *Brit. M. J.* **2:485** (Oct. 13) 1945.

Although it has been proved experimentally that the atrophy of denervated muscle can be prevented to some extent by regular electrical stimulation of the muscle, the conclusion that equally satisfactory results follow the clinical employment of galvanism did not seem warranted without further investigations. Accordingly, Jackson and Seddon undertook a study to estimate muscular wasting by a "comparatively simple and not very accurate method." They present "a short undocumented account" of their findings. The volume of the hand was

measured by a simple fluid displacement method in 164 cases of paralysis of the ulnar nerve, only 54 of which were selected for this report. In only half of these 54 cases was galvanic stimulation employed in treatment.

It was noted that the application of ninety stimuli daily for six days a week almost completely prevented wasting except during the first hundred days after denervation, when the treatment reduced the rate of wasting. The earlier treatment was started the better the results, because the beneficial effect of galvanism was most noticeable soon after denervation. Galvanism did not seem to increase muscle volume but, rather, prevented the inevitable decrease. Observations in individual cases strongly suggested that recovery was better in cases in which galvanism was employed than in the controls, but success depended on the frequency of treatment. There still remains to determine whether galvanism is equally effective in preventing wasting in large masses of muscle.

ECHOLS, New Orleans.

CHANGES IN HUMAN VOLUNTARY MUSCLE IN DENERVATION AND REINNERVATION.

R. E. M. BOWDEN, *Brit. M. J.* 2:487 (Oct. 13) 1945.

Bowden presents a study of the changes in human voluntary muscle during denervation and reinnervation from the standpoint of histology, electrical reactions, electromyography and treatment of paralyzed muscle. The structural changes which occur after denervation are described in detail; they are primarily those of atrophy, and not of degeneration. Up to one year after denervation a good degree of functional recovery may be expected. The degree of functional recovery is also dependent on the nature of the lesion in the nerve. In cases of complete division of the nerve surgical intervention is necessary for recovery. Associated with the structural change there are immediate loss of tone and voluntary and reflex action and a more gradual change in electrical excitability. Electromyographic studies showed that there was no recordable electrical activity in human muscle for about twelve to twenty-eight days after denervation. From twelve to twenty-eight days after denervation fibrillation occurs and persists as long as any contractile denervated fibers remain or until reinnervation is taking place. Surgical repair should be undertaken as soon as possible. Galvanic stimulation has been shown to retard muscular atrophy.

ECHOLS, New Orleans.

Psychiatry and Psychopathology

ELECTROENCEPHALOGRAPHIC AND NEUROLOGICAL STUDIES OF HOMOSEXUALS.

DANIEL SILVERMAN and WILLIAM R. ROSANOFF, *J. Nerv. & Ment. Dis.* 101:311 (April) 1945.

Silverman and Rosanoff studied 55 cases of homosexuality from the point of view of variations in the central nervous system. The cases were selected from the population of the psychopathic unit of the Medical Center for Federal Prisoners, the criteria for selection being the habitual assumption of the female role in the homosexual act or a history of repeated homosexual acts in the free world. Investigative methods included electroencephalographic recording; use of social service records, with special attention to neuropathic heredity, birth injury and severe illness in the first year of life, and routine neurologic examinations. Evidences of neuropathic heredity, such as criminalism, psychoses, mental deficiency, convulsions and alcoholism, was found in 41.8 per cent of cases. In 70.9 per cent of the series there had been an illness or injury possibly affecting the nervous system. In 29.1 per cent of cases there were both positive histories and neurologic findings. The electroencephalograms were classed as abnormal in 50 per cent, as borderline in 23.6 per cent and as normal in 25.5 per cent of cases. The most prominent abnormality was a bilaterally synchronous 5 to 7 per second delta rhythm, originating from the anterior region of the head.

The authors briefly review the literature on the constitutional factors in homosexuality and suggest that homosexuality may be one manifestation of a non-specific, familial neuropathic tendency.

CHODOFF, Langley Field, Va.

AN INTERPRETATION OF THE DIVERGENT OUTCOME OF SCHIZOPHRENIA IN IDENTICAL TWINS. SILVANO ARIETI, *Psychiatric Quart.* **18:587** (Oct.) 1944.

Arieti describes the case of a pair of monozygotic female twins in whom schizophrenia developed. He considers that the symptoms presented by the patients were fundamentally similar. He suggests that the hypochondriacal complaints presented by 1 patient and the somatic delusions of the other may have been "two different degrees or two different manifestations of the same fundamental psychic derangement." The difference is perhaps more important as a sign of the relative intensity of the mental conditions than as pointing to basic differences between them. The psychoneurotic (hypochondriacal) symptoms of the one patient were most prominent just prior to her recovery from her delusions of infidelity, i. e., when she was coming out of her psychosis. He suggests that the neurotic symptoms were part of the defense mechanism against schizophrenia. That patient recovered "(a) who was the more athletic and less asthenic, in agreement with the findings of Kallman and Barrera; (b) whose prepsychotic personality was definitely more extroverted; (c) who had always shown better ability to cope with the problems of life, and (d) whose symptomatology was somewhat atypical because of the presence of many 'psychoneurotic' symptoms." The patient had no specific treatment. Her sister was as deluded as ever after 63 insulin shock treatments and at the time of writing had not lost her delusions.

McCARTER, Boston.

CLINICAL ASPECTS OF DEPRESSION. EDOARDO WEISS, *Psychoanalyt. Quart.* **13:445** (Oct.) 1944.

Weiss states that the division of depressive states into (1) symptomatic depressions, depressive states that are consciously due to some other neurotic condition, and (2) essential depressions, in which the depressive state is itself the immediate and chief reason for the complaint and is not secondary to another neurotic condition, is a distinction hard to maintain because in all cases of the latter type analysis reveals deep neurotic conditions which have produced the depressive state.

Essential depressions have in common the libido-economic factor of lack of interest in anything. Reduction of interest leads to inhibition of activity. Some patients feel greatly distressed by the lack of interest and inhibition of activity; in others all ego feeling seems to be numbed.

A patient with simple depression also may display this numb ego feeling. He may show a decrease in the intensity of his self experience; he is less awake, and the external world conveys to him a much less intense emotional meaning than it does to other persons. In general, his affective responses are weaker. This phenomenon has to be distinguished from a simple lack of interest, although it may lead to such a lack.

Very often simple depressions are complicated by a pessimistic attitude: despondency, the desire to die, pessimism and world weariness.

Depressive states are frequently due to some strong fixation to a love object, which, however, is rejected by the patient himself, so that a great amount of libido remains blocked and unavailable. From the libido-economic point of view this phenomenon can be described as follows: A great amount of libido remains unconsciously attached to the mother or to some other love object, or remains directed toward an unattainable goal. Because of some strong disillusionment, a frustrating waiting for some kind of gratification that never comes, the patient begins to devalue the object or goal, as though he wanted to convince himself of its uselessness as a source of enjoyment. The whole fixated libido exhausts

itself in this lasting affective attitude of rejection of a love object or goal which cannot be relinquished. This produces the clinical picture of an essential depression—the patient shows no interest in anything.

The most manifold neurotic conflicts may be hidden behind the clinical picture of depression. The depressive state is largely due to a continuous process of rejection of some infantile love object or goal, chiefly as a defense measure against an unbearable state of frustration or anxiety. If the analyst interrupts the patient's rejection of the corresponding frustrating goal or object, then the depression may easily be substituted by another clinical picture—hysteria, compulsion neurosis, or even some psychotic disorder—the form depending on the nature of the "rejected situation" and on the development and constitution of the ego. Thus, a depression is often a defense measure against some more serious psychic disorder. From this it appears that one should be very cautious in the analytic approach in cases of depression.

Melancholia is the clearest example of a narcissistic neurosis. The patient's narcissism is injured in the most obvious way: he has more or less lost the faculty to love himself; indeed, he hates himself. When a person becomes aware of guilt or inferiority and then becomes depressed, he is not in the same state as when he is unable to love himself. His self love is merely frustrated. An object love may undergo frustration in an analogous manner if the love object fails to correspond to expectations. In the melancholic response to an equivalent injury the love object would be abandoned and/or hated. The characteristic feature of melancholia is loss of self love and the development of self hatred, due, in the clinical picture, to feelings of guilt and inferiority, regardless of the origin of such feelings. Self accusations may in some measure correspond to reality; they may contain at least some kernel of truth.

In analytic practice melancholic manifestations are found in every kind of neurosis, since many patients experience transitory melancholic states during the course of analytic treatment. The provocation for such reactions is often found in the patient's growing awareness of his own objectionable features. In melancholic episodes which are a reaction to the realization of those aspects of the personality which are antisocial, dishonest or egotistical, the patient's awareness of such traits (Jung would call them his "shadow") is exaggerated. He may feel that he is a despicable, an unworthy person. This state may not yet be a melancholic depression, but if he can no longer love himself then he manifests melancholic characteristics. The inability of the patient to reach an integration between his antisocial wishes and his moral standards causes an unevenness in his ego feeling (a tension); and since in these cases the self love depends on the attitude of the superego, the patient begins to hate himself. This, then, is a melancholic depression. If a patient does not succeed in properly controlling his antisocial drives, the analyst generally welcomes any feeling of uneasiness or depression with which he may react to the realization of his antisocial attitudes, and for a certain time he is left in a low-spirited or depressed mood. Such a depression may be justified and constitutes the normal mental incentive for the development of a controlling power, of learning how to deal with all sorts of instinctual situations. Thus, depression and feelings of guilt may have an objectively valid motivation. Only if the guilt reaction is exaggerated, or, especially, if the patient displays signs of melancholia (self hatred, lack of self love) does the analyst have to intervene. He, as a superego substitute, must convey to the patient the feeling that he does not reject him but accepts him as a whole, that is, with his bad features, while at the same time he attempts to show the patient his good points. He also tries to make clear to him that every person has some antisocial attitudes, that perfection does not exist.

In melancholia there is a persecuting and a persecuted introject. Both introjects are located in the patient himself, so that he persecutes himself or, more correctly, one ego aspect persecutes another ego aspect. The persecuted part, however, may not simply be an introject, because it may or may not have arisen exclusively from an identification with another object. In the manic phase the

"objectionable" introject (the passive one) is projected, while the ego completely assumes the active role of the superego because it no longer feels able to embrace the condemned attitudes. The dominating ego state is the superego state, while other, condemned ego states appear detached from the ego feeling and are projected onto other objects. By means of the aforementioned projection the patient succeeds, in the manic phase, in avoiding conscious mortification and conflict. But since this projection can be withdrawn, allowing such mortifications to become conscious, he is continually threatened by the possibility of melancholia. This is a structural splitting of the ego. The ego aspects are split into two parts, the one subjectively felt as the proper ego (the self) and the other projected. The ego cleavage occurs along the line of demarcation between "id ego" and "super-ego." In paranoia the ego does not cling strongly to the superego; and it is the persecuting introject (the superego), not the persecuted one, as in mania, which has been projected, with the result that the patient feels himself a target of persecution. Prior to this projection the ego was obviously "melancholic," a melancholic state, however, which is resolved in an opposite manner. Thus where the patient with paranoia succeeds in preserving his narcissistic position, the patient with melancholia fails. The more paranoid a personality, the fewer are its possibilities of melancholia.

A successful early analysis in which the dynamic factors explained in this paper are not neglected is the best preventive of a climacteric and presenile depression or melancholia, and also of criminality, when hormonal changes present the ego with too difficult a task of integration. PEARSON, Philadelphia.

A FURTHER CASE OF PARANOID PSYCHOSIS SUCCESSFULLY TREATED BY ADRENAL-ECTOMY. C. ALLEN and L. R. BROSTER, *Brit. M. J.* 1:696 (May 19) 1945.

Allen and Broster report the case of adrenogenital virilism associated with paranoid psychosis in a woman aged 26 in which adrenalectomy was followed by recovery to normal. The patient had previously received electric shock therapy, psychotherapy, insulin therapy and progesterone, without success. This was the sixth case which the authors had seen in which adrenogenital virilism was combined with a psychosis and the fourth in which the psychosis was schizophrenic in nature. They suggest the possibility, although rare, of the occurrence of a syndrome of adrenogenital virilism combined with a paranoid psychosis, since these conditions are occasionally seen in the same patient.

ECHOLS, New Orleans.

PREFRONTAL LOBOTOMY. FEDERICO PASCUAL DEL RONCAL, *Arch. méd. mex.* 2:493 (Sept.); 564 (Oct.) 1944.

The author reports his experiences with a series of 27 lobotomies in 21 patients: 4 with psychasthenia, 3 with paranoid schizophrenia, 7 with catatonic schizophrenia, 3 with hebephrenia, 1 with schizophrenia superimposed on mental deficiency, 2 with involuntional melancholia, and 1 with a psychopathic state. The modified technic of Freeman and Watts was used. Local anesthesia was given, with good results, in more than half the cases. When the patient was very agitated, sodium penthotal was used. None of the patients on whom the operation was performed with local anesthesia exhibited any severe psychologic reaction to the procedure. There were no terror reactions, as reported by Fleming and McKissock. The operation was bilateral and was done in one sitting. The only serious complication was hemorrhage due to the cutting of the anterior cerebral artery in 1 case; death occurred four days after the operation. One patient died nineteen days after operation with septicemia and another four days after intervention with meningitis. In 2 patients there were probably incisions into the frontal horns, with mild fleeting meningeal reactions.

Confusion, torpidity and even somnolence usually followed the second incision. There seemed to be more definite improvement in patients who exhibited severe

mental changes immediately after intervention than in those who showed such changes several hours later. The mental changes usually lasted twenty-four to forty-eight hours, rarely up to a week. Absence of anxiety and agitation was usually noted soon after the initial postoperative confusion. One patient became manic after the operation. Irritability and affective incontinence were rarely seen. There was puerilism in 1 patient after operation. Mild elevation in temperature for twenty-four to seventy-two hours was noted. In a few cases the blood pressure fell during the operation but returned to normal immediately afterward. Headache was frequent but was readily controlled with analgesics. One patient vomited for a few hours. Urinary incontinence was noted in 70 per cent, usually for not more than a week, though in 1 patient it lasted for a month; 1 patient had fecal incontinence for two days. No neurologic signs were noted except in the patient already mentioned, who died as the result of a cerebral hemorrhage. One patient studied electroencephalographically showed delta waves in the frontal region nine days after the operation.

For a short time after intervention most of the patients were frank and talked freely, with little evidence of control. The author reports 1 case of marked sexual erethism; in another case a refined and educated woman told risqué jokes. In both cases the marked changes in behavior lasted only a few days. The most important psychologic sequel of frontal lobotomy was loss of initiative. Two lawyers in the series were able to return home but could not resume their professional activities. Laborers and domestics, on the other hand, were able to go back to work without any evident impairment of efficiency. The author disagrees with those investigators who claim there is no impairment of intelligence. While the lobotomized patient may be able to do as well in a Binet-Simon test as before the operation, there is evidence that the more highly complex intellectual processes, such as judgment, critical faculties and initiative, are affected. Rorschach studies on a few of the patients showed diminished ability to synthesize and a significant narrowing of interests.

The best results were noted with affective disorders. In schizophrenic patients, even those in whom trend reactions persisted, anxiety and agitation were diminished after the operation. Of 6 patients with anxiety in the foreground, 5 had complete clearing of the psychosis and the sixth died after the operation. Two schizophrenic patients had good remissions considering the seriousness of the disease. Three of the 7 catatonic patients had complete remissions; 3 improved, and 1 failed to improve. One of the hebephrenic patients died nineteen days after the operation, 1 was operated on a few times with good results, and 1 had a partial remission.

SAVITSKY, New York.

Diseases of the Brain

ANAEROBIC INFECTION OF THE BRAIN. N. I. GRASHCHENKOV, *Am. Rev. Soviet. Med.* 3:5 (Oct.) 1945.

Grashchenkov reports observations on 607 patients with penetrating wounds and 318 patients with nonpenetrating wounds of the skull. Of this number, 350 patients were under observation at front line clearing stations equipped for bacteriologic study. Cultures of material from the wound were made at operation and when dressings were changed. The wounds of the brain showed *Clostridium perfringens* in 24 per cent of cases, *Clostridium oedematiens* in 4 per cent, *Clostridium sordellii* in 5 per cent and *Clostridium butyricum* in 10 per cent. The corresponding figures for nonpenetrating wounds were 6.7, 2.5 and 0 per cent. The clinical picture in cases of nonpenetrating wounds was considerably milder, and granulations formed promptly even in cases in which pathogenic anaerobes were revealed. Apparently, anaerobes did not find favorable growth conditions in the scalp and disappeared rapidly without producing a reaction. Perforation of the dura mater, however, opened a path for anaerobic infection of the brain. The frequency of anaerobic infection of the lower extremities and that of the brain showed considerable correlation.

Pathogenic anaerobes were isolated from the wounds of 87 patients under observation, or of 14.3 per cent of the patients with penetrating wounds of the skull. These patients were divided into those with acute, progressive and chronic infection and, finally, asymptomatic patients with pathogenic anaerobes in the wounds.

The patients in subgroup 1, those with gas gangrene of the brain, presented the following signs: protrusion and disintegration of brain tissue with necrotic and serous discharge from the wound; sharp putrefactive odor of the wound, with appearance of gas bubbles and edema of the surrounding brain tissue; early meningitis, the cerebrospinal fluid being xanthochromic and containing 100 to 400 cells per cubic millimeter and a slight increase of protein; severe pressure headaches, apathy and prostration; an increase in pulse rate and a slight increase in temperature; leukocytosis (12,000 cells) with lymphopenia, and high erythrocyte sedimentation rate (30 to 50 mm. an hour).

Gas gangrene of the brain almost always ended fatally within nine days. Apathy and disturbance of consciousness were produced by toxemia. *Cl. perfringens* was the predominating organism in infections of this type. Specific anti-gas-gangrene serum neutralized the toxins in cases of gas gangrene of the brain, as well as of the extremities. Large doses temporarily reduced toxemia, decreased apathy and improved the patient's condition.

Sharp, throbbing headaches and a sense of intracranial pressure, particularly near the wound, were caused by the specific edema-producing gas-forming action of anaerobes. This symptom also pointed to the presence of diffuse mild meningitis. A weak Kernig sign and slight nuchal rigidity were also present. The spinal fluid flowed under slightly increased pressure. The neurologic symptoms depended on the localization of the trauma.

The appearance of the wound of the skull was characteristic. The tissues, including the brain, appeared dirty and the adjacent tissues of the scalp dark gray and occasionally necrotic. The brain was friable, and there was no distinct boundary between the involved and the healthy tissue. Granulations were entirely absent. Liquid putrefactive detritus, with streaks of pus and frequently with air bubbles and foul odor, escaped under considerable pressure after incision and drainage. In some cases pressure sores occurred from proximity of the wound to trophic centers and from severe edema and toxemia.

Postmortem examination showed gangrene of brain tissue at the site of the wound and acute edema of the involved hemisphere and, to a less degree, of the opposite one. There were also parenchymatous degeneration of the heart muscle, liver and kidneys and hyperplasia of the spleen. A diagnosis of gas gangrene of the brain can easily be made at autopsy without microscopic examination.

Pathologic changes in subacute and chronic forms failed to show such clearcut characteristics. The chronic form was marked by encapsulated abscesses containing pathogenic anaerobes. They ruptured into the lateral ventricle and resulted in pyocephalus and severe purulent meningitis, particularly at the base of the brain. Macroscopically, these abscesses did not differ from similar abscesses containing putrefactive aerobes and pyogenic cocci. The presence of mixed pathogenic microflora gave the abscesses a distinctive odor. The subacute form of anaerobic infection might produce the same changes in the internal organs as the acute form. Pathologic diagnosis of the subacute form in some cases presented no serious difficulty.

Cultures obtained from wounds of the brain and from the internal organs in cases of acute and subacute infection always showed the presence of pathogenic anaerobes, chiefly *Cl. perfringens*, frequently in association with putrefactive anaerobes. The presence of pathogenic anaerobes in the internal organs, particularly the heart, indicated anaerobic sepsis in the majority of the fatal cases.

The histopathologic picture of the three forms of anaerobic infection revealed specific features. In cases of acute gas gangrene of the brain there were necrotic changes in the cortical cells with karyopyknosis, karyorrhexis and karyolysis.

Some disintegration took place in the deeper layers. An enormous number of bacilli were noted in the region of the wound and also in the opposite hemisphere. The brain substance was filled with gas bubbles and resembled Swiss cheese. There was a mild reaction in the gray and white matter surrounding the necrotic areas. Only occasional round cells and disintegrating leukocytes were seen. Silver and gold stains showed a mild proliferative reaction and degenerative changes in almost all the cells. The brain tissue displayed weak reparative power and only a mild inflammatory reaction. Absence of the border defense led to rapid spread.

Histologic analysis of the area of the wound in 5 cases of subacute infection revealed necrosis with many partly disintegrated polymorphonuclear cells in the periphery. In this boundary zone a sluggish reaction of the histiocytes was observed, which appeared granular. This process spread into the brain by perivascular routes. The walls of the vessels were infiltrated with round cells, and perivascular infiltration consisted of polymorphonuclear cells, glial elements, a small number of histiocytes and large bacilli. Special stains showed disintegration of nerve cell processes and swelling of protoplasm and nuclei of the glial elements. Few astrocytes were encountered in the region of the wound and in the periphery; they were distorted with short, swollen processes and shrunken cell bodies.

In cases of chronic anaerobic infection of the brain histologic examination of the surrounding brain tissue showed pronounced edema and swelling, the tissue resembling a sponge. At the margin of the abscess and throughout the hemisphere numerous degenerating histiocytes and granular cells containing lipids were observed. The nerve cells around the wound and, to a lesser degree, throughout the cortex showed necrosis and neuronophagia, together with destructive changes in the nuclei and protoplasm. There was an enormous number of large, thick bacilli. The vascular plexus of the affected hemisphere contained many distorted histiocytes. With chronic exacerbations diffuse encephalitis occurred. The increased virulence of the pathogenic anaerobes contained in the cerebral abscess damaged the connective tissue. The disturbance of its barrier function led to destruction of the boundary zone and to spread of the inflammation. In such cases there were observed serous meningitis, damaged hepatic cells and proliferation of the spleen.

The most effective method of preventing anaerobic infection of the brain is early and adequate surgical treatment of the wound, followed by administration of polyvalent anti-gas-gangrene serum. The author is convinced that cleaning and surgical aid within the first forty-eight hours after injury and adequate neurosurgical care prevented acute anaerobic infection of the brain. Powdered sulfanilamide in the wound did not prevent its development. The experience of the author at a special clearing station behind the front lines showed that the administration of large doses of polyvalent anti-gas-gangrene serum is essential in all cases of severely lacerated penetrating wounds of the brain.

The method of treatment of such infections under combat conditions, whether in the front lines or at the base hospital, consists in (1) removal of pieces of clothing, soil and foreign bodies, such as missiles, fragments of bone and brain detritus, and (2) combating the intoxication which occurs as a result of the growth of the pathogenic anaerobes.

From personal experience, the author believes that there is no basis for considering all cases of such infections as hopeless. With intensive therapy the disease may be changed from an acute into a subacute or chronic form, with better chances for recovery.

Patients with so-called chronic infection, with encapsulation and subsequent formation of abscesses containing the pathogenic anaerobes, were treated in routine fashion. In the case of a closed wound the author recommends puncture and evacuation of the contents of the sac and irrigation with a solution of sulfanilamide by the method of Spasokukotski and Bakulev or as described by American authors. It was not found advisable to remove the abscess, as this released the

barrier and resulted in rapid spread of an acute specific anaerobic encephalitis and purulent meningitis. An attempt should be made to separate the wound and the drainage tracts from the surrounding brain tissue. When an abscess is treated by puncture, it is recommended that the abscess sac be irrigated with a solution containing specific bacteriophage. Drainage of the opened abscess is recommended when a fistula is present. When the abscess harbors pathogenic anaerobes, it is wise to use three or four doses of polyvalent anti-gas-gangrene serum at the slightest sign of toxemia.

The polyvalent anaerobic bacteriophage is made up of phages against *Cl. perfringens*, *Cl. oedematiens*, *Cl. sordellii* and *Clostridium oedematis maligni*.

When the clinical course is favorable, the gangrenous portion of the brain gradually becomes dry, forming a crust, which separates painlessly. After this the patient's health improves and healing progresses normally.

A subacute form of gas infection was observed at the frontline clearing hospitals and at base hospitals. This form had a course of thirty to sixty days and was characterized by (1) malaise, lasting one month or longer; (2) considerable prolapse of brain tissue; (3) foul-smelling discharge, containing detritus and bubbles of gas; (4) rapid pulse and variable temperature, and (5) frequently signs of meningitis. A fatal outcome was less frequent than in cases of the acute form and death rarely occurred within one month. Bacteriologic examination of the discharge revealed putrefactive anaerobes, with fewer pathogenic anaerobes, and putrefactive aerobes. The methods of treatment are the same as those for acute gas gangrene of the brain, with local applications and subcutaneous injections of specific anaerobic bacteriophages.

The chronic form of gas infection of the brain occurred in 4.7 per cent of cases—usually encountered in the evacuation hospitals at the base and at some distance behind the lines. The duration of the disease was three to four months. This form was observed most frequently in patients who did not receive surgical or other special treatment at the front line clearing hospitals. The wounds usually contained various putrefactive anaerobes and pathogenic anaerobes. Treatment depends on clinical indications and is confined mostly to surgical drainage of the abscess after early diagnosis. To clear up the abscess repeated roentgenologic studies and surgical intervention are required. Anti-gas-gangrene serum is employed when signs of anaerobic intoxication appear.

The accurate diagnosis of anaerobic infection of craniocerebral wounds is established on the basis of bacteriologic cultures from the discharge and from the blood when sepsis is suspected. Constant bacteriologic control is necessary in the treatment of anaerobic infection of the brain. GUTTMAN, Philadelphia.

HEPATOLENTICULAR DEGENERATION: REPORT OF TWO CASES WITH PREDOMINANTLY HEPATOGENIC SYMPTOMS, ONE ASSOCIATED WITH THE CRUVEILHIER-BAUMGARTEN SYNDROME. ERIC WOLLAEGER and HARLEY C. SHANDS, Arch. Int. Med. **75**:151 (March) 1945.

Wollaeger and Shands report observations on 2 cases of hepatolenticular degeneration (Wilson's disease). The patients both presented a rare type of hepatolenticular degeneration in which the hepatic lesion was symptomatically the more prominent. One patient showed advanced disease of the basal nuclei, the symptoms of which disappear largely under treatment with stramonium. He was able to walk. Wilson has mentioned the fluctuating character of neurologic symptoms, but the progressive nature is not usually stressed. The same patient then exhibited evidence of the rare Cruveilhier-Baumgarten syndrome (congenital cirrhosis of the liver), characterized by portal hypertension with evidence of a pronounced umbilical collateral circulation. There was a loud abdominal murmur or thrill. He was then treated for his hepatic condition and received no further treatment for his neurologic symptoms, which he no longer needed.

So far as the authors are aware, this is the first case in which the essential clinical features of hepatolenticular degeneration and of the CruveilhierBaumgarten syndrome have been observed.

GUTTMAN, Philadelphia.

HEMIBALLISMUS. HAROLD KELMAN, *J. Nerv. & Ment. Dis.* **101:362** (April) 1944.

Hemiballismus was first ascribed to a lesion of the corpus Luysii by Jacob, who also stated that a cerebral component was not necessary for the appearance of the condition but that the red nucleus, substantia nigra and pyramidal tracts must be intact. The syndrome is characterized by violent, uncontrollable, purposeless, throwing (ballistic) movements of one upper extremity or of the upper half of the body. They appear suddenly in one upper extremity and then in the homolateral lower extremity. They are rhythmic and continuous, are not influenced by psychic disturbances but cease during sleep. Kelman reports 2 cases, both with autopsy. The first was that of a merchant seaman aged 66 who suddenly began to have attacks of typical left-sided hemiballismus, followed by the development of left spastic hemiplegia and death. Autopsy revealed destruction of the entire right cerebral hemisphere. The posterior hypothalamus and structures distal to it were intact except for an area of destruction in the subthalamic body. In this case, the fact that the attacks at times involved only the hand and at other times spread to the face and to the lower extremity is evidence of somatotopic localization in the corpus Luysii. The second patient, a seaman aged 56, was hospitalized because of the gradual development of athetoid movements of the right extremities. Later there were mental changes and the sudden onset of violent throwing movements of the right extremities. The condition became progressively worse, and he died eight months after the onset of symptoms. Autopsy revealed carcinoma of the lung with a metastasis in the region of the left corpus Luysii. The lesion was so placed as to affect the subthalamicotegmental fibers.

CHODOFF, Langley Field, Va.

NEUROLOGICAL COMPLICATIONS FOLLOWING THE USE OF TYPHOID VACCINE. W. G. PEACHER and R. C. L. ROBERTSON, *J. Nerv. & Ment. Dis.* **101:515** (June) 1945.

Peacher and Robertson report 2 cases in which neurologic complication followed the use of typhoid vaccine. The first case was that of a 28 year old soldier who was treated with intravenous injections of typhoid vaccine for resistant gonorrhoeal urethritis. After the fifth injection he had a series of generalized convulsions, and the temperature rose to 109 F. The next day there was evidence of left hemiparesis, accompanied with intense suboccipital headaches, confusion and drowsiness. Because of a recent head injury, a subdural hematoma was considered. Craniotomy was done on the right side, and a large, soft, necrotic mass was observed subcortically, which on microscopic examination proved to be degenerative. The second case was that of a 41 year old soldier in whom weakness of the right shoulder developed one week after the subcutaneous administration of 0.5 cc. of a bacterial vaccine made from the typhoid and paratyphoid A and B bacilli prepared by the Army Medical College. Examination indicated the presence of involvement of the axillary, musculocutaneous and suprascapular nerves.

In a review of the literature of the neurologic complications of treatment with typhoid vaccine, the authors found reports of Landry's paralysis, polyneuritis, neuritis of individual peripheral nerves and encephalopathy. The complications have been explained on the basis of anaphylaxis; the presence of a neurotoxin or attenuated virus or an associated latent bacterial infection, and stimulation of foci of infection.

CHODOFF, Langley Field, Va.

CENTRAL NERVOUS SYSTEM IN ACUTE DISSEMINATE LUPUS ERYTHEMATOSUS. DAVID DALY, *J. Nerv. & Ment. Dis.* **102:461** (Nov.) 1945.

Daly reviews the literature on complications of lupus erythematosus disseminatus referable to the central nervous system. Toxic delirium, psychotic

states, convulsions, visual disturbances and headache have all been reported. The few neuropathologic reports permit of no clearcut formulation of the changes in the nervous system. Two cases are reported. In the first case there were shifting neurologic signs including weakness of the lower part of the face, reflex changes and a questionable Babinski sign. In the second case confusion and disorientation, headaches and twitchings of the extremities characterized a stormy course, with a fatal termination after twelve weeks in the hospital. At autopsy, the pathologic picture was one of diffuse nonspecific encephalitis with extensive vascular changes and thrombosis. There were acute and chronic degenerative changes in the nerve parenchyma secondary to disturbances in the vascular supply.

CHODOFF, Langley Field, Va.

A FATALITY INCIDENCE IN ELECTROSHOCK TREATMENT. ALEXANDER GRALNICK, *J. Nerv. & Ment. Dis.* **102**:483 (Nov.) 1945.

Gralnick reviews the problem of cerebral changes associated with experimental electric shock. The results have been contradictory, with considerable variation in the neuropathologic findings, depending on whether cats, dogs or monkeys were used. Whether the changes observed in the brains of the animals at autopsy are due to the direct action of the current on the parenchyma or to the production of vascular spasm and hemorrhage by the electric current has not been definitely determined. What part the convulsion itself plays is likewise undecided. Alpers and Hughes reported the observation of extensive punctate hemorrhages in the brains of 2 persons who died after electric shock therapy, but a review of the other 12 reported fatalities failed to show any important neuropathologic changes which could be directly attributed to the treatment.

The case is reported of a man aged 60 who was subjected to two electric shock treatments for a condition diagnosed as involuntional melancholia. The day following the second treatment left hemiplegia developed and he lapsed into coma and died. Autopsy revealed the presence of a large cerebral tumor in the frontal fossa and adherent to the under surface of both frontal lobes. Microscopic examination revealed that this was a meningeal fibroblastoma. In addition there were multiple, scattered and confluent hemorrhages, mostly of recent origin. Other vascular changes present corresponded to the stasis and prestasis phenomena of Pickford and were due to the altered hydrodynamics of the circulation of the blood secondary to the increased intracranial pressure. It was felt that the electric shock treatment might have directly or indirectly aggravated these effects.

Thus, in this case, as in all the other reported instances of fatality due to electric shock, there was a complicating factor of sufficient severity to blur the findings and cast doubt on their general significance. All deaths have occurred in patients who received an excessive amount of treatment, were elderly or had a complicating disease, cerebral or vascular. The evidence at hand indicates that in the human being no specific structural pathologic change is directly referable to electric shock treatment. When electric shock produces permanent damage, there is usually preexisting disease, or the patient is especially sensitive to shock treatment.

CHODOFF, Langley Field, Va.

ROENTGENOLOGIC AND PATHOLOGIC ASPECTS OF PULMONARY TUMORS PROBABLY ALVEOLAR IN ORIGIN. E. F. GEEVER, H. R. CARTER, K. T. NEUBUERGER and E. A. SCHMIDT, *Radiology* **44**:319 (April) 1945.

Geever, Carter, Neubuerger and Schmidt report 6 cases of pulmonary carcinoma, probably alveolar in origin, with autopsy. Two of the patients were under 45 years of age, 1 being a 17 year old girl and the other a man aged 39.

In 1 case the condition was complicated by torulosis of the central nervous system. The patient was a woman aged 53 who complained of blurred vision,

difficulty in speech, drowsiness and loss of weight. The positive findings were emaciation, causeless laughter and giggling, bilateral nystagmus and slight stiffness of the neck. Budding, doubly refractive, yeastlike organisms were observed repeatedly in the spinal fluid, and torula organisms (*Cryptococci hominis*) were isolated from an inoculated mouse and guinea pig. Small areas of increased density in both upper pulmonary fields led to a roentgenologic diagnosis of fungous infection. At autopsy, tumor foci, measuring 0.5 by 1.0 cm., were observed in the lungs and leptomeninges and scattered through the brain. Microscopically, these consisted of cuboidal, epithelial-like neoplastic cells, in a papillary, alveolar arrangement. No cryptococci could be demonstrated, and the diagnosis of torula meningitis was not confirmed.

In 3 of the remaining cases the tumor was also of the multiple nodular type, while in 2 cases it was of the diffuse infiltrative type. Microscopically, all the tumors were much like that in the first cases.

Roentgenologically, in only 1 case did the tumor have the appearance of a primary pulmonary carcinoma. In 2 cases the appearance suggested a metastatic malignant growth in the lung, while in the other 3 cases the structure simulated that of a low grade inflammatory reaction (tuberculous, fungous or nonspecific pneumonitis).

In 2 cases there were no metastases outside the chest, while only in the case of torulosis were cerebral metastases seen. Metastatic sites in the other 3 cases included the periaortic and peripancreatic nodes, the liver, the kidneys, the adrenals and the pancreas.

The authors classify the tumors described as alveolar cell carcinoma, arising probably in the alveolar epithelium of the lung. This classification is based on the microscopic picture and the absence of a point of origin in a bronchus. The extremely rare "multiple pulmonary adenomatosis" is apparently a benign neoplasm also arising from the alveolar pulmonary cells simultaneously at different points.

Other investigators, however, believe the alveolar carcinomas arise from a single focus in a smaller bronchus and then metastasize rapidly to other parts of the lung via the bronchi and lymphatics.

TEPLICK, Washington, D. C.

METHYL BROMIDE POISONING: EFFECTS ON THE NERVOUS SYSTEM. A. BARHAM CARTER, *Brit. M. J.* **1**:43 (Jan. 13) 1945.

Among the toxic effects of methyl bromide poisoning are those on the nervous system. From a review of the cases described in the literature, Carter found sub-acute or chronic effects in approximately half the cases. The neurologic signs are central and peripheral. The central effects are headache, transient diplopia, difficulty in accommodation, dimness of vision, dysarthria, generalized incoordination and vertigo. Thus, the optic nerve, oculomotor nerves, cerebellar connections and posterior columns, with occasional involvement of the higher centers, producing psychic disturbances, are the parts primarily affected. The peripheral effects, which appear to be the result of a toxic peripheral neuritis, consist in numbness, tingling, flaccid paresis and loss of reflexes; there are few sensory changes except for loss of vibratory sense. Treatment is symptomatic; rest in bed and removal from exposure to the gas are sufficient, although convalescence may require as long as a year.

ECHOLS, New Orleans.

CHRONIC INTRACEREBRAL HAEMATOMATA. G. F. ROWBOTHAM and A. G. OGILVIE, *Brit. M. J.* **1**:146 (Feb. 3) 1945.

Rowbotham and Ogilvie describe 2 cases in which a congenital supraclinoid aneurysm became attached to the brain tissue and ruptured intracerebrally to cause a chronic hematoma with resulting hemiplegia. It was thought that some factor other than surface compression was the cause of the hemiplegia. The

secondary rise in intracranial pressure was suggestive of recurrent bleeding, but lumbar puncture proved absence of bleeding into the general subarachnoid spaces. After subsidence of the acute stage of the hemorrhage, the region of the anterior end of the sylvian fissure, wherein lie the middle cerebral artery and its many branches, was explored. A large cyst was encountered at a depth of 2 cm. in the temporal lobe of the brain immediately below the sylvian fissure; its contents were evacuated. Complete recovery of function followed in both cases. The authors explain the sudden impairment of consciousness at the time of rupture of the aneurysm on the basis of a combination of cerebral shock and widespread arterial spasm. The paralysis proved to be due to pressure of the cyst on the middle cerebral artery. The secondary rise in pressure was the result of breakdown of the intracerebral blood clot.

ECHOLS, New Orleans.

Peripheral and Cranial Nerves

BILATERAL ACOUSTIC NEURITIS. M. R. JOHNSON, Arch. Otolaryng. **40**:261 (Oct.) 1944.

Acoustic neuritis has many etiologic possibilities. A review of the literature revealed that infection, vitamin deficiency and the toxic effects of drugs have been designated as causes. The condition usually comes on suddenly. It produces tinnitus and deafness when the cochlear branch is affected; vertigo, disturbances of equilibrium, spontaneous nystagmus and vomiting when the vestibular branch is involved, and a combination of these symptoms when both branches are involved.

The author reports a case of bilateral acoustic neuritis in a white soldier aged 23. Two days prior to admission to the hospital, the patient perspired freely while performing an arduous task in the Army. Military exigencies precluded his leaving his post even though the weather suddenly became colder. After about two hours he began to complain of throbbing pain in the right ear, sore throat and some stiffness in the muscles of the neck. The following day there was impaired hearing in the right ear but no earache. On his admission to the hospital a diagnosis of acute follicular tonsillitis was made, and he was placed under sulfanilamide therapy until the throat showed decided improvement. Six days after admission to the hospital, he complained of right-sided earache, and eleven days after admission, of deafness in the right ear. Hearing tested with the spoken voice was 20/20 in the left ear and 2/20 in the right. Three weeks after admission, the patient could hear nothing with the right ear, and a roaring sensation had developed in the left ear. Medical, surgical, genitourinary and dental consultations revealed nothing of significance. There were no other neurologic signs. In the hope of removing a possible focus of infection, tonsillectomy was done, but the progress of the disease was not curtailed. Ten months after the onset the patient was completely deaf in both ears. No definite statement regarding the cause could be made.

RYAN, Philadelphia.

MÉNIÈRE'S DISEASE. RICHARD F. MOGAN and C. J. BAUMGARTNER, Arch. Otolaryng. **41**:113 (Feb.) 1945.

Ménière's disease is a chain of disturbances, sudden in onset, in otherwise healthy ears, causing nausea, vomiting, loss of equilibrium, nystagmus and total or partial loss of hearing. It is significant that the vestibular and cochlear functions are damaged simultaneously and that frequently the ears are affected at the same time. There are four possible causes of the disease: (1) excessively strong impulses passing along the sympathetic nerves due to pathologic changes in the sympathetic nervous system itself; (2) an excess of vasoconstrictor substances in the blood; (3) an excess of histamine or histamine-like metabolites in the local area, and (4) hypersensitivity of the local area to metabolites, allergens or hormones. The view that exaggerated vasospasm is due to a fault of the

central mechanism, and not to a peripheral lesion, as many think Ménière's disease to be, is strongly supported by postoperative observations. The authors, in discussing 1 of their cases of Ménière's disease in which the superior cervical ganglia were removed, comment on the definite pathologic changes noted in the ganglia.

Apparently, sympathectomy does not completely stabilize the blood flow but prevents maximal constriction or dilatation. The authors call attention to the fact that Ménière's syndrome may be caused by many agents but that the mechanism is the same regardless of the irritant. A vasodilation or a vasoconstriction due to excessive stimulation of either branch of the sympathetic nerve to the internal ear causes excessive responses, as in Raynaud's disease. The effect is either an immediate excessive filtration into the scala media or a secondary reaction, following a marked vasoconstriction.

RYAN, Philadelphia.

NEUROFIBROMA OF THE CAUDA EQUINA. RAPHAEL POMERANZ, *Radiology* **44**:588 (June) 1945.

A 23 year old soldier was admitted with a history of recurring backache for five years, each episode lasting two to three weeks. There were long intervals between attacks. The episodes consisted of burning pain in the lumbosacral region, radiating into the right scrotum and the anteromedial aspect of the right thigh, with occasional numbness and tingling in the lateral portion of the thigh. The pain was aggravated by coughing, sneezing, twisting and bending. Immediately preceding admission, he had a severe attack following exercise, which completely incapacitated him.

Examination revealed a rigid spine, with muscular spasm, weakness and atrophy of both lower extremities, more pronounced on the right. The Lasègue sign was positive bilaterally. No pathologic reflexes were obtained. The spinal fluid showed an increase in protein (4,500 mg. per hundred cubic centimeters). Roentgenograms, showed a narrowed disk between the twelfth dorsal and the first lumbar vertebra, with a small osteophyte on the right side of the twelfth dorsal vertebra. The interpediculate measurement of the first lumbar vertebra was increased, with noticeable flattening of the pedicles.

Myelographic study with Pantopaque (an iodized poppyseed oil, with special cohesive properties) showed obstruction to the cephalic flow of the oil at the mid-portion of the first lumbar vertebra. A concave defect at this point indicated the presence of a rounded tumor. The diagnosis was that of a small neoplasm of the cauda equina, at the level of the first lumbar vertebra, intradural and probably a neurofibroma.

At operation an encapsulated tumor was observed at the suspected level. It was attached to the dura on the right and measured 2.3 by 1.6 by 1.3 cm. Histologic examination proved that the tumor was a neurofibroma. The patient made a complete and uneventful recovery and has been free from symptoms for about three months.

TEPLICK, Washington, D. C.

POLYNEURITIS AFTER JUNGLE SORES. R. L. WARD and A. S. MASON, *Brit. M. J.* **2**:252 (Aug. 25) 1945.

Ward and Mason report their clinical observations in 21 cases of peripheral neuritis subsequent to multiple indolent ulcers ("jungle sores") which occurred during a campaign in the Burmese jungle. The first symptom was blurring of vision, which usually appeared about seven weeks after the onset of the ulcers; sensory symptoms appeared about three weeks later. In the severer forms there were progressive weakness of the extremities, spreading to involve the hips and shoulders; astereognosis, and ataxia. Paralysis of accommodation was an outstanding feature of the disease. Examination of the nervous system revealed the characteristic signs of polyneuritis. Ward and Mason believe that the jungle

sores were infected with diphtheria bacilli and that the polyneuritis was of diphtheritic origin. If this hypothesis is accepted, prophylactic immunization of troops engaged in future jungle operations will become advisable.

ECHOLS, New Orleans.

Treatment, Neurosurgery

MENINGOCOCCIC MENINGITIS: REPORT ON 165 CASES. ANDREW H. MEYER, *Ann. Int. Med.* **22:543** (April) 1945.

Meyer reports on the results of treatment of 165 patients who had meningococcic meningitis.

In 150 cases the etiologic agent was proved bacteriologically. The remaining 15 cases were included because purulent spinal fluid was demonstrated and they occurred during an epidemic period of meningococcic meningitis.

The mortality rate was 5.3 per cent for the entire group and was 4 per cent for the 150 proved cases. In analyzing the causes of death, it was found that death occurred in 6 of the 9 fatal cases in the first twenty-four hours of hospitalization, the clinical diagnosis in 2 of these being the Waterhouse-Friderichsen syndrome. One death resulted from undue delay in diagnosis, and only 2 deaths occurred after adequate treatment.

Sulfadiazine was the chief therapeutic agent employed, but it is felt that meningococcus antitoxin and repeated lumbar punctures to relieve increased intracranial pressure were valuable adjuncts in certain instances.

The following sequelae were encountered: relapse, with subsequent recovery; ulceration of massive areas of purpura, with recovery; quadriplegia and respiratory paralysis, which were successfully treated by means of a respirator and repeated lumbar punctures; ptosis of the right eye and unilateral atrophy of the optic nerve; purulent effusions into the knee joint in 2 cases, in both of which the fluid was sterile on culture and subsequently cleared without drainage; questionable hydrocephalus, in 2 infants; purulent pleural effusion, in 1 case, in which the material was sterile on culture and cleared without drainage, and hemiplegia, in the case of a 59 year old patient with hypertension, in whom thrombophlebitis of the deep veins of the calf had developed.

GUTTMAN, Philadelphia.

THE QUESTION OF ELECTROSHOCK THERAPY IN THE DEPRESSIONS. NATHAN SAVITSKY and SIDNEY TARACHOW, *J. Nerv. & Ment. Dis.* **101:115** (Feb.) 1945.

Savitsky and Tarachow recommend that courses of electroshock treatment of the depressions be shortened. They have found that permanent curative results have been attained after only three to five shocks in some cases, while, on the other hand, psychotic episodes have apparently been exacerbated after prolonged courses of treatment.

In 12 cases, courses consisting of five or less treatments were given extramurally in the office of one of the authors. In these cases, the endogenous depressive syndrome was relatively pure, and there was relative freedom from paranoid, hypochondriacal or neurotic symptoms. Treatment was continued only until the patient was free from symptoms, and there was a strong tendency to complete remission as a result of treatment. The remissions have lasted for from five months to two years.

CHODOFF, Langley Field, Va.

SHOCK TREATMENT IN PSYCHOPATHIC PERSONALITY. HARRY F. DARLING, *J. Nerv. & Ment. Dis.* **101:247** (Mar.) 1945.

Darling describes the results of electroshock treatment in 3 institutional cases of psychopathic personality. In the first case no improvement was noted but definite remissions were obtained in the other 2 and both patients were able to

make good extramural adjustments. The author feels that his results justify further use of electroshock treatment in cases of psychopathic personality.

CHODOFF, Langley Field, Va.

ELECTROCONVULSIVE THERAPY IN THE PRONE POSITION. FRED FELDMAN, SAMUEL SUSSELMAN and S. EUGENE BARRERA, *J. Nerv. & Ment. Dis.* **102**:496 (Nov.) 1945.

In the course of administering combined insulin and electrical shock treatment, there was encountered the problem of preventing the patient from aspirating, during the electrical convulsive treatment, the mucus and saliva which accumulate during the stages of coma of insulin therapy. It was found that placing the patient in the prone position prevented this aspiration and was otherwise entirely satisfactory. The patient is placed in the complete prone position in an ordinary hospital bed. The head is kept in alignment with the rest of the body, the nose and mouth pointing straight down toward the mattress. The patient is supported by three assistants, and no undue extension or flexion of the back is permitted. The method has been used in approximately 50 cases without the development of any serious complications.

CHODOFF, Langley Field, Va.

AMINOACETIC ACID (GLYCINE) IN THE TREATMENT OF DEPRESSION. MAX H. WEINBERG, *J. Nerv. & Ment. Dis.* **102**:601 (Dec.) 1945.

Inspired by the successful use of amino acids in the management of surgical patients with nutritional difficulties, Weinberg treated 19 patients with depression with aminoacetic acid in doses up to 6 Gm. per day, administered orally in the form of the elixir (wine).

Most of the patients with mild depression recovered or improved, but 2 patients with involutional melancholia failed to benefit from the treatment. The author believes that the results are sufficiently encouraging to warrant a further trial of aminoacetic acid in cases of the mild depressions in which treatment can be carried out extramurally.

The improvement resulting from treatment with aminoacetic acid is explained on the basis of the action of the drug in counteracting the loss of appetite, which results in a lowering of serum protein and consequent damage to nerve tissue, possibly on the basis of cerebral edema. In addition, it has been proved that the administration of amino acids not only restores the nitrogen balance but also acts as a stimulant in increasing the patient's appetite.

CHODOFF, Langley Field, Va.

USE OF BENZEDRINE SULPHATE BY PSYCHOPATHS. H. J. SHORVON, *Brit. M. J.* **2**:285 (Sept. 1) 1945.

Shorvon reports the case of a psychopathic patient aged 35 who had been taking an average daily dose of 125 to 150 mg. of amphetamine sulfate at periodic intervals of many months for approximately four years without apparent physical ill effects or addiction. Withdrawal of the drug during one month of hospitalization resulted only in restlessness, sleeplessness and increased hunger; the patient stated that he felt no craving for the drug during that time. Although amphetamine sulfate is considered to have a hypertensive effect, the patient's blood pressure was normal.

ECHOLS, New Orleans

Society Transactions

NEW YORK NEUROLOGICAL SOCIETY AND NEW YORK ACADEMY OF MEDICINE, SECTION OF NEUROLOGY AND PSYCHIATRY

Joseph H. Globus, M.D., *President of the New York Neurological Society, Presiding*

Joint Meeting, Feb. 12, 1946

Parenchymatous Cerebellar Degeneration: Report of Two Cases:

DR. H. HOUSTON MERRITT.

Two cases were presented to illustrate the symptomatology of parenchymatous cerebellar degeneration. This syndrome was first described by Rossi in 1907 and by Marie, Foix and Alajouanine in 1922. Cases of this disease are characterized by the development of cerebellar symptoms in middle-aged persons without any family history of cerebellar disease. In the majority of cases the cerebellar symptoms are most pronounced in the lower extremity. Pathologic examination reveals gross atrophy of the superior part of the vermis and the lateral part of the hemispheres. Microscopically, there is massive destruction of the Purkinje cells with preservation of the basket cells. The cause of the condition is unknown, but chronic alcoholism has been considered a factor in a number of cases. The disease is more common than would be inferred from the small number of cases which have been reported in the literature.

DISCUSSION

DR. S. PHILIP GOODHART: I should like to ask Dr. Merritt his opinion of the classifications of clinical syndromes based on structural changes in the cerebellum and its contiguous and associated centers; I refer to such designations as olivocerebellar, olivopontocerebellar, parenchymatous cerebellar degeneration and the aplasias and dysplasias. The attempt to ascribe definite pathologic changes and localization to certain clinical entities has always seemed to me unjustified, and autopsy observations by no means confirm the clinical picture. Does Dr. Merritt feel that his 2 cases permit exact anatomicopathologic localization? I believe that the designation "parenchymatous cerebellar degeneration" is in keeping with the clinical picture in these cases, but I should like to know his feeling as to the difficulties in classification so often attempted in clinical textbooks and reports. In other words, do clinical signs enable one to localize the lesion? I doubt it.

DR. LEO M. DAVIDOFF: The second patient originally consulted me because some one made a diagnosis of cerebellar tumor; it was obvious from the history and the absence of increased intracranial pressure that he did not have a tumor, and I think that the differential diagnosis in his case is not difficult.

DR. H. HOUSTON MERRITT: It is not possible to make an accurate anatomic diagnosis in cases of this disease. One can only speculate that the patient has the type of clinical entity which has been described as parenchymatous cerebellar cortical degeneration. The classification of the cerebellar syndromes is confused, and there is not time to discuss it here. In the cases in which there is no family history of cerebellar disease and the onset of typical symptoms is in middle life, one can feel fairly certain that they fall into the category of parenchymatous cerebellar degeneration.

Ophthalmoplegic Migraine and a Theoretic Explanation of Its Production: Report of a Case. DR. FOSTER KENNEDY.

A white man aged 63 complained chiefly of double vision. In his teens he was subject to bouts of scotomas and right-sided headaches, which gradually increased

in severity, accompanied with nausea. The headache would last for a day and end after vomiting. During adolescence the headaches occurred as frequently as once every month or two. Occasionally after headache the patient's right eyelid would droop and he would see double for a day or two. As he grew older, the headaches became somewhat less severe but were regularly accompanied with and followed by diplopia for increasingly longer periods, until they would last as long as a month. As the patient reached middle age, the headaches became mild and infrequent, occurring only every six or twelve months. However, the double vision became permanent but was made still worse by mild headache. Vision had diminished in the right eye.

Physical examination revealed a generally healthy elderly man. His right eye deviated far to the right. It could not be turned beyond the midline. Movement produced by the superior oblique muscle was also absent. The right pupil was larger than the left; it was irregular and did not react directly to light. The consensual light reflex was sluggish in the right eye, and the right pupil reacted only slightly in accommodation to near vision. The corneal reflex was present on both sides.

This case was presented as one of ophthalmoplegic migraine. The pathologic process producing this condition has never been satisfactorily defined. According to the theory of migraine which most closely explains the clinical happenings, the migraine is due to localized intracranial edema, probably on an allergic basis, the edema fluid accumulating most frequently and to the greatest extent in the areas within the skull best adapted by formation and the exercise of gravity to permit its accumulation in bulk. The angle made by the slope of the tentorium and the convexity of the meninges is ideal for this purpose, and accumulation of fluid in this position would account for the zeigoscopia through irritation of the angular gyrus and for the transient hemianopsia and, if on the appropriate side, the alexia and the mild hemiplegic signs, often only of a sensory character, so often produced in the course of migrainous attacks.

Compression of the pituitary body by a similar collection of fluid in the sella accounts for the transient abnormalities of function of the pituitary gland which also occur. Collection of fluid in the neighborhood of the sphenoidal ridge can compress the nerves passing through the fissure and so block their function. Severe compression in such a bone-surrounded area can produce such anatomic change as to abrogate function for a time.

It is quite usual to find the paralysis of ophthalmoplegic migraine lasting for several weeks, and even months. It is to be expected that if attacks producing compression of these nerves occur regularly and frequently throughout the greater part of a lifetime complete degeneration of these nerves would result from these repeated insults.

Edema of the facial nerve produces facial paralysis because the bony aqueduct of Fallopius does not permit free swelling of the nerve, so that physiologic, and in some cases anatomic, block takes place. The same process often occurs in the optic nerve by reason of its fibers being tightly bound by the vaginal sheath of the nerve. One repeatedly sees spinal nerve roots giving signs of irritation or depletion of function in toxic states if the intervertebral foramina through which they pass are reduced in size as a result, for instance, of osteoarthritis.

DISCUSSION

DR. H. A. RILEY: My own view of ophthalmoplegic migraine is that it does not exist as an idiopathic form of migraine. In every instance in which attacks of ophthalmoplegic disturbances have occurred in association with headache and postmortem investigation has been carried out, there has always been noted some element of pathologic character which interfered with the function of the particular nerve involved, and not, as Dr. Kennedy suggests, a merely transient functional disturbance associated with stasis of fluid in the vicinity of the nerve itself. Most of the disturbances one finds associated with migraine in which permanent sequelae follow attacks of a reversible character, as in the ophthalmic form, in

which eventual hemianopsia takes place, almost always prove to be the result of the development of arteriosclerotic or other organic processes. In such instances the condition begins with a transient interference with some neural function, and then, as the patient grows older and the sclerosing processes continue, an organic change develops in the blood vessels which results in a permanent defect, such as hemianopsia. In these cases of ophthalmoplegia, as in the cases of facioplegia, the pathologic evidence accumulated has not provided a firm basis for the recognition of these two disorders as a part of the migraine syndrome. In all the recorded cases, this ophthalmoplegia with headache should be looked on as such, but not as constituting a separate form of migraine. It is generally recognized that practically all lesions of the oculomotor nerve are associated with pain and with concomitant headache. Headache is a common accompaniment of all types of ophthalmoplegia. This is quite a different matter from the periodically recurring, transient attack of migraine, in which the patient shows a definite predisposition and there is a hereditary loading from his ancestors. I did not hear enough of Dr. Kennedy's presentation to know whether his patient had a hereditary history of migraine, convulsions, petit mal attacks, psychomotor equivalents or any of the other deviations which are usually found in the antecedents of people with true migraine. I think that until definite evidence is adduced it is unwise to speak of an ophthalmoplegic type of migraine. One can speak of recurrent ophthalmoplegia with headache, but not ophthalmoplegic migraine.

DR. H. HOUSTON MERRITT: I have never had the opportunity of examining pathologically patients with so-called ophthalmoplegic migraine, but I agree with Dr. Riley, on the basis of evidence from the literature and from my experience, that patients with headaches and palsy of the third nerve usually have an organic lesion which would explain the paralysis.

DR. FOSTER KENNEDY: What kind of lesion?

DR. H. HOUSTON MERRITT: Aneurysm or tumor.

DR. FOSTER KENNEDY: Do you mean to say that this man has had an aneurysm since the age of 16?

DR. H. HOUSTON MERRITT: I do not know what this patient has, but it is likely that he has a fixed lesion to explain the palsy of the third nerve.

DR. FOSTER KENNEDY: The patient has a history of attacks which cannot be called anything else but migraine. He has had them since the age of 16, and he still has them at the age of 66. Do you contend that he has an aneurysm? Dr. Riley says he had arteriosclerosis at the beginning, when he was a child.

DR. H. A. RILEY: I did not say that.

DR. FOSTER KENNEDY: That is just talking around the subject, instead of on it. Here is a man who has had typical migraine since the age of 16. He had attacks every month, which lasted a day; he vomited; he saw double, and he went on seeing double after every attack until he finally had a paralysis. I do not know why one should not call it ophthalmoplegic migraine; Charcot did, and his opinion was good enough.

DR. JOSEPH H. GLOBUS: Why do you object to the diagnosis of aneurysm in this case? The fact that the patient has had attacks of headache since he was 16 is not entirely out of accord with such a possibility.

DR. FOSTER KENNEDY: A sensible man bases his life on probabilities, not possibilities. "Possibilities" are lawyers' words. It is most unlikely that this man has had an aneurysm all his life—and one leaking each month or so—he is in good health, and there is no sign of an aneurysm. As he has grown older, his periodic headaches have almost ceased; so I believe my theory of migraine is correct.

DR. JOSEPH H. GLOBUS: Suppose I say an aneurysm is probably present, since he manifests clinical evidence favoring an aneurysm?

DR. FOSTER KENNEDY: He is a permanent employee of Bellevue Hospital, and when he is ready to go to the throne of God, I will let you know.

Progressive Nuclear Ophthalmoplegia, Possibly on the Basis of a Vitamin Deficiency: Report of a Case. DR. SAMUEL KAUFMAN (by invitation).

A 12 year old Cuban boy had the presenting difficulty of severe ptosis of both eyelids. He had had no neuromuscular disability until the age of 9 years, when he began to have trouble in raising his right eyelid. A year later he was unable to open either eye fully. The ptosis on both sides has slowly become worse. He has had no loss of visual acuity and no diplopia. Rest and fatigue play no role. His jaw never fatigues while chewing.

After uncomplicated pertussis, at the age of 2 years, the boy became a feeding problem. He ate little else than milk and starches until the age of 9. With the onset of his present illness, vitamin supplements in large doses were added to his diet. Neostigmine was given by injection and by mouth. No medication has affected his ptosis in any way. He has remained strong and vigorous, although small for his age—54 inches (137 cm.) in height and 57 pounds (25.9 Kg.) in weight. There has been no similar difficulty in the family, nor have any relatives had other congenital or abiotrophic neuromuscular disabilities.

Neurologic Status.—The abnormal findings were limited to his eyes. The visual fields were normal. Visual acuity was 16/20 in each eye. There was no nystagmus. The fundi were normal. The margins of the disks were sharply outlined. The pupils were of normal size and were round, regular and brisk in response to light. There was ptosis on both sides. On gazing straight ahead, the right palpebral fissure measured 2 mm. and the left between 2 and 3 mm. On upward gaze, the right palpebral fissure widened to 3 mm. and the left to 4 mm. There was also limitation of movements of both eyes in all directions. On looking upward, the right eye moved 1 mm. and the left not at all, as compared with the normal excursion of 5 to 7 mm. On looking downward, both eyes moved 5 mm., the normal being accepted as 9 to 10 mm. On looking to the right, the right eye abducted 5 mm., while the left turned inward 2.5 mm. On looking to the left, the left eye turned outward 2 mm. and the right inward 1 mm. The normal for all these movements is 9 to 10 mm. On looking downward, there was a slight inward rotation of the left eye, indicating that the superior oblique was less damaged than the inferior rectus. He did not complain of diplopia, but one of the visual images was suppressed, as could be shown by the mechanical movement of one eyeball, which failed to produce double vision.

The eyes were in normal position. The orbicularis oculi muscle was slightly weak on both sides, the left being weaker than the right. The eyelids elevated normally on wrinkling the forehead.

Laboratory Data.—The blood counts and the blood chemistry were normal; there was no eosinophilia. Examination of the stool showed only Trichiuris. The reaction to tuberculin was negative. Cutaneous tests for parasites, including Echinococcus, parasites of the Tinea group, Schistosoma and Trichinella, gave negative results. Basal metabolism tests, roentgenologic studies and gastric analysis gave normal results, and the specific tests for syphilis were negative. The only abnormality in the spinal fluid was an increase in the total protein to 100 mg. per hundred cubic centimeters.

Conclusion.—The patient has a slowly progressive external ophthalmoplegia. His difficulty started three years ago with ptosis. Now he has weakness, of a variable degree, of all the external ocular muscles and of the orbicularis oculi.

The clinical picture in this case is an interesting one. The etiology and the pathoanatomy of the condition are not definitely known. Possibly the disease picture is the resultant of a congenital nuclear poverty. Possibly there is an independent or associated slowly progressing degeneration of the nuclei of the ocular muscles.

Jolliffe, Wortis and Fein (The Wernicke Syndrome, ARCH. NEUROL. & PSYCHIAT. 46:569 [Oct.] 1941) have shown the relationship between thiamine deficiency and Wernicke's syndrome. Avitaminosis during the seven years preceding the onset of this patient's illness must be considered as a possible etiologic agent.

DISCUSSION

CAPT. ARTHUR ALEXANDER KNAPP (MC), U.S.N.R.: This case has been most interesting: For a number of years my associates and I have done research on groups of young animals in the department of pharmacology, Columbia University College of Physicians and Surgeons. We induced deficiencies in vitamins A, B and D in these several groups and had a group receiving a low caloric intake. In addition to these animals, we had controls at all times. We watched these animals carefully from the inception of the deficiencies to the time they died or were killed, over a period of many months, and in none of them were we able to elicit any signs of internal or external ophthalmoplegia. Clinically, the ophthalmologic picture does not appear to be based on a vitamin deficiency.

DR. H. HOUSTON MERRITT: I should like to ask whether there was a history of ptosis or ophthalmoplegia in this patient's family.

DR. SAMUEL KAUFMAN: There was none.

DR. KURT GOLDSTEIN, Boston: I have seen a number of such patients. Their condition was very similar to this boy's. It began with ptosis, and later paralysis of the external ocular muscles developed. The intrinsic ocular muscles were never affected. One of these boys whom I had the opportunity of observing for many years later acquired paresis of one arm. I thought that the condition was a slowly progressive degeneration of the motor system. One of the boys had congenital syphilis.

DR. FOSTER KENNEDY: I should like to draw attention to the similarity of this condition to Wernicke's syndrome occurring with long-continued alcoholism and deficiency of thiamine.

DR. WILLIAM H. EVERTS: I do not know how long one should assume that this type of deficiency must go on to produce the ocular paralysis. Dr. Kaufman spoke of the European starvation, and there are probably a number here who saw European starvation in the war. I cannot say much about that, for there were no deaths from starvation in the prisoners whom I saw. There was a mass experiment, however, a bitter one, among the American and other allied troops who were taken prisoners by the Japanese and who starved for several years and lost from 60 to 80 pounds (27.2 to 36.3 Kg.) in weight; they had multiple neuritis of a severe degree, with optic nerve atrophy and central scotomas of all grades but no ophthalmoplegia. I had occasion to see many American prisoners brought down from Japan and hospitalized on Saipan and Oahu. Later in Manila, when the Japanese began to come out of the hills (the American Navy had cut off all supplies from Luzon in the fall of 1944, and they had no more food coming in, so that they had this period during which their diet was greatly reduced, consisting in roots and a small amount of rice, and they lost a great deal of weight—the Japanese is a small man anyway, but he lost as much as 50 per cent of his weight) when, I say, they began to come out of the hills in May, June, July and August, we American doctors would see them right on the trains, patient after patient, until in three months we had 6,500 patients; we found that the incidence of beriberi and other vitamin deficiencies was very high in that group, along with other diseases, such as parasitic disorders, malaria and dysentery, but there was no ophthalmoplegia. I had occasion to examine many of these prisoners myself and I know that they did not show as much ophthalmic disease as did the American, British and Australian troops, who had been on a longer starvation diet when they were imprisoned in Korea and Japan. I do not know how long, therefore, one can starve a man or how long he must be on a vitamin-deficient diet before the central nervous system breaks down. Perhaps others have seen it, but it has been commented on many times that intrinsic degeneration of the central nervous system did not occur often. We did see a few cases, in which the disorder was of the combined system type, with peripheral neuritis and degeneration of the optic nerves, beginning most often with a central scotoma, or in the American troops more often with a tendency to night blindness, which was progressive. Often a careful examination of the

visual fields would reveal a scotoma, even when in some instances the patient was not aware of it. A great many of these men responded to multiple vitamin therapy.

DR. CHARLES A. MCKENDREE: One finding in Dr. Kaufman's case disturbs me a little; that is the protein content of the spinal fluid of 100 mg. per hundred cubic centimeters. I should like to ask how that can be correlated with a vitamin deficiency or with a progressive degenerative process.

DR. H. HOUSTON MERRITT: Was a basal metabolism test done?

DR. SAMUEL KAUFMAN: I shall start with Dr. Merritt's question. We made three determinations of the basal metabolic rate, and all gave normal values. The boy did have an increased total protein content of the spinal fluid; I could not explain that adequately myself. Just how much of an increase one would have with a degenerative process in a small area of the central nervous system is questionable.

With respect to avitaminosis in the Pacific area not producing ophthalmoplegia, I can only say that the present case cannot be proved to be one of avitaminosis. I present it as an interesting case. There is a difference between this boy and the Japanese who came out of the hills in Luzon. They were adults. This boy had had vitamin-deficient diet from the age of 2 to 9 years, when he first exhibited ptosis and when vitamin therapy was instituted. Just what the importance of that fact is I cannot state.

DR. WILLIAM H. EVERTS: The Japanese had their wives and small children there, and we had many such families in prisons, often in an extremely starved condition; I assure you that they did not have ophthalmoplegia, for we kept them under observation.

Treatment of Spasmodic Torticollis: Report of Two Cases. DR. TRACY J. PUTNAM and DR. ERNST HERZ (by invitation).

It is by now quite clear that spasmodic torticollis is a variety of dystonia, to be distinguished sharply from disturbances in control of the muscles of the neck of hysterical origin. Occasional encouraging results from psychotherapy and orthopedic measures are probably to be ascribed to remissions or to confusion with other types of torticollis. Systematic psychotherapy in able hands has yielded poor results in a large series of patients treated at the Neurological Institute of New York.

The most widely successful surgical treatment is Dandy's modification of Foerster's operation, which consists in intradural section of the anterior roots of the first to the third cervical spinal nerves and section of the accessory nerves in the neck. A common technical error in carrying out this procedure is to overlook the first nerve root, which is hidden under a slip of the odontoid process. Section of the accessory nerve within the skull seldom produces complete paralysis of the sternocleidomastoid muscle, and section of the nerve just below the mastoid often fails to do so.

In cases in which the Foerster-Dandy procedure fails to give adequate relief, further decrease in spasm may be produced by a modification of the Finney operation, namely, section of the posterior divisions of the cervical roots as they emerge from the foramina. In this manner, the majority of the affected muscles from the fourth to the seventh cervical dermatomes may be denervated, without loss of power of important muscles of the hypoglossal group and of the shoulder. If there is a dystonia affecting the muscles of the back or the extremities, this may often be improved by an anterior chordotomy.

By performing these operations in series, graded to fit the needs of the patient, the majority of sufferers from torticollis may be given sufficient relief to enable them to return to their occupations.

DISCUSSION

DR. LEO M. DAVIDOFF: I should like to ask why it would not be wiser to continue the laminectomy and cut the posterior roots within the spinal canal lower down, that is, from the fourth to the seventh servical, and avoid these bilateral and bloody operations.

DR. H. A. RILEY: I should like to ask whether Dr. Putnam cuts the first, second and third cervical roots intradurally, and also whether he cuts the spinal accessory nerve, from which is derived the further innervation of the sternocleidomastoid and trapezius muscles.

DR. TRACY J. PUTNAM: May I reply first to Dr. Riley's question? Section of the accessory nerve within the skull does not always paralyze the sternocleidomastoid and trapezius muscles, and I therefore often have to cut the accessory nerve in the neck, and sometimes also the posterior divisions of the fourth to the seventh cervical spinal nerves.

In reply to Dr. Davidoff's question, let me point out that the paraspinal operation accomplishes a section of posterior divisions, not of posterior roots. As far as I am aware, division of posterior roots is without effect on torticollis and other dystonias, and motor divisions must be sectioned. I hesitate to divide the complete roots, of course, because this would involve the brachial plexus, but the posterior divisions of the anterior and posterior roots outside the cord can be divided apparently with impunity and still leave very good function of the muscles of the neck.

**Factors Causing Mass Spasms After Transection in the Cord in Man:
A Reexamination. DR. JOHN E. SCARFF and DR. J. LAURENCE POOL
(by invitation).**

Clinical studies showed great variation in both the segmental and the mass reflex activity of the distal segments of the spinal cord after its transection in man. No relation appeared to exist between the level of the transection and the presence or absence of spasms; and in the cases of spasm there was no constant time interval between transection and the appearance of spasms.

These considerations made it appear that the occurrence of mass spasms following transection of the cord could not be satisfactorily explained solely on the basis of the "release" of the isolated segments from the influence of the brain.

Surgical observations revealed marked pathologic changes in and about the distal stump of the traumatically severed cord, which included, in addition to dense adhesions anchoring the stump to the dura, extensive degeneration and gliotic changes within the cord itself.

It was also shown that this portion of the cord at the site of injury had a lowered threshold for both mechanical and electrical stimuli and that nervous impulses induced within this region in response to stimuli were readily transmitted to the more distal segments by way of the dorsal columns. It was further shown that surgical procedures which alter the anatomic condition of the stump caused alteration of the reflex activity of the cord below that level, and, finally, that striking amelioration of spasms could be obtained by interrupting one of the main pathways for transmission of impulses from the stump to the lower segments.

These observations made it clear that factors operating on or within the isolated portion of the cord—especially at the level of the lesion—could play an important role in determining the occurrence, as well as the severity, of mass spasms.

The following "irritative mechanism" was accordingly suggested: Constant or oft repeated traction on the adherent stump of the distal segment, or the irritative effect of gliosis within the stump, could increase the irritability of this portion of the cord and lower its threshold for afferent stimuli. Efferent impulses arising in this hyperexcitable zone are then transmitted to the more distal segments, chiefly by the dorsal columns antidromically, and probably by the internuncial, or propriospinal, system also.

The authors fully recognized that "release" of the cord from the influence of the brain played a primary role in conditioning the isolated segments for the development of spasms. They felt, however, that the actual occurrence of spasms in any given case of transection of the cord was determined by factors operating on or within the distal isolated segments, chiefly at the site of the lesion, and primarily irritative in nature.

DISCUSSION

DR. FRED A. METTLER (by invitation): A presentation which has been as quiet as this is likely to be passed over without one's realizing its heretical implications. However, what we have listened to is almost a complete negation of the present view of spinal man. This opinion of the condition of spinal man has been almost entirely based on the views of Head and Riddoch, gained during World War I. The number of cases of verified transection of the spinal cord in man that have been available for study has been extremely small; Head and Riddoch had 5 cases, of which 3 would measure up to the standard of the cases presented tonight.

What is the present knowledge of the condition of spinal man? A condition of shock is expected to follow transection of the cord, and after this passes it is assumed (not stated by Riddoch, but it has since become the opinion) that the initial reflex to appear is the Babinski. This has been taught in the literature. I suppose you noticed that in none of the present cases did the hallux go up. There were up-going toes in 1 of the cases. It is also said that the deep reflexes return in time and that they subsequently become uniformly overactive. The term "overactive" is used in a general way, commonly without qualification as to the state of the threshold, the area of the reflexogenous zone or the amplitude, force or speed of maturation. In the cases presented, you perhaps again noticed the striking lack of overactivity of the tendon reflexes.

These circumstances might, perhaps, create an erroneous impression. If the whole group of available cases had been considered, it would have been found that in some cases the hallux went up, in some it went down and in some it did neither; that in some cases the tendon reflexes were overactive, as judged in terms of threshold (that is, the thresholds were lowered), and that in others the reflexes were almost impossible to obtain. In some of the cases, if the full data had been presented, you would have seen that there was a variation from side to side in the condition of the reflexes.

It is assumed that after the state of reflex activity is reestablished in spinal man the reflex spread begins to develop. For example, if the patellar tendon is tapped, adduction on the other side occurs, and abnormal reflexes, such as the *reflexe des allongeurs* of Marie and Foix (that curious reflex in which pressure over the loins results in extension of the legs), appear. The stage is now set for the mass response. It is supposed that the mass response is an inevitable characteristic of spinal man in this stage. Nevertheless, here are a number of cases in which it did not occur.

One now has to face this array of facts. The series of cases which has been presented here is more extensive than any previous series (and I doubt whether a similar one will again become available for a long time). In all cases the patients were in good condition; in all the condition was long established, and in all cases on which these conclusions were based the presence of the transection was verified. The pieces of tissue which had been removed from the cord were quite without any conducting strands. Many of the specimens I examined myself, and there was nothing in them that could have conducted any impulses. The transections existed before the operation. In this series of cases we are unable to establish any constant picture. It is obvious that if one were so naive as to construct a diagnosis on a particular reflex one would get into trouble in a series like this. In addition, the general picture is not one of certain and inevitable release so far as the reflexes are concerned, nor is it consistent with the idea that massive spasm always develops.

Why massive spasm develops and why it is absent in some cases is the burden of the speakers' argument. To me, some of the other aspects of the presentation are more interesting, but the features of massive spasm would, perhaps, be more interesting to most of those here. According to the speakers, the ultimate cause of massive spasm is pathologic change in the proximal end of the distal stump. Perhaps, in viewing the spinal patient, we neurologists have

been a little too facile in our thinking about massive spasms; one is likely to recall tracts which normally exist in an acutely transected cord. But the spasms which appear usually occur at a time when many of these tracts, and all the long descending ones, have degenerated. The tracts have been cut; the axons have completely disappeared. It is therefore quite impossible that the spasm could be mediated by tracts which are descending. Therefore the only systems which may be operative in bringing the segments of the cord into the complicated functional correlation seen in massive spasm are the autonomic and the propriospinal system and the ascending tracts. These are the three possibilities. The work which the speakers have done indicates fairly conclusively that, however this integrating mechanism may be set off, the posterior funiculi are the integrating conducting mechanism *par excellence*, though perhaps not necessarily the only one. Stimulation of the posterior funiculi does not require the assumption of antidromic conduction in the full sense of the phrase, because this mechanism is provided with motor collaterals; in other words, the fasciculus gracilis (the fasciculus cuneatus is present only at higher levels) is normally provided with collaterals which connect with the ventral motor cells, whereas many of the other ascending systems do not directly establish such connections. However, the recurrence of massive spasm after the posterior funiculi have been cut would seem to indicate that other systems are available.

I should like to bring this material to your attention not merely as an incidental paper, but as a presentation of material which has been obtained out of a difficult war just fought, and which cannot possibly become available in such a correlated manner in any other way. It is a terrible price to pay for scientific knowledge, and we are required to learn all we can from such material when it becomes available to us.

DR. TRACY J. PUTNAM: Just to clarify the point, I should like to ask Dr. Scarff and Dr. Pool whether they are quite sure that the delay in the development of mass reflexes and spasms was not due to infection, for example, of the bladder. I think there can be no doubt in seeing these patients that they are in good general condition, but it is somewhat difficult to judge the incidence of minor sepsis without a specific statement.

DR. SIDNEY BERMAN: I should like to ask the authors whether curare was used in the cases with massive flexor spasm, and, if so, what effect was noted.

DR. JOHN E. SCARFF: In reply to Dr. Putnam's question, I can only say that at the time we saw the patients they were all on tidal drainage, the urinary tract was clinically clean, and the temperature within normal range. It was a practice overseas to place these patients with spinal injuries on tidal drainage very soon after they were wounded, as far forward even as the evacuation hospitals, and to carry them back while still under that treatment to the Zone of the Interior. The incidence of serious urinary sepsis in cases of spinal injury was slight in the European theater, and during our observation these patients of ours did not suffer from it.

As to the use of curare, we have not given that a fair trial; we are not prepared to express any opinion. I think it may have great possibilities.

NEW YORK NEUROLOGICAL SOCIETY

Joseph H. Globus, *President, Presiding*

Regular Meeting, March 5, 1946

Brain Tumor: Report of Two Cases. DR. BENNO SCHLESINGER (by invitation).

Two cases of brain tumor of surgically unfavorable type, yet with excellent postoperative results, were presented.

DISCUSSION

DR. E. D. FRIEDMAN: I shall confine my comments to the second case, which was observed in the neurologic service at Beth Israel Hospital.

The patient was first admitted in December 1939, with a history of tinnitus in the right ear of three years' duration, deafness in the right ear, and numbness of the right side of the face of one year's duration. The significant findings included nystagmus to the right, absence of the right corneal reflex, sensory disturbances on the right side of the face and impaired hearing on the right, with lateralization to the left in the Weber test. There were also a number of small nodules under the skin of the forearms, which had been present many years. Biopsy of one of the nodules showed a lipoma. The patient refused to undergo operation.

In November 1941 she was readmitted with similar complaints and objective findings. The fundi were normal, but examination revealed slight weakness of the right side of the face of peripheral type and an equivocal plantar response on the left. Spinal puncture revealed clear fluid, which was under an initial pressure of 150 mm. and had a total protein content of 150 mg. per hundred cubic centimeters. Other findings were without significance. Vestibular tests yielded normal responses on the left side and absence of responses on the right. Roentgenographic examination of the skull revealed an enlarged sella turcica, with thinning and rounding of the posterior clinoid processes. The petrous ridges were normal. The patient again refused to undergo operation and left the hospital, against advice.

She was readmitted on June 28, 1945, with the chief complaints of inability to walk, a tendency to fall to the right and deafness and tinnitus on the right. She was lethargic and not well oriented. She cooperated poorly and was incontinent of urine. The blood pressure readings were 180 systolic and 110 diastolic. The fundi were normal except for suspicious blurring of the left disk. The other findings were as previously enumerated. In addition, the abdominal reflexes were absent; the tendon reflexes were more active on the left side than on the right, and there were manifestations of cerebellar involvement on the right side. A Towne view of the skull now revealed thinning of the upper wall of the internal auditory meatus on the right side. Caloric tests showed absence of labyrinthine responses on the right and slight hypofunction of the vertical canals on the left. The patient was persuaded finally to accept surgical treatment. Dr. Schlesinger has already reported on his operative results.

I should like to emphasize the long history, dating back to 1936, and the absence of definite papilledema. This might be explained by the cystic nature of the lesion and by its growth backward, toward the cerebellum, rather than medially, toward the brain stem. Drainage of spinal fluid from the ventricles was therefore not interfered with. It is interesting to note that the protein of the spinal fluid was high from the beginning of her illness. This is a usual finding in cases of acoustic neuroma. It is also worth mentioning that the hypoactivity of the left labyrinth was probably an expression of pressure against the brain stem. This was not sufficient, however, to produce contrecoup phenomena, which are frequently observed in the late stages of these growths.

Encephalomalacia of the Cerebellum and Temporosphenoïd Lobe: Report of a Case. DR. T. E. BAMFORD JR.

The patient, an Italian-born housewife aged 55, had had remarkably good health until the age of 51. In August 1945, she was admitted to the Lenox Hill Hospital, complaining of pain in the left occipital and posterior parietal areas. Movements of the neck caused pain in these areas, but no nuchal rigidity was present. It was felt by the surgeon that her problem was functional, and after discharge she was referred to a psychiatrist who spoke her native language. Following his recommendation, seven electric shocks were administered. Exactly forty-eight hours after each electric shock she was suddenly nauseated and vomited food eaten during the last twelve hours. She was drowsy; her gait and station were normal, but

she showed a slight drift of the left upper extremity. Nystagmus to the left was observed. Lumbar puncture showed normal pressure; the serologic reactions were negative, and the protein measured 168 mg. and the chlorides 635 mg., per hundred cubic centimeters. One week later, during which her condition improved, there developed hyperreflexia on the left side, nystagmus to either side and drifting of the extremities to the left. No choking of the disk was observed, but because of the signs of a lesion in the posterior fossa a ventriculographic examination was made. This showed that both lateral ventricles were slightly enlarged, the left more than the right. The spinal fluid pressure was normal; the protein content was 92 mg. per hundred cubic centimeters. Seven days later she began to vomit and became drowsy. A pneumoencephalogram suggested, by excess of air over the cortex, some degree of cerebral atrophy. The signs of left hemiparesis, drifting to the left and bilateral nystagmus continued, while a Babinski sign appeared on the right side. She continued to grow worse; so it was felt that exploration was indicated. The left posterior fossa revealed a cyst in the cerebellopontile angle about the size of a small seedless grape. The diagnosis was still not clear. The patient recovered to the extent of becoming mentally clear and sitting up to comb her hair. Three days later her temperature rose rapidly to 106 F. Exploration of the operative wound revealed no infection. She died in a few hours.

Postmortem examination showed a cystic area, 4 by 4 cm., in the right inferior cerebellar lobe and one of similar size in the right temporosphenoid lobe.

Microscopically, both cysts showed lymphocytes and monocytes, perivascular collars of lymphocytes and many phagocytes containing pigment. The cerebrum was somewhat swollen. Evidence of operation was present.

The case is presented for discussion of the difficulty in explaining contralateral cerebellar signs, the possibility of electric shock as a cause of the terminal condition and the obscurity of the clocklike vomiting following each electric shock.

DISCUSSION

DR. T. K. DAVIS: Thirty years ago I think this case would have been presented as one of "pseudotumor." That shows that time flies and one's habits of thinking change. I do not want to talk about the many conditions which simulate cerebral tumor. Probably the condition that is most usually confused is thrombosing disease of the brain; the common type, in which a large vessel is thrombosed, leads to a sudden focal lesion, as is all too familiar, and it is usually easily diagnosed. The other type of cerebral thrombosis is diffuse, with slower onset, and only in a later stage does it become focal. With the acute focal thromboses headache is the prodromal symptom. With the diffuse type there is headache also, but in addition there are various hypochondriacal symptoms—changes in behavior and many features which simulate psychoneuroses. I believe that the symptoms which Dr. Bamford described as appearing in his patient in the early part of 1945, and even earlier, were the prodromal symptoms of that type of thrombosing disease.

By the time the patient reached the neurologic service, the picture had changed. She showed drifting of the left hand and some ataxia and then hemiplegia of the same side. The high protein level of the spinal fluid—168 mg. per hundred cubic centimeters on one occasion and over 90 mg. on another—and the xanthochromia were permitted to outweigh the absence of papilledema and the absence of helpful signs in air studies.

Autopsy showed the necrotic areas in the right temporal region and in the right side of the cerebellum. One wonders why only the drifting and the ataxia on the opposite side were evident. Why was the side of the body on which the cerebellar lesion was present so free of signs? The second question is easier to answer than the first, for it is known that half the cerebellum can be removed surgically, or be absent as a result of agenesis, with few if any signs, and also that a slowly developing lesion produces fewer signs. One can understand, therefore, why there were no cerebellar signs on the right side. Their absence on the left side probably rests on histopathologic changes which I am not in a position to demonstrate tonight.

Perhaps I should comment on whether this tumor developed as a result of injury induced by the electric shock therapy. I do not think it did, and I doubt whether any one here thinks so.

DR. J. H. GLOBUS: Was the encephalomalacia of the temporal lobe and cerebellum established as a sufficient cause of death?

DR. T. E. BAMFORD JR.: The pathologic report listed the encephalomalacia as the cause of death, and I shall not try to explain it. The real cause of death probably was the surgical maneuvering in eliminating the neoplasm.

Traumatic Hematomyelia with Unusual Features. DR. AARON BELL.

A slow-witted Negro aged 32 in 1940 received fifty-two weekly injections for syphilis, some in the arm and some in the hip. The circumstances which brought him under my care began on Nov. 5, 1945. All that day he had been lifting bags of feed onto a truck. Toward the end of the day, as he was getting off the truck, the left leg gave way. On the morning of the sixth he consulted Dr. Carl Granger, who found paralysis of the left lower extremity and had him admitted to the Huntington Hospital. On November 7 a lumbar puncture was performed; after this procedure the right lower extremity became weak, and retention in the bladder and bowel developed. He remained in the Huntington Hospital from November 6 to November 10. While he was in the hospital, a retention catheter was installed. The rectal temperature ranged from 99 to 101 F.

He was transferred to the neuropsychiatric service of Lenox Hill Hospital on November 10. His temperature on admission was 101 F., his pulse rate 85 and his respiratory rate 20. Blood pressure was 130 systolic and 76 diastolic. Results of general physical examination were not noteworthy except that they confirmed the appearance of sound strength and good nourishment. The neurologic examination showed flaccid paralysis of both lower extremities; absence of knee and ankle jerks, neutral plantar reflexes and absence of the lower abdominal reflexes, diminished vibratory perception below the left anterior superior spine and impaired joint-position sense in the toes of the left foot; a level at the sixth thoracic dermatome on the left and the tenth thoracic dermatome on the right below which pinprick and temperature were not identified, and normal tactile sensibility. There was retention of urine and feces. No tenderness over the spine was noted.

Roentgenographic examination of the thoracic and lumbar regions of the spine was reported to show a normal condition. A manometric puncture showed a free subarachnoid space and xanthochromic spinal fluid, with a white cell count of 60 and a red cell count of 655 per cubic millimeter, and a 3 plus reaction for globulin. The total protein measured 95 mg., the glucose 38 mg. and the chlorides 682 mg. per hundred cubic centimeters. Culture of the fluid was sterile. The Wassermann reaction was negative. The colloidal gold curve was 0000112220.

The Wassermann reaction of the blood was 2 plus with the alcoholic antigen and negative with the cholesterized antigen. The Kline reaction of the blood was 3 plus. The white blood cell count on admission was 9,900, with 7,470 polymorphonuclear leukocytes.

The patient was in the hospital from Nov. 10, 1945 to Jan. 11, 1946, a period of sixty-three days. Throughout this time he had a spiking septic fever, the temperature ranging from 104 or 105 to 100 or 101 F., the pulse rate from 90 to 120 and the respiratory rate from 20 to 30, except in a period in which the respiratory rate ran as high as 44 a minute and he had pneumonia. The fever did not respond to penicillin and sulfadiazine, given individually or together.

The white blood cell count ranged from 9,900 or 7,740, on his admission, to 28,000, with 88 per cent polymorphonuclear leukocytes, on November 24, and to 22,800, with 84 per cent polymorphonuclear leukocytes, on December 17. Cultures of blood taken on November 13 and 17 were sterile. A guinea pig inoculated with spinal fluid showed no evidence of tuberculosis.

Routine urinalyses showed a 1 to a 3 plus reaction for albumin, from 15 or 20 up to 30 or 70 pus cells per high power field and occasional red blood cells. A culture of the urine yielded *Aerobacter aerogenes*.

Five days after his admission incontinence of feces developed. Trophic sores appeared over the buttocks and the sacrum; these spread and persisted up to the time of his discharge.

Eight days after his admission the left knee became tender, hot and swollen, and 100 cc. of straw-colored, clear fluid was aspirated by the orthopedic surgeon. The fluid was sterile, and the Wassermann reaction was negative. After aspiration, the swelling of the knee subsided and did not recur.

Two weeks after his admission a consolidation of the base of the right lung developed, which responded to administration of penicillin and sulfadiazine. The sputum was positive for *Diplococcus pneumoniae* (101 per high power field) and *Micrococcus catarrhalis* (130 per high power field). The spiking temperature which he had had prior to the appearance of the pneumonia showed no perceptible change during the pneumonia. The respiration became more rapid.

The neurologic status had progressed in many ways, so that on December 4, twenty-four days after his admission, the neural status was as follows: The sensory level to pinprick and temperature was still at the sixth thoracic dermatome on the left side and the tenth thoracic dermatome on the right. Tactile sensibility, which had not been affected, was now lost over the left leg as far as the fourth lumbar dermatome and was diminished from the sixth thoracic to the fourth lumbar dermatome; tactile sense was also diminished on the right side below the tenth thoracic dermatome. Vibration sense was lost below the anterior superior spine bilaterally, and joint-position sense was lost below the ankles. The knee and ankle jerks were absent. The plantar reflexes were neutral; the abdominal reflexes were absent. The patient was incontinent of urine and feces. He had large decubitus sores over the sacrum and buttocks, which did not respond to treatment.

In trying to formulate the problem presented by this patient the following facts had to be harmonized: (a) a history of sudden onset during work; (b) a history of treatment for syphilis, with the Wassermann reaction of the blood still moderately positive; (c) a considerably higher sensory level on the left side than on the right; (d) a continuous septic fever, with a corresponding leukocytosis, and (e) a xanthochromic spinal fluid with an elevated total protein content and negative serologic reactions.

Syphilitic thrombosis, hematomyelia and epidural abscess were considered diagnostic possibilities. The septic fever favored the conception of walled off pus; but the absence of spontaneous pain, the disparity in the sensory levels and the absence of spinal tenderness seemed to argue against an epidural abscess. The septic fever was certainly against the possibility of syphilitic thrombosis or uncomplicated hematomyelia.

The final tentative diagnosis was traumatic hematomyelia complicated by cystitis and decubitus ulceration. The strength of this conception lay in its best agreeing with the neurologic findings, since there is no neural picture too bizarre for hematomyelia; its weakness consisted in the necessity of resorting to the cystitis, urethritis and decubitus ulcers to account for the fever.

To be certain that pus was not being overlooked in the epidural space, an operation was performed by Dr. Echlin, who encountered a fracture of the spinous process of the fourth thoracic vertebra near its base. With the evidence of the fracture, the only plausible diagnosis seemed to be traumatic hematomyelia of the spinal cord. The mechanism of the fracture is hidden, perhaps by an inadequate history.

DISCUSSION

DR. FRANCIS A. ECHLIN: I shall not attempt to discuss this case in detail but will present my observations at operation.

Laminectomy was performed on Dec. 19, 1945, approximately six weeks after the onset of symptoms. It had been decided to explore the cord in the region of the fourth thoracic vertebra, which would correspond approximately to the upper limit of the sensory segmental level. This, it will be remembered, was at the sixth thoracic dermatome on the left side.

A report of my observations follows: With the patient prone on the operating table, the spinous processes of the first, second and third thoracic vertebrae were normally prominent. This was true also of the fifth, sixth and seventh thoracic vertebrae, but the spinous process of the fourth thoracic vertebra was not prominent like the others. Nor could it be properly felt on palpation, there being a slight depression at this level, rather than the normal prominence. As soon as the incision in the skin was made and the ligaments were divided, it was evident that there was a fracture of the spinous process of the fourth thoracic vertebra. The process was freely movable in all directions, and when the ligaments had been stripped from their attachments a complete fracture through the spinous process near its base was visible. A laminectomy was now carried out on the fourth and fifth vertebrae and on the lower half of the spine and laminae of the third thoracic vertebra. No evidence of fracture of the laminae was present, and there was no compression of the spinal cord at this level. There was no evidence of an inflammatory process in the epidural space.

When the dura was opened, the spinal cord beneath the lower portion of the lamina of the fourth vertebra and under the lamina of the fifth vertebra appeared slightly yellowish. Otherwise, the cord appeared within the normal limits. The arachnoid was transparent and was not opened. A small catheter was passed freely upward and downward in the subdural space for a distance of about six vertebrae. There was, therefore, no obstruction in the spinal canal.

After operation, I again questioned the patient concerning direct trauma, but he always denied having had any. It is apparent, however, that he must have had one. Whether the fracture coincided with the onset of probable hematomyelia I am unable to say. Certainly, the level of the fracture corresponded with his upper sensory level.

I should like to ask Dr. Stookey whether he has ever seen a case of hematomyelia in which surgical intervention was of therapeutic value. By this, I refer to the question of drainage of a possible fluid hematoma by incision or aspiration between the posterior columns.

DR. BYRON STOOKEY: When I saw this patient at the Lenox Hill Hospital, I thought he had had an abscess, probably an epidural one, and made that diagnosis. A number of points here are extremely difficult to correlate with the usual conception of traumatic hematomyelia. First, this patient got off a truck and noted that the left leg was weak; the following morning he had paralysis of the left leg, and it was not until twenty-four or thirty-six hours later that he had paralysis of the opposite extremity. Up to this time there had been no disturbance of bladder function. It seems to me that this slow progression of symptoms is hardly compatible with what I know of traumatic hematomyelia. I should have expected that symptoms would develop immediately and that disturbance of bladder function would occur at the beginning; yet none of these things occurred. Furthermore, at the time Dr. Bell saw him, the patient had a disturbance of vibratory sense, which progressed for a time. At Dr. Bell's examination three or four weeks later there had been progression, so that there were considerable loss of vibratory sense and disturbance of tactile sensation. It is unusual in my experience to find such progression in cases of hematomyelia. Furthermore, the patient had a spiking fever from the very beginning, while he was still in Huntington Hospital, and this continued throughout the course of his illness. It is difficult to explain the appearance of a spiking fever before he had been catheterized, or even for a few days after catheterization. During his illness a swelling of the left knee joint developed, and 100 cc. of yellow fluid was removed. I should not know how to account for that on the basis of hematomyelia; I think it could be explained by an osteomyelitis with secondary effusion into the joint. If there were osteomyelitis, however, one would expect further spread of the osteomyelitis and evidence of the osteomyelitic process in the roentgenogram, which has not yet appeared. The evidence to warrant the diagnosis of hematomyelia is the unexplained fracture. This is an undoubted finding, and I presume that on the basis of a fracture of a spinous process at its

base one must assume direct trauma; yet the patient was unaware of any accident. He had performed the work of unloading boxes which weighed 100 pounds (45 Kg.); but this was his occupation, so that one cannot explain the fracture on the basis of unusual muscular effort. Nor have I ever known fracture of a spinous process to occur as the result of muscular effort.

The most likely diagnosis is hematomyelia, though I still accept this with reservation because there are so many points which cannot be satisfactorily explained in accordance with my experience with traumatic hematomyelia. In a case of traumatic hematomyelia I should expect the symptoms to occur at the time of the accident, and they would then regress, rather than progress.

DR. T. K. DAVIS: I cannot add anything to Dr. Bell's presentation. Dr. Stookey has pointed out the difficulties involved in the diagnosis. The patient was admitted with what might be called neurologically a picture of syringomyelia. In view of the operative observations, I think one is compelled to consider hematomyelia the proper diagnosis.

DR. PETER G. DENKER: In view of the difficulties of diagnosis in this case, I should like to recall a similar case of a boy at Bellevue Hospital. Dr. Friedman and Dr. Bell may remember this patient, who presented the clinical picture of syringomyelia on a congenitally syphilitic basis, with positive reactions of the blood and the spinal fluid. Furthermore, and this is the interesting point of similarity, while he was in the ward, a large swelling developed at the elbow, which yielded a clear serous fluid on tapping. Roentgenograms revealed a typical trophic joint. In view of the positive history of syphilis in Dr. Bell's case, it may be that the picture of hematomyelia can best be explained on this basis. Though it is true that hematomyelia can give a bizarre clinical picture, it is likewise true that syphilis of the spinal cord also presents a multiplicity of forms and that syringomyelia on a syphilitic basis has been repeatedly described in the literature. Dr. Foster Kennedy and I reported the case of this boy (Congenital Syphilitic Syringomyelia with Arthropathy of the Elbow, *J. A. M. A.* **114**:408-409 [Feb. 3] 1940).

I should like to ask Dr. Bell whether his patient was given antisymphilitic treatment after the lesion of the spinal cord presented itself.

DR. AARON BELL: He had previously been given antisymphilitic treatment.

DR. RICHARD BRICKNER: I hoped that there might be some discussion of the slow development of symptoms of hematomyelia. I recall a case which was reported at one of the conferences on Dr. Riley's service at the Neurological Institute that appeared to be one of hematomyelia. In this case the symptoms appeared over a period of forty-eight hours. Since then I have seen a similar case. It may be that now and then in hematomyelia there are progressive edema and continued seepage of blood. I raise this question because I am unaware of any accepted explanation of the phenomenon. For that matter, I am not certain that these cases of slow development have been proved beyond doubt to be cases of hematomyelia. If any one has additional information on this matter, I should like to hear it.

DR. IRA COHEN: Perhaps I can answer Dr. Echlin's question in part by reference to 2 cases, in 1 of which there was a real, and in 1 a possible, history of trauma. In the first case, there was a history of trauma, although it had probably no relation to the hematomyelia. A schoolboy fell on the steps at school and was brought into the hospital. I am sorry I cannot recall the details of the progression of the clinical picture, but there was a well defined sensory level, at which I made an exploration. The appearance of the cord was unmistakable in that it was much enlarged and a blue-black hemorrhage was shining through. I incised the cord; there was temporary improvement, but only temporary, and not very much. As I recall, the patient ended his days in Montefiore Hospital, and the hematomyelic cavity was observed to extend from the upper thoracic down well into the lumbar region. While there was a history of trauma, the hematomyelia was probably not of traumatic origin.

The second case is rather more to the point in that an iceman was struck in the lower thoracic region with a large cake of ice with immediate onset of para-

plegia and signs of bladder involvement. Just above the conus a hematomyelia was seen, an unmistakable picture on the operating table, with blue-black hemorrhage showing through. There was improvement in motor power but not in bladder function.

Value of Penicillin in Treatment of Neurosyphilis. DR. BERNHARD DATNER.

Proper evaluation of success in treatment of neurosyphilis has been a problem since Wagner-Jauregg, twenty-seven years ago, reported that malarial treatment of dementia paralytica had brought about satisfactory results in a considerable number of his patients. At that time there were no objective criteria to prove his point other than the clinical improvement which enabled the patient to regain his former social status. However, since temporary remissions were not uncommon in cases of dementia paralytica, many authorities wondered whether the disease process had been definitely arrested and asked for an extended period of observation. A few years later it became obvious that fever therapy, unlike any other form of treatment, prolonged the life span of the patient with this disease. It remained uncertain, however, whether or not the stationary clinical level would be permanently maintained. The closest clinical scrutiny failed to answer this question. It was learned that irreversible and reversible signs and symptoms exist side by side in the disease; that improvement of symptoms may be only transitory, and therefore misleading; that signs and symptoms may persist, or even become more pronounced, although the syphilitic process has been definitely arrested, and, finally, that the syphilitic infection may be very active within the central nervous system and still be asymptomatic.

In view of these difficulties, my colleagues and I turned our attention to the study of the changes in the spinal fluid accompanying the dementia paralytic process and its reversal. We instituted a parallel follow-up study of the clinical status of the patient with frequently repeated examinations of the spinal fluid and soon, as far back as 1923, became convinced that the proper evaluation of the spinal fluid syndrome would enable us to forecast with a considerable degree of accuracy the final outcome of the patient's clinical course. With due attention to all parts of the spinal fluid spectrum, we learned to differentiate between findings indicating the unabated progress of the syphilitic process and those representing the reversal and the final disappearance of the inflammatory degenerative reactions. We finally were able to establish some general rules pertinent to the management of neurosyphilis which, with rare exceptions, have been proved to be valid by most of the workers in the field.

Clinical manifestations are not always a reliable criterion of activity of the syphilitic process. The serologic reactions of the blood are also of little help. The spinal fluid syndrome gives the needed guidance provided the tests are carefully performed and rightly interpreted. The Wassermann test of the spinal fluid determines the specificity, but not the activity, of the process. The presence of more than 4 cells per cubic millimeter indicates activity. Increase of total protein may indicate activity, as may the colloidal gold curve. In cases in which treatment has been carried out, the Wassermann and colloidal gold reactions of the spinal fluid may continue positive for varying lengths of time after treatment has been successful in checking the syphilitic process. If the cell counts are normal and protein determinations show definite improvement six months after therapy is discontinued, it is most unlikely that the infectious process will again become active within the central nervous system. With the advent of penicillin and the demonstration of its remarkable efficacy in the treatment of systemic syphilis, it followed that penicillin would be used in the treatment of neurosyphilis. Again, the question arose how to evaluate the therapeutic effect of the drug, and it was generally felt that an observation period of many years would be necessary to come to a definite conclusion. We, however, having gone through the same difficulties twenty-five years ago, were confident that with the standards we had established the task would be an easier one than was assumed. We were anxious to see whether the follow-up studies of

the spinal fluid syndrome would duplicate all the data which had been observed during the era of fever therapy. Meanwhile, more refined tests, including the titration of Wassermann reagins, electrophotometric determination of the protein content of the spinal fluid and the quantitative determination of the colloidal gold reaction, have become available. All the observations we have so far made on our patients have reaffirmed our original concept that the tendency of the syphilitic process is reflected in the spinal fluid findings and can be read like a spectrum.

The six month interval between the termination of fever therapy and reexamination of the spinal fluid seems too short in the follow-up study of patients with neurosyphilis treated with penicillin. So far, we have observed a subsequent relapse in 3 patients who showed a satisfactory response to treatment as indicated by the spinal fluid syndrome at the end of six months. For this reason, it seems advisable to assume a somewhat reserved attitude toward the transitional spinal fluid spectrum if it is to be evaluated before one year has elapsed.

We have treated a few patients who failed to respond to 2,000,000 units of penicillin with larger doses and have obtained satisfactory results thereafter.

In the accompanying table, the results thus far obtained with penicillin therapy are presented. In contrast to many investigators who used penicillin in combination with other therapeutic agents, e. g., heavy metals, arsenicals or fever, or injected

*Results of Treatment with Penicillin of 112 Patients with Neurosyphilis
Followed Six Months or More*

Diagnosis	Successful	Indefinite	Failure	Total
Asymptomatic type	13	6	0	19
Meningovascular type	15	4	1	20
Tabes dorsalis	26	2	1	29
Dementia paralytica	26	2	0	28
Tabetic form of dementia paralytica.....	15	1	0	16
Total no.	95	15	2	112

it intravenously or intrathecally, we in Bellevue Hospital administered the drug exclusively by intramuscular injection. The only variations were in relation of time and dose. Some patients received a total of 2,000,000 units only, some 3,000,000 or 4,000,000 and a few even larger doses, the maximum dose so far given being 9,000,000 units. The time interval was three hours. The period of treatment lasted from nine to twenty-five days. All the patients were kept in the hospital during the entire course of treatment. The spinal fluid was examined before and after treatment, then every three months for a year and every six months thereafter. The longest period of observation was twenty months.

Only 112 patients are reported on here, although the number of treated patients exceeded 170. Only those patients who remained under observation at least six months are included in the statistical evaluation.

Forty-eight, almost one-half the patients, were under observation for more than a year. The outcome was considered indefinite when the spinal fluid syndrome showed a borderline cell count of 4 or 5 cells per cubic millimeter. However, we expect that some patients in the borderline group may finally be included with those for whom treatment was successful.

As can be seen from the table, the most favorable results were obtained with the so-called parenchymatous type of neurosyphilis. The reason for this paradoxical effect is that we gave only 2,000,000 units of penicillin in cases of asymptomatic and meningovascular syphilis. The failures, therefore, are to be attributed to the inadequate amount of penicillin, and they suggest that the amount of penicillin to be given should not depend on the clinical classification of the patient.

A few words about the effect of penicillin on the clinical manifestations of neurosyphilis: It is obvious that this question has no bearing on asymptomatic neurosyph-

ilis, since, by definition, asymptomatic neurosyphilis is syphilis of the central nervous system without signs and symptoms. Here, the spinal fluid findings are necessarily the only criterion of therapeutic success. Since asymptomatic neurosyphilis in pathoanatomic terms is meningovascular or parenchymatous neurosyphilis, we see no reason that we should change our point of view only because by chance the process has involved structures which give rise to clinical signs or symptoms. We are anxious to efface all clinical manifestations of the process. This, however, is rather a matter of luck than of the effectiveness of the therapeutic endeavor. To quote Vernes, the originator of the measurement of the serologic tests for syphilis, "We can't expect the water which put out the fire to repair the burned beams." It seems to us that the most common mistake is the failure to take into consideration that one is treating neither the signs nor the symptoms of the neurosyphilitic process, which reflects itself in the spinal fluid syndrome, but that one is trying to arrest the pathologic process, irrespective of what damage has already been done and whether it may or may not be reversible.

In summary, I may say, then, that thus far penicillin, when given in adequate doses, has proved to be at least as effective in the treatment of neurosyphilis as the combined fever and specific therapies. We still do not know what may be the optimal relationship of dose and time to obtain maximal therapeutic success.

DISCUSSION

DR. H. HOUSTON MERRITT: We are fortunate in hearing this report, for, so far as I know, Dr. Dattner is the only person who is conducting a thorough study to determine the value of penicillin alone in the treatment of neurosyphilis. Most of the reports from the literature are confused by the fact that the workers combined penicillin treatment with fever therapy or chemotherapy. Dr. Dattner's studies will show what the exact value of penicillin is. All who have had experience in treating neurosyphilis are fervently hoping that penicillin will be the answer to their problem, because the methods of treatment used in the past, although moderately successful, were, to say the least, somewhat barbarous. Neurologists are greatly indebted to Wagner-Jauregg for the introduction of fever therapy, but it is not an ideal method. If a treatment can be found which is harmless to the patient and is as successful as, or more successful than, fever therapy, a great step forward will have been made. Dr. Dattner's report is encouraging, but it is too early to say that penicillin is the answer. It will be some time before it is known how much and how often penicillin must be given. The original idea that 2,000,000 or 3,000,000 units is sufficient will probably prove to be wrong, and it may be shown that 8,000,000 to 10,000,000 units will have to be given, perhaps two or three times, before the process is completely arrested.

I should also like to emphasize Dr. Dattner's statements regarding the results that can be obtained in the treatment of neurosyphilis. It cannot be expected that the treatment will restore dead tissue in the brain or the spinal cord; all that can be hoped for is that the treatment will arrest the process and that the natural reparative processes of the body will ameliorate some of the symptoms.

DR. LEON H. CORNWALL: I can only compliment Dr. Dattner on the study that he has made and the conservative manner in which he has arrived at his conclusions. I find that Dr. Merritt has touched a sensitive spot when he states that this is the only study of the sort that is being made. I am carrying out a similar investigation, and I am certain that many others are. I have nothing to criticize in Dr. Dattner's results or the way in which they have been presented. They accord with the small experience that I have had, but my material has not as yet been intensively studied. After all, the changes reported do not differ much from those obtained with the older methods of treatment except that they are more profound and that the clinical results occur more promptly. I cannot entirely agree with Dr. Merritt that all previous treatment has been barbarous. After all, a régime of intramuscular injections every three hours is not very pleasant. I agree that penicillin therapy has definite advantages over fever therapy, which is certainly a

vigorous method, unsuitable for some patients, and not without dangers that do not obtain with penicillin. My feeling is not based on much information on the subject, but I think the time is not far off when it will be found that there are several factors in penicillin, as there are in the vitamin B complex. The future may reveal many interesting things regarding this extremely valuable preparation.

I note that Dr. Dattner has followed the newer methods used in some quarters for titrating colloidal gold, the reaction of the spinal fluid and the serologic reactions of the blood. From my observation, I have not yet been much impressed with the significance of these titrations. I think that unwarranted interpretations have been made. This opinion may be due to insufficient familiarity with the technics. I made a rather naughty remark once concerning an article that appeared several months ago regarding the significance of colloidal gold reactions. The article appeared to imply that one can make a diagnosis of dementia paralytica from the colloidal gold curve alone. My impression is that one makes this diagnosis from clinical observations and that certain laboratory findings help to confirm it. The naughty remark was that if I had been the editor and had been titling the article, I should have used the caption, "Much Ado about Nothing," and I should have made just one conclusion, "So what?" In saying that, I do not mean to imply any criticism of Dr. Dattner's observations. They have been well presented, and I find nothing with which to disagree.

DR. H. A. RILEY: Has Dr. Dattner any opinion regarding the value of combined malaria and penicillin treatment?

DR. IRVING PARDEE: Has Dr. Dattner had any untoward reactions?

DR. BERNHARD DATNER: I wish to thank Dr. Merritt for his favorable comments. Being associated with his service, I know that we agree in essential points regarding the diagnosis and treatment of neurosyphilis. I must side with him against Dr. Cornwall that the methods used before the advent of penicillin therapy were medieval in character. Although I have been working with malarial therapy from its inception, I should not hesitate for one moment to replace it with penicillin therapy. Treatment with tryparsamide must be considered also as a strenuous form of therapy, for injections must be continued a long time, sometimes for years. Treatment by injections of penicillin, even when given every three hours, compares favorably with it, because it lasts two or three weeks only. We are at present investigating the therapeutic effect of a single daily injection of 300,000 units of penicillin in beeswax and peanut oil. I am quite sure that in the near future we may obtain an equally good effect with one weekly injection of highly concentrated penicillin.

We were at the beginning equally inclined to pay little attention to the modified colloidal gold curve of Lange. However, when numerical values are given to the Wassermann reagins and the proteins, it makes it easier to show the trend of the results by comparing the relative figures for all the tests. The high sensitivity of the colloidal gold curve gives additional information about the nature of the pathologic process. Since dementia paralytica invariably shows a first zone type of curve, the finding of the same type of curve in a case of asymptomatic neurosyphilis is of serious portent. It is no wonder that a patient with asymptomatic neurosyphilis and a first zone type of colloidal gold curve proves overnight to have dementia paralytica.

We were giving penicillin in doses of 30,000 and 40,000 units every three hours.

In reply to Dr. Riley, I wish to stress again that we abstained from combining penicillin with fever in order to gain information on the pure effect of penicillin. Since we know that we shall never have therapeutic success of 100 per cent, it may well be advisable to combine fever with penicillin in treatment of the patient with the refractory condition.

We had only one allergic reaction, which forced us to discontinue treatment of a patient with syphilitic myelitis and disturbances of bladder control. Urticaria, fever and general malaise developed. Otherwise, we had no untoward response.

Myelination of the Central Nervous System of *Natrix sipedon*. DR. FRANCIS JAMES WARNER, Chicago (by invitation).

Myelination occurs first in the cervical region of the spinal cord of *Natrix sipedon*. The medial longitudinal bundle and the lateral vestibulospinal tract are the first tracts to become medullated at the cervical level of the spinal cord. The fasciculus cuneatus is medullated earlier than the fasciculus gracilis. The spinocerebellar and the spinomesencephalic tract are medullated in the spinal cord later than the descending tracts.

In the brain stem, the medial longitudinal bundle, the vestibular nerve and the lateral vestibulospinal tract become medullated early. The dorsal tectobulbar tracts medullate sooner than the ventral tectobulbar tract. The vestibulocerebellar and the spinocerebellar tract do not reach the cerebellum until a fairly late stage (213 mm.). The lateral lemniscus is medullated and can be traced to the inferior corpora quadrigemina at the 188 mm. stage. The cochlear root of the eighth cranial nerve medullates earlier in this snake than in the opossum or the cat (at the 163 mm. stage in *Natrix sipedon*). The optic tracts and the optic layer of the optic tectum do not become medullated until a rather late stage (238 mm.).

The fiber tracts of the spinal cord, medulla and midbrain in *Natrix sipedon* medullate in an order similar to that in the cat, as noted by Tilney and Casamajor (1924), and Langworthy (1929) and also to that of the opossum, as described by Langworthy (1928). Thus, in *Natrix sipedon*, as in marsupials and mammals, the most ancient fiber tracts phylogenetically medullate earlier than the fiber tracts of recent development.

DISCUSSION

DR. OTTO MARBURG: The excellent investigations of Dr. Warner on the snake are also of great importance for our studies of the pathways in man. The simple relations in so low an animal make it possible to recognize the rather complicated relations in man. This is easily seen with the posterior longitudinal system (medial longitudinal bundle), the connection of which with the vestibular centers is distinctly recognizable. It is surprising how well developed this system of primitive orientation in space is in snakes. On the contrary, the red nucleus and its pathways are scarcely developed, an indication of underdevelopment of the mechanisms for the orientation of the body itself. That alone is evidence for the importance of these studies.

Book Reviews

Manual of Diagnostic Psychological Testing. Volume II: Diagnostic Testing of Personality and Ideational Content. By David Rapaport and Roy Schafer. With the Collaboration of Merton Gill. Price, \$0.75. Pp. 100. New York: Josiah Macy Jr. Foundation, 1946, Review Series, Volume III, No. 1.

In volume II the authors pursue the systematic exploration of the diagnostic values of widely used psychologic tests. Under discussion are the Rorschach, the Thematic Apperception and the Word Association Test, elaborately analyzed from the point of view of their rationale as personality evaluators, their clinical application and their statistical validation as diagnostic indicators.

The clinical data were obtained from 217 psychiatric patients, schizophrenia, paranoid reactions, depressions and neuroses being represented. Organic and psychopathic personality entities were not included. As the control, a group of 54 "normal" subjects were selected from the Kansas highway patrol.

To be highly commended is the approach to the formulation of a consistent theory of personality revelation through projective technics, the general projective hypothesis being "that the person's behavior manifestations—including the least and most significant or deviant—are revealing of his personality." This discussion (covered largely in the introductory passages) should prove of interest to both the psychiatrist and the psychologist.

For the clinical psychologist, there is a wealth of specific aid in areas such as the differential diagnosis of groups and subgroups; the precise management of difficulties to be encountered with psychiatric patients; the concrete proposals for positive utilization of negative aspects of the Thematic Apperception Test, such as disguised refusal, and the revision of the Word Association Test to point up areas of conflict.

So many diverse psychologic types have been included under the general classification of schizophrenic disorders that the authors' suggestion of differentiation into a hierarchy of malignancy with reference to findings in psychologic tests is particularly welcome.

After an introductory passage, lauding the simplicity and ease of Rorschach's original scoring, it is difficult to accept the many complex elaborations and refinements then offered by the authors. In view of the already existing variations in scoring, the burden of proof for further changes must fall heavily on the new advocates. While one may be in full accord with the statement that "the Rorschach is the most potent psychological test extant," it is refreshing to find an evaluation of the limitations of this technic (as with paranoid conditions), with positive recommendations for overcoming such lacks through a supplementary battery.

Although the statistical validation is still on an insecure foundation, the wealth of empiric experience and observation is impressive and provocative. This book is highly recommended.

Introduction to Clinical Neurology. By Gordon Holmes, M.D., F.R.S. Price, \$4. Pp. VII, plus 183. Baltimore: Williams & Wilkins Company, 1946.

Dr. Gordon Holmes has presented in this small volume the essence of his teaching at the National Hospital for Nervous Diseases. The book is not intended to take the place of standard textbooks of neurology. Rather than present original research, a review of the literature or case reports, he offers a survey of the field suitable for medical students. It is valuable, because in a few hours' reading one gets a well proportioned discussion of the subject. Disease syndromes are not described, nor are authors and journals cited. The plan of the book is a systematic and beautifully orderly discussion of the functional anatomy and the normal and abnormal physiology of the nervous system, as well as of the clinical methods used in its study.

Dr. Holmes begins with a general discussion of the importance of nervous symptoms and signs, a very brief chapter on the major classes of nervous lesions

and a chapter on the systematic examination of the patient. Succeeding chapters are devoted to the motor systems, muscle tone and its maintenance, and involuntary movements; sensation and its examination; reflexes; vision and ocular movements; postural reactions and the vestibular system; speech, agnosia and apraxia; excretory and autonomic regulation, and the patient's mental state. Each section describes the normal function, the nature of its disorders, with their signs and symptoms, and the tests used in detection of these.

Like many British medical works, this book is particularly well written. Far more detailed information is actually presented than may appear at first glance. Recent developments in such fields as electroencephalography and the study of agnosia and body image are not neglected. The chapters on complex nervous functions, such as speech and ocular movements, always difficult to present clearly, are particularly good. The author carefully prefers descriptive terms, such as "plantar reflex," to eponymous ones. No illustrations are given except a few line drawings and diagrams.

While primarily of value to the beginning student of neurology, this introduction should be examined with interest by all who care to observe the arrangement, the emphasis and the selection of material employed by this great modern neurologist in reviewing his field.

Insight and Personality Adjustment. By Therese Benedek, M.D. Price, \$4. New York: The Ronald Press Co., 1946.

"Love is the goal of human nature and, individually as well as within a nation and among nations, it can be attained only by a complex process of maturation." Dr. Benedek states this in her study of the psychologic effects of war and then proceeds to describe this maturation.

The normal development of various kinds of interpersonal relationships and their disturbance by war form the foundation on which her book is built. Freudian concepts brought up to date and modified by Dr. Benedek are used for the framework. War literature and sketchy fragments of case histories constitute the bricks of the building.

Since children, adolescents, soldiers, their wives and their parents have been affected by war, almost all personality problems created by war are within the scope of the book. Much space is devoted to the differences between masculinity and femininity and to disturbances in their development. It is implied that mature masculinity is characterized by activity, independence, dominance and mastery over the female and that dependence on, or even equality with, the female signifies immaturity or regression. However, this seems questionable, since one sign of a mature adult relationship is marriage, which is based on an acceptance of the interdependence of the sexes.

This book was written for social workers, clergymen, teachers, counselors, psychologists, physicians and psychiatrists. Because of the variety of people for whom it is written, it may seem trite to some and too technical to others. Even though it may give only partial insight, it sheds light on many personality problems created by the war.

Human Embryology. By Bradley M. Patten. Price, \$7. Pp. 776. Philadelphia: The Blakiston Company, 1946.

This new and important textbook is a valuable contribution to medical teaching. Emphasis is given to those aspects of embryology which are of importance as a background of other medical subjects. Functional aspects are well correlated with development, making for greater interest and usefulness. In the chapters dealing with each of the systems, the developmental data are oriented toward practical medicine, and each chapter ends with a discussion of the more common anomalies.

The style of writing is simple and clear; the photographs and drawings are profuse in number and excellent in quality.

This volume should be invaluable not only to medical students, but also to practitioners interested in the embryonic basis of developmental anomalies.

HEADACHE

The Teeth as a Source of Headache and Other Pain

SCHUYLER ROBERTSON, M.D.

HELEN GOODELL, B.S.

AND

HAROLD G. WOLFF, M.D.

NEW YORK

AFFERENT impulses from the teeth are carried by branches of the second and third divisions of the fifth cranial nerve. Through the apex of the tooth, nerves enter the pulp accompanying the larger vessels and form an almost complete mantle around the arteries.¹ Vascular walls in the tooth pulp are innervated by unmyelinated fibers. Nerve fibers from the tooth pulp form a complicated network between the odontoblasts and then pass into the partially calcified layer of the dentine, and sometimes into the inner margin of the calcified dentine itself² (fig. 1).

Brashear³ found that the pulp nerves in human teeth contain more than 50 per cent of unmyelinated and small myelinated nerve fibers less than 6 microns in diameter. The rest vary in size up to 10 microns. No pulp fibers were found to be more than 10 microns in diameter. He observed that thermal, mechanical or chemical stimulation of the dentine of a normal human tooth results in pain, and in no other sensation. Pfaffman⁴ observed that "painful" stimulation of the teeth gives rise only to slowly conducted potentials, presumably related to fibers of smaller diameter. On the other hand, there are nerve fibers of all sizes present in the periodontal tissues, and it is likely that other sensations, such as touch and pressure, in addition to pain, originate in these tissues.³

In the following study an attempt was made to ascertain the distribution and mechanism of headache and other pain in the face and head

From the New York Hospital and the Departments of Medicine and Psychiatry, Cornell University Medical College.

1. Berkelbach van der Sprenkel, H.: Microscopical Investigation of the Tooth and Its Surroundings, *J. Anat.* **70**:233, 1936.

2. Lewinsky, W., and Stewart, D.: The Innervation of the Dentine, *J. Anat.* **70**:349, 1936. Tiegs, O. W.: Further Remarks on the Termination of Nerves in Human Teeth, *ibid.* **72**:234, 1938.

3. Brashear, A. D.: Innervation of the Teeth, *J. Am. Dent. A.* **23**:662, 1936.

4. Pfaffman, C.: Afferent Impulses from the Teeth Due to Pressure and Noxious Stimulation, *J. Physiol.* **97**:207, 1939.

resulting from noxious impulses originating in the teeth. The effects of noxious impulses experimentally induced and of those arising from morbid processes were studied.

METHOD

Two different electrical methods were employed for inducing pain experimentally in the teeth: the one for inducing toothache well above the pain threshold,⁵ and the other for inducing pain only at the pain threshold.⁶ For inducing toothache of high intensity, the Hinsey-Geohegan stimulator was used.⁵ It employed a 60 cycle alternating current, of 110 volts, with a step-down transformer giving a voltage from 0 to 25. The bipolar electrode was insulated to the tips. The handle of the electrode was held by the subject, and its tips were placed securely against a tooth. It was found that the best sites for inducing pain in a tooth were small "pit" caries and traumatic chips in the enamel. Toothaches were induced in 6 subjects, but most of the observations were made on subjects R and G. These 2 subjects discovered defects and enamel chips in

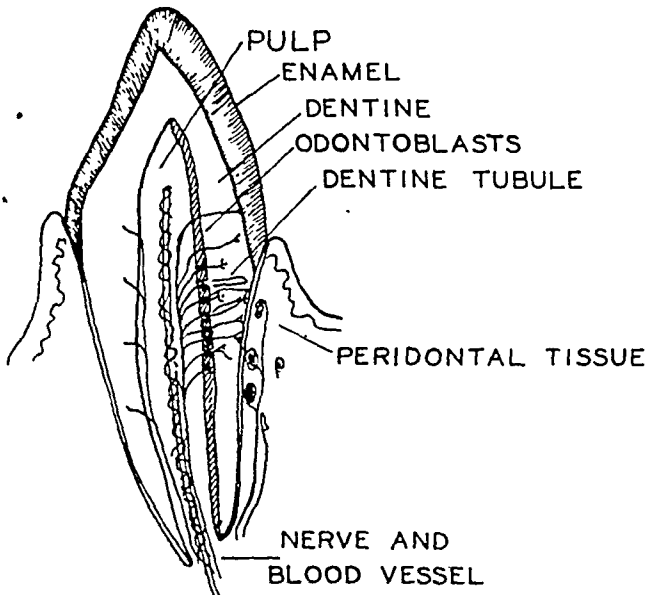

Fig. 1.—Diagram indicating the structure of a tooth and its innervation. Only pain afferent fibers occur within the tooth. Periodontal tissue contains afferent nerves for other sensory modalities.

their teeth which they allowed to remain in an unrepaired state during the period of experimentation.

Pain was estimated on an arbitrary basis of 1 to 10 plus, 10 plus being pain of extremely high intensity, or the "worst" pain the subject had ever experienced. With the subject sitting in a chair and the electrode held firmly in place, the rheostat was gradually advanced from 0 to a voltage sufficient to induce a toothache of 4 to 8 plus intensity. It was the aim to hold the toothache at this intensity for a period of ten minutes. It was observed that there was a predictability in the intensity of the experimentally induced pain arbitrarily called 4 to 8 plus and that variations in intensity of approximately 1 plus could be estimated

5. Hinsey, J. C., and Geohegan, W. A.: Unpublished data.

6. Ziskin, D. E., and Wald, A.: Observations on Electrical Pulp Testing, *J. Dent. Research* 17:79, 1938.

and remembered from day to day. This method of estimating intensity of sensation has been used in the study of "cold pain" and other types of pain.⁷

During preliminary observations it was learned that an amount of current which initially induced toothache soon ceased to induce pain when it was steadily applied. To obviate this, the voltage was gradually increased and the current momentarily interrupted every five to ten seconds. The intensity of the toothache was thus kept continually at approximately 4 to 8 plus.

The second method was used to induce pain at approximately its threshold by stimulating the tooth with a high frequency current by means of a radio frequency "vitalometer" fashioned according to the method of pulp testing devised by Ziskin and Wald.⁶ The instrument applies a potential to the surface of the tooth. Voltage is adjusted through a primary and secondary coupling, and transient peaks of current are generated with frequencies as high as 50,000 cycles per second. A single electrode is applied to the tooth, and the circuit is completed through a coupling held in the subject's hand. With such high frequencies a sensation of burning pain is elicited. The pain threshold is expressed as the smallest voltage which will just elicit this painful sensation.

GENERAL OBSERVATIONS: DESCRIPTION OF THE HEADACHE RESULTING FROM NOXIOUS STIMULATION OF THE TEETH

The headache occurring after experimentally induced toothache is illustrated in the following representative protocols.

SERIES 1.—*Noxious Stimulation of Teeth in the Upper Jaw.*—The points of the stimulating electrode were placed in a defect in the enamel of a premolar or first molar tooth in the upper jaw. Stimulation was begun with 0.5 volt of a current of 60 cycles per second. Pain of 4 to 8 plus intensity experienced locally in the tooth was induced with approximately 1 volt. In order to maintain the toothache at this intensity for a period of ten minutes, the current was broken momentarily at five to ten second intervals, and the voltage was increased gradually to 10 volts. Pain was experienced for the most part locally in the tooth. Occasionally, however, following a momentary break in the stimulating current, the subject experienced a "jab" of more intense pain, described as a "narrow column of pain which spread vertically into the eye, the orbital ridge, and the temple." With extremely intense toothache, pain occasionally spread into adjacent teeth and along the maxilla.

7. (a) Wolf, S., and Hardy, J. D.: Studies on Pain: Observations on Pain Due to Local Cooling and on Factors Involved in the "Cold Pressor" Effect, *J. Clin. Investigation* **20**:521, 1941. (b) Hardy, J. D.; Goodell, H., and Wolff, H. G.: Studies on Pain: Observations on the Hyperalgesia Associated with Referred Pain, *Am. J. Physiol.* **133**: P 316, 1941. (c) Wolff, H. G.: Some Observations on Pain, in *The Harvey Lectures, 1943-1944*, Baltimore, Williams & Wilkins Company, 1944, vol. 39, p. 39. (d) Hardy, J. D.; Wolff, H. G., and Goodell, H.: Studies on Pain: A New Method for Measuring Pain Threshold; Observations on Spatial Summation of Pain, *J. Clin. Investigation* **19**:649, 1940. (e) Hardy, J. D.; Goodell, H., and Wolff, H. G.: Studies on Pain: The Ability to Discriminate Intensities of Pain, to be published.

The period of toothache was accompanied with intense apprehension, profuse salivation, lachrimation, flushing of the face on the side of the stimulation and generalized sweating. When the stimulation of the tooth was terminated, the intense pain in the tooth decreased quickly to a pain of less than 1 plus intensity, lasting approximately two minutes. This pain was then replaced by a feeling of pressure in and around the tooth, which was described as "the sensation of a foreign body lodged between the teeth." Within a few seconds after the termination of the toothache there began a sensation of tightness about the tooth, slight numbness and a sense of fulness over the cheek, and a tight, stiff sensation in the skin and deep tissues in the temporal region, the forehead and the scalp on the same side of the head. There was stiffness on motion of the jaw, and occasionally a sense of fulness in the ear. Within five to ten minutes after all pain in the tooth was terminated, a

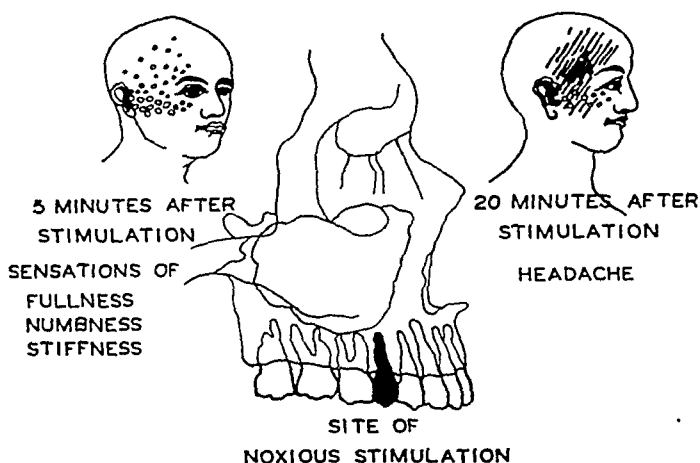

Fig. 2.—Distribution of sensations of fulness, numbness and stiffness and distribution of headache following noxious stimulation of a tooth on the right side of the upper jaw.

steady aching, diffuse pain of 1 plus intensity was experienced in the homolateral temporal region, along the zygomatic ridge and for a short distance over the eye (fig. 2). There was no throbbing component to the pain. Bending over and looking into a bright light increased its intensity. It could usually be eliminated by administration of 0.3 Gm. of acetylsalicylic acid.

The headache reached its maximum distribution and intensity of 2 plus within twenty to thirty minutes after termination of the noxious stimulation and cessation of the toothache (fig. 4). The sensations of tightness, fulness and numbness were comparatively short lived, whereas the headache persisted for from one to eight hours, and in 1 instance for twenty-four hours, gradually diminishing in intensity. During the period of most intense headache, there were photophobia and injection of the conjunctiva. In addition, the temporal muscle and overlying

tissues on the same side as the pain were tender to palpation, and skin over the painful area was hyperalgesic; i. e., pinprick was sharper and persisted longer than in other areas. Associated with the hyperalgesia was a pilomotor reaction, manifested by cutis anserina on the face and arm on the same side. The pain threshold of the hyperalgesic skin as tested by the Hardy-Wolff-Goodell apparatus was not lowered.⁸

SERIES 2.—Noxious Stimulation of Teeth in Lower Jaw.—A lower premolar or first molar tooth was stimulated in the manner previously described, maintaining a toothache of 4 to 8 plus intensity for a period of ten minutes. Throughout the period of stimulation intense aching pain was experienced locally in the tooth, and there was a less intense aching pain throughout the lower jaw, which usually extended into the anterior wall of the auditory canal. At the end of the period of stimu-

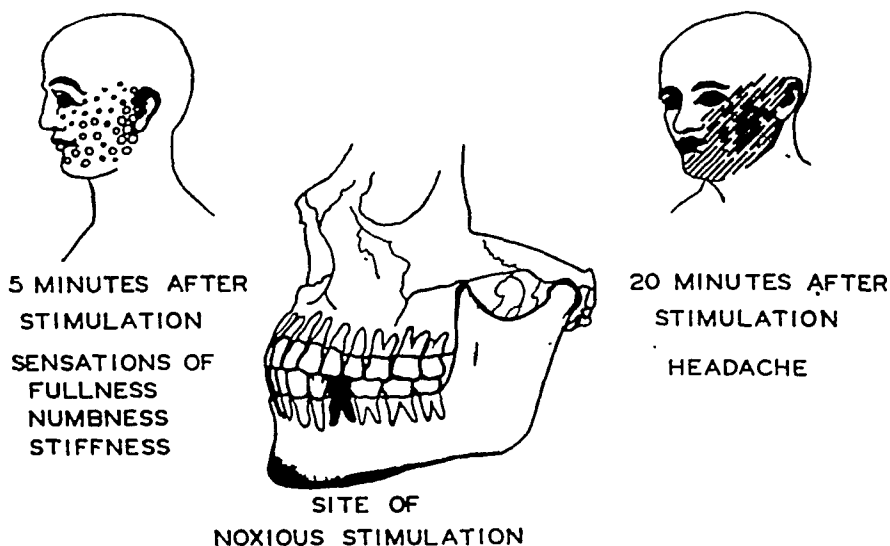

Fig. 3.—Distribution of sensations of fullness, numbness and stiffness and distribution of headache following noxious stimulation of a tooth in the left side of the lower jaw.

lation the pain of high intensity was quickly terminated, but there persisted a sensation of pressure in the tooth. Sometimes, together with the pressure, there was a dull, diffuse, aching pain of low intensity throughout the lower jaw on the side stimulated. During the ten to fifteen minutes following the end of the period of electrical stimulation there developed first a sensation of fullness and heaviness and then, in addition, pain of 2 to 3 plus intensity, which extended throughout the upper and the lower jaw into the area over the zygoma and the temple to the top of the ear. There was also a sensation of fullness and aching in the ear. This primarily "lower half" headache was increased in intensity by biting and by bending over. It persisted for periods of one to eight hours.

8. Footnote 7 a, b, c and d.

The effects of noxious stimulation of teeth in the upper and lower jaws were similar (see figure 3 for distribution of pain) with regard to the accompanying apprehension, lacrimation, salivation, flushing of the face, photophobia and generalized sweating, as well as stiffness of the masseter muscle and the quality of the pain and its response to acetylsalicylic acid.

Toothaches were induced by the method of electrical stimulation described in series 1 and 2 in thirty-two experiments on subjects R and G and in one experiment each on subjects S, W, V and B. Headache did not follow the toothache unless the latter was maintained at 4 to 8 plus intensity for a period of eight to ten minutes. The effects of the noxious stimulation were completely reversible, since no sequelae were noted.

Comment.—A review of the observations on pain in thirty-two experiments in which noxious stimulation of a tooth in the upper or the lower jaw was maintained for ten minutes justifies the following general comment.

Noxious impulses arising from one or more of the upper teeth resulted in pain which was experienced at first locally, and then diffusely, in tissues supplied by the second division of the fifth cranial nerve. Noxious impulses arising from one or more of the lower teeth also caused pain to be experienced at first locally and then widely in the tissues supplied by the third division of the fifth cranial nerve. Often, moreover, the site at which pain was felt was remote from the primary source of noxious impulses. If the noxious stimulation of the teeth was sufficiently intense and prolonged, regardless of the site of origin, the pain usually spread and was experienced also in tissues supplied by the first as well as by the second and third divisions of the fifth cranial nerve. The size of the painful area bore no close relation to the size or localization of the noxious stimulation but prolonged disturbances were more likely to give rise to distant pain than were short-lived stimulations.

Furthermore, homolateral hyperalgesia, tenderness and vasomotor reactions of tissues remote from the source of noxious impulses in the teeth, such as tenderness of the eyeball, reddening of the conjunctiva and tenderness of the temporal and auricular tissues, were common.

STUDIES ON PAIN THRESHOLD OF THE TEETH

Ivy and associates,⁹ using electrical stimulation of the teeth, found that the pain threshold of a tooth is predictable if the stimulating electrode is always placed on the same site. These workers used a filling

9. (a) Goetzl, F. R.; Burrill, D. Y., and Ivy, A. C.: A Critical Analysis of Algesimetric Methods with Suggestions for a Useful Procedure, *Quart. Bull., Northwestern Univ. M. School* 17:280, 1943. (b) Burrill, D. Y.; Goetzl, F. R., and Ivy, A. C.: The Pain Threshold Raising Effects of Amphetamine, *J. Dent. Research* 23:337, 1944.

in a tooth as a site of stimulation and were able to demonstrate a consistent elevation of the pain threshold after the administration of certain analgesics. The modification of the method of Ziskin and Wald,⁶ previously described, was utilized in this study for ascertaining the

TABLE 1.—Intensity of Stimuli Eliciting Pain by Stimulation of Teeth with a Nerve Stimulator (Hinsey-Geohegan), Using 60 Cycle Alternating Current *

Tooth	Right		Left	
	Stimulus, Volts	Effect	Stimulus, Volts	Effect
Subject H. G.				
Central incisor..... (1)	25	No pain	25	Threshold pain
Lateral incisor..... (2)	25	No pain	25	No pain
Canine..... (3)	25	No pain	3.5	Pain
First premolar..... (4)	19	Pain	25	No pain
Second premolar..... (5)	0.5	Pain	25	No pain
First molar..... (6)	15	Pain	21.5	Pain
Second molar..... (7)	2	Pain	23	Pain
Subject S. R.				
Central incisor..... (1)	9.5	Pain	25	No pain
Lateral incisor..... (2)	8	Pain	0.5	Threshold pain
Canine..... (3)	9	Pain	0.5	Threshold pain
First premolar..... (4)	13	Pain	19.5	Pain
Second premolar..... (5)	2	Pain (threshold)	13.5	Pain
First molar..... (6)	16.5	Pain (threshold)	7	Pain
Second molar..... (7)	4.5	Pain	13	Pain

* The apparent variability of the pain threshold in teeth as measured by this technic is demonstrated.

TABLE 2.—Intensity of Stimulus Eliciting Pain by Stimulating Teeth with a High Frequency "Vitalometer" *

Subject	Tooth †	Thresholds	
		Stimulus in Volts at Various Sites	Stimulus in Volts at Same Site
R.....	L 3	6.8, 8.0, 5.4	
	R 3	4.0, 6.5, 5.4, 3.8, 5.3, 5.9	
B.....	L 3	6.0, 4.2, 4.8	4.4, 4.2, 4.2
	R 4	5.3, 6.3, 7.5, 10.5, 8.2, 5.5, 14.0, 5.8	
G.....	L 4	5.7, 3.9, 6.0	
	L 4	3.8, 4.0, 3.6, 4.0
R.....	L 4	10.5, 7.5, 6.0, 4.5, 9.8	
	L 5	9.8, 6.1, 5.5	5.3, 5.8, 5.5
G.....	R 5	7.6, 5.3, 5.5	5.3, 5.5, 5.1
	L 5	3.0, 4.0, 5.0, 5.5	5.0, 5.5, 5.0
G.....	L 6	4.0, 7.5, 1.5, 6.5	

* The variability of the pain threshold at various sites in the same tooth and the relative uniformity of the pain threshold at the same site on repeated trials are demonstrated. † L 3, L 4, L 5 and L 6 indicate the canine, first premolar, second premolar and first molar on the left side of the upper jaw; similarly, R 3, R 4 and R 5 indicate corresponding teeth on the right side.

pain threshold of teeth. The effects of noxious stimulation of a tooth on its pain threshold were also studied.

Observations.—In subjects R, G and B it was observed that there was a considerable variation in the pain threshold from tooth to tooth and at various sites on a single tooth, depending on the thickness and intactness of the enamel at the site of application of the stimulating electrode (tables 1 and 2). There was also no uniformity of the pain threshold from tooth to tooth in the same subject or in corresponding teeth from

one person to another. However, the pain threshold of a single tooth, when the tip of the electrode was placed on the same spot, was uniform within a range of ± 6 per cent.¹⁰ If the electrode was moved on the tooth, variations in the pain threshold as great as 300 per cent were sometimes observed.

EFFECT OF NOXIOUS STIMULATION ON PAIN THRESHOLD OF THE
TEETH AND RELATION OF INTENSITY OF HEADACHE TO
LOWERING OF THRESHOLD

A series of observations on the pain threshold were made on three adjacent teeth in subjects R, G, B and W. The upper premolar and first two molar teeth were used. After four to six consistent threshold measurements on each tooth, the middle one of the three teeth, the first molar, was painfully stimulated for a period of ten minutes, and the toothache was maintained at 4 to 8 plus intensity, as previously described. The pain thresholds of the three teeth were again ascertained after cessation of the painful stimulation and at ten and fifteen minute intervals during the next hour.

Results.—During the period of twenty to thirty minutes after stimulation of the tooth, when the intensity of the headache in the temporal area was at its maximum, the pain threshold of the stimulated tooth, now no longer aching itself, was lowered 35 per cent below its control level (fig. 4). The pain thresholds of the adjacent, "control" teeth were not altered. The "experimental" tooth was also "painful" when cold air was sucked through the mouth or when the subject drank cold water. Two such experiments were performed on subject R, two on subject G, one on subject B and one on subject W.

Comment.—"Hyperalgesia," i. e., overreaction to pinprick, in sites remote from the zone of noxious stimulation is not associated with a lowered pain threshold.¹¹ By contrast, in the zone of noxious stimulation, the pain threshold is appreciably lowered. The aforescribed lowering of the pain threshold of a tooth following noxious stimulation is in accord with the observations of Lewis and Hess¹² and of Schumacher¹³ on the skin. It has also been demonstrated that an agent was present in the blister fluid of skin injured by heat which was capable of lowering the pain threshold in a healthy site in which the fluid was injected.¹⁴

10. Schumacher, G. A.; Goodell, H.; Hardy, J. D., and Wolff, H. G.: Uniformity of the Pain Threshold in Man, *Science* **92**:110, 1940.

11. Hardy and associates.^{7b} Hardy.^{7e}

12. Lewis, T., and Hess, W.: Pain Derived from the Skin and the Mechanism of Its Production, *Clin. Sc.* **1**:39, 1934.

13. Schumacher, G. A.: The Influence of Inflammation on the Pain Threshold of the Skin in Man, *A. Research Nerv. & Ment. Dis., Proc.* (1942) **23**:166, 1943.

14. Bigelow, N., and Goodell, H.: Unpublished observations.

These observations on lowering of the pain threshold in the teeth are also in keeping with the common experience that ordinarily non-noxious stimuli, such as cold or hot water in the mouth, can induce pain in a tooth when it is diseased. Edema, dilatation of blood vessels and cardiac systole, when there are inflammation and lowered pain threshold, also become adequate stimuli and give toothache its characteristic throbbing quality. Furthermore, it was found during high altitude flying that a diseased tooth which did not give rise to pain on the ground became painful with a drop in the barometric pressure. The authors observed that the sooner the pain starts during ascent, the more acute the inflammation in the tooth is likely to be, indicating a low pain threshold in the affected tooth.¹⁵

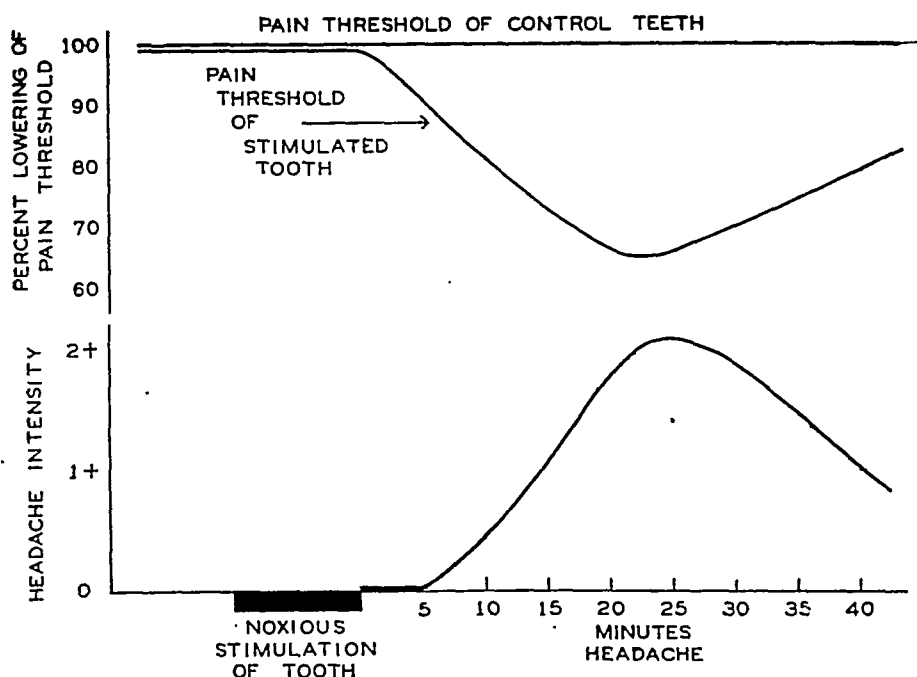

Fig. 4.—Lowering of pain threshold as measured by a "vitalometer" in a tooth which had been noxiously stimulated. The lowering of the pain threshold in the tooth was accompanied with headache on the homolateral side. The pain thresholds of the two adjacent teeth were not altered.

In short, in a tooth with a lowered pain threshold, ordinarily inadequate stimuli become noxious stimuli and give rise to pain. It is postulated that the experimental noxious stimulation of the tooth results in a local inflammatory reaction within the tooth, which outlasts the period of experimental stimulation, and perhaps also in the local liberation of a substance which lowers pain threshold. Because of the lowered pain threshold, minor tissue changes, such as vasodilatation and edema, become capable of evoking impulses which incite central spread of exci-

15. Orban, B., and Richey, B. T.: Toothache Under Conditions Simulating High Altitude Flight, *J. Am. Dent. A.* 32:145, 1945.

tatory effects. These are ultimately experienced as headache remote from the site of stimulation.^{7c}

ANALYSIS OF THE HEADACHE AND OTHER PAIN FROM BRIEF EXPERIMENTAL NOXIOUS STIMULATION OF THE TEETH

A. Effect of Injections of Procaine Hydrochloride into the Tissues in the Zone of Headache.—In three experiments on 2 subjects, R and G, 1 cc. of a 1 per cent solution of procaine hydrochloride was infiltrated intracutaneously into the site of most intense temporal headache. Within a few seconds after the injection there was analgesia of the skin in an area of approximately 4 to 6 sq. cm., and the subjects estimated that a considerable portion of headache was eliminated. The temporal muscle beneath the analgesic skin remained tender to palpation. Pain, however, continued to be experienced over the eye and in the scalp above the analgesic area; and a less intense, diffuse ache seemed

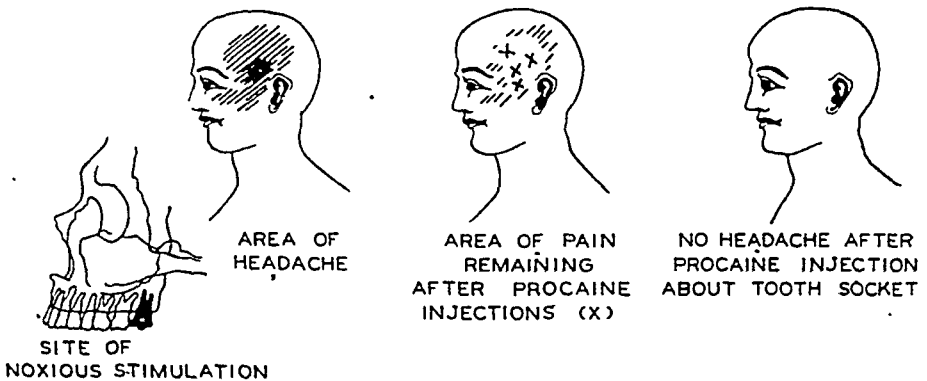

Fig. 5.—Area of headache following noxious stimulation of a tooth and the effect of injections of procaine into the painful area, as compared with the effect of injection of monocaïne into the site of noxious impulses.

to emanate from the temporal muscle underlying the analgesic area. Pain also continued to be experienced along the zygoma and over the outer corner of the eye after the intracutaneous injection of procaine into the temporal area. In subject G, the sensations of fulness and tightness in the upper jaw and of fulness in the ear also continued after elimination of pain in the temporal area. When the procaine was injected intramuscularly, as well as intracutaneously in the temporal region, both subjects experienced a diminution of pain, which again was only partial, as already described and as indicated in figure 5. As the analgesia gradually diminished, the pain returned to its earlier intensity and persisted until it spontaneously subsided or until it was eliminated by administration of acetylsalicylic acid.

B. Effect of Injection of Monocaïne Hydrochloride into the Source of Noxious Stimuli (Afferent Nerve or Tissue About the Tooth).—Local infiltration of the skin and muscle in the area of headache where

pain was most intense failed to eliminate pain and the sensations of fulness and tightness in areas adjacent to the area of analgesia. It was therefore ascertained to what extent these remaining sensations were due to noxious impulses originating in the tooth so recently the site of noxious stimulation and toothache. Therefore, in each of the subjects G and R at approximately twenty minutes after the period of noxious stimulation, when the subsequent headache had developed its maximum intensity of 2 to 3 plus, and was of maximum distribution, as previously described, the tissues around the base of the noxiously stimulated tooth were infiltrated with 1 cc. of a 1 per cent solution of monacaine hydrochloride.¹⁶ Immediately with the development of paresthesia in the gums, and even before the development of analgesia, there was complete elimination of all pain and sensations of fulness and tightness in the head remote from the site of noxious stimulation. In subject G headache returned with the return of sensation in the gums, but subject R remained free of pain.

Experiment: On August 30, for therapeutic reasons, subject R had his third left upper molar tooth extracted at 11:50 a. m. The tissues around the tooth were infiltrated with monacaine hydrochloride before the extraction, and the latter was quickly performed, without pain. One hour and twenty minutes after the extraction, however, the analgesic effect of the monacaine was ended, and he experienced a 1 plus intensity of pain and tenderness in the tooth socket. Ten minutes later there developed a headache similar in every respect to that following the experimentally induced toothache. However, it was of greater intensity and extended over a greater area over the forehead and up to the vertex, beyond its zone of maximum intensity in the temporal area (fig. 5). There were lacrimation and slight reddening of the conjunctiva on the left and erythema of the left side of the face, which extended below the jaw into the neck. The skin over the painful area, especially in the temporal area, was hyperalgesic, and pinprick in this area was accompanied with an extensive pilomotor reaction, as evidenced by cutis anserina over the left side of the neck and the left shoulder and arm.

At 1:50 p. m. the intensity of the headache was 3 plus, and there was pain of 1 plus intensity in the tooth socket. One cubic centimeter of procaine hydrochloride (1 per cent) was injected intracutaneously into the temporal region at the site of maximum intensity of pain and over the area of deep tenderness. The patient reported that the "center" of his headache was eliminated, leaving a fringe of headache of 2 plus intensity (fig. 5) and a deep diffuse ache beneath the area of surface analgesia. The pain in the tooth socket remained unchanged.

16. All the injections for periodontal infiltration in these experiments were performed by Dr. Stanley J. Behrman, of the New York Hospital Department of Dentistry.

Again, at 2:20 p. m., procaine was injected intracutaneously into two additional areas, and at 2:30 p. m., since deep ache still remained, two intramuscular injections were made fanwise into the temporal muscle, as indicated in figure 5. The subject continued to experience pain of 2 plus intensity at the periphery of the analgesic area, but he also described a diffuse ache of 1 plus intensity, which seemed to stem from the analgesic area.

At 4:00 o'clock the effects of the injected procaine had diminished, and the headache was again of 3 plus intensity. The subject reported, "This is the same headache I had following experimentally induced toothache, except that it is more persistent and of slightly greater intensity. The tooth socket is painful." At 4:10 o'clock the left middle superior alveolar nerve was blocked with monacaine hydrochloride. All the headache, including the sensations of fulness and tightness was eliminated at once, and the subject experienced no discomfort until about three hours later, when the action of the analgesic was dissipated.

Comment: The speed of elimination of the headache after blocking of the path of afferent impulses from the injured periodontal tissues of the tooth socket makes it likely that the diffuse headache experienced was caused by the noxious impulses arising from these injured tissues. These noxious impulses gave rise to excitatory processes in the brain stem which spread to exert their effects on many trigeminal structures.

C. Electromyographic Observations During Headache.—Preceding and during the headache which followed experimentally induced toothache there were sensations of fulness and tightness in the temporal region, which sometimes extended to the vertex, and tenderness of the temporal muscle on palpation. The latter often outlasted the period of headache. Also, the masseter muscle was stiff on movement of the jaw.

Electromyograms were recorded from the temporal, occipital and nuchal areas before the ten minute period of noxious stimulation of the tooth, and during and after the headache which followed, on five occasions on subjects R and G. Evidence of transient muscular contraction was noted, but sustained exaggerated muscle potential could not be recorded in these 2 subjects following this short period of painfully noxious stimulation.

ANALYSIS OF HEADACHE FROM SUSTAINED CONTRACTION OF MUSCLES OF THE FACE, HEAD AND NECK SECONDARY TO PROLONGED NOXIOUS IMPULSES ARISING FROM THE TEETH

In contrast to the effects of brief stimulation are those of prolonged periods of noxious impulses arising from the teeth in persons who experience occipital headache and pain in the face and in the side and back of the neck, associated with dental inflammation.

Observation.—A 38 year old nurse had an “excruciating” toothache and headache of 8 to 10 plus intensity of two weeks’ duration associated with osteomyelitis of the right side of the lower jaw. The headache extended from the midline of the chin along the lower jaw to the top of the right ear and into the ear, into the upper jaw, into the neck below the jaw and across the back of the head. All the lower teeth on the right ached and were tender on slight pressure. There was intense pain at the angle of the jaw, and the jaw could be opened no more than 0.5 cm. because of the contraction and extreme tenderness of the masseter muscle. A monacaine block of the mandibular nerve instantly eliminated all the pain in the face. The teeth remained tender to pressure for three to four minutes, until analgesia of the entire lower right side of the jaw was complete. Then the mouth could be opened with but

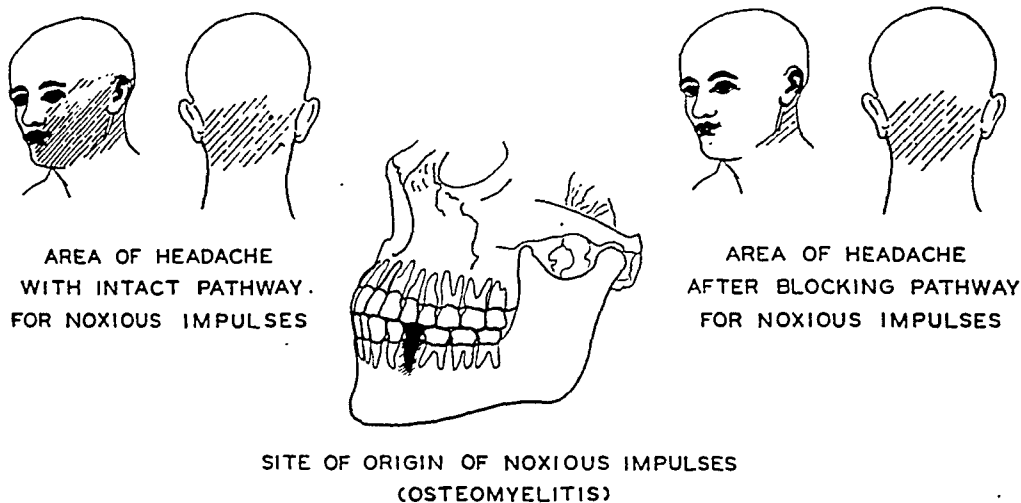

Fig. 6.—Area of distribution of headache accompanying prolonged noxious stimulation in the lower jaw (osteomyelitis), showing headache primarily due to the central spread of the effects of noxious impulses arising in the diseased tooth and headache secondarily arising from contraction of muscles in the head and neck. The former was abolished by blocking the pathway for noxious impulses, whereas the latter persisted for several hours.

slight discomfort. There remained tenderness and pain in the right side of the neck and both superficial and deep tenderness and headache over both sides of the back of the head and neck (fig. 6).

Comment.—These observations demonstrate further that the pain resulting from central spread of excitation over all sensory portions of the involved segments are immediately abolished when the primary source of noxious impulses is blocked. In addition, however, these observations show that sustained contraction of the muscles of the head and neck secondary to noxious impulses arising in any part of the head become in themselves a basis of complaint and headache.¹⁷ These

17. Simons, D. J.; Day, E.; Goodell, H., and Wolff, H. G.: Experimental Studies on Headache: Muscles of the Scalp and Neck as Sources of Pain, *A. Research Nerv. & Ment. Dis., Proc.* (1942) **23**:228, 1943.

persist for some time after elimination of the primary source of noxious impulses. Such a residual muscle pain is similar to that which occurs after the vascular components of migraine headache have been eliminated by ergotamine tartrate. In the case of the teeth, this pain from sustained muscular contraction is notably in the masseter and temporalis muscles, in addition to the muscles of the occiput and neck. Occasionally, therefore, pain from such sustained muscular contraction may be a dominant feature of the discomfort from noxious impulses arising in the teeth.

Clinical Application.—Noxious impulses arising from the teeth and associated with headache, although clinically important, are not a common cause of headache. Headache due to a diseased tooth without toothache is rare. The teeth as a cause of "neuralgia" or other facial pain do not remain obscure. Despite the suggestion that dental inflammation, impaction and exposed dentine may be hidden causes of headache and other pain, clinical experience makes it appear likely that if such conditions are the sources of noxious impulses they make themselves obvious to the patient through pain induced by thermal, mechanical or chemical stimuli. Furthermore, it is possible to ascertain whether a given diseased tooth or teeth are the source of noxious impulses and the cause of headache and other pain by answering the following question: Does procainization of the tissues about the tooth or teeth in question eliminate the headache and other pain, leaving only tenderness and ache in the muscles of the neck and the back of the head? Unless the pain in the face or head is dramatically reduced or eliminated by such measures, such a tooth, even though seriously diseased, is not the cause of the headache or "neuralgia."

Certainly, recurrent or periodic attacks of headache or pain in the face or head of years' standing with intervals of complete freedom from pain in the interims between attacks cannot have their origin in morbid dental processes. Migraine, atypical "neuralgia" or major trigeminal neuralgia never stem from dental disease.

Acetylsalicylic acid, in 0.3 to 0.6 Gm. amounts every two hours; codeine, in 60 mg. amounts, or alcohol (45 per cent, as whisky), in 30 to 60 cc. amounts, alone or in combination with acetylsalicylic acid, taken every three hours, is usually adequate to eliminate headache arising from the teeth, or to make it tolerable until suitable dental procedures can be instituted to remove the source of noxious impulses or until spontaneous regression occurs. The extraction of "suspicious" or diseased teeth for the relief of headache and other head pains is not justified unless it can be demonstrated by the procedure aforementioned that the teeth are directly responsible for the pain.

SUMMARY

By noxious stimulation of healthy and diseased teeth it was possible to analyze a variety of face and head pains which stem from the teeth.

1. The initial pain induced experimentally and felt locally in a tooth had both a burning and an aching quality. The pain secondarily experienced in the head remote from the site of stimulation had only an aching quality.

2. The pain in the head associated with a prolonged toothache, and which was experienced remote from the site of noxious stimulation in the tooth, was of two varieties: (*a*) that due to central spread of excitation and experienced in tissues supplied by the same and adjacent divisions of the fifth cranial nerve, and (*b*) that due to sustained contraction of the muscles of the head and neck resulting secondarily from noxious stimuli arising in the teeth.

3. The pain experienced remote from the site of noxious stimulation in a tooth was often reduced in intensity and in area by local injection of procaine hydrochloride at the site of most intense pain, but was not eliminated.

4. All the pain experienced remote from the site of noxious stimulation in a tooth was of a steady aching quality, and was eliminated by infiltration of monocaine hydrochloride about the primary source of noxious stimuli except that secondarily arising in the muscles of the head and neck as the result of sustained muscular contraction. This component slowly decreased, usually after several hours.

5. Following a period of spontaneous or experimentally induced noxious stimulation in a tooth, the pain threshold of the latter was appreciably lowered. Such lowering of the pain threshold was observed to begin several minutes after the period of noxious stimulation and progressed until ordinarily inadequate stimuli caused both local and remote pain.

6. Such effects of lowering of threshold were localized to the region of noxious stimulation and are comparable to the lowering of pain threshold that follows noxious stimulation of the skin by mechanical, thermal or chemical means.

New York Hospital.

CENTRAL COURSE OF AFFERENT FIBERS FOR PAIN IN FACIAL GLOSSOPHARYNGEAL AND VAGUS NERVES

Clinical Observations

ALF BRODAL, M.D.

OSLO, NORWAY

THE PROGRESS of neurosurgery in modern times not only has facilitated advances in the treatment of diseases of the nervous system but has afforded possibilities for study of many problems of anatomic and physiologic interest in man. The results of surgical interventions to a certain extent may be compared with those of experimental procedures. Especially with respect to sensibility, information of considerable value may be gained from the effects of surgical procedures in man, as many sources of error are inherent in studies of this sort in animals. The present communication is concerned with an instance of this—more precisely, the distribution within the medulla oblongata of the fibers in the facial, glossopharyngeal and vagus nerves conveying impulses of pain.

In 1938 Sjöqvist¹ published a new operative procedure for eliminating pain in the face through cutting the fibers of the bulbospinal tract (descending root) of the trigeminal nerve. Anatomic studies of the trigeminus formed the basis for the operation.

Starting with the assumption set forth by Dandy,² that the relief of facial pain following section of the inferoposterior portion of the trigeminal root at the pons is due to the fibers conducting pain being predominantly assembled in that portion, Sjöqvist undertook an analysis of the fibers in the root of the trigeminal nerve and its branches, in order to settle whether Dandy's assumption was correct and whether other anatomic conditions might explain the failure of the operation in the hands of several neurosurgeons. From correlated anatomic and physiologic studies, it is evident that the rate of conduction in nerve fibers is dependent on their caliber (Gasser and Erlanger and associates). Furthermore, it has been established, e. g., by Zotterman,³ that the different sensory impulses

From the Neurological University Clinic, Oslo (Prof. G. H. Monrad-Krohn, M.D.) and the Anatomical Institute, University of Oslo (Prof. Jan Jansen, M.D.).

1. Sjöqvist, O.: Eine neue Operationsmethode bei Trigeminusneuralgie: Durchschneidung des Tractus spinalis trigemini, *Zentralbl. f. Neurochir.* **2**:274, 1938; Studies on the Pain Conduction in the Trigeminal Nerve, *Acta psychiat. et neurol.*, 1938, supp. 17, p. 1.

2. Dandy, W. E.: An Operation for the Cure of Tic Douloureux: Partial Section of Sensory Roots at Pons, *Arch. Surg.* **18**:678 (Feb.) 1929.

3. Zotterman, Y.: Specific Action Potentials in the Lingual Nerve of Cat, *Skandinav. Arch. f. Physiol.* **75**:105, 1936; A Note on the Relation Between Conduction Rate and Fibre Size in Mammalian Nerves, *ibid.* **77**:123, 1937.

are carried by fibers varying in thickness, the thinnest fibers being those devoted to the conduction of thermal and painful impulses. The last-mentioned observation has received confirmation from anatomic investigations. Thus, Windle⁴ concluded that "painful afferent impulses in the trigeminal nerve probably are transmitted to a large extent by small myelinated and unmyelinated nerve fibers." This is in accordance with evidence previously brought forward by Ranson⁵ in regard to the spinal nerves.

Sjöqvist, in his study of the root and the branches of the trigeminus, was unable to find any grouping or arrangement of fibers for pain and temperature in the root which could explain why a partial section of the root, as practiced by Dandy, would produce a dissociated anesthesia. Similar observations had previously been recorded by Windle.⁴ However, anatomic data are known which demonstrate that these fine myelinated and unmyelinated fibers are fibers which pass to the bulbospinal tract of the trigeminal nerve (Gerard,⁶ Windle⁷), and the idea of relieving trigeminal pain without causing loss of tactile sensibility in the face by cutting the bulbospinal tract occurred to Sjöqvist when he himself, in his studies of the fibers composing the tract, obtained confirmatory results. Approximately 90 per cent of the fibers in the tract were noted to have a diameter less than 4 microns.

Also, clinical observations, anatomically controlled, on patients with syringobulbia or with the Wallenberg syndrome, occlusion of the inferior posterior cerebellar artery, tend to show that the bulbospinal tract and its nucleus are concerned primarily with the conduction of impulses of pain and temperature, whereas tactile sensation is mediated by the principal sensory nucleus of the trigeminal nerve.⁸ Experimentally, Gerard⁶ arrived at the same conclusion after section of the spinal trigeminal tract in cats.

The operative procedure by Sjöqvist consists essentially in placing an incision in the bulbospinal tract of the trigeminal nerve immediately caudal to the lowest filaments of the vagus nerve, and a few millimeters dorsal to them, at a level corresponding approximately to the border between the middle and the caudal third of the olivary eminence. The results of the operation in 9 cases reported in his communication¹ were not satisfactory in all owing primarily to technical factors, but in all but 2 instances there resulted analgesia and thermanesthesia with preserved tactile sensibility in all, or the major part, of the area innervated by the trigeminal nerve. Similar results have been obtained by several other surgeons.⁹

4. Windle, W. F.: The Distribution and Probable Significance of Unmyelinated Nerve Fibers in the Trigeminal Nerve of the Cat, *J. Comp. Neurol.* **41**:453, 1926.

5. Ranson, S. W.: Unmyelinated Nerve Fibers as Conductors of Protopathic Sensation, *Brain* **38**:381, 1915.

6. Gerard, M. W.: Afferent Impulses of the Trigeminal Nerve: The Intramedullary Course of the Painful, Thermal and Tactile Impulses, *Arch. Neurol. & Psychiat.* **9**:306 (March) 1923.

7. Windle, W. F.: Non-Bifurcating Nerve Fibers of the Trigeminal Nerve, *J. Comp. Neurol.* **40**:229, 1926.

8. A survey of published cases of Wallenberg's syndrome is to be found in the paper by Gerard.⁶

Apparently, Sjöqvist and the other authors who have practiced intramedullary tractotomy did not investigate whether the operation was followed by a similar loss of sensation in the areas of the skin and mucous membranes supplied by cranial nerves other than the trigeminus. This, however, is a point of considerable interest, for two reasons. Primarily, an investigation of this topic might give information concerning the central course of the fibers conveying impulses of pain in the facial, glossopharyngeal and vagus nerves in man. Do these fibers join the corresponding fibers from the trigeminus, partaking in the formation of the bulbospinal tract, as there is reason to believe from the phylogenetic point of view? Second, the solution of this question is of some practical relevance, since if the fibers for pain in the nerves mentioned join those in the trigeminus neuralgias of the facial, glossopharyngeal and vagus nerves may also be treated by tractotomy.

The observations on 4 patients who were subjected to intramedullary tractotomy will be reported from this point of view. The operations were performed by Dr. Arne Torkildsen, head surgeon at the neurosurgical section of the Neurological University Clinic in Oslo. It may be briefly stated that in all cases analgesia with preserved tactile sensibility appeared in the trigeminal area after operation, but this question is of no present concern.

Unfortunately, 2 of the patients had already been operated on when I first had the opportunity of examining them. Thus, a preoperative control on the sensibility of the regions of special interest for the present study was not obtained on these 2 patients. However, it is unlikely that there was any analgesia in these areas, as such slight sensory disturbances as were present in the trigeminal area previous to the tractotomy could clearly be accounted for by preceding, more peripheral, operative procedures. The sensibility for pain was tested by pinpricks of varying intensity. Care was taken not to put suggestive questions, e. g., by contrasuggestion.

REPORT OF CASES

CASE 1.—R. A., a stoker aged 41, besides trigeminal neuralgia had had a recurring ventricular ulcer for several years.

9. Among these may be mentioned: (a) Rowbotham, G. F.: Treatment of Pain in the Face by Intramedullary Tractotomy, *Brit. M. J.* **2**:1073, 1938; (b) Observations on the Effect of Trigeminal Denervation, *Brain* **62**:364, 1939. (c) Smyth, G. E.: The Systematization and Central Connections of the Spinal Tract and Nucleus of the Trigeminal Nerve: A Clinical and Pathological Study, *ibid.* **62**:41, 1939. (d) Grant, F. C., and Weinberger, L. M.: Experiences with Intramedullary Tractotomy: I. Relief of Facial Pain and Summary of Operative Results, *Arch. Surg.* **42**:681 (April) 1941. Owing to the war, periodicals from the last years have not been accessible.

His facial pains started in 1935, when he was 32. The pains were felt in the right side of the lower jaw, from which they spread to the upper jaw and sometimes also to the temple. They occurred in paroxysms, in the beginning lasting for only a few minutes and appearing only three to four times a day. Later they occurred more frequently, became more intense and sometimes were more continuously present. Touching the face, chewing or speaking often provoked a paroxysm of pain. Vasomotor disturbances were not present. The patient consulted several physicians and dentists, had several teeth extracted and received injections in the gingiva, with only temporary improvement. After an injection of alcohol in the second branch of the right trigeminal nerve (Dr. Torkildsen), the pain in the upper jaw was absent for a fortnight but then reappeared. On this account he was admitted to the neurosurgical section on Sept. 11, 1944, for operative treatment.

Neurologic examination on his admission revealed sensory disturbances on the right side of the face. The sensitivity to superficial stimuli was slightly diminished in the area of the first branch of the trigeminal and somewhat more decreased in the distribution of the second, and the area of the third branch was nearly

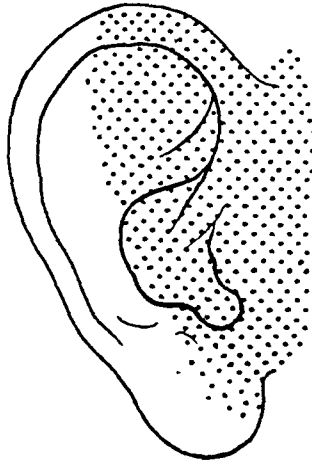

Fig. 1.—The stippled area indicates the distribution of cutaneous analgesia in the auricle in case 1, following tractotomy.

anesthetic. The corneal reflex of the right eye was slightly weakened. No signs of involvement of the motor branch of the fifth nerve were noted.

Besides these changes, there were reduction in hearing of the central, or neurogenic, type on both sides, especially the right, and a moderate increase in the proteins of the cerebrospinal fluid. Encephalographic studies with air did not give satisfactory results. No other abnormalities were revealed by neurologic, ophthalmologic and otolaryngologic examinations.

On September 14 a small suboccipital craniotomy was done and a tractotomy performed according to the method of Sjöqvist (Dr. Arne Torkildsen). The postoperative course was uneventful except for a herpetic eruption on the upper lip. Cerebellar symptoms also appeared on the right side; these, however, gradually became less conspicuous. The pains disappeared.

Postoperative examination of the sensibility of the face disclosed complete analgesia of the entire area of the trigeminal nerve on the right side of the face. The reduction of sensitivity to touch was the same as before the operation. On June 6 and Oct. 13, 1945 the patient was reexamined. On both occasions exactly similar results were obtained. The sensory changes in the face were the same as those observed during his stay in the hospital. The cutaneous area of analgesia

extended also to the auricle, where it included the entire concha practically to the anterior border of the helix (fig. 1). In the same region there was hypesthesia to cold, but the sensation of touch did not show any definite changes. There was no area of analgesia on the medial and posterior surfaces of the ear. The analgesic zone in the concha continued into the external auditory meatus, where it covered the upper, anterior and lower walls. Only in a strip along the posterior wall of the meatus was pinprick felt as painful; in the other places it was perceived as touch only. The same was true in the anterior half, approximately, of the tympanic membrane. In the mouth, there was analgesia on the right side, including the posterior third of the tongue and the soft palate, as well as the right tonsillar region and the right side of the pharynx. The corneal reflex on the right side was very weak, (+), as compared with ++ on the left side.

CASE 2.—A. H., a widow aged 53.

In 1937-1938 the patient had pulmonary tuberculosis, which since has given no symptoms.

Since January 1945 she had been troubled with facial pain, localized especially to the left side of the upper jaw. The pain, which was continuous from the begin-

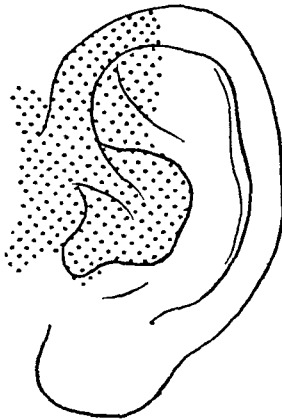

Fig. 2.—The analgesic area in the auricle in case 2.

ning, in a short time spread also to the forehead and the occiput and occurred partly in paroxysms. In April the pain became so severe that she had to use morphine. At the beginning of May injections of alcohol were given in the left supraorbital nerve and the left major occipital nerve. Transitory improvement followed the injections, but as no satisfactory result was obtained she was admitted to the neurosurgical section on May 22, 1945.

Examination on admission revealed a zone of anesthesia to all superficial sensory qualities corresponding to the distribution of the left supraorbital nerve, obviously produced by the previous injection of alcohol into this nerve. Otherwise there were no sensory changes in the face, and the corneal reflexes were alike in the two eyes. There was some tenderness at the point of exit of the left major occipital nerve. Slight edema of the left upper eyelid, appearing after the injection, was noted. Except for some indication of diplopia when the patient looked downward and to the right, no abnormalities were noted at the neurologic examination, which included encephalographic studies and examination of the cerebrospinal fluid.

On May 29 a tractotomy was performed according to the method of Sjöqvist (Dr. Arne Torkildsen). The incision in the medulla oblongata was placed approxi-

mately 2 mm. rostral to the caudal end of the fourth ventricle. Shortly after the operation, the sensibility of the face was examined. The patient did not perceive pinprick as pain, but only as touch, whereas the sensitivity to touch was preserved except in the territory of the first branch of the trigeminus.

The sensory findings were confirmed several times in the following days and likewise on June 6, when she left the hospital, and, finally, on October 22. On all occasions the findings were essentially similar. There was complete anesthesia to all sensory qualities on the left side of the face in the first division of the trigeminus, extending backward to the incision made at the subtentorial craniotomy. The corneal reflex was somewhat weakened on the left side. In the territory of the second and third divisions of the trigeminus a slight hypesthesia to superficial touch was noted, whereas the sensation of pain could not be elicited at all. Pinprick was recognized but was not painful. This analgesic area extended back to the auricle and comprised most of the concha and the anterior upper part of the anthelix, with the fossa triangularis (fig. 2). There was no area of analgesia behind the ear. The appreciation of cold was not reduced in the analgesic area in this case, but according to the patient a certain degree of hyperesthesia to cold was present in this area. The external auditory meatus was analgesic except for a narrow zone on the posterior wall, and the tympanic membrane was also analgesic with the exception of the inferoposterior quadrant. Pinpricks resulting in slight bleeding from the tympanic membrane were not perceived as painful in the other three quadrants. In the mouth there was nearly total analgesia over the left half of the tongue, including its posterior third; the left half of the hard palate and the velum palatinum; the left tonsillar region, and the left half of the pharynx. The sensation of touch was alike on the two sides in the regions mentioned.

After operation cerebellar symptoms occurred in the left extremities, but they were found to be greatly diminished at the control examination in October.

CASE 3.—A. M., a married woman aged 43.

Fourteen years before her troubles started with severe pain in the left side of the face, following a dental infection. In spite of extraction of the infected tooth in the upper jaw, maxillary sinusitis ensued. This was treated surgically; despite this, there continued to be facial pain, localized to the left cheek and the temple. The pains had been continuous and more or less intense; they lasted usually for periods of one to three months, being interrupted by intervals of four weeks or less, in which she was free of pain. She had not observed special trigger points. The pains were described as throbbing and as giving a sensation like being cut with knives.

She was admitted to the neurologic clinic for the first time on Dec. 12, 1944. Neurologic examination revealed anosmia on the left side and somewhat doubtful hypalgesia in the area of the second branch of the trigeminal nerve on the left side. Otherwise the findings were normal. Roentgenographic examination of the head with the nasal sinuses and studies of the cerebrospinal fluid and the blood revealed a normal condition. A resection of the alveolar process on the upper jaw was performed. However, this did not relieve the pain, and on this account she was again admitted in May 1945. The patient was neurotic and mentally rather dull (the intelligence quotient was not determined), and as she gave the impression of exaggerating her troubles operation was postponed. However, as no improvement occurred, she was admitted for tractotomy on Oct. 10, 1945. Examination at this time revealed no change in her condition. Sensibility for pain

and touch was tested specifically in the auricle, the pharynx, the velum palatinum and the tongue and was the same on the two sides.

Tractotomy was performed on October 5 by Dr. Torkildsen. The incision was placed at the inferior end of the fourth ventricle. The sensibility of the face was determined several times during the patient's stay in the hospital and, finally, on October 22, when she left the hospital. There was nearly complete analgesia in the trigeminal area of the left side of the face with retained sensibility to touch. Pinprick was interpreted as touch but not as pain. Analgesia was present over the auricle and appeared to be complete in the concha and the adjoining regions of the antitragus and the crus helicis with the first part of the helix (fig. 3). Likewise, there was a limited area of analgesia on the medial surface of the auricle and the neighboring area of the skin covering the mastoid process. The limits of the latter area were not so sharp as in the concha. In the analgesic areas slight hypesthesia to cold appeared to be present. The external auditory meatus did not react to pain except for the posterior wall of its inner half. With

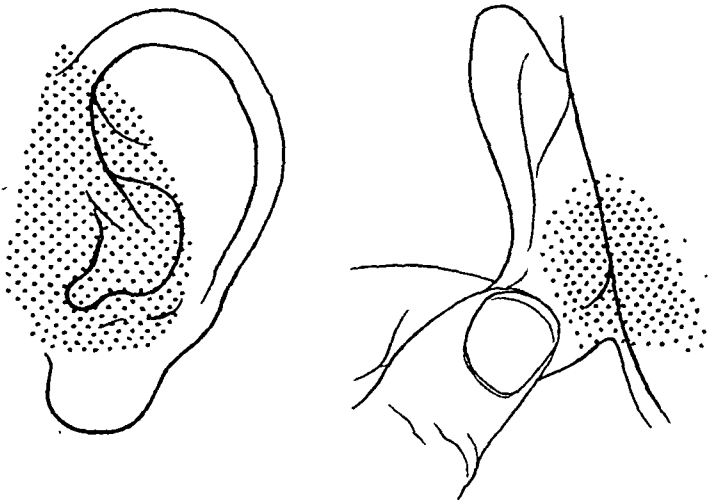

Fig. 3.—The analgesic area in the auricle and behind the ear in case 3.

respect to the tympanic membrane no definite results could be obtained, as the patient became excited during this part of the examination and probably expressed sensations of pain as soon as the membrane was touched. As previously mentioned, she was rather neurotic. With respect to the mucous membranes, the analgesia comprised the entire left half of the tongue, the inside of the cheeks, the tonsils with both palatal arches, the palate and the pharynx, all on the left side, whereas sensation of light touch was preserved. The gagging reflex appeared when the right side of the pharynx was pricked with the pin, but not when the left side was pricked.

CASE 4.—K. H., a merchant aged 46.

The patient had never had any serious illness until the trigeminal pains started, two years before admission. They were localized to the right side of the face and occurred in fits of several minutes' duration a number of times each day. The pains were felt in the right cheek, and at times in the direction of the right ear and temple, and were of a stinging, sharp nature. Chewing, changes in temperature and speaking often provoked attacks. Between the fits the patient sometimes had disagreeable sensations of a "murr" type in the right cheek. Exami-

nation of his teeth and nasal sinuses, including roentgenographic studies, revealed nothing abnormal.

There had been little change in his suffering during the two years. Some time ago he had had a series of roentgen treatments of the right side of the face, but this led to only transient improvement, of approximately two weeks. As he was partially unable to fulfil his duties, he was admitted to the service of Dr. Torkildsen, who performed a tractotomy.

On his admission, on April 25, 1946, the general and neurologic examinations revealed nothing abnormal. Especially was there no sensory change in the face, the mouth and pharynx and the ear. The corneal reflexes were equal, being $+(+)$, on the two sides. The patient was mentally alert and cooperative.

The tractotomy was performed on April 27 by Dr. Torkildsen according to the same principles as those observed with the other patients. After the operation there was complete analgesia of the entire area of the right trigeminal nerve, with possibly a faint trace of hypesthesia to touch.

On May 14 a more thorough sensory investigation showed that there was a very slight hypesthesia to touch in the right trigeminal area, as well as some

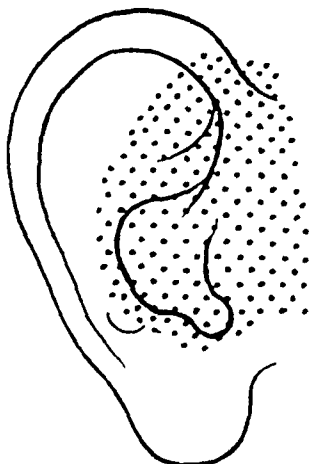

Fig. 4.—The analgesic area in the auricle in case 4.

hypesthesia to thermal stimuli, whereas the analgesia appeared to be complete. The corneal reflex was weakened on the right side, being $+$ on the right side and $+(+)$ on the left side.

The analgesic area extended also to the ear, comprising the concha and the adjacent regions (fig. 4). There was a narrow zone of hypalgesia on the border between the analgesic and the normal cutaneous territory. In the analgesic area a slight hypesthesia to cold was present. Behind the auricle no change could be detected. Examination of the external auditory meatus showed that the analgesia was limited to its anterior wall, whereas pinprick was conceived as painful on the posterior, upper and lower walls. The tympanic membrane exhibited analgesia in its anteroinferior quadrant.

The analgesic area in the oral cavity extended from the trigeminal area proper backward and comprised the right half of the tongue, the right tonsil and tonsillar arches, the right half of the soft palate and the right half of the posterior wall of the pharynx. Rather hard pricks with a sharp needle were not conceived as painful. Sensation to touch was alike on the two sides, and the gagging reflex could be elicited also from the analgesic area.

After the operation the attacks of facial pain disappeared. There were very slight signs of incoordination in the right upper extremity, somewhat more pronounced signs in the lower extremity and some unsteadiness of gait.

COMMENT

It is apparent from the reports that in only 1 of the 4 cases could the facial pain be spoken of as typical trigeminal neuralgia. However, the exact diagnosis of the disturbance is of little importance for the question of interest here. What is remarkable is the fact that in the 4 cases the analgesia following trigeminal tractotomy was not limited to the trigeminal area. In addition, analgesia occurred in the concha of the auricle (which, however, according to Cushing,¹⁰ in some instances is partly supplied by the trigeminus) and in 1 case also in a small region behind the ear; furthermore, it involved the posterior third of the tongue, the tonsillar region and the pharynx, all on the side of operation. The analgesic area continued also into the external auditory meatus, covering in 3 cases approximately the upper, anterior and posterior walls, whereas in 1 case the analgesia was limited to the anterior wall, known from Cushing's work as being supplied by the trigeminal nerve. In 1 case (case 2) the analgesic area definitely exceeded the anterior part of the tympanic membrane. In 3 cases hypesthesia to cold appeared in the concha of the auricle; in the fourth (case 2), however, there was, rather, hyperesthesia for this quality over the concha. The examination of thermal sensibility requires still more mental cooperation on the part of the patient than the study of pain. None of the 4 persons examined fulfilled the conditions necessary for an exact examination of thermal sensibility. A more detailed study of these sensory qualities, especially in the regions of the mucous membranes of difficult accessibility, was not undertaken on this account. In the following discussion, therefore, mainly the relations of the pain impulses will be taken into consideration.

The distribution of the sensory fibers of the trigeminal nerve to the skin and mucous membranes has long been known from anatomic studies. Through operative section of the sensory root of the trigeminal nerve or extirpation of the gasserian ganglion, the trigeminal area has been made accessible also to clinical studies in man. Such studies have been performed by several observers. Foremost among these investigators must be mentioned Cushing, whose excellent paper published in 1904¹⁰ has become classic, presenting, as it does, an exact mapping of the trigeminal area. It can be regarded as an established fact that the trigeminal area in the face extends so far backward as to include the tragus and most of the crus heliis, and in some instances

10. Cushing, H.: The Sensory Distribution of the Fifth Cranial Nerve, *Bull. Johns Hopkins Hosp.* 15:213, 1904.

also the first ascending part of the helix. Furthermore, as a rule, the anterior wall of the external auditory meatus is included, and probably often the anterior part of the tympanic membrane. In the mouth, the area extends as far backward as the row of the circumvallate papillae, includes the arcus glossopalatinus, except for its base, and follows the arcus to the uvula, which it covers. The distribution is entirely homolateral.

Thus, there can be no doubt that in the 4 cases reported in this paper the analgesia resulting from the section of the bulbospinal tract of the trigeminus definitely exceeds the trigeminal area proper, even if a certain allowance is made for overlap with adjoining nerves. Concerning the question as to which nerves are responsible for the additional analgesia, anatomic and clinical observations are available, although at some points there is still diversity of opinion.

Most anatomists are agreed that the glossopharyngeal nerve supplies the posterior third of the tongue not only with gustatory fibers but with fibers of general sensibility as well. Likewise, the tonsillar region and part of the pharynx are regarded as provided with fibers from this nerve. Although cutaneous sensory fibers are present in the glossopharyngeal nerve in lower vertebrates, especially in petromyzonts, plagiostomes and some of the teleosts (Ariëns Kappers, Huber and Crosby¹¹), such fibers apparently have not been definitely established in higher vertebrates. In man the sensory loss following intracranial section of the glossopharyngeal nerve has been investigated in some instances. But whereas Fay¹² in a case of that type could ascertain no sensory loss except for ageusia in the posterior third of the tongue, Reichert,¹³ in 4 cases of glossopharyngeal neuralgia with relief from pain after intracranial section of the nerve proximal to the ganglia, observed constant sensory loss on the posterior third of the tongue, the tonsil, the posterior part of the soft palate and the pharynx from the level of the eustachian tube to the epiglottis. A similar distribution was ascertained in 3 cases by Lewis and Dandy¹⁴ and in 1 case described by Doyle,¹⁵ although in

11. Ariëns Kappers, C. U.; Huber, G. C., and Crosby, E. C.: *The Comparative Anatomy of the Nervous System of Vertebrates, Including Man*, New York, The Macmillan Company, 1936.

12. Fay, T.: *Observations and Results from Intracranial Section of the Glossopharyngeus and Vagus Nerves in Man*, *J. Neurol. & Psychopath.* 8:110, 1927.

13. Reichert, F. L.: *Neuralgias of the Glossopharyngeal Nerve with Particular Reference to the Sensory, Gustatory and Secretory Functions of the Nerve*, *Arch. Neurol. & Psychiat.* 32:1030 (Nov.) 1934.

14. Lewis, D., and Dandy, W. E.: *The Course of the Nerve Fibers Transmitting Sensation of Taste*, *Arch. Surg.* 21:249 (Aug.) 1930.

15. Doyle, J. B.: *Glossopharyngeal Neuralgia*, *Arch. Neurol. & Psychiat.* 9:34 (Jan.) 1923.

this instance the pharyngeal branch of the vagus nerve was included. After all, it appears safe to conclude that the analgesia in these regions in the 4 cases reported in this paper is due to involvement of fibers of the glossopharyngeus.

More contradictory are the views concerning the sensory fibers of the nervus facialis. In 1907 Ramsay Hunt¹⁶ drew attention to the distribution of the vesicles in herpes zoster oticus to the outer surface of the auricle, especially to the concha, to a limited area behind the auricle and to the palate and anterior two thirds of the tongue. Hunt maintained that the localization of the vesicles, as well as of pain, in that form of neuralgia which he termed geniculate neuralgia demonstrated the cutaneous distribution of the fibers of the nervus intermedius. This nerve, according to Hunt, must have other functions besides conveying gustatory and secretory fibers. Although new cases of so-called geniculate neuralgia were reported repeatedly in the following years by himself and other authors, his opinions¹⁶ were violently attacked, chiefly, as it appears, because unequivocal anatomic verification of the occurrence of cutaneous fibers in the facialis-intermedius system in man was lacking. However, data from comparative anatomy do not make it unlikely that in man the facial nerve (the intermedius) may have a vestigial cutaneous component, as such is the case in lower vertebrates, e. g., plagiostomes, amphibia (Herrick,¹⁷ Norris¹⁸ and others), and in 1919 Rhinehart¹⁹ was able to demonstrate that in the mouse some fibers from the nervus intermedius are distributed to the skin of the auricle. This "ramus cutaneus facialis" joins the ramus auricularis vagi, well known to the old anatomists, and the fibers of the two nerves intermingle. In 1928 Larsell and Fenton²⁰ demonstrated in a human fetus of 54 mm. a cutaneous branch of the seventh nerve with a course and termination corresponding to that shown in the mouse by Rhinehart. Thus, it can now scarcely be doubted that also in man the nervus intermedius carries some somatic sensory fibers, ending in the concha of the auricle and having their perikarya in the geniculate ganglion.

16. Hunt, J. R.: Herpetic Inflammation of the Geniculate Ganglion: A New Syndrome and Its Complications, *J. Nerv. & Ment. Dis.* **34**:73, 1907; Geniculate Neuralgia (Neuralgia of the Nervus Facialis), *Arch. Neurol. & Psychiat.* **37**:253 (Feb.) 1937.

17. Herrick, C. J.: The Medulla Oblongata of Larval *Amblystoma*, *J. Comp. Neurol.* **24**:343, 1914.

18. Norris, H. W.: The Cranial Nerves of *Siren Lacertinus*, *J. Morphol.* **24**:245, 1913.

19. Rhinehart, D. A.: The Nervus Facialis of the Albino Mouse, *J. Comp. Neurol.* **30**:81, 1919.

20. Larsell, O., and Fenton, R. A.: The Embryology and Neurohistology of the Sphenopalatine Ganglion Connections: A Contribution to the Study of Otagia, *Laryngoscope* **38**:371, 1928.

The distribution of cutaneous fibers of the vagus (*ramus auricularis*) to the same field, and eventually also to a limited area at the dorso-medial surface of the auricle, must be regarded established. It appears that this area is provided with cutaneous fibers from both the seventh and the tenth nerve. Cushing¹⁰ observed that after section of the ventral cutaneous branches of the superior cervical nerves in man the concha of the auricle retained its normal sensibility, representing thus an area interposed between the trigeminal and the cervical cutaneous areas. Cushing was inclined to attribute the remaining sensibility in these instances to the vagus. However, it must be admitted that observations of this type do not decide the question whether the vagus or the facial nerve or both are responsible for the innervation of the cutaneous area in question. Neither do the experiments by Sherrington²¹ in the macaque, as he himself was aware, carry one beyond the fact that there is a field interposed between the trigeminal and the cervical area. The region with remaining sensibility following section of the trigeminal and the upper cervical roots, according to Sherrington, "takes in practically the whole of the concha, the antitragus, part of the tragus and part of the antihelix; also part of the fossa of the antihelix." The slightly larger extension of the area in the macaque may perhaps be accounted for by difficulties involved in determining exact limits in the experimental animal. Clinical proof that the vagus really participates in the innervation of this field requires the section of one vagus nerve, an operation which, for obvious reasons, is not frequently undertaken. However, a case of this type has been reported by Fay.¹² In his case 2 the vagus and the trigeminal nerve were sectioned on the same side, with a resulting anesthesia which, in addition to the trigeminal field, included the concha, part of the anthelix and a small area behind the ear. In his case 1, in which the fifth, ninth and upper cervical nerves were sectioned, the areas on the auricle remained intact. It may be mentioned in this connection that Clark and Taylor,²² in a case of geniculate neuralgia with section of the *pars intermedia* of the facial nerve, obtained relief from pain. Yet they could not ascertain any sensory loss in the ear three days after the operation.

Whether it is in some instances the vagus, in others the *facialis* or in still others both of them which in man provides the concha, and eventually a little more of the auricle, with cutaneous fibers, the fact of prime interest to the question treated in this communication is that

21. Sherrington, C. S.: Experiments in Examination of the Peripheral Distribution of the Fibers of the Posterior Roots of Some Spinal Nerves: II., *Phil. Tr., London*, s.B 190:45, 1898; abstracted, *Proc. Roy. Soc., London* 60:408, 1896-1897.

22. Clark, L. P., and Taylor, A. S.: True Tic Douloureux of the Sensory Filaments of the Facial Nerve, *J. A. M. A.* 53:2144 (Dec. 25) 1909.

this area is not supplied by the trigeminus. From the findings in these 4 cases in which the tractotomy of Sjöqvist was done, it is clear that the pain impulses from this area of the auricle must join those from the trigeminal field proper, traveling in the bulbospinal tract. The same holds good for the pain-conducting fibers from the posterior third of the tongue, the palatine arches, the tonsil and the pharynx. The fibers from these parts of the mucous membranes probably are conveyed by the glossopharyngeus, there being left open, however, the possibility that some of them take their route through the vagus, usually assumed to partake in the innervation of the pharynx.

The observations concerning the pain fibers to the external auditory meatus and the tympanic membrane in these cases are not wholly satisfactory. In 1 (case 3) the information was unreliable on account of the patient's mental state. In the 3 other cases, however, the areas mentioned by Cushing¹⁰ as supplied by the trigeminal nerve were analgesic. In case 4 the analgesia was limited to this area—the anterior wall of the meatus and the anterior part of the membrane—whereas in the other 2 cases the analgesic area was considerably larger, leaving only a strip on the posterior wall of the meatus and approximately the infero-posterior quadrant of the tympanic membrane with normal sensibility to pain. It is not possible on the basis of these observations to decide whether or not the larger extension is only an expression of individual variation. Considering the constant findings of Cushing, it appears likely that the wider area of analgesia in cases 1 and 2 might be due to a participation of the seventh and/or the tenth cranial nerve in the sensory supply of the external auditory meatus and the tympanic membrane.

From the phylogenetic point of view, the conclusions set forth here appear valid, in accordance with the doctrine of nerve components, i. e., that fibers conveying the same type of impulses have a tendency to pass to the same nucleus. In fact, fibers entering with the seventh, ninth and tenth cranial nerves and joining the bulbospinal tract of the trigeminal nerve (descending root of the trigeminus) have been described in several vertebrates. This is the case in cyclostomes (Jansen,²³ Woodburne²⁴). In ganoids fibers from the glossopharyngeus and the vagus can be seen to penetrate the descending root of the trigeminus and probably contribute to it (Johnston,²⁵ Woodburne²⁴). In teleosts Herrick²⁶ and Woodburne described such fibers from the

23. Jansen, J.: The Brain of *Myxine Glutinosus*, *J. Comp. Neurol.* **49**:359, 1930.

24. Woodburne, R. T.: A Phylogenetic Consideration of the Primary and Secondary Centers and Connections of the Trigeminal Complex in a Series of Vertebrates, *J. Comp. Neurol.* **65**:403, 1936.

25. Johnston, J. B.: Brain of *Acipenser*, *Zool. Jahrb. Abt. f. Anat.* **15**:59, 1901.

26. Herrick, C. J.: The Cranial and First Spinal Nerves of *Menidia*: A Contribution upon the Nerve Components of Bony Fishes, *J. Comp. Neurol.* **9**:21, 1899.

vagus. In amphibia several authors have observed fibers of this type—e. g., Norris,¹⁸ from the facial nerve; Woodburne,²⁴ from the facial and vagus nerves, and Herrick,²⁷ from the glossopharyngeal nerve as well. In reptiles, as well as in birds, Woodburne noted such fibers from the vagus. As concerns mammals (mouse and rabbit), Woodburne, who has recently undertaken an investigation of the trigeminus²⁴ from the phylogenetic standpoint, stated (page 487):

The sensory roots of the glossopharyngeal and the vagus nerves pass through the dorsal portion of the descending root and there appear to be contributions from these nerves to the root.

Obviously, human material is difficult to analyze on this point, the fibers in question constituting only a modest part of the entire root. So far as is known, direct observations on human material are lacking concerning an eventual contribution to the bulbospinal tract of the trigeminus by the facial, glossopharyngeal and vagus nerves. The observations reported in this paper form a clinicoanatomic argument in favor of the presence of such fibers. From the observations in the 4 cases reported here, nothing definite can be said concerning the exact terminal area of the seventh, ninth and tenth nerve fibers within the nucleus of the bulbospinal tract. As recently emphasized by Smyth,²⁶ the weight of evidence favors the conception that the ophthalmic fibers terminate most caudally and the mandibular fibers rostrally within the nucleus.

Another inference which can be drawn from these findings is of a practical clinical nature. Obviously, they tend to widen the range of application of the tractotomy of Sjöqvist. It is to be assumed that this operation might give satisfactory results not only in cases of trigeminal neuralgia but in those of glossopharyngeal, vagal and geniculate neuralgia. Especially in the case of geniculate neuralgia, the tractotomy appears preferable to intracranial section of the seventh nerve, the first procedure being more easily performed and having the advantage of attacking only the pain, without disturbing the other functions of the nerve and without endangering the eighth nerve. However, it must be borne in mind that the indications for performing a tractotomy are somewhat more restricted than those for section of the root, at least of the trigeminus. Furthermore, it appears that after a time a certain degree of facial dysesthesia may occur in some instances.

A problem of more anatomic interest which requires consideration on the basis of the observations reported concerns the criteria for the differentiation between somatic afferent and general visceral afferent fibers and qualities. This matter, however, will not be discussed in this connection.

27. Herrick, C. J.: The Medulla Oblongata of Necturus, *J. Comp. Neurol.* 50:1, 1930

SUMMARY AND CONCLUSIONS

In 4 cases of trigeminal neuralgia in which the tractotomy of Sjöqvist (section of the bulbospinal tract of the trigeminus) was performed the ensuing sensory loss was studied. It is shown that in addition to the analgesia with retained tactile sensibility in the trigeminal area of the face and mouth, known to follow the operation, similar sensory changes occur in other regions. These regions are the concha of the auricle, with more or less of the neighboring part of the anthelix (figs. 1 to 4), the posterior third of the tongue, the tonsils and the pharynx, all on the side of operation. In 1 case, also, a small area behind the ear was included, and in 2 cases the analgesia extended to the posterior, upper and anterior walls of the external auditory meatus. According to previous anatomic and clinical investigations, the regions mentioned are innervated by the seventh, ninth and tenth cranial nerves.

From these observations, it is concluded that the fibers conducting pain impulses in the facialis-intermedius complex, the glossopharyngeus and the vagus join the pain fibers of the trigeminus and accompany them in the bulbospinal tract of the trigeminal nerve (tractus spinalis nervi trigemini, descending root of the trigeminus).

It appears from these observations that neuralgias of the seventh nerve (geniculate neuralgia of Ramsay Hunt), as well as those of the ninth and tenth nerve, may be successfully treated by tractotomy (Sjöqvist), and thereby certain complications not infrequently met with after intracranial section of the nerves in question, especially of the facialis and vagus, avoided.

Department of Human Anatomy, University Museum, Oxford, England.

MENINGEAL REACTION WITH ABSCESS OF THE BRAIN

BERNARD J. ALPERS, M.D.
AND
FRANCIS M. FORSTER, M.D.
PHILADELPHIA

IT IS surprising that relatively little attention has been given to the meningeal reaction associated with abscess of the brain, despite the fact that the clinical diagnosis of brain abscess is often concerned with this feature of the problem. A great deal is known concerning the processes involved in the encapsulation of a brain abscess, but much less is known concerning the reaction in the meninges.

The following study was undertaken in order to determine (1) the reaction of the meninges overlying an abscess of the brain and (2) its relationship to the general problem of diagnosis of abscess and to the process of encapsulation in particular.

MATERIAL AND OBSERVATIONS

Histopathologic studies were made of the meninges in 19 cases with 42 brain abscesses. No cases of generalized purulent meningitis were included in this series. The table presents the results of the study of the meninges, together with relevant data on the patients and the cerebral abscesses. In all but 1 instance (case 18) evidence of meningitis was observed. The inflammatory changes in the meninges were focal and occurred adjacent to or in the neighborhood of the abscess. The proximity of the abscess to the meninges bore some relation to the degree of meningitis present. When the abscess approached the pial border, focal meningitis was well marked, while with the abscess at an appreciable distance from the meninges the inflammatory changes in the meninges were definite but less marked. It was not necessary, however, for the cerebral abscess to abut directly on the sulcal meninges in order to produce inflammatory changes, for an appreciable amount of normal white matter and cortex might intervene between the focal meningitis and the most external portion of the cavity of the abscess.

The focal meningitis encountered in sulci neighboring brain abscesses varied in type from acute purulent to chronic adhesive meningitis. In the acute purulent type the meninges in the sulci were increased

From the Department of Neurology, Jefferson Medical College.

Read at a meeting of the Philadelphia Neurological Society, March 22, 1946.

Clinical and Pathologic Data on a Series of Cases of Brain Abscess

Case No.	Age, Yr.	Duration of Symptoms of Abscess *	Source of Cerebral Abscess †	Cerebral Abscess		Meningeal Changes ‡		
				Location	Capsule †	In Sulci Near Abscess	Sulcal Sealing	In Distant Areas
1	50	4½ mo.	Cryptogenic	Cerebral	+++	Fibrous	++	None
2	31	7 days	Otitis media	Cerebral	—	Acute	+	Few lymphocytes
3	31	3 wk.	Otitis media	Cerebellar	—	Acute	++	None
4	43	—	Frontal sinusitis	Cerebral	+++	Acute	++	None
5	23	—	Osteomyelitis of femur	Cerebral	—	Acute	+	Few lymphocytes and phagocytes; occasional polynuclear
6	38	3 wk.	Frontal sinusitis	Cerebral	—	Acute	+	Few lymphocytes
7	57	4 days	Pulmonary empyema	Cerebellar; cerebral	—	Acute	+	None
8	34	—	Bronchiectasis	Cerebral	+	Subsiding acute	++	None
9	38	—	Cryptogenic	Cerebral	+++	Fibrous with few lymphocytes	++	Scattered lymphocytes, few
10	35	11 days	Bronchiectasis	Cerebral	++	Subsiding acute	++	None
11	39	—	Pulmonary abscess	Cerebral	+	Acute	+	None
12	36	20 days	Pulmonary abscess	Cerebral	++	Fibrous with few lymphocytes	+	None
13	14	3 wk.	Frontal sinusitis	Cerebral	—	Subsiding acute	+	Moderate lymphocytic infiltration
14	13	9 days	Tetralogy of Fallot; endocarditis	Cerebral	+++	Fibrous	+	None
15	21	—	Otitis media	Cerebellar	+++	Fibrous	++	None
16	46	7 days	Pulmonary empyema	Cerebral	++	Fibrous	+	Occasional lymphocyte
17.	44	18 days	Otitis media	Cerebral	++	Lymphocytic infiltration	+	None
18	40	7 days	Otitis media	Cerebral	++	None	0	None
19	17	34 days	Bronchiectasis	Cerebral	++	Lymphocytes and occasional polynuclear cell	+	None

* The minus sign indicates that there was no clinical evidence of cerebral abscess.

† This column presents the infectious processes observed clinically and at autopsy from which the cerebral abscess arose. Cryptogenic indicates that no source was found.

‡ The degree of encapsulation of the abscess is indicated. The minus sign indicates that there was no reparative process of any degree; the number of plus signs indicate the degree of encapsulation with fibrous and glial tissue.

§ "Acute" indicates acute inflammatory changes with polymorphonuclear cells and fibrin. "Subsiding acute" indicates the presence of some polymorphonuclear cells, well developed phagocytosis and some lymphocytic reaction. The presence of "lymphocytes" or "lymphocytic infiltration" with occasional polymorphonuclear cells was considered to represent a later transitional stage. "Fibrous" indicates dense collagenous tissue formation in the meninges, with adhesions to the cortex and a minimum number of lymphocytes. "Sulcal sealing" refers to the state of development of the limitation of inflammation to the depths of the sulci and the retention of a normal state of the meninges over the crown of the gyrus. The last column presents the presence or absence of inflammatory infiltration of the leptomeninges in sections at a distance from the abscess.

in thickness to four to five times the normal and were infiltrated with polymorphonuclear cells and with heavy depositions of fibrin. The cellular infiltration was dense, and the individual polymorphonuclear cells were well preserved. In the acute stages there was no evidence of resolution or of reparative processes. In the chronic adhesive type of meningitis the sulcal meninges were normal or slightly increased in breadth. Demarcation between the pial border and the arachnoid was impossible, and the entire expanse of the leptomeninges was dense fibrous tissue. In this type of change cellular infiltration of the meninges was slight and almost entirely lymphocytic. Only an occasional poly-

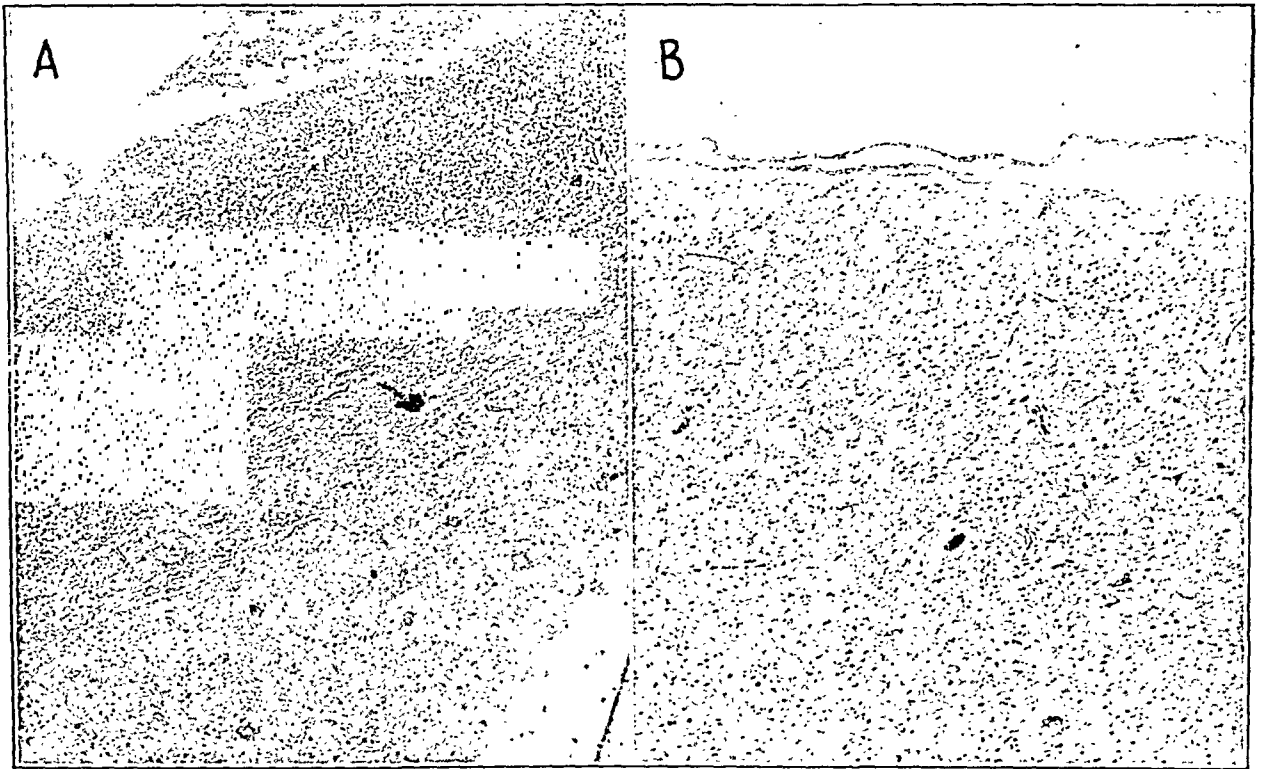

Fig. 1.—*A*, acute purulent meningitis in the vicinity of a cerebral abscess. The meninges are thickened and contain fibrin and leukocytes. *B*, normal state of the meninges over the cerebral cortex at a distance from the abscess. Hematoxylin and eosin stain; $\times 30$.

morphonuclear leukocyte or histiocytic phagocyte was encountered. Between these two extremes of acute inflammation and chronic adhesive change there existed various intermediary stages, illustrating well the reparative process within the sulcal meninges. In the cases in which the condition was described as subsiding acute meningitis, some polymorphonuclear cells were encountered; these cells were frequently in states of poorer preservation than the cells seen in the acute stage. Some fibrin and debris were present. The cellular infiltration also included a fair proportion of lymphocytes and many histiocytic phagocytes, which contained debris. Occasionally in these subsiding states a few fibro-

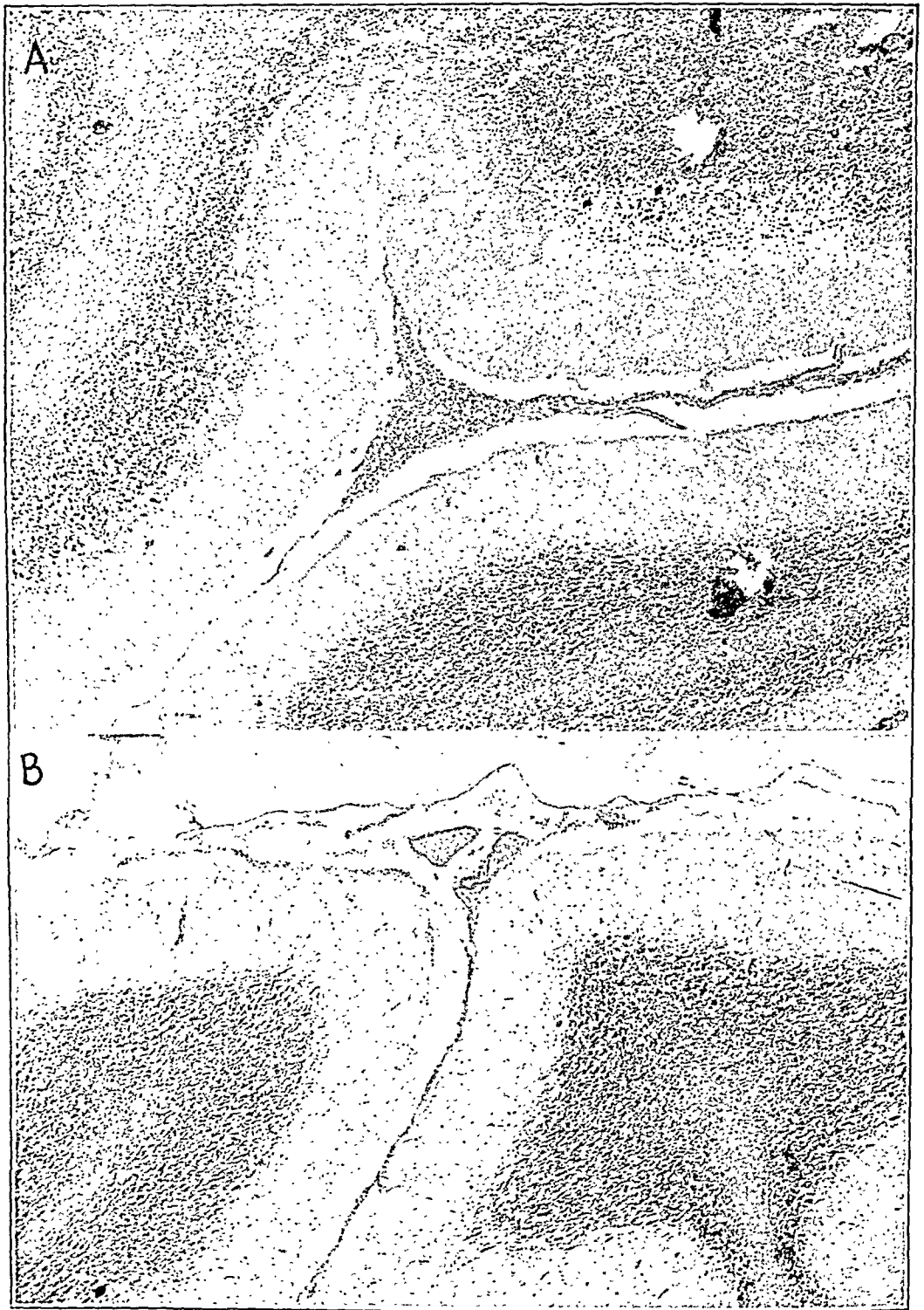

Fig. 2.—*A*, acute inflammation of the meninges in a sulcus of the cerebellum and adjacent to an abscess in the white matter. *B*, normal meninges in the sulcus and over the cerebellar folia adjacent to the folium containing the abscess. Hematoxylin and eosin; $\times 35$.

blasts could be seen in the meninges, thus evidencing the beginning of the chronic state. It was not possible from the material at hand to determine definitely the origin of the fibroblasts, i. e., whether they arose from the pia or from the adventitia of the blood vessels. The meningeal blood vessels in all stages of the meningitis were well preserved, and no cellular infiltration of the vessel walls was encountered.

The inflammatory changes in the meninges adjacent to the cerebral abscesses were in striking contrast to the state of the meninges elsewhere. In 13 cases the meninges at a distance from the abscess were free of cellular infiltration and were in all respects normal. In the remaining 6 cases a moderate number of lymphocytes were scattered through the interstices of the meninges, and in 3 of the 6 cases the cellular infiltration included a few polymorphonuclear cells. In the 6 cases with some cellular infiltration of the meninges at a distance from the abscess, the meninges were not increased in thickness and contained no fibrin or debris, and the cellular infiltration was moderate in degree and in variance to the state of the meninges adjacent to the abscess. This striking difference between the state of the meninges in the neighborhood of the cerebral abscess and over distant portions of the central nervous system indicated that a limiting process had occurred somewhere, with a resultant sealing off of the meningitis. This limitation of the spread of the meningitis takes place for the most part at the apex of the sulcus, where the meninges leave the sulcus and pass over the crown of the cerebral or the cerebellar convolution. The acute type of focal meningitis best demonstrates this limitation of the inflammation, for in this condition the sulcal meninges are greatly thickened and contain a heavy infiltration with polymorphonuclear leukocytes, deposition of fibrin and debris formation. This extends for a considerable distance along the sulcus and reaches the apex, but at the point where the meninges veer to cover the crown of the convolution the acute inflammatory changes halt abruptly, the meninges approach normal thickness, the deposition of fibrin is absent and instead of the vast number of polymorphonuclear leukocytes a few lymphocytes and an occasional polymorphonuclear leukocyte are present. While the inflammatory process in the meninges is thus prevented from spreading through the meninges over the convolutions, there is another but less definite limitation of the spread of the inflammation along the sulcal meninges. In those sections containing a long sulcus with an abscess near the center of the sectioned portion of the sulcus, the meningeal changes were more pronounced in the sulcal meninges near the abscess and less intense in each direction at a distance from the abscess. This was true of the acute, the chronic and the intermediary type of inflammation. These alterations in the degree of inflammation were not so sharply defined as those occurring at the apex of the sulci. In the depths of the sulci,

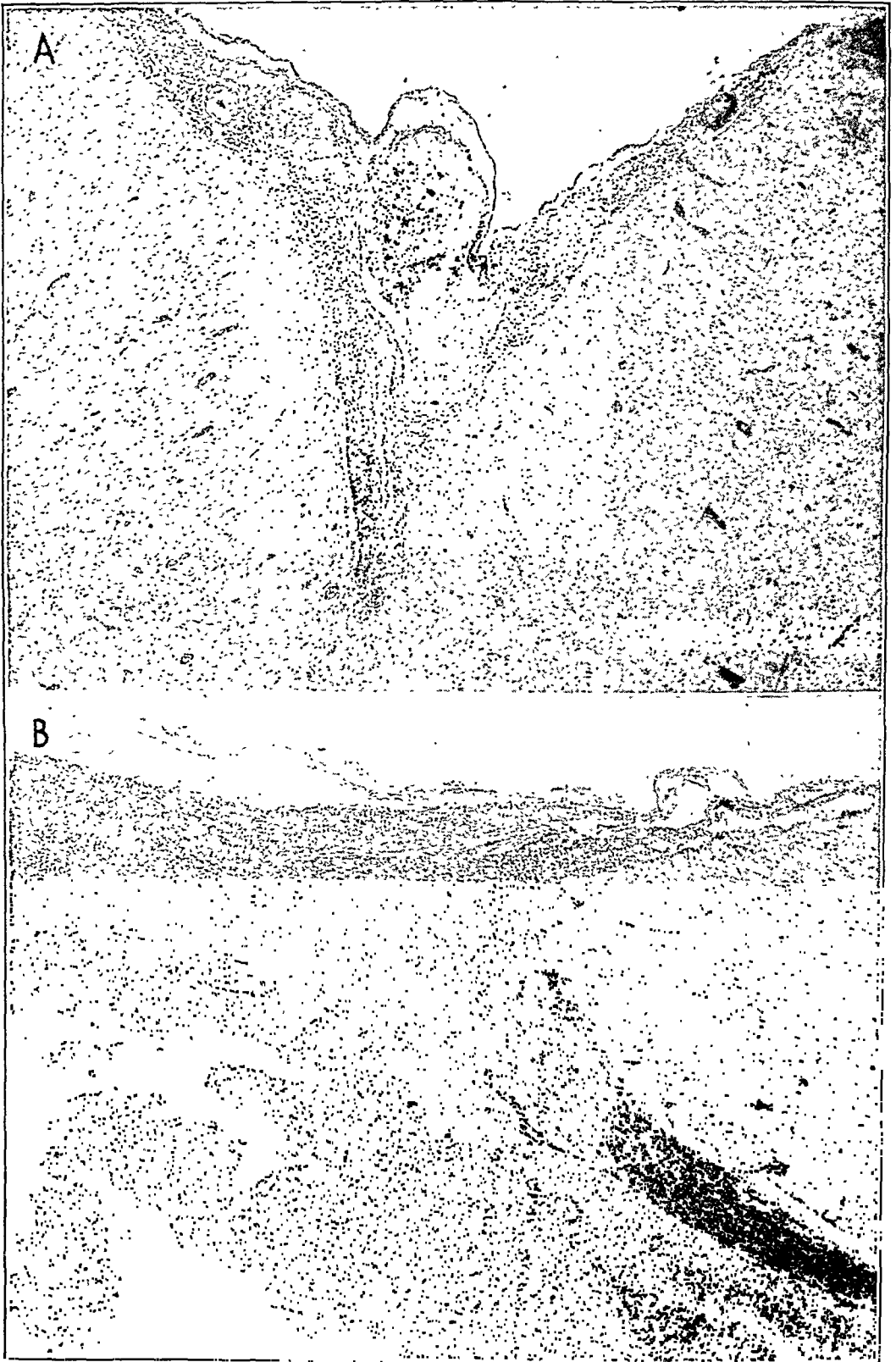

FIGURE 3

(See legend on opposite page)

when an acute inflammatory change was present it extended along the entire sulcal meninges, but in the neighborhood of the abscess the meninges were thicker, and fibrin, debris and polymorphonuclear leukocytes were more prevalent, than at a distance. No variation in the stage of meningitis in a given sulcus was encountered. A sulcus presenting acute alterations nearest the abscess showed acute changes at a distance but of less marked degree. The meningitis associated with brain abscess is restricted to a focal inflammation by the sharp limitation against spread of the process from the sulci to the meninges over the convolutional crowns and by the gradual decrease in the degree of inflammation within the sulci.

The efficacy of this protective function of the meninges can best be appreciated in those cases in which the abscess closely approximates, or even involves, the pia. In such instances (fig. 3 *B*) the meninges near the abscess presented the acute inflammatory changes, but both methods of restricting the spread of the inflammation were effective in preventing generalized meningitis.

The stage of inflammation in the meninges could be correlated rather well with the degree of encapsulation of the abscess. In the 6 cases of acute abscess with no evidence of encapsulation the meningeal changes were of the acute inflammatory type. In 1 of these instances the meningitis gave indication of subsiding, for some phagocytic activity was taking place. The well encapsulated abscesses were accompanied with chronic meningeal changes with 1 exception (case 18), in which the meningeal changes were acute. In this particular instance there were pronounced perivascular infiltrations in the white and the gray matter lying between the capsule of the abscess and the meninges. The correlation between the capsule of the abscess and the type of meningitis indicates that acute abscesses are accompanied with acute focal meningitis, that this meningitis may begin to subside before definite encapsulation occurs but that by the time well defined encapsulation occurs the meningitis has usually become chronic.

COMMENT

The localized meningeal reaction associated with brain abscess has its importance from the standpoint both of its histologic features and of its clinical significance. Relatively little attention has been given to the

Fig. 3.—*A*, limitation of inflammation to the meninges in the sulcus. The abscess lies deep in the white matter and beyond the limits of the illustration. As the meninges approach the crown of the convolution, inflammation decreases. *B*, limitation of inflammation to the meninges in the sulcus. The abscess is superficial and extends through the cerebral cortex. The degree of meningitis is greatly decreased over the crown of the adjacent convolution. Hematoxylin and eosin; $\times 35$.

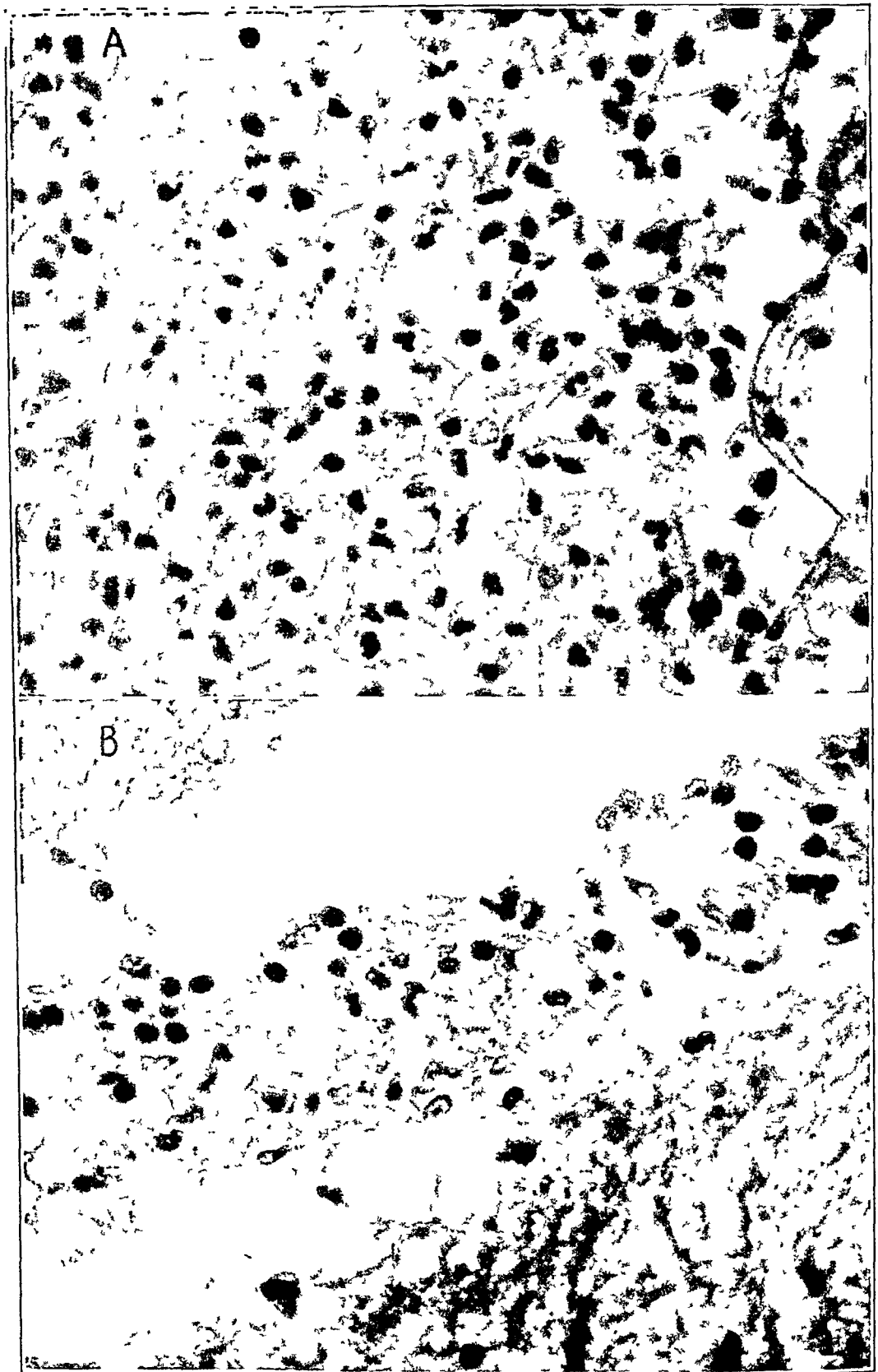

FIGURE 4

(See legend on opposite page)

histologic reaction of the meninges accompanying cerebral abscess, though much has been said concerning the cellular response in the spinal fluid. A survey of the many investigations on the histology of brain abscess disclosed no mention of the meningeal reaction in most cases. Homén¹ called attention to the fact that the meninges overlying the abscess are often involved, that the changes are often confined to the region of the abscess or that the process may spread for a short distance beyond this.

Histologic Features.—From the purely histologic standpoint, several features emerge from our study: 1. A localized meningeal reaction is present in practically every case of brain abscess. In only 1 of 42 abscesses in our series was such a reaction not observed. The reaction varies in content and in the type of cell, depending on the acuteness of the process, being in some instances predominantly polymorphonuclear and in others lymphocytic. 2. The reaction is confined to the overlying gyri and fades off rapidly, so that adjacent gyri reveal no infiltration. Studies of the cortex reveal that only the gyri immediately above the abscess are involved and that adjacent and distant gyri are clean. The meningeal reaction associated with brain abscess is, therefore, in the beginning a localized process, which may in some instances become generalized. 3. The process of localization appears to be accomplished by a limiting process which tends to confine the reaction to the region contiguous to the abscess. The meningeal reaction is confined largely to the sulcus, and the process is sealed off by a meningeal reaction, which prevents spread of the process to adjacent areas. A similar process of limitation was observed by Carmichael, Kernohan and Adson,² who stated:

Abscesses enlarging so as to approach the pial or ependymal surfaces of the brain may give rise to meningitis, although in this instance it is more usual to observe that the enlarging lesion, which is somewhat circumscribed, produces adhesive arachnoiditis, which has the effect of excluding the subarachnoid space and thereby safeguards the organism from meningitis.

1. Homén, E. A.: Experimentelle und pathologische Beiträge zur Kenntnis der Hirnabszesse, ihrer Entstehung und Weiterentwicklung mit spezieller Berücksichtigung der dabei auftretenden Zellformen, Arb. a. d. path. Inst. d. Univ. Helsingfors 1:1-80, 1913.

2. Carmichael, F. A., Jr.; Kernohan, J. W., and Adson, A. W.: Histopathogenesis of Cerebral Abscess, Arch. Neurol. & Psychiat. 42:1001-1029 (Dec.) 1939.

Fig. 4.—Photomicrographs taken with a high power lens of portions of the field in figure 3 B, showing inflammatory changes in the meninges. A shows acute inflammatory changes, with fibrin and polymorphonuclear leukocytes, in the sulcus adjacent to the cortical abscess. B illustrates moderate lymphocytic and fibroblastic response occurring at the crown of the next convolution, where the meningitis is limited in its spread. Hematoxylin and eosin stain; $\times 350$.

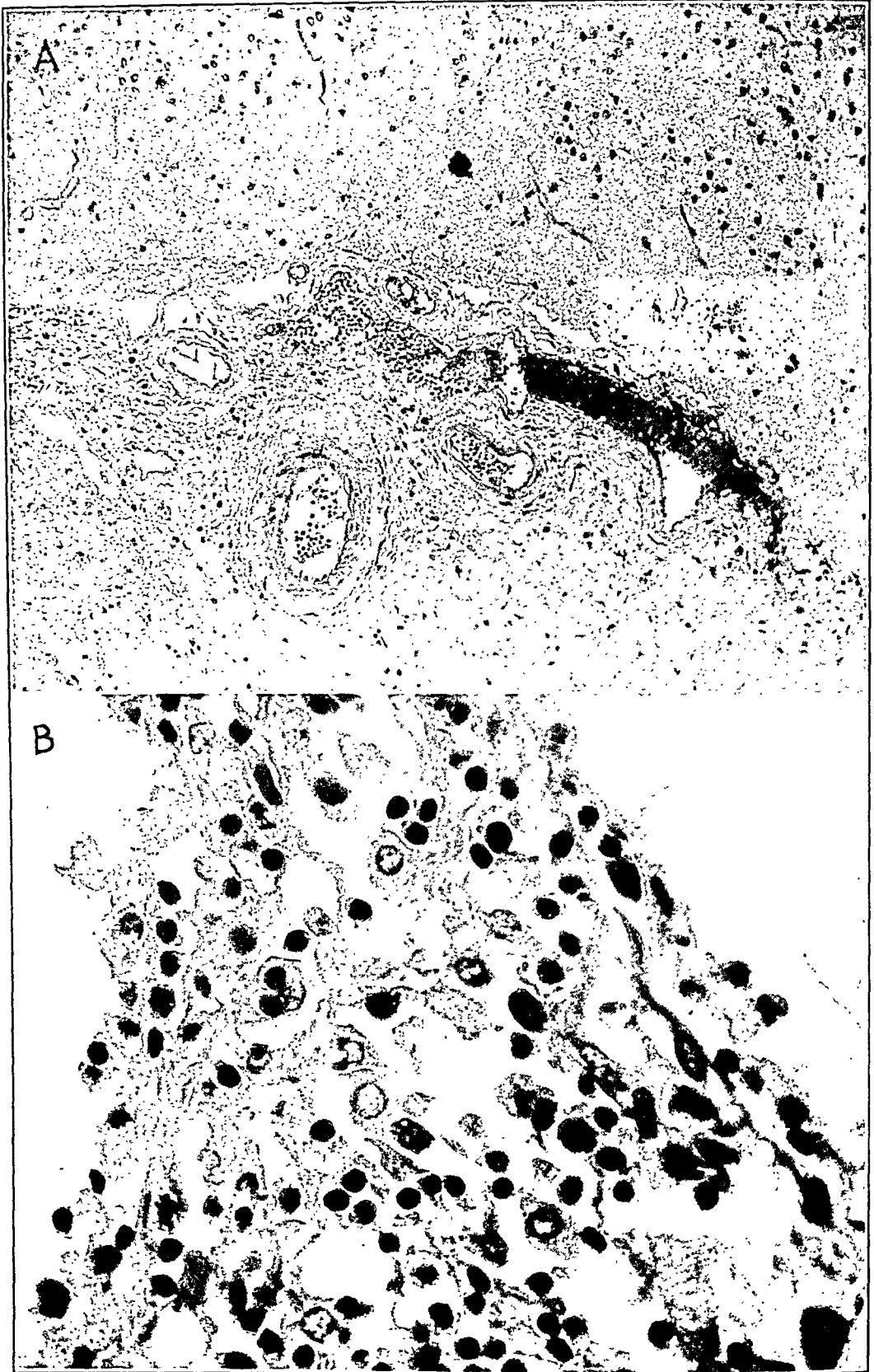

FIGURE 5

(See legend on opposite page)

A limiting reaction similar to that found with brain abscess has been described also in cases of subarachnoid hemorrhage (Alpers and Forster^{2a}).

No bacterial stains were made on our material, so that nothing can be said about the occurrence of bacteria in the meningeal reaction. It is assumed that no bacteria are present, but the circumstances may not always be the same. The probabilities are that the localized meningeal reaction over an abscess is sterile, while generalized meningitis is not, since it is produced by direct extension of the infection from the abscess itself.

The localized meningeal reaction must be regarded as a secondary process, indicative of the underlying inflammation. It is produced by spread along the vessels toward the subarachnoid space, as indicated by Piquet and Boury.³

Then meningeal reaction overlying the brain abscess mirrored with fair accuracy the process of encapsulation of the abscess itself. In general, the meningeal reaction was more profuse and was of a polymorphonuclear type in the acute stages of the abscess and tended to become less pronounced and to take on a lymphocytic formula as the abscess became more chronic and was walled off. The table illustrates the relationship of the meningeal reaction to the process of encapsulation.

Clinical Features.—Correlation of the histologic features of brain abscess and the spinal fluid cell count is desirable to facilitate diagnosis. It is reasonable to assume that a meningeal reaction will be associated with an increase of cells in the spinal fluid, which theoretically should parallel the changes in the meninges. A correlation of this sort was attempted by Woltman,⁴ who observed that the number of neutrophils in the spinal fluid became reduced after the formation of a brain abscess got under way and that a persistence of neutrophils suggested that encapsulation was progressing unfavorably. On the other hand, a small number of lymphocytes in the spinal fluid seemed to indicate better

2a. Alpers, B. J., and Forster, F. M.: The Reparative Process in Subarachnoid Hemorrhage, *J. Neuropath. & Exper. Neurol.* **4**:262, 1945.

3. Piquet, J., and Boury: Contribution à l'étude histologique de l'abcès cérébral, *Ann. d'oto-laryng.*, November 1936, pp. 1113-1143.

4. Woltman, H. W.: Spinal Fluid Cell Count and Encapsulation of Brain Abscess: Attempt to Correlate These Factors, and to Determine Optimal Time for Drainage, *J. A. M. A.* **100**:720-722 (March 11) 1933.

Fig. 5.—Chronic fibrous type of leptomeningitis occurring in the vicinity of an old and well encapsulated abscess. A, $\times 35$. B, $\times 350$, reveals lymphocytosis, some phagocytosis, fibroblasts and collagen. Hematoxylin and eosin stain.

encapsulation and greater resistance. Grant⁵ asserted that "a fluid which is almost always sterile and shows a relatively low cell count suggests abscess."

Studies of the spinal fluid were available in only 7 cases of our series. The number of spinal fluids available for study makes impossible a careful correlation, but it appears to be true that the cell count is higher



Fig. 6.—Meningitis in the sulcus in the vicinity of a cerebral abscess. The degree of meningitis decreases in each direction from the abscess. Hematoxylin and eosin stain; $\times 35$.

with the acute abscess and lower with the more chronic abscess. As Woltman predicted in purely clinical studies, the level of the cell count and the nature of the cells in the spinal fluid are fairly accurate indi-

5. Grant, F. C.: Brain Abscess: Collective Reviews, *Internat. Abstr. Surg.* 72:118-138, 1941; in *Surg., Gynec. & Obst.*, February 1941.

cators of the process of encapsulation. A low lymphocytic pleocytosis should indicate a chronic abscess which is well encapsulated or relatively well encapsulated. That it does not always do so is explained by the fact that the limiting process in the meningeal reaction tends also to seal off the reaction and to prevent the appearance of cells in the spinal fluid. The localized meningeal reaction, therefore, may be sealed off without resulting pleocytosis or with fewer cells than might be anticipated by the activity of the process. A polymorphonuclear pleocytosis, on the other hand, indicates an acute abscess which is not yet encapsulated.

111 North Forty-Ninth Street.
1025 Walnut Street.

DISCUSSION

DR. SHERMAN F. GILPIN JR., Philadelphia: I should like to ask Dr. Alpers a question. Dr. Woltman and Dr. Adson observed that one can tell something about the encapsulation of an abscess from the cell count of the spinal fluid. Early it was predominantly polymorphonuclear and later it was lymphocytic, and they used the dominance of lymphocytes as one of their criteria as to when an abscess should be opened. They also related the time of surgical intervention to the point at which there was no further increase in choking of the optic disks.

I wonder whether there was any similar observation in this series.

DR. FRANCIS C. GRANT, Philadelphia: I gathered from what Dr. Alpers said that there is a definite relationship between the chronicity of the abscess and the change in the cell content of the spinal fluid from polymorphonuclear leukocytes to lymphocytes. This, of course, is what is seen clinically and is one of the criteria on which the encapsulation of the abscess is determined. One of the more important indications for a surgical attack on an abscess is the certainty that the abscess has become encapsulated.

I should like to ask Dr. Alpers whether the abscesses he studied were produced artificially in animals or whether they were abscesses in the human brain.

DR. BERNARD J. ALPERS, Philadelphia: They were abscesses of the human brain.

DR. FRANCIS C. GRANT, Philadelphia: What was the type of these abscesses; were they hematogenous, or were they adjacent to a focus of infection?

DR. BERNARD J. ALPERS, Philadelphia: Some of them were hematogenous, and some arose from extension of infections of the sinuses and mastoid. I cannot give the percentages, because we did not analyze the series in that way.

DR. FRANCIS C. GRANT, Philadelphia: I should like to find out, further, how many of the abscesses were attacked surgically, and whether the operative and the pathologic observations were in agreement with respect to encapsulation.

DR. BERNARD J. ALPERS, Philadelphia: Some of the abscesses were operated on, but I cannot say whether the operative and the pathologic observations were in agreement.

DR. FRANCIS C. GRANT, Philadelphia: Another thing which interested me in this paper was the fact that the stage of meningeal reaction kept pace with the change in the type of cells found in the spinal fluid. I was further interested in the meningeal reaction over the adjacent sulcus or gyrus. Apparently, this meningeal reaction is always on that surface of the brain which lies closest to the

capsule of the abscess. I was also interested to see how closely the apparent time of onset of the abscess could be stated and its development traced throughout its course.

DR. H. T. WYCIŚ, Philadelphia: I should like to ask Dr. Alpers whether there is any relationship between the degree of encapsulation and the type of organism or infection.

DR. JOSEPH C. YASKIN, Philadelphia: I believe that in evaluating the meningeal reaction one must bear in mind the fact that the majority of cerebral abscesses are not hematogenous but arise from infections of the temporal bone and the paranasal sinuses. The infection usually traverses the meninges, often forming an epidural or a subdural abscess before invading the brain substance. It is, therefore, not surprising that meningeal irritation is common in cerebral abscesses of this type.

DR. ROBERT A. GROFF, Philadelphia: I should like to reemphasize a point to which Dr. Grant has already called attention. The presence of a definite meningeal reaction in the nature of an occlusion of the subarachnoid pathways over the abscess explains why meningitis rarely develops as the result of tapping the abscess. The surgeon can tap such an abscess without the thought of producing meningitis.

DR. FRANCIS M. FORSTER, Philadelphia: In reply to Dr. Yaskin's question as to how many of the abscesses of the brain in this series developed by direct spread, I should say that less than one-half arose in this way. The rest were metastatic and secondary to such processes as bronchiectasis and osteomyelitis of the femur.

DR. BERNARD J. ALPERS, Philadelphia: With regard to Dr. Gilpin's question, we were interested in working out this correlation, partly on the basis of Dr. Woltman's work. Dr. Woltman's study was entirely clinical, and we hoped that we should be able to correlate by means of histologic studies what he had demonstrated by clinical means. Our study appears to indicate that Dr. Woltman's observations are true; that there is a correlation between the cell count and the process of encapsulation of the abscess, so that early in the reaction the polymorphonuclear cells predominate and later lymphocytes appear. As the process becomes more chronic, the cell count falls off altogether.

With regard to determining the age of the abscess, we do the best we can. We attempt to date the abscess from the onset of symptoms.

We made no correlation between the encapsulation and the organism. That is a point on which we have no data at all, and it is an extremely important point. We made no bacterial studies. I assume that these meningeal reactions are aseptic and that there are no bacteria.

In response to Dr. Yaskin's question, it is true that abscesses develop adjacent to the mastoid and the sinuses, but it does not necessarily follow that it is by direct contiguity. An abscess may develop in the temporal lobe, without direct extension across the meninges, through thrombophlebitis, which produces relatively little reaction in itself. I do not think that one has to assume a direct extension of the abscess from the mastoid or sinus in order to explain the meningeal reaction. However, I should agree that the possibility exists.

MEASUREMENTS OF PAIN SENSITIVITY IN PATIENTS WITH PSYCHONEUROSIS

WILLIAM P. CHAPMAN, M.D.

JACOB E. FINESINGER, M.D.

CHESTER M. JONES, M.D.

AND

STANLEY COBB, M.D.

With the assistance of George Chesley, M.D., and Benjamin L. Landing, A.B.
BOSTON

THE COMPLAINT of pain has a high incidence in the civilian psychoneuroses, as well as in combat neuroses.¹ It occurs in cases of hysteria and anxiety neurosis as precise descriptions of headache, thoracic pain, cardiac pain and abdominal pain. In cases of hypochondriasis it is described in vaguer terms. It is one of the most difficult symptoms to evaluate and to treat. The problem arises as to whether in psychoneurotic persons one is dealing with thresholds of perception which differ from the normal or with different capacities toward reaction or elaboration of stimuli perceived with equal intensity by the normal person. The purpose of this study is to investigate the threshold of perception and reaction in a series of psychoneurotic patients and in a series of normal control subjects, in an experimental situation.

The Wolff-Hardy apparatus offers an instrument which can be readily used in the investigation of this problem. Values for the perception of pain and its variations have been reported in studies on a large series of normal subjects.² In addition, data are available on the effect of morphine,³ nitrous oxide⁴ and monoacetylmorphine⁵ on the pain

The study was supported by a grant from the Josiah Macy Jr. Foundation, New York.

From the Department of Medicine of the Massachusetts General Hospital; the Massachusetts General Hospital branch of the Hall-Mercer Hospital, and the Departments of Medicine, and Neurology and Psychiatry of the Harvard Medical School.

1. Schwab, R. S.; Finesinger, J. E., and Brazier, M. A. B.: Psychoneuroses Precipitated by Combat, U. S. Nav. M. Bull. **42**:535, 1944.

2. (a) Schumacher, G. A.; Goodell, H.; Hardy, J. D., and Wolff, H. G.: Uniformity of the Pain Threshold in Man, Science **92**:110, 1940. (b) Chapman, W. P., and Jones, C. M.: Variations in Cutaneous and Visceral Pain Sensitivity in Normal Subjects, J. Clin. Investigation **23**:81, 1944.

(Footnotes continued on next page)

threshold; the effects of suggestion have also been reported.⁶ These studies have been concerned essentially with the perception of pain. The present study, of which a preliminary report has been made,⁷ is an attempt to compare a series of 50 patients with various psychoneuroses and 56 normal control subjects with respect to level of perception of pain and of motor reaction to pain. The threshold of perception was determined by measuring the amount of heat in gram calories required to produce a specific subjective sensation or an end point of pain. The reaction value was the amount of heat in gram calories required to produce a motor withdrawal from the source of the pain stimulus.

MATERIAL

The series of psychoneurotic patients consisted of 50 subjects, 15 males and 35 females, who were treated in the psychiatric ward of the Massachusetts General Hospital. The ages ranged from 18 to 45. The group included 22 patients with a disorder diagnosed as anxiety neurosis, 18 patients with hysteria and 10 patients with a reactive depression. The diagnoses for these patients were made in the ward, and they had no other medical or surgical disease. The series of normal control subjects consisted of 56 subjects, 15 males and 41 females. The ages ranged from 18 to 45. The control subjects represented essentially the same economic, occupational, age and ethnic groups as did the patients. It was appreciated that in the selection of any large group of normal persons there is apt to be a small percentage of people with various psychoneurotic symptoms that go undetected. An attempt was made to keep that number at a minimum by means of routine physical examination and taking of medical and psychiatric histories.

METHOD

The method and technic of these pain tests have been described more fully elsewhere.^{2b} In brief, the stimulus was a painful degree of heat applied to the forehead by the Hardy pain apparatus. The source of the stimulus was a 1,000 watt Mazda lamp with a light focused by two planoconvex lenses through an aperture 2.5 sq. cm. in area. The time interval of the stimulus was kept

3. Hardy, J. D.; Wolff, H. G., and Goodell, H.: Studies on Pain: A New Method for Measuring Pain Threshold; Observations on Spatial Summation of Pain, *J. Clin. Investigation* **19**:649, 1940; Studies on Pain: Measurement of the Effect of Morphine, Codeine, and Other Opiates on the Pain Threshold and an Analysis of Their Relation to the Pain Experience, *ibid.* **19**:659, 1940.

4. Chapman, W. P.; Arrowood, J. G., and Beecher, H. K.: The Analgesic Effects of Low Concentrations of Nitrous Oxide Compared in Man with Morphine Sulfate, *J. Clin. Investigation* **22**:871, 1943.

5. Jones, C. M., and Chapman, W. P.: Comparative Study of Analgesic Effect of Morphine Sulfate and Monoacetylmorphine, *Arch. Int. Med.* **73**:322 (April) 1944.

6. Wolff, H. G., and Goodell, H.: The Relation of Attitude and Suggestion to the Perception of and Reaction to Pain, *A. Research Nerv. & Ment. Dis., Proc.* (1942) **23**:434, 1943.

7. Chapman, W. P.: Measurements of Pain Sensitivity in Normal Control Subjects and in Psychoneurotic Patients, *Psychosom. Med.* **6**:252, 1944.

constant at three seconds by a shutter operated by a telechron motor, and the intensity was varied uniformly by means of a wire rheostat. The amount of heat used was measured directly by a radiometer and potentiometer and expressed in absolute end point values of gram calories per second per square centimeter of skin surface. In order to promote the complete absorption of wavelengths, the forehead was first blackened with india ink. The pain perception threshold was taken to be the lowest stimulus necessary to cause a beginning sharp, jabbing or pricking sensation. The pain reaction threshold was the lowest average heat stimulus which caused the subject to wince. This wincing was noted as a beginning contraction of the muscles at the outer canthus of the eye. In addition, a number of the patients showed motor reactivity not only in wincing but in drawing their heads away from the stimulus.

The conditions under which these two end points were measured were standardized in the following manner. Slightly more than half the normal control subjects and the patients were tested by the same observer. To eliminate any variation in the results due to the examiner, the remaining tests on the patients and the normal controls were made by two other observers. Most of the subjects were tested on at least three different test days, each individual test consisting of from ten to fourteen exposures to a series of increasing stimuli, with a two minute interval between each two exposures. The descriptions of the varying sensations were elicited by five neutral questions asked after each exposure. These questions were:

1. What did you feel?
2. How would you describe what you felt when the stimulus was most intense?
3. Was this stimulus as intense as, or less or more intense than, the previous one?
4. Was the sensation you felt then like any you have felt anywhere on your body before?

5. [A card with seven numbered circles, varying in size from a half-dollar to a pencil point, was held before the subject.] Which circle corresponds to the size of the spot on your forehead where the stimulus seemed most intense? [It is characteristic of the stimulus that as it reaches the sharp, piercing end point it seems to focus down to nearly the size of a pencil point.]

The second test was modified in that the subject was asked to keep his head at the aperture until instructed to move it away and also in that he was told how the varying sensations are commonly described. The subject was told, "We are going to tell you how the stimulus is commonly described. At the beginning it feels like a warm glow of heat; as it becomes more intense it feels like a hot or burning sensation. Eventually the sensation changes abruptly from a burn into a sharp, jabbing or pricking sensation, about the size of a pencil point." This modification of technic was made to see whether asking the subject to keep his head at the aperture made any difference in the amount of stimulus causing him to wince and whether he continued to report the same end point value for pain perception after having the various sensations described to him, as he had with the neutral question technic alone.

At the end of each test notations were made as to any possible modifying factors, such as fatigue, nervous tension or apprehension. Inquiry was also made as to the taking of any drugs and the number of hours of sleep. When the tests were completed, "pain" was mentioned for the first time. The subject was asked to define pain and to state whether the initial sharp, piercing end point seemed to him like a beginning pain sensation.

RESULTS

The threshold values for pain perception were essentially the same for psychoneurotic patients and for comparable normal control subjects. Significant differences were observed for the threshold values for motor reaction to pain. As shown in figure 1, the mean value for the pain perception threshold in the patients was 0.288 gram calory per second per square centimeter of skin surface, with a variation of -33 to $+30$ per cent for the patients, as compared with 0.283 gram calory per second per square centimeter, with a variation of -19 to $+33$ per cent for the normal control subjects. The mean individual variation for the normal subjects was 0.011 gram calory per second per square centimeter

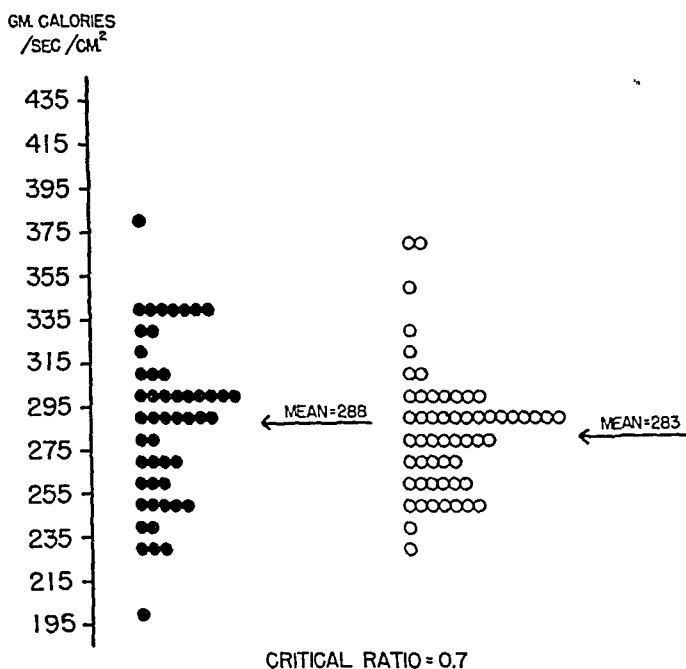

Fig. 1.—Distribution of values for perception of pain in 50 psychoneurotic patients (black circles) and 56 normal control subjects (clear circles).

of skin surface, whereas for the patients the mean individual variation was 0.013 gram calory per second per square centimeter of skin surface.⁸ The mean value, however, for the pain reaction threshold (fig. 2), i. e., the point at which the subjects were found to wince or to show beginning motor withdrawal from the stimulus, was 0.314 gram calory per second per square centimeter of skin surface for the patients, as

8. The lowest value for perception or reaction at which the subject reacted at least on one occasion on a test day (the lowest inconsistent value) was subtracted from the lowest value at which the subject reacted to all exposures on the same test day (lowest consistent value). The average of these differences was calculated for the patients and for the control subjects and is referred to as the mean individual variation.

compared with 0.347 gram calory per second per square centimeter for the normal control subjects. The difference between these mean values is significant, the critical ratio being -3.9 . The mean individual variation in reaction was 0.019 gram calory per second per square centimeter for the patients and 0.011 gram calory per second per square centimeter for the controls, or nearly twice as much for the patients as for the control subjects.

For various reasons, data were not available for the three successive test days for all the patients and for all the control subjects. The data on which figures 1 to 4 were constructed are the summary values

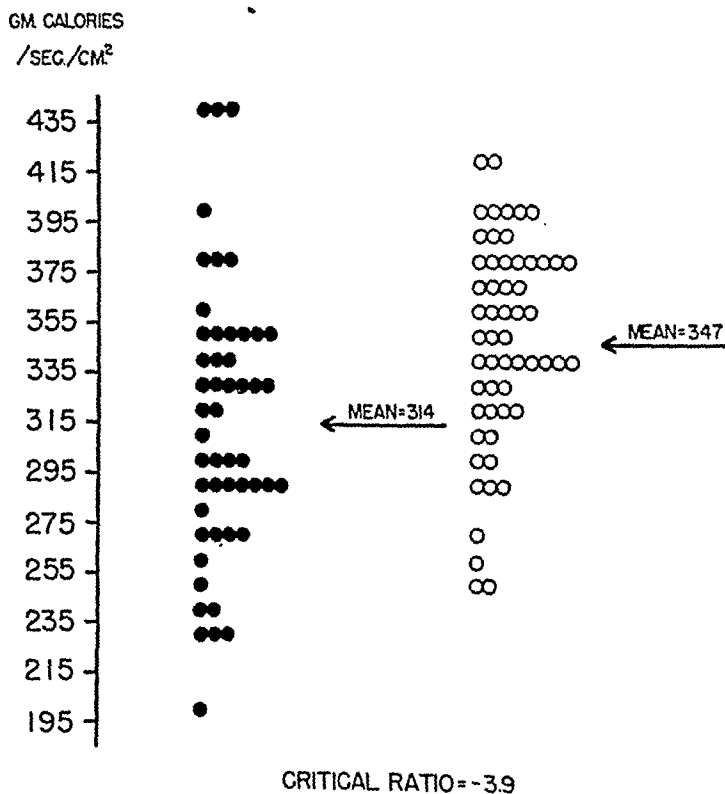

Fig. 2.—Distribution of values for motor reaction to pain in 50 psychoneurotic patients (black circles) and 56 normal control subjects (clear circles).

for perception and reaction. These were obtained by averaging the mean values for three test days whenever this was possible. For 21 patients and for 17 control subjects the summary values were obtained by averaging the mean values for two test days. For 13 patients and for 6 control subjects the summary value is the mean for only one test day.

Distribution frequency curves for the perception and the reaction values for patients and for control subjects are presented in figures 1 and 2. The perception values for the normal controls seem to follow a normal distribution curve, with the mean at 0.288 gram calory per second per square centimeter. The patients show a slightly greater

range, and the distribution tends toward a bimodal type of curve. In the distribution of values for pain reaction, the patients again show a slightly greater range than the controls; both curves tend to show a bimodal distribution. It can be seen (fig. 2) that the values for the control subjects tend to be greater than those for the patients.

Data are presented on the difference between the perception level and the reaction level for both patients and controls. In figure 3 these differences are expressed in absolute values. It can be seen that 20 per cent of the patients and about 4 per cent of the control subjects showed a motor reaction at a stimulus value below that at which they perceived pain. These are shown in the column listed as "differences less

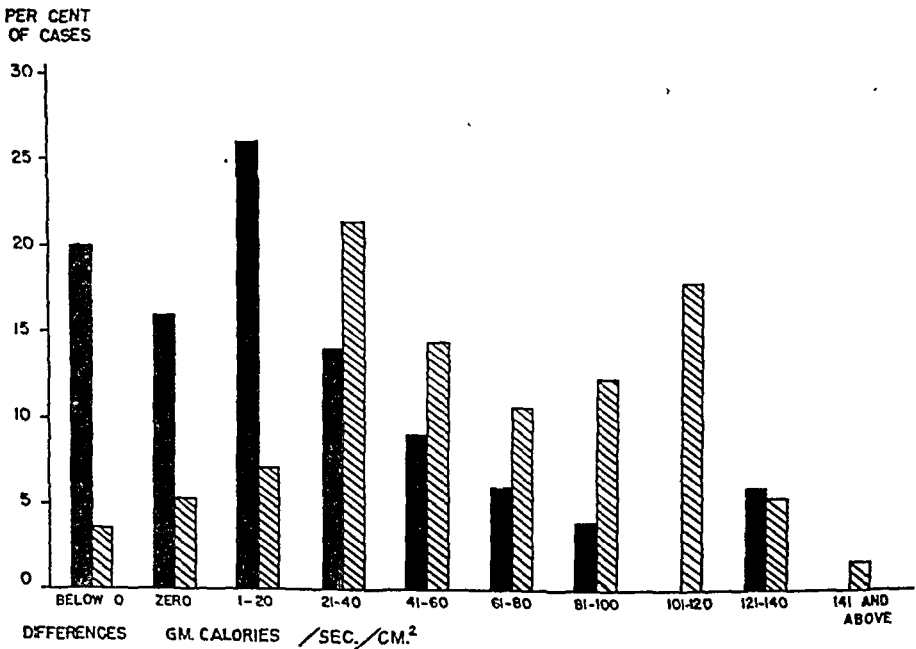

Fig. 3.—Difference between values for perception of and motor reaction to pain in 50 psychoneurotic patients (black areas) and 56 control subjects (cross hatched areas). The values along the abscissa are expressed in terms of gram calories per second per square centimeter of skin surface.

than zero." Seventeen per cent of the patients and 6 per cent of the control subjects had both perception and motor reactions at the same stimulus level. A difference of 1 to 20 points between the perception and the motor reaction level is seen for 26 per cent of the patients and for 7.1 per cent of the normal control subjects. As the difference between the perception levels and the reaction levels become increasingly greater, there are found relatively more control subjects than patients. In figure 4 the same data are presented as per cent differences between perception and reaction levels. Essentially the same trend and the same distribution for patients and for controls are seen.

The foregoing data show a significant difference between the patients and the control subjects in respect to the amount of stimulus necessary to cause the motor reaction. It required significantly less stimulus to evoke the motor reaction in the patients than it did in the control subjects. This was not the case when the perception values for pain were measured. The differences in motor reaction between the controls and the patients are significant when the summary values are used as well as when the values for each test are used (table 1). The critical ratios are significant for all comparisons (tables 1 and 3).

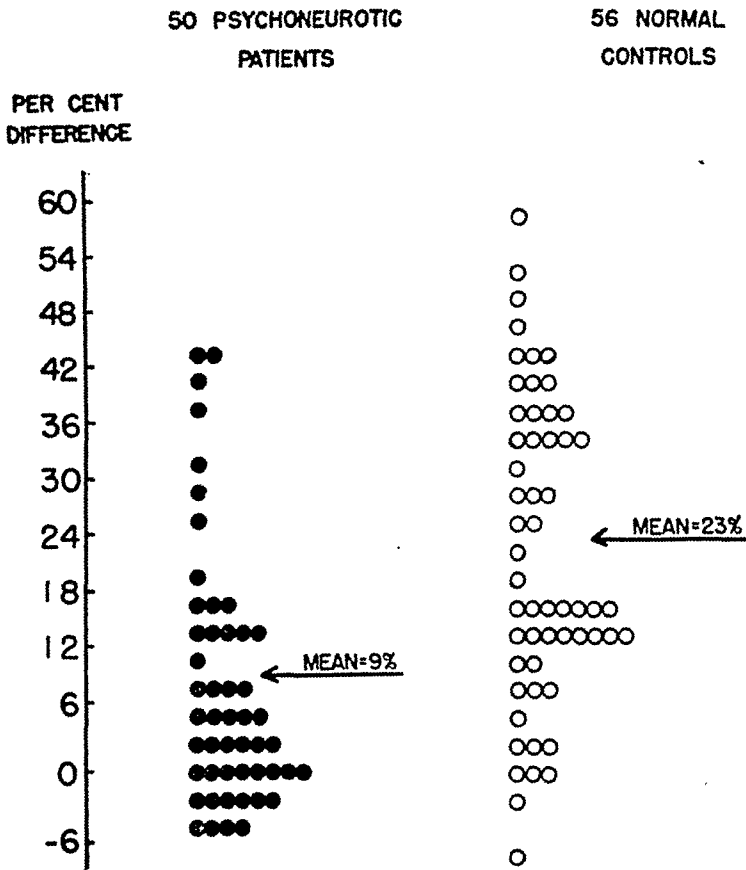

Fig. 4.—Per cent difference between values for perception of and reaction to pain for 50 psychoneurotic patients (black circles) and 56 normal control subjects (clear circles).

In addition to the difference in the wincing reaction, it was noted that a significant number of the patients showed a more pronounced motor withdrawal, to the extent of moving the head away from the aperture. Unfortunately, a consistent record of this more marked withdrawal was not kept until the investigation was well under way. When an attempt was made to elicit the complete withdrawal response, it was found that only 4 per cent of the normal control subjects moved the head away from the aperture when the stimulus had been carried to 0.300 gram calory per second per square centimeter of skin surface. For this same amount of the stimulus 38 per cent of the patients moved

their heads away. The patients therefore exhibited an increased hyperactivity to pain by showing beginning motor withdrawal at a significantly lower level of stimulus than the normal controls, and in a number of cases by showing a more marked motor withdrawal.

TABLE 1.—Difference in Gram Calories Between Threshold Values of Motor Reactivity to Pain and of Pain Perception

	No.	Mean	Standard Deviation	Probable Error	Critical Ratio
Summary Value					
Controls.....	56	0.062	0.041 ± 0.004	0.005	7.08
Patients.....	50	0.027	0.038 ± 0.004		
Values for Individual Tests					
Test 1					
Controls.....	37	0.062	0.037 ± 0.004	0.006	7.53
Patients.....	22	0.014	0.033 ± 0.005		
Test 2					
Controls.....	53	0.060	0.042 ± 0.004	0.006	6.5
Patients.....	42	0.024	0.037 ± 0.004		
Test 3					
Controls.....	49	0.073	0.051 ± 0.005	0.007	6.9
Patients.....	39	0.028	0.039 ± 0.004		

TABLE 2.—Mean Threshold Values* for Pain Perception and Motor Reactivity to Pain for Patients and for Control Subjects

Tests	Patients						Control Subjects					
	Perception			Reaction			Perception			Reaction		
	No. Cases	Mean	S. D.	No. Cases	Mean	S. D.	No. Cases	Mean	S. D.	No. Cases	Mean	S. D.
1	22	0.282	0.036	22	0.296	0.041	37	0.277	0.0272	37	0.341	0.0452
2	42	0.291	0.039	42	0.315	0.053	53	0.281	0.0261	53	0.342	0.0449
3	39	0.278	0.036	39	0.306	0.054	49	0.285	0.0316	49	0.358	0.0492
Summary values	50	0.287	0.0364	50	0.314	0.054	56	0.283	0.0278	56	0.347	0.041

* Values for thresholds are expressed in gram calories per second per square centimeter of skin surface.

TABLE 3.—Statistical Significance of Threshold Values for Perception of and Reaction to Pain for Patients and for Controls

	Controls	Patients
Critical ratio between perception and reaction, test 1.....	-11.0	-1.7
Critical ratio between perception and reaction, test 2.....	-12.8	-3.5
Critical ratio between perception and reaction, test 3.....	-12.9	-3.9
Critical ratio of difference between perception, tests 1, 2 and 3 and reaction tests 1, 2 and 3.....	-14.0	-4.1
Controls and Patients		
Critical ratio of difference between summary values of perception of pain	+0.70	
Critical ratio of difference between summary values of reaction to pain	-3.85	

As regards differences in pain reactivity in the various groups of psychoneurotic patients, there was a tendency for the patients with anxiety neurosis and hysteria to wince with a smaller stimulus than for the patients with hypochondriasis. While these differences are suggestive, this series of cases is too small for one to say definitely that different types of psychoneurotic patients can be distinguished in terms of their reactivity to cutaneous pain.

The foregoing results showed that whereas the patients responded by motor reaction to less stimulation than did the control subjects, this was not true for the perception of pain. We felt that it would be of interest to determine whether the threshold for motor response would increase on repeated tests. A small series of 11 patients were tested on six successive test days. The mean values for each test day in the entire series remained unchanged both for perception and for motor reaction. Repeated testing did not change the threshold values in this series of patients.

COMMENT

These studies demonstrate that psychoneurotic patients require essentially the same amount of stimulus to perceive cutaneous pain as do normal control subjects. The patients differ from the control subjects in that it requires significantly less stimulation to cause a motor withdrawal reaction. It would have been of interest to know whether this hyperactivity was expressed in other ways, such as changes in pulse, blood pressure and respiratory rate. Such data were not obtained, as we wished to avoid unduly complicating the experiment. Such information would be of interest because of the known autonomic instability in certain psychoneurotic patients. When adequate base lines for autonomic activity are established, the effects of pain on these functions will be of interest. For such studies it will be necessary, however, to use a painful stimulus which is maintained for a longer interval than three seconds.

A number of variables are encountered in a study of this nature. They have been discussed at length in another communication^{2b} and may be enumerated here by the following questions:

1. Is the stimulus used a measurable one?
2. Is the stimulus applied to that portion of the body where the neurohistologic variations are at a minimum?
3. Does the stimulus produce a readily appreciated end point of pain?
4. Is proper consideration given to factors which at the time of the test may influence the level of pain sensitivity?
5. Is the proper question technic used to elicit an adequate description of the stimulus?

In the present study these criteria were met by the technic previously described. A point which may be raised regarding this investigation involves the question whether a subject evaluates the sharp, jabbing end point as pain. At the completion of the test the normal control subjects and the patients were asked to define pain. It is noteworthy that 80 per cent of the subjects, in answer to this question, volunteered that pain was something that hurt, and that the beginning sharp, jabbing sensation experienced from the heat was considered painful because of its hurting quality. On the first test day the patients were not told what to expect and were not given any description of the nature of the stimulus or of the reaction. On the second test day, however, they were told what to expect, as previously described. The main values for perception and reaction were essentially the same in test 1 and test 2. This would indicate that the end results were the same whether or not the subject was given a description of the sensation caused by the stimulus.

The results of these experiments on sensitivity and reaction to pain are in keeping with other observations on the reactivity of psychoneurotic patients. During basal conditions, while extraneous stimuli are at a minimum, psychoneurotic patients have significantly greater irregularities in the respiratory pattern⁹ than do schizophrenic patients and normal control subjects. Previous studies have shown that patients with hysteria, anxiety neurosis, phobia and reactive depression show greater reactivity in ventilation, rate of respiration, spirographic irregularities, heart rate and muscular tension in response to ideational, auditory and painful stimuli than do normal control subjects.¹⁰ These experiments indicate that cutaneous pain as elicited by exposure to heat is another form of stimulus to which psychoneurotic patients respond as hyperreactors.

The fact that in these patients the stimulus for the perception of pain was essentially the same as that for the control subjects would indicate that the afferent pathways mediating the painful stimulus function normally in psychoneurotic patients. The explanation for the greater reaction is at present unknown. However, some light on

9. Finesinger, J. E.: The Spirogram in Certain Psychiatric Disorders, *Am. J. Psychiat.* **100**:159, 1943.

10. Finesinger, J. E.: The Effect of Pleasant and Unpleasant Ideas upon the Respiration in Psychoneurotic Patients, *Arch. Neurol. & Psychiat.* **42**:425 (Sept.) 1939. Finesinger, J. E., and Mazick, S. G.: The Effect of a Painful Stimulus and Its Recall upon Respiration in Psychoneurotic Patients, *Psychosom. Med.* **2**:333, 1940. Finesinger, J. E.: The Effect of Pleasant and Unpleasant Ideas on the Respiratory Pattern (Spirogram) in Psychoneurotic Patients, *Am. J. Psychiat.* **100**:659, 1944.

the problem is thrown by a similar study,¹¹ in which it was found that patients whose chief complaint was nervousness showed a lower threshold of reactivity, i. e., greater reaction, than did a similar group of patients whose major complaint was thoracic pain. The perception values for the two groups were essentially the same. This would suggest that the greater reactivity is associated principally with complaints of nervousness in patients in whom this is the chief complaint.

SUMMARY

Measurements on the threshold of perception of pain and the motor reaction to pain were made on a series of 50 psychoneurotic patients and on a series of 56 normal control subjects.

The values for the threshold of perception of pain were essentially the same for the patients and for the control subjects.

The threshold values for the motor reaction to pain were significantly greater for the control subjects than for the patients. A much smaller stimulus was required to evoke a motor response in the patients than in the control subjects.

The evidence indicates that psychoneurotic patients tend to show a greater motor reactivity to a painful stimulus than do normal control subjects.

Massachusetts General Hospital.

11. Chapman, W. P.; Cohen, M. E.; Cobb, S., and White, P. D.: Measurements Related to Pain in Neurocirculatory Asthenia, Combat Fatigue, and Anxiety Neurosis, *J. Clin. Investigation* 25:890 (Nov.) 1946.

INCIDENCE OF COMBAT FATIGUE

COMMANDER PHILIP SOLOMON (MC), U.S.N.R.

IN SPITE of the many papers on combat fatigue which have appeared in the literature since the onset of World War II, there have been few, if any, controlled studies on the incidence of the disorder. My experience as division psychiatrist with a Marine division before, during and after the Okinawa campaign offered an unusual opportunity for the observation of combat fatigue in all stages and for the gathering of appropriate related data. The present paper will present the collected material regarding the incidence of combat fatigue with respect to (1) the individual, (2) the group and (3) the type of warfare.

THE INDIVIDUAL

The following data were obtained from 627 patients with combat fatigue and from a control group of 205 Marines. The patients were seen in the division field hospital, usually within a few hours after they broke down. The control group, taken from the same regiments, were studied after the operation was over. The data were corrected for the time interval. All differences are statistically significant, each difference being three or more times as large as the standard error of the difference.

Age.—The patients with combat fatigue were younger than the controls. The mean age was 21.6 years, as against 23.3 years. Since the older men were exposed to the same hazards as the younger men and were not given favored jobs, it would seem that the greater maturity associated with the older age made for greater stability and resistance to combat fatigue.

Marital Status.—There were more married men among the controls than among the patients with combat fatigue (32 versus 22 per cent). This may be a reflection of the greater age or may be another indication of greater maturity.

Education.—The controls had gone further in school. The means of the highest grade attained was 11, as against 10 for the patients. This difference may be due in part to more younger men among the combat fatigue group having had their education interrupted by the war, or, again, it may be an indication of greater maturity and stability of the

This article has been released for publication by the Division of Publications of the Bureau of Medicine and Surgery of the United States Navy. The opinions and views set forth in this article are those of the writer and are not to be considered as reflecting the policies of the Navy Department.

controls. It will be noted that both groups showed a high level of educational attainment. This is largely due to the fact that the Marines selected for this division were carefully chosen and were minutely screened by training before they entered combat.

Place in the Family.—During the work with the patients with combat fatigue, I was impressed with the seemingly large number of men who were the youngest members of their families. On statistical analysis, however, it developed that the group with combat fatigue and the control group were essentially alike in this respect and that in each the distribution with regard to the position among the siblings was a normal one. This negative finding is mentioned as an interesting illustration of the fallibility of clinical impressions.

Service Life.—The two groups differed slightly in their length of active duty in the service. The mean for the combat fatigue group was twenty-five months, whereas for the controls it was twenty-eight months. However, though they had been on active duty a little less, the combat fatigue group had been overseas a little longer (fourteen months, as against twelve months). They had also seen more action. For only 56 per cent of them was Okinawa their first campaign; for 24 per cent it was their second, and for 20 per cent, their third or fourth. Of the controls, Okinawa was the first campaign for 78 per cent, the second for 10 per cent and the third or fourth for 12 per cent. These findings indicate that the combat fatigue group had been exposed to greater stress in the service.

THE GROUP

During the entire Okinawa operation, which lasted for eighty-two days, 627 patients with combat fatigue were seen at the division field hospital, and an additional 209 were evacuated directly to rear area hospitals. The total of 836 patients constitutes approximately 6 per cent of the total casualties and 3 per cent of the total strength of the division. These figures are far lower than those usually encountered in combat, and they compare most favorably with those of other divisions that took part in the Okinawa operation. In explanation, the following points may be noted:

1. Preventive measures were instituted before the division went into combat. These have been described in a previous paper.¹ Particularly effective were the excellent state of the mental health of the troops, the indoctrination in psychiatric matters of the line officers and the medical officers and the practice of establishing rest camps under line control within the individual combat battalions and regiments.

1. Solomon, P.: Psychiatric Preparations for Combat in a Marine Corps Division, U. S. Nav. M. Bull. 45:310-313 (Aug.) 1945.

2. The morale of the division was especially high throughout the operation, in part because of its unusual success in carrying out its objectives against the enemy. With the exception of one brief period (at Sugar Loaf Hill, to be discussed later), the division was in constant victorious forward motion.

3. The diagnosis of combat fatigue was scrupulously confined to its proper definition of neurotic breakdown in essentially normal persons under the stress of combat.² Cases of blast concussion, exhaustion due to overexertion, heat exhaustion, operational fatigue, preexisting psychoneurosis, personality disorder, reactive depression, manic-depressive disorder and combat psychosis were excluded.

Nearly all the cases of combat fatigue occurred in the infantry regiments. These will be designated as regiments A, B and C. Together, their total strength made up little more than one-half the strength of the division. In the Okinawa operation, the three regiments were exposed to approximately equal durations and intensities of combat. Yet regiment A, which suffered the most deaths and men wounded in action, had by far the least combat fatigue; regiment B, which had the least deaths and the least wounded in action, had the most combat fatigue; regiment C was between in all categories. These discrepancies were found to correlate in interesting fashion with certain characteristics of the individual regiments.

Regiment A had 148 men with combat fatigue, 2,130 wounded in action, 510 deaths and 3,700 total casualties. The ratio of men with combat fatigue to the total casualties was 4.0 per cent, and to the total battle casualties, 5.6 per cent. Regiment A was an old, famous Marine regiment. Its leader was an equally famous colonel, whose leadership and personality characteristics were such that the loyalty of his officers and men toward him can be described only as phenomenal. The medical officers had ample opportunity to witness this fact. The men ignored minor wounds, and it was only with difficulty that some of the more seriously wounded could be kept in the field hospital. "They need me up there," was heard again and again. Evidences of intrepidity, pal spirit and pride in their accomplishments were frequent. Though this paper is concerned only with the incidence of combat fatigue, it may be noted that regiment A, with the lowest incidence of combat fatigue, had the highest rate of return to duty for patients with combat fatigue and the lowest rate of recurrence. There can be little question that these facts are a result of the astoundingly high level of the morale of the men.

2. Solomon, P.: The Diagnosis of Combat Fatigue, U. S. Nav. M. Bull., to be published.

Regiment B had 442 men with combat fatigue, 1,780 wounded in action, 420 deaths and 3,950 total casualties. The ratio of men with combat fatigue to the total casualties was 11.2 per cent and to the total battle casualties, 20.0 per cent. Regiment B was also an old well known Marine regiment, but there was prevalent in it a definite feeling of bitterness and pessimism. The men felt that they had not received adequate recognition for their earlier accomplishments in the war. Their combat efficiency had been extremely high, and they were noted for their meticulous care in planning and well oiled coordination in action.

In regiment B, the division slogan of "Hold high the torch!" was little heard. Instead; the men frequently cried, "Ram high the rod!" or "Hold those baskets higher!" or "See those little purple hearts pinned around the basket!"³ The colonel was an extremely capable man and highly revered. A story was passed around, however, to the effect that the colonel was convinced he was going to "get his" in his third operation, and this was his third operation. The story was no doubt unfounded,⁴ but its acceptance among the men was another indication of the low spirit that prevailed.

In spite of the sardonic pessimism, regiment B turned in a uniformly good performance until the assault began on the Naha-Shuri line. At this time heavy rains turned the battlefield into a sea of mud. The movement of mechanized vehicles was almost impossible. The enemy stood fast and resorted to a heavy concentration of mortar and artillery fire. Each day morale in the regiment sank lower and lower. As casualties mounted and replacements did not arrive, it became generally felt in the regiment that their mission was hopeless. Line officers, medical officers, corpsmen and riflemen all joined in defeatism. The culmination of this occurred at Sugar Loaf Hill, a name that will go down in Marine Corps history. This position changed hands eleven times, but for days it could not be held. Patients with combat fatigue now began turning in in large numbers. "I can't take it, Doc," they would say. For three days there were over a hundred such patients a day. In some decimated companies which were down to 30 or 40 men, the entire group was turned in in a body. Finally, drastic steps were taken to put a stop to this. A modification of assignment and changes in personnel were made. Medical officers, as well as line officers, were switched about. The division psychiatrist visited the regiment daily. Finally, the weather cleared; replacements of men arrived; the enemy line was broken, and the crisis was passed.

3. Gruesome humor referring to "basket cases," in which all four limbs are amputated. All three slogans have a masochistic coloring.

4. It was also not prophetic, though the colonel's successor in command of the regiment was killed at Okinawa.

Regiment C had 240 men with combat fatigue, 1,900 wounded in action, 490 deaths and 3,375 total casualties. The ratio of men with combat fatigue to the total casualties was 7.1 per cent, and to the total battle casualties, 10.0 per cent. Regiment C was made up largely of men recently drafted. The colonel was generally regarded as an excellent man, but there were many who felt he was still fighting the Nicaraguan campaign. He had overtrained his men until they had "gone stale." There was a great deal of carping criticism down through the level of the officers to the men. In maneuvers they rated low efficiency marks resulting in even more strenuous training; yet blunders continued. The officers and men were tired, disgruntled and convinced they were "a hard luck outfit."

In the third week at Okinawa, regiment C again manifested inefficiency. A few ambushes by the enemy and light casualties seemed to stymie them. They were convinced they could not take their assigned objective. Regiment A replaced them and took the enemy position in a breeze, accepting their heavier casualties with apparent disdain. Later in the operation, regiment C, with a new commanding officer, seemed to pull itself together and turned in a sterling performance.

TYPE OF WARFARE

Those who have never been in combat are inclined to think of it as a rather uniform matter: A man is either in combat or he is not. Nothing could be further from the truth. At Okinawa, as in other military operations, whole divisions were sent into "combat." Actually, less than 40 per cent of the personnel of an assault division did the fighting. The remaining 60 per cent or more were never exposed to sufficient stress or strain to produce combat fatigue. Even those who did take part in the actual fighting varied widely in the intensity and duration of their experiences. In the following paragraphs I shall attempt to evaluate the efficacy of the different military phases at Okinawa in the production of combat fatigue.

The Landing.—At Okinawa, the Marines hit their first "cold" beach in World War II. There were practically no casualties of any sort, and of course no combat fatigue. The tension of anticipation, in the normal man, changes rapidly to profound relief and high spirits when no opposition is encountered in the initial assault at the target. In other operations, such as those at Tarawa and Iwo, where the beach was "hot," the emotional strain was extreme, and many cases of combat fatigue resulted in a short time in spite of little physiologic depletion in the men.

Rapid Advance in Northern Okinawa.—The division with which I was privileged to serve advanced rapidly for the first two weeks of the

operation. Enemy resistance was light and scattered. Only the forward patrols saw any real action. There were few casualties and only an occasional case of combat fatigue. Optimism ran high among the men.

The Motobu Peninsula.—A determined enemy in strength was first encountered in the third week, on the Motobu Peninsula. As previously noted, regiment C here ran into difficulty. Two companies were ambushed by the enemy and exposed to heavy machine gun and Nambu fire. There were many casualties, and some of the men who were pinned down could not be rescued for hours. Some 30 cases of combat fatigue resulted, but it was not severe and all the men returned to duty in a few days.

The Resting Stage.—Northern Okinawa was declared secure at the end of the third week. For the next two weeks the division remained relatively inactive. There was constant patrolling, but only scattered sniper fire was met. There were a few enemy air raids, but bombing was light and inaccurate, doing no damage. The chief anxiety during this period concerned the future. There were rumors that the division would make another major landing nearer the enemy homeland. Several men felt that they could not stand another operation and turned in with symptoms of operational fatigue, but there was no combat fatigue.

The Naha-Shuri Line.—At the end of the fifth week the division was relieved by occupation troops and moved south to take over a sector of the line which the enemy was holding in determined fashion against the Army. Heavy fighting of an entirely different sort now began. Progress, as judged by the accomplishments in Northern Okinawa, was extremely slow. Enemy mortar and artillery fire was continuous and often of deadly accuracy. The Marines, who respect good marksmanship, claimed the Japs could drop a knee mortar in a man's pocket at a thousand yards.

As battle casualties mounted to 200 or more a day, combat fatigue became a major problem. Lagging a day or two behind the rise in battle casualties, cases of combat fatigue rose steadily from 20 to 40 or 60 a day. Finally, at the end of a week of this grueling fighting—with constant rain and mud; inadequate food, water, shelter and rest, and under incessant shelling—the nerves of some of the hardest could take no more. Morale in regiment B, which was unsuccessfully attempting to take Sugar Loaf Hill, slumped, and the influx of over 100 cases of combat fatigue a day took place, as has already been described. Many of the men who were brought in at this time were battle-hardened veterans, some in their third or fourth operation. They confessed frankly that they had never seen anything like this before and that they could take it no longer. "If we could only see somebody to shoot at and fight back at, it wouldn't be so bad," they said. These men

showed marked physical depletion. They were haggard, covered with mud and usually sat staring fixedly at the ground with glazed eyes. If a shell fell in the hospital area, they "hit the deck" with the rest; but often they remained there trembling and moaning, unwilling to get up. Some of them reacted with a marked startle response to the noise of their own guns.

With the cracking of the Naha-Shuri line and the capture of Naha, the incidence of combat fatigue rapidly dropped off. Battle casualties continued heavy for another week, but the weather had now improved, replacements had come in, transportation permitted more satisfactory attention to the physical needs of the men, and morale rose because of the victorious progress that had been made. At the end of the eighth week on Okinawa there were a few days of relative quiet in the division while positions were consolidated and preparations were made for the next phase of the operation.

The Orotu Peninsula.—In the tenth week, regiment A made an amphibian landing on the Orotu Peninsula, site of the enemy naval base and of the Naha airfield. Resistance during the landing was light, but the regiment took heavy casualties during the lightning-fast clean-up of the peninsula. Cases of combat fatigue were extremely few, remarkably so in proportion to the heavy battle casualties. In explanation, it may be noted that the casualties were due primarily to small arms fire, which Marines tolerate easily, and that the spirits of the men were high because of their easy landing and rapid forward movement. Besides, the end was now definitely in sight. In the eleventh week there was another relative lull before the attack was launched that carried through to the end of the island.

The Southern Tip.—In the twelfth week the Marines plunged across the southern tip of Okinawa and reached the sea. The remaining enemy forces were cut into small groups and annihilated. Again, there were many battle casualties, but combat fatigue was almost completely absent. The weather became extremely hot at this time, and a few cases were turned in as cases of combat fatigue that were really cases of heat exhaustion. Enemy resistance once more was largely small arms fire, and high spirits prevailed because the final victory was at hand. Furthermore, rumor had it that the division was to be relieved at once and taken to rejoin the rear echelon at a prepared camp in Guam.

The island was officially declared secure on the eighty-second day, but mopping up continued and the division did not embark for two or three more weeks. Combat fatigue ceased with the end of combat. After over a hundred days on Okinawa, there were no regrets at seeing the end of combat, the end of combat fatigue and the end of Okinawa.

INDIVIDUAL STRESSES

A word should be added regarding the evaluation of individual experiences in terms of production of physical and emotional stress and combat fatigue. It was remarkable how little the men seemed to be affected by exposure to the elements. After many days and nights spent in muddy foxholes under constant rain, with practically nothing available in the way of toilet facilities, no hot food, a scarcity of water, almost no chance to sleep because of the lack of shelter, noise and need for alertness, not a single man who broke down with combat fatigue had a word of complaint with respect to these matters. There could be no more convincing demonstration of the importance of a scale of relative values. In training camp and in maneuvers, these same men would set up a hue and cry in typical G. I. style at the slightest inconvenience. But in combat, life itself is at stake, and everything else in the way of physical comforts seems to drop completely out of the picture.

The same was not true in the emotional sphere. Combat demonstrates irrefutably that there are some forces even more potent in motivating behavior than self preservation. What makes a man stay in there and take it when men are being killed all around him? Probably the following reasons, which are noted in the order of their importance:

Compulsion: Fear of the consequences if he tries to get out of it. This no doubt stems from deep-seated submissiveness to authority and acceptance of the father surrogate. In the front lines it seems simply a matter of not wanting to get shot in the back or be court-martialed for "turning tail."

Loyalty: Fealty to his leaders and his buddies. Allegiance to the cause and patriotism seemed far distant. Homosexual roots were not in evidence.

Hope: The sublime faith that he will somehow come through all right. This doubtless arises from a belief in magic, but to the practical Marine it is based on such realistic matters as being relieved regularly by the rotation of troops in the front lines, the superiority of arms and equipment over those of the enemy and confidence in himself and in his leaders. This feeling fluctuates widely, depending on the military state of the operation and the fortunes of war. It rises enormously when victory is in sight.

Emotions of lesser importance, such as hatred for the enemy (sadistic tendencies are rare) and resignation to one's lot (masochistic tendencies are even rarer).

Bearing in mind these reasons that men stay in the lines, it will be easier to understand why they break down neurotically with combat fatigue and leave the lines. The simplest way to cause a large influx

of men with combat fatigue is to make it easy for them to turn in. If, during a prolonged ordeal, such as the one at Sugar Loaf Hill, the compulsion to remain is removed (by defection in command⁵ or over-sympathy on the part of medical officers and corpsmen), combat fatigue will spread like mass hysteria. Under ordinary combat conditions, one of the commonest precipitating factors in combat fatigue in the individual soldier is the death or maiming of one of his buddies. Combat fatigue may be a simple severe grief reaction. Many a man turns in with combat fatigue only after all his buddies are gone. "I don't know these new men," he says. He feels no loyalty toward them. Lack of confidence is a potent factor. "The new lieutenant didn't seem to know what it was all about," one patient said. "The new, green men are no good. They get themselves killed so foolishly. You can't rely on them," said another. When hope changes to despair, combat fatigue is near at hand. Combat fatigue may be the result of an unfortunate accident. When a man unknowingly kills one of his own officers or men, he usually succumbs to combat fatigue. A miraculous escape, as when a shell lands in a group, killing all the others but leaving one man unscathed, often is the harbinger of combat fatigue. "My luck has run out; I know it has," one man said. But by and large, combat fatigue is the result of the accumulation of many stresses and strains, both physical and emotional, with the leading one fear of death, to the point at which the man's threshold is reached and he cannot stand it any longer. "I couldn't take it any more, Doc," is the commonest statement made by patients with combat fatigue.

SUMMARY

A controlled study of the incidence of combat fatigue in a Marine division at Okinawa revealed the following facts:

1. The Individual: Patients with combat fatigue, as compared with controls, were younger and less well educated; fewer were married, and, though they had been in the service a little shorter time they had been overseas longer and had seen more combat. These findings presumably indicate what might have been expected, namely, that the patients with combat fatigue were less mature or less stable and were exposed to greater stress.

2. The Group: There was an unusually low incidence of combat fatigue in the division, which seemed to be due, at least in part, to preventive measures and to the high morale produced by continuous military success. The differences in incidence of combat fatigue in the three infantry regiments correlated closely with the morale factors of the separate regiments.

5. The incidence of combat fatigue in officers was 0.4 per cent, much lower than in enlisted men.

SOLOMON—COMBAT FATIGUE

3. The type of warfare: Exposure to combat is not a uniform matter. The physical and emotional stresses that make for combat fatigue vary greatly according to the type of combat and the personal experiences of the individual soldier in combat. At Okinawa, there were wide variations in the incidence of combat fatigue at different phases of the operation. The factors which abetted the development of combat fatigue were chiefly those that affected the patient emotionally. The most potent, in addition to the fear of being killed, were those that counteracted the basic reasons that a man remains in the lines in spite of his fear of being killed. The basic reasons are considered to be compulsion, loyalty, and hope.

416 North Bedford Drive, Beverly Hills, Calif.

PARAMYOCLONUS MULTIPLEX (FRIEDREICH)

A Clinicotherapeutic Study

ARTHUR A. MORRIS, M.D.

MEMPHIS, TENN.

IN 1881 Friedreich¹ described paramyoclonus multiplex as a syndrome characterized by the occurrence of abrupt twitches in bilaterally symmetric muscle units. The twitches were asynergic and affected only distal muscle groups. During sleep the myoclonic twitches disappeared; but voluntary relaxation, and mechanical, thermal, electrical and emotional stimuli produced an increase in the frequency and degree of contractions. A conspicuous absence of signs and symptoms of disease of the peripheral and central nervous systems was observed.

Since the cause of paramyoclonus multiplex has remained obscure, numerous remedies may be found in the literature. A summary of the various forms of treatment used formally is recorded in table 1. In addition, when the disease occurs after trauma (Starr²), mental and physical exertion or fevers (Raymond,³ Bing,⁴ Keschner,⁵ Lafforgue⁶), or as an accompaniment of lead poisoning (Leusche), dementia paralytica (Gravitz, Williams), endocrine disorder (Magauda), neurosyphilis (Weingrow⁷), anterior poliomyelitis (Bailey), meningoen- cephalitis (Clarke), black widow spider bite (Kirby-Smith⁸) or

From the Department of Neuropsychiatry, Duke University School of Medicine, Durham, N. C.

1. Friedreich, N.: *Neuropathologische Beobachtungen Paramyoclonus multiplex*, *Virchows Arch. f. path. Anat.* **86**:421-436, 1881; translated, *J. Nerv. & Ment. Dis.* **30**:466, 1903.

2. Starr, A.: *Paramyoclonus Multiplex, with a Report of a Case*, *J. Nerv. & Ment. Dis.* **14**:416-427, 1887.

3. Raymond, F.: *Leçons sur les maladies du système nerveux*, Paris, O. Dorn, 1896, p. 550.

4. Bing, R.: *Textbook of Nervous Diseases*, translated and enlarged from the German by W. Haymaker, St. Louis, C. V. Mosby Company, 1939, p. 145.

5. Keschner, M., in Tice, F.: *Practice of Medicine*, New York, W. F. Prior Company, Inc., 1920, chap. 10, p. 418.

6. Lafforgue: *Paramyoclonus d'origine ourlienne*, *Rev. de méd.*, Paris **32**: 303-306, 1912.

7. Weingrow, S. M.: *Paramyoclonus Multiplex and Neurosyphilis*, *J. Nerv. & Ment. Dis.* **85**:557-560, 1937.

8. Kirby-Smith, H. T.: *Black-Widow Spider Bites*, *Tennessee M. J.* **31**: 357-361, 1938.

TABLE 1.—Summary of the Various Treatments Formally Used for Paramyoclonus

Date	Name	Treatment	Results
1881	Friedreich ¹	Liver oil	Unsuccessful
1883	Löwenfeld, 1883 and 184,	Galvanization of spinal cord; galvanization of superior cervical ganglion, with addition of zinc valerianate at same time	Prompt improvement with only galvanization of the superior cervical ganglion; no lasting cures obtained for short period but twitches improved and lasted until death, 2 yr. later returned
1886	Schulze: Neurol. 369, 1886	Strong central galvanization of spinal cord and application of galvanic current to affected muscles in Friedreich's original case	Unsuccessful
1887	Homen, E. A.: Arch. de neurol. 13:	Galvanization of spinal cord	A patient did well a single patient, a mildly anemic woman whose twitches appeared following an abortion
1887	Dechtereff, V.: Arch. f. Psychiat. 19:	Warm baths in quiet circumstances Fowler's solution (solution of potassium arsenite U. S. P.) and zinc valerianate	Effectively woman whose twitches appeared following an abortion Unsuccessful None of the many remedies used singly or in combination were useful
1895	Unverricht ²	Atropine and scopalamine 1/200 grain (0.3 mg.) every 3 hr.;	Some improvement
1902	Langdon, F. W.: J. Nerv. & Ment. Dis. 29: 541-548, 1902	Scopolamine hydrobromate, chloral hydrate and potassium bromide; sodium iodide, chloral hydrate and potassium bromide; every 3 hr. for 3 days; Fowler's solution of Cactus grandiflorus; sodium phosphate; morphine; desiccated thyroid; sodium and arsenic	Slight improvement
1919	Westphal, A.: Arch. f. Psychiat. 60:	Phenobarbital	Had some degree of success in a sporadic case Woman aged 56 who had paramyoclonus multiplex for eighteen years was cured
1922	Roger, H.: Ann. de med., Paris 12:	Intestinal antiseptics and full doses of methenamine (hexamine)	Success in highly selected cases
1923	Ramsay, J. C.: Brit. M. J. 2: 878, 1923	Bilateral ovariectomy. Trial of curettage, Weit-Mitchell regimen, application of powerful electrical currents, arsenic, chloral and bromides, complete on one side and partial on the other, or unilateral vasectomy (in the male) should be tried perhaps ovariectomy and stripping operations for orthopedic tendon transplants and	Used successfully in a sporadic case with symptomatic recovery 3 days after onset
1927	Reid, J.: Practitioner 93: 723-730, 1927	Relief of 10% calcium gluconate combined with 10 grains (0.65 Gm.) of calcium carbonate orally, and 50 grains (3.25 Gm.) of sodium bromide every day for 3 days and sodium bicarbonate orally, and sodium bromide of endocrine glands, galvamic current and sedatives, extracts of hydrotherapy advised	Temporary improvement; bromides and scopalamine advised against
1932	Sauer, R.: J. de neurol. et de psychiat. 32: 307-314, 1932	10 cc. of patient's cerebrospinal fluid given intravenously every week for 7 weeks	Good
1946	Brewster, E. S.: J. Nerv. & Ment. Dis. 93: 723-730, 1941	Galvanic stimulation of muscles and large doses of quinine	No change in symptoms
1943	Keschner ⁵	Galvanic stimulation of muscles and large doses of quinine	Good
1943	Piticariu, cited by Keschner ⁵	Galvanic stimulation of muscles and large doses of quinine	No change in symptoms
1946	Walker, E. F. and Chaney, W. E.: J. Nerv. & Ment. Dis. 103: 234-238, 1946	Galvanic stimulation of muscles and large doses of quinine	No change in symptoms

Friedreich's ataxia (hereditary sclerosis, spinal form) (Keschner⁵), the treatment is reported as best confined to the initial disease.

It is the purpose of this paper to present a case of paramyoclonus multiplex of Friedreich in a woman with a chronic psychosis, to comment on the differential diagnosis of the condition and to report the results of various stimulants and therapeutic procedures used.

PRESENTATION OF A CASE

History.—A white woman aged 46 was seen first at the Duke Hospital in September 1941, complaining of headaches and a draining left ear of thirteen years' duration. She had taken large quantities of bromide powders for relief

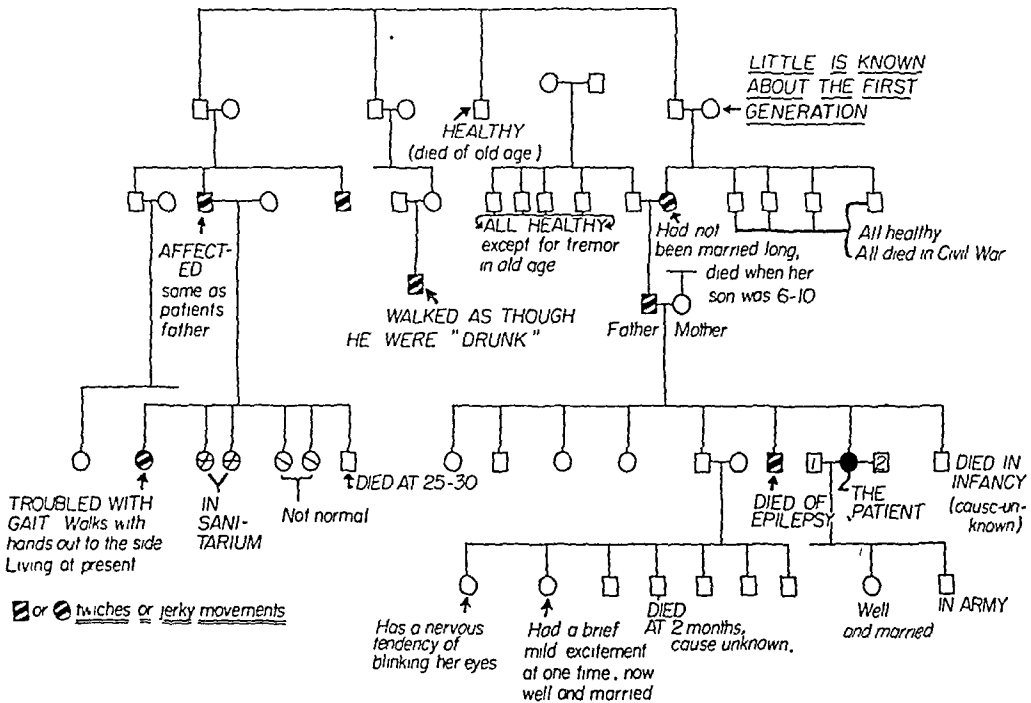

Fig. 1.—Chart illustrating the family history in the case reported. The presence of familial ataxias is suggested in the second generation. There was only 1 instance of idiopathic epilepsy in four generations. Although no relative was shown to have paramyoclonus multiplex, the family history indicates that many members of the family had regressive neurologic disorders.

of headaches, and when examined the blood bromide level was 77 mg. per hundred cubic centimeters. A diagnosis of bromidism with emotional upset, acetanilid poisoning, chronic otitis media and chronic mastoiditis on the left side, septal perforation and deficiency anemia was made. Her hemoglobin concentration was 62 per cent of normal (15.5 Gm. represents 100 per cent). She was advised to return for further study, but she failed to do so.

The patient was not seen again until December 1942. She was referred with the diagnosis of Huntington's chorea. Her family history is shown in figure 1. Born of a normal, uncomplicated delivery, she had a healthy childhood but was always sensitive and was reared by a strict mother. She began school at the age of 6 years and completed five grades before she was forced to stop because

of sickness in the immediate family. She then worked until she was married, at the age of 16 years. She had two children. Her husband drank heavily, and she experienced epigastric pains and jerking sensations whenever he drank. Eventually she was told that she would die because of her nervousness if she did not leave her husband. After seven years of marriage, she separated from him and returned home to live. Here she regained her health and was well until five years later 1924, when she had a sudden pain in the left hypochondrium, after which a cholecystectomy, appendectomy, dilation and curettage were done. From that time she suffered from dysmenorrhea and had considerable menstrual irregularity. She began to take bromide powders. She was admitted to the North Carolina State Hospital at the age of 30 for nervousness, gastric trouble, trembling and vomiting. Here she remained thirty days. At the age of 32 she had a mastoidectomy on the left side. A persistent chronic drainage from the ear followed. At 32 she remarried, and her husband has now been in the Army for twenty-three years. According to the social service report, he was a good husband and did most of the housework. He gave his wife drugs to alleviate such symptoms as a feeling of nervousness, headaches, nausea, vomiting and sinus pains. At 37 she had a tonsillectomy, and at 39 she had an operation on the sinuses.

At 43 she began to have burning in her feet, which occasionally spread as high as the waist. In June 1941, at the age of 45, she became weak and was treated with injections of estrone, which improved her condition temporarily. In August 1941 she noticed numbness and a "funny feeling" in her feet, which increased and spread up her legs, producing a feeling "like icicles on the back of my legs." She was advised to discontinue the use of bromide powders, which she did.

In January 1942 her husband left with the Army, and she returned home to live with her parents. Here she had repeated head colds, a draining left ear, poor appetite, gastric pains, attacks of vomiting and vague pains in her back. She took many drugs but became progressively worse. In June 1942 she voluntarily requested admission to the North Carolina State Hospital, where she was treated for two months for drug addiction. Five days after discharge she reapplied for admission and was kept an additional thirty days. She again left the hospital and after eight days returned for the third time. She was kept until December 1942, when she was transferred to the Duke Hospital. She had made many charges against the hospital and finally added that she became so scared she thought they were going to kill her.

Examination.—Physical examination revealed tenderness over the frontal and maxillary sinuses; chronic otitis media on the left side; complete adentia; two abdominal operative scars; mild cervicitis; external hemorrhoids; thoracic scoliosis, with concavity to the left; paresthesia in the feet and the lower portions of the legs (in the form of numbness for the most part), and frequent spontaneous myoclonic movements of the small toes, especially the second, third and fourth. These movements were symmetric in the region of appearance on the two feet, but asynchronous twitches occurred on the two sides, with considerable irregularity in rate and some variation in excursion. The movements seldom involved the great toes. They were accompanied with pronounced tightening of the long extensor tendons of the affected toes and at times with more extensive waves of movement (myokymia) in the entire calf on either side, particularly on the left. The movements of the small toes could be suppressed at will, though only momentarily, and were virtually eliminated for a longer time by voluntary muscular action of the feet and toes, including constant voluntary pressure of the foot down or back against resistance. The movements were accentuated when the patient was

recumbent. The muscular tone was rather flaccid. The tendon jerks were strikingly exaggerated throughout, with the ankle jerks relatively less accentuated, though brisk. The abdominal reflexes were definitely present only in the upper quadrants. An inconstant response was obtained to stimulation with cotton on the backs of the feet and toes and to pinprick on the pad of the small toe of each foot; the vibratory sense was retained at the wrists and ankles and on the pads of the toes; passive movements were intact, but inconstant responses were obtained to movements made with the small toes. The skin of the body was pallid, with much darker skin on the lower portions of the legs; and a rather pronounced white dermatographia, both to blunt and to sharp strokes on the skin of the trunk and abdomen, was found. Tests of coordination did not suggest ataxia.

The twitches disappeared during sleep, and the electrical reactions were normal. Her hemoglobin concentration was 77 per cent (15.5 Gm. represents 100 per cent); the red blood cells numbered 4,210,000 and the white blood cells 6,600, with a

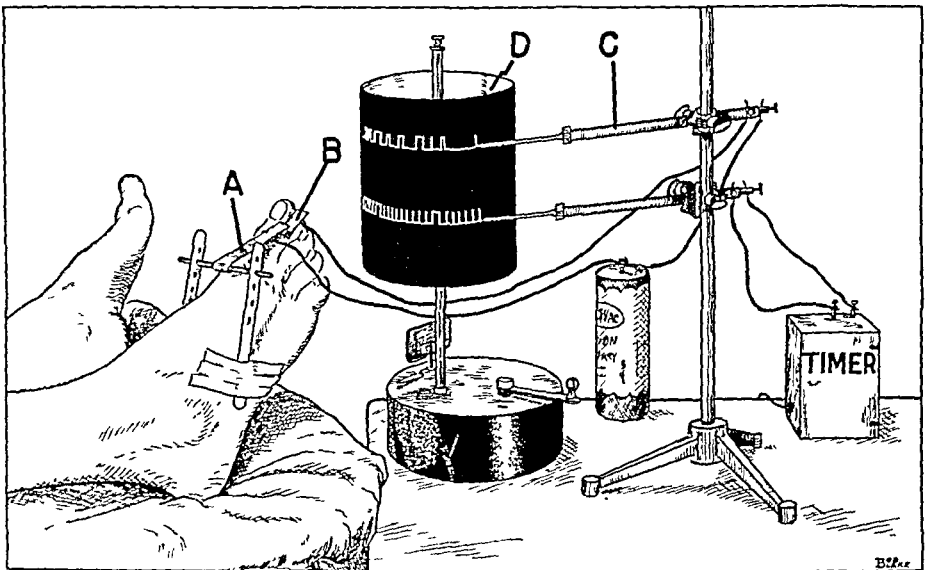

Fig. 2.—Apparatus used in recording the abrupt, bilaterally symmetric twitches affecting the distal muscles of the toes. Contact between points *A* and *B* complete an electrical circuit in series, with a recording electromagnetic timer (*C*). Each dorsal flexion of the toe allows the circuit to be completed, thus marking the contraction on the smoked drum (*D*).

normal differential formula. The Kahn and Kline reactions of the blood were negative. The Weltmann coagulation band was 7. The blood bromide level was normal; the dextrose tolerance test was normal, and serum calcium was 9.5 mg. per hundred cubic centimeters. The phosphorus measured 3.5 mg., and the chlorides 546 mg., per hundred cubic centimeters; the sodium content was 142 milliequivalents, and the potassium 4.6 milliequivalents per liter. The chloride excretion tests gave normal results, and the gastrointestinal series was normal. The spinal fluid dynamics were normal; the protein of the fluid measured 54 mg., the sugar 68 mg. and the chlorides 702 mg., per one hundred cubic centimeters, with a negative Wassermann reaction, and normal colloidal gold and colloidal mastic curves.

Röntgenologic examination of the entire body revealed some fibrosis radiating from the left hilus of the lungs; a definite, but slight, prominence of the vascular markings in the middle meningeal region of the skull; midthoracic scoliosis, with

slight osseous reaction along the right margins, and a fractured ninth rib on the right side.

The electroencephalogram showed low amplitude waves from all regions of the head. Small, rounded, 20 per second waves were scattered throughout the tracings. The recording was not definitely abnormal.

With the Binet form L, the mental age was 14 years 2 months (chronologic age, 56 years), and the intelligence quotient, 94. She was particularly at ease with words but did not do so well in arithmetic reasoning or any other kind of problem situation.

During her six week stay in the Duke Hospital, she was cooperative but insisted on being given numerous medicaments, such as nose drops, ferrous sulfate, vitamins, sedatives, laxatives and "cough syrup." She was given intramuscular injections of liver extract every day, infra-red radiation to the sinuses and massage of the legs, and she had a hemorrhoidectomy. She was discharged in care of her daughter, it being against her will to leave the hospital.

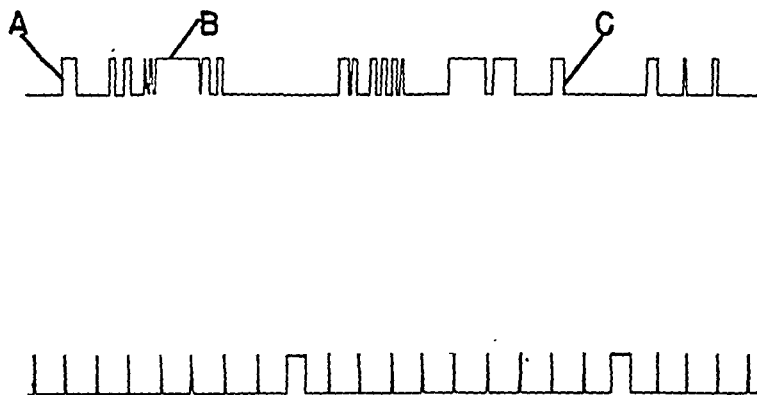

Fig. 3.—Kinetographic tracing (above) of movements of the toes while the patient was at rest. The upstroke (*A*) represents the dorsal flexion of the toes; the broad upper horizontal continuation of the upstroke (*B*), the sustained length of the contraction, and the downstroke (*C*), the release of dorsal contractibility. Below, the time is recorded in seconds.

KINETOGRAPHIC STUDY

Method.—The apparatus shown in figure 2 was used in all recordings. Records of three contractions occurring while the patient was at rest are shown in figure 3. Since the four smaller toes contracted at the same rate, it was necessary to record the movements of only one toe. The apparatus and toes were shielded from the patient's vision in all the recordings shown here.

Observations.—The observations recorded in this report (table 2) suggest that histamine iontophoresis applied over the motor points of the affected muscles and the avoidance of excitement are valuable adjuncts in the treatment of paramyoclonus multiplex. Histamine iontophoresis reduced the twitches from 51.2 to 13.3 per minute in ten minutes on one occasion and from 12.4 to 0.8 per minute in thirty minutes. After insult she cried, and the number of twitches increased from 30.6 to 54 per minute within ten minutes. It is interesting, in view of her psychic abnormalities, that repeated suggestion together with intramuscular injections of isotonic solution of sodium chloride did not change the rate of twitching. Nerve block with procaine offered cessation of twitching for two hours and fifteen minutes. Spinal anesthesia (100 mg of procaine hydrochloride) abolished the twitches bilaterally prior to motor weakness. Presence of the Babinski sign and intactness of

TABLE 2.—Results of Various Stimuli Used in Study of a Psychotic Patient with *Paramyoclonus Multiplex**

Agent	Stimulant	How Used	Amount Used	Effect (Twitches per Min. for 10 Min.)		Comment
				Prior to Application of Stimulant	After Application of Stimulant	
Neostigmine methylsulfate (1:2,000 solution = 0.5 mg.) Histamine phosphate U. S. P. (1:1,000 solution in distilled water)	Intramuscularly (in right arm)	1 cc.	1/11/43, 51.2	21.0	11.6	Patient remained cheerful throughout; talked of husband overseas Patient cheerful; talked of nephew, of whom she held picture in hand Brief pallor, followed by reddening and formation of temporary arterial wheal
				5 volts	1/20/43, 42.4	
Sterile isotonic solution of sodium chloride	Intramuscularly (in right arm)	3 cc.	31.0	31.0	32.0	Patient cooperative throughout, talked of friends at home; solution used several times by injections in hip, with similar results No change in pulse, temperature or respiration Respirations reduced by 2 per min.; no change in blood pressure or size of pupils; drug produced slight drowsiness, followed by light sleep in 1-2 hr., during which time twitches completely disappeared Results obtained four days postoperatively, nausea; no increase in sweating or change in blood pressure; nausea relieved after stimulation begun
				3 cc. (1%) 0.25 Gm. in 20 cc. isotonic saline solution	32.0 27.6	
Procaine hydrochloride U. S. P. Amytal sodium	Intramuscularly Intravenously	5 volts	21.1	23.1	No twitches appeared after 10 min., until 30 min. later; patient cooperative but tired; return to normal control rate in 145 min.; no general effects from procaine	
Mecholyl	Iontophoresis	5 volts	11.3	0.4		
Procaine hydrochloride U. S. P. (nerve block)	Infiltration around common and superficial peroneal nerves	Sufficient to produce anesthesia but not to block movement	22.9	30.6	Patient reactive, complained, felt that no benefit would come from such irritation	
Pinehik	Mechanically	5 min.	21.5	26.8	Patient complained of being afraid of burning blisters on feet; withdrew foot several times	
Heat	Hot metal tubes applied over dorsal surface of skin	Touching intermittently for 5 min.	30.6	54.0	Tears came; patient turned head away; examiner left the room	
Excitement	Scolded	5 min.	41.4	18.1 (all twitches disappeared at end of 7 min. and remained absent thereafter for 50 min.)	Preoperative dose of 1/150 grain (0.4 mg.) atropine; motor power never lost; anesthesia within 2 min.; hemorrhoidectomy begun 11 min. after anesthesia; Babinski sign present 1 min. prior to return of twitches; temperature sense returned 2 min. prior to return of twitches	
Procaine spinal anesthesia	Subarachnoid injection into third lumbar space	100 mg.				

* All results were obtained with the patient in the recumbent position. The recording apparatus was shielded from the patient's vision at all times.

the temperature sense prior to the return of twitches are interesting data for speculation concerning the origin of the twitches. Neostigmine methylsulfate used intramuscularly reduced the rate of twitching by one half. Sodium amytal and mecholyl iontophoresis offered no improvement in the number or the severity of the twitches.

COMMENT

The diagnosis of paramyoclonus was based on the occurrence of abrupt twitches in bilaterally symmetric muscle units, asynergic involvement and implication of distal muscle groups, all in the absence of other signs of involvement of the central nervous system. Many diagnoses were eliminated before the final diagnosis of paramyoclonus multiplex was reached. Syphilis was eliminated on the basis of the negative serologic reactions. Epilepsy was ruled out on the basis of the negative personal history, the lack of electrographic equivalents and the absence of epileptic stigmas. Although one brother had idiopathic epilepsy, the patient did not. Consequently, the diagnosis of Unverricht's⁹ myoclonus epilepsy seemed unlikely. However, the familial disturbance of jerky movements and twitches is confusing (fig. 1). Poisoning from black widow spider bite could not be substantiated in the absence of boardlike abdominal rigidity, fever, leukocytosis or cyanosis. Trichinosis without facial edema, fever, involvement of the lids or eosinophilia, and in the presence of repeated negative examinations of the stools, was ruled out. The history and physical examinations did not suggest poisoning by arsenic or lead. Neuritis, as judged by tenderness of the nerve to pressure, was not encountered. Tetany seemed unlikely when calcium gluconate offered no relief. The Chvostek sign and carpopedal spasm were absent. Epidemic encephalitis deserves attention in view of the delusion and hallucinations; but in the absence of atrophy of the affected muscles, fever, leukocytosis, headache and facial, uvular and pharyngeal myoclonia it was ruled out. In hysteria muscular twitches conform to pattern movements, tend to be purposeful and probably would not eliminate the large toes, whereas the twitching in this case remained localized to the smaller four toes of each foot. Repeated psychic trauma was suffered; drug addiction (bromides) resulted, and the patient presented a maladjusted family history. Finally, after careful psychiatric studies by several examiners, it was concluded that the twitches were organic. Absence of rapid, violent, rhythmic movements; fever; muscular atrophy; occasional convulsions, and a fatal outcome would differentiate this condition from the electric chorea of Dubini. *Maladie des tics impulsif* is more widespread, involves the face and is characterized by definite movements. Careful analysis of the family history

9. Unverricht, H.: Die Myoklonie, Berlin, Franz Deuticke, 1891; Ueber familiäre Myoclonie, Deutsche Ztschr. f. Nervenhe. 7:32-67, 1895.

(fig. 1), absence of choreic movements and absence of progressive mental deterioration would seem to rule out a diagnosis of Huntington's chorea.

Galvanism, sedatives, chloral hydrate, hydrotherapy, rest and avoidance of excitement have been the most popular forms of treatment.

SUMMARY AND CONCLUSIONS

Mechanographic recordings of muscular twitchings and their change in rate after administration of various stimuli, summarized in table 2, were made in a case of paramyoclonus multiplex in which distal muscle groups showed abrupt twitches of bilaterally symmetric muscle units, with asynergic involvement. The literature abounds in methods of treatment, reflecting the obscurity of the disorder. The differential diagnosis of paramyoclonus multiplex involves the consideration of a rather large number of allied possibilities.

The results obtained with various stimuli suggest that, in addition to the general measures outlined in table 1 for the treatment of paramyoclonus multiplex, histamine iontophoresis may be helpful. They also emphasize the importance of avoiding excitement.

525 Physicians and Surgeons Building, Memphis 3, Tenn.

RETINAL PERIPHLEBITIS ASSOCIATED WITH PARAPLEGIA

B. P. SILFVERSKIÖLD, M.D.
STOCKHOLM, SWEDEN

RETINAL periphlebitis is a disease with recurrent hemorrhages into the vitreous and usually occurs in young men. The pathologic characteristic of the disease is a chronic inflammatory exudate within the walls of the vessels, being confined principally to the veins.

Retinal periphlebitis is believed to be due to an inflammation of infectious or toxic origin. It is not a clinical expression of a single disease. It has been found associated with cerebral vascular lesions. The most striking form is juvenile retinoangiopathy, or Eales's disease—recurrent intraocular hemorrhages in young adults. The etiologic factor has not been established; the cause may be a tuberculous, septic focus or thromboangiitis obliterans (Buerger's disease). The condition is found in young adults who have retinal and recurrent vitreal hemorrhages and thromboses, frequently leading to proliferating retinitis, detachment of the retina and glaucoma.

The 3 patients whose cases are reported here were under observation during 1943 and 1944 at the neurologic clinic of the Serafimer Hospital, Stockholm.

CASE 1.—S. Z., a workman aged 27 (1944).

Ocular Disease.—1939: There were retinal periphlebitis of the left eye and proliferating retinitis of the right eye.

March 28, 1939: Right Eye: Opacities were observed in the vitreous, some of them grayish white and others blood colored. Left Eye: No changes were noted.

Jan. 9, 1940: Examination of the right fundus showed large streaks with proliferating vessels.

February 13: Visual acuity was 1/60 in the right eye and 1.0 in the left eye. The right fundus showed white streaks, which were partly vascularized; the left fundus presented hemorrhages inferior to the disk; no hemorrhages were seen in the vitreous.

April 18, 1944: While lifting a heavy car, the patient felt a stab of pain between the shoulder blades, and simultaneously a dark streak appeared before the left eye. The diagnosis was retinal periphlebitis and hemorrhages in the vitreous of the left eye and complicated cataract of the right eye.

The right eye was amaurotic, with total cataract; the left eye had a visual acuity of 0.7; the vitreous was diffusely clouded. Downward, over a considerable area, were visible confluent retinal hemorrhages, with white streaks running along some of the veins. Centrally, only a small hemorrhage was present, just at the disk.

From the neurologic clinic, the Serafimer Hospital (Serafimerlasarettet).

May 2: Visual acuity was 0.9 in the left eye. The hemorrhage was resorbed for the most part.

Sept. 30, 1944: Large isolated opacities were noted in the left eye; some branches of the inferior temporal vein showed sheathing; no fresh changes were apparent.

Neurologic Disease.—May 1944: There was fairly rapidly progressing paraplegia, with incontinence of the urine and feces. After several weeks the legs were almost paralyzed, and the lower halves of the abdominal rectus muscles became parietic. The abdominal and cremasteric reflexes were absent. The muscle reflexes of the legs slowly became exaggerated. The plantar reflexes were of extensor type.

In the figure, *A* shows the area in which sensibility to temperature and pain was lost or reduced. Tactile sensibility and deep sensibility to movements in the toes were not affected to begin with but were later impaired.

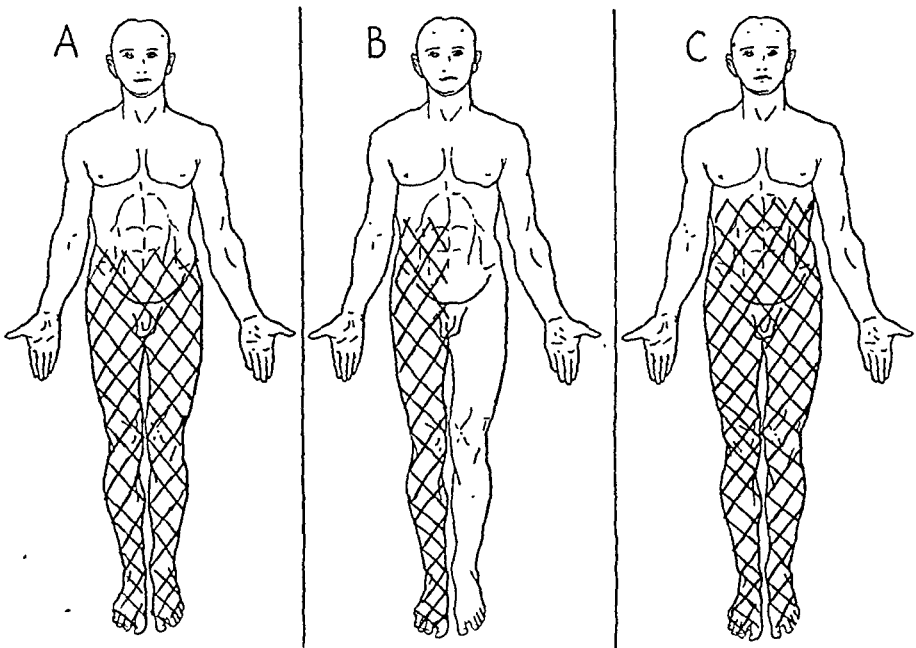

Area of loss or reduction in temperature and pain sensibility (*A*) in case 1, (*B*) in case 2 and (*C*) in case 3.

June 1944: The first examination of the cerebrospinal fluid (lumbar puncture) showed 248 mononuclear cells, 10 polymorphonuclear leukocytes and 21 red cells per 3.2 cu. mm. The mastic curve was 000033. The Pandy reaction was positive. The Nonne-Apelt reaction was negative.

October 1944: On the patient's arrival at this hospital, the cell count was 59 mononuclear cells and 30 polymorphonuclear leukocytes. The total protein of the fluid was somewhat increased; the nitric acid test gave values of H 20 to 40, which correspond to 0.05 to 0.09 Gm. per hundred cubic centimeters.¹ The Wassermann

1. The total protein determinations were carried out with the nitric acid test (Bisgaard's method), which is widely used in Scandinavia. The corresponding absolute total protein values are given according to S. Izikowitz (Methodological and Clinical Studies on Total Protein, Globulin and Albumin Concentrates in the Lumbar Fluid, Stockholm, Karolinska Institutet, 1941).

and Müller conglobation (*Ballung*) reactions were negative. The guinea pig test was negative for tuberculosis. The Loewenstein culture was negative for tubercle bacilli.

Roentgenographic Examination.—The lungs and the spine appeared normal. Myelographic examination with oxygen (cisternal puncture) showed no changes (Lysholm).

Progress.—The general condition was good. The blood pressure was 125 systolic and 80 diastolic. There was no fever. The sedimentation rate was 16 mm. in one hour. The Mantoux test gave a positive reaction. The Wassermann and the Müller conglobation reaction of the blood were negative.

In November 1945 the legs were somewhat less paretic. The general condition was good.

CASE 2.^{1a}—H. B., a porter aged 35 (1943).

Ocular Disease.—At the end of April 1943 some failure of vision was noted in the left eye. Visual acuity was 1.0 in the right eye and 0.7 in the left eye.

Left Eye: Many fine opacities were present in the vitreous; widespread periphlebitic changes with vascular sheaths and fresh hemorrhages were scattered through the fundus, but were most conspicuous temporally and downward.

July 24: Fresh hemorrhages were seen in the left eye.

September 9: Large central hemorrhages concealed the central part of the retina of the left eye and extended into the vitreous. Visual acuity was 2/50 in this eye. The right eye showed no changes.

October 6: Visual acuity in the left eye was limited to ability to count fingers at 30 cm. Small fresh hemorrhages and large organized hemorrhages were present in the central part of the eye.

The diagnosis was retinal periphlebitis of the left eye.

Neurologic Disease.—In June 1943 there was paresis of the bladder; in July 1943, fairly rapidly progressive (in two weeks) paralysis of the legs. The left leg was finally almost completely paralyzed; the strength of the right leg was somewhat less impaired. The abdominal and the cremasteric reflexes were absent but returned several months later. The muscle reflexes gradually became exaggerated. The plantar reflexes were of extensor type.

In the figure, *B* shows the area of loss of pain and temperature sensibility. Tactile sensibility and deep sensibility to movements in the toes were moderately impaired in both legs.

July 1944: The first examination of the cerebrospinal fluid (lumbar puncture) showed 156 mononuclear cells, 4 polymorphonuclear leukocytes and 128 red cells per 3.2 cu. mm. The Pandy test showed traces of globulin. The Nonne-Apelt reaction was negative. There was no definite excess of protein. (The nitric acid test gave values of 10-20, which correspond to 0.03 to 0.05 Gm. per hundred cubic centimeters). The mastic curve was 00010000. The Wassermann and the Müller conglobation reactions were negative. The guinea pig test twice gave a negative reaction for tuberculosis. The Loewenstein culture was negative for tubercle bacilli.

1a. The patient in this case was demonstrated by Dr. E. Franke at a meeting of the Swedish Neurological Association (*Periphlebitis retinae och övergående fokal myelit med Brown-Séquard's syndrom och spinalt block i anslutning till B.C.G. vaccination*, Nord. med tidskr. 23:1496-1497, 1944).

Myelographic examination (Lindgren) with oxygen (by lumbar puncture only) revealed a tumor at the level of the fifth dorsal vertebra (?); somewhat later neurosurgical exploration (Norlén) showed no signs of tumor or arachnoiditis. Roentgenographic examination of the lungs and the spine revealed nothing abnormal.

Progress.—The general condition was good. The blood pressure was 160 systolic and 100 diastolic in June 1943 and 120 systolic and 90 diastolic in July 1943. There was no fever. The sedimentation rate was 4 mm. in one hour. The Wassermann, Kahn and Müller conglobation reactions of the blood were negative. Calmette (BCG) vaccination had been done six months before the illness. The Mantoux reaction was now positive.

From August 1943 there was slow improvement. The patient has been working since the autumn of 1944. He now walks with a stick (September 1945).

CASE 3.—R. S., a salesman, aged 30 (1944).

Ocular Disease.—1932: There was retinal periphlebitis of the right eye.

1934: Retinal periphlebitis was present bilaterally. Visual acuity was 0.2 in the right eye and 1/60 in the left eye. In the left eye, large hemorrhages were present in the vitreous. In the fundus a large hemorrhage lay temporally and downward. In the right eye, abundant minute hemorrhages were present in the vitreous, with papillitis, fresh choroiditis inferior to the disk and perivascular changes in the peripheral parts. The patient was treated with injections of tuberculin. Later more hemorrhages appeared.

1935: At the last examination, visual acuity was 0.5/60 in the right eye and 1/60 in the left eye. Since 1936 no more ocular troubles have occurred.

1944: Visual acuity was 1.0 in the right eye and 0.6 in the left eye. The optic disk was somewhat red, with blurred edges and remnants of exudate on the right disk. Bilaterally white streaks extended into the vitreous.

Neurologic Disease.—May 1944: There was fairly rapidly progressive (in three days) paraplegia and paresis of the bladder. The right leg became paralytic; the left leg became somewhat stronger. The abdominal reflexes were lost. The muscle reflexes of the legs were weak to begin with; the plantar reflexes were extensor in type.

In the figure, *C* shows the area of loss of pain and temperature sensibility. Tactile sensibility was almost unimpaired. Deep sensibility to movements in the toes was lost on the right side and reduced on the left side.

May 1944: The first examination of the cerebrospinal fluid (lumbar puncture) revealed 50 mononuclear cells, 15 polymorphonuclear cells and 224 red cells per 3.2 cu. mm. The Pandy reaction for globulin was positive; the Nonne-Apel't reaction showed traces of globulin. The mastic curve was 00012210. The total protein was somewhat increased. (The nitric acid test gave values of 20 to 40, which correspond to 0.05 to 0.09 Gm. per hundred cubic centimeters.) The Wassermann and the Müller conglobation reactions were negative. The guinea pig test gave a negative reaction. The Loewenstein culture was negative for tubercle bacilli.

Myelographic examination with oxygen (cisternal puncture) revealed nothing abnormal (Lysholm). Roentgenographic examination of the spine showed a normal condition.

Progress.—The general condition was good. The blood pressure was 120 systolic and 80 diastolic in May 1944. There was no fever. The sedimentation

rate was 2 mm. in one hour. The Wassermann, Kahn and Müller conglobation reactions of the blood were negative.

Since July 1944 the patient has been gradually recovering. However, he is still using a wheel chair (September 1945).

In these 3 cases the following essential symptoms were present: (1) a characteristic retinal periphlebitis with recurrent hemorrhages into the vitreous followed by (2) paraplegia with paresis of the bladder and reduced sensibility mainly for pain and temperature (in 1 of the cases there was unilateral reduction only, the picture resembling a Brown-Séquard syndrome) and (3) pleocytosis.

Cases of retinal periphlebitis combined with neurologic disturbances have certainly been described in the literature. In these earlier cases, however, the neurologic symptoms, such as epileptic fits, diplopia and hemiplegia, were not characteristic.

Ballantyne² (1909) observed a picture resembling retinal periphlebitis in 2 patients with renal disease and epileptic fits; later (1937), with Michaelson,³ he described a beautiful case of retinal periphlebitis in a patient with epilepsy of many years' duration and psychic disturbances. Loewenstein,⁴ in 1931, reported a case of obvious retinal periphlebitis and, in 1934, a case of iridocyclitis, in both of which the ocular condition was combined with disseminated neurologic disturbances. He concluded that he had found cases with tuberculosis of the cerebral vessels. Ter Braak and van Herwaarden (1933)⁵ reported cases of what they called ophthalmoenkephalomyelitis, in which the neurologic symptoms resembled disseminated sclerosis (with slight abnormality of the cerebrospinal fluid); the ocular symptom, however, were not characteristic in most of the cases. Marchesani and Stauder⁶ (1935) reported cases in which retinal periphlebitis was more or less closely associated with such conditions as hemiplegia, diplopia and aphasia; the cerebrospinal fluid was not examined. The last-named authors expressed the belief that the morbid picture in their cases was due to thromboangiitis obliterans (Buerger). From some of these articles, one gets the impression that a combination of the ocular disease with neurologic symptoms is fairly common.

2. Ballantyne, A. J.: Transient Convulsions in Two Children with Unusual Changes in the Fundus Oculi, *Ophthalmoscope* 7:662, 1909.

3. Ballantyne, A. J., and Michaelson, I. C.: Case of Perivasculitis Retinae Associated with Symptoms of Cerebral Disease, *Brit. J. Ophth.* 21:22 (Jan.) 1937.

4. Loewenstein, A.: Ueber ein neues Krankheitsbild: Lähmung jugendlicher Individuen als Folge von Blutung aus tuberkulösen Hirngefässen, *Med. Klin.* 27:879-880 (June 12) 1931; Mitteilung über das Krankheitsbild: Rezidivierende Lähmungen als Folge von Blutung aus tuberkulöserkrankten Hirngefässen, *ibid.* 30:868-870 (June 29) 1934.

5. ter Braak, J. G., and van Herwaarden, A.: Ophthalmo-Encephalo-Myelitis (Encephalomyelitis Disseminata [Multiple Sklerose] mit ungewöhnlichen Augenscheinungen), *Klin. Monatsbl. f. Augenh.* 91:316-343 (Sept.) 1933.

6. Marchesani, O., and Stauder, K. H.: Ueber cerebrale Symptome bei Periphlebitis retinae (Angiopathia retinae juvenilis), *Arch. f. Augenh.* 109:281-303, 1935.

It seemed that in these cases the connection between the neurologic symptoms and the ocular disease had too readily been assumed, and for that reason I made an investigation of the incidence of the disease at this clinic.

Retinal periphlebitis is not a common disease. The patient is usually treated in the hospital; nevertheless, only 25 patients with the disease were cared for at the ophthalmologic clinic in Stockholm during the ten year period from 1930 to 1939. The total number of patients at the clinic during the same period was 9,023.

Retinal periphlebitis is rarely seen at the neurologic clinic. I reviewed all 5,500 cases for the ten year period from 1930 to 1939 and found only 1 case in which retinal periphlebitis (residual) could be suspected. The neurologic diagnosis in this case was "encephalopathia chronica; sclerosis disseminata?", and the case is thus another of the type described earlier in the literature.

In order to find out whether retinal periphlebitis is commonly complicated by neurologic disturbances, I also made a follow-up study of the 25 patients with ophthalmologic disorders, the period of observation extending over six to fifteen years. Answers were received from 22 of the patients; none of them had any neurologic disease.

Neurologic complications of retinal periphlebitis must therefore be rare, and earlier investigations are probably misleading on this point. The fact that isolated instances of retinal periphlebitis occur in the great and heterogenous group of cases of chronic encephalopathia and the like evidently does not justify the conclusion that a correlation exists. In the present cases, however, the rare ocular disease appeared as the precursor of an uncommon and characteristic neurologic disorder (the interval between the ocular and the neurologic disease being short, in 2 of the cases). When 3 cases have been found, it seems justifiable to speak of a syndrome.

With regard to the etiologic factors, 5 of these 22 patients had been treated at a sanatorium for tuberculosis of the lungs during the follow-up period, and 2 of them had died. This is of interest, many authors having stated that retinal periphlebitis is a form of tuberculosis. Other causes are possible, however, and the etiologic agent in the present cases must be regarded as unknown. One can, of course, make the guess of disseminated sclerosis, but there is nothing to prove the validity of such an assumption, which would involve the hazardous hypothesis that *sclerose en plaques* can exist as retinal periphlebitis in the anterior part of the eye. Moreover, paraplegia with dissociated sensory loss of this type is not common in cases of disseminated sclerosis.

SUMMARY

Three cases of a remarkable syndrome are described. The patients were all young men about 30 years of age. First they exhibited characteristic retinal periphlebitis with recurrent hemorrhages in the vitreous. After varying intervals of time, four to six weeks only in 2 cases, the ocular disease was followed by subacute paraplegia, with considerable pleocytosis.

During a follow-up period of one to two years the patients were observed to show improvement in varying degrees.

An investigation showed that a combination of retinal periphlebitis and neurologic disease is rare.

Serafimerlasarettet.

CONGENITAL FACIAL PARALYSIS

J. P. MURPHY, M.D.
AND
W. J. GERMAN, M.D.
NEW HAVEN, CONN.

FACIAL paralysis occurring in infancy and childhood may be acquired or congenital. If the former, it is thought to be due to obstetric trauma, is almost always unilateral and is not accompanied with paralysis of other cranial nerves.¹ Congenital facial paralysis, on the other hand, is usually bilateral. Paralysis of the abducens nerves is an almost invariably associated finding, and there are often other evidences of faulty development of the brain stem and cervicobrachial region.²

The occurrence of congenital facial palsy and its association with extraocular paralysis was first described by von Graefe, in 1880, and by Möbius, in 1888 and 1892.^{2f,g} Since that time reports of over 60 cases have appeared in the literature and have been collected by Henderson.^{2f} Of differential diagnostic interest, especially in the event of the rare unilateral case, is that the superior group of facial muscles is always more severely affected than the lower group.^{2b,e} Many combinations of developmental defects accompanying facial diplegia and paralysis of the abducens nerve have been reported. These include paresis or paralysis of the oculomotor, motor trigeminal, glossopharyngeal and hypoglossal nerves, clubfoot and malformation of the upper extremity and chest. In 8 cases there was hypoplasia of one pectoral

From the New Haven Hospital.

1. Bonar, B. E., and Owens, R. W.: Bilateral Congenital Facial Paralysis, *Am. J. Dis. Child.* **38**:1256 (Dec.) 1929.

2. (a) Thomas, H. M.: Congenital Facial Paralysis, *J. Nerv. & Ment. Dis.* **25**:57, 1898. (b) Vogt, O.: Infantile Beweglichkeitsdefekte im Bereich der Hirnnerven, in Lewandowsky, M.: *Handbuch der Neurologie*, Berlin, Julius Springer, 1911. (c) Schmidt, A.: Angeborene multiple Hirnnervenlähmung mit Brustmuskelfect, *Deutsche Ztschr. f. Nervenhe.* **10**:400, 1897. (d) Fry, F. R., and Kasak, M.: Congenital Facial Paralysis, *Arch. Neurol. & Psychiat.* **2**:638 (Dec.) 1919. (e) Ullrich, O., in Bumke, O., and Foerster, O.: *Handbuch der Neurologie*, Berlin, Julius Springer, 1936, vol. 16. (f) Henderson, J. L.: The Congenital Facial Diplegia Syndrome: Clinical Features, Pathology, and Aetiology, *Brain* **62**:381-403, 1939. (g) Hicks, A. M.: Congenital Paralysis of Lateral Rotators of Eyes with Paralysis of Muscles of the Face, *Arch. Ophth.* **30**: 38-42 (July) 1943.

muscle group and mamma, while in 1 instance the musculature of the shoulder girdles was virtually absent.^{2f}

Pathologic examination was made in 4 cases.^{2f} In 2 cases there was gross evidence of hypoplasia of the pons and medulla oblongata, while in all cases the motor cranial nerve nuclei of this region were either absent or composed of pyknotic, hyperchromatic ganglion cells, reduced in number. Bonnevie,³ from a study of a strain of mice (Bagg-

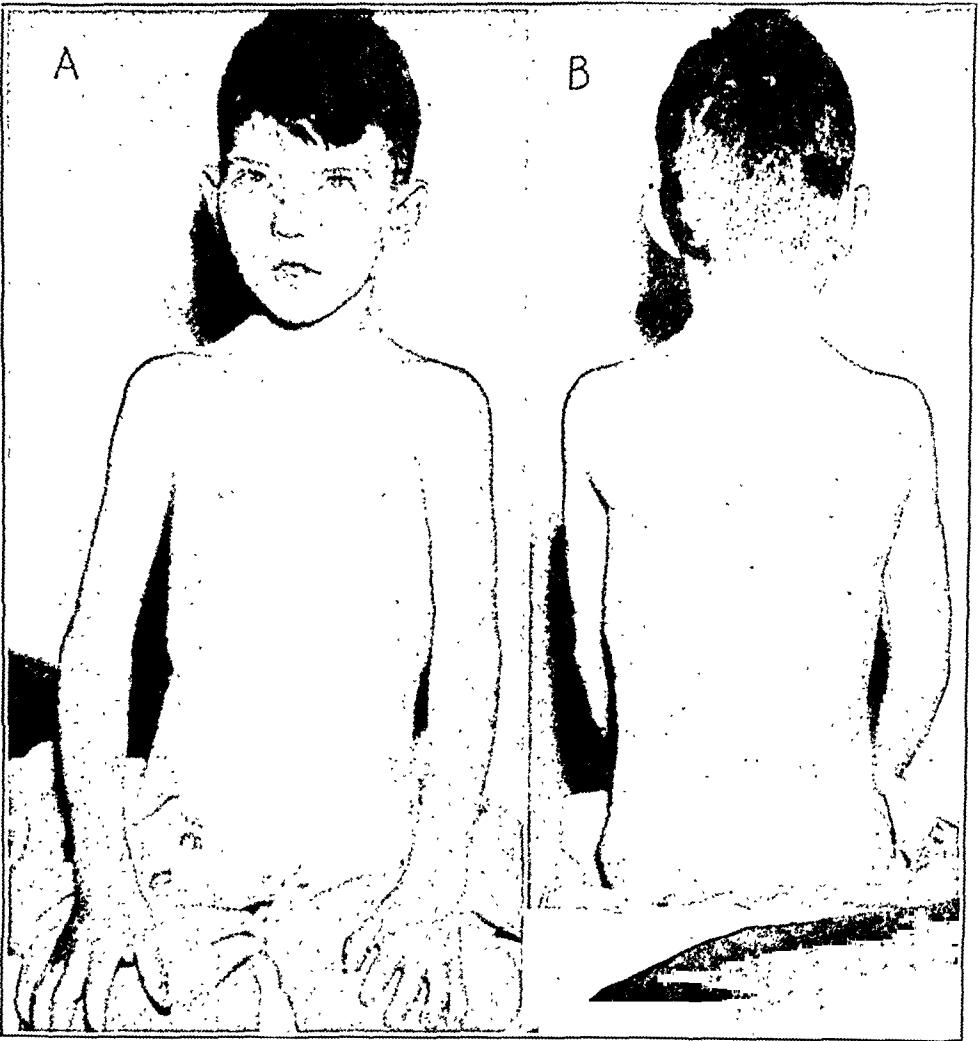

Fig. 1.—*A*, bilateral facial paralysis with associated developmental defects. Note the staring expression, open mouth, hypoplastic left nipple and pectoral muscles and malformed left hand. *B*, posterior view of the same patient, showing small left scapula and virtual absence of the latissimus dorsi muscle on that side.

Little) in which craniobrachial paralysis tends to develop during intra-uterine life, suggested that malformation of the cerebrospinal fluid system is responsible for the development of this condition. There have been no other explanations of the etiologic factor.

3. Bonnevie, K.: Embryological Analysis of Gene Manifestation in Little and Bagg's Abnormal Mouse Tribe, *J. Exper. Zool.* **67**:443, 1934.

The following case is reported not only because of the manifold evidences of agenetic and dysplastic disease of the neuromuscular system but also because of encephalographic findings, thought to indicate hypoplasia of the metencephalon.

REPORT OF A CASE

D. P., a white boy of 8 years, was admitted to the neurosurgical service of the New Haven Hospital on July 19, 1940, because of facial paralysis and maldevelopment of the left hand.

The family history was free from stigmas of congenital defects. The patient was an only child. The mother's course of pregnancy was uncomplicated. The baby was born at full term, spontaneously. He presented an immediate feeding problem—"couldn't get any suction." When the infant was 2 months old, his



Fig. 2.—Encephalogram, right lateral erect projection, showing extreme dilatation of the basal cisterns, particularly the cisterna pontis, the cisterna interpeduncularis and the cisterna chiasmatis.

aunt noticed that he was unable to close the eyelids. It also became apparent that he was unable to look to either side. From early infancy asymmetry of the face was notable and the boy had difficulty in retaining food in his mouth. He drooled almost constantly. He was slow in talking, not being able to form words until the age of 2 years. At 5 years of age it became obvious that the left hand was smaller than the right. There was no evidence of mental defect.

Physical examination revealed a well nourished, friendly and cooperative boy. He had a peculiar unemotional, staring expression, the facies being virtually immobile. The skin of the left half of the face was rough and desquamating; that of the lower eyelids appeared atrophic, and the vibrissae were epilated. There was pronounced bilateral conjunctivitis.

Paralysis of both external rectus muscles was complete. At rest the left eye was rotated inward 15 degrees from the midline. The eyelids could not be closed farther than three-quarters the width of the palpebral fissures. The patient could

not wrinkle the forehead or elevate the eyebrows. The corners of the mouth drooped. The jaw deviated slightly to the left, but the masseters contracted strongly and equally. The gag reflex was sluggish, and the palate was elevated poorly. The mouth remained open, and the patient drooled (fig. 1 *A*).

The skin over the left breast was thin, and the nipple was almost absent. The pectorales, teres major and minor, serratus anterior and latissimus dorsi muscles of the left side of the chest and the left arm were hypoplastic and barely palpable. The left scapula was smaller than the right. The left hand was smaller than the right, and the index and fifth fingers were rather short (fig. 1 *B*).

Encephalographic examination disclosed enlargement of the basal cisterns, particularly the cisterna pontis, the cisterna interpeduncularis and the cisterna chiasmatis. The horizontal distance from the ventral margin of the pons to the floor of the fourth ventricle was decreased from the normal (Davidoff and Dyke⁴; fig. 2).

The rest of the usual laboratory examinations gave results within normal limits.

The multiplicity of physical defects suggests their common developmental nature, and the roentgenographic finding of dilatation of the basal cisterns indicates congenital defect. It is of interest that there was associated maldevelopment of the breast and the muscles of the left side of the chest, as in the cases reported by Schmidt^{2c} and Fry and Kasak,^{2d} among others.

SUMMARY

A case is reported of bilateral facial paralysis, bilateral paralysis of the external rectus, paresis of the muscles of the jaw and palate and defective formation of the musculature of the left side of the chest, the left breast and the left hand. Congenital malformation (nuclear aplasia) of the cranial nerve nuclei is thought to explain the physical defects of the face and eyes. Encephalographic examination disclosed dilatation of the basal cisterns and hypoplasia of the pons.

New Haven Hospital.

4. Davidoff, L. M., and Dyke, C. G.: *The Normal Encephalogram*, Philadelphia, Lea & Febiger, 1937.

COGWHEEL PHENOMENON OF THE EYES

Its Clinical Significance

NATHAN SAVITSKY, M.D.

NEW YORK

AND

N. W. WINKELMAN, M.D.

PHILADELPHIA

THE COGWHEEL phenomenon of the eyes merits further study because of its clinical significance. There is no article on this subject in English. The only comprehensive résumé is one in German by Cords,¹ published as "*Pathologie der Führungsbewegungen*" and consequently completely overlooked for a number of years. The cogwheel phenomenon of the eyes is not mentioned at all in most of the neuro-ophthalmologic texts, such as those of Wilbrand and Sängner,² Posey and Spiller,³ Lapersonne and Cantonnet,⁴ Rea⁵ and Lyle.⁶ Spiegel and Sommer⁷ and Kyrieleis⁸ mentioned it as occurring in postencephalitic paralysis agitans. Adrogué⁹ (1942) referred to the work of Cords.

Javal¹⁰ reported in 1879 that Lamare observed that ocular movements in reading are not smooth or gliding. They are interrupted by "saccadic"

Presented at the Seventy-First Annual Meeting of the American Neurological Association, San Francisco, June 28, 1946.

From the Department of Neurology, Columbia University; the Morrisania City Hospital; the Neuropsychiatric Division, Montefiore Hospital of Chronic Diseases; the Graduate School of Medicine of the University of Pennsylvania, and the Philadelphia Psychiatric Hospital.

1. Cords, R.: *Zur Pathologie der Führungsbewegungen*, Arch. f. Ophth. **123**:173, 1929.

2. Wilbrand, H., and Sängner, A.: *Neurologie des Auges: Ein Handbuch für Nerven und Augenärzte*, Wiesbaden, J. F. Bergmann, 1900-1917.

3. Posey, W. C., and Spiller, W. G.: *Eye and Nervous System*, New York, J. B. Lippincott Company, 1906.

4. Lapersonne, F., and Cantonnet, A.: *Manuel de neurologie oculaire*, ed. 2, Paris, Masson & Cie, 1925.

5. Rea, R. L.: *Neuro-Ophthalmology*, ed. 2, St. Louis, C. V. Mosby Company, 1941.

6. Lyle, D. J.: *Neuro-Ophthalmology*, Springfield, Ill., Charles C Thomas, Publisher, 1945.

7. Spiegel, E. A., and Sommer, I.: *Neurology of the Eye, Ear, Nose and Throat*, New York, Grune & Stratton, Inc., 1944.

8. Kyrieleis, W., in Schieck, F., and Brückner, A.: *Kurzes Handbuch der Ophthalmologie*, Berlin, Julius Springer, 1931, vol. 6, p. 724.

9. Adrogué, E.: *Neurología ocular*, Buenos Aires, El Ateneo, 1942.

10. Javal, E.: *Essai sur la physiologie de la lecture*, Ann. d'ocul. **82**:252, 1879.

movements (Duke-Elder¹¹), the number of jerks remaining constant even though the distance of the text from the eyes varies. In 1891 Landolt¹² noted that the ocular movements were jerky in following a straight line and that the cogwheel phenomenon is more pronounced when the movements are slower. He suggested further study with the use of after-images. Brown,¹³ in 1895, noted little pauses and jerks of the eyeballs on following stationary structures. Dodge,¹⁴ in 1903, stated that in normal persons continuous smooth movements of the eyeballs are seen only in what he chose to call pursuit movements. In 1912 Oehrwall¹⁵ and Gertz¹⁶ noted that the eyes follow moving objects smoothly. Kestenbaum¹⁷ reported in 1921 that gliding or smooth movements of the eyeballs are absent in infants.

In this paper only cogwheel phenomena occurring during follow or pursuit movements are to be considered. Cogwheel movements of the eyes can best be described as repeated, very short pauses of the eyeballs followed by a rapid forward jerk. When a number of these pauses and jerks are present during a single excursion of the eye in one direction, it has to be differentiated from nystagmus. This differentiation is not difficult, because in nystagmus gross to and fro and pendular movements are usually evident. The actual pauses and jerks are not present. It is possible that what has been frequently reported as "nystagmoid jerks" (Zonta,¹⁸ Spadavecchia¹⁹ and Cushing²⁰) was in reality this phenomenon.

The cogwheel phenomenon is considered abnormal when seen as the patient follows a smoothly moving object. The distance of the object

11. Duke-Elder, W. S.: *Text-Book of Ophthalmology: The Development, Form and Function of the Visual Apparatus*, St. Louis, C. V. Mosby Company, 1933, vol. 1, p. 619.

12. Landolt: *Nouvelles recherches sur la physiologie des mouvements des yeux*, *Arch. d'opt.* **11**:385, 1891.

13. Brown, A. C.: *A Lecture on the Relation Between the Movements of the Eyes and the Movements of the Head*, Nature, London **52**: 184, 1895.

14. Dodge, R.: *Five Types of Eye Movements in the Horizontal Meridian Plane of the Field of Regard*, *Am. J. Physiol.* **8**:307, 1903.

15. Oehrwall, H.: *Die Bewegungen des Auges während der Fixierens: II.*, *Skandinav. Arch. f. Physiol.* **27**:304, 1912.

16. Gertz, H.: *Ueber die kompensatorische Gegenwendung der Augen bei spontan bewegtem Kopfe*, *Ztschr. f. Psychol. u. Physiol. d. Sinnesorg. (Abt. 2)* **47**:420, 1912-1913.

17. Kestenbaum, A., cited by Cords.¹

18. Zonta, G.: *I disturbi della motilità oculare nella encefalite epidemica cronica*, *Riv. sper. di freniat.* **63**:374, 1939.

19. Spadavecchia, V.: *Encefalite epidemica e manifestazioni oculari*, *Ann. di ottal. e clin. ocul.* **62**:420, 1934.

20. Cushing, H.: *Tumors of Nervus Acusticus*, Philadelphia, W. B. Saunders Company, 1918, pp. 84-116.

from the eyes does not affect the intensity or frequency of the jerks. They are brought out more readily when the ocular movements are slow. They are most clearly seen in lateral movements, though they have been described in upward (Cords,¹ Gamper and Untersteiner²¹), and even rotary, movements of the eyeballs (Jensen²²). The cogwheel phenomenon may be present only when the eyeballs are moved in one direction. Such unilaterality may have focal significance. We examined a patient with hemiplegia on the right side with definite cogwheel movements of the eyes only on following a moving object toward the hemiplegic side. This was present without paralysis of voluntary conjugate gaze or forced deviation of the eyes and without diplopia with the red glass test. Cords noted a definite positive correlation between the absence of optokinetic nystagmus and the presence of the cogwheel phenomenon. Occasionally it may be present only during the first few movements of the eyeballs, disappearing as the eyeballs continue to move back and forth. Illumination, fatigue or mood of the patient was not found to be a significant factor in our own observations. C. Negro²³ reported the disappearance of the cogwheel phenomenon after instilling cocaine into the conjunctival sacs.

The cogwheel phenomenon is a disorder of pursuit movements. Command or voluntary movements of the eyes and pursuit movements differ physiologically. Bárány,²⁴ in 1907, observed that voluntary lateral movements of the eyeballs take place with less facility than when the eyes follow an object moving laterally. As far back as 1888 Wernicke²⁵ had discussed the difference between optic reflex movements and volitional movements of the eyes. Oppenheim,²⁶ in 1895, noted clearly a dissociation between command and follow or pursuit movements in 4 cases of pseudobulbar palsy. Roth²⁷ made similar observations in 1901 and used the term "ophthalmoplegia dissociata ideo-motor." We recently studied

21. Gamper and Untersteiner: Ueber eine komplex Gebaute postencephalitischen Hyperkinese und ihre möglichen Beziehungen zu dem oralen Einstellautomatismus des Säuglings, *Arch. f. Psychiat.* **71**:282, 1924.

22. Jensen, V. A.: Oculogyri instabilitet som initialsymptom ved dissemineret Sklerose, *Nord. med.* **21**:850, 1944.

23. Negro, C.: Di alcuni fenomeni oculari osservati im parkinsoniani encefalitici, *Minerva med.* **5**:12, 1925.

24. Bárány, R.: Die Untersuchungen der reflektorischen vestibulären und optischen Augenbewegungen und ihre Bedeutung für die topische Diagnostic der Augenmuskellähmungen, *München. med. Wchnschr.* **54**:1072, 1907.

25. Wernicke, C.: Herderkrankung des unteren Scheitelläppchens, *Arch. f. Psychiat.* **20**:243, 1888.

26. Oppenheim, H.: Kurze Mitteilung zur Symptomatologie der Pseudobulbarparalyse, *Fortschr. d. Med.* **13**:1, 1895.

27. Roth, W. C.: Demonstration von Kranken mit Ophthalmoplegie, *Neurol. Centralbl.* **20**:922, 1901.

a woman aged 54 with arterial hypertension who suddenly experienced dizziness and diplopia; the diplopia lasted only a short time. The neurologic examination showed a tegmental peduncular syndrome with ophthalmoplegia internuclearis anterior and a definite dissociation between pursuit and command movements of the eyes.

If the neural mechanism responsible for smooth pursuit movements is diseased or undeveloped, cogwheel phenomena of the eyes are seen. Hughlings Jackson,²⁸ in 1887, reported a case of dementia paralytica with "want of smoothness, in the excursion of the globes." In 1894 he described the phenomenon as punctuation of motions of the eyeballs; he reported seeing it in hemiplegic persons. Abrahamson,²⁹ in 1921, noted the cogwheel phenomenon in cases of chronic encephalitis. Bing³⁰ described the same thing in 1923 and suggested the term "ocular cogwheel phenomenon." Velter,³¹ Leroy,³² Blum³³ and D'Arbela and Montanari³⁴ noted its occurrence in chronic encephalitis but did not report it in their own cases. Tchlenoff and Toulaeva,³⁵ Terrien³⁶ and Gamper and Untersteiner²¹ each mentioned observing it in 1 case of chronic encephalitis. Fischer³⁷ saw this phenomenon in 12 of 20 cases; Young,³⁸ in 25 of 39 cases, and Critchley,³⁹ in 64 of 72 cases. Cords observed it in 21 cases of chronic encephalitis and commented on its importance in the differential diagnosis of this disease.

28. Jackson, J. H., in discussion on Gowers, W. R.: Conjugate Palsy of Ocular Muscles and Nystagmus, *Lancet* **1**:578, 1887.

29. Abrahamson, I.: Motor Disturbances in Lethargic Encephalitis, *Arch. Neurol. & Psychiat.* **5**:33 (Jan.) 1921.

30. Bing, R.: Das Zahnrad-Phänomen und die antagonistische Innervation, *Schweiz. Arch. f. Neurol. u. Psychiat.* **13**:77, 1923.

31. Velter, E.: Troubles oculomoteurs associés et régulation du tonus musculaire, *Arch. d'opht.* **40**:206, 1923.

32. Leroy, A.: Spasme du droit supérieur de l'oeil avec extension de la tête au cours d'un syndrome encéphalitique, *J. de neurol. et psychiat.* **24**:67, 1924.

33. Blum, J.: Contribution à l'étude du syndrome oculo-moteur tardif de l'encéphalite épidémique, *Clin. opht.* **32**:123, 1928.

34. d'Arbela, F., and Montanari, A.: La sintomatologia e le forme cliniche dell'encefalite epidemica, *Riv. di clin. med.* **29**:41, 1928.

35. Tchlenoff, L., and Toulaeva, N.: Syndrome post-encéphalitique infantile, *Rev. neurol.* **33** (pt. 1):563-576, 1926.

36. Terrien, F.: Les séquelles oculaires tardives de l'encéphalite épidémique, *Progrès méd.*, 1935, p. 361.

37. Fischer, B.: Ueber vestibulare Beeinflussung der Augenmuskelstarre bei der Encephalitis epidemica, *Deutsche Ztschr. f. Nervenhe.* **81**:164, 1924.

38. Young, A. W.: A Clinical Analysis of an Extrapyrarnidal Syndrome: Paralysis Agitans and Postencephalitic Parkinsonism, *J. Neurol. & Psychopath.* **8**:9, 1927.

39. Critchley, A. M.: The Ocular Manifestations Following Encephalitis Lethargica, *Bristol Med.-Chir. J.* **45**:113, 1928.

PRESENT STUDY

Our own observations on 64½ patients have shown that this phenomenon may be present in a few conditions other than chronic encephalitis.

Conditions Investigated	Pursuit Movements	
	Present	Absent
Paralysis agitans—postencephalitic	69	4
Paralysis agitans—other types.....	15	10
Head trauma	19	21
Multiple sclerosis	24	19
Cerebral arteriosclerosis	13	20
Cerebral embolization	1	0
Epilepsy without diphenylhydantoin sodium.....	1	45
Epilepsy with diphenylhydantoin sodium.....	48	12
Narcolepsy	0	2
Ménière disease	0	20
Trigeminal neuralgia	0	1
Brain tumor	1	7
Disease of the spinal cord.....	0	10
Lesions of peripheral nerves and roots.....	0	18
Muscle and joint diseases.....	0	13
Functional mental diseases.....	1	93
Neuroses	3	151

We can confirm the great frequency of the cogwheel phenomenon with chronic encephalitis and found it an extremely important diagnostic aid in monosymptomatic and oligosymptomatic cases.

In a case in which an unusual speech defect (stuttering) began at the age of 16 the presence of a cogwheel phenomenon of the eyes focused our attention on the possibility of an encephalitic origin. The therapeutic test with atropine showed a diminution of the cogwheel phenomenon in this and in other cases. The stuttering also improved remarkably under treatment with atropine in the case cited.

Another illustrative case is that of a white woman aged 24, who was first seen in April 1941. There was no history even remotely suggestive of an acute attack of encephalitis. Oculogyric attacks began at the age of 18 and have occurred at irregular but frequent intervals since the onset. Examination showed no objective clinical evidence of chronic encephalitis except for a mild festination of speech. Her gait was normal. There was no increase of tone in any of the extremities. A cogwheel phenomenon in the eyes was noted at the time of the original examination. This further corroborated the diagnosis of chronic encephalitis.

Another case which illustrates the value of the cogwheel phenomenon is exemplified by a white youth aged 17 who was sent into the hospital with a diagnosis of schizophrenia. When first seen by us, he was in bed. The presence of a prominent cogwheel phenomenon in the eyes first directed attention to the true nature of his difficulty—a postencephalitic behavior problem. This was confirmed by the presence of defective decrease in swinging of the right upper limb while walking.

The cogwheel phenomenon of the eyes has been of especial importance to us in our cases of post-traumatic disorders. It is an additional objective sign which in a few unclear cases lends weight to the organicity of the syndrome.

A factory foreman aged 28 had been injured four years previously in a football accident. He was unconscious for five hours. The left ear drum membrane was punctured by the blow to his head. Dizziness with change of position and paroxysmal pains in the head had been present since the accident. He also reported experiencing frequent nausea on arising in the morning. He gave a history of

mild arterial hypertension for six months before the accident. His blood pressure was normal during each of three examinations. There were no positive neurologic signs except for a cogwheel phenomenon of the eyes with pursuit movements during each examination.

Another illustrative case is that of a dentist aged 44 who was seen early in June 1946. He had complained of headaches, dizziness, nervousness, forgetfulness and backache since an accident in September 1943. At this time, he struck his head when a mine blew up an ambulance in which he was riding. He sustained fractures of the left scapula and of the transverse processes of two lumbar vertebrae, a fracture and dislocation of the left clavicle and a severe injury to the right inner ear. There was a functional hemisensory syndrome on the left. The only positive neurologic sign was a cogwheel phenomenon of the eyes on looking to the left.

Another case of a post-traumatic syndrome was that of a man aged 40, who was seen in April 1945. Since an automobile collision on Feb. 13, 1945 he had complained of headaches, nervousness, dizziness with bending, and ready fatigue. He was unconscious for a few minutes after the accident. The neurologic examination revealed nothing abnormal. There was no evidence of psychogenic superimposition. A definite cogwheel phenomenon of the eyes was present.

The phenomenon has been observed in cases of multiple sclerosis.

In a woman aged 24 with mental symptoms resembling schizophrenia the presence of the cogwheel phenomenon suggested an organic neurologic disorder. As the condition progressed, the further signs and symptoms fitted into a symptom complex that was consistent with the diagnosis of multiple sclerosis. The patient died within the past year, and the gross and microscopic studies substantiated the diagnosis. Later in the illness the patient presented nystagmus in addition to the cogwheel phenomenon, and they were distinguishable from each other.

We have seen the cogwheel phenomenon in other cases of multiple sclerosis. In addition to Cords's observation in cases of disseminated sclerosis, Jensen,²² more recently (1944), reported it in 10 per cent of a series of 50 cases. While not as valuable in the differential diagnosis of multiple sclerosis as in that of chronic encephalitis and post-traumatic syndromes, it can still prove useful in early and atypical cases of the disease. A search for this sign should, therefore, be included in the neurologic examination.

As far as we know this sign has not previously been noted in patients under diphenylhydantoin medication. Drug intoxication as a cause of the cogwheel phenomenon was noted only by Cords with phenobarbital poisoning. We have also observed it in cases of bromism. The cogwheel phenomenon has been most striking and most intense with diphenylhydantoin medication. In some cases it has been observed with other disturbances of the central nervous system, such as cerebellar dyssynergia. In a recent case studied by us, the patient had been given 6 grains (0.29 Gm.) of diphenylhydantoin sodium per day for four months. She began to show disturbances in gait and had difficulty in the proper coordination of movements of the hands. This patient showed both the cogwheel

phenomenon and nystagmus. In another patient, a white girl aged 19 years, the cogwheel phenomenon appeared even after one day's treatment with the drug. In no case which we have studied did we observe increasing tolerance to the drug with gradual decrease or lessening of the cogwheel phenomenon as time went on. We have gained the impression from this and from similar cases that when the cogwheel phenomenon occurs it bespeaks the onset of an encephalopathy from the diphenylhydantoin and that the drug should then be used with even greater caution. In practically none of our epileptic controls not taking diphenylhydantoin have we observed similar ocular signs.

We have also seen the cogwheel phenomenon of the eyes in a few cases of hyperthyroidism. Filippi-Gabardi⁴⁰ and F. Negro⁴¹ also reported it in cases of exophthalmic goiter. Cords reported it in cases of cerebral tumor. We observed it only once with a brain tumor, atypical cases of chronic encephalitis and in cases of head injuries.

SUMMARY

1. The occurrence of the cogwheel phenomenon during pursuit movements of the eyes is abnormal.
2. Its presence indicates the existence of organic disease of the brain.
3. It has been seen most strikingly with chronic encephalitis and other organic diseases.
4. We have observed the cogwheel phenomenon of the eyes with diphenylhydantoin and bromide poisoning.
5. The phenomenon has proved of diagnostic value especially in atypical cases of chronic encephalitis and in cases of head injuries.

40. Filippi-Gabardi, E.: I disturbi della motilità oculare estrinseca negli ipertiroidici, Riv. oto-neuro-oftal. **17**:564, 1940.

41. Negro, F.: Le phénomène de la roue dentée dans les syndromes basedowiens, physiopathiques et vestibulaires, Rev. neurol. **1**:502, 1928.

LOCALIZED NONTRAUMATIC NEUROPATHY IN MILITARY PERSONNEL

EDWIN A. WEINSTEIN, M.D.
NEW YORK

WARS HAVE always stimulated interest in peripheral nerve lesions, and World War II has been no exception. During its course a number of cases of an unusual type of neuropathy were reported in Allied troops serving in England,¹ New Zealand and Egypt,² the Mediterranean area³ and the South Pacific.⁴ Although no common etiologic factor was demonstrated, the descriptions appeared to constitute a single clinical entity. The syndrome was characterized by a rapid, often painless, onset; a predominance of motor involvement, with frequently enduring paralysis and atrophy of the affected muscles, and a tendency to limitation to a single extremity, with a predilection for the shoulder girdle. When cases of this type were seen in World War I, they generally were ascribed to the pressure of the soldier's pack, so-called pack palsy. However, in the present series and in the cases described in other areas, this could have been a factor in only a small percentage, as most of the soldiers had duties which did not necessitate their carrying heavy burdens. Accordingly, some other etiologic factor was indicated. The present report deals with a review of the clinical characteristics of the 12 cases studied up to January 1944 in North Africa and 6 more cases seen subsequently in Italy and a consideration of the possible etiologic factors. Three sample case histories are presented.

REPORT OF CASES

CASE 1.—Pfc. R. S., a member of a field artillery battery, was admitted to a general hospital on Aug. 18, 1943. On July 25, while engaging in a boxing bout, he threw up his arm as a guard and felt the entire extremity go dead and numb.

1. Spillane, J. D.: Localized Neuritis of the Shoulder Girdle: Report of Forty-Six Cases in M. E. F., *Lancet* 2:532-535 (Oct. 30) 1943.

2. Burnard, E. D., and Fox, T. G.: Multiple Neuritis of the Shoulder Girdle: Report of Nine Cases Occurring in the Second New Zealand Expeditionary Force, *New Zealand M. J.* 41:342-247 (Dec.) 1942.

3. Weinstein, E. A., and Gersten, D.: An Unusual Type of Peripheral Neuropathy: Report of Thirteen Cases, *M. Bull. North African Theat. Op.* (no. 5) 1:9-11 (May) 1944.

4. Harvey, A. M.; Kuffler, S. W., and Tredway, J. B.: Peripheral Neuritis: Clinical and Physiological Observations on a Series of Twenty Cases, *Bull. U. S. Army M. Dept.*, October 1944, no. 81, pp. 11-12.

The weakness had persisted, without pain at any time. Twelve weeks prior to the onset of illness he had an inoculation for typhoid.

Neurologic examination on his admission showed moderate atrophy of the deltoid, supraspinatus and infraspinatus muscles on the left side. There was complete paralysis of abduction of the left arm. The groove between the left scapula and the thoracic cage was deepened, and the left levator anguli scapulae muscle did not transmit an impulse on coughing, indicating a lesion of the dorsal scapular nerve. There were moderate atrophy and paresis of the biceps and triceps groups on the left and slight impairment of the extensors of the wrist and fingers and the intrinsic muscles of the hand. All the deep reflexes were intact, and there were no sensory changes. Examination of the spinal fluid revealed a clear, acellular fluid with a total protein content of 27.5 mg. per hundred cubic centimeters. Electrical examination showed reaction of degeneration in the left deltoid, supraspinatus and infraspinatus muscles. During a stay in the hospital of over four months, the patient made no improvement, marked atrophy developed and he had to be evacuated for further hospitalization.

The diagnosis was neuropathy involving predominantly the left axillary, dorsal scapular and musculocutaneous nerves.

CASE 2.—Pvt. J. T. G., aged 19, a tank gunner, was admitted to a general hospital near Mateur, Tunisia, on Nov. 28, 1943. He had been well until November 7, when he awoke with paralysis and numbness of the entire left upper extremity. Power gradually returned to the fingers and at the wrist and elbow, but the patient was still unable to raise his left arm. Two weeks after the onset he had slight pain in the arm and shoulder, but this did not persist. He had not been in combat and had experienced no recent trauma. Twelve days before the occurrence of his paralysis he had received a stimulating dose of typhoid vaccine.

Physical examination on his admission showed moderate atrophy of the muscles of the left shoulder girdle and slight atrophy of the left arm and forearm. There was complete paralysis of abduction of the left arm, involving the deltoid, supraspinatus and infraspinatus muscles. On his coughing, no impulse could be felt in the latissimus dorsi and levator anguli scapulae muscles on the left. It was difficult to draw the left arm backward and outward, and the scapula was separated from the thoracic wall, indicating weakness of the rhomboid muscle. There was moderate weakness of the triceps, the extensors at the wrist and the extensors of the fingers supplied by the radial nerve. Tenderness to pressure in the left supraclavicular space was noted. Diminution of perception of pinprick, cotton wool and temperature was found over the dorsum of the left thumb and index finger and in a patch the size of a silver dollar on the lateral surface of the left arm in the distribution of the axillary nerve. The radial, ulnar and triceps reflexes were absent on the left side.

Examinations of the spinal fluid on two occasions showed no cells and a total protein content of 44.8 and 52.6 mg. per hundred cubic centimeters.⁵ The patient showed no improvement. The musculature of the shoulder girdle became conspicuously atrophied without fibrillations. A compensatory scoliosis developed, with the convexity toward the affected side. After three months of illness he had not improved, in spite of physical therapy and administration of thiamine, and he was evacuated to the zone of the interior for further hospitalization.

The diagnosis was neuropathy involving the left axillary, radial, thoracodorsal and dorsal scapular nerves.

5. These are normal values for the technics employed.

CASE 3.—Pfc. P. S., a ward man in a hospital, was admitted to a general hospital on Oct. 8, 1943. On the morning of October 6 he had awakened with pain in the left shoulder. On the following day, while performing calisthenics, he noted that he was unable to raise his arms over his head. Nineteen days prior to the onset of his symptoms he had received an inoculation of typhus vaccine.

Physical examination showed winging of both scapulas and, in addition, paralysis of the left rhomboid and latissimus dorsi muscles. There were no sensory or reflex abnormalities. Examination of the spinal fluid revealed normal dynamics, no cells and a total protein content of 36 mg. per hundred cubic centimeters. Without any specific therapeutic measures, the patient improved and was discharged two weeks after admission, with slight residual winging of the left scapula. One month later there developed a schizophrenic reaction with paranoid delusions. The spinal fluid was again normal, and there was no change in the neurologic signs.

The diagnosis was neuropathy involving the left long thoracic nerve and the right long thoracic, thoracodorsal and dorsal scapular nerves.

CLINICAL FEATURES

The onset of symptoms was rapid in all cases, and disability came on at times with dramatic suddenness. The most common history was that the patient, on arising in the morning, was unable to raise his hand or arm. One soldier while boxing was startled to find that he was unable to elevate his guard. A nurse noticed weakness when she could not extend her hand to brush her hair. Pain was a less prominent feature than weakness. Although pain was present in some degree in 7 of the 18 cases, in only 2 instances, each of involvement of the axillary nerve, was it severe and persistent. A sensation of numbness or deadness was often perceived in the affected member. There were no symptoms of infection, such as sore throat, malaise, chills or fever, and no meningeal signs. In 1 case there had been a recent episode of malaria, but in the others there was no evidence of any systemic disease.

The upper extremities were affected in 16 cases, the paralysis being bilateral in 3. There was no predilection for either side of the body. The most severe damage was sustained by the nerves supplying the muscles of the shoulder girdle (14 cases). The radial nerve was involved in 4 instances, and the common peroneal nerve, in 2, each unilaterally. When the lesion was bilateral, the manifestations were asymmetric. When the disability was confined to a single upper extremity, there was involvement of multiple nerves in the majority of cases. In the 2 cases in which the signs were confined to a lower extremity there was paralysis of only the common peroneal nerve. The incidence of involvement of the nerves is shown in the following tabulation:

Long thoracic	6	Radial	4
Axillary	5	Musculocutaneous	2
Thoracodorsal	4	Ulnar	2
Dorsal scapular	4	Spinal accessory	2
Suprascapular	4	Common peroneal	2

The objective sensory loss was inconspicuous and was overshadowed by the degree of impairment of motor function. Sensory changes occurred mainly with lesions of the axillary and radial nerves and were limited to the isolated sensory supply of the nerve. In 1 case, for instance, a complete motor paralysis of the deltoid was accompanied with only slight hypalgesia. In another, with a complete wrist drop, sensory changes did not appear until several days after the onset of motor weakness. Although some patients complained of burning in the hypesthetic area, herpes did not develop. In the cases with signs referable to the brachial plexus, there was tenderness to pressure in that region. The fact that several of the nerves most commonly affected, the long thoracic, the thoracodorsal and the dorsal scapular, have no sensory cutaneous distribution accentuated the motor aspects of the syndrome.

The paralysis was maximal at the outset and was not progressive. The rate of improvement was extremely variable. Eight of the 18 patients regained power and were able to return to their duties within three to six weeks of the date of onset. In the others, however, a severe degree of paralysis persisted up to more than four months, and the affected muscles had gone on to considerable atrophy, without visible fibrillations. Electrical testing of 5 patients of this group revealed a lack of response to faradic stimulation with retention of galvanic excitability in the affected muscles.

Laboratory procedures showed nothing significant. The spinal fluid showed no increase in the cell count or the protein content. In several cases examinations of the spinal fluid were made at several stages of the illness, without significant change. Studies of the blood showed no leukocytosis or change in the sedimentation rate. Roentgenographic examinations of the spine and extremities also showed a normal condition.

COMMENT

Before it was recognized that these cases represented a clinical entity, there was considerable difficulty in diagnosis. Acute anterior poliomyelitis, a Guillain-Barré type of radiculoneuritis, pack paralysis, "Saturday night" palsy and hysteria were some of the initial impressions. Anterior poliomyelitis was easily eliminated by the absence of any febrile episode or meningeal signs and the presence of a normal, acellular spinal fluid. In the late stage, however, there is little to distinguish the residual paralysis and atrophy of the shoulder girdle from that resulting from poliomyelitis. The normal spinal fluid, likewise, served to exclude an atypical variety of the Guillain-Barré syndrome. A careful history for trauma was taken to rule out a condition analogous to the delayed paralysis that may follow injury to the ulnar nerve. Pack paralysis, the dysfunction of the musculature of the shoulder girdle, involving

chiefly the long thoracic nerve and attributed to the pressure of a heavy pack, was also considered. However, only 2 patients in the entire group had duties that necessitated their shouldering burdens, and neither of them had borne a heavy weight for some time. In the cases involving the radial nerve a "Saturday night" pressure palsy was excluded by the absence of a predisposing alcoholic episode, the long duration of disability with atrophy and the combination with lesions of other nerves. The 2 patients with palsies of the common peroneal nerve did not report a habit of sitting with their legs crossed. A search for so-called toxic factors, such as previous administration of sulfonamide derivatives, was fruitless. All patients had been on a standard Army diet, and there was no suggestion of avitaminosis. It soon became evident that the etiologic factor in the condition was not among the usual inflammatory, traumatic and toxic causes of peripheral nerve disease seen in civilian practice.

The pattern of a sudden onset, predominance of motor involvement with minor objective sensory changes, predilection for the shoulder girdle and tendency to implication of several nerves in a single extremity was striking. These features are identical with those of the peripheral neuropathy that occurs in rare instances after the injection of animal serum, the so-called serum neuritis. Cases have been described by many authors, with reviews by Allen,⁶ Doyle⁷ and Kraus and Chaney.⁸ The onset of paralysis is typically a rapid one, coming on five days to two weeks after injection. Paralysis endures for from one to eighteen months, frequently with wasting of the affected muscles. Objective sensory changes are scant. The most common site of involvement is the nerves supplied by the fifth and sixth cervical segments. In Allen's analysis of 23 cases, involvement of multiple nerves in a single extremity was most common, with a lesser incidence of asymmetric bilaterality. A certain similarity is also present in the type of neuropathy that occurs with periarthritis nodosa. In the cases studied by Wechsler and Bender⁹ the paralysis had a rapid onset, with single and asymmetric multiple nerve palsies, a distribution which the authors point out is rare in other conditions.

Because of this clinical similarity, some clue as to the etiology and pathogenesis in the present cases may be found in a consideration of the mechanism of nerve involvement in serum neuritis and periarthritis

6. Allen, I. M.: The Neurological Complications of Serum Treatment with Report of a Case, *Lancet* **2**:1128-1131 (Nov. 21) 1931.

7. Doyle, J. B.: Neurologic Complications of Serum Sickness, *Am. J. M. Sc.* **185**:484-492 (April) 1933.

8. Kraus, W. M., and Chaney, L. B.: Serum Disease of the Nervous System: Report of Three Cases, *Arch. Neurol. & Psychiat.* **37**:1035-1047 (May) 1937.

9. Wechsler, I. S., and Bender, M. B.: The Neurological Manifestations of Periarthritis Nodosa, *J. Mt. Sinai Hosp.* **8**:1071-1078 (Jan.-Feb.) 1942.

nodosa. The pathologic process in serum neuritis has been the subject of considerable discussion, but the most generally accepted view is that there is a primary disorder of the blood vessels supplying the nerve, with secondary parenchymatous change. It is also believed currently that the lesions of periarteritis nodosa occur on the basis of a hyperergic condition of the arterioles. Rich¹⁰ found an acute arteritis presenting the same histologic picture in cases of both periarteritis nodosa and serum disease. Longcope¹¹ indicated that the neuritis which occurs in each condition is based on similar lesions in the vascular supply of the nerve trunks.

In none of the present cases had serum been administered in the three month period preceding the illness. Also, there was no evidence of generalized vascular disease. However, the sudden, at times apoplectic-form, onset; the fact that the paralysis was initially maximal, and the localized nature of the paralysis suggested some sort of a vascular process. This impression was strengthened by the absence of any preceding trauma or evidence of inflammation. Reasoning by analogy with serum neuritis and periarteritis, one might postulate an anaphylactic or allergic factor. All the patients had received prophylactic injections of typhoid or typhus vaccine from one to twelve weeks prior to the onset of illness. It may be that this introduction of foreign protein is one etiologic factor in the production of increased sensitivity. The proof is not conclusive, as all military personnel are subjected to frequent immunologic procedures. However, in only a small proportion of persons who receive injections of serum do nerve lesions develop. It is also significant that cases of this type did not occur among civilians who did not receive prophylactic injections of vaccine in any quantity.

There have been a few adequately described instances of neural involvement of the type that we have described following administration of vaccine. Robinson¹² treated a patient who experienced foot drop four days after his second injection of typhoid-paratyphoid A and B vaccine. There was no pain and no sensory findings. The onset was rapid, with recovery in three and a half months. Hughes,¹³ working with British troops, stated that he found it not uncommon to meet with cases of involvement of peripheral nerves three to four weeks after an

10. Rich, A. R.: The Role of Hypersensitivity in Periarteritis Nodosa as Indicated by Seven Cases Developing During Serum Sickness and Sulfonamide Therapy, *Bull. Johns Hopkins Hosp.* **71**:123-140 (Sept.) 1942.

11. Longcope, W. T.: Serum Sickness and Analogous Reactions from Certain Drugs, Particularly the Sulfonamides, *Medicine* **22**:251-286 (Sept.) 1943.

12. Robinson, L. J.: Neurologic Complications Following Administration of Vaccines and Serums: Report of Case of Peripheral Paralysis Following Injection of Typhoid Vaccine, *New England J. Med.* **216**:831-837 (May 13) 1937.

13. Hughes, R. R.: Neurologic Complications of Serum and Vaccine Therapy, *Lancet* **2**:464-467 (Oct. 7) 1944.

inoculation with tetanus toxoid or typhoid-paratyphoid A and B vaccine, but his case reports are largely those of patients who received both tetanus toxoid and vaccine. Peacher and Robertson¹⁴ reported the case of a soldier in whom paralysis of the shoulder girdle developed seven days after an injection of typhoid-paratyphoid A and B vaccine. Pain was slight and transient. The deltoid supraspinatus, infraspinatus and biceps muscles were paralyzed and went on to atrophy. The only objective sensory finding was a slight hypesthesia in the distribution of the lateral cutaneous nerve of the forearm.

It is likely, then, that in the cases of peripheral neuropathy described the etiologic factor was not a traumatic or an infectious agent. Rather, the cause may have been a vascular sensitivity provoked by prophylactic injections of vaccine. The occurrence of nerve lesions after administration of serum is well established. It is possible that a neuropathy may develop after injection of a foreign protein, whether it be animal serum or dead bacteria.

It is questionable whether a pack palsy actually exists. The construction of an infantryman's pack makes it practically impossible for the normal brachial plexus to be compressed to the point of producing an enduring paralysis. Denny-Brown and Brenner¹⁵ have demonstrated experimentally the degree of tourniquet pressure necessary to produce a lasting paralysis. This far exceeds the pressure that can be caused by a pack and rifle. Clinically, it is known that pressure palsies only rarely cause atrophy. Rather than to assume that the weight of a pack produces a nerve paralysis, it is more logical to believe that a soldier with an already weakened shoulder girdle will find it difficult and painful to bear weight. The comparatively painless onset of the lesion may leave the soldier with an unnoticed weakness of the serratus magnus or the rhomboid muscle for a time. The disability for ordinary duties will be slight. He will notice discomfort and incapacity and seek medical attention only when he is obliged to carry a large burden or perform heavy work. Woodhall,¹⁶ for instance, cited a case in which there was a known history of weakness of the shoulder girdle and scapular winging. The patient presented the typical clinical picture of pack palsy and was considered to have had an accentuation and spread of his neural dysfunc-

14. Peacher, W. G., and Robertson, R. C. L.: Neurological Complications Following the Use of Typhoid Vaccine, *J. Nerv. & Ment. Dis.* **101**:515-526 (June) 1945.

15. Denny-Brown, D., and Brenner, C.: Paralysis of Nerve Induced by Direct Pressure and by Tourniquet, *Arch. Neurol. & Psychiat.* **51**:1-26 (Jan.) 1944; Lesion in Peripheral Nerve Resulting from Compression by Spring Clip, *ibid.* **52**:1-19 (July) 1944.

16. Woodhall, B.: Pack Palsy, *Bull. U. S. Army M. Dept.*, December 1944, no. 83, pp. 112-117.

tion by the trauma of pack bearing. Thus, pack palsy may be the inability of a poorly innervated shoulder girdle musculature to bear weight.

SUMMARY

Eighteen cases of a type of localized peripheral neuropathy rarely encountered in civilian practice were observed among military personnel in the Mediterranean Theater.

The syndrome was characterized by rapid onset, predominance of motor involvement with scant sensory changes and frequently enduring paralysis and atrophy, with a predilection for the shoulder girdle. The most common pattern was the involvement of multiple nerves in a single extremity, with 3 instances of asymmetric bilaterality.

The etiologic factor is not known. However, close clinical similarity to the type of neuropathy that occasionally follows injection of serum and occurs with periarteritis nodosa is pointed out. It is suggested that the pathologic mechanism may be a similar type of hyperergic vascular reaction. In this case, previous administration of typhoid or typhus vaccine can be a sensitizing agent.

Pack paralysis, the dysfunction of the shoulder girdle musculature ascribed to the pressure of a soldier's pack, is discussed. It is felt that pack palsy does not exist as a primary entity and that in most of the cases so described the neuropathy is actually of the type presented here. The onset of symptoms and signs after carrying a pack is the manifestation of the inability of the previously weakened musculature of the shoulder girdle to bear weight rather than of a primary injury to normal nerves.

30 East Sixtieth Street.

News and Comment

NATIONAL ADVISORY MENTAL HEALTH COUNCIL GRANTS FOR TRAINING PROGRAMS

In accordance with recommendations made recently by the National Advisory Mental Health Council, the United States Public Health Service announces that three types of grants may soon be available under the National Mental Health Act. These grants would provide funds for training, for research and for community services.

The grants will be made to institutions offering training in psychiatry, clinical psychology, psychiatric social work and psychiatric nursing, for the purpose of improvement, expansion and inauguration of training programs in these fields. Application forms and complete information may be obtained from the Training and Standards Section, Mental Hygiene Division, United States Public Health Service, Washington 25, D. C.

The National Advisory Mental Health Council expects to take final action on these applications by the middle of April. Interested schools therefore are urged to make their applications.

The National Advisory Mental Health Council has authorized the United States Public Health Service to grant a total of not more than 600 stipends this year to graduate students in psychiatry, clinical psychology, psychiatric social work and psychiatric nursing. The Council has suggested that the stipends be equally divided among these four fields. The annual stipends range from \$1,000 to \$2,400 for clinical psychologists, psychiatric social workers and psychiatric nurses and up to \$3,600 for psychiatrists, depending on the level of training for which the applicant is eligible. These awards will be made through the institutions collaborating in this phase of the training program of the United States Public Health Service. The names of these institutions will be announced on or about May 1. Interested applicants are requested not to write to training centers or to the United States Public Health Service about these stipends until the May announcement is made.

Grants for research relevant to the problems of mental health may be made on the recommendation of the National Advisory Mental Health Council to public and private institutions and to individuals. Application forms are obtainable now from the Research Grants Division, National Institute of Health, United States Public Health Service, Bethesda 14, Md.

To assist in development of adequate mental health programs at the community level, grants-in-aid will be made to states on a matching basis. These funds are handled by the mental health authority of each state. Professional and lay persons interested in specific service projects should bring their ideas to the attention of their state mental health authority.

Funds to inaugurate actual operation of the programs depend on Congressional appropriations. The earliest date on which such funds may be available is July 1, 1947.

RORSCHACH TEST SEMINAR

The Rorschach test seminar for 1947 at Michael Reese Hospital, Chicago, will be conducted on June 2 to 6, inclusive. Two groups of subjects will be

studied: (a) children presenting personality problems, and (b) adults with severe disturbances, including schizoid reaction patterns. Dr. S. J. Beck will demonstrate the test records and analyze them for the personality structures projected.

The course is open to persons with qualified background. For information write to Psychology Laboratory, Division of Neuropsychiatry, Michael Reese Hospital, Twenty-Ninth Street and Ellis Avenue, Chicago 16.

APPOINTMENT OF NATIONAL DIRECTOR, AMERICAN EPILEPSY LEAGUE, INC.

Mr William H. Savin has been appointed national director of the American Epilepsy League, Inc. A Lt. Col., just released from the Army, Mr. Savin spent three years in Military Government in Italy. Prior to that he was executive director of the Family Service Association in Washington, D. C. Earlier he held an important post in the Philadelphia Community Fund.

The American Epilepsy League, Inc., which was established in 1939, is a national nonprofit organization stimulating interest in research and distributing information on epilepsy written in the light of present day knowledge and conditions.

Under the direction of Mr. Savin, state chapters of the Epilepsy League will be created as the expanded program permits, making it possible to bring more extensive health service and education to the 600,000 epileptic persons in this country.

Mr. Savin assumed his duties at league headquarters, 50 State Street, Boston, on February 15.

Correspondence

METHODS OF FREQUENCY ANALYSIS OF THE ELECTROENCEPHALOGRAM

To the Editor:—In a recent paper, Kaufman and Hoagland (Dominant Brain Wave Frequencies as Measures of Physicochemical Processes in Cerebral Cortex, *ARCH. NEUROL. & PSYCHIAT.* 56: 207 [Aug.] 1946) have presented a critical appraisal of two methods of frequency analysis of the electroencephalogram, one devised by Brazier and Finesinger (Characteristics of the Normal Electroencephalogram: I. A Study of the Occipital Cortical Potentials in Five Hundred Normal Adults, *J. Clin. Investigation* 23: 303, 1944), the other by my associates and me (Engel, G. L.; Romano, J.; Ferris, E. B.; Webb, J. P., and Stevens, C. D.: A Simple Method of Determining Frequency Spectrums in the Electroencephalogram, *ARCH. NEUROL. & PSYCHIAT.* 51: 134 [Feb.] 1944). Our method is compared unfavorably with the Brazier method on the ground that it brings out only empiric changes and “masks the possibility of a rational interpretation of rates of events going on in the brain.” By inference, the Brazier method is free of such objection. We feel that this criticism is based on a number of misconceptions and unduly detracts from the value of the method.

Contrary to the inferences of the authors, we have never claimed that our method is suitable for delineating “controlling kinetic events as rates within the cells.” We do think, however, that it gives some information about the metabolic activities of the cells under certain conditions. Nor do we use the concept of dominant frequency in the manner that Kaufman and Hoagland ascribe to us. In earlier papers, my colleagues and I used “dominant frequency” merely to indicate the frequency or frequencies that made up 50 per cent or more of the record (Engel, Romano and others, 1944. Romano, J., and Engel, G. L.: Delirium: I. Electroencephalographic Data, *ARCH. NEUROL. & PSYCHIAT.* 51: 356 [April] 1944. Engel, G. L., and Romano, J.: Delirium: II. Reversibility of the Electroencephalographic Data with Experimental Procedures, *ibid.* 51: 378 [April] 1944). This was used chiefly as an aid in the tabulation of some of the data. Later we introduced the expression “mean frequency,” which is the arithmetical mean of the distribution of countable waves per second interval (Engel, G. L.; Webb, J. P., and Ferris, E. B.: Quantitative Electroencephalographic Studies of Anoxia in Humans: Comparison with Acute Alcoholic Intoxication and Hypoglycemia, *J. Clin. Investigation* 24: 691, 1945). Obviously, such a mathematical expression can be derived only from countable waves, and low voltage fast activity cannot be included. In studying the effects of small changes in oxygen tension and blood sugar (Engel, Webb and Ferris, 1945) and the influence of certain drugs—alcohol (Engel, G. L., and Rosenbaum, M.: Delirium: III. Electroencephalographic Changes Associated with Acute Alcoholic Intoxication, *ARCH. NEUROL. & PSYCHIAT.* 53: 44 [Jan.] 1945), quinacrine (atabrine) (Engel, G. L.; Romano, J., and Ferris, E. B.: The Effect of Quinacrine on the Central Nervous System, *ARCH. NEUROL. & PSYCHIAT.*, to be published), melar-

sen (a pentavalent arsenical) (Engel, G. L.; Romano, J., and Goldman, L.: Delirium: IV. Quantitative Electroencephalographic Study of a Case of Acute Arsenical Encephalopathy, *ARCH. NEUROL. & PSYCHIAT.* 56: 659 [Dec.] 1946) and Freon (a refrigerant, dichlorodifluoromethane)—on frequency, my colleagues and I intentionally selected subjects whose records showed 90 per cent or more of countable sine waves, and the mean frequency was calculated from the countable portions. Such a method of calculating mean frequencies actually corresponds closely to that used by Hoagland himself in his studies of critical thermal increments (Hoagland, H.: Pacemakers of Human Brain Waves in Normals and in General Paretics, *Am. J. Physiol.* 116: 604, 1936). Kaufman and Hoagland refer to the alpha frequency as the dominant frequency and calculate a "mean alpha frequency" by "simply counting the number of alpha waves per second in records with dominant activity for large samples and averaging, so that mean values statistically significant to 0.1 cycle per second were obtained." As long as the record remains regular and there is no disruption of synchrony, due to the experimental procedure or to artefact, all three methods (Hoagland, Brazier and Engel) should give comparable results. In the example presented by Kaufman and Hoagland, the mean frequency is 9.3 cycles per second; however, the spectrum presented would indicate that this was a somewhat irregular record or that the frequency count was inexpertly done.

Once synchrony begins to be disrupted, the calculation of a mean frequency or the designation of a dominant frequency becomes difficult or impossible and all methods break down. Hoagland (1936), in deriving the critical thermal increment for patients with dementia paralytica ("general paresis"), was thwarted by "irregular alpha waves" or by the disappearance of alpha waves, or he arbitrarily selected runs of regular activity for the calculation, a procedure open to criticism. As the frequencies become slower and the records more irregular, we present only the spectrum of frequency distribution and attempt to derive a mean frequency only from the countable activity, if there is sufficient countable activity to do so. By including a representative sample of the record, one can make a fairly complete characterization of the record.

This raises the fundamental question whether synchrony and frequency are always independent variables, as Kaufman and Hoagland would have one believe. In some circumstances, i. e., with the eyes open or during sleep, they probably are. But under the conditions in which we have used the frequency analysis method we think they are not wholly independent variables. Indeed, we have found that all noxious agents which derange cerebral metabolism not only alter frequency but eventually disrupt synchrony, producing varying degrees of irregularity (Engel, G. L.: The Clinical Applications of Electroencephalography, *ARCH. NEUROL. & PSYCHIAT.* 55: 553 [May] 1946; abstracted, *Cincinnati J. Med.* 27: 151, 1946). For this reason, the concept of a "dominant frequency" becomes less valid as the record becomes more abnormal; and mean frequency, if it can be calculated, while still empiric, probably gives a closer index of metabolic changes than does an arbitrarily selected dominant frequency. The example of opening the eyes, presented by Kaufman and Hoagland, is one obvious exception, and perhaps the Brazier method gives a more accurate picture of kinetics in such

circumstances. However, if the authors had utilized the record of sleep as an illustration, the Brazier method would also give an irrelevant result so far as the kinetics of the chemical reactions are concerned. Obviously, there are other variables that affect frequency and synchrony which may be more or less independent of cellular metabolism. These include the state of the cell membrane and of the surrounding fluid medium, the effects of influent impulses along nerve pathways (i. e., visual impulses), the still hypothetic pacemaker mechanism and the physical properties of oscillating systems and the recording devices (Engel, 1946. Dawson, C. D., and Walter, W. G.: The Scope and Limitation of Visual and Automatic analysis of the Electroencephalogram, *J. Neurol., Neurosurg. & Psychiat.* 7:119, 1944).

Kaufman and Hoagland state that with our method a day to day variation was found in dominant frequency. We have already commented that their definition of "dominant frequency" as applied to our method is not used by us. Actually, calculations of mean frequencies in the records of 3 normal subjects repeated as many as thirty times over the course of five years showed maximum variations in the same subject of 0.5, 0.6 and 1.0 cycle per second, respectively, under comparable conditions. Obviously, "dominant frequency" as applied to our method by Kaufman and Hoagland and "mean frequency" as used by us are not the same.

The hypothetic example of a record produced by an electrical apparatus operating continuously at a rate of 10 per second and then intermittently at the same rate but turned off every five seconds, is not relevant because it is not correct. Analysis of the second record would yield a spectrum of 50 per cent 10 per second waves and 50 per cent uncountable (low voltage fast) waves. That is, half the one second intervals contain 10 waves and half contain no waves. The mean frequency of the countable waves would still be 10 per second. Obviously, the frequency is not 5 per second, as the authors state. Actually, the spectrum of 50 per cent 10 per second activity and 50 per cent uncountable activity characterizes exactly this hypothetic example, more completely indeed than either Brazier's or Hoagland's method.

We agree with Kaufman and Hoagland that it would be desirable to have a method of frequency analysis which would be useful as a measure of underlying chemical kinetics, but we do not believe this is possible of achievement except under certain limited conditions. It may be approximated in the analysis of records with a high per cent time alpha and in experiments in which the synchrony of the alpha activity is not significantly deranged. Under similar experimental conditions and with records having greater than 90 per cent time alpha, mean frequency as calculated by our method would seem to be essentially the same as the mean alpha activity calculated by Hoagland's method and would approach closely the figures obtained by Brazier. However, once the experimental procedure begins to disrupt synchrony, we believe that no method can yield an expression for frequency which is proportional in a quantitative sense to the changes in cellular respiration alone. In such circumstances, the Brazier method becomes relatively useless, whereas our method, even when a mean frequency cannot be calculated, yields a spectrum which gives at a glance an informative, if empiric, summary of the record. In our studies of delirium (Romano, J., and

Engel, G. L.: Delirium: I. Electroencephalographic Data, *ARCH. NEUROL. & PSYCHIAT.* 51:356 [April] 1944. Engel, G. L., and Romano, J.: Delirium: II. Reversibility of the Electroencephalogram with Experimental Procedures, *ibid.* 51:378 [April] 1944), this method yielded meaningful characterizations of all records, whereas we found the method subsequently presented by Brazier (originally devised by Hallowell Davis) totally inadequate for many records.

In summary, then, we believe that the paper of Kaufman and Hoagland is based on an oversimplified concept of the electroencephalogram and that none of the methods they mention can reflect accurately the rates of changes of kinetic processes in the brain, except perhaps in the special circumstances which I have discussed. Our method, on the other hand, has a wide area of applicability as a means of summarizing empirically changes in the electroencephalogram, not only because it takes into account all the variables, but because it still yields an expression for mean frequency which is accurate and meaningful in the circumstances in which such an expression can be meaningful. Far from masking what goes on, our method gives a more complete characterization than any of the other methods discussed. It is also the simplest.

GEORGE L. ENGEL, M.D., Rochester, N. Y.

Strong Memorial Hospital.

Our criticism (Kaufman and Hoagland, 1946) of the Engel method of frequency analysis is based on the inclusion in the frequency measurement of the per cent time the frequencies are present in the record. Our criticism is not of Engel's use of his method, but of its extension as a general method of frequency analysis. An alpha frequency of exactly 10 cycles per second may be present from 5 to 100 per cent of the time from one subject to another, and the same 10 per second frequency may be present in the same subject under different conditions for much or for little time. Alpha frequency is essentially unchanged by opening and closing the eyes and by concentration of attention, though its per cent time present varies widely. Chemical agents may modify each of these variables independently or together, and an analytic tool is needed to separate these effects. The Brazier frequencies are independent of the per cent of time they are present, and the Engel frequencies, because of the nature of his method of averaging, must vary with the per cent time present.

Engel's "mean" frequencies, which are dominant frequencies on his plots, differ from Brazier's "dominant" frequencies by definition, and we do not wish to argue matters of definition. Our point has been to emphasize the existence of these differences and to indicate why their recognition is important in interpreting chemical phenomena in relation to the electroencephalogram. The Brazier dominant frequency is present and measurable in records obscured by both slower and faster waves than the dominant ones, and its changes are changes in true rates, which may be correlated with rates of physicochemical events in the brain.

Engel and his collaborators refer to "dominant" frequency, which in their earlier papers they appear to use interchangeably with their "mean" frequency; e. g., they state, "Our method gives a slightly false impression of the distribution of wavelengths greater or less than the dominant fre-

quency." This we found misleading, but the matter is now clarified by Engel's reply to our paper. Our evidence indicates that in any record as the per cent time alpha decreases from 100, as a limit, the error in frequency increases progressively and the "dominant" frequency, as determined by his method, itself decreases.

While Engel's method is convenient and has proved to be empirically useful in turning up interesting and important data, his mean frequency is not, in our opinion, as satisfactory a measure of rate as is Brazier's dominant frequency. Our data show marked variations with his frequency measure of per cent time alpha, as compared with the results obtained with Brazier's method. True frequency is a reciprocal time, and as such it is a pure measure of rate with the Brazier method and can be studied in persons with a low per cent alpha and with much low voltage fast activity. As Engel points out, the two methods give similar results for records containing high alpha activity. But per cent time alpha in the main certainly varies independently of frequency, and its inclusion in a measure of frequency is dimensionally unsound, and can be practically misleading if these limitations are not clearly borne in mind. This is especially likely to be so if the method should be used by future workers as a quantitative measure in correlating with specific chemical reaction rates.

We agree with Engel's criticism of our hypothetic model of a 10 cycle per second oscillator which is turned on and off every five seconds. If, however, the interval were 0.6 second on and 0.4 second off, this model would give a mean frequency of 6 per second with Engel's method and a dominant frequency of 10 per second with Brazier's method, since, as Engel and associates stated (*ARCH. NEUROL. & PSYCHIAT.* 51: 134 [Feb.] 1944): "When a given interval contained both countable waves and low voltage fast activity, the type which occupied the greater portion of that interval was arbitrarily selected for purposes of designation." If one is interested in the physical system determining the rate of the 10 per second oscillator, a calculated mean rate of 6 per second would be misleading.

The physical sciences have advanced in proportion to the isolation of dimensionally meaningful variables and their apparently "oversimplified" study in functional relations. Brain waves are a manifestation of physicochemical events. As the field widens, it is certain that dimensional clarity, despite its limitations, will prove rewarding, as it has unfailingly been in other physicochemical problems.

HUDSON HOAGLAND, PH.D., Sc.D., Shrewsbury, Mass.

222 Maple Avenue.

Abstracts from Current Literature

EDITED BY DR. BERNARD J. ALPERS

Physiology and Biochemistry

PHYSIOCHEMICAL MECHANISMS IN EXPERIMENTAL EPILEPSY. VICENTE H. CICARDO, *J. Nerv. & Ment. Dis.* **101**:527 (June) 1945.

Cicardo believes that the theories of cerebral hydration, vascular changes, humoral factors and local injury which have been advanced as explanations for the mechanism of the epileptic attack are inadequate. He suggests that, whatever the cause of the attack, cortical excitation appears to be determined by the release of potassium ions by the cortical neurons, which would lead, as in the case of nerve fibers, to depolarization of membranes, with consequent action currents, discharge of motor neurons and, finally convulsions. The author reviews the literature on the effect of the potassium ion on the nervous system. He has shown that during attacks of experimental epilepsy in the dog obtained by electrical stimulation of the brain or by the injection of convulsant drugs, such as metrazol, there is loss of potassium from the brain, as shown by analyses of blood plasma from the superior longitudinal thoracic vein before and immediately after the onset of convulsions. The loss of potassium is of cerebral, and not of muscular, origin, as shown in animals in which convulsions were suppressed by previous section of the medulla or by means of curarizing agents. Mobilization of potassium may be the origin of the action potentials recorded at the level of the cerebral cortex. Increase of cerebral activity accompanied with an increased loss of potassium would have, as a consequence, a parallel increase in the intensity and frequency of brain waves, which are propagated across the motor neurons, with the production of convulsive attacks.

CHODOFF, Langley Field, Va.

THE RELATION BETWEEN THE EFFECTS OF THE BLOOD SUGAR LEVELS AND HYPERVENTILATION ON THE ELECTROENCEPHALOGRAM. M. E. HEPPENSTALL, *J. Neurol., Neurosurg. & Psychiat.* **7**:112 (July-Oct.) 1944.

Since raising the blood sugar above fasting levels tends to prevent the appearance of delta waves on overbreathing, Heppenstall investigated this phenomenon in 71 cases of epilepsy, neurosis, psychopathic personality and post-traumatic states to see whether any group of subjects failed to react in this fashion. Two types of response were found: (1) a type in which raising the level of the blood sugar prevented the appearance of slow rhythms, the level at which stability in the electroencephalogram was achieved being low, probably 120 to 130 mg. per hundred cubic centimeters, and (2) a type in which slow rhythms still appeared, though diminished in number, and were elicited with blood sugar values above 130 mg. per hundred cubic centimeters. No correlation was found to exist between the age and the type of response. The more severe the degree of abnormality in the resting electroencephalogram, the greater was the probability that the response to elevation of the blood sugar would be unstable. Patients with neuroses were found exclusively to show the first type, and patients with epilepsy, the second type; the psychopathic personalities were equally divided on this basis, while, of the patients with post-traumatic states, those with mild head injuries usually showed responses of the first type. In the opinion of the author, the presence of this instability increases the probability that a patient is epileptic and the use of the test in cases of suspected epilepsy is recommended.

MALAMUD, San Francisco.

STUDIES ON AMEBOID MOTION AND SECRETION OF MOTOR END PLATES: V. EXPERIMENTAL PATHOLOGIC EFFECTS OF TRAUMATIC SHOCK ON MOTOR END PLATES IN SKELETAL MUSCLE. EBEN J. CAREY, LEO C. MASSOPUST, WALTER ZEIT, EUGENE HAUSHALTER and JOHN SCHMITZ, *J. Neuropath. & Exper. Neurol.* 4:134 (April) 1945.

Carey and his co-workers report their observations on healthy, white rats (*Mus norvegicus*) which were subjected to trauma of the leg muscles. Pentobarbital sodium was used as the anesthetic, and the experiments were well controlled. Trauma was produced by striking the muscles of a limb with a wooden mallet. The number of blows varied from 50 to 150, with an approximate rate of 30 blows per minute. The striking force was 77 Gm., and the rounded striking face was 0.75 square inch (4.85 sq. cm.) in area. The estimated force was 150 Gm. per square inch (23 Gm. per square centimeter). In this way shock was produced with individual variation in response to a traumatic stimulus. The muscles were excised at different times after the trauma, but in all cases prior to cessation of cardiac and respiratory activities.

Teased muscle fibers prepared by a modified gold method were stained by different technics. Teased muscles previously subjected to gold impregnation gave the best morphologic evidence of secretory activity of the end plates. Over 1,800 gold preparations were studied as a basis for the investigation.

Carey and his co-workers report that the normal control motor end plates in the gastrocnemius muscle of the white rat under pentobarbital anesthesia were 40 to 60 microns in length. The retracted end plates had wide, short axonic terminals surrounded by a rim of the granules of Kühne 5 to 15 microns wide, whereas the expanded end plates had long, slender terminals with a diminished quantity or complete absence of these granules. There was a rhythmic quantitative change in the granules surrounding the normal motor end plates.

Thirty minutes after 50 mallet blows the traumatized gastrocnemius muscle had the majority of its end plates retracted into ball-shaped structures 15 to 60 microns in length, which were impregnated intensely with gold.

From thirty minutes to two hours after the blows ephemeral elongated streamers of Kühne's granules 3 to 500 microns in length appeared concomitantly with the progressive depletion of both the terminal axons of the end plate and the epilemmal axons external to the muscle fiber. These masses of granules were both internal and external to the muscle fiber in about 1 per cent of the motor trees; therefore large quantities of gold-impregnated muscle must be carefully teased in order to detect this evanescent stage in the morphologic depletion or loss of motor innervation of skeletal muscle in the early period following muscle trauma.

For thirty minutes to four hours after muscle trauma, some of the motor trees likewise were completely denuded of end plates, and others showed granular disintegration of the terminal axons of the end plates in various stages.

Concomitant with the substantial morphologic loss of the motor innervation of the gastrocnemius muscle, there was either weak or complete absence of response of the muscle to both direct and indirect electric stimulation through the sciatic nerve when the animal was in the terminal stages of profound shock, and before cessation of cardiac and respiratory activities.

The structural changes of the motor innervation were accompanied with morphologic changes in the skeletal muscle fibers characterized by irregular grouping of the cross striations comparable to certain Liesegang bands, by irregular granulation and by hyaline coagulation of the muscle protoplasm comparable to Zenker's so-called waxy degeneration of Zenker. The muscle nuclei were pyknotic. The morphologic changes were expressions of an underlying alteration in the chemistry of the neuromuscular apparatus and skeletal muscle fiber produced by traumatic shock. They were comparable to the alterations produced by the experimental injection of lactic acid into the zone of motor innervation of skeletal muscle.

The authors suggest that traumatic shock either augments the permeability of the end plates to the transmission of axonic material into the muscle or abnormally produces the delay in the dissolution of secreted nervous material in the muscles in certain places, or that both processes may be involved. This pathologic evidence supports the claim that the motor end plates are small glands of internal secretion. Traumatic shock augments their nervous secretion to the point of acute anatomic loss of certain motor innervations in some traumatized muscles and accompanying explosive degenerative changes of some of the muscle fibers. Excessive acidity due to anoxia may underlie these changes in nerve and muscle subjected to trauma.

GUTTMAN, Philadelphia.

SOME NEW DEVELOPMENTS IN THE MORPHOPHYSIOLOGY OF THE CEREBRAL CORTEX.
S. SARKISOV, *Brit. M. J.* 2:37 (July 14) 1945.

Sarkisov discusses some of the recent developments in the morphophysiology of the cerebral cortex. Pavlov's experiments on the conditioned reflex have led to further investigations on the part which the cortex plays in the most differentiated nervous activity and on the connection of the cortex with the functions of the internal organs. Recent electrophysiologic investigations include studies on the bioelectrical phenomena of the brain, on the finest structural features of the cerebral cortex, on the delicate mechanism involved in cerebral activity, on the electrophysiologic mechanism of the various sections of the central and peripheral nervous system in both the normal and the pathologic state, on the bioelectrical manifestations of the brain under different influences, on changes of the normal brain potentials in cases of mental disease and on bioelectrical manifestations of organic diseases of the brain.

Considerable knowledge has been acquired on the cortical formations and the various architectonic cellular structures of the most highly organized matter of the brain. The methods of architectonic investigation have been of great use in establishing the general features of the structure of the cerebral cortex, its division into separate areas and regions according to the character of the various cellular and fibroid laminae. These studies play a particular part in solving the problem of localization. There remains to ascertain how the formation of the neurons of the cortex in their entirety proceeds and to discover how in the process of development the connections between the various groups of neurons establish themselves inside the individual cortical formations, as well as between the various cortical regions.

ECHOLS, New Orleans.

THE EFFECTS OF HIGH ALTITUDE ON MAN. H. C. MATTHEWS, *Brit. M. J.* 2:75 (July 21) 1945.

This is the first of two Oliver-Sharpes lectures delivered before the Royal College of Physicians of London, on the application of physiologic knowledge to the saving of life and to increasing the efficiency of flying personnel. The physiologic effects of high altitude are (1) the effects of lowered partial pressure of oxygen, which leads to incomplete saturation of the blood with oxygen and may indirectly disturb the carbon dioxide content of the blood, and (2) the effects of lowered atmospheric pressure, which may lead to bubble formation within blood vessels and tissues and to disturbances following expansion of the gas present in the viscera, sinuses and middle ear, and, after injuries to the chest of air within the pleura.

Three primary factors determine the intensity of symptoms due to lack of oxygen: the partial pressure of oxygen during exposure, the duration of exposure and the muscular activity of the subject. The effect of changing from oxygen to air at an altitude of 35,000 feet (10,500 meters) is unconsciousness in less than a minute, respiratory failure in seven to eight minutes and death in ten minutes. Lack of oxygen at an altitude of 5,000 to 10,000 feet (1,500 to 3,000 meters) produces reduced night vision at an altitude of 10,000 to 15,000 feet (3,000 to 4,500

meters), fatigue, headache, errors of judgment and indifferent mental condition; at an altitude of 15,000 to 22,000 feet (4,500 to 6,700 meters), reduced capacity for physical work, euphoria and loss of neuromuscular coordination, and at an altitude of 22,000 to 27,000 feet (6,700 to 8,000 meters), rapid loss of muscular control.

Bubble formation in the blood vessels and tissues at lowered pressure is produced by three main factors: the ratio of pressures and, to a lesser extent, the absolute magnitude of the change in pressure; the rate of change, and local conditions in the tissues. Decompression sickness above 30,000 feet (9,000 meters) is common and starts with pain in the muscles and joints and with pain in the chest, followed by sensory symptoms and anesthesia of the limbs, itching and tingling sensations. These are followed by collapse of central origin, during which the victim suddenly becomes intensely white, the pulse rate becomes slow and imperceptible and consciousness is lost.

With rapid change of pressure the pressure in the sinuses and the middle ear must equalize itself with that outside. If the eustachian tubes are patent, a fall of pressure of half an atmosphere in about half a second can be tolerated by the human subject without discomfort. However, with increasing pressure air must be admitted to the middle ear by opening the eustachian tube; this cannot be done rapidly enough to tolerate descent at anything like this rate.

ECHOLS, New Orleans.

Neuropathology

PARAMYOCLONUS MULTIPLEX. GEORGE B. HASSIN and RICHARD D. KEPNER, *J. Neuropath. & Exper. Neurol.* 4:123 (April) 1945.

Hassin and Kepner report observations on a woman aged 51 who had paramyoclonus multiplex. For twenty-six years the patient had had paranoid schizophrenia and for ten years had had involuntary muscular contractions. These twitchings appeared to constitute a tic. Repeated examination revealed that the contractions affected different groups of muscles at various times, without regularity or sequence. The two sides, as a rule, failed to move together, and the face was not involved, though blinking of the eyes was observed frequently. The contractions were not rhythmic or regular in force or rate; they disappeared during sleep, lasted for weeks and months, and then disappeared, only to reappear after a lapse of time. During the patient's many years under observation at the hospital nothing was noted that would suggest any form of convulsive disorder.

Biopsy of muscle revealed changes in both the parenchyma and the middle layer of the mesoderm, the alterations being especially conspicuous in the latter. They consisted chiefly of hyperplasia of the mesodermal elements of the endomysium, perimysium and adventitial walls and were out of proportion to the parenchymatous changes of the muscle. Hassin and Kepner state that these changes are the result of muscular hyperactivity of many years' duration. They are a manifestation of the wear and tear of some muscle fibers due to overactivity, just as in epilepsy the changes in the brain are to be considered secondary to the convulsions. They conclude that the paramyoclonus multiplex of Friedreich is not an independent morbid entity but a form of incomplete epilepsy, or hysteria.

GUTTMAN, Philadelphia.

CEREBRAL FAT EMBOLISM AFTER ELECTRICAL CONVULSION THERAPY. A. MEYER and D. TEARE, *Brit. M. J.* 2:42 (July 14) 1945.

Fatal accidents following electrical convulsion treatment are rare and are due, according to Alexander and Lowenbach, to three possible mechanisms: direct action of the electric current on the brain tissue through which it passes, resulting in vasoconstriction and blanching of the tissue; excessive stimulation of the vagovasomotor centers of the medulla, causing generalized circulatory disturbances, and impairment of the cardiac-circulatory-respiratory system of the patient to the extent of intolerance to the excessive demands imposed by a convulsion. Meyer

and Teare report the case of a man aged 53 in whom sudden death followed electrical convulsion therapy and was ascribed to cerebral fat embolism. They state that cerebral fat embolism has not yet been described after electrical convulsion treatment, although it has followed shock produced by azoman (triazol) and metrazol. None of the widely recognized causes of fat embolism, including fractures, severe contusion, deep laceration of the skin, severe burns, operations on adipose persons and forceful orthopedic manipulations could be demonstrated post mortem. Other possible causes, such as concussion, convulsions and the blood lipids, were considered, but the authors could not say which of these factors was operative in the case reported.

ECHOLS, New Orleans.

Psychiatry and Psychopathology

A NEW APPROACH TO THE PROBLEM OF HYSTERIA. FRANCIS POLLAK, *J. Nerv. & Ment. Dis.* **101**:268 (March) 1945.

Pollak believes that there is a cerebral basis for many hysterical phenomena and that a close parallelism can be drawn between clearly organic nervous symptoms and those which are usually considered to be purely psychogenic. Examples are given of visual, sensory and motor phenomena originally considered to be hysterical which later proved to be of organic origin. The author points out that the presence of purposiveness is not the exclusive possession of psychogenic phenomena, since purposiveness exists at all levels of development, from the most rudimentary and "physical" to the most complex and "psychic."

CHODOFF, Langley Field, Va.

DELAYED FAVORABLE EFFECTS IN PSYCHOTHERAPY. JOSEPH C. YASKIN, *J. Nerv. & Ment. Dis.* **101**:550 (June) 1945.

Yaskin discusses the conditions under which delayed benefit occurs from psychotherapy and the reasons for its occurrence.

The fundamental disturbance in the psychoneuroses is emotional, and in psychotherapy the attainment of insight by the patient remains largely an emotional process. The intellectual benefits of the so-called insight are probably of secondary importance. The emotional value of the transference relationship between the therapist and the patient is of special importance, and the former must frequently supply actual guidance and give meaning and direction to the experiences and reactions of the patients.

Delayed favorable effects of psychotherapy are observed principally in (1) patients who at the time of the treatment reject psychologic factors as causes of their illness; (2) patients who believe that psychologic causes are responsible for their disabilities but are unable to free themselves of the symptoms; (3) patients in whom external stress and strain cannot be eliminated or corrected at the time of the treatment; (4) patients in whom neurotic symptoms are associated with organic disease; (5) patients with certain constitutional psychopathic states.

The patient who at the beginning rejects psychologic factors as a cause of his disability, the patient with considerable external stress and strain and the patient with existing organic disease may terminate the initial psychotherapy with dissatisfaction, and even resentment, but at a later date have a change of attitude conducive to more satisfactory rapport, perhaps in the hands of another psychotherapist. The initial therapy, though rejected, often leaves a definite therapeutic impression and acts as an "inoculation."

The patient who willingly accepts psychologic causes but fails to make satisfactory progress by reason of the inherent difficulties of emotional exploration and equilibration often discontinues the treatment but nonetheless has already procured some vague feelings and formulation regarding psychologic mechanisms and often unwittingly continues a self analysis, leading to a more satisfactory reevaluation and better adjustments.

CHODOFF, Langley Field, Va.

THE SIGNIFICANCE OF THE DEPTH OF THE PHYSIOLOGIC CUP OF THE OPTIC DISC FOR MENTAL ABILITY. MORTIMER OSTOW, *J. Nerv. & Ment. Dis.* **102:571** (Dec.) 1945.

Since the optic nerve is derived from an outpouching of the brain it has been inferred that variations in the structure of the optic disk might be associated with variations in the physical structure of the brain. Ostow hypothesized that the depth of the physiologic cup of the optic disk might be associated with some aspect of mental function. In order to test the validity of this hypothesis, more than 325 patients at Saint Elizabeths Hospital and 155 patients from the Medical Center for Federal Prisoners were examined ophthalmoscopically and the results compared with the diagnosis of the mental status and with various other factors. Psychometric data were available for 229 of the patients. By means of ophthalmoscopy, the degree of cupping if present was graded as marked, moderate or mild.

In the entire series of 480 patients examined, there appeared to be no relation between the mental diagnosis or a positive family history of mental disease and cupping of the disk. Among the psychotic patients, it was found that 61 per cent of those with mental ages of less than 14 years had flat disks, whereas this was true of only 36 per cent of those with mental ages of 16 years or over. On the other hand, only 17 per cent of the former showed deep cupping, whereas 43 per cent of the latter exhibited deep excavation. Among the nonpsychotic patients there was an even closer correlation between better intelligence and cupping of the disk and between a low intelligence quotient and flat disks.

A possible explanation of the findings would be that both the physiologic cup and intelligence are functions of the excellence of growth and maturation of the central nervous system.

CHODOFF, Langley Field, Va.

TICS AND IMPULSIONS IN CHILDREN: A STUDY OF MOTILITY. MARGARET SCHOENBERGER MAHLER, *Psychoanalyt. Quart.* **13:430** (Oct.) 1944.

Mahler believes that there are three types of impulsions: (1) repetitive, strongly libidinated, simple or complicated motor actions which essentially serve the purpose of discharge, (2) actions which symbolize an aggressive gesture or magic defensive motor action of the ego against intolerable tension and conflict with the outside world and (3) stereotyped performances to obtain mastery of skill or learning or as a mechanism against interference. She considers that the second type constitutes a disturbance which is usually called a tic but which, however, she prefers to classify as "denial by magic repetitive gesture."

She classifies this type into three subtypes:

1. Tics resulting from a conflict between a vicariously used, and therefore overtaxed, affective motility and the claim for control. These tics, first manifested at a very early age in a conspicuous motor restlessness and hypermotility, are characterized by great interchangeability of the movements involved. They can be stopped voluntarily by the child for a period of time when outside pressures or the demands of the superego call for temporary control. The children are often characterized by an abundance of expressive motility. Later, usually at the age of 6 or 7, the impulsions and "tics" lose their volitional nature and their high reversibility potential through the catalyzing influence of the general powerful repression. This type of tic never seems to enter latency.

2. Tics which seem to develop after the child has entered school and has made a fair adjustment. There is always, however, a preschool history of fidgetiness and immaturity in the sense of playfulness. An increase of instinctual tension through trauma (automobile accident) or a sudden heightening of a sense of guilt (Holy Communion, threat of the consequences of masturbation) is followed by volitional, so-called nervous habits, such as blinking, picking the nose or rolling on the stomach. These habits, which are accompanied with an anxiety state, are usually opposed by threats of corporal punishment or of other consequences—a

pressure which facilitates the eruption of the impulse. The real tic, frequently coinciding with or followed by a general bodily jerkiness, appears a few weeks after the child has given up the autoerotic activities. Children with this form of tic are gravely inhibited in their voluntary expression, so that it is sometimes very difficult to get them to talk or to initiate activity. In them, defense and fear of being overpowered by the impulse are uppermost.

The differential diagnosis between tic and chorea is often very difficult. It sometimes happens that children known to have had multiple tics acquire rheumatic fever and chorea many years later. The author has seen at least 1 case in which a child with severe recurrent chorea and rheumatic endocarditis finally exhibited generalized incapacitating tics of a gestural and vocal quality.

3. Tics appearing in adolescents and in adults. These tics seem to have a more localized organ neurotic character and an obstinate local affinity to the eroticized organ, for which the involved muscle group in the tic is used as symbolization. Their psychodynamics is like that of traumatic neuroses. In all probability, they are those tics which Ferenczi described as single and living a so-called parasitic life. They are isolated from the ego function and are therefore very difficult to reach therapeutically.

All tiqueurs have definitely shown highly increased body narcissism, as well as a tendency to hypochondriacal self observation. In all three types of tiqueurs, overstimulation and fixation of component impulses have occurred, and the neuromuscular apparatus underwent vicarious or constitutional hypercatharsis in infancy and early childhood. In addition, infantilization and absolutely or relatively increased and inconsistent restraint of the affective motor component of the ego's kinetic function were noted in the anamnesis in cases of all three types, whereas simultaneously channeled performance motor function and compensatory ideational functions and skills were on the whole neglected. The kinetic function of the ego was especially damaged in those cases in which there was a lack of consistent and moderate general outside control to aid the development of the normal and balanced synthetic function of the ego. Owing to the erotization of the neuromuscular system in these cases, motility lags in development and is not well synthesized.

PEARSON, Philadelphia.

A REVIEW OF PSYCHOLOGICAL WORK AT THE BRAIN INJURIES UNIT, EDINBURGH, 1941-5. O. L. ZANGWILL, *Brit. M. J.* 2:248 (Aug. 25) 1945.

Zangwill reports a review of psychologic work undertaken at the Brain Injuries Unit in Edinburgh during the last four years. This included studies and assessment of high grade intellectual defects, explorations of adjuvant technics in neuropsychiatric diagnosis and practical contributions to reeducation, disposal and resettlement. Some of his observations are enumerated. The author was particularly impressed with the prevalence of cognitive disabilities which have been ascribed to focal lesions. He was able to establish that focal disorders of visual perception, manual skill, language and calculation in their incipient or residual forms commonly take the shape of decrement of special abilities. He noted that some degree of memory or learning defect is extremely common in cases of cerebral lesions. He found that appropriate tests in delimiting the finer grades of organic intellectual impairment have been valuable in the differential diagnosis of organic and psychogenic sequels of head injuries; it was noted that the Rorschach method, in the majority of cases of post-traumatic injury, added little of real value to expert psychiatric assessment. The psychologist's contribution to reeducational procedures consisted in advice regarding these procedures for patients with psychologic handicaps, periodic psychometric assessment of progress made and preliminary exploration of technics which might govern reeducation of special disabilities. The results of psychologic examination were helpful in formulating a general course of rehabilitation and occupational therapy; on the other hand, the therapist's observations frequently indicated special disabilities displayed in a practical setting and suggested more intensive laboratory investigation. The psy-

chologist's findings were sometimes helpful in regard to problems of disposal and resettlement. The unit provided material for psychologic research on orientation in the confusional state, visual agnosia and disorientation associated with lesions of the nondominant hemisphere; clinical tests of memory impairment, and the Rorschach test in cases of acute head injury.

ECHOLS, New Orleans.

Meninges and Blood Vessels

SEQUELAE OF CEREBROSPINAL MENINGITIS. J. A. DEGEN and others, Brit. M. J. 2:243 (Aug. 25) 1945.

Degen and his co-workers undertook a survey in an effort to determine whether there was an appreciable incidence of persistent symptoms following cerebrospinal meningitis and, if there was, to establish their nature and severity. Of the original 1,108 cases of meningitis, follow-up observations in 986 cases were sufficiently long to justify inclusion in the study. The conclusion was drawn that there is an appreciable incidence of persistent symptoms following cerebrospinal meningitis, the nature and severity of which have been defined but the discussion of which has been deliberately avoided.

ECHOLS, New Orleans.

MENINGITIS AFTER SPINAL ANALGESIA. MICHAEL KREMER, Brit. M. J. 2:309 (Sept. 8) 1945.

Kremer reports 7 cases of infection of the subarachnoid space following spinal analgesia, 1 of which was fatal. In addition, he reports a case of meningitis following diagnostic lumbar puncture. The condition is characterized by a low grade infection, chronic in nature with a tendency to relapses; seldom is it immediately serious, because the infecting organisms are rarely of high pathogenicity. The condition has been considered to be (1) due entirely to the irritant action of the spinal analgesic, (2) secondary to infection elsewhere in the body or (3) subsequent to the introduction of infected material along the lumbar puncture needle. Kremer believes that infection due to faulty aseptic technic is the likeliest explanation. Treatment is chiefly prophylactic, but when the complication does occur the infection must be eliminated as soon as possible.

ECHOLS, New Orleans.

A CASE OF PARAPLEGIA AFTER CEREBROSPINAL MENINGITIS. H. HILTON STEWART, Brit. M. J. 2:319 (Sept. 8) 1945.

Stewart reports an unusual case of a 12 year old girl in whom, one year after the acute phase of meningitis, there developed paraplegia which was due to organized adhesive meningitis producing diminution of the blood supply to the middorsal area. The adhesions were divided at operation, but for a year and a half the patient was unable to move her legs. After this time function gradually began to return, and three and a half years after operation there was no disability and examination revealed a completely normal person.

ECHOLS, New Orleans.

MENINGITIS DUE TO PENICILLIN—AND SULPHONAMIDE-SENSITIVE PITTMAN B STRAIN OF H. INFLUENZAE: RECOVERY. D. G. MCINTOSH and CONSTANCE F. DRYSDALE, Brit. M. J. 2:796 (Dec. 8) 1945.

McIntosh and Drysdale report the case of a 2½ year old girl in whom meningitis due to *Haemophilus influenzae* developed during convalescence from meningococcal meningitis, which had been treated with penicillin and sulfadiazine. The patient responded to the administration of these drugs but had a relapse. Since the organism is insensitive to sulfapyridine, sulfamezathine (dimethyl derivative of sulfadiazine) was substituted, after which recovery occurred.

ECHOLS, New Orleans.

Diseases of the Brain

SYPHILITIC HEPATITIS AND GENERAL PARESIS [DEMENTIA PARALYTICA] OCCURRING SIMULTANEOUSLY. R. FINLEY GAYLE JR. and WALTER B. QUISENBERRY, *J. Nerv. & Ment. Dis.* **101**:220 (March) 1945.

Gayle and Quisenberry mention the infrequency with which syphilitic hepatitis and dementia paralytica are associated and report the case of a white man aged 38 in whom the two conditions were coexistent. The hepatitis was of the gummatous type and was associated with jaundice, splenomegaly and fever. The patient received malarial therapy for his neurosyphilis, and the curative effects of this treatment on the hepatitis resulted in a "therapeutic paradox," with consequent portal obstruction, ascites and death.

CHODOFF, Langley Field, Va.

DIFFERENT FORMS OF DIFFUSE SCLEROTIC PROCESS—PELIZAEUS-MERZBACHER DISEASE, STRÜMPPELL'S FAMILIAL SPASTIC SPINAL PARALYSIS, LEUCODYSTROPHY—IN ONE FAMILY. MAX KASTAN, *J. Nerv. & Ment. Dis.* **101**:357 (April) 1945.

Kastan describes a family in which 4 members showed different forms of a diffuse sclerotic process. The presenting case, in which an erroneous diagnosis of multiple sclerosis had previously been made, showed the classic picture of Merzbacher-Pelizaeus disease (aplasia axialis extracorticalis congenita)—masklike face, spastic paralysis of the legs, exaggerated knee reflexes, horizontal nystagmus, ataxia, incoordination and intention tremor. A cousin of the patient, at the age of 25, displayed the characteristic features of spastic spinal paralysis of the familial type. A son of the first patient died at the age of 4, after a history of convulsions, progressive paralysis of the legs and inability to talk. Another son, when examined at the age of 4 years, was unable to walk or talk and showed the Babinski sign, hyperactive reflexes, conjugate deviation and constant seizures. The author suggests that familial spastic paralysis be classified as the spinal type of diffuse sclerosis.

CHODOFF, Langley Field, Va.

CIVILIAN ADVANCES AND INVESTIGATIONS IN NEUROSURGERY DURING THE WAR. COBB PILCHER, *J. Nerv. & Ment. Dis.* **101**:434 (May) 1945.

The problem of "closed" head injury, and particularly of concussion, has been elucidated by the work of Denny-Brown and Russell, which stresses the importance of acceleration of the head in the production of concussion-producing injuries. Walker, using a refined electroencephalographic technic, demonstrated a fleeting excitatory phase at the moment of impact producing concussion. This preceded the suppression of cortical activity, previously known to be characteristic of concussion. Clark and Ward showed that trauma to the head produced by a very rapid wave, of the type caused by "blast" in air or water, does not produce concussion and that this type of injury when applied to the trunk is not transmitted through vascular channels to produce injury to the central nervous system. Windle and his associates have demonstrated degenerative alterations in nerve cells of the cortex and brain stem in association with concussion. The ominous prognostic significance of respiratory disturbances, high temperature, pupillary abnormalities, severe paralysis and compound fractures has been emphasized by Pilcher and Angelucci.

Numerous studies have demonstrated that sulfonamide drugs when applied locally to the brain are safe, in moderate doses, except for sulfathiazole, which is definitely convulsogenic and should never be used.

"Fibrin foam" has been shown to constitute a new and valuable method of hemostasis in neurosurgery. A tough film also prepared from fibrinogen has been used for the repair of dural defects.

The problem of the "post-traumatic syndrome" has been studied from various points of view by Denny-Brown and his co-workers and by Ruesch and Bowman,

and both groups feel that most of the symptoms of this condition are of organic origin.

Cairns and Ascroft, reporting on the late results of wounds of World War I, found an appallingly high percentage of cases of traumatic epilepsy (34 per cent in Ascroft's series) following compound fractures and penetrating wounds.

Repair of defects of the skull with vitallium and tantalum has proved satisfactory in the hands of a number of workers.

It has been fairly generally agreed that operative decompression of a traumatized spinal cord is of value only if paralysis and anesthesia have been delayed or incomplete, if there is indication of continued compression or if a penetrating wound necessitates operation because of bacterial contamination, the presence of a foreign body or displaced fragments of bone.

The surgery of injured peripheral nerves has been advanced by the use of clotted plasma as a "nerve glue" and by the employment of the nonirritating and malleable tantalum as wires for nerve suture. There has been only slight success in the repair of long defects in nerves with autogenous or homogenous nerve grafts.

The electric skin resistance galvanometer of Richter has been an aid in the study of denervated areas.

CHODOFF, Langley Field, Va.

CHANGES IN PERSONALITY AFTER CEREBROSPINAL FEVER. M. NARASIMHA PAI, Brit. M. J. 1:289 (March 3) 1945.

It has been noted that some adults who have apparently recovered from the acute stage of cerebrospinal meningitis may continue to complain of various symptoms, some of which are physiogenic and others psychogenic. Narasimha Pai made a study of 51 such patients and found that they showed a more or less definite syndrome, with individual variations. Definite neuropsychiatric changes appeared to progress until ten to fourteen months after the disease, when they remained more or less stationary. In most of the patients the disorder was predominantly psychogenic. Of 24 patients who were severely ill, 16 showed a syndrome suggestive of organic disease. It was noted that persons with no hereditary tendencies to neurotic breakdown may after an attack of cerebrospinal meningitis exhibit neuropsychiatric changes in personality.

ECHOLS, New Orleans.

TREATMENT OF EPILEPSY BY ELECTRICALLY INDUCED CONVULSIONS. G. CAPLAN, Brit. M. J. 1:511 (April 14) 1945.

Caplan presents a preliminary report of the results of an investigation in which an attempt was made to replace epileptic fits, which may occur anywhere at any time, with convulsions electrically induced under controlled conditions of time and place. The convulsions were induced before breakfast once or twice a week by use of a simplified light weight machine designed by the author. Of 15 epileptic men treated in this way, 11 showed a pronounced reduction in the frequency of grand mal attacks; the other 4 showed no great change. Some improvement in the length and intensity of the postepileptic confusion was also noted. Fourteen of the patients had an associated psychosis, in half of whom this condition was considerably ameliorated. No serious complications occurred.

Caplan presents this report in the hope that it will stimulate further investigation of the method. The selection of the type of case and the duration of the beneficial effect of the treatment have still to be determined. However, the author believes that his results are encouraging enough to warrant further study of the method. The treatment is intended as an adjunct in cases in which fits occur despite a full dose of the anticonvulsant drug.

ECHOLS, New Orleans.

ARSENICAL ENCEPHALOPATHY. G. A. RANSOME, J. C. S. PATERSON and L. M. GUPTA, Brit. M. J. 1:659 (May 12) 1945.

Ransome, Paterson and Gupta briefly review the etiology, symptomatology, diagnosis and treatment of arsenical encephalopathy, with special emphasis on the

value of postural treatment. According to Kinnier Wilson, the condition is fatal in about 75 per cent of cases. The authors describe 5 cases in which recovery followed postural treatment; they attribute survival of their patients to nursing in the sitting position. They summarize their management of such cases as follows: (1) examination of the patient; (2) lumbar puncture; (3) keeping the patient up on a back rest; (4) treatment of complications, such as pulmonary edema, fits and hyperpyrexia; (5) adequate antimalaria therapy; (6) administration of calcium or sodium thiosulfate intravenously, 0.5 Gm., with calcium gluconate and ascorbic acid if available (of doubtful value); (7) adequate hydration and nutrition, with a transnasal intragastric Ryle tube left in situ.

ECHOLS, New Orleans.

Diseases of the Spinal Cord

TWO CASES OF MORVAN'S SYNDROME OF UNCERTAIN CAUSE. HARRY PARKS and O. S. STAPLES, *Arch. Int. Med.* 75:75 (Feb.) 1945.

Parks and Staples report their observations on 2 youngsters who had painless infections and ulcerations of the limbs. In each instance the common neurologic abnormalities consisted of a symmetric peripheral type of hypesthesia involving all four extremities, more pronounced distally than centrally. This was accompanied with trophic changes. Neurologic examinations otherwise revealed nothing significant except that the deep reflexes were either diminished or absent. Roentgenograms revealed as an early lesion loss of tufting of the terminal phalanges in the hands and feet. There was a varying degree of muscular weakness without apparent muscular atrophy. Biopsies of the skin revealed nothing remarkable, and in 1 case examination of a peripheral nerve showed nothing abnormal. There was no evidence of tuberculosis or leprosy.

The authors reviewed all the available reports of Morvan's syndrome in children; 7 cases in all have been described, and they did not present the clinical picture usually associated with syringomyelia.

There is no known cause for this peculiar neurotropic disorder, which occurs in children and runs a chronic course. It may resemble certain forms of syringomyelia but lacks the characteristic segmental distribution of sensory symptoms with disassociated sensory changes ordinarily found in this disease. It lacks also amyotrophy, spasticity and other signs indicating involvement of the upper motor neurons or of the spinal tract. It is not leprosy. It is a rare disease which warrants further study.

GUTTMAN, Philadelphia.

MASSIVE EXTRUSION OF LUMBAR INTERVERTEBRAL DISK. A. VERBRUGGHEN, *Surg., Gynec. & Obst.* 81:269 (Sept.) 1945.

Verbrugghen thinks that insufficient stress has been placed on the serious complications which may occur when the ruptured intervertebral disk is inadequately treated. The extrusion of a large part of a disk may so compress the cauda equina as to cause weakness of one leg with disturbance of urinary function, or even a transverse lesion of the cauda equina with paraplegia and incontinence of the bladder and rectum. Most of the patients with lesions of the cauda equina seen by the author languished for days, weeks or months without a correct diagnosis being made. In all cases the lesion was at the lower lumbar level. The history was characteristically of cogwheel type, with gradually progressive spurts of trouble and the signs were those of acute compression of the cauda equina. The symptom complex varied from slight weakness of the legs below the knee with saddle hypesthesia to severe disturbance of sphincter control. Of 9 patients seen, 8 were operated on, and 1 died before anything could be done. Their cases represent the serious complications seen in 300 consecutive cases of typical herniated nucleus pulposus. In all but 1 of the 9 cases there was a history of backache for years, and in all but 2, a history of both backache and sciatica for

years. A history of trauma was obtained in 3 cases. The bladder mechanism was seriously involved in all but 1 case. Weakness and hypesthesia were observed in varying degrees. The Lasègue sign was positive in all the cases in which it was tested. The deep reflexes in the ankle were affected in all cases. The spine was tender on deep pressure in 6 of 8 cases. The intervertebral space was narrowed at the site of the herniation of the involved disk in 5 of 9 cases. Early diagnosis and operation are essential, but recovery may be slow and incomplete, even if the diagnosis is made early.

J. A. M. A.

SIXTH NERVE PARALYSIS AFTER SPINAL ANALGESIA. W. A. FAIRCLOUGH, Brit. M. J. 2:801 (Dec. 8) 1945.

During a period of two years at the Auckland Hospital New Zealand, paralysis of the sixth nerve following spinal analgesia occurred once in 202 cases. The 10 cases in the series are briefly described. Theories of a mechanical, toxic and inflammatory origin have been suggested to explain the cause of paralysis of the abducens nerve following spinal injection. Fairclough submits some points concerning binocular vision and the necessary faculties concerned in its maintenance that seem to be definite contributing factors in causing the abducens nerve to be so often the earliest cranial nerve to supply clinical evidence of cerebral disease. Relief of the associated headache can be obtained by the inhalation of oxygen and keeping the head in a horizontal position. Covering the deviating eye gives relief for the diplopia.

ECHOLS, New Orleans.

Vegetative and Endocrine Systems

PITUITARY ADENOMA ASSOCIATED WITH CHRONIC DUODENAL ULCER. JOSEPH E. PISETSKY, J. Nerv. & Ment. Dis. 102:537 (Dec.) 1945.

Pisetsky reviews the literature on the association of tumors of the pituitary gland and duodenal ulcer and reports an additional case. The patient had had frontal headache and failing vision associated with bilateral atrophy of the optic nerve for about fifteen years when he began to complain also of abdominal pain. Roentgenologic study in 1936 revealed evidence of both a tumor of the pituitary gland and a nonobstructive duodenal ulcer. In 1937 the patient was given a course of radium cannon treatment directed to the pituitary region. The condition remained stationary until 1941, when abdominal symptoms again appeared, and in 1942 roentgenographic examination revealed an old duodenal ulcer.

The large tumor of the pituitary had undoubtedly exerted pressure on the basal parts of the brain, especially the hypothalamus. There probably was also compression of the cerebral cortex, due to increased intracranial pressure. Thus, by alterations in formation and transmission of impulses to the visceral organs, the cerebral cortex and the hypothalamus could provide the neurologic substrate for the production of a duodenal ulcer. The immediate ulcerogenic process in the stomach may be a combination of increased peristalsis and vasoconstrictor action, resulting in areas of local ischemia, which are then acted on by gastric and duodenal hypersecretion.

CHODOFF, Langley Field, Va.

Book Reviews

Human Genetics. By Reginald Ruggles Gates, Ph.D. Two volumes. Price, \$15. Pp. xvi + 1,518. New York: The Macmillan Company, 1946.

This large work is published in two attractive volumes, which have consecutive pagination. Three chapters of the first volume present a general view of the principles of the science of genetics, and groups of characteristics and abnormalities are discussed in the remaining chapters. Chapters covering neurologic, psychiatric and psychologic conditions appear consecutively in the second volume.

The chapters on general principles, in volume I, may be used as a review of the principles of genetics if their rather great limitations are kept in mind. There is failure to take account of the possibility of transmission of characteristics through substances in the cytoplasm. The revolutionary work of H. J. Müller and others on the environmental influences on mutation rates is not mentioned. The presentation of the concept of penetrance is distorted. This concept will be familiar to few medical readers. The term is used to describe the fact that certain characteristics which are transmitted by genes are found in otherwise similar pedigrees with different frequencies. Thus, blood types, being uninfluenced by any known environmental factor, show 100 per cent penetrance. Rickets, if it is related to a single gene, shows considerably less than 100 per cent penetrance, and shows zero penetrance if the level of vitamin D intake is high enough. Gates explicitly attributes to each gene a specific percentage of penetrance. This obscures the variability of penetrance under different conditions of life and, simultaneously, makes possible the assumption that any disease which tends to have some familial distribution is related to a gene of low penetrance.

The remainder of the two volumes is made up almost entirely of brief summaries of research papers, arranged according to diseases and conditions. Consequently, the work is somewhat like a vast review of the literature. When used as such it will be of some value to persons interested in the field. However, it does not pretend to be a complete review and cannot be considered a critical one. In most cases the author attempts no considered evaluation of the miscellaneous material he presents under a given heading. When he does introduce analysis other than that which comes from the specified sources, he frequently draws conclusions not warranted by the material presented. He consistently sees genetic relations as playing a much greater role than a truly biologic approach would have revealed. The level of reliability is low, although many valuable references are cited. The chapters on "Hereditary Variations," "Defects and Diseases of the Nervous System," "The Inheritance of Mental Defects" and "The Inheritance of Normal Mental Differences" take no account of the evaluation made in 1935 by the American Neurological Association's Committee for the Investigation of Sterilization. These chapters exhibit clearly the result of the bias disclosed by the author on page 43 of volume I: "Those who . . . try to make out that all mankind are a single house-party, lacking only a common feeling of fellowship, do an injustice to science, truth and eugenics, which has never contemplated universal mixture of races as a desirable future for mankind." It is to be expected that this book will be cited frequently by eugenicists and by those who attribute social problems to genetic differences between men. It will be used with the greatest caution by scientists.

CEREBRAL ANOXIA FROM HIGH ALTITUDE ASPHYXIATION

A Clinicopathologic Study of Two Fatal Cases with Unusually Long Survival and a Clinical Report of a Nonfatal Case

LEONARD A. TITRUD, M.D.*
MINNEAPOLIS

AND

LIEUTENANT COLONEL WEBB HAYMAKER †
MEDICAL CORPS, ARMY OF THE UNITED STATES

EXPERIENCES during World War II have made it evident that aviators who collapse as the result of sudden and severe deprivation of oxygen while flying at high altitudes generally die within a few minutes or hours or recover completely. In a series of 181 cases of anoxic anoxia occurring in aviators, Burchell¹ and Burchell and Masland² reported 42 deaths and 139 survivals. Of the fatalities, the majority occurred at altitudes of over 24,000 feet (7,200 meters); in 2 of these cases the period of deprivation of oxygen was less than five minutes and in 20 from five to ten minutes. The men who recovered without subsequent ill effects were unconscious for periods varying in 7 instances from thirty to one hundred and fifty minutes at altitudes of between 27,000 and 28,000 feet (8,200 and 8,400 meters). Ward and Olson³ related the case of an aviator who, owing to a depletion of his oxygen supply was without supplemental oxygen at altitudes between 28,000 and 20,000 feet (8,200 and 6,000 meters) for thirty-nine minutes and at altitudes between 20,000 and 12,000 feet (6,000 and 3,300 meters) for an additional sixteen minutes; he was unconscious for eight hours and semiconscious for twelve more hours and yet recovered completely. He was last examined about seven weeks after the accident. The absence of neurologic residua following deprivation of oxygen to the point of unconsciousness has been recorded also by Wormley,⁴ Horvath, Dill and Corwin,⁵ and von Tavel.⁶

* Formerly a Major in the Medical Corps, Army of the United States.

† With the Army Institute of Pathology, Washington, D. C.

1. Burchell, H. B.: Report of Accidents from Anoxia in Aircraft, Air Surgeon's Bull. (no. 3) 1:20 (Sept.) 1944.

2. Burchell, H. B., and Masland, R. L.: Vital Statistics: Anoxia, Air Surgeon's Bull. (no. 4) 1:5-7 (April) 1944.

3. Ward, R. L., and Olson, O. C.: Report of a Case of Severe Anoxic Anoxia with Recovery, J. Aviation Med. 14:360-365 (Dec.) 1943.

4. Wormley, G. W.: An Anoxia Accident in Eighth Air Force, Air Surgeon's Bull. (no. 9) 1:20-21 (Sept.) 1944.

(Footnotes continued on next page)

In rare instances anoxic anoxia may lead to severe mental and physical incapacitation. Such a case has been described by Church and Loeser.⁷ It concerned a ball turret gunner whose oxygen supply was shot away at an estimated altitude of 22,000 feet (6,600 meters). He was removed from the turret about fourteen minutes later, when the plane had descended to 16,000 feet (4,800 meters). He was semiconscious for approximately two and one-half hours, and when seen in the hospital was maniacal and totally blind. During the next few days his vision was partially restored, and he regained some ability to speak and comprehend. Four weeks after the accident, psychometric tests (Shipley-Hartford and Binet-Simon) revealed a reduction in the mental age to 15½ years.

The data in the foregoing cases would seem to constitute evidence that susceptibility to anoxic anoxia varies considerably. According to McFarland⁸ and Behnke and Willmon,⁹ healthy men are able to tolerate a reduction of oxygen pressure of about one-third that at sea level, which corresponds to an atmosphere at approximately 12,000 feet (3,300 meters). At this altitude the blood has an oxygen saturation of 80 to 85 per cent. At 33,000 feet (10,000 meters) and higher, even pure oxygen does not suffice to sustain consciousness unless under sufficient pressure (Armstrong and Heim¹⁰). It is well known that tolerance to rarefied atmosphere may be increased through gradual adaptation, and even to such a degree that life may be maintained at 23,000 feet (6,900 meters) for ten days (Gemmill¹¹).

This paper presents the cases of 3 aviators who were deprived of oxygen at high altitudes for varying lengths of time and who subsequently exhibited severe mental and physical incapacitation. In 2 cases the outcome was fatal, and in the third the patient was observed clinically for a period of three weeks. Seven other cases, in which relatively

5. Horvath, S. M.; Dill, D. B., and Corwin, W.: Effects on Man of Severe Oxygen Lack, *Am. J. Physiol.* **138**:659-668 (March) 1943.

6. von Tavel, F.: Die Auswirkungen des Sauerstoffmangels auf den menschlichen Organismus bei kurzfristigem Aufenthalt in grosser Höhe: Ein Beitrag zur Frage der Leistungsfähigkeit in Höhenflug, *Helvet. physiol. et pharmacol. acta*, 1943. supp. 1, pp. 1-128.

7. Church, R. E., and Loeser, L. H.: Injury to Cerebral Cortex Following Anoxemia and Exsanguination: Report of Case, *Bull. U. S. Army M. Dept.*, December 1944, no. 83, pp. 104-111.

8. McFarland, R. A.: The Internal Environment and Behavior: I. Introduction and the Rôle of Oxygen, *Am. J. Psychiat.* **97**:858-877 (Jan.) 1941.

9. Behnke, A. R., and Willmon, T. L.: Physiological Effects of High Altitude, *U. S. Nav. M. Bull.* **39**:163-178 (April) 1941.

10. Armstrong, H. G., and Heim, J. W.: Medical Problems of High Altitude Flying, *J. Lab. & Clin. Med.* **26**:263-271 (Oct.) 1940.

11. Gemmill, C. L.: Acclimation to High Altitudes: Review of Physiological Observations, *U. S. Nav. M. Bull.* **39**:178-187 (April) 1941.

sudden death occurred as the result of exposure to an atmosphere at 20,000 to 30,000 feet (6,600 to 9,900 meters) were not included, inasmuch as the pathologic findings were of no moment. All these were studied at a United States Army general hospital in the Mediterranean Theater of Operations during the interval from December 1944 to May 1945.

MATERIAL AND METHODS

Blocks were taken from representative parts of the brain and from all the thoracic and abdominal viscera. They were fixed in solution of formaldehyde U. S. P. (1:4), embedded in paraffin and stained routinely with hematoxylin and eosin. Additional sections of the brain were stained with cresyl violet, and in certain instances for fat with scarlet red, for myelin by a modified Spielmeyer method and for axis-cylinders by the Bodian technic.

PRESENTATION OF CASES

CASE 1.—Clinical History.—A white sergeant aged 21 was admitted to the hospital Nov. 12, 1944. On that day he had gone on a mission over enemy territory. About five minutes after completion of a bomb run at an elevation of more than 20,000 feet (6,600 meters), he was found unconscious in the waist of the ship. The length of time he had been deprived of oxygen could not be determined. Artificial respiration with oxygen was instituted. During the flight back to the base he had a number of convulsions and on arrival was still unconscious.

On entrance to the hospital the patient was delirious. His temperature was 98.8 F., his pulse rate 88 and his respiratory rate 20. Cyanosis of the finger tips was observed. The pupils were dilated and fixed. The eyelids frequently twitched. The abdominal reflexes were absent. The lower extremities were spastic, and the Babinski sign was readily elicited bilaterally. During the course of the examination the patient had convulsive seizures.

Laboratory Data.—The hemoglobin was 14 Gm. per hundred cubic centimeters and the leukocyte count 29,000, of which 85 per cent were neutrophils. The urine was normal. Because of pronounced rigidity of the trunk, a spinal puncture could not be performed.

Treatment.—On entrance to the hospital the patient received a prophylactic inoculation of tetanus antitoxin, and, to combat the convulsive seizures, 15 grains (1 Gm.) of sodium amytal intravenously. Oxygen was administered continuously. As meningitis was suspected, he was given 25,000 units of penicillin sodium intramuscularly every three hours, and on two occasions 5 grains (0.32 Gm.) of sodium sulfadiazine intravenously.

Course.—Several hours after reaching the hospital, the patient's rectal temperature had risen to 102.2 F., the pulse rate to 110 and the respiratory rate to 38. Opisthotonos had increased. The pupils were constricted. Urinary incontinence became evident. On November 13 his general condition remained much the same. The temperature varied from 102 to 104.8 F., the pulse rate from 120 to 140 and the respiratory rate from 34 to 60. Generalized convulsive seizures recurred periodically. Episodes of profuse perspiration also were noted. On November 14 the patient's temperature had risen to 108 F., and his pulse became very rapid and weak. Death occurred approximately forty hours after the accident.

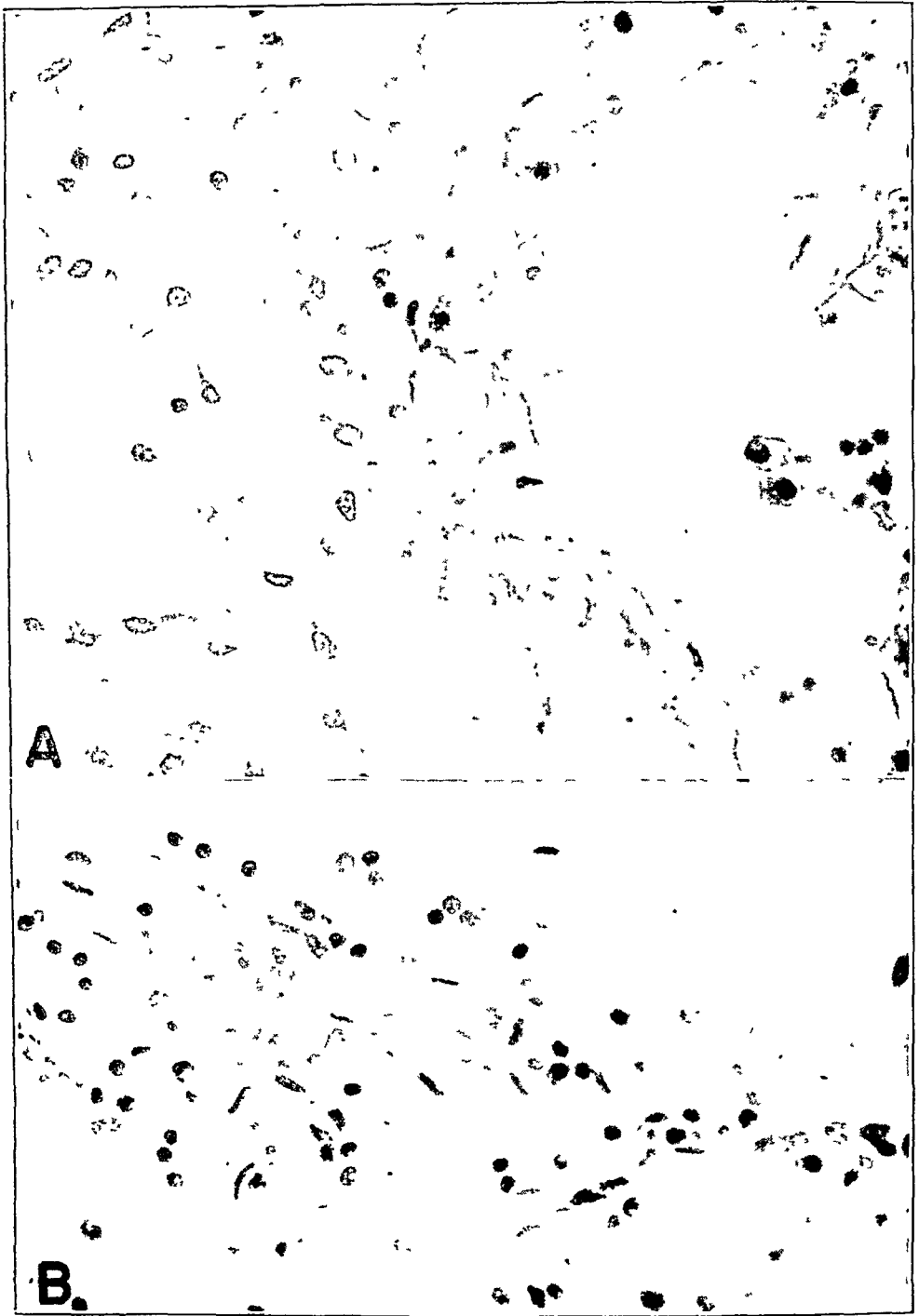

Fig. 1.—In *A* (AIP neg. 94296), from the leptomeninges of the cerebral cortex, there is hyperplasia of trabecular cells, some of which have come to lie free in the arachnoid meshes. An occasional free cell may be hematogenous. In *B* (AIP neg. 94299), from the cerebellar leptomeninges, most of the cells are hematogenous, consisting of lymphocytes, large mononuclears and an occasional neutrophil. Hyperthrophied trabecular cells are scanty. Hematoxylin and eosin stain; $\times 500$.

Gross Autopsy Observations.—Autopsy was performed eight hours after death. The combined weight of the lungs was 1,450 Gm. The bases of both lungs yielded bloody edema fluid. There was a small amount of mucopurulent secretion in the larger bronchi. The heart weighed 300 Gm. Its epicardium was smooth and revealed a few petechiae. The myocardium was rather flabby but otherwise appeared normal. A moderate subendocardial hemorrhage was noted on the septal wall of the left ventricle. The spleen weighed 110 Gm. and was deep red and soft. The liver weighed 1,600 Gm. and the kidneys 100 Gm. each; both organs appeared normal. The rest of the tissues, including the brain, also showed nothing of consequence on gross examination. Spinal fluid taken at autopsy contained 87.6 mg. of protein per hundred cubic centimeters and 175 cells per cubic millimeter; most of the cells were regarded as neutrophils. Cultures of lung tissue yielded *Bacillus subtilis*, and those of the heart and spinal fluid, no growth.

Microscopic Observations.—The heart muscle was the seat of a small hemorrhage. The lungs were congested, and many alveolar sacs contained bloody edema fluid. The liver showed a moderate centrilobular dissociation of cells, and there were a few leukocytes in the sinusoids; a moderate number of cytoplasmic vacuoles, which contained small inclusion-like bodies, were observed. In the adrenal cortex the intracellular lipid substance was equally distributed throughout the cortex but was slightly decreased in quantity. The bone marrow seemed appreciably less cellular than normal for a person in the patient's age group. There was a disproportionately large number of red cell progenitors in relation to the immature granulocytes. Whether this constituted an actual hyperplasia on the part of the nucleated red cells or only a relative increase due to loss of granulocytes could not be decided. Megakaryocytes displayed retrogressive changes, as evidenced by nuclear pyknosis, and even loss of nuclei, but there were considerable numbers of megakaryocytes which appeared normal. A somewhat larger portion of immature megakaryocytic forms than usual were seen, suggesting a regenerative effect. Throughout the marrow there were a moderate number of focal areas of degeneration. No alterations were observed in the remaining thoracic and abdominal viscera.

Study of the central nervous system revealed abnormalities in the leptomeninges and the parenchyma. In the leptomeninges of the cerebrum, brain stem and spinal cord, numerous trabecular cells exhibited reactive changes: Some were slightly enlarged, having spherical, densely chromatic nuclei and scanty cytoplasm, while others were larger and were composed of vesicular nuclei and abundant homogeneous cytoplasm; cells which had become detached from their trabecular framework, coming to lie free in the arachnoid meshes, had all the characteristics of mobile histiocytes (fig. 1A). A few lymphocytes were sometimes encountered in the vicinity of vessels. In the cerebellar leptomeninges there was a predominance of lymphocytes, and an occasional neutrophil was observed (fig. 1B). Small hemorrhages, mostly subpial, were observed in the leptomeninges of both the cerebrum and the cerebellum, and throughout the brain and leptomeninges the vessels were conspicuously engorged.

Changes in the brain were widespread and consisted of necrosis of ganglion cells, on the one hand, and proliferation of blood vessels, on the other. In the cerebral cortex, laminae III through VI were severely affected, many ganglion cells exhibiting shrinkage and other distortions. In moderate numbers of ganglion cells, the cytoplasm, when stained with hematoxylin and eosin, took on a reddish coloration, indicating early necrosis. More advanced necrosis tended to be focal in distribution, the cells in such areas showing pyknosis or disintegration of nuclei,

shrinkage of cytoplasm and chromatolysis (fig. 2 *A*). Often the entire cells were amorphous, as was the case particularly in Sommer's sector of the hippocampus (fig. 2 *B*), and to a somewhat less extent in the nuclei of the floor of the fourth ventricle. Of the other cerebral structures, the putamen and the caudate nucleus were the most affected, many foci of cellular necrosis being present

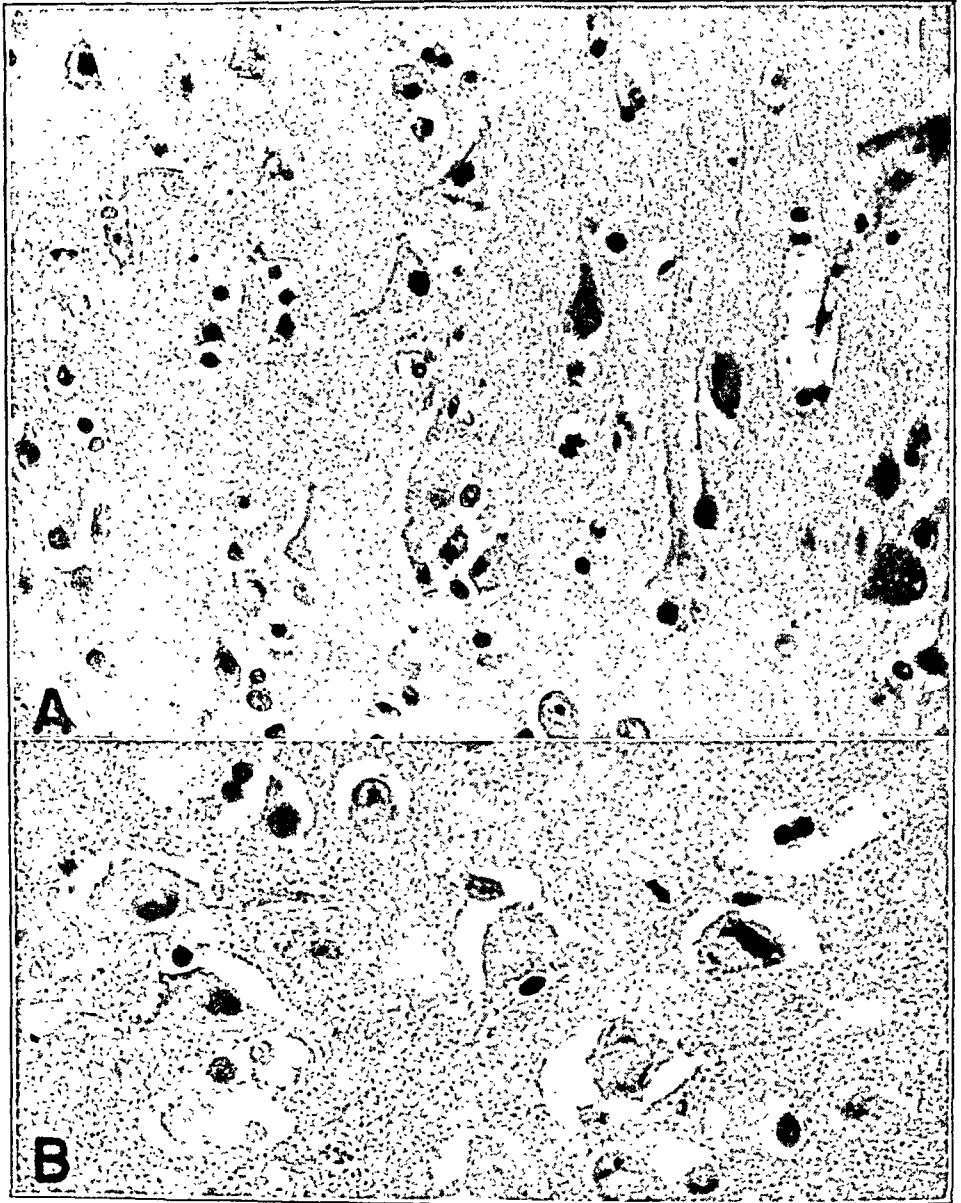

Fig. 2.—In *A*, from lamina IV of the cerebral cortex, virtually all the ganglion cells show evidence of necrosis. Cresyl violet stain; $\times 360$ (AIP neg. 94263). *B* illustrates a similar breakdown of ganglion cells in Sommer's sector of the hippocampus. Same stain; $\times 500$ (AIP neg. 94495).

(fig. 3). The globus pallidus was considerably less involved. The thalamus showed little of note, as was true also of the upper portion of the spinal cord. The cerebellum shared in the damage, many Purkinje cells being distorted or

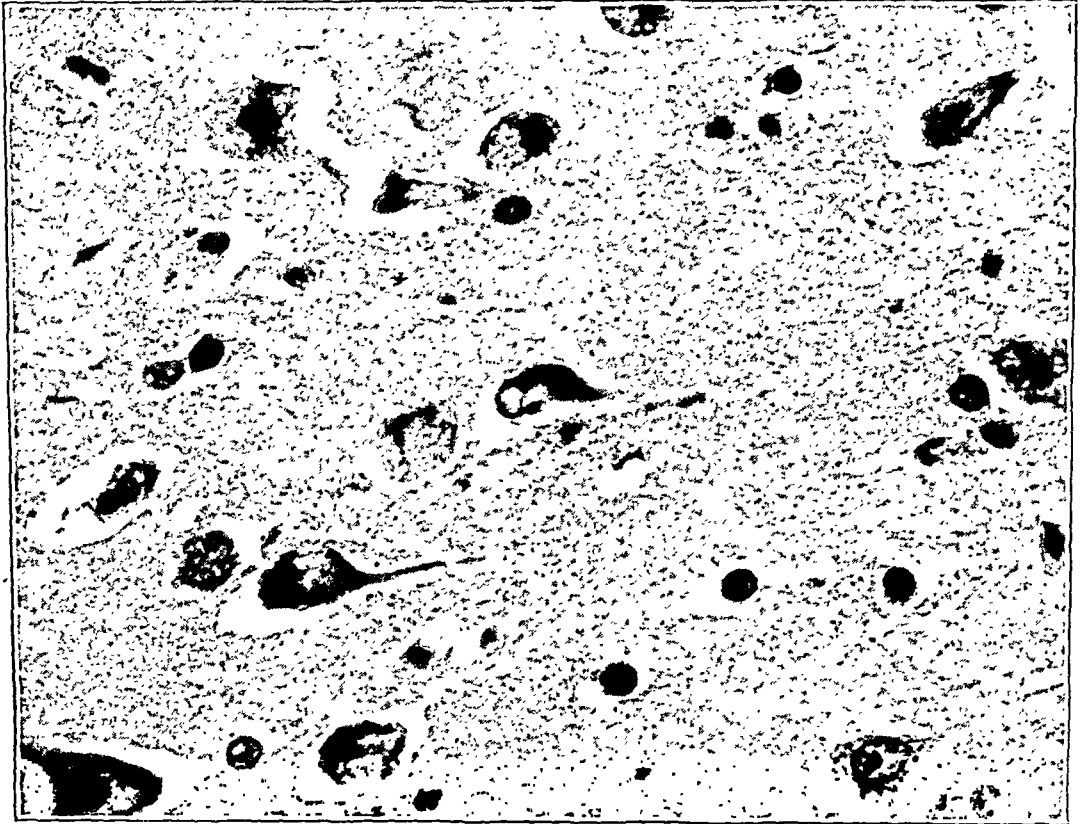

Fig. 3.—A focal area of disintegration of ganglion cells in the head of the caudate nucleus. Cresyl violet stain; $\times 550$ (AIP neg. 94266).

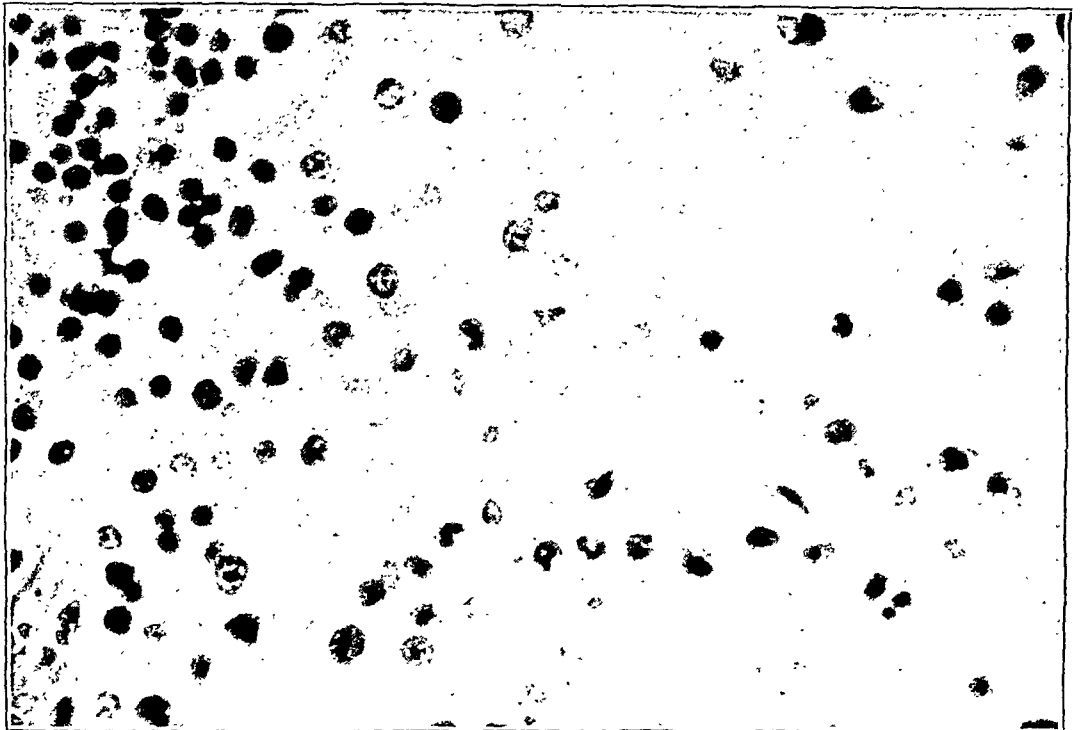

Fig. 4.—A section from the cerebellum, showing a number of hematogenous cells in the molecular layer, some of which are neutrophils. The "ghost" of a Purkinje cell is visible in the left upper portion of the photomicrograph. Hematoxylin and eosin stain; $\times 605$ (AIP neg. 94307).

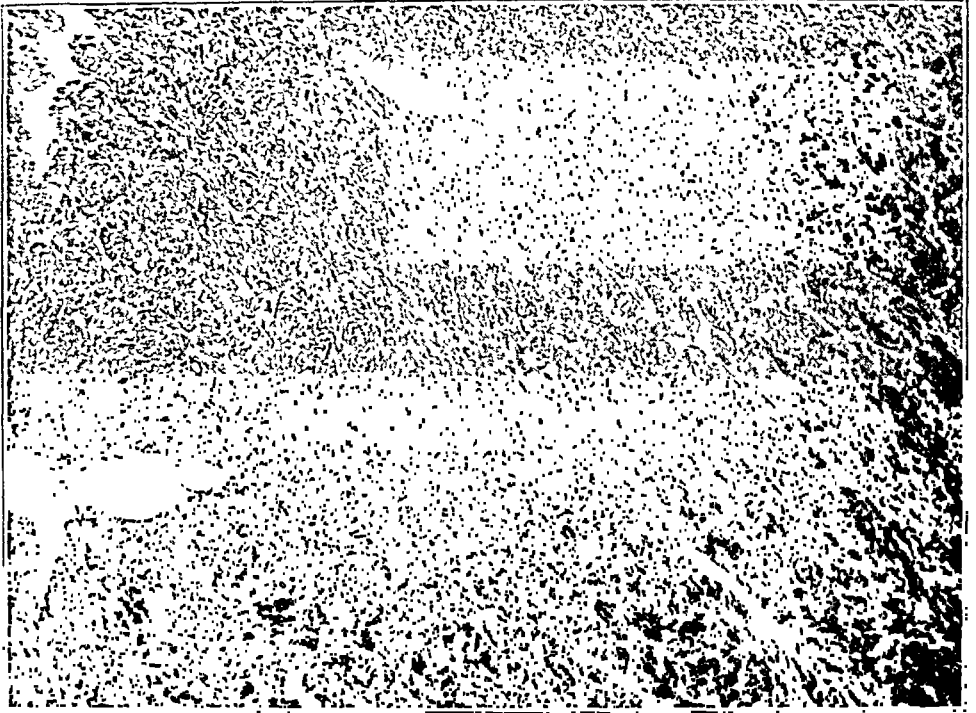

Fig. 5.—A focus of myelin rarefaction on the internal capsule. Lithium carbonate stain; $\times 44$ (AIP neg. 94522).

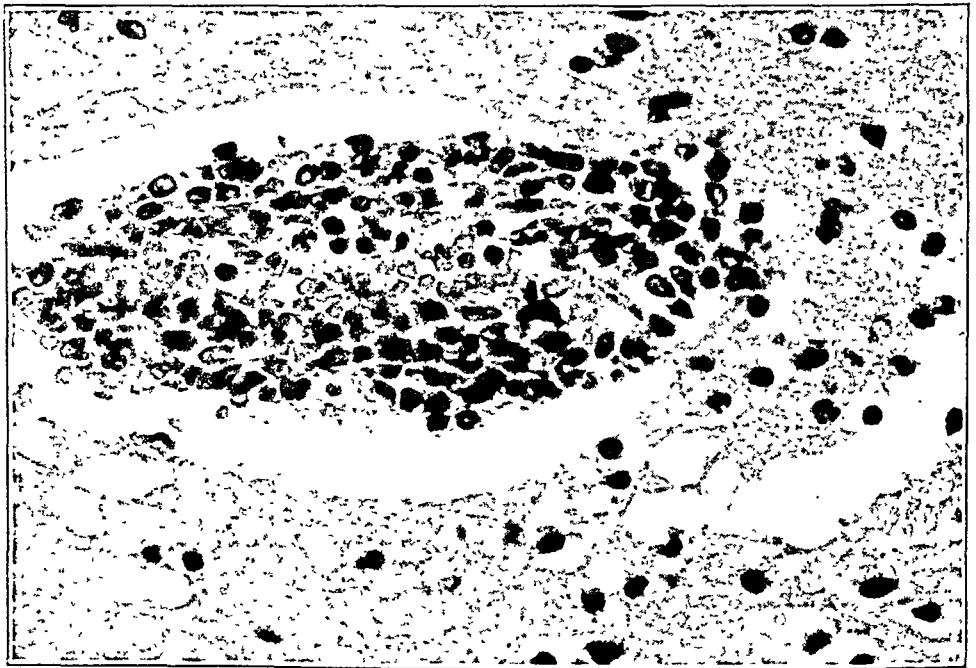

Fig. 6.—A blood vessel in lamina II of the cerebral cortex, displaying a large aggregation of cells in the adventitia and the Robin-Virchow space. Many of the cells have the configuration of lymphocytes. Others are large mononuclears, which may have come from the blood stream or originated from fixed adventitial cells. A few of the cells have invaded the adjoining parenchyma. Hematoxylin and eosin stain; $\times 489$ (AIP neg. 94298).

completely disintegrated, and the molecular layer being invaded here and there by small groups of neutrophils and mononuclear cells (fig. 4). The dentate nucleus showed evidence of moderate cellular damage. Study of the spinal cord revealed disintegration, either partial or complete, in about 50 per cent of the anterior horn cells.

Special stains revealed considerable distortion and disintegration of the myelin of fibers coursing through the putamen, the caudate nucleus and the globus pallidus. Several areas of the internal capsule had a decreased affinity for the myelin stain, the most striking example of which is illustrated in figure 5. Axis-cylinders were not materially affected.

Scanty collections of perivascular lymphocytes were noted in the tegmentum of the pons, the floor of the fourth ventricle and the periventricular region adjacent to the caudate nucleus. Petechial hemorrhages, few in number, predominated in the subcortical white matter, the region of the fourth ventricle and aqueduct, and the nucleus basalis.

A striking feature of this case was the accumulation of mononuclear cells and occasional neutrophils in the adventitia of blood vessels, especially those of the upper laminae of the cortex; the cells, believed to be both hematogenous and of adventitial derivation, frequently extended into the adjoining parenchyma (fig. 6).

Comment.—The damage in the brain in this case was regarded as equivalent to decerebration. This would account for the severity of the opisthotonos, which, together with leukocytosis, led to the erroneous diagnosis of bacterial meningitis.

The widespread cellular necrosis in the brain, the presence of neutrophils in the parenchyma, the reactive changes in the trabecular cells of the leptomeninges, the scant perivascular exudation of inflammatory cells and the proliferation of adventitial histiocytes are all in keeping with the diagnosis of acute severe cerebral anoxia. Virtually the same degree of necrosis, mesodermal reaction and exudation of inflammatory cells was reported by Ginzler and associates¹² in dogs surviving for as short a period as sixteen hours after exposure to cyanide. Severe, and apparently irreversible, changes in ganglion cells without reactive changes may be evident at earlier periods after anoxic insult (Heymans and Bouckaert,¹³ Cannon,¹⁴ Gildea and Cobb¹⁵). There was a tendency in our case for the cellular necrosis to be focal, not only in the brain but also in the bone marrow, but no perivascular distribution of the necrosis was evident. Damage to walls of vessels, said to be a feature in anoxia

12. Ginzler, A.; Haymaker, W.; Bodansky, O., and Ferguson, R. L.: The Occurrence and Distribution of Lesions in the Central Nervous System of Dogs Subjected to Cyanide Poisoning, to be published.

13. Heymans, C., and Bouckaert, J. J.: Sur la survie et la réanimation des centres nerveux, *Compt. rend. Soc. de biol.* **119**:324-326, 1935.

14. Cannon, W. B.: Stresses and Strains of Homeostasis, *Am. J. M. Sc.* **189**:1-14 (Jan.) 1935.

15. Gildea, E. F., and Cobb, S.: The Effects of Anemia on the Cerebral Cortex of the Cat, *Arch. Neurol. & Psychiat.* **23**:876-903 (May) 1930.

(Hoff, Grenell and Fulton¹⁶), could not be established with any degree of certainty in our case, but there was a pronounced engorgement of capillaries and larger vessels, such as has been described by Yant and his associates¹⁷ and others. The presence of cellular disintegration in nuclei of the floor of the fourth ventricle bears out the observations of Rotter,¹⁸ Büchner¹⁹ and Büchner and Luft²⁰ in experimental animals rendered anoxic by various means.

Demyelination, such as occurred in our case, is a variable observation in cases of anoxia. In case 2 of this paper, in which the conditions of the anoxic insult were similar to those in the preceding case, demyelination was absent. Likewise, in 2 instances of anoxia associated with cranial trauma, in which death occurred in one and seven weeks, respectively, and in which necrosis of gray matter was severe, there was demyelination in the first instance but not in the second (Malamud and Haymaker²¹). Myelin remained intact in a case of anoxia occurring as a result of nitrous oxide-oxygen anesthesia (Abbott and Courville²²) and in the great majority of animals exposed to single sublethal doses of cyanide (Ginzler and associates¹²) but was profoundly damaged in animals repeatedly exposed to an oxygen-poor atmosphere (Morrison²³). So far as we are aware, no common denominator for destruction of myelin in cases of anoxia has as yet been found.

The small cytoplasmic vacuoles in the liver in our case were of the same appearance as those observed by Pichotka,²⁴ Müller and Rotter²⁵ and Kritzer²⁶ in anoxic anoxia.

16. Hoff, E. C.; Grenell, R. G., and Fulton, J. F.: Histopathology of the Central Nervous System After Exposure to High Altitudes, Hypoglycemia and Other Conditions Associated with Central Anoxia, *Medicine* **24**:161-217 (May) 1945.

17. Yant, W. P.; Chornyak, J.; Schrenk, H. H.; Patty, F. A., and Sayers, R. R.: Studies in Asphyxia, Public Health Bulletin 211, United States Treasury Department, Public Health Service, 1934, p. 1.

18. Rotter, W.: Ueber hypoxämische Veränderungen des Zentralnervensystems unter Sauerstoffmangelatmung bei normalen Luftdruck, *Beitr. z. path. Anat. u. z. allg. Path.* **101**:23-31, 1938.

19. Büchner, F.: Ueber experimentelle Höhenpathologie, *Luftfahrtmedizin* **5**:1, 1940

20. Büchner, F., and Luft, U.: Hypoxämische Veränderungen des Zentralnervensystems im Experiment, *Beitr. z. path. Anat. u. z. allg. Path.* **96**:549-560, 1936.

21. Malamud, N., and Haymaker, W.: Anoxia Associated with Cerebral Trauma: A Clinico-Pathologic Study of Three Cases, to be published.

22. Abbott, C. N., and Courville, C. B.: Degeneration of the Globus Pallidus After Nitrous Oxide Anesthesia, *Bull. Los Angeles Neurol. Soc.* **3**:46-50 (March) 1938.

23. Morrison, L. R.: Histopathologic Effect of Anoxia on the Central Nervous System, *Arch. Neurol. & Psychiat.* **55**:1-34 (Jan.) 1946.

24. Pichotka, J.: Tierexperimentelle Untersuchungen zur pathologischen Histologie des akuten Höhentodes, *Beitr. z. path. Anat. u. z. allg. Path.* **107**:117-155, 1942.

CASE 2.—*Clinical History.*—A white sergeant aged 22 was on an operational flight at an elevation of 24,000 feet (7,300 meters) on Feb. 7, 1945, when, in the course of caring for a wounded crew member, the tube of his oxygen mask became disconnected. He had been without oxygen for about ten minutes when, at 2:41 p. m., he was found prostrate and unconscious. His respirations were very irregular. The disconnected tube was attached to a regular outlet tube; "emergency rich" oxygen was administered, and then artificial respiration was commenced. After five minutes his breathing again became regular, but unconsciousness persisted. The bomber landed at 4:40 p. m. at an emergency field, and he was taken directly to a field hospital.

On examination there, the patient was cyanotic and spat up frothy blood. The blood pressure was 110 systolic and 68 diastolic, the pulse rate 100 and the respiratory rate 36. The rectal temperature was 99.8 F. With continued administration of oxygen, his color improved and he seemed to comprehend statements, but he was unable to reply to questions or commands. On February 8 there was no change except for the development of a flame-shaped hemorrhage in the right fundus. Administration of oxygen was continued. On February 9 he exhibited "childish mannerisms." He was able to swallow fluids. The erythrocytes totaled 4,260,000 and the leukocytes 9,050 per cubic millimeter; the hemoglobin concentration was 84 per cent. His condition remained unchanged. Administration of oxygen by mask was continued.

On February 12 the patient was transferred to a general hospital. On arrival, his rectal temperature was 100.4 F., his blood pressure 150 systolic and 80 diastolic, his pulse rate 92 and his respiratory rate 20. His color was good and respirations regular. He seemed to have a vague comprehension of statements and apparently recognized objects but was unable to speak or make gestures. There was some ability to swallow. Neurologic examination at this time revealed hypoactive abdominal and cremasteric reflexes, normal biceps and triceps reflexes and hyperactive patellar and achilles reflexes, especially on the left side. The Babinski reflex was positive bilaterally. Ankle clonus could not be elicited. Extensor spasticity of moderate degree was present in all four extremities. The patient was responsive to painful stimuli.

Laboratory Data.—Studies on February 12 yielded the following data: hemoglobin, 14.8 Gm. per hundred cubic centimeters; leukocytes, 11,500, of which 74 per cent were neutrophils and 26 per cent lymphocytes; sedimentation rate (Wintrobe), 17 mm. in one hour; Kahn reaction of the blood, negative; urine, normal except for the presence of 5 to 10 erythrocytes and 6 to 12 leukocytes in each high power field of the centrifuged specimen. Roentgenograms of the skull and chest showed nothing abnormal. An electrocardiogram showed no abnormalities.

Further Course.—During the next three days, administration of oxygen was continued, fluids were given intravenously and penicillin therapy was begun. It was necessary to employ an indwelling urethral catheter. Hourly feedings were given through a nasal tube.

25. Müller, E., and Rotter, W.: Ueber histologische Veränderungen beim akuten Höhentod, Beitr. z. path. Anat. u. z. allg. Path. **107**:156-172 (Sept.) 1942.

26. Kritzler, R. A.: Acute High Altitude Anoxia: Gross and Histologic Observations in Twenty-Seven Cases, War Med. **6**:369-377 (Dec.) 1944.

On February 16, i. e., on the ninth day after onset, the patient's temperature ranged from 101 to 103.6 F. The blood pressure averaged 136 systolic and 88 diastolic; the pulse rate was 120, and respiratory rate, 30. Convulsive seizures, during which the trunk became rigid and the extremities hyperextended, came on at intervals. They were quickly brought under control with the intravenous use of sodium amytal. At times the patient perspired profusely. Studies of the blood on February 16 revealed 13,000 leukocytes, of which 74 per cent were neutrophils, and a sedimentation rate of 47 mm. in one hour. Spinal fluid taken by lumbar puncture was under a pressure of 270 mm. of mercury; the fluid contained 3 leukocytes per cubic millimeter and 23 mg. of protein per hundred cubic centimeters; the Kolmer reaction was negative, and the colloidal gold curve was normal.

On February 20 the patient was still restless and occasionally cried out. At times his eyes were partly open. There were occasional convulsive seizures. Encephalographic studies revealed ventricles of normal size and position. The ventricular fluid was clear and was under a pressure of 270 mm. of mercury; it contained no cells; the total protein measured 16 mg. per hundred cubic centimeters; the colloidal gold curve was 123333210, and the Kolmer test gave a doubtfully positive reaction. An electrocardiogram was normal.

On February 26 the patient seemed somewhat improved. He was able to open and close his mouth and eyes on request. No convulsive seizures had occurred for several days. His color was good, and he seemed fairly alert. However, at 1:15 a. m. on February 27 his temperature commenced to rise, reaching 105.6 F. at 5 a. m. The blood pressure dropped from 108 systolic and 80 diastolic to 62 systolic and 42 diastolic, whereas the pulse rate increased from 140 to 160 and the respiratory rate from 30 to 50 per minute. Shortly after 5 a. m. the patient became dyspneic and coughed up about 100 cc. of clotted blood. There were repeated attacks in which the forearms flexed convulsively at the elbows and the hands at the wrists. The legs were not involved. The pupils were moderately dilated and equal in diameter. The eyes tended to deviate upward and outward. The fundi were normal. All the deep and superficial reflexes were hypoactive. No responses to painful stimuli could be elicited. The Babinski and Hoffmann signs were not elicited. Periodically the hands and fingers were fixed in flexion and the forearms and legs partly flexed. Blood transfusions were given.

During the night of February 27-28 the patient again had hemoptysis and lapsed into a state of shock. Transfusions of blood and plasma were again given. Peripheral vascular collapse and marked pulmonary edema became evident. Death occurred at 11:45 a. m. on February 28, twenty-one days after the onset of anoxia.

Gross Autopsy Observations.—Autopsy was performed two hours post mortem. The essential observations were as follows: The lungs weighed 750 Gm. Over each lower lobe posteriorly a subpleural hemorrhagic area, 2 cm. in diameter, was observed. The larger bronchi contained a small amount of blood-tinged mucus. The heart weighed 300 Gm. The myocardium was flabby but otherwise normal. The spleen weighed 125 Gm. and the liver 1,600 Gm.; neither exhibited abnormalities. Opposite the tracheal bifurcation the esophagus showed a superficial ulcer, 6 by 2 cm. in size. The edges of the ulcer were rolled. In the middle of the base of the ulcer there was a small sinus tract leading through the esophageal wall and into the uppermost portion of the left main bronchus. Here the bronchial mucosa showed a patchy reddened zone 1 cm. in diameter. Below the esophageal ulcer, and about 5 cm. above the cardiac end of the stomach, the mucosa was denuded over an area 4.5 by 1.5 cm. in size but was of natural color. The stomach contained about 1 liter of clotted blood but was otherwise normal. The

kidneys weighed 300 Gm.; section revealed no changes. The bladder mucosa was edematous and hemorrhagic. Culture of blood taken from the heart at autopsy yielded *Staphylococcus aureus*, and the urea nitrogen value was 81 mg. per hundred cubic centimeters. Grossly, the scalp, calvaria, dura, dural sinuses, leptomeninges and cerebral vessels appeared normal. The sphenoidal sinus contained mucopurulent material. The brain weighed 1,350 Gm. On section, the configuration, consistency and markings were in the normal range except for the lenticular nuclei, which were softened and spongy and presented small cavitations.

Microscopic Observations.—The lungs were the seat of moderately advanced lobular pneumonia. In the liver there was moderate to severe centrilobular necrosis. Some of the hepatic cells adjacent to the necrotic areas were hypertrophied. The spleen was moderately congested. In the midportion of the zona fasciculata of the adrenal cortex were many focal areas of large, foamy cells, which resembled those of the normal lipid-filled portions of the cortex, but in such areas moderate numbers of cells were devoid of nuclei and in other ways appeared disintegrated. The cells of the remainder of the cortex exhibited depletion of lipids, as judged by the appearance with the hematoxylin and eosin stain. The bone marrow of the femur was about 75 per cent cellular, whereas normally in persons of the

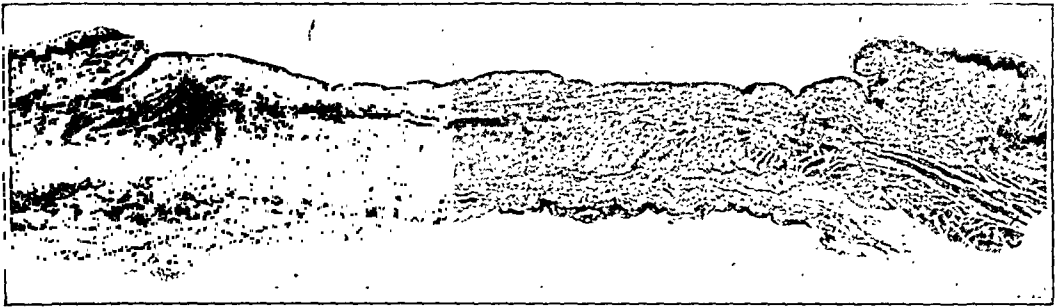

Fig. 7.—Section of the esophagus, showing an ulcer. The edges of the ulcer are rolled, and there is a heavy cellular infiltrate in the muscular and subserous coats. Hematoxylin and eosin stain; $\times 8$ (AIP neg. 95258).

age group of the patient the marrow is almost entirely fat. All cell series participated in the hyperplasia, but granulocytes were strikingly in the foreground, neutrophilic myelocytes predominating. Megakaryocytes were abundant and appeared normal. Red cell progenitors were relatively sparse. The predominantly granulocytic hyperplasia was regarded, at least in part, as a response to the pneumonia. The bladder mucosa was edematous and hemorrhagic. In sections of the esophagus through the region of the ulcer the mucosa was absent, and there was an extensive exudative and productive reaction in the muscular and subserous coats (fig. 7). No other abnormalities of the thoracic and abdominal viscera were encountered.

Study of the central nervous system revealed reactive changes in the leptomeninges and degenerative changes or malacia in certain parts of the brain. In the leptomeninges, especially those overlying the cerebral cortex, moderate numbers of trabecular cells were in the process of developing into histiocytes (fig. 8 A and B), and the adventitia of vessels was hyperplastic (fig. 8 B). A similar, though less conspicuous, accumulation of cells was observed about larger vessels of the brain. Only in the region of the midbrain were lymphocytes noted in the arachnoid meshes, and they were sparse and perivascular in distribution. The cerebral cortex displayed degeneration of laminae III, IV and V at virtually

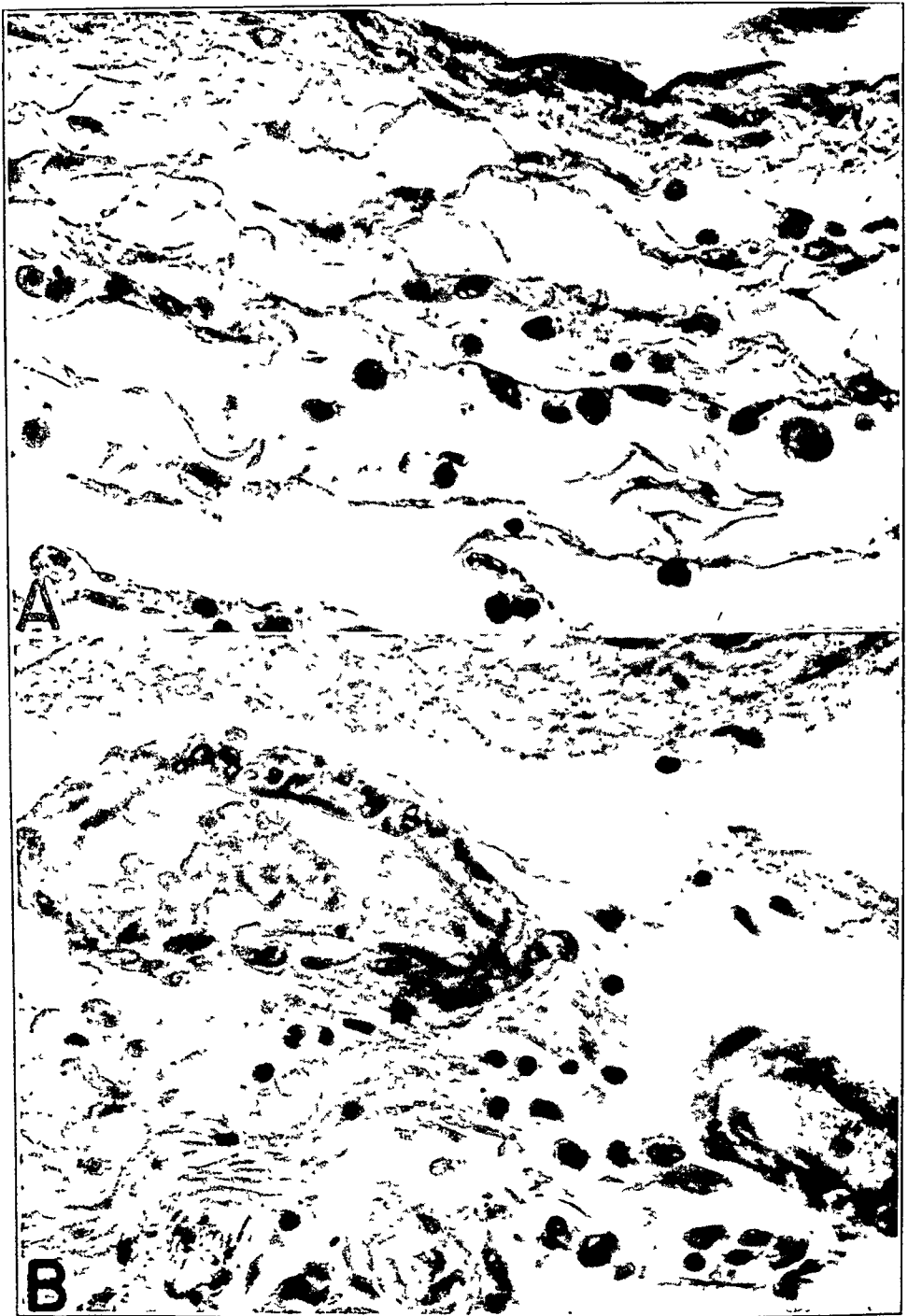

Fig. 8.—In *A*, from the cerebral leptomeninges; there are a number of cells in close relation to the trabecular framework and others in the arachnoid meshes. Virtually all are regarded as arising from fixed tissue cells of the arachnoid. Hematoxylin and eosin stain; $\times 550$ (AIP neg. 94304). In *B*, the cells in the arachnoid are probably both hematogenous and of trabecular origin. The adventitial cells of the vessels are considerably hyperplastic. Same stain; $\times 605$ (AIP neg. 94499).

all levels examined. The degenerative change varied from mild to severe, usually involving a contiguous gyrus or two and leaving unaffected the adjoining gyri. In areas damaged to the greatest degree, many ganglion cells were severely degen-

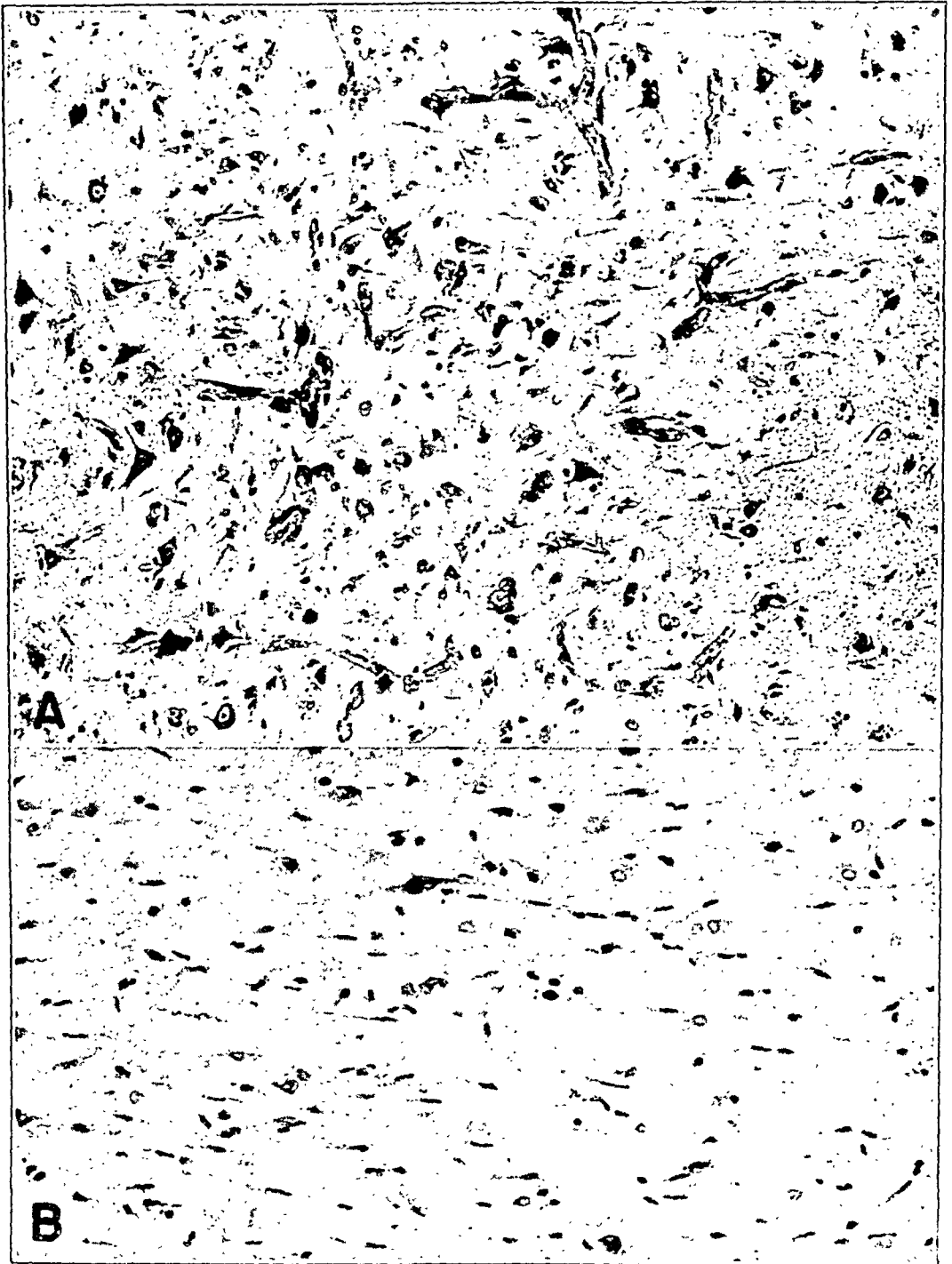

Fig. 9.—In *A*, from the deeper laminae of the cerebral cortex, numerous ganglion cells have disappeared and been replaced by hyperplastic and newly formed blood vessels, microglia and round mononuclear cells, some of which have the appearance of gitter cells. Some gyri of the brain showed more severe laminar degeneration than illustrated here, and others less. Cresyl violet stain; $\times 175$ (AIP neg. 94287). In *B*, from Sommer's sector of the hippocampus, the entire width of the sector has been overgrown by microglia and plump astrocytes, and there are moderate numbers of newly formed capillaries. Only an occasional ganglion cell remains. Same stain; $\times 187$ (AIP neg. 94498).

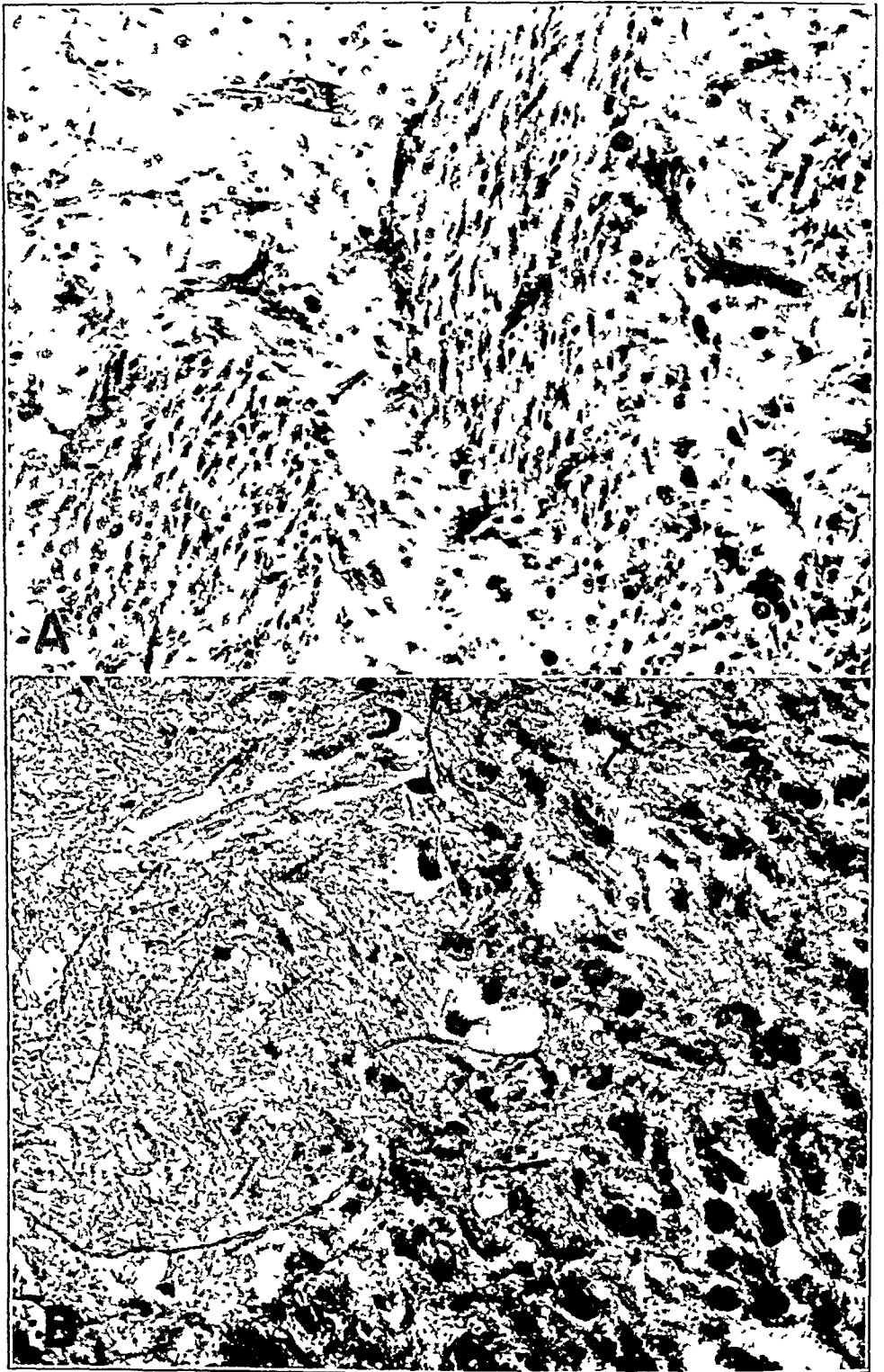

Figure 10

(See legend on opposite page)

erated or had completely disappeared, and vascular proliferation was well advanced. In addition, the degenerated laminae contained moderate numbers of cells having the configuration of microglia. A moderately affected area of the cerebral cortex is illustrated in figure 9 *A*. Astrocytes and oligodendroglia appeared to be less scanty than normal. In the upper cortical laminae, mild reactive changes of vessels were apparent, but the ganglion cells seemed to be in a good state of preservation. In the hippocampus, virtually all the cells of Sommer's sector had disappeared and had been replaced with myriad microglia and moderate numbers of plump astrocytes (fig. 9 *B*); other portions of the hippocampus were within the range of normal. The putamen showed massive malacia, most of the ganglion cells having disintegrated or disappeared and given way to hyperplastic and newly formed blood vessels (fig. 10 *A*). Groups of fibers traversing the putamen displayed remarkable hyperplasia of oligodendroglia and microglia (fig. 10 *A*), a feature not observed in the adjoining anterior commissure. Fat-laden gitter cells stopped short at the borders of the putamen, not affecting the globus pallidus (fig. 10 *B*) except in some sections, where the midportion of the external division of the globus pallidus had undergone necrosis. The caudate nucleus also showed cellular breakdown, formation of gitter cells and proliferation of blood vessels, but the degree of change was somewhat less than in the putamen. Special stains revealed that myelin and axis-cylinders were virtually absent in the putamen and had undergone a reduction in number in the caudate nucleus and in the degenerated laminae of the cerebral cortex; but elsewhere, including the cerebral white matter, the myelin and axis-cylinders were within the limits of normal. The diencephalon, midbrain, pons, medulla oblongata and upper portion of the spinal cord were relatively unaffected. In the cerebellum a moderate number of Purkinje cells had disappeared, and a few were in a state of denegeration. The Bergmann layer was unaltered. The molecular layer was within the range of normal except in isolated regions, where an occasional proliferation of glial cells was observed throughout the entire width of the molecular layer. The leptomeningeal vessels adjacent to such foci were surrounded by small accumulations of lymphocytes and occasional histiocytes. Slight degenerative changes were present in the dentate nucleus.

Petechial hemorrhages in the brain were scant, being most prominent in the wall of the third ventricle.

Comment.—In this case the structures of the brain vulnerable to anoxia were the lower laminae of the cerebral cortex, the putamen, the caudate nucleus, the portion of the pyramidal layer of the hippocampus comprising Sommer's sector and, to a limited degree, the external division of the globus pallidus and the cerebellum. In a series of dogs subjected to cyanide poisoning the necrosis was even more widespread,

EXPLANATION OF FIGURE

Fig. 10.—In *A*, from the putamen, numerous ganglion cells have disappeared. What is left of the putamen is permeated by proliferated blood vessels, microglia and mononuclear cells, many of which are gitter cells. The cells grouped in fascicles are hyperplastic microglia and oligodendrocytes, which have overgrown the fiber bundles normally present in the putamen. Cresyl violet stain; $\times 160$ (AIP neg. 94284). *B* illustrates the transitional zone between the putamen and the globus pallidus. The putamen, to the right, is permeated by fat-laden gitter cells, whereas the globus pallidus is virtually free from them. Sudan III stain; $\times 260$ (AIP neg. 94491).

involving also the substantia nigra and the pulvinar of the thalamus (Ginzler and associates¹²). The relative sparing of the globus pallidus in our case is in contrast to the profound necrosis noted in anoxia associated with carbon monoxide poisoning (Semerak and Bacon,²⁷ Weil²⁸), nitrous oxide-oxygen anesthesia (Lowenberg, Waggoner and Zbinden²⁹; Abbott and Courville²²), trauma (Malamud and Haymaker²¹) and severe secondary anemia (Overhof,³⁰ Scherer³¹) and in experimentally induced anoxic anoxia. The presence of severe damage to the cerebral cortex in both our cases is at variance with some reports in the literature (Büchner and Luft,²⁰ Rotter,¹⁸ Campbell,³² Dellaporta³³ that in anoxic anoxia the cortex is relatively spared. The relatively great involvement of the thalamus observed by Yant and associates¹⁷ in anoxic anoxia was not present in our case.

CASE 3.—At approximately 1 p. m. on Oct. 7, 1944, a B 17 plane, on which the patient, a corporal, was a ball turret gunner, went into a bomb run at an altitude of 27,000 feet. A German 88 mm. shell exploded to the right of the ship, tearing a 5 by 8 foot (150 by 240 cm.) hole in the fuselage and killing two waist gunners. The oxygen apparatus was shot away, necessitating a descent to an elevation of 7,000 feet (2,100 meters). Because of damage to the plane, it was not possible to reach the ball turret gunner, who at the time of the explosion was rendered unconscious, and who remained so during the four and one-half hour return trip to the base.

On admission to a field hospital, at 6 p. m. on October 7, the patient was wildly delirious and very cyanotic. His pulse was rapid. All reflexes were hyperactive, and carpopedal spasm was present. Pentothal was administered intravenously to quiet him. He was kept warm. Two units of plasma was administered. Oxygen was given by the mask method.

Within a few hours the temperature was 100.6 F., the pulse rate 96 and the respiratory rate 24, and the blood pressure was 115 systolic and 75 diastolic. By

27. Semerak, C. B., and Bacon, L. H.: Experimental Lesions of the Brain from Carbon Monoxide, *Arch. Path.* **10**:823-839 (Dec.) 1930.

28. Weil, A.: *Textbook of Neuropathology*, ed. 2, New York, Grune & Stratton, Inc., 1945.

29. Lowenberg, K.; Waggoner, R., and Zbinden, T.: Destruction of the Cerebral Cortex Following Nitrous Oxide-Oxygen Anesthesia, *Ann. Surg.* **104**: 801-810 (Nov.) 1936.

30. Overhof, K.: Ueber das Vorkommen symmetrischer Gehirnerweichungsherde bei sekundärer Blutarmut, *Virchows Arch. f. path. Anat.* **287**:784-789, 1933.

31. Scherer, E.: Symmetrische Erweichungsherde im Globus pallidus bei sekundärer Anämie: Zugleich ein Beitrag zur Morphologie der Pseudokalkablagerung in Hirngefäßen, *Ztschr. f. d. ges. Neurol. u. Psychiat.* **150**:632-639, 1934.

32. Campbell, J. A.: Note on Some Pathological Changes in the Tissues During Attempted Acclimatization to Alterations of O₂-Pressure in the Air, *Brit. J. Exper. Path.* **8**:347-351 (Oct.) 1927.

33. Dellaporta, A. N.: Die Veränderungen des Zentralnervensystems nach Luftverdünnung und nach Hunger, *Beitr. z. path. Anat. u. z. allg. Path.* **102**:268-286, 1939.

October 8 he was semiconscious and still somewhat irrational. His pulse rate averaged 72, and the blood pressure was 130 systolic and 85 diastolic. A roentgenogram of the skull revealed no abnormality. Lumbar puncture revealed a normal cerebrospinal fluid pressure and 11 leukocytes per cubic millimeter of spinal fluid. Bradycardia developed, the pulse rate for two days ranging as low as 44 per minute.

On October 13 the patient was drowsy and was unable to swallow. He did not understand when spoken to. Neurologic examination revealed changes restricted to the left side: paresis of the face (of the central type), decrease in activity of the abdominal reflexes, a hyperactive achilles reflex and positive Hoffmann and Babinski signs. On October 17 the patellar and achilles reflexes were hyperactive, and the Babinski sign on the left side could still be elicited. When questioned, the patient grimaced and groaned but could not speak. As the days passed, he became somewhat more alert but in general remained severely retarded, both physically and mentally. The final diagnosis was that of organic psychosis due to cerebral concussion and anoxia. He was returned to the United States in the latter part of October 1944.

Comment.—In this case the patient is known to have survived for at least three weeks. His physical and mental incapacitation were similar to that in case 2. These 2 cases, as well as that of Church and Loeser,⁷ referred to earlier, are apparently the only ones on record in which sublethal anoxic anoxia produced severe sequelae.

SUMMARY

Three cases of anoxic anoxia occurring in aviators while engaged in combat are presented in detail. In 2 cases the anoxia proved fatal in forty hours and three weeks, respectively, and in the third instance the patient was observed for a period of three weeks and then was transferred to the United States. The degree and duration of anoxia in each case are not completely known. In the first, the accident occurred at an elevation of "more than 20,000 feet," the patient being found unconscious five minutes after completion of a bomb run, at which time resuscitation was commenced. In the second, the patient was exposed to an atmosphere at 24,000 feet for approximately ten minutes. In the third, it was at 27,000 feet that the oxygen tank of the plane was shot away, necessitating a rapid descent to 7,000 feet, during which time no effort could be made to revive the patient.

In the case of approximately forty hours' duration (case 1) a conspicuous necrosis of ganglion cells was observed in laminae III to VI of the cerebral cortex, the striatum, the cerebellum, Sommer's sector of the hippocampus and the anterior horns of the spinal cord, mostly focal in character, and degeneration of myelin in the internal capsule. Also observed were early proliferation of the fixed tissue cells of the leptomeninges and vascular adventitia and mild exudation of lymphocytes and neutrophils into the meshes of the arachnoid, the perivascular spaces and, to a limited extent, the parenchyma of the brain. In the case of

three weeks' duration (case 2) the changes were of virtually the same location except that the cerebral white matter, brain stem and spinal cord were relatively spared. The profound damage in these cases of sudden and severe anoxic anoxia is strikingly similar to that observed in some of the other forms of anoxia.

Division of Neurosurgery, University Hospitals, Minneapolis 14. .
Army Institute of Pathology, Washington, D. C.

CEREBELLAR MEDULLOBLASTOMA IN ADULTS

EUGENE B. SPITZ, M.D.*

HENRY A. SHENKIN, M.D.†

AND

FRANCIS C. GRANT, M.D.

PHILADELPHIA

IN A RECENT survey of 97 consecutive cases of verified medulloblastomas, we noted that 30 patients were 16 years of age or older (fig. 1). The syndrome of the cerebellar medulloblastoma in childhood has been repeatedly emphasized, whereas the occurrence of similar tumors in the adult has received scant attention in the literature.

Cushing,¹ in 1930, reported 61 cases of medulloblastoma, in 21 per cent of which, or 13, the patients were over the age of 16. Ten patients

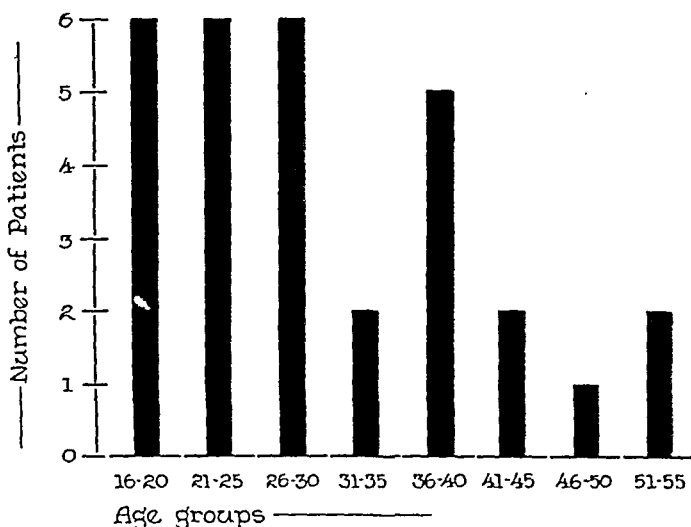

Fig. 1.—Age distribution of 30 verified cases of cerebellar medulloblastoma in adults.

were between the ages of 16 and 30, and 3 were in the age group over 30. His oldest patient was 38.

Dyke and Davidoff² discussed a series of 16 cases of verified medulloblastoma, in which the oldest patient was 24 years of age. They were

* Charles Harrison Frazier Fellow in Neurosurgery.

† Francis Clark Associate in Neurosurgery.

From the Neurosurgical Service, Hospital of the University of Pennsylvania.

1. Cushing, H.: Experiences with Cerebellar Medulloblastomas: Critical Review, *Acta path. et microbiol. Scandinav.* 7:1-86, 1930.

2. Dyke, C., and Davidoff, L.: *Roentgen Treatment of Disease of the Nervous System*, Philadelphia, Lea & Febiger, 1942, p. 81.

impressed with the fact that 3 of their 16 patients were over 20 years of age.

In our own series, of 97 patients, 31 per cent were 16 years of age or older. Of these, 16 were in the age range of 16 to 30 years, and 14 were over 30. Our oldest patient was 55.

SEXUAL INCIDENCE

Cushing's series contained 10 male patients and only 3 female patients over the age of 16. In our somewhat larger series, 18 were females and 12 males. On the basis of the combined figures in the two series, there is no significant statistical difference in the sexual incidence of cerebellar medulloblastoma in the adult.

DURATION OF SYMPTOMS

The average duration of symptoms prior to operation was 3.8 months. The extremes were 1 month and 9 months. This spread is approximately what was found in our series of medulloblastomas occurring in childhood. It had been our previous impression that the average preoperative duration of symptoms in the older age group was considerably greater than that in childhood.

LOCATION OF THE TUMOR

Cushing and others have emphasized that in the adult these tumors are located chiefly in the cerebellar hemispheres, while in childhood they generally occur in the vermis.

In our own series of cases, 15 tumors were limited to one or the other cerebellar hemisphere. Twelve tumors were limited to the vermis, and 3, which had evidently begun in the vermis, later involved one of the hemispheres. This distribution, therefore, does not suggest that the cerebellar hemispheres are the more likely site of the tumor in adults but reveals a distinctly greater tendency to involvement of the hemispheres in adults than in children.

SYMPTOMS

The unvarying location in the midline of the cerebellar medulloblastoma in children leads to an early and a typical clinical syndrome—the triad of increased intracranial pressure, headache, vomiting and papilledema, without focal signs of cerebellar involvement, but soon followed by evidence of trunkal dyssynergia.³

On the basis of the more frequent occurrence of the hemispheric variety in adults, another clinical syndrome was postulated by Cushing, characterized by early objective evidence of cerebellar disturbance. The primary location of the tumor in the adult group was almost equally

3. Grant, F. C.: Clinical Study of Midline Cerebellar Tumors in Children, *S. Clin. North America* 9:1155-1168, 1929.

distributed between vermis and hemisphere. However, in 80 per cent of the hemispheric type definite signs of increased intracranial pressure, such as headache, nausea, vomiting and visual changes, were first to appear with focal cerebellar symptoms following at varying intervals. On the other hand, in 25 per cent of the lesions primary in the vermis the onset was with cerebellar symptoms:

It may be argued that the patient is less likely to notice the fine nuances of cerebellar dysfunction, whereas he is early cognizant of headache. Nevertheless, Cushing was impressed by the early appearance of cerebellar signs in his patients.

Our figures fail to support the hypothetic syndrome of cerebellar medulloblastoma in the adult. Regardless of location, the vast majority of the patients first showed signs of acute progressively increasing intracranial pressure.

PATHOLOGIC PICTURE

Twenty-one medulloblastomas were soft and widely infiltrating, and 9 were fairly discrete and somewhat firmer to palpation. Unfortunately, it seemed to make little difference in the eventual survival of the patient whether or not the tumor was originally described as grossly discrete or widely infiltrating.

Bailey⁴ and associates stated that a few of the so-called medulloblastomas seem to contain more connective tissue than usual and that this variety is likely to occur in adults. This was not true of the cases in our series. Microscopically these tumors in adults were indistinguishable from tumors in a large number of our younger patients (fig. 2).

Of the 21 cases with adequate follow-up observations, the presence of seeding was verified, either at operation or autopsy, in 8, or 38 per cent. The original tumor in 1 of these 8 cases was so discrete as to have been apparently completely removed at operation; yet at reoperation, one year later, seeding tumors were removed from the cauda equina. In the other 7 cases of seeding the primary growth widely infiltrated the cerebellum. In 2 other instances seeding was suggested symptomatically but was never proved.

THERAPY

A consistent plan of action was used in all our cases. An attempt was made in every instance to restore the circulation of the cerebrospinal fluid by unblocking the aqueduct and the fourth ventricle. This often required the removal of large amounts of tumor.

All patients were given adequate radiation therapy according to the methods outlined by the department of radiology of the Hospital of the University of Pennsylvania.⁵ On a number of occasions repeated

4. Bailey, P.; Buchanan, D., and Bucy, P.: *Intracranial Tumors of Infancy and Childhood*. Chicago, University of Chicago Press, 1939, p. 71.

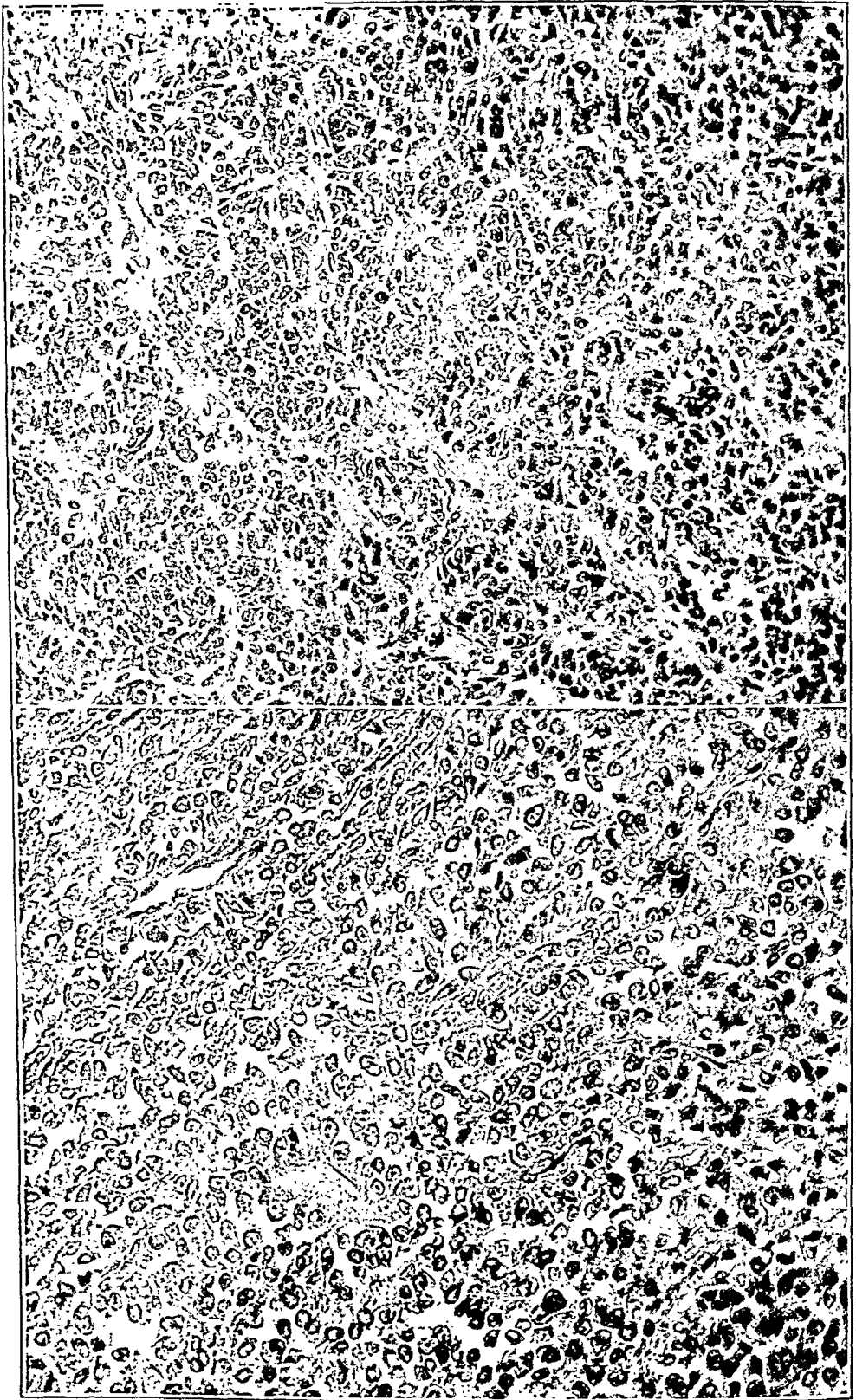

Fig. 2.—Histologic appearance of representative tumors in this series. Hematoxylin and eosin stain; $\times 336$. *A*, section of a tumor of a man aged 43, who was alive six years after radical removal of the tumor and three courses of irradiation therapy. *B*, section of a tumor of a woman aged 38, with five years' survival following radical removal of the tumor and two courses of irradiation therapy.

ventriculoencephalograms, made at the instigation of Dr. E. P. Pendergrass, enabled us to treat the recurrent or seeding tumor before clinical signs were present. Various authors have claimed that radiation therapy with decompression has given results as good as, or better than, attempted radical removal of these tumors followed by roentgen irradiation. Our unvarying operative plan does not permit of comparative studies. However, the statistics on survival for this series might serve as a basis for comparison by others.

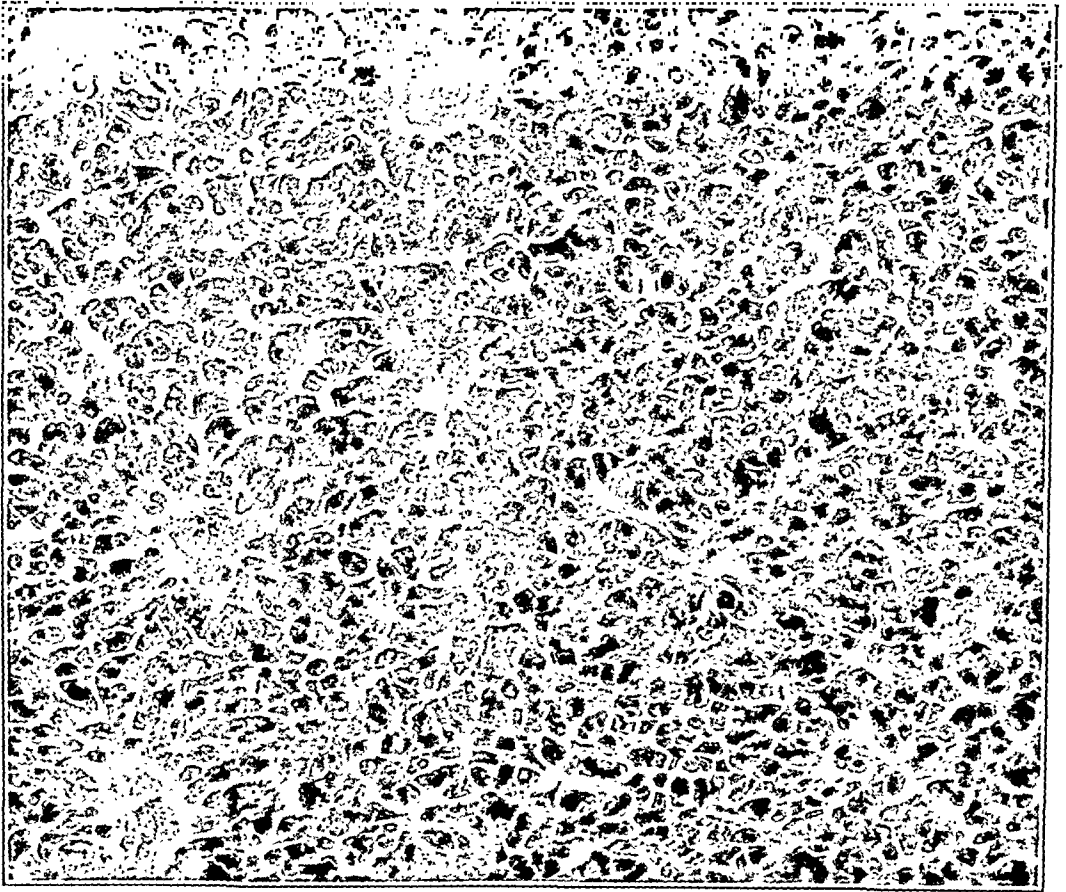

Fig. 2.—C, section of a tumor of a youth aged 16, alive eight years after radical removal of the tumor and four courses of irradiation therapy.

SURVIVAL

It is the general impression that the period of survival for medulloblastomas in adults is somewhat longer than that for medulloblastomas in childhood, no matter what therapy is used.

In our series, 2 patients were not adequately followed, although both are known to have survived at least one year after operation. One

5. Pendergrass, E.; Hodes, P., and Godfrey, E.: The Radium Treatment of Cerebellar Medulloblastoma: Report of Thirty-One Cases, *Am. J. Roentgenol.* 48:776-789, 1942.

patient died before operation and 6 within thirty days of the operation. Of the 21 patients with adequate follow-up data, 1 survived for six months, 3 for twelve months, 4 for two years, 4 for three years, 5 for four years and 1 each for five, six, seven and eight years. Three patients are still alive, three, six and eight years after operation (fig. 3). Thirteen patients, or 62 per cent, survived for three or more years after operation. Nine patients, or 43 per cent, lived for four years or more. Five patients, or 24 per cent, survived for five years or more.

These figures speak for themselves and are definitely at variance with what we found in our childhood group, in which no patient under the age of 16 survived for more than three and a half years.

There did not appear to be any relation between the gross or histologic appearance of the tumor and the ultimate outcome. The patients with

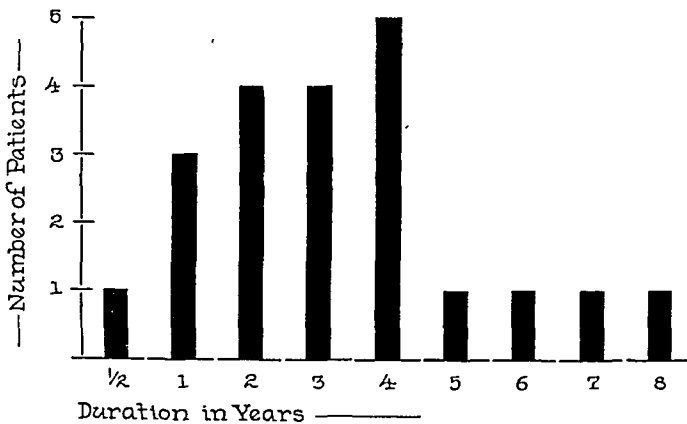

Fig. 3.—Postoperative survival period of 21 adults with verified cerebellar medulloblastomas.

well demarcated tumors fared no better or worse than those with obviously infiltrating ones.

CONCLUSIONS

Cerebellar medulloblastoma is not an unusual tumor in the adult.

Medulloblastomas in adults occur more frequently in the cerebellar hemispheres than do similar tumors in childhood. In our series occurring in adults, approximately 50 per cent were primarily hemispheric in location.

Regardless of this difference in site of origin, the clinical picture in adults did not differ from the usual syndrome noted in childhood.

Seeding occurred in 38 per cent of our patients who were adequately observed.

The tumors were histologically identical with medulloblastomas of the childhood group.

The survival period in adults as a group was definitely longer than that in children.

STATIC TREMOR WITH HEMIPLEGIA

Report of a Case: Development, Progression for Seven Years and
Postmortem Histologic Observations

FRED A. METTLER, M.D., Ph.D.

LEO M. DAVIDOFF, M.D.

AND

RICHARD GRIMES, M.D.

NEW YORK

THE CASE reported here is that of a child with tremor and paresis of the right side which developed over a period of seven years and which was due to a tumor involving the left side of the midbrain and thalamus.

REPORT OF CASE

History and Examination.—M. I. H., a 6 year old girl, came to the Vanderbilt Clinic on Dec. 18, 1936, with a history of increasing tremor of the right antebrachium. This tremor was first noticed on December 8. On December 15 the child was dragging her right foot and there was some tremor of that leg. On December 17 facial asymmetry with overactivity of the left side of the face was observed. Examination disclosed an intention tremor of the right extremities, so severe in the arm that the patient could not write; paresis of the muscles of the right side; absence of the right plantar response, and a patellar clonus on the same side. The child was admitted to Babies Hospital to exclude the presence of a brain tumor.

On the following day the hospital physician recorded no impairment of sensation, a negative Romberg sign, absence of the right abdominal reflexes, positive Babinski and Chaddock signs on the right side, absence of Hoffmann and Mayer signs on this side and a hemiplegic gait. It was his impression that the tremor was present in all muscles of the right upper extremity and shoulder girdle and that it was present at rest, moderately increased when movement was attempted but voluntarily controllable for short periods. Observation when the child was asleep revealed the absence of tremor. On ophthalmologic consultation there were no significant ocular findings.

The neurologic consultant expressed doubt about the right plantar response, stating that this reflex was poorly elicited but that the right hallux remained in the Babinski position most of the time. It was his opinion that the tremor was present in the right leg and the right side of the "trunk" as well as in the arm and was constantly present at rest and during movement, varying only slightly in response to change of position of the arm. He asked for a spinal tap, determination of the sedimentation rate and a roentgenographic examination. The spinal puncture revealed an initial pressure of 50 mm., which rose well on jugu-

From the Department of Neurology, Columbia University College of Physicians and Surgeons; the Montefiore Hospital, and the Department of Surgery, Long Island College of Medicine.

lar pressure. A roentgenogram of the skull disclosed no abnormalities. Two weeks later the neurologic consultant stated the opinion that the tremor was more intense and constant, reaffirmed its presence at rest and during movement and noted that it became worse during movement. He also felt that the paresis was more

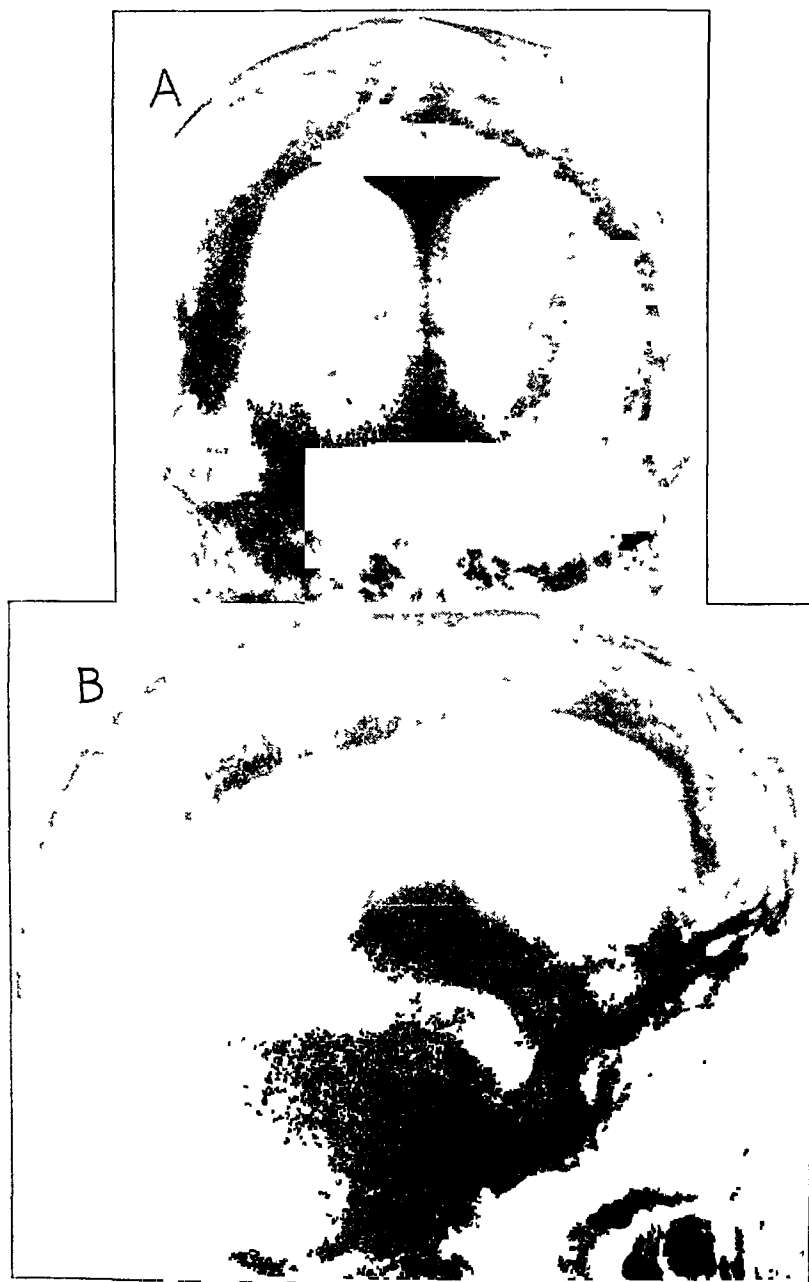

Fig. 1.—*A*, anteroposterior and, *B*, lateral ventriculogram (May 7, 1942).

severe. Examination of the visual fields revealed pronounced concentric constriction of the right field but no abnormality of the left. A pneumoencephalogram (Jan. 8, 1937) disclosed enlargement of the lateral ventricles, especially the left. The left side of the hypothalamic portion of the third ventricle was encroached

on, and there was a concave defect in the rostral margin of the cisterna pontis. The aqueduct and the fourth ventricle were not abnormal. The late Dr. Dyke expressed the opinion that the patient had a suprasellar tumor located to the left of the midline. After the pneumoencephalographic procedure the patient required codeine and phenobarbital. Under such circumstances the tremor could not always be detected at rest but was brought out by voluntary activity (January 10).

Reexamination by the neurologic consultant on January 21 and 28 disclosed that the paresis and tremor had progressed. The gait, in particular, was further impaired. His opinion was shared by the house officer who examined the patient on February 1. He also observed that there was a certain amount of wasting of the muscles of the right hand and that the patient was having difficulty in concentrating and remembering and had become euphoric. A psychiatric consultant concurred in this opinion. Ophthalmologic consultation revealed inadequacy in convergence. Examination of the visual field could not be satisfactorily completed.

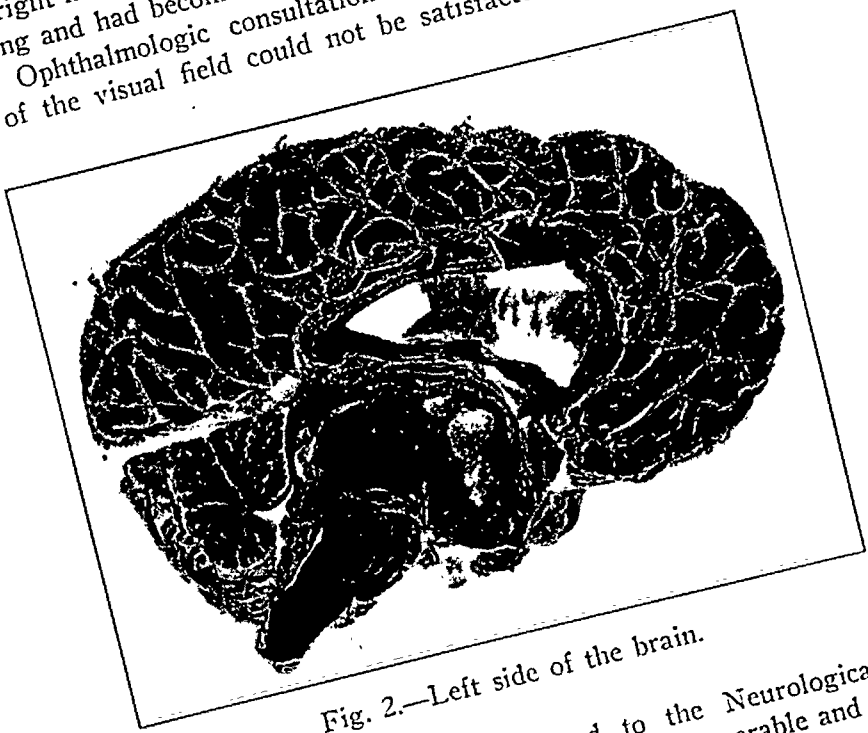

Fig. 2.—Left side of the brain.

Progression.—The patient was transferred to the Neurological Institute of New York, where it was decided that the tumor was inoperable and several courses of high voltage roentgen therapy were given. There was temporary improvement, but deterioration again became progressive in June. There was vomiting; difficulty in speaking developed; the left side of the body became weak, and there was a tendency to fall forward. Papilledema was observed in the right eye. Examination in September revealed paresis of the right side of the face and right convexity of the upper portion of the spine with left convexity in the thoracic region. The right arm was maintained in a position of flexion and was constantly in motion, the movements varying in type (flexion, extension and rotation) and in frequency and force. This activity was increased by attention or use. There were occasional myoclonic movements of the other extremities, involving the right leg particularly and the left leg least. The right upper extremity was useless; the right lower was paretic, and the patient could not stand or walk unaided and was ataxic even when seated. There was resistance to passive movement of the right upper extremity. This resistance was broken by

interference of the tremor. Dysarthria was pronounced. The Babinski phenomenon was encountered bilaterally, and "confirmatory" signs and reflexes were present. Papilledema was observed in both eyes. The patient remained under observation during the last two weeks of September and the first two weeks of October and was found to deteriorate throughout this period.



Fig. 3.—Section through the mesencephalon, showing destruction of the left side of this portion by tumor and preservation of the right basis pedunculi.

Episodes of severe headache and vomiting continued to occur at progressively shorter intervals throughout the next five years, and there was increased failure of vision. During April and May of 1942 she was seen by one of us (L. D.). At that time she presented the appearance of right hemiplegia, including facial paralysis, right wrist drop and a flexor position of the fingers. There was a static, rhythmic tremor, which was accentuated when her attention was distracted.

The report stated: "The deep reflexes were increased. A Babinski phenomenon, with all confirmatory signs and reflexes, was present bilaterally, being greater on the right side than on the left. The abdominal reflexes were diminished on the right." The right pupil was larger than the left; both pupils reacted poorly to light and better in accommodation. The eyegrounds suggested atrophy of the optic nerve.

A ventriculogram showed dilatation of both lateral ventricles (fig. 1 *A* and *B*). The third ventricle was displaced to the right. The dorsum sellae had disappeared, as had the posterior clinoid processes.

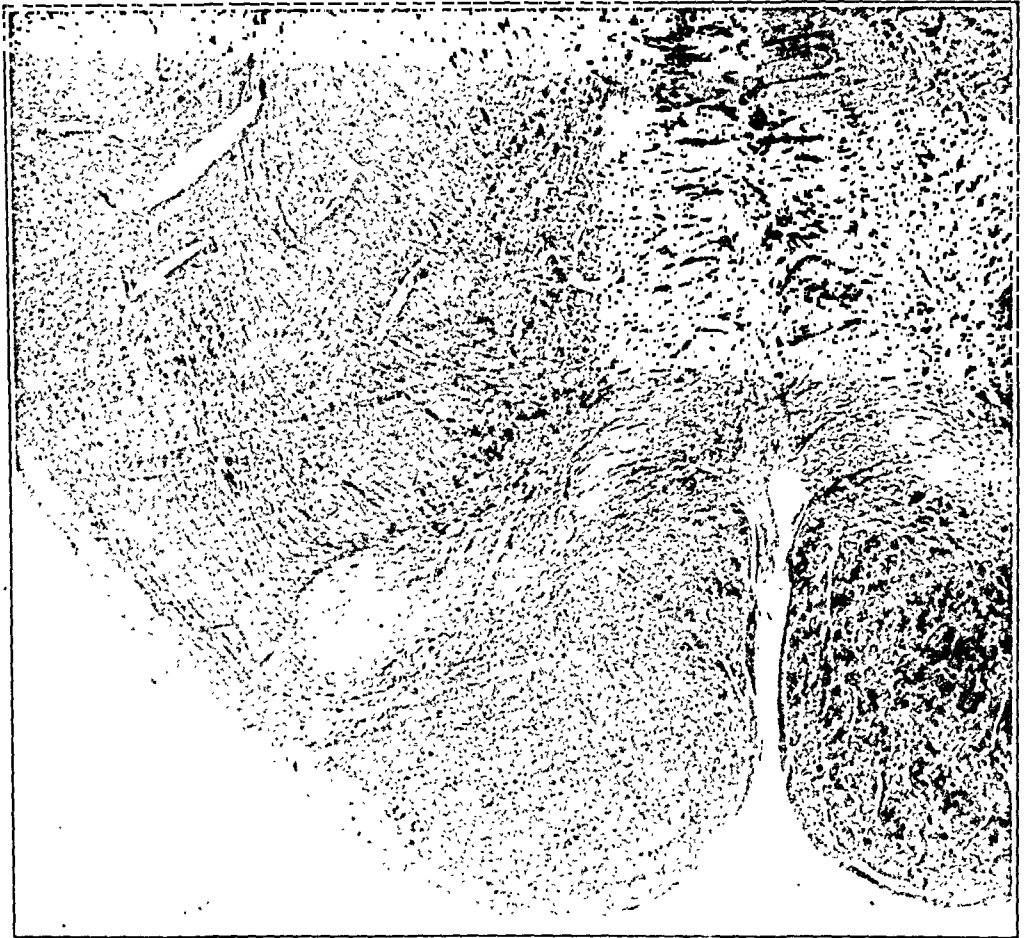

Fig. 4.—Section through the lower end of the inferior olives, showing a degenerated left pyramid and a well stained right pyramid.

On or about July 10, 1943 the patient was seen by one of us (R. G.), who observed a discharge of cerebrospinal fluid. The child was blind and showed "right hemiplegia, with a transient type of tremor in the right upper extremity. The left extremities were also severely paretic." The child died on July 20, 1943, and postmortem examination was performed in King's County Hospital (prosector, Dr. I. Garrow) on the date of death.

Autopsy.—The body was wasted and showed atrophy of the muscles of the right upper extremity. The right wrist and elbow were acutely flexed. The left frontal region exhibited a scar 7 cm. in length. In this region the soft tissues were only loosely attached to the underlying bone, which exhibited two trephine openings, one on either side of the midline and 2 cm. rostral to the frontoparietal

suture. When the calvaria was removed, 0.5 liter of clear cerebrospinal fluid escaped. The brain was removed, fixed and sent for study to the laboratory of Dr. E. Jefferson Browder, in Kings County Hospital. The sella turcica measured 3.2 by 3.5 cm. The pituitary body was compressed.

The remainder of the autopsy is of no importance for the purposes of this report. The anatomic diagnosis was meningitis and cerebral tumor.

Toward the end of 1944 the brain was sent to the laboratories of the department of neurology of the College of Physicians and Surgeons for further study.

Gross Appearance of the Brain.—The brain presented a compressed appearance. The reason was apparent on sagittal section, which revealed a massive polar spongioblastoma located in the position of the diencephalon and mesencephalon. Its position is well shown in the accompanying photograph (fig. 2). It lay in the tissue of the left side of the midbrain and thalamus and had displaced the substance of the right side of the brain far laterally.

Histologic Study.—Histologic examination proved instructive. The left side of the thalamus was quite destroyed by the tumor, which continued through the left side of the mesencephalon and terminated by burrowing through the lower part of the anterior medullary velum into the fourth ventricle. There was no evidence that any of the nuclei of the left side of the mesencephalon remained intact, and all the fiber systems of this region, except for a few fibers, were destroyed; but the mechanisms of the right side, while displaced, were all in good morphologic condition (fig. 3).

It would be unprofitable to attempt to determine just which of the nuclear arrangements of the left side were still functional at the pontile level. In sections through the upper limits of the pons the nuclei pontis were themselves intact, as were the left reticulotegmental and superior central nuclei. Farther caudally a few displaced cells of the nucleus of the mesencephalic root of the left trigeminus were also apparent. About half the cells in the left masticator nucleus were of normal appearance; the rest were pyknotic. The superior olivary nucleus remained intact.

COMMENT

The written record of the present case contains no specific statement as to the rate of the tremor. A check with three of the physicians who saw the patient at times ranging from onset of the disease to termination of its course elicited the unanimous statement that the tremor was of a true alternating type with a rate of from 2 to 3 cycles per second.

It is common clinical knowledge that preexisting abnormal movements are profoundly affected by the appearance of hemiplegia. Parkinson himself observed a case of paralysis agitans in which a stroke appeared and eliminated the tremor, which, however, returned as the patient improved. Gowers¹ stated the situation as follows: "tremor, rhythmical movements and especially irregular movements . . . occur only when there is some return of voluntary power, not when the paralysis remains absolute." This is the current opinion,² which is

1. Gowers, W. R.: A Manual of Diseases of the Nervous System, ed. 2, Philadelphia, P. Blakiston's Son & Co., 1895, vol. 2, p. 85.

2. Wilson, S. A. K.: Modern Problems in Neurology, New York, William Wood & Company, 1929, p. 245.

substantially correct, but with which there are difficulties of interpretation. The implications of this view are that the tremor of parkinsonism requires some degree of activity of the corticospinal system and that the pacemaker for the tremor is therefore in the cortex. Now the presence of some degree of voluntary activity does not necessarily mean that the corticospinal projection is partially active, for complete paralysis does not follow severance of this system. The present case clearly indicates that the pacemaker of the alternating tremor is not the supratentorial neuraxis, and the case is, apparently, unique in that the tremor and paralysis developed *pari passu*.

There is a clear indication that as the right side became quite incapable of voluntary activity the tremor, which at first had an intention component, was completely reduced to a static type.

The tumor undoubtedly began in the thalamus (probably the floor of the third ventricle) and must only subsequently have invaded the internal capsule. It is apparent that intention tremor, the initial symptom, must necessarily have been caused by this central lesion. It was as the tumor spread backward toward the cerebellum and involved more tissue that the tremor assumed a static, in addition to its intentional, character. Since the tremor was a phenomenon of the right side, it is apparent that the backward extension of the neoplasm into the left side of the mesencephalon and infringement on the left brachium conjunctivum had nothing to do with the appearance or development of the tremor. It is worth noting that, although a bilateral Babinski phenomenon was reported to be present as early as September 1937 and continued through 1942, there was no evidence of degeneration in the corticospinal projection from the right cerebral hemisphere when the patient died, in 1943.

Columbia University College of Physicians and Surgeons.

JAPANESE B ENCEPHALITIS

Clinical Observations in an Outbreak on Okinawa Shima

COMMANDER LEON LEWIS (MC), U.S.N.R.

LIEUTENANT COLONEL HARVEY G. TAYLOR
MEDICAL CORPS, ARMY OF THE UNITED STATES

LIEUTENANT MILTON B. SOREM (MC), U.S.N.R.

LIEUTENANT JOHN W. NORCROSS (MC), U.S.N.R.

AND

LIEUTENANT COMMANDER VICTOR H. KINDSVATTER, H(S), U.S.N.R.

DURING the summer of 1945 an outbreak of encephalitis occurred on Okinawa Shima. At the time, the island was the most important advanced base in the Pacific theater. Large forces of American troops were already assembled for the projected invasion of the home islands of Japan, scheduled for the autumn. It was reasonable to assume that these troops were susceptible to an oriental neurotropic virus disease, and the danger of an epidemic was a matter of great concern to the medical departments of the Army and Navy. When the first civilian patients with encephalitis were reported to the island surgeon, a program for their isolation and study was instituted at once. Within a very short time several groups of investigators were engaged in observing various aspects of the disease and active measures were being taken for its control. Hospital facilities were set up by the Military Government Research Center for the care of civilian patients, and laboratory space was provided for members of Naval Medical Research Unit no. 2 and representatives of the Neurotropic Virus Commission. An active program of vaccination was undertaken with Sabin's formaldehyde-inactivated mouse brain vaccine,¹ prepared in anticipation of an epidemic of Japanese B encephalitis and already stored in medical depots on Okinawa. Mosquito control was intensified, and intensive plane spraying of DDT (2,2 bis (*p*-chlorophenyl)-1,1,1-trichloroethane) over areas of native habitations was initiated within two days after the

This article has been released for publication by the Division of Publications of the Bureau of Medicine and Surgery of the United States Navy. The opinions and views set forth in this article are those of the writers and are not to be considered as reflecting the policies of the Navy Department.

1. Sabin, A. B.; Duffey, C. E.; Warren, J.; Ward, R.; Peck, J. L., and Ruchman, I.: The St. Louis and Japanese B Types of Epidemic Encephalitis: Development of Noninfective Vaccines; Report of Basic Data, J. A. M. A. **122**: 477-486 (June 19) 1943.

first recognition of patients with what was assumed to be an arthropod-borne neurotropic virus infection.

It is the purpose of this report to describe the clinical features of the disease as it occurred among Okinawan natives. Additional data collected by cooperating investigators form the basis for reports on the epidemiology of the disease,² serologic reactions,³ histopathology,⁴ studies of possible vectors and reservoirs⁵ and other related problems.

Japanese B encephalitis was first identified as a distinct disease after a large outbreak in 1924, when clinical studies⁶ made it possible to distinguish it from epidemic encephalitis of type A, i. e., von Economo's disease. Although a form of encephalitis appeared in parts of Japan almost every summer and had been recognized clinically as early as 1871, the epidemic of 1924 spread throughout a fairly wide area and resulted in a mortality of approximately 60 per cent among 6,000 reported cases. The heaviest concentration of infection was in the region of the Inland Sea, an area where the disease has remained endemic. During the period from 1924 to 1937 outbreaks occurred yearly, with especially high incidences in 1924, 1929, 1935 and 1937, resulting in a total of 21,355 reported cases.⁷

Similar recurrent appearances of summer or autumn encephalitis were known to have been reported from the Ryukyu Islands, as well as from Formosa, Manchuria and the far-eastern maritime districts of Soviet Russia. The diseases which occur in these regions are believed to be of virus origin, and a specific agent was first isolated by monkey

2. Mosher, W. E.: Japanese "B" Encephalitis: Epidemiological Report of the 1945 Outbreak on Okinawa, to be published.

3. (a) Hodes, H. L.; Thomas, L., and Peck, J. L.: Cause of an Outbreak of Encephalitis Established by Means of Complement Fixation Tests, *Proc. Soc. Exper. Biol. & Med.* **60**:220-225 (Nov.) 1945. (b) Sabin, A. B.: Outbreak of Encephalitis on Okinawa in 1945: Preliminary Report on Status as of August 27, 1945, *J. Mil. Med. in Pacific* **1**:79-84, 1945; (c) Epidemic Encephalitis in Military Personnel: Isolation of Japanese B Virus on Okinawa in 1945, Serologic Diagnosis, Clinical Manifestations, Epidemiologic Aspects and Use of Mouse Brain Vaccine, *J. A. M. A.* **133**:281-293 (Feb. 1) 1947. (d) Hammon, W. McD.: Unpublished data.

4. (a) Zimmerman, H. M.: The Pathology of Japanese "B" Encephalitis, *Am. J. Path.* **22**:965-992 (Sept.) 1946. (b) Haymaker, W., and Sabin, A. B.: The Topography of Lesions in the Central Nervous System in a Case of Japanese B Encephalitis on Okinawa, *Arch. Neurol. & Psychiat.*, to be published.

5. Thomas, L., and Peck, J. L.: Results of Inoculating Okinawan Horses with the Virus of Japanese "B" Encephalitis, *Proc. Soc. Exper. Biol. & Med.* **61**:5-6 (Jan.) 1946. Footnote 3 *b*, *c* and *d*.

6. Kaneko, R., and Aoki, Y.: VIII. Ueber die Encephalitis epidemica in Japan, *Ergebn. d. inn. Med. u. Kinderh.* **34**:342-456, 1928.

7. Epidemic Encephalitis, Third Report of the William J. Matheson Commission for Encephalitis Research, New York, Columbia University Press, 1939, p. 159.

inoculation with brain material from a fatal Japanese case in 1934. Subsequently, study of the virus was facilitated by the finding in 1935 that the mouse is a susceptible host, and research in laboratories in Russia, Japan and the United States has thrown considerable light on its properties. As in the case of western equine and St. Louis type of encephalitis in the United States, there is good evidence that the virus of the Japanese B type of encephalitis of Japan and the maritime districts is transmitted by mosquitoes.⁸ Although sporadic cases occur throughout the year, the disease has a characteristic seasonal recurrence, and the worst outbreaks have appeared during or after periods of hot dry weather.

The first patients with severe encephalitis observed by American physicians in the Ryukyus were seen by Lieut L. M. Miller on Heanza Shima, a small island about 2 miles (3 kilometers) east of Okinawa, on July 8, 1945. Two days later one of us (L. L.) found 4 patients with encephalitis among patients admitted to a large civilian hospital on Okinawa. During the following three months 127 patients were seen by Military Government medical facilities on the two islands, and 66 of the 91 patients found on Okinawa were admitted to the isolation hospital for observation and treatment. The etiologic agent in the disease was first indicated by the results of complement fixation and neutralization tests performed by cooperating investigators, which showed that most of the patients formed specific antibodies against the virus of Japanese B encephalitis during convalescence. An infectious agent, identified as the virus, was subsequently isolated from brain tissue of a patient who died on the fifth day of illness.^{3a-c}

CLINICAL OBSERVATIONS

Age and Sex Distributions.—Of the 66 hospital patients, only 2 were over 30 years of age,⁹ 1, a man aged 36, and the other, a woman aged 51. The highest incidence was in the age groups of 5 to 9 (28 patients) and 12 to 16 years (22 patients). There was 1 infant under 2 years of age (actual age, 6 months), and 4 others were under 5 years of age.

8. Mitamura, T.; Kitaoka, M.; Watanabe, S.; Hosoi, T.; Tenjin, S.; Seki, O.; Nagahata, K.; Jo, K., and Shimizu, M.: Weitere Untersuchungen über die Uebertragung der japanischen epidemischen Enzephalitis durch Mücken, *Tr. Soc. path. jap.* **29**:92-105, 1939. Petrischeva, P. A., and Shubladse, A. K.: The Vectors of the Autumn Encephalitis in the Maritime District, *Ark. biol. nauk.* **59**: 72-77, 1940. Smorodintzeff, A. A.; Newstroeve, V. D., and Chagin, K.: Zur Aetiologie der herbstlichen Enzephalitisausbrüche, *J. Mikrobiol., Epidemiol. u. Immunobiol.*, 1941, no. 2, pp. 3-15.

9. Ages given throughout this report are estimated according to Okinawan custom, which considers the newborn infant 1 year of age, the 1 year old child 2 years of age, and so on. During the first year of life a child is referred to as being less than 2 years old.

The greater prevalence of the disease among the young confirmed previously reported observations in Ryukyu epidemics of encephalitis¹⁰ and agreed with the experience of Okinawan physicians whom we interviewed.

According to the epidemiologist's figures on all the native patients,² males and females were almost equally affected. In the hospital group there were 38 females and 28 males.

Onset of Illness.—It was frequently difficult to obtain a history, since many of the patients were admitted in stupor or coma, frequently unaccompanied by competent informants. However, some information was eventually obtained on all but 2 patients, and the histories of 42 were considered satisfactory sources of clinical data. The onset of illness was described as acute and abrupt in 38 of the 42 patients. There was no instance of gradual development of characteristic symptoms,

TABLE 1.—*Symptoms According to the History**

	No. of Patients	Percentage of 42 Histories
Fever.....	39	93
Headache.....	35	83
Stupor or coma.....	31	74
Convulsions.....	16	38
Personality change.....	15	36
Speech disability.....	15	36
Nausea and vomiting.....	7	17
Diarrhea.....	4	10
Vertigo.....	3	7
Chills.....	2	5

* Based on 42 histories considered adequate.

although there were a few histories of antecedent fever or diarrhea of variable duration. Generally, the patient complained of severe headache accompanied with fever and was disabled within a few hours. Children were described as having onset of symptoms while playing, returning to their homes with severe headache and taking to bed at once. Women who had been working in the fields gave similar stories.

Symptomatology.—The frequency with which various symptoms occurred in the 42 patients with adequate histories is indicated in table 1.

Fever and headache were the most common symptoms. About three fourths of the patients were admitted with a history of severe disturbances of consciousness, and others became drowsy, stuporous or comatose during the period of observation. A history of convulsions was obtained for 16 of the patients with adequate histories, and convulsions were observed in the hospital or recorded in the histories of 22 of the 66 patients. Determination of personality changes was difficult because of the language barrier, but obvious abnormality was evident

10. Footnote 7, p. 164.

to members of the patient's family in 36 per cent of the patients. Disturbance or absence of speech before the onset of stupor or coma was noted in a similar number. Gastrointestinal symptoms were not strikingly frequent. However, nausea, vomiting and diarrhea occurred often enough to indicate a true association with the disease. Diplopia was infrequent, and a clearcut history of its recognition was obtainable for only 1 patient. Vertigo was not common. Chills were reported in only 2 instances.

Physical Findings.—The acute manifestations of this disease were predominantly those ascribed to meningeal irritation, namely, stiffness of the neck and back and limitation of flexion of the lower extremity on the trunk. Early, however, signs of diffuse involvement of the

TABLE 2.—*Observations on Initial Physical Examination*

Physical Findings	No. of Patients	Percentage
Mental status		
Coma.....	16	25
Stupor.....	16	25
Drowsiness; lethargy.....	12	18
Apathy.....	8	12
Restlessness or delirium.....	6	9
Alertness.....	7	11
Stiff neck.....	48	74
Kernig sign.....	41	63
Abnormal abdominal reflexes.....	41	63
Aphasia.....	30	46
Pathologic reflexes.....	28	43
Deep reflexes		
Unequality.....	24	37
Absence or weakness.....	19	29
Hyperactivity.....	6	9
Pupillary disturbance.....	17	26
Disturbance of extraocular muscles.....	16	25
Focal weakness.....	14	22
Rigidity.....	10	15
Tremor.....	8	12
Athetosis.....	1	

nervous system were notable, and some of the patients presented not only stiffness but weakness of the neck, orthotonos, apparent trismus, alterations of consciousness varying from lethargy to deep coma, mental disturbances, reflex abnormalities, paralyzes, tremors, convulsions, nystagmus, oculomotor dissociation, athetosis, loss of muscle tone, distention of the bladder and incontinence of urine. True motor aphasia was a concomitant of right hemiplegia, but transient loss of power of speech without accompanying paralysis was often noted. Table 2 indicates the frequency of certain common signs observed on initial physical examination of 65 of the 66 hospitalized patients.¹¹ Since patients were admitted to the hospital from the first to the twenty-second day following onset of the disease, the data are not indicative of physical findings at comparable stages of the disease. However, they serve to emphasize the variability of the clinical picture as it presented itself to the observers.

11. One record was lost.

Fifty-eight patients, or 89 per cent of those examined, showed disturbed consciousness on admission; only 7 were alert and communicative. Nuchal rigidity was present in 74 per cent of the patients, often associated with stiffness of the back and pain on attempted or passive motion. Stiffness of the neck was most prominent in anteroflexion, but lateral motion was also restricted at times. Kernig's sign was present in 63 per cent of the patients. Tenderness of muscles or nerve trunks was not observed, and sensory examination showed a normal status in those able to cooperate for testing.

Reflex disturbances of all kinds were observed on initial examination, as well as during the course of the illness. In general, suppression of reflexes seemed characteristic of the early phase: About one third of the patients admitted within five days of the onset of symptoms had weakness or absence of tendon reflexes, and in two thirds the abdominal reflexes could not be elicited. Thereafter considerable alteration of reaction was seen from day to day, with a tendency toward spasticity manifested by hemiplegic patients and loss of reflexes by those with progressive deterioration. Pathologic plantar reflexes were present in 43 per cent of the patients on first examination.

The 30 patients listed as having aphasia were those who seemed to have some speech disability other than that due to disturbances of consciousness alone. In some instances several days elapsed after clearing of the sensorium before voluntary speech returned. Typical motor aphasia was seen only with right hemiplegia and was permanent in 1 instance.

Abnormalities of the extraocular muscles noted included strabismus; nystagmus, which was present in 7 patients, and dissociated movements, which were observed in 5 patients. Dissociation was characterized by independent rotation or nystagmus, drifting into extreme divergence, and transient convergence. The frequency of changes in the pupillary reflexes is probably understated, since observation of the deeply pigmented irises was difficult in the bright ward. However, early in the illness the pupils were frequently contracted and fixed to light.

Fourteen patients had weakness of the extremities or the facial muscles, varying from minor paresis to hemiplegia, paraplegia or quadriplegia. Rigidity of varying degree was fairly common: Four patients had trismus and 2 opisthotonos, and in many rigidity was limited to one or more extremities during the early part of the illness. Eight patients showed some form of tremor on admission. Typical athetosis was observed in only 1 patient, but athetoid positions were not uncommon, especially in paralytic extremities. Excessive salivation was observed in 4 patients, all of whom showed evidence of widespread permanent damage to the central nervous system.

COURSE OF THE DISEASE

Duration of Illness.—The shortest interval in which improvement in clinical status was noted was three days; the longest, forty-one days. The duration of illness was extremely variable. However, of the 48 patients who improved after the acute phase, 36 were better within three weeks of onset. Of the 35 patients who finally recovered, 2 were well within nine days and 15 within twenty days of onset. Twelve patients were ill for more than one month, and the longest illness with recovery was fifty-seven days.

Thirteen deaths occurred in the hospitalized group of 66 patients. Nine of the 13 patients died within fifteen days of onset; the others died after thirty-eight, forty-one, forty-eight and fifty-two days of illness, respectively.

Fever.—Of the 29 patients admitted within five days of the onset of illness, 20 were febrile; the temperature curves of 19 were irregular or spiking, and the temperature of 1 was persistently elevated. The duration of fever due to encephalitis per se was difficult to estimate because of a fairly high frequency of complications. However, when 1 patient who had widespread tuberculosis in addition to encephalitis is excluded, the febrile period lasted from three to thirty-two days from the onset of illness. Only 17 patients whose temperature records were adequate were free from complications such as pneumonia, otitis media or cutaneous abscesses. For these patients the febrile period was variable, but for 10 it lasted a week or less. The 4 patients with severe degenerative manifestations who died on the thirty-eighth to the fifty-second day of the disease had elevated temperatures throughout their illnesses, but each of them had some infectious disturbance other than encephalitis—tuberculosis, pneumonia or extreme decubitus ulceration.

Variations in Course.—Although the onset of symptoms was always acute, the course of the disease was sometimes subacute or chronic. Seventeen patients recovered completely after a brief illness, usually lasting less than two weeks. Four without complications, as well as 5 patients with encephalitis and pneumonia, died within fifteen days. The remaining 39 patients had protracted illnesses. Of these, 18 patients made satisfactory recoveries, while 17 showed residual signs of damage to the central nervous system; 4 died after progressive deterioration.

Paralysis.—Twenty-three patients exhibited transient or persistent paralyses. Monoplegia or diplegia was present for one or more days in 5 patients; 2 showed transient facial weakness. Hemiplegia on the right, with complete recovery, was observed in 5 patients and hemiplegia on the left in 1 patient. Two patients had complete hemiplegia on the right with aphasia: One recovered speech and had only residual spastic weakness of the right upper extremity; the other retained a spastic

gait and paralysis of the upper extremity as well as complete motor aphasia (case 4). Two patients were paralyzed in all four extremities until death; the paralysis gradually shifted from the flaccid to the spastic type and was at times of different character in the upper and in the lower extremities. One patient had muscular wasting and showed a characteristic dystrophic type of weakness; ultimately there was full recovery except for the right arm, which remained weak and lacked synergic swing with walking. Another patient survived with moderate deformity of the extremities, quadriplegia and mental deterioration (case 5). Four patients showed progressive weakness, wasting and contracture, until at death there was pronounced deformity as well as paralysis of the extremities. Although the deformity was not identical in all 4 patients, there were certain common characteristics: The upper extremities tended to rotate progressively inward until the dorsa of the hands came into contact with the lateral surfaces of the thighs; the elbows

TABLE 3.—Incidence of Paralyses

	Total No. of Patients
Transient monoplegia or diplegia.....	5
Transient facial weakness.....	2
Transient hemiplegia.....	6
Hemiplegia—persistent paresis.....	2
Persistent quadriplegia.....	2 (fatal)
Dystrophic weakness.....	1
Paralysis with contractures.....	5 (4 fatal)
Total.....	23

were usually extended, the wrists and fingers sharply flexed and the thumbs placed between the fingers. Rigidity and fixation of the deformity gradually increased but was not equal bilaterally. Simultaneously, one or both feet exhibited marked equinus, inversion and planter flexion of the toes, to form the rigid, talon-like arc of the so-called striatal foot. The number of patients with the paralytic manifestations described is shown in table 3.

Disturbances of Consciousness.—Almost every patient in the early stage showed disturbed states of consciousness, varying from apathy to deep coma and two thirds of the patients had a history of stupor or coma. The duration of stupor or coma was six days or less in 24 patients, but 1 patient was comatose for fifty days and another for forty days. Three patients who were comatose for thirty-four, forty and fifty days, respectively, failed to recover.

Tremor.—Tremor was of infrequent occurrence and was more common during the early period of the illness. Twelve patients exhibited tremor at some time in the course of their disease. There was no characteristic pattern, and most of the tremors were bizarre: irregular,

coarse and convulsive, occasionally involving many muscle groups (case 6). At the time of discharge from the hospital only 2 patients exhibited appreciable tremor. One had a tremor of the hands somewhat suggestive of the pill-rolling type and a slight nodding of the head. Both tremors were of only slight degree when the patient left the hospital, two months after onset of illness. In another patient head nodding developed as an acute manifestation on the thirty-fourth day of illness, associated with other symptoms of relapse. Vertical or lateral nodding was periodically present at final observation, on the fifty-ninth day after onset of illness.

Convulsions.—In addition to convulsive twitching involving focal areas, such as an upper extremity and the shoulder girdle, or both extremities in a hemiparetic patient, some patients had typical epileptiform convulsions, with deviation of the head and eyes to one side, clonic

TABLE 4.—*Complications in Course of Illness*

Complications or Coexistent Disease	No. Survived	No. Who Died	Total No.	Per Cent of 65 Patients with the Disease
Pneumonia or pneumonitis....	9	7	16	25
Intestinal helminthiasis.....	23	10	33	51 *
Otitis media.....	12	1	13	20
Corneal ulcer.....	3	0	3	4.6
Malaria.....	4	0	4	6
Decubitus ulcer.....	3	4	7	11
Tuberculosis.....	..	1	1	
Cystitis and pyelitis.....	1	1	2	
Abscesses of the teeth.....	1	0	1	
Snake bite.....	1	0	1	
Cysticercosis.....	0	1	1	
Herpes zoster.....	1	0	1	

* Forty-three stools examined—30, or 70 per cent, positive.

movements of the extremities—usually more pronounced on one side—and rigidity of the trunk. Serial convulsions were occasionally present. There did not appear to be any relation between the occurrence of convulsions and the ultimate outcome of the illness.

Complications.—The coincidental disease processes which were observed (table 4) may be differentiated into those which were important factors in causing morbidity or death and those which were of little prognostic significance. Of the former, pneumonia and pneumonitis were common, having occurred in 16 patients, including 7 in whom the presence of the complication was confirmed at autopsy.¹² Intercurrent malaria was a less serious problem and did not affect the mortality rate.

12. Seven of the patients who died had pneumonia; 5 died after relatively acute and 2 after protracted illnesses. The view expressed about the North American encephalitis,²² that deaths occurring after the third or fourth day are almost invariably due to complications, does not seem to hold here. Four patients who died after seven days of illness failed to show evidences of disease other than that of the central nervous system.

Miliary tuberculosis was discovered post mortem in a patient who died fifty-two days after the onset of encephalitis.¹³ Malnutrition was common and was a difficult problem of management during the lethargic phase of the illness.

Of the purely incidental conditions, helminthiasis was by far the most frequent: Ova or larvae were observed in the stools of 51 per cent of patients and infection, frequently multiple, was noted in 77 per cent at autopsy. Other abnormalities are indicated in table 4.

SEROLOGIC STUDIES

Early and convalescent specimens of blood were obtained from 25 patients by Thomas and Peck.¹⁴ Complement fixation tests performed at the Guam laboratories of Naval Medical Research Unit no. 2 according to the technic of Casals¹⁵ showed a fourfold or greater increase of titer in 22. The serums of 2 patients gave negative reactions, and the serum of 1 patient showed complement fixation in a dilution of 1:8 with both early and convalescent specimens. Accordingly, there was serologic confirmation of the clinical diagnosis in 88 per cent of this series of patients. Neutralization tests were not performed.

Hammon^{3d} also collected specimens of blood from 22 patients, but only during the convalescent phase. Complement fixation tests were performed on these, with the following results: Six were anticomplementary; 3 gave negative reactions and 13 positive reactions. A positive reaction in the virus neutralization test, which was considered indicative of infection with Japanese B encephalitis virus at some time during the patient's life, was obtained for 14 patients; 4 tests gave doubtful results; 4 showed no antibody. In the absence of specimens obtained during the acute phase the results of the neutralization tests are of little diagnostic significance. However, of 14 serums on which both neutralization and complement fixation tests were performed, the results were positive in both tests in 7, positive in 1 and doubtful in the other in 3, negative in both tests in 2, negative in the complement fixation test but positive in the virus neutralization test in 1 and the reverse in 1. These serums were also tested for neutralizing antibody against the viruses of the St. Louis and western equine types of encephalitis, with only 1 doubtful result in each of the two series of tests. These findings furnish additional serologic evidence of the nature of the virus in the Okinawa outbreak and suggest a fair correlation between the results of the two serologic tests during convalescence.

13. There was no tuberculous involvement of the central nervous system. Gross and histologic changes were typical of encephalitis.

14. Thomas, L., and Peck, J. L.: Unpublished data.

15. Casals, J., and Palacios, R.: The Complement Fixation Test in the Diagnosis of Virus Infections of the Central Nervous System. *J. Exper. Med.* **74**:409-426 (Nov.) 1941.

STUDIES OF THE SPINAL FLUID

Equipment for chemical study of the spinal fluid was available for only part of this study, and the difficulty of transporting specimens to other medical facilities precluded a complete set of serial observations. The cerebrospinal fluid pressure was not recorded, and no statement can be made except the general remark that pressure seemed elevated early in the disease and was obviously elevated in 1 infant with an open anterior fontanel. Cytologic findings were extremely variable even early in the illness. In 9 the first specimen of spinal fluid failed to show the presence of leukocytes, and 7 others had only 6 cells or less per cubic millimeter. In most instances, however, there was definite pleocytosis, the count varying from 9 to 955 cells per cubic millimeter. Counts of 250 to 955 cells were noted most frequently before the fifth day of the disease. Even early in the illness there was usually a preponderance of lymphocytes. Only 6 patients had fewer than 50 per cent of lymphocytes during the first fifteen days; during the same period 20 patients had between 90 and 100 per cent lymphocytes.

Subsequent specimens of spinal fluid generally showed a diminishing pleocytosis. There was no instance of a cell count of over 25 per cubic millimeter after the twentieth day of illness. The type of cell, however, in the second and in later specimens of spinal fluid was usually over 75 per cent monocytic.

Qualitative tests for globulin (Pandy) tended to become more frequently positive during the course of the first three weeks of illness. Eighteen of 45 recorded tests on the initial specimen of spinal fluid were reported as positive, while 23 of 44 subsequent specimens were so reported. Total protein, estimated by the tyrosine colorimetric method, ranged from 18.5 to 85.2 mg. per hundred cubic centimeters in 16 initial examinations of the spinal fluid. Eleven values were above the extreme upper limit for the method, namely, 50 mg. per hundred cubic centimeters. Within the first five days after onset of illness 6 fluids showed an excess of total protein, while 4 were within the limits of normal.

Most of the results in 16 initial quantitative estimations of sugar fell within the extreme range of normal for the method, i. e., 50 to 75 mg. per hundred cubic centimeters. Three values were below 50 mg., and 2 above 75 mg., per hundred cubic centimeters. However, 6 values were above the normal range of 60 to 65 mg. per hundred cubic centimeters, and 3 were below, in specimens obtained during the first ten days of illness.

Reexamination of the spinal fluid after the fifteenth day of illness showed rather consistently elevated total protein levels and generally normal values for sugar. In 12 of 21 protein determinations, the results were above 50 mg., and in 3 others between 46 and 50 mg., per hundred cubic centimeters. In 4 instances the protein level was above 75 mg. per

hundred cubic centimeters. In 3 determinations, the sugar level was below 50 mg., in 18 within the range of 50 to 75 mg. and in 4 above 75 mg., per hundred cubic centimeters, between the fifteenth and the fifty-second day of illness. Twenty-six fluids examined for sugar during that interval were reported as follow: Within the strictly normal range of 60 to 65 mg. per hundred cubic centimeters, 4; below 60 mg., 10; above 65 mg., 12. In 4 of the last the value exceeded 85 mg. per hundred cubic centimeters.

HEMATOLOGIC FEATURES

Evaluation of hematologic observations is limited to 26 of the first 58 patients admitted during July and August, who were intensively studied by the hematologist (J. W. N.). The cases selected were those without complicating infections other than helminthiasis. Five patients were seen early in the disease: 2 on the second day and 3 on the third. The composite findings showed an early leukocytosis, with a count of 15,000 to 25,000 and an increase in neutrophils. After the initial elevation the white blood cell count fell below 10,000 before the eighth day in 7 patients. In 7 other patients it remained slightly above 10,000 between the eighth and the fifteenth day of the disease. Only in cases complicated by pneumonia or otitis media was the white cell count elevated after the fifteenth day.

Early in the disease there was a relative and an absolute increase in the neutrophilic cells with a shift to the left and a moderate degree of toxicity, whereas the other white blood cell elements were all strongly depressed. As the acute phase of the disease subsided, these cells returned and the differential count assumed a normal pattern. The eosinophilia normally seen in a high percentage of Okinawan children became evident again in the early stages of improvement. In cases of neurologic relapse or when pneumonia or otitis media complicated the clinical status, the white blood cell count and differential pattern reverted to those changes seen early in the disease.

As improvement took place the lymphocytes at times showed extreme youth and toxicity whereas at others there was no abnormality. There was no characteristic lymphocytic change.

A slight degree of anemia was common, as was to have been anticipated in a population with widespread helminthiasis, subsisting on a diet inadequate in protein and iron. In this group of uncomplicated cases the average red blood cell count was 4,260,000 and the average hemoglobin content was 11.4 Gm. per hundred cubic centimeters (Hellige or copper sulfate specific gravity method).

PSYCHIATRIC OBSERVATIONS

Language barriers made it difficult to evaluate the mental status accurately, and many minor alterations undoubtedly escaped observa-

tion. Among the obviously disturbed patients, there were 10 who showed a high degree of irritability early in the illness and 1 with similar manifestations after apparent convalescence. Eight patients were confused and 5 were apathetic during the early phase. Three exhibited unusual emotional instability characterized by crying, spontaneous laughter and shifting mood. Two were depressed and 3 had frank transient psychoses. In only 2 patients were prolonged severe psychoses observed. The mental state of 1 patient cleared completely except for slight mental retardation several weeks after transfer to the psychiatric ward of a Military Government hospital; the other showed a late tendency toward clearing but was discharged after nearly three months of illness with persistent reactions indicative of organic deterioration (case 7). Mental retardation of varying degree was believed to be present in 13 patients at the time of discharge from the hospital. One of the 5 patients with chronic course and extreme mental deterioration survived as a deformed idiot (case 5).

The high incidence of mental retardation may be spurious, since it is possible that prolonged follow-up observation would have shown considerable improvement in some patients. However, final observation very often revealed sluggishness of response and apparent clouding of the sensorium in patients otherwise fully recovered. One patient who failed to show any tendency toward recovery of interest and physical activity following his acute phase continued to present symptoms of general deterioration, apathy, fixed facies and muscular wasting throughout approximately ten weeks of observation in the hospital and at home.

MORTALITY AND SEQUELAE

The over-all mortality among patients on Okinawa Shima was 28.6 per cent. In the hospital group of 66 patients the mortality was 19.7 per cent. These figures are at variance with reports⁷ of 49.6 to 75.2 per cent in Japanese epidemics (1924 to 1937), although a mortality of 25 to 30 per cent was reported for the age group under 20 in the prefecture of Tokyo in 1935. In general, the mortality rate in Japanese outbreaks has been lower in the younger age groups, and the high percentage of survival in the Okinawa group may be due to the relative youth of the patients.

According to results in this outbreak, about one fourth of the total number of patients and about one third of the survivors had clinical evidence of mental impairment, personality change or disturbed motor function at the time of discharge from the hospital. Allowing for the possibility of further improvement, it is estimated that one fifth of the total series, or one fourth of the survivors, will have suffered permanent damage of varying degree as a result of the disease. Among the serious results to be anticipated, on the basis of information available from this

outbreak and from the review of cases of known postencephalitis, are hemiplegia, hemiparesis, aphasia, cerebellar syndromes, modified paralysis agitans, mental impairment, organic psychotic states and idiocy associated with extreme deformity and paralysis.

PATHOLOGIC STUDY

Pathologic material from most of the 13 cases with autopsy forms the basis for a detailed report on the histologic alterations of the central nervous system in this disease, prepared by Comdr. H. M. Zimmerman.^{4a} The observations in fatal cases described later in this report will indicate the type of changes noted in cases of the acute as well as of the late stages. However, the gross and histologic changes may be briefly summarized as follows:

During the first two weeks the brains in fatal cases showed little distinctive gross abnormality. Injection of pial vessels was noted in every case, and this was associated with flattening of convolutions and apparent swelling of the cerebrum. On section, the intrinsic vessels were prominent and in some cases suggested minute petechiae. Pronounced injection of the vessels of the basal ganglia was seen in 1 patient. The left globus pallidus appeared somewhat softened at the eighth day in 1 brain. At the fifteenth day, the cerebrum of another showed the first clearcut cortical changes. The brain was soft, and the gray matter exhibited focal areas of gelatinous appearance on cut section.

The 4 brains examined from the thirty-eighth to the fifty-second day of the disease showed striking changes. In 1 instance (case 6) a very incomplete gross examination was made of the fresh specimen in order to preserve an almost intact organ for detailed histologic study. However, in all these 4 brains, softening, varying from early injection, accompanied with slight change in substance, to frank cystic degeneration was observed in the substantia nigra or in other nuclear structures of the pons or the midbrain; softening with pallor was present in focal areas in the cerebral cortex, and the cerebellar folia showed loss of gray matter or pallor. Flattening of convolutions was no longer present, but definite focal atrophy with external hydrocephalus of slight degree was observed in each case. The aqueduct was invariably dilated, and the ventricular system showed evidence of early internal hydrocephalus.

In 5 brains in cases of the acute stage examined histologically, Zimmerman reported widespread changes in the ganglion cells, most severe in the cerebellar cortex (fig. 1 *A*) and least marked in the medulla and cord, but involving the cerebral cortex, basal ganglia, cornu ammonis and substantia nigra. The leptomeninges showed mild infiltration by lymphocytes. Perivascular cuffing with lymphocytes, and occasionally monocytes and macrophages (fig. 1 *B*), was present in many different areas, including white matter which was otherwise free from lesions.

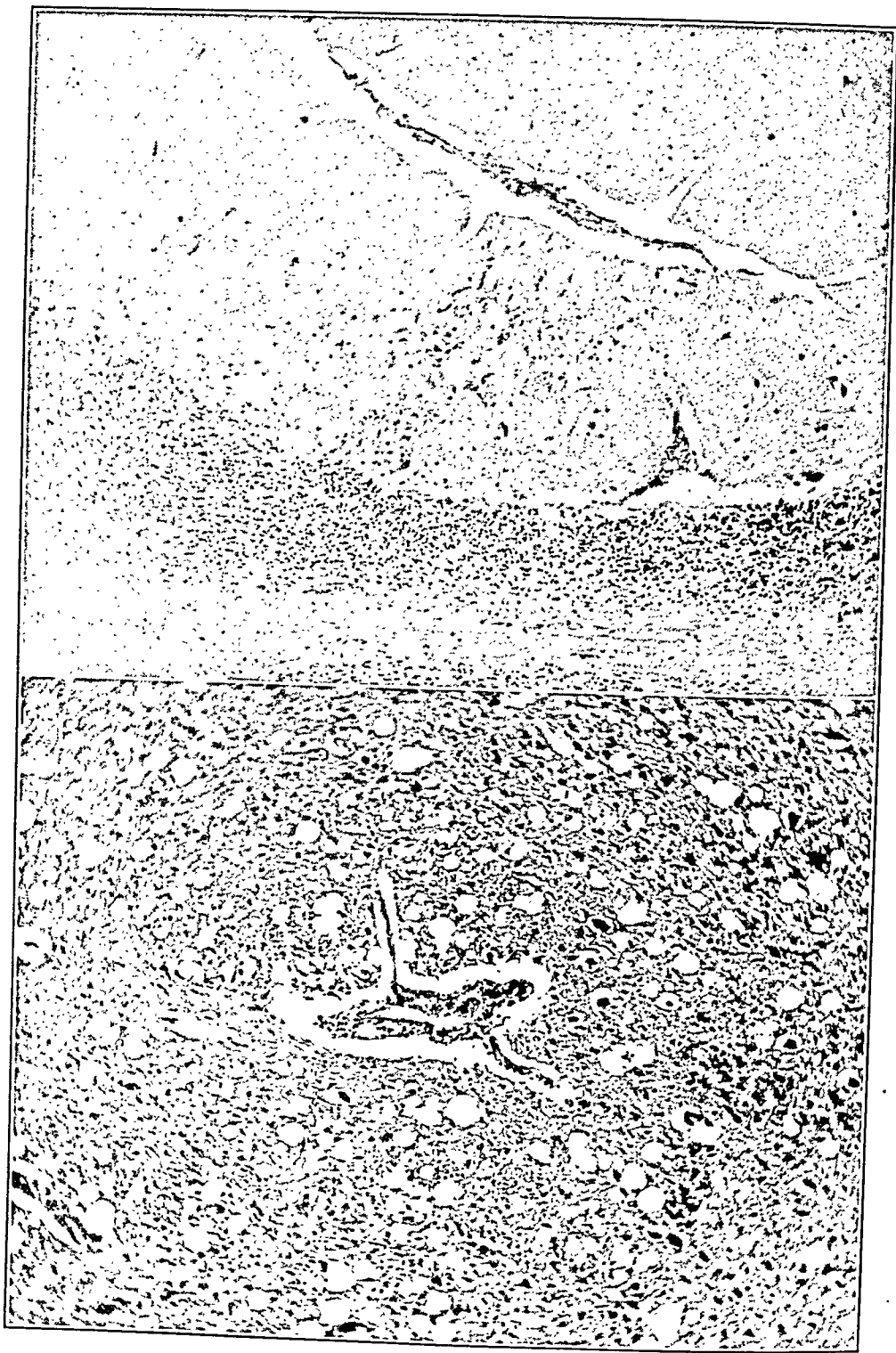

Fig. 1.—*A*, cerebellum, eighth day of disease, showing loss of Purkinje cells and focal glial proliferation in the molecular layer. *B*, midbrain, in a more advanced stage of the disease, showing perivascular infiltration and loose fibrillary stroma containing few ganglion cells; $\times 8$.

Hemorrhages were noted in Virchow-Robin spaces, and also sometimes overrunning the bounds of the perivascular sheaths and lying in the nerve parenchyma. The affected ganglion cells showed varying degrees of disintegration, from eosinophilia to complete destruction. Early leukocytic infiltration about injured cells was followed by microglial proliferation, and after destruction of ganglion cells fat-laden macrophages were in evidence. Sponginess of the interstitium in early lesions was followed by astrocytic proliferation, forerunner of the gliosis seen in later specimens. The lesions of the cerebellar cortex involved principally the Purkinje cells and their dendritic processes.

The brain of a patient who died on the fifth day of illness showed numerous discrete lesions involving various laminae of the cerebral cortex which had a strong resemblance to the "plaques" of multiple sclerosis. Often these "plaques" were infiltrated by leukocytes and gave the appearance of miliary abscesses. This specimen also showed comparable lesions of the basal ganglia, destruction of ganglion cells in pontile nuclei and involvement of cranial nerve nuclei of the medulla, as well as the inferior olives, suggestive of poliomyelitis. The cerebellar cortex showed grossly visible punched-out, spongy plaques of the molecular and Purkinje cell layers, in which the large ganglion cells were severely damaged or had entirely disappeared. In the cervical portion of the spinal cord there were areas of lymphocytic infiltration, edema and neuronal injury of the anterior and posterior cornua which were also suggestive of acute poliomyelitis.

The histopathologic observations in an early fatal case and in a case of death after forty-one days of illness are presented later (cases 2 and 6).

Associated visceral pathologic processes in the necropsy material, aside from pneumonia, were not clearly related to encephalitis. Pneumonia was found in 7 cases in the gross examination and was reported in an additional case after histologic examination. In 2 cases there was insufficient histopathologic evidence to support a diagnosis of encephalitis, and it is possible that pneumonia was not only the cause of death but also the basis for meningismus. However, the cerebrospinal fluid showed pleocytosis in 1 case; and both were clinically typical of the disease and therefore included in this series, although with considerable reservation. It is interesting to note that pneumonia was present in all but 2 cases which terminated within fifteen days but was found in only 2 of the 4 cases in which death occurred after thirty-eight days, and in 1 of these it was associated with miliary tuberculosis. The lesion in the early cases was usually bronchopneumonic, and not the interstitial variety associated with virus infections. The possibility, however, that pulmonary involvement is an intrinsic part of the early phase of infection is worthy of further investigation.

Primary healed tuberculosis was observed in 2 cases, disseminated tuberculosis in 1 case, chronic nephritis in 1 case, cysticercosis of the brain, lungs and epicardium in 1 case, and mesenteric adenitis was prominent in 5 cases. Other incidental observations were cystic ovaries, in 2 cases; hepatomegaly and splenomegaly, in 1 case each, and hydrops of the gallbladder due to obstruction of the cystic duct by a dead ascaris, in 1 case. Decubitus ulceration was extreme in 3 of the 4 cases of the chronic form. Intestinal worms were found in the gastrointestinal tract in 9 of the 13 cases in which it was examined.

DIAGNOSIS

Encephalitis due to the virus designated as the Japanese B type cannot be diagnosed without resort to special serologic and virologic tests. The disease may be suspected and the diagnosis may be entertained on clinical grounds when in known endemic or epidemic areas patients with sudden onset of fever and headache exhibit progressive signs of meningeal irritation, followed by evidences of diffuse disease of the central nervous system. Recognition of the syndrome is not always easy, and the clinical status varies not only from case to case, but often at short intervals in the same case. Quite characteristically during the first few days of illness there are pupillary miosis with impairment of reaction to light, suppression of abdominal reflexes, diminution or inequality of deep reflexes, focal weakness of facial muscles or of one or more extremities, disturbance of consciousness varying from apathy to deep coma, restlessness, confusion, orthotonos, nuchal stiffness and weakness, a positive Kernig sign and, frequently, convulsive episodes. During epidemics the disease may be suspected in patients with only nuchal rigidity and a positive Kernig sign. Pathologic plantar reflexes are frequently elicited, but the reflex findings in general are variable and abnormalities are often fleeting.

The white blood cell count is elevated, and the neutrophils show an increase in number, as well as relative immaturity. Toxic changes are fairly prominent during the acute phase of the illness. Within ten to fifteen days the leukocytosis usually subsides unless there is a complicating infection.

Examination of the cerebrospinal fluid is often of assistance in making the diagnosis, since moderate pleocytosis with initial moderate and later marked lymphocytic preponderance is usually found. The absence of an unusual number of cells does not, however, preclude the diagnosis. Chemical examination of the fluid, particularly the protein and sugar contents, is important in excluding other conditions: In Japanese B encephalitis the protein level may be slightly elevated, and after the first few days the sugar may be slightly higher than normal, though in general deviation from the normal is slight in degree; in tuberculous

meningitis, on the other hand, marked depression of sugar and elevation of protein are highly characteristic.

The diagnosis is established with certainty by isolation of the specific virus and identification by appropriate serologic tests. Although detection of the virus in the blood and the spinal fluid has been reported, attempts to infect mice inoculated with 17 specimens of blood and 16 specimens of spinal fluid obtained during the acute phase of the disease in this group of patients gave negative results.¹⁶ Fresh brain tissue from a case of the early acute stage was the source of successful mouse inoculation with a virus which was serologically identified as that of Japanese B encephalitis.¹⁷

Experience with the complement fixation method of Casals and Palacios,¹⁵ reported by Hodes, Thomas and Peck,^{3a} and work in progress in other laboratories^{3b-d} indicate that this test is of value in determining whether the Japanese B virus is responsible for a particular outbreak, and there is reason to anticipate that early diagnosis may also be facilitated in individual cases. Neutralization of specific virus by convalescent serum is an important diagnostic aid; however, as in the case of the complement fixation test, it is necessary to obtain blood at successive intervals in order to demonstrate a rising titer of neutralizing antibodies. In Okinawa a large percentage of bloods from the normal adult population possess neutralizing power of significant degree,¹⁸ but complement-fixing antibodies are rarely encountered.^{3c,d}

Forty-four patients were admitted to the hospital suspected of having encephalitis but were found to have other conditions causing neurologic manifestations. Tuberculous meningitis was unusually common; the clinical diagnosis was confirmed by autopsy in 8 cases. Malaria, although always of the benign tertian type, was often found to be the cause of symptoms simulating encephalitis. Other conditions encountered were meningococcic meningitis, poliomyelitis, meningismus from pneumonia, subdural or intracranial hemorrhage, brain abscess, brain tumor, shrapnel injury of the brain, cerebral emboli from bacterial endocarditis and epilepsy. In most instances the differential diagnosis was established clinically.

A condition not encountered but frequently suspected, especially early in this study, was tetanus. Several patients had well marked trismus associated with orthotonos when seen by the physician; and, especially because of the high incidence of tetanus among Okinawan civilians injured during the siege of the island, the diagnosis of tetanus was seriously considered. In fact, several patients were admitted with a history of having received one or more injections of tetanus anti-

16. Thomas, L.: Personal communication to the authors.

17. Sabin, A. B.: Personal communication to the authors. Thomas,¹⁶ Sabin,^{2b,c}

18. Thomas,¹⁶ Sabin.^{2c,d}

toxin. Even though injury was not always identifiable, there was usually sufficient scarification from wet cupping or moxocautery to serve as a portal of entry for the tetanus bacillus. The diagnosis was fairly easily ruled out, however, by the presence of high fever, the demonstration that trismus was not fixed, as in tetanus, and the usually prominent evidences of disorder of the central nervous system. Most patients with tetanus were mentally clear early in the illness, whereas disturbance of consciousness was almost the rule in patients with encephalitis.

REPORTS OF CASES

The following case summaries are presented to illustrate the principal clinical varieties of the disease which were observed.

CASE 1.—Acute encephalitis with early recovery.

A 3 year old Okinawan girl, admitted to the hospital on Aug. 11, 1945, had complained of a slight cold and nasal discharge for one week. On August 10 she suddenly had a headache and felt feverish. She became comatose during the night and exhibited constant twitching movements of the right side of the body. On the morning of admission she had a temperature of 101 F.

Physically, the child was well nourished but acutely ill and exhibited continuous clonic convulsive movements of the right arm and leg. Examination at another hospital earlier in the day had shown paralysis of the right side of the body, deviation of the eyes toward the right, absence of reflexes and inability to swallow. There was left internal strabismus; reflexes were not elicited on the right, and only weak triceps and patellar reflexes were present on the left. Abdominal reflexes were absent on the right but normal on the left. There were no pathologic plantar reactions. There was no stiffness of the neck or restriction of flexion of the thigh.

Examination of the spinal fluid revealed 16 lymphocytes per cubic millimeter. On the day of admission the blood count showed 3,790,000 erythrocytes and 23,150 leukocytes per cubic millimeter, with a differential count of 86 polymorphonuclear leukocytes, 3 of which were immature, 8 lymphocytes and 6 per cent monocytes. A total plasma protein of 7.8 Gm. per hundred cubic centimeters and a derived hematocrit level of 36.5 were determined by the copper sulfate falling drop method. The leukocyte count was 18,450 on August 12, 12,400 on August 13, 18,850 on August 14, 12,700 on August 15, 10,100 on August 16, 6,900 on August 18, 11,700 on August 21 and 11,350 on August 26. The differential count showed a gradual diminution of granulocytes and less evidence of toxicity. On August 25 there were 57 polymorphonuclear leukocytes, with only 1 band form, 39 lymphocytes, 2 monocytes and 3 per cent eosinophils. On August 14 the spinal fluid was slightly bloody, but the hemolyzed specimen showed 18 leukocytes, 56 per cent of which were lymphocytes; the globulin was slightly increased, and the sugar was 75 mg. per hundred cubic centimeters. Hookworm ova were present in the feces.

Convulsions continued to occur throughout the first two days of the illness, after which there was transient paralysis of the right arm and leg, lasting only a day. By the third day in the hospital the child was no longer comatose but was extremely irritable and resistant. Internal strabismus was observed for a few days, but this cleared completely. Weakness of the right arm was noted a few days after apparent recovery from paralysis, but this also subsided in a short

time. By the twelfth day after onset of the disease the patient was up and about, active and alert, and had apparently made a fairly complete recovery. Dr. Hammon reported that a specimen of convalescent serum obtained twenty-one days after onset exhibited complement-fixing antibody in significant titer but gave only a low titer in the neutralization test.

CASE 2.—Acute encephalitis, fatal outcome.

On July 7, 1945 the patient, a woman aged 21, suddenly experienced vertigo while walking, soon thereafter had severe headache and fever and took to her bed at once. She became restless and slightly confused; after four days of illness she was unable to understand speech or to communicate with her family. The day before her admission to the hospital, July 13, restless agitation ceased and deep coma supervened. During the first five days of illness fluids were taken fairly well.

Physical examination revealed a well nourished, deeply comatose young woman. The neck was rigid; Kernig's sign was present, and flexion of the thigh caused painful facial grimacing, which revealed a slight weakness of the right side of the face. The pupils were small and fixed to light. Ocular motion was somewhat disassociated. The abdominal reflexes were absent, and tendon reflexes were weakly present.

Examination of the cerebrospinal fluid on admission showed 26 leukocytes per cubic millimeter, of which 40 per cent were lymphocytes. The Pandy test showed a slight increase of globulin. Thick and thin blood smears were negative for plasmodia.

During the first forty-eight hours of hospitalization penicillin was administered intramuscularly in doses of 50,000 units every three hours and intrathecally twice in doses of 15,000 units. On July 15 she was still comatose, and neurologic signs were little altered, although facial weakness was more pronounced. The following day there was evidence of improvement. The patient's eyes were open; she made feeble attempts to speak and tried to cooperate by following simple directions. There were a slight tremor about the mouth and an occasional jerky movement of the extremities. The lower abdominal reflexes were present, and the deep reflexes were somewhat more active. Nuchal stiffness and weakness were pronounced; the back was rigid and flexion of the thigh was limited and painful. General physical examination revealed nothing significant.

On July 18 the patient was semistuporous but made feeble attempts to respond. A coarse tremor of the facial muscles was present, more conspicuous on the right. Passive movement of the extremities caused pain and was resisted. There was a suggestion of cogwheel rigidity of the upper extremities.

This patient was seen during the early phase of the outbreak, before facilities for laboratory study were available. No additional tests were made. After the apparent slight remission, coma deepened; the temperature rose to 105 F., and complete quadriplegia with rigidity of the extremities developed and persisted until death, on July 20.

Autopsy showed no significant visceral lesions. Except for adhesions, at the base of the left lung and a calcific lesion of the upper lobe of this lung, the lungs were clear. The other organs, the lymphatics and the bone marrow were normal. Several *Ascaris lumbricoides* were found in the small bowel. The scalp, skull and dura were normal. The cerebrum showed convolitional flattening and marked injection of all superficial vessels. The white matter showed multiple areas of pinpoint injection. Similar injection was present in the cerebellum and the cervical portion of the spinal cord.

Histologic examination showed that the leptomeninges were focally infiltrated with lymphocytes in the sulci and the anterior fissure. Perivascular cuffing was present in the substantia nigra, the medulla and anterior horns of the spinal cord. Well circumscribed acellular zones of spongy appearance were widely distributed throughout the cortex, the basal ganglia and the hypothalamic nuclei. There was no reparative gliosis. The substantia nigra showed free melanin from disintegrated neurons. The cerebellum was extensively involved, many folia showing complete loss of Purkinje cells. In the cervical portion of the cord the anterior horn cells were damaged, and there was lymphocytic infiltration similar to that seen in poliomyelitis.

CASE 3.—Subacute encephalitis; gradual recovery.

A 5 year old boy complained of headache, fever and stiffness of the neck on August 3. He vomited once during the day. The symptoms persisted; somnolence developed, and by August 6, when he entered the hospital, he was deeply stuporous. His parents noted that an internal squint had developed.

The temperature on admission was 100 F., rose the following morning to 104 F. and descended by irregular spikes during the following four days. He was acutely ill and stuporous and lay quietly on his cot. The pupils were equal but exhibited hippus reaction to light. Ocular motion could not be tested. There was left internal strabismus. The abdominal reflexes were absent; all the deep reflexes were physiologic. Babinski's sign was present bilaterally. The neck was stiff and a neck drop was present; Kernig's sign was positive.

The spinal fluid was clear; there were 86 cells per cubic millimeter, of which 98 per cent were mononuclear. The blood count of August 7 showed 4,230,000 erythrocytes, 12,500 leukocytes, 75 per cent polymorphonuclear leukocytes and 5 per cent band forms. Urinalysis on August 9 revealed albumin, otherwise nothing abnormal. Subsequent laboratory investigations revealed essentially a normal state except that hookworm ova and *Strongyloides* larvae were found in several specimens of stool. The leukocytosis subsided by the third day in the hospital, and the differential count slowly returned to normal after an initial increase in granulocytes. Three later urinalyses showed nothing abnormal. On August 11 there were 8 cells, all lymphocytes; and on August 20 there were only 4 lymphocytes per cubic millimeter of spinal fluid. The last specimen showed 61.9 mg. of protein and 68 mg. of sugar per hundred cubic centimeters. After treatment with tetrachloroethylene and gentian violet medicinal U. S. P., examination on October 4 showed the stool was no longer positive for ova.

The patient's condition changed but little during the first three or four days. He lay quietly in bed, often with the forearms and wrists flexed. Distention of the bladder was noted on August 9, and catheterization was required for the following nine days. After eight days of coma he improved somewhat but remained apathetic, incontinent when bladder function returned and had persistently positive neurologic signs. The deep reflexes were at first less active, then unequal and finally variably hyperactive. Plantar reflexes were at times positive and associated with unsustained clonus at the ankle, at other times normal. Hypodermoclysis was required for a few days, after which fluids were well taken, and on August 17 he was able to eat solid foods. On the thirty-second day of his illness apathy was suddenly replaced with hyperactivity and irritability. At the same time, nuchal rigidity, which had subsided by August 22, began to be noticeable again and was prominent by September 8. Sedation was necessary. When the effect of medication wore off, sudden outcries or infantile whining occurred. At times restraint was necessary to keep the patient from wandering about unsteadily or falling from his cot. This

period of hyperactivity was followed by a short period of stupor, during which corneal ulceration developed. Later he was unusually quiet but had explosive episodes of violent behavior and shrieking, from which he could be aroused by a slap or a dash of cold water.

The abdominal reflexes were present on August 14 but with the temporary relapse in early September were again suppressed and unequal. Babinski's sign was present at various times until late September. Eventually, however, there was complete clearing from the psychologic standpoint, and the neurologic examination revealed an entirely normal state. The patient was discharged with no residua except for a persistent strabismus. Positive complement fixation was reported with this patient's serum by the NAMRU no. 2 laboratory and by Dr. Hammon, who indicated that the specimen he obtained twenty-eight days after onset gave only a doubtful result in the neutralization test.

CASE 4.—Encephalitis with residual hemiparesis and aphasia.

This case of a 7 year old girl was one of the first to come to the attention of a medical officer on Okinawa. She was brought to a Military Government hospital on July 10 in semicoma, with physical signs which suggested a diagnosis of tetanus to the referring physician.

On July 4, while playing out-of-doors, the child suddenly had an acute headache. She seemed to have a high fever when her mother put her to bed. That night stiffness of the neck was observed, and she had one generalized convulsion. During the following six days convulsions occurred about four times daily; consciousness was progressively more blurred, and for two days there was deepening coma. She took fluids fairly well until two days before admission, with difficulty thereafter. Speech function was disturbed from the outset, and, except for calling out for her mother, she had not spoken for about four days.

On admission the temperature was 100.4 F. and the pulse rate 128 per minute. The patient was comatose. There were a great many moxocautery scars and linear scarification over the anterior portion of the trunk, the forehead and the extremities. The pupils were dilated by a mydriatic on admission. There were irregular rotary movements of the eyes but no nystagmus. Hemiparesis on the right with facial weakness was present; Babinski's sign was positive on the right. Kernig's sign was present bilaterally, and motion of the neck was sharply restricted. A moderate degree of trismus was present. No spontaneous movements or tremors were noted. The swallowing reflex was absent. Abdominal reflexes were not elicited, and tendon reflexes were generally hypoactive, although abortive clonus was occasionally elicited on the right. Examination of the heart, lungs, abdomen and ear, nose and throat revealed no abnormalities.

The cerebrospinal fluid was clear and contained only 6 leukocytes per cubic millimeter on initial examination, on July 10. Globulin was not increased, and a culture was reported as sterile.

The temperature varied between 99.8 and 103.4 F. during the first two days, and slight fever persisted until July 18. Penicillin in doses of 50,000 units was administered intramuscularly every three hours for forty-eight hours, and two injections of 15,000 units were administered intrathecally. Weakness of the right extremities progressed to complete paralysis, and speech function was entirely lost. On the seventeenth day of illness the child was alert but extremely irritable and restless. The reflexes gradually returned and for a time were more active on the left; later the typical reflex changes of upper motor neuron paralysis were present, associated with ankle clonus, pathologic plantar reflexes and increasing spasticity. On August 25 minimal improvement of muscular power was noted, and a week later the child

attempted to walk with support. Aphasia remained unaltered, although simple orders were readily followed and it was evident that speech perception was normal.

When the patient was discharged on September 3, she was able to walk a little with support, the right upper extremity was paralyzed and spastic, the skin was hyperhidrotic and soft, saliva drooled from the right angle of the mouth, irritability persisted but there was no evidence of mental retardation despite complete motor aphasia. The last follow-up examination, on October 22, showed little sign of improvement. She could then walk unsupported, swinging the paretic right leg in an abduction arc and bearing her weight on the toes of the right foot. The upper extremity could be moved passively through about 20 degrees, but purposeful acts could not be accomplished. The arm was maintained in almost complete extension and was spastic.

Laboratory findings were not significant; there was no pleocytosis in any of the three specimens of spinal fluid examined. Dr. Hammon reported that a specimen of serum obtained from this patient fifty days after onset contained both neutralizing and complement-fixing antibodies for the Japanese B encephalitis virus.

CASE 5.—Encephalitis with residual quadriplegia and idiocy.

On August 15 a previously normal 5 year old boy became ill suddenly with fever and headache. He was kept at home until August 24, when he was taken to a Military Government hospital at Taira. The parents reported that the child became progressively more stuporous and had been irritable for three days before transfer to the isolation hospital, on August 29. Coma, nuchal rigidity and suppression of reflexes were noted at the first hospital, and the cerebrospinal fluid on August 28 showed 26 cells per cubic millimeter, all mononuclear in type. Pandy's reaction for globulin was positive.

Physical examination on admission showed a quiet, well nourished child who did not appear seriously ill. It was noted, however, that the lower extremities were not voluntarily moved and that there was some degree of flaccidity. The pupils were equal and reacted to light; there was no disorder of the extraocular muscles; the abdominal reflexes were present and active, and the deep reflexes were normal except for the left patellar reflex, which was not elicited. The child was apathetic and did not speak, but he was able to take fluids well. There was slight nuchal rigidity; Kernig's sign was not present.

The cerebrospinal fluid, examined on August 30, showed 50 leukocytes per cubic millimeter, of which 95 per cent were mononuclear; globulin was increased, and there was 82.2 mg. of protein and 50 mg. of sugar, per hundred cubic centimeters. Four days later pleocytosis was no longer present, but Pandy's test showed a 3 plus reaction for globulin; the sugar of the spinal fluid was 43.7 mg. per hundred cubic centimeters. The blood count showed no anemia; the white cells numbered 19,500, of which 80 per cent were granulocytes and 4 per cent band forms. The Kahn reaction was negative; several urinalyses showed nothing significant, and examinations of stool did not disclose ova or parasites.

The patient was fed by gavage and given saline solution by hypodermoclysis during the first week of hospitalization. Thereafter he took milk by mouth and could be fed soft rice and soups. Weakness was progressive, and after three days complete paralysis of all four extremities was noted. For a time about ten days after admission the child seemed more alert, although unable to follow simple commands. The flaccid paralysis then began to show a slight spastic quality. The patient lay in bed with head and eyes deviated to the right; he was incontinent (bladder and bowel) and showed increasing rigidity of the neck and back, with pronounced nuchal weakness. Spasticity of the arms was a forerunner of progressive contracture and postural abnormality (fig. 2). While the thighs remained

flaccid, progressive plantar flexion of the feet developed, more pronounced on the left than the right. Eventually the patient presented a status characterized by loss of all but the most primitive functions, paralysis, deformity and general deterioration. This picture was in the nature of that which was presented by the 4 patients who died after more than a month's illness, but of a less marked degree.

At the time of discharge from the hospital the following description was recorded: "The patient is of the mental level of an idiot; he takes food, cries out in pain, moans when unattended and is incontinent, unresponsive and unable to communicate in any way. He lies in a contorted position with head and eyes turned to the right, the right forearm flexed at the elbow, the fingers clenched and the hand held against the chest. The left forearm is extended and internally rotated, and the wrist and fingers are flexed. The left knee is flexed and rests on the right thigh; the foot is in fixed equinus and internally rotated, the toes are sharply plantar flexed. The right knee is extended, and the foot is plantar flexed. The contractures of the various joints can be passively overcome except at the left foot, left elbow and wrist."

The reflexes varied from day to day. Abdominal reflexes were usually present, and the tendon reflexes were fairly normal at times for about two weeks. Thereafter they were increasingly difficult to elicit and finally only the left knee jerk

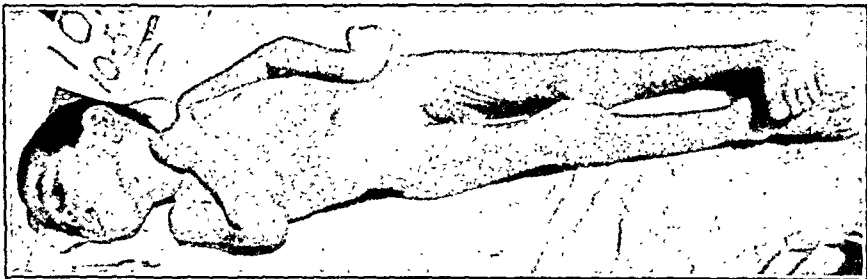

Fig. 2 (case 101).—Patient, fifty-one days after onset of illness. Note deformity of the paralyzed extremities, particularly flexion contracture of the left wrist and hand and the "striatal" foot on the same side.

and the left triceps reflex were present. During the period of almost two months in the hospital there were two febrile episodes, without obvious explanation.

Follow-up examination several weeks after discharge showed no change except increasing inanition. Dr. Hammon reported that a specimen of serum obtained from this patient fourteen days after onset contained neutralizing antibodies and also complement-fixing antibody in low titer.

CASE 6.—Encephalitis: progressive deterioration, fatal outcome.

On September 8, a week after the onset of an acute illness characterized by headache, fever, stiffness of the neck and rigidity of the extremities, a 12 year old girl was brought to the hospital in coma. Consciousness was not regained during the ensuing thirty-five days.

Examination revealed that the patient was somewhat undernourished and comatose, with fixed, pinpoint pupils, an external squint of the right eye, nuchal rigidity and marked restriction in flexion of the thigh. The abdominal reflexes were absent, but the deep reflexes were normal and there were no pathologic plantar signs.

The initial specimen of spinal fluid showed only 9 leukocytes per cubic millimeter, all of which were monocytes; two days later the spinal fluid had no cells, but globulin was slightly increased. The blood count on September 16 showed 13,300

leukocytes, a hemoglobin content of 9.0 Gm. per hundred cubic centimeters and an erythrocyte count of 4,000,000. The differential count was not remarkable. Urinalysis showed a 2 plus reaction for albumin, with no other abnormalities. The plasma protein was normal, and the derived hematocrit reading was 47. Repeated examinations of the stool showed hookworm ova and *Strongyloides* larvae.

Nutrition was maintained with difficulty with gavage, intravenous administration of fluids and some milk by mouth. During the first week deep coma persisted, and the patient lay quietly with the eyes open and the neck rigidly held in extension. Weakness of the extremities was soon followed by progressive rigidity and beginning disfigurement. The reflexes became hyperactive; sustained ankle clonus was obtained on September 23, and at the same time tremor of the hands was first noted. About this time the head and eyes were deviated to the left; both hands were flexed at the wrists, and the lower extremities were maintained in partial flexion (fig. 3). *Flexibilitas cerea* of the upper extremities soon developed and was present in some degree until death. The thumbs were held between the middle and the ring finger, a position maintained even when the hands eventually became

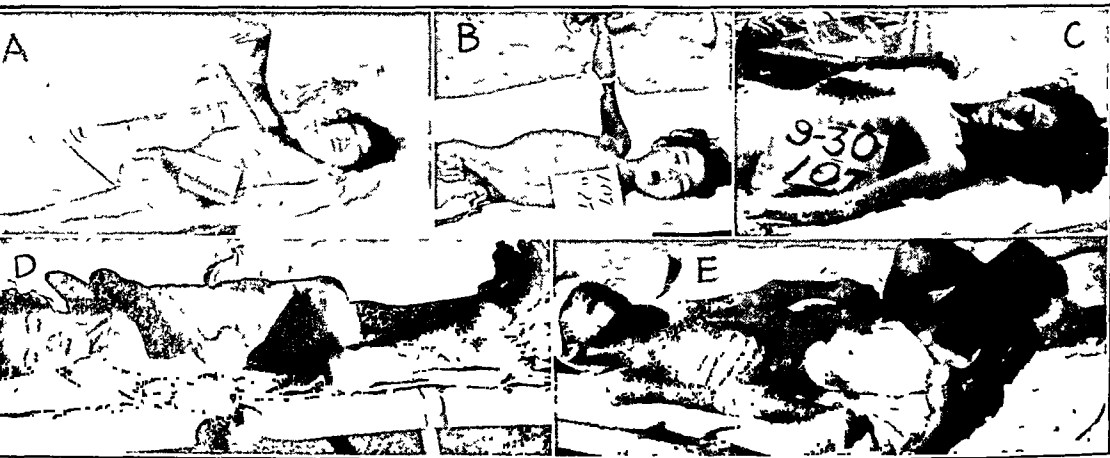

Fig. 3 (case 6).—*A*, twenty days after onset of illness; spontaneous elevation of the upper extremities. *B*, twenty-sixth day of illness; flexion deformity of the hands. *C*, twenty-ninth day; increasing deformity and inanition. *D*, flexion contractures of knees and “striatal” right foot. *E*, terminal phase; extreme deformity and general deterioration.

flexed completely to lie, in the course of time, in direct contact with the volar surfaces of the forearms. Attempts to extend the flexed extremities resulted in grimaces of pain and precipitated universal tremor. The left foot assumed the position of equinus and became progressively more deformed.¹⁹ Clonus was present

19. It is interesting to note that the deformity of the foot in this patient, as well as in the other patients in the chronic stage, with contractures and deterioration, was similar to that which occurs in *dystonia musculorum deformans* and which is described as the “striatal,” or “talon,” foot. The pathologic features of this disease, according to Wechsler (*A Textbook of Clinical Neurology*, ed. 5, Philadelphia, W. B. Saunders Company, 1943, p. 606), are diffuse degenerative changes involving the basal ganglia, midbrain, pons, cerebellum and cerebral cortex. As in encephalitis, designation of focal involvement for the production of deformity, tremor and other disturbances of mobility is rendered extremely uncertain because of the widely scattered lesions.

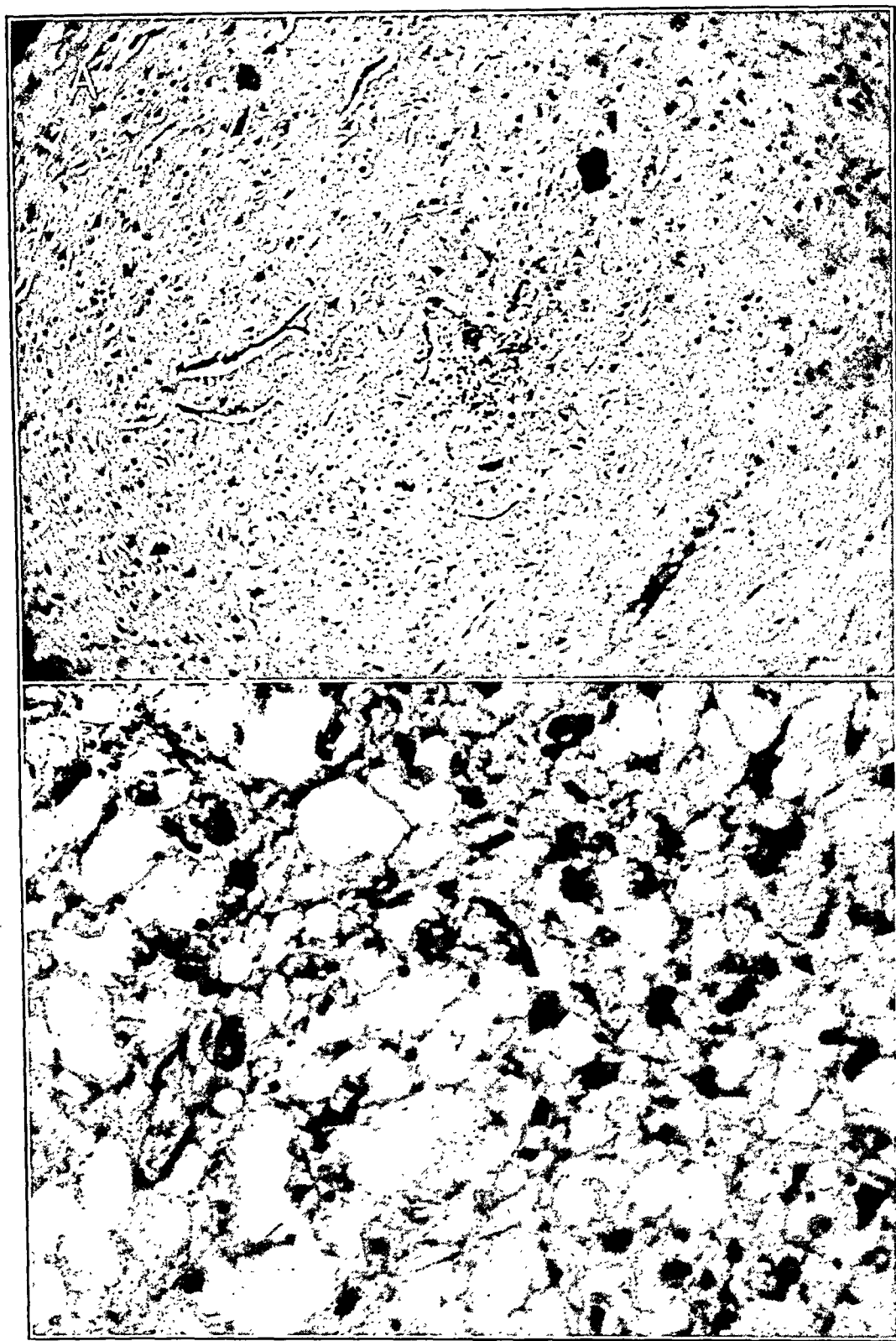

Fig. 4 (case 6).—*A*, focus of necrosis with astrocytic gliosis in the cortical gray matter; $\times 88$. *B*, midbrain (fig. 1 *B*), with softening and fibrillary stroma; $\times 385$.

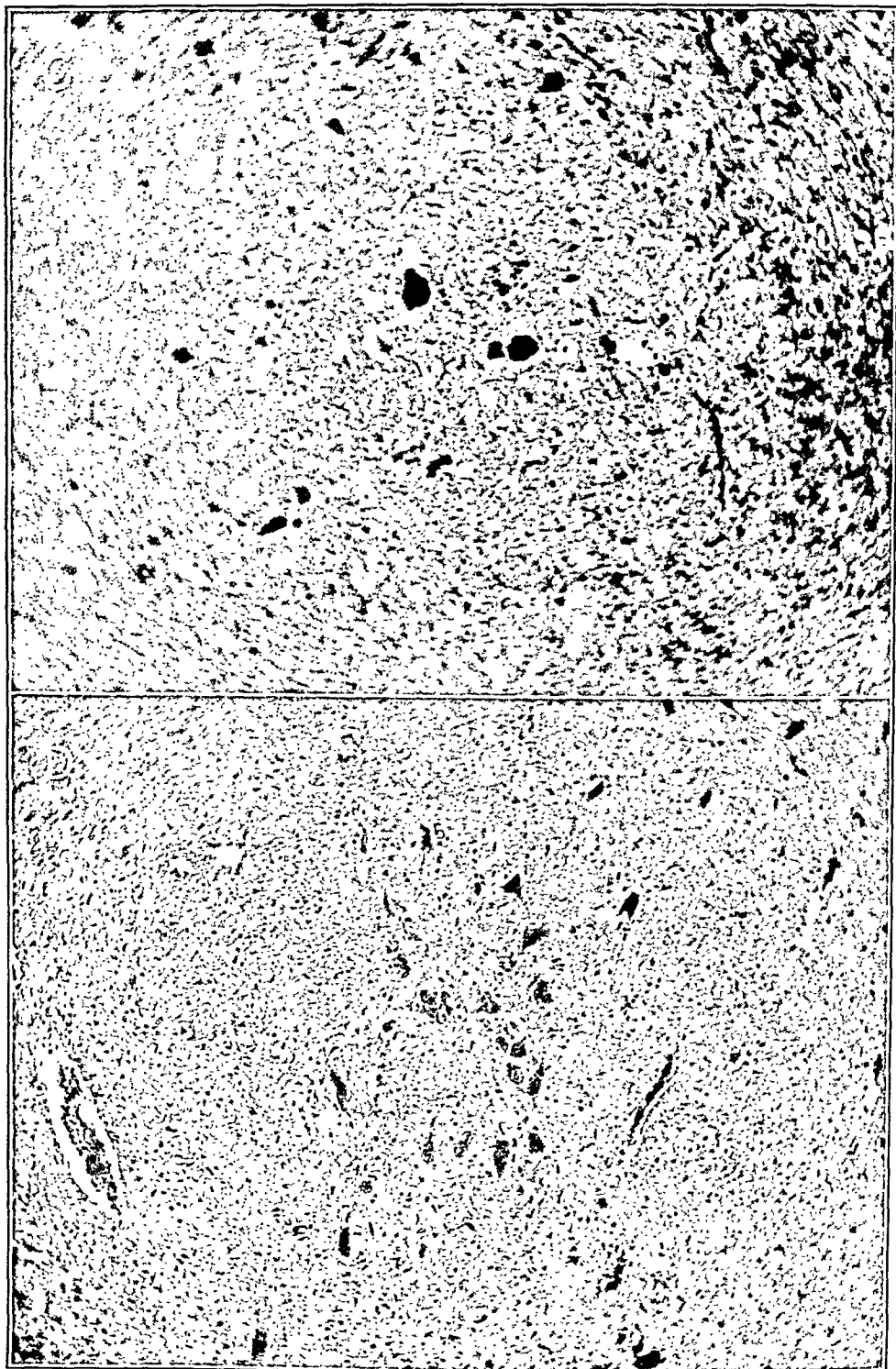

Fig. 4 (continued).—*C*, midbrain, with calcium depositis; $\times 88$. *D*, substantia nigra, with chromatolysis of neurons and glial proliferation; $\times 88$.

on attempted dorsiflexion. Spontaneous elevation of the upper extremities occurred on examination of the lower extremities, and attempted flexion of the neck resulted in increased flexion of the elbows and wrists. Neck drop was not present, but rigidity of the neck and spine was extreme. Decubitus ulceration was at first only moderate in degree, but with increasing deterioration tissue breakdown was unusually rapid. Symmetric bullae appeared at the knees and over the tibial crests; every bony prominence was the site of bluish discoloration and eventually of ulceration. Ultimately the entire sacrum was exposed and both femoral trochanters were denuded. On September 30 tremor of variable intensity was present, involving the facial muscles, the extremities and the trunk. Flexion deformity of the hands, with increasing internal rotation of the upper extremities, resulted in a bizarre position and in ulceration of the radial sides of the forearms from friction on the bedclothes. Spontaneous elevation of the left arm and flexion of the left knee occurred periodically. The mouth was held widely open, and the chin was tremulous. Deformity of the right foot continued to develop until the toes were almost in contact with the skin of the plantar surface, the entire foot forming a fixed arc. Wasting, deformity and rigidity were progressive. Bizarre tremor and spontaneous muscular contractures persisted. During the last three or four days of life the patient was cold and rigid, and the only signs of animation were shallow, infrequent respiration and a faint pulse. Death occurred on the forty-first day of the disease.

During the final three weeks of illness there was an irregular fever, with a maximum temperature of 104 F. Intracutaneous tests with old tuberculin in dilution of 1:10,000 and 1:1,000 gave negative reactions early in October.

Autopsy revealed a wasted, deformed and ulcerated cadaver, the external appearance of which is indicated by the clinical description. The pupils were unequal, the left being larger than the right. The mucosa of the mouth was covered with a thick, dry crust. Incision of the trunk revealed a subcutis devoid of fat and a thin, atrophic musculature. Examination of the viscera revealed no pronounced gross abnormality. Both lungs collapsed and were uniformly crepitant. The myocardium was pale and atrophic. There were slight adhesion of both renal capsules and thinning of the cortex on the right. The hepatic parenchyma appeared somewhat pale, and markings were prominent. The adrenal medulla was congested bilaterally, and the cortex was also congested on the left. The gastrointestinal tract was normal, and no parasites were seen.

The surface of the brain was universally and intensely congested, small vascular radicles forming a prominent network over the entire pial surface. There was considerable convolitional atrophy in the frontal region and at the vertex, involving both parietal lobes. The base of the brain appeared normal. A single cut made into the region of the substantia nigra showed no gross abnormality. When the fixed brain was later sectioned, a gritty sensation was noted on cutting through the basal ganglia.

Histologically, the cortical gray matter showed scattered foci of astrocytic gliosis, probably a later stage of the "plaque" formation seen in earlier specimens (fig. 4A). The putamen, caudate nucleus and pallidum were largely devoid of ganglion cells and were replaced by a loose fibrillary stroma (fig. 4B). Calcium salt was noted in isolated granules and in clumps, at times within macrophages and multinucleated giant cells (fig. 4C). In the caudate nuclei and the substantia nigra (fig. 4D) there were small zones of cystic degeneration and also widespread gliosis, replacing melanin-containing neurons in the latter area. The pons had suffered relatively less injury, but the cerebellar folia were partially or completely depleted of Purkinje cells, and there were indications of damage to the interstitium

as well. The cervical portion of the spinal cord revealed little change other than perivascular cuffing.

CASE 7.—Encephalitis with residual psychosis.

On the fourth day of an illness which began with headache, fever and slight chills, a 15 year old girl was admitted to the hospital in coma. She had been stuporous for three days prior to admission.

Examination revealed fair nutrition and no evidence of disease other than that referable to the nervous system. The patient was comatose; the head and eyes were deviated to the right; the upper extremities were somewhat rigidly held, and attempts to move the neck or flex the extremities evoked painful grimaces. The pupils were small and fixed to light. The abdominal reflexes were absent, and only the ankle jerks were elicited. Nuchal stiffness and the Kernig sign were present.

Initial examination of the spinal fluid, on August 21, showed no cells but a slight increase in globulin. On September 6 there were 18 cells per cubic millimeter, all lymphocytes, and a 1 plus reaction for globulin. The sugar was 50 mg. per hundred cubic centimeters. A third examination, on September 20, again did not reveal cells and showed the same increase in globulin. The protein measured 62.5 mg. and the sugar 76.9 mg., per hundred cubic centimeters. There was only slight initial leukocytosis and no anemia. The differential count was normal. Hookworm ova were found in several specimens of stool, even after administration of hexylresorcinol and tetrachloroethylene. The Kahn reaction of the blood was negative. Late in the illness there was an acute febrile episode, and the blood smear was found to be positive for *Plasmodium vivax*. Treatment with quinacrine hydrochloride (atabrine) was rapidly effectual.

During the first week of hospitalization the patient was quiet and showed pronounced nuchal rigidity, jerky ocular movements, hyperreflexia of the lower extremities, flexion of the upper extremities and resistance to extension and variable pathologic reflexes. For a brief interval there seemed to be indications of improvement: The patient began to take food, seemed to understand simple directions and no longer showed the gross jerky ocular movements described. However, internal strabismus and reflex abnormalities were still present. Mental aberration was first noted about September 4. She soiled herself frequently and no longer seemed to understand directions or inquiries. Her expression was alternately blank and silly or wild; attempts at speech were infrequent and confused. About a week later she was hyperactive, left her bed and dragged the bedclothes about on the floor, entered the beds of other patients and made frequent primitive outcries. Restraint was required for the protection of other patients.

Restlessness increased to the point of continuous agitation and constant, incoherent jabbering. When restrained, she pulled at her bandages and cried out in meaningless sounds. The use of large doses of barbiturates was only partially effective in quieting her. On September 21 Lieut. Comdr. Clark Moloney, psychiatrist at the Military Government Hospital at Jinuza, saw the patient and described her as dystasic, hyperactive, confused, not distractible and restless, with reversion to infantile behavior. The manifestations were considered characteristic of an organic psychosis. At this time the patient threw herself about, walked about the ward on her knees, grimaced constantly, resisted nursing attention and defecated on the floor or in bed.

Wet packs were given daily, at the suggestion of Lieutenant Commander Moloney, and sedation was continued. Until October 13 there was little change. On that date, after administration of a barbiturate and application of wet packs

had failed to quiet the patient, a light chloroform anesthesia was attempted. A short period of apnea ensued, and artificial respiration was required. She then slept quietly for several hours and was quieter the following day. On October 15 she experienced the only lucid interval in her illness: She was able to give her name, age and the name of her village. She recognized being in a hospital but was disoriented as to time and location. She cooperated freely. However, two days later she was again confused at intervals and was noisy and disturbed during the night. Light anesthesia was again attempted on October 18, but without beneficial effect. The condition of the patient remained somewhat better than it was prior to the lucid interval, but the chronicity of her psychotic state was believed established when observation was terminated early in November. During the final period in the hospital there were times when she joined the nurses in singing Okinawan songs, and very occasionally she gave lucid responses. Echolalia was a prominent symptom. She was able to repeat any phrase, English or Japanese, and had none of the commonly encountered difficulty in pronouncing *r* or *l*. Her reactions were generally primitive; her eating habits were animal-like, and infantile mannerisms persisted. Neurologic examination could not be performed. The only abnormality noted was a wide-based, somewhat spastic gait.

NOTE.—Lieut. T. W. Simpson (MC), U. S. N., reexamined this patient in the summer of 1946. A year after the acute episode described, she was reported to have signs of "mild personality change" but was sufficiently well to take care of younger children in her family (Simpson, T. W., and Meiklejohn, G.: Sequelae of Japanese B Encephalitis, to be published).

POSTENCEPHALITIC SYNDROME

While information from Japanese sources was found to be fairly reliable with reference to the symptomatology and course of the acute phase of Japanese B encephalitis, the views which were cited in service publications for the guidance of medical officers²⁰ tended to minimize the frequency and severity of residual manifestations of the disease. The opinion that patients usually recovered completely or did not survive the disease and that postencephalitic states were rare except in infants and elderly persons was generally stated and was also widely held in Okinawa by native physicians interviewed. The possibility that the particular outbreak of 1945 was unusual in respect to residua warranted a search for evidences of postencephalitis in the local population.

Among the many thousands of civilians who were treated in Military Government hospitals and dispensaries, there were few who showed indications of possible postencephalitic syndromes. However, there were several patients in the neuropsychiatric hospital who showed various forms of organic deterioration and who gave histories of an acute febrile illness during the summer or autumn preceding the development of such symptoms as partial paralysis, rigidity, tremor or personality change. One patient who was studied in some detail showed chiefly cerebellar signs: ataxia, wide-based gait, incoordination, dysmetria, dysidiadokokinesis and nystagmus. There was no mental deterioration and no paralysis.

20. Japanese "B" Encephalitis, *Bumed News Letter* 5:1-5 (Feb. 16) 1945.

Although such evidences were found, it is clear that the incidence of postencephalitis is low in view of the supposed frequency of outbreaks of the disease. It is probable that many invalided or disabled persons failed to withstand the hardships of the war, but it must also be recognized that many of the patients who survived during the summer of 1945 because of good medical care would ordinarily have died of inanition, dehydration or complicating infections. Observation of local medical practice and facilities for the care of the sick indicated that parenteral administration of fluids, gavage, adequate use of antibacterial substances and good nursing were not standard therapeutic procedures.

TREATMENT

There is no specific treatment for Japanese B encephalitis. During the period of coma it is urgent that nutrition be maintained by gavage, intravenous administration of fluids and use of vitamin supplements. Depletion of body proteins is sometimes extreme, and the use of plasma or amino acids would probably help prevent decubitus ulceration. There was no opportunity to test the effect of plasma during this outbreak, since the amount available was minimal.

Judicious use of sedatives during periods of restlessness and irritability, frequent changes of posture of comatose patients, catheterization when indicated and similar routine procedures constitute almost all the therapeutic armamentarium available. Frequent lumbar puncture for relief of spinal fluid pressure has been advised in the treatment of encephalitides. In those few cases in which such withdrawal of fluid was practiced there was little indication of benefit. No opinion can be offered as to the advisability of frequent tapping on the basis of this study.

Treatment of complications is of paramount importance, and there can be little doubt that the availability of sulfonamide compounds and penicillin was in part responsible for the relatively low mortality experienced. The nature of the pneumonia frequently found is not certain, but chemotherapy seemed to be effectual in most instances. In some of the early cases large doses of penicillin were given intramuscularly and intrathecally for forty-eight hours. This therapeutic attempt was not followed through, however, since there was not enough of the drug readily available for adequately controlled clinical testing. Although there is no basis for the use of penicillin in virus encephalitis, an adequate therapeutic trial under laboratory control would seem to be indicated, particularly in order to determine the mortality as compared with that in a control group, even if only complicating infections were effectively influenced.

COMMENT

Japanese B encephalitis is one of a large group of arthropod-borne neurotropic virus infections which have been identified as the causes of

serious epidemics and epizootics, as well as endemic foci of disease throughout the world. The epidemiology of many of these infections has been studied in detail, and strains of viruses from animal as well as human infections have been available for research in various scientific institutions. As a consequence, it is now possible to make etiologic diagnoses in most instances, and knowledge of specific agents, common vectors and animal reservoirs facilitates measures for control with use of prophylactic vaccines, insect control or elimination of potential hosts. In this particular instance segregation of native patients and vigorous mosquito control were probably responsible for the low incidence of infection among civilians and a remarkably slight spread to military personnel.² The value of prophylactic vaccination could not be accurately appraised, since there was no opportunity for comparison of morbidity in nonvaccinated subjects and the disease did not reach epidemic proportions in the area where troops were bivouacked.

It was previously pointed out that encephalitis is largely a disease of children in the Ryukyus. As in the case of other infectious diseases, this may be interpreted as an indication of a high degree of immunity in the adult population and an evidence of prolonged endemicity of the disease. Sabin^{3c} found neutralizing antibodies in 90 per cent of the natives (without history of encephalitis) over 20 years of age (series of 30), in 54 per cent in the age group of 10 to 19 years (series of 11) and in none of 16 persons in the age group of 1 to 9 years. Hammon^{3d} reported closely parallel results in a series of 54 normal natives. Positive results were obtained in 87 per cent of persons over 14 years of age (series of 31), in 45 per cent of those 10 to 14 years old (series of 11), in 20 per cent of those 5 to 9 years of age (series of 5) and in none of the 7 under 5 years of age. Thomas and Peck¹⁴ found neutralizing antibodies present in the blood of 27 out of 32 Okinawans over 14 years of age, and in 4 out of 9 children between the ages of 7 and 11, whereas none were detectable by neutralization tests in the blood of 9 infants under 3 years of age.²¹

There are many similarities between Japanese B encephalitis and the common encephalitides of North America. The clinical manifestations of the western equine and the St. Louis type of encephalitis resemble those observed on Okinawa, although generally the American diseases seem less severe, with a mortality of only 5 to 22 per cent, according to Hammon.²² Residua of the three infections appear to be similar in

21. Until recently the rate of attack was higher in adults on the Japanese main islands. However, according to Hammon (personal communication), "in the last ten years the disease has become one of childhood in Japan, with 85 to 90 per cent of the normal population immune in endemic areas."

22. Hammon, W. M.: The Epidemic Encephalitides of North America, *M. Clin. North America* 27:632-650 (May) 1943.

nature and may be equally severe in comparable age groups, although manifestations such as those reported in cases 5 and 6 have not been described in the United States. Typical postencephalitic paralysis agitans is a rare sequel in all three diseases.

Correlation of physical signs and histopathologic changes is difficult because of the extremely widespread nature of the lesions. However, it is interesting that there were few manifestations of cerebellar disturbance in the acute phase of the disease, even though cerebellar injury was most striking in pathologic specimens from cases of the early as well as the late stages. It is possible that signs were masked by interference with function at other levels of motor activity, and it is significant that 1 Okinawan native with a most convincing history of a postencephalitic disorder of the nervous system presented a typical cerebellar syndrome.

The lesion of the Purkinje cells in the cerebellar cortex is a prominent histologic feature of Japanese B encephalitis. Comparable destruction is not encountered with poliomyelitis, nor ordinarily in patients with the western equine, the St. Louis or the von Economo type of encephalitis. The histologic appearance is similar to that which has been described in cases of louping ill, an ovine encephalomyelitis,²³ the virus of which is said to be closely related to that of certain seasonal encephalitides of man. Interestingly, Perdrau,²⁴ who reexamined pathologic material from the original epidemic of encephalomyelitis known as Australian X disease, described changes in the Purkinje cell almost identical with those described by Zimmerman^{4a} and referred to in a previous section. This observation, as well as the similarity of clinical data reported by Cleland and Campbell²⁵ from New South Wales to those reported here, would suggest that the Japanese B and the Australian X disease are closely related, as has already been suggested by others.²⁶ Unfortunately, the laboratory strain of virus from the latter disease has been lost, and serologic investigations of possible etiologic relationships cannot be performed.

The importance of specific diagnosis has already been suggested by allusion to the availability of prophylactic vaccine and to the control measures which may be determined by knowing the mode of transmission of the infection. It is gratifying, therefore, to learn that technologic

23. Brownlee, A., and Wilson, D. R.: Studies in the Histopathology of Louping-ill, *J. Comp. Path. & Therap.* **45**:67-92, 1932.

24. Perdrau, J. R.: The Australian Epidemic of Encephalomyelitis (X Disease), *J. Path. & Bact.* **42**:59-65 (Jan.) 1936.

25. Cleland, J. B., and Campbell, A. W.: Acute Encephalomyelitis: A Clinical and Experimental Investigation of an Australian Epidemic, *Brit. M. J.* **1**:663-666 (May 31) 1919.

26. Sabin, A. B.: Neurotropic Virus Diseases of Man, *J. Pediat.* **19**:445-451 (Oct.) 1941.

facilities are being expanded for more detailed study of virus encephalitides in many parts of the world. American occupation forces in Japan, assisted by civilian experts, prepared against the eventuality of a recurrence of the disease in 1946 and established laboratories capable of performing serologic tests, virus isolation and other special studies. Continued coordinated effort, such as that which has been made possible by military exigency, will doubtless greatly increase knowledge of this group of diseases and lead to their eventual control.

SUMMARY

The clinical characteristics of Japanese B encephalitis as observed in an outbreak in the civilian population of Okinawa Shima are presented by means of analysis of symptoms and physical signs in 65 patients, as well as by detailed reports of 7 cases illustrating variations in the course and outcome of the disease.

The disease was most common among children, resulting in a mortality of approximately 20 per cent, and caused significant permanent disorder of the nervous system of variable degree in at least one fifth of the patients. The manifestations were characteristic of a diffuse encephalomyelitis and resembled those of other neurotropic virus infections. The results of studies of the cerebrospinal fluid and blood are reported, and the results of serologic tests performed by collaborators are discussed.

The gross and histopathologic abnormalities of the nervous system are described, and the lesions are compared with those of other virus encephalitides.

University of California School of Public Health.

INCIDENCE OF ANISOCORIA AND DIFFERENCE IN SIZE OF PALPEBRAL FISSURES IN FIVE HUNDRED NORMAL SUBJECTS

BERNARD C. MEYER, M.D.
NEW YORK

THIS STUDY was made on patients visiting the Consultation Service of the Mount Sinai Hospital (New York). The 500 patients selected showed no neurologic abnormality aside from the two factors under study. In no instance were patients included whose history or neurologic examination could explain the presence of the abnormalities under investigation. These subjects could, therefore, be considered representative of the neurologically sound population. The sexes were about equally represented: 245 males and 255 females. They were of all ages, but most of them were in the third, fourth and fifth decades of life.

PRESENT INVESTIGATION

Method of Examination.—The pupils were examined by having the sitting patient look at the ceiling. A flashlight was directed toward the eyes from below upward in such a manner as to reveal the pupillary outline without causing constriction. Inasmuch as minute differences in pupillary size were not being looked for, no measurements were made. I was concerned with the incidence of an obvious anisocoria, such as might be detected by any careful examiner. The pupils were characterized therefore as equal, perceptibly unequal and markedly unequal. The same criteria were applied to the estimation of differences in the palpebral fissures.

Observations.—Pupils: Equal pupils were noted in 396, or 79.2 of the total number. In 104 subjects (20.8 per cent) the pupils were unequal. Males and females were equally represented—by 52 each. The right pupil was the larger in 54 patients (10.8 per cent) and the left in 50 patients (10.0 per cent). The inequality was clearly perceptible in 84 patients (16.8 per cent) and was pronounced in 20 patients (4.0 per cent).

Palpebral Fissures: Equal palpebral fissures were noted in 293 patients (58.6 per cent). In 207 patients (41.4 per cent) they were unequal, the right being larger in 110 (22.0 per cent) and the left in 97 (19.4 per cent). The inequality was clearly perceptible in 179 subjects (35.8 per cent) and pronounced in 28 (5.6 per cent). It is

From the Consultation Service, Herman Lande, M.D., Medical Director, and the Neurological Service, I. S. Wechsler, M.D., Chief, of the Mount Sinai Hospital.

evident that the incidence of inequality of the palpebral fissures was about twice the incidence of the anisocoria.

Correlation of Anisocoria with Inequality of Palpebral Fissures.—In 56 patients with anisocoria the abnormality was associated with unequal palpebral fissures (53.8 per cent of the total number of persons with anisocoria). The larger pupil was on the same side as the wider fissure in 44 patients (42.3 per cent) and on the opposite side in 12 patients (11.5 per cent). This indicates that when the two abnormalities coexisted the wider pupil and the wider fissure were on the same side nearly four times as frequently as on opposite sides. In 48 patients (46.2 per cent of the total number with anisocoria) the palpebral fissures were equal. Hence anisocoria was accompanied with inequality of the palpebral fissures in about one-half the patients. On the other hand, 151 patients with unequal palpebral fissures (73 per cent of the total number with unequal palpebral fissures) had associated equal pupils.

COMMENT

An earlier view that anisocoria is always pathologic has in recent years undergone some modification. Fuchs¹ recognized the occasional occurrence of congenital anisocoria, a condition which he stated could be recognized from the fact that it has existed throughout the lifetime of the patient, that there is no disturbance in innervation and that the two pupils react equally well. He warned, however, that in general anisocoria is otherwise to be looked on as a pathologic condition. De Schweinitz² stated that the earlier view that inequality of the pupils is always pathologic is subject to revision. He agreed that one could speak of pathologic and nonpathologic anisocoria and that slight differences in the width of the pupils may be compatible with perfect ocular and general health. He cited the assertion of Uthhoff that in non-pathologic anisocoria the pupils are round and react normally, which is not the case with pathologic pupillary inequality. Brooks,³ however, concluded that anisocoria is always pathologic unless it is due to disease of the eyes or to errors of refraction. Behr⁴ conceded that anisocoria could be congenital, but he stated that in such cases the difference between the size of the pupils is slight and attributed it to structural differ-

1. Fuchs, E.: *Diseases of the Eye*, ed. 10, New York, J. B. Lippincott Company, 1932.

2. de Schweinitz, G. E.: *Diseases of the Eye*, ed. 10, Philadelphia, W. B. Saunders Company, 1924.

3. Brooks, E. B.: *Significance of Unequal Pupils*, J. A. M. A. **76**:1145-1147 (April 23) 1921.

4. Behr, C.: *Ergebnisse der Pupillenforschung*, Zentralbl. f. d. ges. Ophth. **32**: 241-257, 1934.

ences in the globe. Collier and Adie⁵ claimed, too, that anisocoria may be congenital or associated with inequalities of the refraction of the two eyes. French⁶ declared that "inequality of the size of the pupils is observed frequently and may have no pathological significance."

Despite these, and other, statements on the matter, it is difficult to find reports in the literature of studies on large numbers of subjects in order to determine the actual incidence of anisocoria. Barrie⁷ examined 326 men and found anisocoria in 35, or about 11 per cent, none of whom showed signs either of ocular disease or of involvement of the central nervous system. The left pupil was larger in 21 men; the right, in 14. He concluded that anisocoria was a frequent physiologic condition and that it may be associated with all refractive errors, especially myopia. He further stated that visual acuity was not adversely affected by anisocoria. A larger study was reported by Snell and Cormack,⁸ who examined 3,000 prisoners and found anisocoria in 576 on the night of their reception at the prison. When reexamined the next morning, after a night's rest, however, 281 (48.8 per cent) of the original 576 men no longer showed any pupillary inequality, a finding which the authors suggested might be due to the effect of fatigue. Persistent anisocoria was noted in 295, or 9.8 per cent of the total number. The authors divided their cases on the basis of +, ++ and + + +, according to the magnitude of the difference in pupillary diameter.

Left Pupil Greater	Right Pupil Greater	Per Cent of Total Series
110 +	75 +	63
54 ++	41 ++	32
9 + + +	6 + + +	5
173	122	100

Excluding the men who presented a history of syphilis (30, or 10.1 per cent), errors of refraction (62, or 21 per cent) and various other conditions (such as head injury, local ocular conditions, aneurysm of the aorta, goiter and torticollis, 21.1 per cent), the authors found 139 men with anisocoria in whom the history and physical examinations revealed no abnormality (about 5 per cent of the total number). This incidence is about one-fourth that reported in the present study, whereas the original examination of Snell and Cormack, on the evening of admission to the prison, disclosed an incidence of anisocoria (19.2 per cent) which corresponds closely to the Mount Sinai Hospital findings.

5. Collier, J., and Adie, W. J., in Price, F. W.: *Textbook of the Practice of Medicine*, ed. 2, London, Oxford University Press, 1926.

6. French, H.: *Index of Differential Diagnosis*, ed. 4, New York, William Wood & Company, 1928.

7. Barrie, T. S.: *Inequality of Pupils*, *Brit. M. J.* 2:514, 1918.

8. Snell, H. K., and Cormack, G. A.; *Incidence of Unequal Pupils in Unconvicted Prisoners*, *Brit. M. J.* 1:672-673, 1938.

That anisocoria can disappear within a twelve hour period is noteworthy and probably accounts for some of the discrepancies between the findings of various investigators.

I know of no other studies on large numbers of subjects.

Unilateral mydriasis or miosis has been noted in association with a wide variety of non-neurologic conditions. Irritation or paralysis of the sympathetic pathways to the pupil may be produced by mediastinal neoplasm, disease of the heart and aorta and apical tuberculosis.⁴ It has also been found in association with local pathologic conditions in the neck, peritonsillar abscess,⁴ disease of the middle ear,⁹ sinusitis² and dental conditions.¹⁰ Salmon¹¹ noted unilateral pupillary dilatation in several cases of ruptured ectopic pregnancy, which he attributed to the effect of irritation of the diaphragm by the intra-abdominal hemorrhage, a factor which similarly seemed to explain the occurrence of pain in the shoulder in these patients.

The fact that in the series being reported a narrower palpebral fissure was found on the side of the smaller pupil in 77.5 per cent of the cases in which both structures were asymmetric might suggest a sympathetic nervous system factor. It must be added, however, that in nearly one-half the patients with anisocoria the palpebral fissures were roughly equal and, further, that in 73 per cent of the patients with inequality of the fissures the pupils were approximately equal. The general clinical picture, moreover, did not provide any evidence of gross involvement of the cervical sympathetic pathways by extrinsic factors: There were no cases of pulmonary tuberculosis, tumor of the superior sulcus, mediastinal disease or significant disease of the aorta or heart. Patients with pathologic conditions in the neck were not included; nor were those with outspoken otologic disease, although the ears were not routinely examined. Patients with obvious local ocular disease were excluded from the series, but studies on differences in refractive errors between the two eyes were not carried out. Moreover, even if some of the cases of anisocoria are to be explained on the latter basis this would in a sense still constitute a "normal" incidence. Reference has already been made to the observation by Snell and Cormack that anisocoria may be noted at one time and not at another. This may be pertinent in the current study, inasmuch as the patients were examined but once. Furthermore, many of the patients presented evidence of an anxiety hysteria, which suggests that the factor of emotional tension may play a role comparable to that which Snell and Cormack attributed to fatigue. (It is certainly true that differences in the size of the

9. Berberich, J.: Pupillary Reactions in Affections of the Ear, *Laryngoscope* 50:555-558, 1940.

10. Piperno, A.: Anisocoria of Dental Origin, *J. Am. Dent. A.* 21:1459-1461, 1934.

11. Salmon, U. J.: Pupillary Sign in Ruptured Ectopic Pregnancy, *Am. J. Obst. & Gynec.* 28:241-243, 1934.

palpebral fissures are very common and, further, that such differences are in some persons quite variable from time to time. Occasionally, after noting an obviously wider fissure on one side, the examiner would later observe just the reverse. Such cases, however, were not reported as manifesting a difference.)

Whatever the cause, the conclusion is justified that there is a "normal" incidence of anisocoria, at least in persons who complain of ill health. In the majority of patients such inequality of pupils was slight, however, and could have been overlooked in a careless examination. In 4 per cent of the patients the inequality was marked. The incidence of unequal palpebral fissures is, similarly, far greater than can be explained on the basis of gross lesions and is also greater than the incidence of anisocoria.

These observations should not be utilized, however, as a justification for disregarding the possible significance of any anisocoria which happens to be noted. Such a conclusion would make this communication a distinct disservice to medical practice. On the contrary, every instance of anisocoria should be considered pathologic and significant until proved otherwise. The purpose of this study is simply to show that this condition has a normal incidence and is occasionally, therefore, without significance.

SUMMARY

Five hundred neurologically normal persons were studied with reference to the incidence of anisocoria and of differences in the width of the palpebral fissures. Nearly 17 per cent of the patients showed a slight but perceptible anisocoria. In 4 per cent the difference in pupillary size was pronounced. Inequality of the palpebral fissures of a slight degree was noted in nearly 36 per cent of the patients. Pronounced differences were noted in nearly 6 per cent. When both the pupils and the fissures were unequal, the smaller pupil and the narrower fissure were on the same side in 77 per cent of the patients. However, in nearly one-half the patients with anisocoria the fissures were equal, and inequality of the fissures was accompanied with equality of the pupils in 73 per cent of the patients revealing unequal fissures. Consequently, inequality or imbalance of sympathetic innervation could be held responsible for at least some instances of the observed anisocoria, but in general no gross factor could be identified as responsible for any asymmetry of sympathetic stimulation. In other instances differences in errors of refraction may play a role in causing unequal pupils. The incidence of inequality of the palpebral fissures is relatively high, and mild degrees may be considered without significance. Anisocoria should never be dismissed as an anomaly until a thorough search reveals no etiologic basis for it.

RELATION OF MENTAL IMAGERY TO HALLUCINATIONS

PHILIP F. DURHAM SEITZ, M.D.

AND

HANS B. MOLHOLM, M.D.

ST. LOUIS

THE CONCEPT that hallucinations are exaggerations of mental imagery has been long in dying. Previous to the present study, the relationship of mental imagery to hallucinations has been investigated experimentally only four times: first by Mourgue,¹ in 1932; then by Cohen,² in 1938; then by Snyder and Cohen,³ in 1940, and, finally, by Roman and Landis,⁴ in 1945. So far as visual and auditory hallucinations are concerned, none of these investigations revealed a direct relationship between the predominating type of mental imagery and the modality of hallucination. Furthermore, our analysis of Cohen's data suggests that with respect to auditory hallucinations there might even be a direct relationship between hallucinations in this modality and relatively deficient imagery in this modality.

The purpose of the present paper is to describe a more extensive investigation than any of the four just mentioned, in which it has been found not only that there is no direct relationship between the predominating type of mental imagery and the modality of hallucination, but that there is a direct relationship between relatively deficient auditory imagery and auditory hallucinations. Enough emphasis will be placed on this observation so that, it is hoped, the concept that hallucinations are exaggerations of mental imagery will no longer be considered seriously but will be properly relegated to that limbo in which are interred those ideas and concepts which have appeared very plausible but which have not been substantiated by experimental investigation.

Before the present investigation is described, it will be convenient to review briefly what other writers have said, and what other investigators

From the Malcolm A. Bliss Psychopathic Institute of the St. Louis City Hospital, and the Department of Neuropsychiatry of Washington University School of Medicine.

1. Mourgue, R.: *Neurobiologie de l'hallucination*, Brussels, Lamertin, 1932, p. 426.

2. Cohen, L. H.: *Imagery and Its Relations to Schizophrenic Symptoms*, *J. Ment. Sc.* **84**:284 (March) 1938.

3. Snyder, W. U., and Cohen, L. H.: *Validity of Imagery-Testing in Schizophrenia*, *Character & Personality* **9**:36 (Sept.) 1940.

4. Roman, R., and Landis, C.: *Hallucinations and Mental Imagery*, *J. Nerv. & Ment. Dis.* **102**:327 (Oct.) 1945.

have found, regarding the relationship of mental imagery to hallucinations. In 1881 Sully⁵ stated:

. . . hallucinations of the insane are due to a projection of mental images which have gained a preternatural persistence and vividness.

Binet and Fere⁶ subscribed to this same concept in 1885. Other authors who concurred with this view were Prince,⁷ in 1922, and Guiraud and Le Cannu,⁸ in 1929. Opposed to the concept that hallucinations are exaggerated mental images were Kadinsky,⁹ in 1881, and de Clerambault,¹⁰ in 1924. Kadinsky, subject to hallucinations himself, stated: In spite of the old widespread theory, in no case can an hallucination arise from a mnemonic sensorial image.

Mourgue¹ was the first investigator to study in a systematic experimental way the relationship between the predominating type of mental imagery and the modality of hallucination; but his report consisted of only 1 case, that of a woman who had had auditory hallucinations for three years but in whom visual imagery predominated.

The first extensive experimental study of the relationship of mental imagery to hallucinations was reported by Cohen² in 1938. That report is valuable not only for the data presented but for its extensive review of the literature on imagery and on the relationship of imagery to hallucinations. According to that review, most people do have a predominating type of imagery that is characteristic for them. Cohen studied the various modalities of mental imagery in 19 schizophrenic patients and in 19 normal control subjects. He compared the mean percentages of the different types of imagery in the patients with the mean percentages of the various types in the subjects. He then compared the predominating type of mental imagery of each patient with the modality in which that patient had hallucinations. From these comparisons he concluded:

There is no relationship between visual imagery and visual hallucinations, nor, strictly speaking, between auditory imagery and auditory hallucinations.

He added, however, that he had found a positive correlation between

5. Sully, J.: *Illusions: A Psychological Study*, London, Kegan Paul, 1881, p. 372.

6. Binet, A., and Fere, C.: *La theorie physiologique de l'hallucinations*, *Rev. Scient.* **9**:49, 1885.

7. Prince, M.: *An Experimental Study of the Mechanisms of Hallucinations*, *J. Nerv. & Ment. Dis.* **56**:248, 1922; *Experimental Study of Mechanism of Hallucinations*, *Arch. Neurol. & Psychiat.* **7**:780 (June) 1922.

8. Guiraud, M. P., and Le Cannu, Y.: *Symptômes primitifs et secondaires de la psychose hallucinatoire chronique*, *Ann. méd.-psychol.* **87**:422, 1929.

9. Kadinsky, V.: *Zur Lehre von den Hallucinationen*, *Arch. f. Psychiat.* **11**:453, 1881.

10. de Clerambault, G. G.: *Les psychoses hallucinatoires chroniques: Analyse*, *Bull. Soc. clin. de méd. ment.* **12**:17, 1924.

kinesthetic hallucinations and increased kinesthetic imagery, and also between "somatic hallucinations" and increased "body imagery," that is, kinesthetic, tactual-temperature and olfactory-gustatory imagery. He then concluded:

. . . the relationships of imagery and hallucinations are different for the visual and auditory modalities than for the kinesthetic, tactual-temperature and olfactory-gustatory modalities.

It should, however, be pointed out that the positive correlation Cohen found between increased kinesthetic imagery and kinesthetic hallucinations may depend on his arbitrary, and perhaps indefensible, assumption that ". . . auditory hallucinations which serve as ideas of influence" are kinesthetic hallucinations. If he had not followed that assumption, his data might even have failed to show a positive correlation between increased kinesthetic imagery and kinesthetic hallucinations.

In 1940 Snyder and Cohen³ studied the validity of testing mental imagery in schizophrenic patients. Although their study was not addressed directly to the problem of the relationship of mental imagery to hallucinations, it does have an indirect influence on that problem because it raises questions about the validity of testing schizophrenic patients with the test previously used by Cohen, and therefore about results obtained with that test. We find that from our study we have data that answer quite adequately all the questions raised by Snyder and Cohen about the validity of testing mental imagery in schizophrenic patients. These data will be presented and discussed at appropriate points in this paper.

The most recent experimental study of the relationship between the predominating type of mental imagery and the modality of hallucination was made in 1945 by Roman and Landis,⁴ who collected evidence on the following two points:

(1) Is there any relationship between the predominant types of mental imagery and types of hallucinations found in psychotic patients; and (2) is there any subjective similarity between experiences of hallucinations and imagery among psychotic patients?

They used a "standardized interview" test that placed emphasis on the intensity of the imagery. The conclusions to which they came were confined to the visual and auditory modalities because hallucinations in the other modalities were so infrequently encountered. Roman and Landis concluded that their findings did not confirm the hypothesis that "hallucinations are but exaggerated imagery processes," but that their data, "by the nature of the method used," could not disprove that hypothesis. They did, however, insist that their study had clarified the issue enough so that if that hypothesis were "to be held and used further" there must be produced more experimental data to support it than exist

at present. With respect to subjective similarity between experiences of hallucinations and imagery, they found that "all patients stated that the experience of hallucination was both qualitatively and quantitatively different from mental imagery." And so the statements of these patients have brought the problem of the relationship of hallucinations to mental imagery back to where, in 1881, Kadinsky,⁹ who was subject to hallucinations himself, had tried to place it when he argued against "the old widespread theory" and insisted that "in no case can an hallucination arise from a mnemonic sensorial image."¹¹

As has already been indicated, the present study was designed to be extensive enough and detailed enough that definite statements could be made about the presence, or the absence, of a direct relationship between the predominating type of mental imagery and the modality of hallucination, and also about the possibility of a direct relationship between a relatively deficient type of mental imagery and the modality of hallucination. In order to show how the work of this study was divided between us, it should be stated that one of us (P. S.), who did all the testing, was not aware that the other's analysis of some data obtained by him with the Kohs Block Design Test, as well as his analysis of Cohen's data, had suggested to him the possibility of a direct relationship between a relatively deficient type of imagery and the modality of hallucination. One of us (P. S.) became aware of the possibility of such a relationship independently when he saw it emerging from the data he was collecting. It can be said, therefore, that we detected this relationship independently, from different sources of information and by different methods of approach.

This study has been oriented and organized with respect to auditory hallucinations not only because auditory hallucinations occur most frequently but because they are the most readily ascertainable, and also the least equivocal, of the different modalities of hallucinations. Therefore, the conclusions drawn from the data of this study will apply only to auditory hallucinations, even though they may appear to have a more general applicability. This study has been supplemented by studying the mental imagery of 10 patients with alcoholic hallucinosis who had had auditory hallucinations but who were completely recovered and ready for discharge when tested. The value of thus supplementing our study will be pointed out and discussed later.

MATERIAL AND METHOD

The test used in this study for determination of mental imagery was the same as that selected by Cohen² for his investigations. It is the so-called test of "concrete imagery," published in the appendix to C. H. Griffitt's "Fundamentals

11. Griffitts, C. H.: *Fundamentals of Vocational Psychology*, New York, The Macmillan Company, 1924, p. 372.

of Vocational Psychology.¹¹ The test consists of 130 test words and phrases to which the patient or subject responds with his initial mental image. After the test was explained to the patient in a standardized manner, routine examples were tried until the examiner was convinced that the patient fully understood the test. A dictaphone was used for recording the responses verbatim. All the patients were tested by this individual method. The normal subjects were tested in a different manner: Two groups of student nurses—44 in one group and 70 in another, totaling 114—were assembled in a small auditorium and were supplied with recording paper and writing implements. The examiner explained the test in the usual manner, including the use of the routine examples. The nurses then wrote down their imagery responses as the examiner recited the test phrases to the group. This method operated satisfactorily and proved to be a rapid method of obtaining a large group of normal records. Since the mean percentages from this group testing coincide almost identically with the mean percentages from Cohen's normal subjects, who were tested individually, the results of the group method are assumed to be valid.

The patients used in this study were selected from the psychiatric service of the Malcolm A. Bliss Psychopathic Institute of the St. Louis City Hospital. The patients were chosen for testing at staff conferences; no patient was selected who seemed unable to cope with the test, so that the testing was not hampered by such factors as inattention or uncooperativeness. Only 5 patients who were selected for testing had to be abandoned, and these were patients who became excited or were unable to cooperate satisfactorily. Experimental results are reported from 40 patients with schizophrenia and 10 patients who had recovered from an alcoholic hallucinosis.

The schizophrenic patients represented two groups of 20 patients each. One group included schizophrenic patients with definite, unequivocal auditory hallucinations. The other group, of 20 patients, included schizophrenic patients considered to be without auditory hallucinations. In order for a patient to be included in the series with auditory hallucinations, he must have experienced audible hallucinations; he must have experienced hallucinatory sound. To be included in the series of patients without auditory hallucinations, the patient must have experienced no audible hallucinations, i. e., no hallucinatory sound. The investigators were careful not to include as patients with auditory hallucinations those who merely experienced marked ideas of reference and/or influence without actually experiencing hallucinatory sound; examples of such patients are those who complain that "thoughts" are put into their minds. We did not consider any such projection experience an auditory hallucination unless the patient experienced hallucinatory, audible sound.

The case of the 10 patients who had recovered from alcoholic hallucinosis were all of the unequivocal type seen in staff conferences during the period of this investigation; these patients were taken as they came, without selection. All 10 had had marked auditory hallucinations; but they were tested after their psychoses and hallucinations had disappeared completely, when they were ready for discharge.

DATA AND RESULTS

The data obtained from the imagery tests on 40 schizophrenic patients are presented in table 1. The presence or absence of hallucinations in any modality has been indicated by placing the percentage of imagery for that modality either in the "hallucination" or in the "no hallucination"

column; furthermore, the first 20 patients indicated in the table are those with auditory hallucinations, and the second 20 are those without auditory hallucinations. It will be noted that the mean percentage of auditory imagery for the 20 patients with auditory hallucinations is 10.0 lower than that for the 20 patients without auditory hallucinations; this difference is highly significant statistically $t = 4.018$; $P < 0.01$. Similarly, the mean percentage of visual imagery for the 11 patients with visual hallucinations is 14.4 lower than that for the 29 patients without visual hallucinations; this difference is also highly significant $t = 4.778$; $P < 0.01$. The mean percentage of kinesthetic imagery for the 6 patients with kinesthetic hallucinations is 11.8 lower than that for the 34 patients without kinesthetic hallucinations; this difference is also highly significant: $t = 2.757$; $P < 0.01$. The difference between the mean percentages of olfactory-gustatory imagery for the patients with hallucinations and the patients without hallucinations is not statistically significant.

It should be emphasized here that this series of schizophrenic patients was selected with respect to the presence or absence of auditory hallucinations. Since one-half the patients in the series had auditory hallucinations with relatively low percentages of auditory imagery, they must necessarily have relatively high percentages in some of the other modalities. For this reason, the mean percentages of imagery will be increased in some of the modalities in which the patients with auditory hallucinations did not hallucinate. It will be seen that this compensatory increase occurred particularly in the visual and kinesthetic modalities: The mean percentage of auditory imagery for the patients without auditory hallucinations is essentially the same as the respective mean for the normal subjects, as indicated at the bottom of table 1, whereas the mean percentages of visual and kinesthetic imagery for the patients without hallucinations in those modalities are considerably greater than the respective means for the normal subjects. It seems to us that the statistically significant differences found between mental imagery and hallucinations in the visual and kinesthetic modalities depend, at least in part, on the relationship between relatively low auditory imagery and auditory hallucinations, and so are in part but indirect manifestations of that relationship. Therefore, the conclusions to be drawn will apply only to the auditory modality. It is felt that any conclusions concerning the visual or kinesthetic modalities will have to be drawn from investigations organized with respect to visual or kinesthetic hallucinations, just as the present study has been organized with respect to auditory hallucinations.

Qualitative observations made during the testing of the 40 schizophrenic patients gave the impression that the patients with auditory hallucinations were able to cooperate in the test just as well as the patients without auditory hallucinations. This impression is supported by the fact that the means of the scorable responses for the two groups

TABLE 1.—Percentages of Mental Imagery in Schizophrenic Patients

Patient	Auditory		Visual		Kinesthetic		Tactile- Temperature, No Hallu- cination	Olfactory- Gustatory	
	Hallu- cination	No Hallu- cination	Hallu- cination	No Hallu- cination	Hallu- cination	No Hallu- cination	Hallu- cination	No Hallu- cination	
AH-1	1.6			77.5		20.9	0.0		0.0
AH-2	3.1			86.2	3.1		5.4		2.3
AH-3	5.4			82.3		6.9	3.1	2.3	
AH-4	8.2			42.7		31.8	12.7		4.6
AH-5	9.5			47.2		35.4	6.3		1.6
AH-6	9.8		22.3			46.4	14.3		7.2
AH-7	10.1			28.2		35.0	15.5		10.5
AH-8	10.8			63.1		18.5	6.2	1.5	
AH-9	11.8			43.1		25.5	9.8		9.8
AH-10	13.0		36.4			36.4	10.4		3.9
AH-11	13.4			19.9		51.6	13.4		1.6
AH-12	15.9		29.4			47.6	5.5		1.6
AH-13	16.4			24.6		36.9	14.8	7.4	
AH-14	16.9			35.4		23.1	13.8		10.8
AH-15	17.1		13.2		26.4		22.5		20.9
AH-16	18.5		30.6		25.0		11.3		14.5
AH-17	18.9			23.5		40.0	12.6		4.9
AH-18	20.1			27.1		27.8	13.4		11.0
AH-19	28.5		7.8			28.5	18.1		17.2
AH-20	31.5		9.2			20.0	19.2		20.0
NAH-1		12.5		40.6		21.1	13.3	12.5	
NAH-2		16.4		39.1		15.6	20.3		8.6
NAH-3		17.5		42.1		29.4	5.5		5.5
NAH-4		19.0		27.8		37.3	7.9		7.9
NAH-5		19.4		22.2		33.3	9.7		15.3
NAH-6		19.8	18.0			26.2	18.8		16.5
NAH-7		19.8	29.2			36.8	7.5		6.6
NAH-8		20.0		28.5		20.0	17.7		13.8
NAH-9		20.3		33.6		25.0	11.7		9.4
NAH-10		20.9		21.7		31.8	13.2		12.4
NAH-11		21.8		23.6		43.6	5.5		5.5
NAH-12		22.5		16.3		29.5	15.5		16.3
NAH-13		26.2		23.8	18.5		22.3		9.2
NAH-14		28.7		31.1		14.8	15.6	9.8	
NAH-15		29.1	12.8			21.4	17.1		19.7
NAH-16		30.0		24.6	15.4		17.7		12.3
NAH-17		32.2		13.6		27.1	16.1	11.0	
NAH-18		32.3	20.7		12.3		16.2		18.5
NAH-19		34.6		18.5		11.5	22.3		13.1
NAH-20		37.5		15.6		15.6	16.4		14.3
Number of patients	20	20	11	29	6	34	40	6	34
Mean percentages	14.0	24.0	20.9	35.3	16.8	28.6	13.0	7.4	10.2
Means for 114 normal subjects		23.2		25.2		21.5	15.9		14.2

TABLE 2.—Comparison of Mean Percentages of Auditory Imagery for Schizophrenic Patients With and Without Auditory Hallucinations and for Normal Subjects

Group	No. of Cases	Mean % Auditory Imagery	σ^m	t	P
Schizophrenic patients with auditory hallucinations	20	14.0	1.725	} 4.018	<0.01
Schizophrenic patients without auditory hallucinations	20	24.0	1.105		
Schizophrenic patients with auditory hallucinations	20	14.0	1.725	} 5.165	<0.01
Normal subjects.....	114	23.2	0.443		
Schizophrenic patients without auditory hallucinations	20	24.0	1.105	} 0.6717	>0.05
Normal subjects.....	114	23.2	0.443		

do not differ significantly: $t = 0.897$; $P > 0.05$. It should be noted, however, that the means of the scorable responses for both groups are significantly lower than the means for the normal subjects.

The three comparisons made in table 2 demonstrate that the mean percentage of auditory imagery for the schizophrenic patients with auditory hallucinations is significantly lower than that for the normal subjects; on the other hand, the schizophrenic patients without auditory hallucinations do not differ significantly from the normal subjects in this respect. These results indicate that the schizophrenic process, per se, is not responsible for the low percentage of auditory imagery in the schizophrenic patients with auditory hallucinations.

TABLE 3.—Percentages of Mental Imagery in Patients Recovered from Alcoholic Hallucinosi*s*

Patient	Auditory	Visual	Kinesthetic	Tactile-Thermal	Olfactory-Gustatory
Alc-1.....	6.9*	62.3	22.3	5.4	3.1
Alc-2.....	8.7*	68.7	9.4	11.7*	1.5*
Alc-3.....	10.5*	50.9	21.8	9.7	7.2
Alc-4.....	13.8*	42.3	16.2	16.9	10.8
Alc-5.....	15.6*	40.6	32.0	7.8	4.0
Alc-6.....	15.6*	45.3	18.8	11.7	8.6
Alc-7.....	16.2*	34.6	29.2	12.3	7.7
Alc-8.....	16.5*	15.7*	41.7	12.6	13.4
Alc-9.....	18.5*	35.4	9.2	26.2	10.8
Alc-10.....	19.2*	33.8*	22.3	12.3	12.3
Mean percentages.....	14.2	43.0	22.3	12.7	7.9
Means for 114 normal subjects.....	23.2	25.2	21.5	15.9	14.2

* Hallucinated in that modality.

The data obtained from the imagery tests on 10 patients recovered from an alcoholic hallucinosi*s* are presented in table 3. All 10 of these patients had had vivid auditory hallucinations. It will be seen that their mean percentage of auditory imagery is 9.0 lower than that for the normal subject; this difference is highly significant statistically: $t = 6.214$; $P < 0.01$. The mean of the scorable responses for the patients with alcoholic hallucinosi*s* does not differ significantly from that for the normal subjects: $t = 1.926$; $P > 0.05$, indicating that the two groups were equally capable of cooperating in the test. It should be emphasized that the alcoholic patients were completely recovered when they were tested.

The two comparisons made in table 4 demonstrate that the mean percentage of auditory imagery for the patients recovered from an alcoholic hallucinosi*s* is significantly lower than that for the normal subjects; on the other hand, the patients recovered from an alcoholic hallucinosi*s* do not differ significantly from the schizophrenic patients with auditory hallucinations in this respect. These comparisons indicate

even more conclusively that the schizophrenic process, per se, is not responsible for the low percentage of auditory imagery in the schizophrenic patients with auditory hallucinations.

Comparison of the predominating type of schizophrenia with the presence or absence of auditory hallucinations revealed the following relationships: Of the schizophrenic patients with auditory hallucinations, 17 were predominantly paranoid, 1 was hebephrenic and 2 were catatonic; of the schizophrenic patients without auditory hallucinations, 11 were predominantly hebephrenic, 9 were paranoid and none was catatonic.

TABLE 4.—*Comparison of Mean Percentages of Auditory Imagery in Patients with Alcoholic Hallucinosiis, Normal Subjects and Schizophrenic Patients with Auditory Hallucinations*

Group	No. of Cases	Mean % Auditory Imagery	σ^m	t	P
Alcoholic hallucinosiis.....	10	14.2	1.379	} 6.214	<0.01
Normal subjects.....	114	23.2	0.443		
Alcoholic hallucinosiis.....	10	14.2	1.379	} 0.0793	>0.05
Schizophrenic patients with auditory hallucinations.....	20	14.0	1.725		

These results emphasize the fact that auditory hallucinations are far more common in patients with paranoid schizophrenia than in any other type of schizophrenia and that hebephrenic patients are least likely to experience hallucinations in the auditory modality.

QUALITATIVE OBSERVATIONS

The data presented have demonstrated that the schizophrenic patients with auditory hallucinations and the patients who had recovered from alcoholic auditory hallucinations were, in general, characterized by a relative deficiency in their auditory imagery. Some qualitative observations made during the testing of these patients give suggestions regarding the nature of this deficiency, as will be seen in the following examples of their responses to specific test phrases.

CASE AH-2.—Schizophrenic patient with vivid auditory hallucinations; auditory imagery 3.1 per cent.

Stimulus: "Voices of the members of your family."

Response: "I see open lips."

Question: "Can you imagine hearing them?"

Answer: "No. Nothing comes out. Only see the mouths open."

CASE AH-3.—Schizophrenic patient with vivid auditory hallucinations; auditory imagery 5.4 per cent.

Stimulus: "Ringing of telephone."

Response: "I can imagine seeing it, but I can't hear it ring."

CASE AH-8.—Schizophrenic patient with marked auditory hallucinations; auditory imagery 10.8 per cent.

Stimulus: "Striking of a clock."

Response: "It must have stopped. I can't hear it. Just see it."

Stimulus: "Ringing of telephone."

Response: "I see it. I was sitting here waiting for it to ring, but it didn't ring. I could only see it."

CASE Alc-2.—Alcoholic patient recovered from vivid auditory hallucinations; auditory imagery 87 per cent.

Stimulus: "Voices of the members of your family."

Response: "I know what they are like, but I can't get a clear effect of the voices. I can't get it in my mind."

Stimulus: "Piano note."

Response: "That means nothing to me. I get no sense whatever. It is hard for me to imagine the sound of things."

CASE NAH-16.—Schizophrenic patient without auditory hallucinations; auditory imagery 30 per cent.

Stimulus: "Striking of a clock."

Response: "Sound. I can hear it so clearly."

Stimulus: "Piano note."

Response: "Hearing. I can hear it so clearly."

The foregoing examples suggest that the patients with auditory hallucinations actually have difficulty in experiencing auditory images, even when they try. This interpretation is supported further by the following two observations:

It was frequently noted in testing the patients with auditory hallucinations that the latent period between test phrase and response was prolonged on those phrases for which auditory responses are usually given. Patients without auditory hallucinations appeared able to bring forth auditory images much more readily.

Furthermore, the patients with auditory hallucinations tended to give nonscorable responses, i. e., associations, definitions and other inadequate responses, only on those tests phrases for which auditory responses are usually given. An association or a definition in response to such a test phrase appeared to represent an attempt by the patient to offer, in lieu of an auditory image, some sort of an answer.

COMMENT

The data presented demonstrate that the mean percentages of auditory imagery for the two groups of patients who had, or had had, auditory hallucinations were significantly lower than those for the two groups of patients who did not have, and had not had, auditory hallucinations. Furthermore, the schizophrenic patients with auditory hallucinations and the patients who had recovered from an alcoholic auditory hallucinosis did not differ significantly with respect to their mean per-

centages of auditory imagery; similarly, the schizophrenic patients without auditory hallucinations and the normal subjects did not differ significantly in this respect.

These findings indicate quite definitely that one of the factors on which auditory hallucinations may depend is a relatively low percentage of auditory imagery. According to this concept, most of those persons who attempt to resolve their personal mental conflicts by projecting them as auditory hallucinations would be found, if they were tested by means of an impersonal projective technique, to have had the hallucinations in a modality of imagery in which they were relatively deficient. This concept implies that relatively deficient auditory imagery is a point of vulnerability and that it is a characteristic of the patient rather than a characteristic of his mental illness.

The problem of conceiving and describing how auditory hallucinations might take place when the auditory imagery is relatively deficient will undoubtedly be much more complicated than it would have been to describe auditory hallucinations as mere exaggerations of an already enhanced and predominating auditory imagery. Therefore, this conceptual and descriptive problem will be deferred to a later occasion, when, in a more general paper, one of us (H. B. M.) will attempt to solve it.

Snyder and Cohen³ have raised questions concerning "the validity of imagery-testing in schizophrenia"; we feel that those questions are answered by the findings of the present study. The questions they raised cannot be answered by the data presented by them because they presented only selected data, and not all their raw data. We have made a point of presenting all our raw data in tables 1 and 3, so that other investigators will be able to analyze our findings and compare them with the data obtained in their own studies. It should also be emphasized that Snyder and Cohen did not separate visual imagery from auditory imagery, but grouped the two types together as one percentage. We have already pointed out that if the percentage of auditory imagery is low there is usually a compensatory increase in the percentage of visual imagery. Therefore, their method of combining the percentages of auditory and visual imagery may have led to their negative results, just as it would have done in our study had we not kept these two modalities separate. Furthermore, we have already stated that Snyder and Cohen did not study the relationship of mental imagery to hallucinations; they were attempting to distinguish schizophrenic patients from normal subjects in terms of an index of combined auditory and visual imagery.

The conclusion offered by Snyder and Cohen that the imagery test "is not a valid diagnostic criterion of imagery in schizophrenia" was based on the fact that Snyder, on testing and comparing the imagery of schizophrenic patients and normal subjects, failed to find the significant difference between them that Cohen² had found. They expressed the

opinion that Cohen's original patients, as a group, were more "disturbed" mentally than the patients tested by Snyder and that this factor was responsible for the significant difference between the percentages of imagery for the schizophrenic patients and the normal subjects in Cohen's investigation. Their descriptions of mentally "disturbed" behavior were, however, so general that we could not use them in classifying our patients. We have already pointed out that our two groups of schizophrenic patients did not differ significantly with respect to cooperativeness, as measured in terms of scorable responses; nevertheless, the mean percentage of auditory imagery for the group with auditory hallucinations was significantly lower than that for the group without auditory hallucinations. Furthermore, the patients who had recovered from alcoholic hallucinosis were not, in any sense of the term, "disturbed" mentally at the time they were tested; yet the mean percentage of auditory imagery for these patients was significantly lower than that for the normal subjects. Since the relationship between relatively low auditory imagery and auditory hallucinations is so obvious in our data, it seems to us that Cohen's original findings were probably due, in large part, not to the fact that his 19 schizophrenic patients were "disturbed" mentally, but to the fact that 18 of them had auditory hallucinations.

SUMMARY

The mental imagery of 40 patients with schizophrenia, 10 patients who had recovered from an alcoholic hallucinosis and 114 normal subjects was tested.

Schizophrenic patients with auditory hallucinations were found to have a significantly lower mean percentage of auditory imagery than either normal subjects or schizophrenic patients without auditory hallucinations. The normal subjects and the schizophrenic patients without auditory hallucinations did not differ significantly in this respect.

Patients who had recovered from alcoholic hallucinosis were found to have a significantly lower mean percentage of auditory imagery than normal subjects. The mean percentages of auditory imagery for patients who had recovered from an alcoholic hallucinosis and for schizophrenic patients with auditory hallucinations did not differ significantly.

Not only do these findings disprove the old theory that auditory hallucinations are exaggerations of predominating auditory imagery, but they suggest the new concept that one of the factors responsible for auditory hallucinations is relatively deficient auditory imagery.

Case Reports

MEDULLOBLASTOMA OF THE CEREBELLUM, WITH SURVIVAL FOR SEVENTEEN YEARS

WILDER PENFIELD, M.D., F.R.S., AND WILLIAM FEINDEL, M.D.
TORONTO, ONTARIO, CANADA

Since the original description of "medulloblastoma cerebelli" by Bailey and Cushing¹ in 1925, this tumor has been generally accepted as a neoplastic entity. It seems to be invariably fatal, in spite of the fact that it is temporarily sensitive to roentgen therapy.

Ingraham and O. T. Bailey² have recorded a case of tumor of the cerebellum treated by roentgen irradiation and identified as a medulloblastoma nineteen years after the first symptoms. More recently, Spitz, Shenkin and Grant³ have pointed out the tendency to longer survival from this tumor in adults. It may therefore be of interest to make brief record of a case in which an adult survived seventeen years after operative removal of a medulloblastoma, the histologic study of which suggested unusually rapid growth.

REPORT OF A CASE

A married woman aged 22 was admitted to the surgical service of the Royal Victoria Hospital on Dec. 16, 1928. She complained of right temporal headache and vomiting for six weeks and blurred vision and diplopia for one week. On admission, she was found to have papilledema of 3 to 4 D. Neurologic examination demonstrated tremor and past pointing in the left hand, pendular knee jerks and absence of the abdominal reflexes. A ventriculogram showed symmetric dilatation of the ventricular system, with no oxygen in the fourth ventricle and none in the subarachnoid space.

Because the history of symptoms was short and the patient had had a series of superficial abscesses for two months, it seemed possible, before the operation, that the lesion of the cerebellum might be an abscess. Suboccipital craniotomy was therefore carried out in such a way as to avoid escape of pus, if found, into the subdural space.

The operative approach was therefore somewhat different. A smaller opening was made and the subdural space walled off. The lesion proved to be a tumor situated in the cerebellum just to the right of the midline and immediately beneath the tentorium. It extended inward to the roof of the fourth ventricle, a depth of 4 to 5 cm. A small incision was made directly over the tumor, and grayish

From the Department of Neurology and Neurosurgery, McGill University, and the Montreal Neurological Institute.

1. Bailey, P., and Cushing, H.: Medulloblastoma Cerebelli, Arch. Neurol. & Psychiat. **14**:192-224 (Aug.) 1925.

2. Ingraham, F. D., and Bailey, O. T.: Cerebellar Medulloblastoma with Verification Nineteen Years After Onset of Symptoms, J. Neurosurg. **1**:252-257 (July) 1944.

3. Spitz, E. B.; Shenkin, H. A.; and Grant, F. C.: Cerebellar Medulloblastoma in Adults, Arch. Neurol. & Psychiat., this issue, p. 417.

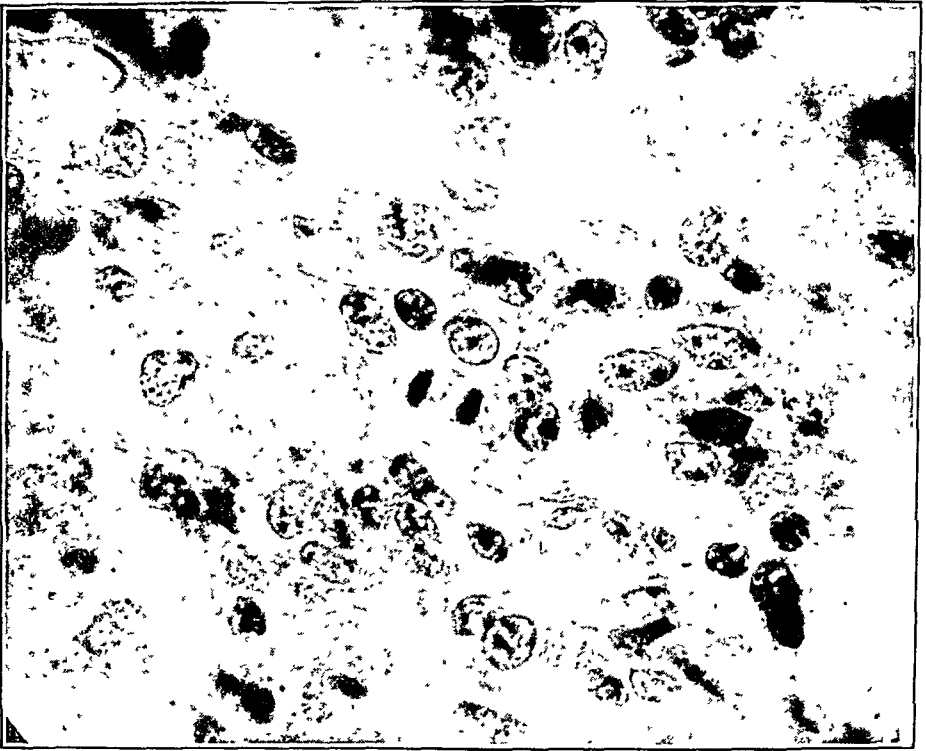

Fig. 1.—Tumor tissue, showing mitotic figures.

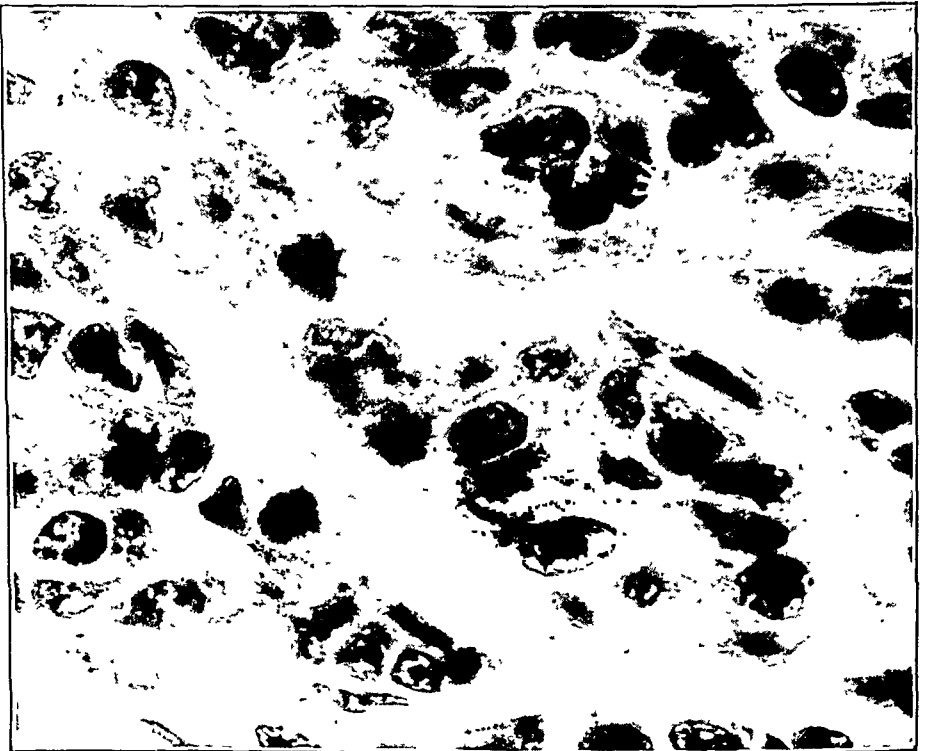

Fig. 2.—Tumor tissue. Note elongation of cytoplasm into short tails. Silver carbonate stain.

yellow neoplastic tissue forced itself out through the opening. The tumor was removed by suction. It contained two moderately firm nodules and was somewhat adherent to the under surface of the tentorium.

Histologic examination of the tissue revealed tumor cells with rounded nuclei. Mitotic figures were numerous (fig. 1). The cell bodies were generally pyriform, the cytoplasm often forming short tails (fig. 2). The cells were arranged in cords between bands of connective tissue, or they appeared as islands surrounded by connective tissue stroma (fig. 3). Not infrequently the cells formed pseudorosettes, as suggested in figure 2.

The material was studied by Dr. William Cone, who made a diagnosis of "medulloblastoma cerebelli" and commented that it seemed to be more rapidly growing than any medulloblastoma he had seen. He added: "The mitotic figures are more numerous and the formation of the cells in columns more striking. There



Fig. 3.—Tumor tissue. Above, the nuclear arrangement is shown. Below, the reticulin fibrils are demonstrated in the connective tissue stroma by means of Laidlaw's silver carbonate stain.

are areas, however, where the pseudorosette formation is quite typical of medulloblastoma."

Roentgen therapy was given after operation, although record of the dosage was lost. The papilledema disappeared, and the patient was in good health, working as a housewife and giving birth to a child four and a half years after operation. At the end of nine years she returned with headache and vomiting and was found to have papilledema a second time.

A second suboccipital craniotomy was carried out, but there was no evidence of neoplasm in the cerebellum and the tissue removed proved on microscopic study to be only scarred cerebellum. It was concluded that there had been recurrence of the neoplasm elsewhere in the cranial cavity. Consequently, the patient was given roentgen therapy, in a dose of 3,800 r to the head and 3,500 r to the spine. Again, she recovered and was well until July 1944, sixteen years after her first admission.

At this time she returned with evidence of increased intracranial pressure, disorientation and loss of memory. She was given roentgen therapy again, in a dose of 11,800 r. She recovered a third time, although more slowly.

Before long, however, symptoms recurred, and she died in October 1945, seventeen years after operative removal and roentgenotherapy of the medulloblastoma. The case bears out the suggestion of Spitz, Shenkin and Grant that adults have a higher degree of resistance to the recurrence of this tumor than children.

Summary.—In this case, a medulloblastoma of the cerebellum made its appearance when the patient was 22 years of age. There was recurrence of symptoms after nine years, and again after sixteen years. In the first (and probably the second) instance, the recurrence was at a distance from the cerebellum, and in each the result of roentgen therapy was initially satisfactory. Although the histologic appearance suggested a high degree of malignancy, there was useful and happy survival for seventeen years.

3801 University Street.

News and Comment

PAUL B. HOEBER, INC., PUBLISHERS OF PSYCHOSOMATIC MEDICINE

Psychosomatic Medicine, the bimonthly journal sponsored by the American Society for Research in Psychosomatic Problems, Inc., was founded in 1939, with the assistance of the Josiah Macy Jr. Foundation, and was sponsored during its first five years of publication by a division of the National Research Council. Beginning with the issue for January-February, 1947, it will be published by Paul B. Hoeber, Inc., Medical Book Department of Harper & Brothers, New York. Dr. Flanders Dunbar, of New York, is editor in chief of the journal, and Dr. Edward Weiss, of Philadelphia, is president of the society for the current year.

The subscription price of the journal is \$6.50 per year. Existing volumes in the series, "*Psychosomatic Medicine Monographs*," published by the society, will hereafter be distributed by Paul B. Hoeber, Inc.

PORTLAND (ORE.) CHILD GUIDANCE CLINIC

Notice is given that the city of Portland (Ore.) is establishing a full time community child guidance clinic. This clinic is to have financial backing of the community chest and a number of other interested agencies in the community. At present there is an opening for a full time psychiatrist and clinical director of that clinic, with a salary between \$10,000 and \$12,000 a year, depending on the qualifications. Further information may be obtained from the Board of Community Child Guidance Clinic. The address is c/o Council of Social Agencies, The Terminal Building, Twelfth and S. W. Morrison, Portland, Ore.

Abstracts from Current Literature

EDITED BY DR. BERNARD J. ALPERS

Physiology and Biochemistry

CHOLINESTERASES IN SYMPATHETIC FIBERS AND GANGLIA. CHARLES H. SAWYER and W. HENRY HOLLINSHEAD, *J. Neurophysiol.* **8:137** (May) 1945.

Sawyer and Hollinshead studied by means of a microchemical method the cholinesterases of the cat's peripheral nerve fibers and ganglia. A wide distribution of both true and pseudocholinesterase was found. Both esterases were present in strong, practically equal, concentrations in the superior cervical ganglia, and both were most active in the region where preganglionic endings and ganglion cells were most concentrated. In the cervical portion of the sympathetic trunk most of the hydrolysis of acetylcholine was found to be performed by true cholinesterase. After preganglionic section true cholinesterase is lost at the same rate by the ganglion and by the degenerating preganglionic fibers. This observation was interpreted as indicating that the common elements of these structures, namely, preganglionic axons and endings, produce the enzyme. Pseudocholinesterase is lost at a much slower rate than is true cholinesterase, indicating its production by an intrinsic element, probably the ganglion cells. Stripping the ganglion resulted in chromatolysis and disappearance of the preganglionic endings. This was associated with total disappearance of true cholinesterase and decrease in the pseudocholinesterase. Sawyer and Hollinshead conclude that these observations emphasize the importance of true cholinesterase in synaptic transmission and minimize the physiologic importance of pseudocholinesterase.

FORSTER, Philadelphia.

CHANGES IN BRAIN POTENTIALS DURING CONVULSIONS INDUCED BY OXYGEN UNDER PRESSURE. ROBERT COHN and ISIDORE GERSH, *J. Neurophysiol.* **8:155** (May) 1945.

Cohn and Gersh studied the electrical activity of the cortex of cats exposed to oxygen under increased pressure. Within one to two minutes after exposure to oxygen under pressure the normal cortical rhythm was interrupted by bursts of slow activity, which became prominent after six and a half minutes and one-half minute later were followed by convulsions and high voltage fast, spiking activity. The authors concluded that the pattern of the brain waves during the convulsions of oxygen poisoning in the cat resembles that observed with other well defined clinical and experimentally induced seizures. Present evidence indicates that a similar pattern would result in human subjects if experiments were to progress to the phase of motor discharge. The data are consistent with the concept that the seizure is the result of interference with basic intracellular, perhaps enzymatic, activity.

FORSTER, Philadelphia.

ELECTROENCEPHALOGRAPHIC CHANGES FOLLOWING HEAD INJURIES IN DOGS. ROBERT S. DOW, GEORGE ULETT and ARCHIE TUNTURI, *J. Neurophysiol.* **8:161** (May) 1945.

Dow, Ulett and Tunturi report the electroencephalographic changes induced in dogs by head injuries. Trauma was produced by a pendulum with a rigid hitting arm, and the animals were so muzzled and fastened as to decelerate the head after it had traveled 6 to 8 inches (15 to 19 cm.). The authors found that dogs are

less susceptible to impacts delivered to the freely moving head than are cats. The effects of impact are greater when the animal is under general than when under local anesthesia. The spindles of high voltage activity, which are characteristic of the records of animals anesthetized with barbiturates, were most susceptible to the effects of trauma. Head injuries affected correct conditioned differentiation to a greater degree and for a longer time than they affected reflex activity and more vital functions. Correct conditioned differentiation appeared to be a more delicate index of cortical function than the electroencephalogram. Dow, Ulett and Tunturi concluded that the evidence indicates that concussion has a direct paralyzing effect of temporary character, independent and beyond any mechanical stimulation of neurons.

FORSTER, Philadelphia.

SENSORY-MOTOR NERVE CROSSES IN THE RAT. PAUL WEISS and MAC V. EDDES JR., *J. Neurophysiol.* 8:173 (May) 1945.

Weiss and Eds reexamined the problem of regeneration of sensory nerve fibers into motor stumps and muscles. Arterial sleeves were employed to effect the crosses. The sensory fibers regenerated into and through the motor nerve with ease and passed the motor point. They pervaded the muscle with a rich network of arborizations and exhibited no sign of selectivity in their regeneration. After regeneration occurred, electrical stimulation of the crossed nerve in most cases yielded a motor response. Stimulation of ventral and posterior roots separately, and stimulation of the peripheral nerve after degeneration of motor fibers following section of the ventral root, revealed that the motor responses depended on the ventral root fibers included in the cross. Atrophy and degeneration occur despite the presence of sensory fibers around muscle fibers. Sensory fibers, therefore, do not affect the trophic condition of the muscle. Weiss and Eds concluded that the failure of sensory fibers to transmit motor impulses could be ascribed to lack of proper structural connection, to biochemical incompatibility or to lack of a mediator of physiologic impulses. There was no histologic evidence of resorption of functionally useless sensory fibers in motor pathways. Muscles with mixed reinnervation demonstrate a disproportionately increased gain in weight. Histologically innervated fiber groups are rather sharply set off from degenerated groups. Earlier reports of motor innervation by sensory nerves can be attributed to the presence of stray motor fibers.

FORSTER, Philadelphia.

THE EFFECT OF ANTICONVULSANT DRUGS ON RECOVERY OF FUNCTION FOLLOWING CEREBRAL CORTICAL LESIONS. CHARLES WESLEY WATSON and MARGARET A. KENNARD, *J. Neurophysiol.* 8:221 (July) 1945.

Since certain stimulants produce a beneficial effect on the rate and degree of recovery of motor function in Macaques (*Macaca mulatta*) from which the motor cortex has been ablated, Fulton and Watson studied the effects of sedatives in the same type of preparation. The motor and premotor areas were ablated from one hemisphere. Two animals were used as controls; 3 received phenobarbital sodium; 1, carbaminoylcholine and atropine; 2, diphenylhydantoin, carbaminoylcholine and atropine, and 1, diphenylhydantoin alone. Both clinical and electroencephalographic observations were made. Watson and Kennard found that prolonged, subhypnotic administration of phenobarbital sodium decreased the rate of recovery of the animals. The enhanced rate of recovery induced by carbaminoylcholine was prevented by the administration of diphenylhydantoin. It did not seem that the latter alone, however, altered significantly the rate of recovery. The electroencephalograms were not affected by diphenylhydantoin or carbaminoylcholine and atropine.

FORSTER, Philadelphia.

CREATINE METABOLISM IN RELATION TO PITUITARY TUMOURS. J. N. CUMINGS, *Brain* 67:265, 1944.

Cumings determined the creatine and creatinine contents of the urine of 8 patients with chromophobic adenomas and of 16 patients with acidophilic adenomas

of the pituitary gland. All patients with chromophobic adenoma showed a normal or slightly increased excretion of creatinine and on some days small amounts of creatine. There was no postoperative alteration in these values. In the cases of acromegaly Cumings observed a definite excretion of creatine and an increased quantity of creatinine in the urine. Cumings concludes that in the absence of thyrotoxicosis urinary excretion of creatine is sufficient to distinguish between the two types of adenoma of the pituitary gland. A creatine tolerance test was devised, consisting of the administration of 1 Gm. of creatine to a fasting patient and determination of the creatine and creatinine contents of the blood and urine. With this method, it was possible to distinguish between the two types of tumors of the pituitary and also to differentiate between dysfunction of the pituitary and the thyroid gland.

FORSTER, Philadelphia.

Psychiatry and Psychopathology

DEFINITION OF PSYCHOPATHIC PERSONALITY. HARRY F. DARLING, *J. Nerv. & Ment. Dis.* **101**:121 (Feb.) 1945.

Darling lists the characteristics of the psychopathic personality as given by various authorities and offers as a definition of the condition the following statement: "Psychopathic personality may be defined as a mental disease which develops before or during puberty, caused by inherited predisposition, or by acquired personality deviation due to psychic or somatic factors or both, which, in turn, cause super-ego deficiency; it is characterized by stereotyped deviations in the moral, social, sexual and emotional components of the personality, without intellectual impairment, psychosis, or neurosis, with lack of more than insight or ability to profit by experience, and is of lifelong duration in almost all cases."

CHODOFF, Washington, D. C.

PSYCHOSOMATIC ASPECTS OF STUTTERING. BERNARD C. MEYER, *J. Nerv. & Ment. Dis.* **101**:127 (Feb.) 1945.

In an effort to clarify some of the controversial aspects of the problem of stuttering, Meyer studied 116 stutterers at the National Hospital for Speech Disorders in New York city from the point of view of the family history and the physical, neurologic and psychiatric status.

Stuttering occurred nearly ten times as frequently in the families of stutterers as in the families of nonstutterers, but the distribution of the disorder did not appear to follow any clearcut, simple mendelian pattern of heredity. In most cases it was not possible to rule out imitation or other nonhereditary factors as responsible for the frequency of familial stuttering. The possibility exists that a tendency to stutter may be part of a complex hereditary pattern.

The neurologic examination failed to reveal consistent evidence of disease of the nervous system except for the rather frequent finding of inequality in the arm swing while walking. The significance of this phenomenon is unknown. Physical examination failed to show evidence of constitutional inferiority or organic disease in a significant number of cases. The most frequently observed abnormalities included moist hands and feet, dilated pupils, hyperactivity of the deep tendon reflexes and vasomotor disturbances of the skin. These findings were considered typical of the state of chronic anxiety, and not characteristic of stutterers alone.

From a study of the handedness and eyedness of the subjects, the author concludes that in more than three fourths of the total number of stutterers studied there was no evidence for the assumption that a dominant cerebral hemisphere had not been established.

Psychiatric investigation revealed that the stutterer is often a schizoid person who displays other disorders than stuttering. Many of the subjects gave a history of bed wetting, nail biting and nightmares. Analysis of the onset of the stutter revealed that in nearly half the cases a specific etiologic agent, such as fright,

trauma, enforced shift of handedness, imitation, illness or surgical operation, was present. The subsequent history of the stutter demonstrated the close association between emotion and the speech disorder.

The author believes that stuttering should be regarded as a single manifestation of a more general neurotic problem and that it represents the resultant of the conscious will to express oneself, on the one hand, and an unconscious inhibition of speech, on the other. The latter appears to serve as a defense against anxiety.

CHODOFF, Washington, D. C.

HEALING MECHANISMS IN THE SHOCK TREATED NEUROTIC PATIENT. JOHN D. MORIARTY and ANDRÉ A. WEIL, *J. Nerv. & Ment. Dis.* **101**:205 (March) 1945.

Moriarty and Weil previously described a new method of treatment of the neuroses, consisting of a combination of convulsive therapy and psychotherapy. With the addition of more patients and as follow-up studies became more extensive, they were able to gain further insight into the interplay of healing mechanisms. They believe that the treatment of the neurotic patient must have a broad basis, which includes various psychosomatic relationships. Many so-called anxiety neuroses, tension states and gastrointestinal and cardiac neuroses are associated with definite physiologic disturbances, which sometimes progress to the point of demonstrable structural change. More specifically, the regulatory mechanisms of the central nervous system are widely disturbed, with special repercussions in the function of the vegetative nervous system. Since shock therapy seems to have an almost specific influence on these regulatory mechanisms, it appears logical to employ it.

The authors have treated 42 neurotic patients, first using metrazol but later changing to electric shock. For the latter they use an apparatus which delivers a unidirectional current, small doses of which are sufficient to produce a convulsion. Usually three to six electric shock treatments have been sufficient. In 16 patients (38 per cent) remissions were produced, while there was improvement in 23 patients (55 per cent) and no change in 3 patients (7 per cent).

The healing mechanisms are based on an interplay of physiologic, psychobiologic and psychologic factors. The physiologic effect is achieved through the stabilizing effect of the shock therapy on the regulatory centers of the central system, especially the hypothalamus. Concomitantly, there occurs reestablishment of previously neurotically inhibited reflex responses, with the disappearance of such symptoms as insomnia, tension and depression. From a psychobiologic viewpoint, convulsive therapy seems to operate by the activation of a deep, primitive "lower level fear." There may be a similarity between the unconscious development of abnormal psychic mechanisms as an escape from life situations and the rejection of these when an apparently fundamental threat to existence makes it better to reject than to retain them. Psychologic healing factors include the development of courage and self confidence and the improvement of morale through the increased operation of the "herd instinct." Psychotherapy is facilitated through a promotion of the state of transference, a setting free of the patient's energy and overcoming of libidinous fixation.

CHODOFF, Washington, D. C.

PATHOLOGICAL WEEPING. PHYLLIS GREENACRE, *Psychoanalyt. Quart.* **14**:62, 1945.

Two types of neurotic weeping are found in the analysis of women patients—shower weeping and stream weeping. In the former, there are copious tears with little provocation and without much sobbing and crying. In the latter, little obvious emotion is evident, but a stream or trickle of tears rolls down the cheek when certain sensitive, deeply repressed subjects are touched in the analytic work. In both, a strong element of exhibitionism together with marked penis envy and some visual fascination based on urination is present. Shower weeping indicates some acceptance of the female role but a rather discouraged attitude about it. This

type weeps in anger and in partial resignation because she cannot approximate male urination. Stream weeping is a substitute for male urination, the penis envy appearing in periodic aggressive demands for the male organ, accompanied with fantasies for its possession. An extreme body-phallus identification may always be present in stream weepers. The author cites 2 cases in support of her thesis. She wonders whether the extravasation of water from the body, whether it appears as a channeled excretory process (as in lacrimation, sweating and urination) or as a local or general transudative edema resulting from severe or prolonged non-specific traumas, is not basically an expression of aggressive defense.

PEARSON, Philadelphia.

CORNELL SERVICE INDEX: A METHOD FOR QUICKLY ASSAYING PERSONALITY AND PSYCHOSOMATIC DISTURBANCES IN MEN IN THE ARMED FORCES. ARTHUR WEIDER, KEEVE BRODMAN, BELA MITTELMAN, DAVID WECHSLER and HAROLD G. WOLFF, *War Med.* 7:209 (April) 1945.

The Cornell Service Index is a simple device for obtaining and evaluating data of military psychiatric significance. It is essentially an anamnesis with quantitative features. It is self administered and may be given to many subjects simultaneously. It can be completed in ten minutes and scored within one minute.

The least disturbing questions are placed at the beginning of each group and the least disturbing groups at the beginning of the form: The order in which the groups appear in the Index is as follows: (a) Questions 1 through 3 are introductory and neutral; (b) questions 4 through 17 concern defects in adjustment to military groups, expressed as feelings of fear and inadequacy; (c) questions 18 through 20 and 24 through 30 concern pathologic mood reactions, especially anxiety and depression; (d) questions 21 through 23 concern neurocirculatory psychosomatic symptoms; (e) questions 31 through 37 concern pathologic startle reactions; (f) questions 38 through 49 concern a variety of other psychosomatic symptoms; (g) questions 50 through 63 concern hypochondriasis and asthenia; (h) questions 64 through 74 concern gastrointestinal psychosomatic symptoms; (i) questions 75 to 79 concern excessive sensitivity and pathologic suspiciousness, and (j) questions 80 through 92 concern symptoms of troublesome psychopathy.

By means of the Index score, a sharp differentiation can be made between persons with little or no psychoneurosis and those in whom psychoneurosis interferes or may interfere seriously with military performance. Ninety-eight per cent of persons with severe psychoneuroses are detected, while 3.5 per cent of ostensibly healthy persons are found to have poor scores.

PEARSON, Philadelphia.

CORNELL SERVICE INDEX: REPORT ON ITS USE IN THE EVALUATION OF PSYCHIATRIC PROBLEMS IN A NAVAL HOSPITAL. NATHANIEL WARNER and MARGARET WILSON GALICO, *War Med.* 7:214 (April) 1945.

Warner and Galico used the Cornell Service Index in the scoring of 1,300 patients and found that the responses obtained distinguished with a high degree of accuracy patients without apparent personality disturbances from those who presented psychiatric complaints of significant degree. The form does not effect a very clear separation between mild and severe personality disturbances, though it is of some help in this differentiation.

It reveals a small number of persons with histories replete with psychoneurotic symptoms who are not thereby prevented from performing their duties adequately. Part of the explanation of this apparent discrepancy lies in the factor of motivation toward the service.

The form does not reveal adequately the histories of subjects who are lacking in awareness of their difficulties. It does not cover many cases of conversion hysteria, and it does not concern itself with sexual disturbances. It does apply adequately to the great majority of patients who come to the attention of the military psychiatrist, and it should prove to be of considerable use in the evaluation of psychiatric disturbances in the members of the armed services.

PEARSON, Philadelphia.

SUBACUTE EMOTIONAL DISTURBANCES INDUCED BY COMBAT. R. A. COHEN and J. G. DELANO, *War Med.* 7:284 (May) 1945.

The majority of patients with subacute emotional disturbances induced by combat presented in common the syndrome of anxiety, heightened irritability, startle reaction and catastrophic nightmares. They showed also a great variety of neurotic disturbances, based on individual life experiences. The more chronically ill showed a narrowing of the range of activities and interests, attitudes of dependence and need for esteem, thinly veiled by aggressive combativeness. A failure of the fight or flight reaction to danger seems to give rise to this syndrome.

Treatment is based on an understanding of the dynamics of each case. A balanced program of education, recreation and work under planned organization and leadership gives a purposeful direction to the daily activities. Group therapy is particularly effective in reenforcing certain psychologic mechanisms which serve to control anxiety, restore the patient's initiative and promote a better adjustment to military life.

The two most important factors in rehabilitation appear to be, first, restoration of the patient's self esteem and resolution of some of his anxiety by individual and group psychotherapy and, second, promotion of his reintegration with the group so that he may regain the important controls over untoward emotional reactions which identification with the group affords.

PEARSON, Philadelphia.

FUNCTIONAL ENURESIS IN THE ARMY: REPORT OF A CLINICAL STUDY OF ONE HUNDRED CASES. HERMAN SHLIONSKY, LOUIE R. SARRACINO and LEDFORD J. BISCHOF, *War Med.* 7:297 (May) 1945.

A clinical neuropsychiatric study was made of 100 men with functional nocturnal enuresis. A high incidence of enuresis was found in the immediate members of their families. The educational and occupational background of the group was below average. A relatively high percentage were below the average in intelligence. There was no evidence of mild or arrested forms of myelodysplasia. The vast majority of the men had various neurotic tendencies and personality disorders. Most showed emotional immaturity, dependence and a passive type of personality. Functional backache was common. The symptom of enuresis in itself creates a difficult situation in the service, but this study shows that the large majority of enuretic adults do not possess emotional or intellectual qualifications for the armed services.

PEARSON, Philadelphia.

CAMPTOCORMIA: A FUNCTIONAL CONDITION OF THE BACK IN THE NEUROTIC SOLDIER. S. A. SANDLER, *War Med.* 8:36 (July) 1945.

Camptocormia is an hysterical phenomenon manifested by pain in the lumbar region and by a bent trunk. The onset of this back-bending phenomenon is concomitant with or preceded by impotentia, which is probably indicative of the soldier's latent homosexuality and castration anxiety.

In this syndrome there is not only the adoration of, but a suppressed ambivalent irritability and hostility against, the father. There is present a strong over-identification with the father, who generally has also had trouble with his back. The ambivalent feeling toward the father reflects itself toward authority in the military situation, with resulting projection of resentment on commissioned and noncommissioned officers. The military situation is the source of constant threat and danger to the ego, which continually strives for its safety and protection. When the pressure becomes too great, the ego wilts and the symptoms of camptocormia develop.

PEARSON, Philadelphia.

Diseases of the Brain

ELECTROENCEPHALOGRAPHIC STUDIES IMMEDIATELY FOLLOWING HEAD INJURY. R. DOW, G. ULETT and J. RAAF, *Am. J. Psychiat.* 101:174 (Sept.) 1944.

Dow, Ulett and Raaf studied the electroencephalograms of 197 patients with mild head injuries. The time interval between injury and the electroencephalo-

graphic study was seldom less than several hours, and the shortest interval was ten minutes. In this group, 173 men and 24 women were used; their ages ranged from 16 to 87 years. As controls, studies were made on 211 persons, ranging in age from 17 to 77 years. Of the 197 patients studied, 187 had lacerations or contusions of the head. Fifty-four of the 197 patients and 70 of the control series gave a history of a blow on the head. In the injured series, the electroencephalographic records showed no greater abnormality than the records of the subjects who had not sustained a previous injury.

The encephalographic unit consisted of a push-pull amplifier with a three channel, ink-writing oscillograph, Grass type. A cubicle was erected to eliminate the outside electrical interference. A head band electrode holder with six spring pressure controls was used instead of the six electrodes sealed with collodion.

From their studies, Dow, Ulett and Raaf draw the following conclusions: 1. Abnormality of the electroencephalogram as a result of mild cerebral trauma disappears within a few minutes. 2. Patients with amnesia following cerebral trauma showed only a slightly greater percentage of abnormal records than the control series even if the records were taken within a few hours of the accident. 3. Abnormality in the electroencephalogram was present if there was impairment of consciousness of any degree at the time of the recording. 4. Electroencephalograms taken within thirty minutes after head injuries displayed a greater percentage of abnormality than those taken after a thirty minute lapse. 5. The average velocity of the striking object or falling head was less than the velocity necessary to produce concussion in experimental animals. 6. The study of electroencephalogram records taken immediately after mild head injury was less reliable than clinical judgment in predicting loss of time from work.

The authors assert that the rapid disappearance of electroencephalographic abnormalities indicates the presence of some mechanism in concussion other than petechial hemorrhage, cerebral contusion, embolic phenomenon or any other histopathologic change which must require several days to disappear.

BORKOWSKI, Philadelphia.

IDEOKINETIC APRAXIA FOLLOWING PARTIAL RECOVERY FROM VISUAL AGNOSIA:
REPORT OF A CASE WITH AUTOPSY. GEORGE N. THOMPSON, Bull. Los Angeles
Neurol. Soc. 10:70 (March-June) 1945.

Thompson reports the case of a married white woman aged 59 who entered the hospital in coma. Two years prior to admission she had had an episode of loss of consciousness, from which she recovered within several hours. She was confused for several weeks, and this symptom subsided. She was then fairly well oriented and mentally clear, except that she had some trouble with figures. She found it difficult and confusing to deal with her ration books and could not be troubled with her bank account. For the next two years she had visual agnosia, alexia and agraphia, with partial recovery.

Eighteen days prior to admission to the hospital she had what appeared to be "another stroke." After this episode ideokinetic apraxia developed, and this persisted. The patient died the day after her admission to the hospital.

At necropsy two vascular lesions were observed in the left hemisphere. One lesion involved exactly the area of the supramarginal gyrus; the other, the entire posterior parieto-occipital region, with its center occupying area 19 of Broadmann. Section revealed that the thrombotic softening in area 19 extended into area 18. A small lesion in the right occipital lobe in areas 17 and 18 of Broadmann was observed. A section made 1.5 cm. higher than the first showed the softening already described, as well as pronounced atrophy of the lesion centered in the area 19 of Broadmann on the left hemisphere. It is of interest to note that there was no hemiplegia. After development of apraxia there was strong unilateral dominance for motor acts. On the other hand, however, cerebral dominance for eugnosia was not marked, as a few weeks after the lesion causing visual agnosia occurred the function of eugnosia reappeared. The transfer of revisualization,

except for symbols, because of interruption of connections to the major angular gyrus, was effected well. This case, then, was one of strong parietal cerebral dominance but weak occipital cerebral dominance, and it represents, according to the author, a deviation from the general rule that unilateral cerebral dominance for motor acts is less marked than that for eugnosia. GUTTMAN, Philadelphia.

A CASE OF "CENTRAL DIABETES MELLITUS." F. R. WOODWARD, Bull. Los Angeles Neurol. Soc. **10:78** (March-June) 1945.

Woodward reports the case of a woman aged 50 who was admitted to the hospital after an acute attack of headache, vomiting, loss of consciousness and involuntary micturition. For some time the patient had had polyphagia and polydipsia. She had numbness of the hands and a sensation as though one of her fingers did not belong to her. For three weeks prior to the acute episode she complained of a severe headache, specifically, an intense pain behind the left ear. About eight months prior to her current difficulties she was told by a physician that she had high blood pressure.

At the time of admission the patient was in a deep coma, with a blood pressure of 236 systolic and 130 diastolic. Significant features on examination were small round pupils, which were fixed in reaction to light; hemorrhages in the periphery of both fundi; absence of deep reflexes, except for normal responses in the left upper limb; Babinski and Oppenheim reflexes on the left side, and rigidity of the neck and the Brudzinski sign.

The urine gave a strongly positive reaction for sugar. The blood sugar measured 305 mg. per hundred cubic centimeters. The carbon dioxide-combining power of the blood was 32 volumes per cent. The spinal fluid was under a pressure of 550 mm. of the fluid, and it was grossly bloody.

The following morning the patient could be aroused somewhat, and hemianopsia was suspected. Right hemiplegia seemed to be developing. It was thought that she had a primary intracerebral and secondary subarachnoid hemorrhage. Three days after admission the patient died.

Examination of the brain revealed only one lesion, a large saccular aneurysm in the third ventricle. This had ruptured.

Woodward states that the syndrome of diabetes mellitus with normal carbon dioxide-combining power of the blood leads one to suspect a lesion about the third ventricle of the brain. In the case here reported, the patient had severe hypertension but was able to carry on her profession until a few months before she died of a "ruptured aneurysm of the circle of Willis." The clinical diabetes was terminated by a classic syndrome of rupture of the aneurysm.

GUTTMAN, Philadelphia.

NEURO-OPTIC MYELITIS: A CLINICOPATHOLOGICAL STUDY OF TWO RELATED CASES. HEINZ KOHUT and RICHARD B. RICHTER, J. Nerv. & Ment. Dis. **101:99** (Feb.) 1945.

Kohut and Richter review the literature on neuro-optic myelitis, emphasizing the controversial position of the syndrome, especially in its relation to acute multiple sclerosis and disseminated encephalomyelitis. Two cases of the condition are reported. The first was that of a white man aged 59 in whom there gradually developed ascending myelitis with a transverse lesion of the cord at about the level of the third dorsal segment and then, while he was still hospitalized, bilateral optic neuritis, which later cleared up. There were no other signs of neurologic damage. The second case was that of a white woman aged 43 who, after acute pharyngitis, had acute bilateral optic neuritis associated with symptoms and signs of ascending myelitis and died on the twelfth day in the hospital. Autopsy was performed, and pathologic study revealed diffuse necrosis of the medulla and spinal cord, characterized by demyelination, destruction of nerve fibers, foci of softening, hemorrhage, status spongiosus, increase in microglia cells and innumerable gitter cells.

There was severe, diffuse retrobulbar neuritis, with demyelination, destruction of nerve fibers, presence of hypertrophic astrocytes and increase in microglia cells, with formation of gitter cells.

The authors assert that the distinctive nature of the 2 cases reported and the absence of dissemination justify placing them in a category of their own. This concept is supported by the pathologic observations in case 2, which do not conform in any way to even the broadest pathologic concept of multiple sclerosis or disseminated encephalomyelitis. Diffuse, massive necrosis of the spinal cord, acute degeneration of the optic nerves and complete absence of dissemination elsewhere in the central nervous system constitute a pathologic complex *sui generis*. The authors feel that neuro-optic myelitis should be considered as a clinicopathologic syndrome, within the broad group of acute toxic and toxi-infectious degenerations of the nervous system.

CHODOFF, Washington, D. C.

TRAUMATIC PNEUMOCEPHALUS. L. H. GARLAND and M. E. MOTTRAM, *Radiology* **44:237** (March) 1945.

Garland and Mottram report a case of traumatic pneumocephalus occurring in a man aged 28 nine weeks after attempted suicide. The bullet entered the right temporal region and produced immediate and permanent blindness of the right eye. Nine weeks later headache, vomiting and drainage of spinal fluid from the nose developed. A roentgenogram showed air in the lateral, third and fourth ventricles and in the right frontal area, in the region of the fracture through the anterior fossa. Complete symptomatic recovery followed rest in bed, and roentgenograms made ten days later showed only a trace of residual air in the ventricles. Undoubtedly, the air entered the brain through the fractured frontal and ethmoidal sinuses.

The vast majority of pneumoceles are the result of fractures of sinuses or mastoid, with the air entering the brain as a result of increased pressure (coughing, sneezing or blowing the nose) or the ball valve action of a piece of tissue or bone. The collection of air may occur within a week after injury or may be delayed as long as ten months. The usual interval before recognition is about one month. The reason for the latent period is unknown.

The symptoms of pneumocephalus may be mild, but there is usually some irritation of the central nervous system, often associated with meningismus or signs of increased intracranial pressure. Without roentgenologic studies, an incorrect diagnosis of cerebral abscess, subdural hemorrhage or meningitis may be made. The mortality is about 40 per cent, with death usually due to meningitis.

TEPLICK, Washington, D. C.

ENCEPHALITIS AND TRAUMA. J. O. TRELLES, *Rev. de neuro-psiquiat.* **7:361**, 1944.

A merchant aged 42 was assaulted and thrown to the ground, sustaining a head injury, with loss of consciousness for a short, but undetermined, period and ecchymoses around the eyelids. Except for occipital headache for a few days, there were no postconcussional complaints. Six weeks later he suddenly became dizzy, complained of occipital headache and became dull and somnolent. Two weeks after this, right hemiplegia developed, with hyperreflexia and a positive Babinski sign, associated with lethargy, torpidity and dysarthria. He was indifferent and confused, yawned frequently and had attacks of paroxysmal laughing and crying. His pulse rate was 56. The urine was normal; urea nitrogen measured 37 mg. per hundred cubic centimeters, and the white blood cell count was 12,600, with 77 per cent polymorphonuclear cells. A few days later the white blood cell count was 8,600, with 76 per cent polymorphonuclear cells. Examination of the spinal fluid on April 30 showed 13 lymphocytes, 97 mg. of glucose and 644 mg. of chlorides per hundred cubic centimeters; the Pandy test gave a negative reaction for globulin, and the Wassermann reaction of the spinal fluid was negative. The fundi showed blurred edges of the disk and dilated veins. There was progressive improvement, and the patient was considered recovered after four months. The clinical picture

was that of encephalitis. On admission, because of the recent history of head trauma, the possibility of a subdural hematoma was considered. The author believes that the trauma created a locus minoris resistentiae in the brain and predisposed to localization of the virus.

SAVITSKY, New York.

Diseases of the Spinal Cord

ABDUCENS PALSY (WITH SUBSEQUENT RECOVERY) FOLLOWING LUMBAR PUNCTURE.
HARRY M. ROBINSON JR., Am. J. Syph., Gonorr. & Ven. Dis. **29**:422 (July) 1945

Robinson reports his observations on a man aged 26 who was subjected to lumbar puncture toward the end of a course of antisyphilitic treatment. The following day he experienced dizziness and severe pain at the site of puncture. The pain, which originated in the lower part of the back, seemed to shoot up to the neck and the back of the head. On the following morning he could not stand without fainting.

Five days after lumbar puncture diplopia developed. He had partial paralysis of the right abducens nerve, with almost complete strabismus of the right eye. Two days later the paralysis of the right sixth nerve was complete. Complete neurologic examination revealed nothing unusual except for involvement of the abducens nerve. About twenty-seven days after lumbar puncture some lateral motion in the right eye was present. Steady improvement followed. There was complete return of function about two months after the lumbar puncture.

GUTTMAN, Philadelphia.

TRANSMISSION OF POLIOMYELITIS BY PATIENT TO PATIENT CONTACT. A. E. CASEY and W. I. FISHBEIN, J. A. M. A. **129**:1141 (Dec. 22) 1945.

Casey and Fishbein, in their study of transmission of poliomyelitis by patient to patient contact, found that of 66 persons in contact with patients with poliomyelitis during the infectious period, 37 had illnesses within six to fifteen days afterward which were compatible with poliomyelitis. Of 109 other children of the same age who resided within the same block as the patient but who had not been in contact with the patient during the infectious period, 4 had illnesses compatible with poliomyelitis, and not 1 had a classic case.

Of 115 control children of the same age as the contacts and noncontacts but who lived ten and fifty blocks distant from the poliomyelitis patients' neighborhood and were apparently without contact with a clinical case, 5 had illnesses compatible with poliomyelitis, and not 1 had a clinical case. There was no statistically significant difference between the noncontacts and the controls in this respect, but there was a highly significant difference between these two groups and the contact group.

The authors came to the following conclusions: Multiple cases of poliomyelitis in the family were the rule rather than the exception when there were other children from 1½ to 8½ years of age in the home. 2. Poliomyelitis was found to be contagious perhaps to the degree of 90 per cent in the 1½ to 3½ year age group but was less so in the older groups. 3. There was no evidence that flies and other insects played a major role in the spread of the disease in the neighborhoods studied, once the disease had been introduced. 4. Only about 1½ out of 6 cases of poliomyelitis would have been diagnosed as such, even under an alert public health reporting system, without an intensive neighborhood study. Illness in the other cases of poliomyelitis was generally so mild that a physician was not consulted. 5. Paralysis developed in about 1 case in 6, and in about 2 cases in 6 the diagnosis could be confirmed only by animal inoculations or by determination of the protein content of the spinal fluid two to seven weeks after onset. 6. Poliomyelitis in the cases studied was usually very mild, but in every instance there was sufficient systemic disturbance to account for thorough immunization. Even

in the mildest cases the protein of the spinal fluid was above 45 mg. per hundred cubic centimeters two to six weeks after onset. 7. Earlier observations by Casey, Aycock, Kessel and Gordon on the infectious and incubation periods are confirmed, and the original high percentage of patient to patient contacts noted in a rural epidemic is substantiated by finding the same conditions in a large urban area like Chicago in a nonepidemic year. 8. Present methods and criteria for the diagnosis of the disease must be revised.

ALPERS, Philadelphia.

TREATMENT OF PREPARALYTIC POLIOMYELITIS WITH GAMMA GLOBULIN. A. M. BAHLMKE and J. E. PERKINS, J. A. M. A. **129**:1146 (Dec. 22) 1945.

Bahlke and Perkins believe it can be conclusively stated that, in a series of 111 patients with preparalytic poliomyelitis observed for approximately six months after onset, no benefit was detectable when 56 of them who had received large doses of gamma globulin intramuscularly in the preparalytic stage were compared with 55 alternate, untreated, controls.

ALPERS, Philadelphia.

A STUDY OF THE ORIGIN OF AN EPIDEMIC OF POLIOMYELITIS. M. L. SMITH, E. M. BRIDGE, H. E. UNDERWOOD and G. E. DALE, J. A. M. A. **129**:1150 (Dec. 22) 1945.

Smith and her co-workers made a study of the origin of an epidemic of poliomyelitis. The work covered the circumstances surrounding the development of the first 3 paralytic cases of poliomyelitis in the 1944 epidemic in the Buffalo area. The evidence indicates that these cases did not arise *de novo*, but were relatively late developments in a cycle which had been in progress, but unsuspected, for approximately three months. Although a period of five and one-half months elapsed between the last reported case of the preceding season and the first of the 1944 epidemic, the interval was only two months prior to the earliest minor illness in 1944 which, on the basis of circumstantial evidence, was caused by the virus of poliomyelitis. In view of the difficulties in recognizing such minor illnesses, it is probable that the virus was continually active in the area throughout the entire period between the two cycles. The incidence of illnesses in the community which were highly suggestive of being nonparalytic forms of the disease was at least five times that of recognized poliomyelitis. The week by week distribution of these suggestive illnesses followed the same general pattern as the reported cases, but began earlier in the season and extended later. Other minor illnesses, simulating ordinary gastrointestinal and respiratory infections, were also widely prevalent. Although no laboratory studies were made, the evidence presented suggested that the Buffalo epidemic was initiated and spread largely through direct human sources, and not from polluted sewage, streams, toilets or unsanitary environmental conditions. It is suggested that the definition of an epidemic of poliomyelitis be broadened to include the preparalytic and postparalytic phases of the cycle.

ALPERS, Philadelphia.

NEURILEMMOMA IN REGION OF THE RIGHT AXILLA IN A CASE OF RECKLINGHAUSEN'S DISEASE: EXTIRPATION; RECOVERY. OSCAR L. GÓMEZ and JOSÉ A. URQUIZO, *Prensa méd. argent.* **32**:497 (March) 1945.

Gómez and Urquizo report the case of a solitary neurofibroma in the right axilla arising from the musculocutaneous nerve in a man aged 21. The tumor had remained about the same size since the patient had noted it, one year prior to its extirpation. There was no pain in the right upper limb, but the patient complained of heaviness and ready fatigue of the limb. No tumors were present in any other part of the body. There were many pigmented spots over the face and body, of irregular size and distribution, with a *café au lait* tint. The tumor on extirpation appeared fusiform and measured 5.5 by 3.5 cm. It was well encapsulated, showed

no signs of malignancy and proved to be a neurofibroma histologically. The fibers of the musculocutaneous nerve were separated, without having been destroyed.

N. SAVITSKY, New York.

TUMOR IN THE NECK AND IN THE RETROPHARYNGEAL SPACE—NEUROFIBROMA.
A. R. ALBANESE, *Prensa méd. argent.* **32**:1763 (Sept. 7) 1945.

In 1940 a woman aged 48 noted an increase in the size of her neck. Dysphagia appeared later. In 1942 the tumor reached its maximum size. The tumor seemed to decrease in size temporarily when her periods reappeared, after amenorrhea for two years. Apparently, an operation was performed during the early part of 1944. Before the operation, extension of the head produced dyspnea. Examination of the throat showed that the posterior wall of the pharynx was pushed forward by the tumor. Roentgenograms showed a retropharyngeal mass, pushing the trachea and esophagus anteriorly. There was no Horner syndrome. The tumor, which was removed by a Kocher incision, measured 10 by 12 by 4 cm. The histologic diagnosis was neurofibroma, arising either from the cervical sympathetic or the pharyngeal plexus. The author notes that the absence of Horner's syndrome does not exclude the sympathetic origin of the tumor. In December 1944 the patient was reexamined. There was definite diminution in volume of the neck. A tumor measuring 3 by 4 cm. was seen in the posterior wall of the pharynx which was either an organized hematoma or part of the tumor which had not been removed.

N. SAVITSKY, New York.

Peripheral and Cranial Nerves

INGRAVESCENT NEURONITIS WITH RECOVERY. J. M. NIELSEN, *Bull. Los Angeles Neurol. Soc.* **10**:77 (March-June) 1945.

Nielsen reports the case of an unmarried white man aged 27 with "slowly developing paralysis." In 1933 the patient first noted "numbness" in the right hand, which felt as though it were asleep. In 1934 the right arm continued to feel numb and became weak, and the patient dragged the right foot. At first he attributed his symptoms to the fact that in 1932 he had sustained a fracture of the right humerus. Motor weakness of the right foot had been present for several months, and then the entire lower limb became numb. The following year the left foot became involved in a fashion similar to that of the right, and the left arm followed in this pattern, except that weakness preceded the numbness. Soon afterward the right side of the tongue became numb and the voice became weak. The weight had dropped from 160 to 100 pounds (72.6 to 45.4 Kg.).

In 1937 the patient was "stiff as a board." He had retention of urine and feces, requiring catheterization and use of enemas. Repeated tests for syphilis gave negative results. He had constant left-sided headaches.

In 1939 gradual improvement set in. In 1943 he was examined by the author. He came in a wheel chair and was able to walk with crutches. Physical examination at that time showed that the patient was well nourished and had regained all his lost weight. There was no muscular atrophy, but his shoulders drooped. Neurologic examination showed spastic paresis. The only other significant finding was old exudate in the fundi, the amount being greater in the right than in the left. The pupils were unequal, measuring 4 mm. in the right eye and 5 mm. in the left eye. The left pupil responded poorly to light and with a hippus. All deep tendon reflexes were distinctly increased. Babinski, Chaddock and Oppenheim reflexes were present bilaterally. Examination for sensory modalities gave normal results, but sphincteric control was impaired.

The patient was observed again in 1944 and was able to walk with two canes. Steady improvement was in evidence.

Nielsen comments that it taxes the imagination to visualize the pathoanatomic process and the type of infection which could thus spread throughout the spinal cord and peripheral nerves over a period of five years and still recede to a great

degree in the course of the next six years. He states that infectious neuronitis must serve as the best diagnosis but that the case, even as such, is unique. The case demonstrates the inadvisability of giving an unequivocally poor prognosis even in an apparently hopeless situation.

GUTTMAN, Philadelphia.

DISTURBANCES IN OCULAR MOTILITY ASSOCIATED WITH HYPERTHYROIDISM.
EUGENIO FILIPPI-GABARDI, Riv. oto-neuro-oftal. **17:564** (Nov.-Dec.) 1940.

Filippi-Gabardi reports a case in which a cogwheel phenomenon of the eyes was noted during the course of hyperthyroidism. A woman aged 31 complained of tremors in the upper limbs and of diplopia. She had sensations of constriction in the throat, dyspnea with exertion, headaches, sweating, occasional vomiting, epigastric distress and recent loss of weight, in spite of adequate intake of food. Examination showed tremors in both the upper and lower limbs, being more pronounced in the upper; mild enlargement of the thyroid gland; a basal metabolic rate of 46 per cent; a blood pressure of 125 systolic and 65 diastolic, and a pulse rate of 92. The oculocardiac reflex was negative; the Graefe, Dalrymple, Stellwag and Gifford signs were absent; the pupils were equal and regular and reacted well to light and in accommodation. At rest both eyeballs showed some inward deviation; when either eye was covered the inward deviation of the covered eye increased; there was normal convergence, but a tendency to immediate return to the position at rest. During lateral movements, while the eyes were following an object, cogwheel movements were noted; these became less noticeable with extreme lateral movement. The cogwheel movements were noted on upward or downward gaze. Examination with the red glass test showed homonymous diplopia, which increased in intensity as the light object approached the point of fixation. The fields were normal; prisms did not correct the diplopia. After treatment for twenty days, diplopia was noted only in the right lateral field, and the mild inward deviation of both eyes disappeared. Improvement was noted in the general condition. After one and a half months the diplopia disappeared entirely, reappearing later on left lateral gaze. The author ascribes the ocular disturbances to impairment of tone of the ocular muscles resulting from a vegetative imbalance which accompanied the hyperthyroidism.

N. SAVITSKY, New York.

Society Transactions

NEW YORK NEUROLOGICAL SOCIETY AND NEW YORK ACADEMY OF MEDICINE, SECTION OF NEUROLOGY AND PSYCHIATRY

Joseph H. Globus, M. D., *President, New York Neurological Society, in the Chair*

Combined Meeting, April 9, 1946

Bilateral and Multiple Ruptured Disk as a Cause of Persistent Symptoms Following Operation for Herniated Disk. DR. FRANCIS A. ECHLIN and CAPTAIN BERTRAM SELVERSTONE and MAJOR WALTER E. SCRIBNER, Medical Corps, Army of the United States.

It has been established that the acute symptoms due to herniated lumbar disk can be relieved by removal of the offending disk in most cases. Permanent relief of acute symptoms has occurred in a large proportion of patients who have been able to avoid undue physical strain after operation.

On the other hand, most surgeons will agree that recurrence or, less often, persistence of moderate to severe symptoms following operation for a herniated lumbar disk is by no means uncommon, especially when the patient has undertaken heavy work. The cause of these symptoms is usually obscure. In the great majority of instances they have occurred in patients who had a solitary herniation which apparently had been adequately removed. Multiple herniations cannot therefore account for the symptoms in these cases. In the present paper, further observations are presented, however, which support the belief that these recurrent or persistent symptoms may at times be due to the presence of bilateral or multiple ruptured disk which may be overlooked at the first operation.

In this presentation, time does not permit a detailed analysis of our observations. Briefly, in a series of 60 cases in which operation was performed about a year ago there were 10 proved instances of multiple herniated disk. In other words, in 16.6 per cent of this series of 60 cases multiple herniated disks (two or more) were encountered in the lumbar region. In addition, in 4 cases bilateral herniation required bilateral exploration for removal.

Experience in the Army has proved that the problem of herniated disk is not a simple one. Recurrence or, less often, persistence of moderate to severe symptoms, both organic and functional, following operation has been only too frequent, especially when the patient has been required to do heavy work. In Army life, a functional element has probably played a greater role in precipitating these symptoms than in civilian life, but in many cases the causative factors are not clear, or at least there is a wide difference of opinion concerning them. In the great majority of cases in which such symptoms were presented a solitary herniated disk had apparently been adequately removed. As pointed out, multiple herniation cannot, therefore, account for the symptoms in this group. It is believed, however, that the series of cases reported illustrate that bilateral or multiple herniation which may be overlooked at the first operation may at times account for this persistence or recurrence of symptoms.

Clinical signs alone usually fail to indicate the presence of more than one herniated disk, and therefore cannot safely be relied on to disclose the multiple lesions under discussion. Myelographic studies with Pantopaque (an iodized poppyseed oil) are helpful in revealing the presence and level of such lesions and, in our opinion, are indicated in all cases. This procedure, however, occasionally may also fail to reveal a ruptured disk, especially when the herniation lies far laterally. In the presence of a negative myelogram, decision to operate will depend on the severity of the symptoms and on whether or not the clinical picture is

characteristic of a herniated disk. Likewise, decision to explore multiple defects will depend on their nature, the patient's symptoms and the surgeon's clinical judgment.

It should be emphasized that, although the removal of multiple ruptured disks will usually relieve acute symptoms, heavy work is probably more likely to precipitate postoperative symptoms in patients with such lesions than in patients who have required the removal of only a single disk. The fact that multiple herniations are relatively common therefore only emphasizes the complexity of the problem.

DISCUSSION

DR. JOSEPH E. J. KING: We are indebted to Dr. Echlin and his associates for their informative presentation. Originally, Dr. Mixter and Dr. Barr, who probably deserve more credit than any one else in this country for establishing herniation of an intervertebral disk as an entity, told us how the definite diagnosis could be made in most cases. They used a radiopaque substance, iodized poppyseed oil 40 per cent. Their precepts were followed for a number of years, by and large, over the country.

It is believed that recently a radiopaque substance, either iodized poppyseed oil 40 per cent or Pantopaque, has not been so widely used as formerly. It is my impression that surgeons and neurologists have relied more on physical and neurologic examinations in making the diagnosis. Moreover, some authors have gone so far as to say that lesions of the intervertebral disk are the most common cause of pain in the lower part of the back, with or without sciatica (Key, J. A. (St. Louis): *Tr. South. S. A.*, 55:150, 1944).

Operations have been carried out without a definite diagnosis of even one herniated intervertebral disk, not to speak of multiple lesions. In fact, I believe most neurosurgeons have operated at some time without the use of iodized poppyseed oil, Pantopaque or air. In some sections it has become almost a fad to recommend operation for herniated disk on the slightest provocation, and at times no such lesion is to be found, unless it is "invented." Some disks have even been designated as "concealed."

I have had no experience with multiple herniated disk. I have operated on patients, with and without the use of a radiopaque substance, and have failed to find a herniated disk. I feel sure that I have missed some. Although most of the patients have been relieved of their pain, others have continued to complain of pain in the back, and some even of pain down the other leg.

This brings me to the point of the authors' presentation. They have shown that multiple lesions exist, and in cases in which the bilaterality was not even to be suspected from the signs and symptoms. Not only that, they have removed these disks in the series of cases cited. These facts explain why some patients in the past have not been relieved of their complaints. The high percentage of cases of multiple lesions in Dr. Echlin's series warrants a more thorough preoperative effort at complete diagnosis than has been made in the past. I am convinced by his experience that roentgenograms with the radiopaque solution in situ should be made routinely when a likelihood of herniation of an intervertebral disk exists. By so doing, the operative results will improve. Although such studies entail more work and consume more time, and although it is tedious to remove the solution, the examination should be carried out. It has been demonstrated that Pantopaque can be removed almost entirely, and the very small amount that may remain is of no concern.

Only today I read an article by Dr. James White, of Boston, and Comdr. T. H. Peterson (MC), U.S.N.R. (Lumbar Herniations of the Intervertebral Disk, *Occup. Med.* 1:145 [Feb.] 1946), in which ten papers were listed, all by recognized authors. An enormous number of cases are represented, about 900, from their various services. White and Peterson classify the results as excellent to good, fair and unsatisfactory. I was surprised that these physicians had good results in about 67 per cent of their patients, 17 per cent of their patients showed improvement,

and in about 13 per cent treatment gave unsatisfactory results or made the condition worse. I think, therefore, that Dr. Echlin's paper is timely.

DR. BYRON STOOKEY: Dr. Echlin let me read his paper, and I am amazed at the number of cases of multiple ruptured disk which he has seen. The frequency with which he has found these lesions is far beyond anything that I have encountered. It may well be that I have missed them; however, the high incidence of multiple herniated disk in the military service may have to do with the special forms of duty. Driving and riding in jeeps or tanks, dive bombing and many other duties associated with combat may be determining factors in the production of multiple herniation of the nucleus pulposus.

For a long time my associates and I refused to use iodized poppyseed oil and resorted to it only occasionally. We have tried oxygen myelography, but I must say that, though this is a procedure which I originally recommended, it is not satisfactory, frequently because the interspace between the fifth lumbar and the first sacral vertebra is not shown and therefore one of the most common locations is not visualized. However, even with Pantopaque, herniations of the nucleus pulposus have not produced any defect in the oil column, and yet at operation the lesions have been encountered.

With an interlaminar approach, neither the strength nor the mechanics of the spine is materially disturbed; hence, when the clinical signs are sufficiently definite an exploration should be made. A negative result in a Pantopaque study does not preclude the existence of a true herniation, and this is especially true with respect to the interspace between the fifth lumbar and the first sacral vertebra. Thus, the diagnosis of herniation of the nucleus pulposus cannot always be made with certainty. The neurologic signs are often equivocal and the Pantopaque studies not necessarily conclusive. The same may be said of myelograms taken with iodized poppyseed oil 40 per cent or oxygen and of oxygen epidurograms.

Dr. Echlin has called attention to the important point that herniation may be multiple, and in his military experience it has been multiple in a relatively large percentage of cases. He has demonstrated without question that a bilateral herniation may exist with signs only on one side and that removal of the herniation from one side, though thorough, does not reduce the herniation on the opposite side. His clinical materials indicate that Pantopaque studies are essential for the diagnosis of multiple herniations. I came to that conclusion reluctantly, because I prefer to make my diagnosis on the basis of the neurologic findings; however, I am sure that I could not establish the diagnosis of multiple herniation on the neurologic signs alone; either Pantopaque studies must be made, or the surgeon must operate without using Pantopaque and explore from two to three lumbar spaces; and as between these two alternations, I prefer the Pantopaque study.

I agree with Dr. King that operation for this lesion has not been so successful as one would wish. A number of patients have continued to complain after removal of the herniation. On the other hand, there are patients in whom no herniation was seen who have been completely relieved of pain. For these reasons, I come to the operation with considerable misgiving. From a purely technical standpoint, the interlaminar approach is simple, disturbing so little of the mechanics of the spine that an exploration can be done with a minimum of injury. With this approach, the patient does not require a fusion unless obvious mechanical disturbances of the spine are demonstrable, and in such a case fusion is not precluded by the simple procedure in an interlaminar approach.

Dr. Echlin is to be congratulated on his thorough study and on his calling our attention to the frequency of multiple herniation and to the fact that the herniation may be bilateral and yet give no signs on one side.

Electroshock and Personality Structure. DR. ERICH P. MOSSE (by invitation).

The effects of electroshock therapy are psychosomatic phenomena. The spectacular changes of behavior are due not only to an alteration in the electrophysio-

chemical metabolism of the brain cells but to the psychologic experience of the shock as well. The individual difference in the types of convulsions is not due alone to weather conditions, application of the electrodes to different spots, differences in thickness of the skull or differences in the current. It is also the patient's willingness, and often observed masochistic eagerness, and his craving for atonement to ease his guilt that keeps the threshold lower in some cases than in others in which aggression, anxiety or stubbornness is a deep-rooted trend of the neurosis.

The psychologic reactions during the ten to thirty minutes following the pulling down of the electric switch have one common denominator: All of them show more or less dramatic signs of regression on the oral or infantile aggressive level, or other infantile sexual manifestations. The success of the treatment is essentially due to a battering down of the defense mechanisms, which is a reaction of the ego to the conflict between the id and the superego. This superego is destroyed or eased by the experience of the shock as an utter punishment by the parent-psychiatrist, in whose basic kindness the patient can confide. Another factor is the temporary impairment of memory. One must conceive of the structure of the whole personality as a kind of tree, which from earliest childhood has kept intact each minute of emotional experience in its time layers. The postshock defects of memory would then mean that the electric current affects that part of the mental apparatus which deals with the selective process of repression. On the one hand, experiences are forgotten; on the other, the forgotten is recalled. This paradox can be understood only if one assumes the existence of a special memory organization, which is affected and stimulated as a whole by the electric shock. In this process of "transmutation" one is not able to discover any specifically selective trends other than those provoked by the easing process of the superego.

The most impressive psychologic effect of the shock is the strengthening of the ego—its detachment from the aforementioned pathologic regressions and, with that, its increased endeavor to give them up. It is significant, in this connection, that a considerable increase of potency can be found in the great majority of patients after the shock. This might be due partly to direct stimulation of neuronc metabolism; however, that does not exclude the fact that the decrease in guilt feelings produced by the atonement through punishment liberates the object cathexis of the blocked and repressed libido. Thus it is understandable why the psychoses show a much better and more spectacular improvement than the psychoneuroses; the accumulated guilt is much more deeply experienced in them than in the neuroses.

DISCUSSION

DR. FOSTER KENNEDY: I was unable to gather everything that Dr. Mosse was saying, but practically everything I heard him say I disagree with. He has made an effort to combine, willy-nilly, something in the psychologic mechanism which has been familiar for the last thirty years, as described by Freud, with an entirely new instrument of treatment and has tried to belittle the latter in terms of the former. Perhaps I have had as much experience as any one with electric "shock" treatment, having begun its use in 1940 and having used it almost daily since that time; so I cannot agree at all with many of Dr. Mosse's statments. For instance, he said that results of electric shock treatment come from "the death threat." That has frequently been said. Perhaps my patients are not as afraid of dying or as anxious to die as are others; but I am quite sure that the "death threat" plays no part in their progress and frequent recovery. One of my patients was a lawyer, a full time associate professor of law. I have seen him through three very severe agitated depressions, two of them in the years before the advent of electric shock treatment. Each of those attacks lasted about five years and confinement in a mental hospital was necessary. In the last attack he severed his trachea, after taking enormous quantities of alcohol, and threw himself into the sea. He was rescued and, with good surgical treatment, was saved, after the expected long illness. During the six months required to recover from his surgical condition, he was as agitated, as ill with somatic sensations and apprehensions of despair as

he had been before he became unconscious through his desperate suicidal attempt. I do not think any one could have had a greater "death threat" than he administered to himself. On his recovery from the operation and illness, I persuaded him to submit to electric shock treatment, which he did, and in three weeks he was entirely free from symptoms. The "death threat" of the electric current evidently did something that the "death threat" of the sea and his severed trachea had not done!

Dr. Mosse said, dogmatically (I am quite sure that I am quoting him correctly) that "no electric shock treatment can cure a mental disease without psychotherapy." Before one can discuss anything, one must define one's terms. A woman aged 78 who had been in Bloomingdale Hospital for about a year with a severe depression, constant agitation, utter despair, constant moaning and sleeplessness can, I suppose, be called psychotic. This woman was cured in two treatments without psychotherapy and has remained free from symptoms and in possession of her normal happy, optimistic personality, for the past three years.

DR. JOHN A. P. MILLET: The last discussion indicates a lack of openness of mind which is regrettable in scientific matters. Much of Dr. Mosse's paper is provocative. One may not agree with all his conclusions. The approach of psychology to shock treatment is still in its infancy, but its application will certainly reveal a great deal about this method, particularly from the standpoint of how to treat the patient both before and after shock. One hears many reports of the threats from shock treatment to the patient's final mental integrity. The lay press has picked up some of these reports; in a recent issue of *Science News Letter* there is such a story. It is incumbent on all scientists who are interested in trying out this important new therapy to be careful what they state in their published articles. The outstanding feature of the treatment—a point on which I can agree with Dr. Kennedy—is that it can cure certain patients without psychotherapy. This does not mean, however, that it cannot be used as an adjuvant to, and as a support for, effective psychotherapy. These are two entirely separate features of the value of treatment. I wonder how many who have used the treatment have been scared off from completing it by the appearance of a new type of psychosis during the treatment period, after five or six applications of the electric current. Certain repressed contents in the personality of the patient are unleashed by the application of electric shock. These secondary psychoses, which Dr. Kalinowsky has so ably presented, are one of the best proofs of this release; as he has also shown, if the treatment is continued, the secondary psychosis will clear up automatically.

The approach to the apparatus in electric shock is, in my opinion, almost as important as the application of the current itself. The nonsense of wheeling in a lot of apparatus and of placing heavy pressure on various parts of the body in order to prevent the patient from some damaging effect of the convulsion is outmoded. Any one who has seen Dr. Kalinowsky demonstrate this treatment, and the ease with which he does it, and has observed the absence of necessity for any forcible holding of the body will become convinced of the danger of such a procedure. I wish to congratulate Dr. Mosse for bringing the psychologic aspects of electroshock treatment to the attention of this audience.

SYMPOSIUM ON THERAPY OF THE PSYCHONEUROSES

Elements in Psychotherapy. DR. CLARENCE P. OBERNDORF.

My thesis is that the element of suggestion, in the sense that suggestion is a transference phenomenon, is essential in all forms of psychotherapy. Constant elements in all psychotherapy are (1) the person or agency instituting the treatment, (2) what is said or done, (3) when it is said or done, (4) how the treatment is administered, and (5) the susceptibility of the person to psychotherapy.

Psychoanalytic investigation has contributed a vast amount of information concerning the mode of operation of all these factors, but in psychoanalysis itself suggestion plays an important role, particularly as related to the person who undertakes the treatment and the way in which he administers it.

Brief reference was made to 2 cases of a condition considered to be a psychoneurosis. In the first case shock therapy had greatly improved the patient's condition after psychoanalytic treatment had failed. In the second case, after long, unsuccessful general psychiatric treatment and shock therapy, psychoanalysis proved strikingly effective.

Results of Hospital Treatment, Including Electric Shock, of Psychoneurotic Patients. DR. JAMES H. WALL (by invitation), and DR. DONALD M. HAMILTON, White Plains, N. Y. (by invitation).

During the past twenty-five years there has been a gradual increase in the number of patients with psychoneurotic disorders admitted to the New York Hospital—Westchester Division. In 1921 there were 21; in 1931, 30, and in 1945, 68. In 1941 and 1942 we made a study of the hospital treatment of patients with psychoneurotic reactions (*Am. J. Psychiat.* 98:551 [Jan.] 1942; 99:243 [Sept.] 1942). It was a review of our experience with 100 men and 100 women patients admitted consecutively over a ten year period. These patients were carefully studied physically, and any physical disorder, which was rare, was treated promptly. The patients were placed on a regular dietary regimen and were encouraged to engage in a full program of occupational therapy, physical education and social activities. The physician directed these activities and conducted the psychotherapeutic interviews. During their hospitalization many patients realized for the first time in their lives the value of regular habits of living.

During the past four years electric shock treatment has been added to this therapeutic program for patients with psychoneurotic disorders. Patients to be given electric shock are selected from those who do not show a quick response to the usual therapeutic regimen of the hospital. We have found that electric shock treatment was indicated for only one third of the patients with psychoneurotic disorders who were admitted to the hospital. The giving of electric shock is carefully timed and is associated with intensive psychotherapy.

From 1942 to 1944, inclusive, a period of three years, 50 patients with psychoneurotic disorders were given electric shock therapy. The results in this group were compared with those obtained in the earlier series of 200 psychoneurotic patients whose treatment was not supplemented with electric shock.

The most striking difference between the two groups is in the average length of hospitalization. In the non-shock-treated group this was eight and three-quarters months, whereas with the shock-treated group it was five and one-half months. Thus the period of hospitalization of the patients who received electric shock therapy was less than two-thirds that of the patients who did not receive this treatment.

The difference in the percentages of recovery of the two groups was not great—39 per cent of the 200 non-shock-treated patients and 46 per cent of the 50 shock-treated patients. This is not an impressive difference, considering the great difference in the size of the two groups. However, 80 per cent of the shock-treated patients had returned home, recovered or with their condition much improved, whereas only 59 per cent of the non-shock-treated patients were so benefited; the status of 151 of the 200 patients who did not have shock treatment was considered to have improved to some degree, whereas that of 48 of 50 of the shock-treated patients was considered to have improved.

Results of Treatment of Psychoneuroses by the General Practitioner: A Follow-Up Study of 500 Patients. DR. PETER G. DENKER.

Five hundred patients with severe psychoneuroses, all of whom had been ill for three to six months before disability benefits were granted, were studied in sequence. All these patients were treated by general practitioners throughout the country, and were not patients of psychiatrists, psychiatric institutions or psychoanalysts. The therapy instituted was of the usual type resorted to by the general

practitioner, with reassurance, suggestion, discussion of conflicts and sedation. With none of the patients was "deep psychotherapy" used. These patients were kept under observation for at least five years, and many of them for as long as ten years, with the results indicated in the tabulation.

Time Required for Apparent Cure After Onset, Yr.	Number	Percentage of Total Series
1.....	233	44.6
1-2.....	135	27.0
2-3.....	48	9.6
3-4.....	26	5.2
4-5.....	18	3.6
Still disabled after 5 yr.....	50	10.0

It can be readily seen, therefore, that in this series of patients with severe psychoneuroses, whose inducement to get well was certainly not helped by the fact that disability benefits were received monthly for the duration of the illness, approximately 45 per cent "recovered" within one year, complained of no further, or only very slight, difficulties and made successful social and economic adjustments. Another 27 per cent took from one to two years for a similarly successful outcome, making a total percentage of "recoveries" of 72 within two years.

These results were compared with various reports in the literature from psychiatrists, psychiatric sanatoriums and psychoanalytic institutes. It was found that approximately the same percentage of cures was reported regardless of the type of psychiatric therapy used; all figures show between 60 and 80 per cent of patients "apparently recovered" or "much improved" within a two year period.

It was concluded that the type of therapy instituted was of secondary importance, provided the patient was treated with sympathetic common sense and great patience on the part of the physician, confidence in the physician being an important factor. The physician should appreciate the importance of the "time factor" in the gradual readjustment of these patients, must allow them adequate opportunity to pour out their apparently never-ending series of complaints and use common sense and honest reassurance in discussing their conflicts with them. He will then be surprised at the remarkable degree of success he can attain without resorting to specialized help, except in the minority of cases.

DISCUSSION ON SYMPOSIUM ON THERAPY OF THE PSYCHONEUROSES

DR. GEORGE BAEHR: After listening to Dr. Denker's paper, I understand why I have been invited to open the discussion—to express my condolence with the psychiatrists, who are no longer needed in care of the psychoneuroses. There is a grain of truth in Dr. Denker's paper. The general practitioner has an important contribution to make, if he knows how. It would have been wrong to have had this discussion end without something being said about the contribution of the general practitioner to psychotherapy and the prevention of disease. Although I cannot agree with Dr. Denker that psychotherapy can be left to the practitioners of medicine, I must admit that the general practitioner is in a position to play a more important role than the psychiatrist in preventive medicine in the field of the psychoneuroses. The psychiatrist's relation to the treatment of the psychoneuroses is like that of the surgeon to surgery; the general practitioner can, and does, handle most of the minor psychoneuroses, although often not very well; he occasionally can handle a major psychoneurosis if he is particularly qualified and if he has a deep interest in his patient and the gifts of human understanding and sympathy. A general practitioner of experience can acquire the proper approach to his patient, so necessary to secure that transference which Dr. Oberndorf emphasized. The chief function of the general practitioner, to my mind, is prevention; he can prevent the development of a great many of the preventable anxieties by his approach to patients with organic disease, and he is in a position

to relieve the anxieties of those who come to him for psychosomatic disorders. One hears a great deal from psychiatrists about the prevention of the psychoneuroses. The overwhelming importance of these disorders is revealed not by mortality, but by the morbidity, statistics, which, if correctly interpreted, indicate that the psychoneuroses play a greater role in human unhappiness and human illness than does cardiac disease, cancer or tuberculosis. As yet, no appreciable progress in prevention has been made, and not much progress will be made until the psychiatrists learn to work in closer relation with the interns and residents in the wards of hospitals and with general practitioners and medical specialists in private practice.

Nation-wide discussions in recent years concerning psychosomatic disorders have brought psychiatry closer to medicine, and medicine closer to psychiatry. The psychiatrist who concerns himself solely with institutional psychiatry or whose days are filled with the private practice of psychoanalysis may be playing an important role in everyday life, but not one of great social significance. A real contribution to social and medical progress can be achieved by psychiatrists who work in close relation to internal medicine, as an integral part of the department of internal medicine of a general hospital. Personal psychiatry must be as integral a division of a department of internal medicine as is the division of cardiac disease or any of the other disciplines of medicine. As internists, we welcome, in fact we plead for, that close relationship. We need it, because as internists we see by far most of the psychoneurotic patients, of whom psychiatrists see only a small fraction. The great majority of the psychoneuroses, which constitute most of the disabilities of everyday life, are our responsibility. We handle them perhaps poorly; we are often responsible for creating them; we need the help and the cooperation of psychiatrists if we, as internists, are to be more effective in preventing disease.

DR. A. A. BRILL: I was very much interested in all the presentations and was particularly pleased to hear what Dr. Baehr has just said, "There is a grain of truth in what Dr. Denker said." Yes, just a grain! When Dr. Denker compares his series of psychoneurotic patients with those who were treated by psychoanalysts, he forgets that the latter belong to quite a different class. They do not come to the analyst after three months of illness. They usually come after years of non-analytic treatment. They represent that percentage of neurotic patients in Dr. Denker's category who do not improve with other treatment. We psychiatrists do not see the neurotic patients who get well in one year, or in two or three years. The neurotic patients who eventually come to me for treatment have already received every sort of therapy for years.

I am also much impressed with what Dr. Baehr said about the responsibility of the internists for the large number of psychoneurotic patients. We have known this for a long time, and I am pleased to hear it corroborated by him. I agree with him that an understanding on the part of the internist and the surgeon of the psychic mechanisms underlying the psychoneurosis not only would obviate much unhappiness but would decrease the number of chronic neuroses, which we psychiatrists find so difficult to cure, and which present such a problem to the state.

I was much impressed with Dr. Mosse's paper. I am in an anomalous situation with respect to shock therapy. I became interested in it when it was applied solely to the treatment of schizophrenia. I saw it first in Europe, particularly in Switzerland, where only Sakel's method was used. I can say that I introduced it into New York city, for on Dr. Sakel's first day here I urged him to instruct the state hospital physicians in his therapeutic methods. I had him meet the state commissioner of mental hygiene and about a dozen of the leading psychiatrists of the state, and he consented to instruct the state hospital physicians. I have, of course, been interested in the results both here and abroad. Having seen a number of panaceas in psychiatry come and go since the turn of this century, I adopted the attitude of watchful waiting. As time went on, I was more and more disappointed in the results obtained in treatment of schizophrenia. The first report

on shock therapy of this disease was made by a commission of leading Swiss psychiatrists, who confined themselves to the treatment of schizophrenia with Sakel's and Meduna's shock methods. They expressed the opinion that shock therapy may "in favorable cases" shorten the attack, an effect which is also possible with other means, but that it has no other effect on the disease. Recently, I read a paper by Dr. Manfred Bleuler, who came to virtually the same conclusion. In his paper (*Das Wesen der Schizophrenieremission nach Shockbehandlung*), based on cases occurring in the Basel Psychiatric Clinic from 1936 to 1941, in which the treatment was successful, he states that the results in the treated patients were the same as those in the patients who were not treated with this method, that biologically cure with shock therapy resembles spontaneous recovery and that the schizophrenic process is not influenced by the treatment. The patients he studied were observed from three to four and a half years after they had been successfully treated with shock.

I assume that Dr. Kennedy's patient was not schizophrenic but had a depression. It is recognized, of course, that patients recover from depressions with or without the help of a psychiatrist. I cannot agree, therefore, with Dr. Kennedy that shock therapy cured his patient. This patient had had two previous attacks, from which he recovered without any shock therapy. In his last attack, he attempted suicide but recovered in eight months, after a few shock treatments. How does one know that the shock therapy had anything to do with his improvement? As a matter of fact, experienced psychiatrists know that after a suicidal attempt the patient invariably recovers from the attack sooner than from attacks without such an act. Dr. Oberndorf might have discussed the meaning of the suicidal attempt. It is in itself a shock which the patient administers to himself. Having thus paid his debt to the superego, the patient recovers without the need of further shock. I do not think that one has the right at present to draw conclusions about the efficacy of shock therapy of depressions from which the patient not only recovers spontaneously but can be "cured" by other, less risky, methods. Every week I see patients with depressions who have not benefited from shock therapy; on the contrary, they claim that the treatment has made them worse. I know of patients who formerly went through depressions and recovered completely in a few months whose attacks were aggravated by shock therapy. Some complain of poor memory and other disagreeable symptoms, which I have no doubt are produced by shock therapy. I feel that psychiatry is at the very beginning of a new experiment which may or may not be recognized later as a therapy of some merit, but until the technic is improved and unified one has no right to talk of "cures." It must be remembered that even schizophrenia, especially the schizoid-manic type, shows spontaneous remissions. Patients with manic-depressive psychosis invariably had remissions, or, perhaps better, recoveries, from the attacks long before shock therapy was heard of.

Psychiatry is on the brink of a new era, perhaps an era of great discoveries, which may come from physical therapy or from psychotherapy, probably from both. In listening to the speakers, however, I was impressed with their all using terms and schemes outlined by Freud. Dr. Mosse attempted to interpret the behavior of the patients during shock therapy in terms of the psychic apparatus. Others may give a different interpretation; this is really immaterial; there is room for various interpretations. Personally, I feel that the only consistent and logical interpretation of neurotic manifestations is the one given by Freud. I was pleased to hear that Dr. Wall and Dr. Hamilton followed essentially this principle. It was gratifying to hear that all the speakers stressed the value of psychotherapy following shock therapy.

DR. FOSTER KENNEDY: It would seem necessary for us to unify our thinking. No one here has made the least attempt to define a neurosis. There are probably as many opinions as to what a neurosis is as there are persons in this room. Neurotic persons act, feel and think unsurely. Some people are unsure in acting, feeling

and thinking from time to time and are valid, well integrated, realistic and well controlled in the intervals between. Why do they become subject to a compulsive neurosis overnight, as many do, and I have seen many do, and remain the victim of a compulsion: to wash continually, to pick up paper, to read numbers, to ascertain in a paranoid way whether their domestic happiness is endangered? Why do some under the whip of these obsessions and ritualistic superstitions in a matter of six months or a year or, as Dr. Denker's figures show, in about two years find the neurosis disappearing? The patient then becomes himself again, whatever may be the treatment—supportive, suggestive or analytic. Most of these patients, whatever treatment is administered, become well in time, and whoever is treating them when they recover gets the credit. I have never deceived myself about this in the past, though I have often had the credit for the cure in such a situation. In the last five or six years I have treated many such patients with electric shock. Many have been old patients; some came to me first twenty-five or thirty years ago. Their own records may be taken as a control. Many were ill with the same symptoms for intermittent periods lasting over six months; some had neurotic periods of three to five years, and in the intervals between they had long periods of normal and courageous living. Dr. Brill asks how I know that my patient, the professor of law, would not have recovered without any shock treatment. My answer is that this patient, who has been under my care twenty-five years, has a history of two previous illnesses during that time, with a definite cycle; one lasted four and a half years and the other five years. I have every reason to believe that he would not have recovered in less than four years without the shock treatment, which cured him within four weeks. Dr. Kalinowsky gave the treatments. Without electric shock treatment I have every reason to believe that the patient would not have recovered. When the treatments were started, he was exactly as ill as when he attempted suicide eight months before.

Of course, psychotherapy must be combined with physical therapy. That is true of all medicine and of all living. It is true of education; it is true of soldiering; it is true of the management of the patient; it is true in every relation between man and man. But "managing" a patient with an agitated melancholia will not "cure" him of the melancholia. In my belief, such a condition is part of the pulse of life to which we human beings are all subject; it is essentially a manic-depressive situation. Pathology having been endowed with a microscope, one has come to think of pathology only in terms of cells and fibers and to neglect the pathology of forces. The great tides of nervous energy kept in balance between pressor and depressor groups are what we live by. We are integrated in unstable equilibrium, like everything else in the universe. We live on a pulse—systole lives by diastole; we are all subject to variations, ebbs and rises of energy—but in the "normal" person these variations do not rise to consciousness. We are not aware consciously of our mild depressions or our mild elations; our better working form, our poorer working form. But a great mass of the population, the neurotic persons, go into depressions, which are exaggerations of the normal man's "slumps," and also into states of high elation. Often in elations such persons do the best work of the world. Musicians and poets are particularly prone to them. This abnormality in the government of emotional rhythm, implemented through the hypothalamus, as all vegetative rhythms, are, causes a change in mood; out of the mood and out of the imbalance the sick man dips down into the strata of consciousness in which he picks up his early life fears and superstitions. We are all superstitious below the surface, and when sufficiently troubled we nip back to our superstitious heritage. Every child is normally a superstitious poet with obsessions. He passes through this period of obsessive thinking, and when he is adult and in a depression he descends to the phylogenetic youth of thinking and feeling—partly to integrate himself against "mental" illness.

The idea of the mind being apart from the body is nonsense. Body and mind must be unified. One must not neglect physiology; one must not neglect psychology. Our words about thinking are a product of our divided allegiance; we readily

locate in "mind" whatever we would like to place elsewhere but, unfortunately, find no room for. The problem has a complexity which has arisen out of our way of speaking—and speech is, after all, a very recent tool. What we say about our inner feelings, our inner lives, is often a poor mirror of what truly goes on. I believe, as I said earlier, that in what has been so poorly called "shock" therapy there is added a great new instrument for the benefit of many obsessive states, depressive states, "mental" illnesses; "shock" therapy has given psychiatry a reliable instrument for the understanding, as well as the treatment, of "neuroses," and to its use there will always be added "psychotherapy," or the management and control of man by man.

DR. LAWRENCE KUBIE: To me this has been a distressing, discouraging and unilluminating discussion—chiefly claims and counterclaims; old catchwords and slogans. In every field of medicine one can hear this sterile debate about how much of the specialist's field the general practitioner can cover adequately. How can such a discussion be freed from bias? Obviously, only by examining precisely what part of the field the general practitioner sees and what part the specialist sees. To compare the "results" secured by the general practitioner with an undifferentiated group of patients with the "results" achieved by the specialist with that fraction which filters through to him is about as meaningful as it would be to compare the "results" obtained by the general practitioner in treating the common cold with the "results" of the specialist in treating tuberculosis, severe pneumonias, chronic bronchiectasis and the like. At the general practitioner's end is a large and heterogeneous array of benign, self-limited illnesses, with here and there a more serious process, which he may or may not recognize early, which fails to yield to his ministrations and which therefore goes to the specialist. At the specialist's end are the severe, chronic, and often neglected and undertreated, conditions which may reach him too late for help, and only after the patient has been knocked around far too long. This principle is so elementary and so universal in medicine that it is something of a shock to hear Dr. Denker use his statistics on compensation cases (notorious for the fact that they are in no way representative of the psychoneuroses as a whole, and for the fact that a large proportion of the patients recover as soon as the compensation issue is settled in one way or another) to prove that the general practitioner achieves the same results as the specialist. It is even more shocking and disturbing to hear this audience, presumably of critically minded and thoughtful persons, taken in and rocking with laughter at this "proof" that there is no need for more psychiatrists.

What type of psychoneuroses does the general practitioner actually see? First, he sees thousands of patients with neuroses which he fails to recognize because the true condition is masked by the common organic ailments which a neurotic patient can use to mask his neurosis (exactly as the hysterical patient can use hysterical symptoms). Most of these patients pass through his office without the general practitioner's even knowing that a neurosis has come his way. He also sees many acute transitory syndromes, such as the acute, transitory anxiety states which manifest themselves in cardiac, respiratory or gastrointestinal disturbances. He sees transitory neurotic depressions. He also sees, and rarely recognizes, the transitory emotional disturbances which mark the early phases of all the more severe psychoses. At the other end is the specialist in the psychiatric hospital, who sees the end results of this early neglect, that is, patients with severe, and sometimes permanent, psychoses who give a life story of early, transitory "neurotic" episodes, the importance of which was underestimated by the general practitioner, who treated them symptomatically. It is easy to fool oneself into thinking one has cured such a patient, but the curing of a symptom by the general practitioner all too often obscures a malignant process, which then goes on unchecked. I wonder whether Dr. Denker and Dr. Kennedy want psychiatry to return to the good old American game of sticking one's head in the sand. To me, it seems that in these last years of the war we psychiatrists have just pulled our heads out of the sand

and that it would be disastrous to bury them again. We cannot go back to treating these important, if transitory, neurotic episodes of childhood, adolescence and early adult life in this old bungling, ineffectual and disastrous fashion.

I hope we shall hear no more laughter about there being no need for more specially trained psychiatrists to deal with this problem.

By contrast, I want to refer to the beautiful presentation of factual data given by Dr. Wall and Dr. Hamilton. It is significant that no one has criticized this. The facts speak for themselves; and it is regrettable that this entire symposium has not been conducted on that level.

In such a symposium, we psychiatrists should begin with some honest self searching—asking ourselves what we know about the basic issue of the symposium. What do we know about the intrinsic and essential nature of the psychotherapeutic process? What do we know of the process of spontaneous recovery? What is the relation of spontaneous recovery to the recoveries that we seem to induce by our intervention, both in the neuroses and in the psychoses? What is the meaning of insight, and the relation of insight to spontaneous health and to the process of cure? What is the difference between the insight of schizophrenia and the insight of the recovery process? What is the difference between the insight which can be induced in a state of narcosis and the insight in the biochemical disturbances which occur after shock? How do the emotional discharge and the insight in such periods integrate with the emotional state and insight in the normal phase? These are a few of the questions which we should ask and discuss in such a symposium, instead of empty claims and counterclaims and vapid philosophizing.

Perhaps it is premature to ask for this, however, so long as all that we know about psychotherapy is learned in private practice. Historically we had to start in that way. Historically, however, we are now at the point at which this must end. The investigation of the psychotherapeutic process must become the concern of a research institute. Perhaps the major defect of this symposium is that it was held twenty-five years too soon.

DR. ISIDOR SILBERMANN: I was particularly impressed with Dr. Kubie's statement that discussions of this kind are not fruitful unless one knows exactly what one is talking about. I should be grateful to Dr. Wall and Dr. Hamilton if they would say a little more about the psychotherapeutic approach used at the Westchester Division of the New York Hospital. They have told how patients are given reassurance and have described various examinations and the use of music therapy, but they have said little about the kind of psychotherapy which is used and how it is carried out. It seems to me that at the modern hospital for mental diseases the dynamic approach must be studied and psychotherapy psychoanalytically directed. My associates and I are doing this at Hillside Hospital and are training our physicians to use this approach.

We do not use electric shock therapy for the psychoneuroses—it is used only for the psychoses. We have seen depressions which have failed to respond to electric shock therapy and which, on further observation, were clarified as neurotic depressions. For this reason, we use only psychotherapy with the psychoneuroses.

Dr. Mosse's subject is extremely interesting; but here, again, it is essential to know exactly what one is talking about. I have heard electric shock therapy discussed empirically by one man and from the psychologic standpoint by another; it is clear that these are two separate and distinct subjects. Dr. Mosse spoke of the relation of electric shock therapy and personality structure, certainly an extremely important topic. It would be wrong to overlook any new therapeutic means or to fail to study such means from every possible point of view. It is of great interest and importance to find out what happens in the psyche of the patient during the time he is undergoing shock treatment. In a paper on the psychologic experiences of patients in shock therapy (*Internat. J. Psycho-Analysis* 21:179, 1940) I came to conclusions similar to those of Dr. Mosse, namely, that

during shock therapy the patient goes through two phases: First, he regresses to a primitive level of his ego structure, and then he passes through a phase of restoration of the ego. If these conclusions are correct, it is obvious that one must help the patient in the restoration of his ego by the application of psychotherapy.

DR. ISRAEL STRAUSS: We have been hearing tonight of curing the psychoneuroses. Every doctor will admit that very little illness is cured by the physician. A surgeon may remove an appendix, but a physician does not cure chronic endocarditis or chronic nephritis. He helps the patient over his crisis. Likewise, in psychiatry, we do not cure many patients. We may send the patient out of the office or the institution apparently cured, with the reservation on our part that he may have a recurrence, just as a man with mitral insufficiency may have a recurrent failure of his heart, or we send him out as a social recovery, which means that he is capable of carrying on. But complete psychiatric cures are not many.

I should like to say a few words about the general practitioner's relation to the neurotic patient, because, unlike most of the men who have discussed the papers tonight, I have been a general practitioner. The general practitioner can, and will, be of tremendous service in handling abnormal personalities if properly prepared. The young physician's training in the hospital is of even greater aid in his approach to a patient than the teaching he receives in a medical school. But today so much stress is laid on the physical condition of a patient and so little attention is paid to his past history, not only physical but psychologic, that the examination often becomes a purely mechanical one. I have seen instances in the medical wards of a large hospital in which even before the attending physician had seen the patient the intern has asked for every form of chemical examination of the blood, roentgenologic studies, examinations of various parts of the body and a schedule of consultations with various specialists of the hospital—in other words, what he is proud to call a complete work-up—and all these, mind you, before any attempt has been made to use the diagnostic acumen of an experienced physician. The result is that when this young practitioner enters the field of private practice his views are so distorted that he is at a loss in approaching the nervous patient; yet I venture to say that in 75 per cent of his practice he will be dealing with patients in whom, in one form or another, the emotional state is a dominating factor. The general practitioner of the past, who knew the patient from birth, through adolescence, to full maturity, and for years thereafter, had such a grasp of the patient's physical and mental attitude and the environmental influences that he was in a position to exercise all the power of that transference which can exist between patient and physician. I wonder, in this connection, how many of the people on Dr. Denker's list lived outside the cities and how many were urban dwellers. A comparison of the results in these two classes of patients would be extremely interesting in showing what the general practitioner could really do.

DR. ERICH P. MOSSE: No one will blame me if I use my one minute to answer Dr. Kennedy. I remember a brilliant discussion of Dr. Kennedy's before the Academy about a year ago in which he stressed his opinion that the phenomenon of life and its pathologic modifications could be understood only as a psychosomatic whole, and that it was due only to the shortcomings in one's own personality organization that one speaks of an organic and a psychologic approach. Today Dr. Kennedy seems to have regressed to a purely bodily approach. I should not go so far as to call his way of discussion insincere, but I felt, when he talked just now, that he had repudiated in essence what he had said before. In my opinion, a neurosis, like every disease, must be treated from both the organic and the psychologic side. A method like electric shock cannot be applied by simply turning a switch, in the belief that thus one cures the patient. That is nothing but a belief in magic. It is just this magic that we as psychiatrists educate our patients not to believe in.

DR. CLARENCE P. OBERNDORF: I believe that the psychoneurotic patients in Dr. Denker's series represent for the most part the anxiety and depressive types, which

often recover spontaneously in time. From personal experience, I should say that the patient who finally comes to the private psychiatrist is one who has been subjected to many forms of treatment before he seeks psychologic aid and, for this reason perhaps, Dr. Denker's statistics are not entirely comparable.

In my own paper this evening, I said that the element of confidence is important in all forms of psychotherapy, and it is not improbable that this faith exists to a greater extent between the patient and his family physician than may occur at the outset of a psychiatric procedure with a new doctor.

Dr. Denker's report inferentially brings in the element of time, which may also operate in the recoveries reported in other forms of psychotherapy, including psychoanalytic treatment, which is sometimes continued over several years.

DR. JAMES H. WALL: I am disappointed that there is doubt as to the type of psychotherapy which we used. In the first place, we treat the patient. We certainly use the psychobiologic and dynamic approach in conjunction with shock treatment, as is illustrated by one of the cases Dr. Hamilton mentioned.

DR. PETER G. DENKER: I am sorry to have to differ with Dr. Brill in some of his comments. I do not believe the patients I presented can fairly be said to have "mild" neuroses, since, as I specifically stated in the paper, they had been totally unable to carry on with any occupation for at least a three to six month period before disability benefits had even begun; from this point on they were disabled for an additional period of one to five years, and 10 per cent were still disabled after this five year period. It is difficult for me to see how such a series differs fundamentally from the series of psychoneurotic patients reported by the psychoanalytic institutes of Chicago and Berlin; if anything, they represent a more severe type, since many of the patients treated by these institutes were ambulatory and sufficiently well adjusted to carry on with their occupations and social obligations. Dr. Brill commented with reference to electric shock, that he could not be sure whether depressed patients treated by this means would not have recovered in the same time without the electric shock therapy. It seems to me that he should apply a similar critical attitude in the therapy of the neuroses. That was the purpose of this study—to see what results were obtained in the treatment of these psychoneuroses when "deeper" psychotherapy was not used. Unless such "control" studies are made, one cannot be scientifically honest in assessing the therapeutic value of any psychiatric or psychoanalytic procedure. I do not understand why psychoanalysts with the large experience of Dr. Brill, of many years, have not published their results in a comprehensive series of cases, whether the cases represented the mild or the more severe type. It is all very well to talk of the results in 2, 3 or a few cases, but unless the experience in a larger series is compared with a similar series in which other therapeutic means were used the effectiveness of the procedure cannot be evaluated.

I fully agree with Dr. Kubie's comments on the importance of such "controls." It would be interesting if, as he suggests, a study were made of the outcome in cases in which no treatment at all was instituted, either by practitioners or by psychiatrists. This, of course, would be extremely difficult. I cannot, agree, however, with Dr. Kubie as to the element of compensation in these cases. The patients did not get well when the compensation ceased, but continued to receive compensation until they were able to adjust adequately and go back to work. He is putting the cart before the horse; as I mentioned in my paper, the fact of monthly income was a definite deterrent to their progress. The results obtained by the general practitioners in this difficult group are therefore all the more admirable.

As to Dr. Strauss's question, it is true that most of these patients were from small towns all over the United States, and the general practitioners knew them and their families well, so that the element of confidence was already present. In most of these towns there was no psychiatrist; so the general practitioner had to see the patient through his long siege, and on the whole did a most capable job.

PHILADELPHIA PSYCHIATRIC SOCIETY

Samuel B. Hadden, M.D., *President, in the Chair**Regular Meeting, April 12, 1946*

The Problem of Alcoholism. DR. BALDWIN L. KEYES.

The enormity of the problem presented by alcoholism staggers the imagination. The average American spends more than 4 per cent of his income for hard liquor. It has been shown that the cost of care for alcoholism in one year in the United States far exceeds \$12,000,000—more than \$1,000,000 a month—and exceeds two thirds of the cost of care of all bodily ills.

Recent studies have shown that in a series of 7,000 cases of alcoholism in three institutions in one of the larger cities the results of treatment were largely ineffective.

It is a healthy omen that legal minds have come to recognize that alcoholism is the demonstration of an illness and therefore that corrective measures must be guided toward care and prevention, rather than punishment and incarceration. In the way of prevention, efforts toward prohibition have been made in many centuries, at various times, and have always proved failures.

The consumer of alcohol seeks the cortical depressant action of alcohol and finds its transient effects a great relief to him, since through them he is separated somewhat from the full realities of himself and his situation, his anxieties and his inhibitions, he regresses comfortably for a few moments, and life with his friends becomes a little more tolerable. Many narcotics and hypnotics have a somewhat similar effect and are habit forming for the same reasons, though most of them are too slow acting to satisfy the man accustomed to the quick relief of alcohol.

Most investigators of the causes of alcoholism are agreed that the largest number of cases depend on recognizable weaknesses and deviations of personality, which, however, may often be the result of depending too much on the use of alcohol to relieve periods of acute stress, until eventually a habit is established and the need of the drug becomes increasingly stronger.

Many have stressed that alcoholism is not hereditary but is an acquired form of self expression, often the result of immature craving for attention, an effort to blot out the present and, at times, an unconscious drive toward self destruction.

Treatment of the alcoholic addict would seem to require primarily a recognition of the difficulties in the individual case, for, though there may be many similarities, especially in mechanism, particular problems exist in each case. Primarily, the patient must himself wish to recover from his alcoholism, for unless he holds to this decision firmly he is certain to fail in any measure outlined to help him.

In many cases, however, the patient cannot reach this conclusion without a great deal of patience, tolerance and understanding on the part of those trying to guide him. It may be necessary to render him inaccessible to alcohol for a time in order that he may remain sober long enough to permit a fuller discussion of his problem and helpful suasion to a point at which he will be interested in a deeper investigation of his inner self. With such patients, institutionalization, even protective custody, is at times necessary. Perhaps the conditioned reflex method of treatment will aid many patients to establish control of their alcoholism long enough to permit psychotherapeutic and other measures to get under way.

There can be no one best type of treatment. Some patients will do well through emotional channels, such as religious conversion; others, through reliance on understanding and responsible companionship, such as that established through Alcoholics Anonymous. Practically all patients will require some form of psychotherapy, especially those with deep-seated personality disorders and serious neuroses.

The Conditioned Reflex Treatment of Alcoholism. DR. WALTER L. VOEGTLIN, Seattle (by invitation).

The treatment of chronic alcoholism by conditioning the patient against alcoholic liquors requires the same scientific approach and the fastidious application of technical details that are necessary in any conditioning experiment. A tendency to lose sight of this important fact has caused certain workers to formulate unscientific, erratic and poorly designed schemes of treatment which, through their very ineffectiveness, may tend to throw discredit on this type of therapy.

A conditioned reflex aversion to liquor is established during the course of five to eight treatment seances. Each seance consists of a conditioning experience, during which the conditioned stimulus (liquor of various kinds) and the unconditioned stimulus (nausea and vomiting after the hypodermic injection of emetine hydrochloride) are impressed on the patient's consciousness in proper sequence. It is of fundamental importance that the exhibition of the conditioned stimulus (liquor) must precede and overlap the exhibition of the unconditioned stimulus (nausea and vomiting). Conditioning procedures are not adapted to use in the home, the office or even a general hospital.

Since the conditioned stimulus is specific in its action, it is necessary to use all possible kinds of liquor during treatment. If this is not done, the patient will acquire an aversion to one or two liquors but not to others.

A high degree of technical skill is requisite in persons administering the treatment seances. It is of particular importance that mature judgment be made the basis of decisions on the following questions: (1) whether the patient is acquiring a true conditioned reflex or merely a distaste for liquor; (2) whether the conditioned reflex is being extinguished as a result of too rapid or too slow progress; (3) whether the progressive seances represent an arithmetical serial potentiation, with each seance more difficult than the preceding one; (4) when the patient has received a maximum conditioned reflex aversion to liquor, and (5) how soon the patient should return for reenforcement.

Over 4,000 patients with chronic alcoholism have been treated by conditioning procedures in the institution with which I am associated during the last ten years. The last comprehensive survey made before the war presented the results of treatment of 1,526 patients and showed that 51.5 per cent had remained totally abstinent for four years or longer after the completion of treatment.

DISCUSSION

DR. SAMUEL B. HADDEN: When Dr. Voegtlin is beginning the conditioned reflex treatment, does he inform the patient of the nature of the injection? Is the patient told of the mechanism of production of the conditioned reflex? I should like to know, also, whether such simple things as a cold in the head may disturb the conditioning of the receptor organs?

DR. C. NELSON DAVIS: Since alcoholism is a disease in itself, many of the patients have persistent vomiting and inability to eat. They may go through a horrible spell because of the vomiting. Nevertheless, having had this experience, they immediately return to drinking. In what way does the conditioned reflex counteract the natural effects of the disease, that is, the vomiting?

DR. O. SPURGEON ENGLISH: Were any relapses represented in the 51 per cent figure cited? What is the program which Dr. Voegtlin and his associates follow in helping the patient make the necessary emotional readjustments after giving up drinking?

DR. WALTER L. VOEGTLIN, Seattle: In reply to Dr. Hadden's question whether we tell the patient what is going on: Formerly we did not. We kept it a secret from him, in the belief that if he knew what we were doing he would not be much impressed with the treatment. In a recent symposium on alcoholism sponsored

by the Yale school, published in the September 1944 issue of the *Quarterly Journal of Studies on Alcohol*, page 212, Dr. A. J. Carlson took us severely to task for being so dishonest as to lie to the patient. His point is probably well taken. It really does not matter whether the patient knows that he is being conditioned. Conditioning will go on whether or not the patient knows that he is being conditioned, and the eliciting of a conditioned reflex is just as incapable of being controlled by the patient's will power as is the eliciting of an unconditioned reflex. We therefore now tell our patients that we are conditioning them. This has the advantage, as you probably noticed in the picture, that the patient is not anxious to drink after he has become ill from the emetine. Yet if he does not drink he cannot be conditioned. He can be told, therefore, that it is necessary for him to cooperate and that he must drink in spite of his not wanting to. I think our results have been better since we started to be honest with the patient.

Infections of the upper respiratory tract are of fundamental importance in conditioning as a whole. Of course, the presence of mucus in the nose, which would prevent the patient from smelling the liquor, would take away a valuable aspect of conditioning, i. e., the olfactory aspect. In that way it is important. It is important also to avoid any extraneous stimulus while the patient is being conditioned. It is for this reason that we have constructed a special treatment room which is sound-proof and which has nothing in it of any particular interest to the patient. Discomfort accompanying any infection tends to take the patient's mind off the fact that he is drinking liquor and that he is being made very ill as a result. A full bladder, a need to move the bowels, an uncomfortable position or a headache—all these are negative stimuli which detract from the effectiveness of the conditioning procedure.

The question why the patient does not acquire a conditioned reflex as a result of becoming sick when he drinks is an interesting one, and the answer is equally interesting. Those who worked with conditioning procedures found very early, and Pavlov made a great deal of this fact, that one cannot condition an anesthetized or a narcotized or an alcoholized experimental animal. The same thing holds true, of course, with the human subject. Simply stated, the patient may be very ill on Saturday night, when he is drinking, but on Sunday morning, when he awakens, he does not remember much about how ill he was; and as a result he does not acquire a conditioned reflex aversion to liquor. This fact is of importance also, I believe, in the attempt to condition with apomorphine as the conditioned stimulus. One is then using a stimulus that narcotizes as soon as it is injected.

In reply to Dr. English, the data as he heard them are correct. We have at present a series of over 4,000 patients who have been treated with this method, although we do not have a statistical analysis of the entire group. The war prevented us from making any recent survey. However, that is being done at the moment, and we expect soon to publish our results. The last survey that we made included over 1,500 patients and was reported by Dr. Frederick Lemere and associates (*The Conditioned Reflex Treatment of Chronic Alcoholism, J. A. M. A.* 120:269 [Sept. 26] 1942). Fifty-one per cent of the patients who had been treated four years or more before the time of the survey were not drinking; i. e., they were entirely abstinent.

The present survey indicates that our later results will not differ greatly from those reported in the series of 1,500 patients. We have definite indications, although the figures are not accurate at this time, that of our patients who were treated ten years ago or longer at least 40 per cent have remained abstemious up to the present. I should like to emphasize that these data relate only to the results of the first treatment. If a patient was treated and began to drink again, and was treated a second time successfully, he was nevertheless counted for statistical purposes as having relapsed. I believe therefore that if we could add to the original successes the successes that result from a second treatment, or possibly even a third treatment, our results might be even a little better than those reported.

The other question that Dr. English has raised is one to which I always get two different and distinct reactions when I present this material. The internists

as a rule are impressed by what they consider a horrible waste of good liquor, whereas usually one or two psychiatrists, particularly those who are accustomed to think in terms of cause and effect, ask whether this method is a logical and a reasonable treatment for alcoholism, for the reason that, as Dr. English pointed out, one takes away the patient's escape mechanism, so to speak, without doing anything constructive about his psychiatric difficulties.

I think this point was also brought out by Dr. Keyes. I am not a psychiatrist, and possibly some may think me presumptuous for even having an opinion on these things; but I believe I have had enough experience with a fairly large number of alcoholic persons to entitle me to an opinion at least. The point brought out by Dr. Keyes, that alcoholic patients are not all of one type, is probably the crux of the matter. Certainly, there is a primary type of alcoholic patient, who drinks as a symptom of an underlying psychiatric difficulty. On the other hand, at least on the West Coast, the great majority of patients are not of that type. They are the persons with so-called secondary alcoholism, which Dr. Keyes mentioned, and have acquired their abnormal and excessive drinking gradually over a period of years as a result of habituation. It has never been proved, I believe, that all alcoholic persons drink because they have psychiatric troubles. I am inclined to think that this idea is one of those things connected with alcoholism which one assumes to be true without having made any scientific analysis. It is possible that some of the new mechanistic methods of assaying personality may yield a pattern into which alcoholic persons may fit, but I doubt it. I believe, therefore, that not all alcoholic persons have to make a readjustment, i. e., a profound readjustment, any more than does the mildly psychoneurotic drinking person. On the other hand, I believe that the patients who drink as a symptom of profound psychiatric imbalance will be mainly benefited by conditioning in that it keeps them sober for a while, so that they are accessible to psychotherapy. I do not believe that conditioning alone would ever cure these patients. In our experience, such patients account for less than 20 per cent of the total number of alcoholic patients.

Suppose, however, that all alcoholic patients have psychiatric difficulties, and that conditioning does nothing to smooth out their psychiatric problems; it does, nevertheless, give the patient an opportunity to remain sober in his normal environment and to readjust spontaneously. Some authors have asserted that patients who have been conditioned do not readjust. I question that statement, for I am certain that no one has ever examined a group of patients who have been treated by conditioning measures to see whether or not they do readjust. In our experience, the patient who stops drinking readjusts very well in his sober life, much better, in fact, than he did in his drinking life. I think, therefore, that it is entirely possible for these patients to readjust spontaneously. The fact that no outside hand is guiding this readjustment should not detract from its value.

Alcoholics Anonymous. DR. C. NELSON DAVIS.

I have observed the work of Alcoholics Anonymous for the past six years. It has been a stimulating and valuable experience. This organization cannot help all alcoholic persons, but it is important to recognize that its members can and do help some.

The question is frequently posed, "How does it work?" I do not know, nor have I heard a satisfactory explanation. There is no pattern, no common denominator, either in the treatment or among the victims of the disease, who represent a cross section of society.

This organization uses in its therapy a composite of many fundamental principles of medicine, psychiatry and religion. I shall mention in outline some mechanisms of the therapy which the members of Alcoholics Anonymous apply.

1. Acceptance of alcoholism as a disease. They accept alcoholism as a disease, without moral stigma, and realize that it can be arrested but never cured. The alcoholic person, they warn, is at all times just one drink removed from his disease.

2. Friendship. Alcoholics Anonymous provides the victim of alcoholism with an entering wedge to an acceptable social level of companionship and friendship. He is no longer an outcast when he enters its membership. He learns to live his life on a twenty-four hour basis, without fear of the future.

3. Personal contact. The individual member of Alcoholics Anonymous reaches out to help a fellow alcoholic addict who sincerely desires to stop drinking, thus utilizing the strong bond which exists among persons with this addiction.

4. Group therapy in open meetings. Testimony, confession and a crystal clear challenge invite the victim of the disease to understand his condition and show him a way to do something about it.

5. Individual psychotherapy in closed meetings. These gatherings, directed by one or more "dry" alcoholic habitués, utilize spiritual power freed from the restrictions of organized religion, urging the acceptance of God (or a "higher power") and leaving the individual to form his own conception of that God or power.

6. Stimulation of the ego. A member of Alcoholics Anonymous knows that he is some one, not just a "drunk." He sees men and women who had reached the lowest rung of the social ladder once again enjoying a life of confidence, socially acceptable and established successfully in their vocations. He is spurred to emulate them.

Alcoholics Anonymous combines in practice accepted fundamentals of medicine and religion, in an effort to help fellow alcoholic addicts who are sincerely desirous of attaining sobriety. This amalgam of many forms of therapy, as blended in the program of the organization, has enabled many alcoholic persons to achieve and maintain sobriety for periods of as long as six years.

A presentation of personal experiences was made by 3 members of the original group of Alcoholics Anonymous of Philadelphia. These members gave convincing and graphic accounts of their experiences in recovery achieved in connection with their associations in Alcoholics Anonymous. In its simplest form, the therapeutic situation includes (a) admission of alcoholism; (b) personality analysis and catharsis; (c) adjustment of personal relations; (d) dependence on some higher power, and (e) working with other alcoholic patients.

DISCUSSION

DR. C. NELSON DAVIS: There is nothing general or specific that one can say about this organization. There is nothing specific that they do, and there is nothing specific that one can find out about the people who attend the meetings. They represent a cross section of society. I shall call attention to some of the many factors that are at work in bringing some of these men to sobriety.

In the early days, these men who came down to St. Luke's and Children's Medical Center were desperately hurt. They had lost their homes and their jobs; they were outcasts from their families and from society. They came from the House of Correction. They came from at least sixteen institutions for the treatment of mental disease and had been in the best and in the worst jails.

First, Alcoholics Anonymous introduces to the individual victim the concept that he is not responsible for his actions but that he is suffering from a disease, that he need not approach the problem as one with a stigma but that he can return to society as he would if he had been hospitalized for pneumonia.

Second, the approach of Alcoholics Anonymous is a means of education. It is an agent for spreading to the family the facts that are known about alcohol. The members have their clubhouse. When the alcoholic addict reaches the bottom rung of the ladder, he has no place to go. He is antisocial, and society does not want him. He is unemployable. The clubhouse gives him a society to enter, and the clubhouse is willing to accept him and carry him through the early days of sobriety and through the days of the "dry jitters." The organization does what medicine cannot do, although it follows a fundamental rule of medicine. It treats the whole man. All that medicine does is to treat the disease and produce sobriety.

in the man, but Alcoholics Anonymous has a twenty-four hour program. He has a clubhouse to go to, and he has a number of friends whom he can contact immediately if he has the impulse to drink. The association is so set up that he can phone some one who will come and sit with him or who will carry him over the period during which he has the desire to drink.

The previous speakers have mentioned the spiritual side. There is no doubt that it does play an important part. Alcoholics Anonymous has helped a great many men. There are since the first year or two 41 members who have remained dry; that is a much better record than I have attained, for my results have been indifferent. The alcoholic addict hurts many people—his father, his mother, his sister, his brother, his employer. He even hurts the physician, for of all the patients the doctor treats the alcoholic is probably the most contemptible, and the one who will not follow advice. Frequently, the alcoholic patient comes to the doctor because he is literally dragged to him, and of course that places the physician at a disadvantage. These men, because of the educational program of Alcoholics Anonymous, seek the organization, and in seeking it they are in a better position to receive what it has to offer. Several years ago Dr. Hadden and I started group therapy at the Presbyterian Hospital. Group therapy is a mechanism which is generally used in the open meetings of the association. The individual members repeat their experiences in somewhat testimonial fashion and state how the organization has helped them. They also have closed meetings, and in the closed meetings they are not far removed from the direct application of psychotherapy.

Therefore, this organization applies many formulas well known to medicine. Not only does it have many points at which to attack the problem, but it does so on a twenty-four hour basis. If it can bring some people to sobriety and make their families and friends happy, it is doing a worth while work.

Book Reviews

L'électro-choc et la psycho-physiologie. By Jean Delay. Price, 230 francs. Pp. 169. Paris: Masson & Cie, 1946.

It is a keen intellectual pleasure to settle down with this volume by a master of French prose. The author, recently visiting this country, has succeeded Henri Claude at Asile Ste. Anne and the Faculté de Médecine and has seven previous monographs to his credit in the past eleven years. That is quite a record, considering that half this time his country was at war and that his teaching was done in difficult circumstances during the occupation of Paris. In this particular volume he attempts to bring some order into the confused theories concerning the mechanism of electroshock.

Electroshock has its principal effects on mood (*humeur*) and on consciousness (*conscience*). "Mood is that fundamental affective toning, rich with all the emotional and instinctual drives, which gives an agreeable or disagreeable flavor to one's state of mind, swinging back and forth between the two extremes of joy and sorrow." Consciousness, the author avers, is "a biologic function, a state of vigilance." As such, it is subject to perturbations running all the way from crystal clear consciousness, through momentary absences and natural sleep, to pathologic sleep, hypnoidal states, confusion, delirium, stupor and coma.

In his study of the effects of passage of the electric current through the brain, the author differentiates five crises of varying durations. These pertain to consciousness, which is lost immediately; to the convulsion, which sets in after a slight delay but is soon over; to the neurovegetative manifestations; to the humoral alterations, and, finally, to the bioelectric changes, which may last for days or weeks after the completion of the course of electroshock. The number of cases studied for such deviations is rather small, and the author relies on prewar physiology for his data, so that his conclusions are broad rather than deep. He emphasizes the importance of the hypothalamus in the alterations in mood that occur as the result of this type of treatment.

There is a great deal of space given to the experimental and neurosurgical observations in relation to the hypothalamus up to 1940. The author stresses particularly the alterations in mood that occur in response to manipulation of the hypothalamus. These experiments, he believes, have an important bearing on the whole question of the psychoses and neuroses. He would assign to the hypothalamus the role of the awakener of consciousness, the cerebral center of affect, "*le noeud de l'élan vital*." While remarking on the functions of the cerebral cortex in bringing the individual into relation with his surroundings, the author stresses the importance of the hypothalamus as the driving power under which the cortex organizes itself for proper function. "Electroshock recalls consciousness to its logic function of vigilance by a process of reintegration inverse to that of dissolution, with both positive and negative aspects, the restoration of mental syntheses and the abolition of oneiric emancipations."

In the chapters devoted to the discussion of mood, the author is rather schematic. He divides functional psychoses into the hyperthymic (manic and depressive states) and the hypothymic (hebephrenic); the latter of which may reveal schizoid, paranoid, catatonic or other manifestations. Electroshock stabilizes the mood disorders, the depressed much more easily than the excited phases, while it has limited effect on the hypothymic states, although bringing about a harmoniously functioning affective state in a certain percentage of cases. He points out that affective disorders are usually accompanied with disturbances in the various appetites for food, drink, sleep and sex, all of which are also influenced by gross lesions of the hypothalamus. He admits that no significant structural alterations are to be seen in

the hypothalamus in either affective or hebephrenic disorders, but, nevertheless, finds abundant reason for incriminating this area. Furthermore, he marshals the evidence in favor of the theory that the convulsion itself is a manifestation of hypothalamic perturbation.

Delay's monograph makes pleasant reading and contains a few new ideas; for instance, that neural pathways are "open" only when their chronaxias correspond, and that the regulation of chronaxia depends on the basal regions of the brain. At the same time, the book gives the impression of being hastily written, with too many repetitions. Looked at as an essay in synthesis, and as part of the development of a capable teacher and investigator, it gives promise of even better essays in times to come.

Diseases of the Nervous System. By F. M. R. Walshe. Price, \$4.50. Pp. 350. Baltimore: Williams & Wilkins Company, 1945.

This relatively small volume, written for students and general practitioners, serves the purpose admirably. The author makes the following points in describing his purpose: (1) to deal only with what is possible in general practice in *the matter of diagnosis*; (2) to omit all *specialized syndromes and terminology* not well known, and (3) to give special emphasis to the life history of any illness, so that one may understand that a nervous disease is a sequence of events rather than the mere localization of a lesion.

The book is written in two sections. The first deals with generalizations in neurologic diagnosis, with a discussion of the anatomy and physiology necessary to make general diagnoses. All controversial theories are omitted. A successful attempt is made to explain the results of various lesions in a simple manner on the basis of physiologic principles. The chapter on factors in diagnosis is broken down into functional subdivisions. The second section deals with the more common diseases of the nervous system. Here, again, they are treated systematically and briefly; differential diagnosis and treatment are both indicated.

A chapter on the general treatment of nervous diseases presents the view that, although many diseases of the nervous system are chronic and not amenable to cure, they need and merit the benefits of physical therapy in order to relieve stiffness and pain and for psychic advantages, since so many of the patients live a long time. Common sense advice is given on the general management of patients, and an evaluation of what is to be expected and what not expected from the various modalities is presented.

A good short chapter on the psychoneuroses is presented in general terms, with considerable attention to the psychosomatic disorders—dynamics are not discussed, and the point is made, perhaps with unwarranted optimism, that most of the psychoneuroses, if correctly diagnosed by the general practitioner, can be adequately handled by superficial therapy. The author correctly emphasizes early correct diagnosis and the importance of not giving the patient a physical diagnosis on which to fixate. The importance of a careful history is reemphasized, and the traumatic effects of "there is nothing the matter" are discussed.

Finally, a simple, systematic outline for the examination of the nervous system is presented.

This book should prove a valuable addition to the library of the practitioner and a practical aid in his ability to understand, diagnose and treat the more common diseases of the nervous system. It should help remove the feeling of helplessness usual in all but the highly trained neurologist.

RELATION BETWEEN ELECTROENCEPHALOGRAPHIC AND HISTOLOGIC CHANGES FOLLOWING THE APPLICATION OF GRADED FORCE TO THE CORTEX

FREDERIC T. ZIMMERMAN, M.D.

AND

TRACY J. PUTNAM, M.D.

NEW YORK

THE electroencephalographic effects of trauma to the brain have been studied by a number of investigators. Williams and Denny-Brown,¹ among others, have shown that a pathologic condition is indicated by the presence of slow waves of increased amplitude following a blow on the skull. These effects were produced experimentally on cats.

The pathologic changes in the various cytologic elements following injury to the brain have also been studied by a number of investigators. The recent work of Rand and Courville describes in detail such histologic changes.²

The present experiments were designed to investigate the possible relationship between the electroencephalographic patterns and the histopathologic changes occurring simultaneously after the application of graded force to the cortex. In order to investigate these changes a specially designed apparatus was used.

MATERIALS AND METHODS

Apparatus.—The traumatizing element (fig. 1 *A* and *B*) consists of an electromagnet with a hinged armature tuned to 60 cycles, alternating current. Mounted on the armature is a bent lucite (methyl methacrylate) rod which strikes the cortex when the armature is attracted by the electromagnet. The traumatizing element is also attached to a fine adjustment mechanism, and both are rigidly mounted to the center of a round bar $\frac{1}{2}$ inch (1.27 cm.) in diameter and 16 inches (40 cm.) in length. Mounted on an animal board on each side are two double upright, rectangular rods. The round bar is held in place by two wing nuts on each double rod.

From the Department of Neurology, Columbia University College of Physicians and Surgeons.

1. Williams, D., and Denny-Brown, D.: Cerebral Electrical Changes in Experimental Concussion, *Brain* **64**:223, 1941.

2. Rand, C. W., and Courville, C. B.: Histologic Changes in the Brain in Cases of Fatal Injury to the Head: VII. Alterations in Nerve Cells, *Arch. Neurol. & Psychiat.* **55**:79 (Feb.) 1946.

This permits adjustment in a vertical plane. The round bar also serves as an axis around which the traumatizer can be rotated. The entire set-up permits universal adjustment of the traumatizer in any plane.

The control electrodes have dimensions identical with the experimental electrodes and are embedded in a straight lucite rod, which is slightly smaller in diameter than the trephine hole. This lucite rod is held in position in a clamping

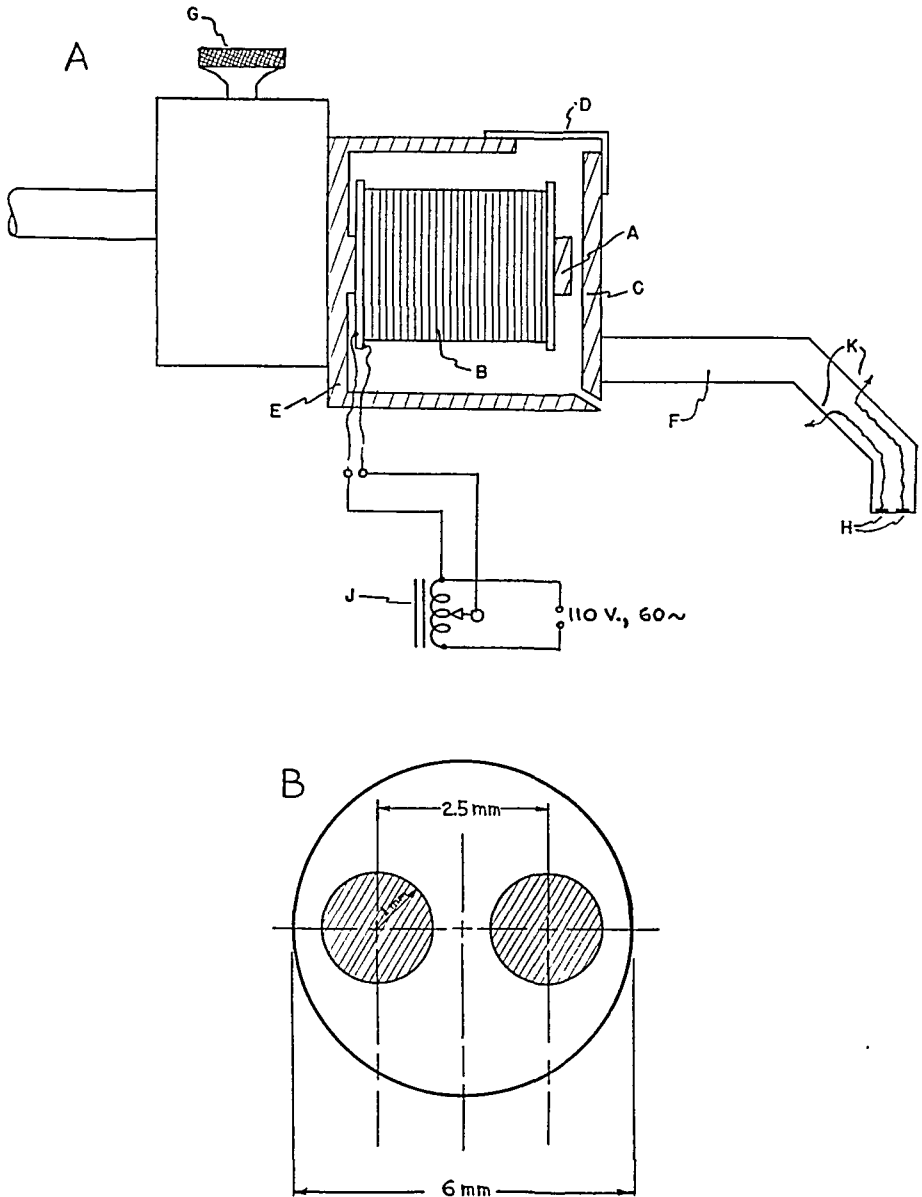

Fig. 1.—*A*, profile diagram of traumatizing element in its circuit. *A*, indicates core; *B*, coil; *C*, vibrating armature; *D*, flat spring brass; *E*, yoke; *F*, lucite rod; *G*, micrometer feed screw; *H*, silver disk electrodes; *J*, variable autotransformer, and *K*, flexible leads to panel board.

B, end view of traumatizing rod. The lucite traumatizing rod is 6 mm. in diameter. Two silver disk electrodes, 2 mm. in diameter, spaced 2.5 mm. on center, are sunk flush with the face of the rod.

collar with set screw. The collar is attached to a universal ball joint clamped rigidly to the round bar.

Method.—One hundred and ninety-five experiments were made on cats, which were selected on the basis of weight and age. All the cats were approximately of the same age, and each weighed about 5 pounds (2.3 Kg.). Pentobarbital sodium was used as an anesthetic and was administered intraperitoneally. The animal was placed on a stand with all four extremities freely movable; the head was firmly held in a head holder. The skull was trephined bilaterally. The burr holes were always placed to secure exposure of the middle suprasylvian gyrus just anterior to its juncture with the posterior suprasylvian gyrus, in the posterior part of the parietal lobe. The dura was always left intact.

The traumatizing rod was lowered with the fine adjustment screw until its face was lightly touching and exactly astride the middle suprasylvian gyrus. The control rod, on the contralateral side, fitted snugly in the burr hole and was likewise lowered until it was just flush with the dura.

The preparation on its stand, the switches and the panel board for the electrodes were placed in a shielded, grounded cage. A Grass three channel, ink-writing oscillograph was used for recording.

The voltage, and therefore the force applied, was varied with an autotransformer connected directly to the electromagnet. Voltages of 50, 85, 100 and 120 volts, respectively, were used, representing a range in force from a barely perceptible vibratory sensation, at 50 volts, to a 6 mm. excursion of the traumatizing hammer, at 120 volts. The time of application varied from three to twenty seconds for each of the voltage categories. A stopwatch was used in varying the duration of the force applied to the cortex.

Bipolar and monopolar potentials were recorded simultaneously on the experimental side. Bipolar potentials only were recorded on the control side.

The electroencephalographic potentials were recorded almost immediately after the application of the force to the cortex, and from the exact area traumatized. Five seconds, on the average, elapsed between the end of trauma and the start of recording. The potentials were recorded through the dura for forty-five minutes following traumatization. A second recording was made on each preparation four days later. The animal was killed immediately after the end of the four day recording. The traumatized areas were marked with a cork borer of the same size as the electrode-bearing rods. A slight indentation just sufficient for subsequent localization was made in the cortex after the dura had been removed.

The brain was immediately fixed in neutral solution of formaldehyde U. S. P. (1:4). A coronal section through the plane of the traumatized and control areas was subsequently made. The sections were stained with cresyl violet.

RESULTS

Electroencephalographic Changes.—As previously stated, traumatizing activity was recorded in terms of voltage (intensity of force) and the duration of the force applied.

The amount of electroencephalographic change was classified under four categories, viz., pronounced, moderate, mild and none, depending on the reduction in amplitude and the presence of slow waves.

Normal, or base line, activity in the narcotized (pentobarbital) cats consists of bursts, each lasting several seconds, of potentials occurring at a rate of 8 to 10 per second and recurring every two or three seconds. Between the bursts, low voltage, irregular activity is seen.

The deviations from the normal base line activity seen in these experiments were reduction in amplitude of varying degree, with loss of superimposed fast activity in the presence of delta waves of varying frequency, amplitude and form, and change in the amplitude and frequency of the pentobarbital spikes.

It will be noted that the intensity and duration of the force applied (fig. 2) produced no apparent electrical change in the categories below

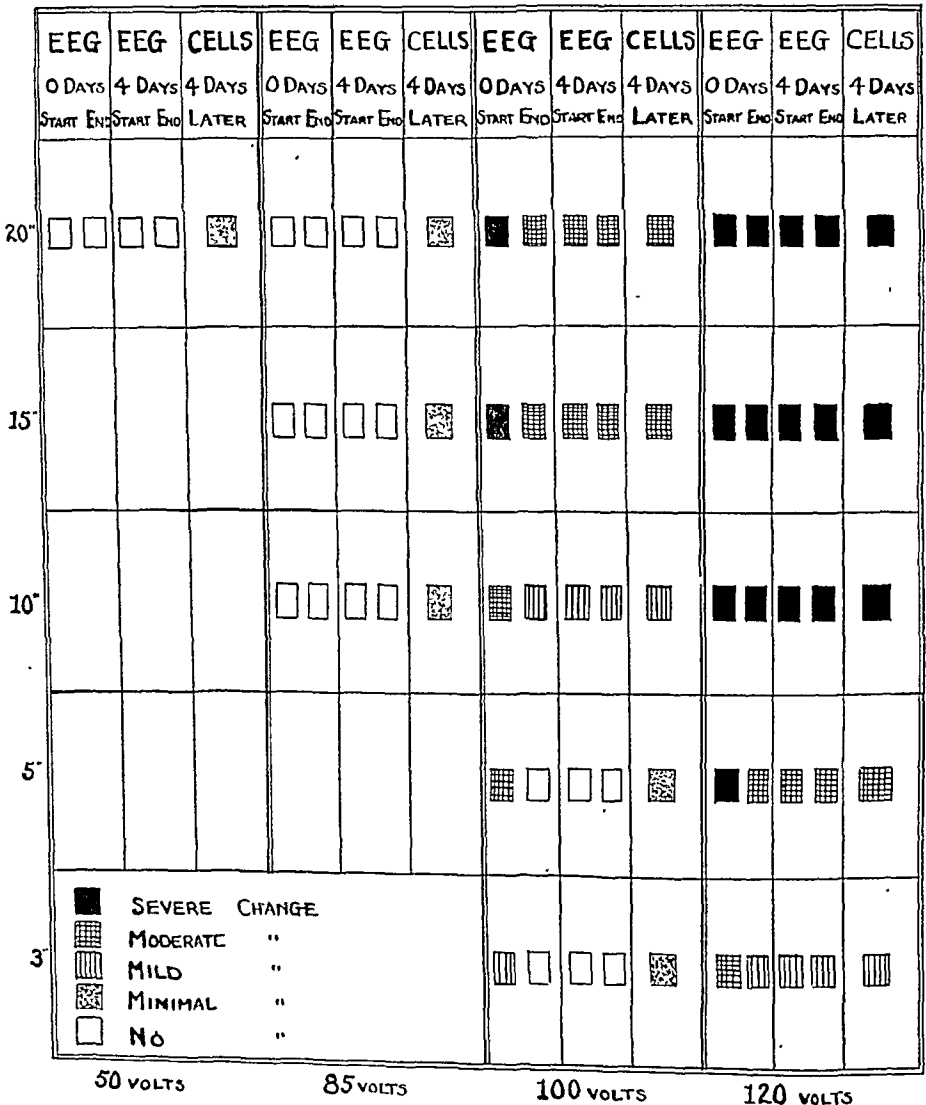

Fig. 2.—Degree of electroencephalographic change immediately after trauma, forty-five minutes later and four days later, and the degree of histologic change four days later, in relation to the intensity and duration of the force applied.

the 100 volt, three second interval. Above this level the electrical changes varied with the intensity and duration of the force applied. The most pronounced changes occurred at the 120 volt level between the ten and the twenty second interval.

Figure 3 represents the most pronounced type of electrical change. The first and third tracings in all figures represent bipolar and monopolar leads, respectively, from the experimental side. The middle tracing represents the contralateral (control) side, recorded with a bipolar lead. In figure 3 *A*, taken with the animal under moderately

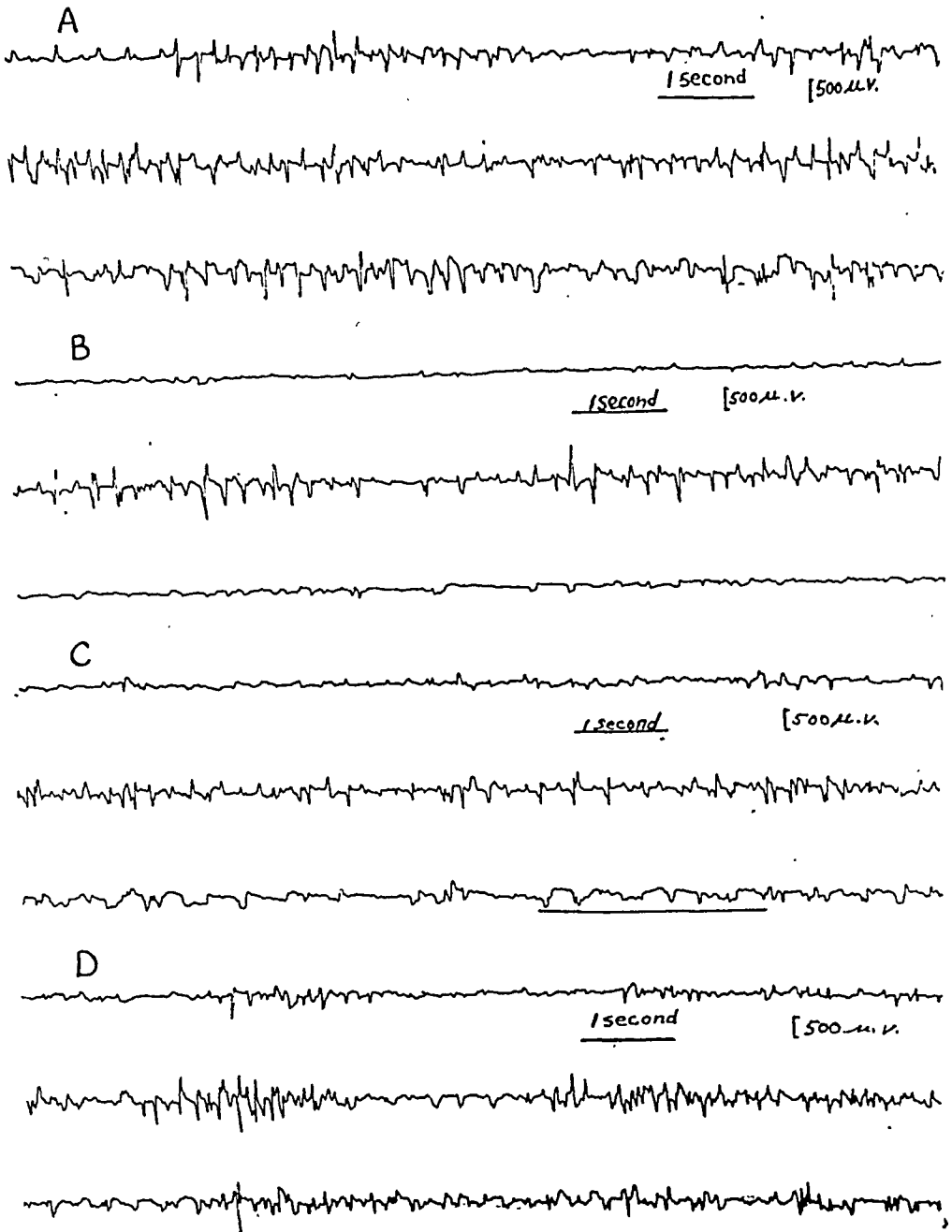

Fig. 3.—Severe electrical change following traumatization of the cortex. The base line activity, immediate changes and changes forty-five minutes and four days after traumatization are shown in *A*, *B*, *C* and *D*, respectively. The first and third tracings in this figure, and in figures 4 to 8, represent the bipolar and the monopolar recording, respectively, from the traumatized area; the middle tracing is a bipolar recording from the corresponding contralateral area. Note the marked reduction in amplitude in leads I and III immediately after trauma and the run of high voltage, slow waves in lead III forty-five minutes after trauma. For details see text.

deep barbiturate (pentobarbital) anesthesia, normal base line activity is seen. Immediately after trauma (fig. 3 *B*) there is a striking reduction in electrical activity in leads I and III with a suggestion of low voltage, flat-topped waves in the monopolar (third) lead. The middle tracing, from the control side, shows some loss in superimposed fast activity and a general slight reduction in amplitude. At the end of forty-five minutes (fig. 3 *C*) a little low voltage, irregular activity is apparent in lead I, with a bare suggestion of barbiturate bursts beginning to appear. In lead III there is an almost continuous run of somewhat irregular, high voltage, slow waves, occurring at a rate of 2 to 3 per second. Most of these waves are flat topped. Four days later (fig. 3 *D*) the bipolar recording in lead I shows distinct low voltage pentobarbital bursts appearing between stretches of inconspicuous electrical activity. The monopolar (third) lead shows some irregular, flat-topped waves between the bursts.

Moderate electrical changes are represented in figure 4. These changes occurred in the 120 volt, five second category (fig. 2). The tracing from lead I in figure 4 *B*, taken immediately after trauma, is again almost a straight line, but with some superimposed, inconspicuous low voltage, irregular activity. Lead II, representing the corresponding area of the contralateral side, shows the same pattern as that described in lead II, figure 3 *B*. In the third, or monopolar, tracing some irregular, high voltage, 2 to 3 per second waves are apparent. This is in contrast to the marked reduction of electrical activity in the corresponding tracing (fig. 3 *B*) representing pronounced electrical changes. The single spikes are artefacts.

After forty-five minutes (fig. 4 *C*) a considerable return of alternating differences in potential is apparent in the bipolar tracing, represented by the first line. The tracing shows abortive pentobarbital bursts and low voltage, irregular activity between the bursts. High voltage, irregular, slow (3 to 4 per second) waves continue to appear in the third, or monopolar, experimental tracing. Some of the latter potentials have a tendency to be roughly square topped. Four days later (fig. 4 *D*) the bipolar experimental tracing shows 2 to 3 per second, medium voltage waves interspersed between similar abortive pentobarbital spikes. The monopolar third lead again approximates more nearly the normal.

Mild electrical changes following trauma are represented in figure 5. The three tracings in figure 5 *A* indicate the usual base line. The experimental bipolar recording immediately following trauma, represented by the first tracing in figure 5 *B*, shows a general, though less prominent, reduction in amplitude with abolition of the pentobarbital spikes. The amount of activity is quite similar to that seen forty-five minutes after severe trauma, shown in the first tracing of figure 3 *C*. In the third tracing (fig. 5 *B*) the irregular, 3 to 4 per second, high

voltage waves appear immediately. The slow waves just mentioned are apparently of lower potential than those seen forty-five minutes after severe trauma (fig. 3 C).

In comparing the first tracing of figure 5 C with the corresponding base line, there is, apparently, considerable return of electrical activity

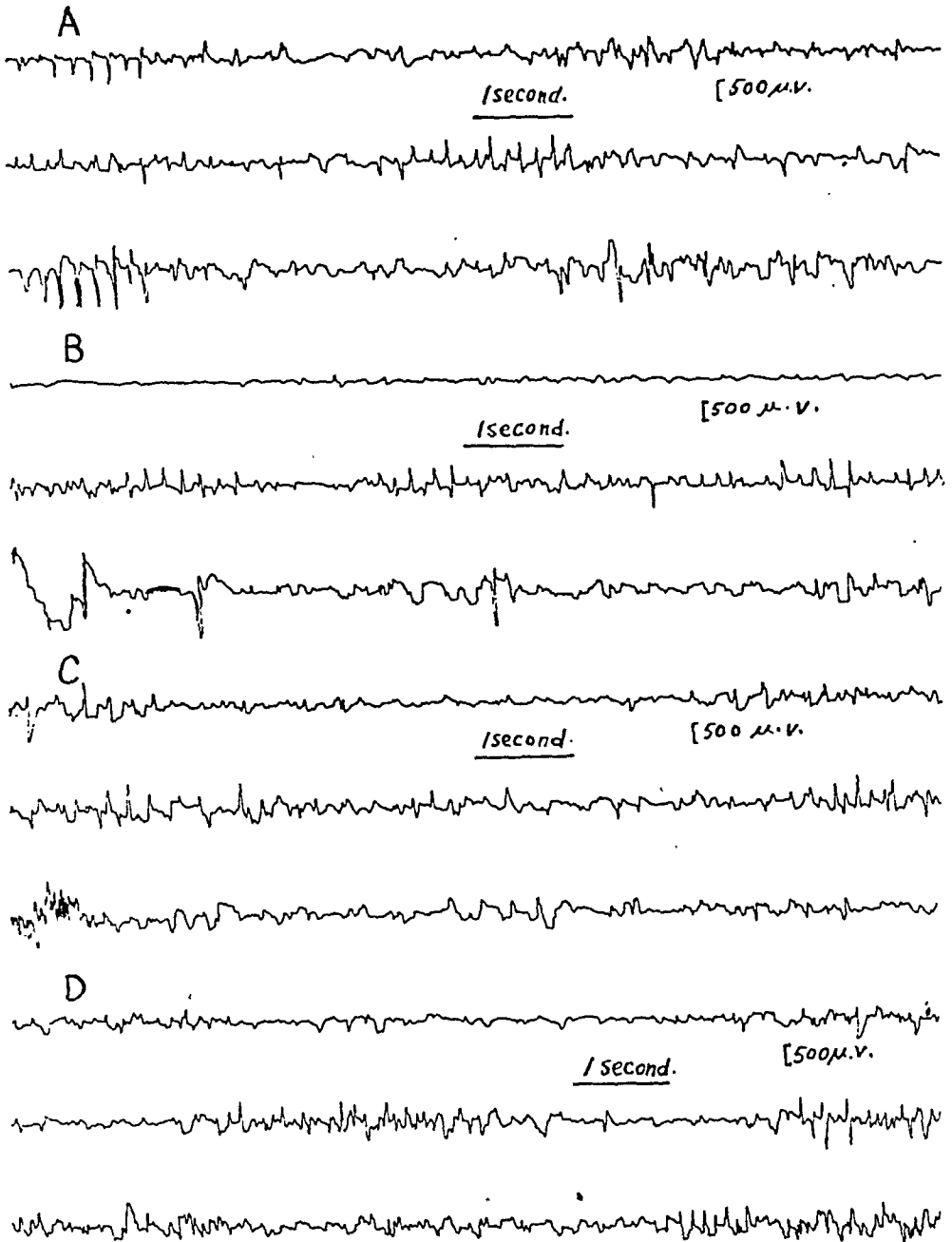

Fig. 4.—Moderate electrical change following traumatization of the cortex. Note the reduction in amplitude in bipolar lead I and the immediate appearance of irregular slow waves in lead III following trauma, in contrast to the later appearance of slow waves shown in figure 3.

forty-five minutes after trauma. The pentobarbital bursts are distinct, although somewhat reduced in amplitude. Medium voltage, slow waves also occur intermittently between the pentobarbital bursts.

Four days later (fig. 5 D) the experimental bipolar tracing (lead I) is practically unchanged, although the occasional medium voltage, slow waves seen forty-five minutes after trauma are not shown in the tracing. The monopolar experimental recordings, both forty-five minutes and four days later, are practically unchanged.

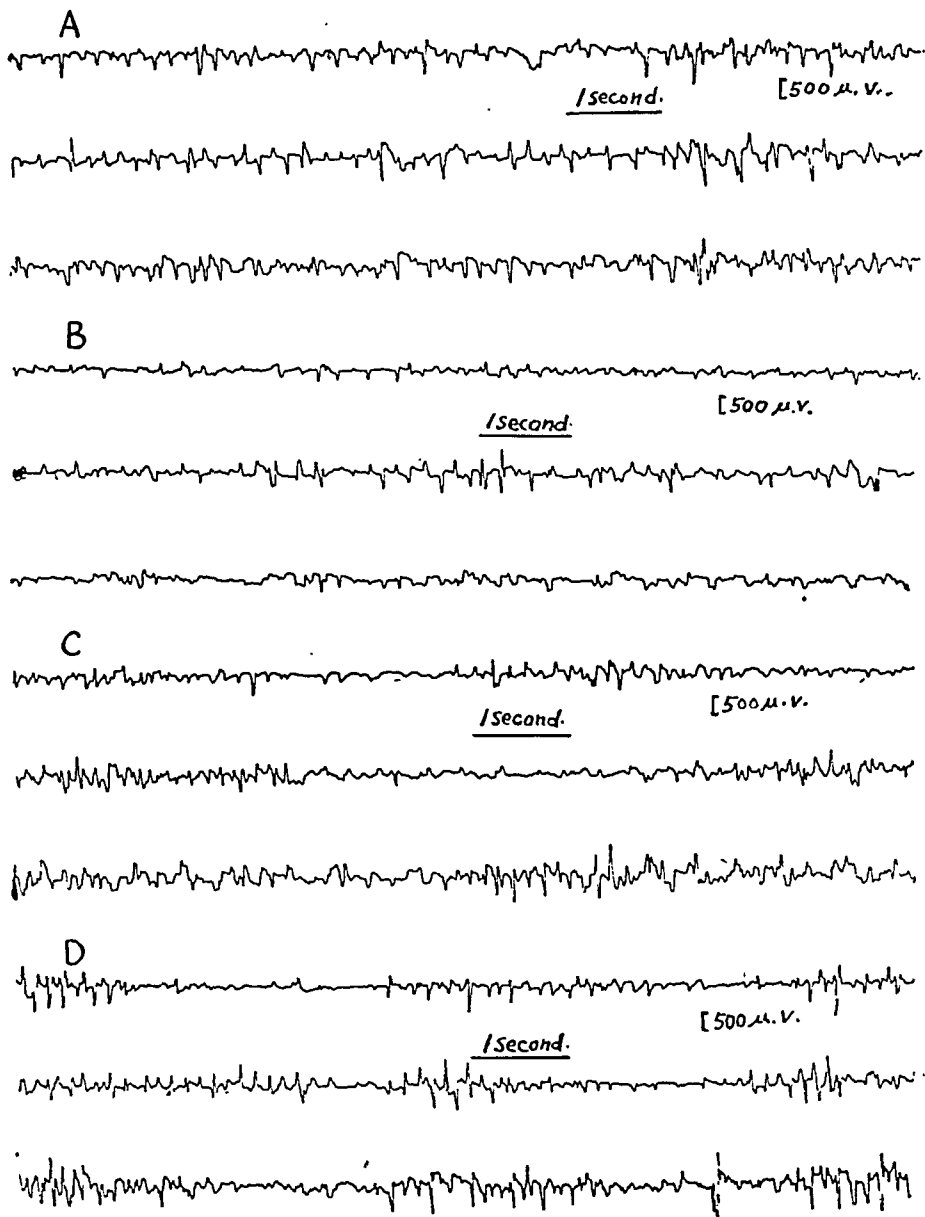

Fig. 5.—Mild electrical change following traumatization of the cortex. Note the less prominent reduction in amplitude in lead I and the continued presence of slow waves in lead III immediately following trauma. For details see text.

It can be seen from figure 2 that in the presence of a normal electroencephalogram minimal histologic changes occurred. Figure 6 represents a tracing recorded after delivering a force represented by 50 volts

for twenty seconds to the cortex. The tracing shows no changes in any of the three recording periods.

Figure 7 represents the same type of recording in a sham experiment. No trauma was applied to the cortex. The tracings in figure 7 *B* were taken after forty-five minutes; those in figure 7 *C* were taken four days later. There is no apparent change.

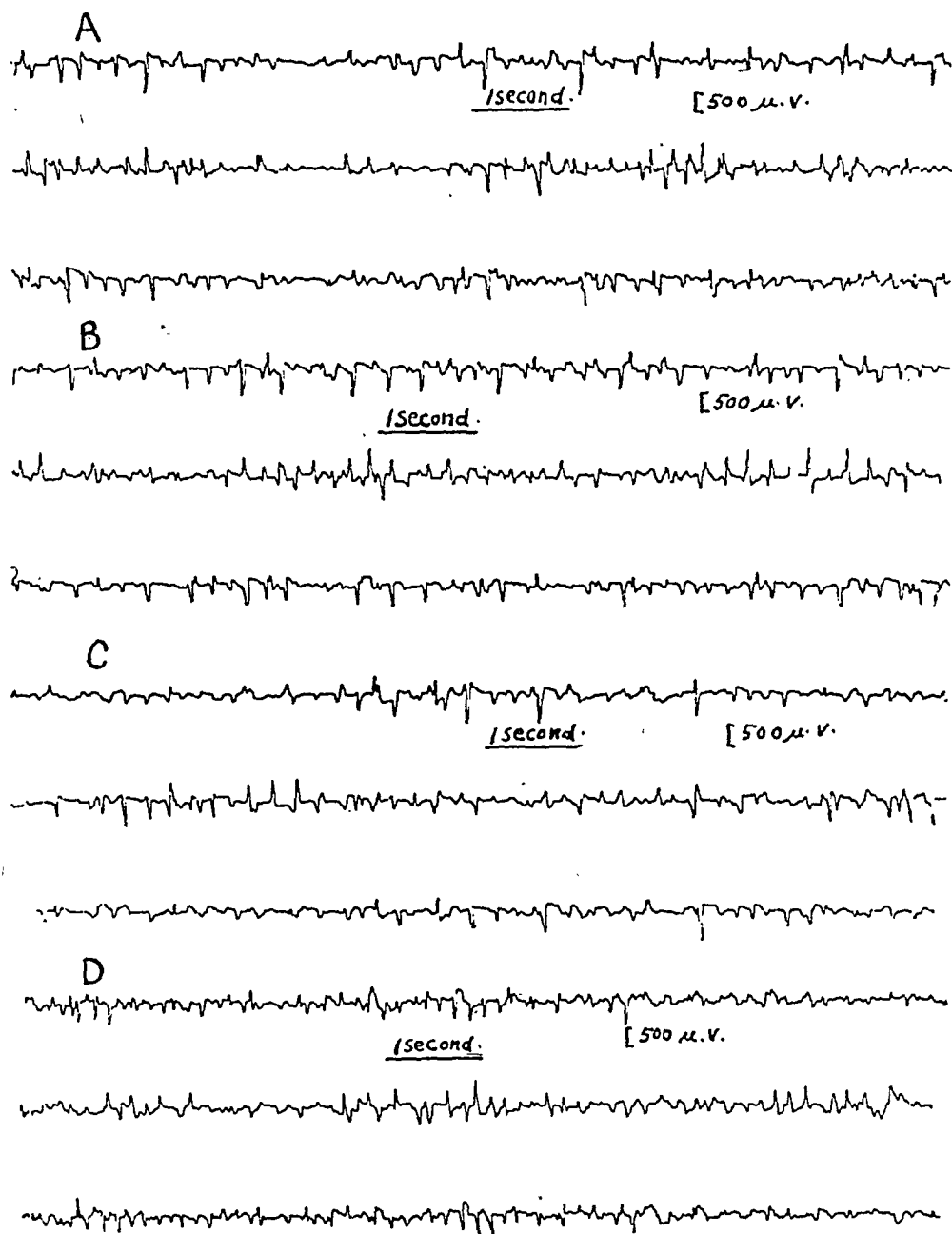

Fig. 6.—Unchanged electrical activity associated with minimal cortical cell damage.

At times it was noted that convulsive patterns were produced when a force equivalent to 120 volts and lasting for twenty seconds was applied to the cortex. These patterns were not always accompanied with convulsive movements. Figure 8 represents a convulsive pattern

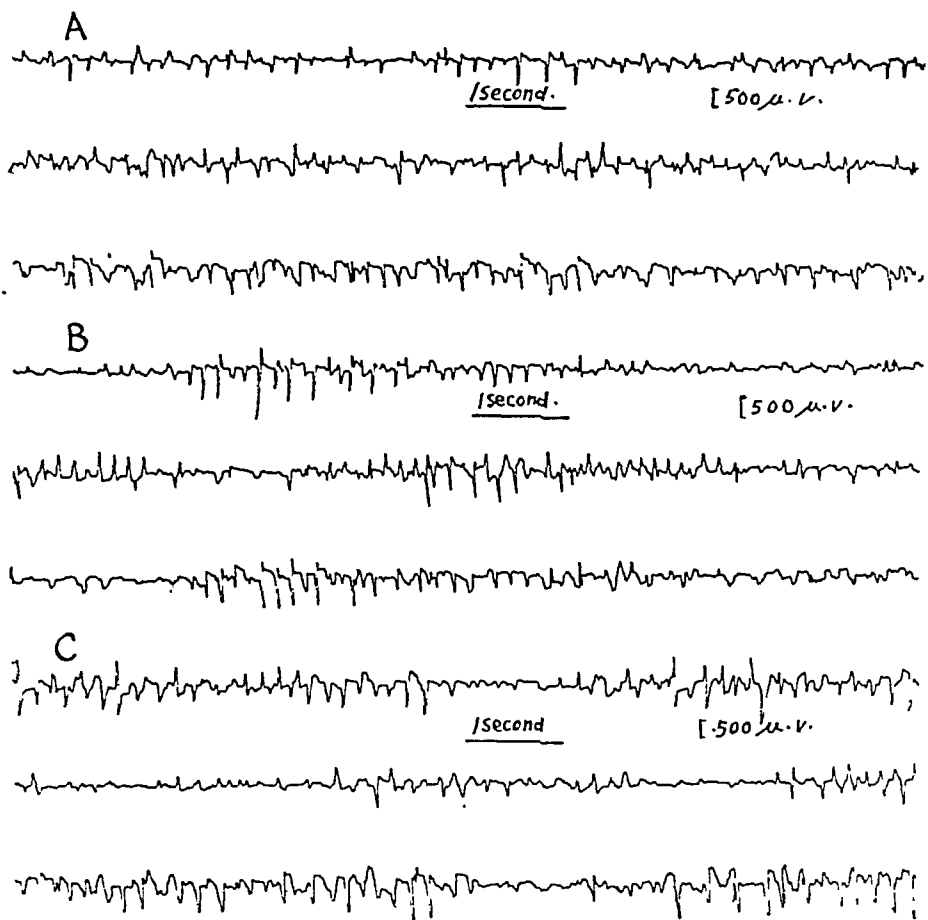

Fig. 7.—Electrical activity observed in a sham experiment at the beginning (A) and the end (B) of a forty-five minute period and four days later (C).

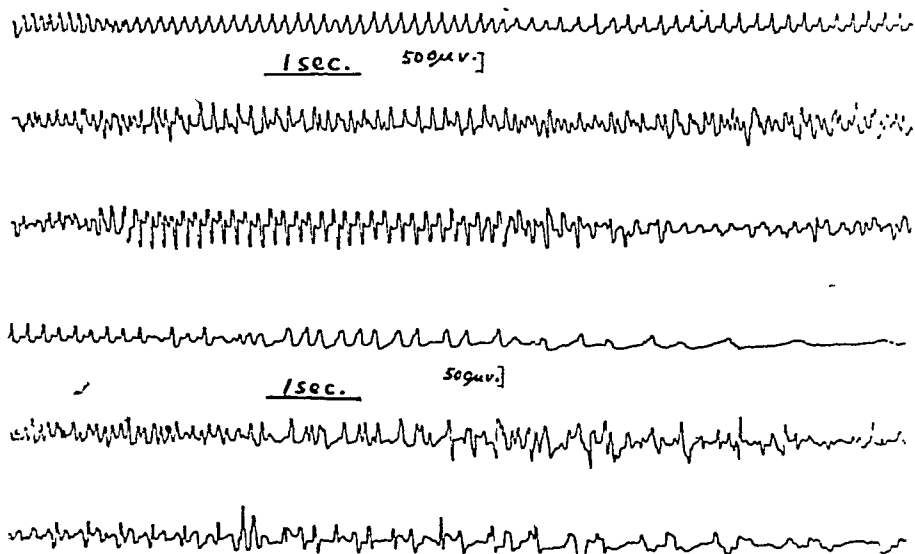

Fig. 8.—Unilateral convulsive pattern produced by traumatization.

recorded immediately after the cessation of trauma. It was not accompanied with convulsive movements. The animal was under rather light anesthesia. Eight per second spikes are seen in both lead I and lead III but are of less amplitude in the bipolar lead I. In the monopolar lead III it can also be seen that the spike formation gradually tapers off into irregular spike and wave formations. The convulsive pattern is likewise confined to the experimentally traumatized side and does not spread to the contralateral (control) side, although the number of single spikes in the early recording on the control side would appear to indicate some irritability of cells on that side.

Histologic Changes.—The histologic changes observed in connection with the previously mentioned categories of electrical change were outstanding in terms of extent and degree of cortical cell damage. The traumatized area could be distinguished easily from the surrounding tissue under the low power lens by its pallid appearance.

The greatest amount of cell damage occurred when a force represented by 120 volts, with a duration ranging from ten to twenty seconds, was applied. The detailed histologic changes seen four days after trauma are shown in figure 9. Under the low power lens, as seen in the upper figure, the traumatized area stands out in sharp relief by virtue of a clearly delineated area of pallor involving all cortical layers. This area of pallor mushrooms out somewhat from the point of impact, as can be seen in this figure. The photomicrograph was taken slightly to the left of the area of greatest damage, which is most obvious along the right hand margin. The normal architectonic arrangement of the cells is disrupted; the cells appear strewn about in a capricious manner, and the field presents a general wind-swept appearance. A reduction in the number of cells is apparent in all layers. Bare areas and shadow-like cells are striking. The cells in the second layer, as can be seen in the lower left portion of figure 9, are swollen, and the margins of many have a "chewed-out" appearance. The pericellular spaces are notably enlarged in many instances. In the same figure, vacuolation and segmentation of the cells are also suggested.

The large pyramidal cells (lower right portion, fig. 9) are in most instances pale, with hazy, indistinct and irregular margins. The nucleus as a rule is eccentrically placed, often lying against the cell membrane, sometimes jutting into it, as though about to extrude into the surrounding medium. The nuclear margins are not sharply outlined but appear irregular and in folds; the nucleus, consequently, is somewhat shrunken. The aforementioned changes are similar to those described by other investigators and have been attributed to the direct effect of trauma, i. e., the shock of injury to the cortex combined with a disturbance of

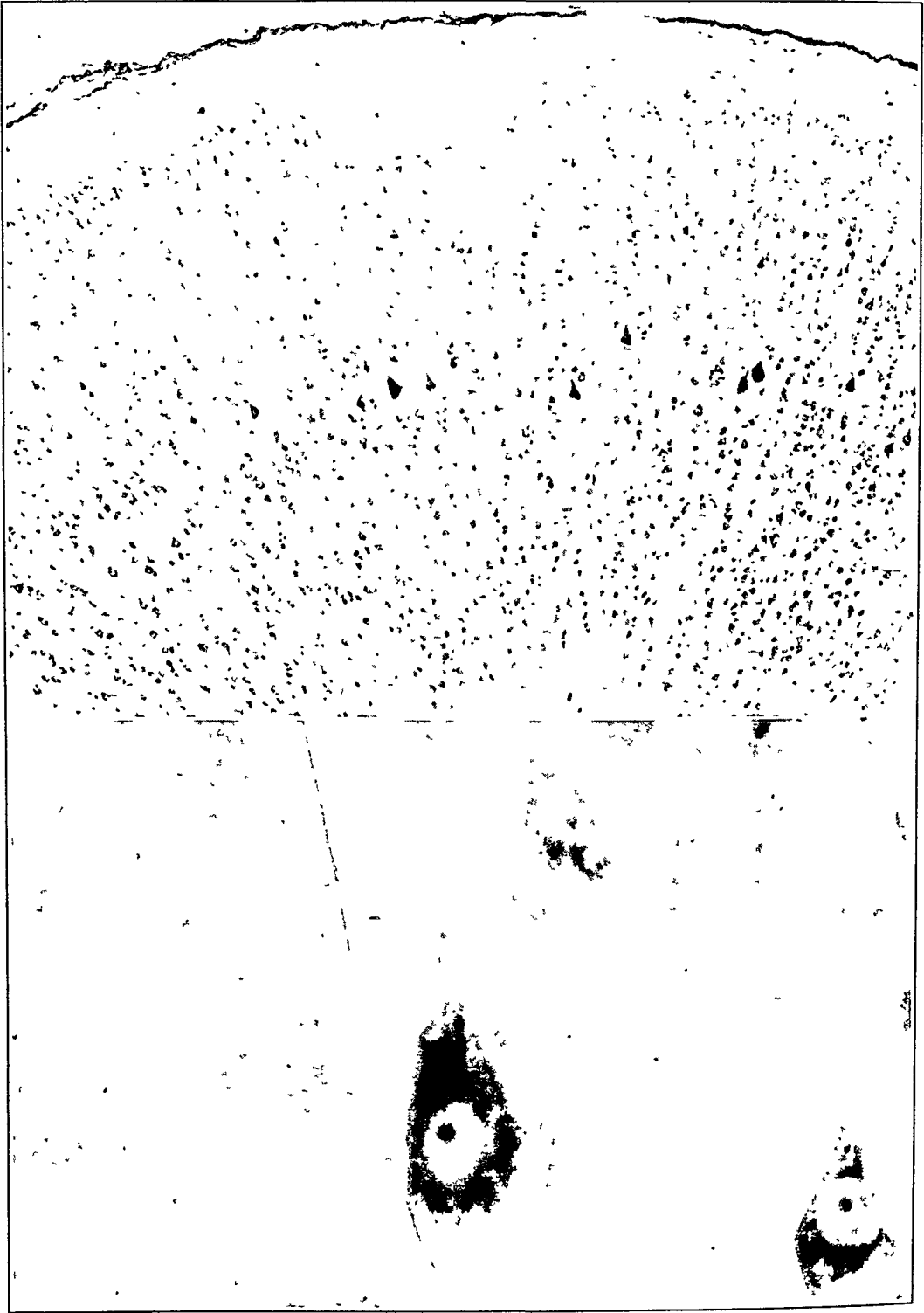

Figure 10

(See legend on opposite page)

The field presents a stippled appearance, especially in the deeper layers. Osnato and Giliberti⁷ also noted an unevenness in the staining qualities of the cortex following injuries to the human brain. The cell pallor, which involves all cortical layers in severe damage, is here most marked in the second layer and the outer portion of the third layer. The cells are still swollen, very pale and indistinct and have the same "chewed-out" appearance (lower left portion, fig. 10). The cellular disarrangement is likewise most marked in the aforementioned layers; below that the disturbance in position of the cells is milder.

Some of the large pyramidal cells are fairly normal in appearance (lower right portion, fig. 10), and their deeper stain largely gives the stippled quality to the field. Other large pyramidal cells which were damaged were moderately pale with irregular margins, but the nucleus was not usually eccentricated.

Mild cellular change is exemplified in figure 11. Under the low power lens (upper figure) the changes are seen to be predominantly in the internal granular layer, with a shading off in severity of cell damage above and below this layer. Architectonic disarrangement, paucity and pallor of cells are still apparent.

The external granular layer is more normal in appearance, and reduction in the number of cells is not so marked but some of the cells show varying degrees of pallor and appear slightly swollen (lower portion, fig. 11).

With minimal cell damage, observed with a normal electroencephalogram, there is no apparent reduction in the number of cells (upper portion, fig. 12). A few pale cells are seen in the third, fourth and fifth cortical layers. A few pyramidal cells also appear somewhat pale (lower right portion, fig. 12), but the majority are normal in appearance. The cells in the second layer are not disarranged, and the apical dendrites point normally toward the surface of the cortex (lower left portion, fig. 12).

7. Osnato, M., and Giliberti, V.: Postconcussion Neurosis: Traumatic Encephalitis; a Conception of Postconcussion Phenomena, *Arch. Neurol. & Psychiat.* **18**: 181 (Aug.) 1927.

Fig. 10.—Moderate cortical cell change.

Upper figure (magnification, 60), damage, as indicated by cell pallor, most pronounced in the second and third layers.

Lower left figure (magnification, 560), swollen, pale and indistinct cells of the second cortical layer.

Lower right figure (magnification, 560), fairly normal large pyramidal cells, contributing to the stippled appearance of the field.

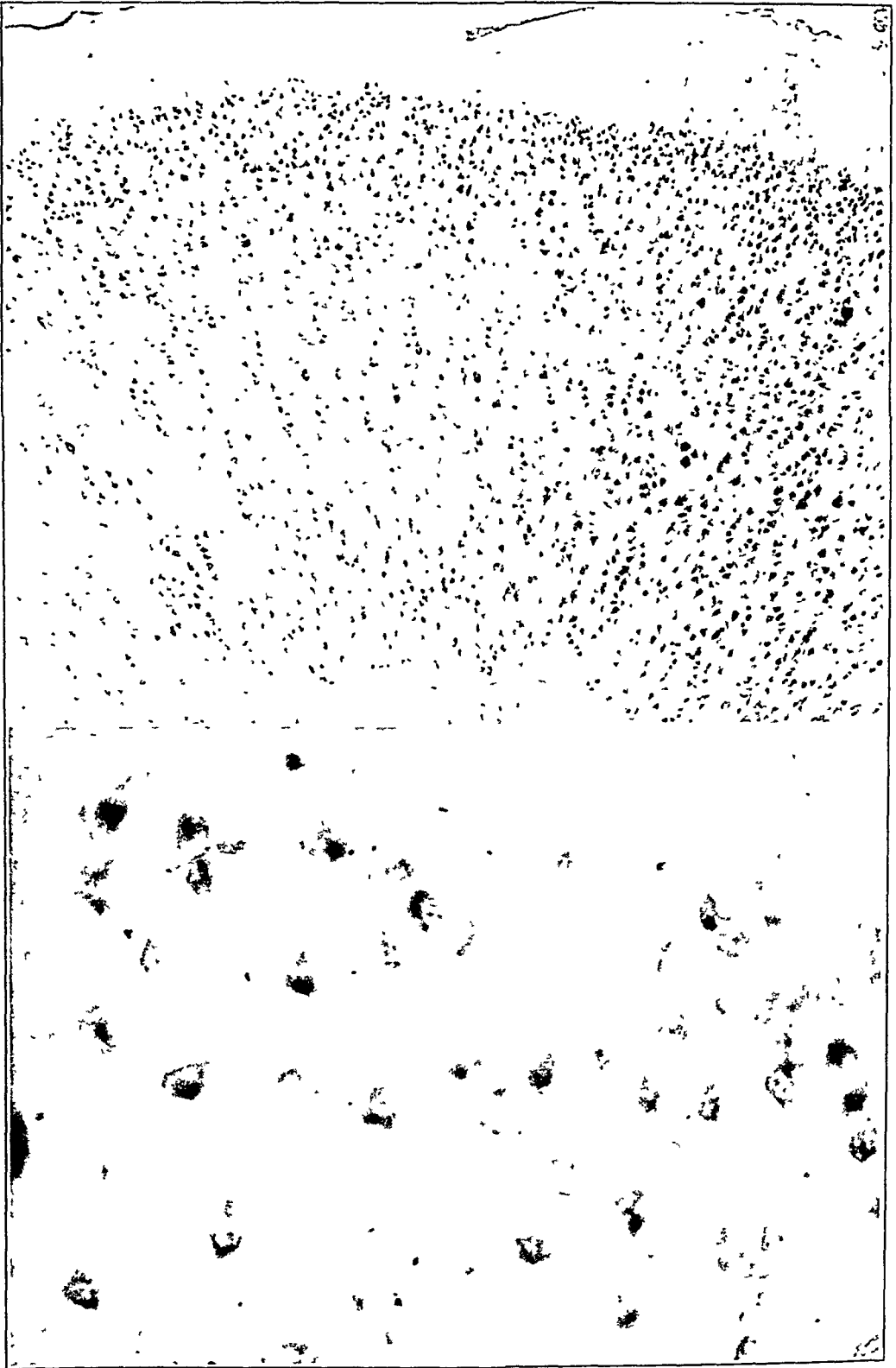

Figure 11

(See legend on opposite page)

Figure 13 illustrates the normal appearance of the cortex following a sham experiment. The general experimental procedure was followed, but without the application of trauma to the cortex.

The histologic picture from the contralateral (control) side invariably revealed slight cell changes when the force applied on the experimental side was sufficient to produce electrical change. The changes, however, were never more than minimal in degree.

In order to investigate the early cell changes following trauma to the cortex, especially in their relation to early electrical changes, an animal was killed at the end of a forty-five minute period of electroencephalographic recording. In this experiment a force equivalent to 100 volts lasting twenty seconds was delivered to the cortex. Figure 14 (upper portion) shows a multiplication of glial elements. This reactive phenomenon is predominantly in the form of a diffuse satellitosis involving the upper three cortical layers. Below these layers the satellitosis is more scattered. In the large pyramidal layer not all the Betz cells are equally affected. In general, satellitosis in this layer is most conspicuous around giant cells, which appear homogeneous, in contrast to cells showing a greater differentiation of the cellular elements. The distribution of this acute cell picture in terms of the cortical layers involved is similar to that seen with moderate cell changes four days later (fig. 10). In the lower, high power, view the glial elements can be seen to consist of oligodendrocytes, microgliaocytes and swollen astrocytes.

Relation Between Electroencephalographic and Histologic Changes.—

The electroencephalographic and the histologic changes are tabulated in terms of intensity and duration of force in figure 2. The extent and degree of cortical cell change at the four day period associated with the corresponding electrical changes for the same period are likewise recorded. The electrical changes are classified as pronounced, moderate, mild and none, in terms of the degree of diminution of electrical activity subsequent to the delivery of the particular force to the cortex.

It will be seen in figure 2 that at the 50 and 85 volt levels histologic changes occurred without corresponding electrical changes in the respective time categories. This would seem to indicate that abnormal electrical changes depend on the number and type of cells damaged. The variability of change in certain cells may be an added factor. Rand

Fig. 11.—Mild cortical damage.

Upper figure (magnification, 60), cell pallor, involving predominantly the internal granular layer, with shading off in severity of damage in the layers above and below.

Lower figure (magnification, 190), cells from the second cortical layer, showing varying degrees of pallor and slight swelling.

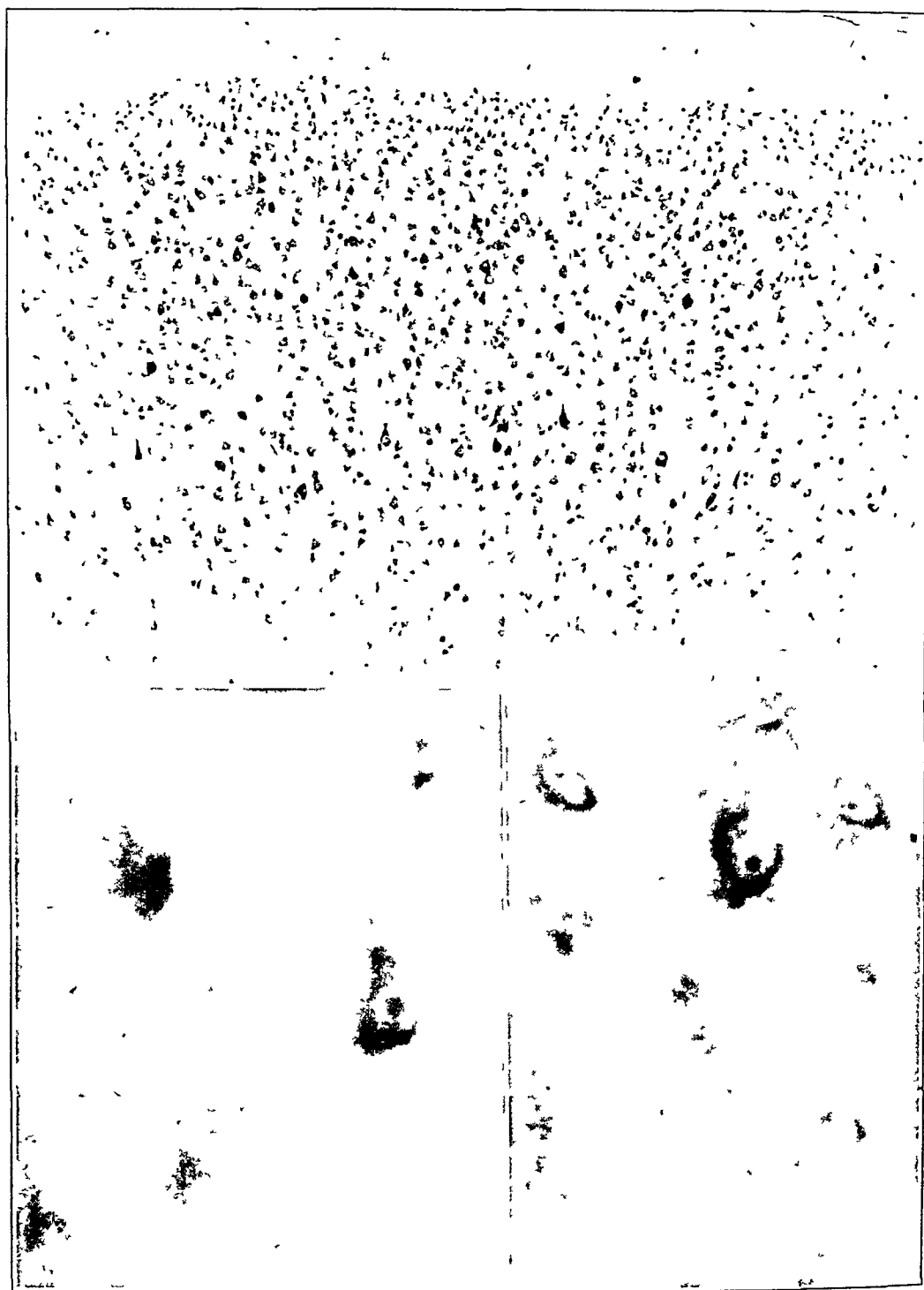

Fig. 12.—Minimal cortical cell change, seen in connection with a normal electroencephalogram.

Upper figure (magnification, 60), scattered, irregular distribution of cell pallor of varying degree.

Lower left figure (magnification, 560), cells of the second layer, showing normal polarity of the dendrites with the surface of the cortex.

Lower right figure (magnification, 560), pale cells in the third cortical layer.

and Courville² at the end of six days observed cells which showed only slight chromatolytic changes and concluded that there was a variability in the "rapidity of loss of tigroid substance." They also expressed the opinion that, among other factors, the "degree of shock of the original injury" accounted for some of the variability.

The degree of shock, the number and type of cells injured and their capacity to resume their normal function would seem to determine not only the degree of electroencephalographic abnormality but also the rapidity with which it returns to normal. There is some evidence in this direction in the electrical and histologic changes indicated in the

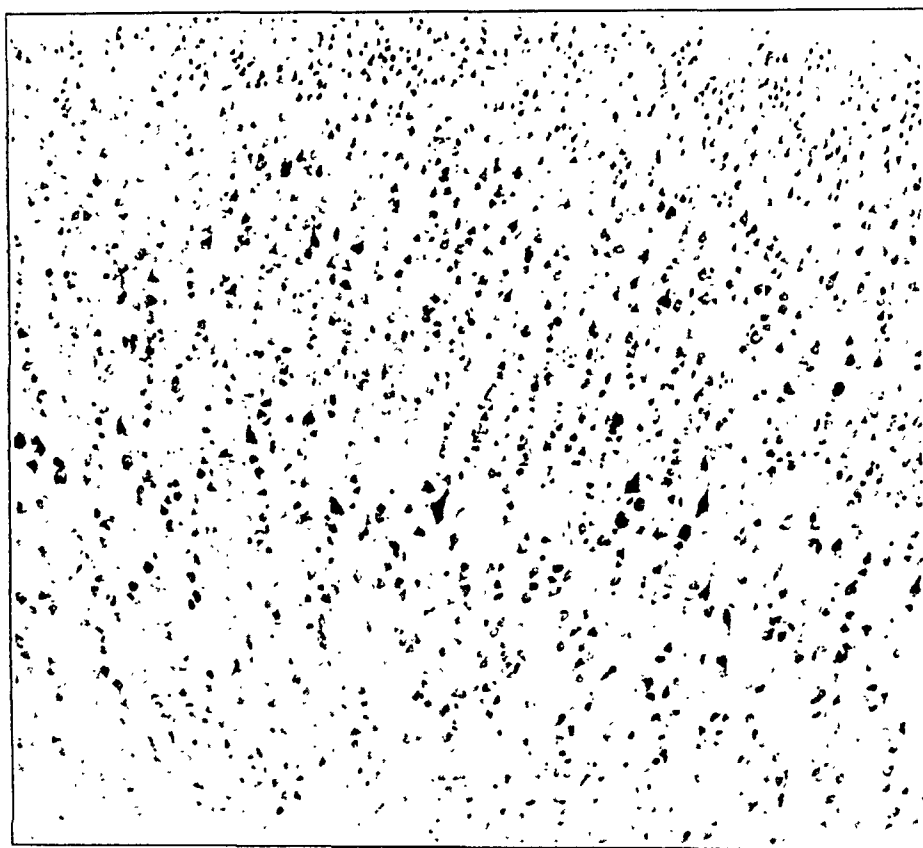

Fig. 13.—Cortical cells from sham experiment; magnification, 60.

100 volt, 3 and 5 second categories shown in figure 2. Immediate electroencephalographic changes are seen which return to normal within forty-five minutes, but which are associated with minimal cell changes at the end of the four day period. This is in contrast to the more persistent electrical changes associated with greater cell damage following greater increments of force.

Similar factors might be the basis of the normal electroencephalograms observed at times in connection with clinical signs of concussion in man. Jasper, Kershman and Elvidge⁸ reported 16 cases in which the patients

8. Jasper, H. H.; Kershman, J., and Elvidge, A. R.: Electroencephalography in Head Injury, *A. Research Nerv. & Ment. Dis., Proc.* (1943) **24**:388, 1945.



Fig. 14.—Traumatized cortex forty-five minutes after severe trauma.

Upper figure (magnification, 60), multiplication of glial elements in the traumatized area.

Lower figure (magnification, 540), details of reactive gliosis, with presence of microglia cells, oligodendrocytes and astrocytes.

had normal electroencephalograms despite a history of loss of consciousness of from eleven to sixty minutes. Similar findings have been reported by Williams⁹ and by Dow, Ulett and Raaf.¹⁰ The latter authors cited a case in which the electroencephalogram was normal within fifteen minutes after the patient sustained a true concussion, as judged by clinical symptoms.

Above the 100 volt, five second level, it will be seen that the degree of histologic and electrical change at the end of the four day period varies with the intensity and duration of the force delivered to the cortex. In addition, the degree of diminution of potential and the amount of reversibility at the end of forty-five minutes in the respective categories appear to be functions of the same force. It is also evident from figure 2 that the capacity to recover, as indicated by the electroencephalographic patterns, is greater within the initial forty-five minute period than after the four day period.

The most pronounced electroencephalographic and histologic changes resulted from the application of a force equivalent to 120 volts within a time range of ten to twenty seconds. A comparison of the four day electroencephalographic record with the corresponding histologic picture shows that the large reduction in amplitude is associated with the most widespread histologic damage, involving all cortical layers.

In comparing the cell changes (fig. 14) occurring forty-five minutes after application of a force of 120 volts for twenty seconds with the corresponding electroencephalographic tracing (fig. 3 C), it is seen that the reduced amplitude and high voltage, slow waves occur in the presence of acute cell changes. The multiplication of glial elements is in striking contrast to the histologic changes occurring four days later. The predominance of slow waves within the forty-five minute period, as against their paucity four days later, and the presence of slow waves in association with a picture of acute cell damage, suggest that the slow waves represent either an effort at, or a stage in, recovery. These observations appear to be in conformity with the direct experimental observations on the electroencephalographic changes following head injury made by Williams and Denny-Brown,¹ who produced cerebral concussion in cats under light pentobarbital and ether anesthesia. They found that concussion was always associated with diminution or cessation of electrical activity and the appearance of abnormally slow waves. In our method of recording, however, with simultaneous bipolar and monopolar tracings from the experimental area, these two effects seem to arise from different

9. Williams, D.: The Electroencephalogram in Acute Head Injuries, *J. Neurol. & Psychiat.* 4:107, 1941.

10. Dow, R. S.; Ulett, G., and Raaf, J.: Electroencephalographic Studies Immediately Following Head Injury, read at the Ninety-Ninth Annual Meeting of the American Psychiatric Association, Detroit, May 10-13, 1943.

levels, with the inference that the delta waves have a deeper origin, since, according to Jasper and associates,¹¹ the monopolar type of recording picks up activity from deeper intracranial structures than does the bipolar method. We were unable to demonstrate cellular changes in the subcortical structures within the limits of the degrees of force applied.

It is also of interest to point out that the type of tracing seen in figure 3 C, with diminished electrical activity in the bipolar recording and simultaneous delta waves in the monopolar tracing, is similar to that described by Jasper, Kershman and Elvidge¹² in recording over extracerebral hematomas. These investigators found a silent area with bipolar recordings and variable delta waves in monopolar records over the same area.

The potentials from the silent area, as exemplified by diminished electrical activity, might presumably arise from the superficial cortical layers. In our experiments, in the categories of pronounced and moderate changes in the electroencephalogram, the cells in these layers, especially the second and the outer portion of the third layer, revealed changes which have been attributed by various investigators to the shock of injury or direct trauma. The diminished electrical activity, therefore, seems to arise from a physiologically silent area.

In comparing electrical and histologic changes designated as moderate (figs. 4 and 10), it may be seen that the most profound cell changes occur in the second and third cortical layers, as indicated by the extent of cell pallor. Below these layers the stippled appearance of the field indicates an irregular and variable amount and degree of cell change. While the experimental bipolar record shows immediate marked diminution of electrical activity, the monopolar experimental record, in contrast to that seen with pronounced changes, now shows irregular high voltage, slow waves which appear almost immediately after trauma. If these slow waves represent an effort on the part of the cells toward recovery, it would seem that this capacity for recovery would be greater with lesser degrees of trauma and the slow waves would consequently appear earlier.

Figure 4 D, representing the electrical pattern at the end of the four day period, reveals considerable return of activity as compared with the corresponding tracing seen with severe damage.

Electroencephalographic changes classified as mild are again significant by the presence of slow waves in the third lead immediately following trauma, a fairly normal pattern in the third lead forty-five minutes

11. Jasper, H. H.; Kershman, J., and Elvidge, A. R.: *Electroencephalography*, in Penfield, W., and Erickson, T. C.: *Epilepsy and Cerebral Localization*, Springfield, Ill., Charles C Thomas, Publisher, 1941, p. 380.

12. Jasper, H. H.; Kershman, J., and Elvidge, A. R.: *Electroencephalographic Studies of Injury to the Head*, Arch. Neurol. & Psychiat. **44**:328 (Aug.) 1940.

afterward and a persistently slight reduction of amplitude in the first lead at the end of the four day period, even though the potential represents a considerable gain over that seen just after trauma. The associated histologic changes are most prominent in the internal granular layer, with a shading off in degree of cell damage above and below this layer.

When a minimal force, represented by 50 volts and lasting twenty seconds, was applied, no electroencephalographic changes occurred at any time within the four day period (fig. 6). The corresponding, four day, histologic section (fig. 12), however, revealed minimal histologic changes scattered throughout all cortical layers. If the electroencephalogram is accepted as the physiologic indicator of underlying structural changes, it would appear that its sensitivity does not extend below a certain critical range. It seems possible, therefore, that such minimal cell changes could represent an organic substrate for the protracted psychic manifestations in those cases of head injury without subsequent clinical and laboratory abnormalities which have been designated as purely functional in nature.

COMMENT AND SUMMARY

Our experiments demonstrate that there is a direct relation between the amount and degree of cortical cell change and the degree of electroencephalographic change following trauma. This relation, however, obtains only above a level sufficient to produce incompletely reversible electrical changes. Below that level cortical cell change results without corresponding electrical change. Within the critical range the amount of electrical and cortical cell change is a function of the intensity and duration of the force applied. The histologic changes, in addition, assume a rather definite pattern. All cortical layers are conspicuously damaged in severe trauma; the second layer and the outer part of the third layer show the greatest cell change after moderate trauma, while the internal granular layer is most severely involved in mild trauma, with a shading off above and below this layer into milder cell changes.

This particular pattern of cortical cell change is similar in some respects to the changes observed by Roncali¹³ in his study of the effect of compression on the cortical cells in dogs. This investigator repeated the earlier work of Neumayer,¹⁴ who studied the cell changes in the

13. Roncali, D. B.: Intorne alle alterazioni nella fina tessitura dell'sostanza nervosa dell'encefalo consecutore delle compressione sperimentale, Arch. ed atti d. Soc. ital. di chir. **12**:144, 1898.

14. Neumayer, L.: Die histologischen Veränderungen der Grosshirnrinde bei localem Druck (Experimentalstudie aus dem histologischen Laboratorium des pathologischen Institutes zu München), Deutsche Ztschr. f. Nervenhe. **8**:167, 1895-1896.

cortex of rabbits by inserting a lead shot 0.5 cm. in diameter between the dura and the calvaria and observing the histologic changes at subsequent intervals. In from ten to fifteen days Roncali observed alterations in the nerve cells of all layers and of all degrees. These alterations were similar to the cell changes observed in our experiments following severe trauma. After five days the cell changes described by Roncali were largely confined to the upper three cell layers. This distribution of cell changes is similar to that occurring in our experiments with moderate trauma. Cell changes which we described as mild would still appear to be more severe than those observed by Roncali at about the twenty-four hour period. Here, he noted beginning degeneration in the cells of the superficial layers. When, however, the differences in criteria, method and type of force applied are taken into consideration, it would appear that the histologic changes in the two experiments have much in common.

Additional evidence also emerges from our data that the degree of electrical reversibility is proportionately greater shortly after trauma than later and that this reversibility is associated with high voltage, slow waves.

With the use of simultaneous bipolar and monopolar recordings from the traumatized area, a technic of localization was utilized which seemed to indicate that the pathologically reduced potentials arise in the superficial cortical layers, while the slow waves of increased amplitude seen in monopolar recordings apparently arise from a disturbance in the deeper cortical layers.

Additional evidence that these pathologically reduced potentials arise in the superficial layers has been supplied by Dusser de Barenne and McCulloch.¹⁵ These investigators demonstrated by laminar thermocoagulation that destruction of the outer two layers of the cortex resulted in "definite reduction in the local action potentials, from which there is some return, though they do not regain their initial size and shape at the end of one hour." Complete destruction of the outer three layers produced a marked reduction in local action potentials, with little or no evidence of return to original size and form, while destruction of the outer four layers reduced the action potentials permanently and almost completely.

The electroencephalographic abnormalities indicated are restricted to the traumatizing electrode. The recorded potentials arise from localized cerebral damage, which is responsible for the electroencephalographic abnormalities. The mild reduction in amplitude and diminution of superimposed fast activity seen at times in the contralateral tracing appear

15. Dusser de Barenne, J. G., and McCulloch, W. S.: Some Effects of Laminar Thermocoagulation upon the Local Action Potentials of the Cerebral Cortex of the Monkey, *Am. J. Physiol.* **114**:692, 1936.

to be the result of mechanical, contrecoup damage rather than of activity conducted across the corpus callosum. This has been demonstrated by Hoefler and Pool¹⁶ by electrical and chemical stimulation of the cortex. These investigators demonstrated that activity from either side of the cortex is conducted along the corpus callosum, but not completely across. When they produced a unilateral (left-sided) seizure after moderately strong stimulation of the opposite (right) motor cortex, spike potentials were recorded from the right motor cortex and the corpus callosum, but not from the left motor cortex. This observation is confirmed in our experiments. When a seizure was produced (fig. 8) by mechanical stimulation of one side of the cortex, spike potentials were recorded from both the bipolar and the monopolar electrode (leads I and III) of the traumatized area, but not from the opposite side (lead II).

The experiments of Walker, Kollros and Case¹⁷ indicate that at the moment of concussion cortical activity is increased in frequency and then decreases for a varying period, until there is little spontaneous activity. When pentobarbital was substituted as an anesthetic for vinylene and procaine, however, there was an immediate decrease in all cortical activity after trauma. This observation is identical with our electroencephalographic findings with pentobarbital anesthesia, although the greater increments of force used in some of our experiments produced a much longer period of depressed cortical activity.

Finally, our experiments indicate that the degree of reduction in electrical potential in the electroencephalogram is directly proportional to the amount of force applied to the cortex. The time of appearance of slow waves seen in connection with head injuries is inversely proportional to the amount of force delivered to the cortex.

CONCLUSIONS

A new method for the study of cortical cell change in connection with electroencephalographic deviations is introduced.

Electroencephalographic changes vary with the amount of cortical cell damage within a certain critical range.

Below this critical range cortical cell change occurs without corresponding electroencephalographic deviations.

Within the critical range the amount of electrical and cortical cell change is directly proportional to the amount of force applied to the cortex.

16. Hoefler, P. F. A., and Pool, J. L.: Conduction of Cortical Impulses and Motor Management of Convulsive Seizures, *Arch. Neurol. & Psychiat.* **50**:381 (Oct.) 1943.

17. Walker, E. A.; Kollros, J. J., and Case, T. J.: Physiologic Basis of Cerebral Concussion, *A. Research Nerv. & Ment. Dis., Proc.* (1943) **24**:437, 1945.

Localized cortical cell damage produces localized electroencephalographic changes.

Histologic changes assume a definite pattern of stratification, according to the amount of force applied to the cortex.

Electroencephalographic changes vary with the amount of force applied to the cortex. Reduction in amplitude is directly proportional to the amount of force delivered. The appearance of slow waves is inversely proportional to the amount of force applied to the cortex.

Unilateral convulsive electrical patterns were produced by the mechanical application of force to the cortex.

An attempt is made to relate our experimental results to the clinical findings following trauma to the head.

· 710 West One Hundred and Sixty-Eighth Street (32).

MALIGNANT CHORDOMA OF THE LUMBAR REGION

Report of a Case with Autopsy; Comment on Unusual Metastases to the Brain, Lungs, Pancreas, Sacrum and Axillary and Iliac Lymph Nodes

ARTHUR A. MORRIS, M.D.

AND

R. RABINOVITCH, M.D.

MONTREAL, CANADA

CHORDOMA is a rarely encountered neoplasm which arises from the cell remnants of the fetal notochord. Notochordal cells are ordinarily present in the adult within the nucleus pulposus of the intervertebral disks. These cells may remain in the centers of the vertebral bodies¹ and on rare occasions may be found in the maxilla or the mandible.

Of the 266 cases recorded in the literature, the lesion was vertebral in only 36. In a small percentage of these cases the growth was in the lumbar region, and in a still smaller percentage widespread metastases occurred to distant organs. We report here a case of chordoma, surgically removed on three occasions, in which unusual metastases were finally presented. The metastases to the brain are believed to be unique.

HISTORY

When von Luschka² first described the chordoma its significant relation to the fetal notochord was not realized. Virchow³ expressed belief that it was the result of degenerative cartilage. Thus, he named it "ecchondrosis physaliphora" ("ecchondrosis," from "cartilage" and "physaliphora," from "vacuole-containing cell"). However, Müller⁴ apparently first advanced the idea that this tumor originates from the notochordal cells. Ribbert and Steiner⁵ rather convincingly established

From the Department of Neurology and Neurosurgery, McGill University, and the Montreal Neurological Institute.

1. Richards, V., and King, O.: Chordoma, *Surgery* 8:409-423, 1940.

2. von Luschka, H.: Die Alterveränderungen der Zwischenwirbelknorpel, *Virchows Arch. f. path. Anat.* 9:312-327, 1855.

3. Virchow, R.: Untersuchungen über die Entwicklung des Schädelgrundes in gesunden und krankhaften Zustände und über den Einfluss derselben auf Schädelform Gesichtsbildung und Gehirnbau, Berlin, Reimer, 1857.

4. Müller, H.: Ueber das Vorkommen von Resten der Chorda dorsalis bei Menschen nach der Geburt und über ihr Verhältniss zu den Gallertgeschwülsten am Clivus, *Ztschr. f. rat. Med.* 2:202-229, 1858.

5. Ribbert, M. W. H., and Steiner, H.: Ueber die Ecchondrosis physalifora spheno-occipitalis nach Untersuchungen von Hermann Steiner, *Centralbl. f. allg. Path. u. path. Anat.* 5:457-461, 1894.

the origin of the chordoma by puncturing the intervertebral disk of rabbits and demonstrating that the proliferation of the herniated nucleus pulposus closely resembled histologically that of the chordoma. In 1919 Potoschnig⁶ reported the first case of chordoma with widespread metastases, the tumor originating in the sacrococcygeal region.

To Klebs⁷ is attributed the report of the first clinical case of chordoma which was located within the cranium. Raul and Diss⁸ reported the first authentic case of vertebral chordoma in 1924. The chordoma was located in the cervical region. DesJacques⁹ and Owen, Hershey and Gurdjian¹⁰ expressed the belief that Trélat's¹¹ case of chondroma of the neck, reported in 1868, was probably one of chordoma and is, then, the earliest case of vertebral chordoma on record.

The history following the experimental work by Ribbert and Steiner⁵ is composed largely of case reports and reviews of the subject. Articles by Stewart¹²; Coenen¹³; Stewart and Morin¹⁴; Machulko-Horbatzewitsch and Rochlin¹⁵; Owen, Hershey and Gurdjian¹⁰; Fletcher, Woltman and Adson¹⁶; Mabrey,¹⁷ and Faust, Gilmore and Mudgett¹⁸ offer complete reviews of the subject.

REVIEW OF CASES REPORTED IN THE LITERATURE

The recent review of Faust, Gilmore and Mudgett¹⁸ shows that only 15.1 per cent of the chordomas are of the vertebral type. The

6. Potoschnig, G.: Ein Fall von malignem Chordom mit Metastasen, Beitr. z. path. Anat. u. z. allg. Path. **65**:356-362, 1919.

7. Klebs, E.: Ein Fall von Eochondrosis spheno-occipitalis amyloacea, Virchows Arch. f. path. Anat. **31**:396, 1864.

8. Raul, P., and Diss, A.: Chordome malin de la colonne vertébrale lombaire, Bull. et mém. Soc. anat. de Paris **94**:395-402, 1924.

9. DesJacques, R.: A propos d'un cas de chondrome de la colonne cervicale, Lyon chir. **24**:40-43, 1927.

10. Owen, C. I.; Hershey, L. N., and Gurdjian, E. S.: Chordoma Dorsalis of the Cervical Spine, Am. J. Cancer **16**:830-840, 1932.

11. Trélat, U.: Encondroma à marche rapide, Gaz. d. hôp. **41**:254, 1868.

12. Stewart, M. J.: Malignant Sacro-Coccygeal Chordoma, J. Path. & Bact. **25**:40-62, 1922.

13. Coenen, H.: Das Chordom, Beitr. z. klin. Chir. **133**:1-77, 1925.

14. Stewart, M. J., and Morin, J. E.: Chordoma: A Review with a Report of a New Sacro-Coccygeal Case, J. Path. & Bact. **29**:41-60, 1926.

15. Machulko-Horbatzewitsch, G. S., and Rochlin, L. L.: Pathomorphologie und Histogenese der Chordome, Arch. f. Psychiat. **89**:222-262, 1930.

16. Fletcher, E. M.; Woltman, H. W., and Adson, A. W.: Sacrococcygeal Chordomas, Arch. Neurol. & Psychiat. **33**:283-299 (Feb.) 1935.

17. Mabrey, R. E.: Chordoma: Study of One Hundred and Fifty Cases, Am. J. Cancer **25**:501-517, 1935.

18. Faust, D. B.; Gilmore, H. R., and Mudgett, C. S.: Chordomata: A Review of the Literature, with Report of a Sacrococcygeal Case, Ann. Int. Med. **21**:678-698, 1944.

classification devised by Coenen¹³ and adapted by Gardner and Turner¹⁹ has been modified slightly by us.

1. Cranial
 - (a) Sphenoid
 - (b) Spheno-occipital (clivus)
 - (c) Nasopharyngeal
 - (d) Dental (including maxillary and mandibular)
2. Vertebral
 - (a) Cervical (including chordomas arising from the odontoid process of the second cervical vertebra)
 - (b) Thoracic
 - (c) Lumbar
3. Sacrococcygeal (caudal)
 - (a) Antesacral
 - (b) Central
 - (c) Retrosacral

The case reported here is that of a vertebral chordoma, although finally the neoplasm largely replaced the entire sacrum.

Thirty-four cases of vertebral chordomas have been recorded. Davison and Weil²⁰ reported a malignant chordoma arising from the body of the third lumbar vertebra. In 1930 Machulko-Horbatzewitsch and Rochlin¹⁶ reviewed 8 cases of vertebral chordoma. In his review of 150 cases in 1935, Mabrey¹⁷ listed 14 cases of vertebral chordoma, the tumor being cervical in 7 cases, thoracic in 2 cases and lumbar in 5 cases. By 1944 Faust, Gilmore and Mudgett¹⁸ had collected 20 cases occurring since 1935, bringing the total number of cases of vertebral chordoma to 34. They also reported a case of sacrococcygeal chordoma which had metastasized to the lungs and the adrenal gland. Since Faust, Gilmore and Mudgett's¹⁸ survey of the literature, 12 cases of chordoma have been recorded, in only 2 of which is the tumor known to be vertebral. In the sacrococcygeal group widespread metastases occurred in over 50 per cent of the cases.¹

Vertebral chordomas, except for the sacrococcygeal group, are largely found in the cervical region.²¹ The lumbar chordomas rank second.¹⁷ A case of chordoma occurring in the lumbar region of an osteomalacic mouse has been reported.²²

REPORT OF CASE²³

Mrs. I. G., a married woman aged 27, was admitted to the Montreal Neurological Institute on Aug. 31, 1943, complaining of pain in the lower part of the

19. Gardner, W. J., and Turner, O.: Cranial Chordomas: Clinical and Pathologic Study, *Arch. Surg.* **42**:411-425 (Feb.) 1941.

20. Davison, C., and Weil, A.: Malignant Chordoma of the Lumbar Region, *Arch. Neurol. & Psychiat.* **19**:415-423 (March) 1928.

21. Adson, A. W.; Kernohan, J. W., and Woltman, H. W.: Cranial and Cervical Chordomas, *Arch. Neurol. & Psychiat.* **33**:247-261 (Feb.) 1935.

22. Morpurgo, B., cited by Coenen.¹³

23. Dr. A. R. Elvidge permitted us to publish this case.

back of four months' duration and sciatic pain on the right side for three years. Occasional sciatic pain on the left side was noted for four months. She vaguely recalled having slipped on the floor, landing in a sitting position, five or six years previously, without noticeable injury or pain in the lower part of the back.

In 1940 she noted a sharp, recurring pain in the right calf, the posterior aspect of the left thigh and the left buttock, which persisted for many months. During the six months prior to admission she had observed that the right ankle seemed smaller than the left. Four months prior to her admission a persistent, sharp, ascending, stabbing pain was felt in both ankles, being more severe in the left one. There was a sensation of heat over the left leg, foot and thigh for about one-half hour every night, with occasional stiffness in the right foot and ankle. For about four months, intermittently, tiredness was felt in both legs, with gradual progressive weakness in both legs, particularly in the right. Codeine was taken to relieve pain, but sleep was poor. Coughing, sneezing, straining or bending forward or backward accentuated the pain in the leg and the lower part of the back.

At the time of onset of symptoms, in 1940, the patient had been treated for "inflammation of the sciatic nerve" and for "improper shoes." She was finally referred to the Montreal Neurological Institute, where a tentative diagnosis of ruptured intervertebral disk or tumor of the cord was made.

Examination revealed that the patient was well developed and well nourished. Pronounced scoliosis with convexity to the left and slight immobility of the lumbar portion of the spine were found. All movements of the spine accentuated the pain in the back and leg. There was tenderness over the fifth lumbar and first sacral transverse processes. The straight leg-raising test provoked neither pain in the back nor sciatic pain.

The patient was mentally alert, cooperative and well oriented, but nervous, rather timid and definitely anxious. The positive neurologic findings were diminution to pinprick over the distribution of the first to the fifth sacral nerves on the right side and a marked diminution in two point sensation over the whole right foot. There was considerable weakness in both legs. The tiptoe position was brief for both feet and was impossible to execute on one foot alone. Dorsiflexion of the foot was weak, especially on the right. There was slight atrophy of the right calf and the right anterior tibial muscle group, with moderate tenderness of the muscles of the right calf. The ankle jerk was absent bilaterally. Routine laboratory analyses gave normal results.

Roentgenographic examination on September 2 showed that the first sacral vertebra was not as completely united to the sacrum as usual, lying moderately higher in relation to the iliac crests and presenting a well formed separated laminal arch. The right sacroiliac joint was a little narrower than the left. The fifth lumbar-first sacral intervertebral disk was slightly narrowed.

A myelogram taken with iodized poppyseed oil showed arrest of the opaque column at the level of the superior border of the fifth lumbar vertebra, with some oil extending as far as the midportion of this vertebra, the level being slightly lower on the left.

Although the presence of a large herniated disk between the fifth lumbar and the first sacral vertebra could not be completely excluded, it was felt that the findings were much more in favor of a neoplasm which was filling the spinal canal.

On September 7 a right hemilaminectomy was performed by Dr. A. R. Elvidge, with subtotal removal of an extradural tumor. This epidural mass was observed lying at the level of the disk between the fifth lumbar and the first sacral vertebra

on the right side. It extended upward along the body of the fifth lumbar vertebra about half its length and into the sacral area for 2 to 3 cm. When the area was first exposed, a grayish, thick fluid was obtained; then grayish white portions of tissue were encountered. The mass was 4 cm. in length and 1 cm. in diameter. Microscopic examination showed that the tissue was a chordoma (fig. 1). A majority of the cells were embryonic, nonvacuolated, polygonal, epithelial types. All forms of transition were present, including the adult notochordal cell.

The postoperative course was uneventful. There was complete relief of sciatic pain; the wound healed satisfactorily, and on September 21 the patient was discharged and advised to return for roentgen therapy.

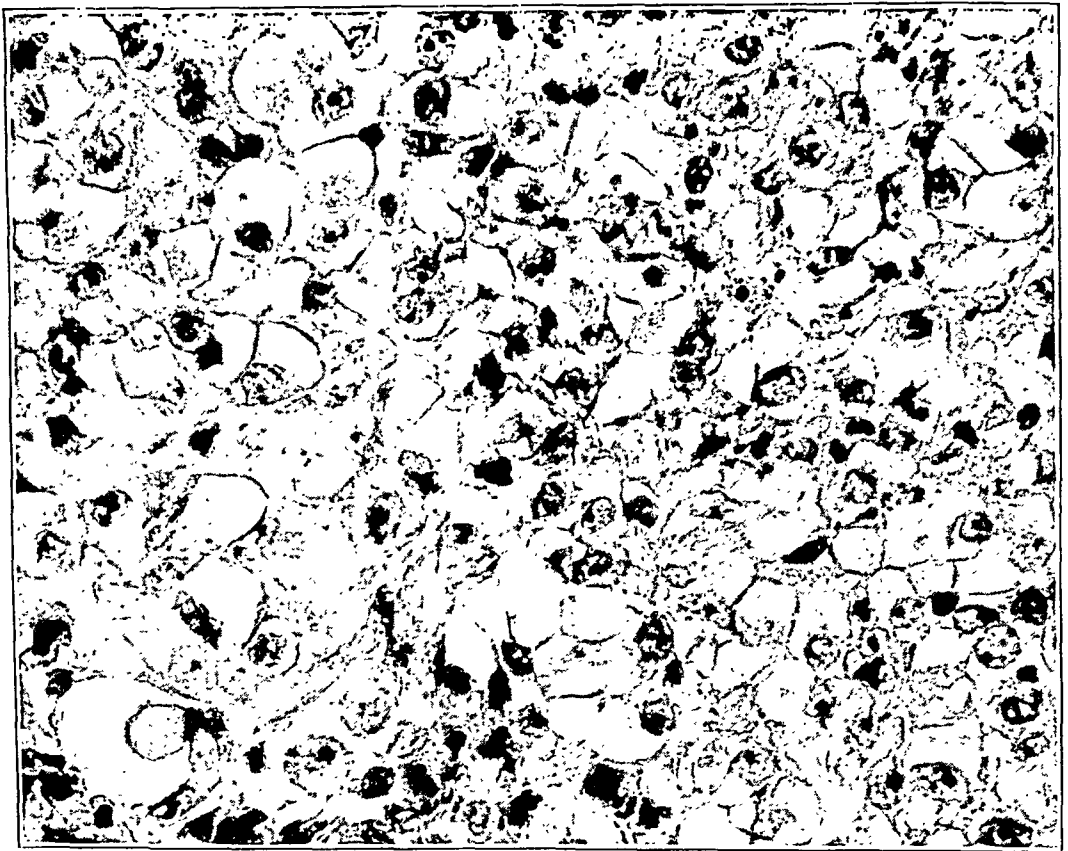

Fig. 1.—Appearance of the initial surgical specimen two years prior to death. Note the huge vacuolated cells with eccentric nuclei. Intracellular glycogen was present, and mitotic figures were not seen.

From Sept. 29 until Nov. 5, 1943 the patient received a full course of high voltage roentgen therapy over the lower lumbar and the sacral region. During this time she complained of mild pain in the lower part of the back. For six months she lived at home, with a fair degree of comfort. In April 1944 she again noted a gradual onset of sciatic pain on the left side, which later was replaced by burning pain. Urinary frequency, associated with anesthetic bowel and urinary movements, appeared, together with weakness in the left leg. She was readmitted to the hospital on June 10, 1944.

Examination revealed weakness of the muscles of the left anterior peroneal group and the calf; absence of the ankle jerk bilaterally; plantar extension on the right; immobility of the lower part of the back; slight scoliosis, with con-

vexity to the left; exquisite tenderness over the fifth lumbar and first sacral spinous processes; limitation of straight leg raising, which was more marked on the left, and analgesia over the area of the first to the fifth sacral vertebra bilaterally.

Roentgenographic examination on June 12, 1944 showed partial removal of the right lamina of the fifth lumbar vertebra. The anterior margin of the spinal canal opposite the first and second sacral vertebrae was farther forward than usual and was partially eroded. On June 23 Dr. Elvidge performed a laminectomy with removal of the recurrent chordoma at the level of the fourth and fifth lumbar and first sacral vertebrae bilaterally. The tissue removed consisted of a large piece of gray friable tissue, measuring 3 by 2 by 1 cm., and several smaller fragments, weighing 6 Gm. Microscopic examination again confirmed the diagnosis of chordoma. A few mitotic figures, not seen previously, were observed.

The patient's condition was improved at the time of her discharge, four months after operation. She no longer complained of sciatica, and the motor power in both legs was fairly good. She was able to walk without help. Roentgenographic examination on Oct. 10, 1944 showed no change.

For four months she suffered occasional sharp, shocklike pains in the buttocks and the posterior aspect of both thighs down to the ankles. The pain became so accentuated that in January 1945 she went to bed permanently. Urinary and rectal stress incontinence had persisted from the time she had last left the hospital.

On Feb. 12, 1945, the patient became completely paralyzed in both legs, with total cessation of pain in both lower limbs. On the following day she was readmitted to the Montreal Neurological Institute, where examination revealed complete paraplegia. There were hyperesthesia and hypalgesia from the twelfth thoracic dermatome down, with loss of sensation over the tenth and eleventh thoracic segments. Roentgenographic examination showed increasing destruction of bone in the sacral region and a lesion involving the body of the eleventh thoracic vertebra.

Dr. Elvidge performed a third laminectomy and removed 15 Gm. of extradural reddish, granular tumor tissue lying over the tenth thoracic vertebra and extending deep into the body of the eleventh thoracic vertebra.

Microscopic examination revealed cells similar to those in the chordoma tissue removed previously. In addition, it was noted that the neoplasm was invading bone to a pronounced extent.

The postoperative course was progressively downhill. Neither motor nor sensory power in the lower limbs was ever regained. A swelling in the left temporal region of the skull developed and was followed by papilledema. Roentgenographic examination of the skull and sinuses on March 28, 1945 showed extensive destruction of a considerable portion of the left side of the skull. This had noticeably increased by April 16. She died six months later.

NECROPSY

General Examination.—Autopsy was performed seventeen hours post mortem. The body was extremely emaciated, and pronounced edema of both feet was noted. Decubitus ulcers were present over both heels, on the right buttock and in the right subscapular region.

A small amount of fluid was present in the pleural cavity amounting to 100 cc. on the right side and 50 cc. on the left side. The portion of the pleural cavity not containing fluid was obliterated by fibrous adhesions. The visceral pleura

bulged on each side, owing to the presence of tumor nodules. In the upper part of the inferior lobe of the left lung and in a corresponding position within the right lung was located a small tumor nodule. In the peripancreatic soft tissues a rather firm, small nodule was identified. The axillary and iliac lymph nodes were almost completely replaced by neoplasm. Examination of other abdominal and thoracic structures showed only signs of severe emaciation.

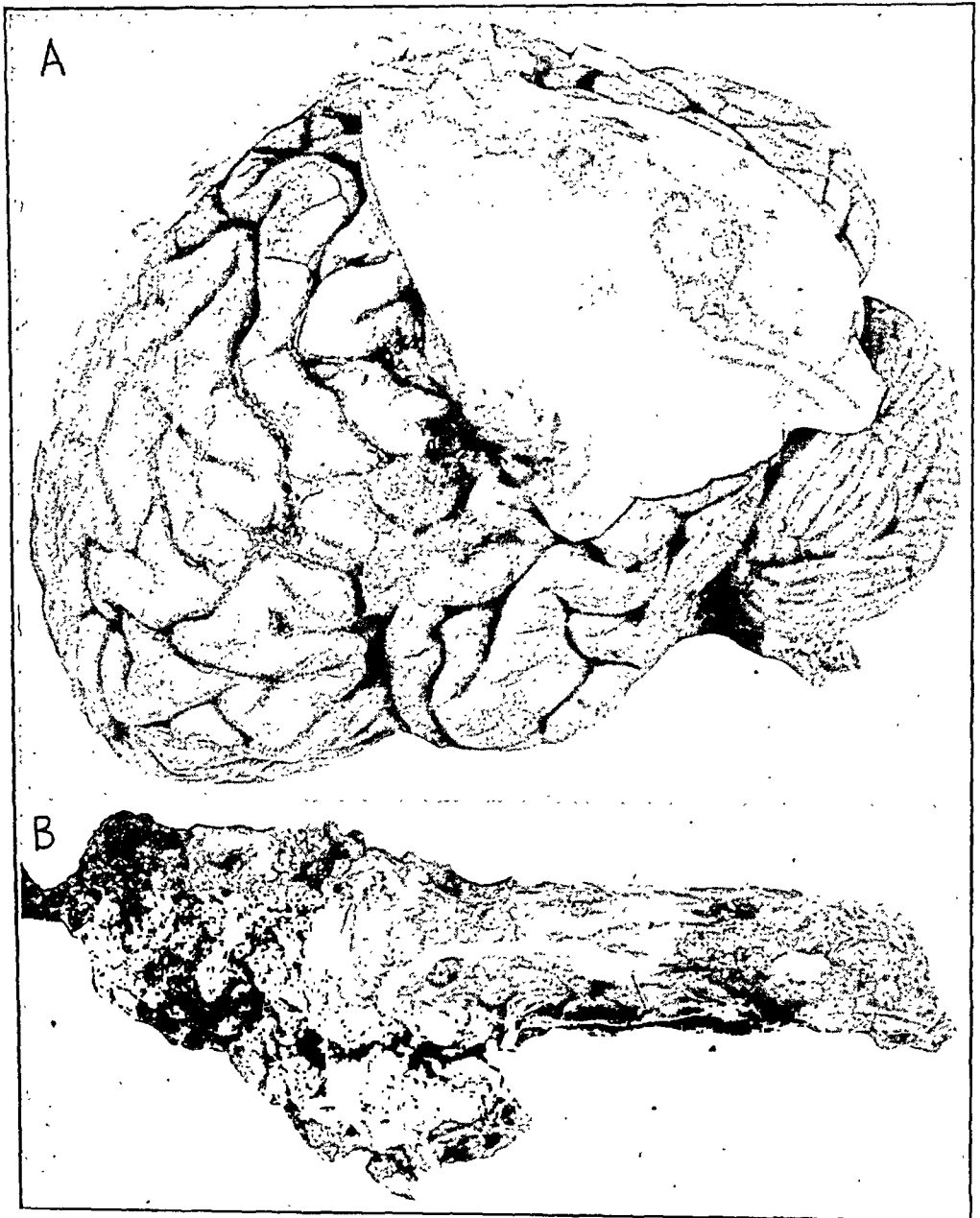

Fig. 2.—*A*, the brain after removal. Note the presence of large dural nodules, one of which is shown invading the brain just above the sylvian fissure. The photomicrographs shown in figures 5 *A* and *B* and 7 are taken from the nodule invading the brain. *B*, gross appearance of the lumbar and sacral regions prior to dissection. Note the massive replacement of the sacrum by the tumor mass. For photomicrographs of sections see figures 5 and 6.

Neurologic Study.—Extensive destruction involved a considerable portion of the left side of the skull. The destruction was most marked in the region of

the coronal suture of the frontal bone. It extended backward into the posterior part of the parietal bone and forward to involve the superior orbital plate.

Over the frontal and temporal regions on the left side the dura was eroded by several nodules projecting from the outer surface of the dura. The reflected dura showed two nodules in the anterior frontal area (fig. 2 A). The arachnoid was thickened. A large, irregular mass, measuring 6 by 4 cm., was attached firmly to the underlying brain. The arachnoid was destroyed at this point, and the brain was invaded by the mass.

Horizontal sections of the brain at 2 cm. intervals revealed no additional lesions. The upper cervical and the thoracic region of the spinal cord appeared normal.

Vertebral Bodies and Sacrum.—The lower part of the vertebral column, from the twelfth thoracic vertebra to the coccyx, was removed (fig. 2 B). The body of the twelfth thoracic vertebra was soft, bloated and soggy, and many soft nodules could be palpated. The bodies of the lumbar vertebrae from the first to the fourth appeared normal. Caudal to the fourth lumbar vertebra the spine was mostly replaced by a large, irregular mass of tumor; yet the shape and appearance of the fifth lumbar vertebra, the sacrum and the coccyx could still be seen. This mass was filled with multiple nodules, which were 0.5 to 3 cm. in diameter. Each nodule was irregular in shape and rubbery in consistency and showed necrotic areas easily detached from the mass. Firm islands of bone were also identified within the tumor.

Transverse Processes and Intervertebral Joints.—The superior articular facets of the sacrum were the only bony structures of the sacrum retaining a normal appearance. The capsules of the joints were destroyed, and there was evidence of marginal softening and darkening of the articular surfaces. There was complete destruction of the joints between the twelfth thoracic and the first lumbar vertebrae. The other intervertebral joints were normal.

Two small nodules of tumor were noted on the left anterolateral aspect of the body of the fourth lumbar vertebra, which were adherent to the anterior longitudinal ligament and to the muscle tendons inserting on the vertebral body at this level. Another such nodule, measuring 2 by 1.5 cm., was observed opposite the left anterolateral aspect of the body of the first lumbar vertebra. It was firmly adherent to the adjacent structures.

Dissection.—A horizontal section was made through the inferior border of the disk between the second and the third lumbar vertebrae, the plane of the cut being slightly inferior and posterior. A midsagittal section through the bodies of the third, fourth and fifth lumbar vertebrae and the sacral tumor mass was prepared. Bilateral laminectomy of the twelfth thoracic and the first and second lumbar vertebrae, a horizontal section parallel to the inferior aspect of the disk between the eleventh and the twelfth thoracic vertebrae and a midsagittal section through the bodies of the twelfth thoracic and the first and second lumbar vertebrae were made.

The section through the disk between the second and the third lumbar vertebrae showed that the annulus fibrosus, the nucleus pulposus and the cartilage plate of the superior aspect of the third lumbar vertebra were intact. The normal appearance of the intervertebral space seemed to rule out metastases by direct extension, suggesting that the disk had acted as a barrier to the spread of the tumor. On removal of the superior cartilage plate, the cancellous bone of the third lumbar vertebra seemed normal. The dura was thickened and

adherent to the intervertebral canal. The meninges and the nerve roots of the cauda equina appeared normal up to the level of this section. In the section below, however, the nerve roots and the pia-arachnoid were fused into one soft, gelatinous mass, in which nerve roots could not be identified. This tumor mass was adherent to the dura.

The midsagittal section through the bodies of the third, fourth and fifth sacral vertebrae and the sacrum showed dissemination of the tumor to all structures. The greatest amount of destruction was in the sacrum and the least in the intervertebral disks.

The sacrum was composed of debris of cancellous bone, tumor and necrotic tissue, forming a firm, ragged, rubbery mass. The largest single tumor nodule lay in the posterior halves of the bodies of the first and second sacral vertebrae. The sacral disks were recognized, their central portions being almost normal in appearance. There was beginning destruction of the anterior and posterior edges. The sacral canal could not be identified.

The body of the fifth lumbar vertebra was almost completely replaced by tumor and necrotic tissue. Fragments of cancellous bone still persisted in the right half of the body of this vertebra.

The body of the fourth lumbar vertebra was grossly normal. There was a dark brown area of liquefaction in its posterior half.

The only pathologic change in the body of the third lumbar vertebra was the presence of a small crypt, 1 cm. in depth, at the level of the upper third of the posterior aspect, establishing a communication between the vertebral canal and the cancellous bone. This crypt contained the same thick, brown, gelatinous substance which was present in the cancellous bone of the fourth lumbar vertebra. The disks between the third and the fourth lumbar and the fourth and the fifth lumbar vertebrae and their limiting cartilage plates were intact.

The bony structure of the spinal canal showed no gross abnormalities anteriorly and laterally, at the levels of the third and fourth lumbar vertebrae. The posterior aspect was softened and partially replaced by tumor. From the fourth lumbar vertebra caudally the spinal canal was destroyed and replaced by tumor. The dura was densely adherent to the canal. The nerve roots could no longer be distinguished. They had fused into a soft, jelly-like mass of tumor and necrotic tissue, which was friable and of a dull gray color and showed scattered flecks of yellow tissue throughout.

On the inner aspect of the removed laminae of the twelfth thoracic and the first and second lumbar vertebrae, there existed small masses of a yellowish, gelatinous substance, resembling fat which had undergone degeneration. This substance was found to dissolve in ether. The nerve roots were normal in appearance. The perineural fat usually observed at the entrance to the foramina was replaced by the same yellowish, gelatinous substance adherent to the ligamentum flavum. A posterior longitudinal incision was made in the dura. There was pronounced vascular congestion of the posterior vessels lying on the nerve roots. The arachnoid was of normal appearance. On dissection, it was noted that the nerve roots could be separated and identified at the level of the second lumbar vertebra. Cephalad to this level they were fused. A few nerves could be lifted away from the bundle peripherally.

The horizontal section parallel to the inferior aspect of the disk between the twelfth thoracic and the first lumbar vertebrae revealed complete destruction of the body of the twelfth thoracic vertebra of the intervertebral canal and its contents, of the disk and its cartilage plates and of the superior aspect of the



Fig. 3.—*A*, photomicrograph showing tumor nodule in a large vein of the lung near the pleura. *B*, neoplasm invading the bone of the skull overlying the dural nodule shown in figure 2 *A*. Hematoxylin and eosin stain.

annulus fibrosus of the disk. A small portion of the annulus of the disk between the twelfth thoracic and the first lumbar vertebrae could be identified.

The midsagittal section through the twelfth thoracic and the first and second lumbar vertebrae showed destruction of the body of the twelfth thoracic vertebra by tumor tissue. The first lumbar vertebra seemed grossly normal in appearance, and the disk between the first and second lumbar vertebrae was intact. The body of the second lumbar vertebra revealed the presence of a large, whitish, calcified nodule, directly above the nucleus pulposus of the disk between the second and the third lumbar vertebrae and distinctly separated from the disk by an intact cartilage plate. A second nodule filled the cancellous bone anteriorly. The central portion of this



Fig. 4.—Marked pleomorphism of cell types in the axillary lymph node. Note the large multinucleated tumor giant cell and the presence of a mitotic figure.

vertebra was replaced by a brown, syrupy substance. The dura was firmly adherent by numerous fine, glossy, distensible membranous bands to the inner surface of the spinal canal. •

HISTOLOGIC REPORT

The section taken through the nodule in the lung revealed mixed atelectasis and emphysema, with some thickening of the pleurae (fig. 3A). Patchy hyperemia of the parenchyma was apparent. Tumor cells were seen within the lymphatics and the blood vessels. The tumor nodule seen grossly was subpleural and necrotic. The tumor cells formed ill defined syncytial sheets and masses. Vacuolated spaces of small size were seen among the tumor cells. The cytoplasm stained deeply with both eosin and hematoxylin. The nuclei were abundant and large, with little chromatin. Prominent nucleoli were common, and pleomorphism was conspicuous.

Sections of the axillary and iliac lymph nodes (fig. 4) revealed that the neoplasm had largely replaced the normal architecture. The tumor cells resembled those

seen in the lungs except that there was a much greater tendency for the cell to preserve its identity as a discrete polygonal entity. In the axillary node, nuclear and cytoplasmic vacuolation was prominent, and necrosis was present. There was an abundance of intercellular and intracellular glycogen, demonstrated by the

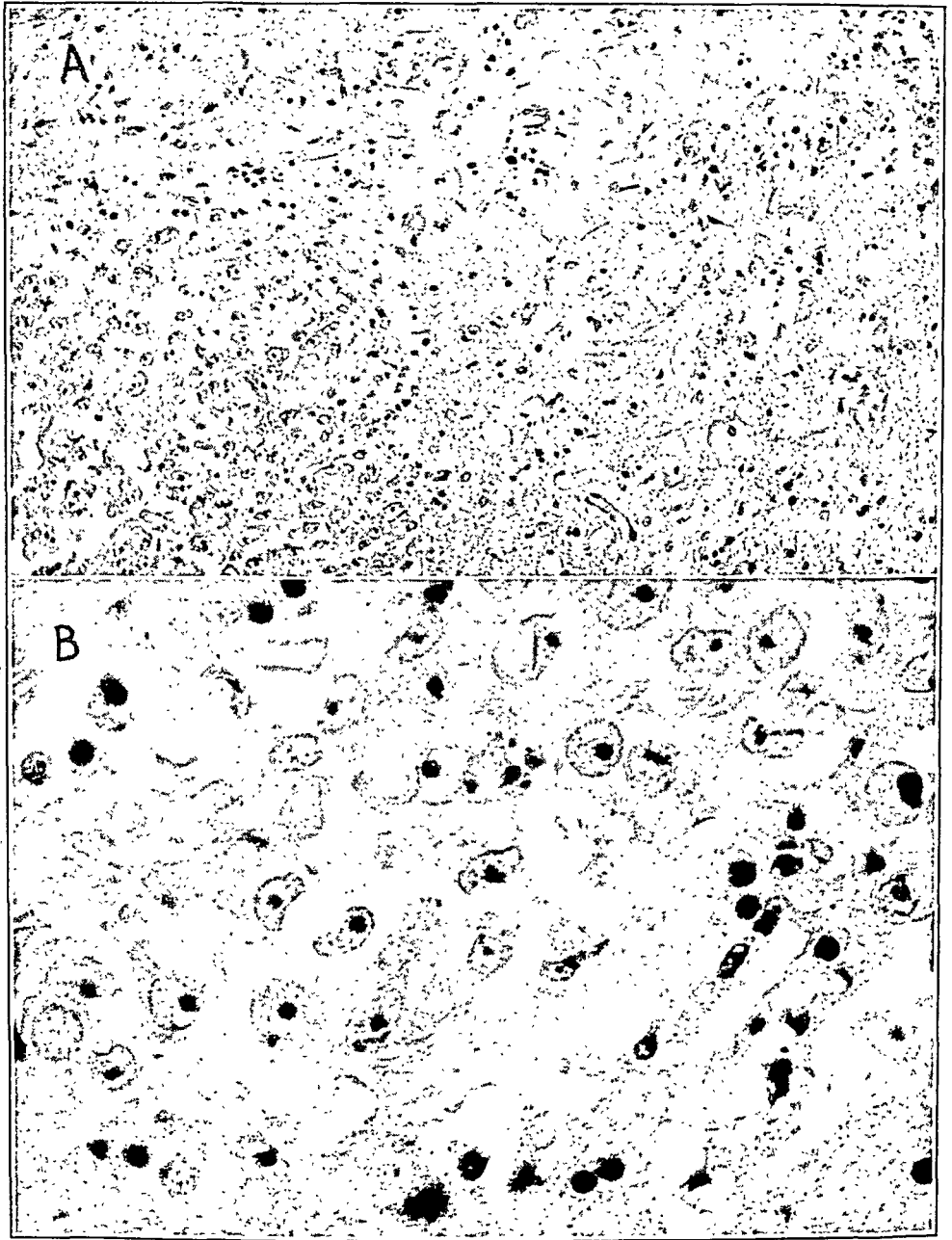

Fig. 5.—Low (*A*) and high (*B*) power views of the tumor invading the left parietal region (fig. 2 *A*). Note the direct invasion, lack of encapsulation of the tumor, presence of scattered neoplastic cells far ahead of the primary mass, large number of plump astrocytes, large cells with prominent nuclei and of varying shapes, hyperchromatic nucleoli and occasional vacuolation of the cytoplasm. Hematoxylin–Van Gieson stain. Compare with figure 7.

Best carmine stain in specimens fixed in alcohol. Vacuolation of cells in the iliac nodes was prominent. The cells tended to be discrete, dark staining and not so large as those of the lung and axillary nodes. They were pleomorphic. Neoplastic cells were noted within the lymphatics and the blood vessels of all the lymph nodes.

A section taken through the skull (fig. 3*B*) revealed predominating destruction of bone by invading tumor. Formation of new bone and proliferation of fibrous tissue were also seen. The cell type showed less pleomorphism and less vacuolation than the cells seen in the metastases in the lungs. Giant cells were observed. Mitotic figures were not seen.

In the peripancreatic tissue a lymph node was almost entirely replaced by tumor. The cell type showed minimal pleomorphism. The cytoplasm stained dark red with eosin. The nucleus was large and round. Chromatin was small in amount and was composed of alternating small and large granular globules. Intracytoplasmic and intranuclear vacuolation was observed but was rather uncommon. Mitoses were frequent.

Routine histologic examination of all other viscera failed to show the presence of metastases.

A section taken through one of the dural nodules demonstrated the neoplastic invasion of the dura. The internal layer was well preserved. The middle and outer layers were replaced by tumor and newly formed fibrous tissue. Projecting from this layer of fibrous and neoplastic tissue was an external nodule of tumor, which was divided into lobules by fibrous tissue. The cell type was pleomorphic and was made up of large polygonal cells. The nucleus presented an irregular outline and little chromatin. A central nucleolus was commonly noted. Intracytoplasmic and intranuclear vacuolation was not uncommon. The intracytoplasmic vacuolation was so great within some of the cells as not only to distend the cell but to give the impression that the nucleus was being expressed from the cytoplasm. Mitoses were not seen.

A section taken from the left frontoparietal region, at the lower end of the rolandic fissure (fig. 5), showed a small tumor nodule invading and destroying the cortex and the underlying white matter. A few smaller nodules were identified within the plexiform layer. The cells were large and closely packed. The pleomorphism was not so prominent as that seen in the lungs and in the lymph nodes. However, intracytoplasmic vacuolations were more numerous. Mitoses were not seen. Small areas of demyelination and small cysts were observed in the white matter. Perivascular infiltration of mononuclear cells was noted deep within the brain. There was surprisingly little glial reaction to the invading neoplasm.

The lesion taken from the extradural space at the level of the fourth lumbar vertebra was rather fibrous. A large sheet of fibrous tissue gave rise to trabeculae, which formed a support for the tumor cells. There were small, suggestive, alveolar-like aggregates of cells; yet in some areas reticulum separated a large number of individual cells. Massive necrosis with huge deposits of fat was observed.

A section taken to demonstrate the relation of the tumor to the lumbar plexus revealed only fragments of nerve fibers enclosed in a large mass of densely fibrous tissue with islands of tumor cells interspersed. The blood vessels of largest caliber were filled with tumor and necrotic debris. Many of the vessels were thrombosed. The most pronounced pleomorphism existed here. Numerous giant cells were seen. Mitoses were common. Many degenerating nuclear forms were observed, and amitotic division was present.

A cross section of the spinal cord at the level of the twelfth thoracic segment showed a greatly thickened dura with a large mass of tumor attached. Arising from the outer layer of the dura were large sheets of fibrous tissue, which divided a necrotic mass into smaller lobules. The same cellular characteristics existed



Fig. 6.—Appearance of the neoplastic nodule lying opposite the left anterolateral aspect of the body of the first lumbar vertebra. High (*A*) and low (*B*) power views, showing the lobular arrangement of the cells within well encapsulated masses of tumor. Note the resemblance to alveolar carcinoma.

here as were seen in the extradural mass which lay opposite the fourth lumbar vertebra. The spinal cord revealed massive destruction, presumably due to extradural pressure.

A section taken from the anterior half of the body of the fourth lumbar vertebra, including the intervertebral disk, the cartilage plate, the annulus fibrosus and the cancellous bone, showed no invasion of the intervertebral disk or of the cartilage plate by tumor tissue. Neoplastic tissue was seen replacing the marrow of the cancellous bone and destroying the bony trabeculae. A section of the tumor nodule on the left anterolateral aspect of the body of the first lumbar vertebra (fig. 6 *A* and *B*) showed the lobular arrangement of cells within well encapsulated masses of tumor resembling alveolar carcinoma.

Dr. Cone²⁴ described a case similar histologically in 1929, emphasizing the presence of intracytoplasmic and intranuclear inclusion bodies. He related the cell type to the cells seen in the notochord of the chick embryo at a stage at which the notochord is disappearing. We were unable to demonstrate these inclusions in our material.

COMMENT

The initial complaints of the patient whose case is reported here were identical with the symptoms and signs of a protruded intervertebral disk at the fifth lumbar–first sacral interspace. For three years sciatica on the right side was present intermittently, following a fall two years previously. The roentgenologic examination proved interesting in showing that the first sacral vertebra was not so completely united to the sacrum as usual, lying moderately higher in relation to the iliac crests and presenting a well formed, separated laminal arch. The diagnosis of tumor of the cord was based on myelographic evidence, and the diagnosis of the tumor type was made from the surgical specimen. At operation, an extradural mass was observed opposite the disk between the fifth lumbar and the first sacral vertebra, which could be followed into the body of the fifth lumbar vertebra.

Three surgical removals were carried out in the lumbar region within a period of one and one-half years. The first operation was followed by a course of roentgen therapy. Between operations the patient was comfortable.

The unusual pathologic features of the case are the metastases to the brain, lungs, pancreas, sacrum and axillary and iliac lymph nodes. The rectum was free of neoplastic involvement. Metastases to the brain have not previously been recorded. Extensive pulmonary metastases have been reported without involvement of the brain.¹⁸

Alezais and Peyron²⁵ presented the histologic criteria for chordoma. They stated that vacuolation of the cellular element, affecting the cytoplasm and the intercellular spaces about the ectoplasm, was a specific characteristic of chordal tissue. Vacuoles were thought to contain a

24. Personal communication to the authors.

25. Alezais, H., and Peyron, A.: Sur l'histiogenèse et l'origine des chordomes, *Compt. rend. Acad. d. sc.* **174**:419-421, 1922.

mucin-like substance. The cellular arrangement was described as that of groups of cells, about cavities, and appearing prismatic or cuboidal. There may be plain strips of cells of epithelial type, with dense cytoplasm filled with vacuoles, interspaced regularly with vascular endothelium. Cellular elements similar to those seen in sarcomas (fusiform or polymorphous in type) may be present. A fine network of fibrils appearing in vacuolated zones tends to make the cellular limits disappear. Alezais and Peyron²⁵ also stated the belief that the various appearances of chordoma lesions correspond to the classic stages of the evolution of the primitive notochord—first a hollow tube, then a solid cord of undifferentiated epithelial cells and, finally, the vacuolation, formation of mucin and fibrillation, which indicate its adaptation to a supporting role. Fletcher, Woltman and Adson¹⁶ expressed the belief that notochordal tumors, although they may resemble either epithelial or mesodermal neoplasms, have specific characteristics. Importance was attached to the formation of intracellular and extracellular mucus; the presence of physaliferous or huge vacuolated, mucus-containing cells; the lobular arrangement of the tumor cells, which usually grow in cords; the occasional occurrence of vacuolation of the nuclei, and the close resemblance to notochordal tissue, as seen in the nucleus pulposus of the intervertebral disks.

The formation of mucus is the most primitive function of notochordal tissue. Thus, its presence in notochordal neoplasms would seem to be of prime importance in making the histologic diagnosis. In the most malignant types of chordoma the production of mucus is the last of the characteristics to disappear as the number of undifferentiated cells increase. The lesions described in the present case showed the presence of both intracellular and extracellular mucus, demonstrated by Best's carmine stain for glycogen on alcohol-fixed tissue. These lesions also show the histologic criteria of advancing malignancy: numerous mitotic figures, cellular pleomorphism, hyperchromatic and irregular nuclei and multinucleated tumor giant cells. Numerous vacuolated nuclei were present in all lesions. Intracytoplasmic and intranuclear inclusion bodies were not demonstrated. The close resemblance to notochordal tissue is suggested by the appearance of the original surgical specimen. Stewart and Morin¹⁴ asserted that the diagnosis of chordoma can be made with certainty only when the characteristic vacuolation and production of mucin are present in at least a portion of the growth.

Whether or not chordomas form cartilage is an interesting point. Faust, Gilmore and Mudgett¹⁸ suggested that areas showing almost acellular fibrillar material, with scattered vacuolated chordoma cells, give the appearance of cartilage. Gardner and Turner¹⁹ included a photomicrograph of tissue which has the appearance of cartilage and which is composed of "vacuolated cells within a homogeneous matrix."

Intranuclear, intracytoplasmic and intercellular glycogen was demonstrated in the original surgical specimen and in the metastatic lesions studied post mortem (fig. 7). The presence of intracellular glycogen has been held responsible for the cytoplasmic vacuolation in every case.²⁶ Nuclear vacuolation has been commented on, but the cause is still undetermined.²⁷ In cases of a highly malignant growth mitoses are common. The odd-shaped nuclear forms, stated by Raul and Diss⁸ to indicate proliferation of cells by amitosis, are not considered evidence of cell multiplication.

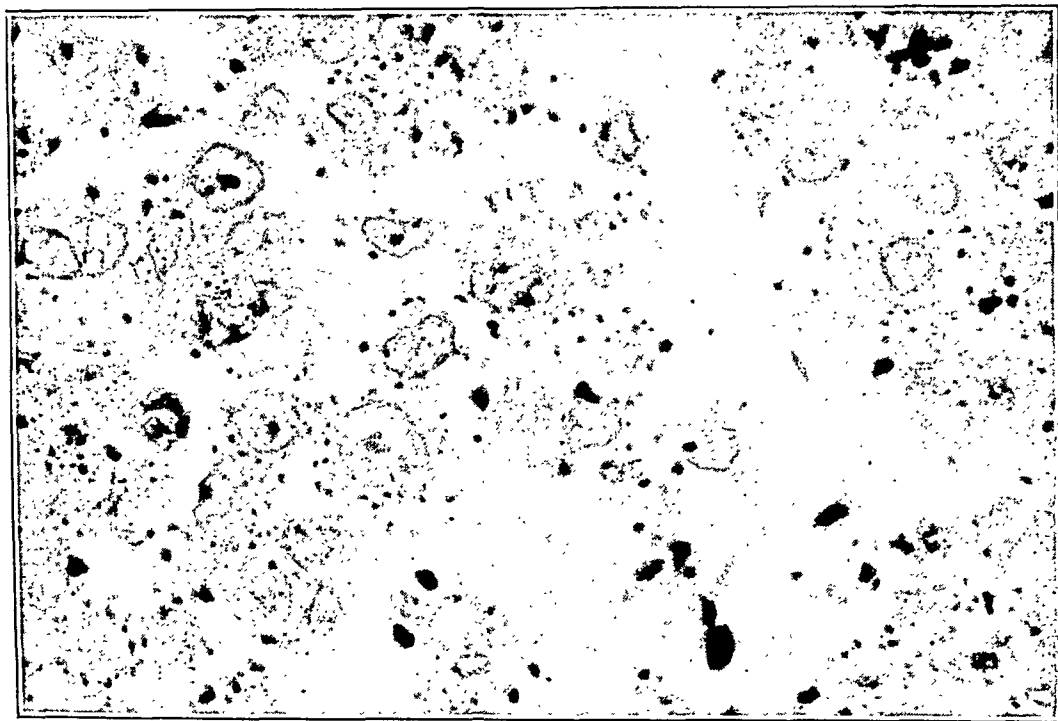

Fig. 7.—Presence of glycogen in the cerebral metastatic lesion. Best's carmine stain for glycogen on alcohol-fixed pyroxylin sections.

SUMMARY

In many of the 34 previously reported cases of vertebral chordoma metastases to various structures have occurred. The case here reported, with metastases to the brain, is believed to be unique, and the neoplasm is classified as vertebral chordoma on the basis of operative studies. Postmortem examination, two and one-half years later, showed metastases to the sacrum, pancreas, lungs, brain and axillary and iliac lymph nodes.

26. Mathias: Ein Beitrag zur Lehre vom malignem Chordom, Verhandl. d. deutsch. path. Gesellsch., 1923, p. 198.

27. Alexander, W. A., and Struthers, J. W.: Sacrococcygeal Chordoma, J Path. & Bact. 29:61-64, 1926. Stewart.¹²

Histologic examination of the lesions revealed the presence of vacuolation of the cellular element, affecting the cytoplasm, nucleus and intercellular spaces about the ectoplasm. The vacuoles were shown to contain a small amount of a mucin-like substance. Cells were arranged about cavities and in lobular forms. Plain strips of cells of epithelial type, with dense cytoplasm filled with vacuoles, interspaced regularly with vascular endothelium, were not uncommon. A fine network of fibrils, appearing in vacuolated zones, could be demonstrated in the local invasive mass of neoplasm. Both mesodermal and epithelial-like sections were identified, the local mass being related more specifically to the epithelial type, while the metastatic lesions resembled the mesodermal type. The close resemblance to notochordal tissue, as seen in the nucleus pulposus of the intervertebral disks, was shown only in the original surgical specimen.

Formation of mucus is considered the most primitive function of notochordal tissue, and the presence of mucus in a portion of the lesions is necessary in arriving at a proper diagnosis of chordoma. Chordomas may form cartilage, or at least cartilage-like structures. That glycogen can be held responsible for vacuolation in every case still remains unproved.

Montreal Neurological Institute.

HISTOPATHOLOGIC CHANGES ASSOCIATED WITH HUMAN POLIOMYELITIS

I. MARK SCHEINKER, M.D.
CINCINNATI

IN SPITE of numerous studies concerning the histopathology of human poliomyelitis, the following problems remain controversial: (1) the localization of the disease and its distribution; (2) the primary type of the essential lesions (whether the alterations in the nerve cells or the inflammatory mesodermal reactions comprise the primary process); (3) the correlation of the neuronal damage and the mesodermal-glial alterations, and (4) the role played by the microglia.

The purpose of this paper is to review some of the conflicting views and to attempt to arrive at an acceptable conclusion concerning some of the aforementioned problems. This presentation is the result of a detailed study of 6 cases of acute anterior poliomyelitis.

Until recently the attention of clinicians and pathologists interested in poliomyelitis was centered almost exclusively on the spinal cord and the medulla. Since 1929, however, when Thomas and Lhermitte³ pointed out that the motor cortex may be affected, increasing attention has been paid to the rest of the central nervous system. A detailed description of all regions of the central nervous system consistently revealing tissue alterations will be given.

HISTOPATHOLOGIC STUDY

The histopathologic lesions were of two principal types: (1) ectodermal changes and (2) mesodermal reactions. The ectodermal alterations were degenerative and the mesodermal proliferative. The former related to susceptible nerve cells; the latter, to microglial elements.

Spinal Cord.—Ectodermal (Degenerative) Changes: Degeneration of nerve cells was at its maximum at the cervical and lumbar levels of the spinal cord, where commonly the large majority of the anterior horn

Read at the Seventy-First Annual Meeting of the American Neurological Association, San Francisco, June 26, 1946.

From the Laboratory of Neuropathology, Cincinnati General Hospital, and the University of Cincinnati College of Medicine.

1 and 2. Footnotes deleted by the author.

3. Thomas, A., and Lhermitte, J.: Les lésions cérébrales et médullaires de la poliomyélite aiguë de l'adulte, *Rev. neurol.* **36**:1242, 1929.

cells were completely destroyed and replaced by a tremendous number of proliferated microglia cells (fig. 1). In the dorsal or the high cervical region in some cases, however, the neuronal destruction was less severe. A considerable number of anterior horn cells were spared from complete destruction; they revealed the following characteristic sequence of degeneration: Central chromatolysis or complete dissolution of the Nissl granules was frequently associated with considerable swelling of both nucleus



Fig. 1—Anterior horn of the cervical portion of the spinal cord. Almost all the nerve cells are destroyed and replaced by a tremendous number of proliferated microglial cells. Cresyl violet stain; $\times 160$.

and cytoplasm, with loss of stainability. Occasionally, however, the nucleus was shrunken, stained darker than usual and occupied an eccentric position in the cell. The cytoplasm had a reticulated appearance and was irregularly outlined, eaten away and invaded by various phagocytes (neuronophagia). In some instances the nerve cells were merely surrounded, but not invaded, by glia cells (satellitosis). In preparations stained with the Bodian silver impregnation method, the intracellular

network appeared distorted, and the neurofibrils were irregularly stained; some of them were heavily impregnated with silver and appeared considerably thicker than normal. In some cells there was granular disintegration or complete loss of the neurofibrils. Neuronal destruction was not always confined to the anterior horn cells; frequently the cells of the posterior horn were damaged, though less severely than those of

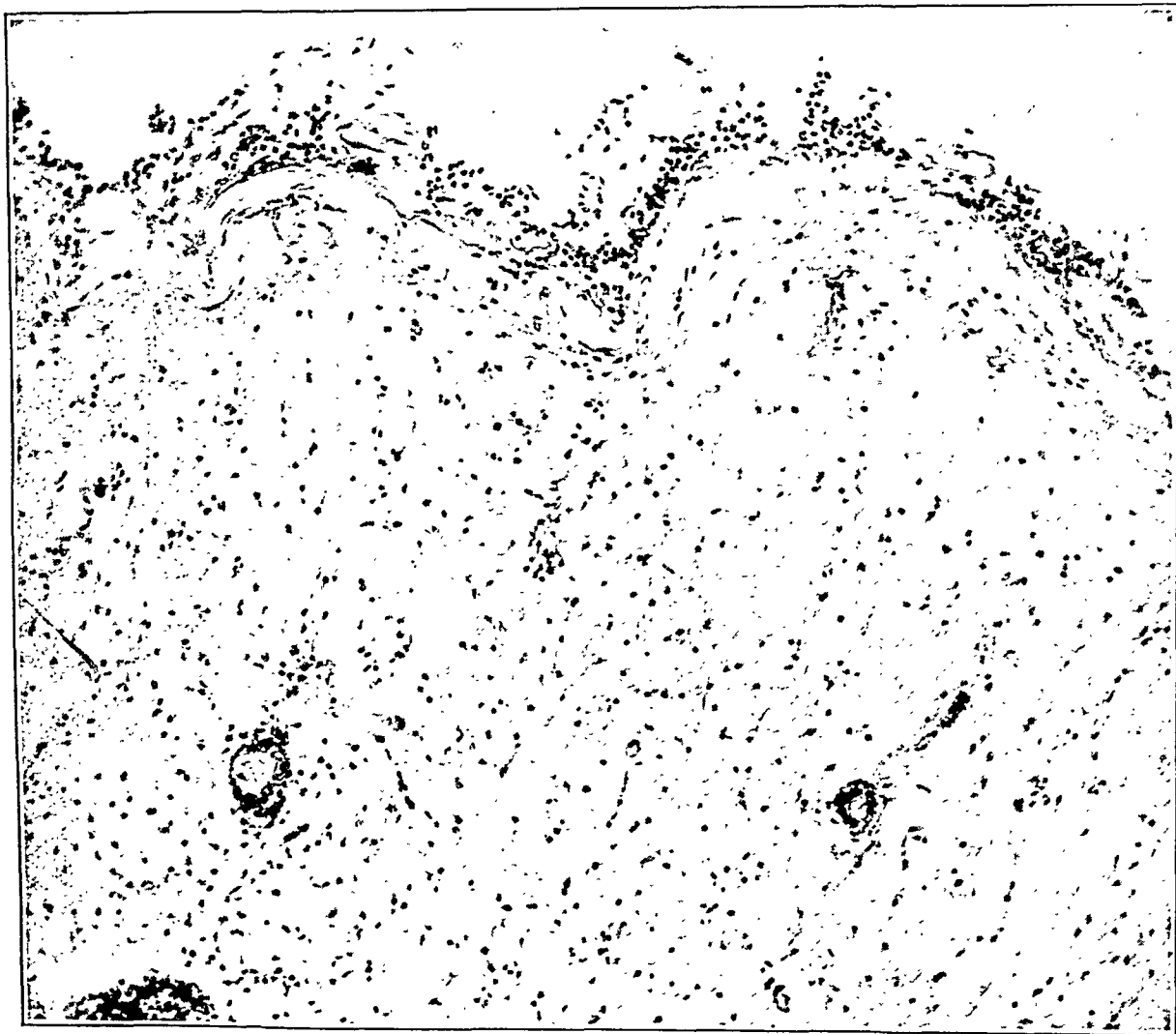

Fig. 2.—Infiltration of the spinal leptomeninges with lymphocytes, fibroblasts and endothelial cells. Cresyl violet stain; $\times 180$.

the anterior horn. The cells of Clarke's column were mostly spared from degeneration.

Mesodermal (Proliferative) Alterations: Concomitant with neuronal destruction, there was a striking proliferation of the microglia. With low magnification the whole gray matter appeared very cellular (fig. 1). The bulk of the cells were involved in very severe neuronal destruction, as in the central portions of the anterior horns; there was a slight degree of perivascular cuffing. The infiltrating cells were predominantly small

lymphocytes, with a variable proportion of adventitial and endothelial elements. These cells were usually confined to the adventitial space of Virchow and Robin. Seldom did the infiltrative cells cross the pial-glia membrane to invade the surrounding nerve tissue. The density of perivascular accumulations of cells was variable; they were either composed of a few lymphocytes or formed a broad cuff, many cells deep.

The inflammatory changes described in the spinal cord were also present in the leptomeninges. Cellular exudates encircled some of the pial vessels (fig. 2). The pia of the anterior median fissure and the

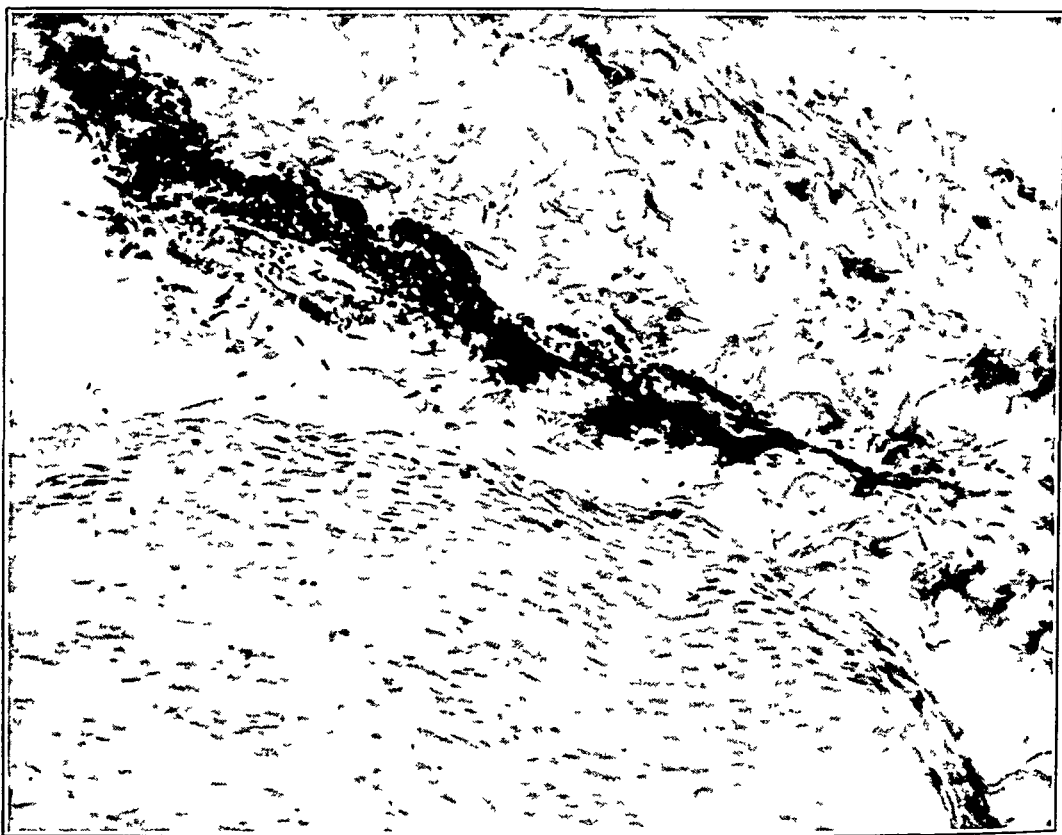

Fig. 3.—Dense accumulation of lymphocytes about the anterior roots of the spinal cord. Hematoxylin and eosin stain; $\times 180$.

zones of entrance of the dorsal nerve roots were the favorite locations for the infiltrates, the composition of which was the same as that of the infiltrates in the spinal cord. Lymphocytes, fibroblasts and endothelial cells were present, in varying quantities. Plasma cells were not seen. It is worth emphasizing that the degree of meningeal infiltration varied considerably at different levels of the spinal cord. The cerebral meninges were affected only in the region of the midbrain and the cerebellum.

Paralleling the destruction of nerve cells and reactive glial changes, a far advanced degeneration of the anterior nerve roots was disclosed.

There was destruction of myelin sheaths, which appeared to be broken up into small fragments. Degeneration of the axons was likewise seen in some of the anterior nerve roots, as well as in the white fibers of the anterior horns. In some cases the anterior nerve roots showed scattered areas of focal infiltration with lymphocytes (fig. 3). The mesodermal as well as the ectodermal, alterations were most pronounced in the cervical and lumbar enlargements, but no level escaped severe damage.

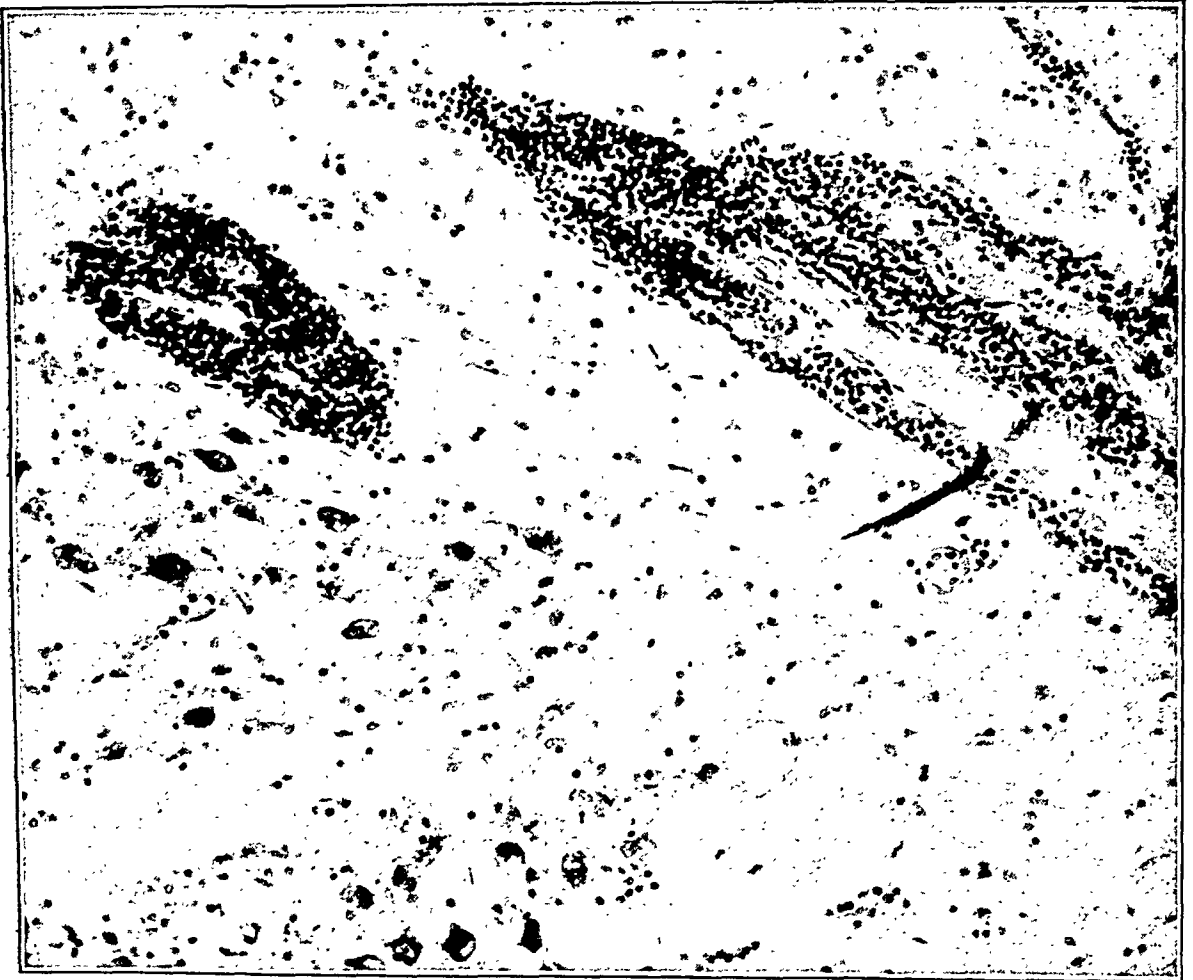

Fig. 4.—Heavy concentration of perivascular cuffing in the substantia reticularis of the medulla. Note the preservation of the nerve cells. Cresyl violet stain; $\times 220$.

Medulla and Pons.—The leptomeninges showed a pronounced infiltration with lymphocytes, especially over the lateral aspects of the medulla and in the immediate vicinity of the fourth ventricle. Engorgement of the adventitial sheaths with hematogenous cells was more pronounced in the medulla and pons than in the cord. A particularly heavy perivascular cuffing was seen in the substantia reticularis, in the region of the nucleus ambiguus, in the dorsal motor nucleus of the vagus nerve and in the floor of the fourth ventricle (figs. 4 and 5). The neuronal

destruction and the microglial proliferation, however, were less pronounced and less severe than in the cord. Actual necrosis of the nerve cells of the vagus except in the nucleus ambiguus and the dorsal motor nucleus was seldom seen. The region of the olives and of the pyramidal tract had completely escaped alteration.

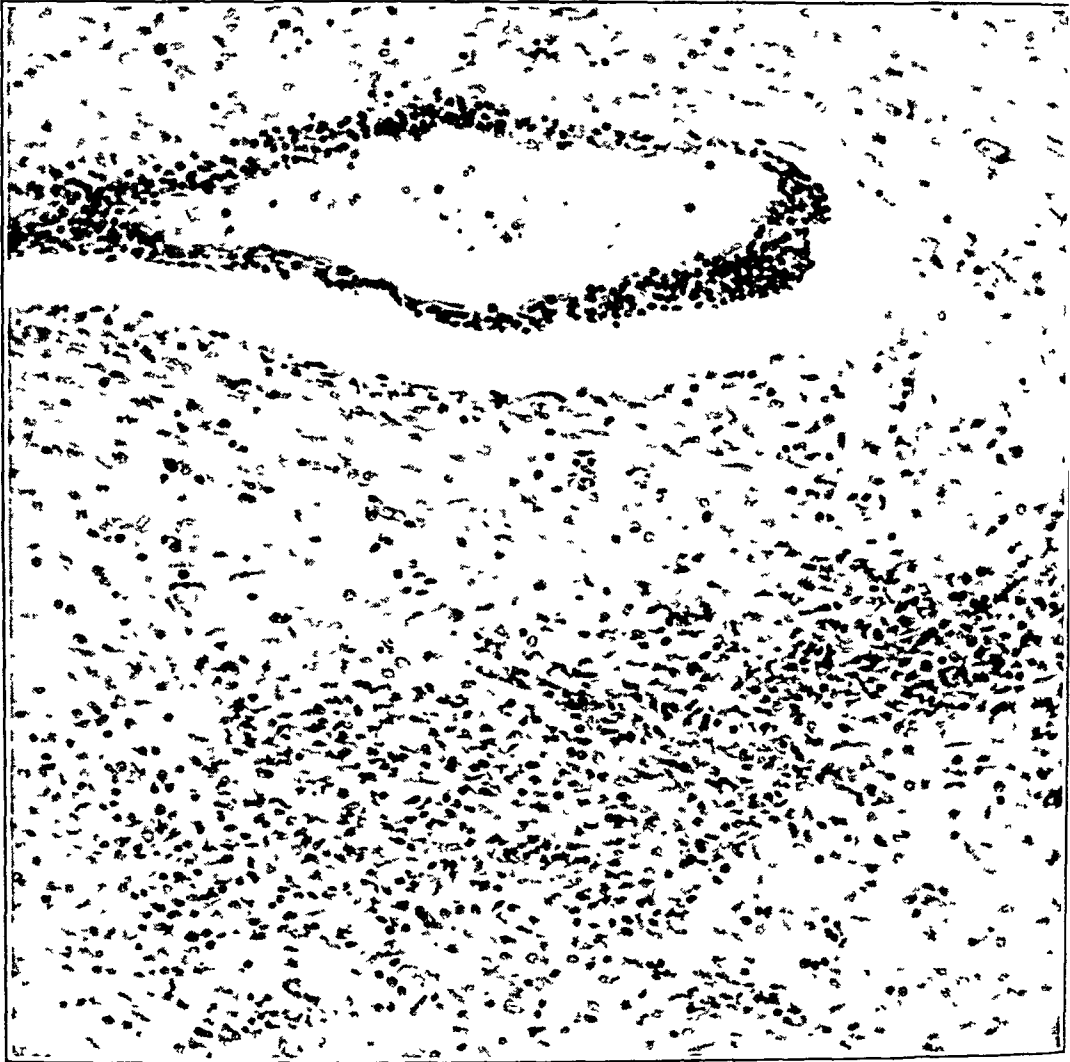

Fig. 5.—Inflammatory changes in the region of the nucleus ambiguus. Note the destruction of nerve cells and the dense proliferation of microglial cells. Cresyl violet stain; $\times 220$.

It is noteworthy that in almost all the cases there were numerous foci of lymphocytes in some of the cranial nerves, being especially pronounced along the vagus.

Midbrain.—Lesions, consisting of dense perivascular infiltration, were more intense in the periaqueductal region and in the substantia nigra than at any other level (fig. 6). As a rule there was little actual

destruction of nerve cells; complete chromatolysis with loss of stainability of the cytoplasm was usually the most advanced change encountered. There were a few disseminated foci of miliary granulomas composed of microglia cells (fig. 7). The leptomeninges, especially those of the interpeduncular region, showed a dense infiltration with lymphocytes (fig. 8).

Basal Ganglia.—Involvement of the hypothalamic nuclei, the corpus striatum and the globus pallidus, was only patchy, irregular and moderate

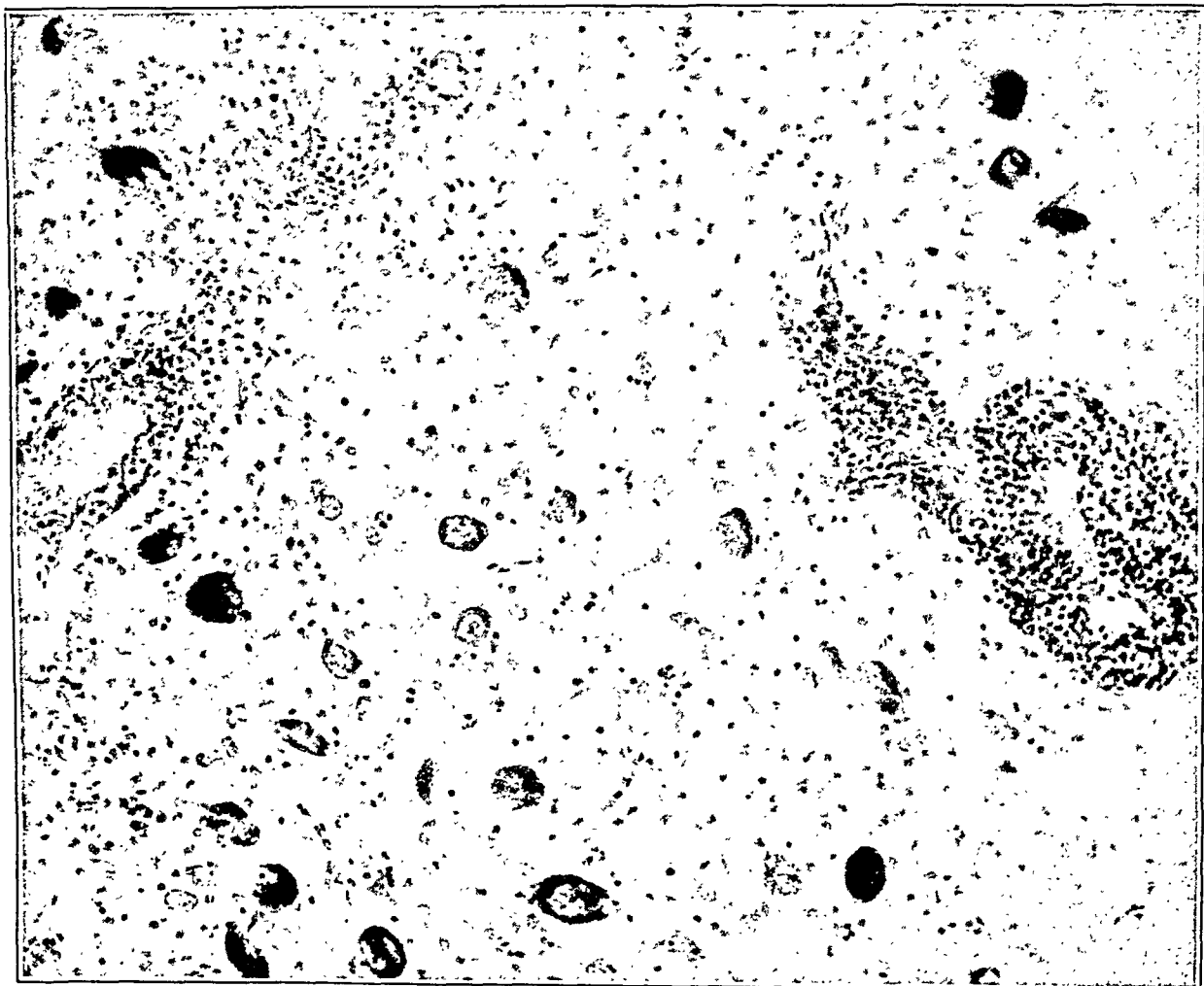
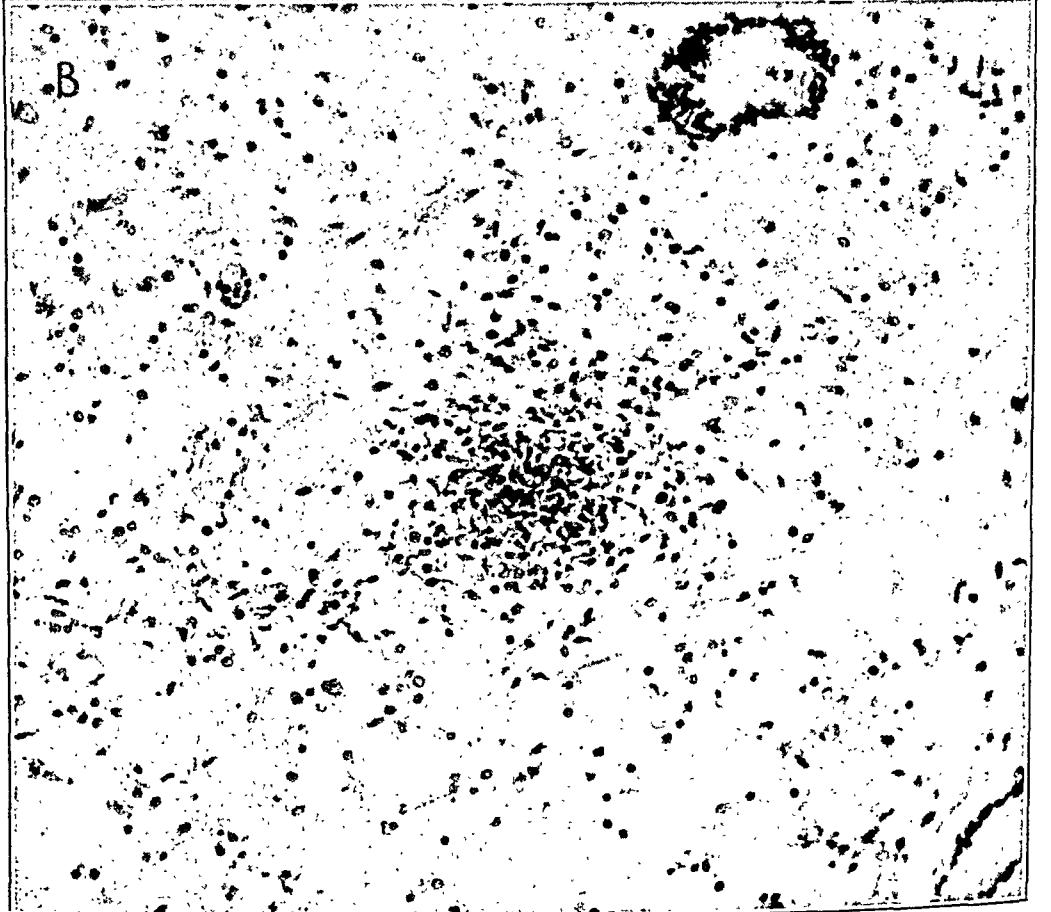
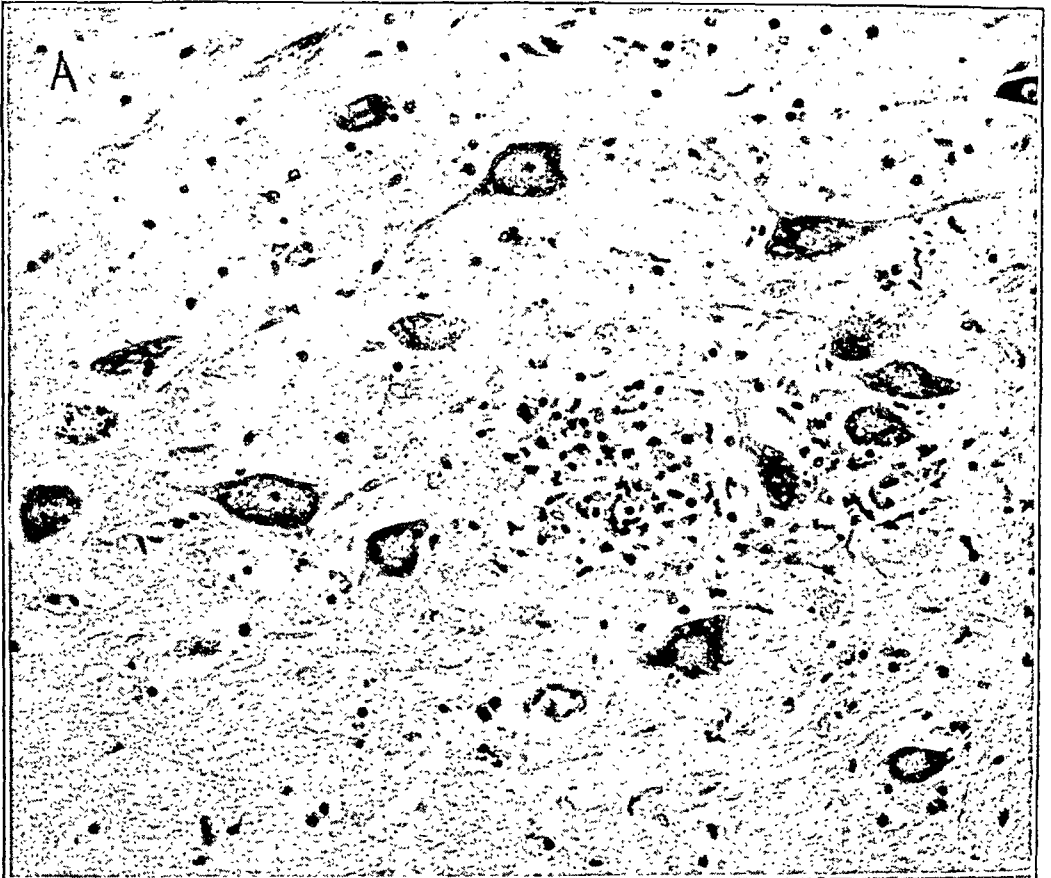

Fig. 6.—Dense perivascular infiltration of the substantia nigra. Note the preservation of nerve cells. Cresyl violet stain; $\times 260$.

in degree. There were a few focal areas of perivascular cuffing, more numerous in the paraventricular regions. Neuronal destruction was not encountered. There were a few disseminated areas of focal accumulations of microglial cells.

Cortex.—In all the cases examined, no alteration of the cortical gray matter was disclosed. The leptomeninges were normal in appearance.



Cerebellum.—The dentate nucleus, the roof nuclei and the white matter often showed lesions, consisting of foci of perivascular infiltration and focal accumulations of microglia cells. There was no evidence of severe neuronal destruction.

GENERAL PATHOLOGIC CONSIDERATIONS

Histopathologic changes, as observed in the present series of cases, seem to indicate that the lesions produced in human poliomyelitis are by no means confined to the anterior horns of the spinal cord. No part of the central nervous system entirely escapes damage. The medulla, pons, midbrain and cerebellum are involved to a great extent in every case. Severe inflammatory lesions are especially pronounced in and around the motor nuclei of the medulla (nucleus ambiguus), in the substantia nigra and in the periaqueductal region. There is no denying, however, that in most cases the brunt of the morbid process is borne by the nerve cells of the anterior horn of the spinal cord (which in all cases studied had undergone almost complete destruction).

Whereas the inflammatory process is more intense in the medulla and midbrain, neuronal destruction in these regions is slight as compared with that in the anterior horns of the spinal cord. Necrosis of nerve cells at higher levels is rare. It is justifiable, therefore, to draw the conclusion that there is no direct parallelism between neuronal destruction and inflammatory reactions. This conclusion contradicts the view of a majority of authors. Beneke,⁴ Strauss,⁵ Wickman,⁶ Walter⁷ and others have expressed the opinion that damage to nerve cells is proportionate to the degree of inflammatory reaction and that the morbid process of poliomyelitis is characterized by a primary interstitial inflammation with secondary damage to the nerve cells. Such a view is not corrob-

4. Beneke: Ueber poliomyelitis acuta, München. med. Wchnschr. **57**:176, 1910.

5. Strauss, I.: The pathology of Acute Poliomyelitis and Its Bearing upon the Symptoms of the Disease, Pediatrics **22**:469, 1910.

6. Wickman, I.: Acute Poliomyelitis, translated by J. Maloney, Nervous and Mental Disease Monograph 16, New York, Nervous and Mental Disease Publishing Company, 1913.

7. Walter, R.: Zur Histopathologie der acuten Poliomyelitis, Deutsche Ztschr. f. Nervenhe. **45**:79, 1912.

Fig. 7.—*A*, miliary granuloma of the midbrain, composed of a small number of microglia cells (early stage). Note the well preserved nerve cells. Cresyl violet stain; $\times 260$.

B, advanced stage of granuloma formation. Cresyl violet stain; $\times 260$.

rated by the present study. The experimental studies of Hurst,⁸ Sabin⁹ and others gave conclusive evidence that neuronal destruction is due to direct action of the virus on the nerve cells, and not to inflammatory reaction. The present study leaves no doubt that the infection in monkeys (as described by Hurst⁸) reproduces accurately the essential features of the morbid process in human poliomyelitis.

In all the cases studied the distribution and severity of the inflammatory changes did not correspond with the degree and distribution of the neuronal damage. Whereas the inflammatory changes were most



Fig. 8.—Perivascular cuffs of the leptomeningeal vessels of the interpeduncular region. Hematoxylin and eosin stain; $\times 140$.

intense in the midbrain and the medulla, the destruction of nerve cells was only slight and insignificant in this region. On the other hand, in the anterior horns of the spinal cord, where the destruction of nerve cells was almost complete, the inflammatory changes were less noticeable than in the medulla and the midbrain. In short, there is no direct parallelism

8. Hurst, E. W.: *Histology of Experimental Poliomyelitis*, *J. Path. & Bact.* **32**:457, 1929.

9. Sabin, A. B.: *Pathology and Pathogenesis of Human Poliomyelitis*, *J. A. M. A.* **120**:506 (Oct. 17) 1942.

between degenerative and inflammatory lesions; they are independent phenomena.

Microglial Reaction.—Little reference is made in the literature to the role and significance of microglial reaction in cases of poliomyelitis in man; yet in all the present cases diffuse proliferation of microglia cells presented itself as a striking, predominant tissue reaction.

Under low magnification, the gray matter of the spinal cord manifested itself as very cellular. The bulk of the cells were com-

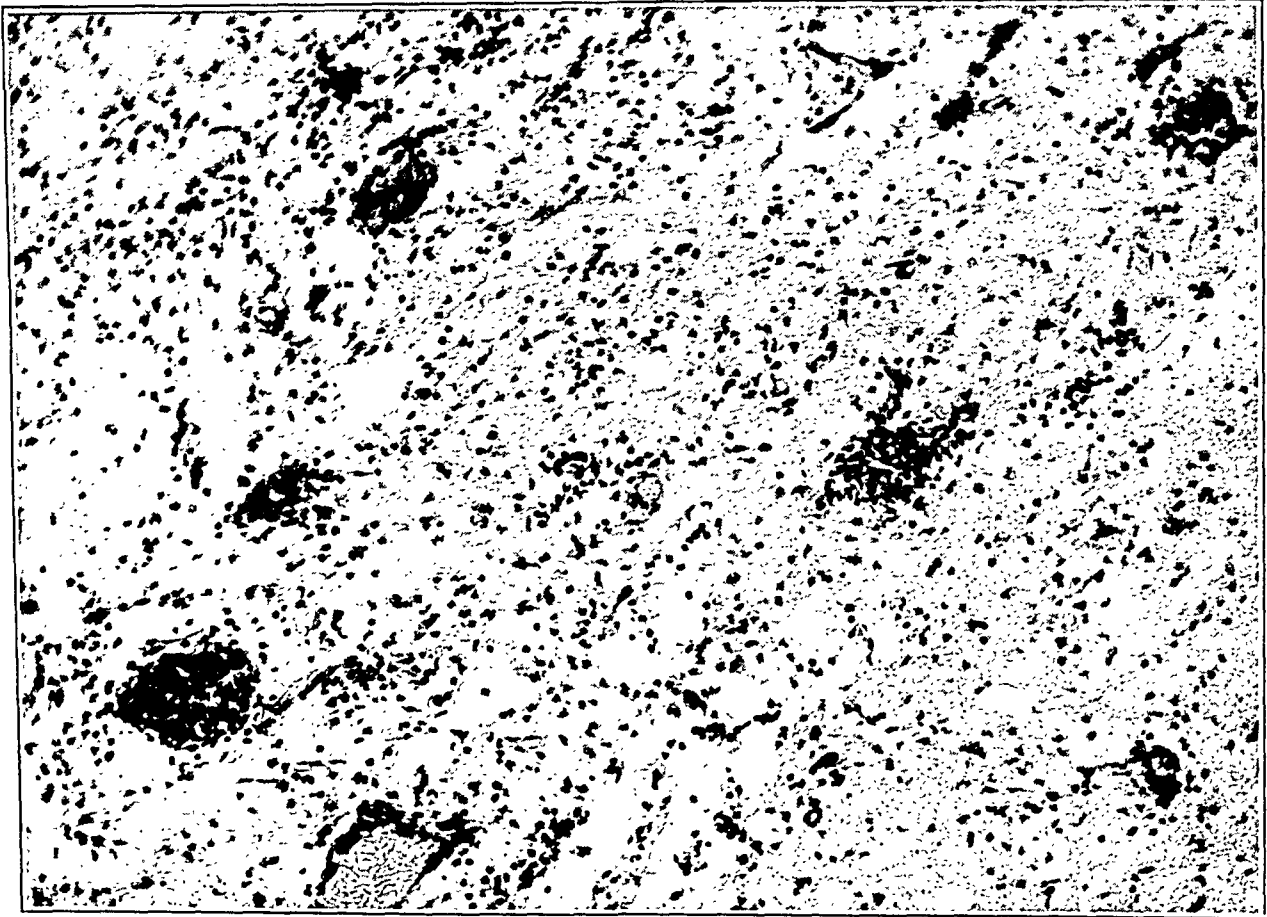

Fig. 9.—Disseminated focal areas of microglial proliferation within the gray matter of the spinal cord; some of the granulomas correspond in position to severely damaged or destroyed nerve cells. Cresyl violet stain; $\times 160$.

posed of a tremendous amount of proliferated microglia cells, which as a rule tended to infiltrate the entire gray matter (fig. 1). Only in those areas in which the neuronal destruction was less severe did some of the microglia cells correspond in position to severely damaged or destroyed nerve cells, whereas others were grouped around small veins and capillaries (fig. 9). In preparations stained with cresyl violet or with hematoxylin and eosin, the nuclei of the microglia cells disclosed a considerable polymorphism and assumed a rod-shaped, oval or irregular outline. The cell bodies were hardly discernible. In sections

stained with the special silver carbonate method of Hortega, the number, arrangement and distribution of the specifically stained microglia cells corresponded with those seen in preparations stained with cresyl violet.

More striking was the focal type of microglial proliferation, characterized by formation of "nodules" or "granulomas." The nodules were widely scattered throughout the gray and the white substance and appeared in cross sections as round or ovoid bodies, composed of compact accumulations of multiform microglia cells (fig. 7). Most of the nodules seemed to be formed around severely damaged or completely destroyed nerve cells.

One of the fundamental problems, the affinity of the virus for the gray matter of the spinal cord, has not yet been solved. There is no real consensus as to the port of entry of the virus and the route traversed on its way to the spinal cord. A study of the distribution of the virus in persons who died of poliomyelitis indicated that the virus is found predominantly in certain regions of the central nervous system and in the alimentary tract (Sabin and Ward¹⁰). The almost regular presence of the virus in the walls of the pharynx or ileum or in the intestinal contents, and its absence from most other tissues that were tested, suggest (according to Sabin and Ward) that the alimentary tract may be the first site attacked by the virus of poliomyelitis. Sabin⁹ indicated that there is a good deal of suggestive evidence that the virus may invade the central nervous system along the fifth, seventh, ninth and tenth cranial nerves from the upper part of the alimentary tract, giving rise to primary bulbar poliomyelitis. Massive inflammatory changes in the medulla and the midbrain, as well as along some of the cranial nerves, as seen in all cases in the present study, seem to corroborate this view. The pronounced concentration of the inflammatory and degenerative processes in the region of the vagal nuclei might be considered suggestive evidence of the possible spread of the virus from the intestine into the central nervous system by way of the afferent and efferent pathways of the vagus.

Movement of virus along nerve structures in the central nervous system of three series of rhesus monkeys after transection of the spinal cord in the midthoracic region was studied by Howe and Bodian.¹¹ The experiments demonstrated clearly that the interruption of the continuity of the spinal cord, the sympathetic nervous system and the subarachnoid space did not prevent the virus from passing into the rostral

10. Sabin, A. B., and Ward, R.: Natural History of Human Poliomyelitis: Elimination of Virus, *J. Exper. Med.* **74**:519, 1941.

11. Bodian, D., and Howe, H. A.: Neurotropism and the Genesis of Cerebral lesions in Poliomyelitis: An Experimental Study, *Bull. Johns Hopkins Hosp.* **68**:58, 1941; Neuropathological Evidence on the Portal of Entry Problem in Human Poliomyelitis, *ibid.* **69**:183, 1941.

portion of the neuraxis. The authors suspected the participation of the vagus nerve in cases in which sympathectomy had been performed. Examination of serial sections of the brains of 4 animals revealed an unusually severe degree of involvement of the vagal nuclei in the medulla.

SUMMARY

Until recently, acute anterior poliomyelitis was regarded by clinicians and pathologists alike as a disease of the anterior horns of the spinal cord. The present study brings out the fact that no part of the central nervous system entirely escapes damage. The medulla, pons, midbrain, hypothalamus and cerebellum were involved to a great extent in every case.

The literature abounds with controversy concerning whether the damage to nerve cells or the inflammatory process constitutes the primary alteration. In all the cases studied there was no direct correlation between the degenerative neuronal changes and the inflammatory reaction. The view is expressed that they are independent phenomena.

Both diffuse and focal proliferations of microglia cells were noted as striking and predominant tissue reactions in all cases.

The pronounced concentration of the inflammatory and degenerative tissue reactions in the region of the vagal nuclei observed in all the cases provides additional suggestive evidence of the possible spread of the virus from the intestine into the central nervous system by way of the afferent and efferent pathways of the vagus nerve (Sabin).

Cincinnati General Hospital.

PHYSIOLOGY OF BOTULINUS TOXIN

LIEUTENANT ARTHUR C. GUYTON (MC), U.S.N.R.

AND

CAPTAIN MARSHALL A. MacDONALD

MEDICAL CORPS, ARMY OF THE UNITED STATES

PREVIOUS studies on the physiology of botulinus toxin have indicated that its action is chiefly on the peripheral rather than the central nervous system.¹ It has also been shown that the nerve trunk and muscle probably are not involved in the poisoning.² By a process of elimination it has therefore been reasoned that poisoning occurs at the myoneural junction. On the basis of pathologic studies, however, effects of botulinus toxin on the central nervous system have been described, but there is little agreement among the various reports.³ Moreover, action of the toxin has been compared to that of curare because the two substances act at approximately the same point in the peripheral nervous system.^{1b} This idea has persisted strongly; but, as will be shown later, it appears to be without foundation.

It has been the purpose of the present investigation to obtain additional evidence for localizing the action of botulinus toxin and to investigate the equally important question of the manner in which the toxin produces its effects. Throughout this study, all experiments have been made with type A botulinus toxin, in distinction to the other types. From additional limited experience with types B, C and E toxin, there is no reason to believe that the different types of toxin vary in their action except in their rate of absorption, in speed of destruction in the body and in quantity necessary to produce poisoning.

Data presented on work carried out at Camp Detrick, Md., between August 1944 and October 1945.

1. (a) Dickson, E. C., and Shevky, E.: Studies on the Manner in Which the Toxin of *Clostridium Botulinum* Acts upon the Body: II. The Effect upon the Voluntary Nervous System, *J. Exper. Med.* **38**:327-346 (Oct.) 1923. (b) Edmunds, C. W., and Long, P. H.: Contribution to the Pathologic Physiology of Botulism, *J. A. M. A.* **81**:542-547 (Aug. 18) 1923.

2. Bishop, G. H., and Bronfenbrenner, J. J.: The Site of Action of Botulinus Toxin, *Am. J. Physiol.* **117**:393-404 (Nov.) 1936.

3. Dickson, E. C., and Shevky, E.: Botulism: Studies on the Manner in Which the Toxin of *Clostridium Botulinum* Acts upon the Body; I. The Effect upon the Autonomic (Involuntary) Nervous System, *J. Exper. Med.* **37**:711-731 (May) 1923.

EXPERIMENTAL METHODS FOR PRODUCING COMPLETE
PARALYSIS OF MUSCLE

In previous experimental studies on botulism in animals no investigator has produced complete paralysis, and the data have been obtained from animals only partially paralyzed. In this present work two methods have been used to produce completely paralyzed experimental animal preparations. One of the methods depends on the local action of botulinus toxin when injected into muscle. This has been strikingly demonstrated in recent studies by one of us (M. A. M.).⁴ On injecting approximately 1 lethal dose of toxin into the gastrocnemius muscle of a guinea pig and two days later, treating the animal systemically with large quantities of antitoxin, it is possible to paralyze completely the gastrocnemius muscle and yet not produce generalized paralysis. The amount of paralysis is determined by measurement of the action potential of the muscle and by measurement of muscular contraction on a kymograph when the sciatic nerve is stimulated. When these measurements are to be made, local anesthesia is produced by sectioning the upper lumbar portion of the spinal cord, with the animal under temporary ether anesthesia. The poisoned muscle may then be studied for as long as forty-eight hours before the animal dies. The unpoisoned gastrocnemius serves as an ideal control.

The second method of producing completely paralyzed preparations is that of keeping a systemically poisoned animal alive until all muscles in the body are paralyzed. This is accomplished by giving artificial respiration to the poisoned animal to offset the effects of respiratory paralysis. Also, vasoconstrictor drugs are given to prevent circulatory collapse. Approximately 1,000,000 rabbit minimal lethal doses of toxin was injected intravenously into each of a series of rabbits. In about one and one-half hours all reflexes in such animals are lost, including the rhythmic nasal reflex of respiration, the corneal reflex, pain reflexes and tendon reflexes. When the animal is lifted in this condition, it is completely flaccid and feels as though it were made of soft rubber. The animal's body becomes colder as time passes, and the final clinical picture is one of profound shock, but the heart continues to beat for several hours.

FURTHER EVIDENCE FOR LOCALIZATION OF BOTULINUS POISONING
AT THE MYONEURAL JUNCTION

Action of Botulinus Toxin on the Nerve.—It has been reported that the oscillogram of an excised nerve is not affected by large concentrations of toxin over a period of several hours.² In this laboratory, the effect of toxin on the intact nerve was studied by oscillographic methods in two series of experiments.

First, in a series of 5 guinea pigs, equal quantities of toxin were injected in the same animal directly into the left gastrocnemius muscle and into the region around the right sciatic nerve near its exit from the pelvis. Oscillographic studies made by stimulating the sciatic nerve at its point of origin and recording from the muscle demonstrated almost complete paralysis of the left gastrocnemius but no paralysis of the right gastrocnemius. This experiment illustrates that botulinus toxin

4. MacDonald, M. A.: Unpublished data.

has much less effect on the nerve trunk than on the muscle. The action in the muscle, however, might be on the muscle itself, on the nerve endings or on terminal nerve fibrils. It is possible, on the other hand, that the upper portion of the nerve is protected by its sheath and that an action of the toxin would be apparent in the proximal portion of the nerve if botulinus toxin could penetrate to the fiber.

Second, in a series of 8 guinea pigs, one of the gastrocnemius muscles of each animal was paralyzed by the method of local injection previously described. In poisoning the gastrocnemius, 1 cc. of solution of the toxin was injected into the proximal portion of the muscle. Actually, most of this solution then diffused into the popliteal space and up the posterior part of the thigh. In every instance the low thigh muscles themselves showed evidence of at least partial paralysis, and atrophy of some of these muscles occurred after a period of several months. The important point, however, is that the sciatic nerve was bathed in toxin solution within the popliteal space. Oscillograms were made from the sciatic nerve immediately proximal to the gastrocnemius muscle of both the paralyzed and the nonparalyzed side over a period of five to forty-two days after poisoning. The average voltage recorded from the nerve of the paralyzed side was 94 per cent of that recorded from the normal side, or, in other words, approximately the same. At the same time, the action potentials from the paralyzed muscles after stimulation of the sciatic nerve averaged only 21 per cent of the normal value over the period of five to forty-two days after injection.

Briefly, it must be mentioned that in still another series, of 16 guinea pigs, the same quantity of toxin as that usually injected into the muscle was injected into the popliteal space. In these animals the gastrocnemius muscles always exhibited some paralysis, but in these muscles the paralysis never occurred as rapidly or as completely as in those muscles which received the toxin directly. Also, when muscles were poisoned directly and oscillograms were obtained during all stages of poisoning, it was noted many times that the action potential of the muscle would disappear but that the action potentials of nerves running adjacent to the muscle electrodes remained of normal value. In these experiments, it was certainly true that the nerves had as good an opportunity to be poisoned as did the muscle itself.

All these experiments tested only the local action of toxin on the nerve, but it is evident that at no time was there impairment of conduction by the nerve; and yet there was no passage of impulse into the muscle. Again, it must be pointed out that the fibrous and myelin sheaths of motor nerves might account for some of the phenomena which have been observed. Regardless of whether this is true, it remains true that quantities of toxin which will not affect the nerve trunk physiologically will cause marked impairment of the passage of impulses from nerve to muscle.

Action of Botulinus Toxin on Musclé.—Study of the muscle itself in botulinus poisoning showed a few changes in its response to direct electrical stimulation. For instance, the threshold of direct stimulation had increased approximately thirty times two days after poisoning. This same increase in threshold occurred in muscles of animals in which the sciatic nerve had been cut for two days. Also, two days after the muscles had been poisoned with botulinus toxin, the contraction as measured on the kymograph decreased to 70 per cent of normal. Here, again, similar results occurred two days after sectioning the sciatic nerve, instead of poisoning the animal. These changes in the muscle, therefore, cannot be ascribed to direct poisoning of the muscle, for the changes take place in muscle denervated by simple mechanical means. On the other hand,

Study of Delay in Conduction at the Sciatic-Gastrocnemius Myoneural Junction

Animal No.	Dose, M.L.D.	Time, Hr.	Poisoned Leg		Normal Leg	
			Synapse Time, Milliseconds	Action Potential, Millivolts	Synapse Time, Milliseconds	Action Potential, Millivolts
1	1	16	0.60	16
2	1	16	0.60	10
3	1	18	0.74	17
4	1	22	0.74	22
5	1	22	0.74	4	0.53	32
6	1	23	0.88	13	0.53	29
7	0.5	23	0.67	13	0.56	26
8	0.5	23	Unmeasurable	1	0.46	53
9	0.5	23	1.03	6	0.60	26
10	0.5	24	0.74	13	0.39	45
11	0.5	17	0.82	6	0.39	56
12	0.5	18½	0.74	17	0.39	39
13	0.5	22	0.82	20	0.53	33
14	0.5	22	0.82	9	0.53	30
15	0.5	24	0.60	9	0.46	30
16	0.5	25	0.60	10	0.24	25
Average	0.69	21	0.74	11.7	0.46	35.3

numerous studies on fatigue, tetanizing studies and measurements of impulse conduction failed entirely to reveal any significant changes from normal. Indeed, muscles which were paralyzed for several months actually became fibrotic and lost considerable mass, as though the nerve had been sectioned; but these muscles remained responsive to direct electrical stimulation at all times. In every way, the muscle in botulinus poisoning was found to be comparable to a denervated muscle, and no physiologic changes were observed which would indicate an action of the toxin on muscle other than that of denervation.

Action of Botulinus Toxin on the Myoneural Junction.—With probable elimination of the nerve trunk and the muscle as loci of botulinus poisoning, it appears that the toxin acts directly on the myoneural junction or on the terminal nerve fibrils. The delay in conduction at the myoneural junction in partially paralyzed preparations was studied, as shown in the table, in an attempt to determine in which of these two

sites the toxin produces its effects. These times of delay were determined oscillographically by measuring the time required for the impulses to travel down the sciatic nerve and into the muscle fibers. From the total conduction time was subtracted the average time for the impulse to travel down the nerve itself, as determined by a separate series of measurements. Reference to the table shows that there is a considerable increase in the delay of conduction at the myoneural junction in botulinus-poisoned preparations.

Also, by making serial recordings of the action potentials from poisoned muscles on motion picture film at intervals of one minute, it was possible to project the records of these action potentials as a continuous motion picture. In 5 such pictures, showing the change in action potential from normal to complete paralysis, the increasing delay is striking.

This increase in delay does not prove that the toxin acts at the myoneural junction, but it is indicative that this junction is altered in botulinus poisoning. This delay might possibly be in the terminal fibrils, but it is doubtful whether as much delay as that noted could take place in these short fibers.

EFFECT OF DRUGS ON BOTULINUS POISONING

Neostigmine.—Various investigators have found that neostigmine and physostigmine have little, if any gross beneficial effect on botulinus-poisoned animals.⁵ Theoretically, if botulinus toxin should act in the same manner as does curare, physostigmine should have a powerful effect in averting paralysis caused by the toxin. A simple experiment, therefore, was designed to prove the validity of these previous reports. Two guinea pigs with approximately 80 per cent paralysis of the gastrocnemius were employed. The gastrocnemius of these animals was stimulated at a rate of four times per second, and contraction of the muscle was recorded on a kymograph. After a control run of five minutes, and while the muscle was still contracting, neostigmine methylsulfate, in a total dose of 0.2 mg., was injected intraperitoneally into each animal over a period of thirty minutes. At the end of this time the animal had gone through all stages of effect of neostigmine, until death occurred from an overdose. Records obtained on the kymograph during these transitional stages showed that neostigmine did not at any time significantly decrease the paralysis.

Acetylcholine.—Because curare prevents contraction of the muscle after intravenous injection of acetylcholine, as well as after stimulation of the nerve,⁶ it was desirable to see whether or not this is true of botulinus

5. (a) Edmunds, C. W., and Keiper, G. F., Jr.: The Action of Botulinus Toxin, *J. A. M. A.* **83**:495-502 (Aug. 16) 1924. MacDonald.⁴

6. Brown, G. L.; Dale, H. H., and Feldberg, W.: Reactions of the Normal Mammalian Muscle to Acetylcholine and to Eserine, *J. Physiol.* **87**:394-424 (Sept. 8) 1936.

toxin. Legs of guinea pigs and rabbits were completely paralyzed by each of the two methods which have been described, and appropriate oscillographic tests were made to be sure that paralysis was complete. In 2 guinea pigs, 30 to 100 micrograms of acetylcholine injected rapidly into the external iliac artery caused a strong contraction of the poisoned leg as well as of the normal (control) leg. In 4 rabbits with paralyzed legs, 10 micrograms of acetylcholine injected similarly produced a strong contraction. The same quantity was necessary to cause contraction of the normal rabbit leg. Therefore, in both guinea pigs and rabbits completely paralyzed muscles still respond to acetylcholine as well as do normal muscles, as measured kymographically. These experiments seem to indicate that acetylcholine is not produced by the end plate in botulinus poisoning. This is not true of curare poisoning.

In several other experiments it was found that nicotine had the same effect on poisoned muscles as did acetylcholine.

ACTION OF BOTULINUS TOXIN ON THE VAGUS NERVE

Several investigators have recorded effects of botulinus toxin on the vagus nerve,⁷ but there is some discrepancy in the statements as to whether vagal paralysis or vagal stimulation is most evident. To clarify this matter, the experiment illustrated in figure 1 was performed with 8 rabbits, using pentobarbital anesthesia and artificial respiration maintained through a tracheal cannula. Standard doses of acetylcholine were injected intermittently into the rabbit's ear vein, and standard tetanizing stimuli were applied intermittently to the peripheral end of the cut left vagus nerve. Both these caused decided fall in blood pressure, as recorded from a femoral cannula. An injection of 1,000,000 rabbit minimal lethal doses of toxin was then given intravenously, and injection of acetylcholine and vagal stimulation were repeated at intervals during the remainder of the experiment. In fifty-five minutes stimulation of the left vagus no longer had any effect on the blood pressure. At this point the intact right vagus was cut and stimulated similarly, with an almost imperceptible effect on the pressure. At the end of ninety-five minutes tugging on both vagus nerves, crushing them and electrically stimulating them had no effect whatever.

The blood pressure continued to respond throughout the experiment to injections of acetylcholine, however, and the heart finally ceased beating at the end of the experiment as a result of one of these injections. It is evident, therefore, that the effect of botulinus toxin on the vagus nerve is exactly the same as the effect on skeletal nerves. It appears that the vagus nerve when poisoned with botulinus toxin, like skeletal nerves, fails to produce acetylcholine at its endings.

7. Bishop and Bronfenbrenner.² Dickson and Shevky.³ Edmunds and Long.^{1b}

Only slight, if any, evidence of vagal stimulation by the toxin was present in these experiments. Certainly, the phase of stimulation is not so marked in vagal stimulation of the heart as it has been shown to be in the salivary glands.⁷

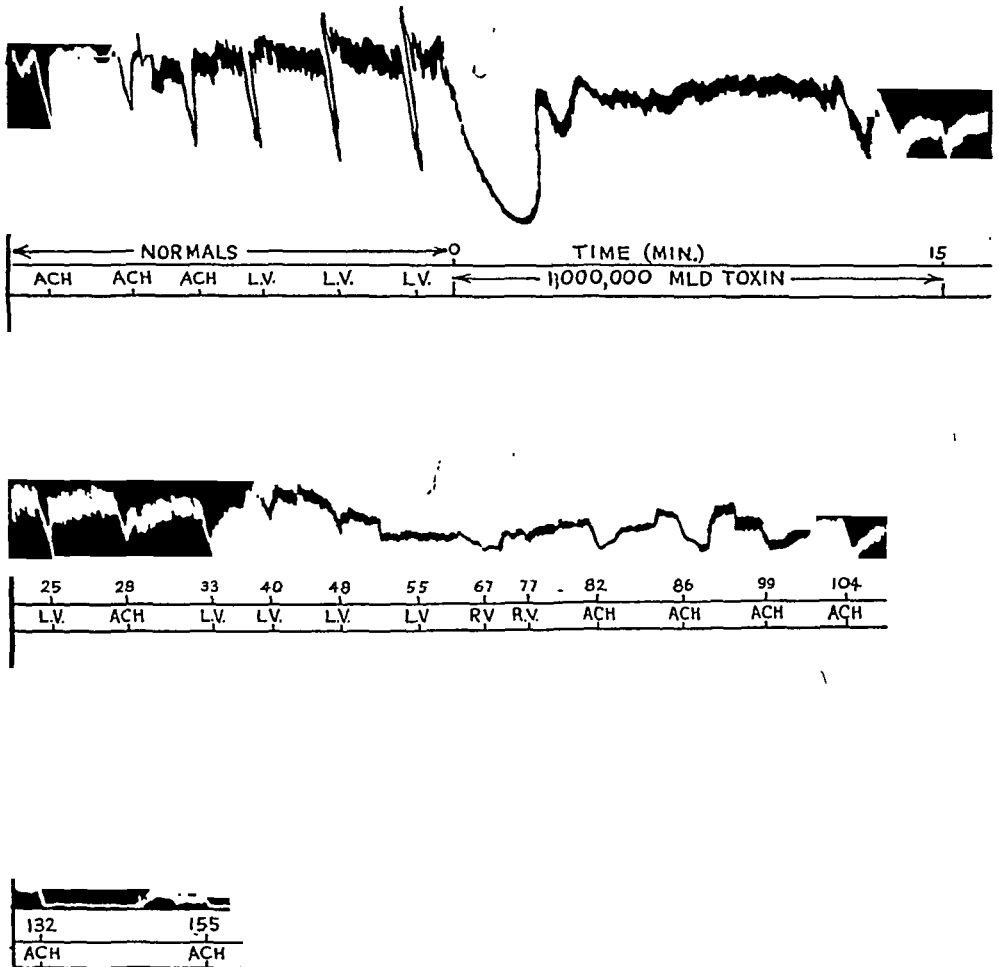

Fig. 1.—Comparative action of vagal stimulation and injection of acetylcholine on the heart during progressive poisoning with botulinus toxin.

L. V. indicates stimulation of the left vagus nerve with a maximal stimulus of 60 a second; *R. V.*, stimulation of the right vagus nerve with a maximal stimulus of 60 a second, and *ACH*, injection of 0.5 microgram of acetylcholine into the marginal ear vein. Normal recordings were obtained during a thirty minute period prior to injection of toxin into the marginal ear vein.

EFFECT OF BOTULINUS TOXIN ON THE CIRCULATION

When a rabbit is systemically poisoned and death from asphyxia prevented by artificial respiration, an effect of botulinus toxin on the circulation then becomes apparent. It has already been noted that vagal impulses to the heart are inhibited. Theoretically, this should cause a rise in blood pressure, but in a series of 10 animals the pressure actually

7. (a) Edmunds and Keiper.^{5a} (b) Dickson and Shevky.⁸

fell as poisoning proceeded. It was found that vasoconstrictor drugs, particularly paredrine hydrobromide (*p*-hydroxy- α -methylphenylethylamine hydrobromide) were efficacious in preventing this fall in pressure provided these drugs were used early in the experiment. Indeed, 1 animal was kept alive for seven hours, or five and one-half hours after all the skeletal muscles were completely paralyzed. Because paredrine hydrobromide has a powerful vasoconstrictor action on the blood vessels but practically no effect on the heart,⁸ it is reasonable to believe that botulinus poisoning causes a peripheral vascular collapse. Also, it appears that the toxin has no direct effect on heart muscle, just as it has no direct effect on skeletal muscle.

The fact that vasoconstrictor drugs have such a powerful effect in maintaining blood pressure probably rules out increased capillary permeability as the cause of lowered pressure. Vasoparalysis, which therefore appears to be the most notable effect that botulinus toxin has on the circulation, might be due, first, to a direct action on smooth muscle; second, to an effect on the sympathetic nervous system, or, third, to an action on the central nervous system. The last of these possibilities seems most likely because of the similarity between synapses in the central nervous system and the nerve endings of skeletal muscle.

EFFECT OF PURE TOXIN ON THE RABBIT

Crude botulinus toxin contains large amounts of impurities carried over from growth mediums. To determine the effect caused by impurities, a rabbit was poisoned with 1,000,000 minimal lethal doses of toxin which had been purified until it was electrophoretically homogeneous and from which pure crystals of toxin had actually been prepared.⁹ This animal failed to show any immediate symptoms whatever, but within thirty minutes respiratory paralysis began to appear, and circulatory effects were evident within one hour. The purified preparation of toxin acted precisely as did the nonpurified toxin except that the immediate fall in blood pressure often seen when crude toxin was injected was not present.

USE OF ANTITOXIN IN TREATMENT OF BOTULINUS POISONING

Delayed Treatment.—It has been the impression that antitoxin is of value only as a prophylactic and is of little value once intoxication has begun.^{7a} To test this premise, 24 guinea pigs were poisoned by injecting a little over 1 lethal dose of toxin subcutaneously. Two days later, after

8. Altschule, M. D., and Iglauer, A.: The Effect of Benzedrine and Paredrine on the Circulation, Metabolism, and Respiration in Normal Man, *J. Clin. Investigation* 19:497-502 (May) 1940.

9. Abrams, A; Kegeles, G., and Hottle, G.: The Purification of Botulinus Type A Toxin, *J. Biol. Chem.*, to be published.

local paralysis at the site of injection was already present and general symptoms were just beginning to appear, 11 animals were treated intraperitoneally with 20 units of botulism antitoxin N.N.R. This was enough to neutralize 20,000 times the amount of toxin given. On further observation of these animals, only 3 of the 11 treated animals died, whereas 12 of 13 of the untreated animals died. This difference indicated forcefully that antitoxin is of value long after exposure to poisoning has taken place, and even after some symptoms of intoxication are present.

Effect of Passive Immunization on the Phenomenon of Local Paralysis from Injection of Botulinus Toxin.—It is of interest from an immunologic point of view to know whether passively injected antitoxin can prevent paralysis due to local injection of toxin into a muscle. Three guinea pigs were passively immunized with 20 units of botulism antitoxin each, and six and one-half hours later 1 minimal lethal dose of toxin was injected into the left gastrocnemius muscle of each animal. On testing these animals by oscillographic and kymographic methods previously described, no paralysis could be detected. In nonimmunized animals this amount of toxin injected locally universally produces complete paralysis of the muscle. Therefore, it is concluded that passive immunization does protect against muscular paralysis due to locally injected toxin.

Irreversibility of Botulinus Poisoning with Antitoxin Therapy.—In order to understand the value of antitoxin in treatment, one must know whether or not the poisoned end plate can be restored to normal with antitoxin. In the experiments on delayed treatment, toxin had been circulating in the body for two days, but the nerve endings had been only partially, if at all, poisoned. To determine the value of antitoxin in treatment of the completely poisoned nerve endings, 25 guinea pigs were poisoned locally in the right gastrocnemius muscle with 1 minimal lethal dose of toxin. Two days later tests showed these muscles to be completely paralyzed. The animals were treated at this time with 20 units of botulism antitoxin, enough to neutralize 20,000 times the amount of toxin injected. On studying these poisoned muscles for contraction and action potentials over a period of several months, there was no evidence that the antitoxin per se had any effect on the course of poisoning. During the twenty days immediately following treatment with antitoxin, which should also be the duration of passive immunization with the antitoxin, no animals showed signs of recovery. It appears, therefore, that once poisoning of the nerve endings has occurred antitoxin has no power to reverse the effects of botulinus toxin.

DURATION OF BOTULINUS POISONING

It has long been the belief that if a patient could be kept alive through the acute phases of botulinus poisoning with artificial respiration his

life could be saved.^{7a} Therefore it was desirable to know how long the effects of botulinus poisoning last. In discussing the methods of producing completely paralyzed preparations, it was pointed out that by local injection one gastrocnemius of an animal can be completely paralyzed while the major portion of the animal's body remains practically unharmed. By this method the right gastrocnemius muscles of 38 guinea pigs were each poisoned with 1 minimal lethal dose of toxin and the animal protected from systemic effects by administration of 20 units of botulism antitoxin two days later. In each animal the right gastrocnemius muscle was completely paralyzed, but the animals otherwise appeared healthy. These animals were killed and studied at intervals during the

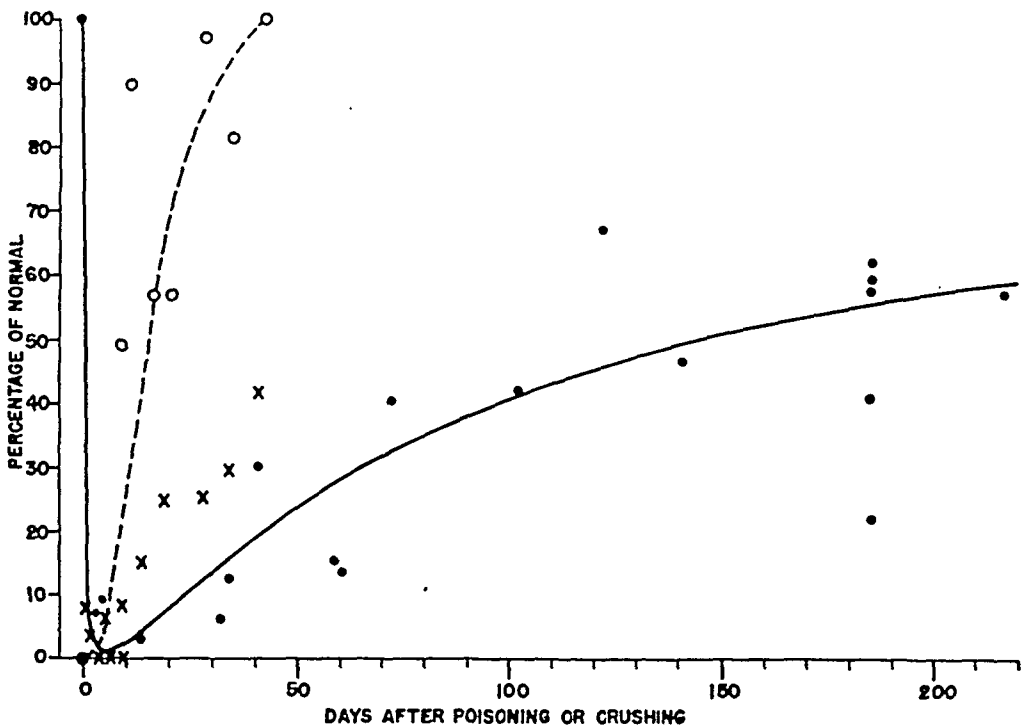

Fig. 2.—Recovery of the action potential in the gastrocnemius muscle of guinea pigs after botulinus poisoning and after crushing the sciatic nerve. The solid line represents poisoned preparations, and the broken line, preparations with a crushed nerve. Circles represent preparations with crushed nerve; dots and crosses, poisoned preparations of two different series.

next year. The muscular contraction and the action potential were recorded from each poisoned gastrocnemius, using the opposite, unpoisoned, gastrocnemius as a control. The solid curve in figure 2 illustrates the recovery of action potential for the next seven months. Recovery of muscular contraction paralleled closely this recovery of action potential. Three animals studied at the end of a year showed approximately 90 per cent recovery. It is hardly possible that any toxin remained in the animal's body during this time, for it must be remembered that enough antitoxin was administered to neutralize 20,000 times the toxin given. This period of one year, therefore, is approximately the time

necessary to repair the damage in guinea pigs caused by botulinus poisoning.

The recovery from botulinus poisoning was found to be approximately ten times as slow as recovery from crushing the sciatic nerve immediately above the gastrocnemius. The latter experiment is illustrated by the broken line in figure 2. Again, it appears from this comparison that the poisoning process is not simply a destruction of nerve fibrils but that it probably has an action at some point which cannot be repaired as quickly as can the fibrils.

HISTOLOGIC STUDIES OF BOTULINUS-POISONED END PLATES

Because toxins which cause semipermanent effects usually produce these effects through morphologic changes, it was anticipated that such

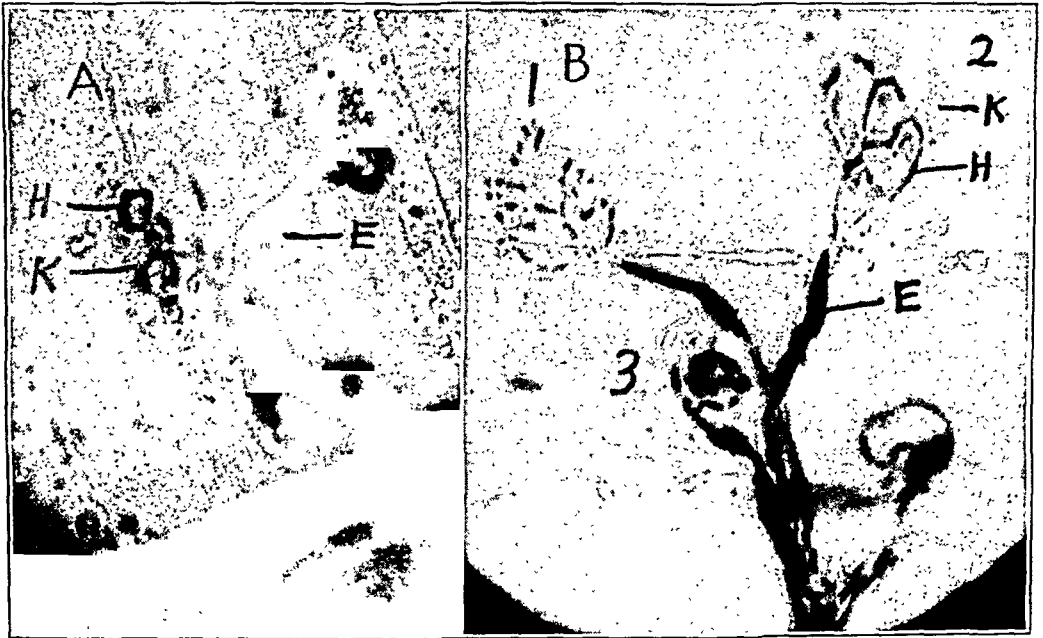

Fig. 3.—Comparison of normal (*A*) and botulinus-poisoned (*B*) end plates; $\times 300$. Note the swelling of poisoned end plates and the absence of granules of Kühne in end plate 1. End plate 3 shows signs of pyknosis. *K* indicates granules of Kühne; *H*, hypolemmal axon, and *E*, epilemmal axon.

changes would be noted on histologic study of poisoned end plates. The end plates from the poisoned gastrocnemius of 14 guinea pigs were studied with the gold chloride and glycerin mount technic. These gastrocnemius muscles had been poisoned from four days to seven months. In acutely poisoned muscles many swollen end plates were seen, as illustrated in figure 3 *B*, and compared with the normal controls of 3 *A*. Often, considerable granulation of the hypolemmal axon was present, and almost always there were dissolution and disappearance of the granules of Kühne. Occasionally pyknotic end plates were encountered. As the

muscles proceeded toward recovery during the next seven months, the swollen end plates disappeared early, and in their place were seen irregular, darkly staining end plates, which became more nearly normal as time passed. At no time did the end plates disappear. Certain histologic changes, therefore, were observed in the end plates of botulinus-poisoned animals, but these changes were not as definite as had been suspected.

TOXICITY OF BOTULINUS TOXIN

No paper on the physiology of botulinus poisoning would be complete without emphasizing the extremely minute quantity of toxin required to produce poisoning. For instance, the minimal lethal dose for a 20 Gm. mouse is 0.000,000,000,03 Gm. of crystalline toxin.⁹ For guinea pigs weighing fifteen times as much the minimal lethal dose is ten times as great; for rabbits weighing 100 times as much it is 100 times as great, and for monkeys weighing 150 times as much it is 300 times as great. In general, except for certain species differences in susceptibility, the lethal dose of toxin varies directly with the weight of the animal. Continuing this reasoning, and considering man to be as susceptible to botulinus poisoning as the monkey per unit weight, the minimal lethal dose for a 70 Kg. man would be approximately 7,000 times the dose for a 20 Gm. mouse. In other words, it would take less than 0.25 microgram of the pure toxin to kill a man. Few, if any, other poisons are known which approach this toxicity.

COMMENT

It appears from this investigation and from previous studies that the action of botulinus toxin is distal to the nerve trunk and yet proximal to the muscle fibers themselves, or, in other words, at the myoneural junction or in the terminal fibrils. The muscle contracts normally on injection of acetylcholine in physiologic amounts. This and several other reasons indicate that there is no basis for the comparison of curare and botulinus toxin. If production of acetylcholine by the poisoned end plate were only diminished, neostigmine should at least partially neutralize the paralysis. For instance, this is true in the case of myasthenia gravis, which has been reported to be caused by a diminished production of acetylcholine.¹⁰ Experiments indicate, however, that neostigmine has little, if any, effect on botulinus poisoning. It appears, therefore, that this poisoning takes place at some point proximal to

10. Harvey, A. M.; Lilienthal, J. L., Jr., and Talbot, S. A.: Observations on the Nature of Myasthenia Gravis: Phenomena of Facilitation and Depression of Neuromuscular Transmission, *Bull. Johns Hopkins Hosp.* **69**:547-565 (Dec.) 1941; Observations on the Nature of Myasthenia Gravis: The Effect of Thyremectomy on Neuromuscular Transmission, *J. Clin. Investigation* **21**:579-588 (Sept.) 1942.

that at which acetylcholine is produced in the end plate. Likewise, it appears that poisoning follows the all or none principle, for if there were a gradual diminution in production of acetylcholine neostigmine should be of value in treatment.

The histologic changes observed in the poisoned end plate are difficult to evaluate, for Carey¹¹ has recently shown that many drugs which do not permanently affect the end plates can cause great contortions and changes in their staining characteristics. It cannot be concluded from the histologic studies presented that there are definite structural changes in the end plate, though the poisoned end plates were not observed to be entirely normal. It would be impossible to say that the effect of toxin is simply a destruction of the end plate, for one must remember that vagal endings, which do not have an end plate, are also poisoned.

There are certain features of the physical and chemical manner of poisoning which have been learned. For instance, recovery from poisoning is not reversible with the use of massive quantities of antitoxin. It appears almost as though the living processes of some fundamental element within the nerve ending were destroyed and that recovery must await regrowth of a new element. It is difficult to believe that poisoning of one year's duration could occur without actual morphologic changes. Assuming the toxin to be equally distributed throughout the body and calculating from the molecular weight of approximately 1,000,000,¹² it would take only one tenth of a molecule per end plate to produce death. This minute quantity of toxin necessary to produce poisoning, the duration of poisoning and the physical properties of the toxin⁹ all tend to characterize the toxin as a destructive enzyme.

The latent period between administration of toxin and the occurrence of symptoms can possibly be explained on physical grounds alone. The high molecular weight of the toxin makes absorption from the tissues very slow, and diffusion of this molecule into the nerve ending would likewise proceed with difficulty.

In passing, it should be mentioned that symptoms referable to the central nervous system are rarely, if ever, encountered with botulinus poisoning. One might easily expect to find an action of this toxin on the brain because of the physiologic similarity of myoneural junctions and synapses in the central nervous system. There is, however, practically no diffusion of protein molecules of any size, much less those with a molecular weight of 1,000,000, through the blood-brain barrier, a fact which possibly explains why one sees no symptoms referable to the brain.

11. Carey, E. J.: Studies on Ameboid Motion and Secretion of Motor End-Plates: III., *Am. J. Path.* **20**:341-393 (March) 1944.

12. Kegeles, G.: Personal communication to the authors.

The comparison of botulinus toxin to tetanus toxin is more than trivial.¹³ The two toxins are produced by organisms which are very similar in their morphologic characteristics, and they are produced under similar conditions. Botulinus toxin is a protein, and tetanus toxin is known to have certain protein reactions, though its exact nature is yet unknown. Also, tetanus toxin has been shown to have a local excitatory action at the nerve ending,¹⁴ which is the site of activity of the botulinus toxin. The fact that botulinus toxin has an excitatory phase for the parasympathetic nervous system has already been mentioned. Because of these similarities, one asks oneself many questions regarding tetanus. Does tetanus produce a long-lasting effect, as does botulinus poisoning? Is the effect of tetanus a morphologic change or a chemical fixation of toxin in nerve cells? Would tetanus toxin produce flaccid paralysis similar to that in botulinus poisoning if the animal were kept alive beyond the excitatory phase? The answers to these questions might give one the clue to the successful treatment of tetanus.

Treatment of botulinus poisoning consists of massive doses of anti-toxin, the use of artificial respiration and in cases of severe poisoning, the administration of vasoconstrictor drugs. The fact that poisoning lasts for many months makes the results of such treatment discouraging. The use of artificial respiration for several months or longer is not practical, and if a patient is poisoned sufficiently to require vasoconstrictor drugs he will probably die anyway. The only real salvation seems to be the early use of antitoxin in doses greater than 100,000 units of multivalent serum. Though antitoxin has been shown to be of value for guinea pigs as long as two days after poisoning, it is still true that its effect decreases exponentially with time. One must remember that once the toxin has reached the nerve ending and produced its damage this action is irreversible for many months.

SUMMARY

Further evidence is presented which indicates that the principal action of botulinus toxin is probably at the myoneural junction, though possibly in the terminal nerve fibrils.

Neostigmine has little or no effect on botulinus poisoning.

Acetylcholine and nicotine injected intra-arterially still cause contraction of the muscle after botulinus poisoning. With curare poisoning such is not the case. This indicates a fundamental difference between curare and botulinus toxin.

13. (a) Abrams and others.⁹ (b) Eaton, M. D., and Gronau, A.: Comparative Studies on the Purification of Tetanus and Diphtheria Toxins, *J. Bact.* **36**:423-432 (Oct.) 1938.

14. Harvey, A. M.: The Action of Tetanus Toxin on Skeletal Muscle, *J. Physiol.* **95**:30P-31P (April 14) 1939.

Experimental evidence is presented to show that acetylcholine probably is not produced by the end plate in poisoned animals. The effect of botulinus toxin probably also occurs proximal to the point at which acetylcholine is produced.

Botulinus poisoning appears to affect the vagus nerve in the same manner as skeletal nerves.

Botulinus poisoning causes peripheral circulatory failure.

Antitoxin is of value in treatment of botulinus poisoning in guinea pigs when administered as late as two days after poisoning.

Passive immunization with antitoxin prevents local, as well as general, effects of botulinus toxin.

The action of toxin on nerve endings cannot be reversed by massive doses of antitoxin.

A series of animals with poisoned gastrocnemius muscle showed only 60 per cent recovery in seven months and 90 per cent recovery in one year. In a similar series with crushed sciatic nerve, instead of poisoned end plates, 100 per cent recovery occurred in one and one-half months.

Histologic studies of end plates from poisoned animals showed bizarre effects, among which was swelling. These effects could be due either to altered activity or to actual structural changes within the end plate.

The long period of recovery and the degree of irreversibility of botulinus poisoning in the end plate discourage belief in the possibility of future improvements in clinical treatment.

Major George Hottle and Lieut. Adolf Abrams furnished the purified preparations of toxin. Cpl. Dellas Cosby assisted in this study.

Massachusetts General Hospital, Boston.

Receiving Hospital, Detroit.

MENINGEAL GLIOMATOSIS

A Study of Forty-Two Cases

FRANK E. POLMETEER, M.D.

Fellow in Neurosurgery, Mayo Foundation

AND

JAMES W. KERNOHAN, M.D.

ROCHESTER, MINN.

THE TERM "meningeal gliomatosis" has been adopted for the title of this study to designate involvement of the leptomeninges by tumors of neuroectodermal origin, in contradistinction to those tumors arising from the mesodermal elements. The terms "gliomatous meningitis" and "tumorous meningitis" erroneously imply an infective process, and for this reason the more descriptive term "meningeal gliomatosis" was chosen.

This study consisted of a review of the gliomas observed at the Mayo Clinic during the period from 1922 to 1942, inclusive, and concerned the finding of metastatic implantations from these gliomas to the leptomeninges of the brain and the spinal cord and the ependyma of the ventricular system. This study was primarily concerned with those gliomas which had established themselves in multiple sites and were responsible for a generalized involvement of the leptomeninges.

Although the earlier literature contains many references to tumors of the central nervous system which had produced local or extensive invasion of the leptomeninges, methods for a more exact classification of such neoplasms have only recently been in use.

Leusden,¹ has been credited as the first to describe an instance of diffuse involvement of the leptomeninges by a tumor, which he termed "gliosarcoma." In 1907 Spiller² described an ependymoma of the fourth ventricle with diffuse involvement of the leptomeninges. To our knowledge, this was the first established instance of meningeal gliomatosis.

From the Department of Neurosurgery, the Mayo Foundation (Dr. Polmeteer), and the Section on Pathologic Anatomy, the Mayo Clinic (Dr. Kernohan).

Abridgment of a thesis submitted by Dr. Polmeteer to the Faculty of the Graduate School of the University of Minnesota in partial fulfillment of the requirements for the degree of Master of Science in Neurosurgery.

1. Leusden, P., cited by Schuberth.⁴

2. Spiller, W. G.: Gliomatosis of the Pia and Metastasis of Glioma, *J. Nerv. & Ment. Dis.* 34:297-302 (May) 1907.

Even as recently as 1924, the condition in many cases reported as "sarcomatosis of the meninges" was in reality "gliomatous" in nature. Bailey and Cushing,³ who made a special study of the medulloblastoma group of gliomas, demonstrated that cells formerly considered sarcomatous were definitely glial and that true "sarcomatosis of the meninges" was extremely rare.

In 1926 Schubert⁴ carefully reviewed the literature in regard to sarcomatosis and gliomatosis involving the leptomeninges and reported 76 cases, in 39 of which the patients had been under his own care.

In 1931 Cairns and Russell⁵ described 8 cases of intracranial and spinal metastasis encountered in 22 consecutive cases of primary cerebral glioma in which necropsy was done. They expressed the opinion that this condition was much more common than had previously been considered.

In this study, we have used the classification of gliomas proposed by Bailey and Cushing. We found 42 instances in which there was generalized meningeal gliomatosis. In 20 of these cases the tumor was a medulloblastoma; in 6, glioblastoma multiforme; in 5, ependymoma; in 5, of the oligodendroglioma group; in 3, astrocytoma; in 2, retinoblastoma, and in 1, a pinealoma.

These implants were studied particularly with reference to proliferation of connective tissue and capillaries and to focal degeneration. The formation of connective tissue in the metastatic implants, which probably represents a reaction of the leptomeninges, was obvious only in the less rapidly growing gliomas, such as the astrocytomas and oligodendrogliomas. However, in 1 case of medulloblastoma an abundance of connective tissue was identified in the metastatic growth. Capillary proliferation in the implants was most prominent in the more malignant varieties of glioma, such as glioblastoma multiforme and retinoblastoma. Occasionally we observed proliferation of the walls of the blood vessels similar to that observed in the parent tumor, especially in cases of glioblastoma multiforme. Regions of degeneration, also, were frequently observed in the metastatic implantations from the more rapidly growing gliomas, especially the retinoblastoma and the glioblastoma multiforme. More rarely, slower-growing gliomas may have regions of necrosis.

3. Bailey, P., and Cushing, H.: A Classification of the Tumors of the Glioma Group on a Histogenetic Basis with a Correlated Study of Prognosis, Philadelphia, J. B. Lippincott Company, 1926.

4. Schubert, O.: Ueber diffuse Sarkomatose und Gliomatose in den Meningen des zentralen Nervensystems, Deutsche Ztschr. f. Nervenhe. **93**:34-60, 1926.

5. Cairns, H., and Russell, D. S.: Intracranial and Spinal Metastases in Gliomas of the Brain, Brain **54**:377-420 (Dec.) 1931.

MEDULLOBLASTOMA

The neoplasm which was given the name "medulloblastoma" by Bailey and Cushing⁶ is primarily a midline cerebellar tumor of childhood, protruding into or filling the fourth ventricle but rarely adhering to its floor or invading the medulla oblongata. Medulloblastoma is generally considered a fairly rapidly growing glioma.

The ability of this tumor to become disseminated by the circulation of the cerebrospinal fluid and implanted widely throughout the subarachnoid space has been recognized for some time. Bailey and Cushing, in a study of 400 cases of gliomas, encountered 29 cases of medulloblastoma in 1 of which the neoplasm had led to widespread meningeal gliomatosis. However, it was thought from clinical evidence that there had been secondary implantations in the leptomeninges of the spinal cord in 3 other instances. In 1 of these cases this assumption was verified subsequently by Elsberg.⁷

We found that medulloblastoma was the form of glioma most frequently responsible for meningeal gliomatosis. It occurred in 20 of a series of 42 cases (47.6 per cent). The average age of the patients was 15.7 years. Nineteen of these gliomas originated in the cerebellum, while 1 arose in the left frontoparietal area of the cerebrum. The particles of tumor followed the pathways of the cerebrospinal fluid, became implanted and grew either as small disks or as a continuous sheet, involving most of the cranial nerves, the spinal cord and the cauda equina (figs. 1 and 2). The extent of spread varied, but some degree of leptomeningeal invasion was rarely absent.

The microscopic appearance of the medulloblastomas was characteristic. They were cellular tumors. Many of the cells were carrot shaped, contained oval or oat-shaped nuclei and were more or less closely packed together, forming small rings, or segments of a larger circle, and thus producing "pseudorosettes." When sections were suitably stained, the clear space in the center of these groups of cells was observed to be occupied by the projections of the carrot-shaped cells. Neurocytes, astrocytes and, occasionally, spongioblasts could be demonstrated in the tumors.

The microscopic structure of the metastatic implants (fig. 3) from the medulloblastoma was similar to that of the parent tumor. We frequently demonstrated "pseudorosettes" more readily than in the primary tumor. Capillary and connective tissue proliferations, which were not

6. Bailey, P., and Cushing, H.: Medulloblastoma Cerebelli: A Common Type of Midcerebellar Glioma of Childhood, *Arch. Neurol. & Psychiat.* **14**:192-223 (Aug.) 1925.

7. Elsberg, C. A.: Tumors of the Spinal Cord: The Symptoms of Irritation and Compression of the Spinal Cord and Nerve Roots; Pathology, Symptomatology, Diagnosis and Treatment. New York, Paul B. Hoeber, 1925, p. 161.

prominent in the primary growths, formed a rather constant feature of the metastatic growths. Capillary proliferation in the metastatic implantations was observed in 18 of the 20 cases studied. Such an adequate blood supply probably was responsible for the infrequency with which regions of degeneration and cyst formations were encountered. Degen-

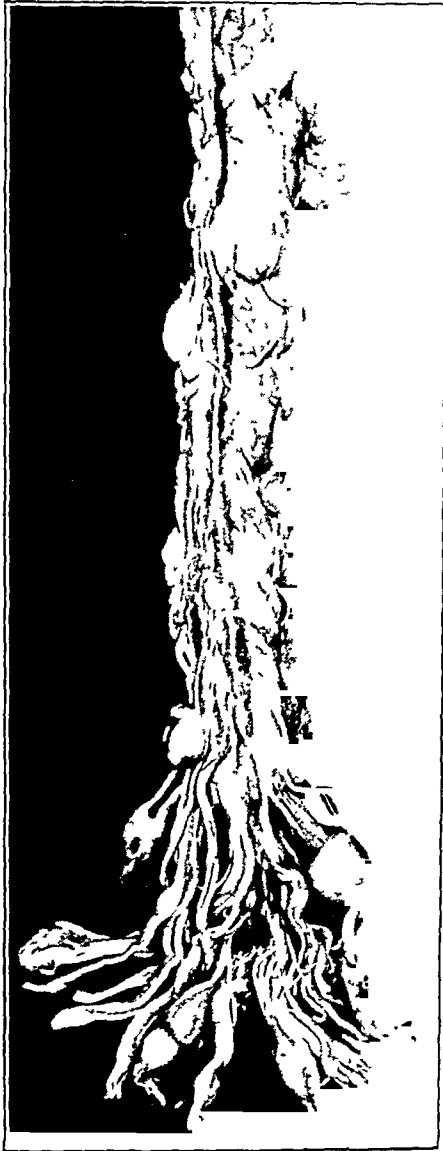

Fig. 1.—Metastatic implants in the leptomeninges of the lower thoracic and the lumbar segments of the spinal cord and cauda equina from a medulloblastoma located in the cerebellum.

erative changes in the metastatic growths were observed in only 1 instance.

In 15 of the 20 cases of medulloblastoma studied in our series, the neoplasm invaded the leptomeninges and produced an overgrowth of

the connective tissue. It was rare that sufficient reticulum existed in the medulloblastoma to make its differentiation from sarcoma difficult.

GLIOBLASTOMA MULTIFORME

Glioblastoma multiforme comprises more than a third of the gliomas occurring in the adult; it occurs in the cerebrum and is invariably the most rapidly growing of the neoplasms derived from the glial cells.

Metastasis of this type of glioma through the cerebrospinal fluid has been recognized only in recent years. Cairns and Russell, in their excellent monograph, recorded only 1 case of glioblastoma multiforme in their series of 8 cases of spinal and intracranial metastasis. Elvidge, Penfield and Cone⁸ encountered 55 cases of this tumor in their series of

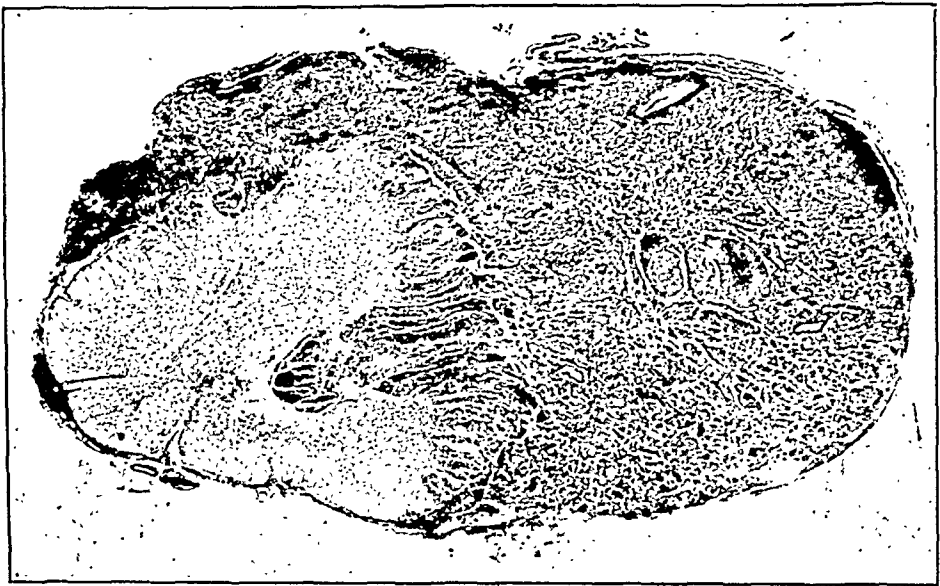

Fig. 2.—Cross section of the upper thoracic segment of the spinal cord, demonstrating the pronounced compression and invasion of the spinal cord by a metastatic tumor, which completely filled the subarachnoid space. The primary tumor was a medulloblastoma of the cerebellum. Hematoxylin and eosin; $\times 9$.

210 verified cases of glioma, or in 26 per cent of the cases studied. They estimated that meningeal involvement by the primary growth occurred in at least 8 per cent of the cases.

In our series of 42 cases of meningeal gliomatosis, we found 6 cases of the glioblastoma multiforme type (14.3 per cent). Each of the tumors was primary in the cerebral hemispheres. Two of the patients were children. The tumor seemed to advance along the principal tracts and frequently spread from one hemisphere to the other across the corpus callosum. The cut surface of the tumor had a characteristic appearance.

8. Elvidge, A.; Penfield, W., and Cone, W.: The Gliomas of the Central Nervous System: A Study of Two Hundred and Ten Verified Cases, *A. Research Nerv. & Ment. Dis., Proc.* (1935) 16:107-181, 1937.

It was variously colored—gray, gray-brown, yellow or red, or a combination of these colors—the result of numerous regions of degeneration with old and recent hemorrhages. Occasionally this tumor was in part cystic.

The microscopic study of glioblastoma multiforme revealed considerable polymorphism of cells, unusual vascular changes and regions of necrosis. There was no type of cell which could be regarded as characteristic; however, cells of the spongioblastic, astroblastic and astrocytic types were present. The most common cell seen, which was small and spindle shaped, was most probably an anaplastic form of the astrocytic series. Giant cells, often multinucleated, were invariably present, and

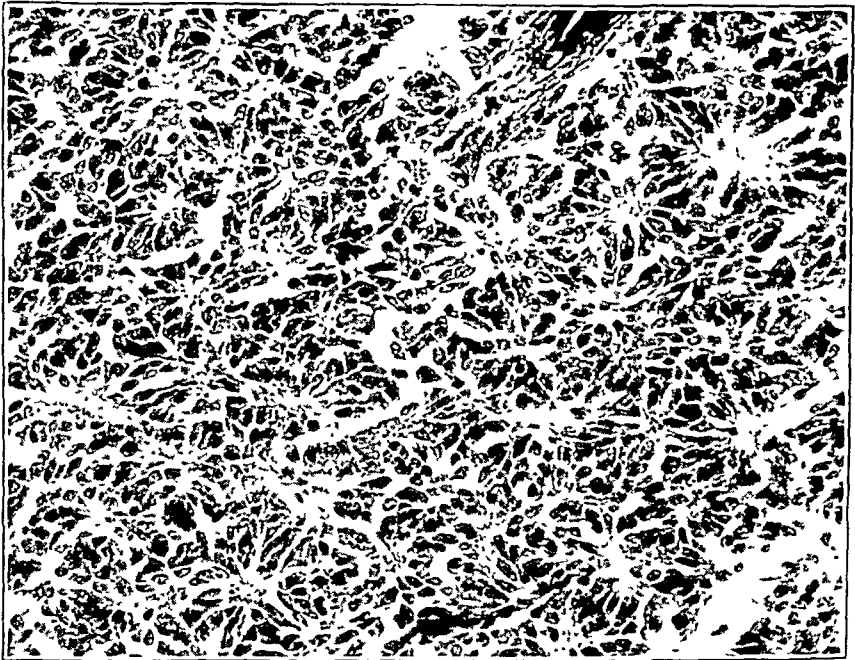

Fig. 3.—Implant in the leptomeninges of the upper cervical segment of the spinal cord from a medulloblastoma originating in the vermis of the cerebellum. This tumor is a typical medulloblastoma. Hematoxylin and eosin; $\times 295$.

numerous mitotic figures were always observed in this tumor. Blood vessels were numerous but quite abnormal in structure. The walls were composed of an abundant endothelial lining supported by a band of fibrous tissue, which often was hyalinized. There was a peculiar overgrowth of the endothelium, which at times became so great that it occluded the vascular lumen, while proliferation of the connective tissue of the adventitia was invariably present. The narrowing or occlusion of the lumen had presumably led to the regions of necrosis.

The histologic structure of the metastatic growths was almost identical with that of the primary tumor; however, capillary proliferation and regions of degeneration were prominent features. There was also considerable local invasion of the adjacent structures by these gliomas.

EPENDYMOMA

In 1907 Spiller reported 1 of the earliest recorded cases of meningeal gliomatosis originating from an ependymoma. This tumor originated in the fourth ventricle and spread to involve the leptomeninges of the brain and spinal cord.

In our series of 42 cases, we observed 5 instances in which meningeal gliomatosis was the result of metastasis from an ependymoma (11.9 per cent). In classifying these tumors, Bailey and Cushing's classification and Kernohan and Fletcher-Kernohan's⁹ subdivisions of the ependymoma group were used. Three of the ependymomas of our series were of the cellular type. Two of these showed acinar-like arrangement in one or another portion. Another tumor was classified as a myxopapillary type of ependymoma, and the fifth, as an ependymoblastoma.

The most common intracranial site for the location of the primary ependymoma is the floor of the fourth ventricle. Kernohan and Fletcher-Kernohan studied 109 ependymomas, 54 of which originated intracranially. Of these, 32, or about 60 per cent, were observed to arise from the floor of the fourth ventricle. Cushing¹⁰ found that the 25 ependymomas in his series constituted approximately 3.6 per cent of the 687 classified gliomas. Nineteen of these tumors (76 per cent) originated from the floor of the fourth ventricle, whereas the 6 other tumors (24 per cent) arose from the ependyma of the lateral or the third ventricle. We found that in our present study 2 ependymomas originated from the floor of the fourth ventricle. Another arose in the third ventricle, and 2 represented intramedullary tumors of the spinal cord.

Ependymoma represents the most common variety of intramedullary neoplasms of the spinal cord. This glioma was present in 51 per cent of the cases of intramedullary tumors of the spinal cord studied by Rasmussen, Kernohan and Adson.¹¹ One of the intramedullary ependymomas of our series originated in the cervical and the other in the thoracic portion of the spinal cord. Both were associated with syringomyelia (fig. 4).

On gross examination, the ependymomas were pale pink or flesh colored, encapsulated, firm and nodular. There was evidence of deposits of calcium and of cyst formation in 1 instance.

9. Kernohan, J. W., and Fletcher-Kernohan, E. M.: Ependymomas: A Study of One Hundred and Nine Cases, *A. Research Nerv. & Ment. Dis., Proc.* (1935) **16**:182-209, 1937.

10. Cushing, H.: *Intracranial Tumours: Notes upon a Series of Two Thousand Verified Cases with Surgical-Mortality Percentages Pertaining Thereto*, Springfield, Ill., Charles C Thomas, Publisher, 1932.

11. Rasmussen, T. B.; Kernohan, J. W., and Adson, A. W.: Pathological Classification, with Surgical Consideration, of Intraspinial Tumors, *Ann. Surg.* **111**:513-530 (April) 1940.

The ependymomas which we studied were classified according to four types of ependymoma first described by Kernohan and Fletcher-Kernohan. These were papilloma choroideum and myxopapillary, epithelial and cellular ependymoma.

The myxopapillary type of ependymoma is also known as the papillary ependymoma and is similar in many respects to the papilloma of the choroid plexus. One of us (J. W. K.) had previously chosen the more descriptive term "myxopapillary ependymoma," instead of "papillary ependymoma," because of the presence of a large amount of mucus within the stroma of the papillary projections of these tumors which was not

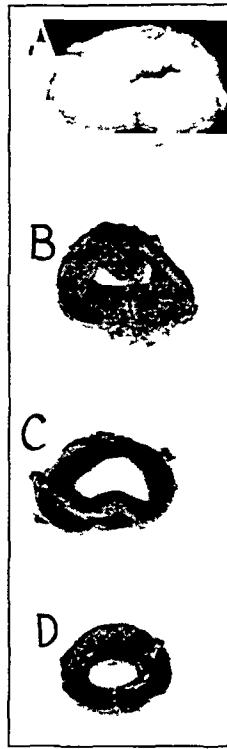

Fig. 4.—Cross sections of the cervical and thoracic portions of the spinal cord, showing the extent of the syringomyelic cavity, which was associated with an intramedullary ependymoma of the eighth cervical segment. *A* indicates the cervical portion above the tumor; *B*, the cervical portion below the tumor; *C*, the high thoracic region, and *D*, the low thoracic region of the cord.

a secretion of the ependymal cells, such as is seen in the cells of the papillomas of the choroid plexus, but represented a myxomatous degeneration of the connective tissue cores of the papillae.

We found only 1 case of myxopapillary ependymoma in our series. The histologic structure of the tumor was typical. The ependymal cells were of the high cuboidal type and had a short, heavy process, which was attached to the connective tissue core of the papilla. The oval nuclei of the cells were large and contained several chromatin granules.

Mitotic figures were not observed. We did not note blepharoplasts in the cytoplasm of these ependymal cells.

Two of our tumors were epithelial ependymomas, both of which occurred in conjunction with the cellular type of ependymoma. The ependymal cells, which were arranged to form canals, resembled those of the central canal of the spinal cord (fig. 5). The cells were not vacuolated or ciliated and contained no mucus. The peripheral ends of the cells usually terminated in a heavy process, which projected into the surrounding tissue. Occasionally these processes became attached to the connective tissue of a nearby blood vessel. The nuclei of these ependymal cells were usually large and elongated. Mitotic figures were not observed.

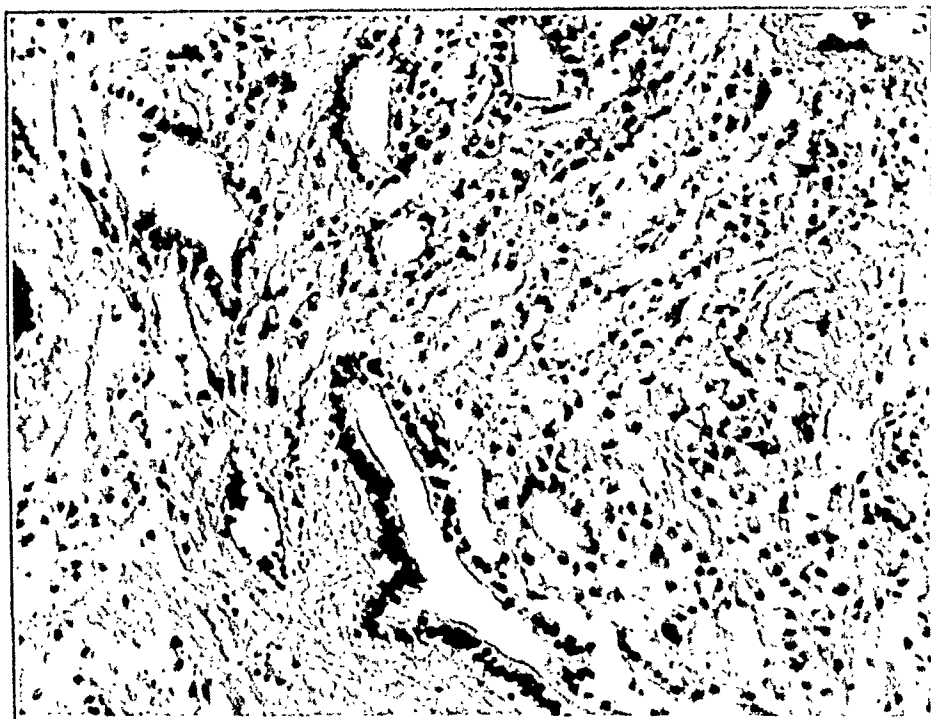

Fig. 5.—One of the epithelial portions of a mixed epithelial and cellular intramedullary ependymoma. The ependymal cells are arranged as canals, which resemble the central canal of the spinal cord. Hematoxylin and eosin; $\times 145$.

The cellular type of ependymoma was the most common variety of ependymoma in our series. The prominent histologic characteristic of the cells of this tumor was their similarity to the astroblasts; however, the nuclei and chromatin granules of the ependymal cells were large, and the tumor cells had no affinity for the gold of Cajal's gold chloride-mercury bichloride (sublimite) impregnation. Occasionally the cells of the tumor had processes which terminated in the neighborhood of a blood vessel. More frequently one or several processes of these cells extended toward a common center, in which no blood vessel was present, thus forming a "pseudorosette." Neuroglial fibrils were not formed by the ependymal cells, and blepharoplasts were not seen. The nuclei of these

ependymal cells were round or oval, and only occasionally were mitotic figures observed. Deposits of calcium were found in 1 of these tumors.

The microscopic structure of the metastatic implantations from the ependymomas closely resembled that of the parent tumor. The metastatic growths were comparatively benign, and we observed only a minimal amount of local infiltration of the surrounding cerebral and spinal tissues. There was little proliferation of connective tissue and no local degenerative change in these metastatic implants. Deposits of calcium were observed in 1 of the ependymomas that we studied, but not in the metastatic growths.

The term "ependymblastoma" was first proposed by Bailey and Cushing to designate tumors of the ependymoma group of gliomas which were composed primarily of ependymal spongioblasts. In our series, this tumor was found in 1 instance (2.4 per cent).

This ependymblastoma on gross examination, was pale, flesh colored and firm and appeared to invade the surrounding tissues of the brain more readily than the ependymomas. The metastatic growths from this tumor showed local infiltration of the surrounding cerebral structures.

The ependymblastoma was more malignant than any of the ependymomas. Histologic examination revealed that the cells of the tumor were slightly larger than those of the ependymomas, and the nuclei were of greater size in proportion to the amount of cytoplasm of the cells. The microscopic appearance was typical and was characterized by the predominance of the ependymal spongioblasts. The nuclei of these cells were elongated or oval and were arranged in "rosette" formation around the numerous thin-walled blood vessels. Mitotic figures were observed commonly.

The histologic structure of the metastatic growths from the ependymblastoma was similar to that of the primary tumor but differed from the structure of the implants of the ependymoma in showing a greater degree of malignancy.

OLIGODENDROGLIOMA

Bailey and Cushing were the first to recognize and classify the oligodendroglioma as a tumor of the central nervous system which was composed almost exclusively of oligodendroglial cells. They found 9 of these tumors in a series of 254 classified gliomas. Later, Bailey and Bucy¹² proved the presence of oligodendroglia in these neoplasms by detailed histologic studies and reported 6 tumors observed subsequent to those originally described by Bailey and Cushing. Cushing found 27 oligodendrogliomas in a series of 687 classified gliomas (3.9 per cent),

12. Bailey, P., and Bucy, P. G.: Oligodendrogliomas of the Brain, *J. Path. & Bact.* **32**:735-751 (Oct.) 1929.

none of which produced generalized meningeal involvement. In 1929 Cairns¹³ was the first to describe an instance of metastasis from this type of glioma through the cerebrospinal fluid. He reported the surgical removal of an oligodendroglioma originating in the frontal lobe of the right cerebral hemisphere, which, three and a half years later, implanted itself in the fourth ventricle and in the occipital horn of each lateral ventricle. In our series of 42 cases, there were 5 instances in which these gliomas (including the oligodendroblastomas) produced generalized gliomatosis of the meninges (11.9 per cent).

Oligodendroglioma is predominantly a tumor affecting adults. For the most part, it originates in the cerebral hemispheres of the brain and in the spinal cord. All the oligodendrogliomas reported by Cushing originated in the cerebral hemispheres. In 25 of the cases (92 per cent) the patient was an adult. We found 2 cases of oligodendroglioma. In 1 case the tumor was situated in the temporal lobe of the right cerebral hemisphere of a man aged 37. In the other the glioma was located in the lower portion of the pons and the medulla of a woman aged 32.

On gross examination, the oligodendrogliomas were observed to be large, moderately firm and reddish gray, with some deposits of calcium. At times there were small regions of degeneration; cyst formation and hemorrhages were observed. Both these tumors seemed well demarcated from the surrounding tissue of the brain, but definite capsules were not present in either instance.

The microscopic features of the oligodendrogliomas were characteristic. These tumors presented a cellular and uniform appearance, with practically no stroma. The edges of the tumors, which macroscopically had seemed so well demarcated, were not sharply defined on histologic examination and blended into the surrounding tissue of the brain. The nuclei of the cells of these gliomas were small, round and regular in size and shape and contained a heavy network of chromatin. When the neoplastic cells were stained with hematoxylin and eosin, the cytoplasm appeared scanty and indistinct and formed the typical "halo" around the small, deeply stained nucleus. The majority of these nuclei, which were smaller than those of the other gliomas, were almost perfectly round and resembled lymphocytes. Mitotic figures were rarely observed. When the cells of these tumors were impregnated successfully by the Hortega silver carbonate method, the nuclei were lightly stained and the cell outline was heavily impregnated. The majority of the cells were packed closely together in a "pavement-like" arrangement, giving them the typical "honeycomb" appearance.

13. Cairns, H.: A Study of Intracranial Surgery, Medical Research Council, Special Report Series, no. 125, London, His Majesty's Stationery Office, 1929, p. 15.

Astrocytes, as well as ependymal cells, were identified in both these tumors. The implants from these gliomas resembled the primary tumors except that the stroma was somewhat more prominent. Regions of degeneration also were observed in these metastatic growths. At times, the tumor blended so uniformly into the adjacent cerebral and spinal tissues that it was difficult to determine accurately the true limits of the metastatic growths.

The term "oligodendroblastoma" has been used to designate the more actively growing types of oligodendroglioma. In our series we found 3 instances in which the oligodendroblastoma was responsible for generalized meningeal gliomatosis (7.1 per cent). Two of these tumors were primary in the cerebral hemisphere, while the third was an intramedullary tumor of the spinal cord.

The cerebral tumors, on gross examination, were grayish red, contained no deposits of calcium and blended uniformly into the surrounding brain. Spinal metastasis was not observed. On histologic examination we observed that these tumors were similar in most respects to the oligodendroglioma but were more malignant; the nuclei of the cells were larger, and the cytoplasm was more readily visible. Mitotic figures were a prominent feature of these tumors.

The intramedullary tumor of the spinal cord which we studied was an oligodendroblastoma of the eighth cervical segment. The cells of this tumor extended through the cerebrospinal fluid and were implanted extensively throughout the subarachnoid space. The leptomeninges of the entire spinal cord and cauda equina, the base of the brain and the cerebral hemispheres were involved by this process of gliomatosis. The microscopic and macroscopic appearance of the spinal oligodendroblastoma was similar to that of the cerebral tumors. The local infiltrations into the cerebral and spinal structures were more evident in the oligodendroblastomas than in the oligodendrogliomas.

ASTROCYTOMA

In the majority of series of verified intracranial tumors, the astrocytomas form one of the largest subdivisions of the glioma group. These tumors may occur anywhere in the cerebrospinal axis and may be solid or cystic. The solid type of tumor is very firm and comparatively avascular and usually originates in the subcortical substance of the cerebral hemispheres, rarely extends to the surface and is covered by the flattened convolutions of the brain. Most astrocytomas of the cerebellum are cystic.

In 1930 Russell and Cairns¹⁴ reported the first instance of meningeal gliomatosis from an astrocytoma. This glioma originated in the

14. Russell, D. S., and Cairns, H.: Spinal Metastases in a Case of Cerebral Glioma of the Type Known as Astrocytoma Fibrillare, *J. Path. & Bact.* **33**:383-391 (April) 1930.

right thalamus and metastasized widely in the subarachnoid space, forming metastatic implantations in the leptomeninges of the entire spinal cord. Doubts concerning this observation were expressed at first by a few authors. However, it was confirmed in 1931 by Cairns and Russell. With the appearance of similar reports in the literature, the ability of the astrocytoma to metastasize through the cerebrospinal fluid and to become implanted in remote positions has now become recognized and accepted.



Fig. 6.—Protoplasmic astrocytoma arising from the corpus callosum and extending into the lateral ventricles. The patient lived eight years after the first symptom and seven years after the first operation.

In our series of 42 cases, we found 3 instances in which metastasis from the astrocytoma type of glioma resulted in generalized meningeal gliomatosis (7.1 per cent). In 2 of these cases the tumor was of the protoplasmic type, and in the third it was a fibrillary astrocytoma. The protoplasmic tumors originated in the corpus callosum (fig. 6) and in the third ventricle, respectively, and occurred in patients 15 and 32 years of age. The fibrillary astrocytoma occurred in an 18 year old girl and was primary in the midbrain. In both the cases of protoplasmic astrocytoma, the implantations of tumor were so abundant that the

leptomeninges appeared thickened and opaque (fig. 7 *A*) and resembled those which are seen commonly in the terminal stages of chronic meningitis. Implants also occurred on, and caused adhesions between, the nerve roots of the cauda equina (fig. 7 *B*). The metastatic growths of the fibrillary astrocytoma were not so extensive as those observed with the protoplasmic variety.



Fig. 7.—*A*, implants in the meninges from the protoplasmic astrocytoma seen in figure 6. Note the small nodules and the opacity of membranes. *B*, implants on the nerve roots of the cauda equina, causing adhesions.

The astrocytomas of our series were of the solid type. On gross examination, the borders appeared to be poorly defined, and only a few small cystic cavities were seen. These tumors had the consistency of rubber, and on cross section they were firm, grayish white and homogeneous. The histologic classification of the protoplasmic and fibrillary astrocytomas was dependent on the predominant type of cell.

We employed the phosphotungstic acid hematoxylin stain and the gold chloride-mercury bichloride impregnation method in the identification of these two types of tumors.

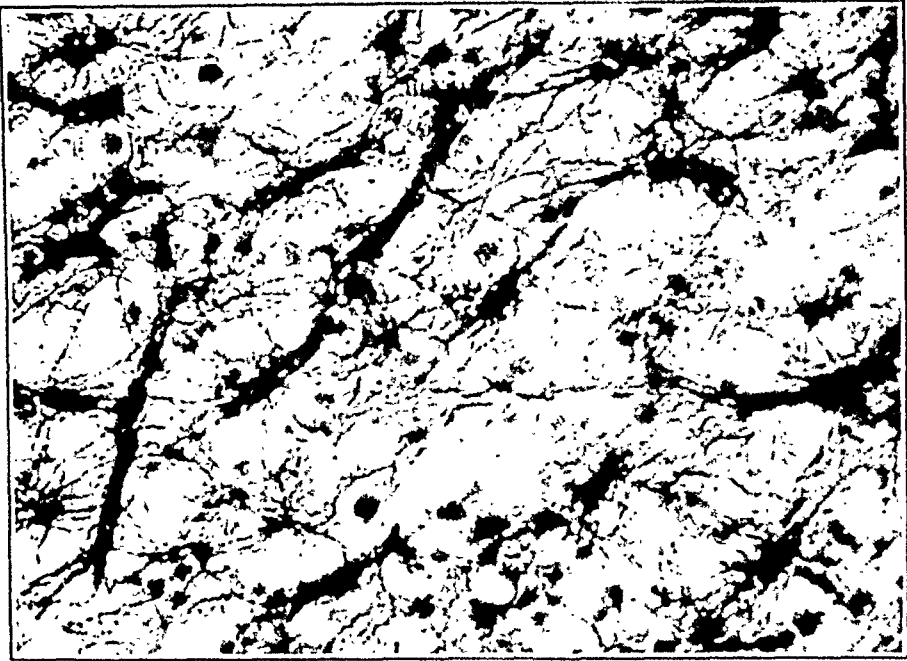

Fig. 8.—Glial process of the tumor cells (protoplasmic astrocytes). Note the abundant capillaries. Cajal's gold chloride-mercury bichloride (sublimite) method; $\times 240$.

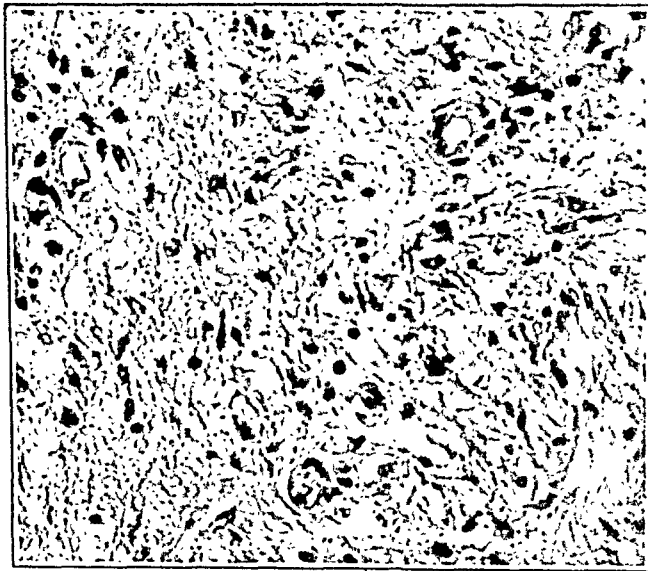

Fig. 9.—Protoplasmic astrocytoma with slight variation in the size and shape of the nuclei. No mitotic figures are visible. Hematoxylin and eosin; $\times 200$.

The matrix of the protoplasmic astrocytomas was coarse and glial processes were common (fig. 8), but glial fibrils were rarely seen. These astrocytomas could possibly be included with the slower-growing

glioblastoma multiforme, since a few multinucleated cells were seen and occasionally amitotic divisions of the nuclei of the cells were encountered. However, mitotic divisions were rarely observed. Vascular changes, such as proliferation of the endothelial cells and adventitia, were noted occasionally in these tumors. In spite of these observations, we consider these 2 tumors as belonging to the class of protoplasmic astrocytoma (fig. 9).

The histologic structure of the fibrillary astrocytoma revealed an abundance of glial fibrils, which formed a dense interlacing network, within which there were scattered nuclei and small blood vessels. The astrocytes and their nuclei were regular in size and distribution, and mitotic figures were rarely seen.

The microscopic appearance of the metastatic implantations from both the protoplasmic and the fibrillary type of astrocytomas was similar to that of the parent tumor. Proliferation of connective tissue was abundant, and there were no regions of degeneration.

RETINOBLASTOMA

Glioma of the retina (retinoblastoma) is a rare neoplasm, often familial, frequently bilateral, and occurs during the period of infancy and early childhood.

We found only 2 cases of such tumors in our series of 42 cases of meningeal gliomatosis (4.8 per cent). The tumors occurred in 4 year old girls, and each originated in the retina of the right eye. In both instances extensive meningeal gliomatosis was present, which involved the leptomeninges of the cerebral hemispheres and the base of the brain. Metastatic nodules of tumor also were observed implanted throughout the ventricular system and around all the cranial nerves.

Gross examination revealed that each tumor was soft and reddish gray and was firmly attached to the surrounding tissue of the brain. In 1 of the cases the tumor infiltrated the left optic nerve so completely that the identification of this structure was difficult, and by this same process the right optic nerve was enlarged to approximately twice its normal size. The metastatic growths from these retinoblastomas were so numerous that the surfaces of the cerebral hemispheres and the cerebellum were almost completely covered by the reddish gray implants.

On histologic examination, the appearance of these tumors was characteristic, with small, dark-staining cells, many typical rosettes and large regions of necrosis. There were numerous mitotic figures.

The metastatic growths from this group of gliomas were as extensive as any of our series. The microscopic structure of the metastatic tissue was identical with that of the parent tumors. Regions of degeneration were prominent features in the implants.

PINEALOMA

Although pinealomas are rare, they constitute a well recognized type of neoplasm. Occasionally the pinealoma forms metastatic growths, which become implanted widely in the leptomeninges of the brain and the spinal cord. We found only 1 instance in our series of 42 cases (2.4 per cent) in which this process occurred. This case has previously been described in detail by Baggenstoss and Love,¹⁵ who in a review of the literature pertaining to this subject found the reports of only 3 similar cases. In another instance, these authors recorded an interesting observation in regard to the metastatic implantation of this tumor. In this case, an infantile type of pinealoma was partially removed in 1937. The patient returned fourteen months later presenting neurologic signs of a lesion of the cauda equina. Lumbar puncture showed a blockage of the circulation of the cerebrospinal fluid. Laminectomy revealed multiple intramedullary and extramedullary tumors of the conus medullaris and cauda equina, the histologic structure of which was identical with that of the original pinealoma.

The pinealoma which we included in our series had extended into, and completely filled, the third ventricle and was implanted throughout the ventricular system. Implants of the tumor also were observed around the roots of most of the cranial nerves and in the leptomeninges of the cerebral hemispheres, the base of the brain, the pons and the medulla. The posterior lobe of the pituitary body was almost completely replaced by the infiltration of these metastatic cells.

Gross examination revealed that the tumor was soft and grayish red and had infiltrated into the surrounding brain. The metastatic implants were numerous throughout the leptomeninges of the brain and spinal cord.

Histologic examination showed that this pinealoma was composed of the typical large parenchymal cells, which were arranged in nests and were separated by columns of connective tissue, infiltrated with clumps of small, round, deeply staining cells, which resembled lymphocytes. Many mitotic figures and giant cells were present.

In histologic structure the implants were identical with the primary tumor, and they had invaded the adjacent portion of the nervous system. There was little connective tissue or capillary proliferation in the metastatic growths. However, regions of degeneration were frequently observed.

FACTORS IN SPREAD OF GLIOMA

Gliomas spread (1) by continuity, (2) by direct extension into the meninges or (3) by their continuous growth; they may reach the ven-

15. Baggenstoss, A. H., and Love, J. G.: Pinealomas, *Arch. Neurol. & Psychiat.* 41:1187-1206 (June) 1939.

tricular system or the subarachnoid space and form metastatic growths by spread through the cerebrospinal fluid.

The rate of the production of metastasis through the cerebrospinal fluid was governed by the location of the primary tumor and by its malignancy. Thus, a comparatively slow-growing ependymoma which may originate from the floor of the fourth ventricle can spread more readily and easily through the cerebrospinal fluid of the subarachnoid space than a similar tumor located in the depths of the brain. The rapidity of growth of the tumor became a greater factor in the production of metastasis when the primary tumor originated at a distance from the pathway of the cerebrospinal fluid.

The potential implantation of these tumors which reached the ventricular surface of the brain or the subarachnoid space was influenced by at least four factors: circulation of the cerebrospinal fluid, alterations of the dynamics of the cerebrospinal fluid, gravity and trauma.

The current of the cerebrospinal fluid was partially responsible for the transportation of small particles of tumor to distant sites. Metastatic particles arising from primary gliomas in contact with the cavities of the ventricular system or the subarachnoid space of the brain and spinal cord can enter the cerebrospinal fluid and become widely disseminated throughout the subarachnoid space by the circulating cerebrospinal fluid.

Alteration of the dynamics of the cerebrospinal fluid was probably also a contributing factor in the dissemination of tumor cells through the subarachnoid space. A slight increase of the intraventricular pressure resulting from a partial block of the ventricular fluid could cause the glial cells to become detached from the main mass of the tumor and enter the circulating cerebrospinal fluid, which could carry the particles of tumor to the points where implantation occurred. The dissemination of metastatic tumor may be augmented by a further increase of intracranial pressure, which may be produced when the patient coughs, sneezes, strains or vomits. This process also may be hastened by a decrease of intracranial pressure resulting from the removal of cerebrospinal fluid during lumbar puncture or the course of surgical procedures.

Retrograde metastasis of the tumor against the decreased current of cerebrospinal fluid may have occurred in those instances in which there was internal hydrocephalus. The medulloblastoma group of gliomas was particularly outstanding in this respect. In our series of 20 cases of medulloblastoma, retrograde ventricular metastasis was present in 8 (40 per cent). The mechanism of retrograde metastasis is not clear. However, the intraventricular pressure is probably at first increased, and subsequently decreased, by the patient in coughing, sneezing, strain-

ing or vomiting. Such fluctuations may be important factors in this process. The performance of ventricular punctures for the temporary relief of increased intracranial pressure also may alter the dynamics of the cerebrospinal fluid and produce retrograde metastasis.

Gravity probably influences the implantation of tumor in the subarachnoid space. We found that a common site of early spinal metastasis from primary cerebral gliomas was the pia-arachnoid overlying the dorsal aspect of the thoracic portion of the spinal cord. It is conceivable that the force of gravity plays an important role in the production of metastatic implantation in the pia-arachnoid of this region, since the majority of the patients who have cerebral gliomas are confined to bed and are forced to lie flat on their backs.

Direct trauma as a result of intracranial operation may dislodge the cells of the tumor from the primary mass, and, on entering the circulation of the cerebrospinal fluid, the dislodged cells may become implanted elsewhere. Such an occurrence, perhaps, is most frequent following the surgical treatment of the gliomas of the posterior fossa. This is particularly true of the friable medulloblastomas.

A sudden increase of intracranial pressure as a result of the patient's coughing, sneezing or vomiting may cause sufficient indirect trauma to dislodge some of the glial cells and produce further metastasis through the cerebrospinal fluid. A sudden jar or a blow on the head may also cause some portions of tumor to be dislodged in the same manner.

Early in the course of meningeal gliomatosis, the metastatic implants and their extensions appeared to be limited to the subarachnoid space. Extensions of the tumors into the adjacent structures of the central nervous system and the subdural space occurred only when the subarachnoid space was completely filled with metastatic tumor at the site of the implantation or when the primary glioma was extremely malignant. We are of the opinion that the restriction of the metastatic tumor to the subarachnoid space is in part at least the result of the normal barriers presented by the leptomeninges. Since there is little or no obstruction to the growth of tumor tissue in the subarachnoid space, extension throughout this cavity is facilitated. Since the vascular pia-arachnoid provides a favorable site for the nourishment and survival of the cells of the tumor, these cells will extend along the surface of this membrane before they will enter the less favorable avascular fibrous arachnoid and the subdural space. However, when metastatic tumors distend the subarachnoid space or when the implants are derived from a malignant variety of glioma, extension into the arachnoid membrane and the central nervous system can be observed.

Although several cases of extracranial metastasis from gliomas have been reported, we found in our series of cases that the metastasis was limited to the central nervous system.

The development of meningeal gliomatosis, therefore, was dependent on a number of factors. The most important factor was access to the pathway of the cerebrospinal fluid, which was determined largely by the location and the malignancy of the primary tumor. The potential implantation of metastatic tumor which reached the surface of the ventricular system or the subarachnoid space was governed by additional factors, such as the circulation of the cerebrospinal fluid, alterations of the dynamics of the cerebrospinal fluid, gravity and trauma. In some instances these factors may occur independently, but more commonly they are in combination.

PATHOLOGIC CHARACTERISTICS

In a review of the pathologic characteristics of the gliomas observed at the Mayo Clinic during the period from 1922 to 1942, inclusive, generalized meningeal gliomatosis was found in 42 instances. We have been unable to confirm the observations of Cairns and Russell in regard to the high frequency of metastasis to the leptomeninges of the spinal cord. However, we are of the opinion that in certain circumstances an extensive involvement of the leptomeninges by metastatic tumor may result from most gliomas.

The metastatic implants which were observed in the walls of the ventricular system and in the pia-arachnoid of the brain and the spinal cord varied greatly in size and distribution. Occasionally these implants were seen as a few small, discrete nodules of tumor in the leptomeninges. At other times, they were microscopic and were found only after a careful histologic study of the entire central nervous system. In other instances, the implants were so numerous that the leptomeninges were opaque and thickened, and occasionally large nodules were visible.

As has been pointed out previously by Cairns and Russell, considerable information may be gained from histologic examination of the metastatic implants if there is doubt as to which type of primary cerebral glioma is involved in the process of meningeal gliomatosis. On several occasions it was necessary to examine the implants histologically before we could classify the cerebral glioma responsible for the metastatic growths. The morphologic character of the cells of the tumor growing on a free surface was different at times from the character of the cells which infiltrated the compact structures of the brain and spinal cord. The histologic structure of the majority of the metastatic implantations, however, was observed to be almost identical with that of the parent tumor. However, the microscopic appearance of the metastatic tissue was frequently somewhat more cellular than that of the primary neoplasm. Occasionally the presence of tumor in the subarachnoid space led to retrograde infiltration of the perivascular spaces of the adjacent

cerebral and spinal structures. The metastatic growths from the more malignant varieties of glioma tended to become invasive and at times almost completely replaced the surrounding structures of the brain and spinal cord, without producing any reaction in these tissues.

GLIAL HETEROTOPIA

The relationship of glial heterotopia to the genesis of a diffuse meningeal gliomatosis should receive consideration. As far as could be ascertained, Wolbach,¹⁶ in 1907, was the first to describe glial heterotopia within the subarachnoid space. These neuroglial nests were observed within the spinal canal of a patient 10 months of age who presented spina bifida with hydrocephalus, as well as a congenital rhabdomyoma of the heart. The nests were most numerous on the dorsal surface of the cervical segment of the spinal cord and were present in the subarachnoid space. At no point were they connected with the spinal cord. These heterotopic glial nests were composed of a dense feltwork of neuroglial fibers, which extended in all directions and were surrounded by a small amount of connective tissue and a few blood vessels, which were derived from the pia mater. The nuclei of the neuroglial fibers were located invariably in the central portion of the tissue and, according to Wolbach, did not differ in any respect from the nuclei of the normal neuroglial tissue in the central nervous system. Two of these neuroglial nests contained ependyma-lined canals, which Wolbach interpreted as further proof of the developmental origin of glial heterotopia.

There have been occasional reports which confirm the observation of Wolbach. In 1931, Kernohan, Woltman and Adson¹⁷ reported 3 instances of gliomas in the subarachnoid space and suggested the possibility of neoplasms originating from such heterotopic masses. In 1936, O. T. Bailey¹⁸ reported a case in which he believed that astrocytoma of the leptomeninges had arisen from a heterotopic neuroglial nest. After the operative procedure, the symptoms progressed, and the patient died thirteen and a half months later. There were neurologic signs of increasing intracranial pressure and bronchopneumonia. Since necropsy was not performed in this case, it is not clear whether the tumor was

16. Wolbach, S. B.: Congenital Rhabdomyoma of the Heart: Report of a Case Associated with Multiple Nests of Neuroglia Tissue in the Meninges of the Spinal Cord, *J. M. Research* **16**:495-520 (July) 1907.

17. Kernohan, J. W.; Woltman, H. W., and Adson, A. W.: Intramedullary Tumors of the Spinal Cord: A Review of Fifty-One Cases, with an Attempt at Histologic Classification, *Arch. Neurol. & Psychiat.* **25**:679-699 (April) 1931.

18. Bailey, O. T.: Relation of Glioma of the Leptomeninges to Neuroglial Nests: Report of a Case of Astrocytoma of the Leptomeninges, *Arch. Path.* **21**:584-600 (May) 1936.

the local extension of a cerebral astrocytoma, a meningeal implantation from a cerebral astrocytoma or an astrocytoma of the leptomeninges which had arisen from a heterotopic neuroglial nest. Bailey, however, mentioned several reasons that he thought the tumor was primary in the leptomeninges:

The clinical manifestations were referred only to the site at which the tumor was seen. When recurrence developed it was at the same site, and no clinical evidence of tumor elsewhere could be observed. When a glioma metastasizes there is usually seeding in the subarachnoid space, and large solitary nodules do not develop. The gliomas giving rise to a meningeal gliomatosis are confined to the most rapidly growing of the group, especially the medulloblastomas and glioblastomas.¹⁸

The fact that clinical manifestations of a tumor situated in another portion of the brain were absent in this case would hardly justify Bailey's assumption that the tumor was primary in its location, since it has been well established that tumors in a "silent area" of the brain, especially the frontal lobes, may reach enormous proportions without producing clinical symptoms or neurologic signs. From our observations, meningeal gliomatosis was not restricted to the medulloblastoma and the glioblastoma multiforme group of gliomas. In certain circumstances, this process might occur with almost any type of glioma.

Bailey reviewed the literature pertaining to neuroglial nests and reported 3 cases which he had observed. The heterotopic glial nests in these cases corresponded closely in general distribution and histologic structure to those originally described by Wolbach. They were characterized by being situated entirely in the subarachnoid space, by having a complete, delicate investment of connective tissue and by being composed exclusively of glial cells and fibers except for the presence of a few small vascular channels, which were derived from the vessels of the pia-arachnoid. Nerve cells were absent from the neuroglial nests studied by Bailey.

In 1930, spinal metastasis from a cerebral astrocytoma was reported by Russell and Cairns. The diagnosis in this instance was at first questioned, but in a later report it was confirmed by Cairns and Russell. In commenting on this case, O. T. Bailey stated that he would rather interpret this case as an instance of multiple neuroglial nests with a glioma arising in one of them because of the histologic similarity between the neuroglial nests and the spinal nodules, the location of these nodules in the subarachnoid space, the histologic character of the glioma (astrocytoma) and the absence of similar observations in other instances of this type of tumor. In our study of the astrocytoma group of glioma, generalized meningeal gliomatosis was observed in 3 cases. In 1 of these cases a large protoplasmic astrocytoma was noted in, and incompletely removed

from, the corpus callosum (fig. 6). The patient died seven and a half years later, and implants were seen along the thoracic portion of the spinal cord and on the cauda equina (fig. 7 *A* and *B*). The implants in the meninges of the thoracic portion of the spinal cord and cauda equina were identical histologically with those of the original tumor (figs. 8 and 9). These observations would tend to corroborate those of Russell and Cairns. However, it is possible that both implants from gliomas and those from heterotopic neuroglial nests are the source of neoplastic processes in the meninges.

SUMMARY

In a survey of the glioma group of neoplasms observed at the Mayo Clinic from 1922 to 1942, inclusive, generalized meningeal gliomatosis was found in 42 instances. The medulloblastoma was responsible for generalized metastasis in 47.6 per cent of the cases. Glioblastoma multiforme represented 14.3 per cent of the series, and the order in which the other types of tumors occurred is as follows: ependymoma and ependymblastoma, 11.9 per cent; oligodendroglioma and oligodendroblastoma, 11.9 per cent; astrocytoma, 7.1 per cent; retinoblastoma, 4.8 per cent, and pinealoma, 2.4 per cent.

Although several instances of extracranial metastasis from gliomas have been reported, we found in our series that the metastatic implants were limited entirely to the central nervous system. Furthermore, the metastatic growths were more or less confined to the subarachnoid space because of the normal barriers formed by the anatomic features of the leptomeninges of the brain and spinal cord. The pia mater and the subarachnoid space, being extremely vascular, furnish a suitable environment for the nutrition and the survival of the cells of the tumor. The extension of the cells is limited peripherally by the fibrous, inelastic and avascular dura mater and arachnoid membrane and centrally by the compact structures of the brain and spinal cord.

The microscopic appearance of the metastatic implants was similar to that of the primary tumor except in 1 instance, in which the subarachnoid extension from an intramedullary cellular ependymoma of the spinal cord assumed the microscopic characteristics of a well differentiated oligodendroglioma. In the majority of the cases the cells of the metastatic tissue were easier to identify than those of the primary tumors, probably because they grew on a free surface and the morphologic characteristics of these cells were unaltered by the pressure of the adjacent cerebral and spinal structures.

The metastatic growths of the tumors exhibited several interesting histologic features. Occasionally the presence of metastatic tumor in the subarachnoid space produced a moderate amount of lymphocytic reaction within the adjacent cerebral and spinal tissues. At times the

leptomeninges produced a proliferation of connective tissue in response to the implantation of metastatic tumor. This was seen most frequently in association with the slow-growing gliomas, such as the astrocytoma and the oligodendroglioma. Capillary proliferation and focal degeneration were observed to be most prominent in the implants from the rapidly growing gliomas.

Contrary to the general belief that only the more malignant varieties of glioma produce generalized meningeal gliomatosis, we found that in certain circumstances this process may result from almost any variety of glioma.

The Mayo Clinic.

EDUCABILITY OF A "DETERIORATED" EPILEPTIC PATIENT

DORIS TWITCHELL-ALLEN, Ph.D.

CINCINNATI

STATEMENT OF PROBLEM

IN THE literature on epilepsy, reference is commonly made to the deteriorated epileptic patient¹ and to progressive deterioration. It is proposed in this paper to raise the question whether there is evidence to justify a continuation of the implication in the literature that there is a special type, or greater degree, or higher incidence, of deterioration in epilepsy than in other diseases, and whether there is justification for the implication that the fits per se lead, or even largely contribute, to deterioration. The following case of a "deteriorated" epileptic patient is presented as the basis for raising such questions.

REPORT OF CASE²

Family Data.—The mother and father, born in Ohio, were of German and Swiss extraction, respectively. The father, a business man, kept his family comfortably, but an unfortunate business venture shortly before his death left his family in straitened circumstances. The children proved themselves to be enterprising and capable. Six earned their way for two or more years at the state university.

No case of epilepsy was found in this family, including the siblings of the parents' families and their children. The electroencephalographic tracings³ made for the mother and 8 of the patient's siblings showed no abnormalities, with or without hyperventilation.

Clinical History.—According to the mother, the patient's first attack occurred on Good Friday, 1923, when he was 6 years old. He was the tenth of 11 children. Labor, birth and developmental history were normal. He escaped the usual dis-

1. (a) Wechsler, I. S.: Textbook of Clinical Neurology, with an Introduction to the History of Neurology, ed. 5, Philadelphia, W. B. Saunders Company, 1943, p. 641. (b) Strecker, E. A., and Ebaugh, F. G.: Practical Clinical Psychiatry, ed. 5, Philadelphia, The Blakiston Company, 1940, p. 187. (c) Ford, F. R.: Diseases of the Nervous System in Infancy, Childhood and Adolescence, ed. 2, Springfield, Ill., Charles C Thomas, Publisher, 1944, p. 1080.

2. The material from the physical examination and the clinical and family histories has been taken largely from a paper by H. D. Fabing and D. Twitchell-Allen (The Case of Eugene Z.: A Preliminary Report, read before the Section on Convulsive Disorders of the American Psychiatric Association, Cincinnati, May 20, 1940).

3. All encephalographic tracings reported in this paper were made and interpreted by Dr. Douglas Goldman, Director, Medical Department, Longview State Hospital, Cincinnati.

eases of childhood. Of possible etiologic significance was a fall down the cellar stairs at the age of 4 years, which rendered him unconscious for several minutes. The family and the priest and nuns of the one school he attended remember that before the onset of seizures he was alert and apparently above average in ability. His seizures varied in frequency from one a week to as many as eighteen grand mal fits in one day. Aura, in the form of abdominal pains, usually preceded the severe spells. A variation of the grand mal attack was the epileptic fugue, in which the patient after the aura and tonic-clonic fit would rouse from the coma and, in a state of confusion, rush out of the house and walk rapidly around the block. At such times he would fight with any one who tried to stop him.

This seventeen year period represents a block of the patient's life, from his sixth to his twenty-third year, which was spent in practical isolation. He tried to complete his first year of school, and in the fall to enter second grade, but he was sent home both times because of frequent spells. In his yard, where many children gathered to play with his siblings, he became more and more an outsider. At the age of 14 he became unmanageable and was placed in the Gallipolis State Hospital, where he remained eighteen months. After returning home, he withdrew increasingly from family activities. The stupor from the fits themselves or from the continuous use of phenobarbital became more and more his characteristic state.

*Physical Examination.*²—The patient was admitted to the hospital on Nov. 8, 1939. He was having a shower of minor seizures, which were accompanied by a fixed, vacant stare or spontaneous giggling or by the head rolling and the eyes closing. General physical and neurologic examinations, a study of the cerebrospinal fluid and roentgenologic studies of the skull gave normal results. Later, an air encephalogram⁴ was concluded to show moderate cortical atrophy. Electroencephalograms, taken at later dates, showed pronounced irregularity in all leads, with little alpha rhythm and predominance of low and high voltage slow waves, of 3 to 7 per second. Subsequent study showed that the patient had a basal metabolic rate of + 15 per cent. A five hour dextrose tolerance curve had a normal configuration, with a fasting level of 94 mg. per hundred cubic centimeters.

When he arrived at the hospital, the patient was taking three doses of elixir of phenobarbital daily, 4 cc. to the dose; he was kept on this medication until November 15. On November 8 he was also placed under treatment with sodium diphenylhydantoin, 1½ grains (0.1 Gm.) three times a day. For one week the patient was taking both phenobarbital and diphenylhydantoin sodium; thereafter he was maintained on the latter alone. Seizures stopped at once with the administration of diphenylhydantoin and have not recurred during the continuation of this medication.

Psychologic Study.—On Nov. 29, 1939 the patient came to me for special study. He shuffled along, with shoulders stooped and head forward, his arms immobile at his sides. The expression on his face was that of a mask. His speech was mumbling. If traditional statements regarding epileptic deterioration had been accepted uncritically, the patient would have been termed deteriorated, particularly since on that day, at the age of 23, the patient obtained a mental age of 6 years and 7 months on the Stanford-Binet Form L Test.

When, during the neurologic study, the patient's medication was changed from phenobarbital to diphenylhydantoin sodium attacks ceased immediately, and the patient suddenly was thrown into a position where he might enter society and

4. This encephalographic study was made by Dr. Joseph P. Evans, of the University of Cincinnati College of Medicine.

5. Footnote deleted by the author.

participate in normal group living. But how much could he learn at the age of 23, after seventeen years of a minimum of thinking, wracked by an estimated minimum of 2,200 grand mal and an untold number of petit mal attacks?

In accordance with the purpose of this investigation, a program was set up to foster continuous progress in mental, social and emotional development. From my first tests to the last test here reported, this program consisted of nine periods. The first was a two month period in the patient's home following the institution of medication with diphenylhydantoin sodium. During this time the patient was encouraged to learn certain habits of self care. For example, one of his brothers taught him to shave himself.

The second period was in my home, where the patient remained for four months as a member of my family. During this time he was tutored two and a half hours daily five days a week by an experienced elementary school teacher. In addition, certain activities were directed toward personality growth, such as trips to the zoo. Some activities emphasized interpersonal relationships, such as having school boys as guests for dinner.

The third period was six months at the Devereux school and camp. This afforded opportunity for the patient to progress in ways in which his development lagged as long as he remained in a family situation. It was thought that the attractiveness of camp activities could enhance the motivation to learn skills and to get along with his peers.

The fourth period was a month in the home of the neurologist, while I was testing him and while plans were being made for another period of individual tutoring.

The fifth period was four months of daily tutoring by an experienced high school teacher, who at the time was a graduate student⁶ at the University of Cincinnati Teachers College. The patient had to live in a city of 500,000 in a boarding home. Daily he had to walk a mile (1.6 kilometers) to the university, crossing streets of heavy traffic. He started weekly lessons in piano, swimming and reading⁷ and biweekly lessons in speech. He ate daily at the student cafeteria, usually with his tutor and other graduate students, whom he heard discuss instructors, assignments, examinations and grades.

The sixth period was four months in his own home. The family was asked to accept him as a normal person and to help him obtain a job. He did attempt two small jobs but was unsuccessful.

The seventh part of the guidance program was a tutoring period of a complete academic year. For vacations he traveled alone the 100 miles (160 kilometers) to his home by train. The program of instruction was similar to that of the previous term except that classes in religious education and art were added. The second semester he entered the Cincinnati Art Academy and worked five mornings a week.⁸ Social contacts with the men and women of the class were one advantage of this course. Paralleling this experience were reading lessons, in which he studied the social concepts found in "Young Citizens in a Democracy: Growing Up"⁹ for third and fourth grade pupils.

6. Munger, I. L.: A Case Study of Delayed Intellectual and Social Development, Teachers College, University of Cincinnati, 1944, unpublished thesis.

7. With the late Miss Frances Jenkins, assistant professor in the University of Cincinnati Teachers College.

8. Under Mr. Willson Y. Stamper, formerly of the Cincinnati Art Academy, now director of the Honolulu School of Art.

9. Jenkins, F., and Campbell, J. T.: Young Citizens in a Democracy: Growing Up, Columbus, Ohio, American Education Press, Inc., 1941.

The eighth period was an unsuccessful attempt to place the patient in a position where he could learn skills useful for earning a living. He was placed on a farm, where he remained only one month.

The ninth period was with his family. He obtained a job as yard man for a neighbor for six hours a day five days a week. During the war period he received more requests to work than he could accept.

Diphenylhydantoin sodium has been used as the anticonvulsant since November 1939. The original dose of 0.3 Gm. daily seemed inadequate, since he was too lethargic for his studies. With 0.4 Gm. the patient could concentrate better. Both 0.5 and 0.6 Gm. daily were tried, and 0.5 Gm. daily was found to be optimal. He received this dose until November 1941, at which time he was placed on a regimen of 0.4 Gm. daily because of slight signs of toxicity. In September 1944 the patient himself decided to reduce the dosage to 0.3 Gm. daily.

Results: The patient's development in terms of his mental age was measured periodically by four standardized tests for intelligence. All four tests, the Stanford-Binet Form L,¹⁰ the Stanford-Binet Form M,¹⁰ the Arthur Performance Form I¹¹ and the Wechsler-Bellevue¹² test, showed an increase in the mental age. The mental age in November 1939 was 6 years 7 months (Stanford-Binet, form L); in June 1944 it was 13 years 2 months (Wechsler-Bellevue). It was seen that the patient's mental age increased at a rate equal to or faster than that of a child of average intelligence and the chronologic age of 6 years 7 months.

On the Wechsler-Bellevue test the ratio of deterioration¹² for each of the three test results over a two year period was 3 per cent or less, and thus noncritical (11 to 20 per cent is "possible deterioration"; above 20 per cent is "definite deterioration"). Failure to find evidence of deterioration in epileptic persons has been reported.¹⁴

The patient learned to follow a day's schedule, to speak with normal enunciation, to swim the crawl stroke and to play simple arrangements of folk songs and classics on the piano. He progressed from preprimer to fourth grade reading.^{14a} His drawing evinced a widened range of thought and loosening of his rigid personality. He obtained and has held a job, earned wage raises, been offered new jobs and bought war bonds.

COMMENT

What is the significance of these results in terms of the concept of epileptic deterioration? This discussion will be limited to idiopathic epilepsy. In the literature such a differentiation has not always been made.

10. Terman, L. M., and Merrill, M. A.: *Measuring Intelligence: A Guide to the Administration of the New Revised Stanford-Binet Tests of Intelligence*, New York, Houghton Mifflin Company, 1937.

11. Arthur, G.: *A Point of Performance Tests*, ed. 2, New York, The Commonwealth Fund, 1943.

12. Wechsler, D.: *The Measurement of Adult Intelligence* ed. 3, Baltimore, Williams & Wilkins Company, 1944.

13. Footnote deleted by the author.

14. Falk, R.; Penrose, L. S., and Clark, E. A.: *The Search for Intellectual Deterioration Among Epileptic Patients*, *Am. J. Ment. Deficiency* **49**:469-471 (April) 1945.

14a. Jenkins, F., and Students: *Jenkins Oral Reading Test, Forms A and B*, Cincinnati, C. A. Gregory Company. Gray, W. S.: *Gray Oral Reading Paragraphs Test*, Bloomington, Ill., Public School Publishing Company.

Authors frequently refer to deterioration as the result of seizures,¹⁵ the progression allegedly being dependent on the frequency of the convulsions. The case here discussed does not substantiate such statements and calls for a redefinition of "deterioration."

Lowered mental functioning may result from prolonged sedation.¹⁶ In the case of this patient, certain improvements occurred immediately after treatment with phenobarbital was discontinued and diphenylhydantoin therapy begun. However, extensive improvement in personality occurred only after close regulation of diphenylhydantoin therapy and a special guidance and tutoring program had been instituted. Experience in this case, and in others reported by Harrower-Erickson,¹⁷ indicates that generalizations regarding permanent change in personality based on sedation are not warranted.

This case supports the theory proposed by Putnam and Merritt¹⁸ that intermittent "dulness" may be one symptom of a pathologic condition of the brain, of which the convulsions themselves are but another aspect. Although control with diphenylhydantoin sodium did not eliminate all fluctuation in this case, careful regulation of the intake of the drug beyond that necessary for cessation of seizures reduced the degree of variability from day to day.

It must be emphasized that in this case an educational program was requisite for reinstatement of any degree of normalcy and that as the patient's needs matured the program had to be changed to afford opportunities for continued growth.

SUMMARY

The case is reported of a white man aged 23 who had had idiopathic epilepsy for seventeen years, with almost continuous grand mal and petit mal seizures, and who at the end of this time appeared to be rather completely deteriorated. Remarkable strides toward normalcy appeared to be the result of removal of phenobarbital medication and close regulation of seizures with diphenylhydantoin sodium, and a psychologic guidance program over a four and a half year period.

15. Graves, R. W., cited by Davison, W. C.: *The Compleat Pediatrician: Diagnostic, Therapeutic and Preventive Pediatrics*, ed. 4, Durham, N. C., Duke University Press, 1943, par. 97. Kanner, L.: *Child Psychiatry*, Springfield, Ill., Charles C Thomas, Publisher, 1935, pp. 176 and 423. Collins, L. A.: *Psychometric Records of Institutionalized Epileptics*, *J. Psychol.* **11**:359-370 (April) 1941. Ford.^{1c} Wechsler.^{1a}

16. Penfield, W., and Erickson, T. C.: *Epilepsy and Cerebral Localization: A Study of the Mechanism, Treatment and Prevention of Epileptic Seizures*, Springfield, Ill., Charles C Thomas, Publisher, 1941, pp. 553 and 554.

17. Harrower-Erickson, M. R.: *Psychological Studies of Patients with Epileptic Seizures*, in Penfield and Erickson,¹⁶ pp. 546-574.

18. Putnam, T. J., and Merritt, H. H.: *Dulness as an Epileptic Equivalent*, *Arch. Neurol. & Psychiat.* **45**:797-813 (May) 1941.

The case appears significant in pointing to the need for clarification of the concept of epileptic deterioration. To this end, it seems important to treat cases of idiopathic epilepsy separately from those of other convulsive disorders in statistical or clinical studies, to use discrimination in applying the concept of the deteriorative results of the seizures themselves, to differentiate the effects of sedatives and intermittent dulness from chronic impairment and to separate those forms of inferior functioning which represent emotional reaction to disease from those derived from neurosomatic deterioration.

30 West Fountain Avenue, Glendale, Ohio.

Case Reports

CONCUSSION OF THE SPINAL CORD

Report of a Case with Radiculoneuritic Manifestations

PAUL CHODOFF, M.D., WASHINGTON, D. C.

THAT a transient abrogation of the functions of the spinal cord may follow direct or indirect trauma to the vertebral column has long been a clinically recognized phenomenon. The pathologic and patho-physiologic basis of concussion of the spinal cord has been the subject of much controversy and is still far from being definitely determined. Part of the confusion surrounding the subject has been due to a disagreement as to whether cases with demonstrable pathologic changes should be included with those of concussion of the spinal cord. Although most authors feel that they should, others (Marburg,¹ Cavichia and Rosa²) maintain that in true concussion of the spinal cord observable changes are reversible or do not occur. Since the syndrome is characterized by evidence of neurologic damage at levels distant from the site of the original trauma, a comprehensive theory of the condition should consider a mechanism of diffusion or dispersal of the lesions, and this has been a further source of difficulty.

On the basis of animal experimentation, Schmauss and Docki³ expressed the belief that the force applied to the vertebral column was transmitted through the cerebrospinal fluid to the spinal cord and its blood vessels, producing hemorrhages and tears of the parenchyma. That such changes actually occur has been demonstrated experimentally in rabbits by Ferraro⁴ and in human autopsy material by Davison.⁵ According to Henneberg,⁶ after concussion a vascular stasis occurs, with resulting degeneration and necrosis of the nerve tissue. Erichsen⁷ advanced the idea of "molecular" disturbances of the cord as a

From the Department of Neurology, George Washington University School of Medicine.

1. Marburg, O.: Rückenmark und Gehirn: I. Die traumatischen Erkrankungen des Rückenmarks, in Bumke, O., and Foerster, O.: Handbuch der Neurologie, Berlin, Julius Springer, 1936, vol. 11, p. 101.

2. Cavichia and Rosa, cited by Ferraro.⁴

3. Schmauss, H., and Docki, S.: Vorlesungen über die pathologische Anatomie des Rückenmarks, Wiesbaden, J. F. Bergmann, 1901.

4. Ferraro, A.: Experimental Medullary Concussion of the Spinal Cord in Rabbits: Histologic Study of Early Stages, Arch. Neurol. & Psychiat. **18**:357-373 (Sept.) 1927.

5. Davison, C.: Pathology of the Spinal Cord as a Result of Trauma, A. Research Nerv. & Ment. Dis., Proc. (1943) **24**:151-187, 1945.

6. Henneberg, R.: Erweichung des Sakralmarkes nach Schuss in die Brustwirbelsäule, Berl. klin. Wchnschr. **52**:859, 1915.

7. Erichsen, J. E.: On Concussion of the Spine, New York, Wm. Wood & Co., 1875.

result of physical impact directly on the vertebrae or of a general shaking or jarring of the body, as when one is riding in a railroad carriage. According to Elsberg,⁸ in persons who recover from damage to the cord within twenty-four to forty-eight hours the lesion responsible is probably edema. Although the results of modern experimental research on the mechanism of cerebral concussion have not as yet been applied to the spinal variety of concussion, there appears to be no reason that the observations of Denny-Brown and Russell⁹ on the effect of sudden acceleration in producing a direct traumatic paralysis of nervous function cannot be true of the spinal cord as well as of the brain. The experiments of Walker and associates,¹⁰ in which the effects of cerebral concussion were explained as the result of a direct traumatic depolarization of many neurons with immediate discharge of axons, followed by after-discharge and then by cortical extinction, offer fruitful possibilities of application to the phenomena of concussion of the spinal cord. This would provide a physiologic basis for some cases of concussion of the spinal cord in which the neurologic abnormalities are of brief duration.

The part played by lesions of the nerve roots and peripheral nerves in cases of concussion of the spinal cord has been recognized in some reports but has not been particularly emphasized. Lhermitte¹¹ stated that radicular changes had been observed in several cases of concussion of the spinal cord but presented no pathologic material of his own. Hassin¹² reported a case in which microscopic lesions of the cauda equina were seen after fracture of the lumbar vertebrae, although there had been no contact between the fractured bone and the damaged nerve tissue. In Davison's⁵ material the nerve roots displayed swelling of the epineurium and perineurium and swelling and disintegration of their myelin sheaths and axis-cylinders. Elsberg⁸ stated the belief that in most cases of trauma to the cord there is an associated lesion of the spinal nerve roots and that occasionally the roots are involved without any evidence of damage to the cord. In the rabbits subjected to experimental concussion by Feraro,⁴ lesions of the nerve roots, particularly the posterior roots, were observed and were attributed to the combined result of the action of the cerebrospinal fluid set in motion by the shock of the injury and the displacement of the spinal cord, producing traction on the relatively fixed roots.

8. Elsberg, C. A.: *Surgical Diseases of the Spinal Cord*, New York, Paul B. Hoeber, Inc., 1941.

9. Denny-Brown, D., and Russell, W. R.: *Experimental Cerebral Concussion*, *Brain* **64**:93-153 (Sept.) 1941.

10. Walker, A. E.; Kollros, J. J., and Case, T. J.: *Physiological Basis of Concussion*, *J. Neurosurg.* **1**:103-116 (March) 1944.

11. Lhermitte, J.: *La section totale de la moelle épinière*, Bourges, Imprimerie V. Tardy, 1919.

12. Hassin, G. B.: *Pathological Considerations of Contusion of Cauda Equina*, *A. Research Nerv. & Ment. Dis., Proc.* (1943) **24**:188-200, 1945.

Scheinker¹³ reviewed the literature on the condition of the peripheral nerves and the spinal nerve roots in cases of concussion of the spinal cord and failed to find a single study prior to the publication of his paper in which histologic changes were reported. In his case, clinical signs of involvement of the spinal nerve roots and the peripheral nerves developed two or three days after an injury to the back in a man aged 51, whose health had previously been good. Death occurred two and one-half months after the injury, and autopsy revealed extensive pathologic changes, consisting of swelling, degeneration and demyelination of the nerve roots and of the peripheral nerves.

In the following case, a typical clinical syndrome of concussion of the spinal cord was associated with certain features strongly suggesting that lesions of the spinal nerve roots and peripheral nerves played a considerable role in producing the total picture.

REPORT OF CASE

A 29 year old sergeant was admitted to the station hospital, Langley Field, Va., on Nov. 21, 1945. Shortly before admission, he had been standing on an outside platform about 4 feet (120 cm.) above the pavement, when his heel caught in the edge of the platform and he had fallen face forward, to the ground. While falling, he had violently thrown his head and shoulders back in an effort to maintain his balance, and this, together with the fact that his heel was caught on the edge, resulted in a marked hyperextension of his back. At the same time he was thrusting his arms and hands forward in an attempt to break the fall. This was only partially successful, and he struck his chin and nose heavily enough to cause bruising and nosebleed. He was immediately conscious of a tingling pain involving the upper extremities and, to a less extent, the entire body below the chest and the lower extremities. He was unable to move his legs or body and for a few minutes could not move his arms. The ability to move his arms returned quickly, but by the time he was first seen in the hospital there was still almost complete paralysis of the lower extremities. At this time there was a sensory level at about the nipple line, below which there was pronounced diminution of all modalities of sensation. The deep reflexes were generally equal and active, and there were no pathologic reflexes.

Within about two hours, the sensory level gradually and steadily fell and the power of movement began to return to the lower extremities. When the return of sensation reached the thighs and legs, it was noted that the area of retreating residual sensory loss assumed a pattern like that of a peripheral polyneuropathy, rather than a segmental distribution. That is, the area of diminished sensation involved both legs in a steadily decreasing stocking distribution. Because of their extreme sensitivity and the continued presence of spontaneous tingling pain, the upper extremities could not be accurately examined.

By the next day, sensation had almost entirely returned to the legs and there was considerable return of motor power to them. In the next week there were complete return of power to the lower extremities and complete return of sensation. The improvement in the upper extremities, however, was much slower and more incomplete. By November 30, the pain and tingling were largely confined

13. Scheinker, I. M.: Post-Traumatic (Concussion) Changes in the Spinal Cord, Roots and the Peripheral Nerves, *J. Neuropath. & Exper. Neurol.* 1:181-187 (April) 1942.

to the portions of the hands and forearms supplied by the ulnar nerve, and there were weakness and sensory diminution in these areas. On December 12, examination revealed no neurologic abnormalities of the lower extremities. Both hands were somewhat mottled, and there was an increase in palmar sweating on both sides. The hands, especially the portions supplied by the ulnar nerve, were hypersensitive to cold and heat and to sudden pressure. The ulnar nerves at the olecranon fossae were insensitive even to strong pressure. There was weakness of flexion movements of the ring and little fingers bilaterally, and the patient could not entirely close his fists. The other fingers were moved freely in all directions, without weakness. There were hypalgesia, hypesthesia and hypothermesthesia over the ring and little fingers, the ulnar portions of the hands and the forearms up to about the elbows. The involvement was about equal on the two sides and corresponded to the eighth cervical and first thoracic dermatomes. There was considerable but incomplete improvement in the next month, so that by January 11 the spontaneous pain was much less severe, there was only slight weakness of flexion of the fingers supplied by the ulnar nerve and the areas of sensory diminution, still equal on the two sides, included only the ring and little fingers and the ulnar portion of the hand as far as the wrist. The patient had no other complaints and was anxious to return to duty.

When he was first seen, there was considerable pain in the dorsal region of the spine. This later became localized at the fourth dorsal vertebra, which remained tender for three weeks. Roentgenograms of the dorsal portion of the spine, including spot films of the fourth dorsal vertebra, taken immediately after the accident and checked later, showed no evidence of osseous damage or displacement. A spinal puncture was not performed until Jan. 15, 1946. At that time the manometric and laboratory findings were within normal limits.

COMMENT

The sequence of events in this case, the sudden indirect trauma without evidence of injury or discoloration of the bony spine, followed immediately by evidence of widespread subcranial neural dysfunction and within a short time thereafter by notable improvement, is compatible with that seen in cases of concussion of the spinal cord. The fact that recovery was not complete and that there were more or less permanent residual symptoms does not at all invalidate the diagnosis, since persistence of symptoms of varying grades of severity frequently occurs. Syndromes simulating amyotrophic lateral sclerosis resulting from concussion of the spinal cord have been reported (Hassin¹⁴).

Analysis of certain features of the case, however, casts doubt on the presumption that the entire picture resulted from purely intramedullary damage to the cord and suggests that radiculoneuritic involvement was also present and played a major role.

Since the accident occurred at a very short distance from the hospital, the patient was seen less than a half-hour after the injury, and the rapidly subsiding sensory impairment could be followed almost from the beginning. As noted in the case report, this was observed to assume a pattern

14. Hassin, G. B.: Concussion of the Spinal Cord: A Case with the Clinical Picture of Amyotrophic Lateral Sclerosis, *Arch. Neurol. & Psychiat.* **10**:194-211 (Aug.) 1923; Traumatic Degeneration of the Spinal Cord (Spinal Concussion), *J. Neuropath. & Exper. Neurol.* **1**:100-110 (Jan.) 1942.

suggestive of widespread but not profound damage to the peripheral nerves, rather than the segmental distribution which would be expected in the case of recovery from an acute insult to the spinal cord itself. In the upper extremities the neuritic pattern was not so apparent, possibly because the extreme hyperalgesia made examination difficult, but more probably because the picture was here complicated by involvement of the lowest cervical and upper dorsal nerve roots, as could be clearly seen later after the early symptoms had disappeared. Examinations subsequent to the first two weeks revealed bilateral sensory loss in the areas of the eighth cervical and first thoracic dermatomes, indicating that the corresponding nerve roots had been damaged by the initial trauma. The tingling "pins and needles" type of pain complained of by the patient was also suggestive of a sudden stretching or percussion of peripheral nerves and nerve roots rather than of an intramedullary lesion, in which case a burning, poorly defined and localized pain would have been more likely. It is of interest that the patient voluntarily described his pain as resembling that which occurs when the "crazy bone" is struck. However, the insensitivity of the ulnar nerves at the olecranon fossae indicated lesions higher up, and the area of sensory loss of the upper extremities was too extensive to be accounted for by ulnar neuropathy alone.

The fact that all modalities of sensation were implicated in both the original and the residual areas of sensory loss, while not ruling out involvement of the entire cord, is more easily explained on the basis of peripheral and radicular lesions. This absence of sensory dissociation is an especially cogent argument in favor of root rather than intramedullary origin for the persistent changes in the upper extremities.

It is thus seen that the type of sensory pattern observed both immediately and later, the kind of pain felt by the patient, the lack of sensory dissociation and the residual root syndrome are strongly suggestive of a predominant radiculoneuritic origin of the symptoms and signs in this case of so-called concussion of the spinal cord. A further analysis of the mechanics of the trauma indicates how this state of affairs could have been brought about. When the patient fell from the platform, with his heels caught on the edge, his efforts to break his fall caused him to throw his hands and arms as far forward as possible, while his shoulders were forcibly drawn back by his attempt to preserve his balance and keep himself from falling. With his heels fixed, there was a pronounced arching of his back during the fall. This combination of movements and counter-movements produced a relative lengthening of all limbs with a consequent general, sudden and brief stretching of the peripheral nerves, while at the same time the maximum possible amount of movement of the spinal cord and attached nerve roots occurred with relation to the fixed spine. It is quite likely that in this process the nerve roots were sufficiently agitated within the intervertebral foramina to cause them to be struck against the containing bony walls. Since the greatest stress occurred at the level of the fourth thoracic vertebra, it is logical to expect the greatest damage to the roots at or near this level, and this actually occurred, since the eighth cervical and first thoracic roots, the sites of the principal damage, were the closest large roots to the vertebral level mentioned. It is also pertinent, as Elsborg⁸ has mentioned, that force applied in the direction of the axis of the vertebral column is more likely

to damage cervical roots, as occurred here, while force applied transversely will result in injury to the lumbar and sacral roots.

That physical impact can produce a transient abrogation of neural functions has long been recognized and has been studied experimentally by Denny-Brown and Brenner,¹⁵ who found that percussion of a nerve will produce with regularity a pseudoneuroma associated with either transient or more permanent paralysis, depending on the intensity of the process. Denny-Brown and Doherty¹⁶ showed that stretch of nerves can similarly produce all gradations between simple pseudoneuroma and spindle neuroma, with resultant temporary or lasting interference with conductivity. Krems, Schoepfle and Erlanger¹⁷ showed that nerves subjected experimentally to sudden compression develop a conduction block distad to the point of application of the compressing force.

If this combination of stretching and concussion of the peripheral nerves and compression of nerve roots can be shown to occur in other cases falling within the limits of concussion of the spinal cord, an adequate and rational explanation for the occurrence of manifestations of neurologic disorder at a distance from the site of the original injury is available, as an alternative to the necessity of postulating the presence of widespread parenchymal tears in every case. In view of the variety of pictures subsumed under the term concussion of the spinal cord and the numerous ways in which they can be caused, it appears possible that closer attention to the peripheral nerves and spinal roots may provide explanations for some of the puzzling features of these cases.

SUMMARY AND CONCLUSIONS

In the case reported, a clinical picture compatible with concussion of the spinal cord appeared after an injury to the dorsal portion of the spine, but on analysis was found to be associated with certain features suggestive of a radiculoneuritic origin of the symptoms and signs.

Stretching of the peripheral nerves and traction and compression of the nerve roots in the intervertebral foramina at the time of the injury are believed to provide the basis for the disturbance in function of the nerves and nerve roots.

In cases of concussion of the spinal cord, radiculoneuritic involvement may explain the occurrence of certain puzzling features and may serve as an alternative explanation to that of widespread parenchymal tears in accounting for signs of neural damage at a distance from the original site of the injury.

2014 R Street, N.W.

15. Denny-Brown, D. E., and Brenner, C.: Lesion of Nerve Produced by Percussion, *Tr. Am. Neurol. A.* **70**:122-128, 1944.

16. Denny-Brown, D. E., and Doherty, M. M.: Effect of Transient Stretching of Peripheral Nerve, *Arch. Neurol. & Psychiat.* **54**:116-129 (Aug.) 1945.

17. Krems, A. D.; Schoepfle, G. M., and Erlanger, J.: Nerve Concussion, *Proc. Soc. Exper. Biol. & Med.* **49**:73-75 (Jan.) 1942.

AN ELECTROENCEPHALOGRAPHIC STUDY OF HELEN KELLER

WILLIAM C. STILL, NEW ORLEANS

ALMOST every one is familiar with the case of Helen Keller and her remarkable mastery of the handicap she suffered so early in life. Hers was a normal life until the age of 19 months, when she had a severe illness, of sudden onset and short duration, which left her totally blind and deaf.

Berger¹ and Loomis, Harvey and Hobart² reported the presence of alpha rhythm in blind persons. Gibbs and Gibbs³ reviewed the literature and studied the effects of auditory, visual and tactile stimuli on the occurrence and amplitude of alpha waves. Visual and auditory stimuli are automatically ruled out in the case of Helen Keller because of her total blindness and deafness, and tactile stimuli, to have any effect on the alpha waves, must attract the subject's attention. Hence, tactile stimulation was the only external stimulation it was necessary to control in this study.

Adrian and Matthews⁴ and Jasper and Andrews⁵ showed that the occipital areas in children and in adults usually have more alpha activity, and the frontal and parietal areas more 15 to 30 cycles per second activity, than any other area.

According to Gibbs and Gibbs,⁶ there are relatively few cases in which the alpha activity, although present in all leads, has a higher amplitude in the frontal and motor (parietal) leads.

These facts are significant in a critical analysis of the electroencephalogram of Helen Keller, who was 64 years of age at the time of this examination.

From the Department of Electroencephalography, LaGarde General Hospital.

1. Berger, H.: Ueber das Elektrenkephalogramm des Menschen, *Arch. f. Psychiat.* **103**:444-454, 1935.

2. Loomis, A. L.; Harvey, E. N., and Hobart, G.: Brain Potentials During Hypnosis, *Science* **83**:239-241 (March 6) 1936.

3. Gibbs, F. A., and Gibbs, E. L.: *Atlas of Electroencephalography*, Cambridge, Mass., Lew A. Cummings Company, 1941, p. 46.

4. Adrian, E. D., and Matthews, B. H. C.: The Berger Rhythm: Potential Changes from the Occipital Lobes in Man, *Brain* **57**:355-385 (Dec.) 1934.

5. Jasper, H. H., and Andrews, H. L.: Electroencephalography: III. Normal Differentiation of Occipital and Precentral Regions in Man, *Arch. Neurol. & Psychiat.* **39**:96-115 (Jan.) 1938.

6. Gibbs and Gibbs,³ pp. 42-44.

METHOD

The electrical activity from four cortical areas was recorded simultaneously with a four channel Grass electroencephalograph. Monopolar leads were used for routine examination, according to Gibbs's standard technic.⁷

Recording was done under standard conditions, namely, in a darkened and electrically shielded room, which was air conditioned. (Warmer climates necessitate air conditioning as an integral part of laboratory facilities if reliable results are to be obtained.) For the patient's comfort, an examining table with an air mattress was substituted for the usual easy chair. In prolonged examinations, the examining table or bed is much preferred, since fatigue is minimized and artefacts due to muscular tension and movement are substantially reduced.

Analysis of this record is primarily in terms of variation in amplitude and of the alpha index. The alpha index is the percentage, that is, the number of centimeters, of alpha activity (at least three consecutive waves of 8.5 to 12.0 cycles

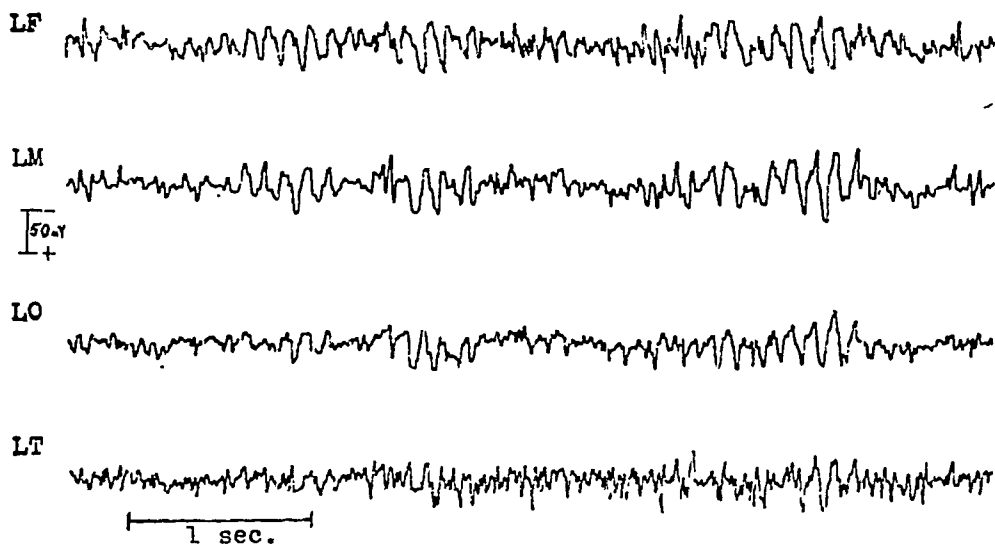

Fig. 1.—Increased amplitude of alpha waves in frontal and motor leads during the resting stage.

per second) in a continuous sample of record 1 meter in length. Alpha indexes were computed for the resting phase of the electroencephalogram and for varying intervals after three minutes of hyperventilation. Amplitude averages for the frontal, motor and occipital areas were computed by measuring each of a representative series of the alpha waves found in the resting stage and in the post-hyperventilation stages. The samples used for measurement of amplitude were the same as those used in determining the alpha indexes.

Since all patients do not cooperate to the same degree in hyperventilation, it has been found desirable in certain instances to allow a longer period for hyperventilation than that adopted by Gibbs and associates.⁸

7. Gibbs and Gibbs,³ p. 22.

8. Gibbs, F. A.; Gibbs, E. L., and Lennox, W. G.: Electroencephalographic Response to Overventilation and Its Relation to Age, *J. Pediat.* **23**:497-505 (Nov.) 1943.

OBSERVATIONS AND RESULTS

In the resting stage, all leads showed moderate low voltage fast (18 to 24 cycles per second) activity interspersed with brief runs of poorly organized 9 to 12 per second waves. The temporal leads showed much fast (18 to 30 cycles per second) activity, which was an artefact due to undiminished muscular tension.

Short runs of alpha activity occurred more frequently and were better organized in the frontal and motor areas than in the occipital area during

Average Amplitudes for Alpha Waves

Cortical Area	Average Amplitude, Microvolts			
	Resting Stage	After Hyperventilation		
		20 Sec.	86.3 Sec.	230 Sec.
Left frontal.....	46.42	Not available after hyperventilation		
Left motor.....	45.24	50.00	41.64	43.43
Left occipital.....	28.24	28.57	37.52	37.36

the resting stage of the record. Also, the alpha potentials recorded from the frontal and motor areas showed a maximum amplitude of 75 microvolts, as compared with the maximum of only 50 microvolts for the potentials from the occipital area. This is just the reverse of the usual finding, for it is the occipital areas which ordinarily show the dominant

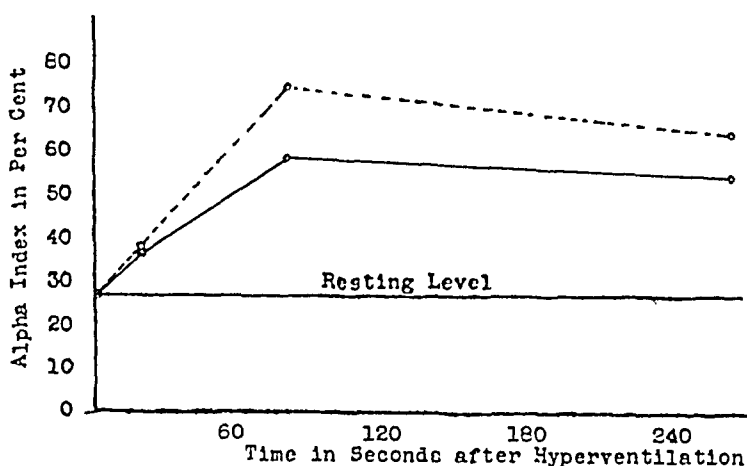

Fig. 2.—Graphic representation of sustained increase in the alpha index after hyperventilation. The solid line indicates the values for the motor lead; the broken line, values for the occipital lead.

activity. This diminished amplitude from the occipital area was constant throughout the record, as can be seen in the table.

Brief localization studies (bipolar recording) on a push-pull circuit were made but revealed no evidence of a focal lesion. After this, monopolar recording was resumed for the hyperventilation run. After three minutes of hyperventilation, no immediate build-up occurred and no seizure discharges were precipitated.

The alpha index for the resting stage of the record was 28.2 per cent. Hyperventilation tended to stabilize the record and increased the alpha activity, particularly in the occipital areas. Twenty seconds after hyperventilation the alpha index rose to 36.0 per cent in the motor lead and 36.95 per cent for the occipital lead. The alpha index reached its peak approximately 86.3 seconds after hyperventilation was concluded, at which time the alpha index was 57.3 per cent for the motor lead and 73.6 per cent for the occipital lead. Four and one-half minutes (two hundred and seventy seconds) after hyperventilation was concluded, the alpha index had decreased to 51.8 per cent for the motor lead and 61.75 per cent for the occipital lead.

SUMMARY

In the resting stage, the electroencephalogram of Helen Keller showed better organized alpha activity in the frontal and motor leads. Consistently, throughout the record, the frontal, and especially the motor, leads showed an amplitude greater than that observed in the occipital leads. Hyperventilation, which increased the alpha activity in the occipital leads, did not increase the amplitude of the potentials from the occipital areas to such an extent that they equaled in amplitude the potentials recorded from the motor areas.

Since all of Helen Keller's learning and experience is through her sense of touch or tactile discrimination, with particular emphasis on the corresponding cortical areas, it is suggested that the amplitudinal differences recorded in the electroencephalogram may be correlated with differences in the functional organization of the cerebral cortex.

LaGarde General Hospital.

Abstracts from Current Literature

EDITED BY DR. BERNARD J. ALPERS

Anatomy and Embryology

DEPLETIONS AND ABNORMALITIES IN THE CERVICAL SYMPATHETIC SYSTEM OF THE CHICK FOLLOWING EXTIRPATION OF NEURAL CREST. CHESTER L. YNTEMA and WARNER S. HAMMOND, *J. Exper. Zool.* **100:237** (Nov.) 1945.

By means of a well controlled technic, Yntema and Hammond accomplished accurate extirpations of the neural crest from the occipital and cervical regions of chick embryos. The results indicate that the cervical sympathetic ganglionic cells arise from local neural crest. The superior cervical ganglion rudiments lie in the neural crest at occipital and upper cervical levels. Both postcarotid and para-vertebral trunks are dependent on the presence of neural crest cells.

When the dorsal neural folds were included in the extirpations, the dorsal parts of the spinal cord were atypical: Definite regions of the cord were absent, or remaining parts showed pronounced overgrowth.

The preganglionic column and its fibers differentiate in the absence of neural crest and of sympathetic ganglia. Ascent of the fibers into the neck depends on the presence of sympathetic ganglia along the path. If cervical sympathetic ganglia differentiate in the absence of preganglionic fibers, these ganglia are smaller than normal.

After removal of the neural crest in the occipital and upper cervical regions, the enteric plexus about the esophagus and stomach contains few, if any, neuroblasts.

After bilateral extirpation of neural crest, rudiments of sympathetic ganglia migrate backward as much as four segments into the rostral end of the area of operation beyond the last spinal ganglion present. There is less migration into the caudal area. Less extensive depletions of spinal and sympathetic ganglia are produced by unilateral extirpation of neural crest.

REID, Boston.

DEVELOPMENT OF THE VASCULAR PATTERN WITHIN THE WALLS OF THE CENTRAL NERVOUS SYSTEM OF THE CHICK EMBRYO. JAMES F. FEENEY JR. and RAY L. WATTERSON, *J. Morphol.* **78:231** (March) 1946.

Feeney and Watterson studied the development of the intraneural vascular pattern at all levels of the neural tube of the chick embryo by means of serial pyroxylin sections of embryos after injection of india ink. The embryos were examined at the 2½, 3, 3½, 4, 5, 6, 7, 8, 9, 10, 12, 14 and 16 day stages. Reconstructions were made of each region of the brain and of the cervical swelling. Other levels of the cord were studied directly from slides.

The first vessels to penetrate the neural tube (between the 72 and the 84 hour stage) enter ventrally, except in the diencephalon and the telencephalon. At the 84 hour stage vessels are seen in the cervical swelling and in all subdivisions of the brain except the telencephalon.

The slow and orderly elaboration of the vessels at the level of the cervical swelling permits the identification of fifteen distinct intraneural vessels. At this level the order of appearance of the individual vessels is remarkably constant. After the twelfth day the intraneural vessels become numerous, and it is suggested that the localized changes controlling morphogenesis become more uniform at this stage.

At the levels of the cord anterior to the cervical swelling and posterior to the lumbosacral swelling, the same vessels arise more slowly. The most posterior part of the cord has no intraneural vessels.

Although the vascular pattern within the walls of the brain evolves rapidly, the sequence of events can be recognized. Fusion of the tips of the first capillaries that enter ventrally (posterior levels) with those that enter laterally (at anterior levels) establishes a paired endoneural sinus. Other interconnections made almost simultaneously form an endoneural plexus on the periphery of the ependyma. The peripheral spread of plexus formation establishes interconnections among vessels within the mantle zone. This sequence of events is most evident in the myelencephalon. The elaboration of specialized structures may modify the basic pattern in other regions of the brain. The development of vascularity within the optic lobes is striking not only because of its regularity but because of its relationship to the stratification of the neural elements of these structures. The ectodermal walls of the epiphysis and of the pars nervosa of the hypophysis, although continuous with the walls of the brain containing intraneural vessels, are free from intraectodermal vascularity.

Vascularization always begins at a specific area in each region of the brain and spreads in specific directions. Each region of the brain seems to develop its vascular pattern independently of adjacent regions.

In the early stages of development of the brain, capillary penetrations come from the lateral surface, whereas in the cord and the myelencephalon ventral penetration of capillaries occurs first.

The most rapid and early development is that of the complex endoneural plexus on the periphery of the ependyma of the brain. The vascular plexus in the mantle zone of the brain always spreads progressively from the ependyma peripherally, while in the cord such spreading from inside to outside occurs only in the marginal zone.

REID, Boston.

Physiology and Biochemistry

THE TRANSFER OF PENICILLIN INTO THE CEREBROSPINAL FLUID FOLLOWING PARENTERAL ADMINISTRATION. WALSH McDERMOTT and RUSSELL A. NELSON, *Am. J. Syph., Gonorr. & Ven. Dis.* 29:403 (July) 1945.

McDermott and Nelson studied the effect of transfer of penicillin into the cerebrospinal fluid of 70 patients with late latent syphilis and other infections of the central nervous system. The tests for penicillin activity of the cerebrospinal fluid were made by four different technics of bioassay.

With the dilution technics of bioassay, no penicillin was demonstrable in the specimens of cerebrospinal fluid obtained from 70 patients who had received penicillin in various dosages by parenteral routes. The presence of neurosyphilis and, in 1 instance, tuberculous meningitis did not alter these results.

Approximately 0.02 unit of penicillin was demonstrable in the cerebrospinal fluid of patients who had received one or two intramuscular injections of 300,000 to 500,000 units of penicillin three to four hours previously.

In concentrations ranging from 0.078 to 1.25 unit of penicillin per cubic centimeter of serum, penicillin is diffusible through artificial membranes *in vitro* and into ascitic fluid *in vivo*. Thus, the failure of the penicillin to appear in the cerebrospinal fluid is not because it is bound to a high degree to nondiffusible elements in the serum.

As a result of their studies, the authors suggest that, since the immediate results of the intramuscular treatment of syphilitic meningitis and other forms of neurosyphilis with penicillin are so promising, it is unnecessary to use the intrathecal route for the treatment of these conditions. In the treatment of purulent meningitis, on the other hand, the administration of penicillin by the intrathecal route cannot be abandoned.

GUTTMAN, Philadelphia.

CHEMICAL CHANGES IN THE CEREBRAL CORTEX ASSOCIATED WITH CONVULSIVE ACTIVITY. W. E. STONE, J. E. WEBSTER and E. S. GURDJIAN, *J. Neurophysiol.* 8:233 (July) 1945.

Stone, Webster and Gurdjian studied dogs under morphine anesthesia and administered metrazol intravenously after curarizing the animals. The electrical

activity of the cortex was recorded directly. During the course of the electrical discharge of seizure type the cortex was frozen *in situ* and specimens were removed for examination. In 4 dogs seizure discharges occurred during morphine anesthesia and without curarization or administration of metrazol. The cortices of these animals were also frozen and portions removed for study. Oxygenation of the blood was usually studied at the time of freezing. The cerebral tissue was studied for its lactic acid, inorganic phosphorus, phosphocreatine phosphorus and adenosine triphosphate contents. During the convulsive seizure discharges following administration of metrazol or occurring spontaneously in the dog anesthetized with morphine there were an increase of cerebral lactic acid and a decrease in cerebral phosphocreatine, with an increase in inorganic phosphate. No alteration of adenosine triphosphate occurred. The cerebral chemical changes during seizures are the same as those found when the oxygen supply is deficient. The oxygen saturation of the blood in the animals studied was in no instance sufficiently low to cause the alterations recorded. Stone, Webster and Gurdjian interpret the chemical alterations of the cerebral cortex during convulsions as indicating a lag of the oxidative processes behind an increased expenditure of energy during convulsive activity.

FORSTER, Philadelphia.

THE FUNCTIONAL SIGNIFICANCE OF THE ROSTRAL CINGULAR CORTEX AS REVEALED BY ITS RESPONSES TO ELECTRICAL STIMULATION. WILBUR K. SMITH, *J. Neurophysiol.* 8:241 (July) 1945.

Smith studied the effects of electrical stimulation of the rostral portion of the cingular cortex of the monkey (*Macaca mulatta*). Stimulation evoked a complex response involving both somatic and autonomic realms. The complete response consisted of opening of the eyes, pupillary dilatation, movements of the lips, vocalization, alterations in respiratory movements, cessation of somatic movements, relaxation of muscular tension, cardiovascular changes and piloerection. In some experiments only a part of this complex could be elicited. Responses from the two sides were identical. The responses were elicited only by repetitive stimuli. Smith points out that the cortex of the cingular gyrus in primates is divisible into two cytoarchitectural areas. The rostral portion, which was studied in these experiments, corresponds to Brodmann's area 24. There is some reason to conclude from these stimulation studies that area 24 is not homogeneous. The complex response elicited by stimulation of the cingular cortex of the macaque bears the connotation of emotional expression and thus implicates the cingular region in the emotive process. The potentiality of the cerebral cortex to produce emotional expression is thus demonstrated.

FORSTER, Philadelphia.

EFFERENT FIBERS OF THE PARIETAL LOBE OF THE CAT (*FELIS DOMESTICUS*). WALTER G. GOBBEL JR. and GEORGE W. LILES, *J. Neurophysiol.* 8:257 (July) 1945.

Gobbel and Liles studied the cytoarchitectonics of the parietal lobe of the cat and searched for a parietospinal system. The parietal lobe was considered as a unit, and no attempt was made to differentiate the individual areas. In 14 adult cats the left parietal lobe was ablated. Areas were determined with reference to Garol's map of the sensory cortex. The animals were observed clinically for three weeks, and then killed. Serial sections of the brain and representative sections of the spinal cord were studied by means of Busch's modification of the Marchi technic. The sections of the parietal cortex removed at operation revealed it to be six layered and to present differences in the depth of the molecular layer. No Betz cells were seen. Association fibers passed from the parietal cortex to the adjacent cerebral lobes, and commissural fibers traveled by way of the corpus callosum to the opposite parietal lobe. Parietothalamic fibers terminated in the thalamic nucleus ventralis posterolateralis, the nucleus ventralis posteromedialis, the nucleus posterior and the pulvinar. Parietotectal fibers ended in the superior colliculus.

The parietal cortex was seen to send fibers through the pyramids to the spinal cord, where they accompanied the lateral corticospinal tract of the opposite side. Gobbel and Liles believe that the function of the parietospinal system is primarily one of sensitization, and since the parietospinal system arises in the part of the cortex concerned with tactile sensibility it is an excellent mechanism for the regulation of orderly motor activity.

FORSTER, Philadelphia.

ELECTROENCEPHALOGRAPHIC STUDIES IN DIABETES MELLITUS. MILTON GREENBLATT, JEAN MURRAY and HOWARD F. ROOT, *New England J. Med.* **234**:119 (Jan. 24) 1946

The authors report on electroencephalographic studies on 40 patients with uncomplicated diabetes mellitus. These studies reveal no evidence of increased abnormalities in the cerebral activity in this series. Long duration of diabetes did not alter the incidence of cerebral dysrhythmia, and the administration of insulin over long periods had no apparent effect on the electroencephalogram. About half the diabetic patients who had frequent, severe reactions to insulin had abnormal electroencephalograms. The authors conclude that the electroencephalogram is of aid in the evaluation of the stability of cortical function of diabetic patients with reactions to insulin.

GUTTMAN, Philadelphia.

PHYSIOLOGIC ABNORMALITIES AND PATHOLOGIC CHANGES FOLLOWING EXPOSURE TO SIMULATED HIGH ALTITUDES. ALFRED F. GOGGIO and GEORGE H. HOUCK, *War Med.* **7**:152 (March) 1945.

This report is based on a study of many thousands of individual "flights" made in low pressure chambers over a period of about eighteen months by young subjects in excellent health and physical training.

After a preliminary ascent to 5,000 feet (1,500 meters), with redescent to ground level, the subjects were taken to 18,000 feet (5,400 meters), where they remained without supplementary oxygen for a period of ten minutes. Modern efficient oxygen equipment was then utilized by all, and the flight was taken to an altitude of 38,000 feet (11,400 meters) for a variable stay. A stop was also made at 30,000 feet (9,000 meters), and then redescent to ground level was accomplished. The total duration of the flight was about two and one-half hours.

At 30,000 feet nearly all subjects experienced pain in the chest and air hunger, aching pains in or near a joint and formication. These reactions are so common that the authors do not consider them in their report. Instead, they discuss the following, less usual, syndromes:

1. Neurocirculatory collapse. At 18,000 feet without supplementary oxygen approximately 2 per cent of the subjects showed a reaction characterized by decided pallor, sweating, bradycardia and a terminal fall in blood pressure, with flaccid unconsciousness. These symptoms were readily removed by the administration of oxygen or by the removal of the subject from the altitude chamber.

2. High altitude reactions. At 30,000 to 38,000 feet more severe reactions occurred, which could be classified into several groups.

(a) Neurologic reactions. These manifestations are extremely varied, from mild reflex changes and anesthetics to paralyses of any part of the body, hemiplegias, generalized and jacksonian seizures, aphasias, dysarthrias, homonymous hemianopsias and all manner of mental phenomena. Fortunately, provided prompt removal of the patient from the altitude chamber is accomplished, almost all these disturbances are transient, although they may be profound and extensive at the time of their occurrence.

(b) Myocardial damage. Definite myocardial damage, that is, alterations in electrocardiographic tracings which are observed after descent from the altitude chamber and which change toward normal progressively over a period of a week to ten days, is also extremely rare in this age group.

(c) High altitude shock. More important in point of numbers and of therapeutic possibilities than either of the two preceding groups, though also not common, are severe "systemic" or "collapse" reactions of the nature of true shock with hemoconcentration which develop at very high altitudes. These symptoms are visual disturbances in the nature of blurring or scotomas, nausea, vomiting, transient loss of consciousness, dull frontal or nasal headache and dizziness. Examination characteristically reveals cold extremities, indicative of poor peripheral circulation, a low blood pressure and often gray cyanosis. Examination of the blood reveals hemoconcentration, which may be progressive over a period of several hours after removal from the chamber and which when extreme appears to be accompanied with a pronounced leukocytosis. The authors report 1 fatal case.

Treatment.—Persons with the reactions of neurocirculatory collapse at 18,000 feet are benefited by an hour or so of recumbency combined with administration of oxygen. For subjects with the neurologic and cardiac types of reaction rest in bed and administration of oxygen by mask are indicated. In cases of high altitude shock patients require intravenous infusion of plasma early and in adequate amounts, controlled by clinical observation of the blood pressure and the temperature of the extremities and hematocrit readings. Oxygen therapy appears to be of definite value also.

PEARSON, Philadelphia.

THE ELECTRICAL DIAGNOSIS OF PERIPHERAL NERVE INJURY. ANTHONY E. RITCHIE, *Brain* 67:273, 1944.

Ritchie studied patients with various lesions of the peripheral nerves and on each he recorded four sets of measurements: (1) the strength-duration relation of threshold electrical stimuli, including chronaxia; (2) the condenser capacities necessary for excitation; (3) the accommodation constants of the muscle during regeneration, and (4) the thresholds of excitability of the nerve-muscle complex to alternating currents of varying frequency. Neither the second nor the fourth method was found to yield consistent results; and, as the third method has been reported in detail, the author confines his observations to the first. The strength-duration relation of threshold shocks is a quantitative elaboration of the familiar galvanic-faradic test. While precise quantitative values cannot be obtained from the use of the induction coil, because of the variability in shape and amplitude of the nerves, a thermionic valve generator provides shocks of known voltage, duration and frequency, thus permitting quantitative values to be derived. Characteristic quantitative differences occur in the excitability of normal and denervated muscles. During denervation the voltage-duration curve is raised, and during the process of reinnervation it falls, so that intermediate values are obtained. Improvement of excitability appears shortly before there is clinical evidence of improvement, and hence is valuable in prognosis. While in pressure paralysis there is no change in faradic responses, minor changes occur constantly in the voltage-duration curves. The distinction which the voltage-duration curves make between normal and paralyzed muscles is in respect to degeneration of motor fibers only, and there is no distinction between wallerian degeneration due to division and that due to damage. In view of the differences in absolute values of strength-duration curves obtained with various means, the current-voltage relations in living tissues are of great importance in quantitative stimulation measurements. Because of the reactance of the tissues, stimuli of definite shape applied at the electrodes give rise to very different potential gradients across the actual excitable region.

FORSTER, Philadelphia.

Neuropathology

ON THE SUSCEPTIBILITY OF MACACUS RHEBUS TO THE VIRUS OF TICK-BORNE ENCEPHALITIS. L. A. SILBER and A. K. SHUBLADZE, *Am. Rev. Soviet Med.* 2:332 (April) 1945.

Silber and Shublazde studied the susceptibility of monkeys to tick-borne encephalitis. Monkeys were inoculated with brain emulsions from recent fatal

human cases of the disease and with brain emulsions of mice infected with subcultured strains of tick-borne encephalitis. All the subcultured strains killed the mice after intracerebral injection in a dilution of 1:1,000,000 and were equally neutralized with the serums of convalescent patients and with the serums of immunized rabbits. Ten per cent brain emulsions were prepared either with Tyrode's solution or with isotonic solution of three chlorides. The monkeys were inoculated intracerebrally, intravenously and intranasally and were observed three months unless they died earlier. The brain, blood, liver and spleen of the animals were examined for virus content by intracerebral inoculation of mice. The brain and other organs of the monkeys were subjected to histologic examination by A. G. Kestner. The serums of the surviving monkeys were tested for virus-neutralizing antibodies.

The authors conclude that *Macacus rhesus* monkeys are susceptible to the virus of tick-borne encephalitis but that the disease is not always fatal. Of 9 monkeys given inoculations in the cerebrum and spinal cord, 3 survived. Intravenous inoculation of 2 monkeys and nasal inoculation of 1 monkey proved ineffective.

The incubation period in *Macacus rhesus* lasts five to nine days, and the average duration of the disease is six to eleven days. The chief symptoms are fever and paralysis of the forelimbs and hindlimbs.

The disease is an acute meningomyeloencephalitis.

Serum antibodies which neutralize the virus of tick-borne encephalitis appear in convalescent monkeys. The antibodies occur late in the disease and are apparently retained in the serum for a long time after recovery. Residual paralysis of the upper extremities is seen in convalescent monkeys and resembles that seen clinically.

The virus of tick-borne encephalitis differs from that of the Japanese summer and the St. Louis type. Louping-ill occupies an intermediate position between St. Louis and the Japanese encephalitis.

GUTTMAN, Philadelphia.

A CONTRIBUTION TO THE STUDY OF DISSEMINATED ENCEPHALOMYELITIS: REPORT OF FOUR CASES PRESENTING THE MANIFESTATIONS OF BOTH NEUROMYELITIS OPTICA AND ALBUMINOCYTOLOGIC DISSOCIATION, ONE WITH NECROPSY FINDINGS. CLEMSON MARSH and SHERMAN S. DEVINE, *Bull. Los Angeles Neurol. Soc.* **10:35** (March-June) 1945.

Marsh and DeVine studied 4 patients who had evidence of both neuromyelitis optica and albuminocytologic dissociation. Necropsy, performed on 1 of the patients, revealed that the central lesion was a demyelinating process involving the peripheral nerves, the spinal cord and the optic chiasm. The white matter of the brain itself seemed to have escaped the process. There was, however, widespread infiltration of the leptomeningeal space and the spinal cord with lymphocytes, suggesting a degree of meningeal reaction. It is of interest that with this lymphocytic reaction, lumbar puncture revealed no pleocytosis.

At present there exist some confusion of terminology, variation in clinical impressions and incomplete agreement as to the histologic changes associated with this syndrome. Some investigators believe that neuromyelitis optica is a toxic-infectious process; others, that it is a virus infection, and others, that neuromyelitis optica, acute multiple sclerosis and disseminated encephalomyelitis cannot be segregated, either clinically or pathologically. Most pathologists believe that there is no conclusive evidence which shows the precise relationship of these conditions.

Marsh and DeVine conclude that "the occurrence of these various common clinical manifestations together with albuminocytologic dissociation found in each of these four patients at one time or another during the course of the illness constitutes presumptive evidence that neuromyelitis optica, Guillain-Barré syndrome and disseminated encephalomyelitis may in some circumstances be caused by the same etiologic agent."

GUTTMAN, Philadelphia.

EXPERIMENTAL TUBERCULOSIS OF THE SPINAL CORD IN A RABBIT. LUCIANO SCHWARTZ, *Rev. neurol. de Buenos Aires* 8:362 (Oct.-Dec.) 1943.

Schwartz injected tubercle bacilli into the subarachnoid and suboccipital spaces of 4 rabbits, which survived twenty-three days, fifty-six days, one month and four months, respectively. Human and bovine tubercle bacilli were used, in varying doses. Tuberculous infection, including meningitis, meningomyelitis, radiculitis, ganglionitis and tuberculomas, was observed in all 4 animals. Maximal involvement was noted in the region of the cauda equina, with predominant paralysis of the hindlimbs. In 1 of the animals inoculated with bovine bacilli, a tuberculoma, 2 mm. in diameter, was observed in the periphery of the lumbar portion of the cord. The tuberculous infiltration extended from this caseous focus and involved the anterior root, the anterolateral tract and part of the anterior horn. In the experimental production of tuberculoma of the central nervous system in rabbits, the duration of infection and the quality and the dose of the bacilli injected play a role.

N. SAVITSKY, New York.

Diseases of the Brain

THE SYMPTOM OF "ELECTRICAL DISCHARGE" IN BRAIN INJURIES. A. V. TRIUMFOV. *Am Rev. Soviet Med.* 2:350 (April) 1945.

Triumfov reports his observations on 2 patients who had the sensation of "electric current" up and down the spine after injury.

One of the patients had had a fracture of the sixth cervical vertebra. He had quadriplegia, which subsided in a few days, with recovery of function within a month. The sensation was described as follows:

"Whenever I bend my head I feel that something is running quickly down my neck and along the spine. If I bend my head still further, this sensation reaches my arms and legs; it is not painful, but unpleasant. The sensation disappears just as soon as I raise my head. Occasionally my arms and especially my fingers become weak; if I hold anything in my hands, I drop it. I must watch my head and hold it upright."

The intensity of this phenomenon lessened gradually, and a month later the patient experienced the sensation of "electric current" down his spine and in his lower extremities only with abrupt bending of the head. The intensity of the sensation was negligible; there was no weakness of the hands. A month later the symptom had disappeared altogether, and no further signs of involvement of the nervous system were noticed. In the course of the war Triumfov encountered a number of cases in which a similar sensation was experienced in bending the head and body forward after injuries of the brain, but not of the spinal cord.

Further studies were made on 23 cases. In 7 cases the wound was located in the occipital region; in 5, in the parieto-occipital region; in 5, in the parietal region; in 2, in the temporal region; in 2, in the temporoparietal region, and in 2, in the coronal region. In 20 cases the dura mater was known to be involved.

A second patient had wounds in the right occipitotemporal region from mine fragments. The dura had been injured. Two or three weeks after complete healing of the wound (three months after the injury) the patient noticed that whenever he bent his head forward, especially with the simultaneous bending of the entire body, he experienced the sensations of an "electric shock" passing down his spine and arms. If he happened to touch an object with his finger tips, he felt an electric current. These paresthesias could not be described by the patient other than as a sensation produced by an "electric current." In his own words, "It is very similar to it." Occasionally he felt, at the same time, weakness of the wrists, particularly the right one (injury to the right occipitotemporal region). This symptom was recorded during a period of one and a half to two months, and decreased gradually. No other sign of injury to the nervous system was observed.

The symptom is purely subjective. So long as the sensation was paresthetic, and not painful, no signs of suffering, such as dilatation of the pupils or changes in the pulse or breathing, were observed.

In the majority of cases the history pointed to signs of meningeal irritation; only in isolated cases were the paresthesias observed against the background of residual meningeal manifestations. Most often the symptom was observed as an isolated phenomenon. Characteristically, its onset was either simultaneously with the healing of the wound or two or three weeks after the wound was healed.

The practical importance of this symptom of "electrical discharge" (*décharge électrique*) is worthy of emphasis. Arising late, often in an isolated form, when other changes of the nervous system are no longer present, and after the wound is healed, it can greatly restrict the efficiency of patients and their ability to engage in military service. In a number of patients the symptom is so intense that the head is held in a fixed position to avoid bending it. The "weak point" of this symptom from the point of view of military examination lies in its subjective nature. However, the sensation experienced by patients is extremely characteristic and is described by them, always in the same way, without leading questions. By persons experienced in electrical work it is never described otherwise than as the sensation produced by an electric current.

It is possible that the peculiar paresthesia reflects injury to the posterior nerve roots of the spinal cord, and occasionally also to the anterior roots, as indicated by the simultaneous weakness of the extremities. It may perhaps be assumed that the symptom is caused by the formation of scar tissues and adhesions in the meninges. It develops gradually and disappears just as gradually, the duration averaging one to two months. Recovery is hastened by therapeutic physical exercise, such as training in the gradual forward bending of the head and body. The symptom is much more pronounced and is more frequent following injury to the brain and spinal cord than it is in disseminated sclerosis.

GUTTMAN, Philadelphia.

CASE OF AMNESIC APHASIA WITH FOCAL LESION IN AREA 37. R. R. WILLIAMS,
Bull. Los Angeles Neurol. Soc. 10:75 (March-June) 1945.

Williams reports on the case of a man aged 67 who was admitted to the hospital because of a "stroke." About three months prior to his admission the patient was treated for "a heart attack." He was confined to bed, and on the morning of the third day he had a "stroke without loss of consciousness but associated with paralysis of the right limbs." At first he was unable to speak, or even to swallow. In about a week the hemiparesis and other signs began to subside. The patient was left with inability to find his words in talking. The residual speech defect was a classic amnesic type of aphasia, with loss of recall of the names of objects and concepts. The patient spoke with circumlocutions; e. g., for "key" he said, "It is to open a door with." At the time of admission to the hospital he was confused, the result of a recent cerebral vascular lesion. Gangrene of his lower extremities developed. He died three days after admission to the hospital.

A lesion in area 37 of Brodmann was suspected, and the brain was sectioned horizontally through Broca's convolution and Wernicke's area. This section revealed only one small lesion, in the left optic radiation bordering on the posterior horn of the ventricle. A section 1 cm. higher and parallel to the first passed through a thrombotic area of softening, 1 cm. in diameter, located directly in area 37. Other sections showed small thrombotic lesions in the centrum semiovale on the left side and in area 6 on the right side.

The vascular supply of area 37 of Brodmann is peculiar in that it is from the third temporal branch of the middle cerebral artery, as well as the posterior cerebral artery. Focal lesions of vascular origin in this region are rare. In the present case the area of cortical involvement was small, but evidently the sub-cortical spread of the lesion had interrupted the corticopetal fibers in this region, which have to do with recollection of the names of objects. The history of an amnesic type of aphasia in the presence of a sharply circumscribed lesion makes this case one of interest in the study of focal lesions associated with aphasia.

GUTTMAN, Philadelphia.

THE SYNDROME OF PHYSICAL OR INTRINSIC ALLERGY OF THE HEAD: III. VASOMOTOR RHINITIS AND THE VASODILATING PAIN SYNDROME; THEIR RELATIONSHIP TO MYALGIA AND ENDOLYMPHATIC HYDROPS (MÉNIÈRE'S DISEASE). H. L. WILLIAMS, Proc. Staff Meet., Mayo Clin. **21**:58 (Feb. 6) 1946.

Williams attempted to determine whether association of the four symptom complexes—myalgia, vasodilating pain, endolymphatic hydrops (Ménière's disease) and vasomotor rhinitis—was frequent enough "to be attributed to some factor other than chance." He studied 362 cases in which one of these diagnoses had been established. In 122 of these cases, or in more than one third, some association of two or more of the syndromes was apparent. The factor in common appears to be mechanical, physical or intrinsic allergy. The symptoms of the various conditions can be relieved by nicotinic acid in a large percentage of cases.

ALPERS, Philadelphia.

MALARIAL PAPILLITIS. ROBERT E. LEWY, War Med. **7**:341 (June) 1945.

Papillitis of the optic nerve is a common concomitant of recurrent malaria. The mechanism of this process is unknown, but the condition probably does not result from medication.

PEARSON, Philadelphia.

FAMILIAL TUBEROSE SCLEROSIS WITH CALCIFICATION. JOHN APLEY, Brain **67**:258, 1944

Apley presents 2 cases of tuberous sclerosis occurring in father and son. The father, who was examined at the age of 36, gave a history of the appearance of seizures and cutaneous lesions at the age of 6 years. Examination revealed that he was of average intelligence, but rather slow of speech, and had an adenoma sebaceum of typical butterfly distribution. A roentgenogram of the skull revealed scattered calcifications. Ophthalmoscopic examination disclosed a gray mass of mulberry appearance at the nasal edge of the left optic disk. The son, aged 5 years 9 months, had had seizures since the age of 15 months. He presented evidence of mental and moral aberration. Cutaneous lesions, resembling adenoma sebaceum, had appeared. Roentgenograms of the skull at the age of 3 years were normal, but those at the age of 5 years 9 months demonstrated several small opacities.

FORSTER, Philadelphia.

PNEUMATOCELE DUE TO FRONTAL TRAUMA. P. W. LONGO, A. M. PIMENTA and F. P. DE AQUINO, Arq. de neuro-psiquiat. **3**:52 (March) 1945.

A man aged 47 was kicked by a horse in the right frontal region, after which he was unconscious for an hour and bled from the nose a few hours later. The next day he was dull and had no appetite. He remained in this state for eight or ten days, when he suddenly complained of severe headache. At the same time there was a watery secretion from the nose. About twenty-five days after the accident he became confused and remained so for four days. Examination one month after injury showed an intermittent flow of clear and bloody fluid from the nose and probable diminution of smell; neurologic examination revealed nothing abnormal. The mental examination showed disorientation, recent memory defect, impairment of sleep rhythm and irritability. Roentgenograms of the skull showed a pneumatocele in the right frontoparietal region with no air in the ventricle; there was no fluid level. The air was definitely present in the intracranial cavity. There was a comminuted fracture of the posterior wall of the right frontal sinus, the roof of the orbit and the right ethmoid bone. There was also a fracture of the nose. Suboccipital puncture showed clear fluid and about 24 cells per cubic millimeter, of which 68 per cent were lymphocytes; the chlorides measured 720 mg. and the albumin 20 mg., per hundred cubic centimeters; the Wassermann reaction was negative. The destroyed bone was removed from the region of the right

frontal sinus. Five cubic centimeters of air was aspirated at the site of a very small defect in the dura. Thirty-six days after the operation no air was seen in the intracranial cavity, and there was striking subjective improvement.

N. SAVITSKY, New York.

ACCIDENT WHICH MIGHT HAVE BEEN ASCRIBED TO PNEUMOENCEPHALOGRAPHY.
JULIO A. GHERSI, *Prensa méd. argent.* **33**:528 (March 8) 1946.

Gheresi reports the case of a woman aged 36 with bitemporal hemianopsia and atrophy of the optic nerve. She was to enter the hospital for air studies to verify the existence of a chiasmal lesion. A few hours before admission, while at home, she suddenly lost consciousness and died. Autopsy revealed an intracranial aneurysm of the internal carotid artery, 4 cm. in diameter; it had ruptured on the day she was supposed to have had the pneumoencephalographic examination. The author reports this case to emphasize that many of the alleged accidents of encephalography are due to the underlying condition. He points out that if rupture of the aneurysm had occurred a few hours later it would have been considered a complication of pneumoencephalography.

N. SAVITSKY, New York.

Treatment, Neurosurgery

ACUTE ALCOHOLISM TREATED WITH INSULIN. SIDNEY TILLIM, *Am. J. Psychiat.* **101**:396 (Nov.) 1944.

Tillim reports 4 cases of acute alcoholism occurring in military personnel in which the condition was treated with injections of insulin. The symptoms varied and consisted of hyperirritability, insomnia, loss of appetite, tremor of the hands and excessive smoking. An initial dose of insulin was given which would produce somnolence, thirst and diaphoresis in one to one and a half hours. The amount varied from 40 to 80 units. A second dose was administered if the first failed to be effective in one hour. In the event of an excessive dose, "fractional neutralization" by intravenous injection of dextrose (5 to 10 Gm.) was employed to produce the desired effect. The treatment continued from two and one-half to three hours and was terminated by oral administration of 8 fluidounces (250 cc.) of fruit juice with an additional ounce (30 Gm.) of sugar. The number of treatments varied from one to four, as needed in the first twenty-four hours. Sedatives were used only sparingly.

Tillim maintains that his method of insulin therapy is superior to others in treating acute alcoholism, in that it shortens the period of disability and is acceptable to the patient. In his method, he is in no hurry to neutralize the insulin reaction, he gives a larger initial dose of insulin and he maintains a good intake of water.

BORKOWSKI, Philadelphia.

TRANSURETHRAL RESECTION OF THE VESICAL NECK IN MANAGEMENT OF CORD
BLADDER. JOHN L. EMMETT, *Proc. Staff Meet., Mayo Clin.* **21**:102 (March 6) 1946.

A previous study by Emmett revealed that in 13 cases of transverse lesion of the spinal cord with retention of urine transurethral resection of the vesical neck was followed by excellent results in 8 cases, by improvement in 2 cases and by no improvement in 3 cases. Emmett reports another case in which a similar procedure produced excellent results in bladder function after a transverse syndrome of the spinal cord resulting from injury.

ALPERS, Philadelphia.

UNILATERAL FACIAL PARALYSIS: CORRECTION WITH TANTALUM WIRE. J. E.
SHEEHAN, *Lancet* **1**:263 (Feb. 23) 1946.

Sheehan reports on the treatment in 8 cases of unilateral facial paralysis with tantalum ribbon and wire. The thicker ribbon was found preferable, as it

immobilized the parts better and tended less to give under the stress of facial motion. The author describes the technic as follows: After the usual preparation, the paralyzed side of the face is anesthetized with 1 per cent procaine hydrochloride, and a curved incision 2 inches (5 cm.) long is made over the temporal muscle above the zygoma and behind the hair line. The temporal fascia is exposed. A long, curved, 18 gage Weck needle is inserted into the lower part of the incision and passed downward between the skin and the mucosa to 8 mm. beyond the midline of the chin, where it emerges. During its course the needle intermittently takes deep bites of tissue. One end of a loop of tantalum wire (or ribbon) is passed through the bore of the needle, which is then withdrawn, carrying the strand of wire back with it to the incision in the temporal area. A second needle is inserted 1 cm. above the first one and follows its course 1 cm. above it. The other end of the loop of tantalum wire is passed through the bore of this needle and is carried back. A vertical incision is made on the chin to connect the upper and lower wires, and the skin on either side is undermined slightly. Tantalum foil is rolled around the loop to prevent the wire from breaking through the tissues, and the incision is closed with ophthalmic gut.

The same procedure is carried out at the angle of the mouth and on the upper lip. In the first instance, the loop is affixed 0.5 cm. from the corner of the mouth. In the second, the lower needle follows the course of the vermilion border to 6 mm. past the midline; the upper needle runs just beneath the base of the nose, so that the pull of the wire helps to straighten the nose.

The three sets of wire (or ribbon) in the temporal incision are then pulled to overcorrect the face slightly and are held in position with clamps. The ends of each set are twisted together; any excess is cut off, and the ends are deeply embedded in the temporal muscle and fascia.

To support the upper eyelid, a needle of shorter design is inserted at the upper portion of the temporal incision and passed under the upper orbital rim, downward and forward, to emerge over the attachment of the internal lateral ligament. A second needle, inserted 1 cm. below the first, takes a course following the lower lid and emerges beneath the attachment of the internal lateral ligament. One end of the wire or ribbon loop is inserted in the lower needle, and a vertical incision, exposing the internal lateral ligament, is made to join the upper and lower wires. The other end of the loop is then inserted in the upper needle, and both needles are withdrawn, leaving the loop moored in the internal lateral ligament. From this point the procedure is the same as for correction of the mouth. When the set of wires supporting the eyelid is securely embedded in the temporal muscle and fascia, the temporal incision is sutured, and sterile bandages are applied. The period of detention in the hospital is brief, twenty-four to seventy-two hours in all. The author concludes that this method is superior to those discredited methods of repair which join nerves of different numbers, producing a slight twitching of the facial muscles at best. In contrast to them, traction with tantalum ribbon or wire appears both to support and balance the face and to overcome the antagonistic pull of the muscles on the unparalyzed side. It seems useful either as a permanent support or as a temporary one, during the regeneration of a nerve, in which case the wires can be removed after recovery.

YASKIN, Camden, N. J.

SUBARACHNOID ALCOHOL INJECTIONS FOR TREATMENT OF PAIN ACCOMPANYING PELVIC NEOPLASMS. O. B. NESTAREZ and S. C. FRANCO, *Rev. neurol. e psiquiat. de São Paulo* 10:3 (Sept.-Oct.) 1944.

Nestarez and Franco report 16 cases in which they employed the method of Dogliotti for the relief of pain resulting from neoplasms of the cervix which extended into the pelvis. The patients complained of severe pain in the lower limbs, abdomen and back, which could not be controlled with other methods. The injections were made with the patient lying in a lateral position, and tilted about 45 degrees ventrally. The site of injection was elevated somewhat, and from 0.4 to

1.5 cc. of absolute alcohol was injected slowly, during periods up to one minute. Each patient was kept in the original position for periods varying from two to four hours. A patient with complicating paralysis of one lower extremity was kept in this position for only ten minutes. The patients were later placed in a ventral position, with the head lowered somewhat, for about twenty-four hours. The injections were all made into the lumbar subarachnoid space. In 2 cases two and three injections were given, respectively. The interval between injections was somewhat less than ten days in 1 case and three months in the other. There were complications in 4 cases, with paralysis of the right lower extremity in 1 case and retention of urine in 3 cases. Good results were obtained in 7 cases, the pain stopping in 1 case for about six months. There was some improvement in 2 cases and transitory relief in 1 case. The period of survival in this series ranged from one to six months.

N. SAVITSKY, New York.

Encephalography, Ventriculography, Roentgenography

NOTES ON THE PATHOLOGY OF CRANIAL TUMORS: I. OSTEOMAS OF THE SKULL, WITH INCIDENTAL MENTION OF THEIR OCCURRENCE IN THE ANCIENT INCAS. KENNETH H. ABBOTT and CYRIL B. COURVILLE, Bull. Los Angeles Neurol. Soc. **10**:19 (March-June) 1945.

Abbott and Courville report on osteomas of the skull, which are probably the most common of all new growths involving the cranium. However, osteomas are relatively rare, especially those which are sufficiently large to necessitate surgical attention. This type of tumor has been recognized since the time of Galen. It is stated that the incidence in the larger neurosurgical clinics is approximately 1 per cent.

Osteomas of the skull are classified into four types: (1) circumscribed osteomas of the cranial vault; (2) diffuse osteomas, arising most commonly from the sphenoid or temporal bone; (3) osteomas of the orbitoethmoidal or orbitomaxillary region, and (4) osteochondromas of the cranial floor.

The circumscribed osteomas of the cranial vault may be subdivided into (1) the small, and usually subclinically, osteoma eburneum, which arises by a broad base with either an indistinct or a sharply circumscribed border, and (2) osteoma spongiosum, which is a larger, more rapidly growing tumor and has a central portion of cancellous bone. The latter tumor sometimes becomes large and pedunculated and requires surgical excision, especially when the inner table of the skull is eroded and some degree of pressure on the underlying structures results in neurologic symptoms.

The diffuse osteomas, arising most commonly from the greater wing of the sphenoid bone, from the petrous portion of the temporal bone or, more rarely, from the orbital roof, are unusual, slowly growing tumors, the orbital type of which often produces exophthalmos and casts a dense paraorbital shadow on the roentgenogram. They are usually amenable to surgical excision.

The orbitoethmoidal (or orbitomaxillary) osteomas are said to have their origin in cartilaginous rests which persist in the line of the frontoethmoidal (or maxilloethmoidal) suture line. These tumors may have a complex localization, invading in their growth two or more of the regional cavities (orbit; frontal or ethmoid sinus, or cranial chamber), or they may be confined within a single cavity, as a result of eccentric growth from a well defined focus. Within such a cavity, the osteoma may become completely detached from its pedicle, resulting in the formation of a "dead osteoma," which is biologically inert.

Osteochondromas arising from the cranial floor are extremely rare growths, but, because of their upward extension into the intracranial space, they are to be classified as one of the many possible tumors which may compromise the intracranial space.

The available facts regarding their location and development suggest that osteomas are the result of some perversion in the union of the suture lines, possibly with the formation of isolated cell rests of osseous or cartilaginous character.

GUTTMAN, Philadelphia.

Congenital Anomalies

CAUSATION OF MONGOLISM. M. ENGLER, *J. Neurol. & Psychiat.* 7:27 (Jan.-April) 1944.

Engler investigated 113 cases of mongolism and found the following exogenous factors to be significant in its causation: In 6.8 per cent of cases there was a considerable degree of ill health or nervousness in the mother during gestation; in the majority of cases the mongolian imbecile was the last born of a rather large family and the age of the mother was usually advanced; in 12.7 per cent an induced miscarriage through abortifacients or curettage occurred immediately before the birth of the mongolian imbecile. The author concluded, on the basis of morbid heredity, that the unhealthy condition of the mucous membrane of the uterus at the time of implantation of the impregnated ovum was the chief cause of mongolism and that one of the main factors contributing to this unhealthy condition was miscarriage.

MALAMUD, Ann Arbor, Mich.

STURGE-WEBER DISEASE. TOBIAS BRAVO and FERNANDO LOAYZA, *Rev. neuro-psiquiat.* 6:317, 1943.

The authors report the first case of Sturge-Weber disease (nevoid amentia) in the Peruvian literature. They were unable to find a similar case in the "American literature." They record the case of an unmarried woman, aged 43, who was admitted to the hospital because of seven convulsive seizures in one day. There was a history of convulsive attacks from the first to the fifth year of life. She had had no attacks for sixteen years.

Examination showed an extensive nevus on the right side of the face, some mental retardation and intracranial calcification. The neurologic examination showed hyperreflexia, a positive Babinski sign, diminished abdominal reflexes and adiadokokinesis, all on the left side. There was no glaucoma. The nature of the seizures suggested a functional or hysterical component.

SAVITSKY, New York.

Society Transactions

PHILADELPHIA NEUROLOGICAL SOCIETY

Robert A. Groff, M.D., *Presiding*

Regular Meeting, April 26, 1946

Remedial Procedures for Handling Aphasic Patients. DR. LOU KENNEDY (by invitation).

A veteran, aged 26, was first seen in September 1945 at the neurophysical rehabilitation clinic, at which time he presented (1) motor aphasia which was complete except for two nonsense syllables and (2) sensory aphasia of sufficient severity to prevent his understanding of all but simple commands.

The patient, who was left handed, received a severe injury to the right side of the brain on Aug. 8, 1943, while in line of duty at an Army camp. After the injury, he remained unconscious for three weeks, talking in delirium during the initial three days of his unconsciousness. Five days after the accident he became very ill, had a temperature of 107 F., was paralyzed on the left side and stopped all talking. At the end of two months he began to walk, dragging the left leg; a month later he began to vocalize, but not to form words. He was discharged with full disability after three months' hospitalization in a base hospital.

During the twenty-two months between his discharge in 1943 and his admission to the neurophysical rehabilitation clinic, he regained the use of his left leg and became fairly skilful in the use of his right hand; but, in spite of two attempts at speech therapy, covering in all a ten week period, he regained no speech.

Studies of the spinal fluid showed pressure of 12 mm. of mercury. A pneumoencephalogram, made by Dr. Temple Fay on Sept. 28, 1945, showed diffuse subarachnoid fibrosis with dilatation of the ventricles and enlargement of the cistern at the base. On the right side there was definite enlargement of the ventricle of focal porencephalic type, which corresponded in location approximately to the area of Broca. The cortical markings could not be visualized above the level of the sylvian fissure.

Dr. Fay made an exploratory trephination in order to establish the cortical lesion by direct observation. He reported the presence of a thin subdural clot, which had become organized and partly adherent to the dura over the cortical surface. There were many small pools of fluid with patches of subarachnoid adhesions, so that some cortical atrophy was present. The sulci were enlarged and the fluid spaces filled, although they had not been clearly demarcated on the pneumoencephalogram, owing, it was thought, to the presence of diffuse subarachnoid adhesions. After the opening of the areas of accumulated fluid in and about the speech zone on the right, the patient made an uneventful recovery from the operative procedure.

The speech program followed a rigid routine of three daily periods of one hour each. Emphasis was placed on the maintenance of rapport between the speech therapist and the patient. A combination of the phonetic method and an association building approach proved effective. Until recently all speech work was carried on in front of a mirror. At first, speech was limited to imitation of the instructor's sound units, words and sentences. Now, the patient asks and answers questions, introducing many new words. The patient showed notable progress in speech comprehension and in utterance, improvement in social adaptation and, of late, an awakening interest in practical considerations. An unexpected aspect of his therapy was the need to emphasize the phonetic, rather than the word association, method. Expected features of the case were perseveration, dysarthria and slowness of utterance.

DISCUSSION

DR. TEMPLE FAY: I should like to demonstrate the encephalograms of Dr. Kennedy's patient. It is interesting that the patient is left handed, and that the apparent defect is very close to the zone of Broca, in the right frontal area. In order to establish the character of the lesion, I made an exploratory trephination on the right side and encountered a thin capsule of what had been a well organized subdural hematoma, not attached to the arachnoid. A great deal of arachnoidal fibrosis was present, with pools of fluid. After drainage of the subarachnoid spaces and some subdural drainage, the patient was referred to Dr. Kennedy. During therapy he has been maintained on a restricted fluid intake. Dr. Kennedy has rehabilitated speech in this patient out of a total loss of speech. In the present case it has required about eight months, with three hours of treatment each day. For two years after his discharge from the Army, the patient had no speech at all except "uh huh" and "unh unh."

DR. MICHAEL SCOTT: Dr. Fay stated that he saw a subdural hematoma on the right side and the pneumoencephalogram showed a dilated ventricle on that side without any shift of the ventricular system to the side opposite the lesion. Since in most cases of subdural hematoma a shift of the ventricular system occurs, what does Dr. Fay believe to be the reason for this dilatation and absence of shift?

DR. TEMPLE FAY: The thickness of the hematoma capsule encountered was inconsequential. It did not amount to more than $\frac{1}{4}$ inch (0.6 cm.). The film shows that the anterior portion of the horn was bulging at the area of Broca. That is not common in my experience. I believe it may have had something to do with the direct lesion on the right side. I understand that the patient was struck on that side.

DR. A. M. ORNSTEEN: The title of this report is "Remedial Procedures for Handling Aphasic Patients." Apparently, they include surgical measures. I am interested in knowing whether the credit for improvement in speech belongs to the surgical procedure or to the training. What was the interval between operation and speech training? How much improvement would have taken place after the operation without speech training, and how much improvement would have taken place with speech training without operation?

I should also like to know whether there was any improvement, and how much, in the year following the patient's discharge from the Army, and before the operation, since his postoperative improvement was so great. How long has it been since you operated, Dr. Fay?

DR. TEMPLE FAY: I operated in October.

DR. A. M. ORNSTEEN: A number of months. I should like to know the comparative postoperative improvement and whether the preoperative status was changed. In order to evaluate the remedial procedures of speech training, psychologic and otherwise, in a case of this sort in which an operation is performed, there must be an interpretation of the status before operation and that after operation. It should also be decided what improvement was to have been expected from the operation alone and whether the pedagogic-psychologic procedures would have done anything without the operation.

To sum up this case report of remedial procedures for handling aphasic patients, I think Dr. Fay ought to express an opinion on this point.

DR. SAMUEL A. ZERITSKY: Overseas, my colleagues and I treated very successfully the regressive psychoneurotic patients exhibiting mutism with sodium amytal narcosis. Out of scientific curiosity, sodium amytal was administered intravenously to 5 soldiers with true organic aphasia due to cerebral injuries. In 3 of these patients we obtained striking results in that during the very period of injection they uttered several distinguishable words, whereas prior to administration of the drug they had never produced any verbalization. I, therefore, wish to suggest that the severe anxiety resulting from a sense of frustration brought on by the aphasic

impediment retards the process of relearning. Perhaps several sessions under "narcosis" will prove a useful adjunct to the course of schooling.

DR. JOSEPH C. YASKIN: Apropos to Dr. Zeritsky's comment, it is well known that an aphasic patient will utter words when emotionally aroused. Many hemiplegic patients will swear brutally in anger, and they can even lift their paralyzed arms under certain emotional excitement, especially in yawning. It is conceivable that sodium amytal may have a similar effect. However, I do not believe that this is the mechanism of reeducation. Dr. Kennedy has done an important piece of work, and it should be encouraged, for undoubtedly there will be many patients with aphasia due to trauma, a type for whom education is worth while. Even for some of the older aphasic patients, with such lesions as embolism and other nonprogressive conditions, education is important. I know from my personal experience that there are too few persons willing, or at least able, to do this type of work.

DR. ROBERT A. GROFF: Dr. Fay, do you think that in your patient Broca's area is being reactivated, or is the training he is receiving creating a new speech center?

DR. TEMPLE FAY: Dr. Zeritsky asked about the use of sodium amytal. It was not used in this case, but I was convinced that the patient had a true organic aphasia.

My surgical work after the encephalographic study was chiefly to verify the condition of the cortex, in view of what I knew Dr. Kennedy might have to do in trying to rehabilitate this man. I did not want to place on her schedule a patient whose cortex had been so destroyed that there might be no chance to bring back speech activity. Certainly, the way his speech has returned indicates to me that it is not a matter of recall alone; you notice how the speech is broken into syllables, like children's when they begin to talk, and is not in entire words.

Dr. Yaskin refers to the familiar emotional outburst in aphasic patients. We have not been able to get this patient to swear. It seems he has scruples against it.

Dr. Kennedy deserves much credit for synthesizing word mechanisms back to an expressional level. The patient's understanding of the word is complete; so the credit for his improvement was not due to operation alone. I think it belongs to Dr. Kennedy and her speech therapy program.

DR. A. M. ORNSTEEN: May I insist on an answer to my questions? Dr. Fay says he verified the condition of the cortex. I do not believe he operates for verification. He did not just take a look. Didn't you do something with the cortex, the fibrosis or the membrane, Dr. Fay?

DR. TEMPLE FAY: I did the Alexander operation of fenestration. I don't know whether it has a record for a high percentage of recoveries.

DR. ROBERT A. GROFF: I am afraid that it has not.

DR. A. M. ORNSTEEN: Do you think you did anything to the circulatory area?

DR. TEMPLE FAY: I believe I gave it better circulation.

DR. A. M. ORNSTEEN: Do you think the patient's verbalization would have improved as a result of that operation?

DR. TEMPLE FAY: I don't think so. I think he would have gained something, but nothing like what we have seen here.

DR. A. M. ORNSTEEN: All right; that is the answer. I wanted your opinion.

DR. JOSEPH C. YASKIN: Several years ago a right-handed patient, after the removal of a tumor in the left cerebral hemisphere, showed stuttering and aphasia, the former predominating. I seriously questioned the existence of aphasia in this patient, but Dr. Groff was emphatic in stating that he was aphasic. Eventually the man recovered. Several weeks ago I saw a young man of a definitely neurotic makeup in whom a severe stuttering and questionable aphasia developed. At the moment I did not know whether the disturbance was organic or functional. Two days later complete hemiplegia developed on the right side, and I learned sub-

sequently that in early in life he had been a bad stutterer. The case presented by Dr. Kennedy is therefore of great interest, since the patient shows much hesitancy in speech in association with his aphasia. I wonder whether Dr. Kennedy can inform me whether or not this patient was a stutterer.

DR. LOU KENNEDY: He was a stutterer, but not in recent years. He stopped stuttering at the age of 16.

DR. MILTON MYERS: Was the patient taught to use his right hand rather than his left in school? It is well known that in some cases stuttering develops from interference with a naturally right-sided brain. According to modern ideas, teachers do not recommend that the pupil be made to use the right hand.

DR. LOU KENNEDY: The patient indicates that his teachers attempted to have him use his right hand for penmanship. Since he did not cooperate, they allowed him to continue writing with his left hand.

Parkinsonian-Like Tremor and Cogwheel Rigidity in a Child Secondary to Massive Ependymoma of the Frontal Lobe and the Caudate Nucleus; Prefrontal Lobectomy, with Cessation of Tremor and Rigidity. DR. MICHAEL SCOTT.

In the past many theories have been advanced as to the neural pathways innervated by lesions causing parkinsonian tremor. On the basis of these neurophysiologic concepts, many investigators (Horsley, 1909; Sachs, 1935; Foerster, 1936; Buch, 1940; Putnam, 1940; Klemme, 1940; Meyers, 1940) have advocated neurosurgical procedures for the relief of these tremors. These operations have included removal of area 4, areas 4 and 6, area 6 alone, section of the head of the caudate nucleus and the ansa lenticularis and section of the corticospinal tract in the cervical portion of the cord. For a complete survey of these theories and procedures, the reader is referred to the report of the Association for Research in Nervous and Mental Diseases (*Diseases of the Basal Ganglia, A. Research Nerv. & Ment. Dis., Proc.* (1940) 21:1, 1942) and to the splendid monograph edited by Paul C. Bucy (*The Precentral Motor Cortex. Illinois Monographs in Medical Sciences, vol. IV. Chicago, University of Illinois Press, 1944*). In April 1943 I presented before the Philadelphia Neurological Society (*Cerebral and Spinal Operations in a Case of Severe Postencephalitic Tremors, ARCH. NEUROL. & PSYCHIAT.* 52:108 [Jan.] 1944) a comparison of the results of operation on the brain and spinal cord of a patient with severe constant bilateral parkinsonian tremors. Cortical area 4 and part of area 6 of the arm center of the right cerebrum were extirpated for the relief of the left-sided tremors, and four months later the corticospinal tract at the third cervical segment on the right side was sectioned for the relief of the right-sided tremors. The tremors were abolished on both sides. One year after the first operation, the left upper extremity showed extensive flexor contracture and was useless. The right hand was held in an extensor pattern. The movements were like the fins of a fish, and the fingers would perform only simple flexor and extensor movements, such as carrying a glass of water to the mouth.

The present case is reported with the hope that it may throw light on the problem of the etiology and treatment of the classic parkinsonian tremor.

REPORT OF A CASE

E. A., a girl aged 4 years, was referred by Dr. Francis Zamborski to the pediatric service of Dr. G. E. Pratt, at the Northeastern Hospital, Philadelphia, in November 1944, because of vomiting, headaches and pronounced tremor and weakness of the right upper extremity. The child was well until September, when headaches and occasional vomiting occurred. In October a gastrointestinal study was made and revealed nothing significant. In early November, tremors of the right upper extremity developed, the headaches and vomiting increased, and the child was admitted on November 14, approximately two months after the onset of symptoms.

The past history was not remarkable. The child was alert. The head was $21\frac{1}{4}$ inches (54 cm.) in circumference, and the anterior fontanel was elevated. The left pupil was slightly larger than the right, but both reacted well. There were bilateral weakness of the sixth nerve, more pronounced on the right, and impairment of vertical gaze. The visual fields showed no impairment in the finger test, and a choked disk of 3 to 4 D. was observed.

There was slight weakness of the muscles of the lower right side of the face. The tongue was protruded in the midline. The deep tendon reflexes were active, especially on the right. There was slight weakness of the right upper extremity, with a static and an intention tremor and cogwheel rigidity on the right side. The static tremors were less pronounced and at times were absent at rest, but as soon as the child was stimulated in any way, became excited or attempted to move her right upper extremity the tremors became intense and increased in proportion to the excitement. There was pronounced ataxia in the finger to nose test on the right side. The right hand, fingers and forearm were held slightly flexed. A grasp reflex was present on the right side and a slight intention tremor on the left side. There was a definite Hoffmann sign on the left side.

The abdominal reflexes were active and equal on the two sides. An equivocal Chaddock sign was present on the left. There was a slight tremor in the right lower extremity. Bilateral ankle clonus was present, being stronger on the left side. The Babinski sign was not elicited. There was no impairment of sensation. There was hirsutism of the arms, legs and back.

The child had incontinence of the bowel and bladder at times. A provisional diagnosis was made of a space-taking lesion in the cerebrum near the midline, extending into the left frontal lobe and the basal ganglia.

The patient was examined by Dr. Alexander Silverstein, attending neurologist, who concurred with these observations but suggested that the presence of a tumor in the posterior fossa, as well as a pinealoma, should be ruled out. The patient was seen by Dr. W. H. Annesley, who confirmed the presence of bilateral choked disk.

The blood count and urinalysis gave normal results. The Wassermann reaction of the blood was negative. Roentgenograms of the skull (Dr. S. Bruck) showed separation of the suture lines, enlargement of the skull, demineralization of the posterior clinoid processes and a small area of erosion in the left frontal area. Roentgenograms of the chest showed nothing abnormal.

A ventriculogram made on December 7 showed that the left ventricle did not fill. The right ventricle showed a small amount of air, which was displaced to the right, suggesting a large lesion in the left frontal area. The fluid from the right ventricle had 10 white cells, no red cells and 40 mg. of protein per hundred cubic centimeters. The fluid from the left ventricle had 50 white cells, 3,000 red cells and 140 mg. of protein per hundred cubic centimeters. The ventricular fluid showed a slightly positive Wassermann reaction, but the colloidal gold curve was normal. (The parents' blood gave negative Wassermann reactions on two separate occasions. A spinal puncture was done on the patient three weeks after the craniotomy. The Wassermann reaction was reported to be moderately positive, and the colloidal gold curve was 1333320000. It was thought that these results represented false positive reactions, possibly secondary to an abnormal amount of protein from the tumor.)

Craniotomy was done in the left frontal area on Dec. 14, 1944, with the patient under anesthesia induced with solution of tribromoethanol U. S. P. and pentothal. A huge, dusky red tumor presented through the cortex and extended to the tip of the left frontal lobe and to the midline. The tumor and brain tissue were honeycombed with cystic areas containing xanthochromic fluid and others which showed old and recent hemorrhages. Although a large portion of the tumor could be freed from the surrounding brain tissue with finger dissection, some of the tumor extended into the ventricle and invaded the caudate nucleus.

In view of the invasive nature of the tumor and the small amount of the frontal lobe tissue remaining, a prefrontal lobectomy was done. It was impossible to know at the time of the operation whether the posterior boundary of the excision extended into the motor area; however, the excision was carried far enough posteriorly to make sure that all tumor tissue above the caudate nucleus was removed. There appeared to be tumor in the falx; accordingly, the anterior third of the sagittal sinus was ligated and this portion of the falx resected. The tumor tissue infiltrating the caudate nucleus was not disturbed because it was thought that the growth was an extensive, malignant one and that any attempt to remove this deep tissue would lead to injury to the internal capsule and paralysis on the opposite side. The dura also showed evidence of infiltration or adhesions of tumor tissue and was removed, including the area where the tumor had eroded into the left frontal bone. No attempt was made to close the dural defect with a graft. The bone flap was replaced and wired into place with stainless steel sutures and the scalp flap closed in the usual manner with interrupted silk sutures.

Dr. William Spaeth described the portion of tumor which was removed as a spherical mass of tissue, approximately 5 cm. in diameter. The tissue was soft and friable, although the mass appeared well encapsulated. At one pole a depressed area containing blood clots was seen.

Dr. E. Agerter described the histologic appearance as follows: "A section of this tumor showed a mass of tumor cells, with a very small amount of supportive tissue. Here and there were cores of fibrous stroma, carrying small blood vessels. They were covered with a layer of very tall, narrow cells, which were fusiform or goblet shaped. These cells and their pattern were typical of ependymoma."

Convalescence was stormy during the first twenty-four hours after operation, with gradual improvement to recovery.

The latest examination, made on April 18, 1946, fourteen months after operation, showed that the child was normal and happy. She had no complaints and was doing well in kindergarten. The pupils were equal and reacted well to light and in accommodation. The external ocular movements were normal. The eye-grounds showed no choking of the disks. The visual fields were normal in the finger test. The cranial nerves were normal except for slight weakness in the lower third of the right side of the face. The tongue was protruded in the midline with no tremor.

The biceps and triceps reflexes were notably decreased on both sides. The Hoffmann sign was not elicited. There was no grasp reflex. Resistance to flexion or extension in the upper extremities was not increased, and cogwheel rigidity was not present. Tremor was entirely absent, both at rest and during volitional movement. There was no dysmetria or ataxia. Muscular power was excellent in both upper extremities. The right patellar reflex was slightly stronger than the left. Babinski, Chaddock, Oppenheim or Gonda signs were absent. There was no ankle clonus. Sensation and motor power were not impaired in any of the extremities.

Comment.—A large ependymoma involving the frontal lobe and the caudate nucleus produced contralateral classic parkinsonian-like tremor and cogwheel rigidity. Removal of the tumor and all the frontal lobe anterior to area 4 resulted in complete cessation of tremors, cogwheel rigidity and excellent motor function up to the time of this report, fourteen months after operation. The tumor tissue in the caudate nucleus, was not removed. The removal of area 4 of the premotor cortex was not necessary for the relief of tremor and rigidity in this case.

I believe that the discrepancies in the results reported by various surgeons who removed the same or different areas of cerebral cortex for the relief of parkinsonian-like tremor may be due (aside from the technical factors) to the variations in the location of the cerebral lesion. Careful analysis of postoperative results in the light of the cause and location of the cerebral lesion producing parkinsonian tremor would be a more accurate surgical approach to this problem.

[The patient was presented before the society for comments and examination.]

DISCUSSION

DR. A SILVERSTEIN: Dr. Scott should be highly commended, not only for his excellent paper but, of greater importance, for the remarkable results in and his successful management of this case. He should be especially complimented on his excellent judgment at the operating table, when he decided to remove such an extensive infiltrating tumor of the brain instead of backing out, as is too frequently done in such cases.

I must question Dr. Scott's interpretation of the "parkinsonian tremor," which he accepted as a sign of involvement of the frontal lobe. He has stressed, with considerable detail, that a lesion of the frontal lobe seldom produces a parkinsonian tremor. One might add that in children, even those with encephalitis lethargica, the parkinsonian syndrome, with or without tremor, is an infrequent occurrence.

My own interpretation of the tremor in this case is quite different from Dr. Scott's. I believe that this sign should not be isolated from the rest of the clinical picture but, rather, should be considered as only one of a group of symptoms. For example, the earliest complaints of vomiting and headache were signs of increased intracranial pressure.

The positive signs, the cracked-pot sound, paralysis of upward gaze, inequality of the pupils, paralysis of the sixth nerve, signs of damage to the pyramidal tract and cerebellar dysfunction, all present bilaterally, were all evidence of compression of the brain stem, possibly with herniation through the tentorium, and generalized intracranial pressure.

In my opinion, the tremor was not the typical "parkinsonian tremor," nor was the posture of the hand of extrapyramidal type. The hand was clenched tightly, with the thumb strongly adducted in the palm of the hand. There were irregular, fairly slow jerking movements, with relatively large excursions when the hand was at rest. This tremor increased on emotional stimulation and became much more pronounced on voluntary movement, suggesting complete decomposition of movement. The tremor resembled the type seen with involvement of the red nucleus and other structures of the brain stem.

In short, I believe that the obvious signs of increased pressure, such as separation of the bones of the skull and choked disk, together with focal signs pointing to involvement of the brain stem (paralysis of upward gaze and bilateral paralysis of the sixth nerve) favor consideration of the tremor as a distant sign of compression of the brain stem rather than a focal sign of involvement of the frontal lobe.

It should also be stressed that the postoperative clinical course, with progressive improvement of the tremor, muscular rigidity and other signs, was a fairly typical result of relief of compression, such as the disappearance of paralysis following the removal of a meningioma. On the other hand, if the tremor were due to involvement of the frontal lobe, surgical ablation of the frontal lobe should have resulted in prompt cessation of the tremor, which it did not.

Dr. Scott has made a valuable contribution to the understanding of the mechanism and surgical management of tremor, and he should be encouraged to continue his particular operation in similar cases in the future. However, more research and experimental work should be done to prove that an ablation of the part of the frontal lobe which he has indicated will successfully eliminate the so-called parkinsonian tremor.

DR. FRANCIS C. FORSTER: I should like to ask Dr. Scott whether some of the suppressor areas of the cortex had been removed with the caudate nucleus. These suppressor areas have been worked out in the subhuman primate brain by Dusser de Barenne and McCullough and their colleagues, and they are known to exist in subprimate species of vertebrates. They exist in the frontal cortex, as well as in other lobes. In the frontal cortex of man, area 4-s has been demonstrated by Bucy and Garol. In your posterior approach to area 4, Dr. Scott, you would probably have encroached on area 4-s and, although it is not fair to ask whether you ablated 4-s, it is a possibility. Area 8-s may possibly have come along with

that. If you removed the caudate nucleus, you would have succeeded in removing the entire corticocaudate circuit. I wonder whether this might enter into the mechanism of the alterations you produced. These parkinsonian tremors arise from disturbing mechanisms within the circuit, and in this instance you would have removed the entire circuit.

DR. H. T. WYCIS: Does Dr. Scott feel that the invasion of the caudate nucleus by the tumor was responsible for disrupting the suppressor circuit? Since areas 4-s and 8-s converge on the caudate nucleus, it is entirely possible that the suppressor circuit was also interrupted, so as to release the parapyramidal system.

With regard to the question asked by Dr. Forster, it is apparent that area 4-s was not disturbed, since in such a case spasticity would certainly have appeared.

DR. FREDERIC H. LEWEY: About twenty-five years ago Schuster presented a series of cases of tumors of the frontal lobe and suggested that the tremor was caused by involvement of the frontal lobe. Necropsy revealed that all the patients with tremor or other signs of parkinsonism showed actual involvement of the basal ganglia by the tumor.

DR. JOSEPH C. YASKIN: The statement was made that a generalized increased intracranial pressure was responsible for the tremor in this case. I do not believe such an explanation is plausible, for one sees many children with increased intracranial pressure who do not show the parkinsonian complex. In evaluating the symptoms in this case, one should bear in mind two facts: (1) The tumor was large enough to press on the caudate nucleus, even though the latter was not invaded; and (2) there is a strong possibility, as Dr. Scott indicated, that the frontocerebellar pathways were involved and that the tremors of cerebellar origin are not always easy to differentiate from those of the extrapyramidal system.

The second suggestion by Dr. Forster was that the neurophysiologic state in children may be very different from that of the adult, and one does not see many tumors of the premotor part of the frontal lobe in children. At least, I have not. Perhaps a study of this particular group of tumors may throw more light on the symptoms in this case.

DR. A. M. ORNSTEEN: In clarifying the issue, there should be definite understanding as to the presence of parkinsonian tremor. If this child had parkinsonian tremor, the discussion is justified from the standpoint of its elimination surgically. If the child had a tremor, not parkinsonian, it is a different concept. I have not heard anything yet to indicate that this child presented a parkinsonian picture. Dr. Silverstein, who saw the child, said the tremor was not parkinsonian. Dr. Scott described the tremor as of the intention type. Rarely is a parkinsonian tremor an intention tremor, except perhaps in the advanced stage. It is usually a tremor of rest. This child did not have the disease more than two months before the operation. The posture of the hand, Dr. Scott said, was not parkinsonian. Dr. Silverman described the hand as clenched, with thumb in palm. The parkinsonian picture, to accept it as a parkinsonian state, has to have hypokinesia or akinesia, spontaneous movements and rigidity. But an intention tremor with a tumor of the frontal lobe cannot be categorically classified as a parkinsonian tremor. It is best, I believe, to refer to it as a tremor due to tumor of the frontal lobe. In that case, it is easier to conceive of tremor because of the widespread connections of the extrapyramidal tracts in passing from the cortex to the basal ganglia. If Dr. Scott would agree that it is a question of tremor due to tumor of the frontal lobe, one might follow right along. If the discussion is limited to a parkinsonian tremor, the hypotheses expounded are not easily followed.

DR. ROBERT A. GROFF: The point was made by Dr. Ornsteen that the tremor displayed by this patient was not "parkinsonian," but simply a tremor. I wish to emphasize this, too. Some may have noticed that when I announced the title of the paper I left out the word "parkinsonian." The description of the tremor does not fit what is considered "parkinsonian."

A number of years ago Dr. Weisenburg said, after a presentation by Dr. Gibbs, of Boston, on localizing signs of cerebral function as presented in 2,000 cases of

cerebral tumor from the Cushing Clinic, that one cannot assume that the signs presented by a cerebral tumor in a particular area are the functions of that area. The factors of increased intracranial pressure and of edema surrounding the tumor must be accounted for, because they cause involvement of areas adjacent to and at a distance from the tumor. My experience has supported this statement, and I think it is dangerous to use tumor location as a basis for localization of cerebral function.

DR. MICHAEL SCOTT: I should like to clarify why I called the tremor in this case a parkinsonian tremor. The child had a constant static tremor in the right hand. When she became excited, the tremor increased in intensity, as does the classic parkinsonian tremor. In addition, there were a pronounced cogwheel rigidity on the side of the tremor and resistance to passive flexion and extension of the forearm.

There was no question in my mind about this. When the child was asked to place her finger on her nose, the tremor increased markedly. Dr. Silverstein states that it is not customary for a parkinsonian tremor to increase on motion. If the members of the society will recall, a few years ago I presented a patient with bilateral parkinsonian tremor; all agreed on the diagnosis and noted that the patient's hands would fly all over her face when she attempted to point to her nose.

Therefore, I still maintain that the patient presented here had a parkinsonian tremor. However, she did not have the set facies and other signs of parkinsonism, and perhaps the term "parkinsonian" should not be used to describe a case in which not all the symptoms of parkinsonism are present. If I am wrong in my opinion as to what constitutes a parkinsonian tremor, I should like to be corrected.

In reply to Dr. Forster's question, it is impossible for me to state the exact area of cortex removed. It is possible that area 4-s was injured. Dr. Yaskin and Dr. Wycis suggested that the tremors might be due to direct pressure by the tumor on the caudate nucleus. This may be so. On the other hand, Ody, in his study of a series of cases, said that contralateral parkinsonian tremor was an unusual symptom with tumors of the basal ganglia. My point is that the associated lesions of the cortex and the basal ganglia produced the tremor.

Effect of Lesions of the Optic Tract and of the Midbrain on Labyrinthine Nystagmus. DR. E. A. SPIEGEL and DR. N. P. SCALA, Washington, D. C. (by invitation).

In previous experiments (Changes in Labyrinthine Excitability with Lesions of Optic Tract and External Geniculate Body, *ARCH. OPHTH.* **34**:408 [Nov.Dec.] 1945), we observed that a marked difference between the nystagmus following clockwise rotation and that following counterclockwise rotation developed after lesions of the optic tract or of the external geniculate body. The duration of the postrotatory nystagmus to the side of operation increased up to three times, and the number of its jerks up to four times, the corresponding values of the nystagmus to the normal side. Our further experiments on cats demonstrate that lesion of the anterior corpus quadrigeminum also induces an increase in the number of jerks and of the duration of the postrotatory nystagmus directed toward the side of the operation. This effect appears independently of the lesion of the occipital lobe. From the present study, and from our previous experiments, it is inferred that the appearance of this directional preponderance of postrotatory nystagmus is due to release of the vestibulo-ocular reflex arc from inhibitory impulses originating in homolateral parts of the retinas. This inhibition is brought about by a cortical and a subcortical apparatus. The superior colliculus is part of the latter mechanism. Thus, these experiments may contribute to an understanding of the little known function of the corpora quadrigemina. The biologic function of this inhibitory mechanism may perhaps be sought in the following direction: The ocular deviation on movements of the head is rather generally considered a

mechanism serving the preservation of a constancy of the visual field. This can be accomplished only if amplitude and speed of the ocular reaction are properly regulated. Retinal impulses checking the vestibulo-ocular reaction may play a part in such a regulation.

This article was published in full in *Confinia neurologica* (7:68, 1946.)

Effect of Cortical Lesions on Labyrinthine Nystagmus. DR. H. T. WYCIS
and DR. E. A. SPIEGEL.

The influence of various unilateral cortical lesions on the ocular reactions to ten alternate clockwise and counterclockwise rotations was studied in dogs and cats. Definite effects were found after occipital or frontal lobectomy, the post-rotatory nystagmus to the side of operation distinctly predominating over that to the normal side ("directional preponderance," i. e., increase in duration and number of jerks to the side of operation and/or decrease to the opposite side). The change lasted from a few days up to two weeks after complete elimination of the area striata, and five to ten days after frontal lobectomy. In a dog in which severe jacksonian convulsions developed it lasted over a period of two months. Superficial lesions of the parietal or temporal lobe had only a slight, if any, effect on the postrotatory nystagmus, while deep-reaching lesions of the temporal lobe produced a definite directional preponderance, apparently due to injury of pathways connecting the area striata with the brain stem. This may explain, at least in part, the observations of Fitzgerald and Hallpike in cases of tumor of the temporal lobe. In further experiments, retinal impulses were eliminated by transection of both optic nerves, and this operation was combined with lobectomies. After the bilateral section of the optic nerve, the duration of the postrotatory nystagmus was increased 2 to 3 times, and the number of jerks 1.4 to 7 times, the preoperative values. In this stage of increased reactivity of the vestibulo-ocular reflex arc, some dogs displayed a pronounced "after-after"-nystagmus following labyrinthine stimulation by turning, the rotation being followed first by a nystagmus in the opposite direction and then by one beating in the direction of rotation.

After elimination of the afferent impulses from the retinas, unilateral occipital lobectomy failed to produce directional preponderance, whereas unilateral frontal lobectomy, if extensive enough, was still able to induce predominance of the post-rotational nystagmus to the side of the cerebral operation. Thus, the influence of the occipital lobe on the vestibulo-ocular reflex arc depends on afferent impulses from the retinas, while in the case of the frontal lobe the retinal impulses are dispensable.

DISCUSSION

DR. B. H. SHUSTER (by invitation): The experimental work of Dr. Spiegel and Dr. Wycis is interesting, but its immediate clinical value is, of course, not immediately evident. Usually, only after accumulation of experimental data does the clinical application become apparent.

As I understand it, Dr. Spiegel and Dr. Wycis have concluded that there is a diminution in vestibular reaction in the animals experimented on after the visual pathways have experimentally been severed. The implication, of course, is that vision is much concerned with the vestibular reaction and that the interception of vision reduces the vestibular activity. Clinically, however, I cannot recall instances in which this was the case. Human beings vary so much in their vestibular sensitivity that it would be difficult to interpret diminution of reaction as concerned with impairment of vision. On the other hand, I have seen cases of pituitary tumor causing blindness in which the reaction to rotation was prolonged beyond the point of that which could be said to be due to vestibular hyperirritability. For instance, in the case I have in mind postrotational nystagmus of about seventy and eighty seconds was manifested as compared with the average of about twenty-five seconds. This, of course, is the opposite of what these animal experiments indicate. I interpret this prolonged reaction as due to hyperirritability of the

labyrinthine nuclei because of intracranial pressure, rather than as associated with the defect in vision resulting from pressure on the optic chiasm.

DR. MILTON MEYERS: I noted that the authors did not attempt any explanation of the after-after-nystagmus. If they have any explanation, we should like to hear it.

DR. JOSEPH C. YASKIN: I have four points in mind which require clarification. First I assume that the pathway which modified the duration of nystagmus passes by the way of the midbrain to the posterior longitudinal bundle. If not, I should like to be corrected. I assume that the pathway starts in the external geniculate body and continues through the superior colliculus to the posterior longitudinal bundle.

The second point is whether or not there is any relation between the adverse fields responsible for the conjugate deviation of the head and eyes observed clinically and the modification of the nystagmus, as suggested by Dr. Wycis' work.

The third point is whether there is any experimental evidence that nystagmus is produced by lesions above the tentorium, except perhaps those of the caudal part of the third ventricle. In a recent paper, De Jong stated emphatically that one is wrong in assuming that nystagmus is rare with diseases above the tentorium. Every time I have made the diagnosis of a supratentorial lesion in the presence of nystagmus I have been wrong.

Last, would not the work of Dr. Wycis and Dr. Spiegel explain some of the phenomena which Dr. Shuster observes and on which he bases his diagnosis of a tumor of the left or the right temporal lobe? Are not the responses elicited by these authors helpful in explaining localization of lesions above the tentorium?

DR. A. M. ORNSTEEN: Is it not known that retinal stimuli and the stability of the extraocular muscles are dependent on each other? This relation is suggested in the searching movements of the eyes in blind people. I am reminded of a physician in town who has progressive myopia and for the past decade has had increasing loss of vision; he is now practically blind. He did not have nystagmus ten years ago, but only last week I noticed what has happened in the past year. His eyes oscillate almost half the width of the palpebral fissures. With increasing loss of vision there is greater instability of extraocular tone and function, indicating that stability of the extraocular muscles depends on retinal impulses.

DR. MICHAEL SCOTT: Do Dr. Spiegel and Dr. Wycis feel that nystagmus or optokinetic nystagmus is of clinical value in localizing lesions of the temporal lobe?

DR. JOSEPH C. YASKIN: The nystagmus Dr. Ornsteen discusses does not belong to the same category as the vestibular, or labyrinthine, type. It has long been recognized that nystagmus incident to amblyopia, appearing early or later in life, is an entirely different phenomenon from nystagmus due to disturbance of the vestibular pathways. Nystagmus may be divided into three types: (1) that belonging to disturbances of vision; (2) that belonging to disturbances of the internal ear, and (3) that belonging to disturbance of the pathways proximal to the labyrinth, and therefore hard to trace. I should like to hear Dr. Spiegel's recent views on that.

DR. A. M. ORNSTEEN: I merely wanted to show with that clinical observation that a relation between retinal impulses and extraocular stability exists. This nystagmus has nothing to do with vestibular nystagmus.

DR. E. A. SPIEGEL: Dr. Shuster has brought up a problem discussed frequently, namely, the relation of experimental and clinical work. One carries on animal experiments for several reasons: to study biologic phenomena and to see certain laws of nature established. But if one is a physician, one is interested in the light these experiments throw on clinical phenomena. One is perhaps justified in assuming that such primitive mechanisms as the reflexes of ocular muscles are similar in animals and in human subjects. Therefore the experimental worker tries to correlate his findings to a certain extent with clinical experience. It should not be forgotten that all Bárány's work was based on old animal experiments

which Hoegyes, a Hungarian physiologist, started and Breuer and Mach later continued.

It seemed to us that the question whether certain lobectomies produce inequality of induced nystagmus is of some clinical interest. For example, the question may arise whether a predominance of induced nystagmus to the right or to the left has localizing value. Two English authors, Fitzgerald and Hallpike, based their clinical studies on experimental work by Bauer and Leidler, Dusser de Barenne and de Kleyn, who found so-called *Nystagmusbereitschaft* to the side of hemispherectomy (*Brain* 65:115, 1942). Fitzgerald and Hallpike translated the term as "directional preponderance of nystagmus" to the side of the cerebral lesion. They tried to apply the phenomenon to the local diagnosis of cerebral tumors. They observed it particularly with tumors of the temporal lobe. Our experiments may perhaps help in understanding their observations, since we noted definite directional preponderance only with lesions of the temporal lobe that reached close to the lateral ventricle. This experiment suggests that the "directional preponderance" observed by Fitzgerald and Hallpike with tumors of the temporal lobe was due to involvement of fiber connections of the occipital lobe with subcortical centers.

Dr. Ornsteen has raised the question whether searching movements in blind people are a special type of nystagmus. We are justified clinically, it seems to me, in differentiating labyrinthine nystagmus from that associated with amaurosis and amblyopia, as Dr. Yaskin has done. This does not preclude, of course, a relationship between these types of nystagmus, and there is a good point in Dr. Ornsteen's argument that the tonicity of the ocular muscles depends, at least partly, on impulses from the retina, and that loss of the centripetal impulses from the retina may result in disturbances in the tonicity of the ocular muscles and in overexcitability of the vestibular nuclei; these factors may play a part in the genesis of searching movements in blind persons, although other factors may be involved.

Dr. Shuster has brought up a second question, namely, whether after-after-nystagmus is a labyrinthine phenomenon or whether it is due to a change in the tonicity of the ocular muscles. It is not difficult to answer this question, for this problem of after-after-nystagmus has not only an objective side, the nystagmic movements, but a subjective side, illusions of rotation. These illusions of rotation have been studied rather extensively by Fischer and Wodak, investigators well trained to observe their sensations. These illusions are rather frequently observed by normal persons. We have had occasion in the last few years to study a large number of normal persons in whom motion sickness was produced by rotation on a modified Bárány chair. We always asked them about the sensations they had after rotation. We confirmed what Wodak and Fischer already had observed, namely, that after the rotations these patients had a sensation of being rotated in the opposite direction if their eyes were closed. In some of the subjects these sensations stopped, and after a certain latent period they had a sensation that the rotation was reversed and that they were rotating in the opposite direction. These are only two phases. Some subjects, as Wodak and Fischer have described, are able to experience many more of these phases. They have described reversal of the phenomena occurring four or five times. These illusions, of course, have nothing to do with innervation of ocular muscles. The eyelids are closed, and retinal stimulation has nothing to do with it. It is a change of excitability in labyrinthine centers.

This brings me to Dr. Meyers' question, the mechanism of the after-after-nystagmus. Dr. Wycis has referred to the explanation briefly. It seems to me that it is to be sought in the following direction: Many central phenomena show periodic fluctuations; the labyrinthine nuclei also discharge periodically, and in this periodic discharge there is an alternate prevalence of direction, first to one side and then to the other. The result is alternation of direction of the postrotatory nystagmus, inducing after-after-nystagmus objectively and illusions of rotation in alternate directions subjectively. After-after-nystagmus has been observed in normal persons not only by Bárány but also by Woletz and Veits, by the latter

authors after a special type of intense rotatory stimulation. These authors even claimed that with their special type of prolonged labyrinthine stimulation they could produce the nystagmus in every subject. In our experimental animals there is an abnormal increase of this phenomenon. What are a few jerks normally become prolonged discharges if the vestibular nuclei are released from retinal inhibition

Dr. Yaskin brought up the problem of pathways. I was careful not to mention that because I did not want to make statements which later I might have to retract. So far as we have studied it, we can only say that we have followed the centripetal inhibitory pathway along the optic tract to the superior colliculus. There are of course various descending pathways from the colliculi. How far these descending pathways make their way with the posterior longitudinal bundle and how far outside, and whether they end in the vestibular nuclei directly or by intermediate neurons of the reticular substance, we can determine only by further study.

With regard to the adersive fields: Dr. Wycis has mentioned that we studied a rather large number of dogs with lesions of the various frontal areas; contrary to our expectations, lesions of area 8 failed to produce directional predominance, and combined lesions of areas 8 and 6 produced only a slight inequality of the postrotatory nystagmus. It seems a rather large lesion of the frontal lobe is necessary to obtain these phenomena.

With regard to the question whether supratentorial lesions can produce nystagmus our experiments have had no direct relation. I can only say that on stimulating the frontal areas one can produce first a deviation of the eyes and that this deviation of the eyes may be followed by rhythmic jerks, which might be similar to a nystagmus. Thus, by stimulating certain frontal areas one may produce eye jerks as part of a jacksonian convulsion. But with a lesion of a cortical area one can produce only directional predominance, not nystagmus, and an additional peripheral factor is needed to produce nystagmus. If these two factors are present—destruction of the frontal lobe and additional peripheral stimulation—prevalence of nystagmus in a certain direction may appear.

Dr. Scott asked about optokinetic nystagmus. Recent studies have shown that two types of optokinetic nystagmus must be differentiated. The first type, which Dr. Scala and I called active optokinetic nystagmus, appears when objects engaging the subject's attention move in the visual field. This is a cortical phenomenon, depending on the occipital lobe. The second type, which we called passive optokinetic nystagmus, is produced only when all objects in the visual field are moved in the same direction (*ter Braak*). This is a subcortical reflex, depending on the superior colliculi. Its pathway and mechanism may be related to the subcortical inhibitory mechanisms from the retina, described here, but this problem requires further study.

DR. HENRY WYCIS: One of the features which distinguish the nystagmus described by Dr. Spiegel and Dr. Scala and that which Dr. Spiegel and I described is the transient effect of the cortical lesion. After cortical procedures we found that induced inequality of nystagmus persisted not longer than two weeks. This may be an important clinical fact, for if these methods are applied to the study of tumors one might be able to see this induced inequality at an early stage of the tumor. However, Fitzgerald and Hallpike observed an inequality in induced nystagmus in the caloric test with tumors of the temporal lobe at a later stage.

I might point out that there are other methods of examining the labyrinth besides the well worn methods of *Bárány*. We are careful to place our animals on a motor-driven chair so that we get as nearly as possible constant preoperative values of labyrinthine excitability.

It was distressing not to be able to locate the specific area of the frontal lobe which was responsible for producing an inequality of induced nystagmus. As I stated, it was only after large combined lesions that we got this inequality. Contrary to our expectations, lesions of the frontal eye fields failed to produce inequality.

Book Reviews

Human Torulosis: A Clinical, Pathological and Microbiological Study, with a Report of Thirteen Cases. By Leonard Cox and Jean C. Tolhurst, Melbourne, Australia. Price, \$7.50. Pp. 149, with 67 illustrations. Melbourne, Australia: Melbourne University Press, 1946.

Torular infection is more prevalent in Australia than elsewhere, although cases have been reported from many parts of the world. The present monograph adds a number of new cases and brings the literature up to date, with 134 references. The work is a scholarly contribution, with all the facets of the disease presented for consideration. *Torula* can infect any part of the body. Pulmonary lesions are particularly stressed, with their resemblance to tuberculosis or tumor in the roentgenogram, and the authors state that their emphasis on the extracerebral lesions has been not because of the importance of these lesions but because of the desire on their part to fill out the gaps in knowledge of the disease.

The usual pitfalls are described—how torulas in the spinal fluid are mistaken for red blood cells, how the concurrence of pulmonary lesions and meningitis leads to the mistaken diagnosis of tuberculosis, how cultures are often discarded before the torulas have a chance to form colonies, how the long period between inoculation and clinical manifestations of the disease in animals (up to six months) renders studies of the pathogenicity somewhat tedious. They recognize torular infection as a systemic disease which becomes fatal when the nervous system is attacked, but even so there are cases of the disease with a proved duration of three to five years in which "torular collections" of large size were observed in the brain.

Torulosis is seldom suspected before examination in the laboratory. Smears from granulomas and cultures of the spinal fluid are the most common measures for diagnosis of the disease during life. Cultures of the blood and urine seldom yield the organism, and animal inoculation is too slow. The microbiologic aspects of *Torula* are studied in detail, with many references; but the authors have apparently not undertaken extensive studies with various strains in the hope of identifying subspecies. Also, there appears to be no great antigenicity in the various strains. The authors reach no startling conclusions, but their monograph serves to focus attention on a disease that is occasionally encountered and that should be more frequently recognized before necropsy. Unfortunately, there has been no progress made in the treatment of torulosis.

Problems in Abnormal Behavior. By Nathaniel Thornton. Price, \$2. Pp. 244. Philadelphia: The Blakiston Company, 1946.

The cover jacket of this book states that the following subjects are treated in this book: psychic functions and psychologic types, mental mechanisms, the development of the sexual impulse, the nature of homosexuality, other irregularities of the sexual impulse, the question of neurosis, the question of psychosis, the scientific interpretation of dreams, the history and theory of psychoanalytic therapy, how internal secretions may affect behavior, some aspects of criminal psychology and the phenomena of epilepsy. One can guess how much "treatment" is given when one learns that the book is 5½ by 8 inches with large margins and large print, and is 244 pages in length, including 15 pages of introduction and 10 pages of index and bibliography, to say nothing of several pages of verse from such revealing sources as Viereck and the author himself.

In his introduction, the author makes a plea for a fair treatment of Freud's ideas. He asks for an open mind, but his begging and pleading for justice lead one to suspect that he is trying to convince himself. If one can learn anything

of Freud's contribution to psychiatry in this "treatment," one must certainly have read Freud's "Collected Papers" first.

This is supposed to be a book of "problems." There is no question about it. The problems are certainly posed. But the psychiatrist is not in need of a brief book like this to formulate the problems of abnormal behavior for himself, and the layman is not in need of more problems—and when the problems need solving mystic verse does not help.

Why this book was written will never be known unless as an opportunity to jump on the psychiatric bandwagon to get something published.

News and Comment

THE AMERICAN SOCIETY OF ELECTROENCEPHALOGRAPHY

The American Society of Electroencephalography will hold its first annual meeting in Atlantic City, N. J., June 13 and 14 at the Marlborough-Blenheim Hotel. The detailed program will be announced in May. The meeting will be open to all interested physicians and physiologists.

CORRECTION

In the article by Drs. Chapman, Finesinger, Jones and Cobb entitled "Measurements of Pain Sensitivity in Patients with Psychoneurosis," in the March issue (ARCH. NEUROL. & PSYCHIAT. 57:321, 1947), the numbers on the ordinate in figures 1 and 2 should be preceded by a decimal point.

LOSS OF AXIS-CYLINDERS IN SCLEROTIC PLAQUES AND SIMILAR LESIONS

TRACY J. PUTNAM, M.D.

LOS ANGELES

AND

LEO ALEXANDER, M.D.

BOSTON

CHARCOT¹ was apparently the first to point out the essential histologic features of sclerotic plaques: the absence of myelin, the presence of axis-cylinders, the fibrous gliosis and the perivascular infiltration with phagocytic cells. This much of his description has been copied in almost every textbook. Two of the other alterations which he clearly recognized have since appeared and disappeared repeatedly in scientific literature: the narrowing and closure of vessels and the loss of axis-cylinders, which, he wrote, "persist in certain number."

Chiefly, apparently, on the basis of the histology of sclerotic plaques Charcot founded the important distinction between secondary and primary degeneration of myelin. Secondary degeneration is the result of the destruction of axis-cylinders, or nerve cells. The neurofibrils disappear distal to the lesion, and the myelin then begins to disintegrate. Primary degeneration is a process which attacks almost all the myelin sheaths in an area of tissue, leaving some or many axis-cylinders intact and giving rise to no conspicuous secondary degeneration. This is a formal definition; in practice a pure primary degeneration is rare or nonexistent. Usually a few axis-cylinders are destroyed, as in the cases Charcot described, and their fibrils degenerate distally but are so scattered that they are not easy to demonstrate. Mere damage to an axis-cylinder, such as may occur in "demyelinating" lesions, does not cause a descending degeneration.

Since the advent of the Weigert stain, which demonstrates loss of myelin so strikingly, the attention of neurologists has tended to become

The expenses of this investigation were defrayed in part by a gift from the Markle Foundation to the Multiple Sclerosis Fund of Harvard University.

From the Department of Neurology, Columbia University College of Physicians and Surgeons, and the Department of Neuropathology, Harvard Medical School.

1. Charcot, J. M.: *Histologie de la sclérose en plaques*, *Gaz. d. hôp.* **41**:554-555, 557-558 and 566, 1868.

centered on the myelin lesion, both in primary and in secondary degeneration. As fixation and embedding for the Weigert process usually make a study of other tissue elements difficult, there has been a tendency to neglect these structures. This has been particularly true of the axis-cylinders.

PREVIOUS STUDIES OF THE AXIS-CYLINDERS IN
SCLEROTIC PLAQUES

A large number of studies have, however, been directed toward the axis-cylinders. Those which were made before the introduction of the Bielschowsky technic may be disregarded (with the exception perhaps of Charcot's, already mentioned, and a few others). The results of these investigations up to 1935 have been well summarized by Marburg.² From an extensive review of the literature and his own numerous observations, he drew the conclusion that the axis-cylinders are usually damaged and in many instances completely destroyed. This is clearly shown in two of his illustrations, of sections stained with the Bielschowsky technic.

While many pathologists have reported damage to axis-cylinders in the plaques of multiple sclerosis, there seems to be a widespread opinion that the extent of damage is relatively slight. Spielmeyer³ spoke of "the characteristic persistence of axis-cylinders, which are noted in the majority of lesions and in the majority of cases of multiple sclerosis in great predominance, an observation which is surprising each time, and which constitutes the essential peculiarity of the disease."

There have been two recent contributions to the problem. In an extensive survey of lesions of multiple sclerosis,⁴ numerous plaques were encountered, especially in the white matter of the hemispheres, in which there appeared to be an extensive loss of axis-cylinders, of possible functional significance. The observations were made chiefly on thin sections stained with the Mallory, Masson and similar technics, but similar observations were made on material stained by the Davenport silver method. Among the lesions studied, there were many in which only sparse axis-cylinders were seen.

These results were criticized by Greenfield and King⁵ on the ground that the stains employed were not sufficiently specific for axis-cylinders. Using the original Bielschowsky technic, of course on frozen sections, they examined over 125 cerebral plaques from 13 cases. They reported:

2. Marburg, O.: Multiple Sklerose, in Bumke, O., and Foerster, O.: *Handbuch der Neurologie*, Berlin, Julius Springer, 1936, vol. 13, pp. 546-693.

3. Spielmeyer, W.: *Infektion und Nervensystem*, Deutsche Ztschr. f. Nervenhe. **110**:290-295, 1929.

4. Putnam, T. J.: *Studies in Multiple Sclerosis: VIII. Etiologic Factors in Multiple Sclerosis*, *Ann. Int. Med.* **9**:854-863 (Jan.) 1936.

5. Greenfield, J. G., and King, L. S.: *Observations on the Histopathology of the Cerebral Lesions in Disseminated Sclerosis*, *Brain* **59**:445-458 (Dec.) 1936.

Less than 10 per cent showed what could be called "severe destruction," the remainder being fairly evenly divided into slight or no loss, and moderate diminution. The extreme degree was not only rare, but where present was always in tissue that was highly rarefied or spongy. [This description fits well the plaques in which gliosis is slight, such as are common in the white matter of the hemispheres.]

What we call severe destruction is reduction in number to one-fifth or one-seventh (approximately) of the normal density of nerve fibers.

They reported no fiber counts, however. In two plaques of 1 case there was extreme softening, so that they could not be cut in frozen section except with gelatin embedding. These two plaques were left out of the statistical study. The authors give no illustrations of axis-cylinders to demonstrate their point.

To a certain extent the criticism of Greenfield and King is justified. There can be no doubt that the Bielschowsky method stains some axis-cylinders which may be missed with anilin dye stains, and even with many of the older silver stains on embedded tissue.

The Bielschowsky stain has its limitation, however. It depends on frozen sections, which are almost impossible to cut from large plaques of intense degeneration, where axis-cylinders are fewest, as the experience of Greenfield and King shows. Frozen sections are necessarily many times as thick as the best paraffin sections, so that a moderate degree of loss of axis-cylinders is difficult to detect. Finally, the Bielschowsky technic is likely to stain a certain number of glial fibrils, especially in old fibrotic lesions of isomorphic gliosis. It has seemed worth while, therefore, to reopen the question.

The ideal method of resolving the difficulty would be to find a stain which combines the best features of the two technics which are found to give conflicting results. Fortunately, such a method has recently become available: the Bodian stain,⁶ which depends on the reduction of a silver proteinate. It can be used on thin paraffin sections; the results are uniform, and there is a general agreement that it stains axis-cylinders with a unique completeness and selectivity. The clarity of the stain for low power enlargements is enhanced by incineration of the sections, as suggested by Rosett.⁷

MATERIAL AND METHODS

Twenty-six blocks, containing 31 distinct plaques, were taken from embedded material from 7 cases of multiple sclerosis. The cases were unselected, except that 2 were included because they were particularly rich in acute lesions. One of these was of the neuromyelitis optica type. Sections cut at 5 microns were

6. Bodian, D.: A New Method for Staining Nerve Fibers and Nerve Endings in Mounted Paraffin Sections, *Anat. Rec.* **65**:89-97 (April) 1936; Staining of Paraffin Section of Nervous Tissues with Activated Protargol: Role of Fixatives, *ibid.* **69**:153-162 (Sept.) 1937.

7. Rosett, J.: A Method of Replacing Nerve Fibers with Fused Gold, *Arch. Neurol. & Psychiat.* **44**:442-443 (Aug.) 1940.

stained by the Bodian method, and adjacent sections, by the Smith-Quigley or the Mahon⁸ method for myelin sheaths. Usually, a series of other stains was available from the same or from adjacent blocks.

For comparison with the lesions of multiple sclerosis, 9 blocks from 2 cases were studied in which there were numerous patches of partial degeneration resulting from such processes as arteriosclerosis and venous thrombosis. These blocks were embedded in paraffin, cut and stained as just described.



Fig. 1.—Sections from the same block of the pons from a case of multiple sclerosis. Above, Mahon stain for myelin; below, Bodian stain for axis-cylinders. Note apparent intactness of axis-cylinders. Lens enlargement.

8. Mahon, G. S.: Stain for Myelin Sheaths in Tissues Embedded in Paraffin, *Arch. Neurol. & Psychiat.* 38:103-107 (July) 1937.

RESULTS

Primary Degeneration.—Of the 29 sclerotic plaques studied, all showed some degree of loss of axis-cylinders. In 2 blocks, both from



Fig. 2.—Sections from the same block taken from the tip of the occipital lobe in a case of multiple sclerosis. Above, Mahon stain for myelin sheaths; below, Bodian stain for axis-cylinders. Note extensive loss of axis-cylinders. Lens enlargement.

the brain stem (fig. 1), the loss of axis-cylinders was not recognizable at low magnifications because of the optical illusion, which has been discussed elsewhere.⁹ With higher magnification some destruction could be observed. In other blocks, chiefly from the white matter of the hemispheres, the loss of axis-cylinders was striking even with the low and the medium power lens (figs. 2, 3 and 4), although there were some parts in most plaques in which loss of axis-cylinders was inconspicuous. In the same plaques, however, areas could be found in which high power fields showed a significant reduction in number of axis-cylinders—obviously a degree of loss of potential functional significance.

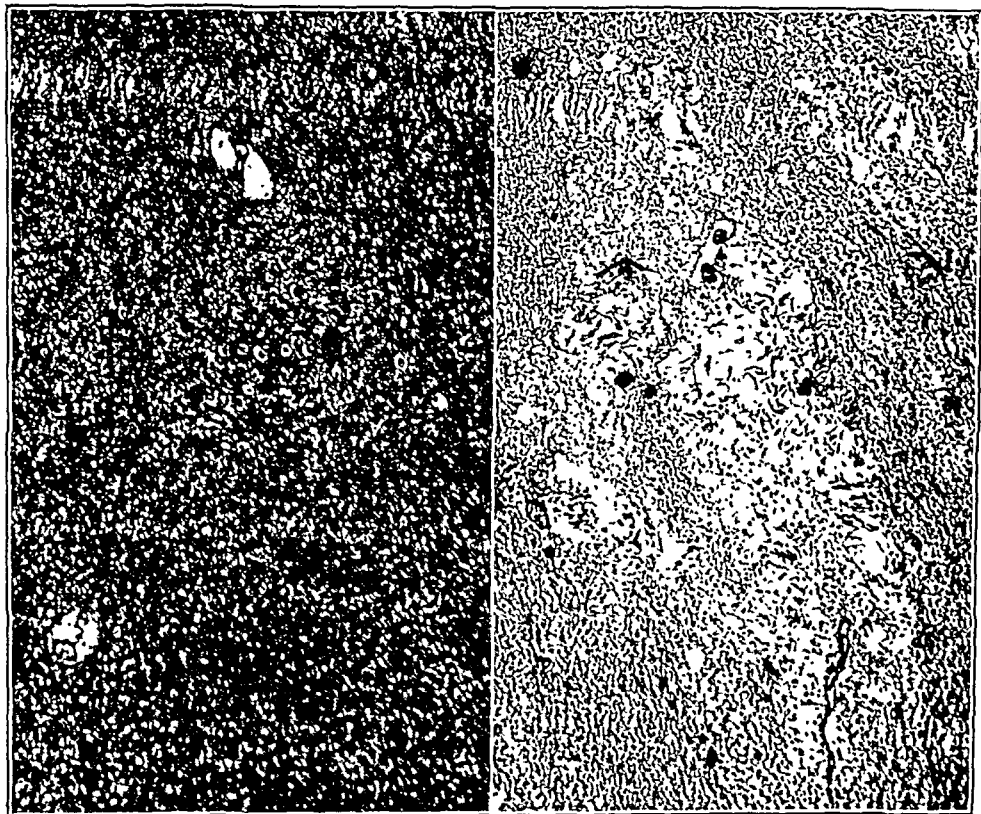

Fig. 3.—Axis-cylinders in relatively normal white matter (left) and in a periventricular plaque (right) from the same slide in an old case of multiple sclerosis. Bodian method; medium power lens.

An attempt was made to carry out the recommendation made in a previous paper,⁹ that actual counts of axis-cylinders should be made. This proved difficult in many cerebral plaques because of the varying directions at which the fibers are running in the cerebral white matter and the resulting density of the feltwork in the relatively normal areas.

9. Alexander, L., and Putnam, T. J.: The Element of Optical Illusion in the Appearance of Preservation of Axis-Cylinders in Certain Lesions of the Central Nervous System, *Arch. Neurol. & Psychiat.* **44**:1312-1318 (Dec.) 1940.

This circumstance may cause the same fiber to be counted more than once in a given section. In the spinal cord, however, with its regular parallel arrangement of tract fibers, axis-cylinders and myelin sheaths can be counted in cross sections as easily as red blood cells in a blood-counting chamber.

An example of such a count is as follows: A section of spinal cord was chosen in which there was a definite sclerotic plaque extending exactly to the ventral septum, with relatively slight loss of axis-cylinders on casual inspection. This was stained by the Bodian method and photographed, together with the corresponding, relatively normal, side

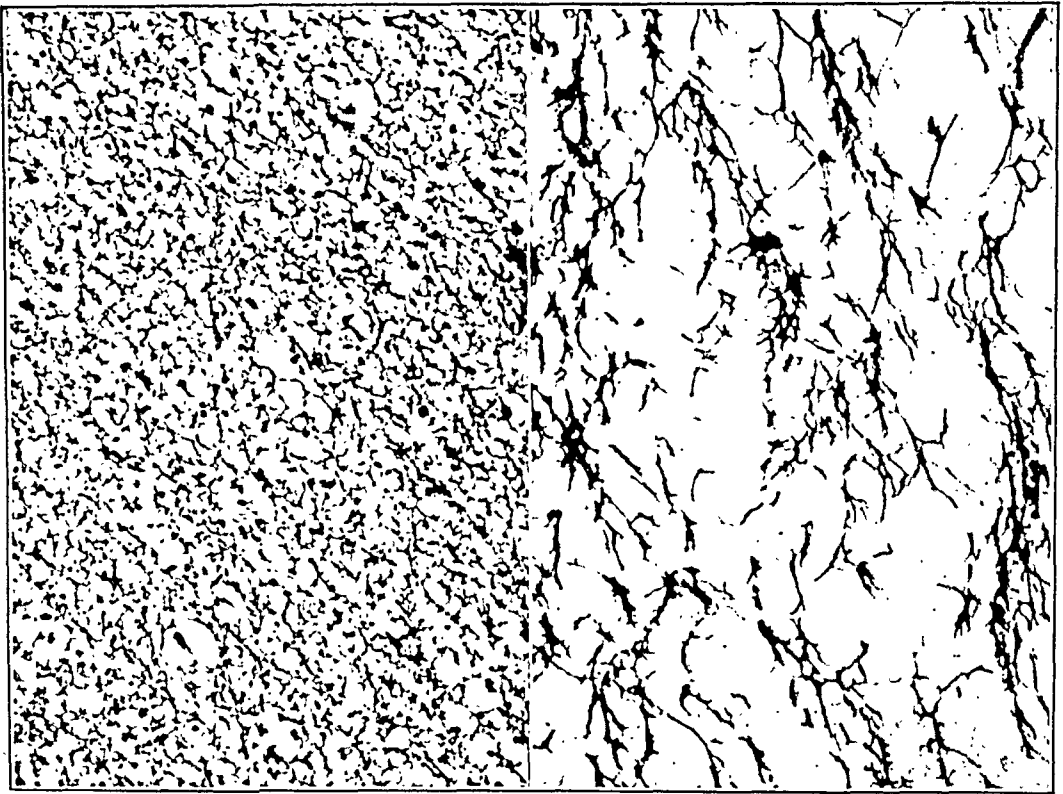

Fig. 4.—Axis-cylinders in relatively normal white matter (left) and in a periventricular plaque (right) from a case of multiple sclerosis. Bodian stain, Rosett modification; high power lens. The appearance under a low power lens suggested little loss of axis-cylinders.

(fig. 5 *A*). Also, two higher enlargements were taken of closely corresponding representative areas on each side of the septum (fig. 5 *B* and *C*). A segment of a micrometer objective was photographed at the same magnification, and from it squares measuring 0.01 mm. on each side were cut. These were used to enclose typical areas in each high power photomicrograph. Five such areas were counted on each side. The results were as follows: relatively normal side, 212, 216, 224, 235, 237 axis-cylinders per 0.01 mm. square, or 1,134 in all; area of plaque, 173, 176, 183, 189, 189 axis-cylinders per 0.01 mm. square, or 890 in all.

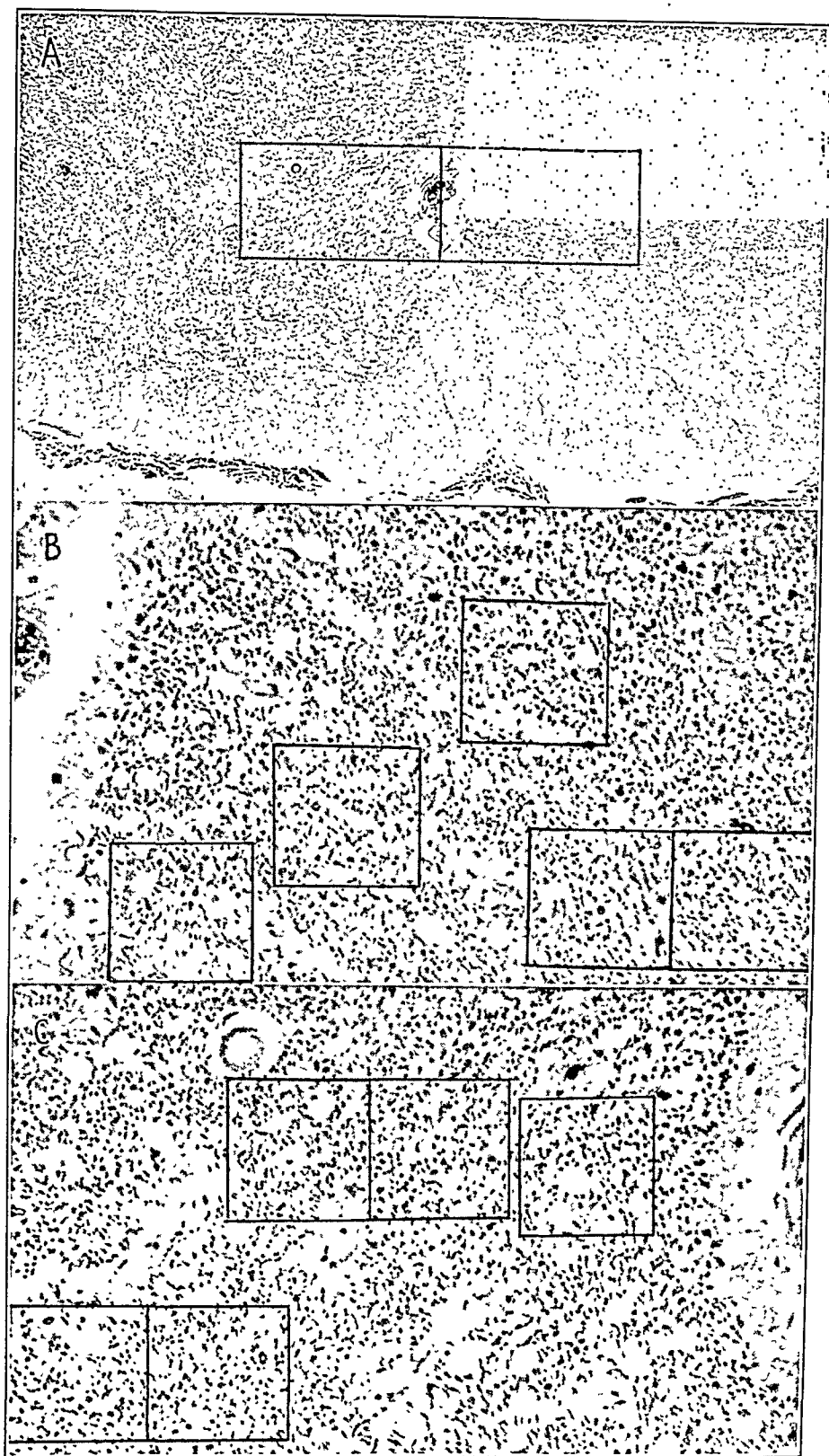

Fig. 5.—Section from the spinal cord in a case of multiple sclerosis, cut at 5 microns and stained by the Bodian method. *A*, low power view, showing at casual glance the apparent intactness of axis-cylinders on both sides and the areas enlarged in *B* and *C*. *B*, right side, relatively normal total number (1,134) of axis-cylinders in five 0.01 mm. squares; *C*; left side, area of plaque, total number (890) of axis-cylinders in five 0.01 mm. squares. The actual squares

In the more acute lesions, in which no fibrous gliosis had taken place, there was much interstitial edema and deformity of the axis-cylinders. Some of them were fragmented; others, thinned, tortuous or swollen. This was particularly striking in a case of the acute type sometimes described as neuromyelitis optica¹⁰ (fig. 6). A group of abnormal, but persistent, axis-cylinders in this case, and the fact that axis-cylinders showing similar changes in experimental lesions apparently recover, suggest that this is a reversible change. These abnormalities were less conspicuous in the older lesions, but it was obvious that the average diameter of axis-cylinders was below normal. Usually the number of axis-cylinders actually missing was greater in the older than in the younger lesions.

On the whole, fibrous gliosis (as demonstrated with Mallory's phosphotungstic acid hematoxylin stain) was inconspicuous in all the cerebral plaques, and it was entirely absent in the acute ones.

Secondary Degeneration.—Another criterion of destruction of axis-cylinders is the production of secondary degeneration by intense lesions lying in regions where most of the fibers have a parallel course. Secondary degeneration of the pyramidal tracts in cases of multiple sclerosis has been reported by Dawson¹¹ and others. We have observed it occasionally. It did not occur in the case of neuromyelitis optica included in the series.

Relation Between Loss of Myelin and Loss of Axis-Cylinders in Other Lesions of Vascular Origin.—The previous quotation from Spielmeyer mentions the fact that a relative persistence of axis-cylinders may occur in any anoxic lesion of the nervous system. Few studies have been devoted to the subject, however. Farnell and Globus¹² called attention to the preservation of axis-cylinders in Binswanger's subcortical encephalopathy, obviously of vascular origin. A general review of the experimental¹³ and pathologic aspects of the subjects¹⁴ has been given elsewhere. In the course of one of these studies, lesions resulting from experimental blockage of cerebral veins by means of a bland oil were

10. Putnam, T. J., and Forster, F. M.: To be published.

11. Dawson, J. W.: *The Histology of Disseminated Sclerosis*, Tr. Roy. Soc. Edinburgh **1**:517-740, 1916.

12. Farnell, F. J., and Globus, J. H.: *Chronic Progressive Vascular Subcortical Encephalopathy: Chronic Progressive Encephalitis of Binswanger*, Arch. Neurol. & Psychiat. **27**:593-604 (March) 1932.

13. Putnam, T. J.: *Studies in Multiple Sclerosis: Encephalitis and Sclerotic Plaques Produced by Venular Obstruction*, Arch. Neurol. & Psychiat. **33**:929-946 (May) 1935.

14. Putnam, T. J., and Alexander, L.: *Tissue Damage Resulting from Disease of Cerebral Blood Vessels*, Proc. A. Research Nerv. & Ment. Dis., Proc. (1937) **18**:544-567, 1938.



Fig. 6.—Sections from a block from the spinal cord in a case of multiple sclerosis of the neuromyelitis optica type. Left, Mahon stain for myelin; right, Bodian stain for axis-cylinders. Note apparent intactness of axis-cylinders. Lens enlargement.

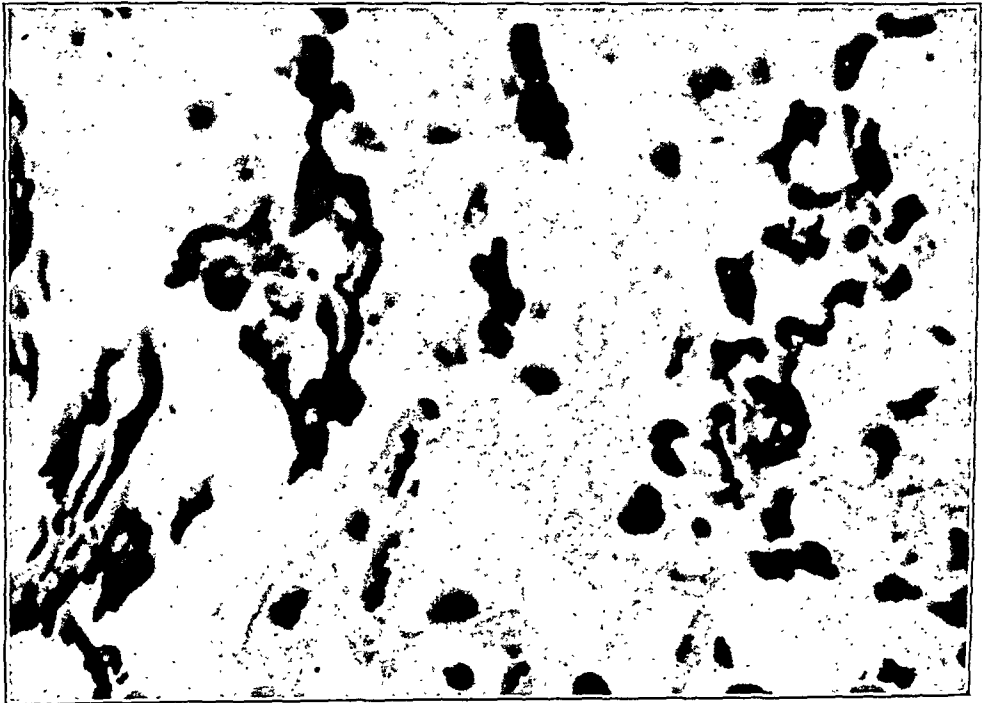

Fig. 7.—Swollen, hyalin-appearing axis-cylinders from the same slide as that shown in figure 6, right side. Bodian stain; oil immersion lens.

observed to consist of as exquisite a local demyelination with preservation of axis-cylinders as has even been encountered in pathologic material of human origin.¹³

In the course of the present study, 2 cases of cerebral arteriosclerosis, infarction and venous thrombosis, chosen at random, were studied in which small or large discrete lesions without actual softening had occurred. In all the lesions examined the degree of destruction of axis-cylinders showed the same range of variation as in the sclerotic plaques—that is, from the situation in which only a few axons per high power field are seen to that in which the density of axons appears altered only by swelling or by interstitial edema at low magnifications (fig. 7).

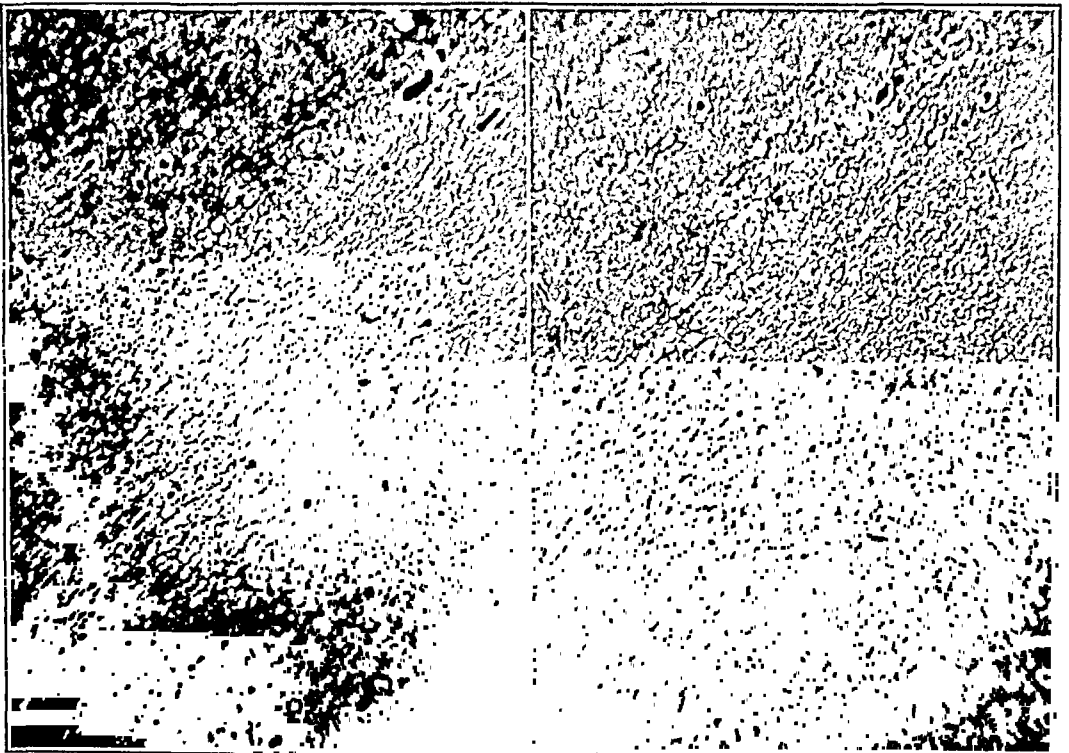

Fig. 8.—Sections from corresponding fields of adjacent sections from a case of cerebral arteriosclerosis. Left, Mahon stain; right, Bodian stain for axis-cylinders. Low power lens. Note the exquisite demyelination, with apparently relatively slight loss of axis-cylinders.

COMMENT

The evidence here presented is obviously compatible with the point of view that has been presented elsewhere,¹⁵ namely, that the parenchymal lesions in multiple sclerosis are secondary to a local disturbance of circulation. It suggests that the conception of a specific process of demyelination peculiar to multiple sclerosis deserves revision.

The fact that fibrous gliosis is not observed in the most acute lesions of multiple sclerosis strongly suggests that the glial scar is secondary

15. Putnam, T. J.: Evidences of Vascular Occlusion in Multiple Sclerosis and Encephalomyelitis, *Arch. Neurol. & Psychiat.* **37**:1298-1321 (June) 1937.

to the local destructive process. This is borne out by various earlier studies of this series¹⁶ and by the more recent observations of Greenfield and King,⁵ who never saw glial fibrosis in lesions less than two weeks old. Greenfield and King preferred a different interpretation of the process and objected to calling the gliosis secondary, but they apparently did not regard it as primary. The gliosis of sclerotic plaques is seldom as dense as that occurring in old secondary degenerations.⁴

The fact that many axis-cylinders are damaged in lesions of multiple sclerosis has also an important bearing on the problem of prognosis and treatment. It is reasonable to assume that the acute stage of swelling and distortion of axis-cylinders corresponds to the acute stage often observed in symptoms. There would appear to be little hope that any form of treatment would increase the number of persisting axis-cylinders once the lesion is formed. On the other hand, only an extension of the lesion would seem likely to injure substantially more axons than those seen damaged in the acute stage.

The clinical corollary is obvious: As has been pointed out elsewhere,¹⁷ the effect of treatment should be estimated by its ability to prevent exacerbation in a significant proportion of cases over a sufficient period, rather than by the improvement in established symptoms which may coincide with its use.

SUMMARY

Studies by means of the Bodian silver stain for axis-cylinders, which is uniquely specific and especially adapted to the purpose, showed that some degree of damage or destruction of axons occurred in all the sclerotic plaques investigated.

In all but 2 of the plaques examined the axis-cylinders were reduced to a small fraction of the normal number.

The pathologic appearance of surviving axis-cylinders was more striking in fresh plaques than in old ones.

Similar changes, of about the same degree of intensity, were seen in some other lesions of vascular origin, not sufficiently intense to cause complete necrosis.

The clinical correlation of these observations, especially with respect to treatment, is discussed.

416 North Bedford Drive, Beverly Hills, Calif.

433 Marlborough Street, Boston.

16. Putnam (footnotes 4, 13 and 15).

17. Putnam, T. J.: The Criteria of Effective Treatment in Multiple Sclerosis, *J. A. M. A.* **112**:2488-2491 (June 17) 1939.

TOPOGRAPHIC DISTRIBUTION OF LESIONS IN CENTRAL NERVOUS SYSTEM IN JAPANESE B ENCEPHALITIS

Nature of the Lesions, with Report of a Case on Okinawa

LIEUTENANT COLONEL WEBB HAYMAKER
MEDICAL CORPS, ARMY OF THE UNITED STATES

AND

ALBERT B. SABIN, M.D.*

CINCINNATI

THE OBJECT of this study was to determine the nature and distribution of various types of lesions in the central nervous system of a patient with Japanese B encephalitis. The case was one that occurred during an outbreak of this disease on Okinawa in the summer of 1945.

REPORT OF CASE

CLINICAL HISTORY

A young white American soldier was admitted to a field hospital on Okinawa on Aug. 4, 1945, in a somnolent state. From his fragmentary story, it appeared that he had become ill about July 28, with headache, fever, pain in the eyes, weakness and dizziness. He stated that he felt "mixed up," that the headache was "terrible" and that during the previous week he had become increasingly drowsy.

On admission, seven to eight days after the onset of illness, his temperature was 104 F. and his pulse rate 100 a minute. He was cooperative one moment and irritable the next. He kept clutching at the bedclothes. He could be awakened with difficulty for questioning but soon lapsed again into a deep sleep. He was unable to state the name of his unit, where he was, the day of the week or the date. His neck was rigid, and pain was elicited on forward flexion of the head. There was no evidence of involvement of the cranial nerves. The optic disks appeared normal. The biceps and triceps reflexes were diminished on both sides; the knee jerks were equal and hyperactive, and the ankle jerks were normal. The abdominal reflexes were hyperactive; the cremasteric reflexes were diminished. The Babinski sign could not be elicited. The cerebrospinal fluid contained 192 cells per cubic millimeter, of which 97 per cent were of mononuclear type, and

From the Army Institute of Pathology, Washington, D. C., and the Children's Hospital Research Foundation, Department of Pediatrics, University of Cincinnati College of Medicine.

* The work on Okinawa, and subsequently in the United States, was done while Dr. Sabin was serving as lieutenant colonel in the Medical Corps, Army of the United States, with the Army Epidemiological Board, Preventive Medicine Service, Office of the Surgeon General, United States Army. The investigation was sponsored by the Commission on Neurotropic Virus Diseases, Army Epidemiological Board.

the Pandy test was reported to give a negative reaction. The leukocyte count of the blood was 10,650, with 77 per cent neutrophils and 23 per cent lymphocytes. No malarial parasites were seen in the blood smear.

On August 5 the patient was completely disoriented, lethargic and rigid. The axillary temperature was 101.6 F., and the pulse rate was 88. Two generalized convulsions occurred. The abdominal reflexes were now absent, and the knee and ankle jerks were exceedingly hyperactive. Ankle clonus was readily elicited. The Hoffmann sign was not elicited. Further examination was not made because of the patient's rigidity and extreme restlessness. He died at 3 a. m. on August 7, about ten days after onset of the illness. Major Wiley L. Forman, of the Medical Corps, supplied the clinical observations on this patient.

Necropsy.—Necropsy was performed five hours after death. Examination of the viscera, by Capt. Robert A. Green and Lieut. Benjamin F. Levy, of the Medical Corps, revealed nothing noteworthy except for slight enlargement of the spleen. The brain and the spinal cord were removed by one of us (A. B. S.) under relatively aseptic conditions. Grossly, the external surface of the brain showed no change other than diffuse congestion. The spinal cord was generally rather soft, and in the lower cervical region was almost mushy.

VIRUS STUDIES

Under sterile conditions, blocks of gray matter, approximately 1 cm. in size, were removed from the frontal, parietal and occipital cortex of both sides, and smaller pieces were taken from the midbrain, pons, médulla oblongata, cerebellar cortex and upper cervical portion of the cord. The tissue was placed in 50 per cent buffered glycerin in saline solution, stored immediately in a refrigerator, then packed in ice and transported to a field laboratory, where at about 5 p. m. of the same day an extract was inoculated into mice.

Although attempts to isolate the virus were unsuccessful, despite the large numbers of lesions observed histologically, it seems desirable to record in detail the procedure employed. One half of each piece of tissue removed was used and the rest saved. What was used was washed only once in saline solution, and about 4 Gm. was ground without abrasive, in 10 cc. of saline solution. The concentrated extract obtained after a short period of centrifugation was injected intracerebrally (0.03 cc.) and intra-abdominally (1.0 cc.) into 5 Swiss albino mice brought from the United States. These mice were kept in screened cans and observed daily. On the fifteenth day after inoculation, 1 of the mice which exhibited a reddish discharge around both eyes, had ruffled fur and in other ways appeared ill, was killed. Part of its brain was passed immediately through 5 more mice, and the rest was stored in 50 per cent buffered glycerin in saline solution in the cold and subsequently was taken to the United States, where on Sept. 21, 1945, it was passed through another 5 mice. The remainder of the original human tissue, after storage in the refrigerator for eleven days, was thoroughly washed in saline solution, and a suspension of it was inoculated into another group of 5 Swiss mice, brought from the United States. All these attempts at inoculation yielded negative results. The subsequent disclosure of widespread cerebral lesions in this case warrants the assumption that the samples taken for animal inoculation were similarly affected but that the lesions no longer contained virus. It has previously been demonstrated¹ in cases of human polio-

1. Sabin, A. B., and Ward, R.: Nature of Non-Paralytic and Transitory Paralytic Poliomyelitis in Rhesus Monkeys Inoculated with Human Virus, *J. Exper. Med.* **73**:757-770, 1941.

myelitis that when death occurred three to four days after onset of paralysis the virus could not be isolated from the spinal cord, medulla oblongata, midbrain or diencephalon, where the lesions were advanced, but could still be obtained from the motor cortex and the contents of the descending colon.

An attempt to isolate virus from cerebrospinal fluid obtained from the patient about eight days after the onset, or two and a half days before death, also yielded negative results. Tests on blood serum taken at the same time indicated that, while complement-fixing antibodies were absent, small but definite amounts of neutralizing antibodies for the Okinawa strain of Japanese B encephalitis virus (isolated from another fatal case²) were present. The results shown in the table indicate that while the neutralization index in the intracerebral test was only 32, that in the intraperitoneal test was at least 10,000. One of us (A. B. S.) has

Neutralization Tests with Serum of the Patient and Japanese B Encephalitis Virus (Okinawa Strain)*

Type of Test	Source of Serum	Dilution of Virus in Mixture						LD ₅₀ Titer of Virus	Neutralization Index †	
		10 ⁻³	10 ⁻⁴	10 ⁻⁵	10 ⁻⁶	10 ⁻⁷	10 ⁻⁸			10 ⁻⁹
Intracerebral	Normal rabbit control.....	4/4‡	3/4	3/4	0/4	10 ^{-8.2}
	Patient.....	3/4	1/4	1/4	...	10 ^{-6.7}	32
Intraperitoneal (14 day old mice)	Normal rabbit control.....	4/4	4/4	3/4	3/3	3/4	3/4	...	10 ^{-8.2} +?
	Patient.....	2/3	2/4	1/4	1/4	0/3	10 ^{-4.2}	10,000 (+?)

* The serum was obtained seven to eight days after onset of the illness, and two and a half days before death.

$$\dagger \text{Neutralization index} = \frac{\text{LD}_{50} \text{ titer of virus in control serum mixtures}}{\text{LD}_{50} \text{ titer of virus in test serum mixtures}}$$

‡ 4/4 indicates that all 4 inoculated mice died of encephalitis; 3/4 that 3 mice died, etc. Similarly, 3/3 indicates that all 3 inoculated mice died, etc.

found that when a very low, questionable neutralization index in the intracerebral test is due to nonspecific factors the intraperitoneal test yields negative results. However, a human serum obtained about three days after onset of Japanese B encephalitis has been found to have an intracerebral neutralization index of 20, whereas in the intraperitoneal test the index was at least 500,000.

MATERIAL AND METHODS FOR HISTOLOGIC STUDY

The material consisted of the entire brain and spinal cord, portions of the peripheral nervous system, the pituitary gland and representative blocks from the thoracic and abdominal viscera. All had been fixed in solution of formaldehyde U. S. P. (1:4).

Since the study was undertaken to gain an understanding of the topographic distribution of the lesions of Japanese B encephalitis, representative blocks of tissue were removed from every level of the central nervous system bilaterally. The

2. Sabin, A. B.: Outbreak of Encephalitis on Okinawa in 1945: Preliminary Report on Status as of 27 August 1945, *J. Mil. Med. in Pacific* 1:79-84, 1945; Epidemic Encephalitis in Military Personnel: Isolation of Japanese B Virus on Okinawa in 1945, Serologic Diagnosis, Clinical Manifestations, Epidemiologic Aspects and Use of Mouse Brain Vaccine, *J. A. M. A.* 133:281-293 (Feb. 1) 1947.

3. Footnote deleted by authors.

cerebral cortex was generously sampled, one or two blocks being taken from each gyrus. From the caudate and lenticular nuclei and the diencephalon the sampling was done at four levels; from the hippocampal formation, at three levels, and from the nucleus amygdalae, at two levels. Two blocks each were obtained from the

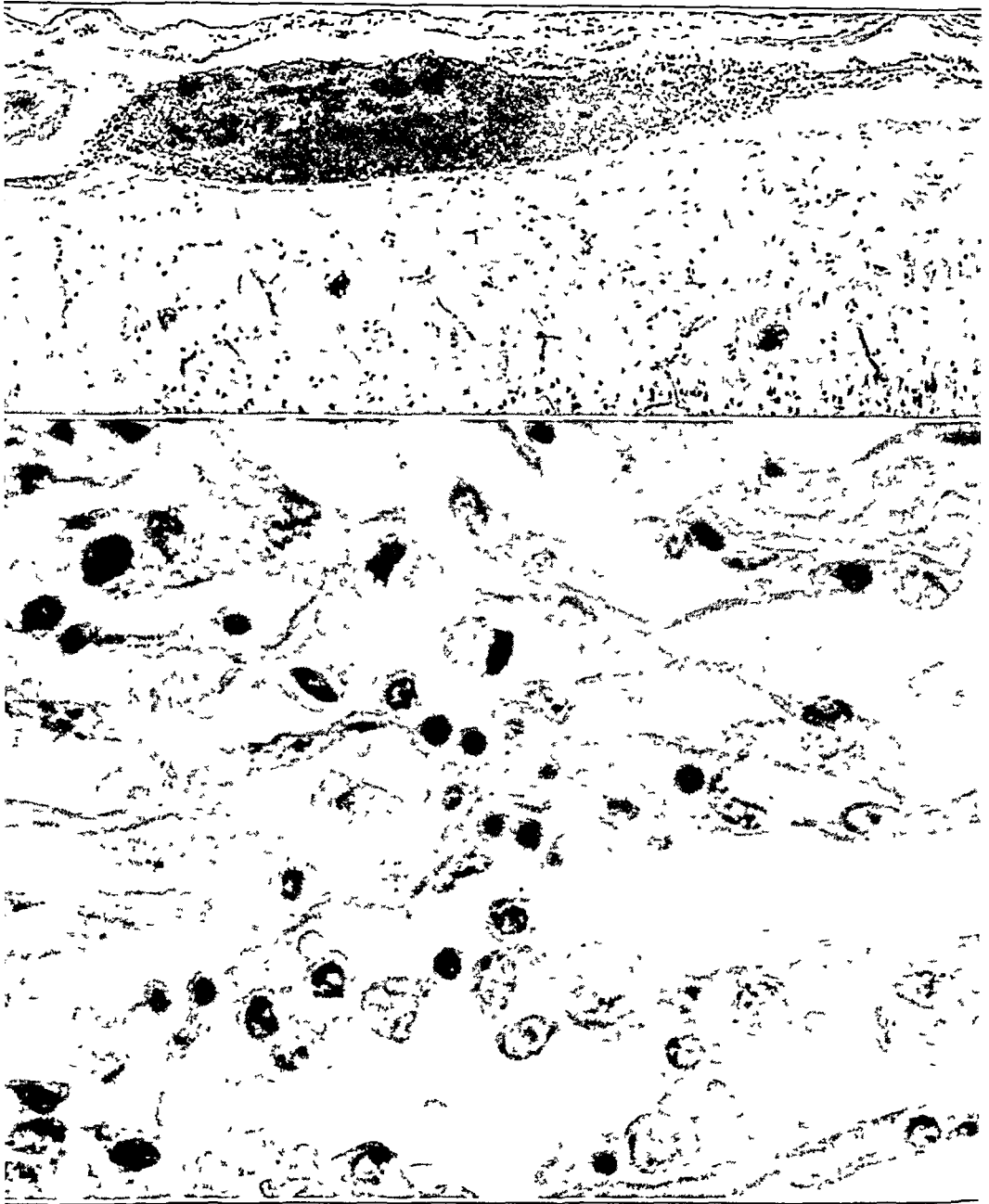

Fig. 1.—Cellular constituents of the leptomeninges. *A* ($\times 100$; AIP neg. 92622), from the medial orbital gyrus, shows a vein surrounded with lymphocytes, some of which trail off into the adjacent arachnoid meshes. A few larger cells in the arachnoid, having the characteristics of histiocytes, also are visible. In *B* ($\times 860$; AIP neg. 93063), from the leptomeninges of the precentral gyrus, some of the small cells may be lymphocytes, but the majority probably represent stages in the development of trabecular cells into histiocytes, of which many are present in the arachnoid meshes. Hematoxylin and eosin stain.

midbrain, the pons and the medulla oblongata, and six, from the spinal cord. Altogether, nine blocks were taken from the cerebellum, three of which contained portions of the dentate or the roof nuclei. The choroid plexuses were included in samples removed from the region of the ventricles.

All the blocks of tissue used in the topographic study were embedded in paraffin, sectioned at 6 microns and stained with hematoxylin and eosin. Additional blocks were embedded in pyroxylin and stained with cresyl violet. Frozen sections were

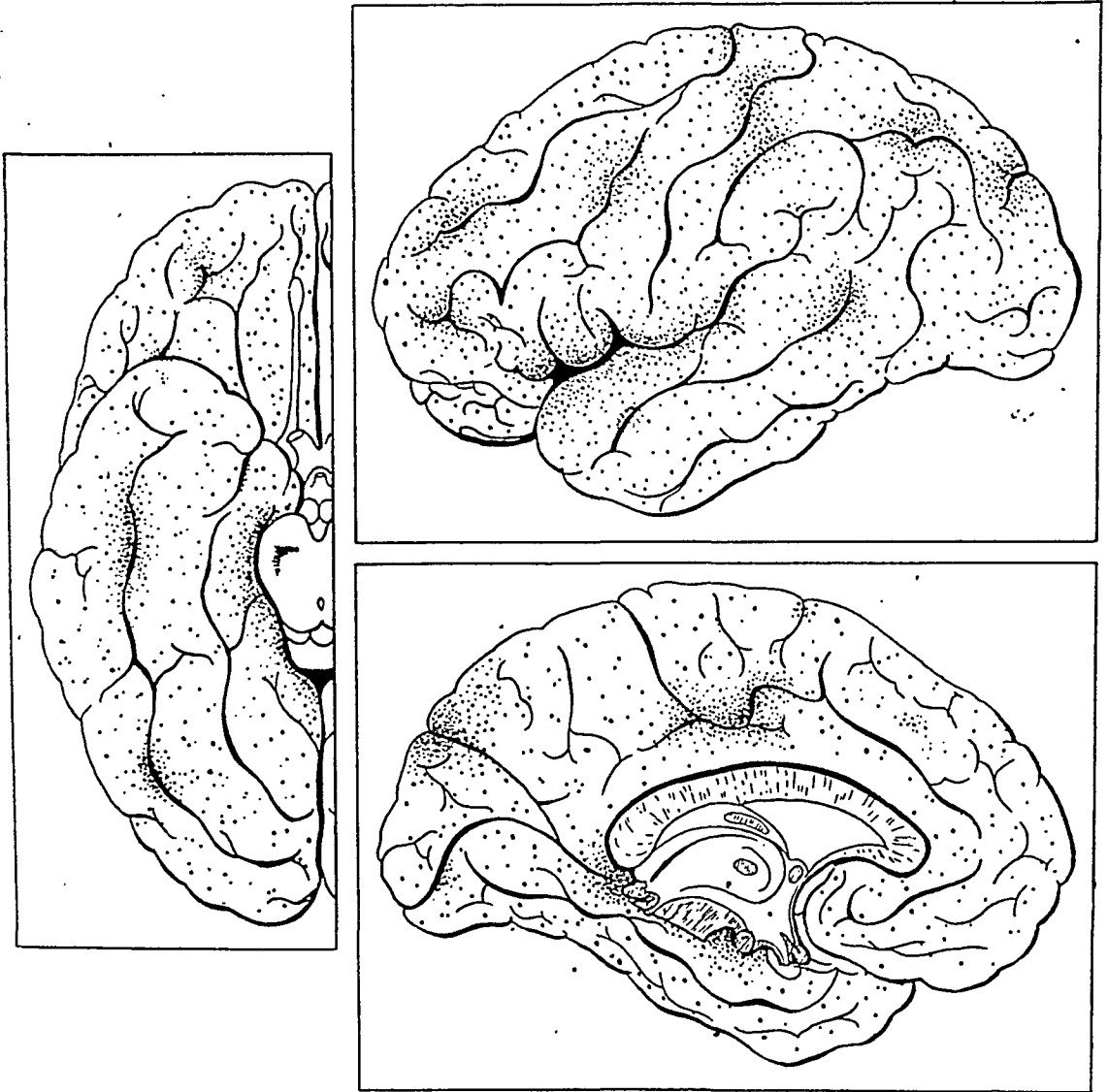

Fig. 2.—Distribution of leptomenigeal cells, both exudative and reactive, over the three surfaces of the brain.

impregnated with silver by the Hortega method and were stained for fat by means of sudan III and for myelin by a modification of the Weigert method.

Preliminary examination of the sections of the brain revealed diffuse involvement of the leptomeninges and a multitude of nodules in the gray matter. In an effort to determine the relative degree of involvement at the various levels of the central nervous system, the following procedure was adopted: Beginning with the cerebral cortex, the number of low power fields (magnification, 35) in

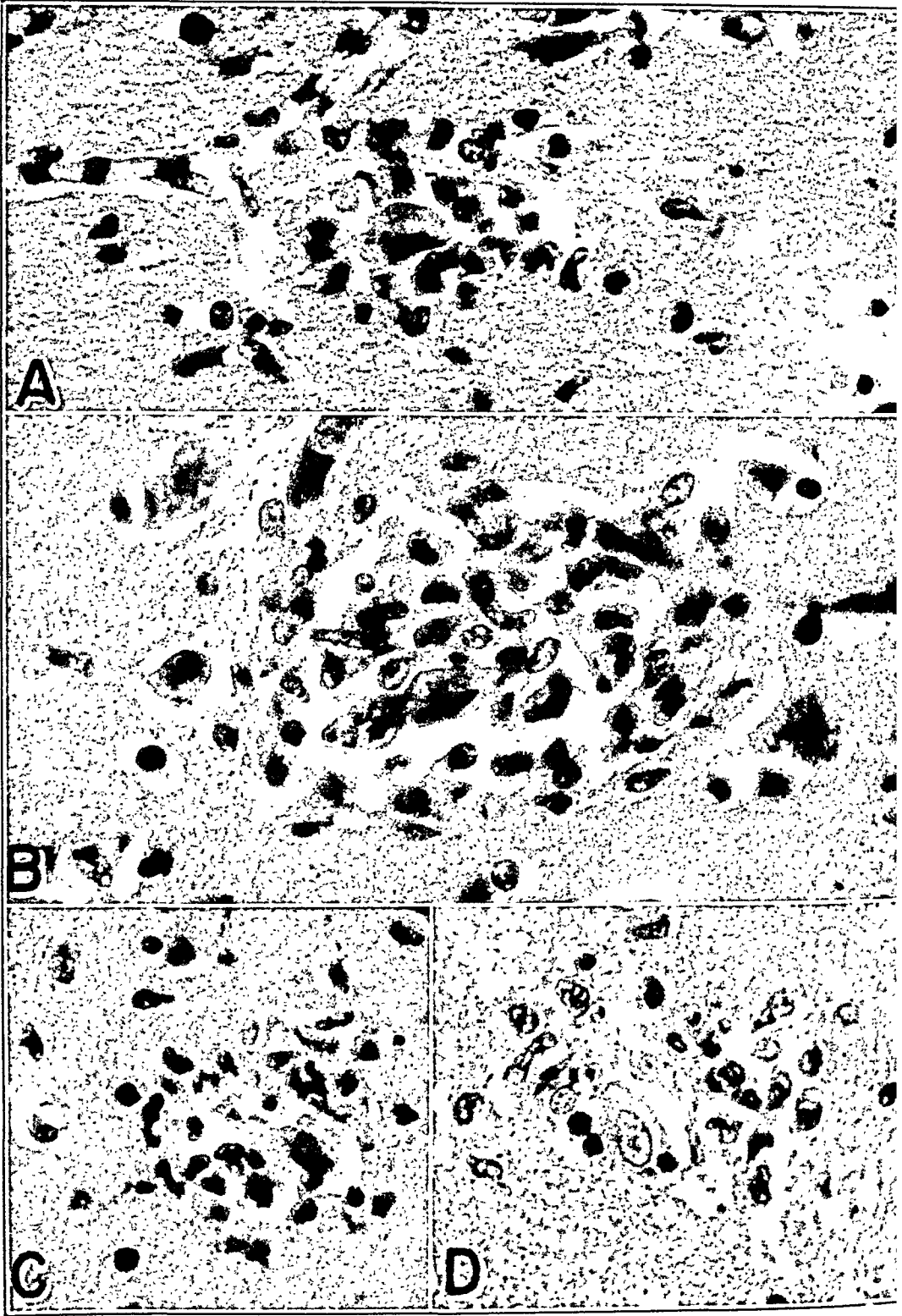

Figure 3

(See legend on opposite page)

each section was determined; then the nodules in all the fields were counted, and from these two figures the number of nodules in each low power field of the cerebral cortex was ascertained. The counts were made first on one side of the brain and then on the other, and an average was struck. The same calculations were carried out in sections of the subcortical white matter. When lesions of the cerebral cortex were diffuse, occupying a lamina or two, they were regarded as the equivalent of two to four nodules. Then the leptomeninges were examined, and the degree of cellular increase was estimated in terms of 1 to 4 plus. The same evaluation was made with respect to inflammatory cells surrounding blood vessels of the cerebral cortex and the subcortical white matter.

The degree of involvement of the cerebral cortex served as the basis for estimating the density of the lesions in the rest of the brain and in the spinal cord. So great were the difficulties entailed in counting the number of microscopic fields in the various areas of gray matter that it was necessary to rely on a visual impression of the number of nodules and of perivascular cuffs of lymphocytes in the respective structures.

HISTOLOGIC OBSERVATIONS

Cellular Constituents in the Leptomeninges and Their Distribution.—The cells occupying the leptomeninges were predominantly lymphocytes and histiocytes. The lymphocytes, with a few plasma cells intermixed, were mainly perivenous in location (fig. 1 *A*), but some were scattered through the meshes of the arachnoid. Perivenous cuffs of lymphocytes frequently extended downward in the Robin-Virchow spaces of cortical veins. The aggregations of lymphocytes were somewhat more numerous within sulci and fissures than over the surface of the brain. The histiocytes, on the other hand, were usually independent of vessels, collections of them lying free in the meshes of the arachnoid. Appearances suggested that many arose in the arachnoid, since all gradations, from hyperplastic trabecular cells to well developed histiocytes, were present (fig. 1 *B*). Phagocytosis of lymphocytes and unidentified debris by histiocytes was frequently observed. Accumulations of histiocytes were most common at the mouth and the base of fissures and sulci.

The over-all distribution of the leptomeningeal reaction is shown in figure 2. The spread was uniform on the three surfaces of the brain, except for concentration in the region of a number of the sulci and fissures. Leptomeningeal reaction over the hypothalamic region and in the interpeduncular fossa was of moderate degree, but was minimal over the midbrain, pons, medulla oblongata, cerebellum and spinal cord. None of the leptomeningeal blood vessels were thrombosed or showed intimal proliferation.

Fig. 3.—Neuronophagic nodules in various stages of development. In *A* ($\times 625$; AIP neg. 92618), from the inferior frontal gyrus, a necrotic ganglion cell is surrounded with pleomorphic mononuclear cells, some of which are emerging from the perineuronal space; similar cells line the edges of the adjacent vessel. In *B* ($\times 700$; AIP neg. 92616), from the same gyrus, appearances suggest that the perineuronal cells may, in part, have arisen from the vessel skirting the left edge of the neuronophagic nodule. In *C* ($\times 600$; AIP neg. 92615), from the precuneus, the perineuronal cells are beginning to invade the parenchyma; the nuclei of most of the cells are irregularly elongated. In *D* ($\times 675$; AIP neg. 94492), from the superior frontal gyrus, it appears likely that the reactive cells lying in the parenchyma adjacent to an intact ganglion cell may have arisen at a level somewhat removed from that photographed. Three oligodendrocytes are in the perineuronal space. Hematoxylin and eosin stain.

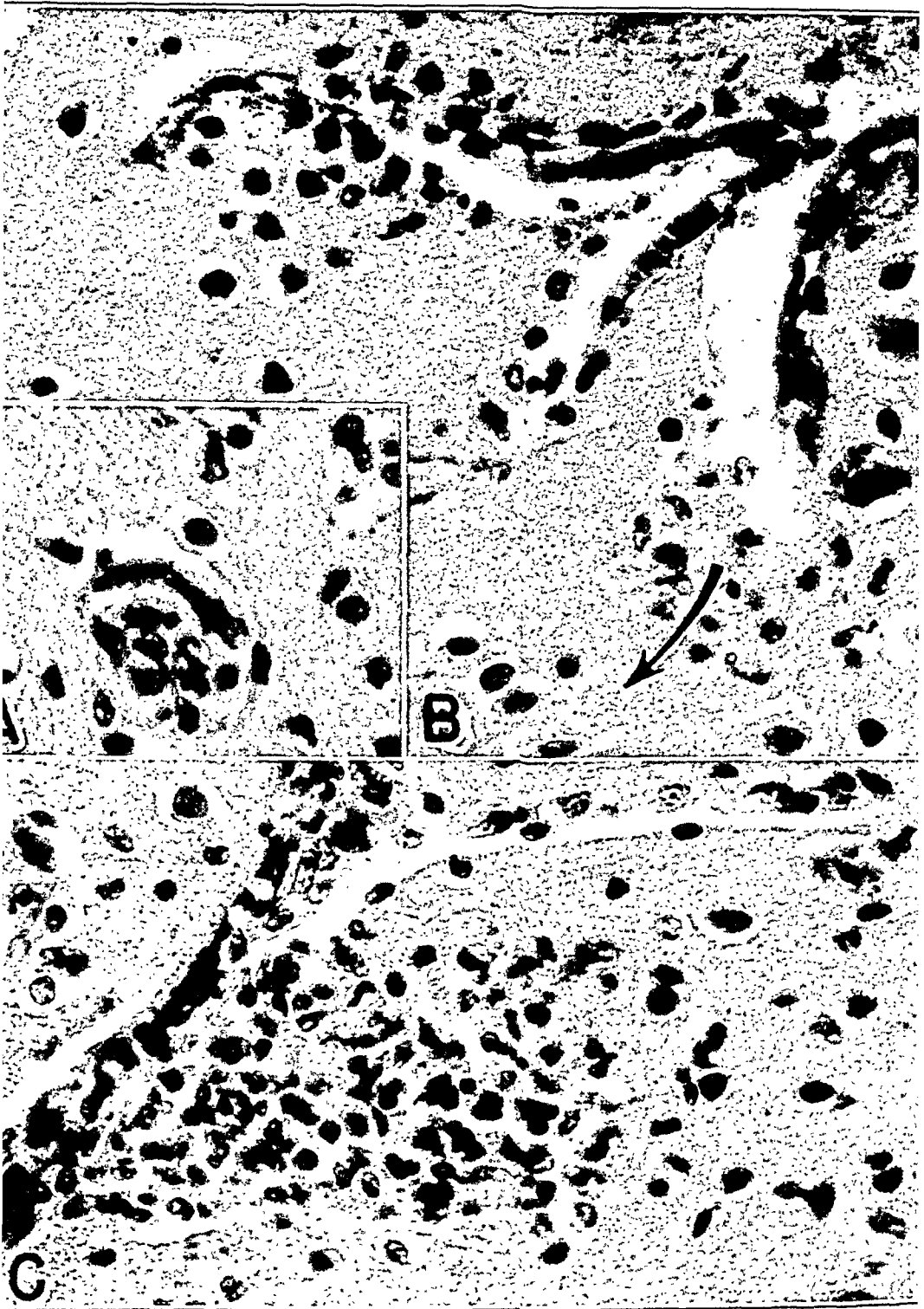

Figure 4

(See legend on opposite page)

Samples of the dura revealed no abnormalities except for an occasional hemorrhage and scattering of lymphocytes in some of the arachnoidal granulations.

Types of Lesions in the Central Nervous System and Their Distribution.—Two types of lesions predominated in the central nervous system: nodules and perivenous cuffs of lymphocytes. These lesions were restricted to the gray matter except for the perivenous cuffs of lymphocytes, which were present to a limited degree in the subcortical white matter.

Nodules of diverse size permeated the gray matter. In the cerebral cortex they were in close relation to degenerated or necrotic ganglion cells and to the walls of blood vessels. Many arising in the vicinity of ganglion cells (neuronophagic nodules) were confined to perineuronal spaces (fig. 3 *A*), sometimes ballooning the space to an extraordinary size (fig. 3 *B*) and frequently extending into the surrounding parenchyma (fig. 3 *C*). Occasionally there were nodules in the parenchyma which surrounded relatively normal ganglion cells (fig. 3 *D*); it is possible that these arose at a level somewhat removed from the one illustrated. The nodules related to blood vessels also varied in size, the smallest consisting of a few cells within the pericapillary spaces (fig. 4 *A*). Appearances indicated that the cells invaded the parenchyma at focal points (fig. 4 *B*), continuing to develop until relatively large nodules were formed (fig. 4 *C*). Often there was no clue as to the origin of larger nodules (fig. 5 *A*).

The cellular composition of all the nodules, whether arising in proximity to ganglion cells or to blood vessels, was essentially the same. Lymphocytes, characterized by a densely chromatic, spherical nucleus and scanty cytoplasm, were generally rather scant and tended to be most numerous in perivascular spaces (fig. 4 *B*). Occasionally cells resembling lymphocytes appeared to be in the process of passing through a vessel wall. However, the predominant cell was of the large mononuclear type, with a moderately chromatic, spherical, ovoid or irregularly elongated nucleus and rather abundant cytoplasm. Whether the majority issued from the blood stream or arose from fixed tissue cells of the adventitia could not be decided from microscopic examination. Appearances suggested that some of the cells within perineuronal spaces may have originated from an adjoining vessel (fig. 3 *B*), but it is plausible to assume that some arose from fixed tissue cells lining the perineuronal space. Hortega microglia cells were absent from the nodules, but cells advancing into the parenchyma (figs. 3 *C* and 4 *B*), and even those within perineuronal spaces (fig. 3 *B*), had pleomorphic nuclei, some of which bore a resemblance to the nuclei of Hortega cells. No gitter cells were observed, and sections of cerebral cortex stained with sudan III disclosed fat globules in only a few perivascular cells and in moderate numbers of ganglion cells. A search for neutrophils in the cerebral cortex was fruitless. Nowhere did astrocytes participate significantly in the reaction. Oligodendroglial satellitosis about ganglion cells was commonly observed in the deeper laminae of the cerebral cortex (fig. 5 *C*).

Fig. 4.—Stages in development of perivascular nodules. In *A* ($\times 700$; AIP neg. 92620), from the precentral gyrus, there is a clump of pericapillary cells which presumably are histiocytes arising in situ. In *B* ($\times 550$; AIP neg. 92617), from the inferior frontal gyrus, the perivascular cells, comprising mononuclear cells, are in the process of invading the parenchyma (see arrow). In *C* ($\times 500$; AIP neg. 92625), from an orbital gyrus, the parenchyma is being invaded by a mass of cells, mainly of the large mononuclear type. Contiguous perivascular spaces are heavily populated with cells, which are presumed to be both hemogenous and adventitial. Hematoxylin and eosin stain.

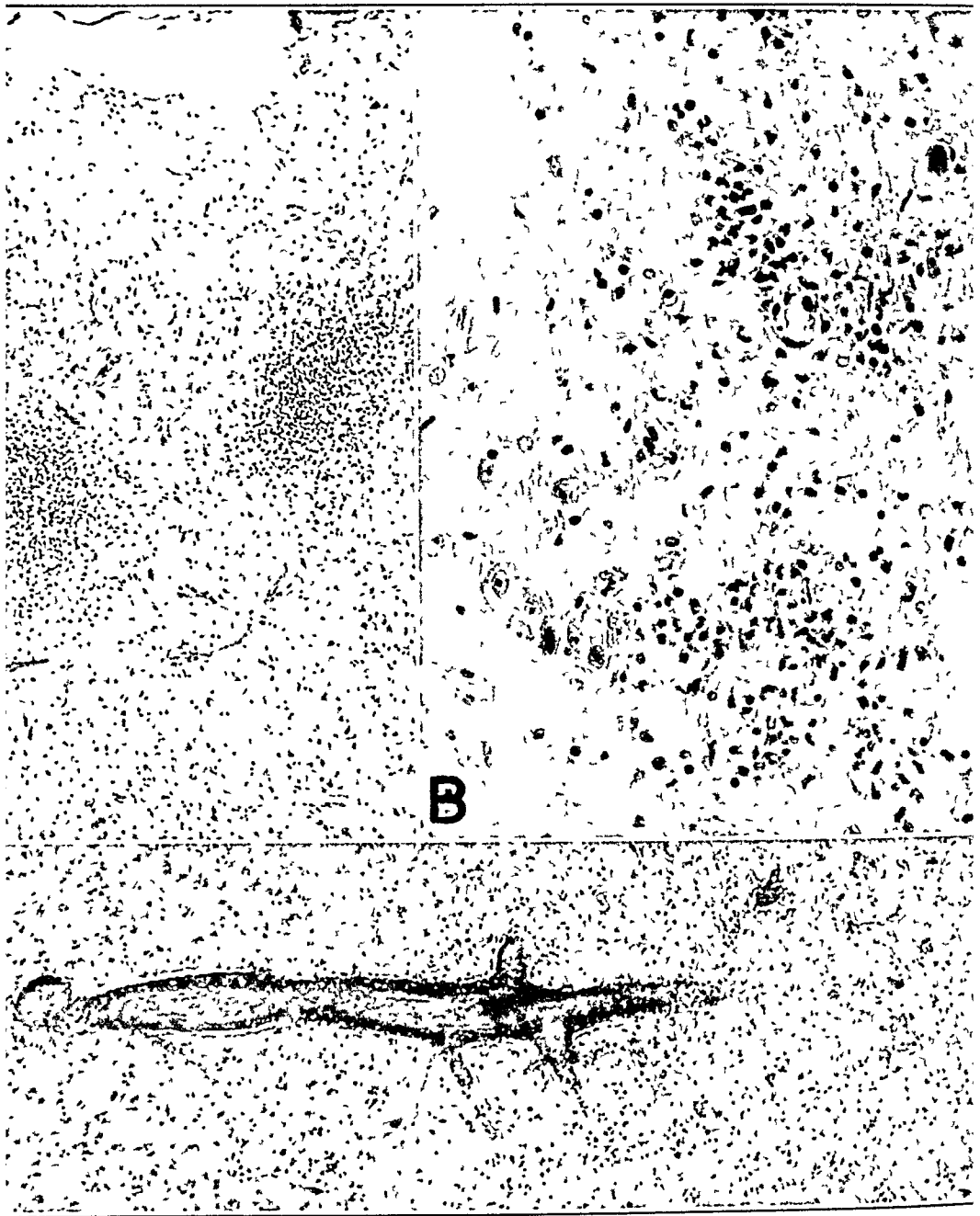

Fig. 5.—In *A* ($\times 69$; AIP neg. 92624), from the anterior part of the cingular gyrus, there are two large nodules, composed chiefly of mononuclear cells. A search failed to reveal neutrophils. In *B* ($\times 210$; AIP neg. 94457), from the hippocampal gyrus, diffuse aggregations of polymorphic mononuclear cells are concentrated around deteriorating ganglion cells and in regions from which ganglion cells have disappeared. In *C* ($\times 64$; AIP neg. 92609), from the superior temporal gyrus, a vein at the corticomedullary junction is surrounded by a collar of lymphocytes. Oligodendroglial satellitosis is prominent. Hematoxylin and eosin stain.

In addition to the relatively discrete nodules, there were areas, involving a lamina or two and including numerous neuronophagic nodules, which were permeated with cells similar to those described in the preceding paragraph (fig. 5 B).

The cerebral white matter was but little affected. Perivenous cuffs of lymphocytes predominated in the zone of the corticomedulullary junction (fig. 5 C). Occasionally there were proliferated oligodendrocytes and mononuclear cells, mainly perivascular in distribution. Neither stains for myelin nor those for fat revealed abnormalities.

The distribution of nodules over the three surfaces of the cerebral cortex is illustrated in figure 6. The numbers give the estimated number of nodules per

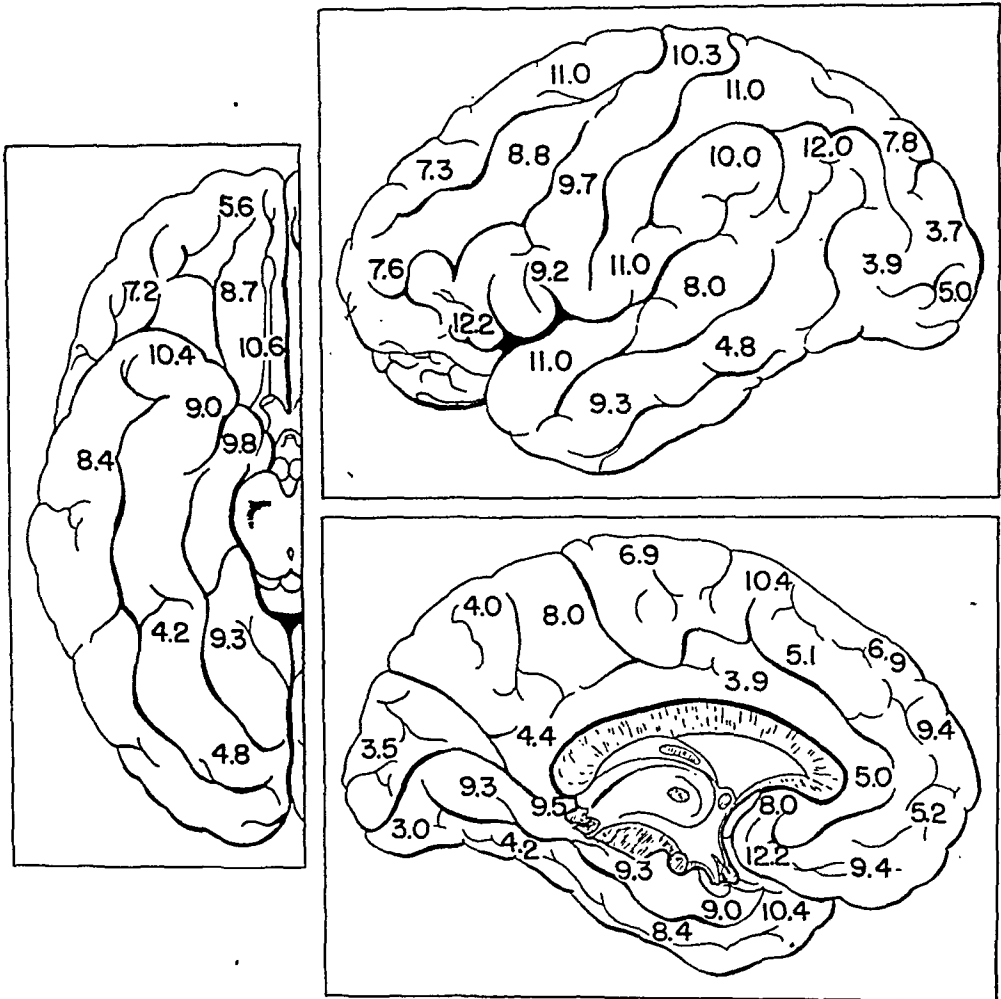

Fig. 6—The three surfaces of the brain, showing the number and distribution of nodules in the cortex. The figures indicate the number of nodules per field at magnification of 35 diameters.

low power field (magnification, 35). They tended to be most numerous in the region of the lateral fissure, the upper convex surface of the brain, the tip of the temporal lobe and the hippocampal and lingual gyri. The occipital lobe contained the fewest. The nodules were present in all laminae of the cerebral cortex, being least numerous in the uppermost.

The relative density of nodules and perivenous accumulations of lymphocytes in transverse sections of the brain, brain stem, spinal cord and cerebellum is illustrated in figure 7. The cuffs of lymphocytes predominated at the cortico-

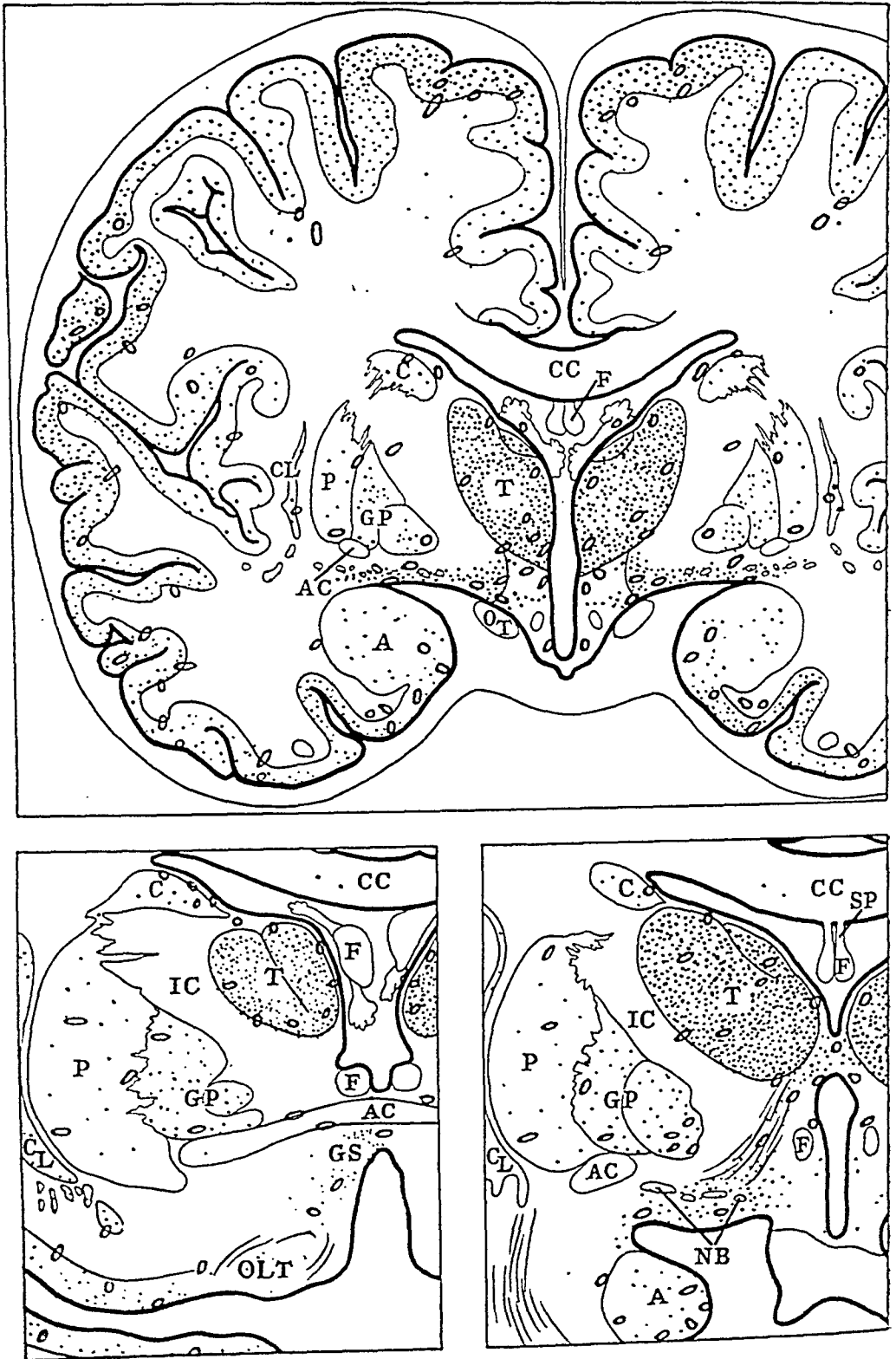
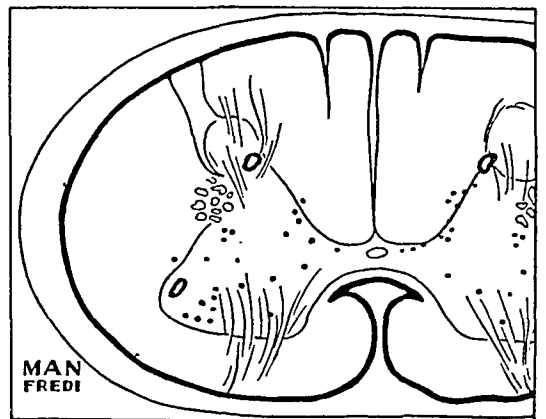
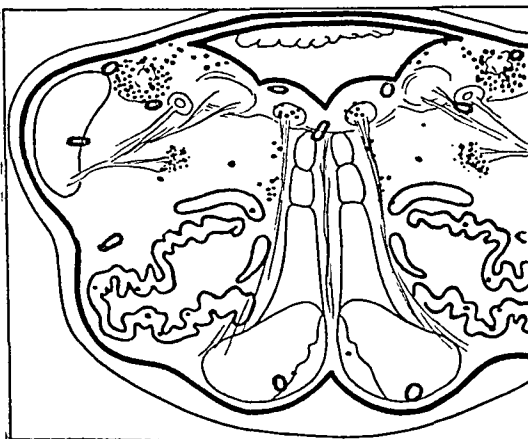
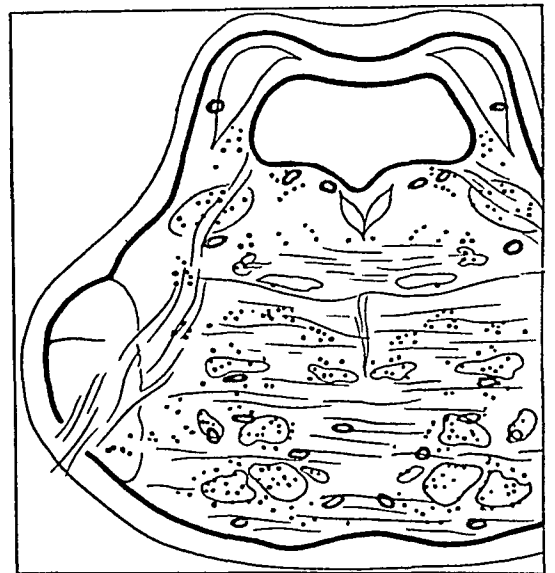
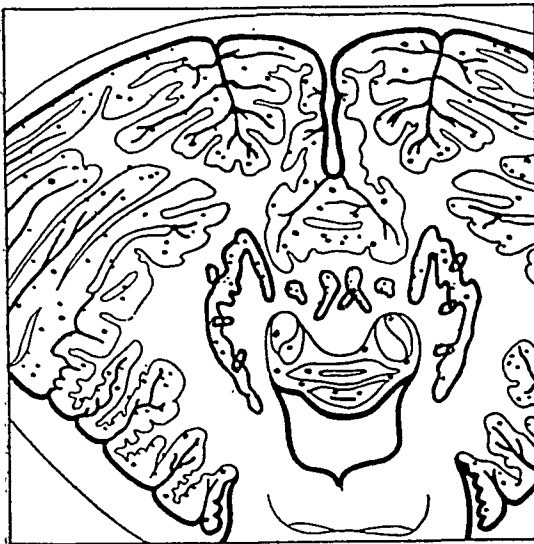
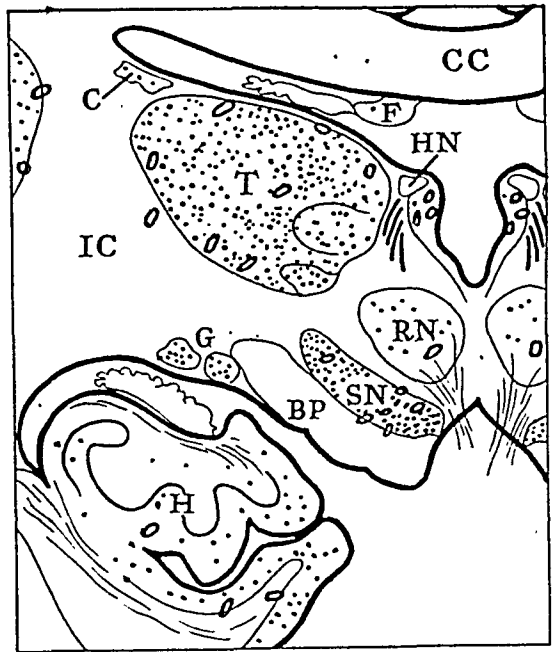
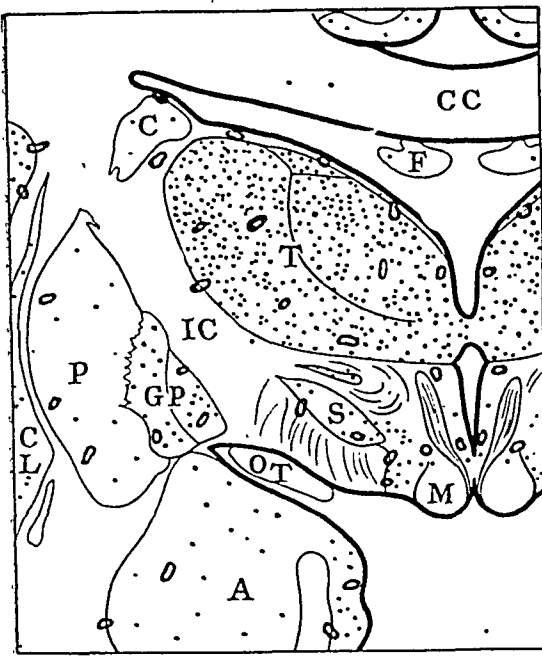

Fig. 7.—Distribution of nodules and perivenous cuffs of lymphocytes in the brain and spinal cord. In some regions, notably the thalamus and the substantia nigra, the nodules tended to be confluent. *A* is nucleus amygdalae; *AC*, anterior commissure; *BP*, basis pedunculi; *C*, caudate nucleus; *CC*, corpus callosum;



MAN
FREDI

CL, claustrum; F, fornix; G, geniculate bodies; GP, globus pallidus; GS, gyrus subcallous; H, hippocampus; HN, habenular nuclei; IC, internal capsule; M, mamillary body; NB, nucleus basalis; OLT, olfactory tubercle; OT, optic tract; P, putamen; RN, red nucleus; S, subthalamic body; SN, substantia nigra; SP, septum pellucidum; T, thalamus.

medullary junction and in the periventricular region adjacent to the head of the caudate nucleus, the thalamus and the habenula. The relative number of nodules in the cerebral cortex shown in figure 7 is based on the numerical estimates indicated in figure 6. The diagrams of the transverse sections illustrate that, so far as the basal ganglia were concerned, the thalamus bore the brunt of the attack. It was riddled with nodules and permeated diffusely with cells, and its vessels were frequently surrounded by lymphocytes. Microscopic examination revealed that many, if not the majority, of the nodules were neuronophagic, most of the cells within pericellular spaces being mononuclear. Invasive cells in the parenchyma were of similar appearance; in addition, there were clumps of neutrophils, which sometimes were perivascular in location. Numerous ganglion cells had disappeared.

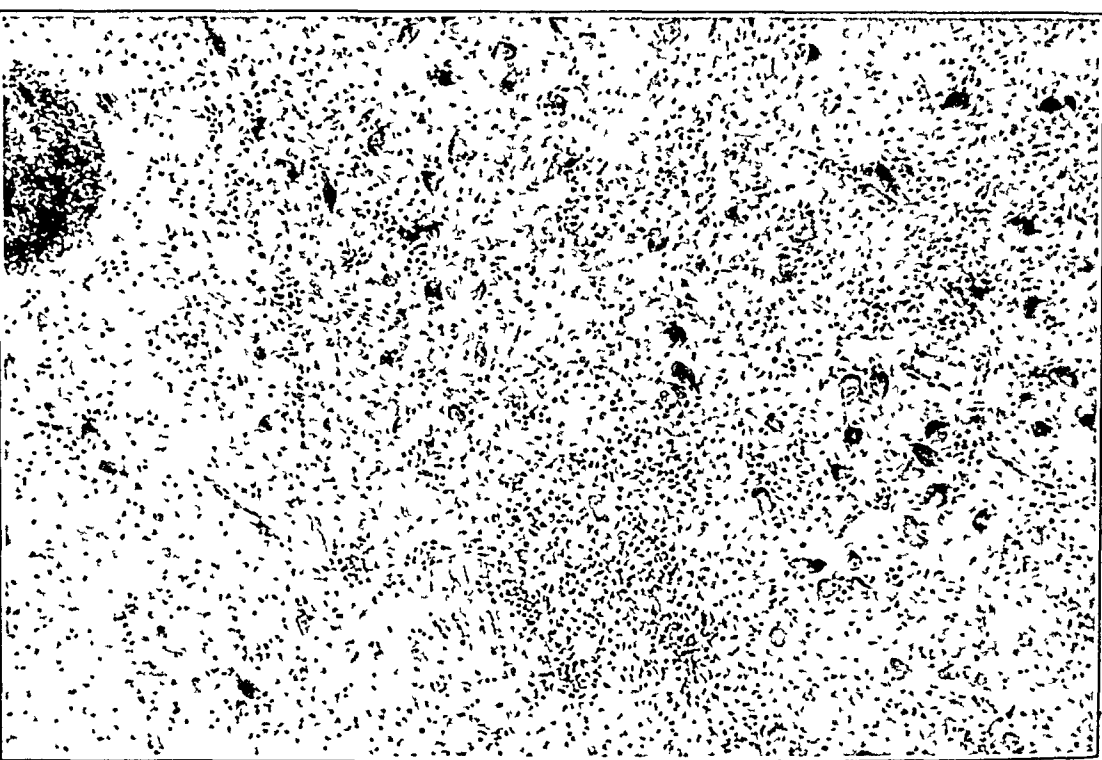

Fig. 8.—Substantia nigra, showing confluence of nodules, many of which are neuronophagic. Numerous ganglion cells are in a disintegrated state or have disappeared. Small clumps of neutrophils were observed in this section. A large perivenous collection of lymphocytes is present in the upper left corner of the photomicrograph. Hematoxylin and eosin stain ($\times 90$; AIP neg. 92685).

The nucleus basalis and the globus pallidus were among the more extensively involved cerebral structures, and after them were the lateral hypothalamic nuclei, the geniculate bodies, the subthalamic nuclei, the hippocampus, the nucleus amygdalae and the olfactory tubercle, in that order. Only in the nucleus amygdalae was there a relatively large area of focal necrosis, at the periphery of which a proliferation of microglia cells had taken place. In the hippocampus, the nodules were strewn in the pyramidal layer (fig. 5 B) and left virtually untouched the gyrus dentatus. Diffuse aggregations of cells sometimes included oligodendrocytes and microglia cells. Sommer's sector was no more affected than other portions of

the pyramidal layer. Lesions in the claustrum, putamen, caudate nucleus, epithalamus and medial hypothalamus were relatively scarce. The choroid plexuses were free from change except around larger vessels, where there were occasional sparse collections of lymphocytes. The olfactory bulbs were not available for study. The olfactory nerves and olfactory striae showed a few perivenous and parenchymal mononuclear cells. Neither the neurohypophysis nor the adenohypophysis revealed abnormalities.

In the midbrain, the substantia nigra was the seat of an extremely heavy concentration of nodules and diffusely distributed cells, together with perivenous collections of lymphocytes (fig. 8); the cell types were similar to those observed in the thalamus. Moderate numbers of ganglion cells had disappeared. The colliculi and the oculomotor and trochlear nuclei were involved to a slighter degree, and the red nucleus and the periaqueductal gray matter, least of all. In the rest of the brain stem, the most intense lesions were in the nuclei pontis. The nuclei in the floor of the fourth ventricle were also rather severely affected, in contrast to the relative sparing of the inferior olivary and arcuate nuclei. Here, as elsewhere in the brain, the white matter was virtually free from change.

Sections of the cerebellum indicated uniform distribution throughout the cerebellar folia. All the nodules were in the molecular layer and often pervaded the Bergmann layer and occasionally encroached on the granular layer. Discrete nodules, usually of greatest diameter at the base of the molecular layer, were most numerous either in regions from which the Purkinje cells had disappeared or in areas in which they were in a state of degeneration (fig. 9 *A* and *B*). More diffuse collections of cells, composed chiefly of the Hortega type, reached from the Bergmann layer to the pia; these, too, predominated in regions where Purkinje cells were damaged or absent (fig. 9 *C*). The dentate and roof nuclei were moderately affected, and, in contrast to the vessels in the rest of the cerebellum, the larger veins were frequently surrounded by lymphocytes.

The picture in the spinal cord was in agreement with that in the brain—the gray matter was involved and the white matter was relatively unaffected. At each spinal level examined, moderate numbers of neuronophagic nodules were sprinkled through the anterior horns (fig. 10 *A*), with a few in the posterior and lateral horns. As in other parts of the central nervous system, the cells in the perineuronal spaces were chiefly of the mononuclear variety. Large areas of the anterior horns were pervaded by these cells, and here and there one encountered neutrophils (fig. 10 *B* and *C*). An occasional gitter cell was observed, and sections stained with sudan III disclosed fat in only a few perivascular histiocytes. A few perivenous cuffs of lymphocytes extended from the anterior horns into the adjacent white matter. Moderate numbers of petechial hemorrhages were seen in the gray matter, especially in the region of the cervical portion of the cord, which on gross examination had an almost mushy appearance. Stains for myelin revealed nothing noteworthy.

Changes in the Peripheral Nervous System.—The gasserian ganglia, one dorsal root ganglion from the thoracic region and several spinal nerve roots were available for study. The only changes in the gasserian ganglia occurred in the surrounding dura, where a few petechial hemorrhages and a sparse sprinkling of lymphocytes and plasma cells were observed. A similar collection of cells was present in the epineurium of the dorsal root ganglion. The spinal nerve roots were without change.

Changes in the Thoracic and Abdominal Viscera.—Abnormalities of the thoracic and abdominal viscera were scanty. In no viscus were changes discerned in the vessel walls. The heart was normal except for an occasional small interstitial

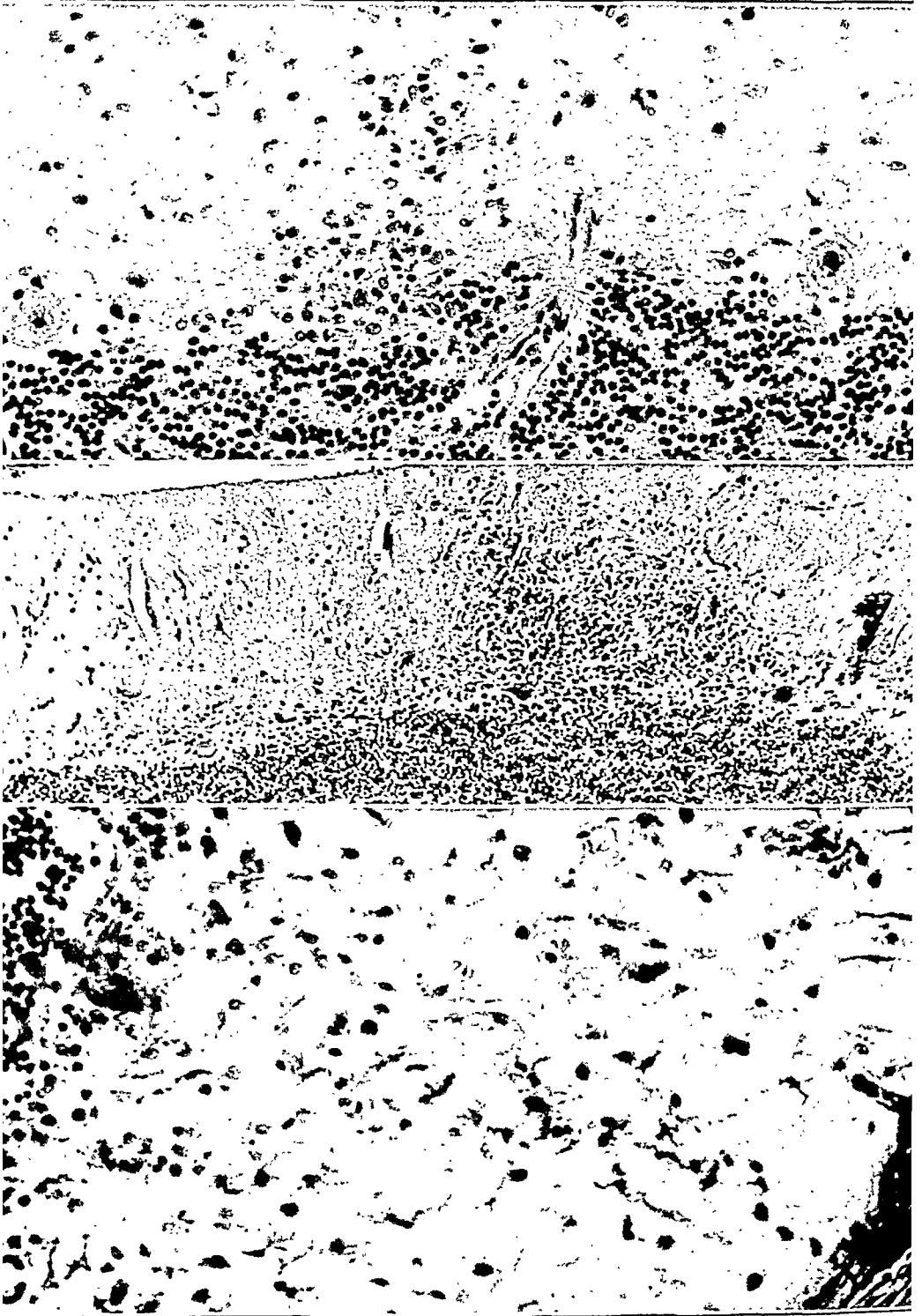

Figure 9

(See legend on opposite page)

collection of Anitschkow myocytes and lymphocytes. The lower lobe of each lung was the seat of acute bronchopneumonia. Both the liver and the spleen were congested, and their reticuloendothelial cells contained pigment, probably malarial. The cells of the adrenal cortex were depleted of lipid, and in the zona fasciculata a slight tubular degeneration, of the type described by Rich,⁴ was observed.

COMMENT

In this fulminant case of Japanese B encephalitis, one was struck, first, with the large number of neuronophagic nodules in all portions of the gray matter, and, second, with the more diffuse aggregations of cells which permeated the parenchyma. The great variation in the stages of evolution of the lesions permitted an evaluation of the nature of the cells participating in the reaction. It was apparent that the infiltrate around large veins was predominantly lymphocytic. The smaller the vessel, the greater the variety of perivascular cell forms; generally large mononuclear cells were in far greater abundance than the smaller, lymphocytic, forms. The same was true of the aggregates of cells surrounding degenerating or necrotic ganglion cells.

The smaller the vessel, the greater was the tendency of the cells to break through the membrana limitans gliae at focal points to invade the parenchyma. Where dense aggregations of cells permeated the parenchyma, a variety of cell forms was observed. If one may assume that these aggregations represent a far-flung invasion from perivascular and perineuronal spaces, spreading diffusely, or from the periphery of compact cell groups (nodules)—as would seem to be the case—one then is justified in concluding that most of the cells are migrants from the blood stream and from the adventitia, a view held by Maximow,⁵ Michels and Globus⁶ and others on the basis of observations on neurotropic virus diseases. The presence of "polyblastic" cells in nodules still confined to perivascular or perineuronal spaces and of cells of the

4. Rich, A. R.: Peculiar Type of Adrenal Cortical Damage Associated with Acute Infections, and Its Possible Relation to Circulatory Collapse, *Bull. Johns Hopkins Hosp.* **74**:1-15, 1944.

5. Maximow, A.: Untersuchungen über Blut und Bindegewebe, *Arch. f. mikr. Anat.* **73**:444-561, 1909; **76**:1-113, 1910; **96**:494-527, 1922.

6. Michels, N. A., and Globus, J. H.: The So-Called Small Round Cell Infiltrations: I. Polio-Encephalitis and Acute Epidemic Encephalitis, *Arch. Path.* **4**:692-731 (Nov.) 1927.

Fig. 9.—Representative lesions in the cerebellum. In *A* ($\times 280$; AIP neg. 94484), a nodule composed of pleomorphic mononuclear cells is present at the base of the molecular layer. Presumably, it is forming at the site of a destroyed Purkinje cell. Hematoxylin and eosin stain. In *B* ($\times 110$; AIP neg. 92621), a nodule of greater scope is illustrated. Hematoxylin and eosin stain. In *C* ($\times 350$; AIP neg. 93073), a diffuse aggregate of cells permeates the entire width of the molecular layer. Some of the cells are in the category of mononuclear cells, but the majority have the characteristics of Hortega cells. One of the Purkinje cells appears to be disintegrated. Cresyl violet stain.

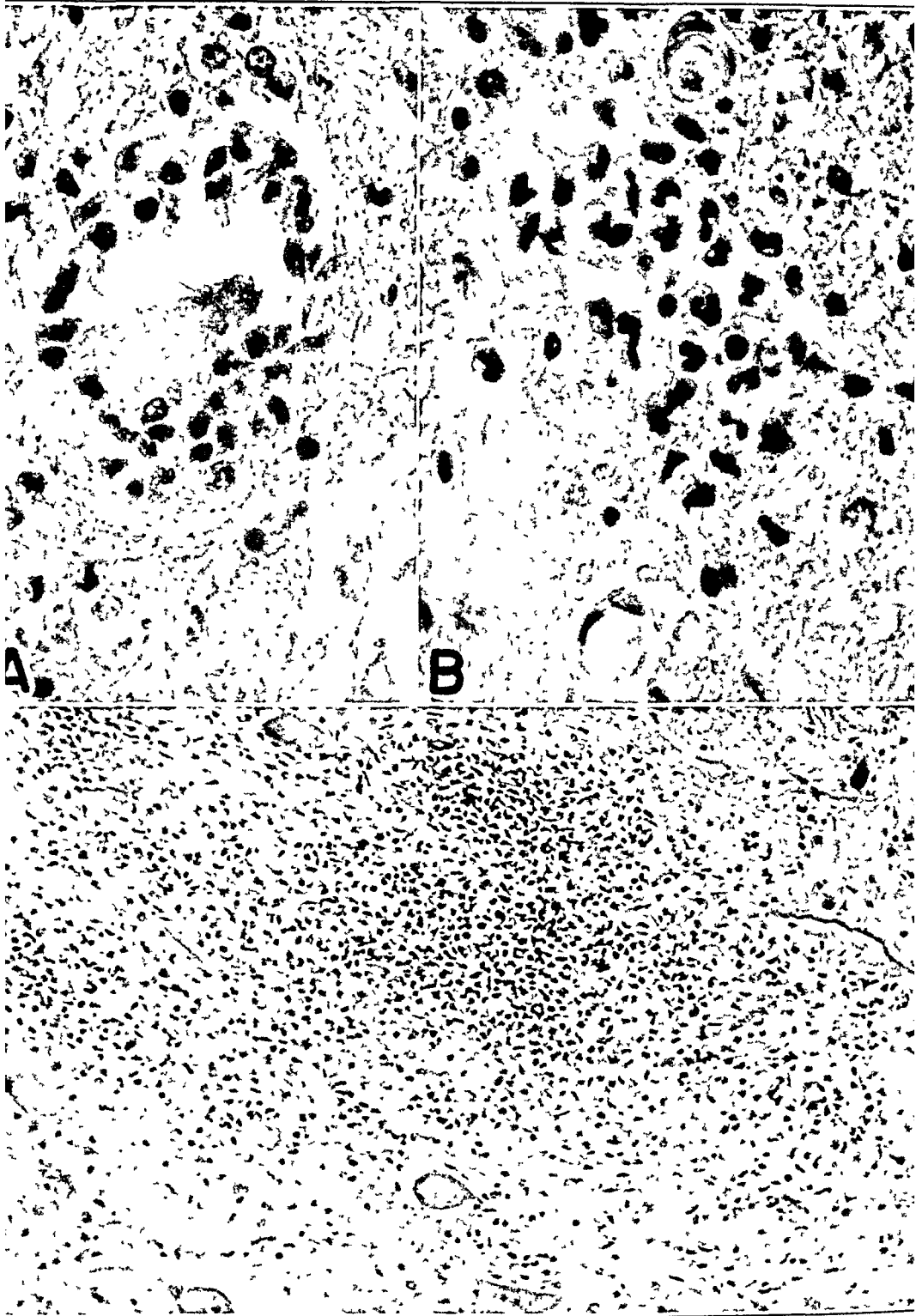

Figure 10

(See legend on opposite page)

same appearance in the front lines of the parenchymal invasion is in disagreement with the view of Hurst⁷ that the great majority of "polyblastic" forms in poliomyelitis—in which the problem of cytogenesis, in our opinion, is virtually the same as that in Japanese B encephalitis—are mobilized Hortega cells. In our case there is no denying the presence of proliferated Hortega cells in some regions of the brain, notably the cerebellum, where they took the form of diffuse aggregates, but it is doubtful whether they were present to any appreciable degree in the dense parenchymal morass. One wonders how frequently in the case of other virus encephalitides the application of "glial nodule" to nodular lesions and of "glial proliferation" to diffuse lesions is ill advised.

In the differential diagnosis of Japanese B encephalitis, as of the other arthropod-borne encephalitides, only two diseases need consideration: lethargic (von Economo) encephalitis and poliomyelitis. The pathologic changes in the substantia nigra in our case were indistinguishable from those of lethargic encephalitis, but the over-all pictures of the two diseases were different. In lethargic encephalitis the lesions in the cerebral cortex seldom, if ever, take the form of nodules; they tend to be more concentrated in the upper portion of the midbrain, the posterior hypothalamus and the subthalamus; they do not affect in so massive a fashion the thalamus, and they often fail to involve appreciably the spinal cord. The lesions in the spinal cord in our case were virtually the same as those in poliomyelitis, except that at some levels they were more spotty than is ordinarily encountered in poliomyelitis. In other ways the two diseases are distinct, there being in poliomyelitis absence of involvement of the cerebral cortex except in the region of the precentral gyrus, sparing of the molecular and the Purkinje cell layers of the cerebellum, though the cerebellar nuclei are affected, and an attack on the spinal root ganglia.⁸

The types of lesions and their distribution in our case were essentially the same as observed by Takeno⁹ in 8 cases of Japanese B encephalitis.

7. Hurst, E. W.: The Histology of Experimental Poliomyelitis, *J. Path. & Bact.* **32**:457-477, 1929.

8. Sabin, A. B.: Pathology and Pathogenesis of Human Poliomyelitis, *J. A. M. A.* **120**:506-511 (Oct. 17) 1942.

9. Takeno, K.: Histopathologie der japanischen epidemischen Encephalitis, *Okayama Igakkai-Zasshi* **44**:1459-1482, 1932.

Fig. 10.—Sections from the anterior horns of the spinal cord. In *A* ($\times 750$; AIP neg. 94446), the perineuronal space surrounding a necrotic ganglion cell is crowded with mononuclear cells. An occasional cell has the features of the oligodendrocyte. In *B* ($\times 810$; AIP neg. 94442), a collection of cells at the periphery of the anterior horn is shown. Some with bilobed and trilobed nuclei are neutrophils; the others are of the mononuclear variety. In *C* ($\times 160$; AIP neg. 94448) is illustrated a densely pervaded area in the anterior horn from which ganglion cells have disappeared. Hematoxylin and eosin stain.

litis occurring in Japan between 1924 and 1929. In all instances the thalamus and the substantia nigra were the structures most severely affected. In cases of short survival infiltration of leukocytes into the parenchyma was an outstanding feature. The inferior olivary nucleus was more often affected in his cases than in our case. Takeno made no mention of the spinal cord. Pathologic changes closely resembling those described by us were observed also in 2 cases of Japanese B encephalitis in Okinawa, from which representative blocks of tissue were submitted to the Army Institute of Pathology by Lieut. Comdr. H. M. Zimmerman¹⁰ of the United States Navy. In 1 case in which the duration of illness was twenty-three days, the thalamus was the seat of widespread and severe malacia, and in the other, in which death occurred in three days, the thalamus contained, in addition to nodules and a diffuse infiltrate, numerous relatively large focal necroses, in which only a spongy network of parenchyma remained. The substantia nigra, cerebellum and spinal cord in these cases were slightly less affected than in our case, while the lesions in the cerebral cortex were of the same severity. It would appear, therefore, that ours is a representative case of Japanese B encephalitis.

CONCLUSIONS

A detailed study of a case of Japanese B encephalitis occurring in a member of the United States armed forces in Okinawa, in which the duration of the illness was approximately ten days, revealed a striking involvement of the gray matter of the central nervous system, relative sparing of the white matter and absence of change in the peripheral nerves and in the thoracic and abdominal viscera. The structures most severely affected were the thalamus, the substantia nigra, the nucleus basalis and the anterior horns of the spinal cord, where the lesions tended to be confluent, and the cerebral cortex and the cerebellum, where they generally were discrete. The presence of neuronophagic nodules in all portions of the gray matter was taken as compelling evidence of damage to ganglion cells by the virus. These nodules, generally spoken of as "glial," we regard as composed of hematogenous and adventitial mononuclear cells.

A review of cases of Japanese B encephalitis previously recorded in the literature and of 2 additional ones that came under our observation, makes it evident that the case described by us is a representative one.

The involvement of the gray matter of all regions of the cerebral cortex and of the molecular and Purkinje cell layers of the cerebellum in cases of Japanese B encephalitis serves to differentiate the topographic distribution of the lesions in this disease from that of the lesions in poliomyelitis.

10. Zimmerman, H. M.: Pathology of Japanese B Encephalitis, *Am. J. Path.* 22:965-991, 1946.

ELECTROCEREBRAL SHOCK THERAPY

A Reconsideration of Former Contraindications

MATTHEW T. MOORE, M.D.

PHILADELPHIA

WITH the advent of new procedures and drugs in the field of applied medicine, there may be a tendency to an overenthusiastic application of these methods, with the result that failures occur in frequently unlooked-for, untoward effects. The result is a swing in the opposite direction of conservatism and overcautiousness, and many patients who would benefit from a new form of treatment are refused it. The severe convulsive reactions encountered with metrazol shock and the early inexperience with methods of overcoming or subduing complications produced a timidity with respect to contraindications which carried over to electric shock therapy.

It is not at all unlikely that the present seemingly drastic and terrifying forms of shock therapy will be superseded by some gentle chemical process based on a rational biochemical-physiologic understanding of the why and wherefore of the salutary response of certain psychoses to shock therapy. Until such time, however, the present day advantages to be obtained from shock therapy should be utilized in properly selected cases.

A sufficiently large body of literature and experience has accumulated to give one information in reevaluating the indications for and contraindications to cerebral electric shock treatment, a complete review of which is much too voluminous to incorporate in this paper. Some of the reviews with respect to the indications for, results of, and complications attending, electric shock treatment may be found in the works of various authors.¹

From the Philadelphia Psychiatric Hospital.

Read before the Section of Nervous and Mental Diseases, at the Ninety-Fifth Annual Session of the American Medical Association, San Francisco, July 4, 1946.

1. (a) Almansi, R., and Impastato, D. J.: Electrically Induced Convulsions in the Treatment of Mental Diseases, *New York State J. Med.* **40**:1315-1316, 1940. (b) Bennett, A. E.: An Evaluation of the Shock Therapies, *Psychiatric Quart.* **19**:465-477, 1945; (c) Unusual Organic Complicating Factors in Convulsive Shock Therapy, *Bull. Menninger Clin.* **8**:71-73, 1944. (d) Bingel, A.: Ueber die psychischen und chirurgischen Komplikationen des Elektrokrampfes, *Allg. Ztschr. f. Psychiat.* **115**:325-343, 1940. (e) Darling, H. F.: Prevention of Fatality and Fracture During Electric Coma Therapy, *J. Nerv. & Ment. Dis.* **100**:70-72, 1944.

(Footnote continued on next page)

The contraindications which, until recently, have been considered an unquestioned barrier to convulsive shock treatment are acute infections and febrile diseases, cardiovascular disease, renal disease, advanced age, bone atrophy in long-bedridden patients, pronounced spinal curvature and osteoarthritis, severe thyrotoxicosis, malignant tumors, thrombo-

(f) Davidoff, E., and Raffaele, A.: Electric Shock Therapy in Involutional Psychoses, *ibid.* **99**:397-405, 1944. (g) Ebaugh, F. G.; Barnacle, C. H., and Neubuerger, K. T.: Fatalities Following Electric Convulsive Therapy: Report of Two Cases with Autopsy, *Arch. Neurol. & Psychiat.* **49**:107-117 (Jan.) 1943. (h) Epstein, J.: Electric Shock Therapy in the Psychoses: Study of One Hundred Cases, *J. Nerv. & Ment. Dis.* **98**:115-129, 1943. (i) Gralnick, A.: Fatalities Associated with Electric Shock Treatment of Psychoses: Report of Two Cases with Autopsy Observation in One of Them, *Arch. Neurol. & Psychiat.* **51**:397-402 (April) 1944; (j) A Three-Year Survey of Electroshock Therapy: Report of Two Hundred and Seventy-Six Cases; Comparative Value of Insulin-Coma Therapy, *Am. J. Psychiat.* **102**:583-593, 1946. (k) Hemphill, R. E.: Electrical Convulsion Therapy: Clinical Observations, *Lancet* **2**:152-154, 1942. (l) Huddleson, J. H.: Complications in Electric Shock Therapy, *Am. J. Psychiat.* **102**:594-598, 1946. (m) Impastato, D. J., and Almansi, R.: Study of Over Two Thousand Cases of Electrofit-Treated Patients, *New York State J. Med.* **43**:2057-2063, 1943; (n) The Electrofit in the Treatment of Mental Disease, *J. Nerv. & Ment. Dis.* **96**:395-409, 1942. (o) Impastato, D. J.; Frosch, J.; Almansi, R., and Wortis, S. B.: The Electrofit in Depression: Comparison of Hospital and Privately Treated Patients, *New York State J. Med.* **45**:179-185, 1945. (p) Jetter, W. W.: Fatal Circulatory Failure Caused by Electric Shock Therapy, *Arch. Neurol. & Psychiat.* **51**:557-563 (June) 1944. (q) Jones, G. L., in symposium on Complications of and Contraindications to Electric Shock Therapy, *ibid.* **49**:788-789 (May) 1943. (r) Kalinowsky, L. B.: Experience with Electric Convulsive Therapy in Various Types of Psychiatric Patients, *Bull. New York Acad. Med.* **20**:485-494, 1944. (s) Kalinowsky, L. B.; Barrera, S. E., and Horwitz, W. A.: Electric Convulsive Therapy of the Psychoneuroses, *Arch. Neurol. & Psychiat.* **52**:498-504 (Dec.) 1944. (t) Kalinowsky, L. B., and Worthing, H. J.: Results with Electric Convulsive Treatment in Two Hundred Cases of Schizophrenia, *Psychiatric Quart.* **17**:144-153, 1943. (u) Kalinowsky, L. B., and Hoch, P. H.: Shock Treatments and Other Somatic Procedures in Psychiatry, New York, Grune & Stratton, Inc., 1946, p. 294. (v) Kalinowsky, L. B.: Electric Convulsive Therapy, with Emphasis on Importance of Adequate Treatment, *Arch. Neurol. & Psychiat.* **50**:652-660 (Dec.) 1943; (w) Organic Psychotic Syndromes Occurring During Electric Convulsive Therapy, *ibid.* **53**:269-273 (April) 1945. (x) Kline, E. M., and Fetterman, J. L.: Electrocardiograph Changes Following Electrically Induced Convulsions, *Am. Heart J.* **24**:665-670, 1942. (y) Kolb, L., and Vogel, V. H.: The Use of Shock Therapy in Three Hundred and Five Mental Hospitals, *Am. J. Psychiat.* **99**:90-100, 1942. (z) Lewis, N. D.: The Present Status of Shock Therapy of Mental Disorders, *Bull. New York Acad. Med.* **19**:227-244, 1943. (a') Lowinger, L., and Huddleson, J. H.: Outcome in Dementia Praecox Under Electric Shock Therapy as Related to Mode of Onset and to Number of Convulsions Induced, *J. Nerv. & Ment. Dis.* **102**:243-246, 1945. (b') Levy, N. A.; Scrota, H. M., and Grinker, R. R.: Disturbance of Brain Function Following Convulsive Shock Therapy, *Arch. Neurol. & Psychiat.* **47**:1009-1029 (June) 1942. (c') Meyer, A., and

phlebitis, advanced general arteriosclerosis, organic disturbances of the central nervous system and tuberculosis, according to Cook² "the most important absolute contraindication . . . even if only latent."

Some of these contraindications can now, in the light of experience and judgment, be eliminated from this category and greater freedom of use of the method be permitted. This applies with respect to cardiovascular diseases with and without hypertension; advanced age; latent, arrested or even active tuberculosis; some cases of generalized arteriosclerosis in which a differential diagnosis between cerebral vascular involvement and involuntal psychosis has not been established; organic disease of the central nervous system, such as dementia paralytica; spinal curvatures, and osteoarthritis.

The present reconsideration of some of the heretofore believed contraindications to electric convulsive treatment is based on a review of the cases of 1,596 intramural and 585 extramural patients treated at the Philadelphia Psychiatric Hospital from Nov. 4, 1940 to May 5, 1946. These 2,181 patients received electric shock treatment either alone or in conjunction with insulin. They received a total of 20,645 convulsive treatments, or an average of 9.5 treatments per patient.

Teare, D.: Cerebral Fat Embolism After Electrical Convulsion Therapy, *Brit. M. J.* **2**:42-44, 1945. (*d'*) Myerson, A.: Further Experience with Electric-Shock Therapy in Mental Disease, *New England J. Med.* **227**:403-407, 1942; (*e'*) Prolonged Cases of Grief Reaction Treated by Electric Shock, *ibid* **230**:255-256, 1944. (*f'*) Napier, F. J.: Death from Electrical Convulsion Therapy, *J. Ment. Sc.* **90**:875-878, 1944. (*g'*) Norman, J., and Worthington, R. V.: Electric Shock Treatment in One Hundred Cases, *Dis. Nerv. System* **5**:236-242, 1944. (*h'*) Olsen, C. W.: An Unusual Reaction to Electroshock Treatment, Unilateral Convulsion and Transient Hemiplegia, *Bull. Los Angeles Neurol. Soc.* **9**:171-173, 1944. (*i'*) Pacella, B. L.: Sequelae and Complications of Convulsive Shock Therapy, *Bull. New York Acad. Med.* **20**:575-587, 1944. (*j'*) Pacella, B. L.; Barrera, S. E., and Kalinowsky, L. B.: Variations in Electroencephalogram Associated with Electric Shock Therapy of Patients with Mental Disorders, *Arch. Neurol. & Psychiat.* **47**:367-384 (March) 1942. (*k'*) Rennie, T. A.: Present Status of Shock Therapy, *Psychiatry* **6**:127-137, 1943. (*l'*) Rosen, S. R.; Secunda, L., and Finley, K.: The Conservative Approach to the Use of Shock Therapy in Mental Illness, *Psychiatric Quart.* **17**:617-641, 1943. (*m'*) Samuel, E.: Complications Arising During Electric Convulsive Therapy, *J. Ment. Sc.* **89**:81-84, 1943. (*n'*) Smith, L. H.; Hastings, D. W., and Hughes, J.: Immediate and Follow-up Results of Electroshock Therapy, *Am. J. Psychiat.* **100**:351-354, 1943. (*o'*) Taylor, H. J., Jr., in symposium on Complications of and Contraindications to Electric Shock Therapy, *Arch. Neurol. & Psychiat.* **49**:789-790 (May) 1943. (*p'*) Taylor, J. H.: A Further Report on the Use of Shock Therapy: Results in One Thousand Three Hundred and Two Cases, *Dis. Nerv. System* **5**:56, 1944. (*q'*) Woolley, L. F.: Immediate Circulatory and Respiratory Effects of Convulsive Shock, *J. Nerv. & Ment. Dis.* **100**:1-23, 1944. (*r'*) Worthing, H. J., and Kalinowsky, L. B.: The Question of Vertebral Fractures in Convulsive Therapy and in Epilepsy, *Am. J. Psychiat.* **98**:533-537, 1942.

2. Cook, L. C.: Recent Progress in Psychiatry: Convulsion Therapy, *J. Ment. Sc.* **90**:435-464, 1944.

Eight of the 9 cases cited here are representative of cases in which some of the previously mentioned contraindications to electric shock treatment existed, and in which the question of weighing the advantages and likelihood of recovery with the use of shock therapy against the potential dangers arose as a problem of the hospital's versus the attending physician's responsibility. Each patient was studied carefully before shock treatment was decided on; precautions were observed at the time of treatment, and a thorough physical check-up was made before further treatments were given.

The results obtained in the treatment of the 1,596 intramural patients were as follows: patients recovered, 552; patients improved, 838; patients unimproved, 201; patients without psychoses, 2; deaths, 2; suicide, 1. The diagnoses for these patients are found in table 1.

TABLE 1.—*Psychiatric Diagnoses for 1,596 Intramural Patients Treated with Electric Shock*

	No. of Patients
Manic-depressive psychosis—all types.....	497
Schizophrenia—all types	478
Involitional psychosis	273
Psychoneuroses	252
Paranoid states	29
Psychosis with cerebral arteriosclerosis.....	14
Psychosis with alcoholism	5
Senile psychosis	4
Psychosis with syphilitic meningoencephalitis.....	4
Mental deficiency without psychosis.....	3
Dementia paralytica	2
Psychosis with cardiovascular disease.....	2
Behavior problem	2
Adult maladjustment	2
Toxic exhaustion state	1
Toxic psychosis—thyroid	1
Psychosis due to lead poisoning.....	1
Psychosis with meningovascular syphills.....	1
Psychosis with organic cerebral disease.....	1
Psychosis with drug addiction.....	1
Epilepsy with equivalent states.....	1
Traumatic psychoneurosis	1
Psychopathic personality with pathologic emotionality..	1
Psychopathic personality with pathologic sexuality....	1
Undiagnosed psychoses	19
Total.....	1,596

It will be noted that organic disease of the brain is well represented in the list of disorders, with cerebral arteriosclerosis and syphilis of the brain predominating. Cerebral arteriosclerosis was a complicating factor in most cases of depression in which electric shock was salutary. Syphilis of the brain, in its various forms, cannot be considered a valid contraindication, the only report to the contrary being that by Heilbrunn and Feldman,³ who observed cardiovascular and respiratory failure in patients whose condition was diagnosed as psychosis with syphilitic meningoencephalitis.

Advanced age is becoming a somewhat relative term, and as a contraindication to electric shock treatment it is not a deterrent per se.

3. Heilbrunn, G., and Feldman, P.: Electric Shock Treatment in General Paresis. *Am. J. Psychiat.* 99:702-705, 1943.

as is already manifest from the reports of several observers.⁴ Of the intramural patients, 39 were over 60, 15 over 65 and 2 over 70, years of age. The oldest patient was 74. Incidentally, the youngest patient in this series was 14. Eighteen patients had general arteriosclerosis and 190 patients had hypertension. No complications followed treatment. Evans⁵ reported 9 patients with systolic pressure over 200 mm. of mercury to whom electroshock treatment was given without complications. In some patients the initial high pressure falls after shock treatment. Kennedy and Wiesel⁶ reported a striking example of this.

The most frequently occurring organic disorder in this series of patients was myocardial disease, in its various forms. Table 2 summarizes the types of cardiac disease encountered.⁷

TABLE 2.—Forms of Myocardial Disease Encountered in Series of 1,596 Patients Treated by Electric Shock *

	No. of Patients
Number of patients with electrocardiographic studies.....	1,756
Diseases of the myocardium.....	57
Rheumatic heart disease.....	25
Hypertensive cardiovascular disease.....	21
Coronary arteriosclerosis.....	16
Coronary artery disease.....	9
Myocardial infarction.....	9
Mitral stenosis.....	7
Aortic stenosis.....	2
Branch bundle block.....	8
Auricular-ventricular block.....	5
Endocarditis.....	1
Other cardiac disturbances.....	78
Total number of patients with heart disorders.....	238

* A more detailed analysis of these conditions and of the electrocardiographic studies is now in preparation.

The following case reports illustrate some of the serious cardiac disturbances, as found on clinical and electrocardiographic study, which were not adversely affected by electric shock treatment, with 1 exception, to be reported later.

CASE 1.—F. A., a married woman aged 59, was first examined on March 2, 1944 and admitted to the hospital on March 13. Six months before there developed anxiety, light-headedness, lack of interest, insomnia, loss of appetite, loss of confidence, depression, lapses of memory and numerous somatic complaints. In December 1943 she was in another psychiatric institution for several weeks, where

4. Evans, V. L.: Convulsive Shock Therapy in Elderly Patients: Risks and Results, *Am. J. Psychiat.* **99**:531-533, 1943. Mayer-Gross, W.: Electric Convulsion Treatment in Patients Over 60, *J. Ment. Sc.* **91**:101-103, 1945.

5. Evans, V. L.: Electroconvulsive Shock Therapy and Cardiovascular Disease, *Ann. Int. Med.* **22**:692-695, 1945.

6. Kennedy, F., and Wiesel, B.: A Report on the Results of Electric Shock Treatment on Mental and Emotional Symptoms, *New York State J. Med.* **42**:1663-1668, 1942.

7. The cardiologic and electrocardiographic studies were made by Dr. Benjamin Gouley, Philadelphia.

shock treatment was refused because of hypertension. After study the diagnosis of involuntal psychosis with depression was made. The systolic blood pressure varied from 180 to 210 mm. of mercury; the diastolic pressure was 110 mm. The electrocardiographic report prior to treatment follows: "The cardiac rate is 68 per minute; the PR interval is 0.16 second; the P waves are split in leads I and III; the QRS complexes are slightly shaded, with left axis deviation. A very small upward deflection is shown in lead IV; the T waves in leads I and II are inverted. The electrocardiographic diagnosis is that of a pathologic condition, the tracing suggesting mild hypertensive cardiovascular disease, dilatation and healed infarction at the apex. The patient should be treated with caution."

Responsibility for treatment was placed by the hospital on the attending physician. After four electric shock treatments with full convulsive reactions, the patient was somewhat confused, and no improvement was observed except in her appetite. At this point the staff physician expressed the belief that her psychosis was due to cerebral arteriosclerosis and suggested termination of treatment. However, shock therapy was continued, and after the sixth treatment striking improvement was apparent. Eight treatments were given, and the patient was discharged one month after admission as recovered. To date, she has maintained complete recovery. The electrocardiogram on April 12, 1944, following the course of treatment, showed no change.

CASE 2.—M. H., a married woman aged 63, was first examined April 14, 1944 and admitted to the hospital April 17. For six years she had shown an increasing degree of mental disturbance, having had several "nervous breakdowns" during the first two of these six years and for the past four years manifesting disinterestedness, a feeling of inadequacy, inertia, numerous somatic complaints, ideas of persecution, irritability, depression and ideas of self destruction. There had been a loss of 50 pounds (22.7 Kg.) in weight, and she was emaciated and dehydrated on admission to the hospital. The diagnosis of manic-depressive psychosis, depressed type, was made. The blood pressure showed systolic variations from 116 to 140 mm. of mercury and a diastolic pressure of 70 to 76 mm. Electrocardiographic studies (April 17) were reported as follows: "The cardiac rate is 75 per minute; the PR interval is 0.16 second; the P waves are of rather low amplitude but otherwise normal; the interval of the QRS complexes is 0.06 second. There is a small initial upward deflection in the direct lead; the T waves are biphasic in lead I, inverted in leads II and III and flat to inverted in lead IV, with a slight elevation of the S-T interval in leads I and II. The electrocardiographic diagnosis is as follows: The tracing suggests a pathologic condition, with widespread myocardial degeneration, due most likely to sclerotic disease of the coronary arteries. The patient should be treated with caution."

Treatment with electric shock was begun, and after induction of the third shock, and again after the termination of twelve shock treatments, the electrocardiographic tracings were repeated. The report on the electrocardiographic studies on June 3, 1944 follows: The cardiac rate is 78 per minute; the PR interval in lead I appears to be 0.18 second; in lead II, and also in lead III, it is more readily observed to be 0.28 second. The initial major deflection in lead IV is missing."

At the time of discharge, on June 3, 1944, the patient had shown notable physical improvement, and, although her psychomotor activity was still subdued, the depression and numerous somatic references had disappeared. Subsequent follow-up observations showed a gain of 15 pounds (6.8 Kg.) in weight and improved adaptability to social and household life.

CASE 3.—F. L. S., an unmarried woman aged 62, was first examined Dec. 20, 1944. During May 1944, after treatment for corneal ulcers, she experienced the fear of becoming blind. She then manifested anxiety, seclusiveness, refusal to eat, wringing of the hands, picking at the skin, ideas of unworthiness, self accusation, somatic delusions and agitation. She was admitted to a hospital for mental diseases in Kansas City, Mo., in August 1944, where she received fifteen metrazol shock treatments. Although some improvement took place, at the time of her discharge, in November, she was still mildly agitated. When examined in December, she presented the clinical picture of agitated involuntional melancholia. Physical exami-

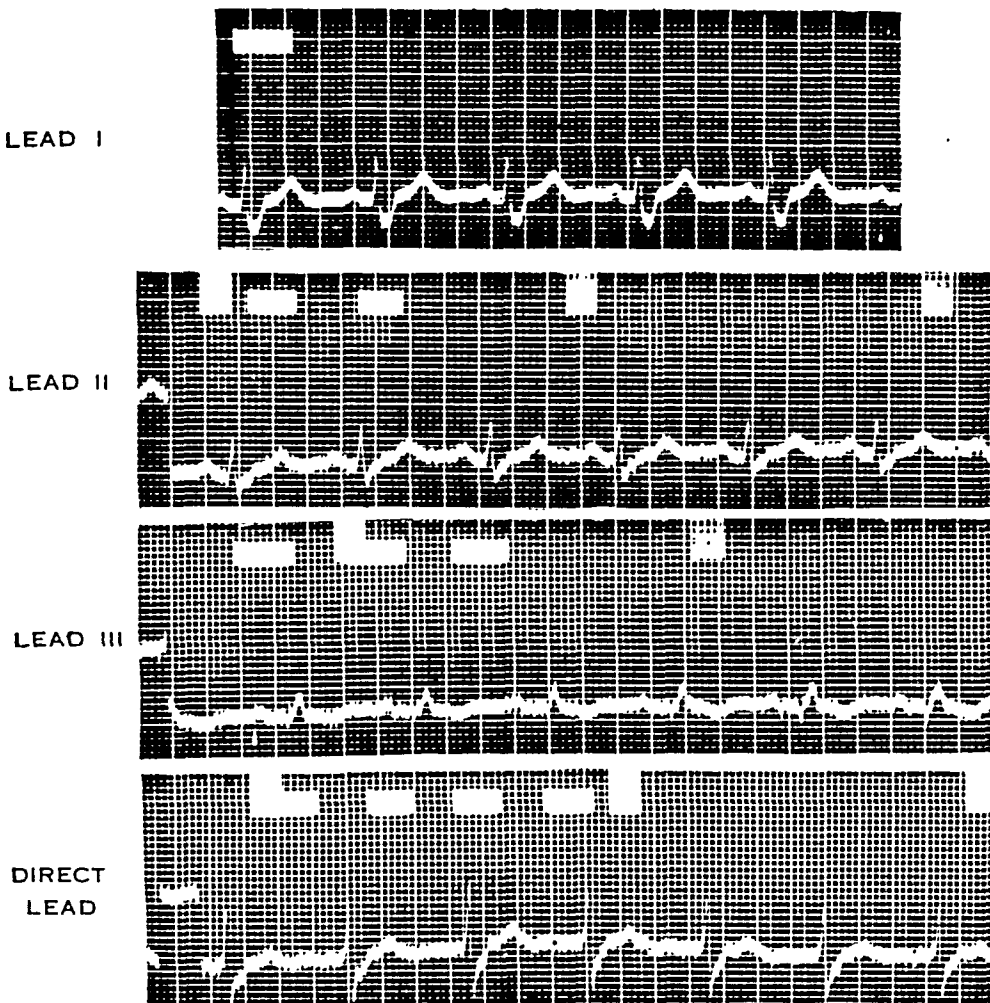

Fig. 1 (case 3).—Electrocardiographic tracing.

nation showed evidence of generalized arteriosclerosis, enlargement of the heart, presystolic and systolic murmurs at the apex and a blood pressure of 175 systolic and 80 diastolic. The electrocardiographic study (December 21) was reported as follows: "The cardiac rate is 78 per minute, with normal sinus rhythm; the PR interval is 0.20 second (with normal top); the P waves show splitting in lead II; the QRS complexes indicate a right bundle branch block; the T waves are upright in leads I, II and IV and inverted in lead III. The electrocardiographic diagnosis is right bundle branch block; delayed A-V conduction time, and cardiac lesions associated with enlargement of and strain on the right ventricle (fig. 1)."

The patient began to show a favorable response after the third shock treatment, and after the seventh electric shock she was slightly euphoric, in contrast to the previous depression. The electrocardiogram on Feb. 5, 1945 was reported as follows: "The interval of the QRS complexes is 0.14 second, indicating right bundle branch block. The tracing remains substantially unchanged. The T wave in lead IV is now inverted, instead of upright." The patient was discharged as recovered.

CASE 4.—S. M., a single man aged 32, was first examined on Feb. 13, 1945 and admitted to the hospital on February 22. Two years before, he had enlisted in the Navy, knowing that he had heart disease, and was subsequently discharged when the cardiac condition was discovered. He stated the belief that he had been "fraudulently discharged." After this there developed ideas of reference (that people were calling him a slacker), suspiciousness and ideas of persecution (of being trailed by the F. B. I. and the Navy intelligence). He became slovenly in attire and abusive and assaultive to his part time common law wife. He was employed up to four weeks prior to admission. He then became greatly agitated and panicky. After psychiatric study, the provisional diagnoses of (1) paranoid psychosis with acute panic state and (2) schizophrenia, paranoid type, were entertained. The referring physician, a cardiologist, stated that the patient had "old rheumatic mitral valvular disease, perfectly compensated." An electrocardiogram (February 26) was reported as follows: "The cardiac rate is 93 per minute; the PR interval is 0.16 second; the P waves are rather prominent in leads II and III; the QRS complexes are 0.09 second and somewhat widened; the S waves are deep in lead II. Left axis deviation is present; the T waves are upright in lead I, biphasic in lead II, inverted in lead III and upright in lead IV; the S-T interval is elevated in lead IV. The electrocardiographic diagnosis is as follows: The tracing suggests hypertensive cardiovascular disease, with myocardial degeneration in the posterior wall of the left ventricle. There is undoubtedly a pathologic condition of the heart of a nature which is serious for a person of the patient's age (32 years). I believe that he has serious disease of the coronary arteries."

"NOTE.—Clinical examination changes somewhat the concept of this case. There is a murmur of aortic regurgitation. The left ventricle is moderately enlarged. There is a presystolic mitral murmur (mitral valvulitis? Austin Flint murmur?). In view of the negative serologic reactions, I suspect that rheumatic disease is the pathologic basis. The electrocardiogram is that of myocardial degeneration. The blood pressure is 135 systolic and 70 diastolic."

After having received his third electric shock treatment, the patient became disorderly and abusive and made an unsuccessful attempt to escape. He was greatly confused and completely lacking in insight. After sixteen days of residence, because of his intractable behavior, he was transferred to another institution. Here he received three more electric shock treatments and made a remarkably rapid recovery, with disappearance of the confusion, agitation and ideas of reference. He was discharged as improved, and recent follow-up observation reveals that he has made a satisfactory social adjustment at his prepsychotic level. Examination by his cardiologist showed no change in the heart.

One of the patients with bundle branch block, a condition which is supposedly fixed in its electrocardiographic and clinical aspects, showed improvement in the electroencephalogram for two weeks during electric shock treatment, with subsequent reversion to the original pattern.

CASE 5.—One of the deaths in this series was that of S. M., a woman aged 52, who had an involuntional depression with distressing agitation. She was known to have had several myocardial infarctions due to disease of the coronary arteries, both from the history and from electrocardiographic studies, and she also had diabetes mellitus. Her blood sugar varied from 130 to 210 mg. per hundred cubic centimeters; despite the risk involved, it was felt advisable, in view of the serious mental disturbance which the patient presented, to give electric shock therapy. She received three treatments, to the first two of which there were a petit mal response and no response, respectively. Only the third treatment resulted in a full convulsive reaction. Substernal pain developed after the third treatment, and an electrocardiogram revealed evidence of a fresh infarction. The patient did moderately well and then died suddenly four weeks after the third treatment. Permission for autopsy was not granted.

In reviewing the results for the 238 patients who presented cardiac disorders of mild, moderate and relatively severe forms, it was felt that, with the exception just cited, they withstood electric shock treatment well. I concur with Pacella,¹¹ who said:

. . . it has been our experience and the experience of many others that individuals with varying degrees of cardiovascular disease, with or without abnormalities in the electrocardiogram, ordinarily tolerate convulsions well, providing the disease is not too acute or severe.

Sixty-three patients in this series showed some form of endocrine disturbance, as seen in the following tabulation.

Endocrine Disorders	No. of Patients
Enlarged thyroid.....	26
Diabetes mellitus.....	12
Pituitary disturbance.....	10
Hyperthyroidism.....	5
Hypothyroidism.....	5
Ovarian dysfunction.....	2
Hypogonadism.....	2
Adenoma of thyroid with toxicity.....	1

The patients with diabetes mellitus were stabilized by dietary measures alone or in conjunction with insulin before treatment was instituted. This condition in no way interfered with or complicated treatment. Despite the absence of complications in the cases of hyperthyroidism and the case of adenoma of the thyroid with toxicity, I should not advocate electric convulsive therapy in a case of pronounced exophthalmic goiter without first giving proper attention to the altered constitutional state and the thyroid gland itself.

It is questionable whether complications have ever arisen during convulsive shock treatment as the result of disturbances of the bony structures and joints themselves. Forty patients, as indicated in the following tabulation, had some type of skeletal disorder. No fractures

Skeletal Disorders	No. of Patients
Scoliosis.....	14
Kyphosis.....	12
Kyphoscoliosis.....	6
Arthritis (chronic).....	6
Osteomyelitis.....	1
Tuberculosis of the shoulder.....	1

or dislocations occurred in this group, and none of the original conditions was worsened. Fractures or dislocations can be minimized or completely avoided by the present method⁸ of proper splinting of the torso, limbs and head, using four or five attendants strategically placed. If fracture should occur, it can mend while the patient is improving mentally.

CASE 6.—F. B., an unmarried woman aged 57, was first examined March 10, 1945 and admitted to the hospital April 6, 1945. Approximately two years before admission a state of anxiety developed and she quit her job as bookkeeper, which she had held with the same concern for thirty-three years. For several months she was bedridden, displaying inertia, self-accusatory ideas and severe insomnia. Her illness had become more pronounced during the last two months and was characterized by hyperreligiosity, ideas of sinfulness and unworthiness, depression, numerous somatic complaints, obsessive thoughts of an obscene, tormenting, distressing nature, restlessness, and at times frenzied agitation. A diagnosis of involuntional psychosis was made.

Physical examination showed a slight woman, weighing 91½ pounds (41.5 Kg.), who had pronounced scoliosis and kyphosis. This had been present since childhood. The heart sounds were irregular, with occasional premature systoles. The blood pressure was 110 systolic and 80 diastolic; the pulse rate was 90. The electrocardiographic report (April 7) was as follows: "The P waves show splitting in leads II and III; the T waves are inverted in leads II and III; the tracing is abnormal. Treatment should be withheld. It is suspected that this patient has coronary arteriosclerosis with degeneration of the posterior wall of the left ventricle, as well as disease of the auricular muscle."

Electric shock therapy was begun, and after the third treatment great improvement was evident in the subsidence of anxiety, disappearance of self-accusatory ideas, cheerful participation in hospital activities and practically complete absence of the former constellation of mental symptoms. The response to therapy was so satisfactory after the fifth treatment that further shocks were considered unnecessary and the patient was discharged as recovered on the twenty-fourth day of hospitalization. The electrocardiogram taken after termination of shock treatment showed no change. Since her discharge from the hospital the patient has gained weight and maintained her state of recovery.

Considerable controversy has arisen regarding the employment of convulsive shock treatment in the presence of pulmonary disease, especially with respect to tuberculosis. It is common psychiatric knowledge that tuberculosis is frequently present in patients with schizophrenia. The coexistence of mental disturbance and pulmonary tuberculosis tends to create a vicious circle, in which there is enhancement of the main difficulties encountered in each disorder. Electric shock therapy can, and does, act in many cases as a means of breaking this vicious circle. Pacella¹¹ cited the cases of 4 patients with latent and active tuberculosis treated with electric shock in whom there were no complications and

8. Moore, M. T.; Winkelman, N. W., and Solis-Cohen, L.: Asymptomatic Vertebral Fractures in Epilepsy: Comparison with Vertebral Fractures Due to Metrazol-Induced Convulsions, *J. Nerv. & Ment. Dis.* 94:309-323, 1941.

no reactivation of the pulmonary process. Smith⁹ administered electric shock therapy to an agitated middle-aged woman who had active tuberculous lesions in both lungs of several years' duration. After she had received twenty convulsive shocks, both her psychiatric and her pulmonary status improved.

In this series, 30 patients had, at the time of treatment or in their past history, some form of pulmonary disease which previously would have prejudiced the consideration of electric shock treatment, as shown in the tabulation.

Pulmonary Disorders	No. of Patients
Chronic tuberculosis.....	8
Pulmonary fibrosis.....	7
Tuberculosis (active).....	2
Tuberculosis in childhood.....	2
Pulmonary emphysema.....	7
Pleural thickening.....	2
Pleuritis.....	1
History of pulmonary abscess (11 years before).....	1

CASE 7.—S. P., a married woman aged 58, was first examined on May 10, 1945 and admitted to the hospital on May 24. During April 1945 she began to lose interest in her personal appearance and in her home. There developed inertia, fear of infecting members of her family as the result of pulmonary tuberculosis she had had thirty years ago, agitation, insomnia and numerous somatic complaints. For two or three weeks before admission her condition worsened, with ideas of inadequacy, hopelessness and suicide. After psychiatric examination the diagnosis of involuntional psychosis was made. Physical examination showed pinpoint pupils (she was using eye drops for glaucoma); expressionless, greasy facies, with the habitus of parkinsonism; an impaired pulmonary note on percussion and moist, subcrepitant, crepitant, crackling and musical rales on auscultation; moderate sclerosis of the peripheral arteries, and a blood pressure of 154 to 180 mm. of mercury systolic and 80 mm. diastolic. The electrocardiographic report (May 26) follows: "The cardiac rate is 116 to 120 per minute with normal sinus rhythm; the PR interval is 0.14 second; the P waves are tall and prominent in leads II and III; the QRS complexes are normal; the T waves are flat in lead I and elevated in leads II, III and IV. The electrocardiographic diagnosis is tachycardia." A roentgenogram of the chest showed diffuse peribronchial fibrosis without evidence of active tuberculosis (fig. 2). Electric shock treatment was instituted, and after the third treatment notable improvement was evident. Treatment was terminated after the sixth electric shock. She had recovered completely from her depression and was cheerful, outgoing and almost vivacious. Physical examination of the chest showed lessening of the rales, and roentgenograms revealed no change. Follow-up studies have shown some improvement in the pulmonary status, and she has continued to remain well mentally.

CASE 8.—S. S., a married woman aged 37, was first examined on Jan. 11, 1946. Six weeks previously there developed an agitated depression with ideas of suicide, superimposed on a chronic anxiety-tension-phobic state. She had had tuberculosis from the age of 15 and was receiving treatment for an active lesion with open cavity in the upper lobe of the left lung (fig. 3A). She was hospitalized but was so agitated that she was forced to leave. It was feared her physical activity

9. Smith, L. J., cited by Pacella.^{11'}

would seriously affect the pulmonary lesion, and after careful study electric shock therapy was advised. The electrocardiogram was normal. From Jan. 18 to May 18, 1946 she received nineteen full convulsive electric shock treatments. After



Fig. 2 (case 7).—Diffuse peribronchial fibrosis in a patient who had had tuberculosis thirty years before.



Fig. 3 (case 8).—*A*, large tuberculous cavity in the upper lobe of the left lung (Sept. 17, 1945); *B*, roentgenogram of the chest taken May 5, 1946.

her fourth treatment the agitation and depression subsided, permitting attendance for treatment at a tuberculosis clinic. A roentgenogram of the chest on May 3.

1945 (fig. 3 B) showed some improvement as compared with the roentgenographic appearance prior to shock therapy.

In the following tabulation are indicated a number of miscellaneous

Miscellaneous Conditions	No. of Patients
Peptic ulcer.....	2
Inguinal hernia.....	2
Paralysis agitans.....	2
Tracheotomy (tube in place).....	1
Nephrolithiasis.....	1
Bell's palsy.....	1
Pregnancy.....	1

conditions found in 10 patients undergoing treatment without complications. Active peptic ulcer with a recent history of bleeding or roentgenographic signs of a crater should be sufficient reason to interdict electroconvulsive therapy. Ziegler¹⁰ reported the case of a patient with gastric ulcer which bled after convulsive treatment. It is advisable, therefore, in cases with a history of ulcer to have proper studies made of the stomach and duodenum if feasible, to rule out active peptic ulcer before resorting to electric convulsive treatment. Inguinal hernia should not constitute a contraindication, since any form of hernia can be adequately restrained during treatment. The patient with tracheotomy was successfully treated for a depression. The pregnant patient in this series was treated when three months pregnant and went on to term, delivering a normal infant. Polatin and Hoch¹¹ and Goldstein and associates¹² reported the use of convulsive shock therapy during pregnancy without affecting the normal course of events.

Deaths from electric convulsive therapy may be expected, since the exact reason for such deaths is still being debated. It is to be hoped, however, that the incidence of such disasters will be materially lowered by the judicious selection of patients who require treatment and yet present attending complicating disorders. The reports in the literature thus far give electric shock therapy a cleaner bill of health than either insulin or metrazol shock treatment.^{1a} Despite precautions, an occasional case will appear which will defy adequate explanation of absence of deleterious effects in a seriously complicated case, on the one hand, or of fatality in a seemingly favorable case, on the other, as illustrated in the following report.

CASE 9.—The second death in this group was that of S. M., a 44 year old, physically normal man, who had been treated for manic-depressive psychosis from

10. Ziegler, L. H., in discussion on Evans, V. L.: Physical Risks in Convulsive Shock Therapy, *Arch. Neurol. & Psychiat.* **48**:1017-1020 (Dec.) 1942.

11. Polatin, P., and Hoch, P.: Electroshock Therapy in Pregnant Mental Patients, *New York State J. Med.* **45**:1562-1563, 1945.

12. Goldstein, H. H.; Weinberg, J., and Sankstone, M. J.: Shock Therapy in Psychosis Complicating Pregnancy: Case Report, *Am. J. Psychiat.* **98**:201-202, 1941.

Jan. 18 to Feb. 20, 1944, receiving twelve electric shock treatments. He was discharged as recovered and returned to work in an airplane factory. During October 1944 he was struck on the head by a fellow-worker and immediately thereafter became depressed, confused, agitated and hallucinated. He was admitted to the hospital on October 26. No evidence of gross organic disturbances could be found. On October 27 he was given three subconvulsive electric shock treatments, and that evening he appeared much calmer. The following morning he was found dead in bed. At autopsy the brain showed intense congestion of the pial veins in the frontal and parietal lobes and small, localized subarachnoid hemorrhages over the tips of both frontal lobes and over the left cerebral hemisphere. Histologic examination revealed congestion and petechial hemorrhages involving the frontal cortex and leptomeninges.

SUMMARY AND CONCLUSIONS

In a series of 2,181 intramural and extramural patients receiving electric convulsive treatment many presented conditions hitherto considered contraindications to convulsive shock therapy, such as cardiovascular disease with and without hypertension, pulmonary tuberculosis, pulmonary fibrosis, skeletal disorders, cerebral arteriosclerosis, general arteriosclerosis, advanced age and organic disease of the central nervous system in the form of syphilitic meningoenkephalitis. With the exception of 1 death, that of a patient with known severe cardiac disease occurring four weeks after a course of three treatments, there were no complications of moment, and the results from the psychiatric standpoint were more than gratifying. A second death occurred in a man aged 44 who offered no contraindications to treatment. Representative cases are cited in which the aforementioned contraindications existed and treatment was safely and successfully carried out.

It is felt that the former arbitrary and rigid contraindications to electric convulsive therapy should be relaxed so that many more persons may derive the benefits to be obtained from such treatment. However, there should be no relaxation in the exercise of proper caution in the selection of patients for treatment, the choice to be determined by the over-all physical status of the patient, the severity of the presenting psychosis, the immediacy of the need of treatment and the promise of a favorable result.

1813 Delancey Street.

ABSTRACT OF DISCUSSION

DR. LOTHAR B. KALINOWSKY, New York: Dr. Moore rightly stresses the need to revise the contraindications to electric shock therapy. Every neuro-psychiatrist has to take an occasional risk when the psychotic manifestations in themselves are more dangerous to a preexisting disease than electric shock therapy. I first saw this illustrated by a tuberculous patient in catatonic stupor; she was doomed because even tube feeding was hardly feasible and her weight had dropped to 68 pounds (30.8 Kg.). Convulsive shock treatment was started

in spite of a constantly elevated temperature. With the improvement of her mental condition her weight rose to over 130 pounds (59 Kg.).

It is regrettable to hear the frequent statement that patients have to be built up physically before electric shock therapy can be started. Actually, this treatment is the best way of increasing the weight of a psychotic patient. It is equally a mistake to preclude from treatment patients suffering from agitated depressions with hypertension. It is one of the most easily demonstrable facts of psychosomatic medicine that an abnormally high blood pressure falls when convulsive therapy removes the emotional strain of the psychosis.

Although many of us have treated patients with cardiac disease, Dr. Moore's rich material is unique. Electrically induced convulsions hardly ever influence electrocardiographic tracings.

In my opinion, the sudden death of the first patient several weeks after treatment cannot be attributed to the treatment. The second fatality has two interesting features: It occurred after a nonconvulsive treatment, which I always consider more dangerous than a convulsion-producing treatment, besides being therapeutically ineffective, and no preexisting disease was present to explain the death. This striking fact common to most of the fatalities reported is less surprising when one realizes that physical disease in epileptic patients is not aggravated by spontaneous convulsions.

I agree that abnormalities of the spine do not predispose to fracture. Dr. Moore uses tight restraint, which in my experience favors, rather than prevents, fracture of the long bones. I avoid any kind of tight restraint. Lately, I have been starting treatment with a low, subconvulsive stimulus in order to make the patient relax, and I follow this immediately with the convulsion-producing amount of current; a patient with relaxed musculature is less apt to have fracture.

It is true that peptic ulcer presents a danger, and I have seen an unrecognized diverticulitis lead to rupture and peritonitis during convulsive therapy.

A definite contraindication not mentioned in this paper is cerebral tumor, as evidenced by several cases of which I know. On the other hand, a neurologic condition without increased intracranial pressure has never been aggravated.

The elimination of most contraindications to electric shock therapy should not lead to its indiscriminate use. The treatment has few contraindications but many unpredictable complications, and the present discussion should not be concluded without a warning against such treatment when it is not strictly indicated.

DR. NATHANIEL W. WINKELMAN, Philadelphia: As the director of the hospital from which this report is presented, I have had the opportunity of seeing a great many of the patients reported on by Dr. Moore. Electric cerebral shock has proved of distinct value in the treatment of many of the psychoses, and it is practically specific for some. The contraindications to treatment with this modality must be carefully evaluated in every case. To deprive a patient with involuntional depression, for example, of this therapy is frequently to sentence him—or, more commonly, her—to a life in a psychiatric institution; yet when this condition strikes the ravages of age may have already made themselves apparent. In the beginning my colleagues and I were probably overcautious in the selection of cases; now the pendulum has swung in the other direction, and treatments are being given in physicians' offices and in outpatient departments. For this reason, from time to time careful reevaluations must be made of the indications for and the contraindications to this means of therapy, which can do much good, but probably can also produce much harm.

A most interesting case was that of a woman physician, about 30 years of age, who was precipitated into a psychosis (catatonic schizophrenia) during her stay

in a tuberculosis sanatorium. Pneumothorax was being induced and she was transferred to the Philadelphia Psychiatric Hospital shortly after the onset of psychotic manifestations. She received both electric and insulin shock, with extremely satisfactory results, and is now practicing medicine.

Dr. Moore's results, I think, are excellent. His patients were a selected group. We do not take senile patients, patients with long-standing schizophrenia or deteriorated patients. Our results are probably much better than those in the average "run of the mill" cases for that reason.

DR. WALTER Z. BARO, Los Angeles: I should like to ask Dr. Moore whether he has the family sign a special release in all cases in which he is a little wary of giving the patient electric shock treatment. I have been with the Veterans Administration for the past eighteen months. My associates and I are handicapped by regulations and procedures, and we are supposed to give electric shock treatment only in cases in which the indications are clear.

I should also like to ask Dr. Moore whether his experience has been the same as ours, namely, that the patient with hypertension has a reduction in blood pressure during electric shock treatment. I remember a man who had continuous hypertension, with a pressure of 190 to 200 systolic, and when we were through with the treatment his blood pressure was normal.

DR. A. E. BENNETT, Omaha: In the experience of my colleagues and myself, the only absolute contraindications have been decompensated cardiac disease, suppurative pulmonary disease and generalized bacteremic infections. I believe there are further contraindications in many of the conditions Dr. Moore has described unless one uses the precaution of preliminary curarization to protect the patient from skeletal and visceral trauma. It is surprising how successful the treatment may be in cases of severe depression complicated by serious organic disease, and I agree that treatment should not be withheld because of such a complication, but that careful medical supervision, combined with the best psychiatric management, will lessen the hazards and improve the end result.

DR. FOSTER KENNEDY, New York: I should like to congratulate Dr. Moore on this paper. As you know, American soldiers, with rare exceptions, were not given the opportunity of this treatment by reason of its being forbidden in Washington. Many American soldiers in Britain had to be "bootlegged" over to Denmark Hill, the British hospital, in order to receive electric shock therapy. The objection of the medical profession at large, and that of a large section of the psychiatric profession, must be overcome, and it will be when the facts are plain; but facts take a great deal of digestion if there is an emotional inhibition against them.

My first patient with severe hypertension was a man aged 65 with extreme agitation and melancholia of three years' standing, who had come from South America for treatment. When I examined him, his blood pressure was 250 systolic and 140 diastolic, and his retinas were covered with hemorrhages. I refused to give him treatment. He went to Canada for six weeks, then came back with his daughters, as badly off as he had been for three years, and he said that if I did not treat him he was going to shoot himself. I treated him, not entirely because of his threat, but because I had seen, in the twenty years before the introduction of electric shock therapy, 2 cases of a condition diagnosed as "malignant" hypertensive vascular disease occurring in the course of an agitated depression cycle in which the diagnosis was disproved by events. I believe that many patients with agitated depressions have extreme hypertension as a result of the same hypothalamic storm as that which causes the severe depression.

I have had to treat 2 patients with multiple sclerosis. I did so with the greatest dislike and was gratified to obtain an excellent result, with improvement in their affective symptoms. This improvement may be due to the fact that their having more liberty and feeling happier made their organic structural disability, may I say, of less moment to them. The same is true in my experience with tuberculosis.

My oldest patient was 80. I have had patients in the late seventies. I have had the good fortune not to have any deaths as yet; but I think that it is pusillanimous in a physician not to have the courage to give his patient the benefit of what he can do. The surgeon has to take risks of losing his patients. The physician must have equal courage with a new medium in order to get justified results.

I do not get a signed release; I get the patient or the patient's relative to sign a permit, as he would do for having his tonsils out. Surgeons do not operate without some sort of signed permission. It is a wise procedure, and a trivial technicality, on the part of the physician to ask the same of patients who are to receive this treatment.

DR. W. J. OTIS, New Orleans: Dr. Moore has reassured us as to what one is able and is unable to do in administering treatment. In a series of 27,000 treatments given by our New Orleans group, with and without curare, there has been no fatality. A member of the family signs the usual request form for the treatment. No matter how secure one may feel in administering the treatment, the usual ritualistic orthopedic and prophylactic measures should be adhered to. In treating patients after an attempt at suicide or with orthopedic and surgical conditions, casts and other protective measurements have been employed. We have used the method as a tranquilizer in cases of the manic phase of dementia paralytica and likewise in cases of the obsession-compulsion types, with gratifying results in both. Our experience has taught us that it should be given only in a hospital under intelligent auspices by a neuropsychiatrist trained in that type of therapy. I should like to ask Dr. Moore what his results with the obsession-compulsion psychosis have been.

DR. EUGENE ZISKIND, Los Angeles: I, too, wish to thank Dr. Moore for his discussion of a practical therapeutic problem. In the past year I have seen 2 patients with acute coronary thrombosis, in each instance precipitated in a person who had a prepsychotic personality, common to the involuntional psychoses, and in whom, concomitant with the coronary thrombosis, there was a picture of agitated depression, raising the question of whether or not these patients did not have involuntional melancholia with paranoid state in addition. I refrained from treating either patient with electric shock, and each died after two weeks of agitated depression, which all concerned felt contributed greatly to the early death. Dr. Abraham Myerson, of Boston, reported safely treating such a patient with electrically induced convulsions. I have as yet not treated such persons. I should like to hear whether Dr. Moore has had any experience with electric shock therapy in cases of coronary thrombosis.

With respect to patients with tuberculosis with induced pneumothorax, I had my first case in 1938, that of a woman with inactive tuberculosis but with pneumothorax. Her involuntional depression was of two years' standing. I refused to treat her, and five years later she was still ill. Two or three years later I had accumulated requests from specialists in tuberculosis to treat 3 other such patients. I had them all admitted to the sanatorium at the same time, after I had gathered sufficient courage. The night before treatment was to start, 1 of the patients,

whose weight had fallen to 87 pounds (39.5 Kg.), bumped into a chair and sustained a pathologic fracture of the femur. I treated the other 2 patients, and they made a recovery from their depression with impunity and in a subsequent follow-up study had no active tuberculosis or mental illness. The patient with the pathologic fracture, whom I never treated, also recovered from her depression but died eight or nine months later of the tuberculosis.

The whole question is one of medical judgment, calling for individualization in each case. The picture will be seen in its entirety only at such time as an analysis is made of the cases of treated and nontreated patients, both with complicating visceral disease.

DR. DOUGLAS GOLDMAN, Cincinnati: The experience of my colleagues and myself has been much like that of Dr. Moore. We have treated patients with all the complicating disorders which he has described. There are some points which I should like to mention. Patients with tuberculosis who have a large scale encroachment on their respiratory capacity with active pneumothorax, and possibly also with thoracoplasty, represent a greater than average risk. We have recently had the experience of a test dose of curare resulting in almost immediate death, before any electric shock treatment was given. Most patients who have loud heart murmurs, particularly those with rheumatic heart disease whose cardiac condition is well compensated, can be treated with impunity; but patients who have had an episode of severe decompensation must be considered to present greater risks than should be taken in some instances. We have had experience in treating patients who had severe osteoporosis, with spontaneous pathologic fractures of the vertebrae. With adequate doses of curare these patients can be treated safely, and often it is the treatment which results in their eventual recovery from the osteoporosis, because it is possible to give them adequate diet and other care. We have not considered age a contraindication to treatment, provided the patient's physical condition was reasonably good and the psychotic condition justified the treatment.

DR. BENJAMIN BOSHES, Chicago: Partially apropos of this paper, and partially in answer to Dr. Kennedy's remarks, I submit the following experience: In the fall of 1942 I brought an electric shock apparatus overseas as part of hospital equipment. The hospital where I was stationed rapidly filled with psychotic patients. The shipmasters refused to accept disturbed patients for return to the States. There were few hospital ships at that time, and any available vessel had to be used. In late February or early March of 1943, after much deliberation, I began the use of electric shock treatment, which was contrary to Army regulations. It was amazing to see how rapidly the acute schizophrenic states underwent remissions. I do not pretend that these disturbances were the so-called dementia precox, but they were often severe psychoneurotic regressions. Other acute psychotic states, including the toxic deliriums incident to acute disease and trauma, responded to this therapy.

I reported my results first in a conference in Oran, Algeria, in September 1943 and subsequently published a paper in the *Medical Bulletin of the Mediterranean Theater*, entitled "Battle Neuroses: Electroshock Treatment of Refractory Cases in the Theater of Operation." The editors apparently thought kindly of the contribution and asked that the paper be forwarded to the United States. It was, and the paper was placed on the agenda of the American Psychiatric Association for its meeting in the spring of 1944. Suddenly, ten days or so before the meeting, I received a letter through official channels stating that such a paper could not be published in the United States because the therapy was contrary to Army

regulations. I canceled the paper on the program. Subsequently, I received a note from General Menninger explaining why the paper could not be published in the States. Dr. Menninger was very kind, but he had to follow regulations.

I sent some of the men with affective disorders back to duty, just as I had sent persons in private practice back to work, and traced them for two or three years. They did well in combat. They held up as well at least as the average person. Some of the men went through as high as three hundred days of combat, without subsequent break. One man required two brief courses of electric shock treatment. The treatment was effective and useful.

Soldiers responded rapidly to electric shock therapy, requiring few treatments as compared with patients in civilian life. In almost three years of psychiatric work overseas, it was my experience that once we had started the use of electric shock we never had to feed a patient by tube or evacuate any one to a ship who required restraint or any unusual care.

DR. MATTHEW T. MOORE, Philadelphia: It is a routine procedure in our institution to have a patient, or the relative, sign permission for treatment. I think I have already answered the question about hypertension.

My results with the obsessive-compulsive psychoneurosis have been uniformly poor. Work recently released from our institution regarding the treatment of various types of psychoneuroses with electric shock has shown that patients who present anxiety-tension states respond fairly well. On the whole, however, we are veering away from the use of electric shock therapy of the psychoneuroses.

Psychiatry is just emerging from its status of a purely descriptive, and somewhat nebulous, branch of general medicine. Only recently has it been able to offer medical men and the general public tangible, pragmatic instrumentalities in the way of treatment, such as narcohypnosis and shock therapy.

The surgeon when faced with the problem of an acute, ruptured appendix, a gangrenous segment of bowel or a pulmonary lesion which requires lobectomy does not hesitate to operate because he knows there is a degree of morbidity and mortality attendant on these procedures. The surgeon is a robust person mentally, and usually physically, and he does not hesitate to drive forward when he realizes that active therapy is essential. He utilizes his skill, experience and judgment where and when indicated. The psychiatrist can do the same. Then let us get down to business and face the responsibilities incident to electric shock therapy.

ELECTROENCEPHALOGRAPHIC STUDY OF ELECTRIC SHOCK THERAPY

Psychotic Patients Treated in a United States Naval Hospital

JOHN D. MORIARTY, M.D.*

LOS ANGELES

AND

JOHN C. SIEMENS, M.D.†

LARKSPUR, CALIF.

IT IS recognized that electric shock therapy produces recovery in a surprising number of mentally sick people, but not a great deal is known about the exact healing mechanisms. In a previous study¹ a broad clinicotheoretic approach was made to this problem, attempting to integrate and correlate various physiologic and psychobiologic factors in the curative process. The present paper is confined primarily to the sequence of neurophysiologic events reflected in the electroencephalographic series. Always keeping in mind that the electroencephalogram registers only the physiologic state of the brain and its disturbances, and chiefly the activity from the convexity of the cerebrum, one can still derive a great deal of information about what occurs when the patient is subjected to a series of electric convulsive treatments.

MATERIAL AND METHODS

Material.—Our patients comprised a series of 106 psychotic men—Naval, Marine and Coast Guard personnel—evacuated from the Pacific area. Most of them had been hospitalized for two to six months before therapy was instituted, but none had been ill longer than one year. In general, all were manifestly psychotic, their psychoses falling into the schizophrenic, schizoaffective and depressive reaction types. The age range was from 18 to 40 years; in general deviations in prepsychotic personality were not as prominent as in civilian groups; and a history of convulsions was not elicited in any case.

Method of Treatment.—No rigid therapeutic regimen was followed. Each patient was given what appeared to be the optimum number of treatments for him—which varied from six to thirty, as the case might be. In general, patients with depressive reactions received about three treatments a week, until a total of eight to twelve was given. The patients with pronounced schizophrenic and profound regressive reactions were usually first given daily treatments; the fre-

* Lieutenant (MC), U. S. N. R., on inactive duty.

† Lieutenant (jg) (MC), U. S. N. R., on inactive duty.

1. Moriarty, J. D., and Weil, A. A.: Healing Mechanisms in the Shock-Treated Neurotic Patient, *J. Nerv. & Ment. Dis.* **101**:205-214 (March) 1945.

quency was then gradually decreased, but the treatments were continued until about twenty to twenty-five had been given.

Two special factors in our technic of treatment must be emphasized: (1) We used unidirectional current throughout the series (Reiter electrostimulator); (2) one shock electrode was applied to the right temple and the other to the vertex. Thus, in every case the same hemisphere (the right) received the primary stimulation. With this technic, a dose of 60 to 80 milliampere seconds (delivered by about 35 volts) is ordinarily sufficient to produce a convulsion—in contrast to the much larger doses (usually 200 to 400 milliampere seconds or more) required with the “standard” bitemporal application of alternating current.

Results of Treatment.—With the procedure outlined, the therapeutic results were satisfactory. Of the entire series of 106 actively psychotic patients, 77 (73 per cent) made a “social recovery,” or had a satisfactory remission, and were discharged home. On the other hand, only 29 patients (27 per cent) either did not improve or failed to maintain their improvement and were transferred elsewhere for further care.

Technic of Electroencephalographic Study.—Except in some of the earliest cases in the series, all electroencephalograms were taken with a six channel Grass apparatus, using fine needle electrodes. Both monopolar and bipolar recordings were routinely taken from homologous frontal, parietal, occipital and temporal areas. The following procedure was followed:

1. Preshock records were taken to determine the physiologic state of the brain of the psychotic patient before treatment and to have a later basis for comparison.

2. Records were taken at various intervals during the course of treatment to establish a sequence of events. In a few cases a tracing was taken during the first hour after treatment.

3. Further electroencephalograms were obtained at various intervals after the conclusion of the course of treatments. However, when possible, most records were taken at about weekly intervals.

Criteria for Analysis of the Electroencephalogram.—It is important to describe in detail the basis of interpretation, since there is considerable variation in method among electroencephalographers.

1. Considerable attention was paid to the general pattern of the record—whether it was regular and coherent, or uneven and disjointed.

2. Most emphasis was placed on the appearance of delta activity (waves with a frequency of less than 8 per second) and on increase in voltage. However, fast activity (18 to 30 per second) of high voltage and, of course, spikes were considered definitely abnormal; but these appeared much less frequently.

3. Definite inequalities in amplitude, asynchronism of homologous areas and other signs of asymmetry were likewise interpreted as abnormal.

For the sake of convenience, the whole series of electroencephalograms was classified in four categories: normal or borderline (figure, *A*); mildly abnormal, e.g., showing some disturbance in pattern and scattered 5 to 7 per second waves of medium voltage (figure, *B*); moderately abnormal, e.g., showing considerable disturbance in pattern, with a large amount of 5 to 7 per second activity and occasional 2 to 4 per second waves (figure, *C*), and highly abnormal, e.g., showing gross fragmentation of pattern and many runs of high voltage 2 to 4 per second waves (figure, *D*).

GENERAL OBSERVATIONS

1. In the entire series of 90 patients, the preshock electroencephalograms of only 4 were definitely abnormal. This is about the same incidence of abnormality as that found in the records of normal control subjects, equated for age and for the absence of a history of convulsions.

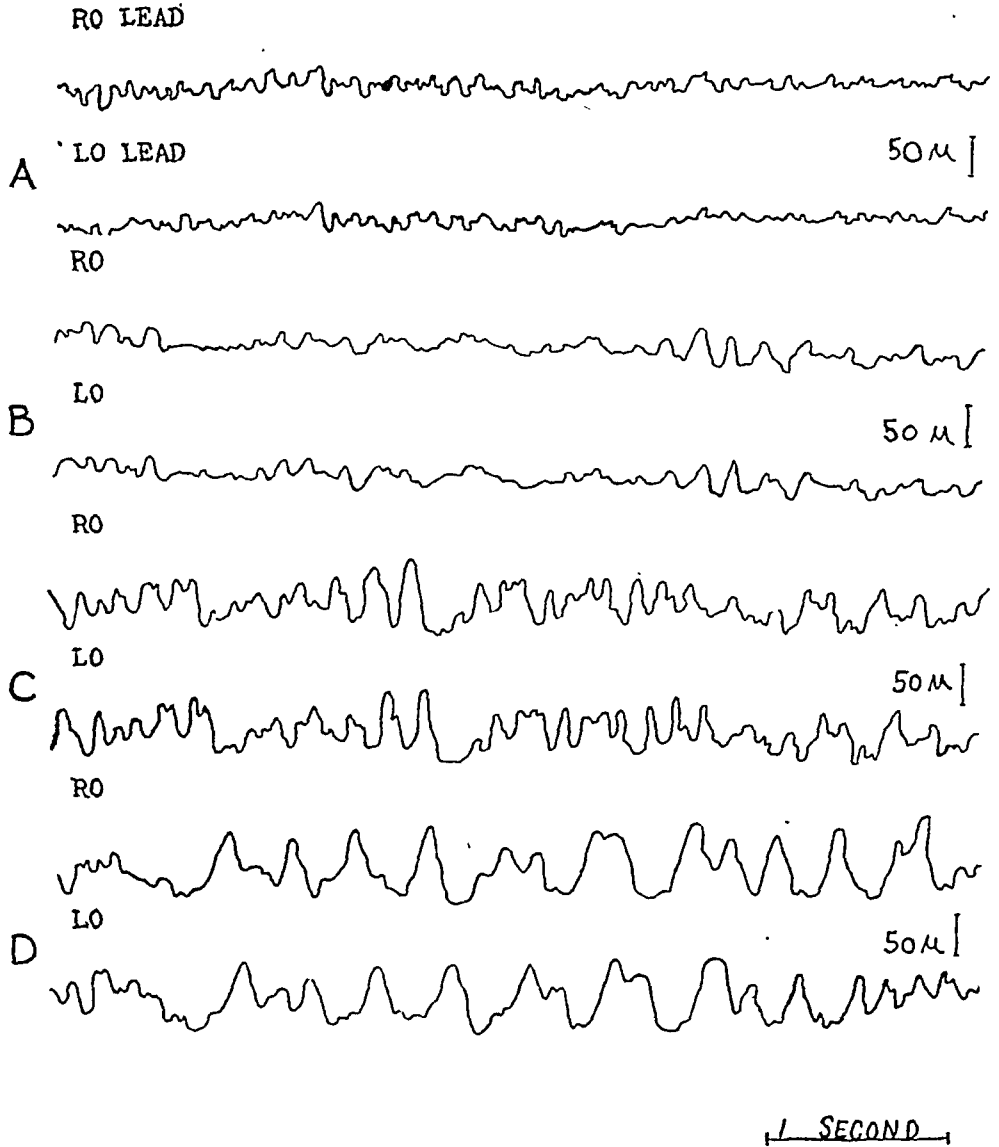

A, normal; *B*, mildly abnormal; *C*, moderately abnormal, and *D*, highly abnormal electroencephalograms.

(It should be mentioned that cooperation in hyperventilation during the recording cannot always be secured from actively psychotic patients.)

2. The electroencephalogram usually showed definite abnormalities (demonstrable at least twenty-four hours later) after three to six electric shock convulsions had been administered.

A general trend toward increased abnormality with more frequent administration and increased number of electric shocks could be demonstrated; i. e., the disturbance of brain waves tended to vary directly with the number and the frequency of the treatments. However, this was true only in general, and for 1 patient no abnormalities in the electroencephalographic series were registered at any time during his recovery, with a course of fourteen treatments. Another patient showed a similarly stable pattern of brain waves during his recovery, with eight treatments. In an occasional case the record reached its maximum abnormality early during treatment and subsequently fluctuated or showed less abnormality during the remainder of the course.

3. The rates of recovery of the electroencephalographic patterns after treatment were arbitrarily classified as rapid, medium and slow. The first type included the records which returned nearly to normal in less than a week; the second, the records (the largest number) which showed considerable subsidence of abnormalities within two weeks, and the third, a few in which definite abnormalities persisted over a month (and perhaps longer).

4. Data obtained with our special shock technic reveal that, although the same hemisphere received the primary stimulation each time, the electroencephalographic disturbances which developed were entirely symmetric and equal in the two hemispheres. In other words, the electroencephalographic abnormalities appear to be due mostly, if not entirely, to the convulsion itself rather than to the electric current which produces the seizure. The one exception to this was in the area of the shock electrode. In about one third of the patients a definite asymmetry in amplitude developed in the temporal areas: i. e., the right (or "shocked") temple showed an appreciably lower voltage, or "flatter" recording, than its homologous area. This abnormality tended to disappear in the post-treatment period, together with other deviations from normal. No persistence of "shock bursts" of high voltage slow waves in the areas of application of the shock electrode was ever found, in contrast to the reports of some investigators. The absence of shock bursts in our records was probably due to the lower voltage and amperage used in our technic.

COMPARISON OF DATA FOR RECOVERED AND FOR UNRECOVERED PATIENTS

Because of the many variables involved, it is difficult to compare the electroencephalograms of patients who recovered and those who did not. However, some noteworthy trends may be profitably mentioned.

1. The average number of treatments given the patients who recovered was almost the same as that given the patients who failed to recover, being fifteen for the former and sixteen for the latter.

2. The degrees of abnormality that developed in the electroencephalograms during the therapeutic course showed the same distribution curve for the two groups, varying with the number and the frequency of the treatments.

3. Likewise, the rate of return of the electroencephalogram to normal after cessation of therapy showed no significant variation between the recovered and the unrecovered patients.

4. The question arises whether there are prognostic implications in the electroencephalograms of psychotic patients being treated with electric shock. On the basis of a small series of cases, Proctor and Goodwin² found that patients with somewhat slow preshock records tended to exhibit prominent delta activity during the course of shock treatments and that none of those patients who did exhibit "3 plus delta" activity showed clinical improvement. On the other hand, Bagchi and associates³ concluded from a study of 54 cases that patients with the greatest amount of preshock electroencephalographic abnormality profited most from electric shock treatment. Turner and associates⁴ stated that whereas one fourth of their patients with normal preshock electroencephalograms recovered, none of the patients with abnormal preshock records did so. In other words, the few studies of the prognostic value of the electroencephalogram in shock therapy fail to show any agreement. These conflicting reports do not surprise us, for a careful review of our series of electroencephalograms fails to disclose any significant trend in the records of the recovered patients which distinguishes them from the records of the patients who failed to recover.

5. Another, related, study of ours deals with an attempt to determine what correlation exists between electroencephalographic abnormalities and the clinical symptoms of the psychosis. A theory of the healing mechanism of convulsive therapy in the psychoses which has been advanced from time to time is that epilepsy is "antagonistic" to schizophrenia. A slightly different statement of this idea of the curative process is that convulsive therapy changes the "schizophrenic brain" into an "epileptic brain," which then proceeds to "heal toward normal." This highly fanciful theory cannot be substantiated by either clinical or electroencephalographic observations. It has already been implied in

2. Proctor, L. D., and Goodwin, J. E.: Comparative Electroencephalographic Observations Following Electroshock Therapy Using Raw 60 Cycle Alternating and Unidirectional Fluctuating Current, *Am. J. Psychiat.* **99**:525-530 (Jan.) 1943.

3. Bagchi, B. K.; Harvell, R. W., and Schmale, H. T.: The Electroencephalographic and Clinical Effects of Electrically Induced Convulsions in the Treatment of Mental Disorders, *Am. J. Psychiat.* **102**:49-61 (July) 1945.

4. Turner, W. J.; Louringer, L., and Huddleson, J. H.: The Correlation of Pre-Electroshock Electroencephalogram and Therapeutic Result in Schizophrenia, *Am. J. Psychiat.* **102**:299-301 (Nov.) 1945.

the prognostic studies previously referred to that individual psychotic manifestations, such as delusions, hallucinations and disorders of mood, disappear or persist, as the case may be, practically independently of alterations in brain waves during convulsive therapy.

An even more surprising lack of correlation is found between electroencephalographic deviations, on the one hand, and sensorial disturbances, impairment of memory and confusion, on the other. Thus, a patient who recovered without showing any electroencephalographic abnormalities in a series of five recordings exhibited simultaneously more than average confusion and patchy amnesia during his course of fourteen treatments. Several patients who recovered remained alert and sensorially clear throughout treatment, despite the development of conspicuously abnormal electroencephalograms. The general trend, of course, was a lack of demonstrable correlation rather than an inverse relationship. It should be mentioned that our therapeutic technic of a unidirectional current given by a vertex-temple system of leads produces far less intellectual disturbance than the conventional technic of treatment, as has been verified repeatedly both by clinical observations and by psychometric tests. As Wilcox⁵ has recently pointed out, the aim of shock therapy is properly facilitation of cerebral activity rather than destruction of brain tissue.

SUMMARY AND CONCLUSIONS

In electroencephalographic studies on a series of 106 psychotic men at a Naval hospital given varying courses of convulsive therapy with unidirectional current, the following observations were made:

1. The preshock electroencephalograms showed no more abnormalities than are found in comparable normal control records.

2. With shock treatment almost all the patients manifested disturbances in cerebral physiology easily demonstrable in the electroencephalogram. The degree of change varied roughly with the number and the frequency of treatments, but there were many noteworthy exceptions.

3. In the majority of cases the electroencephalogram showed a considerable or a complete return to normal within two weeks after cessation of treatment. In a few cases the abnormalities were more persistent.

4. A careful comparative analysis of the electroencephalograms of the recovered patients (73 per cent) failed to reveal any significant difference from the records of the patients who did not recover. It is concluded, therefore, that the electroencephalogram does not offer a prognostic guide in electric shock therapy.

5. Wilcox, P.: Brain Facilitation Not Brain Destruction the Aim of Electroshock Therapy, *Dis. Nerv. System* 7:201-204 (July) 1946.

5. Likewise, no significant correlation was found between the disappearance or persistence of individual psychotic symptoms and the electroencephalographic pattern, or between the degree of sensorial disturbance and memory impairment and the degree of abnormality in the brain waves. It is thus concluded that the obvious changes in cerebral physiology registered in the electroencephalogram do not give a direct clue to the mechanism of healing in electric shock therapy.

1052 West Sixth Street (Los Angeles).
Larkspur, Calif.

ELECTROENCEPHALOGRAPHIC STUDIES FOLLOWING ELECTRIC SHOCK THERAPY

Observations on Fifty-One Patients Treated with Unidirectional Current

ANDRÉ A. WEIL, M.D.*

CLEVELAND

AND

WILLARD C. BRINEGAR, M.D.

Clinical Director and Assistant Superintendent, New Hampshire State Hospital
CONCORD, N. H.

ELECTROENCEPHALOGRAPHIC studies following electric shock treatment have been described by several authors (Levy, Serota and Grinker¹; Hughes, Wigton and Jardon²; Pacella and Barrera³; Fleming, Golla and Walter,⁴ and Bagchi, Howell and Schmale⁵). It is fairly well agreed by all these authors that electroencephalographic tracings after electric shock treatment show a definite resemblance to epileptiform wave patterns (Kalinowsky and Hoch⁶). All these brain waves tracings were obtained after administration of alternating current. The only previous observation on unidirectional, fluctuating current as administered by

From the New Hampshire State Hospital, Concord, New Hampshire.

Presented at a meeting of the Cleveland Neurological Society, June 5, 1946.

* Now at the Neuropsychiatric Institute of Cleveland; formerly Director of Clinical Research, New Hampshire State Hospital.

1. Levy, N. A.; Serota, H. M., and Grinker, R. R.: Electroencephalographic and Clinical Studies Following Convulsive Shock Therapy of Affective Disorders, *Arch. Neurol. & Psychiat.* **46**:542 (Jan.) 1941.

2. Hughes, J.; Wigton, R., and Jardon, F.: Electroencephalographic Studies on Patients Receiving Electric Shock Treatment, *Arch. Neurol. & Psychiat.* **46**:748 (Oct.) 1941.

3. (a) Pacella, B. L., and Barrera, S. E.: Some Considerations of the Electroencephalogram in the "Convulsive State" (Electrically Induced Seizures), *J. Nerv. & Ment. Dis.* **96**:125 (Aug.) 1942; (b) Sequelae and Complications of Convulsive Shock Therapy, *Arch. Neurol. & Psychiat.* **53**:82 (Jan.) 1945. (c) Pacella, B. L.; Barrera, S. E., and Kalinowsky, L.: Variations in Electroencephalogram Associated with Electric Shock Therapy of Patients with Mental Disorders, *ibid.* **47**:367 (March) 1942.

4. Fleming, G. W. T.; Golla, F. L., and Walter, W. G.: Electric-Convulsion Therapy of Schizophrenia, *Lancet* **2**:1353 (Dec. 30) 1939.

5. Bagchi, B. K.; Howell, R. W., and Schmale, H. T.: The Electroencephalographic and Clinical Effects of Electrically Induced Convulsions in the Treatment of Mental Disorders, *Am. J. Psychiat.* **102**:49 (July) 1945.

6. Kalinowsky, L. B., and Hoch, P. H.: Shock Treatments and Other Somatic Procedures in Psychiatry, New York, Grune & Stratton, Inc., 1946.

the Reiter apparatus (Friedman and Wilcox⁷; Friedman⁸) was reported by Proctor and Goodwin.⁹ They found a significant increase in the occurrence of cortical slow wave formations in the subjects receiving alternating current as compared with the subjects receiving unidirectional, fluctuating current.

We have tried to elaborate on their observations in this study, utilizing only unidirectional, fluctuating current. Since most of the papers just mentioned did not stress the importance of a standardized time interval between treatment and electroencephalographic recording, we endeavored to make all our electroencephalographic studies at a constant time interval. Also, in order to obtain more uniform conditions, only female patients were selected. We tried to avoid, at least in the preshock electroencephalogram, obtaining our records at the time of menstruation.

PROCEDURES

Fifty-one patients admitted to the New Hampshire State Hospital for various neuropsychiatric conditions (table 1) were asked to submit themselves to electro-

TABLE 1.—*Distribution of Neuropsychiatric Disturbances in the Series of Fifty-One Patients*

Diagnosis	No. of Patients
Schizophrenia	20
Involuntional psychosis	13
Psychosis due to alcohol.....	1
Manic-depressive psychosis	5
Psychosis with mental deficiency.....	1
Psychosis with psychopathic personality.....	1
Psychoneurosis	10

encephalographic study the day before electric shock treatment was started and again at definitely controlled intervals after treatments ceased, namely, four days after treatment and, again, ten days later.

Electric shock treatments were given three times a week. The number of treatments varied from three to twenty. We believe that with schizophrenic patients administration of more than ten treatments is usually advisable (Kalinowsky¹⁰); however, for various reasons, not all patients in this series received that many treatments.

7. Friedman, E., and Wilcox, P.: Electrostimulated Convulsive Doses in Intact Humans by Means of Unidirectional Currents, *J. Nerv. & Ment. Dis.* **96**: 56 (July) 1942.

8. Friedman, E.: Unidirectional Electrostimulated Convulsive Therapy, *Am. J. Psychiat.* **99**:218 (Sept.) 1942.

9. Proctor, L. D., and Goodwin, J. E.: Comparative Electroencephalographic Observations Following Electro-Shock Therapy, *Am. J. Psychiat.* **99**:525 (June) 1943; Clinical and Electro-Physiological Observations Following Electroshock, *ibid.* **101**:797 (May) 1945.

10. Kalinowsky, L.: Electric Convulsive Therapy with Emphasis on Importance of Adequate Treatment, *Arch. Neurol. & Psychiat.* **50**:652 (Dec.) 1943.

For the purpose of this study, the electroencephalograms were rated as normal, questionably normal, pathologic and grossly pathologic. The following criteria were used in making these ratings:

Normal.—Normal records; records slightly less stable, or records showing atypical ocular movements.

Questionable.—(1) Occipital alpha index less than 10 per cent; (2) some discrepancies between the two hemispheres; (3) extremely "choppy" records; (4) single slow wave activity, between 6 and $7\frac{1}{2}$ per second, without increased voltage, or (5) high frequency runs of less than 25 microvolts.

Pathologic.—(1) Single slow wave activity, between 6 and $7\frac{1}{2}$ per second, with increased voltage; (2) frequent single slow waves, with a rate of less than 6 per second; (3) runs of 6 or $7\frac{1}{2}$ per second waves, or (4) traumatic spikes of less than 30 microvolts; (5) rapid breakdown of pattern during hyperventilation, or (6) high frequency runs of more than 25 microvolts.

Grossly Pathologic.—(1) Spike and wave formations; (2) paroxysms and runs of waves slower than 6 per second; (3) traumatic spikes of high voltage, or (4) high frequency paroxysms of more than 50 microvolts.

We used a three channel Rahm electroencephalograph, writing on thermal Con-tax paper. Electrodes were applied to the frontal, motor and occipital areas bilaterally, with the indifferent electrode from the ear lobes. Hyperventilation was conducted for two minutes. All tracings were obtained with the patient lying down.

The results of our electroencephalographic studies are summarized in table 2.

OBSERVATIONS

The preshock electroencephalogram was normal for 29 patients (59 per cent), questionable for 14 patients (27 per cent), pathologic for 4 patients (7 per cent) and grossly pathologic for 4 patients (7 per cent). The highest percentage of questionable, pathologic and grossly pathologic per shock records was obtained from our manic-depressive patients (80 per cent), closely followed by 65 per cent from our schizophrenic patients; only 38 per cent of our patients with involutional psychosis and 20 per cent of our psychoneurotic patients showed questionable, pathologic or grossly pathologic preshock records. The result for the last group is not quite in keeping with the observations of Pacella, Polatin and Nagler,¹¹ who reported abnormal electroencephalographic patterns in 64 per cent of patients with obsessive-compulsive neuroses.

After treatment an increase in voltage, a decrease in frequency and the appearance of various abnormalities were almost universal. In general, the increase in abnormality of the record was directly proportional to the number of treatments (figure). The percentage of pathologic and grossly pathologic records increased sharply when more treatments were administered. This relation was especially noticeable in the electroencephalogram made four days after shock treatment, whereas that made

11. Pacella, B. L.; Polatin, P., and Nagler, S. H.: Clinical and EEG Studies, in Obsessive-Compulsive States, *Am. J. Psychiat.* **100**:830 (May) 1944.

TABLE 2.—Results of Electroencephalographic Studies Following Electric Shock Therapy

Patient No.	Age, Yr.	Diagnosis	No. of Electric Convulsive Treatments	Post-Treatment Data				
				Pre-shock Electroencephalographic Grading	Four Days		Fourteen Days	
					Electroencephalographic Grading	Clinical Condition	Electroencephalographic Grading	Clinical Condition
1	37	Psychoneurosis, neurasthenia	3	Normal	Improved	Normal	Improved	
2	29	Schizophrenia, catatonic	4	Questionable	Recovered	Questionable	Recovered	
3	61	Psychoneurosis, reactive depressive	4	Normal	Much improved	Pathologic	Much improved	
4	29	Psychosis with psychopathic personality						
6	50	Involuntary psychosis, paranoid	4	Normal	Improved	Normal	Improved	
6	29	Schizophrenia, paranoid	4	Grossly pathologic	Improved	Normal	Improved	
7	39	Psychoneurosis, mixed	5	Pathologic	Much improved	Questionable	Much improved	
8	21	Psychoneurosis, mixed	5	Pathologic	Recovered	Pathologic	Recovered	
9	45	Involuntary psychosis, paranoid	6	Pathologic	Much improved	Questionable	Much improved	
10	42	Psychoneurosis, mixed	6	Questionable	Recovered	Questionable	Recovered	
11	49	Involuntary melancholia	6	Grossly pathologic	Much improved	Normal	Recovered	
12	21	Schizophrenia, paranoid-catatonic	6	Questionable	Unimproved	Grossly pathologic	Unimproved	
13	59	Manic-depressive psychosis, depressive	6	Questionable	Improved	Normal	Improved	
14	27	Schizophrenia, catatonic	6	Grossly pathologic	Recovered	Pathologic	Recovered	
15	47	Involuntary melancholia	6	Normal	Recovered	Pathologic	Recovered	
16	23	Psychoneurosis, reactive depressive	6	Grossly pathologic	Recovered	Pathologic	Recovered	
17	33	Alcoholism, paranoid	7	Pathologic	Recovered	Normal	Recovered	
18	31	Schizophrenia, paranoid	7	Pathologic	Much improved	Normal	Recovered	
19	30	Schizophrenia, catatonic	7	Questionable	Much improved	Normal	Much improved	
20	29	Schizophrenia, catatonic	7	Pathologic	Much improved	Normal	Recovered	
21	50	Manic-depressive, hebephrenic	7	Pathologic	Improved	Grossly pathologic	Improved	
22	33	Psychoneurosis, mixed	7	Pathologic	Improved	Pathologic	Improved	
23	43	Manic-depressive, manic	7	Grossly pathologic	Improved	Normal	Improved	
24	57	Psychoneurosis, mixed	8	Questionable	Recovered	Questionable	Recovered	
25	50	Involuntary melancholia	8	Grossly pathologic	Improved	Grossly pathologic	Improved	
26	28	Psychoneurosis, mixed	8	Normal	Unimproved	Grossly pathologic	Unimproved	
27	43	Involuntary melancholia	8	Pathologic	Much improved	Pathologic	Much improved	
28	59	Involuntary melancholia	8	Normal	Improved	Normal	Improved	
29	57	Involuntary melancholia	8	Pathologic	Recovered	Grossly pathologic	Recovered	
30	18	Schizophrenia, mixed	8	Normal	Much improved	Normal	Slightly improved	
31	40	Manic-depressive, depressive	10	Grossly pathologic	Slightly improved	Questionable	Unimproved	
32	55	Involuntary melancholia	10	Pathologic	Unimproved	Normal	Unimproved	
33	31	Schizophrenia, mixed	10	Grossly pathologic	Improved	Pathologic	Recovered	
34	54	Manic-depressive, depressive	10	Questionable	Recovered	Questionable	Recovered	
35	59	Schizophrenia, mixed	10	Normal	Much improved	Normal	Much improved	
36	25	Schizophrenia, hebephrenic	12	Pathologic	Improved	Grossly pathologic	Recovered	
37	45	Psychoneurosis, mixed	12	Pathologic	Recovered	Normal	Recovered	
38	23	Schizophrenia, mixed	12	Grossly pathologic	Improved	Grossly pathologic	Improved	
39	20	Psychosis with mental deficiency	13	Grossly pathologic	Unimproved	Grossly pathologic	Unimproved	
40	42	Schizophrenia, catatonic	14	Questionable	Much improved	Questionable	Much improved	
41	54	Involuntary melancholia	14	Pathologic	Improved	Questionable	Improved	
42	58	Involuntary melancholia	15	Grossly pathologic	Unimproved	Grossly pathologic	Unimproved	
43	20	Schizophrenia, catatonic	15	Pathologic	Unimproved	Grossly pathologic	Unimproved	
44	51	Involuntary melancholia	15	Pathologic	Improved	Pathologic	Improved	
45	30	Schizophrenia, catatonic	15	Grossly pathologic	Unimproved	Normal	Unimproved	
46	35	Schizophrenia, hebephrenic	15	Questionable	Much improved	Questionable	Much improved	
47	34	Schizophrenia, catatonic	15	Pathologic	Improved	Pathologic	Improved	
48	30	Schizophrenia, paranoid	15	Pathologic	Unimproved	Questionable	Unimproved	
49	61	Involuntary melancholia	16	Questionable	Unimproved	Questionable	Unimproved	
50	20	Schizophrenia, catatonic	17	Normal	Unimproved	Grossly pathologic	Unimproved	
51	35	Schizophrenia, catatonic	20	Questionable	Unimproved	Questionable	Unimproved	

fourteen days after shock returned to a more nearly normal pattern. We found, for instance, that of the patient receiving ten treatments or more not one had a normal record four days after shock, whereas in the group receiving less than ten treatments some retained the normal rating.

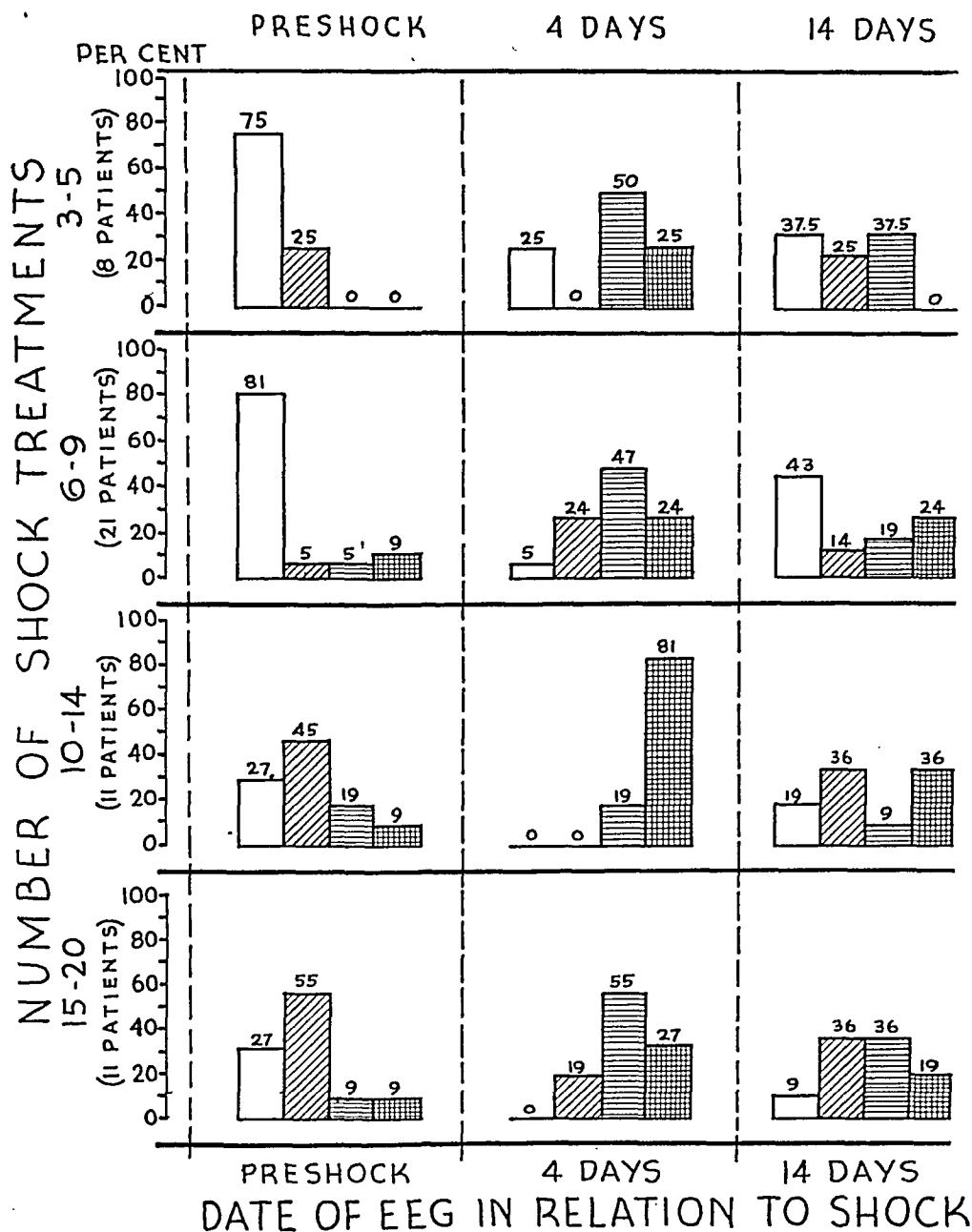

Relation of electroencephalographic abnormalities to number of treatments.

Unshaded areas indicate normal; diagonal-lined areas, questionable; horizontal-lined areas, pathologic, and squared areas, grossly pathologic electroencephalographic tracings.

Similarly, there was a sharp rise in the number of grossly pathologic records as soon as ten or more treatments were administered. It was interesting to see how rapidly the electroencephalogram improved. For

instance, four days after shock treatment, only 6 per cent of the patients showed a normal electroencephalogram and 12 per cent showed questionable, 45 per cent pathologic and 37 per cent grossly pathologic records, whereas fourteen days after shock the percentage of abnormalities in the electroencephalograms had decreased as follows:

Rating	Percentage
Normal.....	29
Questionable.....	16
Pathologic.....	24
Grossly pathologic.....	21

The 29 patients with less than ten shock treatments showed the following ratings fourteen days after shock:

Rating	Percentage
Normal.....	41
Questionable.....	17
Pathologic.....	24
Grossly pathologic.....	17

The corresponding ratings for the 22 patients who received ten or more electric shock treatments were as follows:

Rating	Percentage
Normal.....	14
Questionable.....	36
Pathologic.....	23
Grossly pathologic.....	27

The last figures cited correspond fairly well to those reported by the users of alternating current. However, the patients with less than ten treatments showed a definitely smaller percentage of electroencephalographic abnormalities than did the patients reported on previously after treatment with alternating current. Proctor and Goodwin⁹ also found a significant decrease of slow wave formation when unidirectional, fluctuating current was used instead of alternating current. Pacella and Barerra^{3b} reported in a brief note that they saw only slight changes in electroencephalographic tracings obtained with the unidirectional current from patients who had had a large number of treatments. They concluded:

This observation is in distinct contrast to the effect on the brain potentials with the use of the present standard electric shock machines.

In only 11 per cent of the records did we observe spike-dome formation, whereas in the series of Bagchi and co-workers⁵ this change was observed in 40.7 per cent after the administration of alternating current. Of our electroencephalograms four days after shock, we noticed 26 per cent with long runs of slow, 3 to 7 per second, waves, in contrast to 45.2 per cent in Bagchi's⁵ studies.

Our figures indicate that the abnormalities in the brain waves increase after ten treatments and probably produce longer-lasting disturbances of the cerebral rhythm.

For analysis of the effect of age, we divided our patients into three age groups, namely, from 15 to 24, 25 to 44 and 45 to 62 years. The electroencephalogram fourteen days after shock was taken as a criterion. We noted that the records of the patients of the youngest and the oldest age groups showed the greatest abnormality (table 3), whereas the patients of the 25 to 44 age group were able to retain more normal brain wave patterns after treatment. The factor of age has, in our opinion, often been overlooked by other authors. Hughes and associates² stated that the younger patients showed more abnormal waves but that the older patients were likely to manifest the more pronounced loss of memory.

IMPROVEMENT IN THE ELECTROENCEPHALOGRAM AFTER ELECTRIC SHOCK THERAPY

Levy and associates¹ noticed improvement in the electroencephalogram after a course of electric shock treatments as compared with the pretreatment electroencephalogram. They were inclined to explain this

TABLE 3.—*Electroencephalograms Fourteen Days After Treatment, Correlated with Age*

Age	Normal, %	Questionable, %	Pathologic, %	Grossly Pathologic, %
15 to 24.....	20	20	10	50
25 to 44.....	33	38	25	4
45 to 62.....	28	11	28	34

as due to a decrease in anxiety and tension after electric shock therapy. We made this observation on 4 of our patients whose preshock records had been graded as "grossly pathologic." All these patients had a less abnormal record fourteen days after treatment than they had before treatment. Clinically, 1 of these patients was considered recovered; the condition of the second was improved; that of the third was much improved, and that of the last was unchanged.

For the 5 patients who had pathologic preshock records a similar phenomenon was observed; all but 1 showed a less abnormal record fourteen days after treatment. Two of these patients showed no improvement clinically; 2 were improved, and 1 was considered recovered. In view of these varying clinical results, we cannot accept the explanation given by Levy and associates and must admit that the phenomenon is open to speculation.

ELECTROENCEPHALOGRAPHIC CHANGES AFTER HYPERVENTILATION

Although patterns indistinguishable from those seen in epilepsy occurred frequently in the postshock records of our series, the records showed less change after hyperventilation than one usually sees in the case

of epileptic patients. It is a well established fact that a large proportion of epileptic patients show a significant breakdown of pattern after hyperventilation. Of our electroencephalograms taken four days after shock, only 6 showed this breakdown. This is less than 13 per cent of our 48 patients whose records were classified as other than normal four days after the last treatment. Of the electroencephalograms made fourteen days after shock therapy, only 2 retained a significant breakdown during hyperventilation, or less than 6 per cent of all patients who showed records other than normal fourteen days after the last treatment. We feel that this fact serves as a distinguishing feature in the differentiation of the electroencephalogram of epilepsy and that following electric shock.

CLINICAL CORRELATION OF THE PSYCHIATRIC STATUS AND THE ELECTROENCEPHALOGRAM

Our psychiatric results were graded as follows: No improvement, when there was no improvement at all or very slight improvement; improvement, when the patient still retained definite psychotic or neurotic characteristics despite some clinical improvement, and much improvement when the patient was able to make a social adjustment but retained minor psychopathic reactions and had gained little insight; the patient was classified as recovered when he had gained insight and complete social adjustment without noticeable psychiatric defects.

Proctor and Goodwin,⁹ working with the same type of current as we did, reported in two previous communications that patients having complete remissions did not exhibit severe cerebral dysrhythmia after electric shock therapy. They also stated that patients having social remissions showed much less cortical slow wave activity than the group requiring continued care in a mental hospital. "Therefore, the appearance of cortical dysrhythmia following electric shock treatments has prognostic value."

Turner and associates¹² noted that one fourth of the patients with a normal pattern in the electroencephalogram taken before electric shock treatment left the hospital with their disease much improved or quiescent. "None of those with abnormal records prior to electric shock therapy were able to leave the hospital." Bagchi and associates⁵ stated that there was a suggestion that patients with abnormal preshock electroencephalograms profited more as a group from shock treatment than those with normal electroencephalograms. This seems to be contradictory to the statements of Turner,¹² although both authors used alternating current.

Hughes and co-workers² found no direct correlation between the development of abnormal potentials and either the disappearance of psy-

12. Turner, W. J.; Lowinger, L., and Huddleson, J. H.: The Correlation of Pre-Electroshock Electroencephalogram and Therapeutic Result in Schizophrenia. *Am. J. Psychiat.* **102**:299 (Nov.) 1945.

chotic symptoms or the occurrence of loss of memory and confusion. In checking these somewhat contradictory reports, we made the following observations:

Relation of Number of Electric Shocks Required to the Preshock Electroencephalogram.—Of the 29 patients requiring less than ten treatments, only 21 per cent had preshock records other than normal. However, of the 22 patients requiring more than ten treatments, 73 per cent showed preshock electroencephalograms other than normal. This indicates that a normal brain wave prior to treatment promises a short course

TABLE 4.—*Relation Between Clinical Results of Treatment and the Electroencephalogram Fourteen Days After the Last Treatment*

Clinical Condition	Electroencephalographic Rating Fourteen Days After Treatment							
	Normal		Questionable		Pathologic		Grossly Pathologic	
	No.	%	No.	%	No.	%	No.	%
Recovery.....	5	33	4	31	4	33	1	9
Much improvement.....	2	13	5	38	4	33	1	9
Improvement.....	7	47	0	..	3	25	3	27
No improvement.....	1	7	4	31	1	9	6	55
Number of cases.....	15	100	13	100	12	100	11	100

TABLE 5.—*Correlations Between Preshock Electroencephalogram and Psychiatric Condition After Treatment*

Clinical Condition After Treatment	Preshock Electroencephalographic Rating			
	Normal		Questionable, Pathologic, Grossly Pathologic	
	No.	%	No.	%
Recovery.....	8	28	6	27
Much improvement.....	6	21	4	18
Improvement.....	10	34	5	25
No improvement.....	5	17	7	32

of treatment, and, conversely, an abnormal preshock electroencephalogram may indicate that a longer course of treatment will be necessary.

Relation of Electroencephalogram Fourteen Days After Treatment to Clinical Results.—The results shown in table 4 indicate that a grossly pathologic record fourteen days after the last treatment is usually found in patients showing little or no clinical improvement. On the other hand, patients showing normal electroencephalograms after treatment tend to show clinical improvement.

Relations of Preshock Electroencephalogram to Clinical Results.—Although the results are not very uniform, possibly because of the age factor (table 3), we found that patients with abnormal preshock electro-

encephalograms showed poorer clinical results than patients with normal records (table 5). It may be seen that only 17 per cent of our patients whose condition was unimproved had had a normal preshock electroencephalogram, whereas 32 per cent had had an abnormal electroencephalogram prior to treatment.

Relation of Clinical Improvement to the Alpha Index.—Ten of our patients, 6 of them schizophrenic, showed an alpha index of less than 5 per cent in the preshock electroencephalogram. Seven of these 10 patients showed a well marked alpha pattern in the postshock record. Tillotson and Sulzbach¹³ also noticed that a low preshock alpha index rose after treatment in 25 to 50 per cent of their cases. Levy and co-workers¹ noticed that in some of their cases much beta activity prior to treatment was replaced by regular alpha activity after treatment. They thought that this might be due to alleviation of severe emotional tension. However, this change in the alpha pattern did not correspond to clinical improvement in our cases. Pacella and associates^{3c} made a similar observation.

SUMMARY

Fifty-one patients admitted to the New Hampshire State Hospital received varying numbers of electric shock treatments administered by a machine delivering unidirectional, fluctuating current. Brain waves were recorded prior to treatment, four days after the last treatment and, again, fourteen days thereafter. An analysis of the records revealed the following facts:

1. The highest percentage of abnormal records was obtained in manic-depressive patients, closely followed by that for the schizophrenic group. Patients with involutional psychoses and psychoneuroses demonstrated significantly more normal preshock records.

2. In general, an increase of abnormality in the electroencephalographic record was observed after treatment, characterized by increase in voltage, decrease in frequency and appearance of various other abnormalities.

3. The increase in abnormalities was usually directly proportional to the number of treatments.

4. The electroencephalograms of a large percentage of patients receiving less than ten shock treatments had returned to normal fourteen days after the last treatment. Of the group receiving more than ten treatments, a large proportion retained electroencephalographic abnormalities in this recording.

5. In the group receiving ten treatments or less, the electroencephalographic changes seemed to be less pronounced after shock treatment

13. Tillotson, K. J., and Sulzbach, W.: Electroshock Therapy in Depressive States, *Am. J. Psychiat.* **101**:455 (Jan.) 1945.

when unidirectional current was used than when alternating current was used.

6. The age groups between 15 and 24 years and between 45 and 62 years showed a much higher percentage of grossly pathologic electroencephalograms fourteen days after treatment than did the middle-aged group, between 25 and 44 years.

7. A small percentage of patients showed "improvement" in the electroencephalogram after electric shock treatments as compared with their preshock record, a fact which could not be explained and which was clinically unrelated to improvement.

8. Postshock electroencephalograms closely resembled the records of epileptic patients. However, the breakdown during hyperventilation so characteristic of the electroencephalograms of epileptic patients was rarely observed in the records of patients receiving shock treatment.

9. The following clinical relation between various changes in the brain waves and the psychiatric picture were found: (a) An abnormal preshock electroencephalogram usually indicated that a longer course of treatment was necessary in order to achieve clinical improvement. (b) A highly abnormal electroencephalographic record fourteen days after the last treatment was usually found with patients requiring further hospitalization. (c) A normal preshock electroencephalogram promised a better clinical result from electric shock treatment than an abnormal preshock record.

10528 Park Lane, Cleveland (6).

105 Pleasant Street, Concord, N. H.

Special Articles

ORIENTATION TO FORENSIC PSYCHIATRY

HENRY A. DAVIDSON, M.D.

NEWARK, N. J.

WHILE many branches of the law impinge on the practice of psychiatry, only four will be considered in this paper. These are (1) wills; (2) business contracts; (3) marriage, divorce and annulment, and (4) crimes.

WILLS

A person making a will must (1) know that he is making a will, (2) know the nature and extent of his property and (3) know the natural objects of his bounty. These are the three "tests" which, in a sense, the patient must "pass" before he is considered mentally competent to make a will. The psychiatrist must measure the subject by these three tests. Their meaning may now be considered.

1. Obviously, the testator must know what he is doing when he signs the will. If the psychiatrist is told, on a hypothetical question, that when the will was signed the patient was toxic, dehydrated, feverish, confused and unable to talk, that his hand had to be guided in signing the will, that he showed no recognition of the people around him and that he died a few hours later, the physician will probably feel that the patient did not know that he was making and signing a will. If this is so, the testator fails to pass test 1. He did not know he was making a will; hence the document is invalid.

2. The testator must know the nature and extent of his property. Not that he must know to the square inch the exact acreage of his land, nor that he must remember the serial numbers on his government bonds; but he must have a substantially accurate idea of what he owns. If the will reads, "I bequeath to my loving sister Jane my gold cuff links, to my loving nephew Claude the contents of my safe deposit box and to my loving brother Kilroy the Brooklyn Bridge," the examiner has a right to assume (unless it appears that the testator was trying to be funny) that the patient thought that he owned the Brooklyn Bridge. It would appear that he did not know the extent of his property (obviously not, if he thought the Brooklyn Bridge was part of his own property), and thus he fails to pass test 2, and the will is invalid.

From two lectures delivered in the graduate course in neuropsychiatry, Rutgers University (N. J.), in December 1946.

3. The natural objects of a person's bounty are the people for whom he would naturally want to do favors. If he has any bounty to distribute, he would normally pass it out to his closest relatives, his warmest friends and his most loyal servants. Now, the law does not require a person to bequeath anything to these "natural objects of his bounty." He can cut them off without a penny, and the law will not presume that he lacks testamentary capacity. But it insists that he know who they are. If one is told that the testator thought that his sister Fanny was alive, when actually Fanny died thirty years ago, one is justified in assuming that he did not have a clear idea of the natural objects of his bounty. If he insists that the man who represents himself as his nephew Elmer is actually an impostor, when all the evidence indicates that Elmer is only Elmer, one can safely say that the testator did not know one of the objects of his bounty. Thus, he fails to pass test 3, and the will is invalid.

An important corollary to these criteria is this: The defects in question must arise because of disease of the mind. If the testator did not recognize Elmer because Elmer had been away from home for ten years, this would not invalidate the will, since the nonrecognition would arise from a simple extraneous circumstance, and not from disorder of the mind.

Effect of a Psychosis.—The fact that the testator was psychotic when he made the will does not necessarily invalidate the document. The claimant must prove that the psychosis impaired one of the three essential elements of testamentary capacity. It has been held¹ that an inmate of a psychiatric hospital may make a perfectly valid will. "It is not the medical soundness of mind that governs," explained the court in the *Whitemarsh* case,¹ "but rather testamentary capacity as defined by law. The fact that the testator was committed to an institution for the insane does not justify the assumption that he lacked legal mental capacity." Nor does a formal adjudication of psychosis serve to invalidate the will. The law recognizes that a patient (in a severe depression, for example) might be sick enough to require treatment, institutionalization, even the appointment of a guardian; yet might still know the nature and extent of his property and the natural objects of his bounty. As one court² put it, "The distinction between an adjudication of insanity and an adjudication that he is incompetent to dispose of his property is a substantial one."

On the other hand, a psychosis does invalidate a will if it touches on one of the three elements of testamentary capacity. If, for example, the testator has paranoid delusions (not simple prejudices, but delusions of paranoid intensity) against one of his relatives, the psychosis affects

1. *In re Whitemarsh's Estate* (N. Y.), 234 N. Y. S. 505; *Livandais v. Bynum*, 116 So. 223.

2. *Waters v. Waters*, 207 N. W. 598 (Iowa).

his understanding of the natural objects of his bounty. Similarly, delusions of great wealth or poverty might cause failure under test 2. In such circumstances the will would be invalidated.

Senility.—The boundary between simple senility and senile dementia is a vague one; yet it is the psychiatrist's responsibility to draw the line. "Extreme age, mental sluggishness, and defective memory do not render a testator incapable of making a will if he is able to recall to mind his property and the natural objects of his bounty," said an Illinois court.³ The witnesses will describe the testator's mental capacity by giving anecdotes of his odd behavior. The psychiatrist has to pierce the verbal fog and determine whether the described behavior is that of a psychotic person or simply that of a man in his dotage with no psychotic delusion formation or psychotic dementia. In one case⁴ a will was held lawful, although the court said that the testator "was peevish, childish and made himself obnoxious by continually repeating the stories of his early life. But all these go with advancing years . . . there was nothing in the record to show that he was so lacking in capacity as to be unable to remember and identify his property or unable to remember and identify the natural objects of his bounty." Always, the psychiatrist must return to the three basic criteria and use them as his yardstick. No matter how psychotic the patient, if he passes these tests and if his delusions do not impinge on these specific qualities, the will is valid.

Spiritualism.—Sometimes as a man (or woman) grows old he seeks solace by trying to communicate with friends who have long since died. A belief in spiritualism itself will not invalidate a will,⁵ since obviously such a belief does not necessarily affect the testator's knowledge of his relatives or of his property. On the other hand, if "the testator was laboring under a delusion that the spirits of the dead were directing him in all his business" the will would be invalid,⁶ since the delusion goes beyond belief in spiritualism and affirmatively affects the actual process of making the will. (In this case, the testator obtained advice from the spirits as to how he should dispose of his property.)

Alcoholism and Drug Addiction.—Proof that a testator was chronically alcoholic or a drug addict will not, by itself, overturn a will. The authoritative Alexander⁷ puts it this way:

3. *Forberg v. Maurer*, 168 N. E. 308 (Ill.).

4. *In re Cooper's Estate*, 206 N. W. 95 (Iowa).

5. *Franzman v. Nalty*, 271 S. W. 1034 (Ky.); *Whipple v. Eddy*, 161 Ill. 114; *in re Chaffin's Will*, 32 Wis. 564; *Scott, v. Scott*, 212 Ill. 603; *Gass v. Gass*, 22 Tenn. 277; *Brown v. Ward*, 53 Md. 376, and many others.

6. *Middleditch v. Williams*, 45 N. J. Eq. 726.

7. Alexander, J. E.: *Commentaries on the Law of Wills*, San Francisco, Bender-Moss Company, 1917-1918, vol. 1, sect. 475, cited by the court in *Payne v. Chance*, 4 S. W. (2d) 328 (Texas).

A person through excessive use of drugs or drink may become so obscured that he is, for the time being, comparable to a mad man. In such a condition he cannot make a valid will. But the effects of alcohol and drugs wear off, and though they may leave the user weakened in mind and body, yet so long as there has not been a destruction of the mentality which the law requires for making a will, it cannot be said that the fact that the testator is addicted to drinking or drugs incapacitates him from making a will.

As a matter of fact, a will made while the testator was drunk was admitted to probate in a case⁸ in which it appeared "that his drunkenness did not prevent him from knowing what he was about." The evidence indicated that while the man was drunk he knew he was making a will, knew who his relatives were and how much property he had. On the other hand, the courts will be suspicious of any will signed while the testator was drunk, especially if an heir was with him at the time. Generally speaking, if a testator was under the influence of drugs while making his will, the document will be considered invalid⁹ unless the defense can show affirmatively that the testator met the criteria for legal capacity.

Ideas of Marital Infidelity.—Senile psychotic persons often have delusions of marital infidelity. How about the will of an old person if ideas of infidelity are the only outspoken manifestations of the mental disturbance? The courts draw a line between a belief in the wife's unfaithfulness based on misinterpretation of external circumstances and a belief based on a psychotic delusion. The latter invalidates the will because it comes under the head of test 3. In one such case, the Court¹⁰ said:

. . . to justify the rejection of the will, it must be established that the false belief is the figment of a deranged mind and not the result of an impression produced by extraneous circumstances. The burden is on the petitioner to prove the non-existence of the extrinsic evidence on which the belief rested.

Whims and Prejudices.—A person is entitled to enjoy a wide range of unreasonable prejudices, crackpot ideas and bizarre notions without sacrificing his testamentary capacity. Nephew August may attack the will which disinherited him on the grounds that Aunt Agatha cherished an unreasonable belief that August was the very devil because he had a nose shaped just like her uncle's. If the psychiatrist finds that Aunt Agatha literally thought that August was a devil, this would be a psychotic delusion touching on test 3 and might invalidate the will. But if, as is more likely, Aunt Agatha was using "devil" in a figurative sense, then her unreasonable prejudice does not upset the testament. So, an unreasonable prejudice against the wife in the McDowell case¹⁰

8. *Pierce v. Pierce*, 38 Mich. 412.

9. *Thomas v. Young*, 22 Fed. (2d) 588 (D. C.).

10. *In re McDowell's Will*, 140 Atl. 281 (N. J.).

did not invalidate the will. As a matter of fact, the courts accept a psychosis as an explanation only as a last resort, only if the testator's conduct "did not admit of explanation on any other ground."¹¹

Undue Influences.—It is not the psychiatrist's responsibility to evaluate undue influence. Only an influence which destroys the testator's free agency is an undue influence. It must be, in effect, a substitution of one person's will or intention for another's. The psychiatrist may be able to help the court by indicating whether a person of the temperament described would be unusually gullible or unusually stubborn. For example, if the evidence indicated that one testator had a conversion hysteria and another had a paranoid delusion, the psychiatrist could point out that the former person was far more likely to be responsive to a friend's influence than the latter.

The Psychiatrist's Role.—In most medicolegal cases the physician examines the patient and testifies as to his findings. In cases of will litigation the psychiatrist rarely has the chance to examine the testator, who is necessarily quite dead when the case comes to court. The practitioner usually has to depend on a hypothetical question describing the testator's behavior and to conclude from that whether the subject could have passed the three tests on the day he signed the will. The psychiatrist confers with the attorney in advance of the trial and indicates what facts he will need for an honest opinion. The physician will want to study each of the three tests and ask the lawyer to give him facts focused squarely on these points, as well as general information about the patient's conduct. It is the lawyer's job to find witnesses who have enough knowledge of the testator's behavior to present an adequate description to the court. These facts are then assembled into the hypothesis which is given the psychiatrist, and on which he bases his conclusion as to the mental capacity of the testator.

In the rare cases in which the lawyer has the client examined before the will is prepared, the psychiatrist's job is, of course, much easier. In addition to the routine mental examination, the psychiatrist will want to analyze the patient's thinking from the point of view of the three tests. For example, he will ask the patient to name the members of his family and to indicate their relationships to him, and he will later verify these statements. He will ask the patient for a brief description of each relative, to see whether any undue emotional response is produced when the patient talks about any of them. The physician will take careful and accurate notes and will preserve them. He will prepare a report for the attorney, quote freely and verbatim from the patient's own remarks and be certain that the report contains enough facts to support the conclusion about the patient's mental capacity. He will

11. *Snell v. Weldon*, 243 Ill. 496.

carefully preserve a carbon copy of this report and use it later (when called as a witness) to refresh his memory.

In some cases a psychiatrist who had examined the patient in life for some other purpose is called as a witness after the patient has died. If the examination had revealed no mental derangement, and if the will had been made at about the same time, the physician's opinion is, of course, of prime value to the court. If the examination had revealed a mental disorder, the chances are that the focus of the examination was not on testamentary capacity, so that conclusions as to legal mental capacity have to be made more or less inferentially. Still, this is more direct evidence than reliance on a wholly hypothetical question. Even though he had not examined the patient specifically for testamentary capacity, the physician should be in a position to give honest and accurate answers to such questions as, "Did he have sense enough to know what he was doing when he signed a document?" or "Did his delusions extend to members of his family?"

CONTRACTS

While the physician thinks of a contract as a formal and formidable legal document, the truth is that most contracts are never put in writing. The patient who asks the physician to give him some medicine for his headache is making a contract. So is the customer who enters a store and says, "Give me a package of cigarets." A contract is not valid (except in certain special circumstances) if by reason of mental derangement one of the parties did not know what he was doing. However, the subject's ignorance of what he was doing must be based on mental derangement, and not simply on lack of sophistication or technical knowledge. If, for example, a naive young man is persuaded to buy a business for which he is unfitted, he cannot call on a psychiatrist to help cancel the contract on the grounds that he did not understand the implications of the transaction. Such misunderstanding arose from ignorance, poor judgment or lack of training, not from mental disorder. In general, a contract made by a lunatic is voidable; and if made by a regularly adjudicated lunatic it is void.¹²

Necessities.—Would this doctrine affect the right of a physician to collect for medical services rendered to a psychotic patient? No, because a contract to supply "necessities" to a child or to a lunatic is valid and enforceable. Medical service, like food, is universally considered a "necessity."

Drunkenness.—A contract made with a drunken man cannot generally be enforced against him unless it is for a "necessity." Simple over the counter sales at standard prices are usually considered enforceable contracts. The psychiatrist will be asked whether the degree of

12. *Wadford v. Gillette*, 137 S. E. 314 (N. C.).

drunkenness was such as to strip the participant of any understanding of the implications of the transaction; if it was not, the contract would probably be valid. If it appears that in an expansive mood the drunken person agreed to make a huge purchase, it is probable that the physician will testify that the drunkenness adversely affected his ability to understand the implications of the contract; and since this lack of understanding rose from a mental disorder (acute intoxication) it invalidates the agreement. Only the person who was drunk can petition to have such a contract canceled. The sober participant cannot escape from the contract by pleading that the other was *non compos mentis*.

Psychosis.—If a person is psychotic, but if the casual observer cannot see that he is insane and enters into a contract in good faith, the courts may enforce the contract. Whether they will depends chiefly on whether the deal can be dissolved without any loss being suffered. For instance, a salesman makes a contract to sell a machine to a lunatic, not knowing that the customer is psychotic. The purchaser's guardian appeals to have the agreement voided. This will usually be done if the machine can be sent back in exchange for the money paid out. However, if a plumber spends all day fixing the pipes at the request of a lunatic, it is apparent that the contract cannot be set aside without causing a loss to the plumber. The latter cannot get back his time. In such a case the contract would probably be enforced if the plumber was acting in good faith. If a patient is obviously deranged, it will be assumed that the other participant knew it and that he did not act in good faith.

Mental Deficiency.—It is often easy to sell a bill of goods to a mentally defective person, and the psychiatrist may be called on to help the patient escape from his ill advised financial commitment. If a child of the corresponding mental age would not have been able to understand the implications of the contract, the courts will usually set it aside, unless (as sometimes happens) it appears that the patient's maturity and actual experience with the world make him far shrewder than a child of the same mental age. A man of 50 with a mental age of 8 who has been a self-supporting day laborer all his life is not the same as a normal 8 year old child when it comes to making business agreements. Actually, he has a moderate amount of business judgment, based on years of experience in selling his labor—something that the bright 8 year old child (whose mental age might exceed that of the laborer) would lack. Thus, the psychiatrist should not depend on the parallel with a child of the same mental age in evaluating contractual capacity. The problem is a pragmatic one, to be decided independently on the facts of each transaction. For instance, I examined a mature woman with a mental age of $7\frac{1}{2}$ years who was persuaded

to buy a twenty-four volume encyclopedia. The salesman dazzled her with his assurance that the cost was only 2 cents a page and that she could stretch the instalments over a year. He never told her the actual aggregate cost, and she signed the contract because 2 cents a page seemed very cheap. As the encyclopedia contained 6,000 pages, the customer was committing herself to an aggregate payment of \$120, or \$2.50 a week. It was testified that with her mental age she could not perform the necessary calculation in her head. (She would have had to multiply 0.02 by 6,000 and divide the product by 52 to get the weekly payment figure of \$2.50.) Her failure to see the implications of her contract was rooted in a mental disorder—namely, mental deficiency. Hence the contract was voidable. On the other hand, a farmer with a mental age of $7\frac{1}{2}$ years who had been selling chickens and eggs to neighbors for years could not escape the consequences of an ill advised agreement to sell eggs at a low price on the basis of his mental deficiency because in this instance, unlike the encyclopedia case, the patient's entire background indicated that he could understand such transactions. A general rule about mental age and business capacity is not used. Each case stands on its own feet.

Senility.—A man in his dotage conveyed his house to a seller of oil stock. The children sought to set the contract aside on the ground of lack of contractual capacity because of senility. If the psychiatrist can find evidence of a senile psychosis or senile dementia, the contract will probably be voided. If he reports simple senility, with fragmentary memory defects, childishness, irritability and a fondness for living in the past, the contract will probably stand. The psychiatrist might find some mental trait short of psychosis which specifically impairs contractual capacity. For instance, if he found that the patient was grossly disoriented, though quite free from delusions, he might testify that a man who does not know even in what century he is living can hardly understand a business transaction. In general, the doctrines applying to senility and wills apply also to senility and contracts, though less mentality is required to make a valid will than to make an enforceable contract.

Nonwithdrawability of Action.—Sometimes a mentally deranged person makes an agreement, repents of it, institutes a suit to set it aside and is then influenced to withdraw the suit. As a general rule, a person having once initiated action on the grounds of his own incapacity, cannot withdraw the petition,¹³ because there is too much possibility that he has been prevailed on to stop the action by some one taking advantage of his mental enfeeblement.

13. *Warker v. Warker*, 140 Atl. 889; also, *in re Rhodes's Estate*, 136 Atl. 408, and many others.

MARRIAGE, DIVORCE AND ANNULMENT

While there are many causes for annulling a marriage, only two of them concern the psychiatrist: (1) lack of mental capacity and (2) fraudulent concealment of prior nervous or mental disease.

Annulment for Lack of Mental Capacity.—"The contract to marry is extremely simple. It does not require a high degree of intelligence to comprehend it."¹⁴ That appears to be the opinion of the courts. Thus, a man may be too defective mentally to be permitted to buy a hamburger stand, yet bright enough to be permitted to make a valid marriage contract. While the standard of mental capacity required for marriage is very low, it is still necessary that the partner be free of any mental disorder (at the time of marriage) which would render him incapable of giving his free consent or which would rob him of his ability to understand the "implications" of marriage. If it appears that the person was insane at the time of marriage, he can apply to have the marriage annulled. Similarly, with a person who married while drunk. Many states have laws which forbid ex-inmates of hospitals for mental disease to marry without clearance from the authorities of the hospital. However, violation of such a law will not nullify the marriage; it merely lays the violator open to criminal penalties.

The question which the psychiatrist must answer is this: "Did the party understand the nature of the marriage relationship and the obligations assumed under it?"¹⁵ Generally courts are reluctant to void a marriage. The evidence must be clear, and it must apply to the petitioner's mental state at the time of the marriage. If the evidence is evenly balanced on the two sides, the courts tend to let the marriage stand. On the other hand, if it is clear that the party was psychotic or so drunk or mentally defective at the time as not to understand the obligations, nature and implications of marriage, the annulment will usually be decreed.

An interesting and important question concerns the right of the competent partner to take action under this doctrine. There is no doubt that a person who finds that he married while he was drunk or psychotic can have the marriage annulled. But can the other partner institute such action? For example, a woman marries a man who impresses her with his quiet shyness, his seriousness of purpose and his freedom from vices. Later it appears that the man is a victim of hebephrenic dementia precox. He does not want to annul the marriage. She does. Can she institute action? In most states she can-

14. Singer, H. D., and Krohn, W. O.: *Insanity and Law*, Philadelphia, P. Blakiston's Son & Company, 1924, p. 265.

15. *Adams v. Scott*, 93 Neb. 537; *Hagenson v. Hagenson*, 258 Ill. 197; *Dunphy*, 161 Calif. 380; *Storf v. Papalia*, 24 N. J. Misc. Rep. 146, and many others.

not.¹⁶ However, the New Jersey statute^{16a} (revised Statutes 2:50-1) has the following reference to a suit for annulment based on lack of mental capacity: "Where the competent party is the applicant, such applicant shall have been ignorant of the other's incapacity." Presumably this means that the sane spouse can initiate action. In a recent case,¹⁷ an annulment was granted with the following dictum, "Where defendant lacked capacity to marry and petitioner was ignorant of that, and did not ratify marriage¹⁸ after knowledge of that lack of capacity, he is entitled to a decree of nullity." A similar doctrine seems to prevail in Missouri, where, at the petition of a husband who had lived with his wife almost twenty years, a marriage was annulled when it was shown that she had never had sufficient mental capacity to make a marriage contract.¹⁹ Similarly, in New Hampshire a marriage was annulled at the petition of the competent spouse when it appeared that he had been kept in ignorance of the mental status of his fiancée until after the ceremony.²⁰ Although the apparent ground in this case was fraud, the legal implication is certainly that it was the lack of capacity which nullified the marriage, since an insane person could hardly have engaged in wilful deception. The law on this point—the right of the competent spouse to institute suit—seems to be in a state of flux. Originally, the same rule applied to marriage as to all contracts attacked on the basis of lack of capacity, namely, that only the incompetent party could start suit. However, there appears to be a growing liberalization, the effect of which eventually may be to allow either spouse to open the question.

If one party was drunk during a marriage ceremony, the marriage is voidable at petition of the spouse who was drunk provided that the intoxication was enough to rob him (or her) of the required degree of understanding. That the participant was simply "a bit high" will not be sufficient to void the marriage.²¹ At present there appears to be no way in which the sober spouse can void such a marriage at his (or her) own petition. Even if the decision in *Storf v. Papalia*¹⁷ is sustained, it would not open the door to such actions, because the essential feature in that case was the husband's ignorance of his wife's mental capacity, whereas it is unlikely that a sober man would not realize that his marriage partner was drunk. If a couple marry while one is drunk but continue to live together for any time after the return

.16. Thus, *Sleicher v. Sleicher*, 228 N. Y. S. 711, and *Hoadley v. Hoadley*, 155 N. E. 728.

16a. N. J. Rev. Statutes 2:50-1.

17. *Storf v. Papalia*, 24 N. J. Misc. 146.

18. Ratify here means to continue to live with the spouse as man and wife.

19. *Chapline v. Stone*, 77 Mo. App. 523.

20. *Keyes v. Keyes*, 22 N. H. 553.

21. *Prine v. Prine*, 36 Fla. 676.

of sobriety, this is considered ratification of the marriage, and no suit for annulment on that basis may subsequently be initiated.

The psychiatrist is sometimes asked to pass on the mental state of an old man who has entered into a marriage which, his family suspects, was prompted more by the irritations of a large prostate than by the promptings of true love. The same rules apply. If a senile psychosis was present, the marriage is voidable. If the mental state was one of simple, nonpsychotic senility, the psychiatrist must determine whether the patient was "capable of understanding the nature of the marriage contract and the duties and obligations such a contract entails" (Singer and Krohn¹⁴).

Since a psychoneurosis does not deprive a person of mental capacity, a suit to annul a marriage on that basis cannot be initiated by either party.

One other type of lack^d of capacity may interest the psychiatrist. That is impotence on an emotional basis. The capacity to marry implies a capacity to perform sexual intercourse. A permanently impotent single man is incapable of contracting a valid marriage (except possibly if he had explained that incapacity to his prospective wife and she accepted him in spite of it). If a woman does not know of the existence of a permanent impotence in her fiance, she can ask to have the marriage annulled after she discovers the defect. The impotence may have an emotional basis. However, since it is a simple question of lack of capacity, not a matter of misconduct or wilfulness, the impotence invalidates the marriage regardless of its cause. In a divorce action for constructive desertion (page 742) the emotional nature of the impotence may be a material factor; but not in an action for annulment, where it is relevant only so far as it touches on the question of the permanence of the defect.

Annulment for Fraudulent Concealment of Nervous or Mental Disease.—Fraud implies a wilful intent to deceive. If a spouse deliberately perpetrates a fraud, if the fraud goes to the "essence" of the marriage and if the other partner relied on the misrepresentation, the marriage will usually be annulled. Misrepresenting vocational, social or financial status is not such a fraud as goes to the "essence" of a marriage. Consequently, this kind of misrepresentation is not a valid basis for annulment once the marriage has been consummated. On the other hand, wilful concealment of serious ill health is a fraud that goes to the "essence" of a marriage. Generally the concealment of prior mental disease is not considered a fraud because the mental disorder itself makes the partner incapable of guilty deception. Even if a person has recovered from a psychosis prior to marriage, silence about this is not a fraud because a person recovered from a psychosis rarely considers that he was insane. If he does not think he was ever insane,

then it is scarcely fraud if he does not say so. The result of this doctrine is to make it almost impossible to get an annulment on the grounds of fraud if concealment of mental disease is the basis of the charge.

An excellent illustration is the case of *Buechler v. Simon*.²² In 1906 a young woman spent seven months as a patient at an institution for mental disease. She was discharged as "cured." In 1925 she married. In 1926 an involuntional psychosis developed. Now, for the first time, the husband learned of her previous experience in a psychiatric hospital. He contended that his wife's concealment of that was a fraud. The court refused to annul the marriage, using the following informative language:

The defendant had made no affirmative representation as to her condition. Silence resting on honest belief, even in things false, is not actionable. The defendant was not aware that her nervous breakdown was an attack of insanity. By the time she was married, 20 years later, the breakdown of 1906 was an unpleasant episode and the commitment an accident in the drama of life which she had long since put aside without thought or suspicion of recurrence. When she omitted to recount that experience, it was not a conscious concealment. She did not simulate health, she felt it.

The touchstone of this case can be applied in almost any action to annul on this basis. Still undecided is what would happen if a psychiatrist told a patient that she had recovered from a psychosis and that she should not marry without apprising her fiance of that fact. If the woman married and, in contravention of the physician's advice, concealed her psychiatric history, then it is possible that an annulment might be granted, because the factor of honest error (so prominent in the case of *Buechler v. Simon*) would be absent. On the other hand, if she was insane when she married, an action for fraud could not be maintained because she would not have mental capacity to perpetrate a wilful fraud.

Wilful concealment of a seriously disabling or potentially hereditary nervous disorder would be a fraud if the patient were sane. This is illustrated in the case of *Busch v. Gruber*.²³ Here, an epileptic man, under constant medical treatment, concealed the epilepsy and affirmatively assured his fiancée that he was in good health. Indeed, he boasted that he had never had occasion to visit a physician. After marriage the wife saw him in a fit, learned of the epilepsy and left him. Had she remained with him, she would have ratified the marriage and barred an action to annul. As it was, the court said,

When a man has been suffering from epilepsy but represents that he has never been sick and when after the marriage the wife discovers the disease and straight-away leaves him, she is entitled to have the marriage annulled for fraud notwithstanding consummation.

22. *Buechler v. Simon*, 146 Atl. 420 (N. J.).

23. *Busch v. Gruber*, 131 Atl. 101 (N. J.).

Concealment of previous commitment to a psychiatric hospital is not in itself a fraud except (a) when the person was sane at the time of the marriage and (b) when he had affirmatively stated that he was never at a psychiatric hospital. Mere silence in such a case would not be fraud, because normally the recovered patient does not believe that he was insane and would have no more reason for telling of his stay in a psychiatric hospital than for cataloguing for his fiancée his entire past medical record.

Divorce from an Insane Spouse.—In most states, mental disease is a bar to any divorce action. Since a psychosis is a disease, the other partner has no more basis for asking for a divorce for mental disease than for expecting pneumonia or a fractured leg to be grounds for divorce. In a few states, mental disease is a statutory basis for divorce, but over most of the country this is certainly not true. As a matter of fact, desertion, adultery and cruelty are not grounds for divorce either if the misconduct is committed by an insane spouse.²⁴ As the court said in the case of *Kunz v. Kunz*,²⁴ "Since insanity is no cause for divorce, nothing which is a consequence of it can be."

Constructive Desertion.—The psychiatrist should know that refusal to engage in or to submit to sexual intercourse is considered "desertion" in most states. Hence, if desertion is a cause for divorce, failure to engage in sexual intercourse is also a cause for divorce. The question facing the psychiatrist is whether this is wilful, since only "wilful" desertion is grounds for divorce. If a man falls into an emotional state in which he is unable to have or to maintain an erection, his wife may (after the requisite time) sue for divorce, alleging constructive desertion. The husband could defend on the grounds that his impotence is certainly not "wilful." The wife may retort that since it is not due to "organic" disease it is a mental phenomenon, and therefore related to lack of motivation, and hence to "will." The psychiatrist is asked to give an expert opinion. Most psychiatrists would state that a neurosis is a "disease" which the patient does not acquire voluntarily. Yet, on cross examination, many experts would be jockeyed into admitting that such factors as lack of motivation and secondary gain place neurosis in a somewhat different category from a disease accidentally incurred, such as typhoid.

The situation is even more ambiguous in the case of a wife's refusal to submit to sexual intercourse because of emotional blocking. Here the courts are prone to decide that, since the wife's role could be passive, she could submit if she wanted to, and therefore her refusal is wilful.

24. As in *Tiffany v. Tiffany*, 84 Iowa 122; *Wray v. Wray*, 19 Ala. 522; *Kunz v. Kunz*, 213 N. W. 906; *Broadstreet v. Broadstreet*, 7 Mass. 474, and many other cases.

It takes exceptional eloquence on the part of the psychiatrist to persuade the court that this kind of behavior is a "sickness," not under control of the will.

Adultery.—In all states but South Carolina adultery is grounds for divorce. The psychiatrist comes into the picture when the misbehaving spouse alleges that he is psychotic or that he (or she) is impelled to promiscuous sexual behavior by reason of neurotic personality, alcoholism or constitutional psychopathy. Where psychosis is established, the spouse is not "responsible" for the adultery, and divorce will not be granted. Such a defense as "nymphomania" or "psychopathic personality" rarely impresses the courts, though if it is genuine the psychiatrist is certainly entitled to call the court's attention to modern scientific opinion as to the factor of "wilfulness" in these disorders. Sometimes psychiatric examination of the defendant reveals a clear hypomanic state, which, being technically a psychosis, would, or should, serve as an adequate defense.

Cruelty.—Psychiatrists are sometimes asked to testify that the defendant's behavior caused a "nervous breakdown," a psychoneurosis, or even a psychotic reaction, in the other spouse. The difficulty is that the defense will cite evidence to show that the complainant always had a "tendency" toward nervousness, or even, indeed, that it was complainant's own neurotic personality which caused the defendant's cruelty in the first place. There is a growing tendency to liberalize the concept of "cruelty," so that in most states an emotional trauma is considered as valid a basis for a divorce suit as is a physical injury. (Thus, cases of adultery are only one-fourth as common on the divorce court docket as they were in 1870, whereas cases of cruelty are four times as common. Men are not becoming more cruel to their wives; cruelty is merely being defined more liberally.)

CRIMINAL RESPONSIBILITY

To escape responsibility for his crime, the deranged defendant must show that "he was laboring under such a defect of reason from disease of the mind as not to know the nature and quality of the act, or, if he did know it, that he did not know he was doing what was wrong." This is the *McNaghten* formula,²⁵ and it is the basis for determination of criminal responsibility in every state of the union and in the federal courts, both civilian and military. This formulation is sometimes considered obsolete, since it was laid down in 1843 and one likes to think that psychiatry has made progress since then. However, there seems little chance that the formula will be abandoned or rewritten in the foreseeable future. As one court²⁶ remarked, "the formula is now

25. *Daniel McNaghten's Case*, 8 Eng. Rep. 718, House of Lords, 1843.

26. *State v. Mackin*, 36 Atl. 1040.

so completely imbedded in the administration of criminal law as to be considered no longer subject to challenge."

The psychiatrist's task, then, is to match the defendant's mental status with the formula and report his opinion to the jury, which, in turn, will determine responsibility. It is frequently alleged that "the law is an ass" for supposing that a person could be legally sane and medically insane, or vice versa. However, this is not the state affirmed, and only a person unfamiliar with the subject will make this criticism. When an insane man is convicted of crime he is not thereby declared to be "legally sane." He is merely held to be legally "responsible"—that is, "answerable" for his acts. The distinction between insanity and irresponsibility is perfectly valid. As every psychiatrist knows, some psychotic patients do respond to fear of punishment or promise of reward (that is, they are "responsible"—they respond); others do not. There is thus a vast sociologic difference between these two groups of psychotic persons.

In analyzing the patient's mental state, the psychiatrist must first consider what each clause of the McNaghten formula means.

"Defect of Reason from Disease of the Mind."—The practitioner must first determine whether in fact there was a mental disorder which impaired reasoning. If no mental disorder at all is found, it is scarcely necessary to proceed with the rest of the formulation.

"Know the Nature of the Act."—This means that the patient can perceive the physical characteristics of his act. The nature of the act of pulling a trigger is that something will be hurled out of the gun barrel. Almost every defendant knows the nature of his act, since only an idiot would be unaware of such a simple physical characteristic as the fact that a sharp knife cuts skin. Few subjects will fail this test.

"Know the Quality of the Act."—While the word "quality" is variously defined, I have elsewhere,²⁷ in an analysis of decisions, pointed out that the nearest definition of "quality" is the word "harmfulness." A child who turns on the gas knowing that a vapor will escape and spread through the building certainly knows the "nature" of the act of turning the jet. But if he does not know that this would be harmful to the people in the house he does not know the "quality" of the act. Or, consider this example, "Sir Fitzjames Stephen instances the case of an idiot who cut off the head of a sleeping man, remarking that it would be great fun to see him looking for it when he woke."²⁸ Here, the idiot undoubtedly knew the nature of the act, since the nature

27. Davidson, H. A.: Criminal Responsibility, New Jersey Law Rev. 1:123 (May) 1935.

28. Cited by Mercier, C.: Criminal Responsibility, New York, Physicians and Surgeons Book Company, 1926, p. 215.

of the act of decapitation is that it removes the head from the body—as he obviously knew. But he did not know the harmfulness of such an act, as indicated by his remark. In fact, this is the only clause of the McNaghten formula which would permit the idiot to escape conviction. Mercier²⁸ expressed the belief that the third clause (“did not know he was doing what was wrong”) might exculpate him; but this is unlikely, since it is probable, as Fitzjames Stephen himself put it, that “the idiot would know that people in authority would not approve of this”; thus he would know that the act was wrong. The psychiatrist frequently finds that the patient knew *what* he was doing but that he had no implication of the harmfulness of his act. If this lack of realization was due to ignorance, poor education or unsophistication, it is of no help in exculpating him under the formula. But if this lack of realization is due to mental deficiency, an involuntary toxic state or a psychosis, it comes squarely under this clause of “quality.”

In some states the word “consequences” is used instead of “quality” at this point in the formula. If it means “consequences to the victim” it has practically the same meaning as “quality.” If it means “consequences to the perpetrator” it has no meaning, except possibly ignorance of the law.

Know that the Act Is Wrong.—This is usually the clause on which the entire defense turns. The psychiatrist should know two things about the word “wrong.” First, it is a concrete, not an abstract, concept. It means, “Did he know the particular act was wrong?” and not “Did he have a philosophic concept of good and evil?” Second, it implies that he knew that society considered the act wrong, and not that he himself considered it wrong. For example, a burglar says that he sees nothing wrong in stealing from rich people, who already have more money than they can use. It cannot be argued that he should be excused because he did not know that burglary was wrong. The point is that, while in his private ethical code it may not have been wrong, he did know that the law (the community) considers burglary wrong. On the other hand, suppose a victim of paranoid schizophrenia hears God’s voice commanding him to kill some one. He believes that society would applaud him for following a Divine wish; and since, by reason of his mental disorder, he does not know that the act was wrong he is irresponsible.

The psychiatrist is entitled to consider such behavior as voluntary surrender to the police, statements of repentance and sorrow and flight from the scene as evidence that the subject knew that he was doing something wrong. The physician may also call the court’s attention to the fact that the subject may have known that the act was wrong without realizing how wrong it was. This is especially true with respect to idiots and imbeciles, who may think of an act as being

merely naughty (such as gleefully pushing his brother out the window) when it is actually murderous. In this type of case the defendant has two possible clauses of escape. It may be argued that he did not know the quality (harmfulness) of the act, or that he did not "realize" how wrong it was. The decision rests with the jury, not with the psychiatrist, whose function is simply to place his findings before the jury, together with his own expert opinion as to whether the defendant knew (and to what extent he knew) the nature, quality and wrongfulness of the act.

Many persons who should know better will state that the test of insanity in criminal law is whether the accused knew the difference between right and wrong. This is not only an oversimplified answer; it is a misleading one. Knowing the difference between right and wrong is a matter of ethical philosophy. There was a time when this really was the test, and an unhappy time it was. Consider, for instance, the state of affairs in 1818. A 12 year old child was arrested for stealing spoons—at that time a capital offense. The defense was that he was too young to realize the enormity of the offense. However, the prosecution called the minister, who testified that the child attended church regularly and that the pastor often preached sermons on good and evil and always told his parishioners to do no evil. On this evidence, it was held that the child was guilty because he had been taught the difference between right and wrong. The court²⁹ said that the test was only that the defendant should "have sufficient discernment to distinguish good from evil." If the "right and wrong" test were in use now, this would indeed be a fair criterion. It is true that in some states the phrase "know right from wrong," rather than "know that the act was wrong," is used even today. But always it is used in connection with the particular act. For instance, in military law the formula is given³⁰ in this way: ". . . so free from mental derangement as to be able *concerning the acts charged* . . . to distinguish right from wrong." Thus, while "distinguish right from wrong" is used, the preliminary clause (*italics mine*) makes it clear that it must be applied with respect to the specific act, not with respect to a general ethical philosophy. Many states have similar variants in the phrasing. In California,³¹ for instance, the formula is, ". . . did not know the nature or quality of the act or that it was wrong to commit it" the phrase "to commit it" serving to delimit the general concept of "right and wrong" to the specific act, just as does the phrase "concerning the

29. *St te v. Aaron*, 4 N. J. L. 263.

30. Manual for Courts-Martial, Document 14a, United States War Department, Office of the Judge Advocate General, Washington, D. C., 1928, para. 28a.

31. *People v. Gilberg*, 240 Pac. 1000.

act charged" in military law. In Colorado³¹ the phrase is, "no capacity to understand the nature of the act and no ability to distinguish between right and wrong as applied thereto," the final phrase again removing the test from the realm of the general and ethical to that of the specific and pragmatic. The psychiatrist, therefore, must focus his attention on the patient's evaluation of the specific act, and not on his general ethical philosophy.

Intent, Premeditation and Wilfulness.—Usually a crime requires an overt act plus a specific intent, generally an intent to do harm.³² Some crimes also require an element of premeditation. This offers another possibility for psychiatric analysis, since the physician may find that the defendant knew that the act was wrong, but that by reason of drunkenness, psychosis or deficiency he was unable to form the specific intent. For example, the law presumes that murder is in the second degree and imposes on the state the burden of proving the wilfulness and premeditation necessary to establish a murder in the first degree. The mental state of the defendant might be such that the prosecution could not prove the premeditation or deliberateness essential to the more serious finding; yet the defense would have to concede that the accused knew the nature, quality and wrongfulness of the homicide he had perpetrated. The net result is a sort of partial responsibility. Indeed, if, as lawyers are prone to do, the word "responsibility" is equated with "sanity," the effect is to establish "partial insanity," an admitted psychiatric absurdity, yet one which is logical enough for forensic purposes. In this connection, Glueck³³ stated: "The courts of at least two states have had sufficient vision to cope with the problem of the semi-irresponsible." The states referred to are Utah and New Jersey. In Utah, a court³⁴ has said: "A person's mental condition may not be such as to make him irresponsible, yet it may be such as to relieve him from the supreme penalty." The New Jersey decision³⁵ reads: "If the defendant was so feebleminded as to be incapable of forming the specific intent to kill with its wilful and deliberate character, then his offense would be murder in the second degree."

The physician should understand this concept clearly, since a man's life may depend on it. The psychiatrist is not finished when he decides simply that the accused is or is not psychotic. He must be prepared to say whether the defendant's mental state was such that he was capable of having the degree of intent, wilfulness, deliberateness or premeditation which the law might require for the offense. This is

32. *London v. Officer*, 242 Pac. 989.

33. Glueck, S.: *Mental Disorder and the Criminal Law*, Boston, Little, Brown & Company, 1925, p. 203.

34. *State v. Anselmo*, 148 Pac. 1071.

35. *State v. Schilling*, 112 Atl. 400.

particularly true of crimes committed by psychopathic persons during rages or by drunkards during periods of acute intoxication.

Drunkenness.—As a general rule, a state of alcoholic intoxication is no defense to a crime committed while in that condition, except when a man was made drunk against his will and by force. Such cases must be rare. A nice question is presented in a case of chronic alcoholic psychosis. In such a case the prosecution would admit that the crime was a result of an insane delusion, but would argue that since the insanity was the result of voluntary indulgence in alcohol the defendant was fully responsible. Most courts would probably exculpate the defendant, however, on the theory that his insanity was not a natural result (but a rather unusual result) of his drinking and that in any event he did not wilfully become insane. The psychiatrist's job would be simply to tell the jury that the accused had a psychosis, that it was due to alcohol and that it was a form of insanity.

Drunkenness sometimes robs a crime of one of its elements and thus reduces it to a lesser offense. If a drunkard assaults another man and inflicts grievous bodily harm, he may be indicted for assault with intent to kill or assault with intent to commit mayhem. The psychiatrist might be able to point out that the defendant was so befuddled by liquor that he could not form a clear intent to do anything. If the jury accepts that, the effect would be to reduce the crime to simple assault. Particularly difficult questions are raised by a crime committed during a period of pathologic intoxication. The patient has complete amnesia for his behavior and will never remember having done what he is charged with. But within the framework of his pathologic intoxication he will have acted sanely. He will show premeditation, planning and an effort to escape—all of which suggests that he has full responsibility even though his amnesia is genuine. In delirium tremens, on the other hand, the patient is clearly in no condition to plan, deliberate, weigh consequences, evaluate the wrongfulness of the act or understand its quality.

Some offenses are actually aggravated if the defendant is drunk (reckless driving, for instance), while others may be mitigated provided the psychiatrist satisfies first himself (and later the jury) that the intoxication stripped away one of the mental components of the act (such as intent or premeditation). Courts are not prepared, however, to accept the thesis that acute alcoholism is a disease. To the judges and the jurymen, intoxication is a bad habit and alcoholism a defect of character. The "drunk" usually knows he is doing something wrong. At the moment, however, he does not care.

Irresistible Impulse.—In most states, irresistible impulse is not a defense. A psychasthenic patient with pyromania is guilty of arson in spite of what the psychiatrist says. So is a man who "sees red" and flies into a rage during which he commits an assault.

Irresistible impulse, however, is accepted as a defense in about a dozen states. In Delaware,³⁶ the Supreme Court has spoken of "deprivation of will power to choose whether to do the act or refrain from doing it," and the Supreme Court of Alabama³⁷ has indicated that a defendant might be irresponsible if "by reason of mental disease he had so far lost the power to choose between right and wrong and avoid doing the act that his free agency was destroyed." Both these decisions, in effect if not in intent, provide a legal basis for pleading irresistible impulse. So does the military law, since the relevant phrase³⁸ in the "Manual for Courts-Martial" reads, "A person is not mentally responsible unless he was so free from mental derangement as to be able concerning the particular acts charged both to distinguish right from wrong and to adhere to the right." The last phrase, "to adhere to the right," certainly spells out a defense of irresistible impulse. The psychiatrist could testify with clear conscience, if his patient had genuine kleptomania, that the defendant knew that it was not right to steal but that because of his mental derangement (psychasthenia) he could not "adhere to the right—" or, in the language of the Alabama courts,³⁵ that "his free agency was destroyed," or, using the Delaware court's criterion,³⁶ that he was deprived of "will power to choose whether to do the act or refrain from doing it."

Professor Glueck³⁹ has examined decisions of appellate courts in every state in the union and cites cases showing that irresistible impulse has been accepted as a defense (at least once in each state) in Arkansas,⁴⁰ Colorado,⁴¹ Connecticut,⁴² Indiana,⁴³ Kentucky,⁴⁴ Michigan,⁴⁵ Ohio,⁴⁶ Pennsylvania⁴⁷ and Virginia,⁴⁸ in addition to Delaware³⁶ and Alabama,³⁷ as already indicated. This does not mean, of course, that the doctrine is firmly established in those states, but is simply a statement that in the cases cited the courts felt that the defendant should not be held accountable. Most of the states (certainly at least thirty of them) will not accept the defense of "irresistible impulse" and show little disposi-

36. *State v. Jack*, 58 Atl. 833.

37. *Parsons v. State*, 2 So. 854.

38. A Manual for Courts-Martial, reprint corrected to include the 1928 circulars. Document 14a, United States War Department, Office of the Judge Advocate General, Washington, D. C., 1928, p. 63, para. 78a, subpara. 6.

39. Glueck,³³ pp. 267-273.

40. *Williams v. State*, 50 Ark. 511 (1888).

41. *Ryan v. People*, 60 Colo. 425 (1915).

42. *State v. Saxon*, 87 Conn. 5 (1913).

43. *Morgan v. State*, 130 N. E. 528 (1921).

44. *Hall v. Commonwealth*, 155 Ky. 541 (1913).

45. *People v. Quimby*, 134 Mich. 625 (1903).

46. *Blackburn v. State*, 23 Ohio 146 (1872).

47. *Commonwealth v. Demarzo*, 223 Pa. 573 (1909).

48. *Thurman v. Commonwealth*, 107 Va. 912 (1908).

tion to change their doctrine, no matter how persuasive the psychiatric testimony in individual cases.

Mental Deficiency.—The McNaghten formula applies to mental deficiency, just as to the psychoses. Indeed, lawyers still confuse the two conditions. As recently as 1921, one high court said that “deficiency of intellect is a species of insanity.”⁴⁹ The chief difficulty in applying the formula to mentally defective persons comes when the adult has a mental age in the 6 to 12 year bracket. Here, many psychiatrists reason that an adult with a mental age of, say, 10 years, ought to be judged with the same liberalness as that which would be applied to a 10 year old child. When the accused is a child, the prosecution always has to prove mental capacity to commit the crime. By contrast, if the accused is an adult, the capacity is assumed, and the defense has to prove lack of capacity if this is pleaded. Glueck⁴⁹ contends that “if it were shown that an adult is below the mental age of fourteen, it would seem more in consonance with the law to place the burden of proving mental capacity on the prosecution.” The courts have not accepted Professor Glueck’s recommendation. Thus, in 1 case it was held⁵⁰ that “when a man reaches maturity, the presumption is that he possesses capacity [to commit a crime] and it is for him to overcome the presumption.” This is the general rule in all states.

Psychiatrists often introduce the defendant’s mental age into the record. Judges and juries seem strangely unimpressed with the statement that the adult defendant really has the mind of a child. “Criminal responsibility does not depend on mental age,” said a Massachusetts court⁵⁰ bluntly. Another Eastern court⁵¹ expressed irritation with the whole thesis by saying that “the mental age theory is utterly misleading to a layman and practically useless in the administration of justice.” An Arkansas judge⁵² had this to say, “When an adult has the intelligence of a child of 7, that fact alone cannot be made the test as to whether he is or is not capable of committing a crime.”

Intelligence tests, however, are useful in two particulars: (1) in helping to determine whether the defendant had sufficient wit to form the required degree of intent or deliberation (see paragraph on “intent”) and (2) in assisting the judge in making disposition of a convicted defendant.

Amnesia and Double Personality.—A few years ago a common defense was, “Everything suddenly went black.” More recently this has been replaced by the defense of simple amnesia. “I don’t remember doing any of those things. If they say I did them, I guess I did; but

49. Glueck,³³ p. 196.

50. *Commonwealth v. Stewart*, 151 N. W. 74.

51. *State v. Ehlers*, 119 Atl. 15.

52. *Christwell v. State*, 283 S. W. 981.

I have no recollection of it." Then, when it is demonstrated beyond doubt that the accused did do "those things," the explanation is that he had a double personality, on the Jekyll-Hyde pattern.

With reference to its legal status, the situation of the double personality seems to be this: Conceding that the patient had two personalities—one, the "main" personality, was good; the other, the "secondary" personality, was evil—the offense is now judged within the framework of the secondary personality, and the responsibility is then assigned to the main personality. Two illustrations may be cited.

A man habitually exhibited aggressive or suicidal reactions after he had only "a little" to drink. He invariably had a total (and genuine) amnesia for his actions during this state of pathologic intoxication. In one of these periods he attempted to rape a child. When she screamed, the parents came running out of the house, and the assailant jumped a fence and fled. He displayed great ingenuity in escaping capture, gained his own home and went to bed. He was awakened by police officers, seemed genuinely puzzled by the charge and insisted that he had been home all the time. In spite of positive identification, he would not allow his attorney to introduce any defense of intoxication. He kept repeating in a hurt and bewildered tone that he had not been near the scene of the crime. In this case, the question of responsibility may be considered within the framework of the intoxication, using the McNaghten formula. Since the patient tried to flee and carefully eluded capture, it is apparent that during that period he was conscious that he had done something wrong. The secondary personality thus appears to be criminally responsible. Projecting this responsibility on the main personality, one is forced to conclude that that, too, was responsible.

During the middle of the night, a soldier in a barracks dormitory got up and noisily proceeded to the clothes rack. He walked so carelessly that he awakened several other soldiers in the room. He inserted his hand into the pocket of another man's trousers. The other man got up, restrained him and reported the incident. The accused seemed confused and could say only that he was asleep all the time. His record of past conduct was perfect except for a verified medical history of somnambulism. Apparently, the somnambulistic personality had no consciousness of doing anything wrong, since he made no effort to walk silently. His behavior was designed, in effect, to facilitate capture, not to elude it. This secondary personality had no knowledge of doing anything wrong; and this lack of knowledge was associated with a nervous disorder, i. e., somnambulism. Under the McNaghten formula, the secondary personality was irresponsible. Therefore, under the rule enunciated, the main personality (i. e., the soldier himself) was not responsible:

Faced with a plea of amnesia or double personality, what does the psychiatrist do? He remembers that there are six possible explanations and explores all six of them. Except for some rare or freakish factor, the six explanations for this defense are (1) hysteria, (2) psychosis, (3) alcoholism, (4) head injury, (5) epileptic fugue or (6) the possibility that the defendant is telling a lie, made up out of whole cloth. Hysteria, if present, should be reflected in the total life pattern of the patient. It is also essential to decide whether the sequence of events was (a) first a hysterical fugue, then an offense committed while in

this trance, or (b) first the offense, then a hysterical wiping out of any memory of it. In situation *b* the patient would certainly be responsible. In situation *a* the responsibility would have to be adjudged by the McNaghten formula within the framework of the fugue. Amnesia associated with alcoholism takes one of two forms: ordinary drunkenness or pathologic intoxication. Drunkenness is evaluated as suggested in the paragraph on that subject. Pathologic intoxication is appraised in terms of the McNaghten formula, as applied to the secondary personality. Head injury is a possibility that must not be forgotten. Crimes are often associated with violence to the perpetrator as well as to the victim. An electroencephalogram may be helpful in diagnosis. With respect to behavior during a concussion-induced fugue, the description of the patient's activities should indicate whether he knew what he was doing or whether he really acted automatically; whether he acted as though he felt he were doing something wrong or whether he acted reflexly. Epileptic fugues should be diagnosable by the characteristic electroencephalographic tracing, as well as by an authenticated history of previous fugue states, trances or grand mal attacks.

In all cases in which amnesia or double personality is alleged, the psychiatrist will want to order an electroencephalographic examination and will search the past history for evidence of epileptic attacks, head injury, alcoholic habits and hysterical behavior.

Presumption of Continuity of a Psychosis.—Once it has been established that a person has a psychosis, it is presumed to continue. Discharge from a psychiatric hospital does not automatically adjudicate a return to sanity; it may mean only that the patient no longer needs custodial care or that he cannot profit from further treatment. The ex-inmate of a psychiatric institution is in good position to plead irresponsibility. Such a plea can be refuted, of course; but the point is that the prosecution has to carry that burden of proof. The state can show the hospital discharge, the limited nature of the psychosis and the fact that the patient had lately been conducting himself in a normal manner, all of which might well add up to proof of recovered sanity. Thus, in one case⁵³ the defendant committed a murder two years after discharge from a state hospital. The trial judge ruled (erroneously) that the defendant had to prove a psychosis if that was his plea. Apparently, he could not prove it, and he was convicted. The sentence was reversed by the upper court on the theory that his psychosis, established by his original commitment, must be presumed to continue, and that, if recovery is alleged, it is up to the prosecution to prove the recovery, not up to the defense to prove the psychosis.

53. *Davidson v. State*, 4 S. W. (2d) 74, Texas.

While a previous psychosis is presumed to continue, present insanity will not be historically projected backward. If a defendant acquires a psychosis in jail awaiting trial, this fact has no value in proving that he was psychotic at the time of the crime. As an Alabama court⁵⁴ put it, "The Supreme Court knows of no rule making the establishment of insanity a presumption that the party was insane prior thereto."

When no psychosis is established by past history, the presumption is that the accused is sane, no matter how fantastic the crime. If the defendant alleges irresponsibility, he must prove it. In some states he must prove it "beyond a reasonable doubt"; in others, "by a preponderance of the evidence," and in still others, simply "to the satisfaction of the jury." The degree of proof has some bearing on psychiatric testimony. For instance, one good psychiatrist says the accused is psychotic and another says that he is sane. The jury might happen to feel that the former practitioner was more of an expert or had had better chances to know the defendant than the latter. If "to the satisfaction of the jury" or "by a preponderance of the evidence" is the measure, the defendant would be found not guilty. But if irresponsibility had to be proved "beyond a reasonable doubt" then the proof here would fall short, since if the two experts are so evenly balanced the proof is scarcely "beyond a reasonable doubt."

The Psychiatrist's Role.—Sent to examine a defendant, the psychiatrist should be certain that he is not unfairly trapping the patient into making damaging confidential admissions to a physician which would later be used against him. Legally, the psychiatrist is on solid ground, since submitting to a mental examination is not considered compulsory self incrimination. No person can be compelled to give testimony against himself. If the result of the mental examination is unfavorable to the defense, it might be argued that the psychiatric interview was, in effect, an underhand way of getting the patient to incriminate himself. There is no legal substance to this thesis, but physicians should err on the side of ethical scrupulousness and be sure that there can be no moral basis for it, either. On the legal side, the following two dictums are illuminating:

Testimony showed that the doctor informed the accused that he had been requested by the county attorney to make the examination. He told the accused that he did not have to answer any questions. The accused submitted to the mental tests without objection. Such testimony is admissible when accused submits to an examination if there were no threats, duress, objection or deceptions. Such an examination is not subject to the objection that the defendant was compelled to give testimony against himself.⁵⁵

54. *Birchfield v. State*, 115 So. 297.

55. *Wehenkel v. State*, 218 N. W. 137 (Neb.).

An examination of the defendant to ascertain mental condition is not a deprivation of constitutional rights; nor does such an examination require him to give evidence against himself.⁵⁶

While the psychiatrist is thus legally safe in conducting an examination without consent of (or knowledge of) the defense attorney, it is good form for him to apprise the patient that he is taking notes, that he is going to submit a report to the court (or prosecutor, or probation officer) and that the patient does not have to tell him anything. My own practice is to say: "I'm a doctor, trying to understand how you happened to get into this trouble. You're under no obligation to answer my questions or tell me anything, but I do hope that whatever you do tell me will be the truth. If you'd rather not answer a question, just say so; and it will be perfectly all right. I'm making notes, and afterwards I'll send in a report." It might be expected that such a warning would dry up the patient's flow of words, but it usually has no such effect. At least, after the defendant "warms up" to the subject, he generally talks freely enough.

It is essential that the psychiatrist take elaborate notes and that large fragments of the patient's remarks be written down verbatim—not that such comments have to be included in the report, but, rather, that the examiner may be in a position to support his conclusions by first hand evidence. In Britain⁵⁷ it is considered "not cricket" for the physician to ask the accused whether he has committed the crime, but American psychiatrists often find it impossible to conduct a thorough mental examination without somehow touching on that point. The general technic of the examination differs little from the routine of a psychiatric examination made elsewhere except that the physician must keep the four elements of the McNaghten formula clearly in mind. Did the defendant know the nature of the act? The quality of the act? The wrongfulness of the act? And, if so, was this because of a mental disorder?

It is unwise to conduct this kind of mental examination without a preliminary briefing. The psychiatrist should get the facts from the investigating officer and should ask permission to read the statements of the witnesses and of the accused. For instance, a crime may have been committed in a rage. The witnesses' stories of how the patient

56. *Blocker v. State*, 110 So. 547 (Fla.).

57. For instance, on page 233. Mercier²⁵ warns "the examiner against questioning a prisoner as to whether or not he had committed the offense or as to the circumstances of the crime. I have heard caustic comments from the bench on this practice." Apparently, the British psychiatrist is not expected even to review the surrounding circumstances, let alone the question of guilt. I cannot see how the physician can evaluate the patient's understanding of the particular offense if the interview is subject to this kind of limitation.

looked, what he said, how he acted, are helpful to the examiner in determining whether this mental state was an epileptic furor, a drunken rage, or a momentary lapse of inhibition in an otherwise normal man.

The psychiatrist's next duty is to make up his own mind. Courts are impatient with an examiner whose conclusion is that "in a way he was responsible; yet in another sense he wasn't." True, in most cases, it is not simply a matter of black or white. Still, the courts want help, and the psychiatrist is presumably more of an expert on mental states than any one else. A cleancut, crisp, concrete opinion is expected. As guideposts to reaching a definite decision, the psychiatrist can remember the doctrines with reference to irresistible impulse, alcoholism, mental age, amnesia and the basic McNaghten formula, elaborated earlier in this paper. These provide both a framework around which the examination may be constructed and a battery of criteria by which responsibility may be evaluated.

Actual decision as to the defendant's responsibility is not made by the psychiatrist. It is the function of the jury, or in special cases the prerogative of the judge of the trial or the appellate court. The practitioner does not testify that the defendant was responsible or irresponsible. That would be a usurpation of the jury's function. He testifies as to the clinical diagnosis and as to his opinion of the patient's intent and deliberateness and of his realization of the nature, quality and wrongfulness of his acts. There the psychiatrist's responsibility ends.

533 Mount Prospect Avenue.

Abstracts from Current Literature

EDITED BY DR. BERNARD J. ALPERS

Anatomy and Embryology

THE ROLE OF THE SENSORY FIBERS IN THE DIFFERENTIATION OF THE SPINAL CORD IN SHEEP. DONALD H. BARRON, *J. Exper. Zool.* **100**:431 (Dec.) 1945.

Barron amputated the distal segments of the forelimb in 4 sheep fetuses in utero after their fifty-fifth day of development. It has been shown that at this stage of development mitosis in the anterior cervical and brachial segments of the spinal cord and the associated ganglia has ceased.

Except for the structures associated with remnants of the amputated limbs, the 4 fetuses, recovered near term by cesarian section, appeared to have developed normally.

The individual spinal ganglia of the affected brachial region were reduced in volume and number of neurons in proportion to the extent to which their distal processes normally supplied the limb. The number of fibers extending into the gray matter by the individual dorsal roots of the affected side were in proportion to the number of neurons in the ganglion of origin. When the reduction in volume of gray matter and number of neurons was most pronounced, there was a hypoplasia of neurons of 34 per cent in the substantia gelatinosa and of 13 per cent in the intermediate gray matter of the seventh cervical segment. This hypoplasia on the affected side appears to be the result of the failure of the normal complement of fibers to enter these regions.

The hypothesis that the growing processes of neuroblasts induce indifferent cells of the nervous system to differentiate is supported, although not proved, by these observations.

REID, Boston.

THE DEVELOPMENT OF LATE GASTRULA EXPLANTS OF RANA PIPIENS IN SALT SOLUTION. HARRY S. EMERSON, *J. Exper. Zool.* **100**:497 (Dec.) 1945.

Explants of eight areas from the oval blastopore stage were transplanted into full strength bicarbonate-free Holtfreter salt solution (*Arch. f. Entwicklungsmechn. d. Organ.* **138**:657, 1938). In contrast to other areas, explants of areas 1 and 2 often disintegrated, but all those which overcame the immediate toxic effect lived as long as the initial yolk content of the cells persisted.

The results show that area 1 is presumptive chordamesoderm, areas 2 and 3 are presumptive neural plate, areas 4 through 7 are epidermis and area 8 is presumptive lateral plate mesoderm.

Unlike the behavior of gastrula transplants in regenerating tissue, horny jaws, nasal sacs and lenses come only from explants from the presumptive locations of these organs.

Brain and eyes develop about as well from isolates of ectoderm with as from those without the substratum, while horny jaws and nasal sacs require ectoderm plus substratum. Apparently, horny jaws as well as nasal sacs and neural plate are induced by some part of the archenteron roof. These three organs appear to be induced by different parts of the chordamesoderm acting on the ectoderm at different times during gastrulation.

REID, Boston.

THE DEVELOPMENTAL RELATIONSHIP BETWEEN THE NERVOUS AND EPITHELIAL COMPONENTS OF THE HYPOPHYSIS. ERLING S. HEGRE, *J. Exper. Zool.* **101**:65 (Feb.) 1946.

Hegre made observations on the growth and development of the epithelial rudiment of the hypophysis when grafted by itself or together with tissue from the

diencephalic floor. The tissue was transplanted from *Amblystoma maculatum* embryos (Harrison's stage 33) into the sinus venosus of hosts of the same species (stage 36).

There were three groups of host animals: (1) hosts grafted with the whole pituitary gland; (2) hosts grafted with the epithelial rudiment with a few cells of the diencephalon attached, and (3) hosts grafted with the epithelial rudiment only.

Exposure of the host animals to a light background was used as a test for the presence of a pars intermedia in the developing grafts.

A pars intermedia developed in every case in which the whole pituitary gland was implanted. The sectioned grafts showed typical pituitary tissue, together with recognizable nerve tissue. A pars intermedia developed in 55 per cent of the implants of group 2, and nerve tissue was always found in direct association with this portion of the graft. Pituitary tissue was recovered from 96 per cent of grafts of group 2.

No pars intermedia developed when only the epithelial rudiment was transplanted, although pituitary tissue was recovered from 89 per cent of the animals sectioned.

The author concludes that the presence of nerve tissue (diencephalic floor) is necessary for the formation of a pars intermedia from the epithelial hypophysis in *Amblystoma maculatum*.

REID, Boston.

Physiology and Biochemistry

DEGREE AND NATURE OF REGENERATION OF SPLANCHNIC INNERVATION TO THE ADRENAL GLAND TWO YEARS FOLLOWING COMPLETE BILATERAL SYMPATHECTOMY IN DOGS. J. W. PAPEZ, A. V. JENSEN and H. H. DUKES, *J. Neurophysiol.* 8:1 (Jan.) 1945.

Papez, Jensen and Dukes removed the thoracolumbar portion of the sympathetic chain with the rami communicantes and the splanchnic nerve bilaterally in 2 dogs. No alterations of behavior occurred after the operation. Autopsy two years later showed pseudoregeneration of the sympathetic trunk on one side in 1 animal and bilaterally in the other. These false nerve trunks consisted chiefly of perineurial strands, with only occasional regenerated nerve fibers. The nerve fibers not only were few but were also distorted, and not more than 5 per cent pursued a course to the medulla of the adrenal gland. The authors observed postganglionic vasomotor nerves of moderate amount coming from the celiac and periadrenal ganglia, and these fibers were not affected by section. In a third dog, killed fourteen days after sympathectomy, denervation occurred on one side, and on the other the fibers were in stages of fragmentation and degeneration.

Papez, Jensen and Dukes conclude that regeneration of splanchnic and sympathetic nerves after total sympathectomy is small and that the pseudoregenerated trunks contain few functioning fibers.

FORSTER, Philadelphia.

RESTORATION OF VISION AFTER CROSSINGS OF OPTIC NERVES AND AFTER CONTRALATERAL TRANSPLANTATION OF THE EYE. R. W. SPERRY, *J. Neurophysiol.* 8:15 (Jan.) 1945.

Sperry studied the effects of crossing of the optic nerves in 21 anurans and of contralateral transplantation of the eye in 2 anurans and 12 urodeles. In all experiments intrinsically well organized visuomotor coordinations were recovered. The recovered visuomotor responses, however, were maladapted and were schematically correlated with the anatomic rearrangements. The intrinsic organization, therefore, did not arise from learning but was a product of the process of regeneration. The reestablishment of functional relation between retina and visual centers, therefore, is predetermined by growth-regulating factors and not by functional adaptation.

FORSTER, Philadelphia.

OBSERVATIONS OF GAS BUBBLES IN PIAL VESSELS OF CATS FOLLOWING RAPID DECOMPRESSION FROM HIGH PRESSURE ATMOSPHERES. CARRELL E. WAGNER, *J. Neurophysiol.* 8:29 (Jan.) 1945.

Wagner observed through a Forbes window the pial vessels of cats subjected to compression for one hour, followed by rapid decompression. Gas bubbles appeared in pial arteries before they did in pial veins; the distribution of gas bubbles in other vessels was independent of their appearance in pial vessels. The author concludes that gas bubbles are borne to their site of lodgment as air emboli. The appearance of gas bubbles in the veins is secondary to the decrease in the blood flow through the region.

FORSTER, Philadelphia.

PROPAGATION OF SPREADING CORTICAL DEPRESSION. A. P. LEO and R. S. MORRISON, *J. Neurophysiol.* 8:33 (Jan.) 1945.

Leao and Morrison studied the depression of the cerebral cortex of rabbits induced by electrical stimulation. Spreading depression could be elicited from all areas studied except area Rsg of Rose. When depression was induced in one hemisphere spread to the opposite hemisphere was found to depend on the integrity of the corpus callosum. Spread of the depression was independent of subcortical connections and of the three lower laminae of the cortex. Acute anemia of the cortex lasting up to one minute did not interfere with the spread of depression. Depressions were elicited by short weak tetanic stimulation of the surface of the cortex and stimulation with direct current. An isotonic solution of calcium or potassium was most effective in eliciting the depression. Physostigmine, acetylcholine, strychnine, cocaine, histamine and epinephrine were ineffective. Applications of cocaine to the cortex succeeded in restricting the spread of depression and vasodilatation. Leao and Morrison do not believe that the phenomenon depends on a neuron to neuron transmission of inhibitory impulses.

FORSTER, Philadelphia.

INFLUENCE OF DEPLETION OF DIFFUSIBLE ELECTROLYTES UPON ELECTRICAL ACTIVITY OF THE BRAIN. ERNST P. PICK and MICHAEL M. MILLER, *J. Neurophysiol.* 8:47 (Jan.) 1945.

By immersing frogs in distilled water, Pick and Miller altered the selective permeability of the frog's skin. In this manner they depleted the diffusible electrolytes. Study of the electrical activity of the cortex of the frogs revealed that cortical activity was decreased and that either slow waves appeared or both the frequency and the amplitude of the waves were decreased. The degree of reduction varied with different cortical regions. Unless the electrical activity has been too seriously impaired by loss of electrolytes, the restoration of chlorides results in return of normal electrical activity of the cortex. The depression of electrical activity is considered to be due to the inhibitory effects on oxidative processes of the brain during deprivation of chloride and glucose. Pick and Miller suggest that the successful treatment of shock with saline solution may be due in part to the central action of the saline solution.

FORSTER, Philadelphia.

NERVE REGENERATION IN CATS ON VITAMIN B₁-DEFICIENT DIETS. CHARLES BERRY, CHARLES NEUMANN and JOSEPH C. HINSEY, *J. Neurophysiol.* 8:315 (Sept.) 1945.

Berry, Neumann and Hinsey found that a raw carp diet produced in cats anorexia, ataxia, vestibular disturbances and convulsions. A better controlled tubed, thiamine-deficient diet permitted survival up to one hundred and sixteen days, with only mild ataxia and vestibular signs. Peripheral nerves excised immediately after death from thiamine deficiency were found to conduct impulses, as shown in recordings of action potentials. Microscopic examination of the nerves revealed no degeneration. The tibial, peroneal and saphenous nerves regenerated normally

in the presence of severe thiamine deficiency. Regeneration was determined by growth of the fibers longitudinally and in diameter and by recording the action potentials of the nerves.

FORSTER, Philadelphia.

CARBONIC ANHYDRASE IN THE NERVOUS SYSTEM. HORACE W. DAVENPORT, J. Neurophysiol. 9:41 (Jan.) 1946.

Davenport found that thiophene-2-sulfonamide in concentrations of 27 mg. per hundred cubic centimeters or higher had no effect on the rate of conduction of impulses, voltage capacity curves and recovery of responsiveness in peripheral nerves of cats, the spinal reflexes of decerebrated cats or the electrical activity of the cerebral cortex of anesthetized rabbits. Since carbonic anhydrase of the central nervous system is inhibited more than 99.99 per cent by these concentrations of thiophene-2-sulfonamide, Davenport concludes that catalyzed hydration and dehydration of carbon dioxide are not essential reactions in the nervous system.

FORSTER, Philadelphia.

Neuropathology

A NEW ABSORBABLE MATERIAL FOR USE IN NEUROLOGICAL AND GENERAL SURGERY. E. B. SPITZ, M. ZIFF, C. BRENNER and C. DAVISON, Science 102:621 (Dec. 14) 1945.

In preliminary experiments here reported, pledgets of "aralac" batting (a casein fiber from milk) (30 to 150 mg., total dry weight) were inserted into the subcutaneous tissue, the temporal muscle, the subdural and subarachnoid spaces and the substance of the brain itself in a series of 6 cats. Each operation was performed aseptically with the animal under sodium pentobarbital anesthesia, and the cats were allowed to survive for eleven, eleven, twelve, twenty-three, thirty-five and forty-six days, respectively. At the end of these periods the animals were anesthetized and the brains removed, along with other tissues that had been in contact with the batting. None of the animals showed any ill effects from the insertion of the casein fiber, and each was in good health at the termination of the experiment.

At autopsy, no casein fiber was visible grossly in any specimen. Microscopically small amounts of the fiber remained in the 3 animals that were examined at the end of eleven, eleven and twelve days, respectively. A few of the fibers were bordered with giant cells. The principal tissue reaction consisted of the presence of macrophages or, in a few instances, of polymorphonuclear leukocytes and lymphocytes, on the one hand, and proliferation of fibroblastic and endothelial cells, on the other. In the 3 cats which were allowed to survive the longest no trace of fibers remained. Giant cells were rarely seen in the sections from these animals. The tissue reaction consisted chiefly of proliferation of fibrous tissue and the presence of macrophages at or near the site of implantation. Two animals served as controls, and microscopic sections from these animals revealed that the tissue reaction was slightly greater on the side on which the casein fiber had been implanted. There was no evidence in any section that either the casein fiber itself or its breakdown products were particularly toxic to the cortical cells.

From these preliminary experiments, the authors conclude that casein fiber ("aralac") is rapidly absorbed after septic implantation in the brain, muscle or subcutaneous tissue of the cat. The absorption is accompanied with a mild cellular reaction, similar to that produced by implantation of fibrin foam or oxidized cotton.

GUTTMAN, Philadelphia.

NEUROPATHOLOGIC PROBLEMS AFTER PREFRONTAL LEUKOTOMY. A. MEYER and E. BECK, J. Ment. Sc. 91:411 (Oct.) 1945.

The material reviewed by Meyer and Beck consists of 7 cases of prefrontal leukotomy and an eighth case in which frontal lobectomy had been carried out on

a mentally normal person with a basal meningioma. The last case has proved of great value as a test case for complete severance of fiber connections. In 2 additional cases only macroscopic investigation was performed. All the patients who recovered showed little or moderate deterioration. Clinical complications did not interfere with recovery, and the operation itself produced circumscribed lesions uncomplicated by severe hemorrhage and softening. Of the 3 patients of the unrecovered group, 1 (case 5) was severely deteriorated. The 2 others (cases 3 and 4) were little deteriorated and should have had a fair chance of recovery. However, in case 3 uremia, nicotinic acid deficiency and a senile condition of the brain must be considered as adverse factors. In case 4 the cut was placed too posteriorly, involving the agranular frontal cortex and the caudate nucleus. In addition, extensive hemorrhage had destroyed a considerable part of the white matter of the prefrontal lobe. In case 5 the cut was placed in too anterior a plane. As regards the recovered group, it is surprising how little damage was sufficient to produce a remarkable clinical improvement. The section in these cases was incomplete with regard to severance of the thalamofrontal fibers. From these results it follows that in suitable cases (in which deterioration has not occurred) a good recovery may follow surprisingly incomplete and circumscribed cuts in the white matter of the prefrontal lobe. Recovery may be prevented by an excessive lesion, either by cutting in too posterior a plane or by causing extensive hemorrhage. The avoidance of hemorrhage seems to be a major necessity. There is some evidence that the projection of thalamic fibers to the orbital region is of considerable strength and that the cortex in front of the surgical lesion is not wholly unaffected. The centrum medianum (of the medial nucleus of the thalamus) displays in the human brain a considerable variation of cell density. Its significance requires further investigation. The only conclusion that can be drawn at present is that under both normal and psychotic conditions the centrum medianum is liable to considerable variations in cell density and spacing of cells, which apparently far exceed the variability in animal brains. This variability is of remarkable interest if one regards the nucleus as an association center within the thalamus, which itself appears to be one of the cornerstones of what one might call the anatomic substrate of personality organization. It is the more remarkable, as previous work on individual architectural differences within the cerebral cortex has demonstrated the relative constancy of the cortical pattern. J. A. M. A.

Psychiatry and Psychopathology

HEREDITY IN THE FUNCTIONAL PSYCHOSES. RALPH ROSENBERG, *Am. J. Psychiat.* **101:157** (Sept.) 1944.

Rosanoff studied the role of heredity as an etiologic factor in schizophrenia by its incidence in twins. Of 41 pairs of identical twins, schizophrenia appeared in both members in 68 per cent, and in 32 per cent of the pairs only 1 twin had the disease, indicating the absence of a hereditary basis. In another group (same sex; twins not identical), schizophrenia was present in both twins in only 20 per cent. In the third group (opposite sex; twins not identical), schizophrenia occurred in both twins in only 10 per cent.

Since hereditary relations are the same in the three groups, the difference between twins of the same sex, twins of the opposite sex, and ordinary siblings is a definite measure of environmental differences. Environment, and not heredity, is the vital factor in the development of functional psychoses, as shown by Rosenberg.

BORKOWSKI, Philadelphia.

AFFECTS, PERSONAL AND SOCIAL. GREGORY ZILBOORG, *Psychoanalyt. Quart.* **14:28**, 1945.

There have been, and continue to be, disagreements between the sociologist, the culturalist and the psychoanalyst as to the basis of social psychology. The sociologist and the culturalist reject psychoanalysis as inadequate because it seems to

lack a comprehensive social theory. The psychoanalyst, transposing the general theory of the neuroses onto the field of sociology—where it really is not applicable—decries the sociologist and the culturalist.

Zilboorg states that affects are the best indicators of the forces which are involved in a given aspect of behavior, and he proceeds to contrast the individual affects in the neuroses, in mobs and in social feelings. There are certain outstanding characteristics of social feelings. Man considers his opinions on public issues his own, and in this he differs from a member of a mob. Social affect and behavior are not impulsive, but are stable, steady and marked by an enduring sense of loyalty, particularly toward a specific group within the social whole. This loyalty is combative toward other specific groups. The man who states his social feelings tends to idealize them and to formulate an allegedly rational and ethical ideology. The social group is based not on a solidarity born of love but on a cohesion based on hate of an "external" enemy, supposedly always present and ready to strike.

The determinants for these affects are not purely libidinal in origin. They are cultural economic determinants which utilize the libidinal equipment for the special purpose of a given group. Although the social affects are marked by hate, they also contain love, which in the social affects appears almost impersonal—it is directed toward a remote, invisible goal, i. e., toward a fantasy. Basically, social affects are based on the gratification of pregenital libidinal drives, which all of us are personally attempting to thwart but which can be gratified in the permissive setting afforded by our culture.

PEARSON, Philadelphia.

REPATRIATION: A PSYCHIATRIC STUDY OF 100 NAVAL EX-PRISONERS OF WAR.
W. P. MALLINSON and W. WARREN, *Brit. M. J.* 2:798 (Dec. 8) 1945.

Mallinson and Warren made a psychiatric study of 100 naval ex-prisoners of war in an effort to obtain a clearer picture of the process of resettlement and of the normal reactions following repatriation. Of this number, 71 were apparently making a satisfactory readjustment and 29 exhibited neuropsychiatric symptoms. In the group of 29 patients with abnormal reactions, 25 showed only minor neurotic reactions, and 4 had disorders of sufficient severity to necessitate hospitalization or invalidation. The patients in the abnormal group complained of the usual symptoms of the minor affective disorders, frequently associated with psychosomatic complaints and with restlessness and irritability, and responded to the usual methods of treatment. The most important factor precipitating neurotic reactions was constitutional predisposition; psychogenic factors operating before, during and after captivity also played a part.

ECHOLS, New Orleans.

Diseases of the Brain

NERVOUS SYSTEM DYSFUNCTION IN ADAPTATION TO HIGH ALTITUDE AND AS POSTFLIGHT REACTIONS. GORDON A. BROWN, CHARLES A. CRONICK, HURLEY T. MOTLEY, ELMER J. KOCOUR and WALTER O. KLINGMAN, *War Med.* 7:157 (March) 1945.

This paper is a description of some of the dysfunctions of the nervous system observed in flying personnel of the Army Air Force during and after oxygen-controlled high altitude conditions.

In general, the clinical neurologic reactions fall into the following categories: (1) disturbances of equilibrium and coordination; (2) disturbances of function of large sensory or motor tracts; (3) disturbances of consciousness and cortical function in the nature of amnesia, confusion and disorientation; (4) disturbances suggestive of meningeal irritative phenomena, increased intracranial pressure and migraine-like attacks; (5) disturbances of subcortical mechanisms associated with phenomena of dyskinesia, hyperkinesia and aphasia, and (6) scattered disturbances of the nervous system of minor character.

The authors have classified the disturbances into these categories to emphasize that there seems no one part of the nervous system more resistant or vulnerable than another.

The dysfunction of the nervous system occurs not only during the period of great change in atmospheric pressure but after exposure to conditions of high altitude and return to the ground level, despite a constant oxygen supply. The symptoms are not immediately or shortly relieved by continued administration of oxygen.

Recovery in all cases was prompt and without detectable residual symptoms.

PEARSON, Philadelphia.

CRANIAL DEFECTS FOLLOWING CLOSED HEAD INJURY. T. ALAJOUANINE and R. THUREL, *Rev. neurol.* **77**:71 (March-April) 1945.

Alajouanine and Thurel report 4 of their own cases and cite 2 from the literature in which trauma to the head at birth or very early in life resulted in subsequent development of extensive defects in the cranium at the site of injury. As the skull grows and the brain expands, the site of injury to the bone becomes more extensive. The authors believe the cerebral lesions observed in many of these cases, resulting in hemiplegia and convulsions, are due to hernia of the brain rather than to the defect itself. In case 3 the hemiparesis came on eleven months after the injury, a few months after the loss of cranial substance was observed.

N. SAVITSKY, New York.

TUBERCULOMA OF THE CEREBRUM: OPERATION AND SURVIVAL FOR THREE YEARS. T. ALAJOUANINE and R. THUREL, *Rev. neurol.* **77**:209 (July-Aug.) 1945.

Jacksonian attacks appeared in a girl aged 17 in July 1941. In December 1941 neurologic examination revealed a normal condition. Lumbar puncture yielded normal readings. A pneumoencephalogram showed that the ventricles did not fill; markings on the left side of the brain were somewhat less definite than those on the right. After the insufflation of air there was a remission from the jacksonian attacks of two months. In February 1942 the attacks reappeared, with paralysis of the right upper extremity, hyperreflexia of the right arm and loss of position sense in the last three fingers of the right hand. A second aerogram showed indubitable evidence of an expanding lesion. The patient did not have tuberculosis, but her father died of intestinal tuberculosis and her paternal grandmother of tuberculosis of the spine. A roentgenogram of the chest showed nothing abnormal, and the reaction to tuberculin was negative. Operation, performed on March 6, 1942, revealed a tumor at a depth of 1 cm. in the left frontoparietal cortex. The tumor did not look grossly like a tuberculoma. It was well demarcated from the surrounding tissue of the brain but was difficult to separate from it. During August 1943, pulmonary tuberculosis developed, and in May 1945 she died of tuberculous meningitis. A pneumoencephalogram just before death showed dilatation of the ventricles, especially on the left side, but no evidence of recurrence of the tumor. This case shows that a cerebral tuberculoma can be removed without dissemination of the tubercle bacilli.

N. SAVITSKY, New York.

DIAGNOSIS AND SURGICAL THERAPY OF CEREBRAL MANIFESTATIONS OF THROMBOANGIITIS OBLITERANS (WINIWARTER-BUERGER DISEASE). H. KRAYENBÜHL, *Schweiz. med. Wchnschr.* **75**:1025 (Nov. 24) 1945.

Krayenbühl reports 25 cases of cerebral manifestations of thromboangiitis obliterans (Winiwarter-Buerger disease). In 3 of these cases the cerebral manifestations accompanied a more or less generalized thromboangiitis obliterans, while in 22 the thromboangiitis was restricted to the cerebral blood vessels. Careful cardiovascular examination and cerebral arteriography offer considerable aid in the diagnosis of the rare cases of the first group. Diagnosis proved more difficult in the second group. The age at which the initial symptoms of the disease

occurred varied from 11 to 58 years. Signs of unilateral motor or sensory paralysis of variable degree and extent in all the patients were revealed on examination or by the history. Ocular symptoms were rare. Temporary spasms of the vessels of the retina were not observed. A drop in arterial blood pressure of the retina was demonstrated occasionally. There were no symptoms of increased intracranial pressure. In 12 cases the complete occlusion or a more or less high degree of constriction of the internal carotid artery was demonstrated at the point where the common carotid artery gives off the internal carotid artery; this, therefore, is to be considered as the area of predilection of the vascular process. In 4 cases the occlusion of the internal carotid artery occurred in the carotid "siphon"; this term is applied to the point where the internal carotid artery gives off the middle cerebral artery.

J. A. M. A.

IMPAIRMENT OF PUPILLARY REACTIONS DURING ACCOMMODATION SUPERIMPOSED ON ARGYLL ROBERTSON PUPILS ASSOCIATED WITH TABES DURING ACUTE ANEMIA. BENJAMIN SPOTA and DIEGO BRAGE, *Prensa méd. argent.* 32:1598 (Aug.) 1945.

Spota and Brage report 2 cases of tabes dorsalis with Argyll Robertson pupils, in both of which there was secondary anemia from bleeding hemorrhoids and ulcer of the stomach. There was pronounced impairment of pupillary reactions in accommodation during the period of the anemia. Another case of tabes with Argyll Robertson pupils is recorded in which the pupillary reactions during accommodation became impaired after exposure to carbon monoxide.

These facts indicate that the centers for pupillary reactions during accommodation are diseased to some extent in all cases of tabes. The defect in accommodation becomes clinically manifest when anything interferes with the proper oxygenation of this center.

N. SAVITSKY, New York.

Treatment, Neurosurgery

PENICILLIN IN THE TREATMENT OF SYPHILIS. EDITORIAL, *Ann. Int. Med.* 26:148 (Jan.) 1947.

Like many another new form of therapy, the penicillin treatment of syphilis has progressed through the cycle of dubiety, enthusiasm and reaction. Mahoney's original report that penicillin is effectual against *Treponema pallidum* was received with some caution, but as laboratory and clinical confirmation of this observation rapidly became available reserve quickly gave way to enthusiasm. So promising did this new form of therapy appear that in September 1943, within three months of the first public announcement, a nation-wide cooperative study was organized under the auspices of the Committee on Medical Research. In less than a year penicillin was adopted for routine use in cases of early syphilis by the United States Army. Since then the limitations of this form of therapy gradually have become apparent.

The principal advantages of penicillin in the treatment of syphilis are its lack of toxicity and the fact that the therapeutic schedule need not be inordinately prolonged. Consequently, the full course of treatment is almost invariably completed. This is not the case with any form of arsenotherapy, with which toxic reactions increase in frequency the more the total duration of treatment is compressed and with which case holding becomes increasingly difficult as the period of therapy is prolonged.

To be feasible as an agent for treatment of ambulatory patients with syphilis in the clinic and in the physician's office, a modified preparation of penicillin with prolonged activity is desirable. Many attempts have been made to extend the duration of action of penicillin, either by delaying its absorption or by blocking its excretion by the renal tubules; but by far the most satisfactory modification presently available is the suspension of penicillin in peanut oil and beeswax.

This preparation of penicillin has been used in the treatment of syphilis. Preliminary reports suggest that the results may be sufficiently satisfactory to warrant more widespread application. Treatment schedules utilizing this preparation alone and in combination with oxophenarsine hydrochloride or a bismuth compound are being evaluated currently by the clinics cooperating in the nationwide study of syphilis. Already there is some indication that with administration of as much as 9,600,000 units of penicillin in oil and beeswax over a period of sixteen days there is a not inconsiderable number of treatment failures.

With any schedule of administration of penicillin the data to date indicate that there has been a high incidence of treatment failures. After the Army adopted the schedule of administration of 2,400,000 units in seven and one-half days relapse rates have been several times as high as the rates after any schedule of arsenobismuth therapy, prolonged or intensive, provided that the latter was fully completed.

There is here involved the possibility that penicillin may actually be more efficacious in treatment of early syphilis than appears from this comparison, and that many so-called relapses actually represent reinfection. Unfortunately, this point is incapable of determination on the basis of existing clinical and experimental data.

It is believed that this excessively high incidence of treatment failures with penicillin may be reduced in two ways. The total duration of treatment may be prolonged, in which case there arises the problem of case holding, so frequently encountered during metal chemotherapy. Perhaps a more promising approach is the addition to the penicillin treatment of a scheme of concurrently administered metal chemotherapy.

There is no unanimity of opinion as to the desirability of combining penicillin and oxophenarsine hydrochloride in the routine treatment of early syphilis. Some authors have expressed the belief that the results with penicillin alone, when administered in adequate amounts over a long enough period, are satisfactory in a sufficiently large proportion of patients to justify eliminating arsenicals from the original course of treatment, reserving their use for patients with relapse. Others believe that the additional therapeutic effectiveness provided by arsenic warrants the increased risk.

In the management of neurosyphilis, penicillin is proving of significant worth. On the abnormalities of the cerebrospinal fluid, especially on the pleocytosis and the elevated protein content, which have been considered an indication of the "activity" of the process in the central nervous system (Dattner-Thomas), penicillin exerts a profoundly favorable effect. This is true not only with asymptomatic neurosyphilis but also with the various clinical syndromes of syphilis of the central nervous system, although post-treatment "reactivation" has been noted somewhat more frequently among patients with symptomatic (usually parenchymatous) neurosyphilis than among those with asymptomatic involvement of the neuraxis.

In cases of asymptomatic neurosyphilis, in which the only evidence of involvement of the central nervous system is an abnormal spinal fluid, the result of therapy can be adjudged only by the response of the spinal fluid and the incidence of progression to clinical neurosyphilis. The abnormalities of the spinal fluid in early and in late asymptomatic neurosyphilis respond dramatically to penicillin. Improvement is manifest promptly in the cell count and the protein content, more gradually in the colloidal gold curve, and, last of all, the Wassermann reaction. Normality of the spinal fluid, once achieved, seems usually to be stable. The rapidity with which the spinal fluid becomes normal after penicillin therapy is dependent on the degree of the pretreatment abnormalities and the duration of the syphilitic infection. Abnormalities of lesser degree and those occurring within the first two years of the disease disappear rapidly; those which are more extensive and of longer duration improve slowly over a period of years.

The ultimate result in terms of clinical progression will not be known for many years. If, however, the favorable responses of the spinal fluid thus far noted are sustained, the incidence of clinical neurosyphilis developing in this group of patients should be low.

The clinical manifestations of neurosyphilis are protean: Some are due to active inflammation and others to degenerative processes; some are reversible, and others are the result of irreparable damage of neural tissues. In its effects on these clinical manifestations, which include such widely dissimilar symptom complexes as acute syphilitic meningitis, dementia paralytica, tabes dorsalis and Erb's spastic paraplegia, the presently available information suggests that penicillin is superior to metal chemotherapy but that it gives little promise of clinical results in treatment of parenchymatous neurosyphilis superior to those obtainable with fever therapy.

It should be pointed out, however, that such improvement as does follow penicillin therapy is attained at no risk to the patient, and is obtained in a shorter time and with less inconvenience to him than attends either fever therapy or protracted metal chemotherapy.

With acute syphilitic meningitis the results of therapy with penicillin used alone are excellent, but with parenchymatous neurosyphilis they are less favorable. In at least one clinic which has used both penicillin alone and penicillin as an adjunct to malarial fever therapy, greater success in treatment of dementia paralytica and of tabes dorsalis has been obtained with the combined method. There also are indications that penicillin therapy alone may prove inferior to combined treatment with malaria and penicillin in cases of primary atrophy of the optic nerve, late syphilitic nerve deafness and Erb's spastic paraplegia.

For the present at least, there is reason to believe that the concurrent administration of penicillin and induction of malarial fever offers the patient with late parenchymatous neurosyphilis the greatest promise of a favorable outcome. It is probably the treatment of choice, therefore, in those forms of neurosyphilis which carry a serious risk to life or important bodily function, namely, the meningoencephalitic and the tabetic form of dementia paralytica, primary atrophy of the optic nerve and nerve deafness. In cases of acute syphilitic meningitis, early or late asymptomatic neurosyphilis and meningovascular neurosyphilis, therapy with penicillin alone may be given initially, with good prospects of a favorable response.

The therapeutic problems of tabes dorsalis and Erb's spastic paraplegia require further consideration. With each, the outlook ultimately is for distressingly chronic invalidism. Since, however, the evolution of these conditions is gradual, with no immediate threat to life or vital bodily function, and since the patients frequently are in such poor general physical condition as to be poor risks for fever therapy, it is not unreasonable first to employ a form of therapy (e. g., penicillin) which is completely safe, provided there is any reasonable prospect that such therapy may be beneficial. In tabes dorsalis there is such a prospect, but in Erb's spastic paraplegia there appears to be none.

Prior to the advent of penicillin, it was believed desirable to follow malarial therapy with a prolonged course of metal chemotherapy, not only to consolidate the effects of the fever but to prevent progression of the disease in other organs, particularly the cardiovascular system. The concomitant use of penicillin may well obviate the necessity for subsequent chemotherapy and thus significantly reduce the total duration of treatment.

Moreover, with penicillin, the advantages of fever therapy have been extended to that group of patients who are unsuitable for the full course of malaria inoculations. Rose and his co-workers believe that their results with an abbreviated course of malaria inoculations, given concomitantly with penicillin therapy, were as satisfactory as those with a full course of malaria treatments alone.

Included in this editorial is a discussion of the effects of penicillin on gummatous lesions of the skin, bony skeleton and viscera. The data indicate that the healing process is no more rapid with penicillin than with metal chemotherapy. The inflammatory ocular lesions respond quickly except for interstitial keratitis, in which the results are no better than with older forms of therapy.

In the case of cardiovascular syphilis and of late latent syphilis, the evaluation of the usefulness of any therapeutic agent involves many years of post-treatment observation. There is as yet, therefore, no information as to the results of penicillin therapy in these conditions. Caution has been urged in the use of large initial doses

of penicillin in the presence of overt cardiovascular syphilis, in view of the possible complications from therapeutic shock.

It is obvious, however, that treatment with penicillin offers nothing to patients with late latent syphilis whose serologic reactions remain positive after prolonged chemotherapy. To subject these patients to further therapy of any kind solely for the purpose of attaining seronegativity is to kindle false hopes and to waste time, money and effort.

In the prevention of prenatal infection through treatment of pregnant women with syphilis, penicillin has been highly efficacious. Here it probably is, as Goodwin and Moore have suggested, the present therapy of choice. Penicillin readily passes the placental barrier, and its spirocheticidal action is available to the fetus in utero. Despite the contentions of some authors, it appears not to provoke uterine contractions or to precipitate premature labor. The outlook for a nonsyphilitic child following penicillin therapy is excellent. Even among those mothers whose syphilitic infection has been recently acquired, and in whom the risk to the child is great, there have been remarkably few treatment failures.

In treatment of syphilis, one has in penicillin a drug of negligible toxicity, readily administered but with definite limitations in therapeutic effectiveness. It is far from being the ideal therapeutic agent. Yet it has, for the present at least, a place in the treatment of syphilis as the most desirable therapeutic means at present available for certain of the protean manifestations of this disease, and as an adjunct to older methods in the treatment of others.

GUTTMAN, Philadelphia.

Muscular System

FAMILIAL MYASTHENIA GRAVIS. LODOVICO MANCUSI-UNGARO, *Ann. Int. Med.* **23**:249 (Aug.) 1945.

Mancusi-Ungaro reports the cases of 2 sisters as instances of familial myasthenia gravis. In neither case was there any roentgenographic evidence to suggest mediastinal involvement. Neostigmine was effective in treatment of 1 sister, but not of the other. The author states that, as is well known, remissions are frequent in this state and that the improvement of the one sister may be attributed either to neostigmine or to the natural course of the disease. Both sisters noticed the onset of their symptoms after working in a greatly overheated room.

GUTTMAN, Philadelphia.

AMYOTONIA CONGENITA (OPPENHEIM'S DISEASE): REPORT OF CASE, WITH NECROPSY. J. A. CUNNINGHAM, *South. M. J.* **39**:222 (March) 1946.

The patient, a boy, seemed normal at birth but later showed flaccid extremities and coughed and gurgled as though he was having difficulty in swallowing. At the age of about 6 months he was unable to sit up or hold his head erect, and his arms and legs were flaccid. Treatment with neostigmine hydrochloride and aminoacetic acid was begun, but the infant died several weeks later. On the basis of the history and observations post mortem Cunningham stresses that in this case of clinically diagnosed amyotonia congenita (Oppenheim) the important changes were confined largely to the voluntary muscles and the central nervous system. The cause of death was bronchopneumonia, and possibly asphyxia resulting from impairment of the swallowing reflex. There were also a healing Ghon tubercle and an enlarged thymus. The muscles showed varying amounts of small embryonic muscle spindles with preserved cross striations and easily demonstrated Krause and Hensen membranes, together with some entirely normal muscle. The central nervous system showed depletion in the number of motor ganglion cells in the anterior horns of the cord and diminution in size and distortion of the remaining ganglion cells. The anterior roots were diminished in size and showed faulty or no myelination. There was no demyelination of the tracts in the spinal cord and no evidence of involvement of pyramidal cells of the cerebral cortex.

J. A. M. A.

Society Transactions

BOSTON SOCIETY OF PSYCHIATRY AND NEUROLOGY

Madelaine R. Brown, M.D., *Presiding*

Regular Meeting, Dec. 20, 1945

Extensive Bulbar Trigeminal Tractotomy: Report of Cases. DR. WILLIAM H. SWEET, Birmingham, England.

This paper will be published in a future issue of *Brain*.

Neuropsychiatric Services in the European Theater of Operations. COLONEL LLOYD J. THOMPSON, Medical Corps, Army of the United States.

Neuropsychiatric services in the European Theater of Operations were at all times part of the general medical services. From the beginning, the policy was to have a strong neuropsychiatric section in every general and station hospital. This meant neuropsychiatric wards and consultation, outpatient and rehabilitation services. Each general hospital had a specially constructed closed ward for the neuropsychiatric section.

With some caution, special hospitals for neuropsychiatric patients were organized. At first the appeal was for a unit for psychotic patients, but with increasing emphasis on prevention and rehabilitation "neurosis hospitals," or "mental rehabilitation" units, came into being. Eventually there were four special neuropsychiatric hospitals—two on the Continent and two in England. One unit in England was a holding hospital for psychotic patients, but all four carried out a program of intensive therapy. In the "neurosis centers" an atmosphere of "recovery and return to duty" was created for the patient from the moment he entered the admission office until he was discharged. These hospitals consistently maintained an average rate of return to duty of 80 per cent, and they received patients after other units had been unable to return them to duty.

The School of Neuropsychiatry was really a part of the neuropsychiatric units. This school was opened in April 1943, under the direction of Lieut. Col. Jackson Thomas. At first neuropsychiatrists coming into the Theater with general and station hospitals were given a one month course. Along with this went courses for nurses and enlisted men. Then one week courses for medical officers of ground force units were started. In September 1943, Lieutenant Colonel Thomas was recalled to the Zone of the Interior, and it was not until late in the year that Major Howard Fabing replaced him. From that time until the middle of July 1944 the school concentrated on courses in "first aid psychiatry" for front line medical officers. Approximately 700 such officers attended, and the total attendance at the school was over 1,200.

In the Zone of Communications there were neuropsychiatric services in the two large reenforcement depots and in the disciplinary training centers. Mention should be made of the recovery center for "unwilling soldiers," which was not a medical unit but received trainees only after thorough study in a neuropsychiatric unit.

Concerning Army organization, the reestablishment of the post of division psychiatrist was recommended in September 1942, but it was not until November 1943 that this was done officially. It was necessary to train several men for these positions in the Theater. The division psychiatrist was the keystone of neuropsychiatric services in combat units. He functioned mainly at the level of the

clearing station, where he had one or two tents separate from the others for patients with combat exhaustion. An important part of his work was to see that medical officers in front of him functioned efficiently. Early in combat it was recognized that a division psychiatrist who was having a large percentage of "returns to duty" was not doing a good job forward.

All Armies except the Third Army formed "exhaustion centers" to the rear of divisions. This was accomplished by taking the neuropsychiatrists out of the evacuation hospitals and placing them in a "housekeeping" unit, such as a clearing company. The exhaustion center was in effect a small neuropsychiatric hospital where intensive treatment could be carried out for seven to ten days.

Types of cases and methods of treatment cannot be elaborated on here. It will be seen from the foregoing description that at every echelon, from the aid station at the front to the holding neuropsychiatric hospital in England, neuropsychiatric services were available for triage or adequate treatment. Within Army services, 60 per cent of the neuropsychiatric patients were returned to duty—the majority to combat duty. This does not include the patients who were returned to duty up forward at aid stations. At this rate, 40 out of every 100 neuropsychiatric patients came back to the Zone of Communications. There the neuropsychiatric hospitals returned approximately 80 per cent to duty—usually noncombat duty. This would leave only 8 or 10 of the original 100 for evacuation to the Zone of Interior, and among them would be a few psychotic patients, epileptic patients and others who could not possibly be reclaimed for any type of service.

DISCUSSION

DR. LEO ALEXANDER: It is regrettable that Colonel Thompson could not show the motion picture he had originally intended to exhibit and which he and his staff, especially Major Fabing, prepared in the European Theater of Operations. It is an excellent illustration of the methods of treatment used. The neuropsychiatric organization under Colonel Thompson in the European Theater of Operations was a very effective one. Most of its members have now returned to civilian life.

In studying and treating war neuroses, one could not help being impressed with the pavlovian mechanisms which enter into the making of the neurosis, and with the great importance which constitution plays, in addition to external stress. I found it particularly striking that, in confirmation of Pavlov's observations on animals, persons with "strong nervous systems" tended to respond with states of excitation, while persons with "weak nervous systems" tended to respond with states of inhibition, irrespective of any other diagnostic category, such as anxiety state, hysteria or reactive depression.

In patients who responded with states of excitation, deep narcotherapy of at least three days' duration followed by a period of insulin subshock treatment—combined, of course, with ventilative and encouraging psychotherapy and mobilization of the patient's own internal resources by shifting emphasis—was a form of treatment successful in many cases. Inhibited patients did better with the abreaction forms of therapy; however, in the hospital experience of my colleagues and myself none of the latter group ever attained sufficient improvement to return to combat duty, probably because in this group a greater number of basically weak personalities were present.

It is remarkable how many of the patients with states of excitation recovered sufficiently to go back to combat duty. This occurred only in those of our hospital patients who were Air Force personnel. None of our infantry personnel were returned to combat duty. This was due to the fact that whereas we served as an evacuation hospital as well as a general hospital to the Air Force, we served as a general hospital to the infantry and were thus too far removed in the chain of evacuation to receive any but its most severe psychiatric casualties.

In conclusion, I should like to say that the management of psychiatric treatment in our American Army was highly effective and was superior to that of any other

army in the field. I had an opportunity to compare our methods with the Germans', both by seeking and talking to prisoners of war and by interrogating psychiatric medical officers of all echelons in the German army after they had been taken prisoners. I recall one German medical aid man who had surrendered to our Army during the Battle of the Falaise Gap. He had been under intense combat activity, including shelling, for eighteen days. Gradually he had become tense, could no longer sleep and eat and had difficulty in forcing himself to go after wounded men under fire. He surrendered to the Americans in a setting of combat exhaustion and discouragement. When I saw him a good while later, he expressed guilt feelings about having surrendered. He described his symptoms, which I recognized as typical of combat neurosis, and I asked him whether he had discussed his symptoms with his medical officer. He replied, "Of course not. He would have had to report me, and I would have been shot."

While I found no evidence that the Germans actually shot those of their soldiers who complained of symptoms of combat exhaustion except during the final phases of the war, and then only when they were caught faking wounds by putting on large bandages, they, nevertheless, wanted to create an atmosphere in which soldiers believed that they would be shot if they complained of symptoms of combat fatigue. One of the psychiatrists whom I interrogated stated that he used that technic in his "psychotherapy."

Thus it came about, as Major Fabing so aptly worded it when I talked to him about this problem one evening in Paris, that the men with combat exhaustion in the German army tended to surrender to the enemy, while ours surrendered to their own medical officers.

MAJOR MERRILL MOORE, M. C., A. U. S.: The treatment of the psychoneuroses of war that was used in the South and the Southwest Pacific would be too complex to go into at this late hour; so I shall express only my admiration for the excellent performance of his administrative duties that Colonel Thompson has given. He is too modest to tell us much about the organization that he helped create, which amounted to more than two hundred functioning hospital units at one time. In these, so far as psychiatry was concerned, he directed all procedures, the assignment of personnel and the carrying out of policies. His administrative work in the European Theater was essentially concerned with preventive psychiatry. I hope he will turn over a complete copy of his paper to the Secretary for publication.

LIEUT. COL. WILFRED BLOOMBERG, M. C., A. U. S.: A number of things occur to me. The first has been mentioned, namely, that Colonel Thompson is extraordinarily modest. He has not given us a complete picture of organization, which was so effective in the European Theater of Operations. However, I am delighted to have the Colonel with us and it has given me a chance to hear his story with a beginning, a middle and an end.

The plans for handling psychiatric problems in the Pacific Theater followed much the pattern that was found effective in the European Theater. I think all agree that if it were possible to have strong psychiatric units in all general hospital groups it would be advantageous; but it is not possible. In spite of fancy promises and exaggerations, there were not enough psychiatrists to go around. In the Pacific Theater there was set up and functioning a large station hospital for the care of psychiatric disorders. There was set up and functioning a large general hospital for psychotic men and men who could not be returned to duty. There was set up a large general hospital for minor psychiatric disorders. In the Pacific Theater the formulation of what had been found useful in Europe was accepted.

Also lifted in principle from the European experience was the plan to move psychiatric patients out of general hospitals. If it became necessary to hospitalize them, this was done where there was a special hospital, with special personnel. When these patients had been triaged and screened at the aid station and finally got back to the Zone of the Interior, the neuropsychiatric services were able to get many back to duty.

Kenneth J. Tillotson, M.D., *Presiding*

Regular Meeting, Jan. 17, 1946

Psychosurgery: 1936-1946. DR. WALTER FREEMAN and DR. JAMES W. WATTS, Washington, D. C.

This article will appear in full in a later issue of the ARCHIVES.

DISCUSSION

DR. JAMES L. POPPEN: I have no business to discuss this paper, considering the relatively few patients (100) my colleagues and I have operated on. In this field we have acted purely as technicians. We have depended entirely on psychiatrists at the Boston Psychopathic Hospital to choose the patients they thought suitable for this operation. Dr. Freeman and Dr. Watts should be complimented on popularizing this operation and on treating these tragic patients. When one sees the photographs of the patients before and after operation which Dr. Freeman has shown, one is inclined to laugh at the horrible faces; but it is a tragic situation, and when one meets it personally, perhaps in one's own family, it is not a laughing matter. Not only the patient suffers but the family as well. Some of these patients can be restored to a useful life. If only a few persons can be helped, it is worth while. Dr. Freeman and Dr. Watts have done a great deal to make us realize that lobotomy is of real aid and that it is under rather strong opposition in certain sections. I was rather skeptical about its value at first, but as I have followed the patients after lobotomy I have come to feel it has definite merits. As to choosing patients suitable for lobotomy, I am not qualified to speak. Dr. Solomon has made an excellent study of a series of patients before and after operation.

As to the surgical technic, it hampers me to be guided by some one else as to where to make the incision through the white matter. The open method, in which one can visualize these structures, has merit. Dr. J. G. Lyerly, of Jacksonville, Fla., suggested making a trephine opening so that if bleeding was encountered he could stop it by actual visualization. This is a constructive criticism of the closed method. It seems to me that if the surgeon can actually visualize the structures which he is dividing he can feel competent in doing what he set out to do. I have two slides to show of the method we use at the present time. The brain is somewhat like the face. No two faces are of exactly the same size or shape. The brain also varies in size and shape, especially the ventricles and convolutions. I do not see how one can be accurate by depending on measurement alone. One cannot speak about a millimeter, but one can speak about millimeters. The relationship of the anterior horn of the lateral ventricle to the sphenoid wing varies greatly, especially since many of these patients have enlarged ventricles due to atrophy.

(Slides) I wish to say something about the indications for operation which has nothing to do with psychiatric disorders, but has to do with pain. We had a patient who had severe pain in the left side of the face. A section of the fifth nerve had been performed, but she still complained. She had psychiatric treatment, was taking morphine every three hours and had lost from 180 to 100 pounds (81.6 to 45.4 Kg.) in weight. She could talk of nothing but the pain in her face. Two years ago a section of the frontothalamic tract was made. At present she is a clerk in a store, and, as I understand, is entirely satisfactory in that capacity. She goes to card parties, is perfectly happy and has never asked for morphine or for any other drug since the operation. Dr. Freeman stated that he had a patient on whom a lobotomy was performed for relief of pain associated with carcinoma. Lobotomy is certainly a potentially less serious operation than chordotomy. In some cases lobotomy is of real value in the relief of pain from a fatal carcinoma.

I have been somewhat hesitant about lobotomies in young girls. I wonder about the effect on their morality. Can Dr. Freeman and Dr. Solomon tell us something about that?

DR. WILLIAM JASON MIXTER: I have been interested in this work ever since Dr. Watts and Dr. Freeman started it. It seemed to me that it was a rational procedure, to be carried out in selected cases. It is interesting to see this series of cases enlarged. Dr. Solomon has said there are thousands of patients in Massachusetts who should be operated on. My associates and I have followed the technic of Dr. Freeman and Dr. Watts rather closely at McLean Hospital and at Massachusetts General Hospital, and so far we have been pretty well satisfied. We have had 1 fatality, presumably because the section was placed too far back. It seems to me that we who are surgeons must be guided by the psychiatrists concerning indications for operation; it is their field, not ours. We started with a very small group of patients with agitated depressions. We have operated on 3 patients with pain, 1 of whom was the patient who died. The other 2 were operated on too recently for me to be able to report results, but they seem to be definitely better. I have always questioned a bit the value of lobotomy for schizophrenic patients, and I shall be interested to see how they respond.

It has been a great pleasure to hear Dr. Freeman again, and I only wish that Dr. Watts were here too, to give us his opinion about the surgical approach to this interesting problem.

DR. HARRY C. SOLOMON: As a result of Dr. Freeman and Dr. Watts's pioneering for use against rather widespread skepticism, a noteworthy contribution to psychiatry has been produced. For a number of years many of us read the reports of Drs. Freeman and Watts and thought that, next to Ananias, they were the best story tellers and the best liars the world had heard of. It was argued that it stood to reason that people could not get well because a piece of brain was removed. I held aloof until two years ago, when, in a moment of irresponsibility, I was pushed into this work. Now, like all converts, I should like to do a little evangelical work. The results which my colleagues and I have had have amazed us. Dr. Freeman's statistics are much more valid than ours because of his longer time of observation. At first we thought that this radical operation should be done only on patients with chronic disease of several years' duration which every one had put themselves on record as incurable. Most of these patients had had electric shock, and many of them insulin shock, to see whether they would recover. They were patients who had had from two to twenty years of hospitalization. They made up the majority of our group, and we went rather slowly; but we have had extraordinary results. Up to August, our series contained 23 patients with chronic schizophrenia—very sick patients. The state hospitals sent us patients who presented the most distressing problems in handling. By November 8, 8 of these patients had gone home, 3 were about to be discharged, 5 were front ward instead of back ward patients and a few did not show good results. Some of our patients have made a really extraordinary recovery or improvement. A Harvard graduate, who had been five years in the hospital, is now doing exacting work. The most striking result is a warmth of feeling, i. e., warmth in the expression of affection to their families, which these patients generally show. To see these vituperative and scolding women on admission and then three or four days after operation to see them greeting their families with kind and affectionate regard is an amazing experience. The families are thrilled. You can imagine what they say to us. It is a heartening situation.

That the patients with agitated depressions should show a release of their agitation, quiet down and become rather productive citizens is one thing, but that these chronic, hopeless, unquestionably schizophrenic patients should take a new lease on life and become reasonable persons again is something that has rather shaken my stability. One should give a great deal of credit to Dr. Freeman and Dr. Watts for opening this avenue of endeavor. I am sure there are hundreds of patients' relatives in this country who look on them with something more than kind regard.

Dr. Freeman says patients tend to lose the sense of forecasting the future. I do not think that this is true. I should like to reassure Dr. Poppen's New England

conscience, which makes him worry about the morality of the virgins. Actually, our patients have more, rather than less, of the moral virtues after lobotomy. They have a greater degree of good morals than they had just prior to and during their psychotic behavior. We have been impressed with the fact that, contrary to what one might conclude from the literature, we have not produced vegetative, adipose, lazy, overeating patients. Many remain rather slim and sleek and have better figures than before the operation. I wonder whether a difference in the technic of operation may account for a difference in results.

I suppose all neurosurgeons who perform this operation do it differently, and therefore it has a different effect on the brain. From the mechanistic standpoint, the results should differ according to the place at which the cut is made. We like to think that with the skilful surgery of Dr. Poppen and Dr. Horrax some of the difference in results is due to differences in technic. I shall, finally, call attention to the fact that these patients have a great many other changes in their body responses. There are changes in controls of the autonomic nervous system. Perhaps Dr. Rinkel will tell us something about these effects. Many of the patients with hypertensive disorders have a return to low blood pressure level after operation. There are many extraordinary changes in the physiologic activity of the patient. Our first patient to be operated on had had diabetes for eight years and has been cured of the disease.

DR. MAX RINKEL: Bilateral frontal lobotomy offers a great opportunity for neurophysiologic studies. Freeman and Watts, in their remarkable book on "Psychosurgery" (Springfield, Ill., Charles C Thomas, Publisher, 1942), devote a chapter to the "Relation of the Frontal Lobe to the Autonomic Nervous System." With Drs. M. Greenblatt, G. P. Coon and H. C. Solomon, at the Boston Psychopathic Hospital, I have undertaken a systematic study of the autonomic nervous system on patients who had had bilateral frontal lobotomies. The sympathetic nervous system was examined after intravenous injection of 0.05 mg. of epinephrine hydrochloride in 1 cc. of sterile water over a period of ten seconds. The blood pressure, pulse rate, pulse pressure and other clinical reactions were recorded. The systolic blood pressure rose to twice the level of the controls, and the pulse pressure was tripled. Clinically, shivering and pilomotor reactions were produced. The parasympathetic nervous system was examined by stimulation of the carotid sinus. The effect of stimulation of the carotid sinus was recorded simultaneously with the electroencephalographic and electrocardiographic records. The electroencephalogram in over 90 per cent of cases was characterized by the appearance of high voltage slow waves in the 2 to 5 per cent range of frequency. The electrocardiogram in over 80 per cent of cases disclosed increased QRS-QRS intervals and heart block. Tonic-clonic convulsions occurred in almost 90 per cent. Atropine, in an amount sufficient to produce vagus block, and amphetamine sulfate abolish the carotid sinus reflex, whereas mecholyl enhances it.

Illustrative lantern slides were shown.

DR. KENNETH J. TILLOTSON, Belmont, Mass.: I should like to make a few comments in behalf of my colleagues on the staff of McLean Hospital. We have performed this operation in two series of patients. The first series (1940) consisted of 5 patients with severe agitated depressions. Three made excellent recoveries and 2 had effective changes. In the second series were 11 patients who had been schizophrenic from ten to thirty years. Obviously, we should not expect any remarkable result from patients as deteriorated as these. However, some have shown improvement in their conduct. This raises an important psychologic problem. Some types of schizophrenic patients should have this operation earlier. The early history could show that the prognosis was hopeless. With an early diagnosis, why should not prefrontal lobotomy be done early? The electric shock therapies are not very successful in cases of severe obsessional tension states. Dr. Freeman and Dr. Watts have shown that some schizophrenic patients have gone into the Army after successful recovery from lobotomy.

The cerebral disturbance occasioned by this operation should be considered. One does not know what takes place as a result of the operation or what is the nature of the effect of years of mental illness, an effect which is called deterioration. There is a great deal of work to be done. Many of the symptoms can be reversed with therapy. After lobotomy the "total push" program should add to the beneficial results. A program of reeducation is important in follow-up treatment. The importance of operation on selected schizophrenic patients as soon as the diagnosis can be made is to be emphasized. Certainly, in cases of persistent obsessional tensions it should be done.

DR. FREDERICK WYATT, Belmont, Mass.: The problem of prefrontal lobotomy as a therapeutic measure is one of personality. The way to study the changes which the personality undergoes after operation is through general psychiatric observation and the application of standardized tests. What is known about differences in personality before and after operation? I should like to ask Dr. Freeman about recent advances in psychologic studies, such as were surely undertaken in continuation of those reported in "Psychosurgery." It will be recalled that Dr. Thelma Hunt made the psychologic studies which appeared in that book. She tested 40 patients before and after operation. These patients were selected on the basis of their willingness and ability to go through this procedure. This very fact suggests, however, that the patients were accessible to communication and capable of relatively organized responses and that they were, if at all, not more than slightly deteriorated. Does not this raise a problem? Let it be assumed for present purposes that there are three states of personality: (1) the premorbid personality, (2) the mentally ill personality (if this illness is a schizophrenic psychosis it may have led to deterioration) and (3) the postoperative personality. Dr. Hunt's observation that the intellectual abilities of the patients, as reflected in her tests, were not impaired by the operation is as valid as it can be under the given conditions. One does not know as yet what changes actually occur. Patients with obsessional neuroses are known to maintain a relatively high intellectual acumen, even with the most disabling symptoms. One must not be surprised when the patient shows no major changes in personality. The very fact that psychologic studies were limited to cooperative patients tends to skew the results. On the other hand, there are indications that frontal lobotomy does bring about intellectual changes. Dr. Hunt may not have pressed the point far enough. One would wonder especially whether the ability to perform abstractions and generalizations in Goldstein's sense—a complex of functions which seem to be identical with higher intellectual abilities—had not been impaired by lobotomy and would want this aspect scrutinized with special care.

A few words about our experience with lobotomy at McLean Hospital: The problem there is the reverse of the one just discussed. More than 1 of our patients subjected to lobotomy had been ill for over thirty years and was inaccessible. We were limited entirely to postoperative observations. But lobotomy, in addition to its curative prospects, is an extraordinary experiment—if one applies it, one must make full use of it. The next problem is how to lift a chronic patient out of his state long enough to test him. Various drugs may prove helpful. If one could make systematic studies before and after the operation on patients who were chronically and severely disturbed, one might not only know more definitely what changes of personality lobotomy effects but might also learn more about the obscure concept of deterioration. Every opportunity for postoperative study should be utilized. Observations by the nurses while the patient is in the ward offer a fruitful opportunity. Another is supplied through occupational therapy. My colleagues and I have been working on a form recording the more important and revealing behavioral manifestations of the patient from day to day in that activity. We shall attempt to integrate psychiatric and psychologic data, observations of the nurses and occupational therapy records in order to obtain as comprehensive and multidimensional a picture as possible.

DR. KENNETH J. TILLOTSON, Belmont, Mass.: I should like to ask Dr. Freeman several questions: In patients with obsessional tension states and in patients with the early stages of schizophrenia who have not shown any striking deterioration after prefrontal lobotomy, what type of loss of function, if any, have you observed? Does this operation tend to produce invalidism or deterioration in the patient? The symptoms of "silliness" are, I think, due to the long years of illness preceding operation. Does the electroencephalogram change, and do you routinely inject iodized oil and take encephalograms? You mentioned home environment after operation. What sort of occupational environment do you recommend if patients remain in the hospital?

DR. WALTER FREEMAN, Washington, D. C.: Your discussers have dealt kindly with me. I recall vividly an occasion on which I appeared at a meeting of the Chicago Neurological Society nine years ago; many disparaging remarks were made, and one person said the operation was criminal. I think the attitude has changed because the proof of the pudding is in the eating. I believe it will be of value to answer questions first and then, perhaps, discuss more fully a few of the conclusions which Dr. Watts and I have reached.

What measure of loss of function is there in these cases? What defects in intelligence show up? It is largely a matter of what one calls intelligence. Webster defines intelligence as the ability to apply new methods in the solution of new problems. The problem that confronts most of our patients is that of getting along in the outside world. Take the patients who are suffering from obsessional tension states: Whereas 17 per cent of a fairly large series of such patients were remuneratively employed prior to operation, the figure rose to 67 per cent after operation. These persons are free, cheerful, relaxed and able to carry on a conversation on a variety of topics. They are alert and interested in the happenings of the day. Their capacity for carrying out the various tests, I think, is limited by their satisfaction with their ability to give some answer, not necessarily a perfect or an all-inclusive one. This is the one phenomenon which shows up in a number of the so-called tests of personality function in the Rorschach, the mosaic and the personality test and, to some extent, in the categorical aptitude test, the maze test and the various sorting tests. There probably is a permanent reduction in the richness of the associations which enable a person to see all the implications of the questions and of his replies. In other words, the patient after lobotomy seems to finish his thinking more quickly and with greater satisfaction to himself than the normal person. That is the reverse of the patient who falls into the neurotic or obsessional tension state, who is never satisfied with the results of his thinking.

Electroencephalographic studies have been carried out on our material by Dr. Robert Cohn. They showed that in the early stages after operation there was a disorganization of the alpha rhythm in the frontal leads. There was no particular correlation with the clinical result. Some patients had abnormal records before operation with later improvement. However, the electroencephalograms of others were normal, even though there was pronounced deterioration and repeated severe convulsive seizures had occurred.

Roentgenograms are taken because we want to know why operation sometimes fails. If we find from study of the roentgenograms that the incision has been made with the plane too far forward we are obliged to carry out a second operation to correct that. If the plane is too far posterior, apathy, inertia and permanent invalidism result.

We believe in getting the patient home soon after operation. He passes through a dull stage and then becomes childish, exuberant and overactive, a condition that one recognizes as normal in a child. This phenomenon should be emphasized to the relatives. They should be informed that the patient will misbehave. He may not, and so much the better; but if he does relatives will then not blame the surgeon too much. It is worth while to point out that before operation the patient was not only behaving pretty badly, so much so that he had to be locked up, but was

unhappy and suffering. After operation the behavior is probably no worse; but the patient is not suffering and the family finds it difficult to pity him and treat him like a sick person. When it is explained that he is still sick, but in a different way, and still needs guidance, the family is likely to be more patient.

We have had patients who returned to work seven or eight years after operation. Before operation they had been disabled ten or twelve years. I believe that management of patients in the hospital requires total push, as Dr. Tillotson emphasized. We believe the patient should go home early because that constant social pressure brings him back sooner to adequate social behavior.

I wish I could answer Dr. Wyatt more adequately in regard to intelligence testing. During the war it was impossible to obtain adequate psychiatric studies of these patients. Dr. Wyatt's criticisms are well taken. We hope to correct the shortcomings to some extent in the future. He has made some interesting comments on the deterioration in relation to these tests. It is wholly futile to base one's conclusions concerning intellectual capacity on results with deteriorated patients. One must choose the best patients, patients who maintain a vigorous intellectual life and are disabled by obsessions that do not lead to dissociation of personality. I should choose the patients presenting anxiety states, obsessive tension states and other conditions in which the dissociation of personality is at a minimum.

With respect to surgical technic, I do not think one can say this procedure is better than that until a number of patients have been followed over a period of years. We prefer to place the incisions where we feel they should be. We like to draw on the roentgenogram the place where the incision should lie. That will depend on our estimate of the patient's age, intellectual attainments, social status, psychotic condition and deterioration. We cannot expect to get an adequate result in a patient with chronic schizophrenia by placing the incision in the plane of the coronal suture. We aim to place it 6 to 8 mm. behind it. If we are 3 mm. off in either direction, we may get a bad result. I watched Dr. Poppen do two and a half lobotomy operations today, and I must say they went through with neatness and dispatch and with little bleeding. I could see what he was doing. I could see the bulge of white matter and the various stages of operation. I am pretty sure I could see the anterior cerebral artery in 1 case. My criticisms of Dr. Poppen's method is that he has no permanent record of the exact plane of the incision. He could use tantalum powder and take roentgenograms. We use iodized oil almost routinely. It stays in the incisions. There is no reaction, and we have not noticed any ill effects from its use. Before a final estimate of the value of the open versus the closed operation is made, we shall have to wait a number of years and calculate the results. Will Dr. Poppen get 50 or 20 per cent of his patients back to work? Will he get 50 or 20 per cent out of the hospital and back to their home environment? How many of his patients will relapse; how many will have seizures, and how many will die during operation? I think the Poppen and Lyerly technics will yield adequate results.

Dr. Solomon stressed the ability of these patients to live in harmony with themselves and their environment and to adjust themselves to the needs of the moment. I agree they do handle themselves well. They can go out in the world and attend to the needs of themselves and their customers. Lack of foresight occurs in the early phases and later, particularly in the field of interpersonal relationships. If they would count 20 before they speak and 50 before they strike, it would be better. Many of them have an abundance of energy no longer trammled. They finish their thinking more quickly than the average person. They are direct, practical and uninspired. It takes some indirection, impracticality and inspiration to produce schizophrenia, agitated depression or an obsessive tension state.

Disturbances in morality have been minor. Some patients have been picked up by the police for indecent exposure, but only because of an imperious need to urinate. Fortunately, in our series there have been no serious moral deviations.

Three of our patients married and have had children. I watched 1 of these women through her delivery, and this observation has some relation to the question of pain. During the labor pains she screwed up her face and tugged and sweated and breathed hard, like any one. Between pains she was cheerful, smiling, alert and exhilarated. There was no sham connected with her behavior.

The more this operative procedure is being used, the more indications there are for it: first, for the agitated depressions; then schizophrenia; then the obsessive tension states, for which it is truly specific, and then hysteria, particularly when associated with a great deal of pain. We had a patient, a woman, aged 40, who had gone through twelve or eighteen abdominal operations. She had sustained a minor blow on the head and had had a subtemporal decompression. She also had severe contractures of the limbs with ankylosis and had spent two years in bed because of pain. On the second postoperative day she turned over on her back with a few wincings, but these subsided. On the third day she straightened out her legs. On the fourth day she walked. The pain was severe, but she was no longer afraid of being hurt. The operation was done more than nine years ago, and she has been keeping house and has been regularly employed for the last seven years.

Dr. Rinkel has shown us some interesting work, and Dr. Solomon has presented interesting facts regarding diabetes. We operated on a woman with hypertension in 1937. At that time she had had hypertension and agitated depression for eighteen years, with a blood pressure of 240 systolic and 120 diastolic. When I saw her nearly nine years later, her systolic pressure was 160 and she was leading a contented life in California. Another patient, who had schizophrenia, also had severe rheumatic carditis, and auricular fibrillation. This condition had resisted treatment with nauseating doses of digitalis; after operation the rhythm became normal. Later she had a mental relapse and died of congestive heart failure. Another patient, with psychoneurosis, had had two years of psychoanalysis. He also had subacute bacterial endocarditis. Three operations finally relieved him of his obsessive preoccupation. The endocarditis also cleared up, and the electrocardiogram became normal. Dr. W. W. Eldrige, chief medical officer at St. Elizabeths Hospital, told me of a tuberculous patient who needed five attendants to give him injections. Two operations were required to abolish this behavior, but he gained 40 pounds (18.1 Kg.) and there has been progressive clearing of the pulmonary picture. In the back wards there was a patient who had had to be fed with a tube twice a day for eleven years. It took three men to hold him and one to pass the tube. That was two years ago. He was referred for prefrontal lobotomy. He continued to require tube feedings; one day, however, the attendant went away and left the tube by the side of the patient, and the patient passed the tube himself. A few months later he used only the funnel, and he got a full meal of spaghetti. Now he is feeding himself with a spoon. Why is the recovery progressive in stages this way over long periods? I think the answer to this question contains the nub of the problem of the effect of prefrontal lobotomy. The patient's deviated behavior is the result of cerebral activity, and I believe one must postulate an anatomic substrate for organized, stereotyped behavior. In lobotomy the cortex is traumatized to only a limited degree. The most significant part of the operation is the severing of connections of the frontal lobe with the rest of the brain, particularly the connection between the frontal lobe and the thalamus. In my opinion, it is the emotional component of the psychosis that is removed, abolished, destroyed by the operative procedure, and it is reasonable to assume that it is the emotional component which keeps the psychosis alive. When that emotional component is removed, there is no longer any good reason for the continuation of this peculiar behavior. It has less meaning for the patient; the stimulus is no longer relevant. Therefore the behavior which is carried out after operation undergoes a gradual resolution, with disappearance of most of the abnormal forms.

ILLINOIS PSYCHIATRIC SOCIETY

John J. Madden, M.D., *President, in the Chair*

April 4, 1946

Memorial: Charles F. Read, M.D. DR. GEORGE A. WILTRAKIS.

The Hostile Dependent Behavior Factor in Rehabilitation of Veterans with Psychoneuroses and of the Industrially Injured with Psychologically Protracted Convalescence. DR. ALFRED P. SOLOMON.

One of the most rejected men in society is the industrially injured workman who has a protracted convalescence for psychologic reasons. These are men who have been determined by the surgeons as able to return to work; yet their behavior is a hostile denial of this opinion. This hostile dependent behavior is confronted not only with the traditional contempt of society for those who do not accept responsibilities but also with the contempt of the employer milieu and family. An even severer critic is his own conscience, which does not permit him to face his dependent attitude but, instead, forces him to behave as a sick man needing medical care. The paradox is that, though his complaints are many, what he seeks is not treatment but a diagnosis that will appease his conscience.

The state compensation laws and the general lack of understanding of the psychologic factors involved are largely responsible for the existence of this behavior.

At the state-operated Veterans' Rehabilitation Center of Chicago, experience has been gained in the rehabilitation of veterans with psychoneuroses which can be utilized in the treatment of the industrially injured with a psychologically protracted convalescence. The treatment at the center has as its basis an understanding of the psychologic factors in human relationships. It utilizes an all-day therapy involving recreational and physical educational activities, the arts and crafts, socialization activities and individual and group psychotherapy, all prescribed by the psychiatrist to fit the individual needs of the veteran, so that the rehabilitated veteran will better be able to face the vicissitudes of life and avoid future breakdowns. This vocational rehabilitation program is recommended on a basis of study by a staff psychologist and social worker, as well as a psychiatrist. Important in the treatment at the center is an integration of the teamwork, psychologically oriented, among all members of the staff. The advantage of treatment at a state-operated rehabilitation center is that there is responsibility only to the veteran, the matter of adjustment of pensions requiring no consideration by the staff at the center.

It is believed that the psychotherapeutic lessons learned at the center offer an answer to the parallel problem in industry presented by the injured workmen with psychologically protracted convalescence. However, before psychiatry can make use of these new psychologic technics in rehabilitation, state compensation laws must be investigated by a commission composed of psychiatrists, industrial surgeons, labor leaders and insurance men, so that revision can be made to utilize the psychiatrist as a therapist rather than as a medicolegal diagnostician.

Psychiatric Aspects of Shoplifting. DR. ALEX J. ARIEFF and DR. CAROL G. BOWIE.

In a study of 338 shoplifters referred by the municipal courts to the Psychiatric Institute of the Municipal Courts of Chicago over a five year period, the following facts were elicited:

Between 25 and 30 per cent of arrested shoplifters were referred for psychiatric examination by the courts. Arrested shoplifters constituted about 5 per cent of all apprehended shoplifters.

The value of the articles taken by this group was usually small, averaging \$20 in cost and being of little value to the patient.

There was more shoplifting in the spring and just before Christmas.

The majority of patients were women; 313 of 338 patients analyzed were women.

In 1942 the ratio of these offenses to the total case load was highest, whereas in the last three years of the war the percentage dropped appreciably.

The age groups most involved were the early immature and the middle-aged. Many women in the latter were in the menopausal period.

Of 338 patients, 77 per cent had a definite mental or emotional disorder. The diagnosis for a large percentage of patients was acute anxiety state with mental depression. Marital discord, low economic level and low intellectual level were not factors.

Even the war's continuance did not increase the incidence of shoplifting.

The majority had no previous arrests. Of 42 with previous arrests in 100 sample cases, 24 per cent had had arrests for the same offense.

Forty-nine per cent of the patients were disposed of by court supervision, 36 per cent by psychiatric supervision, 5 per cent by correctional care and 12 per cent by commitment.

News and Comment

TRAINING PROGRAM FOR PSYCHIATRISTS

The American Board of Psychiatry and Neurology, Inc., makes the following suggestions for a three year full time training program for psychiatrists:

1. One year of inpatient work with an adequate variety of psychiatric conditions.
2. Six months of full time outpatient clinic work, or its equivalent, with emphasis on the study and treatment of psychoneurotic patients, with a minimum of twenty interviews per week per resident.
3. Six months of work in neurology—half-time clinical and half-time basic.
4. Six months of half-time service in the psychiatric aspects of general medical and surgical conditions.
5. Six months of half-time work in child psychiatry and experience in working with psychologists and psychiatric social workers.
6. Six months of specialized institutional psychiatry (feeble-mindedness, epilepsy, forensic psychiatry, penology, drug and alcohol addiction, and so forth).
7. During these three years it is recommended that there be available teaching ward rounds, staff conferences, seminars, journal clubs, adequate psychiatric texts and periodicals and participation in some phase of psychiatric investigation.
8. During these three years there should be adequate instruction in the basic psychiatric concepts, as covered in the material recommended in the syllabus of the American Board of Psychiatry and Neurology, Inc.
9. In institutions in which there is no full time senior staff there should be given in the aggregate a minimum of fifteen hours a week of service by the senior attending staff in capacities instructive to the resident staff.
10. In planning or evaluating training, one, two or three year programs may be worked out to include various fractions of the foregoing suggested items. For instance, a resident may devote a full day or a half-day a week to the psychiatric aspects of medical and surgical conditions for a year or so while assuming major clinical responsibilities in a psychiatric hospital.

The only purpose in suggesting the foregoing program is to indicate a desirable spread of experience in the training of a psychiatrist. It is thought unwise for any teaching program to be rigidly or slavishly followed.

RESIDENCY IN PSYCHIATRY, VETERANS ADMINISTRATION HOSPITAL IN NEW ORLEANS

The Veterans Administration Hospital in New Orleans offers a two year residency in neuropsychiatry. This includes work with all phases of the psychoses and psychoneuroses as well as the usual types of neurologic and neurosurgical cases commonly encountered in a five hundred bed hospital. The hospital has recently been designated as a neurosurgery center, and this will increase the number of cases available for neurosurgical study.

In addition to the hospital work, the residents are detached from their duties for a period of six weeks each year, during which they are enrolled as graduate students in the departments of neuroanatomy and neurophysiology at the Tulane University of Louisiana School of Medicine. The department of neuropsychiatry is staffed by members of the faculty of the school of medicine of Tulane University who work at the hospital on a part time basis as consulting and attending physicians. In addition, a professor of psychology and several graduate students study the patients from the various psychological angles. A full time social service worker and several graduate students study the patients from the social standpoint.

For information write the chairman of the dean's committee, Tulane University of Louisiana, 1430 Tulane Avenue, New Orleans 13.

KANSAS PSYCHIATRIC SOCIETY

At a recent meeting of the Kansas Psychiatric Society the following officers were elected for the ensuing year: Dr. Lewis L. Robbins, president; Dr. J. F. Casey, vice president; Dr. Edward D. Greenwood, secretary-treasurer, and Dr. E. M. Wiedenmann and Dr. Paul E. Davis, counsellors.

Book Reviews

22 Cells in Nuremberg. By Douglas M. Kelley, M.D. Price, \$3. Pp. 245. New York: Greenberg, Publisher, Inc., 1947.

This interesting book introduces no new facts about the twenty-two war criminals. Many descriptions fall short and do not give a clear pattern of their personalities. Not new, but significant, is the statement that the trend to aggression has been present in the German people for many decades.

Of all the men on trial, only one, Robert Ley, had pathologic changes in the frontal lobe of the brain. Hitler and Hess showed psychopathologic pictures. Both suffered from hysterical reactions with disturbances of reality and paranoid features. All the others were men with ambition, ability and some cruelty. They were much the same as the people one meets in daily life in offices as business executives, union leaders, officials and others. There was nothing extraordinary about them. The accused and the German people had one thing in common—a lack of maturity, which in the case of the German people was exhibited in the emotional field.

The author answers the argument of the Americans that "we are much too civilized for such a situation to develop and could never regress to a point where a small group could seize total power." He states, "Shocking as it may seem to some of us, we as a people greatly resemble the Germans of two decades ago." He charges the American people with the same immaturity as the Germans. The author feels that the heterogeneity of the structure of the American people produces various forms and states of immaturity. This is a weak protection against a dictatorship by a single man or a small group of men. He feels that only maturity, achieved by education, is a safeguard against events such as those which took place in Germany. It is a remarkable book, which can be highly recommended.

Textbook for Psychiatric Attendants. By Laura W. Fitzsimmons, R.N. Price, \$3.50 Pp. 332. New York: The Macmillan Company, 1947.

In many psychiatric hospitals, the actual daily care of patients is given by attendants. Capable, well trained and enthusiastic attendants contribute in an important way to an efficient psychiatric service.

As indicated in the foreword of this volume, the Nursing Committee of the American Psychiatric Association has focused on the problem of adequate and standardized training for the attendant. With the support of that committee in 1945, Laura W. Fitzsimmons first published "A Manual for Training Attendants in Mental Hospitals," giving a basic formula for a teaching plan.

The volume at hand is a text that may be used by the attendants taking the course outlined in the manual or by those who do not have the benefit of classes.

In reading this book one is struck by the wealth of practical material given in a concise and usable form. While there is sufficient material of a more theoretic nature, in accordance with the modern tendency in teaching nurses and attendants, emphasis is on symptoms rather than diagnoses. Among the topics covered are: the attitude of the attendant, admission procedures, ward observations, suicide prevention, restraints, the handling of visitors, emergencies and first aid, ward housekeeping, mental hygiene for attendants, the attendant's place in occupational therapy, hydrotherapy, the care of disturbed patients, the details of flow baths, packs, administration of medicines and gavage. A section on electric shock and insulin therapy might have been included. While it would be ideal if nurses were always available to assist with these treatments, in actuality in some hospitals the shortage of nurses necessitates the use of attendants.

This volume should be recommended to attendants and will be useful to psychiatrists and nurses concerned with the instruction of attendants.

INDEX TO VOLUME 57

The asterisk (*) preceding the page number indicates an original article in the Archives. Subject entries are made for all articles. Author entries are made for original articles and society transactions. Book Reviews, Obituaries and Society Transactions are indexed under these headings in their alphabetical order under the letters, B, O and S, respectively.

Abbott, K. H.: Abdominal rigidity; symptom of concussion of spinal cord, *220

Abdomen: See also Gastrointestinal Tract; Pelvis; etc.
abdominal rigidity; symptom of concussion of spinal cord, *220

Abnormalities and Deformities: See Twins; and under names of diseases, organs and regions

Abortion; causation of mongolism, 645

Abreaction: See Anesthesia

Abscess: See under names of organs and regions, as Brain; Spine; etc.

Accidents: See Trauma

Accommodation: See Eyes, accommodation and refraction

Acid, Aminoacetic: See Depression

Adenohypophysis: See Pituitary Body

Adenoma; creatine metabolism in relation to pituitary tumors, 487
pituitary adenoma associated with chronic duodenal ulcer, 395

Adrenalectomy: See under Adrenals

Adrenals; degree and nature of regeneration of splanchnic innervation to adrenal gland 2 years following complete bilateral sympathectomy in dogs, 757
paranoid psychosis successfully treated by adrenalectomy; further case, 243

Aeronautics: See Aviation and Aviators

Affects: See Psychoanalysis

Agnosia, Visual: See under Aphasia

Air, Pressure: See also Altitude; Aviation and Aviators
pressure; gas bubbles in plal vessels of cats following rapid decompression from high pressure atmospheres, 758
pressure; physiologic abnormalities and pathologic changes following exposure to simulated high altitudes, 636

Albuminocytologic Dissociation: See Guillain-Barré Syndrome

Alcohol, Addiction: See Alcoholism
Therapy: See Pain

Alcoholics Anonymous: See Alcoholism

Alcoholism, acute, treated with insulin, 642

Alcoholics Anonymous, 516
conditioned reflex treatment, 514
high frequency electric current in treatment of alcoholic hallucinosis, 113
problem of, 513
relation of mental imagery to hallucinations, *469

Alexander, L.: Loss of axis-cylinders in sclerotic plaques and similar lesions, *661

Allergy: See Anaphylaxis and Allergy

Alpers, B. J.: Meningeal reaction with abscess of brain, *307

Altitude: See also Air, pressure; Aviation and Aviators
cerebral anoxia from high altitude asphyxiation; clinicopathologic study of 2 fatal cases with unusually long survival and clinical report of nonfatal case, *397
nervous system dysfunction in adaptation to high altitude and as postflight reactions, 761

Amaurosis: See Blindness

Amblyopia: See Blindness

Amentia: See Feeble-mindedness; Insanity; Mental Diseases; etc.

American Board of Psychiatry and Neurology, 234

Aminoacetic Acid: See Depression

Ammonia: See under Cerebrospinal Fluid

Amnesia; amnesic aphasia with focal lesion in area 37, 640
cerebral blast syndrome in combat soldiers, *14

Amphetamine; use of benzedrine sulfate by psychopaths, 254

Amyotonia Congenita: See Myatonia

Amyotrophy: See Atrophy, muscular

Analgesia: See Anesthesia; Pain

Anaphylaxis and Allergy; syndrome of physical or intrinsic allergy of head; vasomotor rhinitis and vasodilating pain syndrome; their relationship to myalgia and endolymphatic hydrops (Ménière's disease), 641

Anemia, Cerebral: See Brain, blood supply
impairment of pupillary reactions during accommodation superimposed on Argyll Robertson pupils associated with tabes during acute anemia, 763

Anesthesia, abreaction in military setting, *161
blocking of middle cervical and stellate ganglions with descending infiltration anesthesia; technic, accidents and therapeutic indications, 115
meningitis after spinal analgesia, 391
sixth nerve paralysis after spinal analgesia, 395
spinal, neuropsychiatric complications following, 107

Anesthetics: See Anesthesia

Aneurysm; central diabetes mellitus, 493

Angioma; Sturge-Weber disease, 645

Anisocoria: See Pupils

Annulment, orientation to forensic psychiatry, *738

Anomalies: See under names of organs and regions

Anoxia: See Oxygen, deficiency

Anxiety: See Neuroses and Psychoneuroses

Aphasia, Amnesic: See Amnesia
ideokinetic apraxia following partial recovery from visual agnosia; report of case with autopsy, 492
remedial procedures for handling aphasic patients, 646

Apparatus; mechanism of motion sickness, *58
relation between electroencephalographic and histologic changes following application of graded force to cortex, *521
Wolf-Hardy; measurements of pain sensitivity in patients with psychoneurosis, *321; correction, 660

Apraxia, ideokinetic, following partial recovery from visual agnosia; report of case with autopsy, 492

Aralac: See Dressings

Argyll Robertson Pupils: See Pupils

Arief, A. J.: Psychiatric aspects of shoplifting, 777

Armed Forces Personnel: See Aviation and Aviators; Military Medicine; Naval Medicine; Veterans; etc.

Arms: See Extremities; etc.

Arsenic and Arsenic Compounds; arsenical encephalopathy (with emphasis on post-ural treatment), 393

Arteries: See Aneurysm; Blood, pressure; Embolism; Thrombosis; Vasomotor System; etc.
Cerebral: See Brain, blood supply
Retinal: See Retina, blood supply

Arthropathy: See Tabes Dorsalis

Artificial Fever Therapy: See Dementia Paralytica; Neurosyphilis

Astrocytoma, meningeal gliomatosis; study of 42 cases, *604

Athetosis; hemiballismus, 248

Atmosphere: See Air

Atlas and Axis; basilar impression; position of normal odontoid, 106

Atopy: See Anaphylaxis and Allergy

Atrophy: See also under names of organs and regions
Muscular: See also Dystrophy, muscular

Atrophy—Continued

- muscular; changes in human voluntary muscle in denervation and reinnervation (results of galvanism), 240
 muscular; influence of galvanic stimulation on muscle atrophy resulting from denervation, 239
- Aviation and Aviators: See also Air, pressure cerebral anoxia from high altitude asphyxiation; clinicopathologic study of 2 fatal cases with unusually long survival and clinical report of nonfatal case, *397
 effects of high altitude on man, 386
 mechanism of motion sickness, *58
 nervous system dysfunction in adaptation to high altitude and as postflight reactions, 761
 physiologic abnormalities and pathologic changes following exposure to simulated high altitudes, 636
- Avitaminosis: See under Vitamins
- Axilla, Lymph Nodes: See Lymph Nodes
- neurilemmoma in region of right axilla in case of Recklinghausen's disease; extirpation; recovery, 496
- Axis: See Atlas and Axis
- Axons: See Neurons
- Bacilli: See Bacteria
- Back: See Camptocormia
- Bacteria, clostridium; anaerobic infection of brain, 244
 Influenza: See Influenza
 Typhoid Group: See Typhoid
- Bamford, T. E., Jr.: Encephalomalacia of cerebellum and temporosphenoid lobe; report of case, 264
- Barbital and Barbital Derivatives; picrotoxin in barbiturate poisoning, 114
- Barbiturate: See Barbital and Barbital Derivatives
- Barré-Guillain Syndrome: See Guillain-Barré Syndrome
- Barry, H., Jr.: Abnormally large birth weights of psychiatric patients, *98
- Basilar Impression: See Atlas and Axis; Occipital Bone
- Bassett, R. C.: Neurogenic arthropathy (Charcot joint) associated with diabetic neuropathy; report of 2 cases, *173
- Baumgarten-Cruveilhier Syndrome: See Cruveilhier-Baumgarten Syndrome
- Behavior; cultural patterning of maturation in selected primitive societies, 119
 hostile dependent behavior factor in rehabilitation of veterans with psychoneuroses and of industrially injured with psychologically protracted convalescence, 777
 relation between maturation and acculturation, 118
- Bell, A.: Traumatic hematomyelia with unusual features, 266
- Bell's Palsy: See Paralysis, facial
- Benzedrine: See Amphetamine
- Berger Rhythm: See Brain, electroencephalography
- Beverages, Alcoholic: See Alcoholism
- Bilharziasis: See Schistosomiasis
- Birth; abnormally large birth weights of psychiatric patients, *98
- Bladder; cord bladder; restoration of function by transurethral operation, 108
 transurethral resection of vesical neck in management of cord bladder, 642
- Blast: See Explosions
- Blier, J. S.: Electroencephalogram in pitresin hydration test for epilepsy, *211
- Blindness; electroencephalographic study of Helen Keller, *629
 Word Blindness: See Aphasia
- Blood, Circulation: See also Arteries; Cardiovascular Diseases; Vasomotor System; etc.
 circulation of brain and face; determinations of oxygen and sugar in arterial and in internal and external jugular venous blood, *94
 Diseases: See Anemia; etc.
 pressure, high; experimental investigations on causes of centrogenic hypertension associated with intracranial increase in pressure, 106
 proteins; treatment of preparalytic polio-myelitis with gamma globulin, 496

Blood—Continued

- results of treatment of multiple sclerosis with dicoumarin, *1
 Sugar: See also Insulin; etc.
 sugar; relation between effects of blood sugar levels and hyperventilation on electroencephalogram, 384
 Vessels: See also Vasomotor System; etc.
 vessels; gas bubbles in pial vessels of cats following rapid decompression from high pressure atmospheres, 758
- Body, Mind and Body: See under Mind
- Bones: See under names of bones
- BOOK REVIEWS:
- Diseases of Nervous System; F. M. R. Walshe, 520
 Electro-choc et la psycho-physiologie; J. Delay, 519
 Human Embryology; B. M. Patten, 276
 Human Genetics; R. R. Gates, 396
 Human Torulosis: Clinical, Pathological and Microbiological Study, with Report of Thirteen Cases; L. Cox and J. C. Tolhurst, 659
 Insight and Personality Adjustment; T. Benedek, 276
 Introduction to Clinical Neurology; G. Holmes, 275
 Manual of Diagnostic Psychological Testing: II. Diagnostic Testing of Personality and Ideational Content; D. Rapaport and R. Schafer, 275
 Problems in Abnormal Behavior; N. Thornton, 659
 Psychoanalytic Therapy: Principles and Application; F. Alexander, T. M. French and others, 135
 Psychodrama; J. L. Moreno, 136
 Textbook for Psychiatric Attendants; L. W. Fitzsimmons, 780
 Twenty-Two Cells in Nuremberg; D. M. Kelley, 780
- Botulism; physiology of botulinus toxin, *578
- Bourneville's Disease: See Sclerosis, tuberosus
- Bowie, C. G.: Psychiatric aspects of shoplifting, 777
- Brachium Pontis: See Cerebellum
- Brain: See also Cerebellum; Lenticular Nucleus; Medulla Oblongata; Meninges; Nervous System; Thalamus; etc.
 abscess with meningeal reaction, *307
 anaerobic infection of, 244
 Blood Supply: See also Aneurysm; Thrombosis; etc.
 blood supply; circulation of brain and face; determinations of oxygen and sugar in arterial and in internal and external jugular venous blood, *94
 blood supply; volume flow of blood through human brain, *137
 calcification, familial tuberosus sclerosis with, 641
 cerebral anoxia from high altitude asphyxiation; clinicopathologic study of 2 fatal cases with unusually long survival and clinical report of nonfatal case, *397
 cerebral blast syndrome in combat soldiers, *14
 cerebral fat embolism after electrical convulsion therapy, 387
 chemical changes in cerebral cortex associated with convulsive activity, 634
 chronic intracerebral hematoma, 250
 cogwheel phenomenon of eyes; its clinical significance, *362
 Concussion: See Brain, injuries
 congenital facial paralysis, *358
 diagnosis and surgical therapy of cerebral manifestations of thromboangiitis obliterans (Winiwarter-Buerger disease), 762
 Diseases: See also Encephalitis; Insanity; Mental Diseases; etc.
 diseases; arsenical encephalopathy (with emphasis on postural treatment), 393
 diseases; effect of anticonvulsant drugs on recovery of function following cerebral cortical lesions, 487
 diseases; effect of cortical lesions on labyrinthine nystagmus, 655
 diseases; effect of lesions of optic tract and of midbrain on labyrinthine nystagmus, 654

Brain—Continued

- diseases; schistosomiasis of brain due to *Schistosoma japonicum*; report of case, *199
- efferent fibers of parietal lobe of cat (*Felis domesticus*), 635
- electroencephalogram and personality organization in obsessive-compulsive reactions, *71
- electroencephalogram in pitressin hydration test for epilepsy, *211
- electroencephalogram, methods of frequency analysis of, 379
- electroencephalogram, relation between effects of blood sugar levels and hyper-ventilation on, 384
- electroencephalographic and neurologic studies of homosexuals, 240
- electroencephalographic changes following head injuries in dogs, 486
- electroencephalographic studies following electric shock therapy; observations on 51 patients treated with unidirectional current, *719
- electroencephalographic studies immediately following head injury, 491
- electroencephalographic studies in diabetes mellitus, 636
- electroencephalographic study of electric shock therapy; psychotic patients treated in United States Naval Hospital, *712
- electroencephalographic study of Helen Keller, *629
- electroencephalography; changes in brain potentials during convulsions induced by oxygen under pressure, 486
- electroencephalography; effects of pitressin hydration on electroencephalogram; paroxysmal slow activity in nonepileptic patients with previous drug addiction, *78
- electroencephalography; objective method for distinguishing sleep from hypnotic trance, *84
- fatality incidence in electroshock treatment, 249
- functional significance of rostral cingular cortex as revealed by its responses to electrical stimulation, 635
- Inflammation: See Encephalitis
- influence of depletion of diffusible electrolytes on electrical activity of, 758
- Injuries: See also Head, injuries
- injuries; review of psychologic work at Brain Injuries Unit, Edinburgh, 1941-1945, 390
- injuries, symptom of "electrical discharge" in, 639
- Localization of Function: See also Brain, diseases; Brain, pathology; Brain, tumors
- localization of function; amnesic aphasia with focal lesion in area 37, 640
- malignant chordoma of lumbar region; report of case with autopsy; comment on unusual metastases to brain, lungs, pancreas, sacrum and axillary and iliac lymph nodes, *547
- metastases of uterine carcinoma to central nervous system; clinicopathologic study, *186
- new developments in morphophysiology of cerebral cortex, 386
- parkinsonian-like tremor and cogwheel rigidity in child secondary to massive ependymoma of frontal lobe and caudate nucleus; prefrontal lobectomy, with cessation of tremor and rigidity, 649
- pathology; encephalomalacia of cerebellum and temporosphenoid lobe; report of case, 264
- physiochemical mechanisms in experimental epilepsy, 384
- Physiology; See Brain, electroencephalography; Brain, localization of function
- Pressure in: See Cranium, pressure in propagation of spreading cortical depression, 758
- relation between electroencephalographic and histologic changes following application of graded force to cortex, *521
- roentgenography; accident which might have been ascribed to pneumoencephalography, 642
- Sclerosis: See Sclerosis
- Softening: See Brain, pathology

Brain—Continued

- surgery; neuropathologic problems after prefrontal leukotomy, 759
- surgery; new absorbable material (aralac) for use in neurologic and general surgery, 759
- surgery; prefrontal lobotomy, 243
- surgery; psychosurgery: 1936-1946, 770
- Syphilis: See Neurosyphilis
- tuberculoma of cerebrum; operation and survival for 3 years, 762
- tumors; report of 2 cases, 263
- tumors; static tremor with hemiplegia; report of case; development, progression for 7 years and postmortem histologic observations, *423
- Brinegar, W. C.: Electroencephalographic studies following electric shock therapy; observations on 51 patients treated with unidirectional current, *719
- Brodal, A.: Central course of afferent fibers for pain in facial glossopharyngeal and vagus nerves; clinical observations, *292
- Brody, M. W.: Psychiatric characteristics of patients with venereal disease, 125
- Bromide and Bromine; bromide poisoning; cogwheel phenomenon of eyes; its clinical significance, *362
- Buerger-Winiwarter Disease: See Thrombo-anglitis obliterans
- Bullet Wounds: See under Wounds
- Calcification: See Brain
- Caloric Test: See Ear, internal
- Camptocormia, functional condition of back in neurotic soldier, 491
- Cancer: See under names of organs and regions
- Carbohydrates: See Blood, sugar; etc.
- Carbonic Anhydrase: See Enzymes
- Cardiovascular Diseases and electroconvulsive shock therapy, 113
- Cardiovascular System: See Arteries; Vasomotor System; etc.
- Casamajor, L.: Christopher Charles Beling, 233
- Cataphrenia: See under Mental Diseases
- Cataract; dystrophia myotonica (Steinert's disease); importance of cataract and disturbances of metabolism; therapeutic effect of vitamin E, 117
- Catatonla: See Dementia Praecox
- Cauda Equina: See Spinal Cord
- Causalgia: See Neuralgia
- Cells: See also Neurons; etc.
- relation between electroencephalographic and histologic changes following application of graded force to cortex, *521
- Staining: See Stains and Staining
- Cephalalgia: See Headache
- Cerebellum; encephalomalacia of cerebellum and temporosphenoid lobe; report of case, 264
- medulloblastoma in adults, *417
- medulloblastoma with survival for 17 years, *481
- parenchymatous degeneration; report of 2 cases, 255
- Cerebrospinal Fever: See Meningitis
- Cerebrospinal Fluid: See also Spinal Puncture
- Albuminocytologic Dissociation: See Gull-lain-Barré Syndrome
- glutamine and ammonia in spinal fluid of patients with nervous and mental diseases, 239
- transfer of penicillin into spinal fluid following parenteral administration, 634
- Cerebrum: See Brain
- Cervix: See Uterus
- Chapman, W. P.: Measurements of pain sensitivity in patients with psychoneurosis, *321; correction, 660
- Charcot Joint: See Tabes Dorsalis
- Chemotherapy: See Meningitis; Neurosyphilis; etc.
- Chesley, G.: Measurements of pain sensitivity in patients with psychoneurosis, *321; correction, 660
- Chlavacci, L. V.: Result of treatment of multiple sclerosis with dicoumarin, *1
- Child Guidance: See Mental Hygiene
- Children: See also Infants; etc.
- cultural patterning of maturation in selected primitive societies, 119
- Japanese B encephalitis; clinical observations in outbreak on Okinawa Shima, *430

Children—Continued

- Morvan's syndrome of uncertain cause (differentiation from syringomyelia); 2 cases, 394
 relation between maturation and acculturation, 118
 ticks and impulses; study of motility, 389
 transmission of poliomyelitis by patient to patient contact, 495
- Chodoff, P.: Concussion of spinal cord; report of cases with radiculoneuritic manifestations, *623
- Choked Disk: See Neuritis, optic
- Cholinesterase in sympathetic fibers and ganglia, 486
- Chordoma, malignant, of lumbar region; report of case with autopsy; comment on unusual metastases to brain, lungs, pancreas, sacrum and axillary and iliac lymph nodes, *547
- Chordotomy: See under Spinal Cord
- Cipriani, A.: Mechanism of motion sickness, *58
- Circle of Willis: See Aneurysm
- Circulatory Diseases: Blood, circulation; Cardiovascular Diseases
- Clinics; Portland (Oregon) child guidance clinic, 485
- Clostridium: See Bacteria, clostridium
- Cobb, S.: Measurements of pain sensitivity in patients with psychoneurosis, *321; correction, 660
- Cochlea: See Ear, internal
- Cogwheel Phenomenon: See Eyes, movements
- Combat Fatigue: See Fatigue; Neuroses and Psychoneuroses
- Communicable Diseases: See Meningitis; Syphilis; etc.
- Compulsion: See Dementia Precox; Neuroses and Psychoneuroses
- Concussion: See Brain, injuries; Spinal Cord
- Conditioned Reflexes: See under Reflex
- Congress: See Societies
- Contracts; orientation to forensic psychiatry, *735
- Contusions: See Brain, injuries; Head, injuries
- Convalescence; hostile dependent behavior factor in rehabilitation of veterans with psychoneuroses and of industrially injured with psychologically protracted convalescence, 777
- Convulsions: See also Epilepsy
 changes in brain potentials during convulsions induced by oxygen under pressure, 486
 chemical changes in cerebral cortex associated with convulsive activity, 634
 effect of anticonvulsant drugs on recovery of function following cerebral cortical lesions, 487
 Therapeutic: See Dementia Paralytica; Dementia Precox; Insanity; Mental Diseases
- Cornell Service Index: See Mental Tests
- Corpus Restiforme: See under Medulla Oblongata
- Coumarin; results of treatment of multiple sclerosis with dicoumarin, *1
- Cranium: See also Frontal Bone; Head; Occipital Bone
 defects following closed head injury, 762
 Injuries: See Brain, injuries; Head, injuries
 pathology of tumors; osteomas of skull, with incidental mention of their occurrence in ancient Incas, 644
 pressure in; experimental investigations on causes of centrogenic hypertension associated with intracranial increase in pressure, 106
 pressure in; experimental study of relation between pressure of retinal arteries and intracranial pressure, 106
 relation of acute mucosal hemorrhages and ulcers of gastrointestinal tract to intracranial lesions, *145
- Creatine and Creatinine; creatine metabolism in relation to pituitary tumors, 487
 dystrophia myotonica (Steinert's disease); importance of cataract and disturbances of metabolism; therapeutic effect of vitamin E, 117
- Crime and Criminals; orientation to forensic psychiatry, *743
 psychiatric aspects of shoplifting, 777
- Cruveilhier-Baumgarten Syndrome; hepatolenticular degeneration; report of 2 cases with predominantly hepatogenic symptoms, 1 associated with Cruveilhier-Baumgarten syndrome, 247
- Culture; cultural patterning of maturation in selected primitive societies, 119
 relation between maturation and acculturation, 118
- Cysts: See under names of organs and regions
- Cytology: See Cells
- Dattner, B.: Value of penicillin in treatment of neurosyphilis, 270
- Davidoff, L. M.: Static tremor with hemiplegia; report of case; development, progression for 7 years and postmortem histologic observations, *423
- Davidson, H. A.: Orientation to forensic psychiatry, *730
- Davis, C. N.: Alcoholics Anonymous, 516
- Davison, C.: Metastases of uterine carcinoma to central nervous system; clinicopathologic study, *186
- Deaf-Mutism; Ménière's disease in deaf-mute, 109
- Deafness: See also Ear; etc.
 electroencephalographic study of Helen Keller, *629
- Decerebration: See Rigidity
- Defectives: See Feeblemindedness
- Deficiency Diseases: See under Vitamins
- Degeneration, Hepatolenticular: See Lenticular Nucleus, degeneration
- Delusions: See under Dementia Precox, etc.
- Dementia: See Dementia Paralytica; Dementia Precox; Insanity; etc.
- Dementia Paralytica: See also Neurosyphilis
 syphilitic hepatitis and general paresis occurring simultaneously, 392
- Dementia Precox; circulation of brain and face; determinations of oxygen and sugar in arterial and in internal and external jugular venous blood, *94
 heredity in functional psychoses, 760
 interpretation of divergent outcome of schizophrenia in identical twins, 241
 paranoid psychosis successfully treated by adrenalectomy; further case, 243
 physiologic pathology of schizophrenia and manic-depressive psychosis, 127
 relation of mental imagery to hallucinations, *469
- Demobilization: See Military Medicine
- Denker, P. G.: Results of treatment of psychoneuroses by general practitioner; follow-up study of 500 patients, 504
- Dentition: See Teeth
- Depersonalization: See Personality
- Depression: See also Insanity; Mental Diseases; Neuroses and Psychoneuroses
 aminoacetic acid (glycine) in treatment, 254
 question of electroshock therapy in, 253
- Dermatomyositis, 111
- Devic's Disease: See Myelitis; Neuritis, optic
- Diabetes Mellitus: See also Blood sugar
 central, 493
 electroencephalographic studies in, 636
 neurogenic arthropathy (Charcot joint) associated with diabetic neuropathy; report of 2 cases, *173
- Dicoumarin: See Coumarin
- Diencephalon: See Brain
- Dilantin: See Diphenylhydantoin
- Dimitri-Sturge-Weber Syndrome: See Angioma
- Diphenylhydantoin, cogwheel phenomenon of eyes; its clinical significance, *362
- Diplegia: See Paralysis
- Dipsomania: See Alcoholism
- Disk, Choked: See Neuritis, optic
- Intervertebral: See under Spine
- Optic: See Nerves, optic
- Divorce, orientation to forensic psychiatry, *738
- D1 Alpha Tocopherol: See Vitamins, E
- Dressings; new absorbable material (aralac) for use in neurologic and general surgery, 759

- Drugs, Addiction: See also under names of drugs
addiction; effects of pitressin hydration on electroencephalogram; paroxysmal slow activity in nonepileptic patients with previous drug addiction, *78
- Duodenum, Ulcers: See Peptic Ulcer
- Dyes: See Stains and Staining; etc.
- Dynes, J. B.: Objective method for distinguishing sleep from hypnotic trance, *84
- Dyskinesia: See Movements
- Dyspituitarism: See Pituitary Body
- Dystrophy, muscular; dystrophia myotonica (Steinert's disease); importance of cataract and disturbances of metabolism; therapeutic effect of vitamin E, 117
- Ear: See also Deafness
Internal: See also Nerves; Nystagmus, Vertigo, aural; etc.
internal; effect of cortical lesions on labyrinthine nystagmus, 655
internal; effect of lesions of optic tract and of midbrain on labyrinthine nystagmus, 654
- Echlin, F. A.: Bilateral and multiple ruptured disk as cause of persistent symptoms following operation for herniated disk, 499
- Edema: See under names of organs and regions
- Education: See also Internship
course in neurology and psychiatry, Illinois Neuropsychiatric Institute, 134
educability of "deteriorated" epileptic patient, *617
postgraduate courses offered at University of California Medical Center, 134
Rorschach test seminar, 377
- Electricity: See also Electrotherapy; etc.
functional significance of rostral cingular cortex as revealed by its responses to electrical stimulation, 635
- Electrodiagnosis: See Brain, electroencephalography; etc.
electrical diagnosis of peripheral nerve injury, 637
- Electroencephalogram: See under Brain
- Electrolytes; influence of depletion of diffusible electrolytes on electrical activity of brain, 758
- Electromyogram: See Muscles; Spasm
- Electronarcosis: See Anesthesia
- Electrotherapy: See also Dementia Paralytica; Dementia Praecox; Epilepsy; Mental Diseases; Neuroses and Psychoneuroses; Personality; etc.
cerebral fat embolism after electrical convulsion therapy, 387
electrocerebral shock therapy; reconsideration of former contraindications, *693
electroconvulsive shock therapy and cardiovascular disease, 113
electroconvulsive therapy in prone position, 254
electroencephalographic studies following electric shock therapy; observations on 51 patients treated with unidirectional current, *719
electroencephalographic study of electric shock therapy; psychotic patients treated in United States Naval Hospital, *712
electroshock and personality structure, 501
electroshock therapy, 116
electroshock therapy; technic and indications, 116
fatality incidence in electroshock treatment, 249
question of electroshock therapy in depressions, 253
- Embollism: See also Thrombosis
cerebral fat embolism after electrical convulsion therapy, 387
- Emotions; subacute emotional disturbances induced by combat, 491
- Encephalitis: See also Encephalomyelitis and trauma, 494
cogwheel phenomenon of eyes; its clinical significance, *362
Japanese B; clinical observations in outbreak on Okinawa Shima, *430
- Encephalitis—Continued
Japanese B, topographic distribution of lesions in central nervous system in; nature of lesions, with report of case on Okinawa, *673
perilaxialis diffusa; different forms of diffuse sclerotic process—Pelizaeus-Merzbacher disease, Strümpell's familial spastic spinal paralysis, leukodystrophy—in 1 family, 392
susceptibility of *Macacus rhesus* to virus of tick-borne encephalitis, 637
- Encephalography: See Brain, roentgenography
- Encephalomalacia: See Brain, pathology
- Encephalomyelitis, disseminated; report of 4 cases presenting manifestations of both neuromyelitis optica and albuminocytologic dissociation, 1 with necropsy findings, 638
successful treatment of experimental western equine encephalomyelitis with hyperimmune rabbit serum, 112
- Encephalopathy: See under Brain
- Endocrine Glands: See under names of glands
- Endocrine Therapy: See under names of glands and hormones, as Insulin; Pituitary Preparations; Thyroid
- Engel, G. L.: Methods of frequency analysis of electroencephalogram, 379
- Enuresis: See Urination, incontinence
- Environment vs. race; environment as etiologic factor in psychiatric disturbances in infancy, 120
- Enzymes: See also under names of enzymes, as Cholinesterase; etc.
carbonic anhydrase in nervous system, 759
- Ependymoma; meningeal gliomatosis; study of 42 cases, *599
parkinsonian-like tremor and cogwheel rigidity in child secondary to massive ependymoma of frontal lobe and caudate nucleus; prefrontal lobectomy, with cessation of tremor and rigidity, 649
- Epidural Abscess: See under Spine
- Epilepsy: See also Convulsions; Sclerosis, tuberosus
appointment of national director, American Epilepsy League, Inc., 378
educability of "deteriorated" epileptic patient, *617
effects of pitressin hydration on electroencephalogram; paroxysmal slow activity in nonepileptic patients with previous drug addiction, *78
electroencephalogram in pitressin hydration test for, *211
experimental, physicochemical mechanisms in, 384
recent advances in treatment with emphasis on use of tridione, 130
treatment by electrically induced convulsions, 393
treatment with combination of 3-methyl 5, 5 phenylethyl-hydantoin and phenobarbital, 116
- Epiloia: See Sclerosis, tuberosus
- Equilibrium: See Cerebellum; Ear, internal; Nystagmus; Posture; etc.
- Exhaustion: See Fatigue
- Explosions; cerebral blast syndrome in combat soldiers, *14
- Extremities, Paralysis: See also Paralysis; Poliomyelitis
paralysis; paraplegia after cerebrospinal meningitis, 391
paralysis; retinal periphlebitis associated with paraplegia, *351
paralysis; static tremor with hemiplegia; report of case; development, progression for 7 years and postmortem histologic observations, *423
- Extroversion: See under Personality
- Eyelids; incidence of anisocoria and difference in size of palpebral fissures in 500 normal subjects, *464
- Eyes: See also Vision; and under special structures of eyes, i. e., Retina; etc.
accommodation and refraction; impairment of pupillary reactions during accommodation superimposed on Argyll Robertson pupils associated with tabes during acute anemia, 763
Movements: See also under Eyes, paralysis; Nystagmus; etc.

Eyes—Continued

- movements; cogwheel phenomenon; its clinical significance, *362
 movements; disturbances in ocular motility associated with hyperthyroidism, 498
 paralysis; ophthalmoplegic migraine and theoretic explanation of its production; report of case, 255
 paralysis; progressive nuclear ophthalmoplegia, possibly on basis of vitamin deficiency; report of case, 258
 restoration of vision after crossings of optic nerves and after contralateral transplantation of, 757
- Fabing, H. D.:** Cerebral blast syndrome in combat soldiers, *14
- Face, circulation of brain and face; determinations of oxygen and sugar in arterial and in internal and external jugular venous blood, *94**
 gunshot wounds of maxillofacial region with spinal complications, 107
 Paralysis: See Paralysis, facial
- Fantasy:** See Imagination
- Fantopias:** See Hallucinations
- Fatigue, combat, incidence of, *332**
- Feces; chemical determination of tocopherols in liver and muscle; tocopherol in urine and feces, 238**
- Feeble-mindedness, educability of "deteriorated" epileptic patient, *617**
 Sturge-Weber disease, 645
- Feeling:** See Emotions
- Feindel, W.:** Medulloblastoma of cerebellum, with survival for 17 years, *481
- Fetus:** See Labor; Pregnancy
- Fever:** See Malaria; Typhoid; etc.
 Therapeutic: See Dementia Paralytica; Mental Diseases; Neurosyphilis; etc.
- Filum Terminale:** See Spinal Cord
- Finesinger, J. E.:** Measurements of pain sensitivity in patients with psychoneurosis, *321; correction, 660
- Flatau-Schilder's Disease:** See Encephalitis periaxialis diffusa
- Foramen, Intervertebral:** See under Spine
 Magnum: See Medulla Oblongata
- Forster, F. M.:** Meningeal reaction with abscess of brain, *307
- Foster, D. B.:** Neurogenic arthropathy (Charcot joint) associated with diabetic neuropathy; report of 2 cases, *173
- Fractures:** See under names of bones and joints
- Freeman, W.:** Psychosurgery: 1936-1946, 770
- Friedreich's Disease:** See Paramyoclonus multiplex
- Frontal Bone; pneumatocele due to frontal trauma, 641**
- Funiculi, Posterior:** See Spinal Cord
- Galvanism:** See Paralysis, therapy
- Gamma Globulin:** See Blood, proteins
- Ganglion:** See Nervous System; Neurons
- Gastric Crisis:** See Tabes Dorsalis
- Gastric Ulcer:** See Peptic Ulcer
- Gastrointestinal Tract; relation of acute mucosal hemorrhages and ulcers of gastrointestinal tract to intracranial lesions, *145**
- Genitals:** See under names of genitals
- German, W. J.:** Congenital facial paralysis, *358
- Gesell, A.:** Relation between maturation and acculturation, 118
- Gibbs, E. L.:** Volume flow of blood through human brain, *137
- Gibbs, F. A.:** Volume flow of blood through human brain, *137
- Glioma; meningeal gliomatosis; study of 42 cases, *593**
- Globus Pallidus:** See Lenticular Nucleus
- Glutamine:** See Cerebrospinal Fluid
- Glycemia:** See Blood sugar
- Glycine:** See Depression
- Glycosuria:** See Diabetes Mellitus
- Goodell, H.:** Headache; teeth as source of headache and other pain, *277
- Graduate Work:** See Education
- Grant, F. C.:** Cerebellar medulloblastoma in adults, *417
- Grants; National Advisory Mental Health Council grants for training programs, 377**
- Grimes, R.:** Static tremor with hemiplegia; report of case; development, progression for 7 years and postmortem histologic observations, *423
- Grip:** See Influenza
- Growth; cultural patterning of maturation in selected primitive societies, 119**
 relation between maturation and acculturation, 118
- Guillain-Barré Syndrome; concussion of spinal cord; report of cases with radiculoneuritic manifestations, *623**
 disseminated encephalomyelitis; report of 4 cases presenting manifestations of both neuromyelitis optica and albuminocytologic dissociation, 1 with necropsy findings, 638
- Guilt:** See Psychoanalysis
- Guyton, A. C.:** Physiology of botulinus toxin, *578
- Hallucinations; high frequency electric current in treatment of alcoholic hallucinosis, 113**
 relation to mental imagery, *469
- Hamilton, D. M.:** Results of hospital treatment including electric shock of psychoneurotic patients, 504
- Handicapped:** See Feeble-mindedness
- Haymaker, W.:** Cerebral anoxia from high altitude asphyxiation; clinicopathologic study of 2 fatal cases with unusually long survival and clinical report of nonfatal case, *397
 Topographic distribution of lesions in central nervous system in Japanese B encephalitis; nature of lesions, with report of case on Okinawa, *673
- Head:** See also Cranium
 Injuries: See also Brain, injuries; etc.
 injuries; civilian advances and investigations in neurosurgery during war, 392
 injuries; cogwheel phenomenon of eyes; its clinical significance, *362
 injuries; cranial defects following closed head injury, 762
 injuries, electroencephalographic studies immediately following, 491
 injuries; encephalitis and trauma, 494
 injuries; facial palsy in closed head injuries; prognosis, 110
 injuries in dogs, electroencephalographic changes following, 486
- Headache:** See also Migraine
 syndrome of physical or intrinsic allergy of head; vasomotor rhinitis and vasodilating pain syndrome; their relationship to myalgia and endolymphatic hydrops (Ménière's disease), 641
 teeth as source of headache and other pain, *277
- Hearing:** See Deafness
- Heart:** See Blood, circulation; etc.
- Hebephrenia:** See Dementia Precox
- Heine-Medin's Disease:** See Poliomyelitis
- Hematology:** See Blood
- Hematoma, chronic intracerebral, 250**
- Hematomyelia:** See Spinal Cord, hemorrhage
- Hematoxylin:** See Stains and Staining
- Hemiballism:** See Athetosis
- Hemiplegia:** See also Extremities, paralysis; Paralysis
 chronic intracerebral hematomata, 250
 Hemorrhage: See Spinal Cord, hemorrhage; Vitreous Humor, hemorrhage; etc.
- Hepatitis:** See Liver
- Heredity in functional psychoses, 760**
- Herz, E.:** Treatment of spasmodic torticollis; report of 2 cases, 260
- Hindbrain:** See Brain
- Hoagland, H.:** Methods of frequency analysis of electroencephalogram, 382
- Hoerber, Paul B., Inc., publishers of Psychosomatic Medicine, 485**
- Hoff, H.:** Results of treatment of multiple sclerosis with dicoumarin, *1
- Homicide;** See Crime and Criminals
- Homosexuality:** See Sex, perversion
- Hormones:** See Insulin; Pituitary Preparations; etc.
- Hospitals; electroencephalographic study of electric shock therapy; psychotic patients treated in United States Naval Hospital, *712**

- Hospitals—Continued
 neuropsychiatric services in European Theater of Operations, 767
 results of hospital treatment, including electric shock, of psychoneurotic patients, 504
- Hurwitz, R.: Volume flow of blood through human brain, *137
- Hydantoin: See Diphenylhydantoin
- Hyperglycemia: See Blood sugar
- Hyperpyrexia: See Dementia Paralytica; Mental Diseases; Neurosyphilis; etc.
- Hypertension: See Blood pressure, high
- Hyperthyroidism: See Thyroid
- Hypertrophy: See under names of organs and regions
- Hyperventilation: See Respiration
- Hypnosis; abreaction in military setting, *161
 objective method for distinguishing sleep from hypnotic trance, *84
- Hypoglycemia: See Blood sugar
- Hypomania: See Mental Diseases
- Hypophysectomy: See under Pituitary Body
- Hypophysis: See Pituitary Body
- Hypoxia: See Oxygen, deficiency
- Hysteria: See also Neuroses and Psychoneuroses
 new approach to problem of, 388
- Idiocy: See Feeble-mindedness
 Mongolian: See Mongolism
- Idiosyncrasy: See Anaphylaxis and Allergy
- Imagination; relation of mental imagery to hallucinations, *469
- Imbecility: See Feeble-mindedness
- Incas: See Indians, American
- Inclusion Bodies: See Cells; Neurons
- Indians, American; pathology of cranial tumors; osteomas of skull, with incidental mention of their occurrence in ancient Incas, 644
- Industry and Occupations; hostile dependent behavior factor in rehabilitation of veterans with psychoneuroses and of industrially injured with psychologically protracted convalescence, 777
- Inebriety: See Alcoholism
- Infantile Paralysis: See Poliomyelitis
- Infants: See also Children
 environment vs. race; environment as etiologic factor in psychiatric disturbances in infancy, 120
- Influenza; meningitis due to penicillin and sulfonamide-sensitive Pittman B strain of H. influenza; recovery, 391
- Inguinal Glands: See Lymph Nodes
- Injuries: See under Brain; Frontal Bone; Head; Nerves, peripheral; Spinal Cord; etc.
- Insanity: See also Dementia Precox; Depression; Mental Diseases
 Alcoholic: See Alcoholism
 fatality incidence in electroshock treatment, 249
 physiologic pathology of schizophrenia and manic-depressive psychosis, 127
- Instruments: See Apparatus
- Insulin: See also Diabetes Mellitus
 acute alcoholism treated with, 642
- Intelligence; educability of "deteriorated" epileptic patient, *617
 significance of depth of physiologic cup of optic disk for mental ability, 389
- Tests: See Mental Tests
- Internship, residencies in neurology, Veterans Administration, 237
 residency in neuropsychiatry, Southwestern Medical Foundation and Veterans Administration, 237
 residency in psychiatry, Veterans Administration hospital in New Orleans, 779
- Intervertebral Disks: See Spine
- Intestines: See Gastrointestinal Tract; etc.
- Intoxication: See Alcoholism
- Introversion: See under Personality
- Iron Hematoxylin Staining: See Stains and Staining
- Islands of Langerhans: See Pancreas
- Joints, Diseases: See Rheumatism; Tabes Dorsalis; etc.
- Jones, C. M.: Measurements of pain sensitivity in patients with psychoneurosis, *321; correction, 660
- Journals: See Periodicals
- Jungle Sores: See Ulcers, tropical
- Jurisprudence, Medical: See also Alcoholism; Crime and Criminals; etc.
 orientation to forensic psychiatry, *730
- Kaufman, S.: Progressive nuclear ophthalmoplegia possibly on basis of vitamin deficiency; report of case, 258
- Keller, Helen, electroencephalographic study of, *629
- Kennedy, F.: Ophthalmoplegic migraine and theoretic explanation of its production; report of case, 255
- Kennedy, L.: Remedial procedures for handling aphasic patients, 646
- Kennedy Syndrome: See Neuritis, optic
- Kenny Method: See Poliomyelitis
- Kernohan, J. W.: Meningeal gliomatosis; study of 42 cases, *593
- Keyes, B. L.: Problem of alcoholism, 513
- Kindsvatter, V. H.: Japanese B encephalitis; clinical observations in outbreak on Okinawa Shima, *430
- Labor: See also Pregnancy; etc.
 peroneal palsy as complication of parturition, 110
- Labyrinth: See Ear, internal
- Laminectomy: See under Spine
- Landing, B. L.: Measurements of pain sensitivity in patients with psychoneurosis, *321; correction, 660
- Langerhans' Islands: See Pancreas
- Legs: See Extremities
- Lenticular Nucleus, degeneration; hepatolenticular degeneration; report of 2 cases with predominantly hepatogenic syndromes, 1 associated with Cruveilhier-Baumgarten syndrome, 247
- Leukodystrophy: See Encephalitis periaxialis diffusa
- Leukoencephalitis: See Encephalitis periaxialis diffusa
- Leukotomy: See Brain, surgery
- Lewis, L.: Japanese B encephalitis; clinical observations in outbreak on Okinawa Shima, *430
- Lhermitte's Sign: See under Sensation
- Libido: See Psychoanalysis
- Limbs: See Extremities
- Lipin, T.: Metastases of uterine carcinoma to central nervous system; clinicopathologic study, *186
- Lissauer's Paralysis: See Dementia Paralytica Tract: See Spinal Cord
- Little, S. C.: Schistosomiasis of brain due to Schistosoma japonicum; report of case, *199
- Liver; chemical determination of tocopherols in liver and muscle; tocopherol in urine and feces, 238
 syphilitic hepatitis and general paresis (dementia paralytica) occurring simultaneously, 392
- Lobotomy: See Brain, surgery
- Locomotion: See Movements
- Locomotor Ataxia: See Tabes Dorsalis
- Loman, J.: Circulation of brain and face; determinations of oxygen and sugar in arterial and in internal and external jugular venous blood, *94
- Louping III: See Encephalomyelitis
- Ludlum, S. D.: Physiologic pathology of schizophrenia and manic-depressive psychosis, 127
- Lumbar Puncture: See Spinal Puncture
- Lungs: See also Respiration; etc.
 malignant chordoma of lumbar region; report of case with autopsy; comment on unusual metastases to brain, lungs, pancreas, sacrum and axillary and iliac lymph nodes, *547
 roentgenologic and pathologic aspects of pulmonary tumors probably alveolar in origin, 249
- Lupus erythematosus, acute disseminate, central nervous system in, 248
- Lymph Nodes; malignant chordoma of the lumbar region; report of case with autopsy; comment on unusual metastases to brain, lungs, pancreas, sacrum and axillary and iliac lymph nodes, *547
- MacDonald, M. A.: Physiology of botulinus toxin, *578
- McEachern, D.: Mechanism of motion sickness, *58

- Macropsia: See Hallucinations
 Malaria; malarial papillitis, 641
 Therapeutic: See Neurosyphilis
 Malnutrition: See Vitamins; etc.
 Man, Primitive: See also Indians, American primitive; cultural patterning of maturation in selected primitive societies, 119
 Mania: See Insanity; Mental Diseases; etc.
 Marriage; orientation to forensic psychiatry, *738
 Maxwell, H.: Volume flow of blood through human brain, *137
 Mead, M.: Cultural patterning of maturation in selected primitive societies, 119
 Medical Education: See Education
 Medical Jurisprudence: See Jurisprudence, Medical
 Medicine, Aviation: See Aviation and Aviators
 Industrial: See Industry and Occupations
 Military: See Military Medicine
 Naval: See Naval Medicine
 Psychosomatic: See Mind, body and mind
 Medin-Heine Disease: See Poliomyelitis
 Medulla Oblongata: central course of afferent fibers for pain in facial glossopharyngeal and vagus nerves; clinical observations, *292
 Medulloblastoma, cerebellar, in adults, *417
 meningeal gliomatosis; study of 42 cases, *595
 of cerebellum with survival for 17 years, *481
 Melancholia: See Depression; Insanity
 Involuntal: See Mental Diseases
 Memory: See Amnesia
 Ménière's Disease: See Vertigo, aural
 Meninges: See also Pia Mater
 gliomatosis; study of 42 cases, *593
 meningeal reaction with abscess of brain, *307
 Meningitis after spinal analgesia, 391
 cerebrospinal, paraplegia after, 391
 cerebrospinal, sequelae of, 391
 changes in personality after cerebrospinal fever, 393
 due to penicillin and sulfonamide-sensitive Pittman B strain of *H. influenzae*; recovery, 391
 meningeal reaction with abscess of brain, *307
 meningococci; report on 165 cases, 253
 meningococci, treated with sulfadiazine and sulfamerazine; 3 year study, 115
 Meningococci: See under Meningitis
 Meningoencephalitis: See Encephalitis; Meningitis
 Mental Deficiency: See Feeble-mindedness
 Mental Diseases: See also Children; Dementia Paralytica; Dementia Praecox; Feeble-mindedness; Insanity; Mental Hygiene; Neuroses and Psychoneuroses; Personality; Psychiatry; etc.
 abnormally large birth weights of psychiatric patients, *98
 electrocerebral shock therapy; reconsideration of former contraindications, *693
 electroconvulsive shock therapy and cardiovascular disease, 113
 electroencephalographic studies following electric shock therapy; observations on 51 patients treated with unidirectional current, *719
 electroshock therapy, 116
 electroshock therapy; technic and indications, 116
 glutamine and ammonia in spinal fluid of patients with nervous and mental disease, 239
 prefrontal lobotomy, 243
 Mental Hygiene; National Advisory Mental Health Council grants for training programs, 377
 Portland (Oregon) child guidance clinic, 485
 Mental Tests: See also Personality
 Cornell Service Index; method for quickly assaying personality and psychosomatic disturbances in men in armed forces, 490
 Cornell Service Index; report on its use in evaluation of psychiatric problems in naval hospital, 490
 review of psychologic work at Brain Injuries Unit, Edinburgh, 1941-1945, 390
 Rorschach test seminar, 377
 Merritt, H. H.: Parenchymatous cerebellar degeneration; report of 2 cases, 255
 Merzbacher-Pellizaeus Disease: See Encephalitis periaxialis diffusa
 Mesoderm and Mesodermal Tissues; histopathologic changes associated with human poliomyelitis, *565
 Metabolism: See under specific headings, as Brain; Creatine and Creatinine; etc.
 Metals: See Tantalum
 Poisoning: See under names of metals
 Metamorphosis: See Hallucinations
 Methyl Bromide poisoning; effects on nervous system, 250
 Mettler, F. A.: Static tremor with hemiplegia; report of case; development, progression for 7 years and postmortem histologic observations, *423
 Meyer, B. C.: Incidence of anisocoria and difference in size of palpebral fissures in 500 normal subjects, *464
 Micturition: See Urination
 Midbrain: See Brain
 Migraine, ophthalmoplegic, and theoretic explanation of its production; report of case, 255
 Military Medicine: See also Aviation and Aviators; Hospitals; Naval Medicine; Neuroses and Psychoneuroses; etc.
 abractions in military setting, *161
 anaerobic infection of brain, 244
 cerebral blast syndrome in combat soldiers, *14
 Cornell Service Index; method for quickly assaying personality and psychosomatic disturbances in men in armed forces, 490
 functional enuresis in army; report of clinical study of 100 cases, 491
 incidence of combat fatigue, *332
 Japanese B encephalitis; clinical observations in outbreak on Okinawa Shima, *430
 localized nontraumatic neuropathy in military personnel, *369
 neuropsychiatric services in European Theater of Operations, 767
 polyneuritis after jungle sores, 252
 psychiatric characteristics of patients with venereal disease, 125
 subacute emotional disturbances induced by combat, 491
 topographic distribution of lesions in central nervous system in Japanese B encephalitis; nature of lesions, with report of case on Okinawa, *673
 Mind, body and mind; psychosomatic aspects of stuttering, 488
 Diseases: See Dementia Praecox; Insanity; Mental Diseases; etc.
 Molholm, H. B.: Relation of mental imagery to hallucinations, *469
 Mongolism, causation of, 645
 Moore, M. T.: Electrocerebral shock therapy; reconsideration of former contraindications, *693
 Moriarty, J. D.: Electroencephalographic study of electric shock therapy; psychotic patients treated in United States Naval Hospital, *712
 Morons: See Feeble-mindedness
 Morris, A. A.: Malignant chordoma of lumbar region; report of case with autopsy; comment on unusual metastases to brain, lungs, pancreas, sacrum and axillary and iliac lymph nodes, *547
 Paramyoclonus multiplex (Friedreich); clinicotherapeutic study, *342
 Morton, G.: Mechanism of motion sickness, *58
 Morvan Syndrome: See Nervous System
 Mosquitoes: See Encephalitis; Malaria; etc.
 Mosse, E. P.: Electroshock and personality structure, 501
 Motion Sickness: See Aviation and Aviators; Movements
 Motoneurons: See Neurons
 Movements: See also Eyes, movements; Muscles
 measurements of pain sensitivity in patients with psychoneurosis, *321; correction, 660
 mechanism of motion sickness, *58
 tics and impulses in children; study of motility, 389
 Murder: See Crime and Criminals

- Murphey, F.: Schistosomiasis of brain due to *Schistosoma japonicum*; report of case, *199
- Murphy, J. P.: Congenital facial paralysis, *358
- Muscles, ameboid motion and secretion of motor end plates; experimental pathologic effects of traumatic shock on motor end plates in skeletal muscle, 385
- Atrophy: See Atrophy, muscular
- changes in human voluntary muscle in denervation and reinnervation (results of galvanism), 240
- chemical determination of tocopherols in liver and muscle; tocopherol in urine and feces, 238
- Dystrophy: See Dystrophy, muscular
- electromyographic studies in poliomyelitis, 239
- Fatigue: See Fatigue
- influence of galvanic stimulation on muscle atrophy resulting from denervation, 239
- Paralysis: See Paralysis
- physiology of botulinus toxin, *578
- Rigidity: See Rigidity
- Mutism: See Deaf-Mutism
- Myalgia: See Rheumatism
- Myasthenia Gravis, familial, 766
- Myatonia; amyotonia congenita (Oppenheim's disease); report of case with necropsy, 766
- Myelin: See Brain; Encephalitis periaxialis diffusa; Nerves; Nervous System; etc.
- Myelitis: See also Encephalomyelitis
- disseminated encephalomyelitis; report of 4 cases presenting manifestations of both neuromyelitis optica and albuminocytologic dissociation, 1 with necropsy findings, 638
- neuro-optic myelitis; clinicopathologic study of 2 related cases, 493
- Myelomalacia: See under Spinal Cord
- Myelopathy: See Spinal Cord
- Myers, H. J.: Abreaction in military setting, *161
- Myerson, A.: Circulation of brain and face; determinations of oxygen and sugar in arterial and in internal and external jugular venous blood, *94
- Myoclonus: See Paramyoclonus; Spasm; etc.
- Myogram: See Muscles
- Myositis: See Dermatomyositis
- Myotonia: See Dystrophy, muscular
- Narcoanalysis: See Anesthesia
- Narcolepsy: See Sleep
- Narcosis: See Anesthesia
- Narcotics: See under Anesthesia
- Naval Medicine: See also Hospitals; Military Medicine; etc.
- Cornell Service Index; report on its use in evaluation of psychiatric problems in naval hospital, 490
- electroencephalographic study of electric shock therapy; psychotic patients treated in United States Naval Hospital, *712
- repatriation; psychiatric study of 100 naval ex-prisoners of war, 761
- Neck; tumor in neck and in retropharyngeal space—neurofibroma, 497
- Nerves: See also Nervous System; Neuralgia; Neuritis; Paralysis
- ameboid motion and secretion of motor end plates; experimental pathologic effects of traumatic shock on motor end plates in skeletal muscle, 385
- Block: See Anesthesia
- Cells: See Neurons
- central course of afferent fibers for pain in facial glossopharyngeal and vagus nerves; clinical observations, *292
- changes in human voluntary muscle in denervation and reinnervation (results of galvanism), 240
- development of late gastrula explants of *Rana pipiens* in salt solution, 756
- developmental relationship between nervous and epithelial components of hypophysis, 756
- facial, neurinoma of, 109
- headache; teeth as source of headache and other pain, *277
- localized nontraumatic neuropathy in military personnel, *369
- Optic: See also Neuritis, optic
- Nerves—Continued
- optic; restoration of vision after crossings of optic nerves and after contralateral transplantation of eye, 757
- optic; significance of depth of physiologic cup of optic disk for mental ability, 389
- Paralysis: See Paralysis
- peripheral; electrical diagnosis of peripheral nerve injury, 637
- physiology of botulinus toxin, *578
- regeneration in cats on vitamin B₁-deficient diets, 758
- sensory-motor nerve crosses in rat, 487
- sensory; role of sensory fibers in differentiation of spinal cord in sheep, 756
- splanchnic; degree and nature of regeneration of splanchnic innervation to adrenal gland 2 years following complete bilateral sympathectomy in dogs, 757
- Nervous System: See also Brain; Cerebellum; Nerves; Neurons; Reflex; Spinal Cord; etc.
- Blocking: See Anesthesia
- carbonic anhydrase in, 759
- central, in acute disseminate lupus erythematosus, 248
- cholinesterases in sympathetic fibers and ganglia, 486
- depletions and abnormalities in cervical sympathetic system of chick following extirpation of neural crest, 633
- development of vascular pattern within walls of central nervous system of chick embryo, 633
- Diseases: See also Epilepsy; Mental Diseases; Neuritis; Neuroses and Psychoneuroses; etc.
- diseases; glutamine and ammonia in spinal fluid of patients with nervous and mental diseases, 239
- diseases; neurogenic arthropathy (Charcot joint) associated with diabetic neuropathy; report of 2 cases, *173
- diseases; topographic distribution of lesions in central nervous system in Japanese B encephalitis; nature of lesions, with report of case on Okinawa, *673
- dysfunction in adaptation to high altitude and as postflight reactions, 761
- effects of methyl bromide poisoning on, 250
- electroencephalographic and neurologic studies of homosexuals, 240
- histopathologic changes associated with human poliomyelitis, *565
- Japanese B encephalitis; clinical observations in outbreak on Okinawa Shima, *430
- metastases of uterine carcinoma to central nervous system; clinicopathologic study, *186
- Morvan's syndrome of uncertain cause (differentiation from syringomyelia); 2 cases, 394
- myelination of central nervous system of *Natrix sipedon*, 274
- roentgenologic and pathologic aspects of pulmonary tumors probably alveolar in origin, 249
- Surgery: See also Brain, surgery
- surgery; civilian advances and investigations in neurosurgery during war, 392
- Syphilis: See Neurosyphilis
- Tumors: See Neurinoma; Neurofibroma; Neurofibromatosis; etc.
- Nervousness: See Neuroses and Psychoneuroses
- Neuralgia; central course of afferent fibers for pain in facial glossopharyngeal and vagus nerves; clinical observations, *292
- Neurilemmoma in region of right axilla in case of Recklinghausen's disease; extirpation; recovery, 496
- Neurinoma of facial nerve, 109
- Neuritis, bilateral acoustic, 251
- multiple; ingravescant neuritis with recovery, 497
- multiple; polyneuritis after jungle sores, 252
- multiple; polyneuritis following sulfanilamide therapy, 111
- optic; disseminated encephalomyelitis; report of 4 cases presenting manifestations of both neuromyelitis optica and albuminocytologic dissociation, 1 with necropsy findings, 638

- Neuritis—Continued
 optic; malarial papillitis, 641
 optic; neuro-optic myelitis; clinicopathologic study of 2 related cases, 493
- Neurofibroma of cauda equina, 252
 tumor in neck and in retropharyngeal space, 497
- Neurofibromatosis; neurilemma in region of right axilla in case of Recklinghausen's disease; extirpation; recovery, 496
- Neurohypophysis: See Pituitary Body
- Neurology: See also Nerves; Nervous System; Neuropsychiatry; Neuroses and Psychoneuroses; etc.
 American Board of Psychiatry and Neurology, 234
 course in neurology and psychiatry, Illinois Neuropsychiatric Institute, 134
 residences in, Veterans Administration, 237
- Neuromyelitis Optica: See Myelitis; Neuritis, optic
- Neuronitis: See Neuritis, multiple
- Neurons; histopathologic changes associated with human poliomyelitis, *565
 loss of axis-cylinders in sclerotic plaques and similar lesions, *661
- Neuropathy: See under Nerves
- Neuropsychiatry: See also Military Medicine; Neurology; Psychiatry; War; etc.
 neuropsychiatric complications following spinal anesthesia, 107
 neuropsychiatric services in European Theater of Operations, 767
 residency in, Southwestern Medical Foundation and Veterans Administration, 237
- Neuroses and Psychoneuroses: See also Mental Diseases; Nervous System, diseases; etc.
 abreaction in military setting, *161
 camptocormia; functional condition of back in neurotic soldier, 491
 clinical aspects of depression, 240
 Cornell Service Index; method for quickly assaying personality and psychosomatic disturbances in men in armed forces, 490
 Cornell Service Index; report on its use in evaluation of psychiatric problems in naval hospital, 490
 electroencephalogram and personality organization in obsessive-compulsive reactions, *71
 electroencephalographic study of electric shock therapy; psychotic patients treated in United States Naval Hospital, *712
 healing mechanisms in shock treated neurotic patient, 489
 hostile dependent behavior factor in rehabilitation of veterans with psychoneuroses and of industrially injured with psychologically protracted convalescence, 777
 incidence of combat fatigue, *332
 measurements of pain sensitivity in patients with psychoneurosis, *321; correction, 660
 pathologic weeping, 489
 results of hospital treatment, including electric shock, of psychoneurotic patients, 504
 results of treatment of psychoneuroses by general practitioner; follow-up study of 500 patients, 504
 symposium on therapy of psychoneuroses, 503
- Neurosurgery: See Brain, surgery; Nervous System, surgery
- Neurosyphilis: See also Dementia Paralytica; Tabes Dorsalis
 penicillin in treatment of syphilis, 763
 penicillin treatment; preliminary report of 70 cases followed from 4 to 12 months, 112
 public health aspect of malaria therapy of, 113
 transfer of penicillin into spinal fluid following parenteral administration, 634
 value of penicillin in treatment, 270
- Nissl Granules: See Neurons
- Norcross, J. W.: Japanese B encephalitis; clinical observations in outbreak on Okinawa Shima, *430
- Nose, Inflammation: See Rhinitis
- Nucleus Dentatus: See under Cerebellum
 Lateralis Medullae: See Medulla Oblongata
 Pulposus: See Spine, Intervertebral disks
- Nutrition: See Dystrophy; Vitamins
- Nycturia: See Urination, incontinence
- Nystagmus: See also Cerebellum; Ear, internal
 labyrinthine, effect of cortical lesions on, 655
 labyrinthine, effect of lesions of optic tract and of midbrain on, 654
- Oberndorf, C. P.: Elements in psychotherapy, 503
- OBITUARIES:
 Allen, Charles Lewis, 102
 Ariëns Kappers, C. U., 104
 Belling, Christopher Charles, 233
 Burdenko, Nikolai Nilovich, 231
 Shelden, Walter De Witt, 228
- Obsessions: See also Dementia Precox; Neuroses and Psychoneuroses
 electroencephalogram and personality organization in obsessive-compulsive reactions, *71
- Occipital Bone; basilar impression; position of normal odontoid, 106
- Occupations: See Industry and Occupations
- Odontoid Process: See Atlas and Axis
- Oligodendroglioma, meningeal gliomatosis; study of 42 cases, *602
- Oligophrenia: See Feeble-mindedness
- Olivary Body: See Medulla Oblongata
- Ophthalmoplegia: See Eyes, paralysis
- Oppenheim's Disease: See Myatonia
- Optic Disk: See Nerves, optic
 Choked: See Neuritis, optic
- Optic Papilla: See Nerves, optic
- Optic Pathway: See also Brain; Nerves, optic; Thalamus
 effect of lesions of optic tract and of midbrain on labyrinthine nystagmus, 654
 Thalamus: See Thalamus
- Osteoma; pathology of cranial tumors; osteomas of skull, with incidental mention of their occurrence in ancient Incas, 644
- Oxygen: See also Respiration
 changes in brain potentials during convulsions induced by oxygen under pressure, 486
 deficiency; cerebral anoxia from high altitude asphyxiation; clinicopathologic study of 2 fatal cases with unusually long survival and clinical report of nonfatal case, *397
 volume flow of blood through human brain, *137
- Pain: See also Sensation
 headache; teeth as source of headache and other pain, *277
 measurements of pain sensitivity in patients with psychoneurosis, *321; correction, 660
 subarachnoid alcohol injections for treatment of pain accompanying pelvic neoplasms, 643
- Palsy: See Paralysis
- Pancreas; malignant chordoma of lumbar region; report of case with autopsy; comment on unusual metastases to brain, lungs, pancreas, sacrum and axillary and iliac lymph nodes, *547
- Papilledema: See Neuritis, optic
- Papillitis: See Neuritis, optic
- Paralysis: See also Extremities, paralysis; Eyes, paralysis; Hemiplegia; Poliomyelitis
 abducens; sixth nerve paralysis after spinal analgesia, 395
 abducens (with subsequent recovery) following lumbar puncture, 495
 Bell's: See Paralysis, facial
 facial, congenital, *358
 facial, in closed head injuries; prognosis, 110
 facial; neurinoma of facial nerve, 109
 facial, unilateral; correction with tantalum wire, 642
 General: See Dementia Paralytica
 Infantile: See Poliomyelitis
 neurologic complications following use of typhoid vaccine, 248
 Periodic: See Extremities, paralysis

- Paralysis—Continued
 peroneal, as complication of parturition, 110
 spinal; different forms of diffuse sclerotic process—Pelizaeus-Merzbacher disease, Strümpell's familial spastic spinal paralysis, leukodystrophy—in 1 family, 392
 therapy; changes in human voluntary muscle in denervation and reinnervation (results of galvanism), 240
- Paramyoclonus multiplex, 387
 multiplex (Friedreich); clinicotherapeutic study, 342
- Paranoia: See Dementia Praecox
- Paraplegia: See Extremities, paralysis; Paralysis, spinal
- Paresis: See Dementia Paralytica
- Parietal Lobe: See Brain
- Parkinsonism: See also Encephalitis
 parkinsonian-like tremor and cogwheel rigidity in child secondary to massive ependymoma of frontal lobe and caudate nucleus; prefrontal lobectomy, with cessation of tremor and rigidity, 649
- Parturition: See Labor
- Patch Test: See Anaphylaxis and Allergy
- Pelizaeus-Merzbacher Disease: See Encephalitis periaxialis diffusa
- Pelvis; subarachnoid alcohol injections for treatment of pain accompanying pelvic neoplasms, 643
- Penfield, W.: Medulloblastoma of cerebellum, with survival for 17 years, *481
 Nikolai Nilovich Burdenko, 231
- Penicillin; meningitis due to penicillin and sulfonamide-sensitive Pittman B strain of *H. influenzae*; recovery, 391
 Therapy: See Dementia Paralytica; Meningitis; Neurosyphilis; etc.
 transfer into spinal fluid following parenteral administration, 634
- Pentothal: See Anesthesia, spinal
- Peptic Ulcer; pituitary adenoma associated with chronic duodenal ulcer, 395
 relation of acute mucosal hemorrhages and ulcers of gastrointestinal tract to intracranial lesions, *145
- Perception: See Sensation; etc.
- Periodicals; Paul B. Hoeber, Inc., publishers of Psychosomatic Medicine, 485
- Periphelebitis, retinal, associated with paraplegia, *351
- Personality, changes after cerebrospinal fever, 393
 electroencephalogram and personality organization in obsessive-compulsive reactions, *71
 psychopathic, definition of, 488
 psychopathic, shock treatment in, 253
 structure and electroshock, 501
 use of benzedrine sulfate by psychopaths, 254
- Phantasy: See Imagination
- Phobias: See Neuroses and Psychoneuroses
- Phonation: See Speech
- Pia Mater; gas bubbles in pial vessels of cats following rapid decompression from high pressure atmospheres, 758
- Picrotoxin: See Barbitol and Barbitol Derivatives
- Pinealoma; meningeal gliomatosis; study of 42 cases, *609
- Pitressin: See Pituitary Preparations
- Pituitary Body, adenoma associated with chronic duodenal ulcer, 395
 developmental relationship between nervous and epithelial components of hypophysis, 756
 tumors, creatine metabolism in relation to, 487
- Pituitary Preparations; effects of pitressin hydration in electroencephalogram; paroxysmal slow activity in nonepileptic patients with previous drug addiction, *78
 electroencephalogram in pitressin hydration test for epilepsy, *211
- Plasma: See Blood
- Plasmodium Vivax: See Malaria
- Platybasia: See Atlas and Axis; Occipital Bone
- Pneumatocoele: See Pneumocephalus
- Pneumocephalus; pneumatocoele due to frontal trauma, 641
 traumatic, 494
- Pneumoencephalography: See Brain, roentgenography
- Pneumography: See Brain, roentgenography
- Poisons and Poisoning: See under names of various substances, as Barbitol and Barbitol Derivatives; Methyl Bromide; etc.
- Polioencephalitis: See Encephalitis
- Polioencephalomyelitis: See Encephalomyelitis
- Poliomyelitis: See also Encephalomyelitis
 electromyographic studies in, 239
 experimental nonparalytic; frequency and range of pathologic involvement, 238
 human, histopathologic changes associated with, *565
 origin of epidemic, 496
 preparalytic; treatment with gamma globulin, 496
 transmission by patient to patient contact, 495
- Polmeteer, F. E.: Meningeal gliomatosis; study of 42 cases, *593
- Polynuritis: See Neuritis, multiple
- Polyradiculoneuritis: See Guillain-Barré Syndrome
- Pool, J. L.: Factors causing mass spasms after transection in cord in man; reexamination, 261
- Position: See Posture
- Posture; arsenical encephalopathy (with emphasis on postural treatment), 393
 electroconvulsive therapy in prone position, 254
- Potassium; physiochemical mechanisms in experimental epilepsy, 384
- Pregnancy: See also Labor; etc.
 abnormally large birth weights of psychiatric patients, *98
- Pringle's Disease: See Sclerosis, tuberculous
- Prisons and Prisoners; repatriation; psychiatric study of 100 naval ex-prisoners of war, 761
- Procaine: See Anesthesia, spinal
- Proteins in Blood: See Blood, proteins
- Psychiatry: See also Insanity; Jurisprudence, Medical; Mental Diseases; Neuropsychiatry; Psychoanalysis; Psychotherapy; War; etc.
 American Board of Psychiatry and Neurology, 234
 course in neurology and psychiatry, Illinois Neuropsychiatric Institute, 134
 forensic, orientation to, *730
 psychiatric characteristics of patients with venereal disease, 125
 residency in, Veterans Administration hospital in New Orleans, 779
 repatriation; psychiatric study of 100 naval ex-prisoners of war, 761
 training program for psychiatrists, 779
- Psychoanalysis: See also Psychotherapy
 affects, personal and social, 760
 clinical aspects of depression, 241
 electroshock and personality structure, 501
 pathologic weeping, 489
 psychiatric aspects of shoplifting, 777
 ties and impulses in children; study of motility, 389
- Psychobiology: See Mind, body and mind
- Psychology: See also Mental Tests; Personality; War; etc.
 affects, personal and social, 760
- Psychoneuroses: See Neuroses and Psychoneuroses
- Psychoses: See Insanity; Mental Diseases; Neuroses and Psychoneuroses; etc.
- Psychosomatic Medicine: See Periodicals
- Psychosurgery: See Brain, surgery
- Psychotherapy: See also Psychoanalysis
 delayed favorable effects in, 388
 elements in, 503
- Public Health aspect of malaria therapy of neurosyphilis, 113
- Pupils; impairment of pupillary reactions during accommodation superimposed on Argyll Robertson pupils associated with tabes during acute anemia, 763
 incidence of anisocoria and difference in size of palpebral fissure in 500 normal subjects, *464
- Putnam, T. J.: Loss of axis-cylinders in sclerotic plaques and similar lesions, *661
 Relation between electroencephalographic and histologic changes following application of graded force to cortex, *521

- Putnam, T J—Continued
Results of treatment of multiple sclerosis with dicoumarin, *1
Treatment of spasmodic torticollis, report of 2 cases, 260
- Rabinovitch, R Malignant chordoma of lumbar region; report of case with autopsy, comment on unusual metastases to brain, lungs pancreas, sacrum and axillary and iliac lymph nodes, *547
- Races See also Indians, American, etc
vs environment, environment as etiologic factor in psychiatric disturbances in infancy, 120
- Radiculoneuritis See Guillain-Barre Syndrome
- Read, Charles F, memorial, 777
- Recklinghausen's Disease. See Neurofibromatosis
- Reconditioning See Rehabilitation
- Recruits See Military Medicine
- Redlich, F C Electroencephalogram in pitressin hydration test for epilepsv, *211
- Reflex, conditioned, treatment of alcoholism, 514
factors causing mass spasms after transection in cord in man, reexamination, 261
- Rehabilitation See also Hospitals, Military Medicine, Neuroses and Psychoneuroses; etc
hostile dependent behavior factor in rehabilitation of veterans with psychoneuroses and of industrially injured with psychologically protracted convalescence, 777
- Repatriation, psychiatric study of 100 naval ex-prisoners of war, 761
- Residencies See Internship
- Respiration, relation between effects of blood sugar levels and hyperventilation on electroencephalogram 384
volume flow of blood through human brain, *137
- Restiform Body See Medulla Oblongata
- Retina, blood supply, experimental study of relation between pressure of retinal arteries and intracranial pressure, 106
retinal periphlebitis associated with paraplegia, *351
- Retinoblastoma, meningeal glomatosis, study of 42 cases, *608
- Rheumatism, syndrome of physical or intrinsic allergy of head vasomotor rhinitis and vasodilating pain syndrome, their relationship to myalgia and endolymphatic hydrops (Meniere's disease), 641
- Rhinitis syndrome of physical or intrinsic allergy of head, vasomotor rhinitis and vasodilating pain syndrome, their relationship to myalgia and endolymphatic hydrops (Meniere's disease), 641
- Riggs H Case for diagnosis, 128
- Rigidity, abdominal, symptom of concussion of spinal cord, *220
parkinsonian-like tremor and cogwheel rigidity in child secondary to massive ependymoma of frontal lobe and caudate nucleus, prefrontal lobectomy, with cessation of tremor and rigidity, 649
- Robertson, S Headache, teeth as source of headache and other pain, *277
- Rockwell, F V Electroencephalogram and personality organization in obsessive-compulsive reactions, *71
- Roentgen Rays, Therapy See under names of organs, regions and diseases
- Rorschach Test See Mental Tests, Personality
- Rosen, H Abreaction in military setting, *161
- Rupp, C, Jr Case for diagnosis, 128
- Sabin, A B Topographic distribution of lesions in central nervous system in Japanese B encephalitis; nature of lesions, with report of case on Okinawa, *673
- Sacrum, malignant chordoma of lumbar region, report of case with autopsy, comment on unusual metastases to brain, lungs, pancreas, sacrum and axillary and iliac lymph nodes, *547
- Sailors See Naval Medicine, etc
- Savitsky, N Cogwheel phenomenon of eyes, its clinical significance, *362
- Scala, N P Effect of lesions of optic tract and of midbrain on labyrinthine nystagmus 654
- Scarff J E Factors causing mass spasms after transection in cord in man, reexamination, 261
- Scheinkei, I M Histopathologic changes associated with human poliomyelitis, *565
- Schick Test See Diphtheria
- Schilder-Flatau's Disease See Encephalitis perivascularis diffusa
- Schistosomiasis of brain due to *Schistosoma japonicum*, report of case, *199
- Schizophrenia See Dementia Praecox
- Schlesinger, B Brain tumor, 2 cases, 263
- Sclerosis, loss of axis cylinders in sclerotic plaques and similar lesions, *661
multiple, results of treatment with dicoumarin, *1
tuberous, familial, with calcification, 641
- Scott, M Parkinsonian-like tremor and cogwheel rigidity in child secondary to massive ependymoma of frontal lobe and caudate nucleus, prefrontal lobectomy, with cessation of tremor and rigidity, 649
- Scribner, W E Bilateral and multiple ruptured disk as cause of persistent symptoms following operation for herniated disk, 499
- Seitz P F D Relation of mental imagery to hallucinations, *469
- Selverstone, B Bilateral and multiple ruptured disk as cause of persistent symptoms following operation for herniated disk, 499
- Semicircular Canals See Ear, internal
- Sensation See Nerves, sensory, Pain, etc
symptom of "electrical discharge" in brain injuries, 639
- Serum See Blood
Immune See Encephalomyelitis
Sickness See Anaphylaxis and Allergy
- Sex, perversion, electroencephalographic and neurologic studies of homosexuals, 240
- Shenkin, H A Cerebellar medulloblastoma in adults, *417
- Shock, ameboid motion and secretion of motor end plates, experimental pathologic effects of traumatic shock on motor end plates in skeletal muscle, 385
Electric See Dementia Praecox, Electricity, Electrotherapy, Epilepsy, Insanity, Mental Diseases, etc
Emotional See Emotions
- Shoplifting, psychiatric aspects of, 777
- Siemens, J C Electroencephalographic study of electric shock therapy, psychotic patients treated in United States Naval Hospital, *712
- Silfverskiold, B P Retinal periphlebitis associated with paraplegia, *351
- Simons, D J Electroencephalogram and personality organization in obsessive-compulsive reactions, *71
- Skin See Sensation
- Skull See Cranium
- Sleep, objective method for distinguishing sleep from hypnotic trance, *84
- Sleeping Sickness See Encephalitis
- Societies, American Society of Electroencephalography, 660
appointment of national director, American Epilepsy League, Inc, 378
Kansas Psychiatric Society, 779
New York Society of Neurosurgery, 237
- SOCIETY TRANSACTIONS
- Boston Society of Psychiatry and Neurology, 767
- Illinois Psychiatric Society, 777
- New York Neurological Society, 263
- New York Neurological Society and New York Academy of Medicine, Section of Neurology and Psychiatry, 255, 499
- New York Neurological Society and New York Academy of Medicine, Section of Neurology and Psychiatry and Section of Pediatrics, 118
- Philadelphia Neurological Society, 128, 646
- Philadelphia Psychiatric Society, 125, 513
- Sodium Diphenylhydantoinate. See Diphenylhydantoin
- Soldiers. See Military Medicine, Neuroses and Psychoneuroses, etc

- Solomon, A. P.: Incidence of combat fatigue, *332
 Hostile dependent behavior factor in rehabilitation of veterans with psychoneuroses and of industrially injured with psychologically protracted convalescence, 777
 Somnolence: See Sleep
 Sorem, M. B.: Japanese B encephalitis; clinical observations in outbreak on Okinawa Shima, *430
 Southwestern Medical Foundation and Veterans Administration, residency in neuropsychiatry, 237
 Spasm: See also Convulsions; Epilepsy; Tic; etc.
 electromyographic studies in poliomyelitis, 239
 factors causing mass spasms after transection in cord in man; reexamination, 261
 Speech; psychosomatic aspects of stuttering, 488
 remedial procedures for handling aphasic patients, 646
 Spiegel, E. A.: Effect of cortical lesions on labyrinthine nystagmus, 655
 Effect of lesions of optic tract and of mid-brain on labyrinthine nystagmus, 654
 Spinal Cord: See also Meninges; Nervous System; etc.
 abdominal rigidity; symptom of concussion of, *220
 concussion; report of cases with radiculoneuritic manifestations, *623
 cord bladder; restoration of function by transurethral operation, 108
 experimental tuberculosis in rabbit, 639
 factors causing mass spasms after transection in cord in man; reexamination, 261
 gunshot wounds of maxillofacial region with spinal complications, 107
 hemorrhage; traumatic hematomyelia with unusual features, 266
 Inflammation: See Myelitis
 neurofibroma of cauda equina, 252
 parkinsonian-like tremor and cogwheel rigidity in child secondary to massive ependymoma of frontal lobe and caudate nucleus; prefrontal lobectomy, with cessation of tremor and rigidity, 649
 role of sensory fibers in differentiation of spinal cord in sheep, 756
 transurethral resection of vesical neck in management of cord bladder, 642
 Spinal Fluid: See Cerebrospinal Fluid
 Spinal Puncture: See also Cerebrospinal Fluid
 abducens palsy (with subsequent recovery) following, 495
 acute spinal epidural abscess as complication of, 108
 Spine: See also Atlas and Axis; Sacrum
 acute spinal epidural abscess as complication of lumbar puncture, 108
 intervertebral disk; bilateral and multiple ruptured disk as cause of persistent symptoms following operation for ruptured disk, 499
 intervertebral disk, massive extrusion of, 394
 malignant chordoma of lumbar region; report of case with autopsy; comment on unusual metastases to brain, lungs, pancreas, sacrum and axillary and iliac lymph nodes, *547
 Spitz, E. B.: Cerebellar medulloblastoma in adults, *417
 Spitz, R. A.: Environment vs. race; environment as etiologic factor in psychiatric disturbances in infancy, 120
 Stains and Staining; loss of axis-cylinders in sclerotic plaques and similar lesions, *661
 Status Epilepticus: See under Epilepsy
 Steinert's Disease: See Dystrophy, muscular
 Still, W. C.: Electroencephalographic study of Helen Keller, *629
 Stimulation; headache; teeth as source of headache and other pain, *277
 Stomach, Ulcers: See Peptic Ulcer
 Stools: See Feces
 Strassmann, G. S.: Relation of acute mucosal hemorrhages and ulcers of gastrointestinal tract to intracranial lesions, *145
 Strümpell's Disease: See Paralysis, spinal
 Sturge-Weber Disease: See Angioma
 Stuttering: See under Speech
 Subarachnoid Space: See Meninges
 Subdural Spaces: See Meninges
 Sugar in Blood: See Blood sugar
 Sulfadiazine: See Meningitis
 Sulfamerazine: See Meningitis
 Sulfonamides; meningitis due to penicillin and sulfonamide sensitive Pittman B strain of *H. influenzae*; recovery, 391
 polyneuritis following sulfanilamide therapy, 111
 Therapy: See Meningitis; etc.
 Suprarenals: See Adrenals
 Surgery: See also Apparatus; and under organs and regions, as Brain, surgery; Nervous System; Spinal Cord; etc.
 new absorbable material for use in neurologic and general surgery, 759
 Sympathectomy; degree and nature of regeneration of splanchnic innervation to adrenal gland 2 years following complete bilateral sympathectomy in dogs, 757
 Symposium on therapy of psychoneuroses, 503
 Syphills: See also Neurosyphilis; Venereal Diseases; and under names of organs and regions
 penicillin in treatment, 763
 syphilitic hepatitis and general paresis (dementia paralytica) occurring simultaneously, 392
 Syringomyelia; Morvan's syndrome of uncertain cause (differentiation from syringomyelia); 2 cases, 394
 Tabes Dorsalis: See also Neurosyphilis
 impairment of pupillary reactions during accommodation superimposed on Argyll Robertson pupils associated with tabes during acute anemia, 763
 neurogenic arthropathy (Charcot joint) associated with diabetic neuropathy; report of 2 cases, *173
 Tantalum; unilateral facial paralysis; correction with tantalum wire, 642
 Taylor, H. G.: Japanese B encephalitis; clinical observations in outbreak on Okinawa Shima, *430
 Teeth as source of headache and other pain, *277
 Thalamus, tumor; static tremor with hemiplegia; report of case; development, progression for 7 years and postmortem histologic observations, *423
 Thiamine; nerve regeneration in cats on vitamin B₁-deficient diets, 758
 Thompson, L. J.: Neuropsychiatric services in European Theater of Operations, 767
 Thromboangiitis obliterans; diagnosis and surgical therapy of cerebral manifestations of Winwarther-Buerger disease, 762
 Thrombosis: See also Embolism
 results of treatment of multiple sclerosis with dicoumarin, *1
 Thyroid, hyperthyroidism, disturbances in ocular motility associated with, 498
 Thyrotoxicosis: See Thyroid, hyperthyroidism
 Tic: See also Spasm
 and impulses in children; study of motility, 389
 Ticks: See Encephalitis
 Tissue: See Cells
 Staining: See Stains and Staining
 Titrud, L. A.: Cerebral anoxia from high altitude asphyxiation; clinicopathologic study of 2 fatal cases with unusually long survival and clinical report of nonfatal case, *397
 Tocopherol: See Vitamins, E
 Torticollis, spasmodic, treatment of; report of 2 cases, 260
 Torulosis; roentgenologic and pathologic aspects of pulmonary tumors probably alveolar in origin, 249
 Toxicomania: See Drugs, addiction
 Tractotomy: See Medulla Oblongata
 Tractus Solitarius: See Medulla Oblongata
 Transference: See Psychoanalysis
 Transplantation: See Nerves
 Trauma: See also under Brain; Cranium; Head; Spinal Cord; etc.
 relation between electroencephalographic and histologic changes following application of graded force to cortex, *521
 traumatic pneumocephalus, 494

- Tremor:** See also Parkinsonism
parkinsonian-like tremor and cogwheel rigidity in child secondary to massive ependymoma of frontal lobe and caudate nucleus; prefrontal lobectomy, with cessation of tremor and rigidity, 649
static, with hemiplegia; report of case; development, progression for 7 years and postmortem histologic observations, *423
- Tridione:** See Epilepsy
- Tuberculoma of cerebrum;** operation and survival for 3 years, 762
- Tuberculosis:** See under names of organs, regions and diseases, as Spinal Cord; etc.
- Tumors:** See Adenoma; Angioma; Chordoma; Glioma; Medulloblastoma; Neurinoma; Neurofibroma; Osteoma; and under names of organs and regions, as Brain; Cranium; Lungs; Pituitary Body; Spinal Cord; etc.
- Twins;** heredity in functional psychoses, 760
interpretation of divergent outcome of schizophrenia in identical twins, 241
relation between maturation and acculturation, 118
- Twitchell-Allen, D.:** Educability of "deteriorated" epileptic patient, *617
- Typhoid vaccine,** neurologic complications following use of, 248
- Ulcers, Peptic:** See Peptic Ulcer
tropical; polyneuritis after jungle sores, 252
- Unconscious:** See Psychoanalysis
- Urination, incontinence;** functional enuresis in army; report of clinical study of 100 cases, 491
- Urine:** See also Urination
chemical determination of tocopherols in liver and muscle; tocopherol in urine and feces, 238
creatinine metabolism in relation to pituitary tumors, 487
- Uterus:** See also Pelvis
causation of mongolism, 645
metastases of uterine carcinoma to central nervous system; clinicopathologic study, *186
- Vasomotor System:** See also Nervous System; etc.
Ménière's disease, 251
syndrome of physical or intrinsic allergy of head; vasomotor rhinitis and vasodilating pain syndrome; their relationship to myalgia and endolymphatic hydrops (Ménière's disease), 641
- Veins:** See Embolism; Thrombosis; Vasomotor System
Pressure in: See Blood pressure
- Veneral Diseases:** See also Neurosyphilis; Syphilis; etc.
psychiatric characteristics of patients with, 125
- Ventriculography:** See under Brain
- Vertebrae:** See Spine
- Vertigo, aural;** Ménière's disease, 251
aural; Ménière's disease in deaf-mute, 109
aural; syndrome of physical or intrinsic allergy of head; vasomotor rhinitis and vasodilating pain syndrome; their relationship to myalgia and endolymphatic hydrops (Ménière's disease), 641
- Vestibular Apparatus:** See Ear
Nuclei: See Medulla Oblongata
- Veterans:** hostile dependent behavior factor in rehabilitation of veterans with psychoneuroses and of industrially injured with psychologically protracted convalescence, 777
- Veterans Administration and Southwestern Medical Foundation,** residency in neuropsychiatry, 237
residencies in neurology, 237
- Virus:** See Encephalitis; Poliomyelitis; etc.
- Vision:** See also Blindness
restoration after crossings of optic nerves and after contralateral transplantation of eye, 757
- Vitamins, E;** chemical determination of tocopherols in liver and muscle; tocopherol in urine and feces, 238
dystrophia myotonica (Steinert's disease); importance of cataract and disturbances of metabolism; therapeutic effect of vitamin E, 117
progressive nuclear ophthalmoplegia, possibly on basis of vitamin deficiency; report of case, 258
- Vitreous Humor, hemorrhage;** retinal periphlebitis associated with paraplegia, *351
- Voegtlin, W. L.:** Conditioned reflex treatment of alcoholism, 514
- Wall, J. H.:** Results of hospital treatment, including electric shock, of psychoneurotic patients, 504
- War:** See also Aviation and Aviators; Hospitals; Military Medicine; Naval Medicine; Veterans; Wounds; etc.
repatriation; psychiatric study of 100 naval ex-prisoners of war, 761
subacute emotional disturbances induced by combat, 491
- Warner, F. J.:** Myelination of central nervous system of *Natrix sipedon*, 274
- Water;** electroencephalogram in pitressin hydration test for epilepsy, *211
- Watson, C. W.:** Schistosomiasis of brain due to *Schistosoma japonicum*; report of case, *199
- Watts, J. W.:** Psychosurgery: 1936-1946, 770
- Weber-Sturge Syndrome:** See Angioma
- Weeping, pathologic,** 489
- Weight:** See Body, weight
- Well, A. A.:** Electroencephalographic studies following electric shock therapy; observations on 51 patients treated with unidirectional current, *719
- Weinstein, E. A.:** Localized nontraumatic neuropathy in military personnel, *369
- Weitzner, H. G.:** Results of treatment of multiple sclerosis with dicoumarin, *1
- Wikler, A.:** Effects of pitressin hydration on electroencephalogram; paroxysmal slow activity in nonepileptic patients with previous drug addiction, *78
- Willis, Circle of:** See Aneurysm; Brain
- Wills;** orientation to forensic psychiatry, *730
- Wilson's Disease:** See Lenticular Nucleus, degeneration
- Winiwarter-Buerger Disease:** See Thromboangiitis obliterans
- Winkelman, N. W.:** Cogwheel phenomenon of eyes; its clinical significance, *362
- Wolf, K. M.:** Environment vs. race; environment as etiologic factor in psychiatric disturbances in infancy, 120
- Wolf, H. G.:** Headache; teeth as source of headache and other pain, *277
- Woltman, H. W.:** Walter DeWitt Sheldon, 228
- Word Blindness:** See Aphasia
- Wounds:** See also Military Medicine; Naval Medicine; War
gunshot, of maxillofacial region with spinal complications, 107
- Wry-Neck:** See Torticollis
- Wycis, H. T.:** Effect of cortical lesions on labyrinthine nystagmus, 655
- Zimmerman, F. T.:** Relation between electroencephalographic and histologic changes following application of graded force to cortex, *521

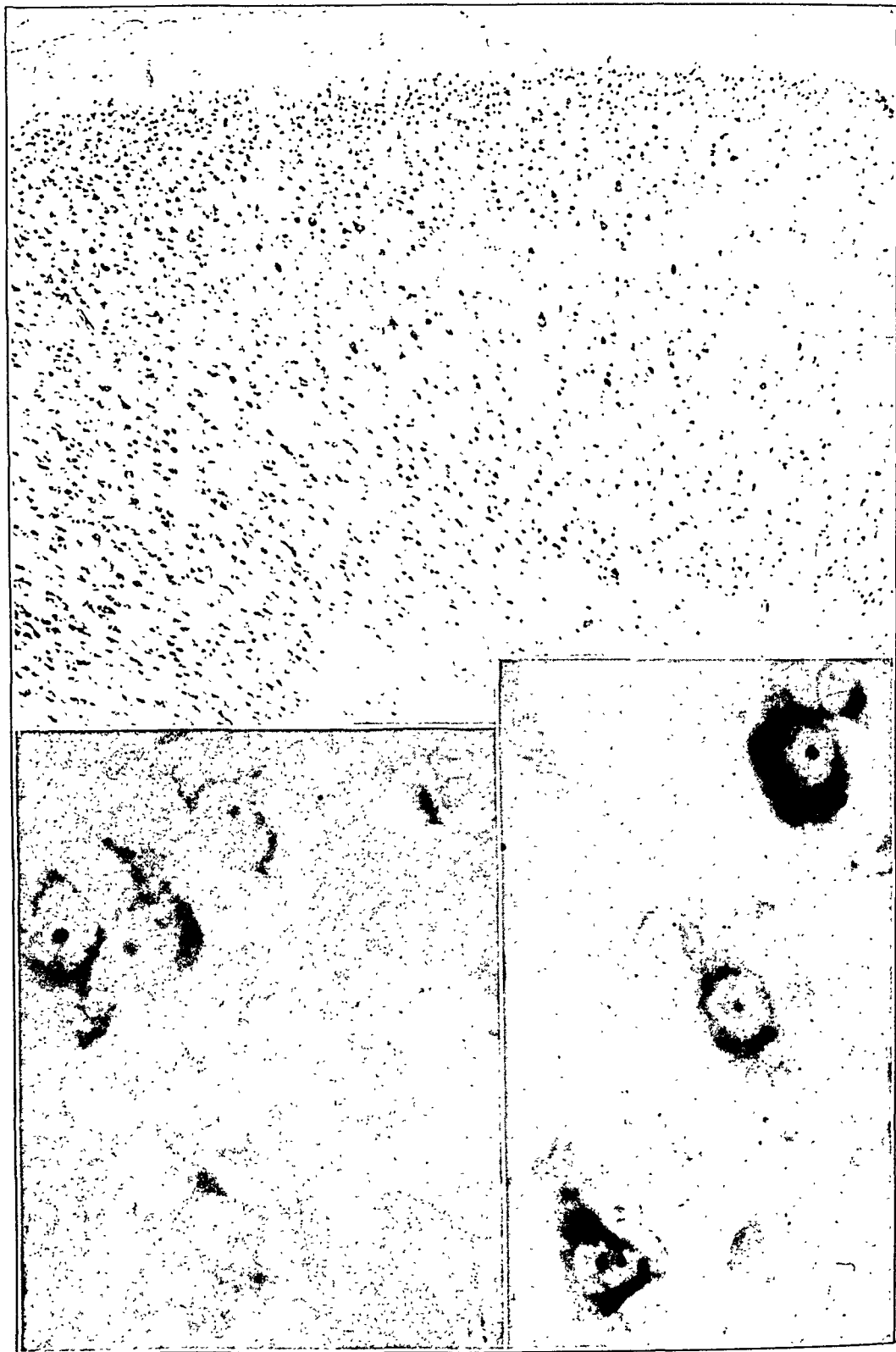

Figure 9

(See legend on opposite page)

the fluid balance in the cerebral tissues. Scagliosi³ studied the histologic effect of striking a series of animals on the head with a hammer and observed that after twenty-four hours the cell had lost its granular substance and assumed a pale blue, homogeneous appearance. Büdinger⁴ also noted a tendency of the cells to lose their staining capacity. Jakob⁵ observed eccentricity of the nucleus in the cells of the cerebral cortex, swelling and early chromatolysis. Windle, Groat and Fox⁶ produced concussion by striking the movable head of the guinea pig and demonstrated that the Nissl bodies were disorganized, some being fragmented and others agglutinated, and that the normal pattern and arrangement of such bodies were significantly changed. Rand and Courville² stated that "the shocking effect of the injury appears to be responsible for loss of the tigroid substance from the cell . . . ; [and] shrinkage of the nucleus, with the assumption of an irregular shape and the formation of folds in the nuclear membrane." These authors concluded that the cell changes may be general, as a result of the shock of the traumatizing force, or consequent to the general edema, with vacuolation, and emphasized the alterations directly resulting from focal injuries to the cortex.

Cellular changes designated as moderate damage are shown in figure 10. Under low magnification (upper figure) the traumatized area is not so sharply delineated from the surrounding cortical tissue.

3. Scagliosi, G.: Ueber die Gehirnerschütterung und die daraus im Gehirn und Rückenmark hervorgerufen histologische Veränderungen, *Virchows Arch. f. path. Anat.* **152**:487, 1898.

4. Büdinger, K.: Ein Beitrag zu der Lehre von der Gehirnerschütterung, *Deutsche Ztschr. f. Chir.* **41**:433, 1895.

5. Jakob, A.: Experimentelle Untersuchungen über die traumatischen Schädigungen des Zentralnervensystems (mit besonderer Berücksichtigung der *Commotio cerebri* und *Kommutationsneurose*), in Nissl, A., and Alzheimer, F.: *Histologie und Histopathologie Arbeiten über die Grosshirnrinde, mit besonderer Berücksichtigung der pathologischen Anatomie der Geisteskrankheiten*, Jena, G. Fischer, 1913, vol. 5.

6. Windle, W. F.; Groat, R. A., and Fox, C. A.: *Experimental Structural Alterations in the Brain During and After Concussion*, *Surg., Gynec. & Obst.* **79**: 561, 1944.

Fig. 9.—Severe cortical cell change.

Upper figure (magnification, 60), uniform cell pallor involving all cortical layers. The photograph was taken slightly to the left of the traumatized area to show the mushrooming extension of the lesion.

Lower left figure (magnification, 560), cells from the second cortical layer, showing swelling, "chewed-out" appearance of the margins and segmentation. The cell in the center of the lower margin, in addition, shows enlargement of the pericellular space.

Lower right figure (magnification, 560), eccentricity of the nucleus of a pyramidal cell.