

Historic, archived document

Do not assume content reflects current scientific knowledge, policies, or practices.

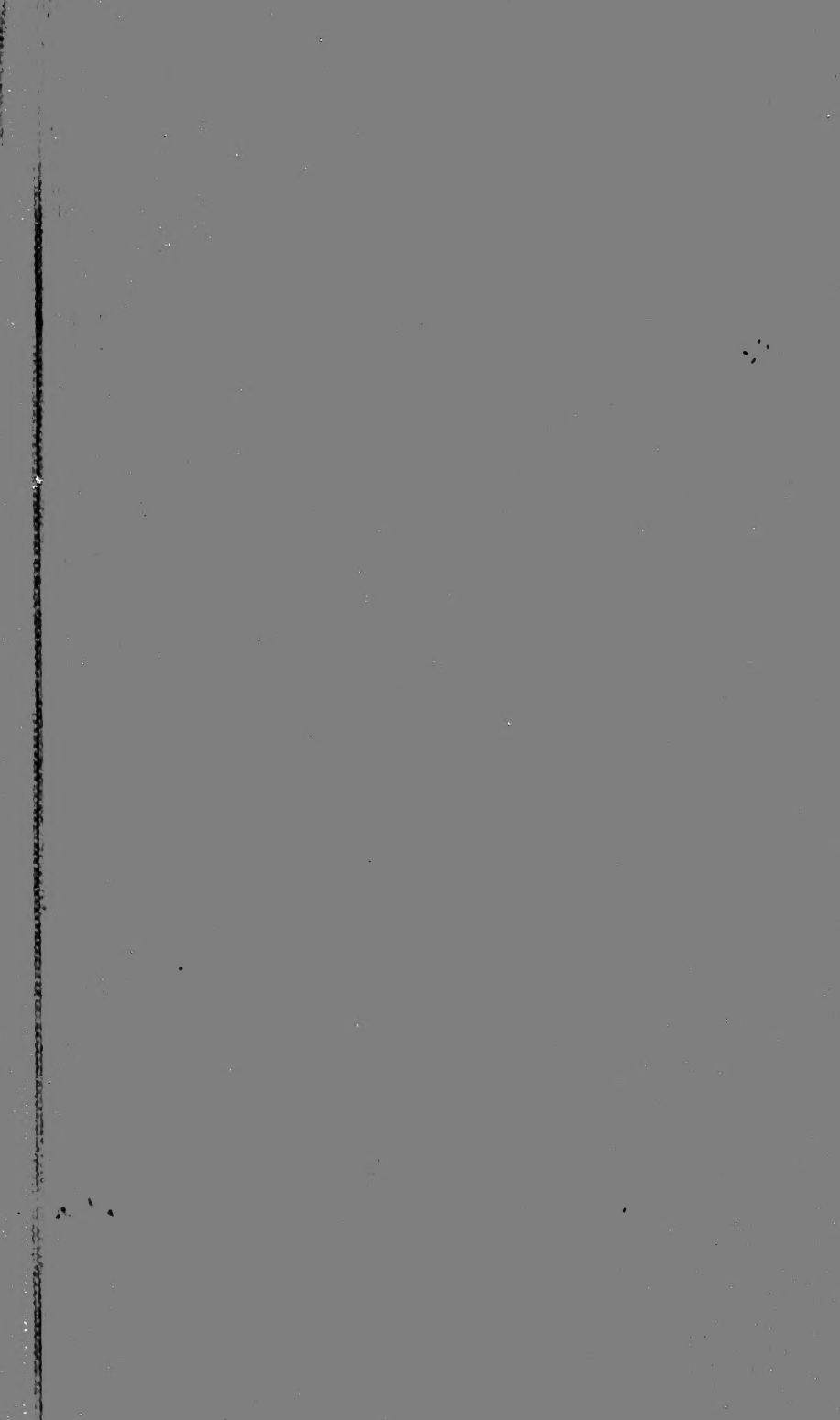

U. S. DEPARTMENT OF AGRICULTURE.
DIVISION OF ENTOMOLOGY.
PERIODICAL BULLETIN.

September, 1892, to July, 1893.

INSECT LIFE.

Vol. V.

DEVOTED TO THE ECONOMY AND LIFE-HABITS OF INSECTS,
ESPECIALLY IN THEIR RELATIONS TO AGRICULTURE.

EDITED BY

C. V. RILEY, Entomologist,

AND

L. O. HOWARD, First Assistant,

WITH THE ASSISTANCE OF OTHER MEMBERS OF THE DIVISIONAL FORCE.

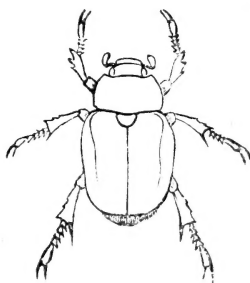

Library, U. S. Department of Agriculture,
Washington, D. C.

[PUBLISHED BY AUTHORITY OF THE SECRETARY OF AGRICULTURE.]

WASHINGTON:
GOVERNMENT PRINTING OFFICE.
1893.

TABLE OF CONTENTS.

CONTENTS OF No. 1.

	Page.
SPECIAL NOTES.....	1
ROSE SAW-FLIES IN THE UNITED STATES (illustrated)..... C. V. Riley..	6
AN EXPERIMENT AGAINST MOSQUITOES..... L. O. Howard..	12
OCCURRENCE OF <i>Bucculatrix canadensisella</i> Chamb. ON BIRCHES IN RHODE ISLAND (illustrated)..... A. S. Packard..	14
NEW INJURIOUS INSECTS OF A YEAR..... C. V. Riley..	16
NOTES ON THE LARVA OF AMPHIZOA (illustrated)..... Henry G. Hubbard..	19
THE DIPTEROUS PARASITE OF <i>Melanoplus devastator</i> in California..... D. W. Coquillett..	22
A NEW SWEET POTATO SAW-FLY (<i>Schizocerus privatus</i> NORT.) (illustrated)..... C. L. Marlatt..	24
ON THE NOMENCLATURE AND ON THE OVIPOSITION OF THE BEAN WEEVIL (<i>Bruchus obtectus</i> Say).....	27
NOTES ON THE HABITS OF SOME SPECIES OF COLEOPTERA OBSERVED IN SAN DIEGO COUNTY, CAL..... F. E. Blaisdell..	33
LUCILIA NOBILIS PARASITIC ON MAN (translation)..... Fr. Meinert..	36
BIOLOGIC NOTES ON NEW MEXICO INSECTS..... C. H. Tyler Townsend..	37
FURTHER NOTES ON THE NEW HERBARIUM PEST..... C. V. Riley..	40
THE AUSTRALIAN ENEMIES OF THE RED AND BLACK SCALES.....	41
EXTRACTS FROM CORRESPONDENCE.....	43
On the Carbon Bisulphide Remedy against stored Grain Pests—On the first use of Paris Green for the Potato-beetle—A Vineyard Pest, <i>Anomala marginata</i> , in North Carolina—A "White Grub" Pest of Sugar Cane in Queensland—A Snout-beetle, <i>Otiorthynchus ovatus</i> , under Carpets—The Grape-seed Weevil—A new Enemy of Cotton—Corn as a Trap Crop for the Boll Worm—Silk Gut from native Silk-worms—Corn Stalk-borer in Virginia—A Leaf-roller on Shade Trees in Colorado—Coloring Matter of the Plant-louse of the Golden Rod.	
NOTES FROM CORRESPONDENTS.....	49
GENERAL NOTES.....	51
Sugar-cane Pin-borer and Cane Disease—Notes from the Jamaica Museum—An Exploded Remedy for the Plum Curculio—Good Work of the Twice-stabbed Ladybird—Notes on Ohio Coleoptera—The Clover-leaf Weevil in Ohio—The Japanese Gypsy Moth and its Parasite—A new Sugar-beet Pest—The larval Habits of <i>Thalpochares cocciphaga</i> —Locusts in Algeria—Changes of Color in <i>Schistocerca peregrina</i> Ol.—Grasshoppers in the East—The Bot-fly of Human Beings—A new Tabanid—The Chinch Bug in Illinois, 1891, 1892—The Mealy Bug damaging Coffee in Mexico—The Hop Plant-louse in Washington—Ticking of the Book Louse—Deltoid Moths—Phæism in Insects—Caution to Hop-growers—A new Simulium—Notes on Economic Entomology—Annual Meeting of the Entomological Society of Ontario.	

CONTENTS OF NO. 2.

	Page.
SPECIAL NOTES	63
FOURTH ANNUAL MEETING OF THE ASSOCIATION OF ECONOMIC ENTOMOLOGISTS	67
PRESIDENT'S OPENING ADDRESS..... <i>J. A. Lintner</i> ..	67
ADDRESS OF FIRST VICE-PRESIDENT	68
<i>S. A. Forbes</i> ..	68
HYPODERAS COLUMBÆ—A NOTE (illustrated).....	77
<i>D. S. Kellicott</i> ..	77
THE POSSIBLE AND ACTUAL INFLUENCE OF IRRIGATION ON INSECT INJURY IN NEW MEXICO.....	78
<i>C. H. Tyler Townsend</i> ..	78
NOTES ON ÆGERIIDÆ OF CENTRAL OHIO, II.....	81
<i>D. S. Kellicott</i> ..	81
THE BEAN WEEVIL.....	86
<i>M. V. Slingerland</i> ..	86
DRASTERIA ERECHTEA.....	87
<i>M. V. Slingerland</i> ..	87
ORTHEZIA INSIGNIS AS A GARDEN PEST.....	89
<i>T. D. A. Cockerell</i> ..	89
SOME FEATURES OF APPARENT JOINT-WORM ATTACK.....	89
<i>F. M. Webster</i> ..	89
A NEW ENEMY TO TIMOTHY GRASS (illustrated).....	90
<i>L. O. Howard</i> ..	90
FOOD-PLANTS OF SOME N. A. MEMBRACIDÆ.....	92
<i>F. W. Goding</i> ..	92
NOTES OF THE YEAR IN NEW JERSEY.....	93
<i>John B. Smith</i> ..	93
THE PEAR-TREE PSYLLA (<i>Psylla pyricola</i>).....	100
<i>M. V. Slingerland</i> ..	100
THE PEAR-LEAF BLISTER MITE (<i>Phytoptus pyri</i>).....	104
<i>M. V. Slingerland</i> ..	104
THE PARSNIP WEB-WORM (<i>Depressaria heracliana</i> DeG.).....	106
<i>E. B. Southwick</i> ..	106
AN EXPERIMENT AGAINST MOSQUITOES.....	109
<i>L. O. Howard</i> ..	109
NOTES FROM THE MISSISSIPPI STATION.....	110
<i>Howard Evarts Weed</i> ..	110
NOTES ON INJURIOUS INSECTS OF 1892.....	111
<i>Herbert Osborn</i> ..	111
KANSAS NOTES.....	114
<i>V. L. Kellogg</i> ..	114
ROSE SAW-FLIES IN THE UNITED STATES	117
<i>C. V. Riley</i> ..	117
NOTES ON PLANT FAUNÆ.....	117
<i>T. D. A. Cockerell</i> ..	117
SPRAYING WITH ARSENITES VS. BEES.....	121
<i>F. M. Webster</i> ..	121
NOTES ON INJURIOUS INSECTS IN CANADA IN 1892.....	124
<i>James Fletcher</i> ..	124
AN AUSTRALIAN SCYMNUS ESTABLISHED AND DESCRIBED IN CALIFORNIA,	127
<i>C. V. Riley</i> ..	127
FURTHER NOTES ON THE FOOD OF <i>Limax campestris</i> BINNEY.....	128
<i>F. M. Webster</i> ..	128
REVISED LIST OF MEMBERS OF THE ASSOCIATION OF ECONOMIC ENTOMOL- OGISTS.....	130
A CURIOUS CHRYSALIS	131
ABSTRACT OF PROCEEDINGS, ROCHESTER MEETING OF THE ENTOMOLOGICAL CLUB, A. A. A. S.....	132
EXTRACTS FROM CORRESPONDENCE.....	135
Notes from Missouri—Parasite of <i>Ceratonia</i> on Elm; Oak Edema in Mich- igan Forests—Success of the Carbon Bisulphide Remedy against the Cabbage Maggot—The Grape-vine Leaf-roller in Texas—Relative De- structiveness of Cut-worms in Meadow and Pasture—Damage to Cattle Hides by the Ox Bot—The Rabbit Bot—Parasites of the Harlequin Cabbage-bug.	
GENERAL NOTES	138
Insects and the Weather—Successful Colonization of <i>Vedalia</i> in Egypt— Jamaica Museum Notes—Recent Entomological Publications by the U. S. National Museum—Galls in Germany—Notes on some bred Species of California parasitic Hymenoptera—A silk-covered Walnut—New Localities for the Mediterranean Flour Moth—Damage by Codling Moth in Nebraska—Success of a <i>Vedalia</i> Importation—Quails <i>versus</i> Potato Bugs—Myrmecophilous Beetles—Mosquito Remedies again— Newspaper Entomology again—Widespread Trouble from the Horn Fly—The Tannin in a Sumach Plant-louse Gall—The Female Rear- horse <i>versus</i> the Male—Ticks in the Leeward Islands—Entomological Society of Washington.	

CONTENTS OF NO. 3.

	Page.
SPECIAL NOTES	147
THE GLASSY-WINGED SHARP-SHOOTER (<i>Homalodisca coagulata</i> Say) (illustrated)	150
THE OSAGE ORANGE PYRALID (<i>Loxostege maclurei</i> Riley) (illustrated)	155
..... <i>Mary E. Murtfeldt</i> ..	
THE FOOD-PLANTS OF SOME JAMAICAN COCCIDÆ	158
..... <i>T. D. A. Cockerell</i> ..	
THE "MAXILLARY TENTACLES" OF PRONUBA (illustrated).....	161
..... <i>John B. Smith</i> ..	
THE POTATO-TUBER MOTH (<i>Lita solanella</i> Boisld.)	163
..... <i>R. Allan Wight</i> ..	
FOOD-PLANTS OF NORTH AMERICAN SPECIES OF BRUCHUS	165
THE STRAWBERRY WEEVIL (<i>Anthonomus signatus</i> Say) (illustrated)	167
..... <i>F. H. Chittenden</i> ..	
DAMAGE TO FORESTS BY THE DESTRUCTIVE PINE BARK BEETLE (<i>Dendroctonus frontalis</i> Zimm.)	187
..... <i>A. D. Hopkins</i> ..	
AN INTERESTING WATER BUG (<i>Rheumatobates rileyi</i> Berg.) (illustrated).....	189
EXTRACTS FROM CORRESPONDENCE	194

Further Notes on the Japanese Gypsy Moth and its Parasite—Injurious Insects in Nebraska: Season 1892—A Household Ant of British Honduras—House Ants of Mexico—The Stony Acorn Gall—Destructive Appearance of the Roller Worm—Swarming of the Archippus Butterfly—An Anthicid Beetle reported as injurious to Fruit—Injury to Hammer-handles—On Remedies for the "Cigarette Beetle"—Correspondence on the Mosquito Remedy—Note on the Drone Fly—Another irregular appearance of the Periodical Cicada—The New York Pear-tree Psylla—A Tropical Cockroach in a New Orleans Greenhouse—Remedies for White Ants in Fruit Trees—A swarm of Spring-tails—Tame Spiders.

NOTES FROM CORRESPONDENTS	202
GENERAL NOTES.....	204

First Larval Stage of the Pea Weevil (illustrated)—Edward Burgess' work in Natural Science—Swarming of the Archippus Butterfly (illustrated)—Unusual abundance of Butterfly Larvæ—Some imported Australian Parasites—A new Parasite of the Red Scale—Parasitism in Bees of the Genus *Stelis*—The Larva of *Harpalus*—Dipterous Larvæ in the Eyes of a Toad—An Insect Transmitter of Contagion—A Scale-insect on the Karoo Bush—The Silk of Spiders—The Mexican Jigger or "Tlalzahuatè"—Obituary—Entomological Society of Washington.

CONTENTS OF NO. 4.

SPECIAL NOTES	213
THE ORANGE ALEYRODES (<i>Aleyrodes citri</i> n. sp.) (illustrated).....	219
THE PEAR-TREE PSYLLA (illustrated)	226
THE LANGDON NON-SWARMING DEVICE (illustrated)	230
..... <i>Frank Benton</i> ..	
NOTES ON APHIDIDÆ	235
..... <i>Herbert Osborn and F. A. Serrine</i> ..	
BELVOSIA—A STUDY (illustrated)	238
..... <i>S. W. Williston, M. D.</i> ..	
OBSERVATIONS ON THE BOLL WORM IN MISSISSIPPI	240
..... <i>S. B. Mullen</i> ..	
NOTES ON ENTILIA SINUATA (illustrated)	243
..... <i>Mrs. M. E. Rice</i> ..	
THE FOOD PLANTS OF SOME JAMAICAN COCCIDÆ—II.....	245
..... <i>T. D. A. Cockerell</i> ..	
OBSERVATIONS ON SOME HYMENOPTEROUS PARASITES OF COLEOPTERA.....	247
..... <i>F. H. Chittenden</i> ..	
REPORT ON THE AUSTRALIAN INSECTS SENT BY ALBERT KOEBELE TO ELWOOD COOPER AND B. M. LELONG.....	251
..... <i>D. W. Coquillett</i> ..	
THE GENUS DENDROTETIX	254
..... <i>C. V. Riley</i> ..	

EXTRACTS FROM CORRESPONDENCE	Page. 256
Color of a Hest and its Relation to Parasitism—Fowls and Toads <i>vs.</i> Garden Insects—Bisulphide of Carbon against Grain Pests; Additional Correspondence—On Irrigation and its Effects on Insects—A tropical Honey Bee—A honey-producing Ant—The Jumping Bean again—A Boll Worm Crusher—Wax Moths in a Cupboard—On the Habits of some Blister-beetles—The Sweet-potato Root-weevil—A Weevil in Mullein Seeds—A new Enemy to Cypress Hedges in California—Another vegetarian Mosquito—The Cluster Fly Household Pest—Chrysanthemums and the Drone-fly—The Orange Fruit-fly in Malta—Plant-bugs injuring Oranges in Florida—Fowls killed by Mole-crickets—Roaches in Brazil—Screw-worms and the man-infesting Bot in Brazil—The Chipping Sparrow and House Wren as Insect Destroyers—The Clover Mite in Houses again—A new Chicken Plague in Texas.	
NOTES FROM CORRESPONDENTS	267
GENERAL NOTES	269
AN Enemy of the Screw Worm Fly—The Archippus Butterfly eaten by Mice—Notes on some Insect Pests of the Fiji Islands—Entomology at the Iowa State University—Local Names for common Insects—Legislation against Spraying—An Exhibition of Spraying Machines—Economic Entomology at the Cape of Good Hope—Parasites of Animals transmissible to Man—Further Illustrations of the Rose Slugs (illustrated)—Cockroach Egg Parasites—The Hymenoptera of Australia—The Genus <i>Mirax</i> —An Important Paper on Butterflies—The Tobacco Sphinx in Louisiana—Canker-worms in California—The Mediterranean Flour Moth in California—Tent Caterpillars in Massachusetts—Results of Codling Moth Legislation in Tasmania—A Vine Pest in Australia—The Sugar-cane Pin-borer again—The Mustard Beetle in England—New Species and Genera of Rhynchophora—Westward Spread of the Clover-leaf Weevil—The larval Habits of the Acalyprate Muscidae—A blood-sucking Chironomid—The Family Apiceridæ—The California Remedy for the San José Scale—Introduction of the Long Scale into California—Imported Scales in California—The Membracidae of North America—A new Enemy of the Tomato—An Insect Enemy of Lace Curtains—Locusts in South Africa—North American Species of <i>Hippiscus</i> —An extreme Case of Norway Itch—On Harvest Spiders—A curious Parasite of the Pelican—Proceedings of the Entomological Society of Washington—Obituary—The Manna Scale—A curious Seed-pod Deformation—The Zebra Caterpillar on the Pacific Coast—Entomological Society of Washington.	

CONTENTS OF No. 5.

SPECIAL NOTES	289
THE PRESENT YEAR'S APPEARANCES OF THE PERIODICAL CICADA	298
FURTHER NOTES ON YUCCA INSECTS AND YUCCA POLLINATION (illustrated)	
..... <i>C. V. Riley, Ph. D.</i>	300
ON THE POLLINATION OF YUCCA WHIPPLEI IN CALIFORNIA	311
THE COCOANUT AND GUAVA MEALY-WING (<i>Aleurodicus cocois</i> Curtis) (illustrated)	314
FURTHER NOTES ON THE COTTONTAIL BOT WITH THE BREEDING AND IDENTIFICATION OF THE FLY	
..... <i>C. H. Tyler Townsend</i>	317
THE SUGAR-BEET WEB-WORM (<i>Loxostege sticticalis</i> L.) (illustrated)	320
REPORT ON A TRIP TO NORTHWEST MISSOURI TO INVESTIGATE GRASSHOPPER INJURIES	323
..... <i>Herbert Osborn</i>	

	Page.
THE ANGOUMOIS GRAIN MOTH OR "FLY WEEVIL" (<i>Gelechia cerealella</i>).....	
..... L. O. Howard..	325
DESCRIPTIONS OF NOCTUIDÆ FROM THE DEATH VALLEY (illustrated).....	
..... J. B. Smith..	328
THE RED-LEGGED FLEA-BEETLE (<i>Crepidodera rufipes</i> L.) (illustrated)	334
EXTRACTS FROM CORRESPONDENCE	342
The Overflow Bug or "Grease Bug," a Plague in California—Is the English Sparrow instrumental in Suppressing the Horse Bot-fly?—Notes on some Gall insects and Parasites—An Intruder in California Vineyards—Living Insects in the Human Ear—Eucalyptus vs. Mosquitos—Another vegetarian Mosquito—Insect Injury to Cactus Plants—Gapes in Fowls—The Clover Mite in Houses—The Utilization of Spider Silk—Further concerning the new Chicken Plague in Texas—Painful Spider Bites—Supposed Gall Mites on Blue Gum.	
NOTES FROM CORRESPONDENTS	349
GENERAL NOTES	351
The Cherry-tree Tortrix (illustrated)—Insects said to Forecast the Weather—What Constitutes a Species—The Ravages of Book Worms—Further on Bee Stings and Rheumatism—The Mediterranean Flour-moth again— <i>Heliothis armiger</i> in Australia—Cut-worm damage to Grapes in California—On the transformations of the Saturniidae—The Tityrus Butterfly attracted to Light—A Banana Borer in Trinidad—The supposed Spread of the Gypsy Moth—Southern Range of the Colorado Potato-beetle—The Spotted Bean-beetle—The Palm Weevil in British Honduras—Alum for Rose Chafers—A Mosquito Exterminator—The Horn Fly in Canada—Recent Studies upon <i>Lachnidium acridiorum</i> Gd.—Gallmaking Coccidæ—The Egyptian <i>Icerya</i> in India—Carbon bisulphide for Hen Lice—The Long Scale not brought from Mexico to California—An enemy of the Oyster-shell Bark-louse of the Apple—An article on Scale-insects—North American Neuroptera—New Entomological Publication—Entomological Society of Ontario—A new patented Insecticide—Why insects infest Plants—Insect legislation in Massachusetts—Borers in Fig Trees—Food of a Tarantula in confinement—Entomological Society of Washington.	

U. S. DEPARTMENT OF AGRICULTURE.

DIVISION OF ENTOMOLOGY.

PERIODICAL BULLETIN.

Issued September, 1892.

Vol. V.

No. 1.

INSECT LIFE.

DEVOTED TO THE ECONOMY AND LIFE-HABITS OF INSECTS,
ESPECIALLY IN THEIR RELATIONS TO AGRICULTURE.

EDITED BY

C. V. RILEY, Entomologist,

AND

L. O. HOWARD, First Assistant,

WITH THE ASSISTANCE OF OTHER MEMBERS OF THE DIVISIONAL FORCE.

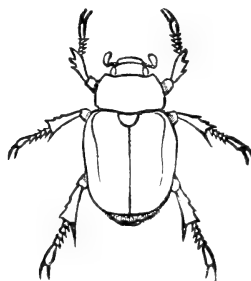

[PUBLISHED BY AUTHORITY OF THE SECRETARY OF AGRICULTURE.]

WASHINGTON:
GOVERNMENT PRINTING OFFICE.
1892.



CONTENTS.

	Page.
SPECIAL NOTES	1
ROSE SAW-FLIES IN THE UNITED STATES (illustrated) C. V. Riley..	6
AN EXPERIMENT AGAINST MOSQUITOES L. O. Howard..	12
OCCURRENCE OF <i>Bucculatrix canadensisella</i> Chamb. ON BIRCHES IN RHODE IS- LAND (illustrated) A. S. Packard..	14
NEW INJURIOUS INSECTS OF A YEAR..... C. V. Riley..	16
NOTES ON THE LARVA OF AMPHIZOA (illustrated) Henry G. Hubbard..	19
THE DIPTEROUS PARASITE OF <i>Melanoplus devastator</i> in California. D. W. Coquillett..	22
A NEW SWEET POTATO SAW-FLY (<i>Schizocerus privatus</i> NORT.) (illustrated). C. L. Marlatt..	24
ON THE NOMENCLATURE AND ON THE OVIPOSITION OF THE BEAN WEEVIL (<i>Bruchus obtectus</i> Say).....	27
NOTES ON THE HABITS OF SOME SPECIES OF COLEOPTERA OBSERVED IN SAN DIEGO COUNTY, CAL..... F. E. Blaisdell..	33
LUCILIA NOBILIS PARASITIC ON MAN (translation) Fr. Meinert..	36
BIOLOGIC NOTES ON NEW MEXICO INSECTS..... C. H. Tyler Townsend..	37
FURTHER NOTES ON THE NEW HERBARIUM PEST..... C. V. Riley..	40
THE AUSTRALIAN ENEMIES OF THE RED AND BLACK SCALES.....	41
EXTRACTS FROM CORRESPONDENCE	43
On the Carbon Bisulphide Remedy against stored Grain Pests—On the first use of Paris Green for the Potato-beetle—A Vineyard Pest, <i>Anomala mar-</i> <i>ginata</i> , in North Carolina—A “White Grub” Pest of Sugar Cane in Queensland—A Snout-beetle, <i>Otiorynchus ovatus</i> , under Carpets—The Grape-seed Weevil—A new Enemy of Cotton—Corn as a Trap Crop for the Boll Worm—Silk Gut from native Silk-worms—Corn Stalk-borer in Virginia—A Leaf-roller on Shade Trees in Colorado—Coloring Matter of the Plant-louse of the Golden Rod	49
NOTES FROM CORRESPONDENCE	49
GENERAL NOTES	51
Sugar-cane Pin-borer and Cane Disease—Notes from the Jamaica Museum— An Exploded Remedy for the Plum Curculio—Good Work of the Twice- stabbed Ladybird—Notes on Ohio Coleoptera—The Clover-leaf Weevil in Ohio—The Japanese Gypsy Moth and its Parasite—A new Sugar- beet Pest—The larval Habits of <i>Thalpochares cocciphaga</i> —Locusts in Algeria—Changes of Color in <i>Schistocerca peregrina</i> Ol.—Grasshoppers in the East—The Bot-fly of Human Beings—A new Tabanid—The Chinch Bug in Illinois, 1891, 1892—The Mealy Bug damaging Coffee in Mexico—The Hop Plant-louse in Washington—Ticking of the Book Louse—Deltoid Moths—Phæism in Insects—Caution to Hop-growers— A new Simulium—Notes on Economic Entomology—Annual Meeting of the Entomological Society of Ontario.	



SPECIAL NOTES.

The Agricultural Gazette of New South Wales.—Part 5 of volume 3, May, 1892, of this interesting journal contains Mr. Olliff's usual entomological notes. He treats in this number an insect which he calls Bronzy Orange Bug (*Oncoscelis sulciventris* Stoll). This insect seems to be a formidable pest in New South Wales, since it damages both fruit and the young shoots and buds by making innumerable punctures with its beak. The eggs are very large and laid in patches on the leaves or twigs. The number of annual generations is not given. The principal remedial work which has been done has been in jarring the bugs from the trees in the cool of the morning or on a cold, dull day, when the insects are more or less torpid. This species, in our opinion, could be readily destroyed by an application of kerosene emulsion. This is the same insect referred to by Mr. Koebele in his account of his trip to Australia in 1888 under the name of "*Aspongopus* sp." Mr. Olliff further treats of the subject of Codling Moth remedies, and reprints the striking experience of Mr. J. S. Lupton from INSECT LIFE. He urges the adoption of American methods.

Report of the Dominion Entomologist for 1891.—The annual report of the officers of the Experimental Farm system of the Dominion of Canada has just reached us in the shape of a royal octavo volume of 350 pages. Mr. James Fletcher's report as Entomologist and Botanist covers pages 192 to 220. The principal insects treated are the Eye-spotted Bud Moth, a new case-bearer of the Apple, the Pear-leaf Blister-mite, the Clover Root-borer, an oat weevil (*Macrops porcellus*), the Red Turnip Beetle (*Entomoscelis adonidis*), and the Pea Weevil. He also includes a section on spraying with the arsenites, in which he particularly reviews the London scare against American apples which attracted so much attention last fall. He gives the result of certain analyses by Mr. Shutt, the Chemist of the Dominion Experiment Farms, which indicated that not the slightest trace of arsenic could be found upon apples which were twice sprayed with Paris green during the month of June. In his Pea-weevil article Mr. Fletcher gives the result of some experiments in regard to the germination of peas which have been infested by the in-

sect, the results of which agree substantially with those of Prof. Popenoe, in Kansas, and to which we referred with some detail in Nos. 9 and 10 of the last volume. He also exposes the fallacy of the statement that weeviled peas can be detected by throwing the seed into water. The note upon the oat weevil is especially interesting, although the author states that the insect shows a greater preference for a wild grass (*Panicum crus-galli*) than for oats. He does not anticipate that it will ever become a serious pest. This species and *Entomoscelis adonidis* are here mentioned for the first time as injuring cultivated crops in this country. The latter is a circumpolar species, common to northern Europe and Asia, and occurs in Montana and Utah, as well as in the Northwest Territories and Manitoba. It was also destructive during the past season to radishes and cabbages.

Wheat Insects in Maryland.—Prof. Doran has published, as indicated in our foot-note,* a short illustrated account of the insects noticed as damaging the grain of wheat during his residence at the Maryland Agricultural College. The species treated are the Angoumois Grain-moth (*Gelechia cerealella*), the Red Grain-beetle (*Silvanus cassiæ*), the Lesser Grain-beetle (*S. surinamensis*), and the “Black Weevil” (*Calandra oryza*), the latter being more commonly known as the Rice Weevil. Prof. Doran has experimented with remedies against the Angoumois Grain-moth and finds that naphthaline is an admirable preventive. It acts more slowly than bisulphide of carbon, but its effects are more lasting. Bisulphide of carbon is recommended for the beetles, but in the only test made, the germination of wheat “was apparently affected unfavorably” by the treatment. An interesting observation on the rise in temperature of middlings infested by *Silvanus cassiæ* is mentioned, but the details of this curious fact will be given in full in No. 3, Vol. II, of the Proceedings of the Entomological Society of Washington.

The American Bot-flies whose Larvæ live in the Skin of Man.†—In a recent paper bearing this title Dr. Blanchard has given us a most valuable critical summary of the literature of the subject. He quotes verbatim the pertinent accounts of thirty-one authors, ranging from De La Condamine, 1749, to Gonnelle, 1889; compares carefully all of the larval descriptions, reproducing nearly all figures ever published, and arrives at the conclusion that four distinct species have been found infesting man.

*Bulletin No. 16 Maryland Agricultural Experiment Station. Insects injurious to the Grain of Wheat. By E. W. Doran, PH. D., 1892.

†Sur les CÉstrides américains dont la larve vit dans la Peau de l'Homme. Par le Dr. Raphael Blanchard. Extrait des Annales de la Société Entom. de France. Paris, 1892.

These four species he carefully describes from their larvæ, separating them by means of a synoptic table, but confesses himself unable to associate them with their adults, with the exception of the *Ver macaque*, which is undoubtedly *Dermatobia noxialis* Goudot. The second species, which he designates as *Torcel*, he believes to have been wrongly referred to *Dermatobia cyaniventris*. The third, designated as *Berne* or *Bicho Berne*, may be *D. cyaniventris*, but this the author states is pure presumption. The fourth, *Ver moyocuil*, is unknown in the perfect state.

The larvæ are distinguished as follows: The *Ver macaque* stands alone in having the second and third segments covered with very fine spinules. The *Berne* has the eighth segment with a row of anteverted spines on the dorsum. The *Torcel* has the third segment with a complete girdle of spines, while in the *Ver moyocuil* this girdle is lacking on the venter.

Fungicides and Insecticides.*—Bulletin No. 17 of the Hatch Experiment Station of Massachusetts is devoted largely to a report of experiments with fungicides, and with fungicides combined with insecticides. A number of expert fruit-growers took part in the experiments, spraying apparatus and chemicals being furnished them, in consideration of accurate work and full reports of results. The fungicides used were Bordeaux mixture, ammoniacal carbonate of copper, and the sulphates of copper and of iron. Paris green was the only insecticide used. The plants experimented upon were Apple, Pear, Plum, Peach, Grape, Potato, and Tomato. The life-histories of the principal fungi affecting the above are briefly given. The principal insects experimented against were the Codling Moth, Plum Curculio, and Tent Caterpillars.

A chapter devoted to the determination of the amount of copper on sprayed fruit, and which bears upon the absurd "grape scare" of last autumn, is of especial interest. Analyses were made to determine the actual quantity of copper adhering to grapes that had been sprayed with Bordeaux mixture. Analysis of the first sample, which was composed of grapes that had been badly disfigured by the fungicide, shows only two thousandths of 1 per cent of oxide of copper. To receive any injurious effects from such bunches of grapes, one would be obliged to eat something like a ton of them—stems, skins, and all. Sample No. 2 showed not even a trace of copper.

From the above it appears that with proper care in the application of the copper solutions, there will not be left even a trace of the copper on the fruit at the time of harvesting, while with the most careless use of the wash no harmful effects will accrue. The sensational account in the *London Pall Mall Gazette* of last autumn that American

* Hatch Experiment Station of the Massachusetts Agricultural College. Bulletin No. 17. Amherst, Mass., April, 1892, [pp. 47, pl. xi, figs. 4].

apples are poisoned with arsenic is referred to, and the determination of the quantity of copper and arsenic adhering to apples which had been sprayed three times with Bordeaux mixture and Paris green was undertaken with still more satisfactory results. The amount of oxide of copper was determined as about five ten-thousandths of an ounce to the barrel. No trace whatever of arsenic was found.

The conclusion reached as the results of the season's work in the use of Bordeaux mixture and Paris green on the plants previously mentioned is that the principal fungi are prevented, tent caterpillars and canker-worms are destroyed, and the injuries of the Codling Moth and Plum Cureulio are largely prevented.

The bulletin concludes with instructions for the use of fungicides and insecticides.

Injurious Insects of South Africa.*—Four items of entomological interest are printed in this report. The Government viticulturist states that the Phylloxera is spreading at such a rate that there is little hope of its being eradicated. The methods that are being adopted are submersion and the cultivation of American vines. The former method has not yet been thoroughly tested, but the latter has thus far been successful. Mr. T. R. Sim contributes "Notes on two Insect Pests." The Fruit Moth (*Achæa chameleon*) is a large species reported to be injurious to all soft fruits, and particularly peaches, by sucking out their juices. This is apparently a new pest in this locality, but the fruit trees were observed to be black with them and the damage done is said to be enormous. A species of ladybird, *Epilachna hirta*, has also done considerable damage in some districts to potatoes and tomatoes. As a remedy the writer makes the following recommendations: "Paris green applied as the Americans apply it for the Colorado Bug is a sure cure on potatoes, but is very poisonous and therefore not to be used on tomatoes." It might be stated, however, that the arsenite may be safely applied to tomatoes until after the plant blooms.

The same writer, in his report as curator of one of the local botanic gardens, states that *Icerya purchasi*, once a nuisance in the gardens, had almost entirely disappeared, having been attacked by a larva (species not stated) that destroyed it in its winter quarters, leaving nothing but the empty skins. Large colonies were thus destroyed.

An Entomological Bulletin from Washington.†—The first entomological bulletin which we have seen from our extreme Northwestern State has just reached us, bearing the title given in our foot-note. Mr. Scobey,

*Cape of Good Hope. Report of the Department of Agriculture for the year 1890-'91. Cape Town, 1891.

†Experiment Station, Pullman, Washington, Bull. 4, Wireworms, by J. O'B. Scobey, Agriculturist. Olympia, Wash., May, 1892.

the agriculturist of the station, gives a six-page illustrated account of *Melanotus communis* and *Agriotes mancus*, compiled mainly from Prof. Comstock's account of these species. Of the wire-worms damaging wheat the present spring in Garfield County, Mr. Scobey identifies 90 per cent as belonging to the former species and 10 per cent to the latter. We doubt the specific accuracy of these determinations, since up to the present time neither of these species has been found in the State of Washington.

Some Live-stock Pests in Louisiana.—In the report of the veterinarian of the Louisiana Agricultural Experiment Station for 1891 some attention is paid to the Horse-bot Fly, Screw-worm Fly, and to the Ox Warble. The notes are prepared from the remedial standpoint, and contain no new facts regarding the life-history. For the Horse Bot it is recommended to attend to the general health and condition of the animal by thorough grooming and cleanliness, and by improving his appetite and digestion by the use of some mineral or vegetable tonic, such as gentian, ginger, cinchona bark, or some of the salts of iron. Under the head of the Screw-worm Fly an interesting case is given, in which the Screw-worms rendered valuable assistance in removing a morbid growth in a hoof crack of a mule brought to the infirmary of the station for treatment. The worms removed the growth completely, and the veterinarian then removed the worms. Nothing is recommended for the Ox Warble except the application of tobacco juice and a two per-cent solution of carbolic acid, to prevent the deposition of the eggs.

Bulletin 30 of the South Dakota Station.—Messrs. I. H. Orcutt, Entomologist, and J. M. Aldrich, Assistant Entomologist, have just published a twenty-page bulletin, in which the new insectary is described, and short articles are given upon parasites of the large Willow Saw-fly; the food habits of the Striped Gopher; applying poison to potatoes; bee-keeping; soapsuds for cabbage lice; kerosene emulsion for lice on stock and for sheep scab; a cheap spraying pump, and general recommendations. Four Hymenopterous parasites are mentioned as affecting *Cimbex americana*, viz: *Cryptus nuncius*, *Opheltes glaucopterus*, *Limneria ferrugineipes*, and *Mesochorus melleus*. Four Dipterous insects are also mentioned as parasites, viz, one species of *Sarcophaga* and three of *Phora*. These, however, in our opinion, should not be considered as true parasites. The authors have concluded that a large proportion of the food of the Striped Gopher (*Spermophilus 13-lineatus*) consists of insects, and these are almost exclusively of injurious species, including principally cut-worms, web-worms and caterpillars. The authors advise the use of strong soapsuds upon cabbage for plant-lice in preference to kerosene emulsion, as they have found that a weak solution of the latter substance

does not kill the lice, while a strong solution injures the cabbages. The emulsion, however, is recommended for lice upon stock, while for sheep scab it is also a most excellent remedy. Under the head of general recommendations, remedies are given for the Willow Saw-fly, Cotton-wood Leaf-beetle, Plant-lice, Cut-worms. Cecropia Moth, Tent Caterpillar, Ash Borer and Potato Beetle.

ROSE SAW-FLIES IN THE UNITED STATES.

By C. V. RILEY.

THE BRISTLY ROSE-WORM.

(*Cladius pectinicornis* Fourcr.)

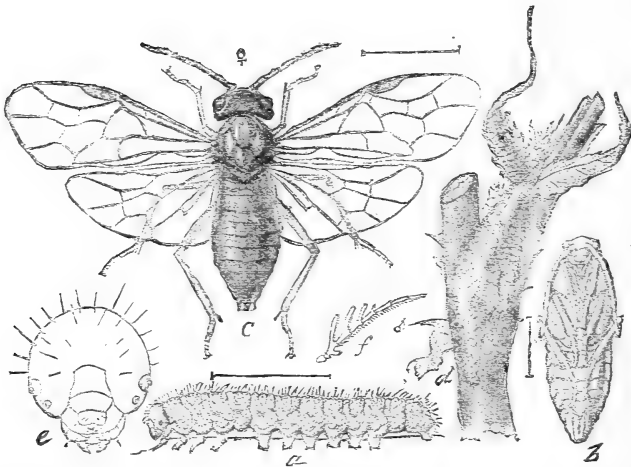

FIG. 1.—*Cladius pectinicornis*: a, larva; b, female pupa; c, female adult; d, cocoon; e, head of larva; f, antenna of male—all enlarged (original).

In 1880 I noticed that most of the leaves of the roses in my garden were badly eaten and mutilated, and, on examination, found that the insects which had been doing this damage were the larvæ of a saw-fly which differed from those of the common Rose Saw-fly (*Monostegia* [*Selandria*] *rosæ* Harris). They were watched until pupation, and the flies which emerged in spring proved to be identical with another of Harris's species, *Cladius isomera*,* which was redescribed by Norton in the Transactions of the American Entomological Society, Philadelphia, 1876, (pp. 74-75). Mr. Norton, at the end of his description, states that a number of the flies were taken by him June 29 on *Clematis virginiana*, near Farmington, Conn., without, however, intimating that this may be the food-plant of the species. Comparison of the description and speci-

*Harris, Catalogue. Norton, Boston Proc., VIII, 1881, 223.

mens of Harris's species with the European *Cladius pectinicornis* Fourer.* proves the two species to be identical. The latter differs in fact in no important feature from, and has recorded of it the same larval characteristics and habits, as the American species. The old name *isomera* of Harris must give place to the name given by Fourcroy at a much earlier date. The introduction of this common European pest of the Rose doubtless took place at an early period. The hibernating larvæ at the base of the plants, or attached to the stems in their parchment-like cocoons, afford an easy method of introduction, and it would indeed have been remarkable if such introduction had not resulted.

Since the first discovery of the larvæ in 1880 the insect has persisted on my rose-bushes, and seems to have steadily increased in the city of Washington. It has also been found in other parts of the country. Its wide distribution and its rose-feeding habit are shown by the following records:

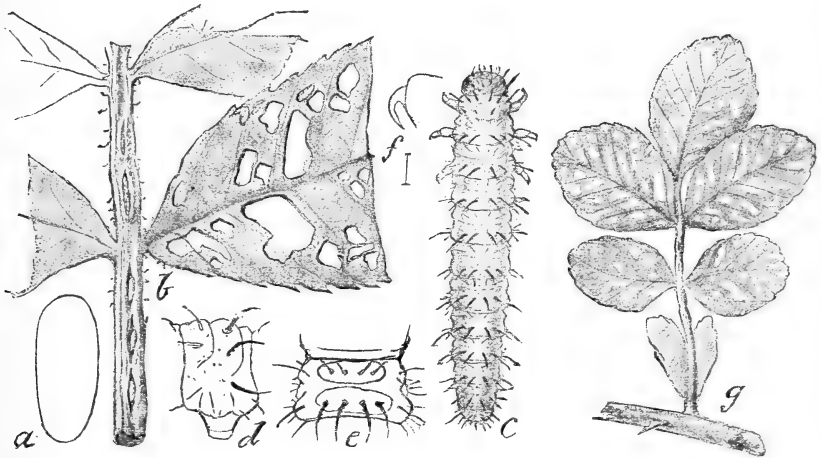

FIG. 2.—*Cladius pectinicornis*: a, egg; b, portion of leaf showing eggs *in situ* and work of young larvæ; c, newly-hatched larvæ; d and e, lateral and dorsal aspect of middle segment of same; f, larval claw; g, rose leaf showing nature of defoliation; all except g enlarged (original).

In May, 1886, a female of this species was discovered by Mr. F. M. Webster, at La Fayette, Ind., just in the act of oviposition, and in September, 1887, the larvæ were observed on some roses at Richfield Springs, N. Y.; while in the fall of 1889 Miss Murtfeldt found the larvæ at Kirkwood, Mo., and gave in Bulletin 22 of this Division a brief account of their habits.

Its mode of work is quite unlike that of the common Rose Saw-fly (*Monostegia rosæ*). Instead of feeding like that species, during its whole larval existence, exclusively upon the upper epidermis of the leaves, these larvæ while quite small feed upon the lower side only. Gradually, however, as they become larger, they eat irregular holes all

over the leaves, until often nothing remains but the stronger ribs. They are always concealed on the lower side, and are not readily noticed, even by an experienced eye, on account of their color, which harmonizes surprisingly with that of the leaves. Another characteristic of this species is, that, instead of descending to the ground to form their cocoons below the surface, as is the case with *M. rosæ*, the larvæ always form their rather delicate and more or less transparent cocoons in autumn in any suitable situation *above ground*, among fallen leaves and other rubbish, while during the warmer months they spin up on the lower side of the leaves or on the stems and branches of the plant upon which they have been feeding.

The first or spring brood of flies appears at Washington from the end of April until about the 20th of May, or even later. In the selection of suitable places for the insertion of her eggs the female again differs markedly from *M. rosæ*, for while this species oviposits under the cuticle of the leaf, as is common with many other species, our *Cladius* selects the upper side of the petiole of the leaves and inserts from one to three eggs, and sometimes more, close behind each other in an oblique slit made by the ovipositor. There are sometimes two or three such groups of eggs in one petiole. The first flies from hibernated cocoons issue as soon as the leaves put forth, and commence at once to oviposit. The eggs hatch in from a week to ten days, and the young larvæ begin feeding during the first week of May. Growth is rapid, and cocoons have been found by the middle of May. The pupa state lasts about fifteen days, so that the second brood of flies appears during the last days of May. At this time the latest larvæ have nearly attained their full growth. The second generation of worms begins work usually the second week in June, and from this time on, until quite late in Fall, larvæ of different stages may be found almost continuously, indicating that there are at least three and perhaps four annual generations, the last of the worms being found even as late as the first week in November. Nevertheless, during July there is comparative cessation of work between the second and third broods of worms, and fresh growth during this period is scarcely affected. The larvæ of the last brood, after having attained full growth, descend to the surface of the ground and spin up beneath any suitable object to pass the winter.

DESCRIPTIVE.

Cladius pectinicornis Fourcr. *Imago*.—Average expanse ♀ 10 mm, ♂ 9 mm. Color black, polished, sparsely and finely pilose. Ocelli red; eyes black and very finely faceted; behind each of the posterior ocelli there is a deep sinus, and a shallow basin inclosing the anterior ocellus. Antennal cavities of the head much excavated, so as to leave in front of the insertion of the antennæ a sharp median carina. Antennæ black; those of the male rather hairy, and with a rather long terminal branch on upper side of joints 3-5 and a very small, tooth-like projection at the end of the sixth. At the base of the lower side of the third there is a prominent, forward-curved, blunt process, while the apex of the third and seventh forms

an acute angle. Palpi black or dusky, the two terminal joints sometimes whitish. Femora black, their extreme tip, the tibiæ and tarsi yellow, the terminal joints of the tarsi and claws are more or less distinctly brown or dusky. In some females the yellow portions of the legs and tarsi are almost white. Tegulæ yellowish; cenchri whitish. Wings violaceous hyaline, sometimes yellowish or pale brownish. Stigma and veins black. Costa pale. The antennæ of the female are simple, quite stout; closely covered with short hairs, those of the two basal joints being somewhat longer and coarser. The lower edge of the third joint is slightly excised, whilst the fourth is slightly stoutish at the apex. On the upper side of the third and fifth there is a quite distinct, short, tooth-like projection.

Described from 17 males and 20 females.

Egg.—Length, 0.8 mm.; color, white. Somewhat flattened, rounded, and stoutest at the anterior end; more pointed at the opposite end.

Larva.—Length of full-grown larva, 16 mm.; diameter, 2.4 mm. Color somewhat variable, ranging from a dirty yellowish-green to a glaucous green; the medio-dorsal line slightly brownish in the paler and slightly darker green in the darker specimens. There may often be noticed a narrow, faintly whitish stigmatal line, and occasionally a rather broad, pale dusky, slightly oblique, subdorsal stripe on pro- and meso-thorax. Head, hairy, greenish-yellow, closely covered with minute, faintly elevated, more or less circular, flat, orange sculpturing, which gives to the head an orange appearance. Clypeus orange, its anterior third greenish, with a small blackish spot at each anterior angle; eyes black; mandibles black or brown at apex. The whole larva is quite bristly, especially at the sides. Each segment is divided by three transverse rows of transversely elongated, polished warts, each giving rise to a number of rather stiff, pale, glistening hairs, legs pale greenish-yellow; claws brownish at tip.

Pupa.—Color, grayish green; the thorax and end of body slightly yellowish; head, whitish-green; ocelli brown; eyes, black. Antennæ, wing-sheaths, and legs white with a slight green tinge.

Cocoon.—Length, 8-9 mm.; color, pale brown. Delicate, semitransparent, spun tightly to the lower surface of the leaves or other objects. It is generally surrounded by an irregular, ragged fringe, indicating a tendency to an additional external cocoon.

THE BANDED EMPHYTUS OR CURLED ROSE WORM.

(*Emphytus cinctus* L.)

In addition to the common Rose Slug (*Monostegia rosæ* Harris), and the species just described, there is a third saw-fly which breeds on the leaves of the Rose in parts of this country. I refer to the imported Rose Saw-fly (*Emphytus cinctus* L.), which was found by Mr. John G. Jack on the Rose at the Arnold Arboretum and in other botanic gardens in Boston and Cambridge. During the years 1887, 1888, and 1889, this insect was reported as being fully as injurious as the common Rose Slug. (See *Garden and Forest*, vol. III, p. 151, March 26, 1890.) Mr. Jack determined this as a European species which he thought to have been recently imported and probably in the stems of rose plants, in which the larva sometimes burrows to undergo its transformations or for winter hibernation, which habit also has led some European observers to consider this insect as a rose stem-borer rather than an external feeder. In the case of this insect again an American species has been characterized (*Emphytus cinctipes* Nort.) which cannot be distinguished, from the description, from the European species and which will un-

doubtedly prove to be identical with the latter. I have not seen authentic specimens of Norton's species, but there are no characters, indicated by Mr. Norton in his description, sufficient to separate the two species. Norton's specimens were collected in New England, but if they prove to be the same as the European species it would indicate that the species was imported very much earlier than Mr. Jack supposed. The European species is widely distributed, occurring throughout southern and central Europe and also in eastern Siberia, and is a well known rose pest, exactly agreeing in habit with the species described by Mr. Jack. Like the larvæ of *Cladius pectinicornis* the larva of this imported insect eats the entire substance of the leaf, but differs from the former in that it eats along the edges of the leaf with the body more or less beneath the leaf, and when at rest remains curled up on the under side of the leaf in a spiral or ball. The larva of the latter is easily distinguished also by being smooth and by having a yellowish-brown head with a broad brownish-black mark above. The body is dark green above, with the sides and legs grayish-white. There are several yearly broods, the larvæ appearing from May to October. The eggs are placed singly, but scattered to the number of three to seven, on the under sides of the leaves and the full-grown larva burrows, as stated, in the rotten wood or the pith of plants—very frequently of rose stems—to pupate or, in the case of the fall brood, to hibernate.

SUMMARY OF THE HABITS OF THE THREE SAW-FLIES AFFECTING ROSES IN THE UNITED STATES.

The following brief summary of the habits of the three species of saw-flies mentioned in the foregoing pages as affecting cultivated roses in this country will serve to enable anyone to distinguish the species and determine the depredator in any particular case.

THE AMERICAN ROSE SLUG (*Monostegia roseæ*).—This is the old and well known species, and the only one which, up to within the last few years, has been recorded as affecting the Rose in this country. It was originally found in the Eastern States, but has now become widely distributed by being transported from place to place in connection with rose plants. It is single brooded, the flies emerging in May, or about the time the Rose is in full leaf. The eggs are circular and are inserted singly in the edge of the leaf, on the under surface. The larva is about one-third of an inch long, and slug-like, the thorax being swollen; but it is not slimy, as is the case with many other allied saw-fly larvæ. It feeds only at night, and always on the upper side of the leaf, skeletonizing it rather than eating the entire substance. During the day it remains at rest, concealed on the under surface of the leaf.

The larval period lasts from fourteen to fifteen days, when the larva abandons the damaged plant and enters the soil, where it constructs a fragile earthen cocoon. In this it remains dormant until the following

spring, transforming to pupa shortly before the emergence of the adult insect in May. The appearance of the adult insects is somewhat irregular, and hence the larvæ are found on rose-bushes over a period of five or six weeks.

THE BRISTLY ROSE WORM (*Cladius pectinicornis*).—This insect produces three, or in some cases, four broods annually. The eggs are inserted in the upper side of the petiole of the leaf, and are placed in rows close behind each other, three or more together. The full-grown larva attains a length of 16 mm., and ranges in color from dirty yellowish-green to a glaucous-green with a dorsal line of a slightly darker green. The head is greenish-yellow and is covered with orange sculpturing. The whole larva is sparsely covered with stiff hairs or bristles, especially at the side. When quite young it skeletonizes the leaves, leaving whitish blotches, but as it grows older it devours irregular holes all over the leaf, eating the entire substance, until frequently nothing is left but the stronger ribs, the larva remaining all the time concealed on the under side of the leaf.

When full-fed it does not leave the plant, at least in the case of the earlier broods, but forms its cocoon, which is composed half of silk, half of some glutinous substance intermixed, and is spun tightly to the lower surface of the leaves or other objects, usually surrounded by an irregular fringe. The fall brood spins up among fallen leaves and other rubbish at the base of the bushes.

THE COILED ROSE WORM (*Emphytus cinctus*).—This insect is double-brooded, and in southern latitudes produces a third brood, the appearance of the worms extending from May to October. The eggs are placed singly to the number of from three to seven on the under surface of the leaves. The larva is easily distinguished from either of the other two by being smooth and by having its yellowish-brown head marked with a broad, brownish-black spot. The body is nearly linear, the under part swollen at the anterior extremity, and is dark-green above, with the sides and legs grayish-white. On reaching full growth, the larvæ bore into the pith of stems of dead rose branches or other plants, in which they pupate, or, in the case of the fall brood, hibernate. The larva eats the entire substance of the leaf, feeding along the edges with the body curled beneath it, and when at rest it remains curled up in a ball on the under surface of the leaf.

REMEDIES.

All three of these species are amenable to the ordinary remedy for saw-fly larvæ, viz, the application of powdered hellebore in water spray. A mixture of two ounces of hellebore to two or three gallons of water will be of sufficient strength to effect the destruction of the larvæ. In the case of the two newer species, *Cladius pectinicornis* and *Emphytus cinctus*, thorough treatment of the first will prevent the reappearance of the later broods, and very frequently hand-picking will be sufficient to check the insects, if carefully done in the case of the first brood.

AN EXPERIMENT AGAINST MOSQUITOES.*

By L. O. HOWARD.

One of the most reasonable of the recommendations which have been made from time to time, and which look toward the reduction of the mosquito plague during the summer months, is the application of kerosene to restricted and fishless breeding ponds. Although this remedy has often been suggested, I know of no careful records of actual experiments, and consequently deem the following account of a recent experience worthy of publication.

On the 5th of July of the present year I noticed for the first time a few mosquitoes on the porch of my cottage, in the Catskill Mountains of New York. The elevation of this cottage is about 2,500 feet, and mosquitoes have hitherto been rare visitors. The month of June, however, was very wet, and as I had noticed several pools of surface water in the immediate vicinity, the presence of these mosquitoes caused me some anxiety, as I feared they would continue to breed throughout the summer and prove a serious annoyance later in the season. One of the surface pools mentioned was situated upon my own grounds, and upon first noticing the mosquitoes I walked out to this spot. It was about dusk, and a dozen or more female mosquitoes were found buzzing about the surface of the water. I immediately sprinkled four ounces of coal oil upon the surface of the pond.

Upon the following day I carefully measured the little pool and found that it contained 60 square feet. From day to day until July 15, when I returned to Washington, observations were made. Severe rainstorms occurred on the 8th and 10th of the month, and after the first of these the pool lost the glassy iridescent surface effect given by the almost continuous but infinitesimally thin layer of kerosene. Nevertheless the insecticidal effect of the latter did not seem to diminish, although I could no longer perceive any coal-oil odor. Many dead insects were found floating upon the surface of the water the next morning after the application, and these increased rapidly up to the time of my departure. The pool, which upon the evening of the 5th had been teeming with animal life, contained no living insects during the following ten days.

The actual good accomplished is shown by the following facts: All aquatic larvæ, including those of the mosquito, were killed. The kerosene, curiously enough, seemed to exercise no deterrent effect upon the adult female mosquitoes. They still continued to attempt to deposit eggs and in this attempt were destroyed. This is, in my opinion, a most important point, and one which has hardly been anticipated.

On the tenth day after the application a careful count of the dead

* Read before the meeting of the Association of Economic Entomologists at Rochester, N. Y., August 16, 1892.

insects floating upon the surface of the water was made over a restricted portion, and from this count the entire insect surface contents of the pool was estimated, with the following result:

Entire number of dead insects floating on the surface.....	7,400
Number of mosquitoes	370
Number of <i>Epirrita inclinatu</i> Walker—a small Geometrid moth.....	148
Number of <i>Heterophleps triguttata</i> H S.—another small Geometrid	42
Number of <i>Chrysops hilaris</i> O. S.—a common gad fly of the region.....	27

These were the most conspicuous. The others were mainly minute Nematocerous Diptera, although there were still a large number of small Heterocerous Lepidoptera, a few aquatic Coleoptera—the largest species being the Dytiscid *Agabus gagates* Aubé—and also a few specimens of Cryptocerate Heteroptera.

It is difficult to say how certain of the non-aquatic species, particularly the Lepidoptera and the Chrysops, happened to be caught. They may have visited the pool to drink or they may have been attracted to its shining surface.

The observation, it seems to me, possesses interest not only as proving definitely the efficacy of the remedy and as showing that adult mosquitoes are killed as well as their early stages, but also as affording an indication as to the amount of kerosene which will prove effective for a given surface of water, and also as affording some indication of the length of time for which a single application will be operative. It is true that upon this last point the observations were not complete, owing to my departure after ten days, but as already indicated, the influence of the kerosene outlasted all ocular or odorous evidence of its presence, and there is every reason to suppose that it would have continued for at least some days longer.

As a general thing, in larger ponds, which are of a more permanent character, the presence of fish is a check upon the multiplication of the mosquito. These insects breed mainly in marshy lands, where small pools, surrounded by wet soil, adjoin each other, and such spots, where accessible, can be readily and economically treated with coal oil. The economy of the operation is shown by a simple estimate from the data which I have given, that 5 gallons of coal oil, costing say 60 cents, will treat 9,600 square feet of water surface, or, to carry the computation still further, a barrel of kerosene, costing \$4.50 will treat 96,000 square feet of water surface.

With this remedy and with the drainage of swamp lands where practicable, with the introduction of fish into ponds in which they do not already occur, and with the careful watching of rain-water barrels and tanks, the mosquito plague in many localities can be readily and greatly lessened. Where mosquitoes breed, however, in the long succession of brackish marshes on the seacoast, remedial work is practically hopeless. I anticipate not the slightest practical outcome from Mr. Robert H. Lamborn's dragon-fly proposition, and believe that relief in

such cases will only come from extensive improvements at the public expense in the way of the filling in and draining of the marshes.

One word more in reference to water tanks. The use of kerosene is of course out of the question in such receptacles. A note was published in *INSECT LIFE* (vol. IV, pp. 223-224) to the effect that the introduction of carp into water tanks in the Riviera was productive of the best results. This is a pertinent suggestion for trial in this country. The U. S. Fish Commission can doubtless furnish a limited number of carp for this purpose. All water tanks and barrels should, however, be tightly covered, and only opened occasionally for the purpose of aerating the water. When thrown open for this purpose it will not be difficult to ascertain whether larval mosquitoes (wrigglers) are present, and if so, and the tank is not too large, they can be removed by means of a fine-meshed hand net.

OCURRENCE OF *BUCCULATRIX CANADENSISELLA* CHAMB. ON BIRCHES IN RHODE ISLAND.

By A. S. PACKARD, *Providence, R. I.*

My attention during the second week in September of last year was called to the widespread occurrence of the larvæ of this insect on the leaves of *Betula populifolia*. Over extensive tracts of woodlands and

fields in east Providence and adjoining portions of Massachusetts, the leaves of birch shrubs and small trees had prematurely turned sere and brown, few healthy green leaves on a tree having been left.

The ravages of this worm seem to have attracted attention elsewhere, as an Attleboro correspondent of the *Providence Journal* for October 6 reported that almost every leaf of the White Birch in Bristol County, Mass., had been eaten by a worm; the account undoubtedly refers to this caterpillar.

This Tineid was first described, but without any information as to its habits, by the late Mr. V. T. Chambers, in the *Canadian Entomologist* for August, 1875

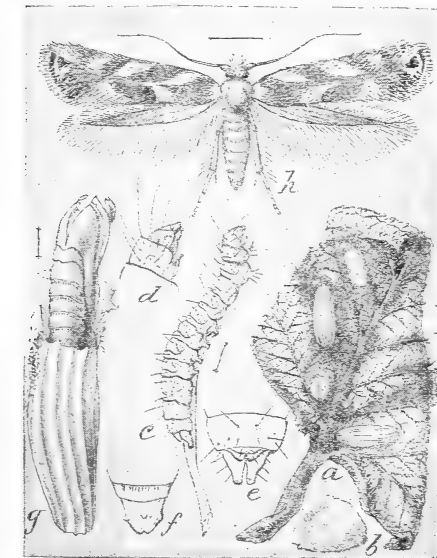

FIG. 3. *Bucculatrix canadensisella*: a, skeletalized birch leaf; b, pseudo-cocoon; c, larva; d, head of same; e, anal segments of same; f, anal segment of pupa; g, cocoon with extended pupa skin; h, moth—all enlarged (original).

(vol. VII, p. 146). Some time ago Dr. J. A. Lintner wrote me regarding

the habits of this insect, kindly sending me his notes, in advance of publication in his annual report for that year.

This account has since been published in Dr. Lintner's Third Report as State Entomologist of New York, and is quoted in full in the Fifth Report of the U. S. Entomological Commission on Forest and Shade Tree Insects.

Mr. Shelby Reed, of Scottsville, Monroe County, N. Y., sends leaves of the Yellow Birch (*Betula lutea*), infested with small caterpillars, which are very numerous (forty-eight having been counted on a single leaf) and eat the upper and lower surfaces of the leaves, leaving only the transparent inner tissue. "The trees infested with them have a brown and scorched appearance, and light comes down through the thickest foliage as through a skylight. * * * A few of the larvæ had spun cocoons on the surface of the leaf when received. On the following day nearly all had made or were engaged in making their cocoons."

Our larvæ agree in all respects with Lintner's description.

The larvæ occur in great numbers, both on the upper and under side of the leaf, eating the parenchyma out of both sides, so as to skeletonize the leaf, which prematurely turns brown, many of them falling off. In confinement it walks slowly, often dropping down and hanging by a thread.

Larva.—Length 5 or 6 mm. The head is about two-thirds as wide as the body where thickest; it is pale honey-yellow. The body is long and slender, tapering regularly towards each extremity; the anal legs are rather large, project well behind the body, and diverge in creeping. The body is pale honey-yellow, with sometimes a slight greenish hue. The hairs are fine, scattered, arising from small pale warts; besides the four dorsal warts, which are arranged in a regular trapezoid, there is a lateral one visible on each side. The surface of the prothoracic segment is large and broad, though not so wide as the second thoracic segment; about six hairs project from the front edge. The segments are all very distinct, the sutures being deeply impressed, while the hinder edge of each segment is slightly raised and thickened. The second and third thoracic segments are much shorter than the prothoracic, while the first and seventh abdominal segments are longer, at least two-thirds, than the eighth. The ninth abdominal segment is much narrower than the eighth, and narrows posteriorly. There are four pairs of middle abdominal legs, and they are of the same color as the body. The oval cylindrical yellowish testes (?) are distinctly visible under the skin of the fifth abdominal segment.

Late in September and early in October the cocoons were found on the birch leaves, but also on those of the Wild Cherry. They are 5 mm. in length, and in shape elongated, oval, sharp at each end, and with eight sharp, high ridges. They are white, turning darker in many cases.

The moths had not, up to December 1, appeared in the tin boxes in which the cocoons had been kept in a warm room, but the chrysalids were alive, and will eventually, without doubt, give out the moths. It is evident that the enormous abundance of this Tineid is to be some-

what periodical, and though much harm is done, rendering the trees unsightly, it happens just before the falling of the leaves.*

NEW INJURIOUS INSECTS OF A YEAR.†

By C. V. RILEY.

It is a common remark of members of this society, as well as of other horticultural societies, the meetings of which I have attended, that their insect enemies are on the increase. In one sense this is undoubtedly true, *i. e.*, the number of insects affecting our fruits as well as our other crops constantly grows as our knowledge of them becomes more and more complete; but I question whether more injury is done today to our fruits than was done fifty years or a hundred years ago. In fact, it is patent that with the advances made of late years in our methods of warfare against these fruit pests less injury relatively is done, but as the area of fruit culture increases so does the aggregate of injury and also the number of species that we have to contend with. It may convey to you some idea of the vastness of the subject of economic entomology for a country as great as ours to give a bare reference to the reports which have come to me within the year or since your last meeting, of insect injury, which is either quite novel or made by species that have hitherto been absolutely unknown.

A small mite, an undescribed species of *Phytoptus*, has been reported on Plum, making a gall on the leaf, from Akron, Ohio, and from Pompanoosuc, Vt.

A new plant-louse belonging to the genus *Myzus* was reported on Cherry from southern Indiana.

* September 14, 1886, we received a large number of larvæ of this insect on leaves of the Yellow Birch, most of which were completely skeletonized, from Mr. Shelby Reed, mentioned in Dr. Lintner's note cited above. Some of the larvæ had already spun their cocoons, and the moths began to issue January 26, 1887, and continued to make their appearance until March 3, 1887, twenty-seven in all issuing from this lot. September 13, 1890, we received similar skeletonized birch leaves with the same larvæ from Mr. F. M. Draper, East Norton, Mass., and, on September 15, others from Mr. William L. Tower, West Bridgewater, Mass. Mr. Draper said in his letter that the birches for miles around had been seriously attacked. The leaves were almost completely skeletonized from the under side, and had scattered over their surface numerous pseudo-cocoons of white silk, which contained the cast skin of the Bucculatrix larva, these seemingly having thus protected themselves during their molting periods. The true cocoons were spun a little later and were all of the usual oblong, longitudinally ribbed, yellowish appearance characteristic of this genus of Tineids. The moths issued, as with the specimens from New York, from the following January until March. A Chalcidid parasite of the genus *Derostenus* was reared from the New York specimens March 3, 1887. Judging from Mr. Draper's account, this insect bids fair to become a serious pest, and there seems little hope of being able to suggest any economical and effective remedy except in the case of isolated ornamental trees.—EDS. INSECT LIFE.

† From a paper read before the American Pomological Society, September, 1891.

A leaf-folder (probably *Cacæcia argyrospila*) was reported on Apple and Gooseberry from Fort Collins and Denver, Colo.

A hairy caterpillar, undetermined, belonging to the genus *Halisidota* was reported on Apple from Highland, N. C.

Another hairy caterpillar belonging to the family Arctiidæ, but previously unobserved, was injurious to Mulberry, Pear, and Apple in Winchester, Mass.

A new species of plant-louse was badly infesting Orange leaves at Los Angeles, Cal.

An Allorhina, a large chafer belonging to the same family as the "rose bug," was quite injurious to fruits in Tombstone, Ariz.

An undescribed *Aphis* is reported on the Pear from La Fayette, Ind.

A species of *Aleyrodes* has been found on strawberry leaves in the District of Columbia, as also a new species of plant-louse.

Sparthocerus diffusus has been very injurious to grape leaves in Waldo, Fla.

A large scale-insect belonging to the genus *Lecanium* has been reported on strawberry leaves from Urbana, Ohio.

A new leaf-roller, belonging to the genus *Semasia*, was found on apple trees near St. Louis, Mo.

A new miner, belonging to the genus *Lithocolletis*, has been found in the epidermis of peach twigs in Napa County, Cal.

One of the fire-blight beetles (*Xyleborus dispar*), long known in Europe and in the eastern States to be injurious to certain fruit trees, was reported as quite injurious to various fruit trees in Nova Scotia.

A new span-worm has been reported on apple trees from La Fayette, Ind.

A flea-beetle (*Haltica ignita*) has proved very injurious to the Strawberry and Peach in Orlando, Fla., Lake City, Fla., Waco, Tex., and in Indiana.

A small mite, probably *Phytoptus pruni*, was injurious to Damson plum trees at Berlin Cross Roads, Ohio.

A little case-bearing Lepidopterous larva, belonging to the genus *Coleophora*, was injurious to the buds of peaches at Akron, Ohio.

A new species of the genus *Lecanium* was found affecting the twigs of plum trees at San José, Cal., and another species of the same genus was found on peach at Ithaca, N. Y.

Chrysochus cobaltinus was found injuring the leaves of young peach trees at San José, Cal.

An unknown Lepidopterous larva, one of the genus *Hyphantria*, was injurious to apple and some other trees at Omaha, Nebr., and Brownwood, Tex.

A bark-borer hitherto unknown to have such habits, viz, *Platypus compositus*, has been found boring in the trunks of orange trees in Lake County, Fla.

A new flat-headed borer has proved quite destructive to the Sharp-

less strawberry at Cœur d'Alene, Idaho. This is a rather remarkable fact, not only because the species of the family Buprestidæ, to which this flat-headed borer belongs, have hitherto been found boring under the bark of hardwood trees, but because the species belongs to an undescribed species of *Chrysobothris*, the same genus to which the Flat-headed Apple-tree Borer belongs, and one which has been recently monographed. In company with it there was an undescribed Lepidopterous crown-borer.

A saw-fly larva (*Janus flaviventris* Fitch) has been found in the stems of Currant at Adrian, Mich.

A case-bearer belonging to the genus *Coleophora*, also undescribed, was reported on orange trees from Los Angeles, Cal.

An undescribed mite of the genus *Tetranychus*, the same genus to which the Red Spider belongs, has been found on lemon trees at Los Angeles, Cal., as also an undescribed Thrips on orange trees in the same locality.

A leaf-hopper (*Typhlocyba rosæ*) has been very numerous on the leaves of apple trees at Burlington, Vt.

A canker-worm belonging to the genus *Anisopteryx* was reported on Plum from Elliott, Cal.

A snout-beetle (*Cercopeus chrysothæus*) belonging to the same family as Fuller's Rose-beetle, and supposed to be the Grape Curculio, was found upon grapevine at Paris, Tex.

A currant-stem borer (*Oberea ocellata*) has been found breeding in the twigs of Peach in Harris County, Tex.

A new span-worm has been found feeding on the bark and young twigs of plum trees and doing considerable damage, at Mitchell, Ind.

A new case-bearer of the genus *Coleophora* was found on the buds of Blackberry in parts of Indiana.

A beetle larva, belonging to the family Tenebrionidæ and somewhat resembling a wire-worm, was very injurious to the roots of peach and plum trees in southern California.

An undescribed bug belonging to the genus *Trapezonotus*, has been very injurious to fruit trees in Lead County, Idaho, by sapping them.

A beetle (*Ptychodes trivittatus*) is reported as girdling the twigs of fig trees at New Orleans, La.

Another snout-beetle (*Thricolepis inornata*) was found injuring the foliage of young prune trees in Salem, Oregon.

A plant-louse, undeterminable, was badly infesting orange leaves at Santa Barbara, Cal.

A larva belonging to the same genus (*Heliothis*) as the Boll Worm was doing great damage to the leaves of apple and quince trees at Cœur d'Alene, Idaho.

An undetermined species of *Lygus*, one of the true bugs, was injuring young pears at South Byron, N. Y.

Fidia longipes and *F. murina*, two leaf-feeding beetles, were injurious to the leaves of grapevine at Vineland, Ark.

A flea-beetle (*Haltica foliacea*) was very injurious to grape foliage at Socorro, N. Mex.

A scale-insect (*Chionaspis biclavis*) was found on orange twigs in California, and in all probability was introduced from Tahiti.

Stictocephala inermis proved very injurious to young peach trees in Tehama County, Cal.

A new *Icerya* (the notorious Fluted Scale of California being the only species of the genus hitherto known in this country) was reported on Rose and other plants at Key West, Fla., and has been described as *I. rosæ*.

An undescribed scale-insect of the genus *Lecanium* was found infesting grape-vines at Hudson, Ohio, and in Pennsylvania.

I have thus enumerated the additions to the list of injurious insects that have incidentally come to the United States Department of Agriculture in this short period, and were I to enumerate those observed by myself and assistants, or recorded by other workers and other institutions the list would simply weary you.

NOTES ON THE LARVA OF AMPHIZOA.

By HENRY G. HUBBARD, *Detroit, Mich.*

In June, 1891, while on a collecting trip to Great Salt Lake and the mountains of Utah, Mr. E. A. Schwarz and the writer found *Amphizoa lecontei*, together with its larva, living in considerable numbers in a cold, clear mountain stream which supplies the city of Salt Lake with its drinking water. Other streams from the Wasatch Mountains emptying into the basin of Great Salt Lake produced the imago, and a single larva from American Fork Canyon presents differences which may be accidental. In May of the present year a single larva, indistinguishable from that of *A. lecontei*, was found at Glenwood Springs, Colo., at the junction of the Roaring Fork with the Grand River. A few weeks later the larva of *Amphizoa insolens*, with the imago, was found by Mr. Schwarz in the ice-cold waters of a mountain torrent at North Bend, in the Cascade Mountains of British Columbia. A

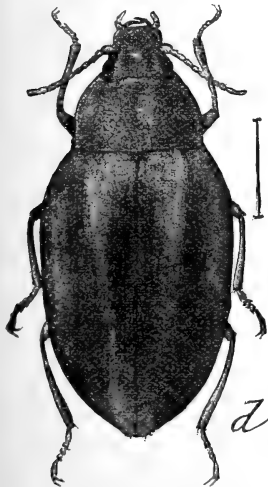

FIG. 4.—*Amphizoa lecontei*: adult, enlarged (original).

careful comparison of the larvæ from British Columbia with those from Utah and Colorado fails to reveal any differences beyond the limits of individual variation and greater intensity of color and distinctness of markings in the

northern specimens. It is doubtful if any more valid distinction than this very common climatic variation exists between the two species of *Amphizoa* now in our catalogue. The form *josephi* has long ago been recognized as having no specific value.

The larva of *Amphizoa* (Fig. 5) is a short-legged, compactly built insect about three-quarters of an inch in length, of an umber-brown color varying to nearly black. The upper surface is convex and strongly chitinized, showing cloudy mottlings, which arrange themselves in longitudinal lines, and in dark specimens disappear, leaving several rows of translucent dots and dashes more or less sharply defined. The under surface is quite flat and naked. The dorsal shields entirely cover the upper surface of each segment and extend outward on the sides, forming explanate lobes. These lobes, evenly rounded on the throax, grow more and more acute posteriorly, and their outer margins give a remarkably regular fusiform outline to the body, which terminates acutely behind. The head is large and prominent, with a group of six

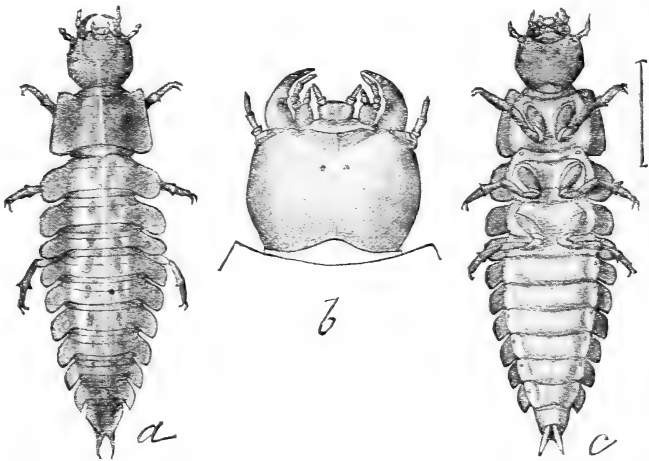

FIG. 5.—*Amphizoa lecontei*: larva, enlarged: a, dorsal view: c, ventral view: b, head, showing mouth-parts, much enlarged (original).

ocelli on each side near the front angles. The antennæ are short, three-jointed, placed just behind the jaws on the side margins. The jaws are deeply channeled within and armed with minute denticulations on the lower cutting edge. The buccal cavity is large, adapted to the mastication of food, and provided with molar plates formed by thickenings of the inner surface of the clypeus above and the mentum below. The maxillæ are stout, basal pieces surmounted by four-jointed palpi and the two-jointed inner lobes. The under lip is broadly transverse and prominent, without ligula, and with short, two-jointed palpi. The legs are widely separated, with six articulations, including the double claws. The abdomen consists of eight segments, and terminates in a pair of short movable spines which enter the eighth segment from

beneath, and are the only visible portions of the rudimentary ninth segment. The anal opening is a narrow slit between the bases of the terminal spines. The animal breathes by means of two large valvular spiracles placed close together at the tip of the eighth segment. Closed or rudimentary stigmata also occur on the mesothorax and on abdominal segments one to seven inclusive.*

The habits of the larva do not differ from those of the imago. Both live in shallow water or under partly submerged stones at the margins of streams. In City Canyon, Utah, larvæ and imago were found together clinging to floating sticks and willow catkins caught in an eddy of the stream. They were feeding apparently upon the drowned insects brought down by the water and lodged in the debris. When disturbed, they released their hold upon the floating fragments, and with outstretched legs sank helplessly to the bottom or were caught and borne away by the current. Although rather sluggish, they can crawl about actively under water, and soon regain the shore if carried beyond their depth.

The larva of *Amphizoa* presents affinities with widely separate groups of the Adephagous series of Coleoptera. The explanate, lobed margins of the dorsal shields and the broadly fusiform shape of the body exactly reproduce the general appearance of the larva of *Cychnus*. The number of the stigmata, structure of the mandibles, and form of the buccal cavity, together with its ambulatory habits, are likewise characters which tend to connect it with the Carabidæ, but the eight-jointed abdomen forbids its entrance into this family. On the other hand, the non-suctorial jaws effectively separate *Amphizoa* from the Dytiscidæ, although it has very many structural affinities with the water beetles, particularly with the tribe *Colymbitini*, for example in the position and structure of the antennæ, the form of the maxillæ and the lower lip, the terminal spiracles of the eighth segment and the cerci arising from a concealed ninth segment, the anal segment being also suppressed. Finally, with the European genus *Pelobius*, *Amphizoa* shares nearly all the distinctively Dytiscid characters which this genus possess. The larva of *Pelobius* is wholly aquatic and breathes by branchiæ, but the obsolete stigmata are indicated precisely as in *Amphizoa*, with the exception of the last pair, which in *Amphizoa* are open spiracles, but in *Pelobius* are suppressed; the terminal eighth segment being prolonged in a swimming stylet. The larva in both genera has non-suctorial jaws. Schiødte's figure of the new-born larva of *Pelobius*, † with its enormously disproportionate, carapace-like head and general crustacean resemblance, suggests the suspicion that *Am-*

* A full description of the larvæ of *Amphizoa* has been presented before the Entomological Society of Washington at its meeting held May 4, 1892, and will be published in vol. II, No. 3, of the Proceedings.

† Krøyer's Naturh. Tidsskrift, vol. VIII, 1872, pl. v, Fig. 1.

phizoa also may have its "Nauplius" stage, and leave the egg as a swimming branchiate animal. Whether this surmise be true or false, the study of these larvæ leads irresistibly to the conclusion that Amphizoa and Pelobius are related ancient types, isolated by the extinction of surrounding forms and preserving synthetic resemblances to many existing families; the affinities of Amphizoa leaning towards the Carabidæ as those of Pelobius do towards the Dytiscidæ. The larval characteristics fully sustain the sound judgment of Dr. Horn in maintaining for Amphizoa its position as the type of a distinct family.

THE DIPTEROUS PARASITE OF MELANOPLUS DEVASTATOR IN CALIFORNIA.

By D. W. COQUILLET, *Los Angeles, Cal.*

On the 22d of October, 1891, in a locality 10 miles from Los Angeles, while examining adult specimens of *Melanoplus devastator*, Scudder, in quest of internal parasites, I found in one of them a dipterous larva apparently nearly full grown. I then collected quite a large number of these locusts and brought them home with me, and the next day five larvæ issued from one of them and soon afterward pupated. The flies issued between the 10th and 13th of the following April. They belong to the old genus *Sarcophaga*, but I am unable to identify them with any of the published descriptions, and in the belief that the species is new, present the following description of it:

Sarcophaga opifera n. sp. ♂.—Front silvery-white pollinose, at narrowest point one-seventh width of head; frontal vitta brown, half as wide as front at narrowest point; the two posterior pairs of frontal bristles directed backward, the others decussate, reaching first third of second antennal joint; no orbital bristles; antennæ, dark brown, reaching three-fourths the distance to the oral margin; third joint scarcely longer than the second; arista black, two-jointed, basal joint as broad as long, the second joint thickened on its basal two-fifths, plumose on its basal two-thirds, bearing two long hairs on its lower side beyond the outermost one on its upper side. Face silvery-white pollinose, but in certain lights showing a brassy tinge; sides of face with a single row of bristles near the eye, those on sides of central depression ascending slightly above tip of antennæ; cheeks one-third height of eyes, densely bristly. Proboscis blackish, slightly shorter than height of head; palpi yellow-brown. Thorax light gray, usually marked with seven black stripes, but some of these are occasionally wanting; three pairs of subdorsal bristles behind the suture. Scutellum gray; a pair of small apical and a second pair of discal bristles, also two lateral pairs of much larger bristles. Abdomen gray, not distinctly checkered, marked with three black vittæ; each segment, except in middle of the dorsum of the first, with a marginal row of bristles; hind margin of the last segment and the genitalia yellow brown. Legs grayish black, all femora and tibiæ bristly; posterior tibiæ not bearded within; claws as long as the last tarsal joint. Tegula whitish-hyaline. Wings grayish-hyaline, base of third vein bristly half way to small cross-vein; other veins bare, first posterior cell open, ending some distance be-

fore apex of wing; elbow of fourth vein forming a right angle, not appendiculate; posterior cross-vein at last third of distance from small cross-vein to the elbow, slightly more transverse than the last half of the apical cross-vein, the latter bowed inward near its base; no costal spine.

♀ Differing from the ♂ as follows: Front nearly one-third width of head; frontal vitta one-third width of front; two pairs of orbital bristles; cheeks nearly one-half height of eyes; scutellum destitute of an apical pair of bristles; claws much shorter than in the ♂.

Length, 5 to 6^{mm}. Described from three males and two females.

The number of locusts infested by these parasites does not appear to be very large. In the locality where I observed them the locusts were quite numerous, and yet not more than 2 percent were infested with these parasites. I notice that in the September number of *INSECT LIFE* for 1889 (page 68), Mr. C. L. Marlatt states that in a certain locality in New Hampshire about 5 percent of the locusts examined by him contained Tachinid or Sarcophagid parasites.

Up to a comparatively recent date the different species of Sarcophaga were very generally supposed to feed in the larva state upon flesh, and for this reason were referred to as "Flesh-flies." And yet, curiously enough, among all the works which I have been able to consult upon this subject I have been unable to find a single recorded instance where a fly of this kind has ever been bred from flesh in this country. On the other hand, I find several instances on record where specimens of Sarcophaga have been bred from living insects.

The earliest case of this kind is that recorded by the late Abbé Provancher, who, in the second volume of *Le Naturaliste Canadien* (p. 18) records having bred a specimen of Sarcophaga from a chrysalis of the Cabbage Butterfly (*Pieris rapae* Schrank). In his Seventh Report on the Insects of Missouri (pp. 180-181), Prof. Riley records having bred a species of Sarcophaga from various kinds of locusts, as also from the Mantis (*Stagmomantis carolina* Burm.), and from the common Walking-stick (*Diapheromera femorata* Say); and in the Fourth Report of the U. S. Entomological Commission (p. 107), he states that a species of Sarcophaga infests the larvæ and chrysalides of the Cotton Moth (*Aletia xyliana* Say). More recently Prof. Townsend has characterized, under the name of *Sarcophaga cimicis*, a species bred by Mr. Aldrich from cocoons of the American Cimex (*Cimex americana* Leach; see the *Canadian Entomologist* for May, 1892, pp. 126-127). In foreign countries *Sarcophaga lineata* is reported to prey upon locusts in the vicinity of the Dardanelles, referred to on page 59 of Appendix VIII, Third Report of the U. S. Entomological Commission. And in the *Agricultural Gazette* for May, 1891, is given a figure and description of a two-winged fly which is stated to infest locusts in various parts of Australia; this fly is there referred to the Tachinidæ, and to the genus Masicera, but judging from the figure and description it clearly belongs to the Sarcophagidæ.

In order to give as far as possible a complete account of the known

habits of the Sarcophagidæ, I may add that in *Psyche* for February, 1892 (pp. 220-221), Prof. Townsend describes a *Sarcophaga helicis* as having been bred from a living snail by Mr. Surface. In his Seventh Report on the Insects of Missouri (p. 181), Prof. Riley states that the larvæ of *Sarcophaga sarraceniæ* feed upon dead insects, and in his Ninth Report (p. 95) he states that they also feed upon the eggs of locusts. A few days ago, Dr. A. Davidson, of this city, submitted to me two male specimens of an undescribed species of *Sarcophaga* which he had bred from larvæ found feeding upon the eggs of the spider, *Phidippus opifex* McCook. These flies differ from the above description of *Sarcophaga opifera* only in the following particulars:

Antennæ black, the third joint one and a half times as long as the second, arista plumose on its basal half, bearing one long hair on its upper side beyond the outermost long one on its lower side. Face with two irregular, widely separated rows of bristles each side. Palpi black. Hind margin of the fourth abdominal segment black, genitalia grayish black, the lower half polished black. Length $6\frac{1}{2}$ to 8^{mm}.

It may be named *Sarcophaga davidsonii* in honor of its discoverer. From the above observations it is very evident that in their habits the Sarcophagidæ are much more closely related to the Tachinidæ than is commonly supposed to be the case.

A NEW SWEET POTATO SAW-FLY.

(*Schizocerus privatus* Norton.)

By C. L. MARLATT.

In the first volume of *INSECT LIFE* (pp. 43-45) an illustrated account was given of a rather rare saw-fly (*Schizocerus ebenus* Norton) which had suddenly appeared in very destructive numbers in the summer of 1886-'87, attacking and nearly destroying the sweet potato crop of Mr. C. Werkle, of Ocean Springs, Miss. Injury to the sweet potato from this insect has not again been brought to my attention. A year ago, however, attention was drawn to injury by the larvæ of a saw-fly to the sweet potato crop in Virginia by the receipt, July 6, 1891, from Mr. G. W. Stockley, of Keller, Accomac County, of specimens of the young larvæ, together with one male and three female flies. (See Extracts from Correspondence, *INSECT LIFE*, vol. IV, p. 74.) The specimens were turned over to me by Prof. Riley for study and report.

Examination of the adults showed that they belonged to a distinct species, but one closely allied to the one mentioned above. This new sweet potato pest belongs to the same genus as the former, and was originally described as *Schizocerus privatus* by Mr. Edw. Norton from

a single female specimen collected at New Orleans, La. (June, 1867, Trans. Am. Ent. Soc., p. 26.)

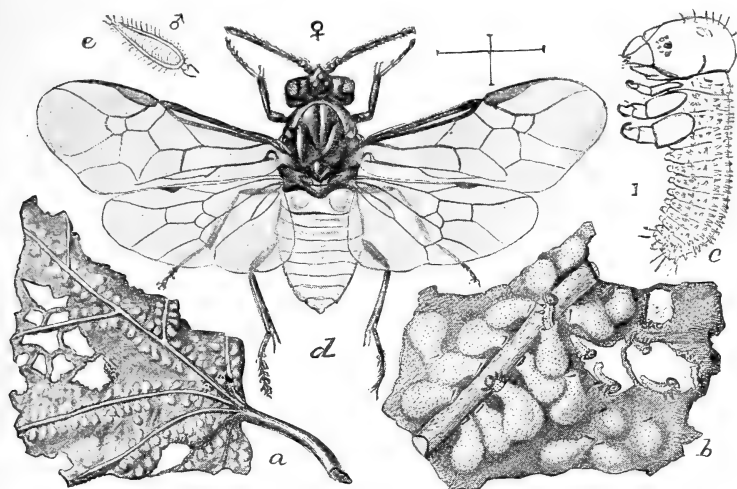

FIG. 6.—*Schizocerus privatus*: a, portion of leaf showing arrangement and appearance of egg-sacs; b, portion of same more enlarged, with escaping larvæ; c, newly-hatched larvæ; d, female fly; e, antenna of male; all enlarged except a (original).

The insect has hitherto been a very rare one, and in fact the male of it has never been described. In a collection of Tenthredinidæ, recently received at the Department for determination from the Michigan Agricultural College, were a number of specimens of both sexes of this species, taken in Michigan; and there is a specimen, bearing the locality label "Nebraska," in the collection of the American Entomological Society of Philadelphia.

The female (Fig. 6 d) is nearly twice the size of the common house-fly, and is shining black, including the legs, except the basal joints (coxæ and trochanters) of the hind pairs; the abdomen is reddish yellow, including also the lateral and ventral portion of the metathorax. The wings are very smoky, almost opaque. The antennæ of the female is simple and consists of three joints, of which the last is very long; in the male this last joint is bifurcate, as shown at e. The male is also considerably smaller than the female, and differs from the latter still further in being entirely black except the legs, which are whitish in part. In coloration this species is almost identical with *S. ebenus*, except that in general the colors are brighter and more sharply defined in the former. The female is, however, more than twice the size of the latter species and much more robust, which differences also hold true, but to a less extent, in the case of the males of the two species. Other important differences may be noted as follows:

As compared with *ebenus*, the head of *privatus* is much less trilobate when viewed from above; the antennæ of the female are more filiform

and the forked joint in the males is relatively shorter. The two species differ also somewhat in venation. With *privatus* the costal and subcostal veins are very broad, very much reducing or almost obliterating the costal cell, which in *ebenus* is of ample proportions. The third submarginal cell is in the former species considerably widened above on the side of the radial nervure, and the third transverso-cubital nervure, which forms the outer border of this cell, is decidedly curved outward, whereas in the latter species the inner and outer bordering nervures are nearly straight and parallel. The under middle cell of the hind wings, also in *privatus*, is only about one-third the length of the upper, while in *ebenus* this cell is at least one-half the length of the upper cell.

In the male of *ebenus* the tibiæ and tarsi are smoky white, the two posterior pairs being darker; in *privatus* these parts are much lighter, almost pure white, except that the tip of the posterior tibiæ is distinctly dusky together with the extremities of all the tarsi.

Mr. Stockley's letter relating to this insect has already been published, but is here reproduced:

I have sent you by today's mail a box containing some flies and their eggs on some sweet potato leaves. Last year was the first time they made their appearance in my potato patch. They came the 1st of July and deposited their eggs on the eaves; when the eggs hatched these worms would eat the leaves to a comb. This continued for about four weeks. The potatoes, wherever the fly was, did not make any yield at all. This year the fly made its appearance at the same time they did last year. Will you please tell me what kind of a fly it is and whether it will do any serious damage?

The deposition of the eggs in the under side of the leaf by the female fly is shown, natural size, at *a*. It will be seen that they are placed for the most part in parallel rows bordering the principal veins, the incisions of the ovipositor being next to the veins. When first deposited the position of the egg is shown by a circular or oval blister, at one side of which is the discolored slit in the epidermis made in inserting the egg. As is the case with saw-flies generally the egg expands considerably before the hatching of the larva—increasing the prominence of the blister-like spot—and on the emergence of the young larva through the slit left by the ovipositor the blister is lengthened and gives the pouch-like or guttiform appearance shown enlarged at *b*.

None but young larvæ were received, and these, together with the other material, were dried and no opportunity offered to obtain the later stages.

The larvæ closely resemble those of *ebenus*, figured in the article cited on that species, both in general appearance and in the disposition of the spines on the body. A newly-hatched larva is shown in outline at *c*.

A single cocoon of this saw-fly was received, from which a very handsome Tachinid parasite was reared. The cocoon is about five-sixteenths

of an inch long, oval, and is constructed of a loose mesh of a brownish silky or glutinous material.

I hope another year to get additional material and complete the study of the biology of this interesting insect or that this fragmentary account of it may lead others more favorably situated to supply the facts now lacking in relation to the later larval stages and hibernation.

Prompt application of the arsenicals will doubtless be an effective remedy for this insect, though judging from analogy, hellebore will also prove effective, and, other things being equal, preferable.

ON THE NOMENCLATURE AND ON THE OVIPOSITION OF THE BEAN WEEVIL.

(*Bruchus obtectus* Say.)

In double number 9 and 10 of the last volume of INSECT LIFE (pp. 297 to 302) we published editorially a popular article upon the Bean and Pea Weevils, referring to the former under our old name of *Bruchus fabæ* Riley, promising, however, in a foot-note to discuss the question of synonymy in a succeeding number of this publication.

At the time (1870) when we originally proposed the new name of *Bruchus fabæ* in our Third Report on the Insects of Missouri (p. 55) we paid considerable attention to the matter of its validity as a species. Up to that time the weevil bred commonly from cultivated beans had been considered by most coleopterists, following the authority of Dr. George H. Horn, to be identical with Say's *Bruchus obsoletus*. We showed that it differed from *obsoletus* in the following points:

Obsoletus is a smaller species, dark gray, with the antennæ all dark, the pygidium not rufous, the thorax with a perceptibly darker dorsal shade so that the sides appear more cinereous, a white scutel, and each interstitial line of the elytra with a slight appearance of alternating whitish and dusky along its whole length; for though there is nothing in Say's language to indicate whether it is the interstitial lines that alternate transversely, whitish and dusky, or each line that so alternates longitudinally, I find from an examination of a specimen in the Walsh collection that the latter is the case, and so much so that the insect almost appears speckled. The two species differ both in size and color, though, as Say's description is short and imperfect, it is not surprising that *fabæ* should have been referred to it.

Prior to the time of our description the Bean Weevil had been for several years labeled in eastern insect collections "*Bruchus fabæ*," and this name was disseminated by F. G. Sanborn and credited to Fabricius. We could find no notice of the species in any of the writings of Fabricius and for that reason adopted the eminently appropriate name *fabæ* for our own.

In 1872 we were informed that Dr. Fitch had described the Bean

Weevil under the same name *Bruchus fabæ*, and wrote him under date February 4, 1872, as follows:

I have been expecting a fulfilment of your promise to write to me. I am especially anxious to make the proper corrections as to the nomenclature of *Bruchus fabæ*, in my forthcoming report; but can not well do so until I receive from you the paper in which you originally described it under that name or a copy of it. Can you not send it?

This, however, was toward the end of the working career of the celebrated New York State Entomologist, and we received no reply.

Eighteen years later Mr. Scudder bought Fitch's manuscript notes from Dr. A. E. Foote, of Philadelphia, and gave them to the Boston Society of Natural History. Mr. Samuel Henshaw, the Assistant Curator of the Society, began arranging them somewhat after the manner of the Harris manuscript, and among the note-books found our letter just quoted. He found, moreover, notes by Fitch bearing upon the point, and was kind enough to copy them and send them to us (October 7, 1890) as the first reference he had seen to *Bruchus fabæ* Fitch. We give the transcript from Fitch's notes:

In August, 1860, I received from W. R. Staples, secretary of the Rhode Island Society for the Encouragement of Domestic Industry, a small parcel of beans infested by insects, the result of my examination of which I communicated to him in the following letter, which was published in the Transactions of the Society for that year, page 62, this volume having been issued in February, 1861.

He stated in the accompanying communication that the stored beans in the city of Providence were quite generally preyed upon by this insect. I subsequently learned it was common in and around the city of New York and other places along the seaboard, and from complaints made by prisoners in the late civil war of the wormy beans furnished them for food, and which were so loathsome to them, I infer this insect to be common through the Southern States. Mr. Riley having received specimens from Massachusetts ticketed as being the *Bruchus fabæ* of Fab., and finding no such name in the works of Fab., described it as a new species under this name in his Third Report, page 52 [*sic*]:

The confusion regarding the existence of a *Bruchus fabæ* Fab. is further explained in Dr. Fitch's notes as follows, the "Boston entomologist" being probably Mr. F. G. Sanborn referred to above:

Specimens were sent from Rhode Island in 1862 to the Boston Entomologist, probably ticketed "*Bruchus fabæ* Fh." The abbreviation was no doubt misread "Fb," and thus this has become common in the collections as a Fabrician species. Mr. Riley, finding Fabricius had described no species under this name, gives it as a new species in his Third Report, page 55. What is here presented will clear this matter of the misapprehensions which have been so widely prevalent.

Fitch's conclusion in regard to the matter is undoubtedly correct. The misapprehension was a most natural one, but fortunately the confusion arising therefrom was not very great. Mr. Henshaw also forwarded to us a proof slip (also found among Fitch's notes) of Fitch's letter to the secretary of the Rhode Island Society for the Encouragement of Domestic Industry, giving his description of the Bean Weevil under the name of *Bruchus fabæ*.

We append for wider circulation a copy of Fitch's published letter previously referred to.

W. R. STAPLES:

Secretary of the Rhode Island Society for the Encouragement of Domestic Industry:

DEAR SIR: Whoever inspects beans infested with the insect which you send me will at once infer that this depredator is closely akin to the well-known Pea-bug, or Pea weevil, as it might better be called—the *Bruchus pisi* of Linnæus—the beans being perforated with large round holes, similar to those in the pea, where the insect has escaped, or presenting a discolored spot, under which is a round cavity, in which the creature is still lying; the only important difference being, that as the bean is a much larger fruit, several holes, usually as many as six and sometimes twelve, are bored in it, instead of the single hole which we see in peas. And on inspecting this insect, I find it to be a weevil so similar in its general appearance to that of the pea that persons who have not made this class of animals a special study would probably infer it to be the very same insect, somewhat modified in consequence of its being reared upon slightly different food. But on close inspection, it will be found to differ essentially from that insect, in many points of its structure and colors.

From the examination I am at present to make, I do not recognize this as a species that has been heretofore described. I infer it has but recently been noticed in your vicinity, and it would hence appear to have been introduced, probably, from some foreign country. It, however, is unlike the *Bruchus rufimanus* and *granarius* common insects in Southern Europe, which prey upon beans in this same manner. In addition to these, I see a Brazilian species has been named *B. phaseoli* by M. Chevrolat, a name implying it to subsist on the bean, but I have not the work of this author at hand. Upon a kind of wild bean growing in Indiana, Mr. Say met with a beetle which he names *B. obscurus*, which appears to approach nearer to this insect than does any other species to which I can refer. Under the circumstances, the best service I can render will be to present a name for this insect, with such a description of it as will serve to plainly distinguish it, and thus open the way for future researches to determine whether it really is a species which has lurked unnoticed in the world until the present time. I would therefore name it the Bean-weevil (*Bruchus fabæ*). It is slightly smaller than our pea-weevil, its length being from $\frac{1}{100}$ to $\frac{1}{100}$ of an inch. It is of a black color, more or less densely coated over with tarnished yellowish gray pubescence, and is particularly distinguished from other species by having the four first and last joints of its antennæ, and all its legs, of a rusty or pale dull yellowish color, with only the under side of the hind thighs black. Along the middle of its thorax is a faint whitish stripe, which has an impressed line at its hind end. Its wing-covers have impressed lines or striæ, the interstices between which are alternately of a faint whitish color, this color, being most clear and distinct along the middle of the third interstice between two faint blackish spots, which are placed on this interstice, a few other blackish spots being also perceptible here and there, outside of this. The abdomen or hind body is pale dull yellow, with a black band on the fore part of each joint, and its flattened tip, beyond the ends of the wing-covers, is obscure grayish, with a faint whitish stripe along its middle. On the under side of the hind thighs, near their end, is a little projecting spine, like the point of a thorn, with a similar very minute one at its hind base, followed by a more minute, blunt-pointed one.

The habits and transformations of this insect will probably be found to vary but little from those of the pea-weevil; and the same remedies doubtless will be as efficacious against the one as the other. It is generally known that the Pea-weevil rarely injures the embryo or germ of the future sprout, and that "buggy peas" may consequently be used for seed; though the plants from them will probably be puny and feeble during the first stages of their growth. This Bean-weevil is a more invet-

erate enemy, for in most instances I find the germ is devoured, rendering the beans as worthless for seed as they are for food.

We have for some time intended to discuss this matter in print, but in the meantime Dr. Lintner in his Seventh Report on the Insects of New York has gone quite fully into the matter in his usual thorough and characteristic manner, and has republished Fitch's letter to the secretary of the society above mentioned.

Dr. Lintner doubts the propriety of adopting Say's names for this Bean Weevil, and although he writes, under protest, Say's name *obsoletus* at the head of his article, thus following the nomenclature presented in Dr. Horn's Revision of the Bruchidæ, he is nevertheless of the opinion that custom, and even the rules of nomenclature, would justify us in writing *Bruchus fabæ* Fitch. We are so fully in accord with his views that we quote the following paragraph:

It would better accord with custom and rules of nomenclature if, instead of clinging pertinaciously to Say's name in the belief that we know the insect to which it was applied, that it be rejected on the ground of its having been accompanied with merely a definition—without description such as leaves no room for reasonable doubt. Such rejection has been repeatedly made, as notably with scores of Walker's "species." In that event—as the description of Dr. Fitch unmistakably indicates our Bean Weevil, and as it has priority of and fully accords with the *varicornis* of LeConte, the *fabæ* of Riley, and the *obsoletus* of Horn—"obsoletus Say" would give place to *fabæ* Fitch.

The reasons which we gave in 1871 for considering the Bean Weevil distinct from *obsoletus* seem to us as good to-day as they did then, and we have since obtained substantial indirect evidence against Dr. Horn's claim. Say mentions having found *obsoletus* on a species of *Astragalus* from which he also obtained *Apion segnipès*. We have always believed that *obsoletus* would be rediscovered, and have for years sought to ascertain more of the food plants of our Bruchidæ. Now in Mr. Schwarz's collection we have a *Bruchus* in connection with this very *Apion segnipès* on *Tephrosia virginiana* near Washington, and this *Bruchus* agrees in size and all other characteristics fully with Say's description of *obsoletus*, and further corresponds, as we distinctly recollect, with the specimen thus marked which we referred to as having seen in Walsh's old collection, thus indicating that the species occurs likewise in the Mississippi Valley. With all due respect to authority, therefore, we think that the case against our Bean Weevil being *obsoletus* is sufficiently made out, and that we must not follow Dr. Horn in his rather arbitrary conclusion. In point of fact, as all who have gone over the descriptions carefully will admit, *obtectus* Say, which precedes *obsoletus* in the descriptions, is more plainly referable to our Bean Weevil. Under the strict law of priority, therefore, our Bean Weevil should be written *Bruchus obtectus* Say.

In reference to the European nomenclature of our Bean Weevil, Baudi, in his monograph of the European Bruchidæ (Deutsch. Ent.

Zeit. xxxi, 1887, p. 48) doubtless has some good reason (such as the examination of original types) for identifying *obtectus* Say as *irresectus* Fahræus. But we can not see that he has any good reason for giving it precedence in time over Say's name. On the contrary, chronologically, the synonymy of the species would in our judgment stand thus:

- 1831—*Bruchus obtectus* Say.
 1833—*Bruchus leguminarius* (Chevrolat) Gyll.
 1839—*Bruchus irresectus* (Schönherr) Fahræus.
 1839—*Bruchus pallidipes* (Chevrolat) Fahræus.
 1854—*Bruchus subellipticus* Wollaston.
 1861—*Bruchus fabæ* Fitch.
 1867—*Bruchus breweri* Crotch.
 1871—*Bruchus fabæ* Riley.
 1873—*Bruchus obsoletus* (Say) Horn.
 1889—*Bruchus subarmatus* Janson (?=*subarmatus* Gyll.).

Bruchus varicornis Lec. is a manuscript name; *B. obscurus* (Say) Fitch is a *lapsus calami* for *obsoletus* Say; while *B. acupunctus* Chevr. appears to be a mere label or manuscript name. Baudi (*l. c.*, p. 49) indicates that *irresectus* is labeled in the Turin Royal Museum as (*Mylabris*) *acupuncta* Chevr. from Louisiana, and that a second specimen is also labeled (*M.*) *leguminaria* Chevr., this last probably sent by Chevrolat himself. Thus, aside from the fact that the description of *leguminarius* tallies very well with our Bean Weevil, we have this identification by Baudi.

To sum up the question of nomenclature, our Bean Weevil, on the strict law of priority, must be known as *Bruchus obtectus* Say until someone shall resurrect some hitherto unrecognized and earlier published name that can be proved to refer to it.

It is a widely distributed species, according to the authorities, having been reported from Central and South America, Madeira, Canaries, Mediterranean countries, the Alps, western France, Spain, Persia, etc. It is doubtless cosmopolitan, like so many species carried by commerce in stored products, and its wide distribution and the early European references to it really make it questionable whether it is to be considered any longer as a native American species. This question acquires an additional interest from the consideration that if it were once determined not to be an indigene it is improbable that Say would have found it on any wild leguminous plant.

OVIPOSITION IN THE FIELD.

Notwithstanding the wide distribution of the species it is only during the present year that its habits in the field have been in any way carefully studied. It is not necessary in this connection to repeat anything in reference to the oviposition of the species in stored beans, as we have fully described the method and the eggs on page 300 of vol. IV, INSECT LIFE. We realized, however, that more careful observations were needed as to the habits of the species in the field, as we have for

some time doubted whether the eggs found on bean pods were really those of this species. It has been currently stated that the eggs are laid on the bean pods something as in the case of the Pea Weevil, and it is true that eggs are found upon bean pods fastened very much as those of *Bruchus pisi* are fastened to pea pods; but upon carefully comparing them with those laid upon stored beans we find that the two do not fully agree, the former, in color and form, more nearly resembling those of *B. pisi*. We were thus forced to the conclusion that there was some other species working upon beans in the field, as we know there are other species working upon stored beans. Thus we received in January, 1885, *Bruchus quadrimaculatus* Fabr., swarming in what are called "black-eyed table beans" from Texas that were exhibited at the Atlanta Cotton Exposition. In oviposition in the stored beans this species differs from the common Bean Weevil under discussion in that it deposits its eggs in the beans. We have also received an allied species, *Bruchus scutellaris*, in 1885 from Mr. F. M. Webster, breeding in beans from the New Orleans Exposition. It is more than probable, therefore, that the eggs which are attached externally to the pods of beans in the field belong to one or the other of these last-mentioned weevils, and in fact they correspond in form and color with those of *B. quadrimaculatus*. Realizing that more careful observations were needed as to the habits of the common Bean Weevil in the field, and having a number of different kinds of dwarf beans growing in our garden at "Sunbury" the present summer, we have made a point of looking more carefully into the matter, and our examination showed that the parent *Bruchus obtectus* invariably oviposits within the pod, either using her jaws to make a slit or hole in the pod through which to insert the eggs, or waiting until the beans are sufficiently ripe to cause a partial opening of the pod, and then thrusting the eggs into the slit in masses. The perforation is almost always made along the ventral suture near a funiculus, and the eggs are most abundantly found within the pods that have already turned yellow and which contain the fully developed beans. Another peculiarity is that the post-embryonic larva, while capable of eating its way into the bean, very much prefers to enter through some perforation already made by one of its associates, so that in the same bean several larvæ are frequently found with but one perforation, all having entered through the same hole. That the eggs are frequently thrust into the green pod, though we have not yet found them in such, is proved by the fact that green pods which have been isolated have given out a number of beetles whenever the beans have been fully developed within them, though the pods themselves show no perforation. This would indicate that in the green pods the punctures close up. The development is very rapid, and at Washington beans taken from the field give out the mature weevils from the second week of August on, and commence at once to propa-

gate again. We have also been not a little astonished at the great abundance of the beetles reared from beans gathered in the field. From one of the green pods above alluded to, gathered July 15, we had obtained by August 15 no less than 62 individuals, and from a pod that was mature and yellow when gathered we have obtained no less than 91 beetles. The largest number of eggs which we have found in a single pod is 82, and these were thrust at the anterior end through a hole that had been gnawed by some Lepidopterous larva and not made by the parent weevil.

In size there is also very great variation, some specimens being really smaller than the typical specimens of the true *obsoletus*.

We hope in a forthcoming number to give all our notes on the food habits of the Bruchidæ.

NOTES ON THE HABITS OF SOME SPECIES OF COLEOPTERA OBSERVED IN SAN DIEGO COUNTY, CAL.

By F. E. BLAISDELL, M.D., *Mokelumne Hill, Cal*

BUPRESTIDÆ.

Chrysobothris femorata Fab.—Pupæ and beetles have been taken from their burrows in the bark of the trunk of the Live Oak (*Quercus agrifolia*.)

Chrysobothris semisculpta Lec.—Bred from the half-dead limbs of Apple and Live Oak.

Chrysobothris californica Lec.—Extremely injurious to apple trees.

CLERIDÆ.

Cymatodera ovipennis Lec.—Larvæ taken from the burrows of *Ipochus fasciatus* in *Rhus integrifolia*. An immature beetle was taken from its cell in one of the burrows November 18.

PTINIDÆ.

Sitodrepa panicea Linn.—I have taken the beetles in large numbers from the following dried, compressed medicinal plants as they occur in drug stores: *Conium maculatum*, *Populus tremuloides*, *Hepatica triloba*, *Salvia officinalis*, *Hyoscyamus niger*, *Chimaphila umbellata*, *Borago officinalis*, *Convallaria multiflora*, *Leontodon taraxacum*, *Melissa officinalis*, *Origanum marjoramum*, *Aralia racemosa*, *Celastrus scandens*, *Mentha piperita*, *Spiræa tomentosa*, *Asclepias syriaca*, *Atropa belladonna*. Does considerable damage to herbarium specimens.

Polycaon stoutii Lec.—Bred from Live Oak. Have taken it from burrows in almond trees and *Eucalyptus globularis*.

Polycaon confertus Lec.—Bred from larvæ found in the Live Oak and Almond. The beetles of both species of *Polycaon* have been observed to bore burrows into living trees.

Psoa 4-signata Horn.—I have bred this species from the dry prunings of the Grape-vine. Have observed the larvæ and pupæ in the dead stubs on living vines. Beetles appear in March, flying about in the vineyards during the heat of the day.

Lyctus striatus Melsh.—Bred from the branches of *Quercus agrifolia* and *Q. dubiosa*.

CUPESIDÆ.

Cupes lobiceps Lec.—Observed in all stages of development in the decaying stumps of the Live Oak.

CIOIDÆ.

Cis dichrous Lec.—Bred from a species of fungus which grows upon the Live Oak.

CERAMBYCIDÆ.

Ergates spiculatus Lec.—Larvæ obtained from the decaying roots of coniferous trees.

Prionus californicus Mots.—The larvæ of this species live in the decaying and rotten stumps and roots of the Live Oak. They never attack the living or sound wood. The beetles are plentiful at evening about groves, during July and August.

Phymatodes obscurus Lec.—I have bred this beetle from branches of the Live Oak.

Eme gracilis Lec.—Bred from the dead wood of *Quercus agrifolia* at Poway.

Elaphidion imbelle Lec.—Larvæ of this species plentiful in the dead wood of the Live Oak. The beetles are common beneath bark in August.

Megobrium edwardsii Lec.—Two beetles taken from beneath the bark of the Live Oak; one was just about to escape from its burrow.

Xylotrechus nauticus Mann.—Abundant about Live Oak groves during the months of July and August. The larvæ and pupæ have been taken from the dead branches and trunk of the Oak. The beetle is both diurnal and nocturnal in its habits, becoming active near the middle of the afternoon, continuing so until late in the evening. This insect is of considerable economic interest, being one of the few which commits serious damage to the wood of the *Eucalyptus globulus* in the United States. Several years ago it was stated by the tree-growers that Eucalypti were free from the ravages of pests, and that the wood was valuable for wagon-work, posts, etc., which greatly increased the

number planted. After a time many were cut down and piled to season with bark *in situ*; after several months' time the logs were overhauled and found to be perforated in all directions by a borer. The canals were filled with excrementitious matter; the subcortical furrows formed a dense network over the surface of the wood, partly involving the bark. Logs a foot in diameter were completely perforated. Many dead and living beetles were taken from the burrows; numerous larvæ were also obtained. Actual experience proved that such logs were absolutely useless even for posts, as rapid decay was induced by the entrance of moisture to the deeper parts.

Desmocerus auripennis Chev.—Bred from the dead wood of *Sambucus glaucus*.

Ipochus fasciatus Lec.—Larvæ taken from the wood of *Rhus integrifolia* at Coronado, and *Rhus laurina* at Poway.—*I. pubescens* Casey is similar in habits.

CHRYSOMELIDÆ.

Lema nigrovittata Guer.—In both the larval and imaginal states feeds upon the leaves and flowers of *Datura meteloides*. The eggs are laid in clusters of four to eight on the under side of the leaves. The larvæ cover themselves with excrement. They also feed on the cultivated *Datura*, *Burgmansia*, and *Cestrum aurantiacum*. *Sinea diadema*, a predaceous Hemipteron feeds upon the larvæ.

Trirhabda luteocincta Lec.—The larvæ and beetles feed upon *Artemisia californica*. The larvæ first appear in February, and after attaining their growth descend into the ground to pupate. The first beetles appear by the last of April.

Haltica torquata Lec.—Feeds upon the leaves of the Grape-vine and *Adenostoma sparsifolia*.

TENEBRIONIDÆ.

Phlæodes diabolicus Lec.—I have taken the larvæ and pupæ of this species from the decaying stumps of the Live Oak. These beetles feed on a large, tough species of fungus which grows upon the Oak. Once I took thirty specimens from one large fungus.

Iphthimus levissimus Casey.—An immature beetle was taken from a stump of a Live Oak.

Gnathocerus cornutus Fab.—Observed in all stages of development in ground cereals of the stores.

CALANDRIDÆ.

Scyphophorus acupunctatus Gyll.—I have found this species upon the trunks of grapevines at Poway; it feeds upon the sap.

Scyphophorus yuccæ Horn.—Feeds upon the sap of the *Yucca whipplei*. The larvæ live within the caudex.

Micracis hirtellus Lec.—Bred from dead Willow at Poway.

Chætophlæus hystrix Lec.—I have bred this rare beetle from the dead wood of *Rhus integrifolia*.

Pityophthorus digestus Lec.—Associated with the preceding species and bred from the same wood.

LUCILIA NOBILIS PARASITIC ON MAN.

By FR. MEINERT.

[Translated by MARTIN L. LINELL from the Særtryk af Entomologiske Meddelelser, 1 Bind, 3 Hefte, 1888.]

It is an old story that the human body is subject to attack from several ecto- and endo-parasitic insects, and a whole literature is cited by Hagen on *Insecta in corpore humano*. It is principally Dipterous larvæ that are recorded and described as occurring in the stomach, or vomited through the mouth, or in the intestine or ejected through the anus, or carried out with the urine, or occurring in the nasal cavities, or finally living beneath the skin, in the eyes or in the ear. All recorded cases are not reliable, and the present author will not deny that he belongs to the skeptics in regard to many published stories, and he also thoroughly doubts that any Dipteran is sufficiently specialized to live exclusively in or upon man, not even excepting the South American *Lucilia hominivorax*.

In recent years Dr. G. Joseph, in Breslau, has applied himself to the subject of diseases caused by or accompanied with attacks by Dipterous larvæ, and he has established or more definitely determined a peculiar form of disease—Myiasis or Fly-disease—in several chief forms, partly as *Myiasis dermatosa muscosa* (caused by Muscidæ) and *M. der. æstrosa* (caused by *Æstridæ*), partly as *Myiasis interna* and *M. septica*. Among the Dipterous larvæ mentioned by Joseph the larvæ of *Sarcophila wohlfarti* may be of special interest. The fly was raised from larvæ that occurred in the nasal cavities and in the ear of man, first by Wohlfart (1770) and more recently and in larger numbers by Portschinsky (1875-'84), who has satisfactorily studied the species. At large the fly is very rarely found. Joseph gives in his essay "Ueber *Myiasis externa dermatosa*, 1887," a description of the fly and its larva.

At the end of August, 1887, I received from Dr. A. Iverson a dozen rather small Dipterous larvæ that were said to have been taken from the ear of a man with ear discharges, and which he thought he got by sleeping on the grass. The larvæ came in glycerine and were partly shriveled up, and I therefore did not think fit to do anything with them, but wrote back that it was probably *Sarc. wohlfarti*, although

this species had not hitherto been known to occur in this country. A few days later I received from Prof. R. Bergh two larvæ, coming from the same patient, but this time they were alive, and in the glass vial with them I also found pieces of muscle and small fat cells in decomposition, wherein the larva moved freely and in a lively manner. The next day one of the larvæ had already quit the putrefying and malodorous mass and had pupated on the inside of the stopple, and the next day also the other larva was found to have pupated. I successfully raised the fly, and after ten to eleven days there emerged a pair of insects, which, however, were not the expected *Sarc. wohlfarti*, but belonged to the genus *Lucilia* - *L. nobilis* Meig. Of this genus we have with us eight species, of which one (*L. cæsar*) is one of our commonest green metallic flies. That the fly reared is one of our rarest species of *Lucilia* I do not think of any importance in regard to the special habitat of the larva, as all the eight species resemble each other so much as to cause mistakes, and it is not reasonable that one of them should have a mode of living, different from the others, in regard to parasitism on man. Besides it is already known that this genus in Europe occurs with man, but it is recorded as a rule only as vomited from the stomach. Finally, I will only remark that in the possession of Dr. Borries I have seen a pair of this species, reared from larvæ, coming from the above-mentioned patient at the general hospital.

The following is an extract from the hospital journal:

A seaman took a bath at the seashore and afterwards lay down to sleep on a sunny spot near the shore and close to a cave; seaweed was in the neighborhood. Awakening he felt a strong humming in his ears and had a sensation of water in them, which in the next few days changed to strong pains that prevented him from sleeping and were followed by discharge of blood and pus from both ears, but especially from the left, and from his nose. Was taken to the general hospital August 21. Complained of heavy tormenting pains in both ears, from which flowed pus mixed with blood. After cleansing with water there were discharged, especially from the left ear, some white maggots (dipterous larvæ), which seemed to stop up the ear cavity. Could not hear a pocket watch close to his ear. Nose and ears both attacked. Complained August 22 continuously of pains, especially in his left ear, which seemed filled up with living maggots, of which some regularly leave at every washing; no maggots found in his right ear. August 23, only one large maggot was discharged, and he himself thought that this was the last one. The otoscope showed strong constriction of both ear tubes, etc. The discharge soon stopped completely.

BIOLOGIC NOTES ON NEW MEXICO INSECTS.

By C. H. TYLER TOWNSEND, *Las Cruces, N. Mex.*

The observations herein published have been collected from time to time on the native insects of this Territory, especially of the southern portion. As it is not practical at this date to publish them in station bulletins, they are offered here, especially as they are of much scientific

and considerable economic importance and will add not a little to our knowledge of the southwestern fauna.

COLEOPTERA.

Rhizophagus sp.—Collected a large number of a small, elongate beetle of this genus on a living 12-foot flower stalk of *Dasyilirion wheeleri*, in Soledad Cañon, Organ Mountains, May 23. The beetles were distinctly seen to be eating into the young paniculate flower buds, which were at this date just developing beneath large protecting scales on the main stalk. Under these scales the beetles were numerous and not only the embryo flowers, but the stems which held them, had been extensively eaten. Beetles determined by Dr. H. Skinner; plant by Mr. W. H. Evans.

Gyascutus planicosta Lec.—This large Buprestid was found July 8 on mesquite bushes (*Prosopis juliflora*) and later on flowers of the same. On July 17 great numbers were seen on flowers of *Larrea mexicana* or Creosote Bush. When found on the flowers they are covered with pollen, giving them a rich yellow color. Determined by Dr. Skinner.

Thryncopyge alacris Lec.?—This is a beautiful Buprestid of an orange yellow and purplish blue or green color. It bores the dead standing last year's flower stalks of *Dasyilirion wheeleri*, the eggs being undoubtedly inserted when the stalk is green. The dry stalks are very woody and hard, and dead imagoes of this species were found in them August 22, in the San Andres Mountains. Almost every last year's *Dasyilirion* stalk in this region is bored and tunneled throughout its length by this Buprestid. On May 18 large numbers of live pupæ were found in the stalks and a very few larvæ. The larvæ were apparently about full grown, and these are undoubtedly last year's stalks. This Buprestid requires but one year for its transformations. Some of the pupæ were beginning to assume the chitinized condition and color of the imago, but most of them were still white. The pupa of a hymenopterous parasite was found in a thin silken cocoon in one of the burrows. May 29 to 31, eight of these beetles emerged from sections of stalks which had been placed in breeding cages. Identified by comparison with plate of Mexican Buprestidæ, in *La Natureza*, by Dr. Eugène Dugès.

Macroductylus uniformis Horn.—The *Macroductylus* referred to in *INSECT LIFE* (vol. IV, p. 26), proves to be this species. It has been found eating the leaves of grapevine (l. c.). Determined by Dr. Skinner.

Anomala binotata Gyll.—Several taken May 23 on flowers of *Robinia neomexicana*, in Soledad Cañon. Determined by Dr. Skinner.

Allorhina mutabilis Gory.—This was referred to as *A. nitida* both in *INSECT LIFE* (vol. IV, p. 26) and in *Bulletin No. 3, New Mexico Station* (p. 15); and later as *A. sobrina* var. (on authority of Dr. E. Dugès), in *Bulletin No. 5, New Mexico Station* (p. 10). It has recently been determined by Dr. Skinner as this species.

Prionus californicus Mots.—The borers mentioned in *Bulletin No. 5,*

New Mexico Station (p. 9), under head of "Root-Borers," belong to this and perhaps one or two other species. An adult captured here was determined by Dr. Skinner as this species.

Tragidion armatum Lec.—This Cerambycid bores the flower-stalks of *Yucca angustifolia*. On May 24 and 30, adults of this species were found gnawing green flower-stalks, in some places; on latter date numerous fresh scars were noticed. I could, however, discover no eggs beneath these scars. On May 19 of the following year, a fully transformed adult was found within its burrow in a dead and dried last year's flower-stalk of this *Yucca*. It was apparently just ready to emerge from the stalk, as it was very active. Determined by Dr. Skinner.

Schizax senex Lec.—On April 14 a small specimen of this species was found, transformed and dead, in a gallery in dead wood of a growing Apricot tree. It had changed to the beetle in a little horizontal burrow or cell at the top of its rather long vertical gallery. Determined by Dr. Skinner.

Sphanotheucus suturalis Lec.—A pair of this longicorn was taken *in coitu*, July 8, on Mesquite (*Prosopis juliflora*). Determined by Dr. Skinner.

Pachybrachys atomarius Melsh.—May 12 and later this species was beaten from Mesquite (*P. juliflora*). Very probably feeds on this plant. Determined by Dr. Riley.

Chrysomela exclamationis Fab.—Taken in small numbers, through June, on Sunflower (*Helianthus* sp.). Determined by Dr. Skinner.

Chrysomela dislocata Rog.—Taken June 29 and 30 on *Malvastrum* sp. Determined by Dr. Skinner.

Diabrotica tenella Lec.—On page 16 of Bulletin No. 3, New Mexico Station, this beetle is referred to as *D. 12-punctata* Oliv., of which it has been considered a variety. It is there recorded as eating tender leaves and blossoms of peas in April. It is found through July on Squash, Sorghum, and many other plants. September 1 it was received from Mr. F. E. Downs, of Eddy, N. Mex., with report that it was eating everything—trees, vegetables, and even potatoes. Mr. Downs's ranch is in the Guadalupe Mountains, about 35 miles from Eddy, and at an elevation of about 5,000 feet. Determined by Dr. Skinner.

Haltica foliacea Lec.—This beetle was referred to on page 6 of Bulletin No. 3, New Mexico Station, as *Graptodera chalybea* Illig. Found through June on the vine and on a tall weed (*Enothera* sp.?), the leaves of which it had perfectly riddled with holes. July 8, and for some time previously, reported on Apple, particularly young trees. On July 24 it was received from Mr. Downs, of Eddy, N. Mex., with report that it had just destroyed the leaves for him on 1,000 apple grafts. Determined by Dr. Skinner.

Cryptoglossa laevis Lec.—This Tenebrionid is very common in houses here, but is met with only in the adult state. It is crepuscular, and

emerges at night from holes and cracks in the walls. One day in March, after a slight rainfall, several dozen of these beetles were counted crawling from holes in the ground near the base of an adobe wall in one of the streets of the town. Determined by Dr. Skinner.

Pyrota postica Lec.—This large black and yellow Meloid occurs very numerous on *Larrea mexicana*, or Creosote Bush, particularly on the flowers. Determined by Dr. Skinner.

Myodites nevadicus Lec.—Two specimens of this Stylops-like beetle were taken on flowers in May and June. I am strongly of the opinion that this is the adult of a parasite which I have taken from the abdomens of our common yellow social wasp, *Polistes aurifer*. Determined by Dr. Skinner.

Eupagoderes decipiens Lec.—Beaten May 10 from flowers and foliage of Mesquite (*P. juliflora*). Whether or not they breed in this shrub, it is certain that they feed on it in the perfect state. The jaws of each of three specimens taken were gummed with the greenish chlorophyll upon which they had evidently been feeding. These beetles were infested with red mites. Determined by Dr. Skinner.

Pandeletejus cinereus Horn.—Beaten in large numbers from Mesquite (*P. juliflora*), May 12 and later. It was noticed *in coitu* May 16. It may breed in the Mesquite pods. Determined by Dr. Riley.

FURTHER NOTES ON THE NEW HERBARIUM PEST.

By C. V. RILEY.

My friend Mr. R. McLachlan, of Lewisham, England, has kindly called my attention in connection with the article on "A New Herbarium Pest," INSECT LIFE, vol. IV (pp. 108-113), to the fact that a similar insect, viz, *Acidalia herbariata* Fab., has long been known to injure herbarium specimens in Europe, but is perhaps more injurious in herbalists' shops than in museums, and that the figure of our American insect looks a good deal like it.

The descriptions of *Acidalia herbariata* show it to be allied to *Carphoxera ptelearia*, but, nevertheless, when carefully compared, the two are found to be very different structurally. Dr. F. J. M. Hylaerts gives, in the *Annales de la Société Entomologique de Belgique*, 1878 (vol. XXI, pp. 5-8), the fullest descriptions accessible of the larva and pupa of *A. herbariata*, and notwithstanding the minuteness of the descriptions, no mention is made of the structural characters to which I called attention, both in the larva and pupa of *Carphoxera*. The colorational marks are also quite different, though in this respect, so far as the larva is concerned, they are admitted to be quite variable. *Acidalia pusillaria* Hübner (Samm. Eur. Schm., Geom. Fig. 99) and *A. microsaria* Boisd. are synonyms of *herbariata*, Fabr., and neither of these

last-mentioned authors gives any characterization that would indicate the structural peculiarities of *Carphoxera*. The other figures (Fischer v. Rosl., Pl. 61; Dup. v, Pl. 173, Fig. 5) accessible of *A. herbariata* also show a different insect, but as both figures and descriptions are often defective, I was anxious to be able to compare actual specimens, and though I have been unable so far to obtain the adolescent states of the European insect, I have obtained a pair of the imagos through Dr. Staudinger. They confirm the differences, and show the European moth to be twice as large, more glossy, and differently marked in detail.

Aside from colorational differences, therefore, *Carphoxera ptelearia* is easily distinguished from *Acidalia herbariata* by the spatulate tubercles of the larva, by the lateral projection on the fifth abdominal joint of the pupa, and by much smaller size, more pulverulent, less glossy scaling, and different markings in the imago.

Coming, as the American insect evidently did, from the more arid regions of Mexico and the Southwest, it did not occur to me to look into the European literature of the subject of Lepidopterous herbarium pests, and the statement in reference to *Carphoxera* that "this is the first true Geometrid, so far as I know, recorded as feeding on dry and dead vegetation," should have been qualified by "in America." I note also that according to Guenée *Hyria auroraria* has a taste in the larval state for dry leaves.

Dr. J. N. Rose informs me that Mr. S. Parrish, of San Bernardino, Cal., reports a similar larva in his herbarium, while the following extract from a letter from Walter H. Evans, of Crawfordsville, Ind., March 7, 1892, would indicate that the species has been introduced there also from Arizona plants:

Just after your paper in the Botanical Gazette on a new herbarium pest, I found three larvæ in some Arizona plants of last season's collecting, which I intended sending you, but failed to do so. They were mislaid, but if I can find the box in which I placed them, shall still do so. The plants most attacked were Pentstemon and Castilleja, which were riddled.

THE AUSTRALIAN ENEMIES OF THE RED AND BLACK SCALES.

Mr. Koebele's hopes that in *Orcus chalybeus* he had found and sent to California an insect which would prove as important an enemy of the Red Scale as *Vedalia cardinalis* proved for the Fluted Scale, seem so far not to have been justified. Under date of June 8, Mr. Coquillett wrote us as follows:

In regard to *Orcus chalybeus* I will say that yesterday I spent several hours looking for them among the orange trees where I turned some of them loose from time to time, and found several of the beetles. The last that I turned loose in this locality was about two months ago (April 15). Those seen yesterday were enjoying the luxury of doing nothing. It has now been over six months since I received the first

consignment of these early birds (November 28). In the year 1888, the first *Vedalias* reached me November 30, and by the next June they had cleared several trees of *Icearya* and I had sent many colonies to various fruit-growers. The statement that has been published, that the *Orci* would be to the Red Scale what the *Vedalia* has been to the *Icearya*, comes wide of the mark. They are not one-tenth as efficient as the *Vedalias*. From the last consignment received from Koebele, May 14, I selected about twenty-five specimens of *Orcus chalybeus*, of both sexes, and placed them in a large glass jar supplied with orange twigs infested with Red, Black, and Soft Brown Scales and Aphids, replenishing the jar every few days with new material; I kept the jar in my office and examined it at short intervals, but up to date not an egg has been laid, nor have I seen the beetles paired. *Orcus australasiae* has acted in the same way. Under similar conditions, *Leis conformis* paired and laid eggs freely, and I have its larva in the fourth stage. *Psyllobora galbula?* also paired and laid eggs when treated in this way. Of course, it is possible that the *Orci* may require very hot weather before they propagate freely. It has been exceptionally cool here thus far this spring. They have not done any better under a tent inclosing an infested orange tree. It is quite certain that both species of *Orcus* are permanently established here.

July 27 he again wrote us, giving the results of further observations, which, while proving that this ladybird is now reproducing in California, gives no added hope of rapid multiplication and the consequent value of the species as a destroyer of the Red Scale:

Yesterday I examined the orange and lemon trees in this city where I had turned loose the living specimens of *Orcus chalybeus* received from Mr. Koebele prior to the middle of April. About three-quarters of an hour was spent in searching for these insects, and during that time one cluster of eggs, a nearly grown larva, a dozen pupæ, besides several empty pupa cases, also a dozen beetles, were found, mostly upon the tree upon which I originally placed the beetles, a few being found upon the trees immediately adjoining this one. The results of this examination confirm my previously expressed opinion that this species is now established in this State beyond a peradventure.

The following description of some of the early stages of *Orcus chalybeus* has also been transmitted to us by Mr. Coquillett, and we take the first opportunity to place it upon record:

ORCUS CHALYBEUS.

Egg.—Light lemon-yellow, smooth and polished, except the upper end, which is very scabrous; form, elongate-oval, being slightly over twice as long as its greatest diameter; length, $1\frac{1}{2}$ mm.

Attached at one end, which is slightly flattened. Deposited on the upper side of an orange leaf in a cluster numbering five eggs.

Mature larva.—Body whitish, marked each side with a subdorsal and a suprastigmatal row of black spots, situated at the base of the spines, the spots darkest in the center, not extending upon the first segment, the two spots on each side of the second segment united into a single spot, as are also those on the third segment, these spots being more conspicuous than those on any of the remaining segments: first segment bearing twelve spines, six in a transverse row on the front edge, an oblique pair each side near the middle of the segment, and two subdorsal spines near the hind margin of this segment, one on either side of the middle of the dorsum; second segment bearing eight spines, four in a transverse row, and below each of the lowest ones is a pair of spines placed longitudinally; each of segments three to seven bears six spines arranged in a transverse row; segments eight, nine, and ten each bears four spines arranged in a transverse row; segment eleven bears a single pair of spines

arranged transversely, while the twelfth or last segment is destitute of spines; the spines above mentioned bear several lateral and apical bristles, those at the apex being somewhat over one-half as long as the spine itself; the spines are quite dusky, except those lowest down on each side of the body, which are white; length, nearly 7 mm.

When about to pupate the larva attaches itself by the hind end of its body to a leaf or other object, and the old larval skin splits open from the head to the ninth segment.

Pupa thinly covered with a light-yellow pubescence, light citron-yellow; head nearly surrounded with blackish; first segment marked with two oblique black spots on the dorsum, second segment marked with two similar but much larger spots, third segment marked with two smaller black spots, fourth segment marked with two dusky dots which are scarcely apparent; fifth, sixth, seventh, and eighth segments each marked with two somewhat transverse black spots, those on the sixth and seventh segments larger than any of the others; wing-cases bordered above with black; length 5 mm.

The other species of *Orcus*, namely, *Orcus australasiae*, however, seems to be doing better. Mr. Coquillett formed this impression some time since, and further observations confirm its correctness. He finds it difficult, as above stated, to rear *O. chalybeus* in confinement, since the larvæ appear to attack only the recently hatched scale-insects. The larvæ of *O. australasiae*, however, being larger and stronger than those of the other species, tear off the hard shell of the Red Scale and feed upon the insect itself. Moreover, it breeds more surely. From some cause, climatic or otherwise, *O. chalybeus* is unsuccessful in transforming in the majority of cases. For instance, out of a cluster of five eggs of *chalybeus*, attached to the upper side of an orange leaf at one of Mr. Coquillett's breeding stations, only a single egg hatched, and out of eight pupæ collected at the same time, only two produced beetles.

EXTRACTS FROM CORRESPONDENCE.

On the Carbon Bisulphide Remedy against stored Grain Pests.

Allow me to add an important item in the method of keeping weevils and rats out of a corn crib, by the use of the vapor of bisulphuret, or bisulphide, of carbon.

The improvement I expect to make this year is to place on the floor of the bin an oblong box made out of two 12-inch boards, the upper part coming to a sharp point. The box is to be long enough to run two-thirds through the bin, boxed up at the inner end to give it support. There is to be for a few feet from the inner upper edge an opening cut out about half an inch wide to give free vent for the vapor to penetrate the corn. The necessity of this arrangement is, after the bisulphide has disappeared by evaporation, to replace it with a fresh supply. This is to be done in particular to keep out rats the year round. One good fumigation of the vapor is sufficient to kill the weevils, but it will take somewhat a continuation of the evaporation to keep out rats.

As you are aware, the bisulphide of carbon is a highly volatile fluid, and the contents in an open bottle will readily disappear by evaporation. To replenish the fluid by the use of the long box, say every few months, would be all that is required, and instead of using several bottles at once imbedded in the corn, I would use but

a single bottle at a time. By this method the experiment will be brought to a successful issue, and the expense of protecting a bin of corn is not materially increased, but rather diminished.

To place a bottle of bisulphide in the box described, take a wooden shovel with a little box attached at the end of it to snugly hold the bottle. Let the handle be about an arm's length shorter than the box. Before introducing the fluid I would close up the bottle with a few layers of muslin, and by the aid of the shovel place it inside of the box, nearly to the inner end, leaving the shovel with the bottle inside; then close up the entrance at the door with old bags or something of the kind.

I learn that some have apprehensions as to the personal safety in using the bisulphide of carbon, and the effect it may have on the corn. As I have ascertained by experiments, the line of ignition is close to the body of the fluid itself, therefore there is no danger in taking a light into the bin. As to the effect on the corn, everything is in its favor. My last year's corn treated with the carbon proved that hardly a kernel failed to germinate, and the shucks were eaten by the stock, I thought, with unusual relish. The cause of this is obvious. The corn grew rapidly and with vigor, and was considered the best in the neighborhood. Whether the bisulphide had anything to do with it, I will not say; but I am somewhat inclined to think it had. We know that solutions of some of the metallic salts have a tendency to stimulate favorably the growth of seed that is immersed in it.

I only know of one great danger in handling the bisulphide, in which I nearly lost my own life. The experimenter may pour it into the opening of an ants' nest, to destroy them, and safely ignite it at the hole with a match. After the explosion it leaves for a while an invisible flame at the opening. If he is tempted to recharge the opening from a full bottle of the fluid in his hands it will explode and send him without a moment's notice into the other world!

It is supposed that nearly 50 per cent of the corn in Texas is annually destroyed by weevils and rats. The destruction is so great that nearly all the corn used in this part of the State comes from Kansas.—[G. P. Hachenberg, M. D., Texas, June 25, 1892.]

On the first Use of Paris Green for the Potato-beetle.

Yours of recent date, asking for corroborative testimony about my having used Paris green for poisoning Potato beetles in 1867, was duly received. In reply I can only say that I can find nothing of published record to confirm my statement. Twenty-five years make sad havoc with memories as well as with friends themselves. Those who are still alive of my friends gave the subject so little thought that they have no idea of the date. The newspaper which published the clergyman's article suspended publication about eighteen years ago. Its then editor and the clergyman who wrote the article have been dead many years. So you can see the difficulty in my way. But I am positive in the date. The fact that I let slip a grand opportunity to make money out of the discovery is not the least among many reasons why I have the date firmly fixed in my mind.—[Byron Markham, Michigan, June 3, 1892.]

REPLY.—The Entomologist regrets the absence of corroborative testimony concerning your use of Paris green against the Colorado Potato-beetle in 1867, and though he has no reason for doubting your statement the record as he has published it is justified and can not well be altered.—[June 7, 1892.]

A Vineyard Pest, *Anomala marginata*, in North Carolina.

I forward by this mail some specimens of a beetle for identification. It appeared about the time the "Rose Bug" disappeared, about June 10. I had noticed it during former seasons; but only isolated specimens appeared. Now, however, the beetles are swarming in great numbers and have done much damage, notably on a plant of one-year-old grapevines, where the foliage presents the appearance of lace work. They

have not attacked the berries at all. They are also attacking the foliage of apple and plum trees. I do not find them on pear. I have been deterred from trying the effects of spraying the vines with arsenites, because of the advanced growth of the berries, but find that the Bordeaux mixture has no effect on them. Unlike the "Rose Bug," they make a prolonged stay, and for that reason are greatly to be dreaded. I have destroyed them by thousands, by shaking them off the vines, into pans of water with a little kerosene oil in them. I find no difficulty in doing this, as they let go the moment the leaf is touched. On reaching the ground they burrow like a mole, and as quick as a wink. I have kept all my available force at work for some time destroying them as above mentioned; but, as they have apparently come to spend the summer, this method, in a large vineyard, is very expensive. Any information you can give me regarding preventive or destructive agents and their use will be thankfully received.—[John K. Hoyt, North Carolina, July 8, 1892.]

REPLY.—The insect injuring your grapes and apples is a Scarabæid beetle, *Anomala marginata*, previously mentioned in INSECT LIFE, Vol. I, p. 220, as injuring the Vine in Texas. This species has not hitherto been noticed as far as we know to attack the Apple and Plum. Spraying with one of the arsenicals would be the most certain and thorough remedy, but, as you say, in the case of advanced growth of the berries such spraying might be attended with some danger. If you could spray the other plants which are also attacked by the insect, its numbers would doubtless be greatly reduced. You might also try dusting the vines with lime or spraying them with a 15 per cent dilution of the kerosene emulsion, either of which would probably make the vines distasteful to the insects and cause them to seek elsewhere for food. The method of destroying them which you have followed, namely, by shaking them into water with a little kerosene, is a good one, except for the fact that it is a temporary expedient and does not deter fresh hordes of beetles from attacking the vines.—[July 13, 1892.]

A "White Grub" Pest of Sugar Cane in Queensland.

It has been in my mind for some time to write you concerning an insect which interests Queensland planters in a very practical way and about which I hope to interest you. Our plantations, particularly those devoted to the growth of Sugar Cane, are just now suffering from the ravages of a dreadful scourge in the shape of a grub, very like the larva of the *Lachnosterna fusca* of your country. This grub literally swarms in nearly all the cane fields the whole length of the Queensland coast. I can give you many facts to show the extraordinary voracity of this pest and the extent of its ravages. One planter assured me that upon an estate of 1,000 acres he has lost 400 acres of cane. Another figures his loss during the past at between £4,000 and £5,000 sterling. Cases of this kind might be multiplied almost indefinitely.

I may say that the insect itself is known as *Lepidiota squamulata*. So far planters are powerless in its presence. The only attempt at circumventing it is made by hand picking. In the South Sea Islands a boy follows every plow with a four-quart tin pail, and very frequently he is able to fill this pail in going across a small field. The traveling inspector of the Colonial Sugar Refining Company tells me that upon one of their plantations they have during the past season picked of these grubs no less than 700 pounds weight from a single acre. You do things in a large way in America, but can you beat this?

I have recommended the planters to try kainit, which I see referred to in INSECT LIFE as having been useful in the case of cutworms and other underground larvæ, but so far the kainit has not the slightest influence in checking the ravages of this grub. Can you suggest anything in the way of a remedy? If you can only give us a hint in this direction that is at all workable I can promise you that your reputation in Australia, great as it now is, would be made so far as we could make it. I notice in one of the American papers a statement to the effect that a French com-

pany is sending out hermetically sealed vials containing a fungus which is said to be most destructive to larvæ like the one under consideration. Do you know anything about it?

I get INSECT LIFE regularly and value it highly. * * * [E. M. Shelton, Queensland, Australia, June 8, 1892.]

REPLY.— * * * The insect which you report as so seriously affecting sugarcane plantations on the Queensland coast is, from the very nature of the case, as you will readily see, a most difficult one to counteract. The occurrence of this insect and its work have never been brought to my attention and its habits in the imago state are altogether unknown to me, though I doubt not similar to various American Lachnosternas. In this country, particularly here in Washington, we have very successfully treated lawns infested with white grub by soaking the ground with kerosene emulsion, as described in the first volume of INSECT LIFE on page 48, and I believe that this will perhaps prove to be the only practical remedy against your insect. The emulsion of kerosene could be distributed by means of some of the injecting devices manufactured in France for use in disinfecting vineyards of the Phylloxera with bisulphide of carbon, and this latter substance, too, would be an effective remedy against the grub were it not for the expense of applying it on so large a scale. The expense of the application would also be a great obstacle to the use of kerosene emulsion, though this last would be much cheaper than the bisulphide. At this distance and in entire ignorance of the habits of the adult insect, I can give you no further advice as to the best remedies. It is possible that the food-habits of the adult insect will furnish a more easy and practical, not to say cheaper, method of controlling it. This would be the case if the beetle is known to feed on any plant which could be sprayed with Paris green or London purple. I should be glad to get specimens of the insect in all stages, and also, if you can furnish it, a full account of its habits in other than the larva state.

With regard to the White Grub fungus which the French firms are advertising, I have no confidence whatever in it. I have experimented with it and believe that the results have been generally overstated and that the fungus is being pushed merely as a speculation. * * * [July 14, 1892.]

A Snout-beetle, *Otiorhynchus ovatus*, under Carpets.

Inclosed please find a number of beetles found under the edge of a carpet. Have been noticed by a number of families in this vicinity under carpets. Would like to know whether they eat the carpet or prey on the "Buffalo Bug" which has been destroying the carpet under which the inclosed were found. Would be pleased to learn the name, habits, and something of the life-history of these insects.—[Paul Van Riper, Michigan, July 27, 1892.]

REPLY.—The beetles which you find under carpets in your vicinity belong to the species known as *Otiorhynchus ovatus* Linn., of the Snout-beetle family Otiorhynchidæ. This insect is common to Europe and Siberia and was doubtless introduced at an early date, although the first record of its occurrences here was published in 1873. It is a northern species, being restricted to our most Northern States and Canada, and is in some localities commonly known as "the graveyard bug." In the Annual Report of the State Board of Agriculture of Michigan for 1883 (pp. 425-429) Mr. C. M. Weed gave an account of the main facts in the life-history of the insect, proposing for it the name "Strawberry Crown Girdler" from the habits of the larva of girdling the crowns of the Strawberry. Prof. A. J. Cook found the adults of this species feeding on the leaves of Borage, and it is probably, like a congeneric and closely related species, *O. sulcatus* Fab., a very general feeder. A short account of the latter will be found in vol. IV of this periodical (pp. 222-223).

Your experience in finding these beetles congregated indoors is interesting but not unprecedented. In the Michigan report, above referred to, brief mention is made of Dr. J. A. Lintner's having found a house swarming with them, and in Dr. Lintner's

Second Report of the injurious and other Insects of the State of New York a precisely similar instance is recorded. No explanation, however, has been offered of the phenomenon. This species is strictly phytophagic and it would be as impossible for it to feed upon the carpets as it would be to prey upon the "Buffalo Bugs." The beetles are nocturnal, and hide in dark places by day, venturing forth at night to feed. They are also gregarious and wingless.

A possible explanation of this occurrence in dwellings offers itself. They might have been feeding on vegetation of some sort in the immediate vicinity of, and probably actually in contact with, the house infested. With the approach of day they would naturally seek some dark hiding place, and after crawling into the house were unable to find their way out. This would be the more likely in dwellings covered at some point with climbing vines.—[August 2, 1892.]

The Grape-seed Weevil.

I send for your examination a few grape berries punctured by an insect, same as I attempted to describe in letter to you last January, and in reply to which you said there were two insects which punctured grape berries and asked me for specimens.

I am glad to say I can furnish but few specimens this year, my vineyard being almost clear of them, whilst last year my whole crop as well as my neighbors', were destroyed. I have sprayed with Bordeaux mixture five times this season and so far have been clear from black rot. I have not gathered a pint of rotten berries from two acres of grapevines. My neighbors who have not sprayed report only a defective berry here and there, consequently can see no difference between sprayed and unsprayed vines.—[Thos. R. Walker, Kentucky, July 25, 1892.]

REPLY.—Examination of specimens sent shows that your grapes are infested by the so-called Grape-seed Weevil (*Craponius inæqualis*), which is one of the most difficult insects to fight. If you knew the exact time at which the insect laid its eggs something might be done in the vineyards, if not too large, by jarring the insects upon sheets saturated with kerosene, and it is likely, as is the case with the Plum Curculio, that the weevils feed for a time in the spring before the grapes are large enough for egg laying. If this should prove to be correct a spraying with an arsenical solution would destroy them before they have an opportunity to oviposit.—[August 1, 1892.]

A new Enemy of Cotton.

I send three specimens of insects. The little black ones are doing great damage to cotton blossoms. The speckled one was with them, but not so numerous. The long one was also engaged in eating the cotton blossoms. In looking over a ten-acre plot of cotton, at least one-fourth of the cotton squares were stripped of their leaves. Would like to know about them, and remedy.—[J. S. Davitt, Polk County, Georgia, July 12, 1892.]

REPLY.— * * * The "little black" beetle is *Luperus brunneus*, of the family Chrysomelidæ, or leaf-beetles. This is known to injure the blossoms of hollyhocks and the silk of corn, but has never been reported before as a serious enemy of cotton. The "speckled" beetle is *Megilla maculata*, one of our commonest species of lady-birds (Coccinellidæ). Since its food consists mainly of plant-lice, which are so abundant on Cotton, it must be considered as a beneficial insect. The "long" specimen is *Monocrepidius vespertinus*, of the family Elateridæ, or click-beetles. It has frequently been observed to feed on the leaves or blossoms of cotton throughout the whole cotton belt, but it is not common enough to do any serious damage.

It is safe to say, therefore, that the damage you complain of has been caused by the *Luperus* mentioned above, and if this species should continue to be troublesome I would advise the use of the arsenites as practiced against the Cotton Worm.—[July 29, 1892.]

Corn as a Trap Crop for the Boll Worm.

My mind is made up now concerning the protection afforded tomatoes by corn. My tomatoes suffered badly during the presence of second broods of worms in June. No silks in corn 200 yards away. Third brood of worms plentiful in corn in silk; no worms in tomatoes in same patch. At a neighbor's farm, a second brood of worms ate or bored into at least 50 per cent of tomatoes; corn not in silk. Third brood plentiful in corn when in silk; no worms in tomatoes in same patch. The above verifies observations of last season, though my object then was to test preference for host plants then in my garden. We say that at other gardens, not referred to above, have found conditions as mentioned, and I am perfectly satisfied that any tomato crop can be protected by judicious use of corn, by crushing the first brood in the tops of corn early in and throughout May, or by planting an extra early variety of corn that will be in silk by the 1st of June. * * * The fourth brood of worms will be at work about August 15 in trap corn that is planted for protection of cotton, and which, I am certain, will prove satisfactory in every instance tried. I fully indorse the report of your able field agent, Mr. Mally, on every practical point, and would emphasize all he says in the strongest terms concerning corn as a trap for the worms—plantings adapted to the appearance of the different broods; in fact, I believe it to be the only sure and certain way to protect a cotton crop. Poisons should be abandoned, for reasons set forth on page 53, Bulletin 26, of your Division. Tried them thoroughly last season. Lights are a failure, as proved under all circumstances, and, as I conceive, our only hope is trapping in corn, colonizing the worms, and centralizing natural enemies.—[S. B. Mullen, Mississippi, July 18, 1892.]

Silk Gut from native Silk-worms.

I am endeavoring to breed the larvæ of *Attacus cecropia*, *A. polyphemus*, and *A. luna*, with a view to obtaining silk gut stronger and longer than that at present furnished to anglers by that of the *Sericaria mori*. I have already a good supply of eggs awaiting development, and if you could give me any hint as to food or method of keeping and rearing I shall esteem it a great favor.—[John Harrington Keene, New York, June 27, 1892.]

REPLY.—* * * You will have little difficulty in rearing the larvæ if you inclose them upon a branch of the tree upon which they naturally feed. Use a very large mosquito-netting bag for this purpose, and watch it carefully to see that no holes are worn into it through which a bird could get entrance. The *cecropia* can be reared to the best advantage upon Apple, the *polyphemus* upon Elm, Maple, or Willow, and the *luna* upon Beech, Butternut, Birch, or Liquidambar. The Department has never furnished eggs of any insect except the Silk-worm of commerce, and since July, 1891, has not been able to furnish even these, since Congress has abolished the work of the silk section. I shall be glad to learn the results of your experiments.—[June 28, 1892.]

Corn Stalk-borer in Virginia.

Accompanying this are some stalks of corn badly eaten by worms. These are some of the worst specimens, but whole fields are attacked. Please give me your best method of counteracting them, or of preventing their depredations. They seem to be increasing every year, and with dry or unfavorable weather they may destroy the corn crop. With fine growing weather the corn seems to be strong enough to overcome their effects in a measure.—[P. C. Waring, Virginia, June 23, 1892.]

REPLY.—The insect which is damaging your corn is the Larger Corn Stalk-borer (*Diatrea saccharalis*). This species has been treated in Nos. 3 and 4, volume IV, INSECT LIFE, where you will find all the information we have to give. If, after reading this article, you have any additional facts to convey, the Entomologist will be very glad to receive them.—[June 28, 1892.]

A Leaf-roller on Shade Trees in Colorado.

We send specimens of the Canker-worms which infest our trees. In all cases they seem to start on the Box-elder trees, and from that drift over to the Maples, Elms, and finally even affect the Spruce trees. We have found the spraying you recommend to be very efficacious.—[The Roberts Hardware Company, Colorado, June 23, 1892.]

REPLY.— * * * The larvæ which you send and which were infesting your Box-elder shade trees can not be called Canker-worms, as they belong to the so-called Leaf-rollers (family Tortricidæ). The species is in all probability the Box-elder Leaf-roller (*Cacæcia semiferrana*), described and figured by Professor Gillette upon pages 10 to 15 of Bulletin No. 19 of the State Agricultural College Station, Fort Collins, Colo., although it differs in some respects from the published description. I would advise you to send to that station for a copy of this bulletin.—[June 28, 1892.]

Coloring Matter of the Plant-louse of the Golden Rod.

Two or three plants of Golden Rod have appeared in my garden, and have been allowed for variety to remain. During the last two years I have noticed immense gatherings of a reddish insect. A kind of ladybird assembled with them, and I noticed that whenever any of the insects were crushed a deep-red fluid remained. As I got the impression that these insects were "Buffalo Moths" I destroyed them. This year, however, they appear again, and now I find myself impressed with the idea that these insects are similar to, if not the actual Cochineal of commerce. As you are aware, the Cochineal bugs feed on the Cactus plant, are scraped off, killed in hot water, dried and sold for dye. This merchandise comes from Mexico. As I can not decide this matter I send you, for inspection, a cluster. I do not know that the ladybird is a progenitor—she may be only a visitor.—* * * [John P. Ellis, Flushing, N. Y., May 10, 1892.]

REPLY.—* * * The reddish insect which you notice upon Golden Rod is a plant-louse known as *Siphonophora rudbeckia*, and has no connection whatever with either of the insects you mention. The ladybirds which you notice among the plant-lice were feeding upon them. I can not refer you to any published account of any experiments with these bright-colored plant-lice in view of utilizing the coloring matter commercially. Some twelve years ago some experiments in this direction were instituted by the late Dr. W. S. Barnard, then of Cornell University, with this identical species, but they resulted in failure, from what cause we are unaware.—[June 14, 1892.]

NOTES FROM CORRESPONDENTS.

Spread of the Horn Fly.—A correspondent in Uniontown, Pa., writes us that the Horn Fly has made its appearance in that vicinity, having first been noticed last season and having become very abundant the present summer. While spending a few weeks in Greene County, N. Y., we noticed this insect in comparative abundance, but not yet numerous enough to attract attention to the habit of congregating upon the horns. Another new locality has been given us by Mr. J. H. Woodruff, of Watertown, Conn., who has found the fly to be very abundant in his vicinity, and still another locality is Waller County, Tex. We are indebted to Mr. F. W. Thurow for specimens from this region. During the month of August complaints have also come in from quite a number of correspondents, among others from the following: Elisha Slade, Bristol County, Mass.; Miss E. J. Phillips, Cuyahoga County, Ohio; George L. Oliver, Otsego County, N. Y.; Devoe and Shumway, Montgomery County, N. Y.; T. C. Ross, Jefferson County, Iowa; B. F. Koons, Tolland County, Conn.; I. N. Rauls, Citrus County, Fla.

Tent Caterpillars on Hop in Washington.—A species of the genus *Clisiocampa*, allied to the eastern Tent Caterpillar of the orchard, has been doing considerable damage to the hop vines in one or two localities in the State of Washington, as we learn from Mr. Giles Farmin. In one restricted locality they reduced the crop one-half.

An unusual Occurrence of Cicada.—Our old-time correspondent, Mr. B. H. Brodnax, of Brodnax, La., wrote us last May that he had heard the song of the Periodical Cicada on May 3, and asked us to identify the brood. After a careful survey of the field we arrived at the conclusion that the specimens occurring at Brodnax this year must be the precursors of *tredecim* brood XVIII which is due in that locality in 1894, the last appearance having been in 1881. These precursors or stragglers are not uncommon and we often hear of them one year before or one year after the regular year, but an advance of two years is more unusual and is well worthy of record.

The "Stink Bush."—We recently published a note in *INSECT LIFE* relative to the insecticide properties of the bush which is known in the Southern States as "Stink Bush." We were unable at the time to give a proper identification of this plant, but through the kindness of Mr. S. B. Mullen, of Harrisville, Miss., we have received specimens, and are able to state that this plant is *Illicium floridanum*. It is an aromatic shrub belonging to the Magnolia family, and is known perhaps more commonly as Wild Anise. We have had as yet only hearsay evidence concerning the insect-killing properties of this species, but have asked Mr. Mullen, in whose vicinity it grows abundantly, and who is fitted for careful work, to conduct some well-planned experiments and to report.

Further Success of Vedalia in Egypt.—Rear-Admiral Blomfield, to whom we sent several consignments of *Vedalia* for use against Egyptian Fluted Scale, and whose letters announcing the success of the later consignments we have published from time to time, has written us that the beneficial Australian insect has recently made its appearance in a garden in Ramleh, a distance of more than three miles from the original trees upon which the first specimens were reported. The experiment is evidently turning out very successfully.

The Colorado Potato-beetle in the South.—We received in the early part of the season specimens of the Colorado Potato-beetle from Port Royal, S. C., with the report that they are abundant and threatening damage. We wrote the correspondent, Mr. H. D. Elliott, that the locality was too far south to anticipate much injury, that the insect had made sporadic appearances at different points in the same locality, and had disappeared almost immediately, so that he had not much to fear. Within a month from the date of our communication the insect disappeared and it has not been seen since.

The Rascal Leaf-crumpler in Texas.—This insect, which frequently does great damage to orchard trees, has recently made a most destructive appearance in the vicinity of Houston, Tex., a locality from which it has not heretofore been reported in numbers.

Extraordinary Abundance of the Oak Pruner.—Mr. Jno. B. Watson, of Philadelphia, has sent us specimens of twigs of Black Oak from Bucks County, Pa., which have been cut off in great numbers by the Oak Pruner (*Elaphidion villosum*). Mr. Watson writes that cartloads of branches can be gathered up from the ground through the oak forests. We do not remember to have known this insect to be so abundant before. The remedy, however, is simple, and if the fallen branches are collected and burned at this time of the year, or later, the forests will not be harmed to anything like the same extent next season.

The Stalk-borer on Cotton.—That widespread and polyphagic insect, the Potato or Tomato Stalk-borer (*Gortyna nitela*), has recently been doing considerable damage to Cotton in the vicinity of Macon, Tenn. While this destructive species has been reported as affecting almost every cultivated plant which has a stalk big enough to be bored, we have never known it to be injurious to Cotton before to any extent.

A new Locality for *Gossyparia ulmi*.—Mr. C. H. Rowe, of Malden, Mass., has sent us specimens of this interesting imported European bark-louse which he found upon the underside of the limbs of an elm tree at Brighton, Mass. It will be recollected that Mr. Howard treated this insect in Vol. II, pp. 34 to 41, and that it has been previously found in Boston, New York, and Washington.

Dr. Hulst's Collection of Lepidoptera.—We learn from Dr. Geo. D. Hulst that he has donated his collection of Lepidoptera to Rutgers College. The collection is reported to be very rich in Catocala, as we know it to be in the Geometrina and Pyralidina, two groups in which Dr. Hulst has more particularly worked and which he retains for the present in Brooklyn.

GENERAL NOTES.

SUGAR-CANE PIN-BORER AND CANE DISEASE.

We have just received from Mr. J. M. Hart, F. L. S., of the Royal Botanic Gardens of Trinidad, a stylographic circular on the sugar-cane disease and its relation to the Pin-borer, *Xyleborus perforans* Woll.,* together with the following letter of transmittal. The circular is published entire, as it is a matter concerning which we have had considerable to say of late in these pages.

ROYAL BOTANIC GARDENS, *Trinidad, July 12, 1892.*

* * * I have the honor to send you a few notes on our cane disease, which I think perhaps will interest you. I was one of those on the original committee of the agricultural board of Trinidad, who thought that the *Xyleborus* was altogether to blame. Subsequent investigations under the microscope showed that the canes, or most of them, were first subject to the attack of a microscopic fungus, and that the attack of the beetle was subsequent to the attack of the fungus, until the numbers so increased that the insect had for very life's sake to feed upon the nearest available food, *i. e.*, healthy canes. I am one of those persons who, from many years of experience in the cultivation of plants, have come to the conclusion that plants in a weak state, from whatever cause, are liable to the attacks of insects more than those in a healthy state, and that it is the weakness of the plant that invites the insect attack. Plants, it is true, may be attacked when healthy and rendered unhealthy, but the chances are that if in robust health they are well able to fight their insect enemies, and to survive their attack or rather outgrow them. Insect attacks, I believe, often spread and become epidemic in character among healthy plants, after they have been introduced and allowed to increase in abnormal numbers on unhealthy plants

Our canes here have suffered from an alternation of dry and wet years, and as a matter of fact, our sugar-planters never dream of an alternation, but plant cane, generation after generation without change of even the variety cultivated or of the stock with other estates. For long years this has answered, but, though brought up by manures to a state of apparent "vegetative vigor," the canes are actually constitutionally weak and liable to insect and fungus attack in unfavorable seasons. The *Xyleborus* has appeared and is credited with the mischief, simply because the first cause (fungus) was unsuspected and unknown and unseen.

* In recent numbers (vol. IV, pp. 342 and 402) we published notes on what is probably the same insect, viz, *X. pubescens* Zimm. In our first note the species was, through a clerical error, incorrectly referred to as "*X. piceus* Zimm."—EDS.

CIRCULAR.

CANE DISEASE.

In canes from fields which have this year been seriously attacked by the Pin-borer, *Xyleborus perforans* Woll., there has also been observed the mycelium of an unknown microscopic fungus. The attack of this fungus appears in most cases to precede the attack of the borer, and may be known to exist whenever the "red stain" or patch is found to be present. This fungus permeates the cells of the cane, especially at the node, and the affected cells soon give rise to the stain referred to. The *Xyleborus* entering such fungus-infected canes soon completes their destruction. Prof. D. Albuquerque, of Barbados, reports that he is able to confirm the presence of the fungus, and after a further examination, at my suggestion, he has accumulated evidence that the fungus is the original cause of the mischief. He also records that the Bourbon cane is the greatest sufferer.

T. D. A. Cockerell, Esq., of Jamaica, says: "From the known habits of the *Xyleborus* he should expect it to attack canes severely injured in any way by moth, weevil, fungus, or mechanical means." Prof. C. V. Riley, United States Entomologist, says he feels "reasonably sure that the *Xyleborus* is not the culprit." Mr. Cockerell has found on affected canes from Barbados and Jamaica a new species of fungus, which it is proposed to call *Trullula sacchari*. Specimens of infected canes kept under different conditions in Trinidad have also developed one or more species of fungi. The appearance of the fungus on one specimen is very similar to that of the well known *Puccinia granarius* or Wheat Rust. The connection of these fungi with the mycelium of the fungus which permeates the cells of our canes is, however, not yet clearly established. Specimens have been sent for the determination of specialists in this branch, and their reply is awaited with interest. If it be shown that these fungi are of the same character as *Puccinia* a step will be gained, from the fact that that fungus is known to develop in alternate generations on different plants. At one season and in one form on the Barberry and at another season and in another form on Wheat, and we may thus infer that the host plants of our fungus may be found in proximity to each other, and this opens the possibility of our being able to destroy them during some period of their development.

The serious nature of the attack should incite our planters to an endeavor to mitigate the evil as much as possible, by taking care to burn all cane refuse of every kind clean off the fields, and not leave a single particle of vegetable matter in which either the fungus or the beetle could develop.

The greatest pains should be taken also to change the kind of canes cultivated for those of other districts, and as far as possible to cultivate the land alternately with different crops.

NOTES FROM THE JAMAICA MUSEUM.

We have previously noticed an interesting series of stylographic circulars issued by Mr. T. D. A. Cockerell, Curator at Kingston, Jamaica. We are in receipt of Nos. 8, 9, 14, and 15 of the series, and find in them much matter of interest. No. 8 is devoted to the consideration of the deceptive resemblances in nature; No. 9 to the St. Andrew's Cotton Stainer (*Dysdercus andreae*), which we have already mentioned as taking the place of our Red Bug or Cotton Stainer (*D. suturellus*) in Jamaica; No. 14, Scale-insects from Antigua, and No. 15, Sugar-cane pests in Trinidad and Barbados. In No. 9 Mr. Cockerell suggests as remedies for the Cotton Stainer to destroy the wild, native food-plants in the neighborhood of the crop to be protected and to make heaps of the sugar-cane

refuse, cotton seed, etc., to which the insects will be attracted in numbers, when they may be killed by drenching them with hot water. This is an old remedy, recommended by Glover many years ago. In No. 7 seven species of scale-insects are mentioned, while in No. 15 some little consideration is given to the subject of the new Sugar-cane Pin-borer, to which we have just referred in these pages. Mr. Cockerell agrees with us that the insect is not a prime cause of damage to the sugar cane, but follows injury due to other causes.

AN EXPLODED REMEDY FOR THE PLUM CURCULIO.

We are surprised to notice still going the rounds of the press an account, often with editorial indorsement, of a curculio remedy which has long since been proved unavailing. It consists in tying corncobs soaked in molasses on the branches of the tree to be protected, and the theory is that the insect will lay its eggs in the sweetened corncobs in preference to laying them in the fruit!

Another of these utterly worthless pseudo-remedies which, we regret to say, has found space in some of our most valuable journals, is of practically the same nature, except that in place of corncobs the writer advises the use of tomato cans filled with a mixture of molasses, vinegar, and water.

Those of our readers who are interested in this subject are referred to our Annual Report for 1888, where will be found sixteen pages (pp. 64-79) devoted to remedies for this pest.

GOOD WORK OF THE TWICE-STABBED LADYBIRD.

The *California Fruit Grower* has published the statement that Mr. N. W. Motheral procured in 1890 a number of specimens of *Chilocorus bivulnerus* in San Diego County, and placed them in some orchards in Tulare County which were infested by the San José Scale (*Aspidiotus perniciosus*). They did not appear to multiply greatly until last spring, when immense numbers appeared simultaneously and completely cleared the orchards of Tulare County of the scales; trees which had not been sprayed being as completely cleared as those which had been sprayed.

NOTES ON OHIO COLEOPTERA.

We have received from our esteemed correspondent Mr. Charles Dury, of Cincinnati, Ohio, a consignment of specimens, mostly Coleoptera, for the collection of the U. S. National Museum. The following abstract from his correspondence is of special interest as bearing on the life-habits of Coleoptera:

In regard to *Valgus*, we always take *canaliculatus*, by beating vegetation, mostly Haw Apple, while we always find *squamiger* under bark or about dead timber—the form with the prolonged pygidium is always found on dead timber. I never examined this pygidium, but supposed it was a protruded ovipositor. I see on looking closely that it is a prolongation of the pygidium. * * * In regard to the supposed larvæ of *Dryops*, they were from a small stream in Kentucky and found adhering to sub

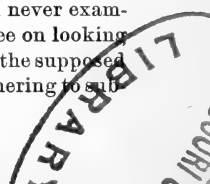

merged twigs in company with *Dryops fastigiatus*. So we supposed they were the larvæ of that species, as no *Psephenus* ever occurred there that I know of.

Saperda calcarata is playing havoc with the Silver Poplar here. They attack the trunks and bore them full of holes, which weakens the tree, and at the first wind-storm the top breaks off at the point. I was out yesterday and beat a number of *Clytanthus albofasciatus* from Wild Grape-vine, and as this was one of your desiderata, I have set aside a pair for you.

THE CLOVER-LEAF WEEVIL IN OHIO.

This insect has been spreading southward since we first treated it in 1882, but has not extended its work to the West as rapidly as might have been expected. In Newspaper Bulletin No. 93 of the Ohio Experimental Station Mr. Webster records it from Lake and Portage Counties, Ohio, and where it seems to have appeared in sufficient numbers to do some damage. We have not before noted the fact that for several years this insect has been very abundant in the vicinity of Washington, D. C. Nothing in the way of remedies seems to have been discovered since the publication of our article in 1882. Where the stubble can be burned during the winter the numbers of the insect can be greatly reduced, but plowing under during May, although it necessitates some loss, will be the most efficacious remedy.

THE JAPANESE GYPSY MOTH AND ITS PARASITE.

It will be remembered that we have been in correspondence with the Rev. H. Loomis, Yokohama, in reference to a *Microgasterin* parasite of the Gypsy Moth of Japan, which latter he supposed to be identical with the same species which is creating such great havoc in Massachusetts at present. The parasite proved to be a new species of the genus *Apanteles*, and on the occasion of a recent visit to this country Mr. Loomis brought specimens with him in the cocoon state, which were turned over to the Gypsy Moth Commission. None of the adult parasites emerged, so far as we have been able to learn. Mr. Loomis called upon us in Washington and we urged him to send specimens of the host insect. This he has recently done, and it turns out that the Japanese Moth is, as we suspected, and as Mr. W. F. Kirby conjectured in an early number of *INSECT LIFE*, different from the European species which has been introduced into this country. The Japanese species is *Oeneria japonica*. It is a larger insect than the Gypsy Moth of Massachusetts, but is so closely related that there is every reason to suppose that this parasite will affect our species. This is all the more likely to be the case as the parasites of the genus *Apanteles* seldom confine themselves to a single species of host insect, while many of them are very general feeders. In fact, we anticipate that some of our native congeneric species of this genus will acquire a taste for the imported caterpillar.

A NEW SUGAR-BEET PEST.

An interesting addition to Mr. Lawrence Bruner's list of sugar-beet insects has come to the front this summer on the grounds of the Sugar Beet Station of the Chemical Division of this Department at Schuyler, Nebr. In the third week in July the experiment plats were found to be badly "ragged" by a small dark-green caterpillar of great activity and voracious appetite. Experiments with different insecticides were immediately instituted by Mr. C. B. Edson, who was temporarily in charge of the work during the absence of Mr. Walter Maxwell. Paris green, Persian insect powder, and white hellebore were tried, with varying results. Specimens of the insect were forwarded to Washington. The moth has not yet been reared, and the caterpillar is new to the national collection. It bears a close resemblance to the Garden Web-worm (*Eurycreon rantalis*=*Loxostege similalis* Gn.), which in 1885 damaged cotton, corn, and different garden vegetables in Kansas, Colorado, Nebraska, Texas, and the Indian Territory, and which we treated at some length in our annual report for that year. The sugar-beet larvæ, however, are darker in color and differ somewhat in the arrangement of the tubercles, but will probably prove to belong to the same genus. In fact, in August Mr. Maxwell sent us specimens of *Loxostege sticticalis* L., which were flying in great numbers and resting on the under sides of the beet leaves, and which will in all probability prove to be the adult of the injurious caterpillar. Unless Mr. Edson's remedial work has been very complete another generation will probably appear the present summer, and we will endeavor to give a detailed account before the close of the season.

THE LARVAL HABITS OF *Thalpochares cocciphaga*.

This interesting little Noctuid moth, which has been imported from Australia on several occasions through Mr. Koebele's assistance, is, as will be remembered by those who have read Bulletin 21 of this Division, an important enemy of the Black Scale in Australia. Mr. Koebele's 1888 sendings were unsuccessful, as the specimens all died after their receipt in California. Recently, however, many other specimens have been received in good condition, and have been carefully placed in advantageous positions upon infested olive trees at Los Angeles. The following extract from a letter recently received from Mr. Coquillett gives an interesting account of the larval habits, but is discouraging in view of their expected efficacy against the Black Scale:

Several days ago I removed about a dozen larvæ of *Thalpochares cocciphaga* from their cocoons and placed them in a box upon some twigs thickly infested with Black Scales. Although the prolegs of these larvæ are abortive, they are furnished with hooks at the tip, and the larvæ are able to crawl about, but they move very slowly and do not use the last, or anal, pair of prolegs, but hold the posterior end of the body slightly elevated above the surface upon which they are crawling. These larvæ are very pugnacious, and whenever two of them meet a fight is almost certain to occur,

each trying to seize with its mandibles the mouth-parts of the other. Occasionally one would thus seize one of the mandibles of its opponent, and would shake the head and forepart of the body of the latter from side to side, somewhat as a terrier shakes a rat, and sometimes his jaws would lose their hold and come together with such force as to produce a distinct clicking sound. They never attack the soft parts of the body, the objective point being the mouth-parts, and these do not appear to become injured in these attacks. Size does not count for much, since a small larva will, without the slightest hesitation, attack one that is twice as large as itself. They appear to enjoy these fights very much; I have seen two of them fight almost continuously for fully ten minutes. Sometimes three of them would be thus engaged, two at a time, changing around so that neither of them would be idle for any great length of time. They do not appear to be very great feeders. During the past four days the above larvæ have devoured only a portion of the Black Scale.

The following is from a later communication (July 11):

I have finally succeeded in obtaining fertile eggs and young larvæ of *Thalpochares cocciphaga*. The egg is turnip-shaped, about twice as broad as high, and with a deep concavity on the upper end, in the center of which is a rounded tubercle; the surface is covered with raised lines forming shallow cells of various shapes and sizes. The eggs are deposited singly. The recently hatched larva, like the full-grown one, is provided with only two pairs of abdominal prolegs, these being on the eighth and ninth segments. The moths remain at rest during the daytime, and become active early in the evening. I have now quite a number of these moths, so that the introduction of this species into California is pretty well assured.

LOCUSTS IN ALGERIA.

We have already published a notice of the locust invasion of Algeria during the past two or three years, and have briefly described the methods employed by the French Government to check their ravages. From a press clipping dated May 19 it appears that the locusts are returning this year in greater numbers than ever, and it is now thought that they come clear across the desert from the Soudan. Great clouds of the locusts, sufficiently numerous in places to fairly darken the sun, have already been seen on the northern edge of the Sahara, and it is believed that they have journeyed northward from the Niger River, in the Soudan, where, about a month before, similar clouds of the insects were reported.

CHANGES OF COLOR IN *Schistocerca peregrina* OL.

In the "Bulletin des Séances de la Société Entomologique de France" for January 27, 1892, M. Künckel d'Herculeis, whose investigations in Algeria of the Migratory Locusts of Africa we have previously alluded to, has an article upon the changes of color which *Schistocerca peregrina* Oliv. undergoes after attaining maturity. Since the inquiry of M. Selys-Longchamps in 1877, on the European appearances of migratory locusts, it has been generally held that *S. peregrina* is represented by two varieties, the one yellow, originating in the north of Africa, and the other rose-colored and originating in Senegal. Olivier himself, in his original description of the species, remarks upon this rose-colored

variety, which has been figured by Audinet-Serville (1839) and described since that time by a number of observers of the insect invasions of Algeria. M. d'Herculais, however, says that his observations establish the fact that all the changes of color which are observed in this species—*i. e.*, from rose-colored to red, to gray, to sienna, to citron yellow—mark so many stages of growth, and serve as a criterion to determine, first, the origin of the invasion, and second, the period when the first egg-laying may be accomplished. For instance, the locusts described in December in the extreme south were of a carmine red; they were hatched at least a month before; they were developed at a distance of at least thirty days' march. They would take several weeks to assume the yellow tint, and could not lay eggs until two months, at least, had gone by. When they had assumed the sienna color pairing and copulation began; when the yellow stage was reached, pairing and copulation were renewed. There may be pairing between yellow males and sienna-colored females, and *vice versa*. The red-colored locusts, which do not pair, and the females of which, consequently, do not lay eggs, are those which the inhabitants of the Sahara gather and eat. The action of light upon the changes of color is very marked; young locusts raised in the shade do not exhibit the vivid colors of their brothers who have lived in the full light of the sun. From these changes of color, M. d'Herculais suspects the presence of zoönerythrine, a red pigment discovered by Merejkowsky in many invertebrates, notably among the Crustaceans, but not described as occurring in insects. It is a substance which corresponds to the hemoglobin in vertebrates.

“GRASSHOPPERS” IN THE EAST.

The extraordinary abundance of local non-migratory locusts, or “grasshoppers,” in different parts of the country last year led us to expect reports of similar occurrences the present season. Up to the present time, however, comparatively few such reports have been brought to our attention. The first notice was in the *St. Louis Republic*, June 17, where it was reported that at Washington, Miss., one planter is stated to have lost 200 acres of cotton through grasshoppers.

No further reports were heard until, during the first part of August, the hoppers made their appearance in the gardens of Hagerstown, Md., making havoc with sweet corn and other garden vegetables. About the same time a number of reports came in from western Pennsylvania. The *Newcastle News* of August 6, the *Lock Haven Express* of August 9, the *Pittsburgh Leader* of August 11, the *Pittsburgh Despatch* of August 17, the *Mauch Chunk Times* of August 15, a West Newton journal of August 11, the *Washington Observer* of August 12, the *Leechburgh Advance* of August 12, and the *Greensburg Press* of August 16, all contained items announcing that considerable damage was being done to the oat crop in their respective neighborhoods. The

Pittsburgh Despatch of August 17 contained an interview with Dr. John Hamilton, who stated that the abundance of grasshoppers in the vicinity of Pittsburgh was due to the extended drouth, hardly a drop of rain having fallen since July 3. The second week in August wheat and oats in the vicinity of Newark, Ohio, were damaged, and corn near the lower end of Seneca Lake, N. Y.

THE BOT-FLY OF HUMAN BEINGS.

Apropos of our editorial review of Prof. Blanchard's summary of the Oestridæ which burrow beneath the skin of man, we may mention an interesting communication which we have just received from Mr. David Logan, now connected with the Gypsy Moth Commission, of Massachusetts. Mr. Logan writes us that he has been familiar with the species having this disagreeable habit, first in Honduras on the Rio Tinto, but more abundantly on the Rio Magdalena, near Mompos and upon the River Sinu, 30 leagues south of Carthagena, in the United States of Colombia. In his nineteen years' experience in tropical forests he estimates that he has had at least a hundred of these parasites in different parts of his body and at one time had eighteen of the maggots squeezed out of his back. He had been for weeks in the woods hunting mahogany, and there were neither cattle nor people anywhere around. It was, in fact, in a perfect wilderness. He is in doubt as to whether the eggs are laid on the skin or upon the bushes and come off upon the clothing of people passing. Naked Indians, he states, had not one-tenth as many as whites who wore shirts.

Mr. Logan further states that the natives believe that the grubs are produced by a species of yellow mosquito, and have named the larva *gusano de mosquito*. The back and shoulders of human beings appear to be specially subject to attack, although the *gusano* sometimes shows itself in other places, and Mr. Logan was once attacked in the upper lip. The first evidence of the presence of the grubs in the skin is the appearance of a little swelling resembling a small boil, not painful, but giving to the victim a feeling of uneasiness. On close observation a minute orifice may be seen in the center of this swelling. When first detected the larva is usually of about the size of a pinhead. It works chiefly at night and not continuously, but intermittently. Mr. Logan had never kept specimens in his person for study or experiment, but at one time had one for about six weeks in his shoulder. It was at this stage at least an inch long when contracted, and when elongated about an inch and a quarter in length. There were rings around the body apparently covered with minute hairs or spinules, the body being narrowed at the ends and much thicker than the head. The common remedy adopted was to place a piece of leaf tobacco over the perforation in the skin, and soon after the maggot could be squeezed out.

As to the deposition of the eggs we have information from other ob-

servers that the flies have been seen to oviposit on the skin, and it is easily conceived that the young grubs will more easily travel and get purchase to enter the skin where persons are clothed than otherwise. The absence of cattle or people from the locality on the Sinu is not necessarily an argument in favor of oviposition upon vegetation, since the insects may, and undoubtedly do, breed in wild animals. It is likely that the species concerned is *Dermatobia noxialis*, commonly known in the Spanish Americas as *Ver macaque*.

A NEW TABANID.

In *Psyche* for March, 1892, Mr. J. M. Aldrich, of Brookings, S. Dak., describes a new genus and species of Tabanidæ, *Goniops hippoboscoides*. The general appearance of the fly is that of a particularly fine, large, silvery Hippoboscid with brown wings, but an examination showed it to be a true Tabanid. Its habits are stated to be unknown, but from its appearance the conclusion is probable that it lives like a Hippoboscid upon some bird or mammal. Figures of the adult fly, of a side view of the head and of an antenna, are given.

THE CHINCH BUG IN ILLINOIS, 1891-1892.

Under the above caption Prof. S. A. Forbes presents an interesting article in Bulletin 19 of the University of Illinois Experiment Station (pp. 44-48). He refers to the almost uniformly high temperature of the past two summers (1890-1891), accompanied with a very small rainfall, in northern and central Illinois, which favored unusually the development of the Chinch Bug in these sections, and make it reasonable to expect considerable loss for the present summer should similar conditions prevail.

The facts concerning the distribution of the Chinch Bug in the central counties of the State are given, and also for the center of the northern or rather northeastern counties of the State, where the prospect for further injury is more serious. The facts brought out show that the cereal crops of a considerable part of Illinois are in danger in the immediate future unless the conditions of the weather are very unfavorable to the multiplication of the Chinch Bug.

The article concludes with a summary of the practical measures of defense, consisting in the destruction of the bugs by fire before they leave their winter quarters; the support of the infested crop by the use of fertilizers; the destruction of the insect in small grains when they appear very abundantly in patches; arresting their movements and destroying them as they pass from field to field at harvest, and taking steps to promptly disseminate their natural contagious diseases.

Referring to the latter measure, he says that the subject of the use of contagious insect diseases is still in the experimental stage, the relation of this method to various weather conditions being as yet particularly

doubtful. He adds, however, that its promise is such as to make it well worth while for anyone interested to try the experiment thoroughly and carefully, and he offers to supply material for infection to anyone desiring to experiment.

THE MEALY BUG DAMAGING COFFEE IN MEXICO.

Among the many applications which we have received, since the successful introduction of *Vedalia* into California, for specimens of this beneficial insect, to be used against other scales in different parts of the world, none has been of more interest than one recently received from Señor Juan N. Navarro, Mexican consul-general in New York City. Señor Navarro wrote us at the request of the Governor of the State of Michoacan for specimens of *Vedalia* for use against a scale insect which is damaging the coffee crop in that State. We replied that *Vedalia* was of practical benefit against *Icerya* only, and that we very much doubted whether any good could be accomplished by sending it to Mexico. We requested, however, specimens of the scale-insect damaging coffee, and have recently received a number in alcohol, which indicate that the species doing this damage is our common green-house Mealy Bug (*Dactylopius destructor*). We have advised the use of the kerosene emulsion spray against this important pest.

THE HOP PLANT-LOUSE IN WASHINGTON.

The latest advices from the State of Washington indicate that the Hop Plant-louse has made its appearance in numbers upon the hop vines. Hop-growers are spraying very extensively, different mixtures being used. The principal are the kerosene emulsion, the whale-oil soap emulsion, and the quassia decoction. A machine known as the roller sprayer has been extensively used, with much success. Since the publication of Prof. Washburn's very satisfactory defense of kerosene emulsion, we have seen less of the opposition to this substance.

TICKING OF THE BOOK LOUSE.

Mr. C. J. Gahan, in exhibiting specimens to the Entomological Society of London of the common Book Louse, *Atropos pulsatorius* Fabr., stated that he had heard it making a ticking noise similar to that made by the "death watch" (*Anobium*). We put this on record as corroborative evidence of the power of making such noise possessed by *Atropos*, which many have felt doubtful of on account of its minute size and soft body covering.

DELTOID MOTHS.

Prof. J. B. Smith, New Brunswick, N. J., is engaged on a monographic revision of the Deltoid group of the Noctuidæ and desires material from all parts of the country. He will name and return all

material sent him for the privilege of retaining such specimens as may be needed for description or for completing the collection of the U. S. National Museum. We earnestly hope that those of our readers who are sufficiently interested will, by complying with this request, help themselves, Prof. Smith, and Lepidopterology; for every encouragement should be given to those who have the time and the ability to do good monographic work, which is the chief means by which our science is advanced along systematic lines.

PHÆISM IN INSECTS.

In connection with the exhibition of dark specimens of *Zygæna minor*, at a recent meeting of the Entomological Society of London, which were not representatives of complete melanism, Mr. J. Jenner Weir suggests the use of the word phæism as a correct term to apply to such departures from the normal coloration of the species.

CAUTION TO HOP-GROWERS.

Apropos of what has recently been said in these pages regarding the superiority of the kerosene emulsion over the quassia chips, we quote the following editorial from the *California Fruit Grower* of August 6:

Smooth agents are said to be reaping quite a harvest from the Washington hop-growers in the sale of quassia chips and other alleged remedies for the Hop Louse. Hop-growers would do well to seek such information as they need from responsible sources, such as the experiment stations, or reputable journals, rather than give their confidence and good money to wholly irresponsible traveling agents.

A NEW SIMULIUM.

A new Simulium allied to the notorious Buffalo Gnat of the South is reported from southern New Mexico by Mr. C. H. T. Townsend, who states that it breeds in the Rio Grande, issuing during May and June. These gnats are a great annoyance to man, more so apparently than to animals, and many persons are stated to be so susceptible to them as to preserve through the gnat season a chronic inflammation of the exposed parts of the face and neck resulting from the repeated bites which in some instances give rise to sores. The inclination of the gnats to flight increases with the advance of the season, but they disappear with the falling of the water to its normal level in the rivers. The habits and early stages have not been investigated, and the female fly, comprising the biting swarms, only has been studied. The species is described as *Simulium occidentalis*.

NOTES ON ECONOMIC ENTOMOLOGY.

Entomological News for September (vol. III, pp. 181-183) has just reached our table as we go to press, and we are pleased to notice a departure in the establishment in this number of a new department, that of Economic Entomology.

In accordance with the lines laid down at its inception, this journal has been devoted mainly to subjects of general interest to the collector and student of insect life, and in particular to short articles and notes, news items, doings of societies, etc. It is to be hoped that the new department will be a valuable and permanent one. Under the general heading, "Notes on Economic Entomology," abstracts are given on the following topics of economic interest: Mr. Bruner's remarks on the corn-meal remedy for Cabbage Worms, as published in Bulletin No. 27 of this Division; potassium iodide for bee stings; soapsuds for Cabbage Lice; a curculio-remedy; and a short note contributed by Mr. Wm. J. Fox on the occurrence of *Calandra remotepunctata* in stored Barley. Mr. Fox is in error, however, in assuming that this species has not heretofore been noticed as attacking grain, as we have in mind several published records of this habit. B. D. Walsh (Journal Ills. State Agr. Soc., January, 1862) remarks on the occurrence of this species in Wheat. W. E. Saunders (Can. Ent., vol. xv, p. 81) cites an instance of the larvæ feeding on Pearl Barley. Dr. John Hamilton (Tr. Am. Ent. Soc., vol. xvi, p. 158) states that the species depredates on grain. Walsh's article was also reprinted in 1863 (Proc. Bos. Soc. Nat. Hist., vol. ix, p. 311).

ANNUAL MEETING OF THE ENTOMOLOGICAL SOCIETY OF ONTARIO.

The twenty-ninth annual meeting of the Entomological Society of Ontario was held at London, Ontario, August 31, 1892. President C. J. S. Bethune gave the opening address, and, in speaking of the principal insect damage of the year, made special mention of the following species: Eye-spotted Bud Moth, Zebra Caterpillar, Cabbage Root Maggot, Pear-leaf Blister Mite, Fall Web-worm, Grape-vine Flea-beetle, Clover Root-borer, Wheat-stem Maggot, the Horn Fly, besides cut-worms, canker-worms, and grasshoppers. The Horn Fly has probably been the most formidable of all the pests mentioned. The following officers were elected for the ensuing year: President, W. H. Harrington; vice-president, J. M. Denton; secretary, W. E. Saunders; treasurer, J. A. Balkwell; librarian and curator, J. A. Moffat. Rev. C. J. S. Bethune was re-elected editor of the *Canadian Entomologist*.

U. S. DEPARTMENT OF AGRICULTURE.

DIVISION OF ENTOMOLOGY.

PERIODICAL BULLETIN.

Issued November, 1892.

Vol. V.

No. 2.

INSECT LIFE.

DEVOTED TO THE ECONOMY AND LIFE-HABITS OF INSECTS,
ESPECIALLY IN THEIR RELATIONS TO AGRICULTURE.

EDITED BY

C. V. RILEY, Entomologist,

AND

L. O. HOWARD, First Assistant,

WITH THE ASSISTANCE OF OTHER MEMBERS OF THE DIVISIONAL FORCE.

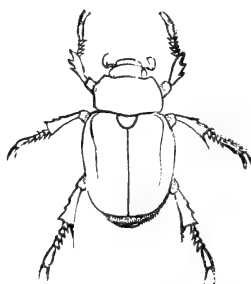

{ PUBLISHED BY AUTHORITY OF THE SECRETARY OF AGRICULTURE. }

WASHINGTON:
GOVERNMENT PRINTING OFFICE.
1892.

CONTENTS.

	Page.
SPECIAL NOTES	63
FOURTH ANNUAL MEETING OF THE ASSOCIATION OF ECONOMIC ENTOMOLOGISTS	67
PRESIDENT'S OPENING ADDRESS.....J. A. Lintner..	67
ADDRESS OF FIRST VICE-PRESIDENT.....S. A. Forbes..	68
HYPODERAS COLUMBÆ—A NOTE (illustrated).....D. S. Kellicott..	77
THE POSSIBLE AND ACTUAL INFLUENCE OF IRRIGATION ON INSECT IN- JURY IN NEW MEXICO.....C. H. Tyler Townsend..	78
NOTES ON ÆGERIIDÆ OF CENTRAL OHIO, II.....D. S. Kellicott..	81
THE BEAN WEEVIL.....M. V. Slingerland..	86
DRASTERIA ERECHTEA.....M. V. Slingerland..	87
ORTHEZIA INSIGNIS AS A GARDEN PEST.....T. D. A. Cockerell..	89
SOME FEATURES OF APPARENT JOINT-WORM ATTACKF. M. Webster..	89
A NEW ENEMY TO TIMOTHY GRASS (illustrated).....L. O. Howard..	90
FOOD-PLANTS OF SOME N. A. MEMBRACIDÆ.....F. W. Goding..	92
NOTES OF THE YEAR IN NEW JERSEY.....John B. Smith..	93
THE PEAR-TREE PSYLLA (<i>Psylla pyricola</i>).....M. V. Slingerland..	100
THE PEAR-LEAF BLISTER MITE (<i>Phytoptus pyri</i>).....M. V. Slingerland..	104
THE PARSNIP WEB-WORM (<i>Depressaria heractiana</i> DeG.)..E. B. Southwick..	106
AN EXPERIMENT AGAINST MOSQUITOES.....L. O. Howard..	109
NOTES FROM THE MISSISSIPPI STATION.....Howard Evarts Weed..	110
NOTES ON INJURIOUS INSECTS OF 1892.....Herbert Osborn..	111
KANSAS NOTES.....V. L. Kellogg..	114
ROSE SAW-FLIES IN THE UNITED STATES.....C. V. Riley..	117
NOTES ON PLANT FAUNÆ.....T. D. A. Cockerell..	117
SPRAYING WITH ARSENITES VS. BEES.....F. M. Webster..	121
NOTES ON INJURIOUS INSECTS IN CANADA IN 1892'.....James Fletcher..	124
AN AUSTRALIAN SCYMNUS ESTABLISHED AND DESCRIBED IN CALIFORNIA,C. V. Riley..	127
FURTHER NOTES ON THE FOOD OF <i>Limax campestris</i> BINNEY..F. M. Webster..	128
REVISED LIST OF MEMBERS OF THE ASSOCIATION OF ECONOMIC ENTO- MOLOGISTS.....	130
A CURIOUS CHRYSALIS	131
ABSTRACT OF PROCEEDINGS, ROCHESTER MEETING OF THE ENTOMOLOGICAL CLUB, A. A. A. S.....	132
EXTRACTS FROM CORRESPONDENCE	135
Notes from Missouri—Parasite of <i>Ceratonia</i> on Elm; Oak Edema in Michi- gan Forests—Success of the Carbon Bisulphide Remedy against the Cabbage Maggot—The Grape-vine Leaf-roller in Texas—Relative De- structiveness of Cut-worms in Meadow and Pasture—Damage to Cattle Hides by the Ox Bot—The Rabbit Bot—Parasites of the Harlequin Cabbage Bug.	
GENERAL NOTES	138
Insects and the Weather—Successful Colonization of <i>Vedalia</i> in Egypt— Jamaica Museum Notes—Recent Entomological Publications by the U.S. National Museum—Galls in Germany—Notes on some bred Species of California parasitic Hymenoptera—A silk-covered Walnut—New Local- ities for the Mediterranean Flour Moth—Damage by Codling Moth in Ne- braska—Success of a <i>Vedalia</i> Importation—Quails <i>versus</i> Potato Bugs— Myrmecophilous Beetles—Mosquito Remedies again—Newspaper Ento- mology again—Widespread Trouble from the Horn Fly—The Tannin in a Sumach Plant-louse Gall—The Female Rear-horse <i>versus</i> the Male—Ticks in the Leeward Islands—Entomological Society of Wash- ington.	

SPECIAL NOTES.

The Association of Economic Entomologists.—The larger part of the present number is taken up with the Proceedings of the Sixth Meeting of the Association of Economic Entomologists, held in connection with the meeting of the American Association for the Advancement of Science, at Rochester, N. Y., August 15 and 16 last. These proceedings are published in accordance with a resolution of the Association requesting their publication in *INSECT LIFE*. The papers are mostly by station entomologists and, with the discussions, will be found of much practical and scientific interest. The Association is strong and successful, and has, we hope, a long and important life before it.

Agricultural Gazette of New South Wales.—Part 6, vol. III, of this publication, issued June, 1892, contains, under the head of Entomological Notes, by A. Sidney Olliff, some account of the Cherry Tree Borer (*Cryptophasa unipuncta* Don.) at Blackheath; the introduction of the fig insect, *Blastophaga psenes* Linn., into Australia; and a walking-stick insect destroying forest trees. Under the head of the introduction of the Blastophaga, Mr. Olliff quotes a resolution by the Australian Association for the Advancement of Science, passed at the meeting held at Hobart in January, 1892, to the effect that the Association recommends that steps be taken to introduce the Caprifig and the fig insect from Smyrna. Mr. Olliff then quotes at length from the opinions of Mayer and Solms-Laubach and from the account of Mr. Eisen of the efforts to introduce *Blastophaga psenes* into California, recently published in *INSECT LIFE*. He states that both the Smyrna fig and the Caprifig already grow in certain localities in New South Wales, and concludes that it will be well to follow the example of California and introduce the Blastophaga, as well as to conduct experiments with the native Australian fig insect, *Pleistodontes imperialis* Saund. For the second time since our account of the damage done to forest trees in northwestern New York by the "walking-stick," *Diaperomera femorata*, in 1878, a species of this family has been reported as doing extensive damage to vegetation. Mr. Olliff's notes give an account of the extraordinary increase of *Acrophylla tessellata* in New South Wales.

Four hundred acres of trees—Oak, Turpentine, Ironwood, Bloodwood, and Gum (in the order named)—have been entirely denuded the present season. The remedy used was to jar the insects from the trees and crush them on the surface of the ground. In the New York case it will be remembered that we found that the insects dropped their eggs upon the ground, where they were easily destroyed by burning over the leaves. The only other occurrence of this character which we recollect to have seen was noted by Mr. Olliff in the same journal for June, 1891. In this case the species was *Podocanthus wilkinsoni*.

Transactions of the New Zealand Institute for 1891.—The Transactions and Proceedings of the New Zealand Institute for 1891, volume XXIV, Wellington, May, 1892, have just reached us in the form of a large volume of 755 octavo pages. The volume possesses special interest from an entomological standpoint since it contains a further instalment of Mr. Maskell's important "Coccid Notes," a communication describing new species of Lepidoptera by E. Meyrick, a catalogue of the described species of New Zealand Araneidæ by A. T. Urquhart, with descriptions of new species of Araneæ by the same author, and a paper on instincts of insects by G. V. Hudson.

Mr. Maskell's paper covers some 65 pages and is illustrated by thirteen carefully executed plates. A number of new species and genera are described and all the new forms are carefully figured. The paper is accompanied by a partial bibliography and also by a most interesting description of Mr. Maskell's mode of systematic investigation, giving an account of his method of preparing specimens for study. We regret to notice that he still retains his eccentric terminations for his larger groups. The reported proceedings of the seven local societies which together compose the Institute indicate a vivid interest in scientific matters in New Zealand. The discussions of the Wellington Philosophical Society are reported in a particularly full manner and indicate that among the members of the society there are many men of broad scientific information.

Insects injuring the Cabbage in Mississippi.—Mr. H. E. Weed, of the Mississippi Station, publishes in Bulletin 21 of the Station (June, 1892) an illustrated account of the insects which he has found injuring cabbages in the State of Mississippi. Twelve species, ranging from the Imported Cabbage Worm to the Wavy-striped Flea-beetle, are mentioned, and the principal point of economic importance which is brought out relates to the remedies for the Harlequin Cabbage Bug. Mr. Weed has followed out the idea, which he was the first to suggest, of killing the

early generations of this insect upon mustard or radish plants by the application of pure kerosene or a very strong kerosene emulsion, and now advocates the planting of a strip of mustard through the field which is to be devoted to cabbages. The insects will congregate upon the mustard and may easily be destroyed in the way mentioned. Mr. Weed elaborated this idea still further and summarized the life history and literature of this insect in a paper read before the Society for the Promotion of Agricultural Science at its Rochester meeting, August 16.

Entomology in Trinidad.—We have received two numbers of a publication entitled “Journal of the Trinidad Field Naturalists’ Club,” which has been sent to us by our correspondent, Mr. H. Caracciolo, of Port of Spain, the president of the club. No. 3, vol. I, August 1892, contains a number of notes of entomological interest, the most important one being a case of the larvæ of *Lucilia hominivorax* in the nostrils of a woman, reported by a resident physician of Port of Spain who signs only his initials. Mr. Caracciolo brings together a long series of notes on different insects, mainly compiled from American sources; Mr. J. Edward Tanner contributes a note on the Leaf-cutting Ant, *Ecodoma cephalotes*, and Mr. W. F. Kirby, of the British Museum, describes a new butterfly from Trinidad, *Tithorea flavescens*. The number immediately preceding contained several entomological notes, the principal article being a draft of a report by the committee of the club upon the small sugar-cane borer, which we hope to refer to at length in a summary of the habits of and literature concerning this important Scolytid. We are much pleased to see this evidence of activity among the residents of the British West Indies in the direction of entomology. The field is a most interesting one and almost unexplored.

Scale-insects in New Mexico.—As Bulletin 7 of the New Mexico Agricultural Experiment Station, Prof. C. H. Tyler Townsend publishes an account of the scale-insects which he has studied in that State. The paper includes a section on the classification of scale insects, another upon their general habits, one on parasites and other enemies, and a long account of remedies. Ten species receive detailed consideration, the new ones being a new species of *Aspidiotus* on *Chilopsis saligna*, a new species of *Lecanium* upon Robinia to which we have given the manuscript name of *Lecanium robinia*; a new species of the same genus upon Peach, which Prof. Townsend has popularly designated as the Soft Peach Scale, a new *Lecanodiaspis* on Yucca, which we have called in manuscript *Lecanodiaspis yucca*, and a new genus and species upon Mesquite. The three plates are reprinted, from electrotypes derived from this Division.

Department of Agriculture of British Columbia.—In the First Report of the Department of Agriculture of British Columbia (1891), Mr. James R. Anderson, Statistician of the Department, includes a summary of the principal insect pests of British Columbia, and some general remarks upon the amount of damage done by destructive insects, quoted largely from Mr. James Fletcher's evidence before the select standing committee of the House of Commons of the Dominion of Canada, which has already been noticed in these pages. The insects mentioned are all such as are common in our Northwestern States, with the exception of the Vancouver Island Oak-looper, *Ellopiia somniaria*.

Recent Entomological Work of the Iowa Station.—Bulletins 16, 17, and 18 of the Iowa Agricultural Experiment Station for February, May, and August, 1892, each contain a single entomological article.

The first of these is by Herbert Osborn and is entitled "Lice affecting domestic animals." It is in the main an extract from the writer's work on this subject, published as Bulletin No. 7 of this Division. It is illustrated by 14 cuts from the same source and covers pages 330 to 353 of Bulletin No. 16.

The entomological portion of Bulletin No. 17 (pp. 444-453) is devoted to the "Effects of spraying on plants and fruit, and notes on insects." In the part of this article on spraying the writer quotes largely from Farmers' Bulletin No. 7 of this Department, and in the second part gives some entomological notes from a correspondent, Miss Alda M. Sharp. An interesting part of Miss Sharp's communication refers to a species of bot in the necks of cats, probably *Dermatobia noxialis*.

The third article (pp. 506-516, Bull. No. 18) is the joint work of Messrs. Herbert Osborn and H. A. Gossard, and is entitled "Reports on injurious insects." The following species are treated: The Clay-colored Bill-bug (*Sphenophorus ochreus*), the Little Brown Bill-bug (*Sphenophorus parvulus*), Strawberry slugs, and the Diamond-back Turnip Moth (*Plutella cruciferarum*). The Strawberry slug which does the principal damage in Iowa is *Monostegia ignota*. Some interesting notes are given on the successful treatment of this insect with London purple, one pound to 200 gallons of water.

The Horn Fly in Florida.—In Bulletin 17 of the Florida Experiment Station, Mr. P. H. Rolfs, the entomologist of the station, gives a summary of the life history of the Horn Fly (*Hamatobia serrata*) and fixes the date of its first appearance in Florida as the spring of 1891 or late in 1890. He reproduces the figures of this insect given in our account of it in INSECT LIFE (vol. II).

FOURTH ANNUAL MEETING OF THE ASSOCIATION OF ECONOMIC ENTOMOLOGISTS

AUGUST 15—MORNING SESSION.

The Association met at 10 a. m. in Room 14, University of Rochester, Rochester, N. Y., August 15, 1892. The following officers and members were present:

President, J. A. Lintner, Albany, N. Y.; First Vice-president, S. A. Forbes, Champaign, Ill.; Secretary, F. M. Webster, Wooster, Ohio; C. J. S. Bethune, Port Hope, Ontario; James Fletcher, Ottawa, Canada; L. O. Howard, Washington, D. C.; D. S. Kellicott, Columbus, Ohio; Herbert Osborn, Ames, Iowa; C. H. Perkins, Burlington, Vt.; C. V. Riley, Washington, D. C.; P. H. Rolfs, Lake City, Fla.; M. V. Slingerland, Ithaca, N. Y.; John B. Smith, New Brunswick, N. J.; E. B. Southwick, New York City; H. E. Weed, Agricultural College, Miss.

In addition to these members, a number of visitors were present at each session. On opening the session President Lintner made the following remarks:

PRESIDENT'S OPENING ADDRESS.

GENTLEMEN: It gives me pleasure to welcome you to the fourth annual meeting of our Association. Our preceding meetings have been pleasant and profitable to all of our members who have been in attendance, and I trust that this will prove equally so, and that its benefits may go out to many who are not with us, and that it will tend to advance largely the interests of economic entomology—the science to which most of us have consecrated our best energies and our lives, and which, year by year, is demonstrating more clearly its ability to minister to the comfort and well-being of our fellow-men and to the productive wealth of our country.

I am very glad that I can be with you at this time; but, in consideration of the great honor you have done me, in conferring upon me the presidency of this Association, I deeply regret that I have not been able to meet an important requirement of the office. It is made the duty of the president to present an annual address. A serious attack of that atrocious disease, *la grippe*, which confined me to my house for more than three months, followed by a longer period of convalescence, extending up to the present, has prevented the preparation of an address such as I would be willing should follow the very able ones to

which it has been our privilege to listen. That you might not be deprived of your due, I have made request, almost at the last moment, of our First Vice-president that he should, if possible, assume my duty. Notwithstanding his all-engrossing official labors, he has most kindly and considerately consented to relieve me from what would, at this time, have been a burden which I did not dare to bear.

My personal regret that I have been compelled to delegate duty to another is tempered by the assurance that I feel that the Association will have no cause to regret the substitution.

ADDRESS OF FIRST VICE-PRESIDENT.

By S. A. FORBES, *Champaign, Ill.*

LADIES AND GENTLEMEN, MEMBERS OF THE ASSOCIATION: When the doubly unwelcome news came to me from Dr. Lintner that the state of his health would not permit him to prepare the presidential address of the year for this Association, and that he therefore felt obliged to request that I should perform this duty in his place, my time was already fully engaged up to and far beyond the present meeting. I have consequently been able to make only a scanty provision for the emergency, and shall have to claim your indulgence for presenting to you, not a presidential address properly so called, but a brief and hurriedly prepared substitute for one.

For one thing, I have not been able to look the whole field of progress over in our department of scientific work with the careful impartiality which the preparation of such an address requires, and must speak to you chiefly, therefore, of those features of the year's work which have happened to strike my attention most forcibly; and my treatment of the matter will unavoidably have a one-sided character, due to personal interest and personal bias.

I shall make no further apology for mentioning first and foremost the work of the year on the contagious diseases of insects. While these cases of plant parasitism of insects are perhaps not as commonly or as widely prevalent as those of insect parasitism, and while they are more subject, as a rule, to differences of condition, and are consequently less reliable in practice, several of them have this great practical advantage: that the parasitic organisms can be bred and multiplied enormously without the use of the insect body as a medium. The insect enemies of insects have been hitherto reared only on other insects. We know of no artificial food for them by which they may be made ready in advance, as a standing army by whose aid to suppress sudden or overwhelming insurrection. I may say, in passing, that I have hoped that some families of predaceous insects—the Coccinellidæ and a part of the Carabidæ, for example—which feed under certain circumstances upon vegetable food, might be reared as vegetarians, and thus accumulated for use at will as carnivorous enemies of insect

life. The observation made some years ago that most Coccinellidæ feed largely, and sometimes wholly, upon fungi of common occurrence and easy culture, first suggested this idea to me, but I do not know that it has ever been experimentally tested.

Several of the plant parasites of insects, on the other hand, feed greedily on very common substances, and may be kept in stock, consequently, or made to multiply on occasion with enormous rapidity, and so scattered broadcast where and when most needed. This is true of all the bacterial germs of insect disease thus far studied, and also of certain higher fungi infesting insects.

On two of the latter work of importance has been done during the year—on a species chiefly studied abroad, known in the papers of Giard, of France, as *Isaria densa*, and in those of Prillieux and Delacroix as *Botrytis tenella*; and on an American species whose determination, like that of the preceding, the botanists interested have not yet finally settled on, but which now passes among us as *Sporotrichum globuliferum*. Some laboratory work and a good deal of field experimentation with this latter fungus is reported by Chancellor Snow, of Kansas, in his voluminous and important report published in April, 1892. It was also studied briefly by Prof. Roland Thaxter, in 1891, by whom the fact of its ready culture on agar was determined; and it has been the subject of almost continuous observation and experimentation at my own office and in the field since May 11 of last year. This fungus, which springs from minute white “spores,” or so-called conidia, penetrates the living insect, and finally imbeds the dead body of its host in a thick felt of white fibers, which become covered with myriads of white or slightly yellowish spores collected in globular heads. It does not form resting spores, belonging, in fact, to an order of fungi in which such spores have never been found, but it may nevertheless be preserved in a living state for many months—certainly over the winter—by simply drying out the ripe conidia. We have so preserved it, in fact, for an entire year, and have found by experiment that the vitality of its conidia is proof against at least ordinary winter temperatures, and against a summer heat of 104° F. It attacks a great variety of insects of all orders, but with various degrees of virulence, according to the kind of insect, the resisting power of the individual, the condition of the weather, and apparently also to some extent according to the previous history of the spores used for infection. That is, it seems likely at present, although not certainly proven, that spores from artificial cultures on nutritive media take effect on insects less promptly and certainly than those derived from growths on insects themselves.

This fungus may be cultivated in large quantity very readily in disinfected fruit jars on corn meal soaked with beef broth, the growth forming a thick layer of dust-like spores on the surface, which may be brushed or scraped off and preserved for use in homeopathic vials, plugged with cotton. I give here this sketch of the present state of

our knowledge of the economics of this because species several of the facts mentioned above have been either ascertained or verified during the year by Chancellor Snow, Prof. Thaxter, or myself.

The so-called *Botrytis tenella* has been extensively advertised in Europe by a firm of Parisian chemists, who send out the spores in plugged test tubes, at 6 francs a tube. I have obtained two of these packages from these dealers—who, by the way, want an American agent—and one directly from Prof. Giard himself. From these tubes cultures have been made by Prof. Thaxter and by Mr. Marten in my laboratory, and experiments have been tried with the product on the white grub, for whose destruction this fungus is especially recommended, and on various other insect larvæ. I may be permitted to add that it has proven with us much less effective, even for the white grub, than our own *Sporotrichum*.

Perhaps the first international exchange of living insect fungi for economic use was made this year with Prof. Giard, to whom I sent a package of *Sporotrichum* in exchange for *Botrytis tenella*. I mention this merely to suggest the possibilities evident in this direction.

Another fungus insect disease, the so-called blue fungus disease of the chinch bug, due to a species now called, on Prof. Thaxter's authority, *Empusa aphidis*, has been handled chiefly by Prof. Snow, who used it, with the other diseases of that insect, by the well-known method of contagion, for the wholesale destruction of chinch bugs in the field. It is incapable of artificial culture, but may perhaps be kept in hand alive in relatively small quantity by using hothouse plant-lice as a medium.

Upon the bacterial diseases of insects I do not know that anything definite and conclusive has been done within the year. The discovery reported by me in September, 1891, of the normal and uniform occurrence of several species of bacteria in special appendages of the alimentary canal of certain families of Heteroptera, at all ages of the insect, has involved in doubt a good deal of our earlier work on the bacterial diseases of Hemiptera, and greatly enhanced the difficulty of their investigation. I will mention here in passing, however, the observation recorded in the paper referred to, that cases of apparent disease frequently occur among chinch bugs, in which the mucous membrane of the alimentary appendages in question becomes completely disorganized and broken up, with an accompanying increase in the number of these bacteria. This is a point which we have carefully and repeatedly verified during the present season.

A study of the bacterial diseases of the cotton boll worm is briefly reported, but not fully described, by Mr. Mally in Bulletin No. 26 of the United States Division of Entomology. One of these diseases is there identified with the common white plague of the European cabbage worm and the cabbage *Plusia*, but economic experiments with this disease seem to have had only negative results.

In Europe, besides the articles of Giard, I have noted in my imperfect reading only an unsuccessful experiment with a parasitic fungus of the migratory locust, reported as *Lachnidium acridiorum*.

I must not leave this subject without more special reference to the remarkably extensive, suggestive, and thoroughly conscientious work of Prof. Snow on the propagation and dissemination of the diseases of the chinch bug, set forth with considerable detail in his report already referred to. Excepting the war on the gypsy moth in Massachusetts, it is the largest practical undertaking of the year in economic entomology.

Certainly this whole interesting and, as I believe, really promising subject has now been so far opened up that neither entomologists nor botanists will be willing to set it aside until it has been thoroughly and critically investigated. It is a very extensive subject when one thinks of the number of fungous species capable of killing insects, of the number of insect species subject to their attack, and of the limited natural distribution of many of the fungus forms, and when one learns—as he will shortly by experience—the numerous and various conditions which will affect both laboratory experiments and field applications. I need not say that the whole matter is involved in difficulties such as make absolutely necessary the strictest methods of experimental science. Without these we should presently find ourselves swamped by a mass of errors or dubious results which could best be disposed of by leaving them on one side as hindrances rather than helps to progress.

We ought also carefully to guard the agricultural public against the disposition of a certain number always to run after any new thing, especially if it has a sensational character. The credit of an unfinished investigation may easily be completely broken down in advance by a too eager appropriation of unverified results. The idea of starting a flame of insect disease in one corner of an infested field to run speedily over the ground, destroying the insect enemies of the crop with no injury to the crop itself, is so attractive to the credulous or to the especially enterprising farmer that he is likely to trust the safety of his crop prematurely to this method to the neglect of other more certain, but more expensive measures; and if a failure follows, whatever the causes or the circumstances, the reaction will be likely to strike too hard and often in the wrong place.

The kindred and really much less difficult subject of the insect parasites of insects has received practical attention in this country, so far as I have seen, only from the agents of the U. S. Department of Agriculture. Mr. Koebele's repeated journeys to Australia in behalf of the orange-grower have attracted general attention. They have resulted in additional importations, more or less successful, to this country of a new *Vedalia* feeding on *Icerya purchasi*; of two species of *Coccinellidæ* (belonging to the genus *Orcus*), enemies of the red scale and other *Coccidæ*; of a number of *Scymnids*; of a *Coccinellid* devouring *Dactylo-*

pius; of a lepidopterous enemy of the larger scales, like *Lecanium*, and of an enemy of the woolly root-louse of the apple, imported from Australia.

To the above list of importations of insect parasites should be added one in which I became personally interested through the kindness of Dr. Riley, more important, if possible, than any of the foregoing because affecting a more destructive insect of a more valuable crop. I refer to a European parasite of the Hessian fly, known hitherto as *Semiotellus nigripes*, of Lindeman, but which should really be known as *Entedon epigonus* of Walker, as I am informed by Prof. Riley, who has compared it with Walker's type in the British Museum. This parasite, received in Hessian-fly puparia coming originally from England, was successfully bred in small, inclosed plat experiments at Champaign, Ill., and the bred adults were released in wheat fields in that State, which were themselves suitably infested by the Hessian fly. Observations and collections made in and about those fields this season have as yet failed to detect the introduced species, but this need not surprise us, especially as the period of its emergence from the parasitized puparia has not yet passed. Scattering widely, as these parasites probably do at best, it may be some years, if the experiment is successful, before their presence is made manifest.

Exportations of American parasites, native or naturalized, have likewise been made to Honolulu, New Zealand, and Australia, to the Cape of Good Hope, and to Alexandria in Egypt. One of special interest to American entomology is a *Raphidia*, found to destroy the larva and pupa of the codling moth in California, which seems to have been successfully exported by Mr. Koebele to New Zealand.

I need not say to this Association that practical results of the highest economic value have already been reported in this most interesting field and that it will be a crime against the horticultural and agricultural interests of the country to fail to provide in the most liberal way for a work so sound in method and so certainly valuable in result. It is eminently a national work and of far greater than national importance.

And next we turn to a department of investigation which has been commonly claimed hitherto by the economic entomologists, but which really stands for the most part fairly across the boundary line of horticulture and agriculture. I refer to experiments with insecticides. So far as the effect of insecticides immediately on insects themselves is concerned, we may very properly claim this subject for economic entomology; but I am not sure that we do well to abandon our proper work for observations on the effect of the arsenites on the foliage of plants, or for experiments with various kinds of insecticide apparatus, or for any other similar subjects which do not call for the special knowledge or the special methods of the entomologist, but which may very properly be left to the economic botanist or the expert horticultural investigator. This subject of insecticides has been a very inviting one to the

beginner, because it is easily investigated and is immediately fruitful of practical results; and no small amount of excellent work has been done on it during the past year, as for several years preceding. The arsenical poisons have been, as heretofore, by far the most extensively handled in experimental work, as by Washburn, in Oregon, who has brought the expense of sprayings for the codling moth down to 11 cents a tree each; and by Orcutt, in South Dakota, where a horse apparatus for the distribution of poisons in the potato field has been devised and successfully used; and by Woodworth, who reports from California, as the result of a long list of comparative trials, that 1 pound of Paris green to 160 gallons of water served the best purpose for the apple and the pear, and saved two-thirds of the fruit which would otherwise have gone to the codling moth; and by Comstock and Slingerland in New York, where the arsenical poisons were proven to be without effect on wireworms; and in New Jersey, by John B. Smith, who found it practicable to destroy the elm leaf-beetle with London purple; and again by Woodworth, who has done a large amount of valuable work, of a kind which I have already characterized as horticultural, in determining precisely the effect on different kinds of foliage of various percentages of arsenical compounds or mixtures under various conditions of application. Osborn, in Iowa, has found the arsenite of ammonia effective against many kinds of insects and not noticeably injurious to foliage. Fernald uses a pound of Paris green to 160 gallons of water—a level teaspoonful to a pailful—as a safe and effective application for various cranberry insects, and finds as the outcome of a long series of careful comparative experiments that a pound of Paris green to 200 or 300 gallons of water is safe for the apple and destructive to tent caterpillars of all ages. Another useful insecticide is the XO dust, recommended for plant-lice by Miss Murtfeldt, of Missouri, and by Prof. John B. Smith, for the cabbage worm. The extensive insecticide work in Massachusetts done in connection with the remarkable campaign there against the gypsy moth must have received the careful attention of every American economic entomologist.

Kerosene emulsion has been fully studied as to methods of preparation with various kinds of soap, hard and soft, and with milk, by Cook, of Michigan; has been used with success by Fletcher, of Canada, for the cabbage *Plutella*; by Fernald, of Massachusetts, on the red spider; by Dr. Jabez Fisher, of the same State, for the pear-tree *Psylla*; by Richman, in Utah, for the cabbage flea-beetle, and by Osborn, in Iowa, for plant-lice of all descriptions. Applied to the asparagus beetle by Smith, in New Jersey, it killed a large part of the larvæ, but not the eggs. A notable idea in the application of kerosene has been worked out by Goff, the experiment station horticulturist in Wisconsin, who has devised a pump and nozzle by which kerosene and water are mixed immediately at the nozzle in any desired proportions, and thrown out as a fine spray without the necessity of previous emulsification.

Concerning pyrethrum, I have seen practically nothing new contributed during the year. Of the insecticides less commonly used, Fletcher has found white hellebore sufficient for the destruction of the cabbage maggot; Washburn has protected radishes against the flea-beetle with a strong tobacco water; Coquillett has experimented further and with good success with lime, salt, and sulphur for the scale insects; both he and Miss Murtfeldt have tried the new thymo-cresol, with especially encouraging results thus far, for scale insects and plant-lice only; and Garman has found the Bordeaux mixture to have insecticide properties hitherto unsuspected. Of other miscellaneous insecticide experiments I can recall only those of Osborn, some showing the precise value of the kerosene pan for the grass insects, and others, still more important, by which as many as 376,000 grass insects per acre (mostly leaf-hoppers and young grasshoppers) were taken by simply dragging over the grass a sheet of iron coated with coal tar on the upper surface.

Concerning that great department of economic work in entomology, which consists of the invention and trial of variations of agricultural and horticultural practice with a view to the control of insect injuries, I regret to say that I have little to report. The most important experiments published during the year are those carried on by Comstock, of New York, in the course of his studies on the wireworms. The often recommended and almost standard remedy, a clean fallow, for these insects was absolutely without effect. Just as many wireworms remained alive after a year in his breeding cage where no vegetation had been allowed to grow, as in his check cage, where grass had been kept growing continuously. Similar failures resulted from sowings of buckwheat, mustard, and rape, and the application of fertilizers of various sorts. In fact, nothing tried was found to serve for the destruction of the larvæ, the only method of value arrived at taking effect on the pupæ and adults in the earth. This was plowing in the interval between August and the following winter, the plowing to be followed by a thorough pulverization of the soil for the destruction of the earthen cells of the pupæ and adults.

In this connection I may also mention Osborn's observation that the clover-seed caterpillar may be destroyed completely by cutting the clover while this insect is in the larval state; and the fact reported in the *Farmers' Review*, of Chicago, that the Mammoth Clover blooms and ripens between broods of the clover-seed midge, and thus escapes that insect enemy.

I cannot pass this point without remarking on what seems to me a loss of opportunity by experiment station entomologists in their failure to avail themselves more generally of the experimental resources of the stations for a trial of variations in agricultural method—in cropping, in preparation of the soil, in cultivation and management of the crops, and the like—as a means of prevention and remedy applicable to the leading insect enemies of the principal farm crops. The fact that

agricultural entomology has lagged so far behind horticultural is largely due to the lack in the past of just those facilities for experimentation on a large scale and during a term of years which, now that we have them at our disposal, we seem not wholly to appreciate.

To the foregoing very imperfect summary of recent progress in the immediate applications of economic entomology I shall now be able to add only a few references to some of the more important publications of the year, dealing elaborately with single insects especially interesting from our present point of view, or bringing together in a more or less exhaustive and monographic form the facts concerning economic groups. Under the latter head we may place an article by Bruner, of Nebraska, on the corn insects, published in his report as entomologist of the Nebraska Experiment Station; a paper on experiments with the cranberry insects, contributed by Fernald, of Massachusetts; the admirable, original, and highly valuable work of Osborn on the grass insects; the model investigations of Comstock and Slingerland on the wireworms, already mentioned; Webster's paper on insects injurious to wheat, in the Bulletin of the Ohio Experiment Station; the paper by H. E. Weed, of Mississippi, on cabbage insects, published in the Experiment Station Bulletin of that State; a bulletin by Smith on the blackberry insects of New Jersey; Bulletins 25 and 27 of the Division of Entomology, U. S. Department of Agriculture, on the destructive locusts of the West; a notable discussion of the scale-insects of California by Coquillett, in Bulletin 26 of the same series; and my own articles on the white grubs and on the fruit insects of southern Illinois, the latter published in the last volume of the Transactions of our State Horticultural Society.

No single insect has received greater attention recently than the gypsy moth in Massachusetts, and we shall probably have at this meeting an authoritative description of the progress of the remarkable measures taken for its destruction there. We must all hope that the result may be such as to establish a firm precedent for the intervention of the power of the State, guided by expert advice, in emergencies of that description.

Reference should also be made here to Mally's published work on the cotton-boll worm in the South, and to Webster's on the crane flies in clover and in wheat following that crop.

Of a great quantity of notes on the life histories and habits of injurious and beneficial insects, and of a considerable number of descriptions of immature stages of those whose life-history has been hitherto but imperfectly known, I can here say nothing. The entomologists in the newer States have an extraordinary opportunity—which they are not slow to improve—for new work of this kind, and even for the discovery and description of new economic species. Nor can I pause to consider advances in apiculture, nor in the culture of the silk-producing insects. An exhaustive treatment of the topic which naturally falls to me would

require mention also of new descriptive monographs, of analytical synopses, and of various other important helps to the determination of species so necessary to our work.

I have even omitted all notice of one important branch of economic entomology, in which I take, myself, a strong special interest, which calls loudly for continuous and active investigation, and which promises a great body of fresh and valuable results. I allude to the study of our American aquatic insects, especially in their relations to fish culture. Now that it has become a fixed feature of the plan of work of the United States Fish Commission to improve and increase the fish supply of our interior waters generally, aquatic entomology, and especially the breeding, determination, description, and illustration of the aquatic larvæ and pupæ of insects, with studies of their distribution, habits, food, and bionomic relations generally, becomes a matter of first-class economic interest. I need not say that the field is new and scarcely occupied at all, or that, although it clearly belongs to us, it has not even been recognized by ourselves hitherto as coming within our sphere.

From the little that I have been able to lay before you of the really important mass of new matter contributed to knowledge during the year by the economic entomologists of America, you may see—what, indeed, no one of you needs to be told—that we are in the midst of a new era of discovery in this field, a period of activity quite unexampled in the history of this country and of the world. This present time is certain to become classic in the history of American entomology. The establishment of the State universities and of the State experiment stations throughout our country has had an effect on investigation in those departments of knowledge which have most to do with the interests of the people, which may be compared, for that sphere, to the effect of the revival of learning in the middle ages. We, as a body, are but at the beginning of a career which cannot but influence greatly the direction and development of applied biology in this country and throughout the world, and must have at least a reflex and secondary effect on pure biology as well. We have, therefore, not only every reason for hopefulness, but for a substantial assurance of an eminent future for this association. I trust that the present meeting may help us forward notably, and that we may go up to the assembly of the entomologists of the world to be held next year at the Columbian Exposition in Chicago, prepared to represent worthily in our department of activity the country and the institutions which have given us so enviable an opportunity.

On motion of Mr. Southwick, seconded by Mr. Smith, the following were appointed by the President a committee on Vice-president's address: Mr. Southwick, chairman; Mr. Smith, Mr. Kellicott. Mr. M. V. Slingerland, of Ithaca, N. Y., was proposed for active membership,

and Mr. Charles French, Melbourne, Australia, Mr. E. C. Cotes, Calcutta, British India, and Mr. W. M. Schöyen, Christiania, Norway, were proposed for foreign membership.

The following paper was then presented:

HYPODERAS COLUMBÆ—A NOTE.

By D. S. KELLICOTT, *Columbus, Ohio.*

In April last a student in the laboratory of the Ohio State University called my attention to the peculiar appearance of the thymus of a domestic pigeon which he was dissecting. Examination soon showed that numerous individuals of a mite were the cause of the mottled and granular appearance which attracted attention.

The species seems to be *Hypoderas columbæ*, although the archaic figure published by the describer and copied by Murray must leave some doubt.

The facts of its occurrence are as follows: About a dozen pigeons were examined for the parasite, and all the older ones, about half the number, harbored some examples. Two were found containing multitudes; they were lodged in the substance of the thymus and in such numbers, in the two, as to strikingly change its appearance, as noted above. They were also in great numbers about the precava and its branches. A few were seen in the loose tissue about other vessels of the thorax and in the subcutaneous.

In the thymus the mites were found somewhat parallel in groups of half a dozen or more; the individuals of the groups were held together by a débris consisting mainly of granules and numerous blood corpuscles. From material preserved some time in alcohol the mites could be dissected out as from a cyst.

The relatively long, slightly depressed animals, by measurement of a large number, gave dimensions as follows: length, 1.5^{mm}; width, .45^{mm}.

The sketch will show in detail the form of body, position, and structure of the appendages. Figure 7 represents the average example seen from below, magnified 56 + times. *A*, the chitinous framework about the anterior pairs of legs; this extends upwards and anteriorly upon the dorsal aspect; *B*, the chitinous framework about the posterior pairs of legs; *C*, three chitinous buttons.

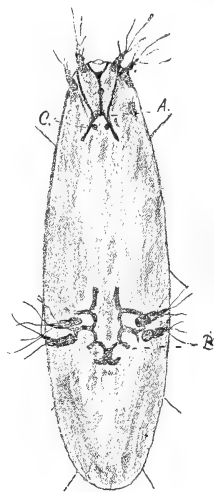

FIG. 7.—*Hypoderas columbæ*: highly magnified; *A*, chitinous framework about anterior legs; *B*, chitinous framework about posterior legs; *C*, chitinous buttons (Kellcott del.).

The discussion which followed Mr. Kellicott's paper related very largely to the preparation of these and similar delicate insects for preservation and study. Mr. Forbes strongly recommended cochineal staining fluid for this purpose.

The next paper was read by the Secretary, the author being unable to attend.

THE POSSIBLE AND ACTUAL INFLUENCE OF IRRIGATION ON INSECT INJURY IN NEW MEXICO.

By C. H. TYLER TOWNSEND, *Las Cruces, N. Mex.*

Being situated, as the New Mexico Experiment Station is, in a region where the average rainfall is less than five inches, the question of the influence which irrigation may exert on insect injury becomes with us an important one. The methods of irrigation in practice here are such as to confine the water wholly to the river valleys, over which it is distributed by a system of acequias, it being impossible on the present plan to conduct the water on to the mesas, which are uniformly dry and barren. Therefore, the actual influence which irrigation has on injurious insects in this region does not possess the scope given to the subject in Mr. Howard's able article in *INSECT LIFE* (vol. II, pp. 215-222), but is confined to the possible effects upon the various pests which infest our orchards, vineyards, ranches, and gardens.

Certain insects, which spend more or less of their life on or in the ground, are readily affected by this means. On the other hand, many which pass most of their existence on trees or high plants, are not so easily reached. The most satisfactory way in which to treat the subject will be to consider separately our various pests, especially those which are not amenable to ordinary treatment, taking up the more injurious ones first.

The Vine Leaf-hopper (*Typhlocyba vitifex*) may be considered our most injurious insect at the present time. If we consider its amenableness to irrigation, we notice that from the egg to the adult it is continually on the upper portions of the plant, except that when newly hatched the young are mostly on the lower leaves, in which the eggs were deposited when these were the only leaves out. It would hardly be possible to raise the water in a vineyard sufficiently to submerge these lower leaves without its breaking out, unless vineyards were surrounded by moderately high levees or embankments. Then it would be a question whether such flooding of the vines would not do more injury than do the hoppers; or whether the young hoppers would not take warning and have time to get on to the higher leaves during the gradual rise of the water. The old hoppers would not be affected seriously unless the water was high enough to nearly cover the vines. It may be thought that turning on the water in the winter would destroy the hibernating hoppers.

Even granting that this would be a practical remedy, the winter irrigation would be likely to cause the death of the vines by inducing growth too early in the season before danger from frost is over. Cleaning the vineyard completely of all rubbish and leaves in the fall would probably be less expensive in the end; and even then the adjoining lands often could be neither cleaned nor irrigated, and would furnish abundant facilities for the hibernation of the insects.

It was attempted last summer to kill the hopper at La Mesa, 16 miles south of here, by turning on the water and then splashing each vine with the view of knocking the insects off into it. It met with poor success and was bad on the vineyard besides, by tramping and disturbing the soil while in a state of mud.

It would seem, therefore, that irrigation would be of little use against this insect. It is not at present directed against it, and probably never will be, since kerosene emulsion is much cheaper and more effective.

The Codling Moth (*Carpocapsa pomonella*) is not yet causing much injury in the vicinity of the station, but is doing so, however, farther north in the Territory. Here is an insect whose life-history is such that it will be considerably affected by an intelligent system of irrigation directed against it. If the water be turned on at the proper season and left for a sufficient length of time, all larvæ in fallen apples will be destroyed. This means would doubtless kill by far the most of the brood, since only a small proportion of the infested apples, as a general rule, remain upon the tree. Used in conjunction with the arsenites, this treatment would be of much value.

The Peach-tree Borer (*Sannina exitiosa*) does not seem to be affected by irrigation (as noted in Bull. 3, New Mex. Station, June, 1891, p. 14), even though the water be allowed to stand for a considerable time and be given thorough access to the roots. It is probable that the borer is protected by the gummy exudation it causes, which, so far as I have been able to determine, covers the entrance to its tunnel and excludes the water.

The Green June-beetle (*Allorhina mutabilis*) would not be amenable to this treatment (as pointed out in Bull. 5, New Mex. Stn., March, 1892, p. 11), or would be but very little affected by it in all probability. The grubs often go to a considerable depth and would be practically below reach of the effects of irrigation. Besides there are large as well as small areas of ground in which the insects doubtless breed, situated in proximity to cultivated portions which could not well be irrigated. In fact such wholesale irrigation as would be required to destroy this and other insects would consume, at certain seasons of the year, many times the amount of the water which flows down the nearly dry bed of the Rio Grande.

There is one point which should be mentioned. If found feasible to irrigate extensively at the usual date of issuance of these beetles from

the ground, concerted irrigation continued for a proper length of time might have a marked effect on this as well as other insects and yet not be found of special disadvantage to crops or fruit.

No doubt irrigation would have little effect on the San José or other scale insects. They can be controlled by other and more effectual means, to which, as an accompaniment, irrigation would prove of no value.

Root-borers of Apple, Quince, or Vine (grubs of *Prionus californicus* and other species) would not be affected particularly in their tunnels in the live wood of the roots, as they are at some distance below ground. Besides it has recently been found that many fruit trees have been killed here by over or improper irrigation, or irrigation at the wrong time of day. Such soaking of the ground as would be necessary to reach these borers would greatly injure the trees. The adult beetles could not be reached by this means.

The flea-beetle (*Haltica foliacea*), which is often very injurious to young apple grafts, might, from its very habit of attacking only the smallest trees whose leaves are near the ground, be controlled largely by proper irrigation.

The Fall Web-worm, which is very abundant on our cottonwoods, could also be controlled on such trees as are situated on irrigable ground; since the turning on of the water would kill great numbers of the larvæ which, so far as my observation goes here, largely seek the ground for transforming.

Such irrigation would also kill the Cottonwood Leaf-miner, referred to in INSECT LIFE (vol. IV, pp. 26-27), which I have been unable to breed as yet, but which I find goes into the earth to pupate. For cottonwoods situated along the roads and sides of streets, such treatment would be wholly impracticable, and the only remedy for either insect would, in this case, be the arsenites.

A native harvest-fly (*Cicada ochreoptera*) does much damage here to twigs and young branches of deciduous fruit trees, especially Pear and Plum. It might prove susceptible to irrigation if the latter were applied at the time when the pupæ issue from the ground.

There is a considerable number of alfalfa insects, more or less injurious, such as lepidopterous larvæ, Capsidæ, leaf-hoppers, and dipterous larvæ, some of which would be and doubtless are extensively checked in their depredations on this valuable forage plant by the process of irrigation. The water is not turned on high enough, however, nor continued for a sufficient length of time, to accomplish any effectual destruction of the insects. The Capsidæ are apparently the least affected.

As mentioned in INSECT LIFE (vol. IV, p. 25), irrigation will doubtless have considerable effect on the Southern sugar-cane borer (*Diatraea saccharalis*), many dead pupæ of which were found in the roots of corn on the college farm last year.

As the Boll Worm (*Heliothis armigera*) pupates in the ground, it can also be largely destroyed by the same means.

Such insects as the Bean Ladybird (*Epilachna corrupta*), the Harlequin Cabbage-bug (*Murgantia histrionica*), the Squash Bug (*Anasa tristis*), and the cabbage-worms (larvæ of *Pieris* and *Plusia*), would doubtless be much affected by submersion of the plants for a considerable time.

Finally, as remarked by the author in *Psyche* (vol. VI, p. 106), our system of irrigation from the Rio Grande River must greatly aid in the dispersion through this valley of our native species of Simulium (*S. occidentale*). These gnats are a great plague to mankind in this region through the spring months, and this is one of the few adverse bearings of the question of irrigation, as practiced here at the present time, on injurious insects.

On the whole, we may safely conclude that, as an adjunct to the proper use of the arsenites and kerosene, irrigation can be made to exert a valuable influence upon the problem of insect injury in New Mexico, and elsewhere as well. Many of the insects for which irrigation would prove a sovereign remedy have not yet reached us here, especially in the southern portion of the Territory. Such are the Chinch Bug, Phylloxera, and Rocky Mountain Locust. When these insects arrive the general usefulness of irrigation in controlling insect injury will, as a matter of course, be considerably extended in this region.

Mr. Smith questioned somewhat the effect of irrigation on the eggs of locusts. In the cranberry marshes submerging did not in all cases destroy the vitality of eggs of some species, and he thought this might prove true with other species in New Mexico.

Mr. Lintner thought that not only the effect of water, but of some insecticides as well, on the eggs of insects was a subject about which we needed much better information than we at present possessed.

Mr. Smith said that kerosene emulsion of ordinary strength would not destroy the eggs of the Squash Bug or of the Elm Leaf-beetle, and eggs of museum pests had been unaffected by an application of carbon bisulphide to the boxes of insects where they occurred.

Mr. Forbes thought, as the protoplasm in the egg was the part which we desired to destroy, we should experiment with such substances or insecticides as would be most likely to destroy protoplasm.

Mr. Smith suggested that, after all, the main effect of kerosene emulsion on insects might be through the respiratory system.

The following paper was then read:

NOTES ON ÆGERIIDÆ OF CENTRAL OHIO—II.

By D. S. KELLICOTT, *Columbus, Ohio.*

The first collection of notes on the Ægeriidæ of central Ohio was published in the current volume of the *Canadian Entomologist*. Since the former notes left my hands additional observations have been made and a few more species collected. Inasmuch as I shall have some-

thing to say of the destructive habits of the larvæ of these species, this seems to be the appropriate place to present these notes.

Melittia ceto West.—Concerning this species, in view of the facts cited I said in the former paper: "It seems in view of the facts at hand that in central Ohio and south it is double-brooded." In the May number of the *Canadian Entomologist* Prof. J. B. Smith has an interesting note throwing light upon this question; his quotation from the manuscript drawings by Abbot clearly prove that in Georgia it has two annual broods. He also cites the facts of his own observation in New Jersey, and expresses his disagreement with my inference for the latitude of central Ohio. He may be right; I am simply waiting to see. I still think there is something in its life-history not yet explained.

Larvæ put into breeding cages in September last gave imagos in May and June. Larvæ were found destroying the squash plants early in July; by the 15th to 20th I transferred the plants to breeding cages with larvæ of different sizes. These shall be carefully watched and the result reported.*

Sciapteron tricincta Harris.—This species was reared by me several years since at Buffalo, N. Y., from enlargements of the branches and stems of *Populus candicans* and *Salix* caused by the larvæ of *Saperda mæsta* and *Saperda concolor*. The present season I have found it at Columbus, with similar habits, in the stems of the willow injured and enlarged by the larva of *S. concolor*. The beetles appeared from the middle of May to the middle of June; the female gnaws deeply through the bark into the wood, generally near a branch, and places an egg at the bottom of each pit; the larva is soon burrowing under the bark and into the wood; there are often several at the same point. The *Æge-*rians appear later, in June and July, and place their eggs in the excrescences caused by the boring young of the beetle. I have not yet found instances in which it was clearly apparent that the young *Sciapteron*

* NOTE. August 8.—By August 1 a few larvæ had left the stems and entered the ground; by the 8th, the day of last examination, many had done so; small ones are comparatively few.

Among the smaller ones there was an abundance of that second form described by Prof. Scudder in *Psyche*, vol. iv, p. 303. Some of these were isolated, and after a few days they molted, giving the typical form. This seems to prove that there is but one species.

It may be interesting to note that these larvæ will feed in the stems and roots of *Echinocystis lobata*; also in the fruit of the Muskmelon. I have not watched them to maturity in either.

August 27.—On returning home, August 25, I found that three imagos had emerged in the vivaria from larvæ transferred from the field between July 15 and August 1; my son had noted the dates of appearance as follows: One each on the 20th, 21st, and 23d; since then two more have come out, and seven fresh imagos have been captured in the field. These facts I consider sufficient to prove that in central Ohio there may be a second brood.

had made its own way into uninjured stems. This fine moth is seldom seen on the wing, but is easily obtained by gathering the stems infested by *Saperda* in May and keeping them moist for a few weeks.

Egeria corni Hy. Edw.—The trunks of the maples at Columbus are greatly disfigured by the larva of *Egeria acerni*. The branches also suffer to a large extent by the action of another *Egeriid* infesting them. The former pest is confined almost wholly to the trunks of shade trees; the latter occurs in both shade and forest trees, most numerous in the latter or perhaps in isolated trees in the fields.

The branches ranging from mere twigs to those an inch or two in diameter are found much enlarged, often at several different points, into rough barked and gnarled excrescences; these are often nearly globular; more often, however, oblong, and frequently there are openings into the center of the stem. On cutting into the wood it is found to be mined in various directions and decaying; this often causes the branch to die or so weakens it that the winds throw them down. There may be one or more larvæ in a single excrescence.

The mature larvæ are 12 to 15^{mm} long; body slender, white; the skin is transversely folded, especially in the thoracic rings and there is a strong longitudinal substigmatal fold. The head is smooth, pale brown, with the anterior edge of the clypeus, labium, and mandibles black; the thoracic shield smooth, broad, and colorless; feet pale yellow; stigmata small, round, pale yellow; piliferous spots scarcely perceptible; fine, short hairs chestnut.

The larva changes to pupa in a thick, gummy cocoon strengthened exteriorly by bits of wood and placed in cells just under the bark with a thin outer shell remaining to be broken up by the pupa at the final change, the pupa skin remaining protruded.

The pupa measures 10^{mm}, slender, light brown, with the usual transverse denticles on the dorsal abdominal segments and a circle of stouter teeth about the abdominal tip; the clypeus is armed with spine or tooth.

The moths issued this year from May 11 to July 15. It is a pretty species, the sexes differing somewhat in appearance, the female being easily mistaken for that of *acerni*, although smaller.

The male expands 17^{mm}; the color deep black with some metallic scales; the narrow clothed margins of the wings and heavy discal bar deeper than the apical patch which is more bronze brown; fringes concolorous except the anterior third of inner margin, which is yellow. Clypeus with white lateral lines; palpi light orange, except the blackish third joint and outer side of second apically; collar same color as palpi; antennæ black, slightly washed with white on outer edge of apical third. The thorax yellow below, black above, with long golden cilia about the insertion of the wings. Abdomen black above, same below, with more or less of golden scales running up on the sides at edges of rings, and on fourth ring giving a narrow band, in some seen

faintly, in other dorsal rings. Anal tuft ample, black above and laterally at base; below deep reddish orange. Claspers yellow. Legs: coxæ golden; other joints black outwardly, golden inwardly to claws; last pair with middle of tibia and tips of basal joints ringed with golden; the inner side of fore tibiæ are light orange; spurs concolorous with the golden yellow legs.

The female expands 20^{mm}. General color the same as male, but differs in having less black at tips of palpi; in having much more golden beneath the abdomen; in having the same extending over dorsum so that nearly all the rings are faintly edged and the fourth with a broad band, and in having no black in the ample caudal tuft, which is deep reddish orange.

I have compared the moth with Henry Edwards's description of *Ægeria* and conclude it is his *Ægeria corni*, although one cannot be positive without comparing the type. He had before him only one male taken in Purgatory Swamp, Mass., and the description is not all that could be wished. My specimens differ slightly from the description and vary considerably, frequently more than some of Mr. Edwards's species differ from one another. I will point out some differences which it seems to me are easily reconciled. He gives expanse of *corni* 15^{mm}; the smallest of mine (males) is 15^{mm}, the largest 18^{mm}, average 17^{mm}; he says "no bands;" some of mine are scarcely banded after storage in the cabinet a month; he says spurs light orange, in mine they are not—the only real difference between his descriptions and my moths.

Before our next annual meeting I shall try to compare my moths with the type and shall take pleasure in reporting the results.

Is the moth an inquilin? It would seem so: yet after much searching I have found only one beetle borer that would probably serve as a fore-runner. This was found in an excrescence of *Acer dasycarpum*. The *Ægerian* is far more abundant in *Acer saccharinum*.

Ægeria rubristigma, n. sp.—Whilst searching in excrescences on the oak for examples of *Ægeria gallivora*, I came upon the present species which is less common than *gallivora*. It is a perfectly distinct species and apparently undescribed; hence, I propose to describe it under the name given above. One male and one female obtained.

Female: Fore wings purple black with red scales between the veins and the square stigma at end of cell red; borders of hind wings very narrow, costa reddish; fringes ample, black, yellow at basal third of inner margin of hind pair; beneath fore wings yellow to stigma which is deep orange, beyond the borders and veins black with reddish between; hind wings with costa yellow, also anterior third of inner margin. Head all blue-black with milk-white lines before the eyes; collar yellow; palpi with basal joint black, second black except the front margin which is yellow as is the whole of the third joint; the antennæ are wholly black except the under side of the basal ring which is yellow. Thorax—uniform blue-black with color extending upon the base of wings; metathorax golden yellow; beneath, color as above with a light yellow, almost white, spot under the insertion of the wings. Abdomen concolorous with thorax above and below; the second segment has a narrow dorsal band, the

fourth a wide one extending entirely around the body, and the last with a narrow band all golden yellow; tuft at end of abdomen concolorous above and below with a line of yellow hairs laterally. Legs blue-black varied as follows: fore coxæ outwardly, fore tibiæ, all the tarsi, the spurs, and a band at the middle and apex of the hind tibiæ, yellow; the tarsi, however, have some dark scales, sometimes appearing faintly banded.

The male agrees with the foregoing, except that the abdominal bands are less distinct and the yellow in the caudal tuft is wanting.

Expands 17^{mm}.

Obtained from Cynips gall on twigs of *Quercus palustris*, collected by my friend E. E. Bogue at Sugar Grove, Ohio, and by myself at Central College, Ohio. One imago appeared June 10 and one July 15.

The pupa has the usual form, length 12^{mm}, armed, clypeal spine flattened to a cutting edge apically; there is a median ridge on the dorsum of mesothorax, and on either side of it a parallel groove.

The pupa cell is excavated in the pithy substance of the gall and lined with silk.

This moth should be compared sufficiently for separation with other species from *Quercus* galls. It differs from *hospes* and *gallivora* as follows: Front blue-black, whilst they have front white; legs black, they have legs yellow; palpi black and yellow, they all yellow with mere tip black. *Rubristigma* has red bar, they black. Compared with *Ægeria querci* from galls on Live Oak, it is twice as large. *Querci* has lemon yellow lines on side of thorax, antennæ brown, yellowish beneath, has nearly all the abdominal rings with bands, costa lemon yellow beneath, leg joints whitish, pectus lemon yellow; in all these points *rubristigma* differs decidedly. The differences are also as striking with *nicotianæ*, with which Henry Edwards compared *querci*, a species having a fiery red discal mark.

Mr. Smith stated that adults of the Squash Borer, *Melittia ceto*, from last year's larvæ, were at present flying on Long Island, and that all stages of the insect might just now be obtained in the same field. The moths collect in the evening on the upper side of the leaves, and are there destroyed in great numbers by farmers.

Mr. Kellicott stated that full-fed larvæ of this species began to take to the ground the last days of July in the vicinity of Columbus, Ohio. The second species or stage, mentioned by Mr. Scudder as occurring at Cape Cod, was also present in abundance, and seemed perfectly distinct.*

* Under date of August 25 a note was received from Mr. Kellicott, stating that from larvæ entering the ground late in July there had appeared adults during his absence on the following dates: August 20, 22, and 23, all being active *M. ceto*. This seems to settle the question of the number of broods in central Ohio. There must be two.—SECRETARY. See also foot-note on p. 82.—EDS.

Messrs. Forbes, Slingerland, and Smith were of the opinion that none of the Ægerians were attracted by electric lights.

The next paper presented was on—

THE BEAN WEEVIL.

By M. V. SLINGERLAND, *Ithaca, N. Y.*

The Bean Weevil has recently received considerable attention from entomological writers. Its habit of breeding freely in dry beans has been strongly emphasized, and several interesting features of the first larval stage are noted. Its life history has been regarded as similar to that of the Pea Weevil, *Bruchus pisi*, the egg being laid upon the outside of the pod, the young larva hatching therefrom, boring through the pod and entering the seed, the adults appearing later through a circular opening cut in the shell. The Bean Weevil differs, however, in that more than one may develop in a single seed, and that the Pea Weevil does not appear to breed in dry peas.

No one seems to have seen the eggs of the Bean Weevil laid upon the pod, however, and by confining the beetles in cages with growing beans I have found that this is not their normal method of oviposition. The eggs are laid within the cavity of the pod. This is accomplished in the following manner: The beetle first gnaws a narrow slit about 1 mm. in length through the ventral suture of the pod. It then forces its long, curved, semichitinous, telescopic ovipositor through the slit and deposits its eggs in a cluster inside the pod. The beetles oviposited only on the larger green pods. I have not had an opportunity to study the ovipositor of the Pea Weevil, which would prove interesting in this connection.

After emerging from dry beans, the beetles soon copulate and oviposit, and die in a few days; but when placed in a cage on the growing plant they remained alive feeding upon the parenchyma of the leaves for a month or more. Should it be found that they thus feed in the spring awaiting the growth of the pods, remedies for combatting the pest in the field will suggest themselves.

I have reared several broods of the weevils in dry beans and find that, even when the experiment was conducted in the slightly varying temperature of an office, the season noticeably affected their development. For instance, when the eggs were laid in March adults issued in about eighty days, while in July beetles emerged from beans upon which eggs had been laid only forty-eight days before.

I find the duration of the egg stage in dry beans in summer to be about twelve days; of the larval stage twenty-four days; of the pupal stage, eleven days. During the colder months the stages were passed in twenty, forty-two, and eighteen days, respectively.

Experiments with bisulphide of carbon show that it will destroy all stages of the insect, eggs, larvæ of all sizes, pupæ, and adults. Infested beans were also placed in hot water, 145° F., for one minute, but neither larvæ, pupæ, nor beetles were all killed.

In reply to a question, Mr. Slingerland stated that he had not observed the adult weevils feeding in the field while waiting for the development of the beans. Mr. Smith had kept adults in a jar for six months, and at the end of that time had found adults, larvæ, and eggs, the latter glued to the beans. Mr. Lintner called attention to the fact that the larva, before pupating, left the cell in which it had developed and constructed a second, in which it pupated and from which the adult emerged.

The following paper was then read:

DRASTERIA ERECHTEA.

By M. V. SLINGERLAND, Ithaca, N. Y.

Drasteria erechtea is one of the most common and widely distributed Noctuid moths met with in grass lands. The larvæ are loopers, and feed mostly at night, upon the leaves of grass and clover. During 1889 over two thousand specimens of *Drasteria* were taken in six trap lanterns at Ithaca, N. Y. Although not yet recorded as a serious pest, an insect occurring in such large numbers must be a constant drain on the grass crop. During 1891 I therefore bred what I supposed was *erechtea*, describing all the stages. While critically studying this material in connection with the trap-lantern specimens, I accidentally discovered that my bred specimens were structurally distinct from many of the others, thus indicating that two species had been confused under *erechtea*. Since, through the kindness of entomologists, I have examined nearly three hundred specimens from all sections of the country, and I am convinced that the heterogeneous material existing in all large collections under the name *erechtea* is composed of two, about equally common, distinct species. From an exhaustive study of synonymical nomenclature, I believe these species should be called *erechtea* Cramer and *crassiuscula* Haworth, with *ochrea* and *distincta* as varieties of the latter.

I now have a large series of bred specimens of all stages of both species. In the egg and early larval stages there are no noticeable specific differences, but the mature larvæ of *erechtea* are less variable, of a more uniform yellowish green instead of reddish brown color, and they have a broad, very distinct, bright yellow substigmatal stripe. By the following tabular statement the moths may best be distinguished:

Crassiuscula has the front wings above of either a distinct violaceous, brown, or red shade, with the two large dark bands very variable,

often shading into the ground color on the outer edge or coalescing near the inner margin; all the markings, especially the subapical dentate spots, equally distinct in both sexes; right clasper of male with two rather long teeth; ventral portion of the seventh abdominal segment of female broader than long, with caudal margin broadly emarginate.

Erechtea has the front wings above of a dark or light drab gray (in many females with brown or olivaceous) shade, with the two large dark bands always separate, distinct, and well defined toward the inner margin in the male; in the female the markings always much less distinct, the subapical dentate spots never as distinct as in the male or as in the female of *crassiuscula*; right clasper of male with but one long curved tooth; ventral portion of the seventh abdominal segment of the female as long as broad, with the caudal margin broadly rounded.

Crassiuscula is slightly smaller, more variable, and marked alike in both sexes. *Erechtea* is very constant among the males, but variations of brown and olivaceous occur among females from the same brood of larvæ. After a few specimens of each species have been separated, these differences will be very noticeable, but specimens occur which it is almost impossible to separate by markings alone, and the structural characters must then be examined. These sexual structures are a very striking peculiarity of Drasteria. The asymmetry of the male genitalia, so far as I know, has not been before met with among the Heterocera. The differences in the female structures noted are very surprising between two such closely allied species. These sexual structures vary slightly in individuals, but never grade toward each other.

There are three broods of *crassiuscula* annually in New York, moths appearing in May, July, and September. About one-half of the mid-summer brood and all of the fall brood hibernated as pupæ in cocoons of grass and clover leaves. The moths emerging in the spring are on an average smaller than the others, but both large and small appear in all the broods.

The life-history of *erechtea* is similar, I think. I now have larvæ of the second brood from moths emerging in July.

Should the species ever become serious pests, I believe the plowing of infested fields would destroy many larvæ and pupæ.

AFTERNOON SESSION.

The Association met, as per adjournment, at 2 p. m.; the minutes of the previous session were read and approved.

On motion of Mr. Smith, seconded by Mr. Forbes, it was decided that at future meetings the minutes of the first day's sessions should be presented and passed upon at the morning session of second day.

Mr. Slingerland was elected to active membership, and Messrs. E. C. Cotes, Charles French, and W. M. Schøyen to foreign membership.

The author not being present, the following paper was read by the Secretary:

ORTHEZIA INSIGNIS AS A GARDEN PEST.

By T. D. A. COCKERELL, *Kingston, Jamaica.*

This interesting species was described by Mr. Douglas in the *Entomologist's Monthly Magazine*, January, 1888, p. 169, from specimens found in England on *Strobilanthes*, and it was afterwards ascertained to attack a variety of exotic plants in the hothouses at Kew and elsewhere. In "Timehri," December, 1889, p. 308, Mr. S. V. McIntire records its occurrence in British Guiana, and in the same journal for December, 1890, p. 304, Mr. R. Ward gives further particulars of its habits in that country.

In Jamaica I have observed it somewhat commonly on roadside weeds, and, although positive information on this head is wanting, it is very probable that it abounds throughout the island at moderate elevations. As a pest it was first brought to my notice by Miss L. A. Long, who found it very injurious to a small species of *Coleus*, in Kingston, February, 1892. On June 14, Mr. E. Nuttall brought to the museum a large number of specimens on the leaf-stalks of white violets from Halfway Tree, stating that they were very harmful and interfered with the proper development of the flowers.

As remarked by Mr. Ward, it infests herbaceous plants, and there does not seem any probability that it will cause serious injury to any crop; but as a garden and hothouse pest it is evidently liable to become exceedingly troublesome if not checked by prompt and thorough measures. It does not appear from any records accessible to me that the species is found in the United States, although in *INSECT LIFE*, vol. III, p. 124, there is mention of an undescribed *Orthezia* or *Coleus* in New York and California. It is very possibly common in the West Indies, though only known as yet from one island, and if it does not yet occur in the Southern States it may be expected at any time.

Mr. Webster presented some notes on—

SOME FEATURES OF APPARENT JOINT-WORM ATTACK.

By F. M. WEBSTER, *Wooster, Ohio.*

[Secretary's Abstract.]

He stated that the matter was not presented as a final conclusion, as he had not yet reared the depredator, and though in many respects the attack seemed to agree with that of *Isosoma hordei*, as described by Harris and Fitch, yet in many other features it appeared different. In all cases, and he had examined hundreds of wheat straws from northern Ohio, the attack was always above the upper joint. In two cases the upper joint and the one below had been attacked. From many thorough examinations he had found that the stem itself had not been eaten into, the cells being formed in the sheath, but owing to the

pressure of the galls on the tender stem the latter had become distorted and the upper portion with the head, where one was produced, was greatly aborted. He had, from these galls, reared several parasites, and these were at present emerging, some of them being engaged in ovipositing in the dry galls, and he supposed they were parasitizing the now full-grown larvæ of the true gall maker, whatever that might be. From a lot of infested stems he had reared the following: *Eupelmus allynii* French; *Semiotellus chalcidiphagus* Walsh; a Eurytomid; *Merizus isosomatis* Riley, and *Websteria tritici* Ashm. MS. Some of these he had, during previous years, reared from *Isosoma tritici*, but he had been told by Messrs. Howard and Ashmead that it would be necessary to be most positive about the habits of the *Websteria* on account of the widely differing habits of its nearest allies. Therefore he would delay final publication until the whole matter had been cleared up. A large number of dried specimens of the affected straws were shown, illustrating the work of the depredator, in stems from 4 to 20 inches in length.

The following paper was then read by the author:

A NEW ENEMY TO TIMOTHY GRASS.

By L. O. HOWARD.

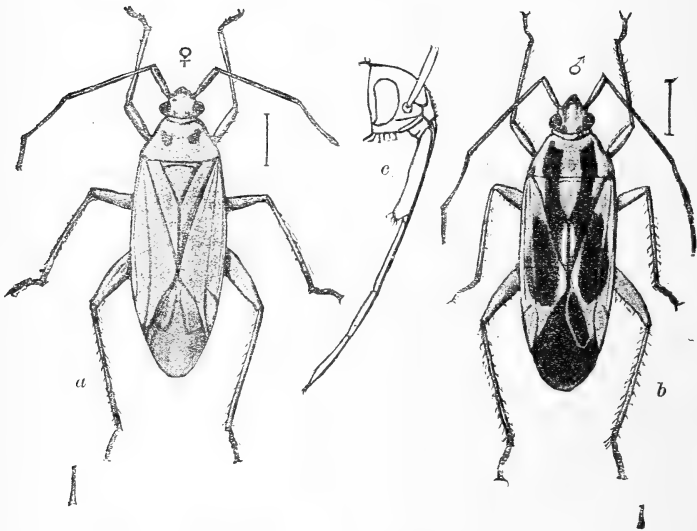

Fig. 8.—*Oncognathus binotatus*: a, female; b, male—enlarged; c, head from side—still more enlarged (original).

There is a handsome plant-bug of the family Capsidæ which was described many years ago by Fabricius as *Capsus binotatus*, but which was placed by Fieber in his new genus *Oncognathus* in his revision of the genera of this group in 1858, and which is found in different parts of the

world. It is comparatively common all through Europe, and is found also in Abyssinia. It also occurs in different parts of the United States, where it has a general distribution as indicated by Uhler in his catalogue. Mr. O. Heidemann, of Washington, informs me that he has taken it in comparative abundance in Washington during the months of May and June by sweeping the grass, and that he has also met with it in Maryland, and at Berkeley Springs, in West Virginia, late in June. The European distribution of the species, according to Flor, is Sweden, Curland, Russia, between the Ural and the Volga, Germany, Switzerland, France, North Italy, and England. The only European reference to food-plant which I find by a cursory examination is by Kaltenbach, who records it on *Chenopodium*.

In July of the present year I found this species in a limited locality on Oteora Mountain, Greene County, N. Y., and only at an elevation of 2,500 feet. The flora of the mountain was wild, but at the plateau level mentioned some patches of timothy had sprung up about the cottages, and upon the heads of this grass from July 1 to 15 these plant-bugs were found in extraordinary numbers. Almost every head examined carried from six to fifteen bugs, which were busily engaged in sucking the juice of the plant. I found them in no case puncturing the stem. The heads at this time were in full flower, and while I was called away so early that I was unable to see the full effect of the work of the insects, it seems certain that they must have destroyed all chances of the maturing of the seed.

While possessing the habit common to many Capsidæ of running around the head when approached and hiding on the opposite side, they were loath to take wing, and were readily captured by sweeping or even by the cyanide bottle. All stages of the insect were found, with the exception of the egg. The timothy heads were spotted to a certain extent with black excrement.

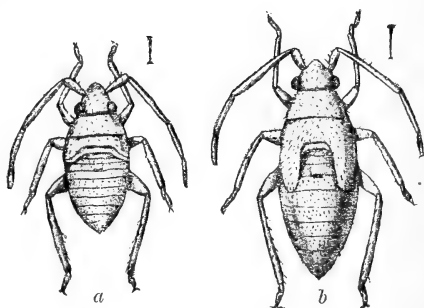

Fig. 9.—*Oncognathus binotatus*: a, larva; b, nymph—enlarged (original).

Perhaps the most curious part of the observation lies in the fact that 200 feet below this point of the mountain not a bug could be found, while 500 feet below there were very extensive timothy meadows in a condition of rank growth, and I spent upwards of an hour in one of these fields searching for the insect, but without success.

This interesting case of local damage, although occurring to me at first to be dependent upon elevation, must have been due to some other as yet undiscovered local cause, or perhaps it is a beginning of

a new taste on the part of the insect which may ultimately lead to considerable damage to the important timothy crop.

A late letter from Prof. P. R. Uhler informs me that the species was first brought to his notice about twenty years ago, from Canada. Since then, he states, it has spread to Baltimore, where it is occasionally very numerous, locally, along the edges of fields of wheat, oats and timothy, in June.

Mr. Smith stated that he had found the species in New Jersey, at an elevation of only 15 to 20 feet above tide water.

Mr. Osborn said the species occurred in Iowa, but had not been observed on Timothy.

Mr. Webster said that *Leptopterna dolabrata* Linn. had developed in the grass and clover fields, in Ohio, in immense numbers the present year. While many farmers were, for a time, considerably worried over their appearance, no damage had been reported.

The next paper was read by the Secretary.

FOOD-PLANTS OF SOME N. A. MEMBRACIDÆ.

By F. W. GODING, *Rutland, Ill.*

Subfamily Centrotinæ.

<i>Insects.</i>	<i>Food-plants.</i>
Centrodontus atlas Godg.....	Leaves and twigs of <i>Larix mexicana</i> .
Microcentrus caryæ Fitch.....	Hickory, Walnut.

Subfamily Darninæ.

Stictopelta marmorata Godg.....	Mesquite (<i>Prosopis juliflora</i>).
---------------------------------	---

Subfamily Smiliinæ.

Ceresa diceras Say.....	Low bushes, tall herbage, grass.
Ceresa bubalus Fabr.....	Apple, Potato, Tomato, Pear, Peach, Plum, Grape, Apricot, Almond, Willow, Locust, Japan Lily, Grass.
Ceresa brevicornis Fh.....	Hickory.
Stictiocephala lutea Walk.....	Wheat.
Stictiocephala inermis Fabr.....	Plum, Oats, Oak, Alfalfa, grass, weeds.
Acutalis calva Say.....	<i>Eupatorium maculatum</i> , Honey Locust.
Acutalis dorsalis Fh.....	Grape.
Entilia sinuata Fabr.....	Potato, Ragweed (Ambrosia), woods.
Publilia modesta Uhler.....	<i>Glycyrrhiza lepidota</i> , Mesquite (<i>P. juliflora</i>).
Publilia bicinctura Godg.....	<i>Ica xanthiifolia</i> , <i>Glycyrrhiza lepidota</i> .
Publilia concava Say.....	Canada Thistle, grass, weeds.
Smilia camelus Fabr.....	Black and Red Oak, weeds along shore of Lake Michigan.
Cyrtosia fenestrata Fh.....	Oak.
Cyrtosia pallidifrontis Emmons.....	Oak.
Cyrtosia vau Say.....	Walnut, Hickory, Oak.
Atymna inornata Say.....	Chestnut, Linden, Oak, Hickory.
Atymna viridis Emmons.....	Oats.

Vanduzea arquata Say	Oak.
Vanduzea vestita Godg	Flowers and foliage of Mesquite (<i>Prosopis juliflora</i>).
Ophiderma flava Godg	Laurel Oak.
Ophiderma flavicephala Godg	Laurel Oak.
Thelia cratægi Fh	Oak, Apple, Thorn.
Thelia uhleri Stal	Wild Plum, Virginia Creeper.
Thelia univittata Harris	Oak, Grape.
Thelia acuminata Fabr	Locust, Pear, Chestnut, various bushes.
Thelia bimaculata Fabr	Locust, Elder, Black Willow.
Telamona magniloba Godg	Wild Grape.
Telamona fasciata et unicolor Fh	<i>Ampelopsis quinquefolia</i> , Grape.
Telamona monticola Fabr. = querci Fh. (?)	Oak, Linden.
Telamona reclivata Fh	Oak, Chestnut.
Telamona irrorata Godg	Oak.
Telamona coryli et tristis Fh	Hazelnut.
Telamona excelsa Fairm (?)	All oaks, except <i>Quercus macrocarpa</i> .
Telamona ellæ Godg	Black Willow.
Heliria scalaris Fairm	Beech.
Heliria strombergii Godg	Black Willow.
Carynota mera Say	Butternut, Hickory, Oak.
Carynota marmorata Say	Oak.
Archasia galeata Germ	Eupatorium, <i>Verbena hastata</i> , Oak.

Subfamily **Membracinae**.

Enchenopa binotata Say	Butternut, Birch, Apple, Walnut, Grape, Hop-tree (<i>Ptelea trifoliata</i>), Locust, Redbud, <i>Celastrus scandens</i> , Cherry, Viburnum, Ceanothus, White Birch, weeds.
Campylenchia curvata Fabr	Bushes and weeds.

Subfamily **Hoplophorinae**.

Hoplophora 4-lineata Say	Oak, weeds, bushes.
--------------------------------	---------------------

I am indebted for many of the above facts to Prof. S. A. Forbes, Mr. C. W. Stromberg, Prof. C. P. Gillette, and Prof. C. F. Baker. Other papers on the food-plants of our Membracidae will be published as rapidly as data are obtained. Local lists will be thankfully received and due credit given.

In the discussion that followed, in which Messrs. Smith, Lintner, Osborn, and Webster participated, strong objections were urged against the use of indefinite terms as weeds, bushes, and shrubs, which might mean any one or more of many species of plants. If the food-plant could not be designated, at least generically, by the original observer it should not be cited at all, in giving the food-habits of insects. The information to be of any value should be more exact.

NOTES OF THE YEAR IN NEW JERSEY.

By JOHN B. SMITH, *New Brunswick, N. J.*

The summer of 1892, so far as it has passed, has been, entomologically, a quiet and uneventful one. There has been no disastrous outbreak, no sudden appearance of any new pest, and yet the annual tax levied by insects has scarcely decreased. There has been an increase of injury

from Curculio and Codling Moths, due to the excessive crop of 1891, when in many unsprayed orchards myriads of specimens developed, and the comparative scarcity of fruit in 1892, which is nearly all required by the excessive number of insects craving sustenance. Even in sprayed orchards injury is quite marked, while in some that are unsprayed 95 per cent of the fruit is wormy and the rest is deformed by Curculio punctures. I have counted thirty-five crescents on a single apple no larger than a walnut. The Pear Midge has reached New Brunswick, and has, probably, been there since 1891 at least. Found a few infested pears in a well-kept orchard, and in a neighboring, uncared-for lot of trees, many of them Lawrence, I found a considerable percentage of infested fruit. I have been unable to trace it either south or west of here, and there are some orchards on the direct line between Elizabeth and New Brunswick where it has not been found.

On Cranberry I found, locally, a species of *Cacœcia* not yet determined and not heretofore recorded on this food-plant. Grasshoppers are complained of as more injurious than ever on the bogs and in some localities have taken to late cabbages.

Cabbages, by the by, and Cauliflower as well, have suffered rather more than usual from the Root Maggot and from the larva of *Pieris rapæ*.

Growers are rather reticent on the subject, but I have reason to believe that a considerable amount of protection from "cabbage worms" is obtained by the use of Paris green.

Early tomatoes have suffered unusually in the southern part of the State from an attack by the larva of *Heliothis armiger*. The early fruit pays so extremely well that truckers are anxious to gain even a day when possible, and every tomato counts. As the earliest fruit was most infested the money injury caused by the insect was quite out of proportion to the actual percentage of fruit destroyed. The larva is locally known as the "heart worm."

Crioceris 12-punctatus has made its appearance near Swedesboro in southern New Jersey. I found it only on volunteer asparagus shoots near the railroad track, and it does not seem to have entered the cultivated beds across the fence.

On May 30, I found one specimen; on June 11, three specimens, and on the 28th, a considerable number of them. July 13 I sought in vain for more, and I have not been in the locality since. How extended its distribution may be in the State I do not know; it has not been complained of as yet, nor has it been taken by the Philadelphia collectors.

Some criticism of my Rose-chafer bulletin was made because I did not personally test the kerosene emulsion, relying upon Col. A. W. Pearson's dicit that it was ineffective. I had tested the pyrethro-kerosene mixture, and finding it ineffectual could not believe that kerosene alone could be more efficient. To make assurance doubly sure, however, I made a series of experiments at Vineland, using the Riley-Hub-

bard formula with a slight accidental excess of soap and diluted the emulsion with eleven parts of water. Sprayed a clump of roses which were full of beetles and spread a canvass on the ground underneath for facility of observation. The spraying was done by means of a Eureka knapsack pump with Vermorel nozzle and was more thorough than would be possible in field practice on grape-vines.

The first experiment was made before 9 a. m., while yet the beetles were somewhat sluggish, and they were well soured. Not a score of them fell to the ground, and of these all but two or three flew off as soon as the sun dried their wings. The defunct specimens were examined and proved worn out females. The experiments were duplicated later in the day on another bush, with the same results. Two separate lots were dipped into the mixture and completely submerged for a moment. These were placed on the ground in the sun, and, as soon as they dried off, at least 75 per cent of them took flight, a few of them only remaining at the end of half an hour. Even were it more effectual the vines could not stand many sprayings of so strong a kerosene mixture. I can therefore confirm, from direct experiment, the statement heretofore based on Col. Pearson's experience.

The insect was less abundant this year in most of the localities previously worst infested, while it did injury in some localities previously nearly exempt. It was much more local than usual, vineyards even in the same mile square being very unequally infested.

There seems to be also a slight change in taste, for apples were preferred to grapes on Col. Pearson's farm, while roses remained prime favorites, even those drenched with the kerosene mixture being eaten readily without apparent injury to the beetles.

At Hammonton strawberries were somewhat injured, but as a whole the insects were less abundant than for several years past and in some cases lime dusted on the plants served as a complete protection, there being an abundance of more palatable food for the smaller number of beetles. Near Lakewood *Anomala lucicola* made its appearance as an enemy to Grape, skeletonizing the leaves. The larva develops in much the same localities as the *Macroductylus*, but is smoother and more yellow. When full grown the larval skin splits along the back, but remains entire as a covering to the pupa, which develops within it. I do not remember having seen this feature noted of any larva of this group. The beetle was unusually abundant in some localities in south Jersey, but was not complained of as otherwise injurious.

Some little attention was also devoted to Black and Raspberry insects early in the year. *Agrilus ruficollis* has killed off many carelessly trimmed fields and I have found it in both Blackcap and in Red Raspberry canes, in which it does not do any injury.

The stem-borer which I mentioned in my report of last year as probably Lepidopterous, from a fragment, proves a saw-fly which I have

not yet determined. It is quite generally parasitized and I got only two adults. The common practice of topping the canes destroys most of the larvæ and the insect is thus not likely to become seriously troublesome. I have found it also in Raspberry canes.

Last year I found only a few isolated specimens of the larvæ of *Selandria rubi*, and, hearing nothing of any injury from this slug, did not even mention it in my bulletin. This year the insect developed abnormally in some plantations and destroyed the fruit on many acres of raspberries and on a few acres of blackberries. Even where not positively injurious, it was much more abundant than last year.

I found also, quite commonly, a leaf-roller larva on Blackberry, from which I bred a species of *Phoxopteris* closely allied to *fragariæ* Riley. It did no real damage, but its occurrence is interesting, because I did not see it at all last year.

The sweet-potato crop is an important one in New Jersey, and no better-flavored tubers are raised anywhere. The vines suffer from a variety of insects, and special attention was paid to them during the season. All the Cassids, so well figured in Dr. Riley's Second Missouri Report, are represented in this State, but are single brooded. A little pest that has thus far baffled my efforts to get at its life-history is a flea-beetle, *Chatocnema confinis* Lec. It makes its appearance quite early, as soon as sweet potatoes are set out, and that is anywhere from May 1 to June 1.

It starts generally from the edges of the field adjoining a road fence or a wood, and spreads rapidly over the whole field, eating peculiar and characteristic channels on the upper surface. The leaves dry up and die, and often this kills the plant; I watched the insects from the middle of May to the middle of June, when they had about disappeared, and I failed utterly in finding any trace of their larvæ on sweet-potato vines. I examined a large number of plants from the roots to the tip of the runners, slicing them up completely, and did not see anything that looked like a beetle larva. The inference is that the beetle breeds on some other plant, though I failed to find them anywhere else. In some fields cutworms did considerable injury in their well-known way. I bred none to maturity, but the larvæ seemed to be very like those of *Carneades messoria*, and so Dr. Riley determined them for me.

It is rather curious that all these sweet potato pests attack the vines almost immediately after planting, when they are least able to resist attack. After the vine starts running it is beyond danger of injury.

Insects injurious to the Cucurbitaceæ have formed the main line of study during the season, and of these pests the Squash Borer (*Melittia ceto*) has received the most attention.

I have succeeded in clearing up about all of the moot points in its life-history, and have found what I think is a practical way to prevent serious injury. To ascertain about how many eggs a single female

might lay, and how they compared on the same date, six specimens, taken on July 16, were dissected, with the following result:

No.	Developed.	Undeveloped.	Total.
1....	50	60	110
2....	94	30	124
3....	10	80	90
4....	20	64	84
5....	4	10	14
6..	20	64	84

Four specimens, taken August 6, gave the following result:

No.	Developed.	Undeveloped.	Total.
1....	124	88	212
2....	10	68	78
3....	20	78	98
4....	74	44	118

As developed eggs were counted those that were of full size and of a light-brown color, showing a completely chitinized coat. No. 1 of the lot of August 6 was taken in copulation, and it may be assumed that no eggs had yet been laid. The very large number of developed eggs—124—points to a very rapid oviposition, and this is borne out by observations in the field, the female flitting busily from hill to hill and leaving an egg at every point. What length of time an individual might live has not been ascertained. The insects are rather less common in New Jersey and do not extend over so long a period as they do on Long Island, where Mr. J. V. D. Walker, of Jamaica, introduced me to some very fine squash patches and likewise to a very choice article of mosquito, far superior to anything produced in New Jersey.

I had expected to spend considerable time on the Melon Louse, which for two years had done great injury, and in 1891 had destroyed completely many acres of cantaloupes and cucumbers; but it made its appearance this year only long enough to disappear.

On June 27 I found a few winged viviparous females on melons; some had just come along from somewhere; some were surrounded by a small progeny, and sometimes a small progeny existed without any stem-mother.

The most rigid and careful search in fields on melons for the second year, and which were badly injured in 1891, failed to reveal any specimens on the roots or in the soil, while the plants were not a bit more infested than they were in neighboring fields. On a cucumber patch in another locality I found the Aphids much further advanced, and several colonies of the wingless product of the stem-mother were surrounded by flourishing families of their own. Everything pointed to a favorable season for observation then and next day, when I found the same state of affairs at the opposite side of the State. Between

June 29 and July 5 there was an assorted variety of weather; rain, hail, cyclonic wind storms, and other similar manifestations followed in rapid succession. On July 5, when I again visited the fields, I did not find a single colony of *Aphis cucumeris* on either melon or cucumber, nor have I found more than an isolated specimen here and there since that time. This state of affairs exists all over the truck region of the State, and none of the hundreds of melon and cucumber fields examined showed any trace of injury by the Aphids. So far as my observations go, I am now inclined to believe that the Aphid has an alternate food-plant on which is passed the period between August 1, when it usually disappears from the cucurbs, and June 15, when it reappears on them. This is a belief without much observation to support it, and is put forth as a suggestion merely.

Epilachna borealis, larva and imago, has increased steadily in the last years, and now ranks as an annoying pest, even slightly injurious locally. While it is phytophagic in all active stages, the young larvæ show a somewhat carnivorous tendency. I have noticed on several occasions that the first one or two larvæ from an egg cluster would eat into every unhatched egg in the group before attacking the leaf.

Diabrotica vittata does comparatively little injury with us. It is abundant enough, but is amenable to discipline in the form of plaster, with or without Paris green. Abundant as is the imago on all cucurbs, I have as yet found only a single larva on all the plants I have sliced up. I have seen traces of its work in some instances in the form of channels eaten in the bark of the root; but it certainly is not injurious in this stage in New Jersey. I have pulled up dozens of wilting cantaloupes and many more squash vines and have carefully examined them, yet I have found only a single larva, and in no case was the wilting caused by it. Do the larvæ perhaps have another food-plant? A grower at Esopus, on the Hudson, destroys many of the beetles by sending a man through his patch morning or evening to collect the closed male flowers, in which the insects hide, often in large numbers.

There has been another appearance of the larva of *Phytonomus punctatus*, the Clover-leaf Beetle, threatening serious injury; but it was again checked by the fungous disease that destroyed so large a proportion of the specimens in 1890 and 1891.

The Entomologist has not been overwhelmed with novelties, but he considers that he has work ahead for another season at least, even if nothing new turns up.

Mr. Howard stated that the new asparagus beetle, *Crioceris 12-punctatus*, seems to be spreading very slowly. He also expressed astonishment that the Rose Chafer did not yield to the effect of pyrethro-kerosene emulsion in view of the statement of Prof. Cook in 1891.

Mr. Webster thought it little use to attempt to fight this pest with insecticides, which only killed, and did not protect from continued attack. It seemed to matter little how many were destroyed, as their

places were soon filled by others, and fruit-growers in his State had found it impossible to even partly protect themselves in this manner.

Mr. Lintner thought that the breeding grounds of the pest should be searched for and the larvæ destroyed.

Mr. Smith said he had not found larvæ in damp localities, where they were said to occur, but in dry, sandy grounds.

Mr. Osborn felt quite sure that the larvæ of *Diabrotica vittata* must have other food-plants besides the Cucurbitaceæ. He also expressed the opinion that the arsenites might be safely used on Cabbage, in fighting cabbage worms, if the poison was used with proper caution.

Mr. Howard said that about Washington both the native and imported species of *Pieris* are very destructive to Cabbage, as well as *Plusia brassicæ*, *Plutella cruciferarum*, *Pionea rimosalis*, *Mamestra picta*, and *M. trifolii*, the last-named species being the most difficult to kill. Certain truck farmers, he said, are using arsenical poisons on Cabbage as the only good remedy, but are doing it very secretly.

Mr. Lintner expressed surprise that the Plum Curculio (*Conotrachelus nenuphar*) should be so destructive to the apple crop in New Jersey. No such damage to this crop, by this pest, had been reported in New York.

A specimen of the Asparagus Beetle (*Crioceris asparagi*), taken that day in Rochester, N. Y., was exhibited by a young man, Mr. Ira Wile, not a member of the Association.

Mr. Webster stated that the Clover-leaf Weevil (*Phytonomus punctatus*) had appeared in northeastern Ohio in destructive numbers. He had observed it at Chautauqua Lake, New York, in 1888. The Clover Root-borer (*Hylastes trifolii*) had been sent him from northern Ohio, with the complaint that it burrowed in the roots of peas. Specimens of the depredator and its work had accompanied the complaint. The ground where the attacked peas were growing had not been devoted to clover for several years. *Otiorhynchus ovatus* had shown a fondness for the foliage of the Musk Melon in Wayne County, Ohio, and was very abundant about the vines. No material injury could, however, be traced to their work.

Mr. Lintner said that the last-named species had been reported in New York as infesting dwellings in great numbers, and Mr. Howard said the same had been reported to the Department of Agriculture from Ohio.

Mr. Kellicott offered the following resolution:

Resolved, That we respectfully request the publication, as heretofore, of the Proceedings of the present meeting in INSECT LIFE, and that the Secretary be asked to prepare the same for publication; and that he also be asked to prepare an abstract of the Proceedings and request the publication of the same in the *Canadian Entomologist*.

On motion of Mr. Southwick, seconded by Mr. Smith, the resolution was adopted.

The President appointed as committee on nomination of officers Messrs. Webster, Kellicott, and Southwick.

The Association then adjourned to meet at 10 a. m. August 16.

AUGUST 16—MORNING SESSION.

The Association commenced at 10 a. m., President Lintner in the chair. The minutes of the preceding session were read and approved. On motion of Mr. Osborn the Secretary was instructed to assess the members sufficiently to provide funds for paying the necessary expenses. Carried.

Mr. Kellicott offered the following resolution, which was adopted by the Association:

Resolved, That one member of this Association be appointed a committee (to act with similar committees appointed by other societies) to confer with the council of the A. A. S. regarding a change in the day of the week set for the beginning of its annual meetings.

Mr. Kellicott was appointed by the President as a committee to proceed in accordance with this resolution.

The first paper brought before the Association was as follows:

THE PEAR-TREE PSYLLA.

(*Psylla pyricola*.)

By M. V. SLINGERLAND, Ithaca, N. Y.

This insect appeared in enormous numbers in different parts of this State, especially in the Hudson River Valley and at Ithaca, during 1891; and orchards which promised 1,200 barrels of fruit at blossoming time developed less than 100 barrels; leaves and blighted fruit dropped in August, and some trees were killed. It is one of the most serious pests that pear-growers have to fear.

The adult insect measures scarcely three millimeters in length, is very active, and strikingly resembles a Cicada in miniature. The nymphs are oval, exceedingly flat objects, of a light yellowish color when young, but becoming blackish with distinct markings when full grown. The light yellowish cylindrical-ovate eggs, which are scarcely visible to the unaided eye, are attached by a short stalk near the larger end, and have a long slender thread projecting from the smaller end.

My observations upon this pest began in December, 1891. At that time adults and a few nymphs were found hidden in the crevices of the bark of the pear trees; no eggs were found. The hibernating adults were watched, and the trees carefully examined at various times during the winter, but no eggs were laid until about April 10, when the adults were frequently seen in copulation. These eggs were laid in the creases of the younger branches, about the bases of terminal buds. Eggs on branches brought into the insectary at this time hatched in

eleven days, but in the field the nymphs did not emerge until about May 10, when the leaves had begun to unfold. The minute creatures immediately crawled as far as possible into the leaf axils and began sucking the sap. This seems to be the favorite point of attack through the season, and nymphs are invariably found in the leaf axils or on the stems of the fruit, unless very numerous, when they cluster about the branches just below the leaves or along the midrib of the leaves. They prefer the younger and tenderer branches and leaves, which often droop early in the season from the excessive loss of sap occasioned.

By careful observations upon isolated individuals, I have found that the nymphs moult five times, including the one at which the adult insect appears.

Adults of the first spring brood began to appear about June 1. For two days after emerging they were of a greenish color and then took on the characteristic red and black markings. Eggs from these adults were plentiful about June 15 and were found on the under side of the younger leaves, usually partially hidden in the pubescence along each side the midrib. Adults of this second brood appeared in about thirty days, or July 15. There will thus be at least three and probably four broods during the season. During the summer all stages of the insect may be found on the trees, owing to the overlapping of the broods.

The summer forms of the adults are smaller and less intense in coloring than the hibernating adults. In the former the front wings are of a yellowish tinge, and the veins, even in dark specimens, are light yellow, while the front wings of the latter are nearly transparent, with dark shades in the cells and very dark brown or black veins. After a careful comparison of both forms with the descriptions of the four known pear *Psyllas*, *pyri*, *pyricola*, *pyrisuga*, and *simulans*, I am led to believe that the insect in question is *Psylla pyricola*, and that *Psylla simulans* is the winter variety or hibernating form of *pyricola*.

Last year the nymphs were so numerous by June 15 that the honeydew secreted covered the branches and trunks of the trees, and was accompanied by the usual black fungus, which gave the trees a very smoky, unhealthy appearance. The honeydew appears to be secreted only by the nymphs, but in what manner I do not know. The excrement and honeydew are distinct, the former having a firm, whitish appearance, while the latter is clear, like water. I think both secretions come from the anus.

REMEDIES.

I have fought this pest in all its stages except the adult. It is claimed by those who tried spraying the adults in the summer that they were exceedingly active and arose from the tree in a cloud as soon as the spray struck the leaves; possibly some were killed upon returning to the tree by the adhering spray. The hibernating forms, however, are quite inactive, sometimes coming from their hiding places and crawling

about the branches, and I believe many of them would be destroyed by washing the trees thoroughly with a dilute kerosene emulsion in the winter.

Many entomologists advise the use of kerosene emulsion to destroy the eggs of Aphids and, as the eggs of the pear *Psylla* were similar, I confidently expected to be able to easily destroy the exposed eggs laid in the spring. In brief, the results of my experiments were, that nymphs emerged from eggs which had been dipped in the following substances: Kerosene emulsion diluted to 33 per cent kerosene, or diluted to 17 per cent, and heated to 130° F.; pure kerosene, benzine, turpentine, pure, and as an emulsion; resin wash, triple strength; whale-oil soap, and sulphide of potash wash, and carbolic acid and concentrated potash when diluted so as not to injure the buds, did not kill the eggs. It is thus seen to be impracticable to try to fight the pest in the egg state. I notice in the last June number of *INSECT LIFE* a communication which records similar unsuccessful results in trying to destroy the eggs of Aphids. In the reply the writer still adheres to the belief that they may be killed by kerosene emulsion, but I have been unable to find any account of previous careful experiments in this line. I believe that there is too much theory and too little scientific practice put into our recommendations for destroying not only the eggs of Aphids, but other stages of other insects as well.

Failing to check the pest in its egg state, I began experiments upon the nymphs and very soon found that they were very susceptible to kerosene emulsion even when diluted to 2 per cent kerosene. As they congregate in the leaf axils, the emulsion would the more easily run down the leaf petiole and destroy them almost as soon as they were touched by it. Field experiments showed that fully 90 per cent of the nymphs of all sizes could thus be reached and killed by one spraying. This is, therefore, the stage in which to fight the pest.

Some claimed that last year there was so much honeydew that the nymphs were completely enveloped in it, thus protecting them from the insecticide. I have sometimes seen a few nymphs thus covered, but I noticed that the rains washed off the secretion to a large extent. I therefore believe that a very practicable method of combating this serious pest is to spray the trees with kerosene emulsion diluted to 2 per cent kerosene in the spring soon after the leaves have unfolded; the proper time in this State this year was about May 15. The best time would be after a rain when the trees have become dry again. There would then be less honeydew to protect the nymphs. A rain soon after spraying does not lessen the destructive effect of the emulsion, which kills almost instantly. A second spraying a few days later would be advisable. Of course other broods of the nymphs may be destroyed later, but it is important that the early brood be checked, for the greater part of the damage is done before June 15.

The pest has not appeared in such alarming numbers this year as one

would expect from its great abundance last year, due, I think, to some extent to the fact that the trees were coated with a sheet of ice for nearly a week at one time during the winter when many of the hibernating adults must have perished. This year the trees are infested, but not to an alarming extent, and they are making a good growth; but, owing to the great drain of last year, but few trees blossomed, and those which did had not sufficient strength to develop the fruit.

Mr. Osborn asked if the insect was not easily killed on the wing. Mr. Slingerland stated in reply that he had understood that the adults took wing as soon as any attempt was made to spray the trees upon which they were located. In reply to a question of the southern limit of the species in New York he stated that he had no information of its occurrence farther south than Catskill Landing, on the Hudson River.

Mr. Riley believed the author was correct in his identification of the species, and in the conclusion that *simulans* was but a form of *pyricola*. He also fully agreed with the statement made by the author in regard to the effect of kerosene emulsion on the eggs of insects; that the published statements as to its effect upon insect eggs were in many cases hypothetical, and not based on actual experience, was but too manifest. His own experiments have been largely confined to the eggs of Aphididæ which vary considerably in thickness of shell, but so far as his observations went they would indicate that a strong kerosene emulsion, while not causing the eggs to shrivel at first, would in the end destroy—*i. e.*, prevent the hatching—of large numbers, especially where the treatment was repeated. Experiments on the eggs of *Aleyrodes* on the Orange gave similar results. He would call attention to two facts which would, to some extent, explain the varying experience in this particular line; first, the difference in resisting power and thickness of egg-covering; secondly, the character of the emulsion and the method of its application. A stable emulsion, made according to the Hubbard formula and applied in a very fine spray, would be much more effective than an unstable emulsion applied in a coarser spray. The value of the emulsion depended largely on the extent of the divisibility of the oil globules in the menstruum or emulsifying agent; where these particles were relatively large no amount of spraying would cause any of the oil to adhere to a highly polished surface like that of most insect eggs, whereas when the particles were microscopically minute and the spraying very fine, the particles would be more apt to settle upon such a surface.

Mr. Lintner stated that in spraying for the *Psylla*, only the Cyclone nozzle should be used, as it discharged the liquid in such a manner as not to agitate the foliage, and thus disturb the insects, who were thus drenched without warning.

Mr. Smith said that he had been very successful with kerosene emulsion in destroying the eggs of *Pulvinaria innumerabilis*, and in

New Jersey growers at Vineland destroy the grape-vine leaf-hoppers, by tarring both sides of a stiff card-board about 15 by 20 inches nailed to a wooden handle of some kind. The grower walks between the rows, stirring the vines so as to induce the specimens to fly, and waving the tarred boards forward and backward most of the specimens are captured. More are captured on the back of the board than are taken on the front of it. Two or three journeys through the vineyard are usually sufficient to clear it of insects.

Mr. Riley stated that there could be no doubt as to the dual nature of honeydew, or rather of its treble nature, as he had long been satisfied of the facts from his own observation. The liquid thrown off by the honey tubes is frequently ejected to a considerable distance and showered in the form of a fine dew upon the foliage beneath, and this is the explanation of the very general glossiness of the leaves of trees affected by certain species of Aphides, especially in early summer. That the excrement is also liquid and saccharine may be easily proved by observation not only in this family, but in the Coccidæ, while there is a third kind of honey dew which has no connection with insect secretion, but is an extravasation of the sap of plants caused particularly by great extremes of temperature during rapid growth.

THE PEAR-LEAF BLISTER MITE.

(*Phytoptus pyri*.)

By M. V. SLINGERLAND, Ithaca, N. Y.

This pest is alarmingly on the increase in the United States and Canada, and threatens very serious injury to our pear interests unless speedily checked. The mite was discussed at some length in Bulletin 23 of the Cornell Experiment Station. Since then I have made a few additional observations and have discovered what I believe will prove a practicable method of exterminating the pest.

The life-history of the mite appears to be, in brief, as follows: The mites which are hardly visible to the unaided eye appear on the leaves as they are unfolding in the spring and form small bright red spots or blisters, having small openings on the lower side of the leaf; the eggs are laid within the galls and the young escape through the opening and form new galls. As the season advances the galls change color, and about June 1 they are green, distinguishable from the remainder of the leaf only by their slightly raised corky appearance. In about a week they assume the characteristic black or brown color which they retain until the leaves fall in autumn. When very numerous, the galls coalesce and often cover nearly the whole leaf. In the autumn, before the leaves fall, the mites leave the galls and enter the winter buds. Usually they are to be found beneath the two or three outer scales of

the terminal buds where they remain until the leaves unfold in the spring.

It is thus seen that the pest is well protected at all seasons from any poisonous application which might be made. We found that kerosene emulsion would not reach them while in the galls, and it was thought recourse must be had to mechanical means, such as removing and burning the infested leaves which might be practicable on a few choice trees, or by carefully pruning and burning the young wood in the winter, thus destroying the hibernating mites. Both these methods would be laborious and impracticable on a large scale.

While experimenting to learn the effect of pure kerosene on dormant wood, I noticed the thoroughness with which the oil penetrated every crevice of the wood, and at once suspected that it might be used with effectiveness against the Pear Mite while in its winter quarters. Last fall I therefore marked several small trees which were very badly infested, and in February two trees were treated with pure kerosene; on another tree kerosene emulsion (Riley-Hubbard formula) diluted with $2\frac{1}{3}$ parts of water was applied with a brush. One tree was left untreated as a check. This spring the mites appeared in force on the check tree, but upon the trees treated with the kerosene emulsion not more than a dozen galls have been formed, the pest thus being nearly exterminated. The trees treated with pure kerosene were very seriously injured, but the only effect upon the tree treated with the emulsion was a slight retardation in the unfolding of the leaves in the spring.

This single experiment on so small a scale is of course only an indicator, but could anyone have seen the check tree and the one treated with the emulsion last season and this, I think he would agree that the result strongly fortifies the statement that in kerosene emulsion containing at most 20 per cent of kerosene we have a very practicable remedy for this pest when in its winter quarters.

The coming winter more extensive experiments will be made and next spring I hope to report equal success with even a less percentage of kerosene applied with a common sprayer.

Mr. Lintner reported the insect as excessively abundant in eastern New York, and Mr. Webster reported it very abundant in Ohio, and stated that spraying with Bordeaux mixture had not shown any beneficial effect.

Mr. Smith stated that in New Jersey the *Phytoptus pyri* has been more than usually abundant. It is, however, very much less troublesome in sprayed orchards than in those unsprayed. The station recommends for orchard practice a spraying before the flower buds open, using carbonate of copper dissolved in ammonia as the fungicide, and London purple as the insecticide. Two sprayings with the same mixture are made after the fruit has set, and after that the fungicide, alone is used. In orchards so treated no injury was done, while in untreated

orchards a large proportion of leaves were lost. In the sprayed orchards plant-lice were also very much less troublesome than in those unsprayed.

The following paper was then read:

THE PARSNIP WEB-WORM.

(*Depressaria heracliana* DeG.)

By E. B. SOUTHWICK, *New York City.*

In the year 1887 I first began to make observations on this insect, but had for many years before noticed it working upon the wild parsnip in the field and along the fences and ditches.

On the farm where I spent my vacations in the summer, at New Baltimore, N. Y., the wild parsnip grew in the greatest perfection, and here the Web-worm was found, but on an island in the Hudson River opposite this farm I never saw one of these insects, although there were acres of wild parsnip, even more luxuriant in growth than upon the upland.

In meadows that were annually producing hay and along the ditches and fences of the farm they were very abundant and afforded a fine field for the collector of Hymenoptera and Diptera, and while collecting and studying these forms of insect life, my attention was directed to this very destructive insect working upon the umbels and other parts of the plant. In this case, however, they were doing no especial damage, for the wild parsnips were considered a curse among the farmers. Had these parsnips, however, been cultivated for their seed, the damage would have been very great, and a different aspect would have been given to the case, and a cry of alarm raised.

In that year I made many notes as to their habits and manner of working, but it was not until the next year that I bred them and obtained the imago.

In 1889 I again bred numbers of them, but not until 1890 did I succeed in obtaining parasites from them. I then collected a barrel of the stalks and brought them to New York City, as I had before done, and placed them in my glass breeding cages. From this lot I obtained many moths and three species of a Hymenopterous parasite and one Dipterous.

The Hymenoptera, Mr. Ashmead said, were species of *Limneria*, but he could not at that time quite determine what particular species they were. This breeding of parasites was quite interesting to me, for Dr. Riley, in *INSECT LIFE*, had said that no parasites, as far as he knew, had ever been bred in this country, and Dr. Bethune also stated that he knew of none, and both Dr. Riley and Dr. Bethune had given this insect some attention. Other parasites have, however, been bred from it in other countries, for which see the article in *INSECT LIFE*, some of these

parasites being found in the roots of the parsnip, together with the pupa cases of the moth. I have never examined the roots of the plant to see if the larvæ did go down into them, but I presume they do so when very abundant and can not find sufficient accommodation in the stalk itself, which is often very full of the silken cocoons of the pupæ. Many of the larvæ had eaten through the nodes, and even the internodes of the stalk were perforated. The habits of entering the stalk at the node seemed to be preferred, however, after the leaves and sheaths had been devoured and under the frass collected at that point.

The stalks of the parsnip in this field were so completely stripped of every umbel and leaf that they presented nothing more than a mass of dry sticks standing among the grass, and in this case materially lessening the seed crop, and therefore the plants for the coming year.

Sometimes as many as five of the pupæ would be alongside of each other, but each in its own silken cell.

The larvæ taken by me in 1887 were found in the first week of July, the most of them at that time having entered the stem to pupate. In 1888 it was the last week in June, and then all were in active operation under cover of their webs.

No doubt birds do feed upon these larvæ, and Bethune says the Hairy Woodpecker (*Picus villosus*) visited the parsnip stalks in his garden daily and pecked away at the larvæ and pupæ within. Although birds abounded in the meadows and adjacent woodland, yet after several years observation I have never seen a bird obtaining its food from this source, although nothing could be easier to obtain, or more delicious when obtained, than the larvæ of this insect. I have examined hundreds of webs, and while I have found many empty of larvæ, I have attributed their absence to be charged more against the Potter Wasp than to the work of birds, who either do not know a good thing when they see it or fail to see it altogether.

I discovered that one of the worst enemies the Web-worm had was the Potter Wasp (*Eumenes fraterna*), a veritable canine in propensities for hunting and capturing the caterpillar.

One of these wasps would alight on the umbel in which a web was situated and would begin to peer into it first at one end, then at the other, all the time getting more and more excited. On discovering the worm within it would commence to run its abdomen into the end of the web, with its head directed towards the opposite end, trying in this way to eject the occupant, and every now and then darting at the orifice as the worm would approach it. In this way it would work for a long time, first at one end and then at the other, no doubt each time thrusting out its sting. In this way it continued, packing the silken cell at each end until it became too short to longer cover the larva and keep out of reach of sting and jaws and it was forced to show itself, when the mandibles of the wasp sank deep into it and it was dragged forth from its burrow. Sometimes this was done with great difficulty, but

by repeated stings and jerks it would finally be dislodged, when the wasp would again sting it and then fly away with it to its cell as food for its young.

A few days before I had found on an old golden-rod stalk in an open woods four cells of the Potter Wasp, and all were filled with larvæ, many of which were the larvæ of the Parsnip Web-worm, and all of them nearly the same size, the size, no doubt, easiest to dislodge, or at least easiest to carry.

Last summer, 1891, I discovered another means at work reducing the larvæ of the Web-worm. Along a great ditch that ran through the farm the parsnips were very abundant, and on them I found that some disease, apparently, had destroyed many of the larvæ, they being dead in their webs and of a black color and in every case very soft and flabby. This I attributed to a fungus attack, for in this strip about five-eighths of the larvæ were dead. I collected a large number of them, but could find no marks of the sting of a wasp upon them, for I thought perhaps this might have something to do with their destruction. While the tendency of the poison of the wasp is to preserve them alive, although paralyzed for a while, I therefore tried to find some that were in this condition, perhaps recently stung, but could find none but what were black and flabby; and this, with the fact that I could find none of the dead ones on any other part of the farm, led me to believe that the destruction was due to some bacterial (?) germ, perhaps.

Dr. Riley quotes Stainton as saying that the eggs of the Web-worm are deposited in the spring by the hibernated female moth upon the undeveloped umbels of the Parsnip, and Dr. Riley adds that it is not at present known whether there are two broods, though this is quite probable.

It seems to me it would be poor economy to force, at such an early date, these moths into hibernation, for the dangers from their natural enemies would be so great at that season, as to almost, if not quite, exterminate them. With this end in view I have diligently searched for a second brood, and thought they would be found on the Wild Carrot later in the season, but all my searching has failed to reveal a single larva of this moth on the Wild Carrot, although this plant was everywhere abundant, to a degree detrimental to the growth of grass and other crops.

I placed a lot of the moths in a roomy cage with plants of the Wild Carrot, but they seemed to care for nothing, but were continually crawling under anything that would cover them, or they would remain quiescent at all times. No eggs, as far as I could discover, were ever deposited, although they lived for some time, and the carrots with roots also gave them ample temptation, as they were growing, to do so. I darkened the cage, but that did not seem to make them any more active. When disturbed they would dart about with great rapidity and force. I kept some of them until the 29th day of August, and, although the

conditions for hibernation, and even food, if they desired it, in the form of honey, was given them, they all died.

I was at the farm the second week in August last year, 1891, and found many of the moths about the house and outbuildings. In the carriage house, where I had a work table, I could see them running behind the joists and even over my table and under the boxes thereon, their flat bodies enabling them to crawl into very narrow places. This habit of crawling behind and under cover looks as if they were seeking a place to hibernate. They could be seen behind the blinds on the house, and when these were opened or closed would immediately disappear behind them again.

In December of the same year I again visited the farm, and, determining to see if any of the moths could be found, I searched around the buildings, and behind an old-fashioned lantern I found one of the moths as lively as could be, although the weather was very cold; and further search revealed many of them hidden away behind pieces of boards and old shingles that had been stuck in behind the studding. New Year's night, on retiring to our room, Mrs. Southwick discovered one of the moths on the lace curtain, and together we found several of them under the lambrequin over the window, commencing the new year apparently with as much vigor as they had when they emerged from the parsnip stalk. This does not prove they are but one brooded, or that there is only one brood during the year, but it seems to prove that they do hibernate and perhaps may be the same moths I so often saw on the window blinds in August. Yet, I do think it is poor economy to commence to hibernate thus early in the season. Perhaps the moths do go out nights and eke out a precarious living from the flowers until autumn; but I have collected with lights, and sugared a great deal here, yet have failed to take a single one or see a moth resembling it.

Discussion of Mr. Southwick's paper was deferred, in order to admit of the presentation of a paper on—

AN EXPERIMENT AGAINST MOSQUITOES.

By L. O. HOWARD.

[This paper has been already published in *INSECT LIFE*, vol. v., pp. 12-14.]

As Secretary of the Society for Promotion of Agricultural Science, Mr. Howard extended an invitation to the Association to meet with his Society at 2.30 p. m., to listen to entomological papers by Messrs. Herbert Osborn and H. E. Weed.

On motion the invitation was accepted.

In discussing Mr. Howard's paper Mr. Riley stated that he was glad to note the practical suggestions thrown out by Mr. Howard, in regard to preventing the development of the Mosquito.

The idea of doing anything at all practical on an extensive scale by the rearing of dragon-flies had always seemed to him somewhat visionary, whereas the use of kerosene in special cases promised satisfactory results. Mr. Howard's careful experiments were the first, he believed, to show how very effective under certain circumstances kerosene was.

In discussing Mr. Southwick's paper Mr. Forbes thought that much might be accomplished by artificial diffusion of the disease mentioned as attacking the *Depressaria* larvæ, by Mr. Southwick.

Mr. Lintner had been troubled by a similar disease, working among the larvæ of several *Lepidoptera* in his breeding cages.

The following notes were then presented :

NOTES FROM THE MISSISSIPPI STATION.

By HOWARD EVARTS WEED, *Agricultural College, Miss.*

The following short notes embrace only notices of some of the more common insects which have been especially injurious during the past season.

In October of last year the Horn Fly was quite abundant in some of the eastern portions of the State, but by many was not supposed to be a new pest. One point in regard to this insect has been especially noticed this season, which I do not find mentioned by those who have given the subject especial attention. This is in regard to what cattle are especially attacked. Riley and Howard in *INSECT LIFE* (vol. II, p. 100) say: "Certain cattle again will be covered with flies and will lose condition rapidly, while others are but slightly troubled," but so far as I know no writers have mentioned just what cattle are most attacked. I have found that the dark-colored cattle are most attacked, as, *e. g.*, a black cow will be covered with the flies while a white cow, standing alongside, will be almost if not entirely free. The experiments of Riley, Howard, Smith, and others in regard to the application of various substances to the cattle as preventives have been repeated with nearly the same results. So far as I know we have no substances which will keep the flies from the cattle long enough to be of practical benefit. Early in July the kerosene emulsion remedy was given a thorough test. The milk emulsion was used diluted to one-twelfth. The spray was applied by means of a knapsack pump at milking time in the morning for three days, when the flies had so disappeared that they were not again numerous for three weeks.

Chinch Bugs were reported in small numbers early in May, but none were to be found by the middle of June.

Cerotoma caminea is very injurious to beans throughout Mississippi. The dark yellow eggs of this insect are laid around the stem just below the surface, from six to ten in a cluster. The larvæ eat around and within the stem. There are two broods a season, the beetles being

most common in April and July. The broods overlap, however, so that the beetles are to be found at most any season. The first brood is produced upon garden beans and the second upon cow peas. The mature insects eat holes in the leaves, which habit is especially noticed with the first brood upon beans.

Mecyna reversalis has been very injurious this season to various species of Lupines growing in the grass experiment beds.

Arctia phyllira has this season proved a new and serious pest to Cotton in a limited area about eight miles from the Experiment Station. About the middle of June several acres of cotton were entirely stripped by this insect. Should this species increase to any extent it may some time prove a more serious pest to the cotton crop than either the Leaf Worm or the Boll Worm.

Mr. Bethune stated that the Horn Fly had this month been noticed for the first time in the Province of Ontario, at Oshawa, Toronto, and London, and was creating some alarm among stock-owners.

Mr. Webster stated that last fall, at Columbus, Ohio, he had found that 20 per cent of the flies taken from cattle were infested by a very small mite belonging to the family Gamasidæ.

Mr. Smith said that the Horn Fly was now not more abundant in New Jersey than the ordinary Cattle Fly (*Stomoxys calcitrans*).

Mr. Kellicott stated that his son had recently written him of the abundance of the Horn Fly in central Michigan.

Mr. Weed stated that dark-colored cattle were worse attacked than those of other colors. Mr. Smith said the Jerseys suffered most, while Mr. Webster said at Columbus, Ohio, last year, the red shorthorns were the worst afflicted. Mr. Weed reported the pest in Louisiana and Mr. Webster from western Indiana, it having first appeared in that State in the summer of 1891, about Richmond.

Mr. P. H. Rolfs, of the Florida station, stated that this insect made its appearance in his State about a year ago and had now spread nearly to the central part of the peninsula of Florida, moving southward, and in the opposite direction from which cattle were being shipped. They appear in April, and therefore their season of breeding is much more protracted than farther north.

The following paper was then read:

NOTES ON INJURIOUS INSECTS OF 1892.

By HERBERT OSBORN, *Ames, Iowa.*

Up to the present time no prominent outbreak of insects has occurred in Iowa, nor, so far as I know, in the western portion of the Mississippi valley. Plant-lice have been noticeably few in number, especially as compared with last year. Their ranks were much depleted by para-

sites in the latter part of last season and the effect of this depletion is still evident. Quite likely also the climatic conditions of the present season helped to prevent their increase.

The "bill bugs" have for the first time caused serious injuries in the State, *Sphenophorus parvulus* being the species that seems most widespread and destructive. *Sphenophorus ochreus* is often seen, but has not been reported in the same destructive numbers as *parvulus*. It is not likely to cause extensive damage in Iowa, as there are not such large areas of swampy land, producing rushes, as in some neighboring States, the draining and cultivation of which results in such increase of their damage. There is, I believe, so far no evidence of their attacks upon valuable crops except in the imago stage. *Sphenophorus parvulus* seems, however, to have increased rapidly in late years and threatens to become a very serious pest.

An outbreak of the Army Worm (*Leucania unipuncta*) in Muscatine County has been reported to me with the statement that much damage was being done, but I have not as yet learned how extensive an area is affected.

The common species of locusts (Acridiidae) have been quite abundant, and though not causing particularly noticeable losses have drawn extensively upon crops. They attacked particularly grass and clover.

Several species of *Lachnosterna* were plentiful during the spring, those in greatest numbers being *L. fusca*, *implicita*, and *gibbosa*; others in less abundance were *grandis*, *dubia*, and *arcuata*.

Plutella cruciferarum has been unusually plentiful on Cruciferous plants and especially destructive on some experimental patches of Rape on the College Farm.

The Colorado Potato-beetle has not been seen and its absence is so marked as to occasion comment.

Pieris rapae has been very scarce so far, probably in part at least on account of the multiplication of the *Apanteles glomeratus*, which became very abundant last year. I hardly think the explanation of a writer in one of the State papers, "doubtless due to cold weather," need be resorted to.

The Plum Curculio has scarcely been seen, but the almost total failure of the plums to set may be sufficient reason for the curculios not being noticed.

The Clover-seed Caterpillar (*Grapholitha interstinctana* Clem.), which was very abundant last year, is still numerous, but I think less abundant and destructive than last year. The Clover-seed Midge (*Cecidomyia leguminicola*) has been destructive in some parts of the State, but samples sent me have been found to produce a large proportion of parasites, and I suspect that these will soon serve to check its destructive multiplication, as in Eastern States. The samples of Clover with Midge are often accompanied with specimens of the Clover Thrips (*Phlæothrips nigra*) with the question whether they are adult midges, or sometimes

whether the red larvæ of the Phlœothrips are larvæ of Cecidomyia. The Thrips is almost constantly to be found in clover heads and it is perhaps not strange that persons unused to separating different kinds of insects, in looking for minute species in Clover heads, should be deceived by these little creatures, conspicuous from their numbers if not from their size.

The Jassidæ, occurring upon grasses, have been present in their usual abundance, and have been watched during the season especially to determine important steps in their life-history. The first point which it was our effort to determine was as to the method of hibernation. Adults of *Deltocephalus inimicus* and *debilis* and *Agallia sanguineolenta* had been taken in sheltered locations last season up to the time that winter actually set in, and with the opening of spring search was at once begun for them in such places as they were most certain to appear. The only species found, however, was *Agallia sanguineolenta*, and no specimens whatever of *Deltocephalus* were found. Search for adults began March 8 and continued till larvæ appeared all over grass land, and had adults been present they could scarcely have escaped notice. This seemed to show pretty fully that eggs must be deposited in fall and that the adults perished during winter if not in late autumn. To determine more certainly the place of deposition of eggs and whether adults could possibly survive the winter to oviposit, a pen was made about 6 by 10 feet in size, inclosed by boards placed close together and set down into the ground, 2 feet in height, and with all cracks or openings closely stopped, but open above to sun and rain. This was carefully examined to make certain of the absence of the adults and repeatedly searched to make sure of any introduction of Jassids. Larvæ from without could not possibly enter, as they can jump but a few inches from the ground at best and very little when first hatched, while the possibility of adults getting into this inclosure, even if any had been found in any place, were very slight indeed, and any such would have been found in the frequent examinations of the pen. As soon, however, as larvæ appeared over grass lands in general, and they appeared in millions within a few days of the time that the very first were found, this inclosure also contained larvæ in numbers. The proof therefore seems conclusive that larvæ hatch from eggs that have been deposited in the grass in the autumn or early winter preceding.

The first larvæ were seen April 23 in grass on the south side of one of the college buildings, but had not appeared elsewhere, nor did they appear in great numbers till May 12, evidently being retarded by cold and wet weather. The larvæ taken April 23 were nearly black in color and developed into *D. inimicus*, one adult being secured June 29. Larvæ of the same species of later broods are usually much lighter colored, almost whitish, with occasional individuals of darker color, and after first or second moult all present a characteristic marking, consisting of a black lateral margin to thorax and abdomen. Larvæ of *D. inimicus*

and *D. debilis*, though very similar when first hatched, are readily separated after the first or second moult by this character, *debilis* being uniformly light. Adults of *D. debilis* were first taken June 2, and appeared in general ten days to two weeks before adults of *inimicus*, though, as before stated, the first larvæ, found April 23, developed into *inimicus* by June 29.

Adults of *debilis* confined in breeding jars June 3 died in about ten days, and larvæ hatched in these jars July 5, so the period of incubation for this generation, and with breeding jar conditions, would be between three and four weeks. The bulk of this second generation are disappearing (August 12), and if larvæ of a third brood appear in two or three weeks there might possibly be four broods in the season.

Adults of *D. inimicus* were confined in jars with Blue Grass July 8, and all adults were dead about the 15th of the same month, and larvæ appeared the 25th. The period of incubation could not have been more than seventeen nor less than ten days. The first two specimens of which we have record moulted July 29, or four days after hatching; the second moult occurred August 6, or eight days after first moult. Other specimens gave second moult on 8th, 6th, 8th, 10th, and 10th of August, respectively.

Possibly there are only two broods of *D. inimicus*, but more probably three, at any rate, in seasons of ordinary length, as I believe their rapidity of development is considerably affected by weather. When ready to emerge the larva ascends some blade of grass, invariably with the head directed upward, the usual position at all times, and fastening itself to the stem, the skin splits along the center of the back and the insect emerges and the cast skins will often be seen adhering to the blades of grass some time after the moulting has occurred.

A large per cent, possibly 10 per cent, of the spring broods of larvæ were infested with small red mites, some of them almost as large as their hosts, and these likely weaken them, if not causing any more serious result, and may do a little toward checking their injuries.

Mr. Osborn then read the following notes on Kansas insects, by request of the author:

KANSAS NOTES.

By V. L. KELLOGG, *Lawrence, Kans.*

The two chief insect enemies of the Kansas farmer are the Chinch Bug and Hessian Fly. No year but is marked by the ravages of these pests to a greater or less extent in some part or over the whole of the State.

The Hessian Fly (*Cecidomyia destructor*) was present in usual numbers in 1891. It has been estimated that the Hessian Fly annually curtails the wheat crop of Kansas by 10 per cent. This year (1892) this pest seems to be in unusually small numbers. The hibernating individuals

(in flaxseed stage) appear as adults about the middle of May. Larvæ and pupæ are found through June. Kansas winter wheat is harvested from June 15 to July 15.

The Chinch Bug (*Blissus leucopterus*) has been fairly numerous this year (1892), but there is no unusual amount of damage. The bug is reported from sixty-five out of the one hundred and four counties of the State. Prof. F. H. Snow has received applications this year from about 3,000 Kansas farmers for bugs infected with the contagious diseases maintained in his laboratories. Adults which have hibernated begin to appear in the fields of winter wheat about April 1. The farmers begin to complain during the last half of the month. The young bugs appear in June and during this month the serious injuries to wheat occur. At harvest time the bugs leave the wheat fields and enter the fields of young corn. In 1891 Chinch Bugs were abundant. Infected bugs were sent by Prof. Snow in 1891 into seventy-eight counties of the State. Since 1883, four years (1886-1889) have been especially marked as Chinch Bug years. The portion of the State in which the bug is especially prevalent is included between the meridians of 96° and 98° west and extends entirely across the State from north to south.

The Wheat Straw-worm (*Isosoma tritici*).—A considerable amount of injury to Kansas wheat accredited to the Hessian Fly is really done by the Wheat Straw-worm. In 1891 this insect was reported from about one-fourth of the counties of the State, being especially prevalent in central and western Kansas. Adults issued in March and April from last year's wheat straws, either in stubble or volunteer or stack, and oviposit on the young winter wheat. The adults of this brood emerge in the latter part of May and early part of June. The eggs are laid in the now maturing wheat and the larvæ pupate in the stubble or in the stack before winter. The larvæ usually lie just above the second node below the head. In a bunch of straws from Russell County over 75 per cent were infested. In these straws 40 per cent of the pupæ were found above the first node below the head, 50 per cent above the second node, and 10 per cent elsewhere. They lie in small, gnawed-out cells and the heads are almost invariably directed upward, *i. e.*, toward the head end of the straw. *Eupelmus allynii* proves an effective natural check to this pest, the parasitism being noticed in all examinations made. As but about 5 per cent of the straw-worm flies have wings the pest does not spread rapidly and local efforts in fighting it by burning old stacks and stubble containing pupæ in the winter or early spring are very effective.

The Wheat-head Worm (*Leucania albilinia*).—This pest annually does some damage in the State. The worms feed after dark, and occasionally occur in sufficient numbers to practically ruin a field of wheat. They appear chiefly in fields planted on stubble ground; wheat planted on ground which has been fallow for a year or more rarely suffers. The larvæ appear in June.

The Southern Corn Root-worm (*Diabrotica 12-punctata*).—This insect has been noted in southern Kansas. It may be working northward. The Western Corn Root-worm (*D. longicornis*) is not an uncommon pest in the State. In 1891 they were reported from many localities.

The Ham Fly *Piophilæ casei*.—The packing houses of Kansas City, Mo., are seriously troubled by this pest. The larvæ, or "skippers," live in and on the smoked meats, ham and bacon. The fly is probably identical with the Cheese Skipper fly, although larvæ kept in breeding cages with ham and bacon did not take at all kindly to cheese to which they were removed. As shown by breeding-cage data, the egg stage lasts about four days, the larval stage about two weeks, and the pupal stage one week. The flies lived from six days to two weeks in breeding cages.

The Bag Worm *Thyridopteryx ephemeraformis*.—This pest of evergreen trees is at present doing much damage in the State. Cedars and Arbor Vitæ seem especially attacked. Box-elders suffer somewhat.

Locusts *Acridiida*.—*Melanoplus bicittatus* and *M. differentialis* annually do some damage in extreme western Kansas. From Hamilton County reports come of their presence now (August 1) in large numbers. The pests are attacking fruit trees, Mulberry and Catalpa trees. *Dissosteira longipennis*, which last year alarmed residents of eastern Colorado and western Kansas, is at present locally hurtful, but no serious crop destruction is threatened.

Bibio sp.—A species of *Bibio* closely allied to *B. nemoratus*, but probably distinct from it (Dr. Williston on casual examination pronounces the species undescribed), appeared in large numbers in many Kansas wheat fields during the last week of April. It was reported from seven western counties. Larvæ were found, February 10, in large numbers in a wheat field in Pratt County; some were found also in soil in some hotbeds where flowers were growing. Adults were reported April 17 and from then constantly until the end of the first week in May. A correspondent in Lincoln County noted that pupation began about April 20, the adult flies appearing by April 27. After the adults appeared he could not find a single larva.

The flies were very abundant wherever present and occasioned much alarm. However, no injury to the wheat has been definitely traced to them. The fields most badly infested gave no signs of unusual injury. The flies disappeared suddenly and simultaneously. With the *Bibios* several Anthomyiid species in lesser numbers appeared. *Sciara* sp. was sent in from several fields.

Other injurious insects of the season noted are Melon Aphis (*Aphis cucumeris*), last week in July on cucumber and melon vines; Angoumois Grain-moth (*Gelechia cerealella*), attacking corn two years old in crib; last year's corn under same roof with 10 feet alleyway between was not attacked.

Discussion of this paper was deferred until the afternoon session.
The next paper was on the—

ROSE SAW-FLIES IN THE UNITED STATES.

By C. V. RILEY.

[This paper was published in No. 1 of the current volume of *INSECT LIFE* (pp. 6-11.)]

Association adjourned to meet at 2 p. m.

AFTERNOON SESSION.

The Association convened at 2 p. m., but at once adjourned to meet with the Society for Promotion of Agricultural Science, to be present at the reading of an entomological paper by Mr. Osborn on "Further notes on the treatment of grass insects," and also a paper on "The Harlequin Cabbage Bug," by Mr. Weed.

On reassembling, the credentials of Mr. P. H. Rolfs, of Lake City, Fla., were presented by Mr. Webster; H. A. Gossard, Ames, Iowa, by Mr. Osborn; and C. F. Baker, of Fort Collins, Colo., by Mr. Weed.

The three gentlemen were elected to active membership on motion of Mr. Forbes. The committee on address of Vice-President presented the following report:

Your committee would respectfully report that the address by the Vice-President in his résumé of the work in economic entomology during the past year be highly commended, and that his recommendation in regard to work in aquatic entomology bearing upon fish-culture, be recommended as worthy the attention of economic entomologists.

E. B. SOUTHWICK,
Chairman.

D. S. KELLICOTT,
J. B. SMITH,

Committee.

This report was accepted by the Association, as read.

The Secretary then read the following paper:

NOTES ON PLANT FAUNÆ.

By T. D. A. COCKERELL, *Kingston, Jamaica.*

Anyone who devotes himself to the study of entomology cannot fail to observe that the limits of faunæ are not always geographical in the ordinary sense, inasmuch as a genus or family of plants, or even animals, may support an insect fauna quite as peculiar to it as that of most countries or islands. The recognition of this fact has given rise to some very interesting researches, of which it is hard to say whether they are more important from the strictly scientific or the economic point of view.

Prof. Packard's recent amended Report on Forest Insects is an example of this kind of work, the value of which must constantly have been felt by every member of this Association. Even in Jamaica, where we have to deal with a very different fauna, it is continually consulted on all sorts of points and has to be placed among the two dozen or so books which are always in the workroom at one's elbow.

I have thought that this Association might suitably consider the desirability of continuing and greatly extending this kind of research, and the following notes are put together as a slight contribution to the discussion of the subject.

In the first place, we are very familiar with the fact that some insects are strictly confined to one genus or even one species of plant, while others seem almost omnivorous. In 1879 I found the larvæ of *Deilephila euphorbiæ* upon Sea-spurge in Madeira and brought some half-grown and young larvæ to England. In the neighborhood of Chiselhurst, where I was stopping, no Sea-spurge was to be obtained, and, as I could by no means get the larvæ to eat any of the Euphorbiæ that grew there, they all perished. Yet a nearly related species, *Deilephila lineata*, is one of the most promiscuous feeders among the Lepidoptera. From this and many other instances which might be given, it appears that the habits of exclusive or promiscuous feeding are not generic in their range, but vary greatly among members of a single genus.

Considering this from a Darwinian point of view, we may perhaps trace out a sort of cycle of events, comprising the rise, multiplication, decrease, and extinction of a species. This is not a suitable time for going into great detail in a matter of this sort, but briefly, I suppose the course of events may often have been as follows:

Suppose a common and widely distributed species, which lives on several plants, to be attacked by many enemies, so that it is in danger of not being able to maintain itself. The individuals living on every kind of plant will vary somewhat, and there will be a tendency for different variations to survive on different plants, owing to the fact that each kind of plant constitutes a somewhat different environment. For example, if the insect lives on the bark of trees the tendency will be for a flat variety to preponderate or survive on a tree with smooth bark and a narrow variety on a tree with crevices in the bark, etc. Now the enemies of this insect, or at least the most serious of them, will be in the habit of examining the several plants it infests, and in this examination will naturally look for most and see most readily the typical or ordinary form, not that which has begun to diverge from the normal. Consequently, the diverging races will be specially favored by immunity from attack, whatever the character of their divergence, even though not obviously protective, and the tendency will be to accentuate the differences, and ultimately to lead to the formation of a number of new species, each confined to a single species or perhaps genus of plants.

In this way, I suppose, may have arisen such species as *Deilephila euphorbiae*, which are very restricted in their diet; and from them, perhaps without modification except in habit, those which are omnivorous.

Take now a species of restricted habits which has arisen as above described. It has had its origin through possessing certain advantages, but now that it is established it has to face new difficulties. The plant may become extinct or so rare that the individuals of it are few and far between, and dangers of this sort do not trouble omnivorous species. The means of spreading into new territories, which omnivorous species have in so marked a degree, is naturally very restricted in the case of those which can only live on one or a few plants. Added to this, the enemies which troubled the ancestor of the new species would, for their lives' sake, be obliged to turn their attention to the modified and restricted forms, the old omnivorous type having become extinct. Having done this, no doubt by a process of natural selection among themselves, these enemies would become excessively troublesome, since the supply of food would now be in each case more limited and more local in distribution, and consequently more easy to exterminate. But among the progeny of the new species there would be variations towards omnivorousness, and such would survive if the adverse conditions became sufficiently pressing, leading to the formation of a new omnivorous form, which would very possibly differ only in its omnivorousness from the type whence it was immediately derived. Such a form would, for the time being, have advantages owing to the fact that enemies had learned to look for the insect only on certain plants, and any tendency to split up would be checked by crossing and the advantage derived from continuity, so to speak, until the conditions described at the beginning of the cycle once more began to arise.

I have put this very briefly, but I hope sufficiently clearly to be understood. Hereafter I may go into further detail and give numerous instances in illustration. If insect life really does present such cycles as here outlined we can see how to account for many apparent anomalies of habit and many apparently useless specific characters.

According to the above hypothesis, it is clear that, although there would be two distinct changes in the cycle, only one of them, that from omnivorousness to a special diet, would be necessarily or probably accompanied by such changes as to lead to the formation of what we should term a new species. This, I take it, is very important as explaining certain apparently anomalous facts. For example, it is not easy to see how two closely allied Lepidoptera could have been developed, each inhabiting the same two species of trees, say the Oak and the Elm, unless we suppose that originally one was peculiar to one and the other peculiar to the other tree and that both have varied towards omnivorousness. Let *A*, *B*, *C*, *D* stand for four different plants and

horizontal lines for distinct species; the three phases of the cycle may be expressed by means of a diagram, thus:

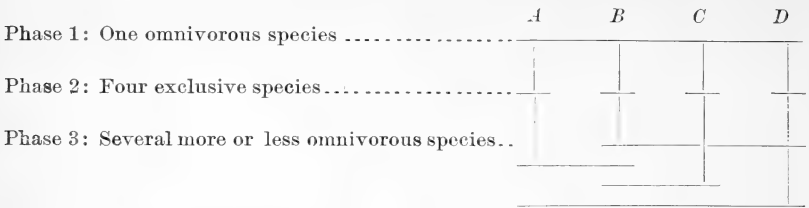

The vertical lines express continuous descent.

Following on Phase 3, ordinary natural selection might eliminate all but one of the new omnivorous species, as they would evidently come closely into competition. If such elimination occurred, we should start again as in Phase 1 of the diagram; but, if, as is perhaps usually the case, the elimination was only partial when the breaking up began anew, the result would probably be an increase in the total number of species.

When classifying the fauna of any plant or group of plants, we should, according to the above hypothesis, need to distinguish two classes, as follows:

(1) An *Endogenetic* class, consisting of species which had their origin on the plant or plants under consideration.

(2) An *Exogenetic* class, consisting of species which had their origin on other plants.

I use the terms *endogenetic* and *exogenetic* as being the best I can think of at present; but I am not quite pleased with them and shall be glad if some member of the Association can substitute better ones. Other terms I had thought of were *original* and *derived*, but *original* is open to the objection that it conveys the idea that the species was always to be found on the plant, whereas, in all probability, the species of plant existed long before the particular species of insect came into existence. But, setting aside the question of terms, I think there can be no doubt that the distinction is a proper one to make, although it must be admitted that in many cases it will be very difficult to tell exactly which class a given insect should be referred to. The same difficulty meets us when we try to learn which of two countries, both inhabited by a species, gave birth to that species, but to my mind the interest of the inquiry is not lessened by the difficulties it presents.

The *endogenetic* class will, of course, have to be divided again into two subclasses, which are of extreme importance from an economic point of view:

(1a) The *univorous* subclass, of species still restricted to the plant on which they originated.

(1b) The *multivorous* subclass, of species which have become modified in the direction of omnivorousness.

The *exogenetic* species are of course all *multivorous* also, and, as regards the insects themselves, the latter division, between *univorous* and *multivorous*, is the only real one; but when we are studying the faunæ of special plants both distinctions have to be considered.

The operations of man are continually tending to change univorous species into more or less multivorous ones and to multiply the number of exogenetic species in plant faunæ. The various destructive Coccidæ, for example, *Icerya purchasi*, afford excellent instances of this and show us how we should constantly be on our guard against species which, undisturbed and in their native country, appear harmless.

It is remarkable, too, how rapidly some plants, when brought to new countries, will acquire a new exogenetic fauna. Thus, a few days ago I noticed a cultivated Chrysanthemum in Kingston badly attacked by *Lecanium* (*Bernardia*) *hemisphæricum* and *Orthezia insignis*; and an olive tree in the back yard of the museum is very severely attacked by *Aspidiotus personatus*, with *A. ficus* and *A. articulatus* in lesser numbers.

Finally, I would venture to urge that copious records of plant faunæ should be made on a careful plan. It is not sufficient to merely record the occurrence of an insect on some plant. We should be supplied with details as to locality, abundance, presence of other insects, parts of the plant infested, etc. Such details, indeed, would increase the length of the records considerably, but I believe that a few full statements are of more value than a large number of mere lists of names, for this reason, that the latter have sooner or later to be gone over again and the observations repeated in order to obtain necessary particulars.

I had intended to append a number of my notes on the plant faunæ of Jamaica, but this paper has already become too long, so I am sure you will be glad that I should refrain from doing so.

SPRAYING WITH ARSENITES VS. BEES.

By F. M. WEBSTER, *Wooster, Ohio.*

Although much has been said with regard to the effect upon bees of spraying fruit trees with arsenites while in bloom, there seem to have been no careful experiments made for the purpose of securing exact proof, and therefore all assertions were necessarily very largely opinionative. Bee-keepers were, as a rule, of the opinion that bees would be killed by spraying the bloom, some because their bees had died, others because some one else said such results would follow. Most entomologists did not care to express an opinion based on the very little accurate information on hand, while others, including the writer, doubted the fatality of the measure, because it was thought that the poison thus applied would either blast the bloom, and thus render it distasteful, or the poison would not reach the nectar, and, being insoluble, otherwise would not affect the bees. In order to fully test the matter, the following

experiment was undertaken, being in accordance with an agreement made at the Washington meeting of the Association of Economic Entomologists, by which a series of experiments with the same object in view were to be carried on by Mr. James Fletcher, Entomologist of the Dominion of Canada, Dr. J. A. Lintner, State Entomologist of New York, and myself.

A mixture of Paris green, 4 ounces to 50 gallons of water, was sprayed on a Lombard plum tree in full bloom, at 2 p. m., April 29. The quantity of the mixture used was sufficient to wet thoroughly without dripping. The upper portion of the tree to the lower branches was covered with a square of thin brown sheeting of the brand "Utica C" and held down by ropes and stakes at the corners. The lower portion, including a space of about 8 feet square, was inclosed by mosquito netting sewed to the sheeting above and fastened below so as to prevent the escape of the bees. The ground thus inclosed was covered with the same material as the top cover. At 7.30 p. m. the hive, which had been placed near this tree some two weeks before, was moved into the inclosure and the whole secured. Dead bees began to be observed on the ground cover early on the morning of the 30th, and by 10 a. m. a considerable number had died and fallen on the cloth. Others were evidently exhausting themselves in trying to escape. At 1.30 p. m. there were a large number of dead and dying bees on the cloth, and it was thought advisable to remove the cover from the tree and allow the injured bees to escape. At 5 p. m. several hundred bees were either dead or dying, and enough were gathered from the cloth on the ground to fill a box of $21\frac{5}{8}$ cubic inches capacity, while others were clinging to the upper covering nearly or quite dead.

May 2 four analyses were made by Mr. Falkenbach, chemist of the Ohio Experiment Station, using the Marsh method, which indicates only the presence or absence of arsenic without revealing the exact amount when present. First, a large number of the dead bees were tested and arsenic found present. Second, more bees were thoroughly washed to remove any of the poison which might have become attached to their bodies, but the presence of arsenic was clearly shown. Third, a large number of bees were washed as in preparing for the second analysis, and their bodies divided, the abdomens being analyzed separately, but the presence of arsenic was still shown, though but a mere trace. Fourth, the remainder of the bodies, less the wings, were subjected to the same analyses, and arsenic shown to be present in greater amount than in the third analysis.

The balance of the dead bees were thrown out, but several days later, during which time there had been a severe thunder shower, a considerable number were picked up and thoroughly washed, first with water and then with a weak solution of ammonia, as a still further precaution toward removing all poison from the outer surface of the bodies of the bees. The results of the analysis, however, did not materially differ from those previously made.

The second experiment was on the Apple, the colonies of bees, two in number, having been placed under separate trees several weeks earlier. Six trees were sprayed while in full bloom, four of these standing in a row, sheets 24 feet square being placed underneath each, and, in case of the two under which bees had been placed, the sheets were drawn under the hives. Two other trees a short distance away were treated the same, except that sheets were placed underneath but one. All trees were sprayed May 4 with solution, as in case of first experiment. For one week search was made each morning for dead bees, both under the trees and about the hives. At the end of this time fifty-six bees had been picked up, one of them belonging to a wild variety, and one young one had been carried out from one of the hives. Analyses of some of these showed traces of arsenic. Although bees were, on several occasions during the time given, observed frequenting the bloom in great numbers, nevertheless the weather conditions were, as a rule, unfavorable to the full activity of bees. At times there was a sharp, damp wind blowing, and at others it was cloudy with light rains. Therefore I do not consider the results gained as being satisfactory, though I believe I have shown the fallacy of attempting to get results of any value to bee-keepers by experimenting with bees in confined quarters. Also, I believe I have shown that during seasons of bad weather—that is, cold and cloudy with light rains, but insufficient to wash the poison from the trees—little or no fatal results to bees will follow spraying apple trees while in bloom. I do feel, however, that the all-important question of what the result would be if the weather conditions were every way favorable to the full activity of the bees still remains unsettled.

A third experiment was attempted on the bloom of the Raspberry, but frequent drenching rains which occurred almost daily, and often several times in a day, forced us to abandon it. I hope, however, another year to be able to present more decided and satisfactory results.

Mr. Smith said that he felt confident the bees confined on the plum tree killed themselves in their attempts to escape. He could, however, see no use in spraying while fruit was in bloom. Mr. Howard, from experiments which he had made with bees inclosed upon plants surrounded with gauze, was confident that mortality among the bees was rather the result of confinement than of the arsenical poison. Mr. Osborn thought it important to settle the question in regard to the effect of spraying on bees. Mr. Slingerland said it might be necessary to spray about the blooming season in order to destroy the Bud-worm on Apple. Mr. Lintner hoped to see the matter settled, so that people might know if it were possible to spray during the blooming season if they saw fit and without fear of injury to bees.

The following notes were presented by the author:

NOTES ON INJURIOUS INSECTS IN CANADA IN 1892.

By JAMES FLETCHER, *Ottawa, Canada.*

There have been no outbreaks of injurious insects in Canada during the past season which demand special mention.

Cutworms, usually so abundant, were very little complained of. The species most abundant at Ottawa was *Agrotis ochreogaster*. I was able to clear up part of the life-history of this species during the past season. Eggs laid by a female caught in the field during October only hatched the following spring (April 20). They were full-grown and pupated on June 10, and the first moths appeared July 20. These eggs were laid by a female of the form *ochreogaster*, and all the thirteen larvæ carried to maturity produced that form also. The larvæ from the time they first hatched had the appearance and habits of cutworms. This is one of our most injurious species in Canada, the larvæ as a rule lasting from the end of May to the first week in July. Notwithstanding the late appearance of the moth which laid the eggs above referred to, and the fact that they did not hatch until the following spring, I am of the impression that there is only one brood in a year, and that some of the larvæ hatch from early eggs in the autumn, but others not till the spring. Larvæ which are apparently too large to have grown to such a size the same season are frequently found early in the spring; but this matter requires further investigation. The moths of this usually abundant species have been remarkably rare during the present summer.

The root maggots of cabbages, onions, radishes, and turnips, have been perhaps the most destructive pests of the year. For garden application hellebore tea and kerosene emulsion applied at the roots have been successful, but for field practice I must confess that so far I have been unable to discover a practical remedy, and I lay the matter before the Association, and shall be obliged for any suggestions, as this is now a most serious matter, particularly in turnip fields.

Grass insects have received much attention. The injury known as "Silvertop" has been remarkably prevalent, and is due to several insects, primarily to small leaf-hoppers, in the stems of some of the larger grasses to *Meromyza americana*, and perhaps to a Thrips. Considerable injury has undoubtedly been done on lawns and in meadows by a Thrips which attacks the blades of grass, and leaves undoubted evidence of its presence by the very characteristic injury. The question as to whether Thripidæ attack vegetation is quite settled, so far as I am concerned. I can recognize the injury of these insects at once by the whitened tissues of the leaves dotted with dark excrementitious matter.

During the past summer Thripidæ have been most troublesome in our greenhouses at Ottawa, attacking almost every plant, but particularly

Chrysanthemums, Mimuluses, Cinerarias, and Fuchsias. The attacked leaves turn white and become distorted. Kerosene emulsion very much diluted has proved effective in destroying them.

The larvæ of *Hadena devastatrix* were abundant at the roots of grasses and did considerable harm. Several larvæ of *Gortyna cataphracta* were found attacking the young shoots of some of the large-stemmed grasses, as *Phalaris arundinacea* and *Elymus canadensis*, a curious and unusual attack by the same insect was upon the fruit of the Gooseberry. It is a regular pest every year in the stems of tomatoes, potatoes, and other succulent plants, particularly lilies. *Gortyna nitela* I have not so far found in the Ottawa district. Another species of the same genus, *Gortyna immanis*, has developed into a serious pest in the hop-growing districts of Ontario, and has been studied during the past summer. The egg is laid on the young shoots when about a foot above the ground, and for a short time the young larva bores in the center of the leading shoot and causes the distortion known as "bull-heads." After this it drops to the ground and attacks the plant at the collar just beneath the surface of the ground, and is then the "collar-worm" of hop-growers. The perfect insect, a large, handsome moth, of a rich, warm brown, shaded with darker lines, and a rosy tinge, appears during August and September, and hibernates in the perfect state. *Ichneumon subdolos* has been bred from the pupæ.

Canker-worms have been abundant in the Ottawa district on ashes and basswoods, but not on apple trees. These same caterpillars (*A. pometaria*) have again this year been injuriously abundant in Winnipeg upon the ash-leaved maples used as shade trees.

A serious attack upon grass lands, by an insect which has never before, in my experience, been noticeably injurious, was that of *Otenucha virginica*, which was reported from Nova Scotia. The larvæ are interesting from their very different coloration during the last moult, when they are yellowish white, and the preceding ones, when they are black and white, with yellow ornamentations. *Phytoptus pyri*, the Pear-leaf Blister Mite, has been frequently complained of, and I fear is spreading in Canada.

The Zebra Caterpillar of *Mamestra picta* has been unusually abundant, and is, I believe, literally omnivorous, almost every plant being eaten by it. It has proved injuriously abundant upon cabbages, asparagus, peas and sweet peas, clover, and several trees in the Botanical Garden, as Menzies and Douglas Spruces, Willows, etc.

Another pest which has been remarkably abundant this year, is the Fall Web-worm, *Hyphantria cunea*.

Hæmatobia serrata, the Horn Fly, has at last made its appearance in Canada. First reported at Oshawa, Ontario, it has now appeared from the extreme west of the Province of Ontario down to Boucherville, some miles east of Montreal. The same exaggerated statements as to injuries caused by it have, of course, accompanied its appearance as in the United States.

Cantharis nuttalli.—I have received specimens from four or five correspondents in the Northwest Territories of this handsome blister beetle. The crop it was most injurious to was Broad Beans.

Parasites of many kinds have been particularly noticeable during the past season. The eggs of the Vancouver Island Oak-looper (*Ellopiia somnaria*) were largely parasitised by a minute black Proctotrypid. A consignment of bark sent to me by Mr. W. H. Danby, of Victoria, British Columbia, showed many larvæ and pupæ which had been killed by the Entomophthorous fungus *Sporotrichum globuliferum* the previous autumn. The species hibernates in the egg form, and with one single exception all the eggs sent were parasitised by the species mentioned.

Nematus ribesii.—Since many years ago Dr. Lintner recorded finding a Trichogramma in the eggs of the Imported Currant Saw-fly, I have searched assiduously for the parasite. Until the present summer I never could find it. This year, however, I found it in three separate localities in the neighborhood of Ottawa. The first of these was near Arnprior, about 40 miles from Ottawa. The eggs of the *Nematus* when attached turn jet black and shining. The same thing was the case with a single egg of *Papilio turnus*, taken at Nepigon, from which I bred a swarm of minute parasites of this same genus. Egg clusters of *Mamestra picta* have also given a Trichogramma and another black Proctotrypid in large numbers.

Pteromalus puparum has been extremely abundant and useful in keeping *Pieris rapæ* in check.

Mr. Forbes said: "I do not know whether the entomologists present are all yet satisfied as to the food habits of our common species of Thrips and their relations to vegetation, about which there has been in the past a good deal of doubt. An unpublished experiment of mine, made April 23, 1889, seems, however, to settle the matter, at least so far as the common yellow Thrips, known to us as *T. tritici*, is concerned.

"There was during that year an enormous amount of the peculiar blighting of strawberries known to strawberry-growers as 'buttoning,' accompanied by a truly astonishing number of the above Thrips upon the flowers, which they sometimes almost literally covered as soon as opened, penetrating them, in fact, while still in the bud. In order to determine the effect of this Thrips' attack upon the plant, I transferred strawberry plants to pots, placing them under large bell jars in my office, and keeping them under observation for several days. Under one of the bell jars a large number of Thrips were introduced, obtained by sweeping the blossoms of pear and cherry trees. The other pot was kept under similar conditions as a check. In a short time an injury to the blossoms of the infested plant was quite manifest. It appeared first as brownish, and later as blackish, specks upon the pistil and filaments of the anthers, then upon the bases of the petals, and finally even upon the calyx and flower stem. All these parts gradually blackened and withered, the flowers sometimes drying up completely.

"As the injury began before it was possible for the seed to have been fertilized, its effect to blast the flower was evident; and as the botanists tell us that the receptacle of the strawberry will not swell out to form the fruit unless the seed develops, the connection of the Thrips with the so-called 'buttoning' seems beyond dispute.

"This species attacked in a similar way flowers of raspberries and blackberries, and with a like effect.

"I may also say concerning the relation of Thrips to 'silver-top' in Grass, that as far back as 1883 I made some studies in northern Illinois of 'silver-top' in timothy, in which I reached a provisional conclusion that this injury was sometimes due to Thrips; but as I could not verify my supposition I dropped the matter at the time. I proceeded by collecting several hundred stems of timothy in which the whitening of the heads was just beginning to show, and examined them in comparison with others clearly uninjured. A large percentage of the former contained the Thrips in numbers ranging from one to half a dozen, behind the upper sheath of the stem, usually just above the upper node, while the sound stems were almost invariably without them. Comstock's later observations on the breeding habits of the Thrips finally confirmed what was with me only a supposition."

Mr. Webster stated that a species of Thrips had attacked young onions growing in the greenhouses of the Experiment Station at Columbus, feeding on the extremities of the young tops."

Mr. Howard said that Mr. Fletcher's experience with blister beetles the present season was a common one, species having been sent to the Department of Agriculture with reports of damage from all parts of the country. He suggested that their extraordinary abundance was probably due to the great abundance of grasshoppers last year.

Mr. Forbes said that some years ago in Illinois these beetles had been exceedingly and destructively abundant following a season of great abundance of grasshoppers.

Mr. Riley presented the following paper:

AN AUSTRALIAN SCYMNUS ESTABLISHED AND DESCRIBED IN CALIFORNIA.

By C. V. RILEY.

The rapidity with which the Australian *Vedalia cardinalis* has established itself in California is familiar to everyone. But the *Vedalia* was not the only scale-feeding Coccinellid which was sent or brought over by Mr. Koebele on his first trip to Australia in 1888-'89. Among others, he brought several species of the genus *Scymnus*, which in due time were set at liberty in the vicinity of Los Angeles. One of these, subsequently described by Dr. D. Sharp as *Scymnus restitutor* (INSECT LIFE, vol. 1, p. 364), was lost sight of, while another much smaller

species, originally collected by Mr. Koebele near Sydney, New South Wales (see Bull. No. 21, Division of Entomology, p. 24), turned up the present year in a rather amusing way. In the March number of *Entomological News* (vol. III, 1892, p. 51), Dr. F. E. Blaisdell describes a new Californian *Scymnus* under the name of *S. lophanthæ*. He found it preying on the San José Scale (*Aspidiotus perniciosus*), which infested the limbs of *Acacia lophanthæ* at the Coronado Parks, near San Diego in southern California. It is a very inconspicuous species of reddish color, the thorax often having an indefinite dark spot on the disk, and the elytra being of a blackish bronze color. The last-mentioned character is foreign to our native species of *Scymnus*, which never show any trace of metallic color, and, for this reason, I at once suspected, upon reading the description, that *S. lophanthæ* was one of the species introduced from Australia. Upon comparing Dr. Blaisdell's description with the sample specimens sent by Mr. Koebele from his first and second trips to Australia, I had no difficulty in identifying *S. lophanthæ* with the species from Sydney mentioned above. Subsequently Mr. D. W. Coquillett sent me a specimen, recently captured near Los Angeles, which fully confirmed this identification. Whether or not the species has been previously described from Australia I have no special means of knowing, but it does not appear to be among those described by Mr. Blackburn in 1889. (Trans., etc., Royal Soc. South Australia, vol. XI, pp. 191-198.) It is closely allied to *S. fagus* Brown, from New Zealand, and distinguished therefrom only by its finer and sparser elytral punctations and the greater extent of the pale thoracic color.

Dr. Blaisdell does not mention in his description the structural characters of the species, the more important of which are as follows: Prosternal lines long, straight, and slightly converging anteriorly; post-mesocoxal line slightly reascending externally; post-metacoxal line complete, almost reaching the first abdominal suture; elytral epipleuræ horizontal, reaching beyond third abdominal segment, slightly concave; inner marginal line not leaving the margin.

The beetle and its larva are quite abundant in the Coronado parks, according to Dr. Blaisdell; and since it also occurs near Los Angeles, there can be no doubt that this useful little Coccinellid has fully established itself in southern California.

This was followed by a short paper, being—

FURTHER NOTES ON THE FOOD OF LIMAX CAMPESTRIS BINNEY.

By F. M. WEBSTER, Wooster, Ohio.

In INSECT LIFE (vol. IV, p. 348) are given some observations of mine relative to the destruction of Aphides by this mollusk. While the conclusions there reached, viz, "that the instance observed was exceptional and probably does not promise any particular benefit," are perhaps correct, yet some further observations may place the matter in a

better light and prove interesting to both the entomologist and conchologist.

On the same bench in the insectary where the observations were made were growing probably twelve to fifteen wild and cultivated plants, Dock being one of the former. In the course of time this last became thickly populated with Aphides, comprising for the most part apterous females and their progeny. My attention was first drawn to the matter by the fact that where these slugs were on the leaves there were great numbers of the Aphis in front of them, but very few in their rear. On placing an Aphis within the reach of one, it grasped it in its jaws and devoured it. Another and still another followed. Then after patient watching I saw it capture others without assistance.

At the other end of this bench, perhaps four yards distant, was growing probably a square yard of wheat, and adjoining this a similar plat of lettuce, which is given by Mr. Binney as one of its food-plants. The mollusks had been observed repeatedly feeding on the lettuce, of which, as the plants were large, there was always more than an abundance. But they also climbed the leaves and stems of the wheat to the height of 8 or 10 inches, and crawling along the larger leaves cleared them almost completely of the Aphidids, which in this case was *Phorodon mahaleb* Fonsc. So, then, it would seem that this food was taken of their own volition, and, indeed, they made considerable effort to get it, as they did not, so far as I could see, attack the wheat. The slugs were observed to feed as above stated only during the night and on afternoons of very dark cloudy days.

The market gardener or florist, whose interest is wholly in his plants, would, as a matter of course, be quick to observe any injury to them. The entomologist, whose eyes and mind have had a different training, would be much more likely to notice such variations in food habits. Therefore it seems to me at least possible for the much abused slug to, in part at least, repay for the injury caused by its plant-feeding proclivities by destroying other enemies of that plant. The lettuce was also infested by another species of Aphis, and, had the slugs confined their attention to them, it might have been, to some extent, an act of self-preservation, on the score of protecting its food-plant. But they voluntarily went to the wheat, upon which they did not subsist, nor was it likely that the juices of the Aphids which they ate savored of lettuce. It is entirely beyond my desire to magnify either the importance of these observations or the possible usefulness of this *Limax*. The desire to be just, without being unjustly just, has prompted the presentation of this whole matter.

Mr. Riley thought it an illustration of the ease with which some animals may pass from food comprising soft plants to the soft, juicy bodies of some insects.

Mr. Bethune had observed repeatedly slugs feeding on the mixture of beer and sugar used in sugaring for moths.

Mr. Howard reported good success with lime in destroying the large *Limax flavus* in gardens in Georgetown, D. C.

The committee on nomination of officers presented a report making the following recommendations:

- For President, S. A. Forbes, Champaign, Ill.
- For First Vice-President, C. J. S. Bethune, Port Hope, Ont.
- For Second Vice-President John B. Smith, New Brunswick, N. J.
- For Secretary, H. Garman, Lexington, Ky.

The report was accepted, and officers elected in accordance with the recommendations.

On motion of Mr. Weed, seconded by Mr. Howard, the matter of next meeting was left to the decision of the officers elect. Amended by Mr. Osborn, so as to instruct said officers to call the next meeting two days in advance of that of the American Association for the Advancement of Science. The motion prevailed as amended.

Minutes of the days' sessions were presented and passed upon.

After extending votes of thanks to the President and Secretary for their efforts in securing the success of the meeting, the Association adjourned.

F. M. WEBSTER,
Secretary.

REVISED LIST OF MEMBERS OF THE ASSOCIATION OF ECONOMIC ENTOMOLOGISTS.

AMERICAN MEMBERS.

- | | |
|---|---|
| <p>J. M. Aldrich, Brookings, S. Dak.
 William B. Alwood, Blacksburg, Va.
 William H. Ashmead, Department Agriculture, Washington, D. C.
 George F. Atkinson, Ithaca, N. Y.
 C. F. Baker, Fort Collins, Colo.
 M. H. Beckwith, Newark, Del.
 Charles J. S. Bethune, Port Hope, Ontario, Can.
 Lawrence Bruner, West Point, Nebr.
 John P. Campbell, Athens, Ga.
 F. H. Chittenden, Department Agriculture, Washington, D. C.
 J. H. Comstock, Ithaca, N. Y.
 A. J. Cook, Agricultural College, Mich.
 D. W. Coquillett, Los Angeles, Cal.
 A. B. Cordley, Department Agriculture, Washington, D. C.
 E. W. Doran, Agricultural College, Md.
 C. H. Fernald, Amherst, Mass.
 James Fletcher, Ottawa, Ontario, Can.
 S. A. Forbes, Champaign, Ill.</p> | <p>H. Garman, Lexington, Ky.
 C. P. Gillette, Fort Collins, Colo.
 F. W. Goding, Rutland, Ill.
 H. A. Gossard, Ames, Iowa.
 C. W. Hargitt, Syracuse, N. Y.
 Charles A. Hart, Champaign, Ill.
 F. L. Harvey, Orono, Me.
 F. H. Hillman, Reno, Nev.
 Geo. H. Hudson, Plattsburg, N. Y.
 Geo. D. Hulst, 15 Himrod street, Brooklyn, N. Y.
 L. O. Howard, Department Agriculture, Washington, D. C.
 D. S. Kellicott, Columbus, Ohio.
 J. A. Lintner, State House, Albany, N. Y.
 Otto Lugger, St. Anthony Park, Minn.
 B. Pickman Mann, Patent Office, Washington, D. C.
 C. L. Marlatt, Department Agriculture, Washington, D. C.
 John Marten, Champaign, Ill.
 H. A. Morgan, Baton Rouge, La.</p> |
|---|---|

AMERICAN MEMBERS—Continued.

- | | |
|---|---|
| Mary E. Murtfeldt, Kirkwood, Mo. | E. B. Southwick, Central Park, New York City. |
| F. J. Niswander, Laramie, Wyo. | J. M. Stedman, Durham, N. C. |
| Herbert Osborn, Ames, Iowa. | James Stimson, Watsonville, Cal. |
| A. S. Packard, Providence, R. I. | H. E. Summers, Champaign, Ill. |
| Theo. Pergande, Department Agriculture, Washington, D. C. | Roland Thaxter, Cambridge, Mass. |
| C. H. Perkins, Burlington, Vt. | J. W. Toumey, Tucson, Ariz. |
| E. A. Popenoe, Manhattan, Kans. | C. H. Tyler Townsend, Las Cruces, N. Mex. |
| E. Baynes Reed, Esquimault, B. C. | F. L. Washburn, Corvallis, Oregon. |
| C. V. Riley, Department Agriculture, Washington, D. C. | F. M. Webster, Wooster, Ohio. |
| P. H. Rolfs, Lake City, Fla. | Clarence M. Weed, Hanover, N. H. |
| M. V. Slingerland, Ithaca, N. Y. | H. E. Weed, Agricultural College, Miss. |
| John B. Smith, New Brunswick, N. J. | E. V. Wilcox, Cambridge, Mass. |
| F. H. Snow, Lawrence, Kans. | C. W. Woodworth, Berkeley, Cal. |

FOREIGN MEMBERS.

- | | |
|--|---|
| T. D. A. Cockerell, Kingston, Jamaica, W. I. | A. Sidney Olliff, Australian Museum, Sydney, N. S. W. |
| E. C. Cotes, Indian Museum, Calcutta, British India. | Arthur E. Shipley, Cambridge, England. |
| Charles French, Government Building, Melbourne, Australia. | W. M. Schøyen, Christiania, Norway. |
| | H. Tryon, Brisbane, Queensland. |
- Eleanor A. Ormerod, Torrington House, St. Albans, England.

A CURIOUS CHRYSALIS.

We have not previously noticed the remarkable Bombycid chrysalis figured by Dr. W. J. Holland (in *Psyche*, vol. VI, No. 190, at plate 5). Dr. Holland states in the accompanying text, which occurs in one of his articles entitled "Notes upon the Transformations of some African Lepidoptera," that this is the only instance with which he is familiar where the pupa of a Bombycid moth is suspended from the cremaster, as are many butterfly chrysalids. The species is *Saturnia arnobia* Westw., and the specimens were found by Mr. Good in West Africa near the town of Kangwe. Mr. Good at first thought that he had the chrysalis of *Papilio antimachus* or *P. zalmoxis*, although the general facies was Bombycid. There were several rows of spines upon the abdominal segments and at least four large spines on the dorsum of the thorax. The color of the chrysalis was dark green, changing to pale green just before disclosing the moth. Each one hung suspended by its anal end from the twig and was partly inclosed by a few silken threads spun from one neighboring leaf or twig to another.

ABSTRACT OF PROCEEDINGS, ROCHESTER MEETING OF THE ENTOMOLOGICAL CLUB, AMERICAN ASSOCIATION FOR THE ADVANCEMENT OF SCIENCE.

AUGUST 17-19, 1892.

Seven sessions of the Club were held in the Rochester University, Rochester, N. Y., with an attendance of 25 members and an average attendance at each meeting of 15. The following brief abstract of the papers read at the different sessions has been prepared for INSECT LIFE by the Secretary upon the resolution of the Club.

The first meeting, August 17, was opened by the President, Mr. E. A. Schwarz, of Washington, with his annual address. Mr. Schwarz took up Prof. Osborn's suggestion proposed at the Washington meeting of the club, to prepare, by coöperation, a scientific manual on North American insects. He reviewed the work hitherto done on North American Coleopterology, and pointed out that, so far as classification is concerned, a manual of Coleoptera giving synopses of genera and species can now be prepared which, in usefulness and scientific value, would compare favorably with Redtenbacher's well known work on European Coleoptera. Proceeding to the biologic branches of Coleopterology he showed that, mainly owing to the many difficulties which surround the subject, the work hitherto done is very fragmentary and in part also unsatisfactory. He concluded his address with an appeal for more work and more workers in the biology of the Coleoptera.

Mr. D. S. Kellicott presented a paper on the preparatory stages of *Calothyranis amaturaria*, showing that the larvæ of this species are very abundant during July and August at Columbus, Ohio, upon *Polygonum dumetorum*.

Mr. F. M. Webster gave some notes on the insects reared from a gall on *Muhlenbergia mexicana*, showing that six species have been reared, as follows: An Oscioid, a Pteromalid, a Eurytomid, great numbers of Lasioptera, several Polygnotus, and several Eupelmus.

Dr. C. W. Stiles discussed a cutaneous disease of cattle, in which slight lumps are to be seen along the back and flanks. Upon examination these were found to be caused by an Arachnoid, *Demodex* sp.

Prof. C. V. Riley read a paper showing that *Galeruca xanthomelana* is polygoneutic at Washington, normally two and sometimes three broods occurring there. The greater part of the second brood hibernates, though a few lay eggs for a third generation.

The same insect was shown by Prof. John B. Smith to be monogoneutic at New Brunswick, N. J. This one brood goes into winter quarters at about the same time as the second brood at Washington.

In discussing these two papers, Mr. Riley thought the peculiar difference in habit in this species at the two places mentioned could be easily explained by heredity. Acquired beneficial characters have fixed themselves upon the species, and this explains why its habits differ so markedly in the two localities. He thought that if specimens were sent to New Brunswick from Washington they would be double brooded there, while specimens from New Brunswick would remain single brooded at Washington, irrespective of climate. He would expect, however, some deviation from the normal habit in both cases.

In a paper entitled "The Inhabitants of a Fungus," Mr. H. G. Hubbard spoke of the various insects, Coleoptera, Hemiptera, and Lepidoptera, and their larvæ, as observed by him to live in a peculiar fungus, *Cryptoporus obvolutus* Peck, which grows on burned pine logs in British Columbia. Some of these insects are merely predaceous, while others feed on all parts of the fungus and are of no special interest. More interest is attached to those species which develop within the natural cavity of the fungus. From the peculiar structure of the latter Mr. Hubbard concluded that mainly, if not entirely, by the aid of these insects (more especially *Epurava monogama*) the spores of the fungus are transported from place to place. To the agency of another Coleopter, *Platydemus oregonense*, Mr. Hubbard is inclined to ascribe the production of the peculiar filaments which form within the veil of the fungus.

In his paper on the American Bean Weevil, Prof. C. V. Riley discussed the nomenclature of this insect, and concluded that on the strict law of priority it must be known as *Bruchus obtectus* Say, until some hitherto unrecognized and unpublished name can be proved to refer to it. He treated the oviposition of *Bruchus* in the field, and showed that the parent insect oviposits within the pod, either using her jaws to make a hole in the pod through which to insert the eggs, or waiting until the beans are sufficiently ripe to cause a partial opening of the pod and then thrusting the eggs into the slit in masses.

Mr. Webster introduced Dr. Edward Murphy, of New Harmony, Ind., who was personally acquainted with Thomas Say for eight years before the death of the latter in 1834. Dr. Murphy gave the club an interesting account of Mr. Say, his life, peculiarities, and habits.

Mr. H. G. Hubbard's paper on *Xenos* gave a vivid picture of the life history and habits of this parasitic beetle from specimens obtained from colonies of *Polistes* kept in confinement.

The male *Xenos* uniformly issued from the puparia very early in the morning. They are extremely short-lived and delicate insects, being unable to stand the full light of the sun. They are further incapable of resting on account of the rudimentary development of the legs and during the few minutes of their life fly about with such swiftness that the eye of the observer would be unable to perceive their presence in the breeding cage but for the peculiar attitude assumed by the wasps.

These, imbued with a natural hatred of the parasites, are constantly on the alert and eager to catch the beetles as they dart from side to side of the cage. After a few minutes the Xenos falls exhausted to the ground when the wasps at once pounce upon it and chew it up.

This communication was greatly applauded and drew out an interesting discussion.

Mr. Schwarz read a paper on the males of the Scolytid genus *Xyleborus*. The males of all species of this genus differ from the females remarkably in general appearance and structural characters and have been described by Zimmerman and Leconte as different species. It is only by observation in the field that the two sexes can be recognized as belonging to the same species. A provisional synonymic list of our species was presented.

Mr. Herbert Osborn gave some notes on the species of *Acanthia*, describing *hirundinis*, *pipistrellæ*, and *columbaria*, the author's object being to ascertain the prevalence of these species in this country.

Mr. James Fletcher gave an account of the insects collected by him in a recent trip to Nepigon, north shore of Lake Superior, dwelling mainly on the habits and earlier stages of certain Lepidoptera and Coleoptera.

Some interesting notes on the Arthropoda of Liberia, Africa, based upon a six months visit to that country, were read by Mr. O. F. Cook.

The life history of the northern Mole Cricket was given by Mr. E. W. Doran, descriptions being given of the various stages of this species (*Gryllotalpa borealis*), with a short account of its habits in confinement.

Miss Mary E. Murtfeldt's paper on the Osage Orange Pyralid was read and will be published in full in INSECT LIFE.

Mr. E. W. Claypole gave an account of a borer (*Janus flaviventris*) in the stem of the Red Currant.

"Notes on the insect fauna of the Mississippi bottoms," by Mr. Howard Evarts Weed, gave an account of the fauna of the country adjacent to the Mississippi River, with a list of the most common species collected.

A paper entitled, "Do Termites cultivate Fungi," by O. F. Cook, discussed the Termites of Liberia and their relation to certain supposed fungi which grow in the nests of the White Ants.

Miss Mary E. Murtfeldt's paper on the Web-worm Tiger was an account of *Plochionus timidus* as an enemy of the Fall Web-worm.

The committee appointed in reference to an entomological congress to be held in connection with the meeting of the Club in 1893, reported in favor of such a congress, and the officers of the Club were instructed to invite foreign entomologists to be present at the next meeting.

The committee appointed in reference to a manual of entomology reported progress and was continued another year.

The officers elected for the ensuing year were: President, Charles J. S. Bethune; Vice-President, H. G. Hubbard; Secretary, C. L. Marlatt.

HOWARD EVARTS WEED,

Secretary.

EXTRACTS FROM CORRESPONDENCE.

Notes from Missouri.

* * * The development of the Oak Chermes seems to me very anomalous. Unless the insect has entirely eluded me all development for the season stopped at the point of hatching and dispersing. Since then, although I have examined the infested trees every few days throughout the summer, there has been no change. Occasionally a cluster of the salmon-colored larvæ may be found in a dormant condition under the scales at the base of the new growth. I infer from this that the larvæ become active very early in the spring and pass their transformations at that season when the sap flows most freely and their natural enemies are less numerous. I send examples of the most conspicuous and effective of these enemies. I also put in some other things in which you may be interested.

If you could see the ruinous work of the Osage Orange Pyralid on the hedges around Kirkwood this summer you would be better able to realize the baneful importance of the insect than you can from any description of mine.

As a rule the usual pests have not been troublesome this year, with the exception of the Codling Moth. Strange to say the Colorado Potato-beetle seems to have entirely deserted us. I have looked in vain for a few larvæ on which to test some decoctions which I fancied might prove useful insecticides, but I could not find even one. Do not infer from this that the potato crop is good, for, for some climatic reason, it never was poorer throughout this region. [Mary E. Murtfeldt, Missouri, September 6, 1892.

[In connection with the above, Miss Murtfeldt sent certain species for determination, on some of which were interesting notes, as follows:]

Erochomus tripustulatus.—This beautiful Coccinellid, if I am not mistaken, was rare in this locality until last year. It is the most important of the foes of the Oak Chermes, the larvæ tearing open the scales and feeding voraciously upon the eggs and young.

Pentaria trifasciata is an interesting little beetle, which I bred from larvæ living upon the scales of Chermes.

Chiloneurus albicornus and *Encyrtus* sp.—The most important of the Hymenopterous parasites of the Oak Chermes.

Tetrastichus sp.—I think this tiny fly is a "secondary" parasite.

Hemiptychus punctatus.—I do not know whether this beetle bred from the scales of the insect or from the twigs of the tree, but I have reason for suspecting the former.

Trichobaris trinotata var.—I bred two specimens of this pretty curculio from the woody stems of *Solanum carolinense*.

Trypeta electa Say.—The larvæ of this fly were in almost every fruit of *Solanum carolinense* last fall, destroying a large proportion of the seed. The scarcity of the weed hereabout this season may perhaps be in great measure attributed to this insect. I had a great many in rearing jars, but was not very successful in breeding them.

Phædotoma sanguinea is parasitic on the above. It resembles species that I have found bred from the larger Microlepidoptera, but as this was from a Dipteron it may be distinct.

Parexorista sp.?—Especially interesting from the fact of its breeding in the Acorn Carpopapsa.

Piophilæ casei.—I have recently bred these flies from some infested ham sent me

from a packing house. The larvæ could not be distinguished from cheese skippers, and the fly, also, is very like that *Piophilæ*. Is it distinct? I can not find anything about "meat skippers" in any work in my library.

Simplosis dolichogaster.—A *Gracilaria* parasite.

Cecidomyia robinia.—The larvæ of these flies cause a gall-like thickening and curling of the edges of the leaves of Black Locust (*Robinia pseudacacia*).

Apanteles sp.—This species was bred from larvæ of *Colias philodice*, but seems to be the same as the Cabbage-worm parasite, although the cocoons were a much deeper yellow.

Parasite of *Ceratonia* on Elm; Oak Edema in Michigan Forests.

I send cocoons of a species of Ichneumon Fly produced by larvæ which emerged, September 7 and 8, from a larva of *Ceratonia amyntor* feeding upon Elm. The larvæ as they emerged were larger than the species of *Microgaster* commonly infesting *Sphinx* larvæ, and of a grayish-white color, but beyond that and the fact that it was a species with which I was unacquainted, I made no observations upon them.

The forest and shade trees in this vicinity are suffering severely this fall from lepidopterous larvæ of several species. Oaks are the worst infested and in the majority of cases the larvæ are those of *Edema albifrons*, the ravages of which are as serious as they were last fall when large tracts of oak forests were stripped quite bare of foliage.

The only remedies so far applied consist in girdling the trunks of the trees, at a height of 3 or 4 feet, with either cotton or a band of sticky fly paper. Then some persons pick off and destroy the larvæ which gather below these obstructions which they are unable to pass in their journey up the trunk. Of course this method is of value only in preserving uninfested trees and preventing the return of larvæ once dislodged.—[Robert H. Wolcott, Michigan, September 12, 1895.]

REPLY.—You are correct in supposing that these cocoons are not those of the common *Apanteles* (old genus *Microgaster*) so often reared from *Sphinx* larvæ. They are the cocoons of *Microplitis ceratonia* Riley, described in a paper entitled Notes on North American *Microgaster*s in the Transactions of the St. Louis Academy of Sciences (vol. IV, pp. 295-315). The cocoons which you send are described and figured in the *American Entomologist* for February, 1870 (vol. II, p. 128).—[September 14, 1892.]

Success of the Carbon Bisulphide Remedy against the Cabbage Maggot.

I received in due time your letter of June 7, recommending the use of bisulphide of carbon for the Cabbage Maggot. I applied, as directed, on the 11th and discovered the plants so treated very seriously wilted on the 13th. They remained in this condition for several days, but recovered from the effects of the carbon, and when cutting time came there was no difference either as to the time of heading or the number of salable heads in the rows containing three hundred and twenty-five to the row. I examined the ground and the roots of the plants and found every worm of every kind dead. My conclusion is that if the remedy had been applied at least one month earlier I might have saved the 25 per cent I lost. At the time I applied the carbon, most of the maggots had gone into the pupa state, and their course had been about run. I read the statement somewhere that muriate of potash, if liberally applied, would not only kill the young worms, but act as a fertilizer, too. Do you know this to be a fact?—[P. D. Barnhart, Pennsylvania.]

REPLY.—The success of your experiments with bisulphide of carbon for the Cabbage Maggot is gratifying. We are familiar with the recommendations concerning muriate of potash, but have not, as yet, experimented with this substance.—[September 26, 1892.]

The Grape-vine Leaf-roller in Texas.

Will you please give me some information in regard to the treatment of the "leaf-roller" *Desmia maculalis*? It has utterly defoliated the grapes here. I have just come here and am unable to say how much injury it has done over the State.—[R. H. Price, Professor of Horticulture, Texas, September 9, 1892.]

REPLY.—The Grape-vine Leaf-roller, *Desmia maculalis*, is two-brooded in Missouri, passing the winter in the chrysalis state. In Texas there may be more generations, but the method of hibernation should be the same. Carefully raking up and burning the leaves during the winter is a good remedy. In small vineyards the folded leaves may be picked by hand late in the season before the leaves fall, or earlier in summer the worms may easily be crushed by hand within the leaf. Such an extraordinary abundance as you indicate is unusual, and would justify the use of arsenicals in early summer.—[September 14, 1892.]

Relative Destructiveness of Cut-worms in Meadow and Pasture.

In INSECT LIFE (vol. IV, p. 400) is a note where an Iowa correspondent has mistaken cut-worms for tumble-bugs. I have had a good many years' experience with cut-worms, as I plow up more or less sod for corn every year. I have never had corn damaged to any extent on land that had been mowed, but always the damage was where it had been pastured, and the longer it had been pastured the worse the damage from cut-worms has always been. I have found fall plowing to be of some benefit, but not a remedy.

In 1891 I had a field of corn planted on sod, one-half of which was divided off with temporary fence and mowed, and the other pastured. All the meadow was fall plowed, and about one-half of the pasture around the outside; balance was plowed late in spring. The fence was removed and all planted together, May 28 and 29 (late planting pays here), on purpose to avoid cut-worms. On the meadow land there was not a hill destroyed by cut-worms, while the pasture part was all cut off several times and only escaped complete destruction by the disappearance of the worms before the corn roots were entirely exhausted. As it was the crop was damaged considerably. On the part of the pasture land fall plowed they were not quite so bad as on the spring plowed. They were mostly the brown-striped cut-worm, and disappeared about June 16.

I have given the above as a sample of my experience for the last nine years, when I first began to notice the difference between meadow and pasture with regard to cut-worms. * * *—[H. J. Giddings, Iowa, September 20, 1892.]

Damage to Cattle Hides by the Ox Bot.

* * * Having been practical tanners ourselves we can testify to the immense damage to hides perpetrated by the Bot Fly. It seems to us that farmers should be systematically and vigorously reminded of the terrible loss occasioned by grub holes in cattle hides. We are constantly calling attention to this in our paper, but the Department of Agriculture has it in its power to do more effective work than ourselves. The schools and colleges of agriculture in the different States would probably coöperate in putting down this nuisance if the remedies were placed before them. We shall do our best to persuade the big packers of Chicago and other cities to remind shippers of cattle that a little more attention paid to grub holes would make the beast worth from 50 cents to \$1 more. * * *—[R. C. JACOBSEN, Ed. *Hide and Leather*, Chicago, Ill., June 20, 1892.]

The Rabbit Bot.

FIRST LETTER.—I take pleasure in sending by this mail one of three larvæ taken today from the skin of the throat of a young rabbit two to two and a half months old. The rabbit appeared to have suffered a great deal of pain, as I caught it with

my hands quite easily. In this connection I would state that all the young rabbits—killed in mowing—upon this plantation, for the last two years had these larvæ about their necks. [John N. Johnson, Virginia, July 21, 1892.]

NOTE.—The specimen sent was the larva of the Rabbit Bot (*Cuterebra cuniculi*).

SECOND LETTER.—This evening I killed a rabbit about one-third grown. Between the fore limbs were two worms imbedded in the skin. The entire body except an exposed portion was covered with stiff black hairs. This part was the free end and was flush with the surface of the skin. Parting the fur at this point one might think he was looking at a warty appearance on the rabbit's skin. The rabbit was fat and otherwise in good condition.

What is this worm? Does it feed upon the rabbit or does it draw its subsistence from the outside world by means of the exposed part? * * * [W. C. Smith, Indiana, August 3, 1892.]

REPLY.—The insect which you found infesting the rabbit is the common Rabbit Bot (*Cuterebra cuniculi*). This insect belongs to the family of two-winged flies known as the *Cestrinæ*, which includes the common Ox Warble and Bot-fly of the Horse and the Sheep Bot and other similar parasites of many wild animals. It derives its nourishment from the animal itself and not from the "outside world." * * * After reaching full growth, these grubs leave the rabbit by issuing through the perforation of the skin and drop to the ground, where they transform to puparia, from which the adult flies subsequently emerge.—[August 6, 1892.]

Parasites of the Harlequin Cabbage Bug.

I send the following: (1) Small parasites on eggs of Harlequin Bug. (2) Larger do. (3) Cocoon of No. 2. (4) Eggs of Harlequin Bug. Out of over 1,000 eggs but very few Harlequin Bugs hatched. Kindly identify the parasites for me. * * * [H. A. Morgan, Louisiana, September 9, 1892.]

REPLY.—It is interesting to know that you have at last reared a parasite from the eggs of the Harlequin Cabbage Bug. So far as we know, none has ever been reared heretofore, although we always supposed that these eggs would prove to be parasitised by some species of the subfamily *Scelioninæ*. This supposition your smaller parasite proves correct. It is a new species of the genus *Trissolcus*, to which Mr. Ashmead has given the manuscript name *T. murgantiæ*. It will be described in his forthcoming monograph of the *Proctotrypidæ* of North America. The two other parasites are, in my opinion, not to be connected with the eggs of the Harlequin Bug. The larger one is a species of *Apanteles* and the smaller one is a common parasite of *Apanteles* cocoons known as *Glyphe viridascens* Walsh. It is likely that the *Apanteles* was parasitic upon some *Lepidopterous* larva feeding upon the same leaf upon which the eggs of the *Murgantia* were laid and that the cocoon cluster was accidentally attached to the egg mass. You should be able to settle this point positively, however, by future observations.—[September 14, 1892.]

GENERAL NOTES.

INSECTS AND THE WEATHER.

Prof. Harrington, chief of the Weather Bureau of this Department, is preparing a work upon weather proverbs, including all the information obtainable regarding animal and vegetable kingdoms in so far as members of either give indication of changes in the weather, and has asked us for data concerning insects.

The literature of this interesting subject is not extensive, although many ideas concerning the connection of insects with the weather are current in different parts of the country, and undoubted facts have been observed relative to the instinctive knowledge which these creatures possess of changes in the weather. We therefore appeal to the readers of INSECT LIFE for assistance in this matter. Please send us any ideas current in your part of the country or any facts which you may have observed.

SUCCESSFUL COLONIZATION OF VEDALIA IN EGYPT.

In a preceding number (vol. IV, p. 349), we announced the successful arrival at Alexandria, Egypt, of a small consignment of living specimens of *Vedalia cardinallis*, the little Australian ladybird. It was hoped at the time that this insect would prove as efficient in destroying the Egyptian Fluted Scale (*Icerya aegyptiacum*) as it has been in California, New Zealand, and elsewhere against the *Icerya purchasi*. In our last number (p. 50) allusion was made to a recent report of our esteemed correspondent, Rear-Admiral R. N. Blomfield, R. N., of the success of our last consignment and of its voluntary spread from the original colony. Through the kindness of this gentleman we have recently received a communication from Mr. J. H. Marsden of Alexandria, who reports that the *Vedalia* is becoming very generally distributed in that region. Mr. Marsden had started near Bulkeley Station, a small colony of about a dozen specimens taken from the garden of Nubar Pasha. These were placed on a rose bush infested with the *Icerya* scales and soon reproduced. Fearing that their progress might be retarded owing to the rapid disappearance of the scales, search was made and a branch of an orange tree, "apparently full of the pest" was found, but on careful examination it was seen that all the *Iceryas* had been killed, and all of the orange trees in this garden being in a similar condition, difficulty was experienced in finding any living scales to serve as a fresh food supply. The *Vedalias*, however, were abundant in all stages. A month later on visiting this garden the ladybirds had also disappeared and Mr. Marsden felt confident that the pest had, in this short time, been practically exterminated. But as has been the case in other countries where introduced the *Iceryas* soon recovered from the first onslaught of the little destroyer, and are again at work. They are, however, accompanied by the *Vedalias* in one stage or another. Mr. Marsden has kindly offered to report anything that may be worthy of note in the future.

JAMAICA MUSEUM NOTES.

We have received from Mr. T. D. A. Cockerell, Curator of the Museum of the Institute of Jamaica, Kingston, Nos. 19, 23, and 24 of the stencil-process notes of the Museum. No. 19 records the finding of a new wax insect, *Ceroplastes utilis*, n. sp., which produces such an abun-

dance of wax that Mr. Cockerell deems it of commercial importance, and a new lac insect, *Tachardia gemmifera*, with which, however, the lac is not at all abundant. Number 23 records the rediscovery of *Peripatus* in Jamaica, and the fact that the species is being studied by Dr. Grabham and Mr. Cockerell. It has not yet been determined whether it is a new species, or whether it is identical with the Venezuelan species, *P. edwardsi*. No. 24 is entitled "New enemies of Scale Insects," and mentions particularly a Lepidopterous enemy of *Ceroplastes* which Mr. Cockerell thinks may be a species of *Thalpochares*, a *Chrysopa*, and a Chalcidid parasite of a *Lecanium* on *Terminalia*.

RECENT ENTOMOLOGICAL PUBLICATIONS BY THE U. S. NATIONAL MUSEUM.

Since we last mentioned the publications of an entomological nature emanating from the U. S. National Museum, there have appeared in addition (1) Directions for Collecting and Preserving Insects by C. V. Riley [Part F, Bulletin 39]; (2) Revision of the Genus *Cucullia*; Revision of the *Dicopinæ*; Revision of *Xylomiges* and *Morrisonia*, by John B. Smith (Nos. 890-892), and (3) Insects of the subfamily *Encyrtinæ* with Branched Antennæ, by L. O. Howard [No. 905].

GALLS IN GERMANY.

Dr. D. H. R. von Schlechtendal's important contribution to science entitled "Die Gallbildungen (Zöoëcidien) des deutschen Gefäßpflanzen" has reached us under separate cover, extracted from the Jahresbericht des Vereins für Naturkunde zu Zwickau, 1891. The plan of this work comprises an arrangement of all the galls produced by animals known in Germany, according to the botanical classification of the plants which bear them. Under each plant species is given a synoptical table of its galls, running to the name of the gall insect, wherever this is known. The work is of the greatest value to students of insects, but it is surprising to notice how large is the number of cases in which the creature producing the gall has not been reared, or at least not specifically determined. When this is the case with a country like Germany, the fauna of which is so well known, American students need not feel ashamed of the condition of our knowledge in this direction. The number of the distinct galls runs up to 1,322. The work covers 114 pages and is well indexed, both zoölogically and botanically, according to the families and genera in botany and genera and species in zoölogy. Mr. Ashmead's synopsis of the Cynipid Galls is the only approach to a work of this character which we have in this country.

NOTES ON SOME BRED SPECIES OF CALIFORNIA PARASITIC HYMENOPTERA.

We have lately received from our agent, Mr. D. W. Coquillett, stationed at Los Angeles, Cal., a small lot of Hymenoptera for identifica-

tion with accompanying letter of transmittal dated September 2, containing brief notes on their breeding habits. These notes are of such interest that we take the present occasion to place some of the principal facts on record:

Monodontomerus montiragus Ashm.—Bred in August by Dr. A. Davidson, from a larva or pupa of a wild bee. Bred August 24 from a pupa of *Xylocopa* sp.

Polychroma sp.—Bred July 30 from a larva or pupa of *Chrysobothris* sp.

Pteromalus puparum.—Four ♂♂ and 56 ♀♀ specimens issued May 6 from a chrysalis of *Pyrameis carya*.

Praon chenopodiaphidis issued about June 10 from *Aphis rumicis* fastened to the leaf by their silken cocoons. (See INSECT LIFE, vol. IV, p. 196.)

Bracon sp. Bred with the above.

Isocratus vulgaris Walk.—Bred with the above.

Bracon sp.—Bred in May and June from larvæ or pupæ of *Tychius semisquamosus*.

Bracon sp.—Bred in May from *Thalpochares cocciphaga* received from Australia.

Limneria fugitiva Say.—Bred May 28 from a caterpillar of *Clisiocampa californica*.

A SILK-COVERED WALNUT.

Mr. Percy E. Clarke, of the U. S. Patent Office, has sent us an English walnut completely and curiously encased in a fine gray silken envelope, sufficiently dense to hide the contents. The nut was picked in this condition from a tree growing on Capitol Hill, Washington, D. C. In our opinion this silken casing was produced by the larva of the Hand-maid Moth (*Datana integerrima*), since these caterpillars have the habit of congregating together and spinning a carpet of silk during the first and second molts. That they should have thus surrounded a spherical nut, however, is somewhat strange.

NEW LOCALITIES FOR THE MEDITERRANEAN FLOUR MOTH.

This important enemy of stored cereal products has recently made its appearance in Jamaica, W. I., and in California, and it appears to be only a question of time when the species will be found in nearly all parts of the world. Mr. T. D. A. Cockerell informed us in a recent communication that he had found a "fine lot of larvæ of *Ephestia kühniella* in oatmeal bought in the streets of Kingston, Jamaica," and Mr. W. G. Johnson, of Palo Alto, Cal., sends us specimens of the same insect under date of August 30, with the information that it is making its appearance in one of the largest mills on the Pacific coast and is making rapid progress toward the destruction of the cereals in the mill.

DAMAGE BY CODLING MOTH IN NEBRASKA.

Prof. Edw. Daniels, in a recent conversation, informed us that having traveled through the State of Nebraska the present summer he felt himself in position to estimate the loss from Codling moth the present season in that State to be \$2,000,000, nearly all of which might have been saved by spraying. It is an "off" year for apples, but fully enough

would set to make half a crop. As usual, however, in such years the number of insects produced by the full crop of the preceding year has been so great as to totally ruin the crop wherever spraying has not been resorted to.

SUCCESS OF A VEDALIA IMPORTATION.

We have already noted the fact that a sending of *Vedalia cardinalis*, which we made through Mr. Coquillett to Dr. Locking of Nelson, New Zealand, who had been designated to us by Mr. R. Allan Wight, arrived in good condition. We learn from the *New Zealand Farmer* of August, 1892, that the insects multiplied very rapidly, ate all of the *Iceryas* that were present at the original point of colonization and then migrated to the neighboring gardens, clearing off the *Iceryas* as they traveled. The success of this experiment was as marked in a small way as was the California importation.

Since receiving this number of the *New Zealand Farmer* we have had the pleasure of a letter from Mr. Wight giving further details. We quote a portion of the letter referring to this matter, and a second paragraph referring to Mr. Wight's own sending of *Vedalia* from a locality of great abundance at Whangarei, together with some comments upon the new *Vedalia* mentioned on page 289 of the last volume of *INSECT LIFE*. Mr. Wight's explanation concerning the new species is ingenious but it will require an examination from a trained student of the Coccinellidæ to settle the matter.

Dr. Locking gave me a full account of your last successful sending of *Vedalia* to Nelson, and I have also, since then, sent them a large consignment from Whangarei, where I found them in millions. The Nelson people have held a meeting, at which you have been very warmly thanked for your great kindness, and they have written to inform me that *Icerya* is very fast disappearing from their orange and lemon trees that were dying before. * * *

I think I mentioned that I had successfully sent boxes of *Vedalia cardinalis* to New South Wales, Victoria, and all over New Zealand. The harvest I found at Whangarei was a rich one, sometimes a single shake brought over 200 into my umbrella. I found that there were always a few *Icerya* eggs, those immediately under the mother scale, that were imbedded in so fluffy a cotton that the little beetles could not get at them, although starving, and Mr. French found that those I sent him tried to eat the mealy bug (*Dactylopius*) and could not do so, because the fluff clung round their legs and jaws. I also found that a large proportion of the females came out of the pupa red, without the black markings. I had often observed (as long ago as 1882-'84) that certain Lepidoptera were deficient in the black markings and that these were insects exposed to the sun in the pupa stage, and I always found the deficiency most marked where I had bred the insects in wooden boxes (in the dark). I tried the experiment with *Vedalia* and I found similar results, also most of those I sent to Mr. Olliff were in the pupa state (in dark boxes), and he had a great number of specimens of these badly marked ones. The female pupa exposes more of its inmate to the sun than the male, the weather, when I collected, was also very cloudy. Mr. Olliff has taken these for an undescribed species and named them *Norius wightii*, taking Mulsant's original genus, and giving me credit for a new species, but I think that he is wrong, and that it is just as I explain, but what struck me is

a mention in INSECT LIFE of Mr. Koebele's having seen (or there having been) in Mr. Olliff's possession a new species of *Vedalia*, and I know he had no others but what I sent him, because he was so destitute of specimens that he wanted to borrow one to make a drawing from.

QUAILS VERSUS POTATO BUGS.

Mr. E. H. Stowe, of Pompei, Mich., has been good enough to send us a clipping from the *Gratiot Journal*, in which the statement is made on the authority of Rev. J. E. Long, pastor of the Presbyterian Church of Ithaca, Mich., that "several weeks ago a pair of quails flew up out of his garden. In making the turn about the corner of the house, one of them missed its reckoning in some way, and, striking the house, fell dead. On examining its distended crop, 101 potato bugs were found, the little fellow's breakfast, for the bugs were yet alive and began to move about when brought to the fresh air."

The great value of the quail as an insectivorous bird is abundantly recognized, but we have never before met with a similar instance of voracity in a potato field.

MYRMECOPHILOUS BEETLES.

Under the title "Notes on some Myrmecophilous Coleoptera," Mr. H. F. Wickham publishes some interesting notes in *Psyche* for September, 1892 (vol. VI. pp. 321-323), on ten species of Coleoptera that are inquilinous in ants' nests in the West. *Heterius hornii* is described as new and a number of Tenebrionidæ are mentioned as probably true myrmecophiles.

MOSQUITO REMEDIES AGAIN.

In the *Scientific American* for September 10 is published a communication from M. Kawn, of Bangkok, Siam, apropos of the note entitled "The Best Mosquito Remedy," which appeared in INSECT LIFE (vol. III, p. 223), and was republished in the *Scientific American*. Mr. Kawn states that in Siam it is the custom to place an iron nail in the water jars, since the water jars are the breeding places of the mosquitoes. The rusting of the nail acts as a deterrent and the mosquitoes will not breed in the water. For the first few days after placing nails in the water the mosquitoes continue to breed, and Mr. Kawn heats his nails red-hot, which produces an immediate effect. We are somewhat skeptical as to the success of this remedy, but are open to conviction.

An ingenious method of capturing adult mosquitoes in the house is in extensive use in some localities in New Jersey. We have not seen it described in print, and mention it here in the hope that it may be new to some of our readers. It consists in nailing to the end, or rather the top, of a stick the lid of a small tin box, such as a yeast-powder box. The stick must be long enough to enable the operator to reach the ceiling, and the tin cover of the box is nailed to it in an inverted position.

Into this receptacle is then poured a tablespoonful of kerosene, and the mosquitoes at rest upon the ceiling are easily trapped by simply placing this kerosene cup under them and close up to the ceiling. In their endeavor to escape they fall at once into the kerosene and are killed. On the morning of September 25 the writer captured in this way seventy-five mosquitoes on the ceiling of the room which he had occupied during the night. Most of the seventy-five were filled with blood, which, we think, is a sufficient argument in favor of performing the operation before going to bed rather than after arising! This was at Montclair, N. J.

NEWSPAPER ENTOMOLOGY AGAIN.

Even the apparently truthful and perfectly circumstantial stories which appear as press dispatches in the columns of some of our best newspapers will bear investigation. A prominent New York daily, for instance, in the early part of September, published a dispatch from Newark, N. J., stating that five horses had died from the attacks of Texas Flies (meaning, doubtless, the Horn Fly, *Hæmatobia serrata*). As this insect does not infest horses, and as the death of an animal from its direct attack has not hitherto been substantiated, we wrote to the gentleman whose name and address was given, and received the following statement from Dr. James D. Hopkins, veterinary surgeon, of Newark, which indicates that our preconceived ideas in regard to the truthfulness of the dispatch were correct:

Mr. ———— lost five horses, two from heat and three from colic or enteritis. I attended three of them; the other two died before aid could be summoned, but the history of the case indicated plainly the cause of death. Mr. ———— talked a good deal about the sudden and peculiar deaths of his horses, and the newspapers made a mess (as usual) of it, although I gave them full information on the subject.

WIDESPREAD TROUBLE FROM THE HORN FLY.

It is remarkable with what rapidity the Horn Fly (*Hæmatobia serrata*) has spread over the country. All through the Northern States and up into Canada it is becoming a grievous pest. We spent some time during August on the shores of Lake Ontario, and it was piteous to see the suffering of the cattle along the highways. In many instances farmers were obliged to cover their animals to give them partial protection. Our old friend, Dr. Charles Mohr, of Mobile, Ala., informs us that he has been much pestered by what he calls a new fly, which has appeared this year in vast numbers in Mobile, and from his description we have no doubt that the fly is the one in question. Reports have come to us from quite a number of places in the north. Mr. Fletcher and Dr. Bethune, as appears in the minutes of the Association of Economic Entomologists, report it at various places in Canada, and in addition to the localities mentioned on page 49 of the previous number, and we have received specimens from Fort Plain and Upper Jay, N. Y., Fairfield, Iowa, Harris County, Tex., and Brandon, Vt. The extremely rapid spread of this

insect all over the country is additional evidence of its importation from Europe although we have previously practically settled this point, showing, in 1889 (INSECT LIFE, vol. II, p. 96), that it was probably first imported in the year 1886 in the vicinity of New York City. It is interesting to note how generally the popular name "Texas Fly" or "Texas Horn Fly" is applied to this insect throughout the North. This is an unfortunate cognomen and indicates an entirely erroneous idea of its origin.

THE TANNIN IN A SUMACH PLANT-LOUSE GALL.

We are informed by Prof. Henry Trimble, of the Philadelphia College of Pharmacy, that the gall of *Pemphigus rhois* Fitch upon *Rhus glabrus*, specimens of which he sent us for determination, contains nearly as much tannin as the ordinary commercial Cynipid gall from China and Japan, viz, from 60 to 70 per cent. While this fact may not prove of commercial value, it is interesting to know that the galls contain three times as much tannin as the foliage of the Sumach, the action of the insect seeming to concentrate the tannin of the plant in the gall formation.

THE FEMALE REAR-HORSE VERSUS THE MALE.

It is a well-known fact that the male insect of the family Mantidæ approaches the female at the risk of his life. Several instances have been recorded where the female has devoured the male, and we have reason to believe that many similar unrecorded observations have been made. In *Science* (vol. VIII, p. 326, Oct. 8, 1886) we described an instance in which the male gained connection with the female only after his head, front legs, and one-third of his thorax had been devoured, and we surmised that the act of copulation might ordinarily take place while the female was making a meal of her unfortunate mate. This, however, seems not to be the invariable rule. Col. John Bowles, of Washington, D. C., brought us on the 8th of September a pair of *Stagmomantis carolina*, which he had carefully watched. When he found them they were *in copula* and the male was uninjured. While he watched, however, the female turned her head and began to rapidly devour the head of the male. The male remained perfectly quiet and made no effort to escape. She ate up his head, his front legs, and was busily engaged upon his thorax, when Col. Bowles, wishing to save the specimens in that condition, killed her by painting her head with a camel's hair brush dipped in chloroform. The observer supposed that the male was already dead, but immediately upon the death of the female the mutilated male made violent efforts to escape, but before he succeeded in doing so he was pinned by Col. Bowles in the normal position and the specimen was brought to us. The nonchalance with which the male devoted himself to the sacrifice and the struggles which he made immediately upon the death of the female indicated to Col. Bowles' mind that the male has no serious objection to this method of suicide.

TICKS IN THE LEEWARD ISLANDS.

In the supplement to the Leeward Islands Gazette of April 28, 1892, is published an interesting article entitled "Notes on Ticks," which comprises a general summary of the habits of these parasites on domestic animals, and a somewhat extended series of notes on *Ixodes ricinus*, which is followed by an article on the connection between ticks and cattle disease, in which the recent investigations of the Bureau of Animal Industry of this Department are summarized.

ENTOMOLOGICAL SOCIETY OF WASHINGTON.

October 6, 1892.—Theodore Holm, Department of Agriculture, Washington, D. C., was elected an active member. The following were elected corresponding members: Prof. J. W. Jenks, Brown University, Providence, R. I.; T. D. A. Cockerell, Institute of Jamaica, Kingston, Jamaica; Miss E. A. Ormerod, St. Albans, England; W. Jülich and A. Luetgens, New York City; Prof. S. A. Forbes, John Marten, and C. A. Hart, Champaign, Ill.; Prof. C. W. Hargitt, Syracuse, N. Y.; Prof. T. Thorell, Montpellier, France; Prof. W. Kulszynski, Cracow, Austria; A. D. Hopkins, Morgantown, W. Va., and Dr. F. W. Goding, Rutland, Ill.

Upon a special invitation Mr. Hopkins gave an account of a recent visit to Europe for the purpose of studying certain Scolytidæ injurious to pine trees. He had brought back with him a large number of specimens of the European *Clerus formicarius* alive for the purpose of introducing them into pine forests in West Virginia infested by *Dendroctonus frontalis*. Discussed by Messrs. Riley, Howard, and Marlatt.

Mr. Ashmead presented a paper upon the Eucharidæ of the United States, and exhibited specimens of a number of species of this group which was formerly placed in the Chalcididæ, but which he thinks is entitled to family rank. Discussed by Messrs. Riley and Howard.

Prof. Riley presented some miscellaneous notes, reading at length from a letter received from Dr. Borries, of Copenhagen, upon the evidence of phytophagic habit in two species of the Chalcidid genus *Megastigmus*. He also read extracts from a communication from Prof. J. B. Smith, who had found the eggs of a second brood of *Galeruca xanthomelana* at New Brunswick, N. J. This, Prof. Riley said, was in accordance with his anticipations; and he further stated that eggs of this species were now being laid in the District of Columbia, these being deposited by the fourth brood of beetles, counting the hibernating beetles as the first brood. These notes were discussed by Messrs. Howard, Ashmead, and Marlatt.

Under the order of short notes and exhibition of specimens Mr. Ashmead exhibited the plates of his forthcoming monograph of the Proctotrypidæ of North America.

Mr. Heidemann showed a large series of specimens of *Rheumatobates rileyi* Bergroth, including males, females, and immature specimens, which he had found during the previous week in the Chesapeake and Ohio Canal, near Washington. The only known specimen of this insect up to the present time was captured by Rev. J. L. Zabriskie, near Flushing, Long Island, and was figured in *INSECT LIFE*, vol. IV, p. 199. He called attention to the structural peculiarities of the female sex, which differed in certain respects from the male, as shown in *INSECT LIFE*.

E. W. DORAN,
Secretary pro tem.

U. S. DEPARTMENT OF AGRICULTURE.

DIVISION OF ENTOMOLOGY.

PERIODICAL BULLETIN.

Issued January, 1893.

Vol. V.

No. 3.

INSECT LIFE.

DEVOTED TO THE ECONOMY AND LIFE-HABITS OF INSECTS,
ESPECIALLY IN THEIR RELATIONS TO AGRICULTURE.

EDITED BY

C. V. RILEY, Entomologist,

AND

L. O. HOWARD, First Assistant,

WITH THE ASSISTANCE OF OTHER MEMBERS OF THE DIVISIONAL FORCE.

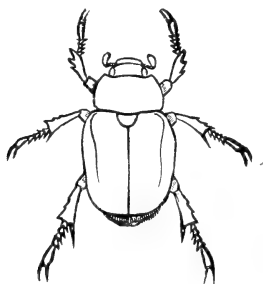

[PUBLISHED BY AUTHORITY OF THE SECRETARY OF AGRICULTURE.]

WASHINGTON:
GOVERNMENT PRINTING OFFICE.
1893.

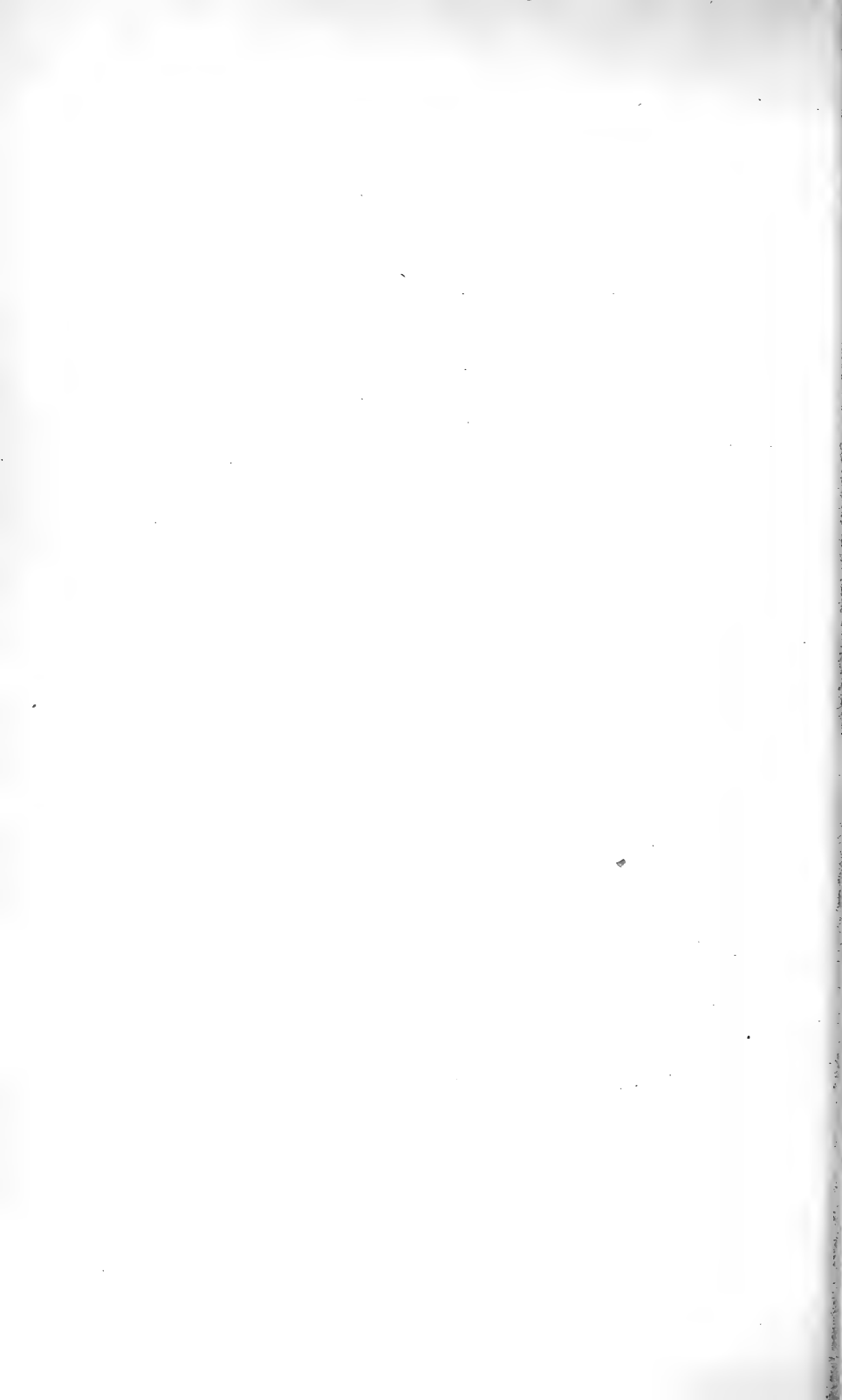

CONTENTS.

	Page.
SPECIAL NOTES.....	147
THE GLASSY-WINGED SHARP-SHOOTER (<i>Homalodisca coagulata</i> Say) (illustrated)	150
THE OSAGE ORANGE PYRALID (<i>Loxostege macluræ</i> Riley) (illustrated)	
Mary E. Murtfeldt..	155
THE FOOD-PLANTS OF SOME JAMAICAN COCCIDÆ	158
T. D. A. Cockerell..	
THE "MAXILLARY TENTACLES" OF PRONUBA (<i>illustrated</i>)	161
John B. Smith..	
THE POTATO-TUBER MOTH (<i>Lita solanella</i> Boisd.)	163
R. Allan Wight..	
FOOD-PLANTS OF NORTH AMERICAN SPECIES OF BRUCHUS.....	165
THE STRAWBERRY WEEVIL (<i>Anthonomus signatus</i> Say) (illustrated)	
F. H. Chittenden..	167
DAMAGE TO FORESTS BY THE DESTRUCTIVE PINE BARK BEETLE (<i>Dendroctonus frontalis</i> Zimm.)	187
A. D. Hopkins..	
AN INTERESTING WATER BUG (<i>Rheumatobates rileyi</i> Berg.) (illustrated).....	189
EXTRACTS FROM CORRESPONDENCE	194
Further Notes on the Japanese Gypsy Moth and its Parasite—Injurious Insects in Nebraska: Season 1892—A Household Ant of British Honduras—House Ants of Mexico—The Stony Acorn Gall—Destructive Appearance of the Roller Worm—Swarming of the Archippus Butterfly—An Anthicid Beetle reported as injurious to Fruit—Injury to Hammer-handles—On Remedies for the "Cigarette Beetle"—Correspondence on the Mosquito Remedy—Note on the Drone Fly—Another irregular appearance of the Periodical Cicada—The New York Pear-tree Psylla—A Tropical Cockroach in a New Orleans Greenhouse—Remedies for White Ants in Fruit Trees—A swarm of Spring-tails—Tame Spiders.	
NOTES FROM CORRESPONDENCE.....	202
GENERAL NOTES	204
First Larval Stage of the Pea Weevil (illustrated)—Edward Burgess' work in Natural Science—Swarming of the Archippus Butterfly (illustrated)—Unusual abundance of Butterfly Larvæ—Some imported Australian Parasites—A new Parasite of the Red Scale—Parasitism in Bees of the Genus <i>Stelis</i> —The Larva of <i>Harpalus</i> —Dipterous Larvæ in the Eyes of a Toad—An Insect Transmitter of Contagion—A Scale-insect on the Karoo Bush—The silk of Spiders—The Mexican Jigger or "Tlalza-huate"—Obituary—Entomological Society of Washington.	

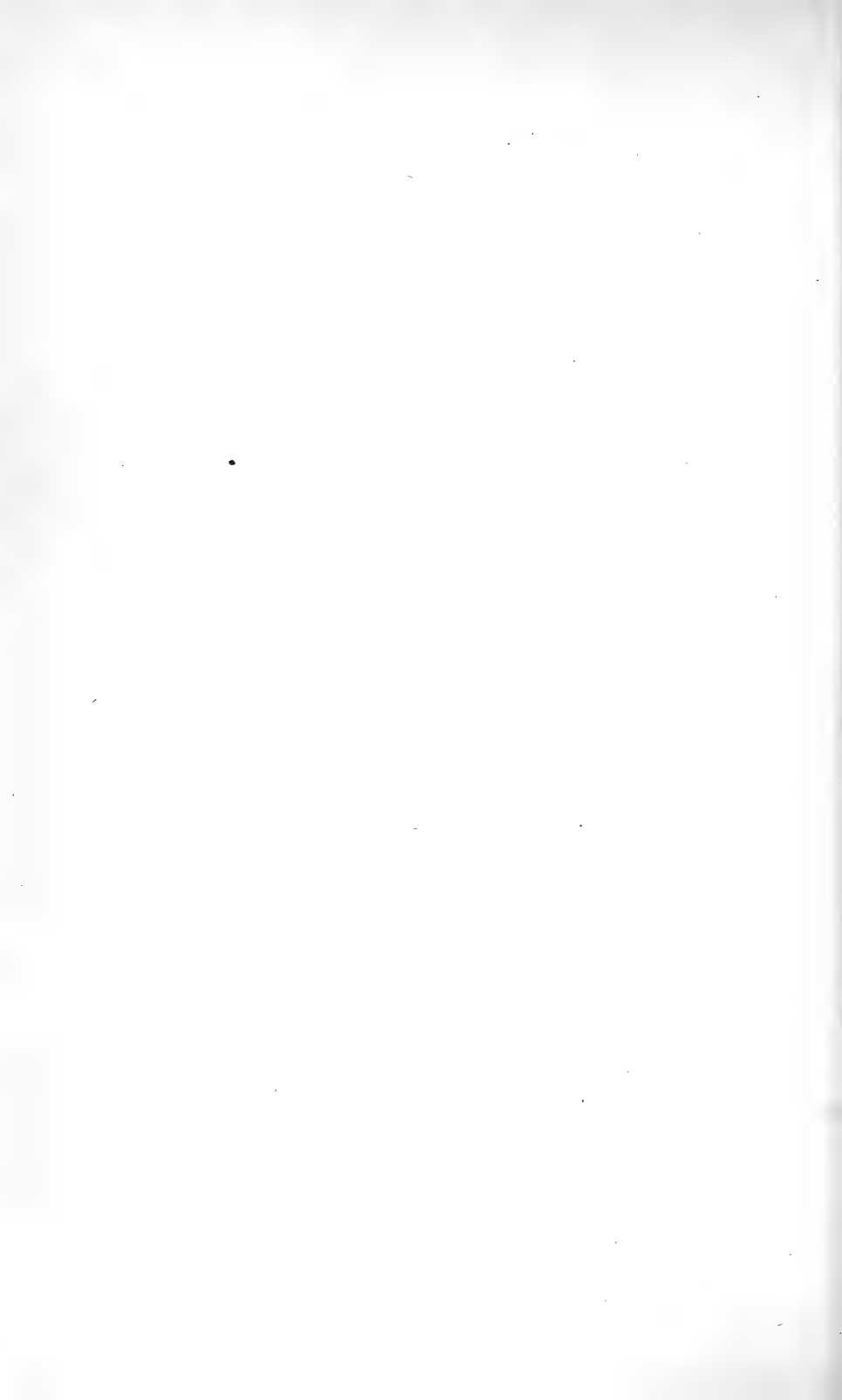

SPECIAL NOTES.

A Text-book of Agricultural Entomology.—We have just received from Miss E. A. Ormerod a copy of her new "Text-book of Agricultural Entomology," which has just been published by Simpkin, Marshall, Hamilton, Kent & Co. (Limited), London, 1892. The first edition of this text-book was published in 1884, and consisted of ten lectures delivered in 1883 at the Institute of Agriculture of South Kensington. The first edition met with almost no sale until last year, when attention was drawn to it as conveying information in one of the branches of agricultural instruction brought forward under the arrangements of the new County Councils, and it then sold off so rapidly as to necessitate the preparation of a second edition. In a handy volume of two hundred and thirty odd pages Miss Ormerod has condensed a great deal of information which will be useful to English farmers and fruit-growers, and has illustrated her text by over 160 figures, 50 of them being drawn from life, while the others are taken from previous publications. The arrangement of the work is on the plan of the little Italian work of Dr. Franceschini, which we reviewed some time ago. In other words, instead of arranging the subjects under the crops which they infest, they are arranged according to zoölogical classification. Chapters I and II are devoted to a consideration of the different states and the classification of insects; chapters III and IV to injurious insects of the order Diptera; chapters V and VI to the Coleoptera; chapters VII and VIII to the Lepidoptera and Hymenoptera, respectively; chapter IX to the Homoptera, and chapter X to the Mollusca and Anguillulidæ, etc. The latest remedies known to the author are usually given. English horticulturists have not taken up the arsenical poisons so widely used in this country until the last year or two, but Miss Ormerod recommends them for leaf eating caterpillars in the orchards, although she does not give proportions and methods of application on account of the necessity for restricting the size of her volume. She covers the point, however, by offering in a foot-note to send a pamphlet giving all necessary details to all applicants gratuitously. The emulsions of kerosene and soap are mentioned only incidentally, and no space is given to the important subject of insecticide machinery. In spite of these omissions the work is a most convenient one and will serve to extend a knowledge of injurious insects among the class of people who most need this information.

Food of the Robin.—In Bulletin 43 of the Ohio Agricultural Experiment Station Mr. E. V. Wilcox summarizes his recent extensive investigations upon the food of the Robin. We have previously noticed a preliminary article upon this subject, published in the Journal of the Columbus Horticultural Society. In this later paper Mr. Wilcox reviews the literature of the subject, critically examining the statements of S. A. Forbes and F. H. King, and tabulates the stomach contents examined by himself. These are 60 of birds shot in April, 18 in May, 49 in June, 45 in July, and 15 in August, a total of 187 in all. The totals of insect contents are as follows: 52.4 per cent of beneficial species, 18.6 per cent of injurious species, and 28.9 per cent of neutral species. The question of damage to fruit is considered, and in summing it up Mr. Wilcox concludes that the fruit-grower should be allowed to kill the Robin during the season when it is most harmful, and should not, as at present, be in danger of arrest and fine for shooting these birds in his own garden. In arriving at this result he allows for the possibility that, as contended by Forbes, the services of the predaceous beetles which the Robin destroys have been overestimated. Following this paper by Mr. Wilcox are some remarks by the Horticulturist of the Station, Mr. W. J. Green, in which the fondness of the Robin for berries is shown, and the sensible point is made that whatever the services of the Robin to the public in general may be, the tax upon berry-growers is too great for them to bear alone. Following Mr. Green's remarks is a statement from Mr. F. M. Webster, Entomologist of the Ohio Station, giving the results of the examination of 14 stomachs of birds shot in meadows, Mr. Wilcox's specimens having been mainly taken from birds shot in a fruit-growing section. Mr. Webster shows that although the larvæ of crane-flies were very abundant in the fields in which the Robins were killed, only 3 of the 14 had eaten these larvæ and only 1 had made a full meal of this food. He generalizes from this that while Robins get from grasslands in April and May a large part of their food, it has so far proven to consist mainly of insects of whose destructive propensities we have as yet no proof. The trouble here is, however, that Tipulid larvæ are so soft that remains are not apt to be found unless they were recently swallowed.

A Bulletin from Oklahoma.—Bulletin 3 of the Oklahoma Agricultural Experiment Station, published June 3, 1892, contains 20 pages of insect notes by the Director of the Station, Dr. J. C. Neal. The bulletin is entirely compiled, and treats of the Imported Cabbage Butterfly, the Cabbage Plusia, Cut Worms, the Boll Worm, the Striped Melon-beetle, the Twig Girdler, the Chinch Bug, the Horn Fly, and the different formulas for insecticides.

North American species of Tachytes.—Mr. W. J. Fox, of Philadelphia, has just published a monograph of the North American species of Tachytes in the Transactions of the American Entomological Society, August, 1892. The paper covers pages 234 to 252 of the nineteenth volume of the Transactions, and is illustrated by Plate XI. Mr. Fox has found 23 species of this interesting genus in North America, and these he separates by means of useful synoptical tables of both sexes, re-describing all of the old species and adding a number of new ones. Mr. Fox has been taking up one genus after another of the Fossorial Wasps, and has also recently monographed the Larrid genus *Astata* in the current volume of the *Canadian Entomologist* (pp. 232–235).

Who are the Readers of Insect Life.—Some months since, wishing to reduce the mailing list for INSECT LIFE and weed out those who were not specially interested in the publication, a circular was sent out asking the return of a card, properly filled out, by those who still wished to have the publication sent to them. One of the questions asked was concerning the occupation of the individual. The cards are now about all in and the tabulation of this matter of the occupation of those who have shown enough interest in entomology to wish to continue the receipt of INSECT LIFE is interesting and suggestive. As might be expected, farmers, fruit-growers, and gardeners head the list in point of numbers. Of these there are 1,076; of periodicals, libraries, scientific societies, etc., there are 669; of entomologists and naturalists in general there are 583; teachers, including college professors, 285; physicians, including veterinarians, druggists, and dentists, 153; persons engaged in mercantile pursuits of all kinds (general merchandise, real estate, insurance, clerks, etc.), 157; students, 124; literary men, including editors, journalists, publishers, and reporters, 63; mechanics, artizans, and laborers, 41; Government employés, at Washington and elsewhere (except Department of Agriculture), 40; clergymen, 29; lawyers, 27; chemists, 20; engineers, mining, civil and electrical, 17; bankers, 7; artists, 6; geologists, 6; poultrymen, 5; architects and landscape gardeners, 4; horticultural inspectors, silk culturists, bee-keepers, U. S. Army and retired, 3 each; comptrollers, and inspectors of insect pests, 2 each; artificial-fly maker, bar-keeper, barber, butcher, capitalist, carpet layer, compositor, clerk of court, commissioner of agriculture, commissioner of horticulture, contractor, cigar maker, dealer in surgical instruments, engraver, member of foreign legation, ice dealer, inspector of grain, inspector of customs, jeweler, kiln burner, Member of Congress, miller, music dealer, milkman, policeman, restaurateur, stockman, superintendent children's aid society, telegraph operator, sculptor, watchmaker, agent, 1 each.

It is probable that nearly all of the correspondents who occupy themselves with commerce and professional pursuits, aside from teaching,

derive their interest in INSECT LIFE through the possession of a garden or farm, so that the publication measurably reaches just the class of people for whom it is intended. This statement is not founded upon guess-work since many of these individuals have made such statements to us in correspondence, a number of bankers and merchants having stated that they own farms.

An interesting case is that of a merchant in Connecticut, who writes that he keeps an "old-fashioned country store," and that a large number of his customers are farmers and others who own homes, and are interested in fruit and berries. He keeps a file of INSECT LIFE at his store for the benefit of his customers.

The expressions of interest in the publication and the estimates of its practical value have been very gratifying, and we take this occasion to thank our readers for their kind words and for their prompt replies to the circular.

THE GLASSY-WINGED SHARP-SHOOTER.

(*Homalodisca coagulata* Say.)

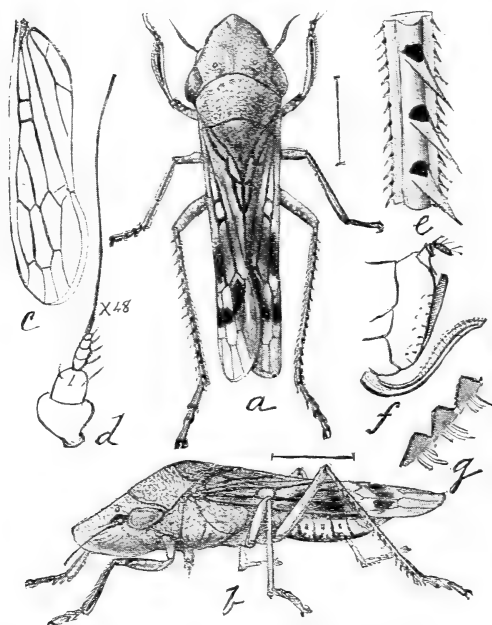

FIG. 10.—*Homalodisca coagulata*: a, adult ♀ seen from above; b, same, side view; c, venation of forewing—enlarged; d, antenna; e, section of hind tibia; f, ♀ genitalia—still more enlarged; g, serrations of ovipositor—still more enlarged (original).

There is a not uncommon leaf-hopper of the family Cercopidæ, found chiefly in the South, which occasions much damage to vegetation, but the depredations of which have not been recognized by writers

upon economic entomology. This is *Homalodisca coagulata*, a species described by Say in 1832 from specimens captured by Barabino in Louisiana. It is generally known as the "Sharp-shooter" in the South, on account of the peculiar effect of its puncture on young cotton bolls, which look as though pierced by a minute bullet, and also because of its rapid and forcible ejection of minute drops of liquid. It is a large species, nearly half an inch in length, and somewhat resembles the common *Proconia undata*, a species common in the Southern States and which is frequently responsible for the "weeping trees" to which we have several times referred in the pages of INSECT LIFE. The two species are, in fact, often associated with each other on the same plant and are commonly confounded. The species under consideration, however, may at once be distinguished from the *Proconia* by its more elongate snout and by the more shining and glassy appearance of its wing-covers, as well as by many other minute but more important structural characters.

In July, 1885, we received specimens of the *Homalodisca* from Mr. L. C. Bryan, of Savannah, Ga., who had found it injuring the LeConte Pear. Mr. Bryan described it as being very shy and difficult to catch, and stated that it sucked the sap from the pear leaves. He mentioned it also in an article entitled "What is to be the future of the LeConte Pear," in the *Savannah Weekly News*, of about July 16, 1885.

In August, 1887, other specimens were received, together with a few of *Proconia undata*, from Mr. C. F. A. Bielby, of Deland, Fla., who found them in considerable numbers upon the twigs of the new growth and that of the previous year in an orange orchard affected by "die-back." Mr. Bielby had watched them most carefully and described their extreme shyness and their interesting habit of ejecting a spray of fluid from the anus. He could not see them feeding on the twigs, but strongly suspected that they were, at least in part, responsible for the "die-back." In later letters he stated that he had seen the insect insert its beak into the young wood, and surmised, from the color of the fluid contents of the abdomen, that it fed upon the yellow essential oil. This correspondence with Mr. Bielby is published in full in INSECT LIFE, vol. I (pp. 52-54). As there stated in our published answers, it is impossible to connect the punctures of this or any other orange-feeding insect with the disease known as "die-back." Even the so-called "die-back fungus" is secondary in its attack, and the disease itself is probably physiological, or rather not caused by any parasite, either animal or vegetable.

In June, 1891, we again received specimens, and this time from Mr. Louis Biediger, of Idlewild, Bexar County, Tex. Mr. Biediger wrote us that he found them upon his wild mulberry trees and that the trees were "full of them." Up to the time of writing (May 29, 1891) he had not been able to see that they had caused any appreciable damage.

In August of the present year (1892) still other specimens of the

same insect were received from Mr. L. Donner, manager of the Halls Island Farms, near Beaufort, S. C., who had found them upon his asparagus plants.

A little later our old-time correspondent, Judge Lawrence C. Johnson, wrote us from Meridian, Miss., under date of September 25, and transmitted among other entomological specimens a single female of this species taken on a cabbage stalk.

During the summer of 1891 two of our assistants, Messrs. F. W. Mally and Nathan Banks, while engaged in the Boll Worm investigation at Shreveport, La., found that this species is largely responsible for a somewhat peculiar damage to cotton, known locally as "sharp-shooter" attack. Under our instructions these gentlemen made a careful study of this particular damage, and from their reports we gain the following information:

In Louisiana this species is quite abundant upon the cotton plants in certain fields from the first of June on through the season. The fields in which it is most abundant are those bordered by young poplars along the bayous. Prior to the first of June the insect occurs upon the poplars. About that time, however, the young growth becomes so hard that they migrate to cotton, which crop they damage by feeding and by oviposition. As shown in the figure, the ovipositor of the female (Fig. 10 *f*) consists of two saw-blades, and with these she punctures vegetable tissue for the reception of her eggs. Upon cotton the eggs are most frequently laid within the young forms or squares. Mr. Mally observed the act of oviposition twice, and describes it as follows:

The female braced herself upon all legs, the head and anterior portion of the body elevated. The very thin pointed ovipositor was then exerted, and by a forcible sawing-like operation was gradually inserted underneath the epidermis. The channel was made concave, the distal end almost coming to the surface again. The long, slightly curved, cylindrical white egg was then introduced, and the ovipositor withdrawn. The time occupied by this process was about one or two minutes. After a short interval a second egg was laid in like manner alongside of the first, but slightly in advance of it. A few hours after deposition slight, pale, blister-like swellings were noted over the points where the eggs were found.

The duration of the egg state was not ascertained. The newly-hatched young was noted and was found to be nearly white, carrying its abdomen elevated almost at right angles to the body. It is shy, like the more mature individuals, and hides among the very young leaves or the involucre. In this stage the insect feeds by puncturing the epidermis at the base of the flower bud, or the very young bolls, or the short, tender peduncles. After this puncturing the form or small boll "flares," turns pale, and drops off, the only indication of damage being a small black spot, and it is these spots which the planters call "sharp-shooter" work. By many this damage has been attributed to the Boll Worm, and attention was drawn to it many years ago by Glover, who, however, did not ascertain the real perpetrator of the damage, considering it to be probably the work of some heteropterous insect.

The young molt several times before gaining wings, and in the specimens in the collection about seven stages, without counting egg and adult, are found. The characteristic elevation of the abdomen persists in the pupa state, becoming, however, less marked as the insect grows older. It persists, however, to a slight extent in the adult, which thrusts its abdomen out from beneath its wings and turns the tip slightly upwards in discharging the drops of saccharine liquid common to many of the members of this group of insects. With each successive molt the insect becomes darker, and the pupa is bluish or lead-colored and runs about the plants with much more freedom than when younger. The full-grown insects are found most frequently upon the central stem of the plant. As noted by all of the observers who sent in specimens, they are very active and shy, running up and down the stalk and dodging from side to side.

The adult insect is brownish, sometimes tinged with bluish. The wing-covers are glassy and shiny, being nearly transparent near base, and becoming smoky for the outward three-fifths. There is a large reddish blotch just beyond the middle and near the anterior border. Fresh females often have a white powdery spot superimposed upon this reddish spot. This white spot is easily rubbed off, and is not apparent after the insect is a few days old. It is probably waxy in its nature. The head and thorax are mottled with dark brown and honey-yellow, and the abdomen, as seen from the side, is marked with large yellow bands, the spiracles remaining brown. The under part of the body is in general honey-yellow, somewhat mottled with brown. In flying from plant to plant the insects make a slight but distinct buzzing sound. When feeding they rest head downwards upon the central stem and incline the tip of the abdomen outwards, ejecting when in this position several drops of liquid in quick succession. In spite of the shyness of the insect, the female is not readily disturbed when ovipositing. A specimen dissected by Mr. Banks on July 15 was found to contain 19 eggs. The observations of Messrs. Mally and Banks indicate that there are certainly two, and possibly three, broods during the season. The adults make their appearance in numbers about June 1, and by the middle or latter part of June many young are found. The second brood begins ovipositing about the latter part of July, and after the first days in August the adults become less abundant. Experiments made indicate that while the males are readily attracted to light, the female is very rarely caught in this way. For instance, of 22 specimens trapped, 20 were males and 2 females, and on July 19, of 9 specimens caught at light all were males. Upon the cotton plants, however, there were usually more females than males, and this was the case at the very times when the lamp experiments were being made.

We are, unfortunately, not familiar with the method of hibernation, and unless this, when ascertained, should afford some ready means of destroying the insect, the best remedy will consist in the application of

dilute kerosene emulsion. The tarred-shield method in use against the leaf-hoppers of the family Jassidæ, and particularly the Typhlocibins of *Erythroneura* and allied genera, will not avail here, since, as already indicated, the insects do not fly out from the plant when disturbed, as does the Grape Leaf-hopper, for instance, but simply hide behind the stalk or twig upon which they have been feeding.

Where "sharp-shooter" work is prevalent in a cotton field it will probably pay to make a single application of the emulsion to the young poplar growth along the borders of the field about the second week in May. Many individuals will thus be killed which would otherwise migrate to the cotton plants and lay their eggs for a new generation. It will also pay the cotton-grower to cut down a large part of the young poplar growth along the streams and bayous, so as to concentrate the insects as much as possible. It is important to note in this connection that the insect is absent, or very rare, in cotton fields which are not contiguous to poplars. The insect will always be difficult to fight on account of its numerous food-plants, but a restricted garden crop like asparagus, of sufficient value to warrant the expense, can be protected by an occasional thorough spraying.

The discharge of drops of liquid by the pupa and adult is a most interesting habit and is common to a large number of leaf-hoppers of the family Cercopidæ, varying, however, in degree. *Proconia undata* and the species under consideration seem to have been most frequently noticed, both on account of their more copious discharge and on account of the abundance of the insects. The liquid is thrown out from the anus in several small drops, frequently in an almost continuous spray. The discharge is most copious when the insect is disturbed, and there seems to be an effort to throw it in the direction of the intruder, so that it probably acts as a defense against natural enemies. No scientific observations have been made upon this secretion. It is too abundant to be secreted by specialized glands, and it is doubtless simply the excremental fluid of the insect. It is rather whitish when it dries upon leaves below the insect, and is slightly saccharine, although it does not seem to have as great an attraction to bees, wasps, and ants, and other honey-lovers, as does the secretion of plant-lice and certain of the larger scale-insects.

In INSECT LIFE (vol. I, pp. 52-54) we have published in full the correspondence with Mr. Bielby referred to above. Mr. Bielby's observations have been very careful and he gives an interesting account of the habits of the adults with some details regarding the liquid secretion. In volume II (pp. 160-161) we noticed a newspaper article regarding weeping trees, the remarkable phenomenon proving to be caused by the abundance of *Proconia undata*, while in volume III (p. 415) we published an interesting account of another weeping tree from a Mississippi correspondent, Mr. R. J. McGuire.

THE OSAGE ORANGE PYRALID.

(*Loxostege macluræ*, n. sp., Riley.)

By MARY E. MURTFELDT, Kirkwood, Mo.

To begin with a premise which no one æsthetically cultured will controvert, no fence of any sort, be it massive wall or delicate tracery of iron work, can compare in beauty and in harmony with the general features of a landscape with a well-kept hedge; and the Osage Orange is preëminently the hedge plant of the United States. True, it does not thrive in very northern latitudes, but in all other sections, from southern Texas to northern Iowa, it adapts itself readily to all varieties of soil and surface, and, with far less care and in a shorter time than any other shrub, it forms a beautiful, luxuriant, and impenetrable barrier.

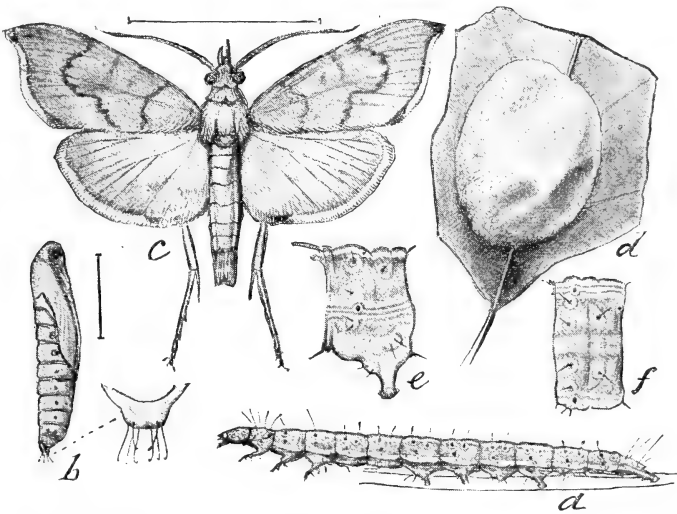

FIG. 11.—*Loxostege macluræ*: a larva; b, pupa; c, adult; d, cocoon—enlarged; e, side view of abdominal segment of larva; f, dorsal view of same—still more enlarged (original).

Hitherto one of its especial merits has been its comparative immunity from insect attacks. Occasionally it suffers, in common with soft maples, grape-vines, elms, and some other trees and shrubs, from the Coccid, *Pulvinaria innumerabilis*, while it is annually preyed upon, to some extent, by various Orthoptera, among which the Margined Cricket (*Nemobius marginata*) is at times conspicuously destructive. The pretty little leaf-hoppers, *Flata conica* and *Pæcilloptera pruinosa*, especially the former, may be seen in summer ranged in close ranks along the tender shoots, which are weakened and distorted by the innumerable punctures. The Tortricids, *Teras pastiana*, *Cacæcia rosaceana*, and *Lophoderus triferana* web and curl a few of the leaves and a handsome Cerambycid, *Dorcaschema wildii* bores the older wood, sometimes to the extent of killing an entire plant, but, until two years ago, it has never, to my knowledge,

had an insect foe peculiar to itself. In the late summer of 1890 the hedges in and around Kirkwood and throughout St. Louis County gave evidence of some unusual insect work. The leaves were somewhat webbed and eaten into holes so numerous and close together that they had the appearance of very open-meshed lace. Of many only the midrib and larger veins remained. Repeated examinations failed to reveal any insect in numbers at all corresponding to the amount of damage, and for that year the depredator escaped recognition.

Last September, however, the mystery was solved by the discovery, on the under side of a leaf, of several slender, watery-green larvæ of Pyralid affinities, extended close to and along the veins. Having once obtained a clue to their appearance and habits they were found to be very numerous and of all sizes, from those only one-eighth inch in length and no thicker than a thread, to those three-fourths of an inch long by one-tenth in diameter. The colors are remarkably imitative. Up to the third molt they are of a whitish translucent green and it is almost impossible to distinguish them stretched out along the veins of the under surface. After the last larval molt they assume the pale grayish indistinctly mottled color of the bark of the mature wood of the plant. These colors, in connection with their habit of feeding only at night and of retiring during the day to the interior of the hedge, where the young rest in security on the under sides of the leaves, while those more nearly mature stretch themselves along the stems, render them among the most illusive of larvæ, and after I had reared them in the breeding cage as well as carefully noted their traits in the open air, I was not surprised that they had for so long successfully evaded detection in spite of the evidences of their presence in the ragged and sickly appearing foliage.

There are two distinct broods annually, but the moths issue irregularly, live for a considerable time, and the larvæ grow rather slowly, so that the latter may be found in greater or less numbers from the middle of May until the latter part of October.

The moths begin to emerge in the spring about the first of May, and shortly after begin ovipositing.

The eggs are laid in little masses of from 25 to 30 on the under surfaces of the leaves. They are oval, flattened, .5^{mm} in length, pale green, shading to a whitish margin, and overlap like the scales of a fish, but not so regularly. They are attached and protected by a varnish-like fluid extruded with them, which hardens upon exposure to the air. The larvæ hatch, simultaneously, in seven or eight days, and remain in company for a short time, gnawing the parenchyma in small spots from the under surface of the leaf on which they are hatched. They are at first about 2^{mm} in length, very slender, and of a pale translucent green color. They spin a slight web, and if the plant is shaken let themselves down by an invisible thread. After the first molt they separate, seldom more than two or three of a size being afterwards found upon the same leaf.

They retain the glassy whitish green color, occasionally varied with a tinge of pink, until the fourth age, after which they are seldom found upon the leaves in the daytime, as their more opaque and darker colors would render them conspicuous to their enemies.

Maturity is reached in from twenty to twenty-five days unless the food supply has been irregular, in which case they grow for an entire month or more. They spin considerable web to guide themselves back and forth or to suspend themselves if the foliage be shaken. This silk though very fine is remarkable for its strength. The full grown larva is 25^{mm} in length and between 3 and 4^{mm} in diameter, according as it is extended in crawling or somewhat contracted in repose. The form is slightly depressed and tapers toward either end. In some specimens it is of a pinkish or brownish gray, very indistinctly striped even on the sides. In others it becomes of an opaque olive green, with an irregular, ivory white stigmatal band, and finer interrupted dorsal and lateral stripes of the same color. The minute piliferous spots are black, surrounded with a whitish ring, hairs black. Head distinctly bilobed, pale brown with transverse bands of a slightly darker shade. The legs and prolegs are rather long and the latter are surrounded with a few stout bristles. The cocoon is formed upon the ground among the fallen leaves. It is of irregular shape, rather flat, and of very tough silk of a dingy brown color. The pupa is slender, elongate and smooth, of a bright, pale golden brown color. The imago appears in about two weeks in midsummer, the second brood hibernating in the pupa state.

Dr. Riley thinks the species undescribed, and if it should prove to be so will appropriately locate and characterize it.

The larvæ may be kept in check by careful spraying with any of the arsenical insecticides. I have not as yet experimented with any others.

EDITORIAL NOTE.—The above paper by Miss Murtfeldt was read before the Entomological Club of the A. A. A. S., and is published by request in *INSECT LIFE*. We have had for some time in our collection specimens of this interesting Pyralid obtained in 1879 at Columbus, Tex., when, during our sojourn there with Mr. E. A. Schwarz, the larvæ were found quite abundant on the Osage Orange, in one particular case defoliating the tree. The first imago issued July 19 of that year. We supplement Miss Murtfeldt's article by a brief characterization of the moth, which is an undescribed species, and which Prof. C. H. Fernald, to whom we submitted specimens, would place in the genus *Loxostege* Hübner. This genus, according to Hübner's characterization, is distinguished chiefly by the falcate form of the front wings. In general coloration and markings, and in the form of the wings, the species reminds one of a diminutive specimen of the common Cotton Worm Moth (*Aletia xyliana*). The genus *Loxostege* is not recognized by Heinemann, but as the genera *Eurycreon* and *Botys*, to which the types of *Loxostege* have been referred, contain a large number of species, Prof. Fernald, who is monographing the family, doubt-

less finds good grounds for retaining Hübner's term. The figure of the cocoon which we have had prepared to illustrate this article represents a somewhat abnormal form. As a rule the cocoon is more or less hidden within the folds of the leaf. The insect is a southwestern form, and its sudden occurrence near St. Louis would indicate that it is spreading northward.—C. V. R.

Loxostege maclura n. sp.—Average expanse, 23^{mm}. General color above, lustrous, pale-gray, argillaceous, with a more or less decided olivaceous tint, according to the specimen, the legs, venter, hair on thorax beneath, basal joint of palpi, borders of occipital tuft, and sometimes the basal joint of antennæ and base of tongue above, white. Eyes large, naked, varying from olive-green to dark-brown; occiput, narrow between the eyes, with a dense and evenly shorn tuft approaching in form a parallelogram; palpi, densely clothed, the terminal joint porrect; tongue, with the basal portion, clothed. Primaries with the dusky transverse lines as follows: Basal line across basal one-fourth of wing beginning at the sub-costal vein, angulate basally to the median vein, then posteriorly to vein 1, and then almost straight across the wing to the inner border. Median line across the middle of the wing, also beginning, in a more or less distinct spot, at the sub-costal vein, and running irregularly with two more decided curves outward between the bases of vein 4 and vein 2, and with two curves inward from about vein 1 to the inner border. The posterior stripe starts at the costa, where it is most distinct, about the posterior fourth of the wing, and runs in a series of scallops nearly directly across the wing to vein 4, and then joins the median line about its middle. Costa somewhat darker than the general surface, the coloring intensifying to the falcate apex, which is more or less intensely black. Fringes white, with a black coincident inner border. Secondaries scarcely paler than the primaries, and with a faint lunulate dark line across outer third; this line obsolete in some specimens; fringes white or but very slightly darker, with coincident inner shade. Under surface more silvery than the upper surface, the primaries having but a faint discal spot and lunule and the merest trace of the posterior dark line; the costa and the terminal space are, however, generally paler than the rest of the wing: Secondaries with transverse line more distinct than on upper surface. Described from 10 specimens, reared from Texas and Missouri.

There is considerable variation in the dusky lines, which are (in two specimens) very distinct and continuous (especially the posterior one), but ordinarily they are more intense on the veins and subobsolete between them. In the ♂ the undersurfaces are more distinctly silvery than in the female, while in this last the dusky line on secondaries is most distinctly shown. The fringes sometimes show a double coincident dark shade and sometimes a distinct paler coincident inner line.

THE FOOD PLANTS OF SOME JAMAICAN COCCIDÆ.

By T. D. A. COCKERELL, *Kingston, Jamaica.*

During the last few months I have been systematically examining various cultivated plants in order to ascertain what species of Coccidæ, if any, infested them. The result shows that in Kingston many species, especially trees and shrubs, suffer from the attacks of scale-insects, and also that the same scales not unfrequently occur on many different hosts. It is not supposed, of course, that the food plants here given are always or often the natural hosts of the various Coccidæ now found

on them, but for several reasons it is interesting to learn what takes place under cultivation as well as in a state of nature. From an economic point of view, especially, facts of this kind may be of importance, because it may well happen that a destructive scale is brought into a country on a plant of small value, whence spreading, it attacks other species which form the staple crops on which the welfare of the population depends.

Much of the material examined was collected by my assistant, Mr. F. Da Costa; in every case, when I did not obtain the material myself, the name of the collector is given.

(1) *Achras sapota* L. (Sapotaceæ).—In June Mrs. Swainson told me she had found *Vinsonia stellifera* Westw. on this species in Kingston; later, Dr. Plaxton sent some leaves, with many *V. stellifera* on their under sides.

(2) *Anacardium occidentale* L. (Terebinthaceæ).—A leaf picked in Kingston (Mrs. Swainson) in June had on its upper side a few *Aspidiotus articulatus*, Morg.; there were also on the leaf a few *Aspidiotus personatus*, Comst., a very young *Ceroplastes* (gray, with white center and fourteen white rays) and a very young pale greenish *Lecanium*.

(3) *Artocarpus incisa* L. f. (Urticaceæ).—On June 9 I found leaves of Bread fruit in Manchester Square, Kingston, with many *Aspid. articulatus* and *A. ficus* Riley on them; on one leaf the two species were crowded together in one or two places, leaving the rest of the leaf almost free. I found also some *A. personatus*.

(4) *Areca catechu* L. (Palmeæ).—A young plant growing in a pot at Cavaliers, Pen., September, 1892, had on the upper side of its leaves many *Aspidiotus ficus* and several *A. aurantii* Mask.; also a few *Lecanium hemisphaericum* Targ. The presence of *A. aurantii* and the absence of *A. articulatus* is noteworthy. Mr. Coquillett has also found the Red Scale on palms (Bull. No. 26, Div. Ent., p. 15), and as these are often taken from one country to another in pots, the possibility of so increasing the range of *A. aurantii* should be considered.

(5) *Anthurium lanceolatum* Kth. (Aroidæ).—In Dr. Strachan's garden, in Kingston, I find the leaves infested with *Ceroplastes floridensis* Comst., *Parlatoria*, and *Lecanium*. The *Lecanium* is a dull greenish flat species like *hesperidum*, with (at least in juv.) the sides of the posterior cleft contiguous and the margin with short simple hairs; anal plates yellowish with brown tips; eyes black, very distinct, placed close to margin.

(6) *Brunfelsia americana*, Sw. (Solanaceæ).—Leaves gathered in the Parade Garden, Kingston, June, 1892 (Da Costa), had on their upper sides several *Aspidiotus articulatus*, and one juvenile *Ceroplastes*, apparently *floridensis*.

(7) *Cassia fistula*, L. (Leguminosæ).—Leaves from the Parade Garden, June (Da Costa), had on their uppersides plenty of *Aspidiotus articulatus*, also a few *A. personatus*, which seemed not to be thriving.

(8.) *Chrysophyllum cainito*, L. (Sapotaceæ).—In Manchester Square, Kingston, I found *Aspid. articulatus* on the upper sides of the leaves; afterwards (June 14), in Duke street, I found *A. articulatus*, *A. personatus*, and *Pulvinaria cupaniae*, Ckll. MS.*; also, a few specimens of a small *Diaspis* or *Chionaspis*, which I did not study.

*Details of this species will be published later. It is very common on Akee (*Cupania edulis*, Camb.), in Kingston. The ♂, before they produce their egg sacs, are green, active, and resemble in shape the flat species of *Lecanium*. Length of ♂ with egg-sac about 5 mill. Antennæ 8-jointed; third much longest; fourth as long or a little longer than second; fifth a little shorter than fourth; sixth, seventh, eighth, subequal, eighth shortest of all, a little elongate; second, fifth, and sixth joints each with a long hair. Tibia about twice length of tarsus.

(9) *Chrysanthemum* (Compositæ).—In Dr. Strachan's garden in Kingston I found the ordinary cultivated species very badly infested by *Lecanium hemisphæricum*, and less severely by *Orthesia insignis*, Dougl.

(10) *Ficus* (Urticacæ).—On a large *Ficus* tree in the yard of the Museum, *Ceroplastes floridensis* is common, with *Aspid. articulatus*, *A. ficus*, and *A. personatus*. *A. ficus* is on the under side of the leaves, but the other two species of the genus mainly on the upper.

(11) *Grewia rothii* (Tiliacæ).—Leaves from the Parade Garden in June (Da Costa) had a few young *Ceroplastes floridensis* on their upper sides.

(12) *Ixora coccinea* (Rubiaceæ).—Leaves from the Parade Garden in June (Da Costa) had on their upper sides some very young *Ceroplastes*, apparently *floridensis*. *Ixora* sp. in Dr. Strachan's garden was badly attacked by *Lecanium hemisphæricum*.

(13) *Iambosa malaccensis* (L.) D. C. (Myrtacæ).—In June Mrs. Swainson brought me leaves picked in Kingston, on the under sides of which were several *Vinsonia stellifera*, and some *Lecanium mangifera*, green.

(14) *Musa* (Musacæ).—In August I found several *Aspid. articulatus* on a leaf in the garden of the Museum. A young banana in the Museum yard, recently planted, soon had on it an adult, or nearly adult, scale of *Ceroplastes floridensis*. It was doubtless blown as a larva from an overhanging *Ficus*. In September the same tree had on it also *A. articulatus*, *A. personatus*, and *A. ficus*, but the two latter species seemed not to thrive.

(15) *Meyenia alba* (Acanthacæ).—A specimen from the Parade Garden, June (Da Costa), had on it a few *Lecanium oleæ* Bern.

(16) *Murraya* (Aurantiacæ).—In June Mr. C. B. Taylor brought me a twig of this shrub, obtained in Kingston, with *Aspid. articulatus* and *Mytilaspis citricola* (Pack.). Comstock remarks (1883, Report, p. 117) that *M. citricola* is only found on *Citrus* trees, and now that an exception to this statement is found it is interesting to note that the plant is of the same natural order.

(17) *Mangifera indica*, L. (Terebinthacæ).—(a) In June Mrs. Swainson brought me leaves of Mango picked in Kingston, on which were several *Vinsonia stellifera*, some *Aspidiotus personatus*, and two small scales of *A. articulatus*.

(b) In June I found in Manchester Square, Kingston, leaves of Mango on which were *Lecanium oleæ*, *L. mangifera*, *Ceroplastes* (apparently *floridensis*), *Vinsonia*, *Aspidiotus personatus*, and *Aspidiotus* n. sp.

(c) In June Miss Helen Kilburn sent me two green mangoes, from Kingston, much infested by *Dactylopius longifilis*, Comst. (♀'s and young); there were also two specimens of a flat *Aspidiotus*, each making a pale patch on the fruit.

(18) *Merium oleander* (Apocynacæ).—Leaves of oleander received from Mr. Rouse in June had on them *Aspid. ficus*, *A. articulatus*, and *A. personatus*.

(19) *Olea hispanica* (Oleacæ).—On leaves from the Parade Garden, June (Da Costa), were very many *Aspid. personatus* and a few *A. articulatus*.

(20) *Persea persea* (L.) = *gratissima*, G. (Laurineæ).—In June Mrs. Swainson brought me a leaf picked in Kingston on which were many *Aspid. personatus*, and one or two *A. articulatus*.

(21) *Punica granatum* L. (Lythracæ).—A plant in garden of Museum has *Aleurodes* sp. on the under sides of the leaves and above is infested by *Aspidiotus personatus*, *A. articulatus*, and *A. sp.* (scale white, circular or nearly so, exuviae covered, orange brown, first skin nipple-like and shiny; ♀ plump, rounded, orange). There are also a few examples of a small *Chionaspis*, probably *C. minor* Mask.

(22) *Portlandia grandiflora*, L. (Rubiaceæ).—Leaves from the Parade Garden, in June (Da Costa), had on their upper sides specimens of *Aspidiotus articulatus*.

(23) *Vitis vinifera*, L. (Ampelideæ).—In September my wife found a specimen of *Lecanium oleæ* on a black grape.

THE MAXILLARY TENTACLES OF PRONUBA.*

By JOHN B. SMITH, Sc. D., *New Brunswick, N. J.*

In his excellent studies on the genus *Pronuba* Dr. C. V. Riley has called special attention to the peculiarities of the mouth structure, and particularly to the development of a so-called "maxillary tentacle." The figures given of this structure in the various species are so excellent that they at once aroused a suspicion in my mind that, while they were really special developments in one sense of the term, so far as we now know unique in Lepidoptera, yet that there were similar or homologous structures elsewhere, in other orders; that is to say, there is really no new organ or process, only a mere adaptation or development of a known maxillary sclerite, which is paralleled by more or less similar developments or adaptations of the same sclerite in other groups. To the courtesy of Dr. Riley I owe a supply of alcoholic specimens of *Pronuba yuccasella* for examination, and from a careful study of these I have concluded that the so-called "tentacle" is really an extension of the palpifer or palpus bearer. Of all the Lepidoptera known to me, *Pronuba* has the maxillary sclerites best developed. Dr. Riley has called attention to the fact that the two halves of the spiral tongue are not united, as is usual in the higher Lepidoptera, to form a tube, and I find that when the two maxillæ are dissected off the structure bears a remarkable resemblance to that found in the Coleopterous genus *Nemognatha*, and while the lacinia is wanting, some of the other sclerites are even better marked. A comparison of the figures of *Nemognatha* and *Pronuba* male will at once emphasize this similarity.

In the male *Pronuba* the "maxillary tentacle" is not developed; but if we examine the large sclerite at the base of the palpus, which is a palpifer without doubt, we see, evidently, the structure whose specialization forms the "tentacle." This special development of the palpifer is not unique in *Pronuba*, but is of common occurrence in the piercing Diptera, *Erax* offering an excellent example. In a paper published by me in the *Trans. Am. Ent. Soc.*, xvii, 1890, I showed the modifications of this structure in the Diptera; but I was unable at that time to decide whether I had to do with a palpifer or with a stipes, because specialization and division of parts was carried to such an extent that the connection between the original sclerites was obscured. In the Hemiptera as well, the same sclerite is developed into a piercing organ, although the maxillary palpi themselves are rudimentary.

It may be objected that these structures of the Diptera and Hemiptera are rigid, chitinous processes, without tactile functions, while in *Pronuba* the process is flexible and set with numerous tactile or specialized spinules. This kind of change, however, is not unusual in insects, and precisely the same difference appears between the rigid chitinous ligula

*Read before Section F of the A. A. A. S., at the Rochester meeting, August 18, 1892.

of the piercing flies and the flexible, sensitive ligula of the bees. In the structure of the galea, yet more marked changes occur, the difference between the palpiform organs in some Coleoptera, the united rigid beak-like form in the Hemiptera, the flexible coil-like structure in the Lepidoptera, and the peculiar tongue-like organ in some Diptera being vastly greater than anything seen in the palpifer. In the Panorpidae of the order Neuroptera we have, however, a development of the palpifer, which is not rigid, but is membranous, though not flexible, and which is set with hair which, in part at least, is tactile in function.

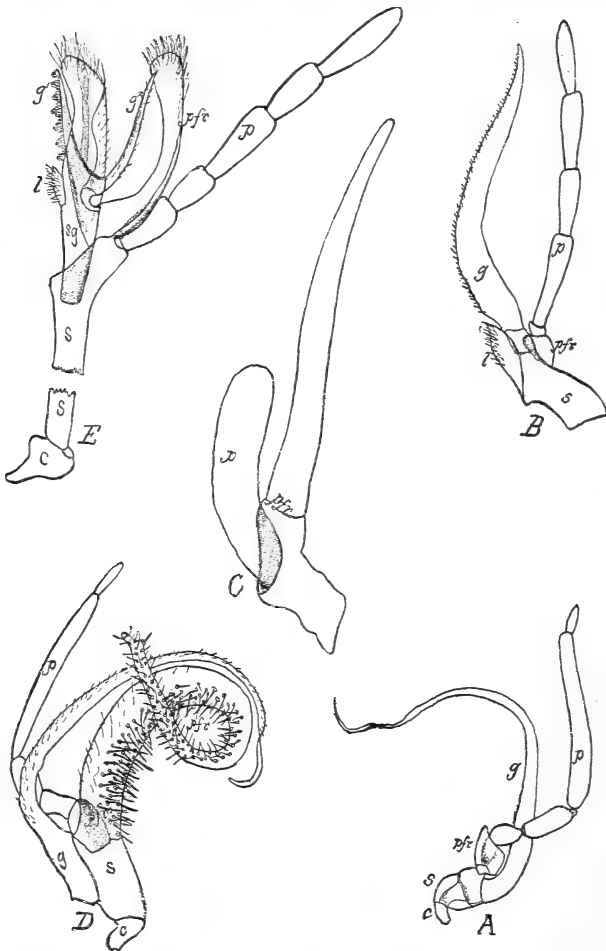

FIG. 12.—A, Maxilla of *Pronuba* ♂ c, cardo; s, stipes; pfr, palpifer; p, palpus; g, galea. B, Maxilla of *Nemognatha*, s, stipes; pfr, palpifer; p, palpus; g, galea; l, lacinia. C, p, palpus; pfr, palpifer of *Erax*. D, Maxilla of *Pronuba* ♀ c, cardo; s, stipes; pfr, palpifer; p, palpus; g, galea. E, Maxilla of *Bittacus*, c, cardo; s, stipes; pfr, palpifer; p, palpus; g¹, galea, first joint; g², galea, second joint; sg, sub-galea; l, lacinia. (From drawings by John B. Smith.)

In this same family of Panorpidae we have, by the by, a most remarkable example of the elongation of the mouth parts. The lacinia is small, yet obvious; the subgalea is elongated from each side, forming

lobes; each joint of the galea is elongated between these lobes and, finally, the palpifer is a flattened, elongated, partly membranous process, from the base of which the palpus arises. The figure of the *Bittacus* maxilla shows only incompletely the really remarkable structure of this family. My studies on it are yet too incomplete to make generalization safe, but I believe that they will afford a most valuable clew to the line in which certain mouth structures have developed.

The conclusion after an examination of these structures is irresistible; the flexible process in *Pronuba* is an extension of the palpifer, homologous with the rigid piercing structure in the Hemiptera and piercing Diptera, and with the more membranous structure in the Panorpidae. It is a special development only in the sense that it is adapted for a special duty, and in the same sense that the ligula in *Tabanus* and in *Apis* are each special developments for the advantage of these insects.

THE POTATO-TUBER MOTH.

(*Lita solanella* Boisd.)

By R. ALLAN WIGHT, *Paeroa*, N. Z.

Mr. Koebele in his "Report of a Trip to Australia, to investigate the Natural Enemies of the Fluted Scale" (p. 25) writes: "The small Tineid, so destructive to potatoes in California, and no doubt already distributed over the most of the Western States, has been known in New Zealand for years, and it is doing the same mischief all over Australia, where it originated. In conversation with a merchant from Denver, Colo., recently, he said that a year ago he received three cart loads of California potatoes infested with these worms to such a degree that they could not be sold." As far as the New Zealand pest of the potato goes, it may very probably be native to Australia, where it has been known to exist for a great many years, but there can be no doubt that it is also native in New Zealand. There is in New Zealand a plant which grows in very watery swamps and gullies where water habitually lies. This plant is a species of flag, resembling what is called the "Coofers Flag." It grows to a height of some eight or nine feet, and always on the richest soil. The natives call it "Raufo" and use it extensively for lining their houses, and a great variety of other purposes. Its botanical name is *Typha angustifolia*, and it has a head very like that of the bulrush, only larger, being about eight inches long. This head, when ripe, bursts out into a fine downy material, and makes a bed as good as feathers, and even softer. The early settlers were very fond of gathering this substance to make their beds of, but there was one drawback in its being infested with disgusting maggots, and the down had to be baked in order to get rid of them. It is now nearly

forty years ago that the writer's attention was requested to these maggots, and they proved to be the larvæ of the small Tineid moth, *Lita solanella*. The natives have a knowledge of these larvæ being in the Raufo ever since they remember. It was not until about 1862 that these moths were heard of attacking the potato. About that time their ravages became so serious as very materially to affect the value of the crop and cause great loss to the farmers, and also to the natives. The general impression has always been that the abnormal habit was taught by the Europeans using the *angustifolia* as thatch for their potato houses. There is another and equally probable cause, that in older times the natives lived more on dry ground, on hills, and scoria land, and grew their crops there, but of later years both natives and Europeans have grown potatoes on land intersected by wet gullies, where the plant abounds. Be this as it may, there seems but little doubt that the insect is a native of New Zealand. The moth attacks the potato by laying its eggs on the stem, near the bottom. This is done just as they have died down and are ripe enough to harvest. The larvæ on being hatched enter the ground and attack the tubers, the outer portions of which they run burrows in, so that they become unfit for any purpose. Any potatoes left exposed in the field are attacked, and the attack goes on during the harvest and after the potatoes are housed. The native cure is to place live shellfish on the top of their potatoes in the houses, and they say that the unpleasant odor drives away the moth, but the truth is more likely that it hides the true nature of the contents of the house from the insect. The cure which the writer has advised, and which has always been attended with a good deal of success, is to harrow the potato stalks up in heaps and burn them before digging the roots, having previously planted full depth and molded very well up. This does not bring the tubers to the surface, and it facilitates the harvest, but care should be taken to keep the harrows just clear of the digging, and to keep the potatoes well and constantly covered during the harvest, and when they are carted to remove them to a place distant from the field, and also from the *Angustifolia*. As soon as the stalks die down the crop should be well rolled. Probably the use of Paris green might be attended with benefit, as the larvæ are in no hurry to reach the tubers. This is the only case in which the sparrow is of real benefit. It catches so many of these moths as to make a most material difference in their numbers, and in some instances the pest has been cleared, seemingly, altogether. The sparrow, however, gets more credit than he deserves. The great reduction—in fact, in some districts the disappearance—of the Army Caterpillars that used to destroy grain crops is owing to a wonderful increase of two species of well-known Ichneumonid flies that prey upon the larvæ of Noctuid moths, and not to the exertions of the sparrow.

FOOD-PLANTS OF NORTH AMERICAN SPECIES OF BRUCHUS.

FROM OUR OWN RECORDS.

Bruchus pisi Linn.—Frequently bred from peas.

Bruchus rufimanus Boh.—Bred from pea pods imported from Switzerland (Dr. G. H. Horn, Trans. Amer. Ent. Soc., vol. IV No. 1873, p. 313). Also bred from peas distributed by the U. S. Department of Agriculture in 1890.

Bruchus chinensis Linn.—(=*scutellaris*, Fabr., Gyll.).—Bred from beans at the New Orleans Exposition, July, 1885; also found infesting Chinese beans in the Seed Division of the U. S. Department of Agriculture.

Bruchus quadrimaculatus Fabr.—Infesting “Black-eyed table beans” from Texas at the Atlanta Cotton Exhibition; also bred from cow peas (*Dolichos* sp.) from Texas.

Bruchus discoideus Say.—Infests seeds of *Ipomea* (Riley, Third Missouri Report, 1871, p. 45).

Bruchus ulkei Horn.—The single specimen in our collection is without locality label, but bears this inscription: “Feeds on broad-podded Palo berde, Chelly.” Palo berde is the popular name for Parkinsonia.

Bruchus bivulneratus Horn.—Bred from seeds of *Cassia marilandica* at St. Louis, Mo., January, Riley’s notes, 1876.

Bruchus cruentatus Horn.—A specimen from the Riley collection is labeled, “In fruit of Parkinsonia, Arizona. Collected by Dr. Pringle. Sent by L. H. Hosford, Charlotte, Vt.”

Bruchus pruininus Horn.—A specimen from the Riley collection is labeled, “In seeds of *Olneya tosata*, Arizona. A. S. Fuller, 1874.” The name of the plant is misspelled on the label.

Bruchus prosopis Lec.—Bred from pods of *Prosopis juliflora*, Death Valley and Panamint Valley, Cal., April, 1889.

Bruchus protractus Horn.—Obtained with the preceding from the same plants and the same localities.

Bruchus n. sp.—Bred from pods of *Prosopis pubescens*, at San Diego, Cal., April 11, 1889.

Bruchus alboscute'llatus Horn.—Bred from seeds of *Ludwigia alternifolia*, at Washington, D. C.

Bruchus obtectus Say.—Frequently bred from cultivated beans.

Bruchus fraterculus Horn.—Infests the seeds of *Hedysarum boreale*, at American Fork, Utah. (Schwarz.)

Bruchus amicus Horn.—Lives in the seed of *Parkinsonia torreyana* and *P. microphylla*, in Arizona; specimens sent by L. H. Hosford, Charlotte, Vt., January 9, 1882.

Bruchus hibisci Ol.—Bred from seed of *Hibiscus moscheutos*, at Bluffton, S. C., and Washington, D. C.; also from seed of *H.* sp. (*militaris*?), at St. Louis, Mo.

Bruchus schrankiæ Horn.—One specimen, bred by us at St. Louis, Mo.,

from seeds of *Schrankia uncinata* (Dr. G. H. Horn—Trans. Amer. Ent. Soc., vol. IV, 1873, p. 340).

Bruchus exiguus Horn.—Specimens from the Riley collection bred from seeds of *Amorpha fruticosa* by A. H. Mundt, Fairbury, Ill.; also bred from the same plant at Washington, D. C.

Bruchus sp.—Larva in seeds of *Phaseolus pauciflorus*, at St. Louis, Mo., in September. The imago was not reared.

Bruchus sp.—In seeds of Loco Weed, at Fort Collins, Colo. The larva only has been observed.

Bruchus sp.—The eggs of what is evidently a *Bruchus* occur on the pods of *Acacia filicina* in the collection from southern Arizona.

RECORDED ELSEWHERE.

Bruchus discoideus Say.—“In seeds of *Ipomœa leptophylla*.”—F. H. Snow (Trans. Kans. Ac. Sc., vol. V, 1877, p. 18).

Bruchus aureolus Horn (smaller form).—“Occurs in Owen’s Valley (Cal.) on the flowers of *Astragalus*.”—Dr. G. H. Horn (Trans. Amer. Ent. Soc., vol. IV, 1873, p. 340).

Bruchus pruininus Horn.—“This species is found on the ironwood tree of Arizona.”—Dr. G. H. Horn (loc. cit., p. 528).—This plant is, in all probability, *Olneya tesota*.

Bruchus desertorum Lec.—“Found in the same plants with *B. uniformis* and *prosopis*.”—Dr. J. L. Leconte (Proc. Ac. Nat. Sc. Phil., vol. X, 1858, p. 78).—Occurs in the seed of the Screw Bean, *Strombocarpus pubescens*, in Arizona.”—Dr. G. H. Horn (Trans. Amer. Ent. Soc., vol. IV, 1873, p. 329).

Bruchus uniformis Lec.—“Abundant in the pods of *Prosopis* and *Strombocarpus*, Colorado Desert.”—Dr. J. L. Leconte (Proc. Ac. Nat. Sc. Phil., vol. X, 1858, p. 77).

Bruchus prosopis Lec.—“Found with *B. uniformis*.”—Dr. J. L. Leconte (loc. cit., p. 78).

NOTE.—Of the remaining North American Bruchidæ, *Caryoborus arthriticus* breeds in the fruit of palmetto trees (genus *Sabal*) and *Spermophagus robinie* is well known to infest the seeds of *Gleditschia triacanthos*.

The food-plants of a few Mexican species of *Bruchus* may also be recorded here. The species were all found at the Department of Agriculture in seeds collected by Dr. Edward Palmer in northern Mexico.

Bruchus longicollis Fahr., in seeds of *Canavalbia* n. sp.

Bruchus compactus Sharp, ? in seeds of *Ipomœa* sp.

Bruchus lucosomus Sharp., in seeds of *Ipomœa* sp.

Bruchus desertorum Lec, in seeds of plant 1108 (Palmer).

Bruchus (No. 4324) in seeds of plant 305 (Palmer).

THE STRAWBERRY WEEVIL.

(*Anthonomus signatus* Say.)

By F. H. CHITTENDEN.

In the Annual Report of the Entomologist for 1885 (pp. 276–282) an account is given of this little strawberry pest which includes a summary of its past history, a report of the injuries and habits of the insect as observed that year on Staten Island, and a full description of the adult and its varieties. Illustrations were also furnished of the imago enlarged and of a group of the same feeding on the strawberry blossoms. These figures are reproduced herewith. (Figs. 13 and 15.)

Upon the appearance of this insect in the spring of 1892, near Washington, I was instructed by Dr. Riley to make a careful investigation of the life-history of the species and to prepare a complete account of the insect as a crop pest. This paper is the result of this investigation, in the course of which I have had access to Dr. Riley's notes and those of the Division, and have been assisted by Dr. Riley's advice.

PAST HISTORY.

This insect was first noticed as injurious to the Strawberry in 1871, and an account of its injuries at Silver Hill, Md., was published by Townend Glover, in the Monthly Report of this Department for November-December, 1871, and in the Annual Report of the same year. In 1873 it was found by Prof. Riley injuring strawberries in the vicinity of St. Louis, Mo. In 1883 Prof. A. J. Cook published a short account of its depredations in Phoenix, Mich., and in 1888 mentions it as injurious in Pontiac, Mich. In 1884 and 1885 it was injurious on Staten Island. During the year 1887 serious injuries were reported from Cowansville, Province of Quebec, Canada, mention being made of the fact by Mr. James Fletcher in his report as Entomologist and Botanist of the Experimental Farms of Canada for that year.

No subsequent mention of injuries so far as can be learned was made, and its life-history remained unknown until the publication of an article by Mr. Fletcher in his report for 1890 (pp. 173–175). In February of the previous year Mr. W. A. Hale wrote Mr. Fletcher, giving the first true account of the insect's breeding habits. He had for several years suffered from its ravages, and had succeeded in ascertaining that it attacked all staminate varieties, and that the egg is deposited in the unopened flower-buds in which the insect undergoes all its transformations. Mr. Hale also stated that the insect was noticed at Hamilton, Canada, in 1886.



FIG. 13.—*Anthonomus signatus*: Spray of strawberry, showing beetles at work—natural size (after Riley).

In June of 1891 specimens were received at the Department from Dr. George Dimmock of Canobie Lake, N. H., with the statement that they were proving quite destructive to the buds of blackberries, especially the Wachusett variety. (INSECT LIFE, vol. IV, p. 76.)

THIS YEAR'S INVESTIGATIONS.

During the past season the Division was notified that this insect was making its appearance in numbers in several localities about Washington, notably in Anne Arundel, Caroline, Baltimore, and Prince George's counties in Maryland, and in Fairfax and Alexandria counties, Virginia, and several large strawberry-growers were reported as suffering severe loss.

Mr. H. E. Van Deman, Chief of the Division of Pomology, made extensive trips early in the season through the fruit-growing regions of Maryland and Virginia, and reported that the strawberry crop in the districts visited was about two-thirds short. This shortage, though attributed to hail, of which there were two or three severe storms during the month of May, was probably due largely to the Strawberry Weevil. One such case of reported damage by hail actually proved on investigation to be due to the ravages of this species.

On account of the small size of the insect and its peculiar manner of working it often escapes notice and the fruit-grower, unless forewarned, seldom discovers his loss until berry-picking time approaches, and even then the author of the mischief is not suspected; hail, frost, and anything but the true reason being ascribed as cause for the crop's failure.

Injury to "Sharpless" and other full-flowered varieties has been very general in this region, probably over a much wider area both this year and in past seasons than will ever be known.

Several trips were made to infested localities in the immediate neighborhood, and although work was begun too late in the season for the investigation of certain points in the life-history of the insect that it is desirable to know, a number of new facts of interest were ascertained which will aid materially in our efforts to obtain a remedy or preventive against future attacks.

Injuries were not reported until considerable damage had been done and I was not able to begin investigations until May 17, when in company with Mr. A. B. Cordley, of this Division, I visited the farms of Messrs. Sprankle and Phillips, at Falls Church, Va.

The insects had not been discovered on Mr. Sprankle's place until the 1st of May and at the time of our first visit were rapidly disappearing. The work of this insect had been noticed the preceding year, 1891, but no perceptible damage had been done. Mr. Sprankle's field is about four acres in extent and composed of staminate berries, principally of the "Sharpless" and "Kentucky" varieties. It was estimated that at least 75 per cent of this crop was lost this year. These were all first season vines.

The neighboring patches of the Messrs. Phillips also showed considerable damage. A patch composed of "Crescents," a pistillate or imperfect-bearing variety, with occasional rows of "Sharpless" plants interspersed for fertilization, was damaged about 15 per cent. A second bed composed of staminate plants was about half destroyed, and a third bed of "Wilsons," a full-flowered or perfect variety like the "Sharpless," was damaged to nearly the same extent.

The insects were also found at work at Carlin Springs, two miles east of Falls Church.

Mr. G. W. Donaldson, of "Dixie Landing," Va., a few miles from Washington, reported injury to his berries, but when his place was visited, June 6, the beetles of both broods had practically disappeared from the strawberry beds as none were to be seen on the few plants still flowering at this time. His crop of "Sharpless" berries was nearly all destroyed, "Wilsons" damaged about one-third, while no injury was perceptible on "Mt. Vernon" and "Crescent" varieties. The strawberries on the adjoining farm of W. C. Donaldson, had been similarly attacked. No damage had been noticed the previous year.

Since this paper was prepared for the press Mr. M. H. Beckwith has published a short article on this species in Bulletin XVIII of the Delaware Experiment Station, in which he reports injuries to strawberries in the vicinity of the towns of Dover, Hartley, Camden, Wyoming, Smyrna, and Clayton, Delaware. Specimens were kept under observation by him and the adults bred, but no new points in the insect's life-history were developed. Mr. Beckwith's statement that the beetles were found on young peach trees in September is significant, and I would not be surprised to learn that the insect breeds in the buds of peaches and other Rosaceæ, whose blossoms furnish the requisite conditions for its development. Mr. Beckwith states that the reared beetles mated but no eggs were found, duplicating our own observations, with the exception that although the insects apparently paired, actual copulation did not take place in our breeding cages. As to his surmise that there are probably two and possibly three broods during the season the investigations this year indicate that the insect is normally single brooded. The occurrence of this species later than July has also been noted by Dr. John Hamilton (*Canadian Entomologist*, vol. XXIV, p. 41), who states that specimens may be found throughout the season. These late occurrences are probably quite rare and do not necessarily point to a second annual generation.

Other Cases of local Damage.—From information kindly communicated by Mr. Sprankle concerning local injuries it would seem that the ravages of this strawberry pest have been widespread through Alexandria and Fairfax counties. A few facts with regard to some of the many cases reported by him are here repeated.

Mr. E. C. Walker had noticed the insect and its work in his strawberry beds for four or five years past, but had not observed any injury

of moment until 1890, when he lost about a quarter of his crop. On the year following no serious damage was apparent, but in the present year his crop has been all but destroyed. Mr. W. A. Taylor, of the Division of Pomology, visited Mr. Walker's place June 1, and at my suggestion kindly made a careful investigation of the injured vines. He places 85 per cent as a conservative estimate on the injury to the "Sharpless" variety. In some "trusses" only a single berry to eleven dead buds were counted. The "Charles Downing" variety on these premises was damaged about 25 per cent and the "Crescent" about 15 per cent.

Mr. Alfred B. Clark reported severe injury to his "Sharpless" berries, and "Crescents" not materially damaged. Mr. Clark further stated that the "Wilson" strawberries of a neighbor of his were nearly as badly damaged as "Sharpless." He had noticed the work of this insect in former years and once or twice it had been as injurious as during the present season.

A Mr. Jacobs reported his "Sharpless" so badly cut that he had about decided to plow them up.

A family by the name of Kirby had suffered the usual amount of damage to "Sharpless" berries; "Kentucky" variety injured in less degree, and other varieties not much troubled.

A Mr. Crimmins stated that the weevil had "mowed" his "Sharpless" berries, but his "Crescents" had not been injured.

Mr. Barnum, an extensive grower of small fruits, near Lewinville, also complained that the weevil had taken the largest part of his "Sharpless" berries.

From Mr. L. S. Abbott I also obtained some facts regarding damage in Fairfax County. Mr. W. F. Birch reported his crop of "Sharpless" berries a failure, while "Manchester" and "Crescent" bore abundant crops. Mr. Frank Birch claimed to have lost his entire crop of "Sharpless." His vines bore absolutely nothing.

Mr. H. T. Curtiss, of Ridgely, Carolina County, Md., in correspondence with the Division of Pomology, stated that his berries were being destroyed by an insect called the Strawberry Curculio. These insects were particularly severe upon "Monmouth," "Pineapple," "Jessie," and "Gandy's Prize," all staminate or perfect-flowered varieties. He thinks the "Belmont" more free from attack than any other variety.

WORK OF THE INSECT.

Appearance of infested Fields.—The four-acre patch of Mr. Sprinkle presented a peculiar appearance when visited during the middle of May. Instead of a field blooming with strawberry blossoms only from one to three flowers, rarely more, and a similar number of ripening berries were to be seen on a single plant, but many new buds were developing unharmed on account of the disappearance of a great proportion of the insects. Of the injured buds at this time about half

were dried or drooping on the flower-stalks, while the other half had fallen, the severed stem showing where the insect had been at work. Two of these injured sprays are shown in the accompanying figure.

A similar appearance was presented in other badly damaged fields. Only in very rare cases was every bud on a plant killed.

How Damage is done.—The principal damage is done by the adult beetles puncturing the pedicel or flower-stem a short distance below the flower-buds. The order of proceeding has not been ascertained, but the egg is deposited in the fully-formed bud which is attacked usually just before blooming, and the stem is injured in such manner as to kill the plant above the point of attack, causing the bud to droop, turn brown, and die, afterwards in most cases to drop to the ground. The severed ends of the stems present the appearance of having been girdled. The

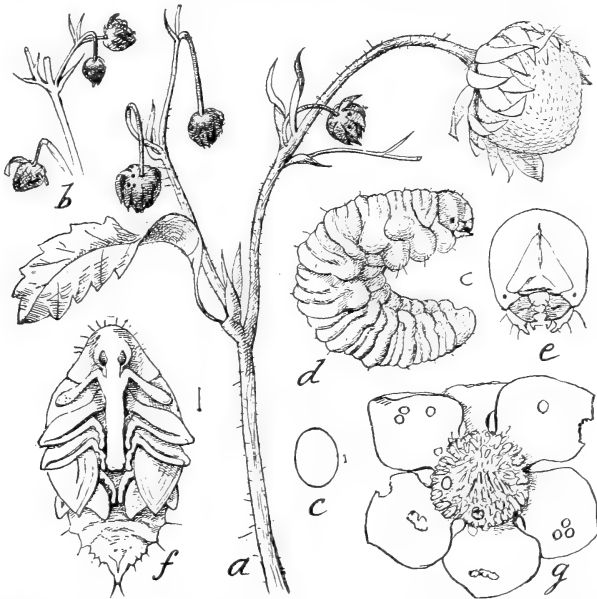

FIG. 14.—*Anthonomus signatus*: a, b, Strawberry spray, showing work in bud and stem—natural size; c, outline of egg; d, larva; e, head of larva—much enlarged; f, pupa; g, open bud, showing location of egg on left and punctures made by snout of beetle on petals. (Original.)

buds are not severed outright, as far as can be ascertained, but remain for a longer or shorter time on the vines before falling. Neither do they always contain larvæ, since some buds, particularly those that were gathered late in the season, and which had been attacked and killed, did not show when opened any evidence of having been perforated for any other purpose than for food.

The flower-stems are cut at varying distances from the bud. An eighth of an inch might be given as the average, but specimens are commonly found that are punctured at both longer and shorter distances from the bud, from a sixteenth or shorter, to one and three-quarters of an inch and even longer.

The object obtained by the puncture of the flower-stem is two-fold. First, the development of the bud is arrested, the outer envelopes of sepals and petals turn hard and dry, remain folded, and thus retain the pollen and the eggs or growing larvæ of the insect. If the flowers were permitted to develop, the pollen, which furnishes the principal food supply of the larvæ, would be lost and the larvæ would, therefore, in any event die of starvation if indeed they did not drop out when the flower opened or were not crowded out by the growing berry. Berries were seen that showed scars on one side as if development had been stopped at this point either by the punctures of the beetle or by the work of the larvæ which had hatched and failed to mature. It is not to be believed that a single minute puncture made in the bud, such as so small an insect is capable of making, could possibly kill the bud, but a slight injury is sufficient to kill the narrow and delicate stem above the point of attack. The second result obtained is that the bud in most instances drops off in a few days to the ground, where it is kept more or less moist. If allowed to remain on the stem in ordinarily dry weather the injured buds would eventually become so dry as to prevent the development of the insect within.

To test this matter a quantity of injured strawberry buds with their contained larvæ were kept in the Insectary under different conditions or degrees of moisture. A number of the insects failed to reach maturity in such buds as had become extremely dry. A second lot, gathered from the vines late in the season, and which had probably remained exposed to the sun for a considerable time, did not yield as many of the insects as those which were taken from the ground at the same time. A third lot was kept constantly moistened and became covered with mold, but the insects thrived still better under these conditions and not an instance was observed where they or their parasites died from exposure to this excessive moisture or mold.

It has been noticed that in cases where strawberry buds escape the destroyer and throw out blossoms they usually remain thereafter unharmed, but larvæ have been found in full-blown but deadened flowers the pedicels of which showed no signs of puncture, and beetles have matured in flowers that had been injured, but not in such degree as to prevent them from closing up and retaining the pollen.

Nearly all of the injured buds gathered early in the season and which bore external evidence of having been attacked at the customary time, *i. e.*, just before blossoming, contained larvæ, a single individual to the bud, and a large number were opened before more than one was found. In the few buds that harbored two larvæ, they occupied opposite sides and there was ample room and food for both.

Work on Blackberry.—A blackberry patch at Falls Church, of the variety known as "Early Harvest," was visited June 3, and although the bushes were covered with white blossoms betokening under normal conditions a rich crop of berries, it was soon seen that the insect had been at work, but not in the same uniform manner as on strawberry,

some plants being noticeably more injured than others. An estimate of the total damage done to the patch is about 20 per cent. Badly damaged sprays selected at random showed an average of five or six injured buds to each flower cluster. On one large spray over two-thirds had been killed.

From the examination of material collected at this date it was ascertained that the work of the Strawberry Weevil on Blackberry does not differ materially either in appearance or in ultimate injury from that on the Strawberry. Some differences, however, were noted. It will be remembered that nearly all injured strawberry buds taken from the fields May 17 contained larvæ or eggs. The punctures were in nearly every instance plainly seen both on the buds and on the stem beneath. The latter were in many cases nearly cut through. On the blackberry only a small proportion of the blighted buds showed the punctures plainly, and some, although cut at the stem, did not reveal any punctures whatever on the calyx, or on the corolla when the bud was opened. In other cases where no punctures were visible on the outer surface of the calyx an examination of the corolla within showed punctures in several places. Sometimes the wounded spot in the calyx had healed up or grown over so as to be nearly invisible, and in other cases the punctures had been made between the sepals or leaves of the calyx. Only eggs and freshly hatched larvæ were found at this date and a considerable percentage (20 per cent) of the injured buds were entirely empty.

Certain Varieties more affected than Others.—It has always been noticed when opportunity has offered for comparison that the varieties of strawberry, termed variously perfect-bearing, staminate, bisexual or hermaphrodite are more severely injured than the pistillates or imperfect bearers, but no cause for this difference has been assigned. It has also been observed that "Sharpless" plants were much more badly damaged than other staminate varieties. Observations made this season will, I think, explain the reasons. These observations indicate that the injury to strawberry by this insect is in direct proportion (1) to the quantity of pollen produced, and (2) to the amount of exposure of the growing buds and the flowers to the sun.

That pollen constitutes by far the larger proportion of the food of the adults is, I believe, beyond question. It not only furnishes a large portion of the food of the growing larva but is without doubt essential to its development. Those varieties whose flowers produce the greatest quantity of pollen naturally serve to attract the most beetles, hence the more pollen produced the greater the injury. This explains why the "Sharpless" and other staminates are more severely attacked than pistillates like the "Crescents," but I am indebted to Mr. W. A. Taylor for an explanation of why "Sharpless" berries should be more affected than other staminate varieties.

On the farm of Mr. Walker two varieties, "Sharpless" and "Charles Downing," were growing, affording an excellent opportunity for comparison. These varieties produce a similar amount of pollen, but in the

latter the buds and flowers are better protected from the rays of the sun and are hence not so much frequented by the beetles, but as corroborative testimony of the effect of shade a row of "Sharpless" berries on this place which was encroached upon and shaded on the west side by a field of rye, was found to bear double the number of berries of those in other parts of the field that were not shaded.

It will be noticed in the report of local damage that "Crescents" in some fields were damaged 15 per cent while in others they were not apparently harmed. An explanation of this may be found in the fact that this variety varies, some lots producing much more pollen than others, and are injured in proportion.

Raspberries of the "Black Cap" varieties appear to be for some reason strangely exempt from the attack of the Strawberry Weevil, but whether or not the Red Raspberry enjoys the same immunity has not been ascertained. On Mr. Sprankle's place at Falls Church a patch of "Black Caps" which is located between the infested strawberry bed and blackberry bushes previously referred to, was repeatedly examined for traces of the attack of this insect, but most careful search failed to show any signs of injury, and no beetles were found even with the aid of a beating net.

Wild Food-plants.—Cultivated strawberry has now become the favorite food-plant of this species of *Anthonomus*. From finding cultivated blackberries infested one would naturally expect to find them on the wild plants and such has proved to be the case. Wild blackberries bloomed this season throughout the month of June, and on the 3d of this month at Falls Church were in full bloom and fairly well peopled with beetles, cultivated plants of the immediate vicinity being out of bloom and deserted.

The wild plant, *Rubus villosus*, is probably the natural food-plant of this species. Dewberries, *Rubus canadensis*, were examined and a number of injured buds were found, but on closer inspection proved to contain only Dipterous larvæ. It is still somewhat doubtful whether this species is attacked or not, but in any event not to a great extent.

Wild strawberries and the little yellow-flowered Cinquefoil, *Potentilla canadensis*, were growing at Falls Church, and these and several other berry-producing plants were carefully examined. Wild strawberry plants were quite scarce here and no berries at all were to be found, the buds having nearly all dropped off. Larvæ were found in the few that were still attached to the vines. The *Potentilla* was in full bloom June 3, beetles were found on the flowers, and larvæ less than half grown were taken from injured buds.

The beetles found upon or bred from Wild Strawberry are necessarily smaller on account of the extremely limited food supply. They are also much darker than the average and have all the appearance of a distinct species. The individuals captured on *Potentilla* have the same size and appearance.

Several varieties of blueberries and huckleberries (*Vaccinium* spp. and *Gaylussacia resinosa*) were found to have been attacked by some insect, but the nature of the work in the buds or ripening berries plainly showed that it was not this *Anthonomus*. I believe it impossible for this species to breed in these plants. The adult beetles also frequent a number of flowers besides those already mentioned, among them the Flowering Dogwood (*Cornus florida*) in early May, and Wild Bergamot or Horse-mint (*Monarda fistulosa*) late in June. The beetles were swarming on the last-mentioned plant at this date, but after the first week of July they are seldom met with, and it is presumed that they begin to hibernate at this time, as they have not been traced further.

In past years Dr. Riley found this species in Missouri in July on Grape blossoms and Yucca flowers, and Dr. Hamilton has taken it abundantly on *Tilia* and *Rhus* in Pennsylvania (*Can. Ent.*, vol. XXIV, p. 41).

Differences due to Food-plants.—A marked difference is manifest between the immature stages found on Strawberry and Blackberry, and still further variations might be found to exist in individuals living upon other plants. No differences have been observed among the very young larvæ that could be attributed to difference in food-habit, but in more mature larvæ and in the pupæ a marked dissimilarity in color is apparent. Specimens taken from strawberry buds are of a decided yellow, while those from blackberry are nearly white.

In the adult beetles bred this year those which first matured average larger, and lighter and brighter colored, and are more distinctly marked on the elytra than such as were bred later.* The differences in adult individuals due to different food-plants have already been mentioned.

The Species doing the Damage.—It will be noticed by comparing the heading of the present article with that used by Dr. Riley in the 1885 Report that the species is now referred to as *Anthonomus signatus*, while in the earlier article it was called *musculus*. This apparent discrepancy cannot better be accounted for than by quoting from the original article (p. 280): “* * * This strawberry pest was referred by Mr. Glover to *Anthonomus signatus* Say, and a number of our own specimens agree so closely with Say’s original description of *A. signatus* as well as with Dr. LeConte’s description, that there can hardly be any doubt about the correctness of the determination. A number of other specimens, however, which were sent to Dr. LeConte were returned to us with the determination ‘*A. musculus* Say,’ and trusting to Dr. LeConte’s authority we have, in our correspondence, referred to this strawberry pest as *A. musculus* Say.”

* NOTE.—Specimens collected at Ithaca, N. Y., years ago are nearly a third larger and much brighter colored than any observed this year about Washington.

A very careful comparison made at that time by Dr. Riley of a large series of specimens collected from strawberry plants showed a perfect agreement both with Say's description of *signatus* and with specimens identified by our highest authority on this order as *musculus*. It is not to be wondered at, then, that relying on the correctness of this determination of *musculus* he, as well as Mr. E. A. Schwarz, who indorsed this opinion (*Entomologica Americana*, vol. III, p. 14), should have been misled into the belief that the two species were identical, and to the adoption of the name *musculus* as having priority.



FIG. 15.—*Anthonomus signatus*: Adult beetle—natural size (after Riley).

At that time *musculus* and *signatus* were very generally misnamed in collections, owing to the fact that no one had studied them sufficiently. Since the appearance, however, of Dr. W. G. Dietz's paper on *Anthonomini* I have entertained some doubts regarding the identity of the strawberry species, recent examination of our entire material showing, as before, complete agreement of all forms as one species, viz, *signatus*. To decisively settle the doubtful point specimens were sent to Dr. Dietz, who also determined them as *signatus*. Subsequent examination shows that all our material found on Strawberry, including the specimens determined by Dr. Le Conte as *musculus*, belongs to this species. It should be added that there were no specimens of the true *musculus* in the National Collection at the time of publication of the first article. On the receipt of a pair kindly sent to the Department by Dr. Dietz, however, the specific distinctness of *signatus* and *musculus* was made clear, since with both species available for comparison their separation is not difficult. The beetle is illustrated at Figs. 15 and 16.

Anthonomus signatus, as defined by Dr. Dietz, has the second joint of the funicle distinctly longer than the third. *A. musculus* differs in having the second joint of the funicle scarcely longer than the third, a difference which is usually apparent in fresh, but difficult to detect in old specimens without relaxing them. The thorax of the latter is less rounded on the sides and the suture is always darker.

Anthonomus musculus is apparently a much rarer insect than its injurious congener. Comparatively few specimens have been taken in this locality by local collectors, and its larval habits are still unknown. Dr. Hamilton (*Can. Ent.*, vol. xxiv, p. 41) says that it is not common at Allegheny, Pa., where he has found it exclusively on huckleberry blossoms from the middle of May till the first of June. It has been taken about Washington as late as July 10.



FIG. 16.—*Anthonomus signatus*: Adult beetle—natural size (original).

LIFE-HISTORY.

The Egg.—The egg of *Anthonomus signatus* is oval, and from about one-fifth to one-quarter longer than wide. The surface is perfectly smooth and highly polished. It is translucent, and the general color is a pale yellow. In size the egg is rather large in proportion to that of the adult insect. Measurements of different eggs showed a variation of from .48–.58^{mm} in length to .37–.47^{mm} in breadth.

Oviposition.—The greater part of two days was spent in an attempt to observe the method of oviposition, to secure eggs for study, and to ascertain the period of incubation. Although several females that were almost constantly under observation repeatedly punctured the buds, oviposition did not take place at this time. Subsequently, when the imprisoned insects had ceased work, eggs were discovered in these buds. Of the other buds that had been punctured in the breeding cages a few were opened and found to be empty. By this time it was too late to carry on this stage of the investigation, as the egg supply of the insects in confinement was apparently exhausted. Although the females did not oviposit while watched, it is presumed that some of the punctures were made for the purpose of oviposition, and enough was seen to demonstrate that this operation varies somewhat in method and time consumed according to circumstances.

The following notes, made on specimens confined in the breeding cages, may be of interest, although more extended observations are necessary to be of substantial value.

The first specimen—presumably female—consumed seven minutes in perforating the buds, when it withdrew, as if frightened. The second specimen was a female, and was accompanied by the male. She had just begun puncturing a fully-formed flower-bud when first seen. In two minutes she had inserted her rostrum the full length, *i. e.*, nearly to the eyes, or about on a level with the joints of her antennæ. She then immediately withdrew, and after resting a minute turned about and backed straight toward the punctured spot, which was plainly visible. Unfortunately at this juncture, although the back of the insect was toward the observer, she evidently became very much alarmed—about nothing as far as could be determined—the male evidently sharing in her anxiety. After running about, rather excitedly it was thought, for a few moments, she departed. During the entire time this female was accompanied by the male, but copulation did not take place.

Egg-laying on strawberry begins in this vicinity in April, probably as soon as the staminate buds begin to mature, and continues through May, or until the plants cease blooming. When the blackberries bloom, which they do about four weeks later than the strawberry, the latter is deserted and the blackberries attacked in turn.

Method of puncturing the Bud.—One specimen was watched while performing this operation that faced the observer, a second specimen was observed in an opposite direction, thus the method of work was noted.

In making the puncture the insect uses its whole body, all three pairs of legs performing their part. The insect's beak is worked, rather slowly, from side to side, and as the beak penetrates, the forelegs are gradually spread wider and wider apart as if pulling, while the hind pair are correspondingly elevated as if they were used to push the snout deeper, the middle pair of legs being used as a fulcrum. Naturally it takes longer to penetrate the calyx, but after this is once pierced through the work goes on more rapidly.

The method of cutting into the stem below the bud was not observed.

The Larva.—The larva of the Strawberry Weevil is of the usual Curculionid form, and, like so many others of this large family, offers no salient characters for specific description. In general appearance it resembles the familiar grubs or "worms" found in plums and cherries and in nuts and acorns—the larvæ of the Plum Curculio, and the Nut-weevils (*Balaninus*) respectively. The body is arched or curved, cylindrical, and strongly rugose or wrinkled and very sparsely covered with hairs. Like other Curculionids it is destitute of legs, their place being supplied by well-defined fleshy tubercles or pads as shown in the figure (Fig. 14 *d*). It is somewhat more slender than the larva of Curculionidæ generally, and slightly more slender than the example figured. The drawing was made from a larva which pupated the following day, and is consequently more robust than those a few days younger. The color of individuals, as has already been stated, varies from nearly white in those infesting the Blackberry to a decided yellow in specimens taken from Strawberry. The head is darker, brownish, and the mouth-parts are deeper brown, the color deepening at the dorsal anterior angles of the mandibles.

The average length of the full-grown larva in its natural curved position is 2^{mm}; greatest dorsal length about 3^{mm}.

Although no characters are discernible that might be construed as specific, some superficial characteristics might be mentioned. A noticeable peculiarity of the larva is its almost perfect helplessness when separated from its natural environment. Passing as it does its entire existence from egg to pupa in the bud, it has no need for organs of locomotion, and has evidently no means whatever of progression when placed on a flat surface. The mature larva remains almost constantly in a curved position, the dorsal line of the body describing about two-thirds of a nearly perfect circle.

The larvæ feed at first on pollen and the more tender parts of the unopened flower, the stamens and pistils, but when these are consumed the harder receptacle is attacked. In large buds only a small portion of the contents is consumed, the larva remaining on the side where hatched and gradually eating out a small hole around it, but in small buds it consumed the entire contents, leaving only the two outer envelopes. Numbers of such small buds were opened in which the larvæ were found full-grown and almost completely filling the interior with

their bodies and the accumulated excrement or frass, which is cast in the form of long, fine, curling black strings.

After attaining full growth the larva ceases to feed for a day or more and then transforms to pupa. If the buds are opened at this time it will be noticed that the inhabitants are very active, wriggling about constantly. These motions are continued by the pupa, which is exceedingly irritable if touched.

The Pupa.—A hollow cocoon-like receptacle or pupal cell is formed by the larva of the accumulated frass or castings, in the construction of which it uses some sort of sticky secretion or exudation, and this is then rolled smooth by the wriggling larva and pupa within. The constant motion of the insect as larva and pupa also serves to prevent it from becoming fastened to the sides of this receptacle. Within this cell the pupal stage is passed. This stage is shown at Fig. 14 *f*. A large proportion of specimens taken in the field had assumed the pupa state by the first week of June, and before the end of the week nearly all the imagos of this lot were disclosed. Pupæ were found this season from the latter part of May till the first week in July.

Issuance of the Imago.—The larva ordinarily remains on the side of the bud where the egg was inserted, and the adult beetle, when hatched, has only to cut through a thin layer of the dry calyx and corolla. The imago issues from a circular hole cut out on one side and usually at a point equally distant from the top and bottom of the bud. The place of issuance is often concealed more or less by an overlapping sepal of the outer row. Mature beetles, as has been said, began to issue during the first week of June, and nearly all the beetles of the lot from which these bred had developed within a week thereafter. From examination of the few buds of wild strawberry obtained, it is believed that the insect will average a week or more later on these, as no imagos were found until June.

The Insect probably single-brooded.—As to the number of annual generations the following facts would appear to indicate only a single brood.

First. None of the bred specimens in our vivaria were actually observed *in copula*, although they apparently paired in a few instances; consequently oviposition did not take place.

Second. The new brood of beetles which hatch in June disappears soon after maturing, and it is more than likely that they begin to hibernate at this time.

Third. This insect is in all probability, like many allied species, restricted to a single group of plants, the family Rosaceæ, and the possibility of a second brood necessitates a larval food-plant outside of this family, as no Rosaceæ bloom in this locality after the Wild Blackberry ceases to bear flowers.

Fourth. Late appearances of the beetles, such as have been recorded, are exceptional, judging from our own experience, and, although diffi-

cult of explanation, seems to be on a par with similar late occurrences of many other insects which might be mentioned.

Habits of the Adults.—The adult beetles, when not occupied in some manner in providing for the continuance of the species, may be seen sunning themselves in the flowers, or with their snouts buried among the anthers feeding on pollen.

There are reasons for the belief that it is principally the males that loiter within the blossoms, where they wait for their mates, while the latter are busied in the more serious occupation of oviposition. Pollen furnishes apparently by far the largest proportion of the adult food supply, but the petals are also nibbled and often completely destroyed. A certain amount of liquid food is necessary to these little creatures and a quantity of the juice and of stem tissue is doubtless absorbed while puncturing the buds and stems during the process of oviposition. The leaves are never attacked as far as observed. In the breeding cage a number of beetles were found feeding upon the pollen of injured buds, that had been opened and were old and brown. Numbers congregated on the immature fruit where they fed upon pollen and possibly on both stamens and pistils, and still others were seen to penetrate the unexpanded buds in search of food. It is somewhat uncertain whether the insects act in this manner in the field, but it is likely that they do so to a certain extent, for in cases observed in confinement there was an abundance of blossoms in the cage and there was no reason why the insects should have acted otherwise than in nature. Many buds were opened, particularly late in the season, that had been killed by the insects and in which neither eggs nor larvæ could be found.

In puncturing the buds for feeding purposes the motions of the insect are substantially as when drilling a hole for oviposition, but with the addition that the insect partially withdraws its beak from time to time, as if to masticate, and devour what particles had been dislodged, and then again plunges it in at a different angle.

As to the other habits of these beetles they are comparatively sluggish, but more active than many of the Rynchophora. They seldom fly, but crawl from one part of a plant to another and even across the ground when they wish to reach other plants. Their flight, as observed in a large breeding cage, is quite rapid. Although ordinarily so loth to take to wing I have seen a male insect fly a distance of two inches to reach a female perched on a flower belonging to another plant. It is probable that the females fly less often than the males.

When busily feeding with their snouts in a flower they are not easily alarmed, but when not so engaged they quickly roll to the ground if disturbed and remain there with their legs and antennæ rigidly drawn together, after the manner of their kind. On bright, warm days, however, they seldom remain thus more than a minute at a time.

At the times when the strawberry fields were visited comparatively

few of the beetles were at work in the flowers in the mornings, but later, in the heat of the afternoon, they were much more numerous.

Summary of the Life-history.—A brief summary of the life-history of this species, based on the past year's observations in this locality, is given herewith.

The insect undergoes true hibernation, *i. e.*, in the adult state, and in April individuals of this hibernating brood begin to crawl forth from their winter quarters, fly to the nearest flowers, and commence feeding. They probably continue to issue from their hiding places for a month after the first arrivals make their appearance.

Strawberry buds are attacked as soon as they are fully matured. Staminate varieties begin blooming in the neighborhood of Washington as early some seasons as the second week in April, and it is probable that they begin their bud-destroying labors here at least by the middle of April, egg-laying commencing at this time and continuing through the month of May, although the principal damage to this crop is done from the latter part of April till toward the middle of May.

Blackberries are invaded in turn at the time that the plants begin blooming, or about four or five weeks later than the Strawberry. Wild Blackberry is visited still later and the beetles continue on this plant for some time.

The injury to these plants is done by the female in the course of oviposition, and is produced by puncturing the stems just beneath the buds, causing the death of the plant above the point of attack. A single egg is deposited at this time in each flower-bud.

The larvæ are believed to hatch within from three to five or six days after the egg is deposited in the bud, and probably attain their full growth three or four weeks thereafter, when they transform to pupæ.

The pupal stage lasts from about five to eight days, according to thermometric conditions, and the first mature insects of the new brood begin to issue from the strawberry buds toward the end of May, continuing through the month of June, and in exceptional cases into July. The beetles are so seldom seen after the middle of July that they are believed to begin to hibernate at this time.

Our observations indicate only a single annual generation.

All of the earlier stages of the insect are passed in the bud. It never attacks the fruit.

PARASITES AND NATURAL ENEMIES.

Four species of parasites were bred during the season from the Strawberry Weevil, two species of Braconidæ and two Chalcidids of the subfamily Pteromalinæ. One of these, *Calyptus tibiator* Cr., is described; the remainder are new and are described in the note appended by Mr. W. H. Ashmead, who is making a special study of these forms.

Calyptus tibiator Cr. was by far the most abundant species of this year. Specimens issued from June 10 to 20.

Bracon anthonomi Ashm. A single specimen was found in its web in a strawberry bud in the field June 3, from which the imago issued June 20.

Catolaccus anthonomi Ashm. Two specimens, male and female, were reared from strawberry buds June 8 and 9.

Catolaccus incertus Ashm. was nearly as abundant as *Calyptus tibiator*. Adults issued June 7 to 12.

All of these parasites were bred from buds gathered late in the season. A single example of *Calyptus tibiator* was obtained from a bud taken in June. The two commoner species breed indifferently in Strawberry and Blackberry, both cultivated and wild. All are primary parasites and normally solitary, only a single individual infesting the host insect.

No insects, birds, or other animals have been observed preying upon *Anthonomus* in the field, but it is probable that a few species do so to a limited extent. Only two species of predaceous insects were even seen on infested plants, both occurring on Wild Blackberry. These were a pair of *Phymata wolffi*, a Heteropteron well known as an enemy to Lepidoptera and to bees, and two examples of Cleridæ. The former species was probably in search of larger game, but the Clerids, *Clerus rosmarus*, might have been engaged in devouring the strawberry weevils. This species is known to live upon other small beetles, and our captures readily devoured the strawberry weevils in confinement.

REMEDIES.

A number of remedies have been suggested, a few have been experimented with, but none, so far as I know, have been actually tested.

Of insecticides, the arsenites are of doubtful value, and there is possible danger of poisoning the fruit. As already pointed out in Dr. Riley's article on this subject, the kerosene emulsion, or pyrethrum dusted on the plants, would doubtless prove effective against the adult insect while at work, and gas-lime, or saw-dust impregnated with crude carbolic acid, or some other repellent, might be tried.

Now that the life-history of the insect is known, a number of other remedies suggest themselves.

In the first place, where staminate berries are extensively grown for the market, all wild plants and old strawberry beds that might serve as breeding places for this and other pests should be burned and cleaned away. There can be little doubt that the species under consideration, *Anthonomus signatus*, is derived from the Wild Blackberry, and unless the strawberry beds are completely covered over as described later on, all these wild bushes in the neighborhood of the strawberry beds should be destroyed.

Another remedy would be to collect the injured buds and place them in a box or barrel covered with cloth or wire-netting with meshes just large enough to permit the escape of the parasites, which are consid-

erably smaller than their host, but small enough to retain the beetles. A fine mesh of what is known as bobbin-net mosquito netting would answer the purpose admirably. It is somewhat doubtful if this remedy would be profitable except on small beds. The parasites are undoubtedly of great value in keeping this insect in check, but it is probable that none of the four species observed this year are peculiar to the Strawberry Weevil.

Taking advantage of our knowledge of the preference of this insect for those varieties of berries which bear an abundance of pollen, we might use the earliest staminate as a trap crop for the hibernating brood of beetles.

Trap Crops.—A few of these plants, *e. g.*, “Stevens,” “Michel,” “May King,” and “Hoffman” varieties might be planted in or near beds of late growing berries, and the insects destroyed daily by the application of insecticides, or, if sufficiently abundant, by beating them from the flowers into pans filled with water, covered with a thin scum of kerosene.

As a trap for the new brood which hatches about berry-picking time, the Wild Bergamot should produce excellent results. It has been demonstrated this year that sweeping and beating after the second week in May are of no avail against the early brood and it is doubtful if these methods would be of much service in capturing the beetles when more numerous early in the season on account of their habit of dropping to the ground at the slightest alarm. But still later in the season the insect may be readily captured with an ordinary sweep net. They fairly swarm on the Wild Bergamot or Horse-mint when this plant begins blooming during the latter part of June and thousands can be captured at this time and destroyed. Later, after the first week in July, the beetles are scarce. This plant has a wide distribution, being found from New Hampshire south to Florida and particularly westward. It is a common and well-known species, but for the benefit of any who may not recognize it by either of its popular names, it may be said that the flowers are large, showy, and purplish or rose-colored, looking somewhat like gigantic heads of Red Clover. The plant often grows in dense masses and to a height of from 2 to 5 feet. The stem is square, leaves opposite, and the flowers have a powerful and persistent and rather agreeable odor. It is quite hardy and can doubtless be readily transplanted or grown from the seed, and if properly cared for might serve as an ornament, as well as an insect trap.

Our surest remedy, however, would be preventive.

Covering Beds as a Preventive.—As a preventive it is only necessary to cover the plants with some light material, such as muslin or ordinary mosquito netting. Mr. Fletcher has suggested the use of old newspapers for this purpose and possibly they might prove of considerable value. They should be placed with their edges overlapping and held down with stones or clods of earth.

A certain remedy, however, would be found in covering the beds with frames of muslin. I would strongly advise this remedy where "Sharpless" and the like are extensively grown.

As to the method of covering, this is a matter which might, perhaps, as well be left to the ingenuity of the grower. A good plan has been devised by Mr. O. W. Blacknall, an account of which will be found in *Garden and Forest* for February 10, 1892 (p. 68). Mr. Blacknall's method has been followed for a number of years, for forcing strawberries, and is described as inexpensive and effective. By it he succeeds in obtaining strawberries a week and even ten days earlier, of superior size and quality, and in addition they are protected both from frost and, if pollen bearers, from our Strawberry Weevil.

The benefit derived from this plan is then, four-fold, viz., protection from frost, and from insects, earlier, and stronger growth. Mr. Blacknall also believes that the process of pollenization is aided, the cloth covering serving to keep the pollen-laden currents of air nearer the ground and among the plants. The material used is known as tobacco cloth or plant-bed cloth and costs about 2 cents a yard. The following is an abstract of his method:

After many experiments in search of a cheap and effective way of holding the cloth in place, I use small sticks of riven pine, known here as tobacco sticks, which are about three-quarters of an inch square. These sticks are sawed up into stakes fifteen inches long, and sharpened at one end. The other end for about half-way is smoothed with a drawing-knife and a wood rasp if necessary, so as to remove all splinters and irregularities which could tear the cloth. A very small hole is then bored about one inch from the smooth end. Into this hole a section of small, soft wire, say No. 17, about six inches long is run and bent around and wrapped on itself so as to hold securely. The other end of the wire is bent either before or after putting in the stake into a hook to hold the cloth. The hook should extend about three inches clear of the stake.

These stakes should now be driven into the ground for about half their length, placing them three feet apart in rows thirty-four inches apart, as some allowance must be made for the shrinking of the cloth, which is a yard wide. Turn the hooks the way the rows run, and let them all point in the same direction.

They are now ready for the cloth. If the hooks set to the east—and I set mine that way as our hardest winds come from the west—begin at the western end of the row. Run the hooks through the selvage of the cloth on each side and lock the outside row of hooks as you go, by twisting the wire around on itself. Leave the inside row of hooks open till you bring up the other width of cloth. Then when the selvage of that is caught on them lock those hooks, leaving what is then the inside row unlocked to hold the cloth on the next trip up. Always go back to the same end to start. When the bed is covered lock the outside row of hooks also.

Your bed is now covered solid with cloth except for the small gaps along the rows of stakes, and if they are placed in straight rows and driven perpendicularly, the gaps will be too small to do any harm. As the cloth is stretched only four inches from the ground and is quite elastic, snow presses it down without tearing it. When the danger from snow is past and the plants about ready to bloom, the covering can by a few minutes' work be raised to quite eight inches from the ground, in this wise: Begin at the end opposite to that on which you began to attach the cloth and bend the soft wire hooks straight upward over the stakes and leave them there. The cloth is so elastic that it can be walked on without injury except very near to a stake.

When the berries ripen remove the cloth, fold and tie it up neatly. Well handled it will last three years. The stakes should be pulled up and kept where the hooks will not rust too badly.

The covering in any case should be placed over the beds before the plants begin to blossom and attract the beetle, and may be removed when the crop is harvested. If so crude a remedy as old newspapers be used, these would probably better be removed after remaining for two or three weeks.

It has for some time been customary to burn over strawberry beds as soon as the fruit has been harvested, as a preventive of rust and various insects. This is a most excellent practice, but is probably of little avail against the Strawberry Weevil, as by the time the berries are picked the insects have practically all left the vines.

It is earnestly requested that such of our readers as may have an opportunity during the coming season to test the remedies herein suggested will report results.

DESCRIPTIONS OF THE PARASITES MENTIONED.

BRACON ANTHONOMI sp. n. Ashmead.

Male.—Length, 2^{mm}. Brownish-yellow; stemmaticum, occiput, and antennæ black; antennæ 26-jointed, a little longer than the body, with the flagellar joints about twice as long as thick. Thorax smooth, polished, the mesonotum trilobed, the lateral lobes being slightly dusky near the tegulæ. Wings greyish-hyaline, the stigma and venation fuscous; second abscissa of radius very slightly more than twice the length of the first; recurrent nervure not interstitial, joining the first submarginal cell before its apex. Legs yellowish, pilose; last joint of anterior tarsi, middle and posterior tarsi, and the posterior tibiæ toward hips, fuscous. Abdomen elliptic-oval, granulated, the first segment with a V-shaped sulcus, the inclosure thus formed convexly elevated; first and second segments about equal and a little longer than the others; following segments very slightly subequal.

Hab.: Washington, D. C.

Described from a single ♂ specimen, reared June 8, 1892, from *Anthonomus signatus*.

CATOLACCUS ANTHONOMI sp. n. Ashmead.

Female.—Length, 2.8^{mm}. Blue; head and thorax faintly tinged with metallic green; flagellum brown; scape, trochanters, tips of femora, and the tibiæ and tarsi honey-yellow; coxæ and femora bluish, the hind coxæ punctate, the inner ridge with a fine pubescence. Head and thorax confluent punctate; frons impressed; ocelli red; clypeus sinuate at the middle. Antennæ 13-jointed, inserted on the middle of the face; scape slender, cylindrical, about half the length of the flagellum; pedicel smaller and slenderer than the first flagellar joint; flagellum cylindrical of nearly a uniform thickness throughout, the club being scarcely thicker

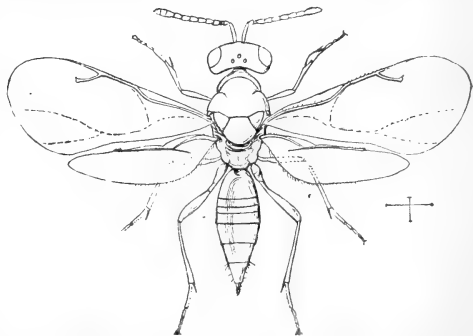

FIG. 17.—*Catolaccus anthonomi* Ashm., enlarged (original).

than the funicle, the first funicle joint being a little the longest joint, the following joints scarcely perceptibly subequal. Thorax ovoid, the collar rounded, nearly of an equal length throughout; parapsidal furrows indicated only anteriorly; metathorax two-thirds the length of the scutellum, the spiracles close to the postscutellar fold, elliptic-oval, the lateral folds complete, and there is a slight median carina at base. Wings hyaline, the venation pale yellowish, the stigmal vein two-thirds the length of the postmarginal ending in a small stigma, the marginal vein about as long as the postmarginal. Abdomen conic-ovate, about as long as the head and thorax together, subsessile, its base slightly produced beneath the neck of the metathorax, segments 1, 5, 6, and 7 about equal in length, about as long as the 2, 3, and 4 combined, 2 and 3 very short, together only slightly longer than 4.

Male.—Length 2^{mm}. Golden green, confluent punctate; scape and legs, except hind coxæ and femora, yellow; the tip of the hind femora also yellow; flagellum pale brown, pubescent; the pedicel small, smooth, dusky; terminal joints of funicle very slightly longer than thick; the basal joints about 1½ times as long as thick. Abdomen oblong-oval, the first and fifth segments the longest; the other segments, except the last, short, about equal in length.

Hab.: Washington, D. C.

Described from 1 ♂ and 1 ♀ specimen, reared June 8 and 9, 1892, from *Anthonomus signatus*.

CATOLACCUS INCERTUS sp. n. Ashmead.

Female.—Length, 2^{mm}. Head and thorax metallic green, confluent punctate, covered with rigid white hairs; abdomen conic, subcompressed, bluish black; scape, trochanters, apices of the femora and tibiæ and tarsi, honey-yellow, the hind tibiæ dusky at the middle; flagellum subclavate, brown, the first funicle joint the longest, about 1½ times as long as wide, the others very slightly subequal, the last being very slightly longer than wide, the club 3-jointed, slightly stouter than the funicle, the second joint the longest and widest. The head is a little wider than the thorax, the vertex therefore wide, the ocelli arranged in a slight curved line, the clypeus medially emarginate. Thorax ovoid, the collar distinct but short, the mesonotum wider than long with the parapsidal furrows indicated only anteriorly, scutellum convex, metathorax half the length of the scutellum, punctate, with a slight median carina at base, the spiracles oval close to the post-scutellar fold, the surface behind them deeply depressed, with no lateral folds. Wings hyaline, the venation brownish-yellow, the stigmal vein clavate about half the length of the marginal, the club brown, the marginal vein two-thirds the length of the submarginal, the post-marginal vein one-half longer than the stigmal. Abdomen as long as the head and thorax united, the first body segment and the third about equal and slightly longer than any of the others.

Male.—Length, 1.1^{mm}. Dull bluish or blue-black, with sometimes a slight bronzy tinge on the head and thorax above, the rigid pubescence subobsolete; second abdominal segment, scape, knees, tips of tibiæ and tarsi, except the last joint, honey-yellow, or whitish yellow; flagellum, brown, covered with a fine, long pubescence, the pedicel stouter and about twice the length of the first funicle joint, the following joints about equal, a little longer than thick; the club pointed, usually contracted in drying and not as thick as the funicle.

Hab.: Washington, D. C.

Described from 2 ♂♂, 1 ♀ specimen; reared June 7, 1892, from *Anthonomus signatus*.

DAMAGE TO FORESTS BY THE DESTRUCTIVE PINE BARK-BEETLE.

(*Dendroctonus frontalis* Zimm.)

By A. D. HOPKINS, Morgantown, W. Va.

It appears that an unhealthy condition of the pine forests in West Virginia and Virginia has existed in certain points in the Allegheny Mountain range and adjacent foothills since about the year 1888, but had only attracted local attention until within the last two years, when its rapid spread and increasing devastation brought the matter to public notice, and it was referred to this Station, and to me, for investigation. I have, therefore, made two extended journeys through the eastern portion of our State, one in May and the other in July of this year, for the purpose of ascertaining the character and cause of the trouble and the extent of the damage, and also to discover, if possible, a remedy.

It was found that when this trouble commences in a healthy forest groups of trees numbering from two to a dozen or more are noticed dying the first year. The foliage on such trees first turns yellow and then red, as if killed by fire. The second year this peculiar condition will have spread until the groups of dying trees extend over one to ten or more acres; and by the third year the entire forest of pine trees of all kinds, on hundreds of acres, is often found dead and dying.

After studying all the conditions found, and a due consideration of all the visible and probable elements which might produce them, I was convinced that a single species of Coleopterous insect, *Dendroctonus frontalis*, was to blame for the primary attack and resulting death of the trees.

From personal observation it is found that the dead and dying condition of the Pine extends from near the Pennsylvania line in Maryland on the north; through Hampshire, Hardy, Grant, Pendleton, Randolph, Pocahontas, and Greenbrier, to Summers and Raleigh counties in West Virginia on the south; and from inquiry and correspondence I learn that the same condition extends through about an equal area in Virginia. Therefore, it would seem that the ravages of this beetle extends over an area of at least 10,000 square miles, including portions of West Virginia, Virginia, and Maryland, on which five species of Pine and Black Spruce are being damaged and killed to a greater or less extent by them. In certain sections entire forests of Pine, including all species on several square miles, are dead, and have been a total loss. The greatest destruction has been in the forests of the common Pitch Pine (*P. rigida* Miller), and the Scrub Pine (*P. inops* Ait), and in the less common but more valuable Yellow Pine (*P. echinata* Mill).

The extensive and valuable forests of Black Spruce (*Abies* [*Picea marianna*] *nigra* Pain), and White Pine (*Pinus strobus* L.) in West Virginia, are being invaded by the insects; therefore, owners who have large in-

terests in such timber are becoming alarmed. The ravages of the insects in the other pines have been of such a serious character, the spread so rapid, and the destruction so complete, that there is really good cause for alarm, and should this destructive work continue in the Spruce and White Pine of our State, and the invasions of this insect extend into the great pine forests of the Southern States, many millions of dollars will be added to the great loss already sustained.

REMEDIES CONSIDERED.

At first, a remedy against the rapidly spreading ravages of the beetles seemed out of the question, but when it was found that they had just commenced their attack upon the forests of Black Spruce and White Pine, it indicated that possibly some method could be found by which the healthy and more valuable portions of these forests could be protected.

The method of cutting and burning the first infested trees to destroy the insects was considered, but it was found that it could not be generally practiced in our West Virginia forests, owing to many difficulties and conditions rendering this as well as other like methods impracticable.

The occurrence of a similar trouble in our Spruce forests between 1882 and 1889 caused, evidently, by the Spruce-bark Beetle (*Polygraphus rufipennis*), was, I have every reason to believe, brought to an end principally by the appearance of some six species of parasites and predaceous insects, which were found preying upon it. This, together with the well-known success of the introduction of the *Vedalia cardinalis* from Australia into California, resulting in the destruction of the *Icerya*, led me to consider similar methods of combating the Destructive Pine-bark Beetle, and to carry into effect a previously contemplated experiment of introducing certain insects from Europe to feed upon some of our injurious bark beetles.

By correspondence with Mr. Eichhoff, Oberförster, Strasburg, Germany, I learned that a certain beetle, *Clerus formicarius* L., was a "great destroyer of Scolytids" in the forests there, and from my knowledge of the habits of the nearly-related species, *Thanasimus dubius* Fab., I felt that it would be a most desirable species to introduce into our forests to feed upon the "Destructive Pine-Bark Beetle," and possibly check its ravages. Therefore, the experiment of introducing this beneficial European species into our State for this purpose was recommended to our Station officials and to owners of the threatened Spruce and White Pine forests. This proposed experiment was at once approved and the Station, aided by liberal contributions from four of the principal lumber companies, sent me to Europe in quest of such insects as, in my judgment, would, when introduced into our forests, accomplish the desired end. I, therefore, proceeded at once to Germany, sailing from New York on August 17, and arriving at Strasburg on Au-

gust 27, and after visiting some of the principal Pine and Spruce forests of Alsace-Lorraine and Saxony, in Germany; Schwyz, Lucerne, and the Oberland Bernese Alps in Switzerland, I started back to America on September 25, with over one thousand live specimens of *Clerus formicarius*, which was found to be especially destructive to various bark beetles in all of the forests visited. After my return here on October 8, I found that the European species would readily attack and devour the Destructive Pine-Bark Beetle, as well as other bark beetles nearly related to it.

From what I have observed and learned of this European bark-beetle destroyer, I am confident that under proper management it will check the ravages of the destructive pine-bark beetle, and that this enemy of scolytids will, in time, prove a valued protector of the pine and spruce forests of this country. We have, therefore, arranged to introduce the beetle into our infested forests in the greatest possible numbers.

A detailed account of the investigations referred to in this article will appear in a forthcoming bulletin, to be issued from the station at an early date.

AN INTERESTING WATER BUG.

(*Rheumatobates rileyi* Bergroth).

In INSECT LIFE (vol. IV, December, 1891, pp. 198-200) we described and figured a remarkably interesting aquatic Heteropter, captured by the Rev. J. L. Zabriskie, of Flatbush, L. I., in July, 1890, in the stream of the waterworks at Flatbush. We stated in our brief notice that the insect was plainly a member of the family Hydrobatidæ and came closest to *Metrobates*.

Soon thereafter we received the communication from Dr. E. Bergroth, of Tammerfors, Finland, which is published in INSECT LIFE (vol. IV, p. 321), in which he says: "The insect undoubtedly belongs to a new genus and species, which I propose to name *Rheumatobates rileyi*. It is, with the recently described genera *Hermatobates* Carp. and *Hemidiptera* Leon, one of the most curious and interesting *Hydrometridæ* hitherto discovered."

We have been anxious to obtain further specimens of this curious insect, and Mr. O. Heidemann has recently succeeded in finding it in numbers, in both sexes, along the Potomac Canal, just above Washington. Through his kindness in donating a number of specimens to the National Museum, we are enabled to present herewith a full description of both sexes of the imago, as well as of the adolescent states. The excellent figures which accompany the article have also been made by Mr. Heidemann, who, in addition to being our chief Washington student of the Heteroptera, is an expert draftsman and engraver.

Aside from the peculiar structures of this insect it is interesting in furnishing two forms of the male; a normal form departing less from the family type than the abnormal form, which has characteristically enlarged and spinose antennæ and swollen and curved hind thighs. In these two specialized characters, however, there is considerable variation, in some specimens the antennæ being twice as thick as in others, while again the hind thigh is sometimes much less noticeably thickened and curved, but approaches more nearly to that of the normal male.

There is also slight variation in all details, both as to coloration and relative proportion of joints, and detailed armature of legs and antennæ, a fact which is brought out very strikingly by the examination of over 200 specimens.

RHEUMATOBATES RILEYI Bergroth. *Imago* ♂ (abnormal form).—Length 2.2 to 3^{mm}. Velvety black, disc of abdomen slightly pruinose; under side of head and thorax, anterior coxæ, except behind, basal two-thirds of anterior femora, middle coxæ beneath and at base, hind coxæ, basal part of hind trochanters, a central spot on

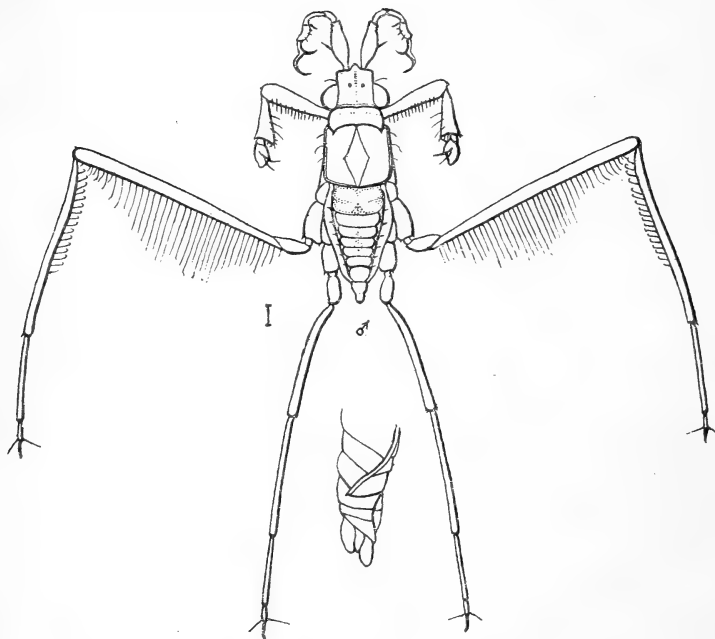

FIG. 18.—*Rheumatobates rileyi*—normal male, enlarged, the lower figure showing abdomen from side (Heidemann, del.).

each ventral segment on lateral margins of abdomen, basal one-third of first antennal joint, a transverse subquadrate spot on pronotum and either a triangular, heart-shaped, lozenge-shaped, or linear spot on mesonotum, all yellow or yellowish-white; on mesopleura, some distance above middle coxæ, is an oblong darker yellow spot. Head about as long as width between eyes; tylus prominent, about as long as wide. Eyes large, subglobular, strongly faceted, with a tubercle beneath and furnished with two or three long hairs issuing from posterior margin. Rostrum 3-jointed, short, stout, acuminate at tip, and extending to between anterior coxæ; joint 1 stoutest, about as long as 3, 2 slightly longer than 1 and 3 together, acuminate. Antennæ

4-jointed, two and a half times as long as head; joint 1, two-thirds as long as anterior femur, stout, swollen at middle, with some sparse hairs; beneath, slightly beyond middle, armed with a strong truncate spine and a little before this spine with a tuft of stiff bristles; joint 2, not quite as long as thick, armed with an acute spine at the extreme base below; joint 3, rather strongly curved and slightly twisted, basal three-fourths cylindrical, apical one-fourth enlarged, with a pale oval disc or cushion beneath, its margin surrounded by several bristles; joint 4, rather more than one-half as long as 3, acute at tip and giving off a short tubercle below, a little beyond middle. Thorax and abdomen together subovate-acuminate, a little more than three times as long as wide; pronotum large, transverse, three times as wide as long, with posterior angles rounded; mesonotum three times as long as pronotum; metanotum not visible from above. Abdomen conical, with lateral margins slightly reflexed, and terminating in a conical point; at base nearly as wide as thorax; joint 1 occupying nearly one-third of the surface; 2 to 8 short, subequal; 9 longer, conical. Anterior legs short, stout, pubescent; femora slightly longer than tibiae and tarsi together, fringed beneath with a single row of black bristles; tibiae, about half as long as

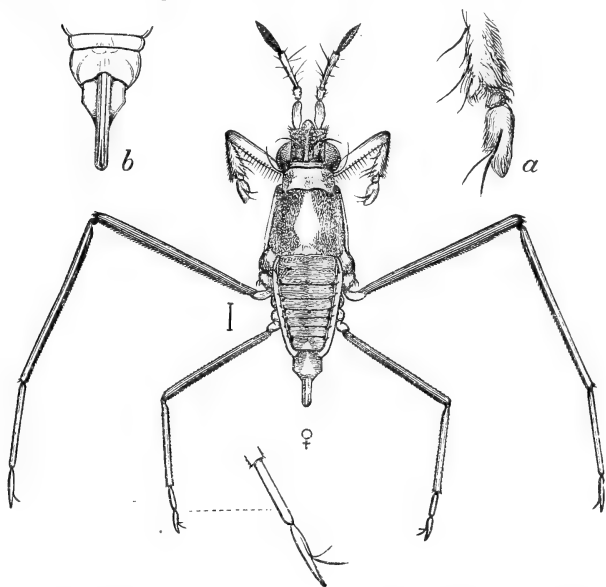

FIG. 19.—*Rheumatobates rileyi*—female imago, with the hind tarsus enlarged; *a*, tarsus of foreleg; *b*, anal segment from below—still more enlarged (Heidemann, del.).

femora, with three or four long bristles beneath; tarsi short, 2-jointed, about two-thirds as long as tibiae, joint 1 one-half as long as 2, last joint emarginate beneath a little before apex, from which emargination issues a single black claw; from base of claw springs a stiff bristle which could be mistaken for a second claw. Middle legs much the longest, cylindrical, tapering toward tarsi, fully four times as long as anterior pair, or one-fourth longer than posterior pair; femora, one-fourth longer than tibiae, fimbriate, with long hairs beneath; tibiae, with only basal half fimbriate, hairs usually hooked or curved; tarsi, about one-third shorter than tibiae, 2-jointed, joint 1 about twice as long as 2, the latter emarginate beneath at about basal one-fourth, with a single claw and a bristle. Posterior legs with femora stout, strongly curved, and acutely produced at apex beyond articulation of tibiae, tip furnished with several long hairs; a little before tip is a spine-like process or prong, with a tuft of bristles near base; basal, third of femora within with a row of long hairs; joint 2 of trochanters large, densely hairy above and below; tibiae, subclavate, articulating

with femora, outwardly, a little before the apex and slightly curved in opposite direction; inwardly, at basal one-fourth, is a tuft of very long bristles, usually closely united and having the appearance of a long spine; upper margin fimbriate with usually a tuft of hair outwardly some distance from apex; tarsi, long, slender, a little longer than tibiae, 2-jointed, joint 1 very long, almost as long as tibia; joint 2, short, scarcely more than one-sixth the length of 1, contracted beneath at basal third, the origin of the single long, slender claw, and an accompanying bristle as with the other tarsi.

♂ *Normal form* (Fig. 18).—This is the most common form found associated with the females. It agrees fairly well with the abnormal form, except as follows: Slightly larger, average length from 3 to 3.1^{mm}; joint 2 of antennae with no spine at base within, joint 4 being longer; prong-like process also longer and situated before middle of joint; anterior legs short, stout, not quite half as long as the posterior legs, tibiae and tarsi together not longer than femora, the latter bare, with a row of black bristles beneath; tibiae twice as long as tarsi, covered with a short dense pubescence, with two long hairs beneath; tibial spur blunt and apparently composed of a tuft of stiff bristles; tarsi 2-jointed, first joint very small, second long, apical half beneath emarginated, base of emargination being the point of origin of the single large claw and a long black hair or bristle; middle legs very long, one-third longer than hind legs, cylindrical; femora but slightly longer or not longer than tibiae, with a fringe

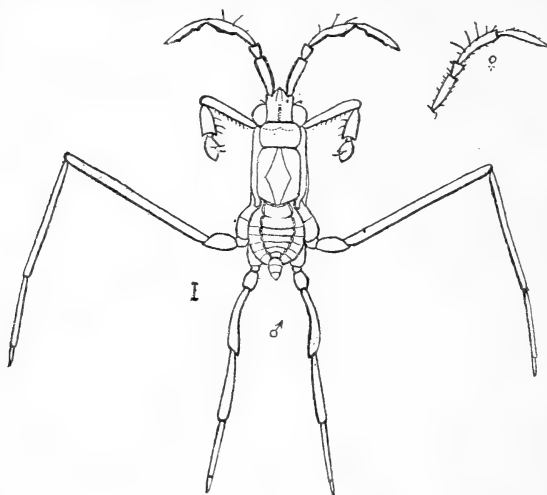

FIG. 20.—*Rheumatobates rileyi*; male larva, enlarged, with female antenna shown at right (Heidemann, del.).

of very long hairs beneath at middle, fringe at the distal ends shorter, hairs usually curved; tarsi two-thirds as long as tibiae, 2-jointed, joint 1 three times as long as 2; joint 2 emarginate beneath near middle with a single claw and a bristle; hind legs much shorter, not fimbriate beneath, femora almost straight, not thickened or curved as in the abnormal form, and a little shorter than tibiae; tarsi 2-jointed, joint 2 shorter, only a little more than one-third as long as 1, emarginate beneath at about one-third its length for the reception of the long slender claw; abdomen relatively longer, last segment conical. It also differs somewhat from abnormal form in color, the yellow marks being more variable. The pale blotch on the mesonotum sometimes subsobsolete or entirely wanting; head black beneath, mesosternum pale, but with a large V-shaped black spot or medially black with an inversely V-shaped yellow spot, while the venter is usually entirely black.

Imago ♀ (Fig. 18).—Readily distinguish from ♂ as follows: The antennae are always slender, without spines or processes; joint 3 furnished with long hairs; joint

1 with basal half white; yellowish white spot on the mesonotum always present, diamond shaped or elongate; tip of the abdomen terminating in a long style-like process, little more than four times as long as thick; dorsal abdominal segments large with an obconical white spot at apex; venter whitish; legs never fimbriate beneath; middle coxæ outwardly at base with a small white spot never present in male; hind femora distinctly longer than tibiæ, tarsi only about half as long as tibiæ, rarely a little longer.

Larva ♂ (Fig. 19).—Length about 2^{mm}. Differs from the imago in having spines and processes of antennæ undeveloped, although relative proportions of joints are about the same, joint 3 having 3 long hairs, but without specialized disc; 4 a little dilated below at middle, where in a future stage issues the prong-like process of imago: legs without fimbriæ beneath; anterior tibiæ and tarsi being shorter comparatively and stouter than in either of the forms of the imago: abdomen much shorter than thorax, margins dilated, dorsum concave, joints 8 and 9 conjoined and issuing as a conical projection from an emargination in joint 7.

Larva ♀.—Differs from male larva in having antennæ always slender, and the joints without spines or processes, joint 3 only with several long hairs; abdomen very short, joints 8 and 9 forming a long cone-like projection; hind legs a little more slender than in male larva and in proportion to middle legs a little shorter; relative length of the joints differing, tibiæ much shorter than femora; tarsi somewhat shorter than in ♂; whitish or yellowish spots less distinct.

The following table will indicate the difference between *Rheumatobates* and *Metrobates*, to which it comes closest, as we stated in our earlier article:

Metrobates.

General form oval obese, antennæ ♀ with the first joint very long and slender, as long as the three following united, or about as long as the front femur; second joint longer than the third.

♂ antennæ slender, the first joint very long, subclavate, a little longer than the three following united, fimbriate beneath; second joint nearly as long as the two following united; joints 2 and 3 thickened at tip with a small tuft of bristles beneath.

Legs simple, normal, with no fimbria beneath.

Rheumatobates.

General form elongate, subovate, antennæ ♀ with the first joint short, scarcely one-third the length of the front femur; second joint very short, about one-third the length of the third.

♂ antennæ stout, the first joint much swollen, shorter than the three following united, with a stout strong spine beneath near the middle; second joint very short, only about twice as long as thick, in fully formed ♂ with a spine at base within; third joint longer than the fourth, curved and thickened at tip, with a large disc beneath and a spine; fourth joint with a prong-like process.

Legs in ♂ with middle femora and tibiæ strongly fimbriate, the hind femora strongly curved in abnormal form, etc.

The peculiar disc-like organ or enlargement of the short antennal joint near the apex below exists only in the male sex. It varies in size with the age of the individual. In the very young larva it is not present and there is only a slight thickening of this portion of the joint. In the older larva it is present in a more or less rudimentary form and attains its highest development in the adult. It consists of a broadening of the under surface of the joint, the face assuming a whitish membranous appearance, slightly concave, with a slight ridge at the mar-

gins of the concavity, and its rim is surrounded by long sparse bristles. Studied under the high power of the microscope the face is seen to be furnished with sparse short hairs each arising from a slight tubercle. In younger individuals the surface is very faintly pubescent. There is nothing in its intimate structure to suggest a sucking disc and it is probable that Dr. Bergroth's inference that it might be such an organ is incorrect. It should be stated that at the time Dr. Bergroth made this suggestion we knew only this sex and the very fact that the female does not possess it goes to prove that it is not developed for the purpose of enabling the insect to cling to stones in swift currents as was hinted. It is undoubtedly a secondary sexual character and unless it possesses some important office in the act of coition it will be difficult to surmise its *raison d'être*. There is a possibility that its function is sensory, but we have not had the opportunity to study its nerve supply.

At our request Mr. Heidemann has prepared the following account of his observations upon the habits of the species:

"This interesting bug lives in clear running waters, and seems to prefer points where the bed of the stream is rocky. I was unable to find specimens at any other point on the canal, except at one very rocky spot. I found the insects skimming over the surface of the water in considerable numbers and in the same lively manner as do the insects of the allied genera *Metrobates* and *Stephania*. They were very shy and dived quickly beneath the surface when approached, and were therefore difficult to capture. On the sides of the canal where there was only a little ripple on the water I saw them more active immediately above stones covered with slimy mud. I also noticed a few specimens of *Stephania* in company with them. I captured with my net specimens in all stages of development, from the young larva up to the full grown adult. It is my opinion that there is more than one brood during the year, since on the 4th of June I captured a single larva on the same spot. I did not, however, at that time recognize its true affinities."

EXTRACTS FROM CORRESPONDENCE.

Further Notes on the Japanese Gypsy Moth and its Parasites.

I read with interest the report of the meeting of the Gypsy Moth Commission, which appeared in *INSECT LIFE*, VOL. III (p. 368).

I have had but one poor specimen of *Ocneria dispar* to compare my specimen with, but having heard that *dispar* was in Yezo, and as the appearance and habits are so nearly identical, I took it for granted that it was *Ocneria dispar* without careful examination.

Your statement that *Ocneria japonica* is somewhat larger than *dispar* is not conclusive to my mind that the two are not identical. We have specimens of *Pieris rapæ* that reach a maximum of two inches and three-quarters, and *Papilio machaon*

attain an expanse of five and a quarter inches. Is it not possible, therefore, that the larger size and even other variations are due to temperature changes?

In the Report of the Transactions of the Asiatic Society for Japan, dated June, 1875, Mr. Pryor says "he has found some Japanese insects the larvæ of which are quite different from the British ones, but the imago is the same." He has proved by actual breeding that the temperature alone causes extraordinary changes.

I find on examination that what you call *Ocneria japonica* is given in Pryor's List of Japanese Moths as "*Porthetria japonica*." It was first called *Lymantria dispar*, but was afterward changed.

I still believe that the Ichneumon Fly found here will destroy the *Ocneria dispar*. It will require demonstration to prove the contrary, as their food and habits are identical as far as I can learn. It is the destructive power of this *Microgaster* that prevents the moth from being a formidable scourge in Japan. It is really wonderful how effectively it works. On this account the moths and caterpillars are constantly diminished.

I send you the freshest specimens of cocoons that I could find. I am sorry that they have proved unproductive.—[H. Loomis, Japan, September 1, 1892.]

REPLY.—There can be no doubt as to the specific distinctness of *Ocneria japonica* and *O. dispar*. What you state as to the size and variation of larva are well-known entomological facts. The other points of difference are more important, however. Both sexes of *japonica* average a third larger than *dispar*. The coloration is more suffused and the markings are less distinct. The cross bands in the front wings of the female are nearly absent in *japonica*, while the male lacks entirely the differentiations of color into brown and fawn, and here, too, the transverse bands are indistinct or wanting. The generic names which have been previously used for this form, viz, *Porthetria* and *Lymantria*, have no particular significance, as they indicate simply the opinions of certain authors as to the generic position of the insect. Generic names are constantly changing. You are doubtless correct, however, in believing that the two species are so closely related that the *Apanteles* which you have found will prey upon both.—[September 29, 1892].

Injurious Insects in Nebraska: Season 1892.

Some insects have appeared in more injurious numbers than heretofore, while others have been very inconspicuous. The Apple-tree Tent-caterpillar was more plentiful than last season, as was also the Yellow-necked Apple-tree Caterpillar (*Datana ministra*), the latter more injurious than for some years past. The Codling Moth was not able to do any damage of note, as the apple crop is an entire failure. Some think that will have the effect of checking the ravages of this moth on the next crop. The Walnut Caterpillar (*Datana angusii*) made its first appearance July 22 and did the usual amount of damage. The Willow Saw-fly (*Cimbex americana*) was present, but in greatly diminished numbers. The larvæ and beetles of the May Beetles (*Lachnosterna* spp.) were very numerous, but did not do as much damage as in the previous year to corn. The Corn Root-worm (*Diabrotica longicornis*) was not so numerous as last year, although the mature beetles seemed much more numerous. Have not heard any serious complaints of the worm doing damage to corn. The Chinch Bug was present in some localities, but did comparatively little damage. The Green-striped Maple-worm was far worse than for some years past, completely defoliating trees in many places. The larvæ of the Spingids, or hawk moths, were very abundant during the first part of July and were quite injurious to tomatoes later in the season. The Green Cabbage-worm is very numerous, completely destroying all late cabbages, making the crop very scarce. This worm has been increasing in numbers each year.—[William N. Hunter, Nebraska, October 20, 1892.]

House Ants of Mexico.

House ants, or, as they are called, *Hormiga asqueles*, are the house scavengers. They make occasional visits to the buildings to eat the insects that bore into the wood. Previous to one of these visits the furniture of a room will be strewn with particles that fall from the ceiling above; after one of the periodical visits for some time that ceases.

While stopping at the Hotel Bola de Oro at Tepic, suddenly one afternoon late these insects came in countless numbers. They assailed the dining room so that supper had to be taken outdoors. Next morning my room was covered with them; they swarmed over the roof, the walls, floor, and into every sheet of paper with or without botanical specimens. For two days they were masters of the situation. If I sat down to change dryers or whatever else, they swarmed over me to so great an extent, biting so furiously, that I quit the room. The second day they disappeared to overhaul the rest of the building.

For fear they might make lodgment among the botanical specimens I instituted search, and found among the dried plants of one sheet the ants that are in the accompanying bottle. They were all dead. What produced death I can not say.—[Edward Palmer, Tepic, Mexico.]

NOTE.—The specimens which accompanied this communication belonged to a new species of the genus *Eciton* not represented in the National Collection, and which can not be determined by any of the works on Formicidæ in Washington.

The Stony Acorn Gall.

You have described a gall or galls on acorns—did you ever find any in the nut? I came across two examples last autumn in which the cotyledons were pitted with the small cells of some Cynipid, but in spite of all care I failed to get the flies. I inclose parts of the infested nuts.—[Mary E. Murtfeldt, Missouri, September 17, 1892.]

REPLY.—This gall in acorns has been known for a good many years, original specimens having been received by Dr. Riley from Thomas Meehan in 1872. Later Mr. H. G. Hubbard found it at Detroit, Mich., in 1875, and what is probably the same thing was recently received from Mr. Koebele at Alameda, Cal. The species has not been described, although a few of the flies have been obtained. They bear his manuscript name of *Callirhytes fruticola* in the collection. It is peculiar in the fact that the entire interior of the acorn is filled with the Cynipid cells, the walls of which are extremely hard.—[September 29, 1892].

Destructive Appearance of the Roller Worm.

Can you give me any information on what are called roll worms? The moth seems to lay the eggs on the underside of the leaves of all kinds of beans, which hatch into a worm that rolls the leaf around itself. They are very destructive, especially to all members of the bean family. If you know of any method of checking them I shall be deeply obliged to learn of it.—[C. G. Philips, Dade County, Fla., September 19, 1892.]

REPLY.—* * * The "Roller worm" which you mentioned is the larva of a common butterfly known as *Eudamus proteus*. In spite of the fact that the caterpillars feed in the folded leaf the majority may be killed with Paris green or London purple applied in the proportion of one-fourth pound of the poison to fifty gallons of water. In a small garden, however, the best plan is to go through with a pair of shears clipping through the middle of each leaf roll and thus destroying the larva. In the Annual Report of this Department for 1879 will be found an account of this insect on pages 269, 270. It is also injurious to turnips and cabbages.—[October 1, 1892.]

Swarming of the Archippus Butterfly.

October 5, I saw a rare occurrence, swarming or migration of the Archippus. On the 4th I made a trip some four miles east of here to see a case of Texas Fever, in company with Dr. M. Francis, Veterinarian of Texas Station, and along a "Draw" where Red-bud, Persimmon, etc., were thick, I found hundreds of these butterflies "roosting" at 3 P. M. They were as thick as the leaves on the shrubs, and often I could catch six or eight at one sweep of my 18-inch net.

October 5, at 8 A. M., they began swarming, and at 9 the air, as far as one could see east and west, from 40 to 200 feet above the ground, the butterflies were flying to the south, apparently one every few feet; often a cloud of several hundred would pass, almost in a solid body, enough to cast a shadow. At 2 P. M. they diminished in numbers and flew lower down. From the best information I can get this swarm extended 20 miles east and west and were in motion steadily southward from 8 A. M. to 3 P. M.

October 6, a smaller swarm was seen from 10 to 3 P. M., but diminished in numbers. I thought this worthy of record as no one here recollected seeing such a migration before.—[Dr. J. C. Neal, Oklahoma.]

An Anthicid Beetle reported as injurious to Fruit.

I found some specimens of a gray beetle which is doing some damage to our fruit crops in the spring of the year, about April. They first make their appearance on peach trees, the tender leaves of which they appear to eat. In May they are plentiful on cherries and later on on apricots, peaches, nectarines, plums, prunes, etc., even on early apples. Quinces are the only fruit they refuse. The damage, however, is principally to cherries and apricots. As late in the year as this I find them on peaches. They follow birds that have partly eaten the fruit, when they eat to the pits of fruit where they hide. When the fruit is handled they leave it at once, so they are seldom seen on fruit outside of the orchard. I believe the beetle is a native here. The damage by them so far is small, and I do not think they ever become troublesome, yet it is well to watch them. I have never seen them fly.—[John J. Jones, Los Angeles County, Cal., September, 1892.]

REPLY.— * * * The insect in question is known scientifically as *Notoxus calcaratus*. It is a member of the Coleopterous family Anthicidæ, none of which, so far as is known, are ever injurious. The habit which you have observed is interesting but is probably exceptional, as none of our eastern species of *Notoxus* have been reported as affecting vegetation. One of our common species occurs in the South on the flowers of cotton and doubtless feeds on the pollen. You are right in your conclusion that these insects are not the primary cause of the damage. Many species of insects, particularly beetles, which do not normally attack fruit are often sent to this Department with the report that they are injurious, but investigation usually proves that they follow the attacks of other insects, or, as in your case, of birds, being attracted by the flowing juices upon which they largely feed. Among the most common beetles having similar habits may be mentioned different species of *Euphoria*, *Allorhina* and *Ips*. These also feed upon flowing sap. Your statement that the *Notoxus* appears to eat the tender leaves of peach requires verification and we shall be greatly obliged if you will report further observations.—[October 8, 1892.]

Injury to Hammer-handles.

In my business I handle a great many hardwood handles for hammers, axes, etc., and I find that I lose a great many annually from the ravages of a little insect or wood-borer, which thoroughly honeycombs a handle in a very short space of time, leaving the handle a mere shell with innumerable small holes on the outside, and grinding the inside into a powder as fine as flour. I have found it a very difficult

matter to find specimens of this insect—the few that we have examined with a magnifying glass are smaller than a flea, and of a milk-white color with long antennæ, although one was discovered considerably larger, about the size of a flea, and dark colored, but was the only one. I would like to ask you: (1) The scientific name and common name of the insect. (2) A remedy, if there is any, to prevent the destructive work of this little pest.—[C. Ducomman, Los Angeles County, Cal., September 7, 1892, to Editor "Scientific American."]

REPLY.—(1) There are several Coleopterous insects of the family Ptinidæ known to infest dry hard wood that is used for handles of various implements. Since Mr. Ducomman does not send any specimens, it is impossible to name the particular species which does the damage. It is, however, in all probability, one of the Powder-post beetles, genus *Lyctus*, of which *L. striatus* and *L. paralleloipedus* have been observed under conditions similar to those described by Mr. Ducomman. They are small, elongate, brownish beetles, and their larvæ small, six-legged yellowish-white grubs, with their bodies always curved near the tail end.

(2) The beetles and their larvæ may be destroyed by immersing the infested handles in kerosene for a short time. It is quite important, however, to thoroughly disinfect in this manner all handles which show the least trace of the presence of the beetle. The entire stock of handles kept in the store should be carefully inspected from time to time. The presence of the beetles may be easily detected from the small circular holes through which the beetles have entered the wood, or from the little heaps of fine saw-dust which accumulate beneath the infested handles.

[The above correspondence has also been published in the *Scientific American* of October 1, 1892.]

On Remedies for the "Cigarette Beetle."

As yet we are unable to estimate the damage done by the "Cigarette Beetle" *Lasioderma serricorne*, but we are now making a test by having placed 36 cases which are infested with them into cold storage, but the time is short to decide whether this process will kill them. You advise us to keep the windows closed at night; we notice that in cool weather they become rather stiff and are unable to move, but just as soon as it gets a little warmer they become more active. As our nights are rather cold at present might it not be well for us to leave our windows open at night? Can you give us any idea as to how these insects get into our place or whether they originated in our house. We at first discovered them in a lot of fine cuts.—[Hettermann Bros., Kentucky, October 7, 1892.]

REPLY.—* * * In view of the cool nights at the present time it may be as well to do as you suggest and leave your windows open at night. It will become necessary, however, to take strenuous methods in case you wish to rid your establishments of the insects. The tobacco which is worst infested should be burned or submitted to the fumes of bisulphide of carbon or thoroughly steamed, the latter probably being the easiest method to adopt. The insects will be much more easily killed by a very high temperature than by a very low one and the success of your cold storage experiment is open to some doubt. The Entomologist would be very glad to be informed, however, as to how it turns out. The insects could not have "originated" in your house, but must have been brought in in one stage or another with tobacco or perhaps have flown in in the beetle stage from some neighboring establishment. They are not absolutely confined to tobacco for food, but are found also in pepper, spices, and other pungent substances. They may have come to you from some drug store or from some large grocery establishment, perhaps, should there be such in your immediate neighborhood. It is more likely, however, that they were brought in with tobacco.—[October 12, 1892.]

Correspondence on the Mosquito Remedy.

An article in *INSECT LIFE* written by you on the prevention of mosquitoes has much interested me. I supposed the plan mentioned by you was original with me, as I had never seen it proposed before it occurred to me. It appears quite possible to me to treat large tracts of land in the manner you have tried on a small scale.

Although I have not given the subject proper scientific study, I have observed enough to learn that mosquitoes will only breed where there are rather small-sized pools of water that is not agitated and is warmed by the sun. Such pools are found in the salt marshes along the coast. In many places they are, without doubt, too numerous to make any attempt to destroy their contents successful, but in a large number of tracts of salt meadow land there are comparatively few collections of water, and here, it seems to me, the petroleum or other insecticide could be effectively applied. By careful study and experiment the smallest quantity of the insecticide could be found and the exact time that it would remain operative. Even, suppose this quantity should amount to large proportions and should cost a good deal of money, the advantage gained would be so great that the plan could be carried out. To free a mosquito-infested district from the pest, in many parts of the country, would increase values of lands thousands, perhaps millions of dollars, and land-owners would gladly pay for it. I myself am an owner of land along the Sound and I would be most happy to add my share to a fund to relieve us from the pest.

Could the plan of ridding a district from mosquitoes be shown to be feasible by some authority on entomology I think an association could be formed to carry it out. Please inform me whether it is within the province of your Department to assist in such an undertaking. If not, perhaps *INSECT LIFE* might agitate the subject and awaken sufficient interest in the matter to have means provided to test the mosquito destroying plan.—[Dr. Wooster Beach, New York, N. Y., October 14, 1892, to L. O. Howard.]

REPLY.—* * * I do not claim to have originated the plan of treating breeding pools with kerosene as a remedy against mosquitoes, but it is a remedy which has been floating around in the air for the past twenty years if not longer. I began studying entomology in 1866, and it seems to me that I have always been familiar with the suggestion. It has been published, however, very rarely, and no accounts of accurate experiments have ever been put in print so far as I know, except the one of mine which you are kind enough to compliment. I fully believe that in many localities the remedy will pay and that, as you suggest, there is room for further experiment, although it seems to me that I have effectually proved the efficiency and economy of the plan. I have shown that one barrel of kerosene will treat 96,000 square feet of water surface and that the effect of this treatment will last longer than ten days, even if rain storms intervene. Calculate for yourself on the basis of the 370 mosquitoes my little experiment killed. All were females. Suppose each female to have laid 200 eggs. Barring accidents, in twenty days there would have been from those 370 mosquitoes seventy-four thousand individuals. One-half of these being females and each laying 200 eggs, in six weeks from the time of my experiment there would have been seven million four hundred thousand mosquitoes! Such figures as these are to a certain extent defective, but they indicate possibilities and they give at least a faint idea of what can be done by work of this kind *early in the season*. It is within the province of this Division to undertake experiments of this character, and I think it quite likely that further experiments will be made next season. * * * I can assure you that if I had the misfortune to live in a mosquito-ridden neighborhood I should agitate the matter among my property-holding neighbors and I think it would not be difficult to arouse such a public sentiment that active remedial work would be undertaken.—[L. O. H., October 15, 1892.]

Note on the Drone Fly.

I send a cage of insects which made their advent in our greenhouse with the blooming of *Farfugium grande* in the economy of which flower they are apparently in some manner concerned. They act like bees, and greatly resemble them not only in the busy way in which they work among the flowers, but in the way they fly, and carry their hind legs—imitating the pollen-freighted limbs of the bee. All whose attention I have called to them, or to whom I have shown the insects mistake them for Honey Bees. I find, however, they have no sting, and have the head and proboscis of a fly. They evidently fulfill the same office with relation to the composite above-mentioned as the Honey Bee, of which they are such a good imitation. * * *—[Ernest Walker, Indiana, October 27, 1892.]

REPLY.—The insect is a true fly known as the Drone Fly, *Eristalis tenax*. The larva of this insect is one of the rat-tailed maggots, so called for the reason that the anal segments of the body are attenuated and telescopic, the spiracles being situated at the tip, thus enabling the larva to breathe while its body is embedded in liquid filth. The adult fly is frequently found in greenhouses, and is supposed to be a valuable aid in the fertilization of chrysanthemums and several other plants. Its resemblance to the Honey Bee is common to other members of the Dipterous family Syrphidæ, as well as the family Bombyliidæ.—[October 31, 1892.]

Another irregular Appearance of the Periodical Cicada.

During last June the Periodical Cicada was quite common here; in an oak grove on my place I could sometimes hear four or five singing at once. I captured several imagos and found a number of pupa cases attached to leaves and twigs.

I thought it was unusual to find them in such numbers four years after their regular visit. The last regular year was 1888. I would have sent the above sooner, but although it was interesting to me I did not know it would be worth sending, till I read your note in last INSECT LIFE (p. 50).—[H. J. Giddings, Iowa, October 6, 1892.]

REPLY.—The instance which you mention is very interesting if true, but your explanation that these Cicadas are laggards from brood V (1888) is probably incorrect. It is much more likely that they are the precursors of Brood XI, which will appear in parts of North Carolina, Virginia, Maryland, Indiana, Illinois, and Colorado next year (1893). Your locality will be a new one for the brood, and we shall be glad to be notified next year in case you see any specimens. In 1876 this brood was not observed even in Illinois, but in 1842 and 1859 it was seen near Alton.—[October 10, 1892.]

The New York Pear-tree Psylla.

* * * Will you please give me the reference to Foerster's description of *Psylla pyricola*? Are you quite sure of the reference of our Hudson River species to *pyricola*? The front wings are not as Loew describes them, "without any markings whatever," but are distinctly marked with the spots in basal cell shown in the figure given by Thomas in the Eighth Illinois Report, p. 13, and less plainly on the hinder wings. I have an example in which the wings are without markings, but unfortunately with no date or locality.—[Dr. J. A. Lintner, New York, October 24, 1892.]

REPLY.—* * * The common Pear-tree Psylla of Massachusetts and New York is unquestionably *P. pyricola* Foerster, and agrees perfectly with European specimens sent me by Dr. Loew. It was originally described by Foerster in "Uebersicht der Gattungen und Arten in der Familie der Psylloden," Verhandl. d. naturh. Vereines d. preuss. Rheinlande, 1848, Vol. V., p. 77. This citation is taken from Loew's "Revision der paläarktischen Psylloden" since our only copy of Foerster's paper has been mislaid. The blackish spot in the clavus and posterior basal cell of the front wing

of *P. pyricola* is particularly mentioned by Loew (see translation in INSECT LIFE, vol. IV, p. 127, line 6 from bottom). The color of the wing described (l. c., p. 128) refers to the disc of the wing in comparison with *P. pyri*.

There occurs, however, another imported Pear-tree Psylla in your State, viz: *Psylla simulans* Foerst., which is somewhat larger than *P. pyricola* and has indefinite dusky spots on the forewings between the radius and the veins composing the cubitus; but we agree with Slingerland that this is but the hibernating form of *pyricola*.—[October 29, 1892.]

A Tropical Cockroach in a New Orleans Greenhouse.

We send you by this mail insects received from a correspondent at New Orleans. Will you identify them for us, and suggest some means of destroying them? They are destructive to palms and ferns, eating out the heart. They attack the large *Alsophilas* with avidity.—[American Florist Company, Chicago, Ill., October 5, 1892.]

REPLY.—The insect which you send is a cockroach which has been apparently imported from the West Indies into New Orleans, as it is not known to occur normally in this country. It is known scientifically as *Panchlora surinamensis*. It will pay your correspondent to make every effort to stamp the species out in his greenhouse, either by means of an arsenical spray or by the free use of California Buchach.—[October 12, 1892.]

Remedies for White Ants in Fruit Trees.

I send a root, a section of the body, and some branches of an apple tree that died lately, without any apparent cause; also some branches of a cherry tree. You will observe that this apple tree has been broken off about eight inches below the surface of the ground and near the root. We are not aware that it has met with any accident, and the break must have been the result of some disease which weakened the fiber.—[G. O. Shields, New Mexico, November 1, 1892.]

REPLY.—An examination of the sections of apple tree shows that it has been damaged by Termites or White Ants, and probably by the species known as *Termes flavipes*. Nests and colonies of these insects are ordinarily found in deeply-buried decaying roots, or in the hearts of stumps and logs of large size. They extend their operations to very great distances, excavating underground tunnels. Growing wood is not the natural food of the insects and is only attacked by them under exceptional circumstances. Recently transplanted trees whose roots have suffered mutilation, or those which have been planted too deep, or which have too much earth heaped around the crown, are subject to much damage by Termites, but old and well established trees are not greatly liable to their attacks, except through disease or other injuries by which dead and unhealthy wood is produced. The principal precautions to be taken against these insects are to remove all decaying wood from the orchards to avoid mulches, except where necessary for other reasons, leaving the crown of the tree exposed to the air, and avoid deep planting. As to remedies, when the decay is discovered early enough, it will be well to remove the earth about the crown and principal roots, cutting away all dead wood and bark and pouring on hot water. A dilute kerosene emulsion, applied as to grapes, will also destroy all insects which may be present. Young trees of some varieties which have been completely girdled may be saved, if taken in time, by inarching scions between the root below and the stock above, thus reestablishing the connection between the two. The tree will in time restore the eroded bark, and the scions may be allowed to remain or may be afterwards cut out. A poultice of mud and cow-dung applied to the injured part will protect it and materially assist in the formation of new wood and bark. In place of the inarching scions, young cuttings may be planted close to the base of the tree and subsequently their tops may be grafted into the trunk.—[November 10, 1892.]

A Swarm of Spring-tails.

The inclosed insects were found in the public road, and were dipped up into the bottle just as we send them to you. When turned loose they jump from 3 to 5 or 6 inches. At first I thought they had wings, but looking at them through the microscope I find no wings, and I can not see any extra legs for jumping. They were in the road in vast numbers, several quarts of them, creating the impression that some one had lost a quantity of gunpowder. * * *—[J. S. Wilson, South Carolina, October 20, 1892.]

REPLY.—The insect which you found in pools of water by the roadside is one of the "spring-tails" known scientifically as *Achorutes armatus*. It is closely related to the so-called "snow flea" (*Achorutes nivicola*), a species which occurs frequently upon the surface of snow in great numbers in the winter time. The insect jumps not by the aid of its legs, as you seem to suppose, but by means of a spring under the abdomen. These creatures are not injurious to living plants, but feed upon dead and decaying vegetation.—[October 25, 1892.]

Tame spiders.

I send specimens of a very handsome spider, with "cocoon" containing eggs. These spiders spin a funnel-shaped web, behind which they remain concealed until some unwary insect enters, when they spring out. They are very handsome, with their striped legs and reddish body spotted with white. This one is very tame. For months it has lived over the head of my bed, allowing me to examine it. When it began to get uneasy I placed it in a box, where it spun a beautiful covering for its eggs. I am very partial to spiders, and never destroy one nor its web unless I am compelled to do so. In my own room I let them have full sway. There are probably fifty spiders there now and they never molest me. I find them all over the bed clothes. I believe the stories of their poisonous bites to be largely exaggerated. We have here those large, black spiders mentioned by John March in *INSECT LIFE* for August, 1892 (vol. IV, p. 398). I found one of them curled up under my baby's neck one morning. This one did not attempt to fight, but if prodded with a stick they will fight back.—[Mrs. M. E. Rice, Pennsylvania, October 15, 1892.]

NOTE.—The spider sent is *Epeira trifolium* Hentz.

NOTES FROM CORRESPONDENTS.

A new Bark-louse on Orange.—We have received from Mr. Coquillett, Los Angeles, Cal., specimens of a new species of the genus *Pseudococcus*, which was found upon Orange at Riverside, Cal., by Dr. Clafin. The same gentleman also found specimens of this same insect both above and below ground on *Solanum douglasii* growing in the vicinity of the orange tree upon which the other specimens were found. As soon as we succeed in getting a good series illustrating all stages we may describe the species.

Damage to Cigars in Brazil and the West Indies.—Mr. Herbert H. Smith, who has spent many years in collecting in South America and Mexico, informs us that some insect does a vast amount of damage to cigars in Brazil and the West Indies. Having never seen the insect he is unable to identify the species, but states that it bores into the cigars, riddling them with holes of about the diameter of a No. 3 Klä-ger pin.

This insect is in all probability *Lasioderma serricorne*, the so-called "Cigarette Beetle," a cosmopolitan species of miscellaneous food-habits, but best known as a pest

in tobacco warehouses. References have been made to this insect in *INSECT LIFE*, volume I, pp. 357 and 358, and volume II, pp. 368-9.

Dark-colored Cattle most subject to Horn Fly Attack.—Apropos of the subject of the color of a host and its relation to parasitism or insect attack, which was discussed on page 265 of the last volume of *INSECT LIFE* (volume IV), it may be of interest to state that one of our correspondents, Mr. H. B. Paxton, of Lake County, Fla., asserts that the Horn Fly appears to show a preference for dark-colored, dark brindle, or black cattle. This is a direct contradiction to the statement of Prof. Wallace in his work on Darwinism. In preceding pages of the current number it will be noticed that Mr. H. E. Weed, entomologist of the Mississippi Experiment Station, made a similar statement before the last meeting of the Association of Economic Entomologists. We might repeat here Mr. Howard's assertion referred to in volume IV (pp. 205) that there is no connection between the color of cattle and the Horn Fly.

Scale-insects not poisonous.—Some time ago Prof. E. R. Lake, of the Washington State Agricultural College, wrote us that the inspector of fruit pests for that State asserts that the use of fruit affected with San José scale is injurious to the human system. He states that certain physicians have had cases to treat wherein children have evidently been poisoned by the use of fruit affected by this insect. The idea of any scale-insect being poisonous is a novel one, though there is no innate improbability of its being the case.

A Beetle destroying Smuts in Herbarium.—Prof. G. F. Atkinson sent us, before leaving the Institute of Technology, Auburn, Ala., specimens of a beetle which he found destroying the smuts preserved in the herbarium of the Institute. The beetle proved to be *Lathridius filiformis*, Gyllh.

Junonia cænia on Block Island.—Prof. W. W. Bailey, of Brown University, informs us that among other Lepidoptera collected by his son upon Block Island the past summer were specimens of *Junonia cænia*, which were confined to a very limited district about the Great Salt Pond.

The Saddle-back on Helianthus.—Mr. W. J. Morrison, of New York City, informs us that he found on September 7 a colony of the Saddle-back Caterpillar (*Empretia stimulea*) on the foliage of *Helianthus globosus* var. *fistulosus*. Although the larva of this moth is known to feed on quite a variety of plants it has not hitherto been recorded on this species to our knowledge.

Damage to Cocoa in Trinidad.—We have received from Mr. J. H. Hart, of the Royal Botanic Gardens at Trinidad, specimens of a leaf-hopper with the information that it is attacking the Chocolate Plant (*Theobroma cacao*) on that island. This insect is a handsome species of the family Membracidae, belonging probably to the genus *Horicola*.

"June Bugs" making Mischief in California Nurseries.—San Diego County, Cal., is reported to be afflicted with "June Bugs." Mr. W. Chappelow, of Monrovia, Cal., writes that whole orchards of young trees have been defoliated by them the past season. The insect is not known in his own neighborhood, and as no specimens of the insect doing the mischief have yet reached us we are unable to identify the pest.

Orange Scale-insects in Bermuda.—We have received from Mr. F. L. McIlvane, of Hamilton, Bermuda, branches of orange and lime trees infested indiscriminately by *Aspidiotus citricola* and *Chionaspis citri*. The interesting point about this sending is that while *A. citricola* is the most injurious scale-insect of the orange in Florida, it is rare in Louisiana, while with *Chionaspis citri* the case is exactly reversed, since this species abounds in Louisiana and is scarce in Florida. Here in Bermuda, however, we have a common meeting ground of the two species, and it is likely that in the West Indies we have the original home of each.

On the Habits of the "Variegated Cone-nose."—Regarding the habits of *Conorhinus variegatus*, Mr. J. N. Forbes, of Washington County, Fla., writes that they

frequently fly into houses late in winter and in early spring, but are seldom seen after June. During this season they pay almost nightly visits to such households as are not protected by screens. When splitting fire-wood they are often found collected by the dozen in hollow places in the wood. He has observed them with snouts buried in the leaf stems of sweet potato and grapes. Spraying with London purple produced good results.

New Food-plant for *Sphingicampa bicolor*.—Mr. George H. Berry, of Cedar Rapids, Iowa, informs us that he has found the larva of this Ceratocampid moth feeding in numbers upon the Kentucky Coffee Tree (*Gymnocladus canadensis*). The species is recorded only upon *Gleditschia*.

The Horn Fly in Oklahoma.—Dr. J. C. Neal, Director of the Agricultural Experiment Station, Stillwater, Okla., notifies us, under date of October 8, that the Horn Fly made its appearance in that vicinity about September 1 of the present year.

Another "Weeping Tree."—Dr. Neal also informs us in the communication above mentioned that two "raining trees" have recently been found on the bank of a little stream near Stillwater. One is a large Cottonwood and the other a Box-elder. A constant shower fell all day, showing plainly in the sun light like a veritable rainfall. Dr. Neal visited the trees and captured some of the insects discharging the liquid and sent them to us. The insect was, as in many other cases, *Proconia undata* Fab.

The Leopard Moth and its European Enemies.—Mr. Herman Meeske, of Brooklyn, N. Y., has called our attention to the fact that *Zenzera pyrina* is by no means as abundant in Europe as it has already become in the vicinity of Brooklyn, and he suggests the desirability of importing European parasites. He deprecates the unrestricted importation of living pupæ of European species by collectors, and justly says: "What would people think if an individual, for his own pleasure, should import the cholera germ?"

Injury to Sorghum Tips.—An Arkansas correspondent, Mr. W. C. Brass, has mailed us, under date October 17, specimens of sorghum tips badly damaged by a long-horned grasshopper, *Orchelimum glabberimum*, which has the habit of puncturing pithy stalks of different plants for the purpose of laying its eggs. A ready remedy for this insect will be found in burning infested canes with the eggs contained in them.

GENERAL NOTES.

FIRST LARVAL STAGE OF THE PEA WEEVIL.

Under this caption we published, upon page 392 of volume IV, a short account of the eggs and first larva of *Bruchus pisi*, comparing them with those of the Bean Weevil treated upon page 301 of the same volume. The figure prepared to accompany this note on page 392 was inadvertently omitted and is given herewith. It indicates well the shortness of the postembryonic legs as compared with those of the Bean Weevil and the differences in the peculiar spinous processes of the pronotum. It also shows the mines exceptionally made by the young larva in the pod itself before entering the individual peas. It will be understood that the section of the pod shown in the upper right-hand corner of the figure is seen from the exterior, while the section shown immediately beneath it is seen from the interior of the pod.

EDWARD BURGESS'S WORK IN NATURAL SCIENCE.

Mr. Samuel H. Scudder, in the Proceedings of the Boston Society of Natural History (volume xxv, pp. 358-364), gives an appreciative account of the work which the late Edward Burgess did in natural history. Mr. Burgess was associated with Mr. Scudder in the early part of his work in entomology, and one of his first contributions was published conjointly with Mr. Scudder. Although a close student of the Diptera, Mr. Scudder shows that Mr. Burgess's best work was done in insect anatomy, and that, although familiar with many species of two-

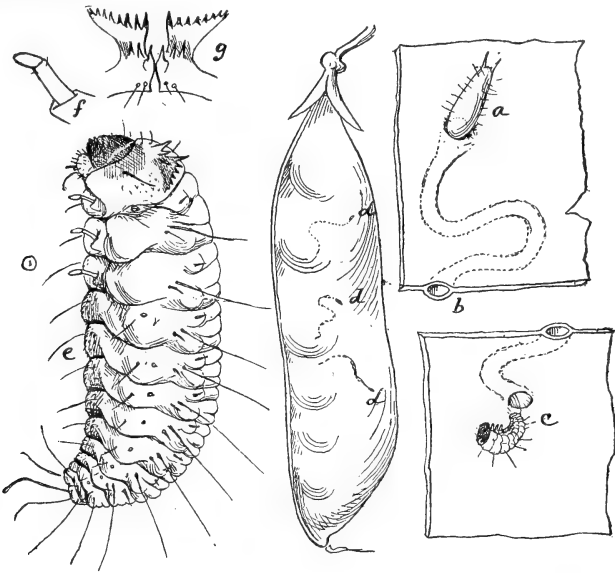

FIG. 21.—*Bruchus pisi* L., first larval stage; a, egg on pod; b, cross section of opening of mine; c, young larva and opening on inside of pod by which it has entered—enlarged; d, d, d, eggs—natural size; e, first larva—greatly enlarged; f, postembryonic leg; g, prothoracic spinous processes—still more enlarged (original).

winged flies, he never described but four new species. His work upon the anatomy of the Psocidæ, and particularly that upon the Milkweed Butterfly, are justly cited as models. The same may be said of the work which he did for us, in connection with Dr. C. S. Minot, on the anatomy of the Cotton Worm. When Mr. Burgess left entomology for the designing of yachts the former science lost one of its ablest American students, but the world at large undoubtedly derived more immediate benefit from his labors in the latter direction.

SWARMING OF THE ARCHIPPUS BUTTERFLY.

The swarming in the spring and fall of this large cosmopolitan butterfly has been frequently noticed and often discussed in entomological periodicals. It migrates to the north in the spring and to the south in

the fall. It seems to have been more than usually abundant this summer in many localities in this country, and as a result its migrations this autumn have been more frequently noticed than usual. In this number we publish a note from Dr. Neal, of Oklahoma, upon such an occurrence in his locality, and we have noticed in the *Cleveland Plaindealer* of September 20 a most interesting account of the passage of immense swarms over that city. The head-lines of the article are so characteristic of American journalism that they will bear repeating: "MANY MILLIONS. *Swarms of Butterflies Invaded Cleveland, and Everybody Gazed at the Wonderful Sight—A Beautiful Vision of Orange Yellow—Strange Flight of the Insects from North to South—Mistaken for Cholera Germs—Immigrants Who Disregarded Mayor Rose's Proclamation.*" At the University of Minnesota these migrations have been noticed for several years by Prof. Luggler, of the Agricultural Experiment Station, and this year Prof. C. F. Nachtrieb, of

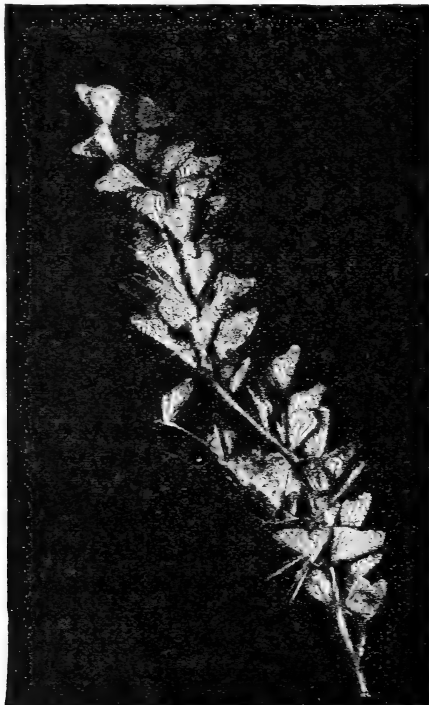

FIG. 22.—*Archippus* butterflies resting at night during migration period—reduced (from a photograph by Prof. C. F. Nachtrieb).

the Department of Animal Biology, succeeded in taking a good photograph of the butterflies resting at night from their long journey. The photograph was taken by means of an electric light and is here reproduced by the courtesy of Prof. Nachtrieb. A similar figure drawn in rough outlines was published by Dr. Roland Thaxter in the *Canadian Entomologist* a number of years ago.

UNUSUAL ABUNDANCE OF BUTTERFLY LARVÆ.

A gentleman residing at Falls Church, Va., brought into the office on November 5 a specimen of the caterpillar of *Papilio troilus*, one of the large, black, swallow-tail butterflies, sometimes known as the Green-clouded Swallow-tail. He said that the foreman of his farm had brought him this specimen, with the statement that, although he had never seen such a creature before, they were now present by hundreds upon the Sassafras bushes, which they were defoliating. Specimens of the foliage accompanying the caterpillar were already dry and yellow in color, and the larva itself was of a dirty yellow hue, closely approximating that of the leaves, and offering a marked contrast to its earlier bright green coloration. The date, November 5, is unusually late for this larva to be still feeding, and its abundance, as indicated by the title to this note, is also unusual.

SOME IMPORTED AUSTRALIAN PARASITES.

Mr. Koebele has recently sent us a few parasites reared in Australia from scale-insects common to Australia and California, and also a few species parasitic upon the scale-insect enemies which he has brought over to California. From several of the Coccinellid larvæ he has reared a new species of *Homalotylus*, and another species of the same genus on *Rhizobius ventralis*. From a larva of *Scymnus flavifrons* he sends a species of *Pachyneuron* which, however, is secondary. From *Rhizobius debilis* he has reared an Encyrtine, forming a new genus near *Aphycus*. From *Lecanium hesperidum* he sends a species of the genus *Comys*. From a Mealy Bug of the genus *Dactylopius* he sends a species of *Aphycus* and a species of *Encyrtus*, while from *Lecanium oleæ*, the common black scale, he has reared in Australia *Dilophogaster californica*, an insect which is a very effective enemy of the same scale in California. From the eggs of *Icerya* he sends *Ophelosia crawfordi*. From the scale-feeding larva of *Thalpochares cocciphaga* he sends a species of *Cryptus* and one of *Bracon*. From *Aphis brassicæ* he has reared *Lipolexis rapæ* Curtis, a species which is now common to Europe, America, and Australia. He has also sent a species of *Eupelmus* found ovipositing upon a larva or chrysalis of a Tineid which feeds upon *Chionaspis citri*.

A NEW PARASITE OF THE RED SCALE.

We have recently received from Mr. Coquillett, of Los Angeles, four female specimens of *Aphelinus diaspidis* Howard, three of which were captured upon Orange leaves infested by *Aspidiotus aurantii*, while the fourth was found engaged in ovipositing in one of these scale insects. This is a new habit for this species which was originally described by Mr. Howard from specimens of *Diaspis rosæ* sent to the Division from Fort Read, Fla., by Col. B. F. Whitner, in 1880, and from other speci-

mens of the same scale on Blackberry collected by Mr. T. C. Chamberlin at Santa Barbara, Cal. In Bulletin No. 5 of this Division (p. 25) other specimens of this species are recorded as having been reared from a *Mytilaspis* upon an undetermined species of *Dycaste* from Japan, which we received in 1874 from the late Dr. George Thurber, of the *American Agriculturist*. The fact that this species is now found to attack the Red Scale (and we consider Mr. Coquillett's observations to indicate more than a mere probability) is interesting and important, since but one true parasite has previously been recorded from this insect, viz. the so-called *Coccophagus citrinus* Craw. which does not seem to be multiplying rapidly.

PARASITISM IN BEES OF THE GENUS *STELIS*.

That the Apid genus *Stelis* develops in the cells of the allied genus *Osmia* has been known for some time, but the exact nature of the parasitism, and more especially when and how the *Osmia* larva is destroyed by the *Stelis* larva, have hitherto not been explained. In a recent number of the *Zoologischer Anzeiger* (vol. xv, No. 383, February 1, 1892, pp. 41-43), Mr. C. Verhoeff, of Bonn, Germany, summarizes the results of a series of careful observations which throw a flood of light on the subject. The species observed are *Osmia leucomelaena* K. and *Stelis minuta* Nyl.

The species of *Osmia* construct cells in the interior of hollowed twigs in the manner of *Megachile* and similar bees. At the bottom of the cell the female *Osmia* first puts a layer of pollen which is to serve as food for the nearly full-grown larva. Above this pollen, the bee commences to store the cell with prepared bee-bread. At this moment the female *Stelis* watches her opportunity to lay an egg in the *Osmia* cell, the egg thus being always near the bottom posterior end of the food mass. Unaware of the presence of the parasite egg, the *Osmia* female continues her work, and, after nearly filling the cell, deposits her own egg on the top anterior end of the food-mass. The cell is then closed with a layer of macerated particles of plants and a second cell prepared above the first. The *Stelis* larva hatches but little earlier than that of the *Osmia*, and both larvæ feed on the food-mass, the parasite larva at the bottom, the host larva at the top. The latter remains stationary at the top and grows very slowly; the parasite larva grows more rapidly, and gradually works its way upward through the food-mass, thus gradually approaching the *Osmia* larva. The crisis finally comes: the *Stelis* larva encounters the *Osmia* larva—a short but deadly combat ensues—the *Osmia* larva is easily overpowered and killed by the much larger and stronger parasite, and its body is devoured by the latter within one or two days.

It is thus evident that *Stelis* furnishes another illustration of that partial parasitism which I have shown to be the rule with the *Meloidæ*, but differs in that the parent introduces her egg into the host cell in-

stead of placing it where the triungulin may itself seek and secure its food, or where it may cling to and be carried by the host female into her cell.—[C. V. Riley, in *Scientific American* of November 19, 1892.]

THE LARVA OF HARPALUS.

Dr. J. A. Lintner, State Entomologist of New York, has recently written us about a figure of a supposed Harpalus larva on page 97 of our Ninth Report on the Insects of Missouri. In Dr. Lintner's bulletin on "Cut-worms," page 25, he has reproduced this figure and has called it *Harpalus*, possibly *caliginosus*, whereas Saunders, in his "Fruit Insects," page 185, gives it as *H. pennsylvanicus*. We have intended for some time to publish a statement concerning this figure, and this question of Dr. Lintner's gives us the opportunity. The drawing was one of our early ones, and was originally made for Walsh (see *Amer. Ent.*, vol. I, p. 34). We used it, but always with a query as to its nature. At that time very little was known of Carabidous larvæ, but from our subsequent breeding of *H. pennsylvanicus*, and from the more recent literature, we now question whether the figure in question is that of a Harpalus larva. The antennæ and tarsi of the figure remind one of a Staphylinid larva, but the markings of the abdominal joint point toward the larva of a Pterostichus or an allied genus. At any rate, this larva has never been bred. On the other hand, our Figure 27 of the Ninth Report on the Insects of Missouri (reproduced in the First Rept. U. S. Entom. Comm., p. 290, Fig. 24), is that of Harpalus.—[C. V. R.]

DIPTEROUS LARVÆ IN THE EYE OF A TOAD.

In the "*Særtryk af Entom. Medd. 2. B. 2. H.*," Dr. Fr. Meinert publishes a most interesting article under the title of "Larvæ Luciliæ sp. in orbita Bufonis vulgaris." It seems that a toad was brought to him which had been unfortunately killed in hot water before he saw it, in the right eye of which were found seven small dipterous larvæ, while upon the back of its head were several eggs. After careful study, Dr. Meinert decided that these larvæ belonged to some species of the genus *Lucilia*, and was inclined to think that they hatched from the eggs observed upon the skin of the back of the head, and made their way from that point to the eye. He reviews the literature of dipterous larvæ inhabiting the Bufonidæ, and shows that the general consensus of opinion concerning cases previously observed has been that the larvæ found did not primarily attack the healthy animal, but that the eggs were laid upon injured individuals in sores and cancerous spots. The case described by himself, however, indicates that here, at least, the attack was primary. The Dipterous larvæ were killed with the toad, so that there was no opportunity to rear the adult fly.

AN INSECT TRANSMITTER OF CONTAGION.

Insects, particularly our common household species, are frequently accused of being the agencies of transmission of contagious diseases. The House Fly, Blue-bottle Fly, Mosquito, the Bed Bug, and the so-called "Yellow fever Fly" are often under suspicion, and occasional instances of suspected cases are mentioned in the daily press and in medical journals. The following, from the *Medical Record* of September 17, 1892, is interesting, if true:

Bedbugs, according to Dr. Dewèvre, may be carriers of tuberculosis contagion. His attention was called to this possibility by a case of tuberculosis occurring in a young man who slept in a bed formerly occupied by his brother, who died of the disease. The room had been thoroughly disinfected, but the bedstead had for some reason escaped this salutary process. Dr. Dewèvre observed that the young man had been bitten by the insects, and, securing some of them, found them full of tubercle bacilli. He afterward put some presumably healthy bugs in contact with tuberculous sputum, and was able to obtain from them, several weeks later, some excellent cultures of tubercle bacilli. The bugs seemed lively, however, and had no cough, night sweats, or other of the familiar clinical symptoms of the disease.

A SCALE INSECT ON THE KAROO BUSH.

The *Agricultural Journal*, of Cape Colony, in its issue of September 8, 1892, records the occurrence of a new scale insect in great numbers on a fodder plant known as the Karoo Bush, at Eland's Drift, in the southeastern province. Mr. P. Troskie, who sent specimens to the local Department of Agriculture, wrote in July that, in spite of abundant rains, the Karoo looked as though suffering from a heavy drought. The specimens were examined at Cape Town by Mr. Peringuey, who determined them as belonging to Ceroplastes, and who advised the burning of the bushes on a large scale as a palliative. The waxy covering of the insect, it is thought, will aid in this destruction by fire, while as the bushes were already dead at the time of writing they would be of no further use as fodder and would at the same time burn more readily.

THE SILK OF SPIDERS.

In the *Revue des Sciences Naturelles appliquées* for March, 1892, there is a paper by Rev. P. Camboué on the silk of spiders. After giving a history of the attempts to obtain and use the silk of spiders, he gives some interesting experiments of his own, made on a large orb-weaving spider of Madagascar, *Nephila madagascariensis* Vinson. He finds that the spider furnishes the most silk after she has laid her eggs. From one spider there was obtained in twenty-seven days nearly four thousand meters of silk. The silk was of a golden-yellow color. He gives the plan of an apparatus for winding the silk, which, however, as he says, is imperfect. Nothing, however, was done as to the raising and keeping of the spiders in large numbers, undoubtedly the most serious question.—Nathan Banks.

THE MEXICAN JIGGER OR "TLALZAHUATE."

In No. 6, vol. IV, of "*El Estudio*," the organ of the National Medical Institute of Mexico (pp. 196-99), is published an interesting article by Fernando Altamirano upon a larval Trombidium, known commonly throughout Mexico by the Aztec name "Tlalzahuate," which signifies literally "grain of earth," and which evidently closely resembles the two larval forms of this genus which we described a number of years ago as *Leptus autumnalis* and *Leptus irritans*. The pest is common in parts of Mexico and adheres to and burrows into the skin of human beings. It is reddish in color and lives upon plants, particularly upon Sedges. The author describes a somewhat serious case of injury by this mite to Sr. Rafael Rebollar, who spent eight days during October at Tamascaltepec, and who became badly infested with the mites. Upon his return to the City of Mexico his skin presented a very peculiar appearance. The pathological features of the inflammation and the subsequent ulceration are carefully described by Dr. Altamirano, together with the treatment, which was principally the application of phenic washes and iodoform powder. No trace of the insect could be seen in any of the blisters or ulcerated spots, and the question is discussed as to whether the ultimate sores were really occasioned by the "Tlalzahuates." Judging from our experience with the allied species in this country, the extreme inflammation and ulceration described in this case was probably produced partly by the violent scratching in which the patient admittedly indulged, and partly by the condition of the blood. Following Dr. Altamirano's paper is a careful description of the mite itself by Dr. Alfredo Dugès, of Guanajuato, but without the determination of the specific name of the adult Trombidium. The paper is accompanied by a full-page plate figuring the mite and its enlarged mouth-parts and tarsi.

OBITUARY.

Three entomologists of world-wide reputation have died during the past summer.

Dr. Hermann Burmeister, born January 15, 1807, died from the result of an accident at Buenos Ayres, May 2, 1892. He was the author of the well-known "*Handbuch der Entomologie*" and removed from Germany to South America, where he became the Director of the Museum of Natural History, Buenos Ayres, in 1861.

In June Dr. Carl A. Dohrn died at Stettin, Germany, in the 86th year of his age. Dr. Dohrn was president of the Entomological Society of Stettin for upwards of forty years and during that period was the editor of the "*Stettiner Entomologischer Zeitung*." His special work was in the order Coleoptera, but he was a man of wide information.

Major-General F. O. G. Quedenfeldt died recently in Berlin, at the age of 75. He was a well-known writer upon Coleoptera and was par-

ticularly well informed concerning the coleopterous fauna of Africa, nearly all of the 37 entomological articles which he has published since 1880 referring to this subject.

ENTOMOLOGICAL SOCIETY OF WASHINGTON

November 3, 1892.—Dr. George Marx presented a paper on spider's web, showing specimens of a peculiar fleecy substance which had been sent in to the National Museum from California, and which had more recently been collected in Florida in large masses after a rain storm. Some difference of opinion existed as to the nature of the substance, but after careful chemical and microscopical tests, Dr. Marx decided that it was composed of masses of threads of gossamer spiders, collected in the air by winds and thrown to the ground in rain storms. Discussed by Messrs. Riley, Stiles, Fernow, Howard, Mann, Ashmead, Marlatt, and Schwarz.

Mr. Howard then read two papers by Mr. Townsend entitled "Notes on certain Cecidomyiidous Galls on Cornus," and "Notes on some Cecidomyiidae of the vicinity of Washington, D. C." The latter paper contained notes upon *Cecidomyia serrulata*, *C. chrysopsidis* and *Diplosis resinicola*. These papers were discussed by Messrs. Riley, Ashmead, Marlatt, Howard, and Schwarz.

Mr. Chittenden presented for publication a paper entitled "Biologic Notes on some Species of Scolytidae."

Following the reading of the papers specimens were exhibited by Messrs. Schwarz and Ashmead.

December 1, 1892.—The following officers were elected:

President, C. V. Riley; vice-presidents, W. H. Ashmead and C. W. Stiles; recording secretary, C. L. Marlatt; corresponding secretary, L. O. Howard; treasurer, E. A. Schwarz; executive committee, the officers and Dr. W. H. Fox, Dr. Geo. Marx, and Mr. B. E. Fernow. Mr. Frank Benton was elected an active member.

The retiring president, Dr. C. V. Riley, delivered his annual address on the subject of "Parasitism in Insects." The address began with a definition of the term and a classification of the subject, and then treated in detail the following subdivisions: (1) The Parasites among Insects proper, by Orders; (2) Origin of Insect Parasitism; (3) Effects of the Parasitic Life; (4) Economic bearings of the subject. At the conclusion of the address, on motion of Dr. Gill, the thanks of the Society were voted to the president.

E. W. DORAN,
Recording Secretary, pro tem.





U. S. DEPARTMENT OF AGRICULTURE.

DIVISION OF ENTOMOLOGY.

PERIODICAL BULLETIN.

Issued April, 1893.

Vol. V.

No. 4.

INSECT LIFE.

DEVOTED TO THE ECONOMY AND LIFE-HABITS OF INSECTS,
ESPECIALLY IN THEIR RELATIONS TO AGRICULTURE.

EDITED BY

C. V. RILEY, Entomologist,

AND

L. O. HOWARD, First Assistant,

WITH THE ASSISTANCE OF OTHER MEMBERS OF THE DIVISIONAL FORCE.

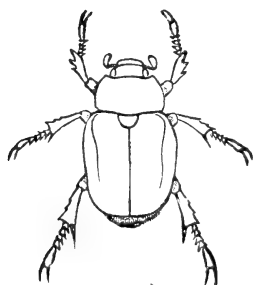

[PUBLISHED BY AUTHORITY OF THE SECRETARY OF AGRICULTURE.]

WASHINGTON:
GOVERNMENT PRINTING OFFICE.
1893.

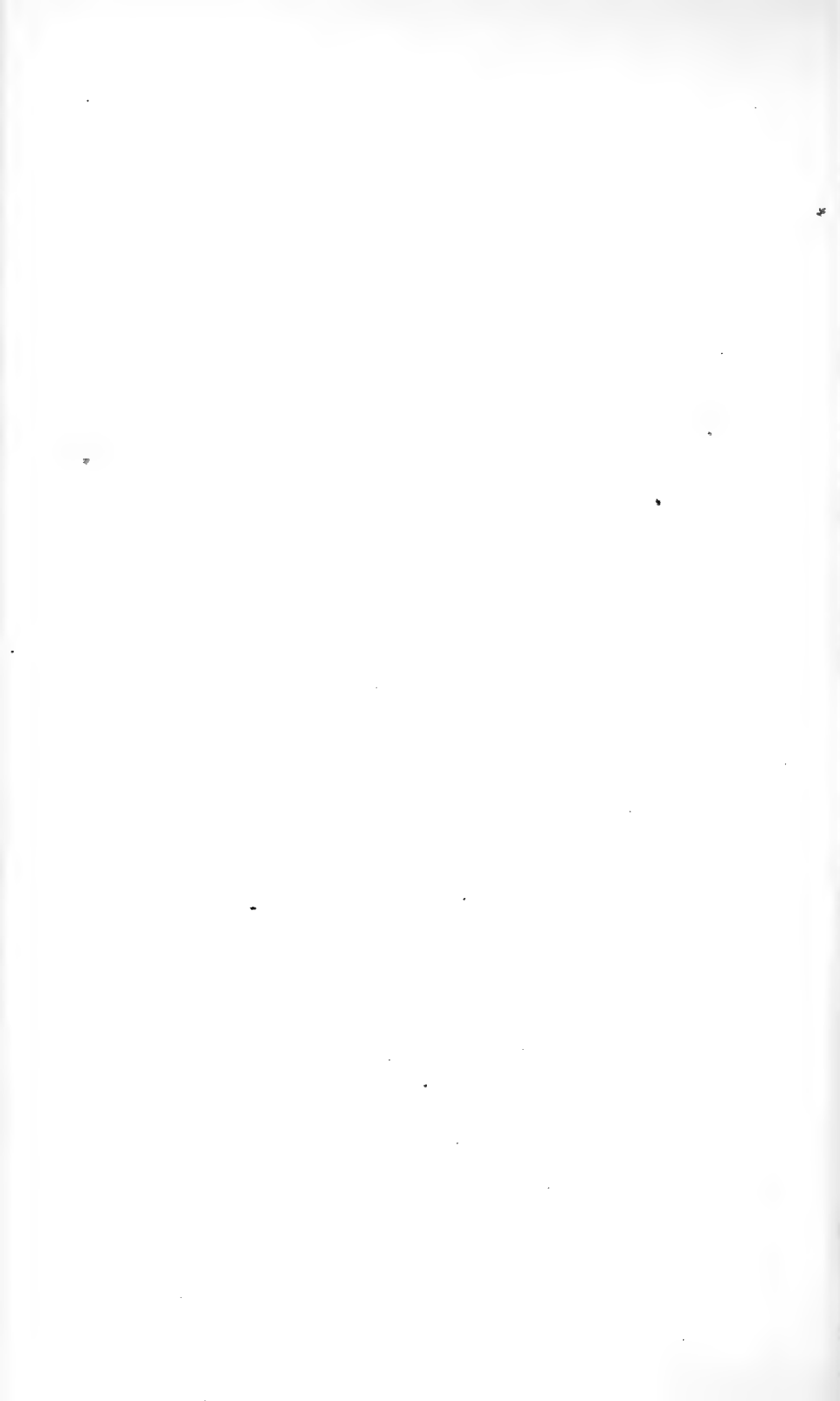

CONTENTS.

	Page.
SPECIAL NOTES	213
THE ORANGE ALEYRODES (<i>Aleyrodes citri</i> n. sp.) (illustrated).....	219
THE PEAR-TREE PSYLLA (illustrated).....	226
THE LANGDON NON-SWARMING DEVICE (illustrated)..... <i>Frank Benton</i> ..	230
NOTES ON APHIDIDÆ	235
..... <i>Herbert Osborn and F. A. Svirine</i> ..	
BELVOSIA—A STUDY (illustrated).....	238
..... <i>S. W. Williston, M. D.</i> ..	
OBSERVATIONS ON THE BOLL WORM IN MISSISSIPPI	240
..... <i>S. B. Mullen</i> ..	
NOTES ON ENTILIA SINUATA (illustrated).....	243
..... <i>Mrs. M. E. Rice</i> ..	
THE FOOD PLANTS OF SOME JAMAICAN COCCIDÆ—II.....	245
..... <i>T. D. A. Cockerell</i> ..	
OBSERVATIONS ON SOME HYMENOPTEROUS PARASITES OF COLEOPTERA.....	
..... <i>F. H. Chittenden</i> ..	247
REPORT ON THE AUSTRALIAN INSECTS SENT BY ALBERT KOEBELE TO ELL- WOOD COOPER AND B. M. LELONG.....	251
..... <i>D. W. Coquillett</i> ..	
THE GENUS DENDROTETTIX	254
..... <i>C. V. Riley</i> ..	
EXTRACTS FROM CORRESPONDENCE.....	256
Color of a Host and its Relation to Parasitism—Fowls and Toads vs. Gar- den Insects—Bisulphide of Carbon against Grain Pests; Addi- tional Correspondence—On Irrigation and its Effects on Insects—A tropical Honey Bee—A honey-producing Ant—The Jumping Bean again—A Boll Worm Crusher—Wax Moths in a Cupboard—On the Habits of some Blister-beetles—The Sweet-potato Root-weevil—A Weevil in Mullein Seeds—A new Enemy to Cypress Hedges in Califor- nia—Another vegetarian Mosquito—The Cluster Fly Household Pest— Chrysanthemums and the Drone-fly—The Orange Fruit-fly in Malta— Plant-bugs injuring Oranges in Florida—Fowls killed by Mole-crick- ets—Roaches in Brazil—Screw-worms and the man-infesting Bot in Brazil—The Chipping Sparrow and House Wren as Insect Destroyers— The Clover Mite in Houses again—A new Chicken Plague in Texas....	267
NOTES FROM CORRESPONDENTS	269
GENERAL NOTES.....	269
An Enemy of the 'Screw Worm Fly'—The Archippus Butterfly eaten by Mice—Notes on some Insect Pests of the Fiji Islands—Entomology at the Iowa State University—Local Names for common Insects—Kero- sene Emulsion Formulas—Legislation against Spraying—An Exhibi- tion of Spraying Machines—Economic Entomology at the Cape of Good Hope—Parasites of Animals transmissible to Man—Further Illustrations of the Rose Slugs (illustrated)—Cockroach Egg Para- sites—The Hymenoptera of Australia—The Genus <i>Mirax</i> —An Impor- tant Paper on Butterflies—The Tobacco Sphinx in Louisiana—Canker- worms in California—The Mediterranean Flour Moth in California— Tent Caterpillars in Massachusetts—Results of Codling Moth Legisla- tion in Tasmania—A Vine Pest in Australia—The Sugar-cane Pin-borer again—The Mustard Beetle in England—New Species and Genera of <i>Rhynchophora</i> —Westward Spread of the Clover-leaf Weevil—The larval Habits of the Acalyprate Muscidæ—A blood-sucking Chiro- nomid—The Family Apiceridæ—The California Remedy for the San José Scale—Introduction of the Long Scale into California—Imported Scales in California—The Membracidæ of North America—A new Enemy of the Tomato—An Insect Enemy of Lace Curtains—Locusts in South Africa—North American Species of <i>Hippiscus</i> —An extreme Case of Norway Itch—On Harvest Spiders—A curious Parasite of the Pelic- can—The Manna Scale—A curious Seed-pod Deformation—The Zebra Caterpillar on the Pacific Coast—Proceedings of the Entomological So- ciety of Washington—Obituary—Entomological Society of Washington.	



SPECIAL NOTES.

The Delay in this Number.—The publication of the present number of INSECT LIFE has been unusually delayed, partly on account of the illness and absence of the Entomologist during January, and partly for other reasons. The volume will probably be completed in five numbers instead of six as in Volume IV, and will contain approximately the same amount of matter as the preceding volumes.

Bulletin 20 of the Massachusetts Experiment Station.*—In this bulletin Prof. C. H. Fernald treats of several insects which have been selected at the request of the Massachusetts Society for Promoting Agriculture, the Society appropriating funds by which the edition of the bulletin has been increased to three times its usual size. The insects are all well known pests and while they have been carefully studied at the Amherst station, the author has attempted to present brief digests of habits rather than to give anything new. He recommends legislation to compel negligent farmers to destroy the nests of the Tent-caterpillar and to provide for its destruction on public lands and forests. The insects treated are canker-worms, Apple-tree Tent-caterpillar, Fall Web-worm and the tussock moths. The tussock moths mentioned are the common White-marked (*Orgyia leucostigma*), the Willow Tussock-moth (*Orgyia defnita*), and the Imported Tussock-moth (*Orgyia antiqua*). For canker-worms, banding and the Paris green treatment are recommended; for tent-caterpillars and Fall Web-worm the destruction of the eggs and tents, and for the tussock moths spraying with Paris green.

Bulletin 48 of the Cornell Experiment Station.†—In this Bulletin Mr. E. G. Lodeman discusses the efficacy of spraying apple orchards in a wet season against fungus diseases and insect pests, chiefly the Codling

* Hatch Experiment Station of the Massachusetts Agricultural College. Bulletin No. 20. Report on Insects. Amherst, Mass., January, 1893.

† Bulletin 48, Cornell University Agricultural Experiment Station. Horticultural Division. Ithaca, N. Y., December, 1892. Spraying Apple Orchards in a Wet Season. By E. G. Lodeman, Assistant in Horticulture.

Moth. With the results of the fungus treatment we will not deal, but his experiments from an entomological standpoint show that the insecticidal value of Paris green does not appear to be materially affected whether applied alone or in combination with Bordeaux mixture, while in the combination its value is greater than that of London purple similarly applied. During wet weather, applications should be made every seven to ten days, the cost of the combination spray being 7 cents per tree, or about 25 cents for four applications, this number being sufficient in even very wet seasons.

Root Knots on Fruit Trees and Vines.—The California Agricultural Experiment Station has published a little leaflet entitled Bulletin No. 99, on the subject of root knots on various fruit trees and vines. Mechanical galls, plant-louse galls, tubercle galls, club-root galls, and Nematode galls are treated briefly, and the principal portion of the leaflet is devoted to a consideration of some peculiar crown galls, usually arising from one side of the crown as a simple swelling of fleshy substance, about the consistency of a potato, or perhaps somewhat harder. Several theories accounting for the formation of these galls are discussed, and the whole question is left open. The remedy proposed is to remove and burn these galls as soon as found and make an antiseptic application to the point of removal. Bordeaux mixture is recommended for this purpose. The trees so treated should be examined from time to time, for at least a year, and the knot should be destroyed in case it reappears. All stock affected by the knot should be rejected, and great care should be taken to destroy everything showing any evidence of the disease.

The Agricultural Gazette of New South Wales.—The September (1892) number of this valuable publication has recently reached us. Mr. Olliff, the Government entomologist, announces the appearance in Australia of the San José Scale (*Aspidiotus perniciosus*) and the Greedy Scale (*Aspidiotus rapax*), hitherto known only in California. He summarizes the American remedies for these scales. A short illustrated account is given of two leaf-eating beetles which do considerable damage in vegetable gardens, the one being known as the Banded Pumpkin-beetle (*Aulacophora hilaris*) and the other as the Two-spotted Monolepta (*Monolepta rosea*). The Diamond-back Cabbage-moth (*Plutella cruciferarum*) is recorded from Tangoa, one of the New Hebrides, and the Potato Moth (*Lita solanella*) is reported as destroying Tobacco at Tamworth, New South Wales.

The Codling Moth in Australia.—The Department of Agriculture of New South Wales has published, as Entomological Bulletin No. 1, a 14-page pamphlet by Mr. A. Sidney Olliff, Government Entomologist,

on the subject of the Codling Moth. Mr. Olliff has given in a condensed form an account of the American observations on this insect, and has introduced some local matter of interest. He shows that in Sydney there are two, and probably three, annual generations. The remedies recommended are, as in this country, Paris Green, and the trap-bandage system. Reference is made to the recent use of a large number of lamp traps in orchards. Mr. Olliff's investigations, however, have failed to show that any good is accomplished by the use of lights. He states that he has had many opportunities of capturing moths at lights in orchards, and while the Codling Moth could be taken freely at dusk, on no occasion has he seen a single specimen of the pest attracted by the lamp. "Last season," he says, "Mr. P. C. L. Shepherd, who had been testing the usefulness of a lamp trap in an orchard infested by the Codling Moth, brought me the contents of his trap, and I found numbers of small *Geometrina*, *Noctuina*, and various *Tortricidæ*, but not a single specimen of the apple pest, and this is the result that has attended the examination of the contents of each lamp that has been submitted to me." This is quite in accordance with experience which we published over twenty years since in this country. The full-page plate accompanying the bulletin represents two sections of injured apples, some of the American natural enemies, the Codling Moth itself, and *Cacaecia postvittana*, an apple-feeding *Tortricid* which is sometimes mistaken for the Codling Moth.

Entomological News.—This periodical has lately made two innovations. It has begun a special economic department, edited by Prof. J. B. Smith, and no longer gives abstracts of the contents of foreign entomological journals, or of such only items as refer to American entomology. As to the former department a better choice than Prof. Smith could not have been made, though considering the large number of official publications, both State and national, more or less fully devoted to applied entomology, the demand for private publication on the subject cannot be pressing. The other innovation we regret and must view as a retrogression; for if there was one feature which made *Entomological News* unique and useful to all entomologists it was this bibliographical department. Even those who have access to the larger number of the entomological publications of the world cannot examine them all and a current statement of the contents of all in compact form is invaluable. Such a department might well be made more, rather than less complete, and would secure more subscribers than any other feature.

Kansas Injurious Insects.—A handy pamphlet of some 125 pages has just been published by the University of Kansas at Lawrence, entitled "Common Injurious Insects of Kansas," by Vernon L. Kellogg. The

matter is arranged according to the crops infested and is preceded by a short account of remedies in general and an introduction on the metamorphoses of insects. All of the principal crop pests are treated, each subject comprising the four sub-heads of Diagnosis, Description and Life-history, Remedies, and Kansas Notes. Under the latter head are given the original observations of the pamphlet. The author seems to have familiarized himself quite thoroughly with the literature and his summaries are well condensed and useful. The sixty-one figures are many of them borrowed, but about thirty are original. This is a more useful pamphlet than a similar one issued some four years ago by the Nebraska Experiment Station, largely on account of its condensation and practical arrangement, to say nothing of the evidently superior information of the author.

A New Wheat Insect in Minnesota.—In a recent bulletin of the Minnesota Agricultural Experiment Station* Mr. Otto Lugger presents a preliminary report upon a new insect injurious to Wheat, which will prove to be one of the frit flies, although the adult has not yet been reared. The insect is present in great numbers and promises great loss in 1893 unless remedial measures are undertaken. The insect hibernates in the culms in stubble fields, and Mr. Lugger advises the plowing up of all such fields. In some places during 1892 one-fourth of the entire crop was destroyed. The species may prove to be identical with that found in Canada and Kentucky, and which has been tentatively determined by Mr. Garman as *Oscinis variabilis* Loew.

A Tasmanian Handbook of Insect Pests.—The Department of Agriculture of Tasmania has issued as its first bulletin a little work entitled "A Handbook to the Insect Pests of Farm and Orchard: Their Life History and Methods of Prevention." Part I. By Edward H. Thompson. Launceston: 1892.

The author treats especially of the desirability of a quarantine against introduced pests, gives a section upon the life history of insects, some little account of injurious fungi, and dwells at length upon the Codling Moth. The other insects treated are the Oyster-shell Bark-louse of the Apple; the Woolly Root-louse; the common Pear Slug; the Cherry Borer Moth, as Henry Edwards's *Cryptophasa unipunctata* is called; the Bud Curculio (a species of *Perperus*); two apple-root borers (*Leptops hopei* and *Leptops robustus*); the Pear-blight Beetle, and a few other species of less importance. A list of twenty-one remedies is given, and five appendices follow, *a*, giving a list of insect-eating birds; *b*, a sum-

* University of Minnesota. Agricultural Experiment Station. Bulletin No. 23, St. Anthony's Park, Minn., September, 1892.

mary of Dr. Packard's classification of insects; *c*, an account of arsenical spraying; *d*, a paragraph on a fungus disease known as Black Spot, and *e*, on spray pumps and spraying materials. The work is of handy size, and is illustrated by fair wood-cuts, original in design and execution.

Recent Bulletins of the Delaware Experiment Station.*—In Bulletin No. 14 of this Station, which has been long delayed, Prof. A. T. Neal, the Director, reports the results of some experiments with fertilizers in combating insects, in which he comes to the conclusion that nitrate of soda excels potash and phosphoric acid compounds in its powers to protect plants against cut-worms and other insects affecting young corn. Mr. M. H. Beckwith follows with a short account of *Crambus caliginosellus*, which he found feeding upon corn at the Station and which we have already referred to on page 42 of Volume IV. As this insect is one of the old Clemensian species there would seem to be little need of the technical description which Mr. Beckwith gives.

In Bulletin No. 18† Mr. Beckwith treats of the Strawberry Weevil on pages 11 to 16. This insect, it seems, has been very destructive to the strawberry crop in parts of Kent County, Delaware, during the early summer of 1892, and Mr. Beckwith has made careful observations on the life-history of the insect, his results coinciding in the main with those which have been made in the vicinity of Washington and which were given in full in the last number of INSECT LIFE.

Bulletin No. 90 of the New Jersey Experiment Station.—In this Bulletin Prof. J. B. Smith, Entomologist to the Station, treats of grasshoppers, locusts, and crickets, particularly with reference to their injury, or supposed injury, to the cranberry crop. He finds that the general idea among the cranberry growers is that the true or short-horned locusts are responsible for the peculiar and common damage to the berries themselves, which consists in eating directly into the seed from one side of the berry. Prof. Smith shows that this damage is not done by Acridiidae but by Locustidae, and probably by one or two species of katydids. This point he reaches by comparison of the heads and digestive systems, as well as by examinations of crop contents and actual feeding experiments. He gives original illustrations of the mouth-parts of insects of these two families, as well as of certain crickets, and also shows by photographic reproduction the inner surface of the crop of one insect of each of these families, and also of a cockroach. The re-

* Delaware College Agricultural Experiment Station. Bulletin No. XIV. Newark, Delaware, December, 1891.

† Bulletin No. XVIII, September, 1892.

medial measures suggested for this particular damage are to keep the bog clear of other vegetation and as wet as consistent with good culture; to keep the marginal ditch wide, clean, and at least partially filled with water, and to keep the dams clear of vegetation.

The bulletin is an excellent illustration of the value of thorough, scientific work in settling mooted questions and correcting common error. We can see no good purpose, however, in encouraging the perpetuation of popular error in this country by rejecting the term "locust" for the short-horned locusts simply because the technical family name *Locustidæ* has come to refer to the long-horned species; while the argument of popular use is without force when dealing with popular error, and would oblige us to call "turtles" "salamanders," and "gophers" "turtles" in some parts of the country, or perpetrate many other ridiculous local usages, some of which are indicated in the item on popular names for our commoner insects in this number of *INSECT LIFE*. The more recent classifications will also give *Locustidæ* priority for the true or short-horned locusts (Smith's "grasshoppers"); include the long-horned species or true grasshoppers in the *Phasganuridæ* and the tree-inhabiting katydids in the *Pseudophyllidæ*.

New Publications of this Division.—Bulletin No. 28, entitled "The More Destructive Locusts of America north of Mexico," by Lawrence Bruner, was issued April 8, 1893. It consists of an illustrated account of 19 species of *Acridiinæ* which have occurred in this country in such numbers as to attract particular notice, or which from their known habits and relationships, are liable to become injurious. Each species is fully described in all its stages, so far as these are known, and its range and particular habits are given. The bulletin will enable the ready determination of the particular species in any future locust outbreak.

Bulletin 29, also just published, gives the concluding facts in the investigation of the Cotton Boll Worm (*Heliothis armiger*) which we carried on during 1891 and 1892, mainly through our former assistant, Mr. F. W. Mally, who is the author of the report. Few new facts are brought out, but the bulletin gives the results of some accurate experiments which will be of interest, and we trust of value, to cotton-growers in the regions where this destructive insect is particularly abundant.

Changes of Address.—For the benefit of the correspondents of three of our former assistants, Messrs. F. W. Mally, A. B. Cordley, and Nathan Banks, we wish to state that none of these gentlemen are at present connected with this Division. Mr. Mally's address is East Des Moines, Iowa; Mr. Cordley's is Pinckney, Mich., and Mr. Banks's is Sea Cliff, Long Island, N. Y.

THE ORANGE ALEYRODES.

(Aleyrodes citri n. sp.)

Order HOMOPTERA: Family ALEYRODIDÆ.

It has been our intention for some time to prepare an editorial paper on the curious little insects of this family, and we begin with what is perhaps the most important of the species in the United States. The family Aleyrodidæ is not a large one, although its species are of the greatest interest structurally and of frequent importance economically. Up to the present time less than fifty species have been described, and only four of our North American species have received names. All of the described forms have been placed in the genus *Aleyrodes* except

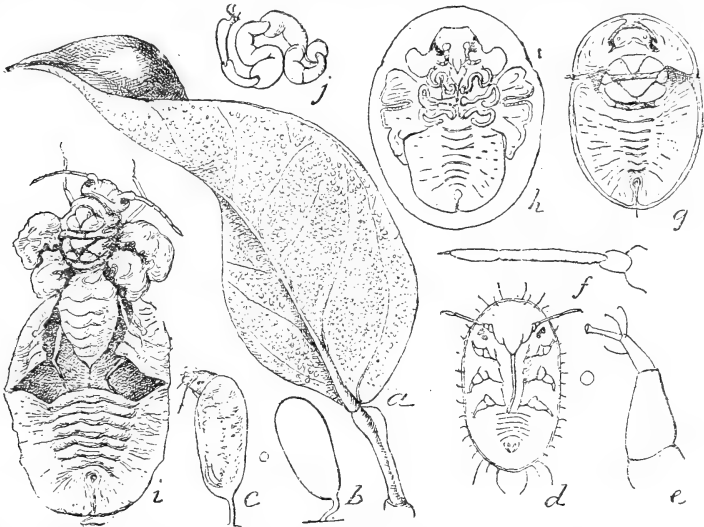

FIG. 23.—*Aleyrodes citri* Riley and Howard: *a*, orange leaf badly infested by full-grown larvæ—natural size; *b*, outline of egg; *c*, young larva in the act of hatching from egg; *d*, newly hatched larva seen from below—enlarged; *e*, leg of *d*; *f*, antenna of *d*—still more enlarged; *g*, advanced pupa; *h*, adult nearly ready to emerge and seen through pupa skin; *i*, adult with wings still unfolded in the act of emerging from pupa shell—enlarged; *j*, leg of *h*—still more enlarged (original).

three species, for which Signoret erected the genus *Spondylia* (afterwards found to fall before Maskell's *Inglina*, erroneously supposed by the latter to belong to the Coccidæ), and two other species for which Mr. A. C. F. Morgan has erected the genus *Aleurodicus* (*Ent. Month. Mag.*, vol. XXVIII, pp. 29–33, 1892). One of the American species, Shimer's *A. asarumis*, we also find to belong to *Aleurodicus*.

For many years an important and interesting species of the type genus has been known to infest orange trees in Florida and in more northern greenhouses, and more recently the same form has appeared in injurious numbers in the orange groves of Louisiana. In the *Florida Dispatch*, new series, vol. XI, November, 1885, this species received the name of *Aleyrodes citri* at the hands of Mr. Ashmead. The *Florida Dispatch*, however, is a local newspaper of no scientific pretensions,

and the description accompanying the name was entirely insufficient to enable recognition aside from the food-plant. We adopt the name in connection with a full description, not with a view of encouraging such mode of publication, which is not sanctioned by the canons of nomenclature formulated and generally accepted, but as a manuscript name, satisfactory in itself, the authority to be recognized for it being comparatively immaterial.

Our first acquaintance with the species was in June, 1878, when we found it occurring in profuse abundance on the leaves of the citrus trees in the orangery of this Department. Some observations were made upon its life-history during that summer, and all of its stages were observed. During the following years we observed it in Florida and it was studied by two of our agents, Mr. H. G. Hubbard, at Crescent City, and the late Jos. Voyle, at Gainesville. The species was not treated in Mr. Hubbard's report on the insects affecting the Orange, as we wished to give it a fuller consideration than could then have been given, and other duties prevented doing so in time. Moreover, at the time when Mr. Hubbard's report was prepared the insect had not become of especial economic importance.

Since that time many further notes have been made in Washington, and we have received the species from Pass Christian, Miss., New Orleans, La., Baton Rouge, La., Raleigh, N. C., and many Florida localities, and during the past year or two it has become so multiplied in parts of Louisiana and Florida as to deserve immediate attention.

DESCRIPTIVE.

ALEYRODES CITRI n. sp. **EGG** (Fig. 23*b*).—Length, from 0.2^{mm} to 0.23^{mm}; with a comparatively slender pedicel or foot-stalk about one-third the length of the egg proper and somewhat knobbed at base. Width about one-fourth the length, widest portion somewhat beyond the middle or at about the point where the eyes of the embryo are subsequently seen. Surface highly polished, with no sculpturing; color pale yellow with a faint greenish tinge, somewhat darker than the under surface of the orange leaf; stem very pale brownish, darker at base. Surface frequently appearing pruinose.

LARVA.—*First stage* (Fig. 23*d*). Length when first hatched about 0.3^{mm}; color, pale greenish-yellow, with two large irregular darker yellow spots on the dorsum of the abdomen; all four eyes purplish-red; shape regularly elliptical; margin of body with 38 minute tubercles, each bearing a bristle of which 4 anal and 6 cephalic are specially long; abdominal segments well separated and especially visible ventrally; cephalo-thoracic and thoracic articulations invisible. Antennæ 3- or 4-jointed; basal joint short and stout; joint 2 somewhat longer than joint 1 but narrower; joint 3 four times as long as joint 2 and about one-half as wide; joint 4 one-half as long as 3 and of equal width, the articulation between 3 and 4 very difficult to define and frequently invisible. Legs very short and stout; tarsi with three crotchets and a flat disc at tip. Rostrum apparently ex-articulate, the extensile portion reaching beyond hind coxæ. Anal orifice semicircular in shape and bounded posteriorly by a slight chitinous thickening of the integument. *Second stage*. Broadly ovate, flat; color immediately after the molt almost white with an irregular longitudinal greenish-yellow spot on side of dorsal line, covering joints 4 to 7 of the abdomen, and a faint greenish-yellow spot near anterior outer angle of prothorax; eyes small, more distinct than in first stage, purplish in color. Entire dorsum densely rugose; tubercles of the margin absent except two on head and four at the anal end of the body. **A**

distinct slit is visible dorsally from the anal opening to the hind margin of the body; projecting from the anal opening is a conical truncate organ bearing a central papilla. Legs extremely short and stout, almost rudimentary and difficult to distinguish. Antennae in this stage have not been made out. *Third stage.* Almost precisely resembles second stage except from its greater size. No sex distinction yet noticeable. *Fourth stage.* Length about 1.4 mm, width, 1 mm. Quite similar to third stage, but all marginal tubercles and bristles are lost except a minute bristle on each side some distance anterior to the terminal cleft. Dorsal surface densely rugulose, with numerous fine and granulate striae, becoming more distinct toward the margin, giving this almost the appearance of being serrate. Shape broadly oval, flat, with a slight median longitudinal carina crossed by 12 short transverse ridges indicating the segments. Color, pale green, almost translucent, and resembling so closely the appearance of a leaf that the insect is extremely difficult to detect with the naked eye. Dividing line between head and thorax, with transverse dorsal ridges and

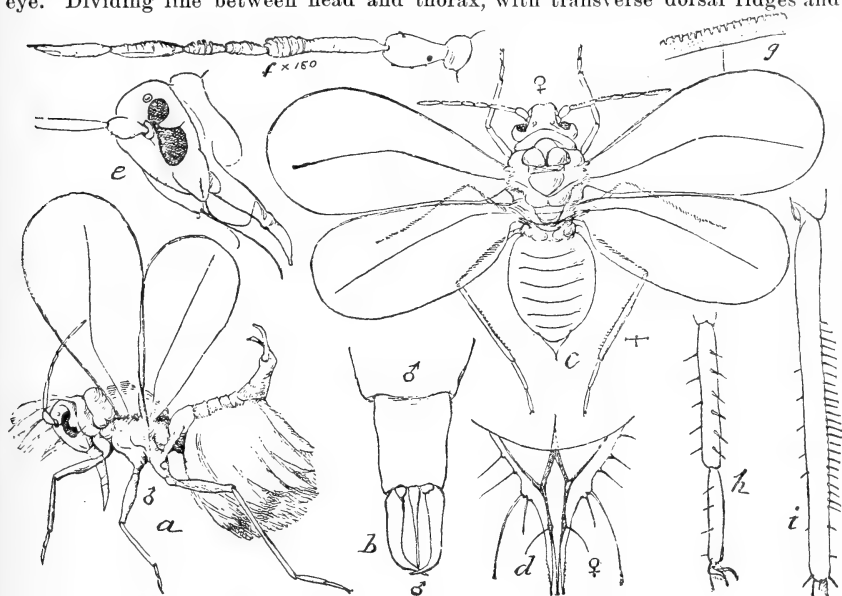

FIG. 24.—*Aleyrodes citri* Riley and Howard: *a*, adult male seen from side and showing waxy tufts, *b*, anal segments and claspers of same seen from above; *c*, adult female seen from above, with wings spread; *d*, anal segment and ovipositor of the same; *e*, head of same from side; *f*, antenna of same; *g*, costal border of fore-wing; *h*, hind tarsus; *i*, hind tibia; *a* and *c* enlarged, *b*, *d*, *e*, *f*, *g*, *h*, *i* still more enlarged (original).

margins of the anal cleft sometimes pale yellowish, with the anal opening more or less distinctly orange; eyes invisible; legs and antennae short and stout, the latter appearing inarticulate; tarsi terminating in a large sucking disk.

PUPA (Fig. 23 *g*).—Length, when fully mature, 1.4 mm, transverse diameter, 0.8 mm to 1 mm; broadly oval; color, pale greenish-yellow, becoming more yellowish when maturing; thoracic lobes and spaces between dorsal carinae of abdomen of a brighter green; a distinct orange or sometimes quite bright red medio-dorsal spot at anterior end of abdomen; anal ring, brown; eyes, purplish. A low medio-dorsal ridge or carina and corresponding depressions each side of it extends from the head to the anal ring, traversed by short transverse ridges on the thorax and on the abdomen, terminating in a low subdorsal ridge; from these ridges numerous very fine granulated striae radiate all around the body to the lateral margin; a short transverse ridge near posterior margin of head and a curved impressed line in front of it. A minute brown tubercle at the anterior end of the subdorsal carina. From a pore at the edge of the body, between the head and thorax and tip of anal slit, issues a very

fine glistening white curled thread of excretion. Legs and antennæ of the pupa can not be made out, but after the imago has left the shell they are quite readily traced in the exuvium. Antennæ short and stout, apparently 3-jointed, though the divisions are much obliterated; the last joint longest, almost as long as the other two combined, with quite a number of irregular annulations; tip provided with a stout spine. Antennæ folded backward covering almost completely the anterior pair of legs, which are projected forward. Legs short and very stout, especially the two posterior pairs. There is scarcely an indication of a division between the different joints. Tarsus very short, stout, and rounded, with quite a long claw at tip. Anal opening dorsal, semicircular, and protected by four slender, forward-directed hairs.

IMAGO, ♀ (Fig. 24 c).—Length, 1.4^{mm}; expanse, 2.8^{mm}; four-jointed rostrum about as stout as legs; joint 1 shortest, joint 2 longest, and about as long as 3 and 4 together; joint 3 somewhat longer than joint 1 and a little shorter than 4. Joint 1 of the 7-jointed antennæ very short, as broad as long, subcylindrical, slightly wider distally; joint 2 twice as long as 1, strongly clavate, and at tip somewhat broader than 1, bearing 3 or 4 short hairs arising from small tubercles; joint 3 longest, about twice as long as 2, slenderer than this and with a very narrow insertion, rather abruptly stouter at apical third, corrugated and terminating above in a small callosity resembling a similar organ in *Phylloxera*; joints 4 and 5 sub-equal in length, each nearly as long as 2, joint 5 bearing a short spine anteriorly near apex; joints 6 and 7 sub-equal in length, each somewhat longer than 2, 7 with a stout spine at tip; joints 4 and 7 somewhat corrugate or annulate, but less so than apical third of 3. The 2-jointed tarsi about half the length of the tibia, joint 1 of the hind tarsus bearing 6 rather stout spines on each side; joint 2 supporting at base 3 rather prominent claws, the middle one longest. Ovipositor short, acute, and retractile. Eyes divided into two by a curved pointed projection from middle of cheek, the upper portion being smaller than the lower portion. Wings clear, colorless; costa delicately serrate. General color, light orange yellow, tip of rostrum black, tarsi and part of tibia orange.

IMAGO, ♂ (Fig. 24 a).—The male resembles the female in all important respects except in being smaller. Claspers about as long as preceding abdominal joint, or one-fifth the length of the abdomen, curved gently upwards and inwards, each bearing 4 or 5 equidistant minute cylindrical piliferous tubercles on upper and outer edge; style almost as long as claspers, rather stout at base, more slender toward tip terminating in a stout spine at upper end. Head and abdomen with heavy tufts of wax soon after issuing from pupa.

HABITS AND LIFE HISTORY.

As a rule the insect passes the winter in the full-grown larval condition. The detailed observations have all been made at Washington, and dates and periods will doubtless vary considerably out of doors in the Gulf States. Here, however, the adult insects issue during April, and begin to lay their eggs about or before the middle of the month. The eggs are attached to the under sides of the leaves by means of the pedicel described above.

Twenty-six females were examined by crushing the abdomens under a cover glass, April 21, to ascertain the number of eggs. This was found to vary from 7 to 25, but many of those examined had evidently already oviposited to some extent, and it is safe to say that the average number is close to the maximum of these figures.

Adults which have hibernated as full-grown larvæ continue to emerge as late as the middle of May, but where the leaves are badly attacked so as to be practically incrustated with the insects, about 2 per cent never

succeed in emerging. This is almost invariably the case when the hinder part of the body of one individual overlaps the fore-part of the body of another. The skin of the latter may then split, but the adult is unable to lift the body of the other sufficiently to issue unharmed. When the insect is ready to emerge from the pupa shell, the skin splits along the median line from near the front edge of the head to the front edge of the abdomen, and thence transversely to the lateral margin, as indicated in Fig. 23 *i*. The thorax of the adult insect is then pushed out first, and afterwards, gradually and slowly, the head. After the head has been extruded the insect remains stationary in an upright position. The legs seem to be free at this stage, but are not withdrawn from the pupa shell. The wings are rolled up as indicated in the figure just referred to, and make their appearance with extreme slowness, the legs remaining within the shell apparently to give a purchase which assists in this extrusion of the wings. Just before the adult is ready to issue from the pupa shell the latter becomes transparent, so that the contained insect, shrunken away from the skin, is plainly seen in all of its details, as shown at Fig. 23 *h*. In this stage the insect looks like the pupa of a Psyllid.

The color of the adult just after issuing differs somewhat from that of the more mature individuals. The thoracic lobes are bright lemon-yellow and highly polished, the head and prothorax are milk white, the antennæ pale yellow, eyes reddish brown, ocelli colorless, lower lobe of eyes purple. The wings at first appear perfectly colorless and transparent with the costa pale yellowish, the powdery whiteness so characteristic of these flies gradually appearing.

The eggs seem to be laid by preference upon the new leaves in April and May, although old leaves are also frequently well covered. The eggs remain usually about two weeks at this time of the year before hatching, although some remain unhatched for three weeks or a little longer. The egg splits along the margin at the end farthest from the pedicel and extending for some distance down the sides, so that when the young larva issues the eggshell resembles to a slight extent a bivalve shell, especially that of a freshwater clam.

The young larva is comparatively active, and crawls usually a short distance from the shell before beginning to feed. It remains in the first stage from two to four weeks before molting. The cast skins are very delicate and usually drop to the ground or are blown away by the wind, so that very few of them remain attached to the leaf. The exact periods between the succeeding molts have not been satisfactorily ascertained, but by June 14 a majority of the individuals have cast three skins.

In preparing for a molt the insect curves the abdomen upwards at considerably more than a right angle, moving it also occasionally up and down. The margin of the abdomen has at the same time a slightly undulating motion. During these movements the insect is shrinking away from the lateral margin until it eventually occupies only about one-third of the original lateral space, causing a distinct dorsal and

ventral median ridge. The skin then splits, not on the dorsum, as would be expected, but either at the anterior end or underneath the head. The head and prothorax are then pushed out and the skin is gradually worked backwards by means of the abdominal motions, the portion already out swelling as soon as it is free.

By the end of June the adults begin to issue in numbers, and experiments were made at this time to ascertain the length of life of the adult with the result that while one individual lived for 20 days, the great majority died before the end of 9 days. Some experiments made during the latter half of May show that the life duration is considerably shorter in the spring, the longest lived individuals reaching only the age of 7 days. Retarded individuals in the Insectary emerged the middle of August.

Eggs were again laid by these adults and since no further flight of adults was noticed, full-grown larvæ from these eggs in the main carried the species through the winter, making but two annual generations.

The dates given in the above account of the life history correspond reasonably well with those of corresponding periods in the insect's life in Florida, as indicated by the receipt of many specimens from Mr. C. H. Foster, of Manatee, during April and May. March 31 the specimens received from this gentleman were all in the last larval or pupal stage. April 6, eggs had already been laid, and from his correspondence we gather that oviposition continued until April 19. In a letter just received Mr. Foster informs us that adults were observed flying during March and April, June and July, and in September, thus indicating three annual generations in Florida.

In Louisiana, where the insect is known as the "White Fly," the species hibernates in the same way, as we learn from Prof. H. A. Morgan, and is especially injurious to nursery stock, causing a very marked check in the growth.

REMEDIES.

The most satisfactory remedy consists in the use of the ordinary kerosene emulsion sprayed at the proper time. Mr. Foster was kind enough to send us the most abundant material from trees in his orchard which he sprayed with standard emulsion upon our recommendation in the spring of 1892, and from careful laboratory examination of this material, from both sprayed and unsprayed trees, we are able to speak with some certainty as to the effects of the applications. In February Mr. Foster wrote us concerning an application which he had made of a lime and sulphur wash to a certain proportion of his trees. Samples which he sent indicated that more than half of the insects upon the treated trees were still alive. We advised him to substitute the kerosene emulsion and to spray at the time when adult insects were most abundant and again at the time when the young lice had issued for the most part. His first kerosene emulsion spraying was performed on March 30, and examination showed that out of a total of 229 full-grown larvæ and pupæ 157 had been killed by the application. Later spraying was performed

on the 9th and 14th of April, and while the spray destroyed the adults which it struck, the eggs were somewhat variously affected. Many of the lice received with check lots from unsprayed trees failed to hatch in both instances, the death of the leaf seeming to affect the vitality of the insect.

Several satisfactory lots were received later, however, from which by comparing the hatched with the unhatched eggs we were able to approximate the proportion destroyed by spraying. Thus, on May 6 two batches of leaves were received, the one from unsprayed trees and the other from sprayed trees. On eight leaves of the sprayed lot there were approximately 20,500 eggs, ranging from 1,000 to 5,000 on each leaf. Of these 1,230 had hatched, or about one-sixteenth, while upon the check leaves unsprayed the proportion of hatched eggs ranged from one-half to three-fourths of the whole, the remaining ones being still sound. It must be remarked further that only a small proportion of the larvæ which had hatched from the eggs upon the sprayed trees had settled and appeared in a healthy condition, but owing to the fact that the leaves were plucked and transmitted through the mail, we are unable to state the precise significance which this condition of affairs may have. It was noticed, however, that upon the unsprayed leaves a considerable portion of the larvæ were still present, some already in the second stage and apparently in a healthy condition.

Another spraying was made by Mr. Foster upon May 4, at which date the majority of the eggs had hatched. Here again transmission through the mail dissipated any exact conclusions to be arrived at from the office examination, but the indications all favor the conclusion that the spraying was successful. Large numbers of egg shells were found upon leaves sent in after this spraying, but very few larvæ were found. The great majority had apparently been killed and had dropped. Of those which settled the greater number were dead and had turned brown and at least one-half of the few still alive were apparently affected by the emulsion. In round numbers about one-tenth of one per cent of the hatched larvæ were still living and as just stated only about one-half of these appeared healthy.

From these experiments we may state that the best time to spray is after the eggs have hatched, and we may approximately indicate as the best means of selecting the proper time, say three weeks after the bulk of the adult insects of the spring brood are seen to be flying about the trees. This should be supplemented by spraying at the corresponding period in September, and as a result the numbers of the insects will probably be reduced to such an extent that they will do little injury the following year unless the trees are again stocked from neighboring unsprayed groves.

NATURAL ENEMIES.

The ordinary scale-feeding insects, so many of which have been enumerated in Mr. Hubbard's report on insects affecting the Orange, feed

with equal rapacity upon this insect. From this particular species we have reared no parasites, but in general the Aleyrodidæ are quite subject to the attacks of Hymenopterous parasites peculiar to them. We have reared several species of these parasites from other species of this family in this country, but we will leave their characterization and consideration to a future article, in which we hope at the same time to describe several species of the family Aleyrodidæ found commonly upon different trees in the United States.

THE PEAR-TREE PSYLLA.

As an elaboration of the short paper published in No. 2 of the current volume of *INSECT LIFE*, and first read before the Association of Economic Entomologists at Rochester, Mr. Slingerland gives the results of his observations upon this important pear tree pest in one of the most creditable and useful of the station bulletins.*

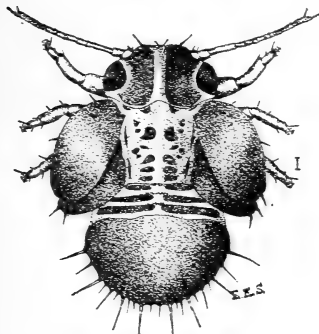

FIG. 25.—*Psylla pyricola*: full-grown nymph, dorsal view—enlarged (after Slingerland).

Psylla pyricola is an old offender and its natural history has been repeatedly treated both in Europe and America, but never before so thoroughly as has been done by Mr. Slingerland. It appears from his careful observations, made in 1892, that the hibernating imagos emerge from their winter retreats on the first warm days of spring, copulate, and commence

to lay eggs about the middle of April. The eggs hatched about four weeks later, and the imagos of this first summer generation appeared from June 10 to June 15. The cycle of the second generation was completed about one month afterwards, that of a third generation also one month after the second (about August 20), and the imagos of a fourth generation, which issued toward the end of September, lived throughout the winter.

The development of the second generation was carefully followed out with the following result:

Duration of egg state from 8 to 10 days.

First larval stage: duration six or seven days. Larva 0.013 inch in length, antennæ 3-jointed; wing-pads not visible; general color pale translucent yellow, without markings; abdomen more opaque and darker.

Second larval stage: duration about four days. Larva one-third larger than first stage, but of same color, except that the tips of antennæ are black. Antennæ 4-jointed; segments of abdomen more distinct, and wing-pads developing.

Third larval stage: duration about three days. Larva 0.027 inch in length; black



FIG. 26.—*Psylla pyricola*: adult—enlarged (after Slingerland).

* Bulletin 44, Cornell University Agricultural Experiment Station, Entomological Division. Ithaca, N. Y., October, 1892.

markings begin to appear; wing-pads larger and blackish; antennæ 6- or 7-jointed, the last three joints being black.

Fourth larval stage: duration about four days. Length of larva 0.038 inch; black markings usually quite distinct; wing-pads still larger; antennæ 8-jointed.

Fifth stage: duration five or six days. This proved to be the pupa state, and the pupa differs from the preceding larval stage only in the more intense and more numerous markings on the thorax.

Not the least interesting point in Mr. Slingerland's account is the discovery that *Psylla pyricola* offers a very marked example of seasonal dimorphism. That hibernating imagos of Psyllidæ usually differ from the summer generation in the more intense coloration of the body, and sometimes also of the wings, has long been known, and the explanation given for this difference is that Psyllidæ acquire their full coloration very slowly and that the older they become the more pronounced and darker are the markings. The short-lived summer generation or generations are thus, as a rule, lighter-colored than the long-lived winter generation, and the latter gradually acquires the more intense color. This is well exemplified in our common *Trioza tripunctata* Fitch and *Aphalar acalthe* L., which have at least two annual generations,* but in these instances there is no sharp delineation between the summer and winter forms. Now, Mr. Slingerland establishes the fact that in the winter generation of *Ps. pyricola* there is no such gradual change in coloration, but that in the fall of the year there issues from the nymphs a hibernating generation of imagos which are at once uniformly different from the imagos of the summer generations. Mr. Slingerland says:



FIG. 27.—*Psylla pyricola*:
Egg—enlarged (after
Slingerland).

The hibernating adults differ from the summer adults in size, being nearly one-third larger; in their much darker coloring, the crimson becoming a dark reddish brown; and especially in the coloration of the front wings. The summer forms or typical *pyricola* have the veins, even in darker specimens, of a light yellowish brown color, and the whole front wing has a slight yellowish tinge. The veins of the wings of the hibernating adult are invariably of a dark brown or black color; the front wings are quite transparent, with more or less blackish shades in the cells and a blackish shade in the basal cell along the whole suture of the clavus. The male genitalia differ slightly in size in the two forms.

This winter form has been identified as the *Ps. simulans* Förster, which by European authors has always been considered as specifically distinct from *Ps. pyricola*.

The discovery of this seasonal dimorphism is certainly a matter of great interest, but that the last word has not yet been said on the subject would appear from the fact (overlooked by Mr. Slingerland) that

* Other hibernating Psyllidæ, which, in all probability, have two or more annual generations, *e. g.*, our common grass Psyllids, *Livia vernalis* and *L. maculipennis* Fitch, do not differ appreciably from the summer forms. All specimens of the genus *Pachypsylla* found in early spring are darker or more sordid than those found late in the fall, but in this genus there is no summer generation of imagos.

Psylla simulans is in Europe a summer form. Dr. Franz Löw* distinctly states: "The imagines were found in summer on these plants"

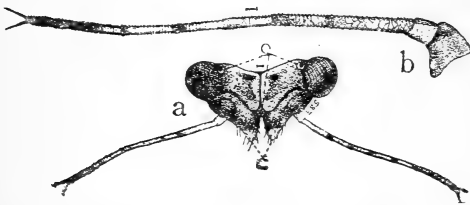

FIG. 28.—*Psylla pyricola*: a, head of adult, front view; c, cones of clypeus; o, ocelli; b, antenna of adult—all enlarged (after Slingerland).

[*Pyrus malus* and *P. communis*]; and at another place† he states that the specimens were found by himself: "I found this species hitherto only on the apple tree in company with *Ps. pyricola*." Mr. John Scott‡ says of his *Ps. pyri* (= *simulans*): "It lives on pear trees, and is to be found from June to October;"

but this is apparently not based on actual observation, and probably taken from Curtis's account of *Psylla pyri* (= *pyricola*). Finally, it is more than probable that hibernating specimens of *Ps. pyricola* have been collected and examined by authorities in Europe. Dr. Fr. Löw would scarcely have made the statement regarding the hibernation of this species without having seen specimens found in winter time.§

There is plainly an error somewhere and the following explanations suggest themselves: (1) Either Mr. Slingerland may have been dealing with two distinct species occurring at the same time on his trees; or (2) we have been mistaken in the identification of the winter form as *simulans* (the determination was made from a study of descriptions and not from comparison of specimens); or (3) the European observations are faulty; or (4) the hibernating form in central Europe extends into summer. We feel confidence in Mr. Slingerland's views, and shall expect the final explanation to justify them.

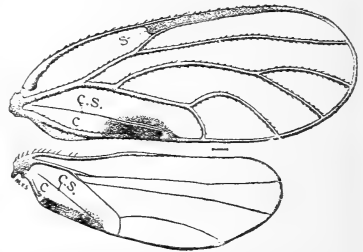

FIG. 29.—*Psylla pyricola*: venation of wings; s, stigma; c, clavus; c.s, claval suture—enlarged (after Slingerland).

The various life-habits of both the adolescent and adult stages of the insect are more or less fully dealt with by Mr. Slingerland, and of the many interesting and novel observations we select here for quotation those made on the honey-dew:

Many have supposed that the honey-dew, so conspicuous a feature in severe attacks of this pest, is the sap of the tree which exudes through the punctures made by the insects. As the honey-dew occurs in such immense quantities it does seem almost impossible that it is wholly the secretion of the little creatures. All of this fluid does, however, first pass through the body of the insect. The amount which a

* Uebersicht d. Psyll. von Oesterreich-Ungarn, etc., 1888, p. 15.

† Neue Beiträge, etc., 1886, p. 157.

‡ Trans. Ent. Soc., London, 1876, p. 537.

§ In his Revision d. paläarct. Psyll., 1882, p. 232, Dr. Löw seems to be inclined to consider *Ps. argyrostigma* Först. as the winter form of *Ps. simulans*.

single individual will secrete during its lifetime is small, but when many thousands of the insects occur on a tree the aggregate becomes large. A single nymph isolated in a cage secreted at least four drops (*i. e.* four minims) of the fluid before it became an adult. Thus fifteen nymphs would secrete one drachm.

The food of the insect consists entirely of the sap of the tree. * * * In the case of the nymphs most of the food is elaborated into honey-dew; some is assimilated, and the waste matter voided as excrement. The adults, however, seem to secrete no honey-dew, all the food being assimilated. Consequently the adults void considerable quantities of excrement, much more than do the nymphs.

The honey-dew and excrement are very different substances, but the fact does not seem to have been before observed. The honey-dew is a clear, water-like liquid and forms into globules when secreted. The excrement, however, is a whitish semi-solid substance which is voided in long cylindrical strings or minute whitish balls which roll from the anus like quicksilver globules. * * * Many observations were made to discover, if possible, the manner in which the honey-dew was secreted by the nymphs. It has been supposed that the secretion came either from the long so-called wax-hairs around the edge of the abdomen, or from excretory pores on the dorsum of the abdomen. Globules of honey-dew were, however, seen attached to the nymphs in such a position that it seemed very improbable that it came from either of the above sources; it seemed that it must have been secreted from the anus of the nymph. A German observer now asserts that the honey-dew secreted by the common plant-lice or Aphids comes from the anus, and not from the honey-tubes as commonly supposed.* Honey-dew thus seems to be what might rightly be called the fluid excrement of the insect.

A full account is given of an extensive series of experiments to ascertain the best remedy. All experiments upon the eggs failed but the young nymphs were shown to be very susceptible to the action of kerosene. The standard emulsion, even when diluted with 25 parts of water and thus containing less than 3 per cent of kerosene, was very efficacious. From 75 to 90 per cent were killed with one spraying in this proportion. The nymphs have a habit of clustering in the leaf axils and as the liquid naturally runs down the leaf petioles and twigs the insects are readily reached. Two quarts of the dilution were sufficient for a large dwarf pear tree and thirteen such trees can easily be sprayed in half an hour with a knapsack sprayer. The best time to spray is said to be in the early spring just after the leaves have expanded.

Very full technical descriptions are given of the full-grown nymph and the summer and winter forms of the adults.

In the description of the imago Mr. Slingerland introduces for the various parts of the body a terminology which differs from any other in use for this family. In fact, in the Psyllidæ we have almost as many different terminologies as there are authors. This by no means facilitates the study of these insects, and there is no good reason for the term "clypeus" or "cones of the clypeus" (see Fig. 28, *c*) for that part of the head which, following Löw, we have called "frontal cones" (Scott's "face lobes"). In Psyllidæ the clypeus is to be looked for on the underside of the head where it is visible as a more or less knob-shaped (very rarely more elongate) protuberance a little in front of the anterior coxæ. The

* M. Büsgen, *Jenaische Zeitschrift*, vol. xxv, pp. 339-428 (1891).

term "epicranium" used by Mr. Slingerland is no improvement on "vertex" (Scott's "crown of the head.")

The penis in *Psyllidæ* is not a paired organ as described by Mr. Slingerland but consists of a single very slender tube which is geniculated in the middle. In most cabinet specimens it is either folded up and entirely hidden from view within the trough of the lower genital plate or only the angle formed by the geniculation of the middle is visible.

Mr. Slingerland calls attention in a note to a stupid error in the translation from Löw in *INSECT LIFE* (vol. IV, p. 127.).

Original figures are given of the egg, the full-grown nymph, the adult insect, enlarged genital segments of the male and female, of the head and antennæ of the adult and of the venation of the wings. With the author's permission and assistance we reproduce some of these. The bulletin closes with a careful bibliography and synonymy.

THE LANGDON NON-SWARMING DEVICE.

By FRANK BENTON.

Complete control of natural swarming has long been regarded by apiarists as one of the most desirable points to accomplish in connection with their pursuit. Yet, up to the present time, notwithstanding the improvements which modern ideas in apiculture have suggested in this direction, they have had to admit it one of the most puzzling with which they have had to do.

The advantages in being able to suppress at will and without detriment to the colony the desire on the part of the bees to swarm are numerous. Chief among these may be mentioned: There need not then be the great interruption to honey storing which the issuance of swarms brings in the height of the honey yield. The apiarist could have all his return in the shape of honey instead of partly in the form of swarms, clearly an advantage when the number of his colonies had reached the limit of his field or as many as he could well care for and remunerative prices could not be obtained for the surplus stock. The time and labor expended in watching for and hiving swarms would be saved. Losses through the absconding of swarms would be avoided. Even with all reasonable care such losses often occur.

Centuries ago the Greeks recognizing some of the advantages which the control of swarming would give to the bee-keeper, practiced with their basket-hives furnished with bars across the tops, the transfer of combs with adhering bees to new hives thus forming artificial swarms. This is interesting to note as being the first recorded attempt to control swarming. Contardi, who wrote in 1768, describes these hives and says: "When the bees should swarm those people do nothing but to take out some of these bars to which the bees attach their combs, and

they place them upon another basket or hive. It is in this manner that the Greeks multiply their hives." The abbot, Della Rocca, of Syra, in the Grecian archipelago, in his *Traité complet sur les Abeilles*, published at Paris in 1790, mentions this as "a method of the ancient Greeks for the multiplication of swarms, which is employed today by the inhabitants of the Island of Candia." And Liger, the author of *La Maison rustique*, in the eighth edition published in 1742, gives a figure of one of these basket hives, which is here reproduced (Fig. 30).

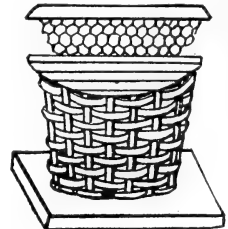

FIG. 30.—Ancient Greek movable comb hive. (From *La Maison rustique*, published in 1742).

Most of the systems of preventing or limiting natural swarming have depended upon the formation of a limited number of artificial swarms, frequent destruction of queen-cells by the bee-keeper, close use of the honey-extractor, the combining of after-swarms, changing places for hives, replacing of all queens annually, supplying empty space for comb-building below the brood-nest or between the brood-nest and flight-hole, or there has been some combination of these methods.

NON-SWARMING BEES, AUTOMATIC SWARM-HIVERS, ETC.

From time to time queens have been advertised as bred from "non-swarming strains of bees." While it is very reasonable to suppose

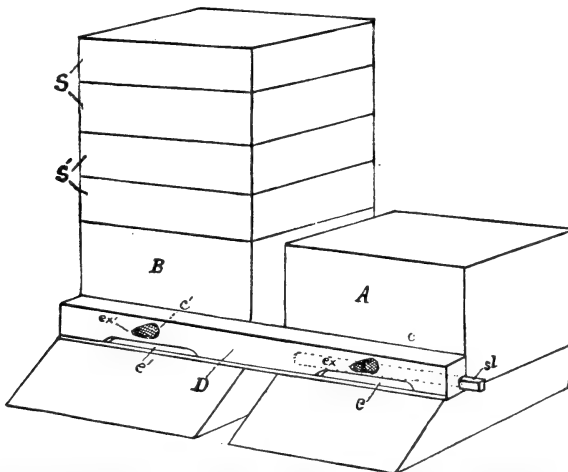

FIG. 31.—Bee-hives with Langdon non-swarmers attached: A, B, hives; S, S', supers; D, non-swarming device; e, e', entrances corresponding to hive-entrances; sl, slide for closing entrance; c, c', conical wire-cloth bee-escapes; ex, ex', exits of same.

that the inclination to swarm might be decreased considerably by long-continued, careful selection, such as could be given had we better control over mating, it is safe to say that comparatively slight permanent results have thus far been attained in this direction. And since swarms

would issue various devices have been constructed to warn the owner or to prevent loss during his absence. Electric attachments and telephone lines have been put up, adjusted entrances to confine queens, traps to catch the latter, and decoy-hives have been used, and at last the automatic or self-hiver has been evolved after many experiments and much thought on the part of apiarian inventors. Although the self-hiver in its more perfected form has scarcely been subjected to a thorough test it promises to do all that has been expected of it. But it will not

TAKE AWAY THE DESIRE TO SWARM.

This is exactly what Mr. H. P. Langdon, of East Constable, N. Y., says he can do by the use of the non-swarming attachment invented by him and now for the first time made public. Moreover, he keeps all of the field force of his colonies storing surplus honey under the most favorable conditions as long as there is any honey to be obtained in field or forest, and simplifies to such an extent the work of the apiary during this portion of the year that he can attend to several times as many colonies as under the old way.

The immediate condition which incites a colony of bees to swarm has been quite well recognized as its general prosperity—its populousness, the abundance of honey secretion, and crowded condition of the brood combs, or, in general, such circumstances as favor the production of surplus honey, especially surplus comb honey, and it has of course been taken for granted that honey could not be secured if these conditions were changed. Nor would it, without any knowledge of the system proposed by Mr. Langdon, be easy for experienced bee-keepers to believe that all it proposes to do could be accomplished without much

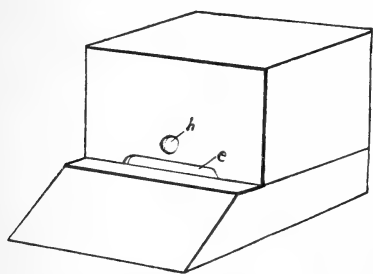

FIG. 32.—Hive showing entrance (e) and hole (h), corresponding to like apertures on back of non-swarmers.

manipulation and perhaps also the use of some complicated device. I was, however, agreeably surprised at the whole simplicity of Mr. Langdon's plan, when, in December last, he made it known to me and sent a non-swarmers for purposes of illustration. And in answer to his request as to what I thought of it, I wrote him at once that I was of the opinion that he had made one of the most valuable additions to the list of apiarian inventions that had appeared for a long time—one that, after the frame hive, would rank equal with or ahead of the honey-extractor and comb-foundation machine.

Mr. Langdon has applied for letters patent on his device in this and other countries, and with the specifications as a basis, a copy of which

was, however, agreeably surprised at the whole simplicity of Mr. Langdon's plan, when, in December last, he made it known to me and sent a non-swarmers for purposes of illustration. And in answer to his request as to what I thought of it, I wrote him at once that I was of the opinion that he had made one of the most valuable additions to the list

he has kindly sent to me; together with permission to make the matter public, I have written the following

DESCRIPTION OF THE DEVICE AND SYSTEM.

At the beginning of the honey season the non-swarmer device, D, shown in Fig. 31, is placed at the entrances of two contiguous hives each of which contains a queen and full colony of bees. The continuous passageways, *e* and *e'*, on the underside of the device, correspond to the entrances of the hives A and B, respectively. The bees will then pass, quite undisturbed, out of and into their respective hives through these passageways. By inserting the slide, *sl*, in the end of the non-swarmer until it occupies the position indicated by the dotted horizontal lines the passageway leading to hive A will be closed at its juncture with the hive-entrance, preventing any bees from entering said hive. The wire-cloth cone exit, *ex*, still permits flight-bees to come out of hive A, as a hole, *h*, Fig. 33, through the non-swarmer connects

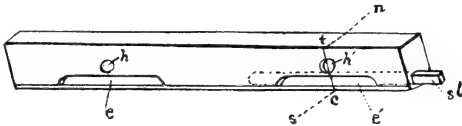

FIG. 33.—Langdon Non-swarmer Device—rear view, showing apertures (*e*, *e'* and *h*, *h'*), corresponding to similar openings in the fronts of hives.

the cone exit with a corresponding hole, *h*, Fig. 32, in the front of the hive. The super cases S of hive A are then placed on those of hive B.

The flight bees of hive A finding their hive-entrance closed on their return are, upon alighting at the entrance *e*, Fig. 31, attracted along the gallery shown at *g*, in the cross section, Fig. 34, by the buzzing of the bees at the entrance *e'* of hive B, and enter said hive. This withdrawal of the field-bees from hive A leaves this hive so depopulated and so disconcerts the nurse bees left therein that they will not swarm; meanwhile work is going on without interruption in the supers on hive B by the field force of both hives.

At the expiration of eight to ten days, thus before the bees of hive B have made preparations to swarm, the supers, S and S', Fig. 31, on this hive are all transferred to hive A, the slide, *sl*, is withdrawn from entrance *e'*, thus opening this hive, and is inserted in the opposite end of the non-swarmer

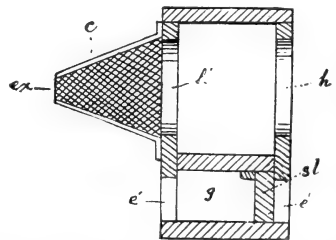

FIG. 34.—Langdon Non-swarmer Device—cross-section at *sectn.*, Fig. 33 (lettering as before).

so as to close the entrance, *e'*, to hive B. The bees thus excluded from hive B will be called along the gallery, *g*, Fig. 34, of the non-swarmer by the bees at the entrance, *e*, and with these

bees will enter hive A, thus bringing about in hive B the same conditions as were previously induced in hive A by closing the latter. At the same time the field-bees of both hives are working continuously in the supers on the hive A, the entrance of which is open, and the flight bees in hive B are escaping through the cone exit, *ex'*, and joining those of hive A.

In about a week the supers are again placed upon hive B the entrance to which is then opened while that of hive A is closed. In another week another transfer is made, and so on alternately during the flow of honey.

This alternate running of the field-bees from one hive to another and back again, and the simultaneous transfer of the supers, so disturbs the plans of the nurse-bees and temporarily depopulates the hives successively closed, that organization for swarming is not effected, hence, *no swarms issue, and the field-bees of both hives work unitedly and without interruption throughout the entire gathering season.*

ADVANTAGES OF THIS SYSTEM.

The experienced bee-master will not only readily see that this meets the requirements mentioned in the first part of this article as advantageous to secure, but also that in many other ways it is likely to prove a system of great value in the apiary. Mr. Langdon has mentioned some of these and I will therefore quote from his letter:

(1) Two light colonies that would not do much in sections if working separately make one good one by running the field force of both into the same set of supers.

(2) No bait sections are needed, as the bees can be crowded into the sections without swarming.

(3) The honey will be finished in better condition, that is, with less travel-stain, because the union of the field forces enables them to complete the work in less time.

(4) There will be fewer unfinished sections at the close of the honey harvest, for the reason just mentioned.

(5) Also for the same reason honey can be taken off by the full case instead of by the section or holder full.

(6) Drones will be fewer in number, as a double handful will often be killed off in the closed hive while the other is storing honey rapidly.

(7) Artificial swarms and nuclei can be more easily made, as combs of brood and bees can be taken from the closed hive in which the queen can be found very quickly.

As there is in carrying out this system of swarm prevention no caging of queens, cutting out of queen cells, manipulation of brood combs or even opening of the brood chambers at all during the honey season, and all the vexatious watching for swarms and the labor and time involved in securing these are done away with, and instead of this a simple manipulation attended to not oftener than once a week is substituted, it is plain that very many more colonies can be managed by one person, and, indeed, Mr. Langdon informs me that he "can care for 200 colonies with one day's work in a week with no help, instead of working

all the time with 100 colonies." It will, therefore, prove a great boon to all having numerous out-apiaries.

One of the greatest advantages over any plan for the prevention of swarming yet proposed, which Mr. Langdon's system will have, should it prove on further trial all that it now promises, is that it will not only prevent more effectually than any other the actual issuance of swarms, but, while not requiring any manipulation antagonistic to the known instincts of bees, it will prevent all desire to swarm—will completely do away with the "swarming fever," so fatal to the hopes of the comb-honey producer. Another great feature of it will be the more rigid selection of breeding stock, which it will facilitate. Intelligent selection can accomplish for this pursuit as much as it has done for the breeders of our larger domestic animals. Furthermore, a strong natural inclination toward swarming on the part of any race of bees, otherwise possessed of very desirable traits, will not, under this system, oblige the rejection of such race. Eventually the disposition to swarm must through constant suppression become less, or, in time it may even disappear, giving us the long-sought non-swarming strain.

THE SYSTEM TESTED PRACTICALLY.

A brief statement of the success which has attended Mr. Langdon's practical test of his system during 1892 will be of interest in this connection. In a letter dated December 24, 1892, he wrote:

Last season I tried the device on 100 hives. Except in one instance the bees did no fighting. Why they do not fight when united in this way I can not say. It certainly did not discourage them in honey gathering, for my yield from the 100 hives was 6,000 pounds of comb honey, or an average of 60 pounds per hive, some pairs yielding 150 pounds, and it has been counted a poor season for bees in my locality this year. After one season's trial of the device and plan I do not know of a single fault or objection to it.

NOTES ON APHIDIDÆ.*

By HERBERT OSBORN and F. A. SIRRINE, *Ames, Iowa.*

The following notes upon the habits of certain species of Aphides can not be considered as absolutely proving migrations, though it is thought for some of them that the observations approach demonstration.† We would prefer, of course, to be able to state our conclusions

*Under this title the authors presented at the meeting of the Iowa Academy of Sciences, December 28, 1892, a number of additions to the list of known Iowa species and some biological notes. The latter only are reproduced here.

†We have made many similar observations and a large number are recorded in our notes, yet unpublished. We can thus confirm several of the observations of Prof. Osborn and Mr. Sirrime, and particularly the one regarding the apparent identity of *Colopha ulmicola* and *C. eragrostidis*. We are convinced of the identity of these two species which occur commonly upon *Ulmus* and *Eragrostis* at Washington, although we have not succeeded in satisfactorily colonizing individuals from the grass upon the tree.—C. V. R.

with greater certainty and it might be wiser to hold these notes for future proof. Experience, however, has shown that it is often impossible to find material for continuous study in any one locality and we hope that the publication of the facts gathered so far may assist in the collection of proof relating to the exact cycles of some of the migratory species in this interesting group. We are aware, of course, of the studies of Lichtenstein and others in this field, but only a portion of the papers containing their results are accessible at present, and so far as we know no observations have been made on the particular species here mentioned. So that in any case they may be considered independent observations and, if duplicating work already done, furnish confirmatory evidence.

Siphonophora sp.—Found abundantly on leaves of Hop Hornbeam (*Ostrya virginica*). It is apparently identical with *S. geranii* Oestlund, on geranium and we suspect will be found to be migratory between these two plants.

Rhopalosiphum nymphææ L.—On *Nymphæa odorata*, Pond Lily. What is apparently the same species occurred also on the Arrow Leaf, *Sagittaria variabilis*, and this may doubtless be considered as a host plant.

Hyalopterus pruni Fab.—On Plum and Choke Cherry.

Hyalopterus arundinis Fab.—(= *pruni* Fab. ?).—On *Phragmites communis*. At first only the winged form of *Hyalopterus pruni* was found on the Plum and in no case was the apterous viviparous form found. The blades of *Phragmites* showed that the Aphidids had been there for some time and probably for the most of the summer. Pupæ of both viviparous females and of the males were found in the colonies on *Phragmites*. There is no difference in structural characters of the winged viviparous forms found on Plum and those found on *Phragmites*. Slight differences may be noted in color, evidently due to age. Hence it seemed more than probable that this Aphidid migrated from the grass to leaves of some of the plum family to deposit the oviparous females, the latter depositing their eggs around the buds.

Winged forms were taken from the grass and confined on leaves of Plum. These winged forms established colonies of oviparous individuals and these deposited eggs around the buds.

Monellia caryella Fitch.—On *Hicoria alba* and *amara*. One specimen listed in previous list, a single specimen from a small colony having been secured a few years ago. The species was rather common this season, a point of interest, since this species was for some thirty years after its description by Fitch unrecognized by any other entomologist, but was a few years ago recorded in Minnesota by Mr. Oestlund about the same time our specimen was taken here.

Callipterus bellus Walsh.—On *Quercus coccinea*? In markings this resembles *Monellia*.

Callipterus asclepiadis Monell.—On *Asclepias cornutum*.

Callipterus discolor Monell.—On Oak. This and the preceding seem to be identical so far as descriptive characters go, even when compared

side by side in fresh specimens. It seemed possible that they move from Milkweed to Oak in autumn, but egg-laying broods and eggs were found on both plants.

Tetraneura graminis Monell.—On *Leersia virginica*.

Tetraneura ulmi L.—On *Ulmus americana*. Winged forms of *Tetraneura graminis* were found dying from *Leersia virginica* and at the same time winged specimens of *Tetraneura ulmi* were observed alighting and hiding under rough bark of the Elm, where afterward the peculiar males and females of the latter were found, as also the single egg of the female.

Colopha ulmicola Fitch.—Specimens this season were taken on the bark of Cork Elm in October.

Colopha eragrostidis Middleton.—On *Eragrostis frankii* and *purshii*. Not compared with the original description. So far as descriptive characters go, there is no difference between this species and the *ulmicola* occurring on Elm.

Pemphigus attenuatus n. sp.—On *Smilax rotundifolia*. They accumulate in colonies extending for a foot or more along the vine and give it the appearance of being two or three times its normal diameter and of a grayish woolly surface, or as if covered with some abnormal growth. The lice hang by their beaks, with the end of the body held at right angles to the vine, so that the outer surface is quite uniform. Some specimens, nearly the same if not identical with the winged forms on *Smilax*, were taken in August, 1889. These were covered with an extremely long, white excretion. In flight the dense cottony mass made them appear like large flakes of snow.

DESCRIPTION.—Body robust, purple, black. Head broad. Antennæ wide apart, nearly as long as body, dusky throughout. Wings narrow, attenuate at tip, veins very slender. Legs black, tibiæ slightly pale toward apex. Described at time of collecting.

Alate viviparous form.—Length of body, 1.8 to 2^{mm}; of antennæ, 1.33 to 1.34 (I, 0.5^{mm}; II, 0.12^{mm}; III, 0.22^{mm}; IV, 0.25^{mm}; V, 0.30^{mm}; VI, including nail, 0.30^{mm}). Width of body, 0.7^{mm}. Length of wing, 3.6 to 3.9^{mm}; width, 1^{mm}. Rostrum reaching beyond second pair of coxæ. Wings narrow, pointed, from which the name is derived. Third discoidal obsolete at base, the first and second discoidals approximate at point of issue. The same is true of the discoidals of hind wings. Stigma long and narrow. Stigmal vein nearly straight and running nearly to apex of wing, approaching in this respect some species of *Lachnus*. Cauda and cornicles obsolete. Antennæ not annulate, third joint with a few enlarged sensoria, remaining joints slightly rough or irregularly rugose. From specimens in balsam.

Apterous viviparous form.—Length of body, 3.50 to 3.90^{mm}; width, 1.80 to 2^{mm}. Length of antennæ, 1.30 to 1.40^{mm} (joint I, 0.10^{mm}; II, 0.15^{mm}; III, 0.32^{mm}; IV, 0.25^{mm}; V, 0.27^{mm}; VI, 0.30^{mm}). Antennæ slightly roughened and with a few hairs. Rostrum reaching second pair of coxæ, stout. Body walls and appendages brown, the fluids of the body give a dark olive-green background, while the whole surface is covered with a gray flocculent secretion.

In balsam the color changes to a purple black. Cauda obsolete. Cornicles barely indicated.

Apterous males or larvæ (?)—Length of body, 1^{mm}; width, 0.4 to 0.5^{mm}. Rostrum reaching nearly to end of abdomen, stout. Antennæ length 0.7^{mm}; only five joints visible. Eyes small, red.

BELVOSIA—A STUDY.

By S. W. WILLISTON, M. D., *Lawrence, Kans.*

In Brauer and Bergenstamm's recent work on the "Muscaria schizometopa" there is given a list of over four hundred genera of Tachinidæ accepted by the authors, one hundred and eighty of which have been recently proposed by themselves. To these must be added forty-three proposed by Townsend within the past two years, making altogether about four hundred and fifty current genera in this one family.

It may be interesting to note that the entire number of species studied by Brauer and Bergenstamm is given at fifteen hundred. Presumably a large proportion of these were from Europe, where the family has been most studied, especially by Desvoidy, Rondani, Schiner, and Kowarz. In the United States there are, I am confident, at least six hundred species in collections at the present time, and probably more than twice as many in reality.* At present the North American species are distributed among about one hundred and thirty genera, about one-half of which are unknown to occur outside of these limits—a remarkably high proportion.

It will be a long time before the family is as well known as are many other families of American Diptera, and the reasons therefor are not hard to find. Species, genera, and even families show such slight plastic or colorational differences that only the most patient study will define their limits. At the present time there is a decided tendency to base the classification of even the higher groups upon apparently trivial characters. Most naturalists have long since abandoned the idea that genera, or even families, represent anything but the conveniences of classification, and the recent writers on this family are probably right in seizing upon any characters that will satisfactorily group the vast number of species irrespective of their relative values. But it is very probable that, in the proposal of so many genera in such rapid succession, many characters have been employed which future research will show to be entirely inadequate. We yet know very little about individual variations in this family, or the real value of many of the characters now used. The absence or presence of a bristle may be found to represent a group of species, but we should first learn how constant the character is in species.

What I would here offer are the results of a study of considerable material, which has until recently been considered to belong to a single species, but which is now thought to appertain to distinct genera. I have selected and figured, almost at haphazard, nine specimens, every one of which presents so-called specific or generic characters. I could

* My own collection of South American Tachinidæ includes over four hundred species.

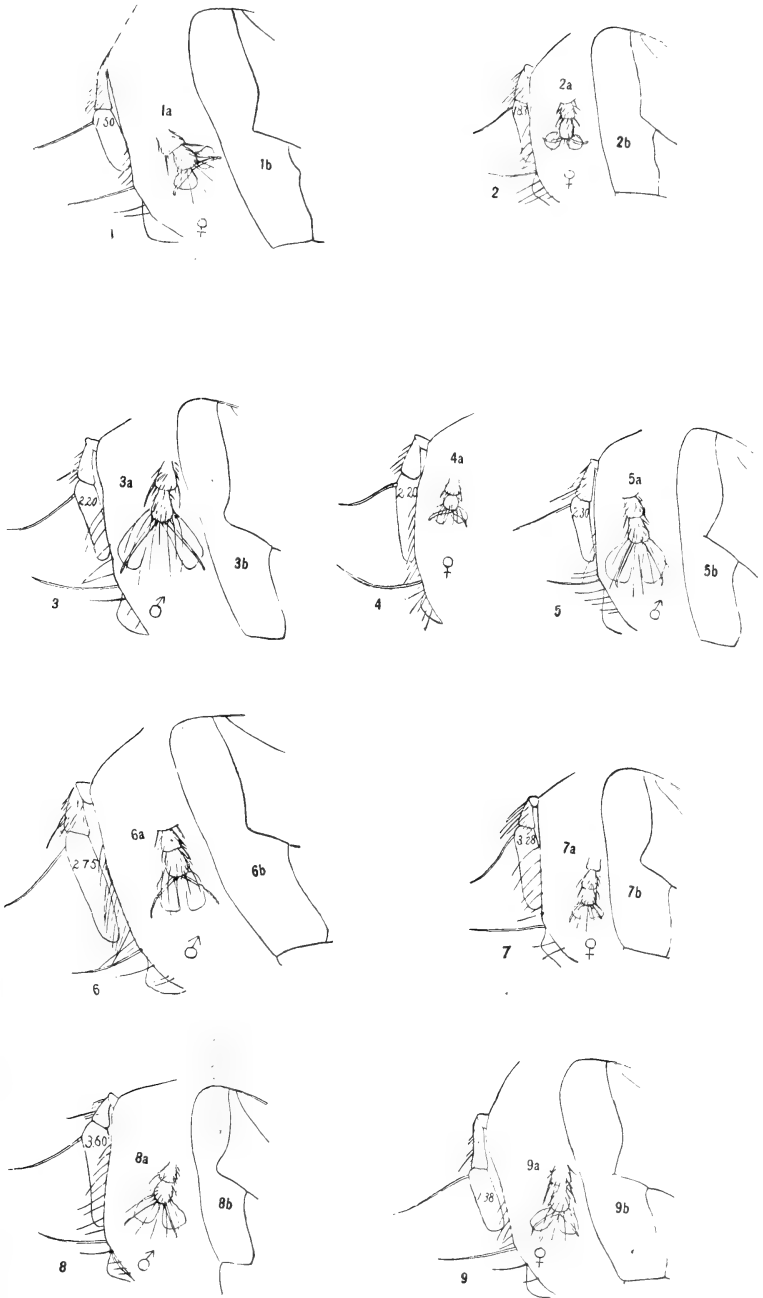

VARIATIONS IN THE OLD *BELVOSIA BIFASCIATA* FAB.—ENLARGED.
(From drawings by Dr. S. W. Williston.)

probably have added nearly as many more from among my forty specimens, but what I here give will suffice for the present. I would premise their discussion with the statement that each one of the figures has been made very carefully with a camera lucida, and are all magnified, so far as possible, the same.

In the Transactions of the American Entomological Society (vol. XIII, p. 302), I ventured the opinion that what had previously been considered as the two sexes of *Belvosia bifasciata* in reality represented two distinct species. The reasons that I gave were the differences in the lengths of the antennal joints and the course of the last section of the fourth longitudinal vein, to which Townsend has recently added the bristles of the facial ridges. Apparently without due deliberation, Brauer and Bergenstamm later* made use of these characters to distinguish the forms generically.

As most of the characters which these authors use for this group seem of doubtful value, I will quote rather fully from their writings, as follows:

Vibrissæ reaching beyond the middle of the face. Head swollen, as in *Gonia*. Face perpendicular, os somewhat retreating. Vibrissal angle situated rather high above the oral margin, the latter somewhat projecting below *Willistonidae*

Sides of the face broad, hairy on the upper part only. Third joint of the antennæ 2-3 times as long as the second, long, linear. Arista thick, second joint short. Male without, female with, 3-4 orbital bristles. First posterior cell terminating before the tip of the wing, open. Angle with or without a small stump [Faltenzinke].

Third joint of the antennæ not three times as long as the second (2-2½). Angle of the fourth longitudinal vein approximated to the posterior margin, V-shaped, with a small stump. Claws of the male much elongated, of the female short

..... *Williston* *esuriens*, *bicincta*, etc.

Angle of the fourth longitudinal vein obtuse [i. e. rounded, stumpf-winkelig], not approximated to the border, separated at least as widely as from the posterior cross-vein. Claws of the male short and like those of the female. Third antennal joint fully three times as long as the second

..... *Latreillia bifasciata*

I have omitted some portions of the diagnoses as irrelevant, and have inserted *W. bicincta* from their later list.

It seems that the authors must have studied additional material later, as in the second part of the work (p. 45) they say that "the length of the antennal joints will not distinguish between the two genera, *Williston* and *Latreillia*, and should be stricken from the diagnoses." They still retain the two genera and the "family," however, apparently upon the antennal and neurational characters.

Let us now compare the figures (see Plate I). In Fig. 9 it is seen that the third joint of the antennæ is but 1.38 times the length of the second joint, and the last section of the fourth vein (9b) is angulated and with a stump of a vein. The figure clearly represents a *Williston* B. and B. In Fig. 1 the third joint is longer, and there is no stump of a vein; still, the species will go readily in *Williston* by throwing out the character of the "stump." Fig. 2b shows the species to be a *Latreil-*

* Die Zweifl. d. k. Museums zu Wien, vol. iv, p. 29.

lia, though the third antennal joint is less than twice the length of the second; the antennal character here loses its generic value. Fig. 3 shows the markedly characteristic claws of *Willistonina*, and the approximation of the angle to the hind border; but the angle is markedly rounded, a distinguishing character of *Latreillia*; evidently the "stumpfwinkelig" angle has to be given up. Fig. 4 is that of a typical female of *Willistonina*. In Fig. 5 we get all the characters of a *Willistonina*; there can be no doubt about this specimen, though the claws are not as large as in the specimen from which Fig. 3 was taken. Fig. 6 must go in *Latreillia*, though the claws are enlarged and the third joint of the antennæ is not "reichlich dreimal so lang als das zweite." Figs. 7 and 8 show the third joint of the antennæ much elongated, the claws of the male enlarged, the rounded angle of *Latreillia*, and the marked approximation of the angle in *Sb*; here we must abandon the claw-character.

Do these characters need any comment? I trow not.

Examining now the bristles of the sides of the face one will see that they are as variable as the other characters.

Again, the pollinose band on the third abdominal segment shows a gradual variation from one covering the segment to an entire absence in the specimens from which Figs. 7 and 8 were taken, and which are, evidently, *B. leucopyga* v. d. Wulp.

It seems evident, from the foregoing, that most of the characters used by Brauer and Bergenstamm for this group are worthless, and it gives me pleasure to relegate to oblivion both of their generic names. The question remains: Are all these characters specific? That I will not attempt to answer; but, if so, instead of the three or four species now placed in *Belvosia*, there must be at least a dozen.

Seriously, is not the stock of Tachinid genera sufficiently large for the present? Would it not be advisable to study species more before making every trivial character the basis of a new genus?

I will add that Fig. 1 was drawn from a St. Dominican specimen; Fig. 2 from one from Minnesota; Fig. 6 from one from Pennsylvania; Fig. 9 from California, and the remainder from Brazilian specimens.

OBSERVATIONS ON THE BOLL WORM IN MISSISSIPPI.

By S. B. MULLEN, *Harrisville, Miss.*

Not long since I promised to give, somewhat in detail, the results of my observations, in connection with work done on the Boll Worm in Mississippi, during the seasons of 1890, 1891, and 1892. At the beginning I either accepted some of the old theories or assumed one, with a purpose of establishing the same, and will say that to you my methods in many instances would appear very crude, but I hope that you will

bear in mind that my observations were made from a practical and not from a scientific standpoint. Therefore, when I saw that no good practical results could be obtained from a certain line of work it was immediately abandoned.

HABITS OF MOTH AND LARVA.—I believe that a few years ago these moths were regarded as almost strictly nocturnal in their habits. This is certainly not the case, either in feeding or oviposition, for on various occasions have I noticed them feeding freely during all hours except the early morning hours, and during the present season, especially, have noted them depositing their eggs in broad daylight, even on the dead blades of corn, but upon this point I will have more to say further on.

HOST PLANTS.—Corn is unquestionably the most preferred in a general way to all others as plants for depositing their eggs on, but they prefer plants blooming and fruiting to corn not yet tasseling and silking—a fact worthy of note. To illustrate: Should tomatoes be blooming and fruiting with corn growing by it not yet tasseling and silking, the eggs will be placed on tomatoes, but should the corn be in silk and tassel the eggs will be placed on the corn. Therefore, to protect a tomato crop the corn must be planted early and the first brood of worms crushed in the buds of the corn (not destroy the corn to get rid of the worms, as has been suggested). Let this corn be an extra early variety, and even then the tomatoes should be early also; the silk and tassels will attract the moths. But in case growers do not wish corn to remain throughout the season, if this corn be carefully watched up to the last of May but few moths will be on hand to infest the tomatoes with the second brood, and this is the brood dreaded by tomato-growers south of Kentucky or Missouri.

With cotton growers the idea is to destroy every insect, at all times, and under all circumstances. Should every southern farmer turn wrong-side outward every corn or cotton bed during early winter, but a few seasons would elapse before the Boll Worm would become a thing of the past. Two furrows with a 12-inch steel plow would accomplish this, two furrows to the row, with double team. Again, should planters and farmers determine to feed them out of cotton, corn is the cheapest and best way to do it. We know that the fourth brood is the one that plays havoc with our cotton crops unless it is late cotton; then it is the fifth brood. Adopt different ages of corn with peas planted and that will be blooming from the 1st of August on, and all will be well. Whenever these moths have filled themselves on the nectar of peas they become sluggish in their habits, and if corn is near by they will invariably lay their eggs on it. Either the surface or position of the blades seem to suit them, though dead, better than anything else to place their eggs upon. They are very fond of hiding during the day in rank peavines, grasses, and weeds around ditches and at the ends of cotton or corn rows, and I have noticed that badly cultivated grass

fields have always suffered more than fields cultivated well and kept clean.

FOOD-PLANTS OF THE MOTH.—Peas certainly occupy the first place as food-plants of the moths, in fact, nearly all insects seem to be very fond of them, ants, wasps, yellow jackets, etc. Therefore, whatever means we desire to use for their destruction should be placed near these, and, as stated above, corn will furnish the best trap that can be used. A small patch near peas will attract them, and the number of eggs laid upon them will prove a surprise to anyone who has not made careful observations on this point, and many have suggested that the corn would be injured in a corresponding measure as the number of worms increased. This is not my experience, for their cannibalistic habit serves as a check in this direction.

DISEASES.—During the season of 1880 a pale green, whitish-striped worm infested my rice, and I feared would destroy it, but after a short time they became diseased and the whole brood died out. During the latter part of the summer of 1890 I found the Boll Worms dying in a certain piece of late cotton. I watched the progress of the disease with a great deal of interest and found that most of the worms died from it. (See *Home and Farm*, December 15, 1890; also with Mally during spring of 1891.) They were found rigid, lying around the base of the form, "just as they laid down their tools," with a mold substance forming in the rings of the segments. These facts may prove of scientific interest, but I can not see how they may prove of any practical value to cotton growers, as a single dead specimen from disease was all that was found last year, and only a few this year.

NATURAL ENEMIES.—Nothing ranks with the Sapsucker as a destructive agent. When conditions and arrangements are effected, if we could or would arrange early corn about our cotton that would be silking the last of May and first of June, no doubt nearly or all of these worms could be trapped in it, and then, if there is no dying timber near, the Sapsucker will get the remaining worm or two left on the ears of corn. I have in mind the extra early varieties of corn, and I hope the Department will furnish me with the earliest variety obtainable and results will be given to you. This season much decaying timber around my farm prevented such satisfactory results as were obtained last season, or hoped for this; the birds very often worked or fed in the timber when but for the presence of the timber they would have been in the corn; last year they cleaned up all worms in my trap corn on Brush Creek. The Southern Sapsucker does no injury to corn; he seldom fails to find his worm, and as soon as it is taken out flies to another ear, and so on. It is a reflection on humanity to be guilty of this destruction. The Blue Jay and the Red Cockatoo Woodpecker, though destructive to worms, will eat corn, and a line of distinction should be drawn. Second in rank should be placed the Soldier Bugs. While making observations in the field I have often been amused watching

these insects lingering about a form. The first favorable opportunity that presented itself it would approach a worm, thrust its lance into it and in a short time the worm would drop down limp, suspended, as the bug rested and filled itself from the life fluids of the worm. It has appeared to me that they never become prominent in this work until the season is well advanced, and no way has suggested itself to me by which we might facilitate it. Many worms are infested with parasites, but we are equally powerless to facilitate their work. Ants destroy some small worms, but no doubt you have noticed how quickly a half-grown Boll Worm can dispatch an ant, unless the ant makes the attack near the head and where the worm can not reach it. One effort is generally sufficient and the ant is cut in two. I believe that *Heliothis* is the most vicious worm we have here.

HIBERNATION.—It is possible that some of the insects pass the winter in the moth state, but I have never been able to find them if such is the case, though I made careful observations on that point last winter, while I find and destroy them by hundreds in the pupa state and think that the normal way in which the winter is passed.

None but one raising cotton, tomatoes, and other vegetables here in the South from year to year can place a proper estimate upon the damage done by these worms. They are an abiding scourge, and he who proves himself able to control them should be recognized as a benefactor to his race. There is yet much to learn, and during the last three seasons I have learned much, and shall continue my observations and work next season, and, while I am sure that the means as suggested above will prove effectual in some cases, different methods adapted to different surroundings must be employed.

NOTES ON *ENTILIA SINUATA*.

By MRS. M. E. RICE, *Coryville, Pa.*

This insect was first observed on Sunflower July 15, 1892; a few were pairing. The eggs are laid in the midrib of the leaf, almost invariably on the under side. They began to hatch September 1, and almost all, a large number, were out September 10. I destroyed the *Entilias* on fifty leaves. By actual count there were over a thousand, and many more were knocked off by a heavy shower the night before.

Sunflower leaves infested by the larvæ die, the whole plant looking as if scorched. The larvæ are very small when first hatched, but soon grow to full size—in about two weeks when attended by ants, and in less than a week when undisturbed—when they split open on the back and the insect emerges in an imperfect form.

The larva is pale green, thickly dotted with black, and bears very little resemblance to the perfect insect. The latter, when it emerges, is also pale green. In three hours it assumes the perfect form, only still greenish white in color. Nearly every colony had members ranging in size from tiny, newly hatched larvæ to perfect insects. Many larvæ, as well as old ones, were infested with a small red mite, which also infests the Tarnished Plant Bug.

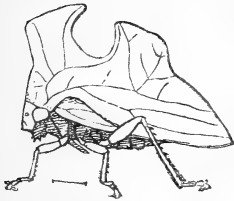

FIG. 25. *Entilia sinuata*:
adult—enlarged (original).

Almost every colony was guarded by one or more ants. One colony consisted of many larvæ and perfect insects, each group guarded by medium sized ants, which were all black, except the central portion of the body, which is brown. When I raised a leaf to examine closer the ants gave battle and bit my finger. I gently drew them away, when every insect, perfect and larvæ, began to scatter with astonishing alacrity all over the plant. The ants returned and "rounded them up" exactly as a collie does sheep, placing one ant as guard if the colony was small, more if large. When one strays away an ant at ones goes after it, and with infinite patience gently drives it home again. They constantly pat and press them with their antennæ as they do the Aphides. I have numbers of Aphides in my garden almost deserted by ants, which assiduously attended them before the *Entilia* hatched. When the larvæ split on the back the ants supervise the process, seeming to peel the empty larval case off. When the insect emerges one or more ants anxiously tend it, passing their antennæ over it repeatedly. I "cut out" a newly hatched *Entilia* and it at once made for the upper side of the leaf. Very few are ever found on the upper side of a leaf. An ant was detailed to bring it back, which it finally did. It then stayed with the rest. Immense numbers of *Entilia sinuata* were present about one hundred feet away, and these were tended by medium sized black ants. A very large ant-hill is in the center of this flower garden. I believe they attract or introduce Aphides to the vicinity of their abode. These were arrant cowards, and when touched dropped some five or six feet to the ground; otherwise they conducted themselves like their black and brown relatives. Twenty minutes afterward the *Entilias* were quiet and the ants on guard. When one considers the fact that *Entilia sinuata* in perfect form can both fly and jump—had one jump four feet and fly ten feet from my hand this evening—the control that the ants maintain over them is remarkable. In fact, as I told the hired man (who patiently listens to all the new "old facts" I discover), Solomon knew what he was talking about when he said: "Go to the ant, thou sluggard; consider her ways and be wise." I am fully convinced both from observation and reading that ants have reasoning powers.

I have found *Entilia sinuata* quite plentiful in woods on the underbrush, also on different species of flowers. They suck the juices from

the ribs and veins of the leaves and in small numbers do no harm. There are thousands of them on the flowers in my garden. They would, no doubt, spread over the garden were it not that the ants do not allow them to roam. Two ants were watching about a dozen full-grown *Entilias* and when I drove them away the *Entilias* hopped and flew off "forty ways for Sunday," reminding me of a flock of school children when school is out.

Have only found it breeding on Spikenard, *Aralia racemosa* (?).

THE FOOD PLANTS OF SOME JAMAICAN COCCIDÆ, (II).

By T. D. A. COCKERELL, *Kingston, Jamaica.*

The present paper continues a series of records commenced in *INSECT LIFE*, vol. v., pp. 158-160. The numbers of genera not previously listed continue on from the last there mentioned; but genera previously listed, whether or not the species is the same, have their old numbers, with a letter added.

(24) *Aralia guilfoylei* (Araliaceæ).—At the Parade Garden, Kingston, March 1, had a few *Aspidiotus articulatus* and *A. personatus* on the upper side of the leaves.

(25) *Apeiba tibourbou* (Tiliaceæ).—At the Parade Garden, Kingston, March 1, had some *Aspidiotus personatus* and many *A. articulatus* on upper side of leaves.

(26) *Coffea* (Rubiaceæ).—A few *Aspidiotus articulatus* were found on leaves of Coffee sent by Mr. W. W. Wynne from Brokenhurst, Mandeville.

(27) *Cupania edulis* Camb. (Sapindaceæ).—A small akee tree in Kingston, December 18, had on upper side of leaves a few *Aspidiotus articulatus* and *A. personatus*; and on midrib, petiole, and stem many *Planchonia (Asterodiaspis olim) pustulans*, Ckll.

(28) *Erythrina umbrosa* (Leguminosæ).—At the Parade Garden, Kingston, March 1, had *Aspidiotus personatus*, *A. articulatus*, and *Ceroplastes floridensis* on the upper side of the leaves.

(29) *Guaiacum officinale* L. (Zygophyllaceæ).—On a lignum-vitæ tree in Kingston, February 1, I found an adult and a young scale of *Ceroplastes cirripediformis*, 3 or 4 *C. floridensis*, and one adult *Lecanium oleæ*. On January 29, I found one scale of *Aspidiotus articulatus* on a small lignum-vitæ tree in Kingston, but most of the *Aspidioti* on the tree, at least, were *A. aurantii*.

(30) *Hibiscus purpureus f. semi-plena* Hort. (Malvaceæ).—At the Parade Garden, Kingston, March 1, had a few *Aspidiotus articulatus* on upper side of leaves.

(31) *Hippeastrum equestre* (Amaryllidaceæ).—At the Parade Garden, Kingston, March 1, had on upper side of leaves one *Lecanium oleæ*, and several specimens of an oval moderately convex red-brown *Lecanium* which can by no means be separated for *L. hesperidum* L.

(32) *Latania aurea* (Palmaceæ).—At the Parade Garden, Kingston, March 1, had on upper side of leaves a few *Aspidiotus personatus*.

(14b) *Musa* (Musaceæ).—In Kingston I found one specimen of *Aspidiotus palma* on a leaf. It proved to be infested by a minute brown hymenopterous parasite, having pointed wings with an enormous fringe, tibiæ spurred, tarsi apparently 4-jointed, with last joint longest. This parasite can not well be identified, as it had not emerged from the scale, and I only found it in a fragmentary condition when ex-

aming the host after immersion in soda. It is interesting to find that this *A. palma*, though away from its normal food-plant, was either followed by one of its parasites or attacked by one that preys on other Diaspinæ which infest the Banana.

(33) *Melicocca bijuga* L. (Sapindaceæ).—In Kingston I find on the upper side of leaves of Genip, *Ceroplastes floridensis*, *Aspidiotus personatus*, and *A. articulatus*.

(34) *Phoenix dactylifera* (Palmaceæ).—A tree in the Parade Garden, Kingston, March 1, was very much infested by the fungus *Graphiola phaniceis*, which seems to prevent Coccids from attacking the tree. I found only some very young scales, apparently *Aspidiotus articulatus*.

(35) *Sabal* (Palmaceæ).—*S. palmetto* and *S. umbraculifolia* at the Parade Garden, Kingston, March 1, had a few *Aspidiotus articulatus* and *A. personatus* on the leaves.

(36) *Thevetia nerifolia* (Apocynaceæ).—At the Parade Garden, Kingston, has *Aspidiotus personatus* and *A. articulatus* on upper side of leaves.

(23b) *Vitis vinifera* L. (Ampelidaceæ).—On a grape-vine in Kingston I found a little colony of *Chionaspis*, ♂ and ♀, infesting the upper side of a leaf. These were no doubt *C. minor* Mask., though I could not find a ♀ to examine, although there were scales. Eggs orange, numerous. ♂ scale rather longer perhaps than usual in *minor*. Many mites among the scales.

(30b) *Hibiscus* (Malvaceæ).—In Kingston I find colonies of *Chionaspis minor*, ♂ and ♀, on upper sides of the leaves. They turn the leaf yellow at the place attacked. The body of an adult ♀ is strongly suffused with verdigris-green, and some of the eggs are verdigris-green. Is this a parasitic growth, like that referred to in "The Microscope," by Jabez Hogg (12th Ed., 1887), p. 605.?

(37) *Bignonia magnifica* (Bignoniaceæ).—A plant growing at Cavaliers, Kingston, presents one scale of *Aspidiotus articulatus* on upper side of a leaf; on the under sides of the leaves are a few *Aspidiotus ficus*, and plenty of *Pulvinaria cupanie* Ckll., with *Diplois* pupa-shells projecting from the ovisacs.

(38) *Calotropis procera*, R. Br. (Asclepiadaceæ).—A plant at the Parade Garden, Kingston, September (Da Costa), has a very few *Aspidiotus personatus* on upper side of leaves; but on the stems very many *Diaspis lanatus* Ckll.

(39) *Jasminum pubescens* (Jasminaceæ).—At the Parade Garden, Kingston, September (Da Costa); on upper side of leaf a great many *Aspidiotus personatus*, with a few *A. ficus*, and one or two *A. articulatus*. On under side of leaf, a few *A. personatus*. On the stem, *Aspidiotus* n. sp., and bright red mites with very long hairs at the ends of first pair of legs.

(39b) *Jasminum sambac*.—At the Parade Garden, Kingston, September (Da Costa); on upper side of leaves many *Aspidiotus articulatus*; on under side specimens of a small palé brown *Lecanium*, which, although differing a little from the usual form in appearance, can only be referred to *L. mangifera* Green, on account of their blunt-pyriform or subtriangular shape, and the branched hairs round the margin. With reference to this and the last host-plant it is interesting to note that two plants of the same genus, from the same garden, are not affected in the same way by Coccidæ.

(40) *Lawsonia inermis* (Lythraceæ).—At the Parade Garden, Kingston, September (Da Costa); on upper side of leaves, many *Aspidiotus articulatus* and *A. personatus*; on under side of leaves, 2 black *Aleyrodes* scales, 2 *Aspidiotus ficus*, and 1 *A. personatus*. I also found on the leaves some young individuals of *Ceroplastes*.

(41) *Psidium guava* Radd. (Myrtaceæ).—On a guava tree in Kingston, January 29, I found *Dactylopius longifilis*.

(42) *Gossypium barbadense* L. (Malvaceæ).—On February 26, in Kingston, I found many *Dactylopius virgatus* Ckll. n. sp. on under sides of leaves of Cotton. Two males were found; the ♂ of this species appears brown examined after death by transmitted light, but seen alive it is dark olive-gray, with the caudal filaments white, and the wings shining iridescent red-purple. *D. virgatus* occurs on several plants in Kingston, and is a very destructive species. The ♀ has fairly long caudal filaments, but lacks the lateral filaments of *longifilis*. A full description of it will be published elsewhere.

(43) *Viola* (Violaceæ).—In March, 1893, Mr. Nuttall brought me a loaf of white violet from Halfway Tree, with *Dactylopius virgatus* infesting the under side at the base. The specimens were very strongly banded.

(44) *Cycas media* (Cycadaceæ).—Plants in Castleton Gardens (Campbell) were badly infested by *Diaspis lanatus* Ckll.

(45) *Argyrea speciosa* (Convolvulaceæ).—A plant in Dr. Strachan's garden in Kingston had *Diaspis lanatus* in abundance on the stem.

(46) *Pelargonium* (Geraniaceæ).—A plant at Cinchona (Harris) was badly infested by *Diaspis lanatus*. I at first supposed these scales to represent a species distinct from *lanatus*, but have quite abandoned this view on further study.

(30c) *Hibiscus (Abelmoschus) esculentus*.—Plants in Castleton Gardens (Campbell) were badly infested by *Diaspis lanatus*. At first I also thought this was a distinct species, but am now persuaded that it is only *lanatus*.

(47) *Solanum tuberosum* (Solanaceæ).—On a potato stem from Farm House, Pedro (J. Richard Reece), I found a ♀ of *Orthezia insignis* with several young.

(48) *Mentha* (Labiatae).—On a garden mint gathered in Kingston by Mr. Hall were many *Orthezia insignis*, and also a few very young specimens of some *Lecanium* or *Pulvinaria*.

(49) *Verbena* (Verbenaceæ).—Mr. Nuttall tells me that at Halfway Tree he finds *Orthezia insignis* infesting *Verbena*.

(50) *Myosotis* (Boraginaceæ).—I learn from Mr. Nuttall that *Orthezia insignis* also infested *Myosotis* at Halfway Tree.

(21b) *Punica granatum* L.—In the garden of the Museum, Kingston, I find several *Ceroplastes floridensis* on leaves of Pomegranate.

(17d) *Mangifera indica* L.—In Kingston, January, 1893, I found *Ceroplastes floridensis* on leaves of Mango.

OBSERVATIONS ON SOME HYMENOPTEROUS PARASITES OF COLEOPTERA.

By F. H. CHITTENDEN.

The following notes are the result of personal observations made by the writer mainly before becoming connected with Government work at Washington, and are supplementary to the records, by Prof. Riley and others, as published from time to time in previous volumes of INSECT LIFE.

ICHNEUMONIDÆ.

Ephialtes irritator Fabr. was reared from its larvæ found living externally on the larvæ of the Cerambycid, *Liopus variegatus* Hald., breeding under the bark of the Box-elder, *Negundo aceroides* (*Acer negundo*). Larvæ were found in the vicinity of Washington, D. C., May 24. Within four days thereafter they had spun their cocoons, grouping them together with two old empty cocoons of the previous year's brood. These cocoons were at first white, but in a few days slowly began assuming a darker brown hue. June 2 the first pupa was found, and June 5 the first imago, a female, appeared, and in a day or two had liberated herself by gnawing through the cocoon. This insect has been previously bred from an unknown Cerambycid under

the bark of Oak, as shown by the records of the Division, published in *INSECT LIFE* (vol. III, p. 461).

BRACONIDÆ.

Bracon simplex Cress. The cocoons of this species were of quite common occurrence in the nests constructed by, and characteristic of, *Rhagium lineatum* under the bark of white and pitch pine trees, within which the beetles undergo their transformations. Parasites reared at Ithaca, N. Y., in confinement under nearly natural conditions, issued from May 19 to June 11, and specimens were captured flying about pine logs at a later date. This species has been also reared in the Division from an unbred Cerambycid under oak bark, as recorded in *INSECT LIFE*, vol. II, p. 348, and by Mr. A. D. Hopkins from wood of Beech and Spruce infested by Cerambycidæ and Buprestidæ (l. c., vol. IV, p. 256).

Bracon eurygaster Brullé was bred from small branches of Quince that had been amputated by *Elaphidion villosum* Fab. the only other species reared from this wood. Also reared under similar conditions by Mr. Hopkins, from elm wood infested by an unknown Longicorn (l. c., vol. IV, p. 257). South Woodstock, Conn.

Bracon erythrogaster Brullé was reared from hickory wood infested almost exclusively with *Cyllene picta*. Specimens were also taken under the bark of Oak where they were probably parasitic on some other common Longicorn. Ithaca, N. Y.

Doryctes radiatus Cr. was bred from flattened cocoons similar to those of *Bracon* found under the bark of newly felled hickory wood infested with *Cyllene picta*, on which species it is doubtless parasitic. Imagos emerged in June. Specimens were also taken in the field, May 26. Ithaca, N. Y.

Cænophanes dinoderi Ashm. MS. bred out from some pieces of dead oak wood together with the Ptinid, *Dinoderus punctatus*, the only other species found. The beetles were extremely abundant; the parasites were rare. Date of emergence not noted. Flatbush, L. I.

Cænophanes utilis Cr. was reared from larvæ of *Liopus cinereus* Lec., found boring the twigs of Locust (*Robinia pseudacacia*). All stages were taken April 21, one adult already dead. The first pupa was seen May 8; this prepared to transform May 22 and the adult insect was found May 25. One larva transformed to pupa as late as June 10. Many of these Cerambycid larvæ were parasitized. Ithaca, N. Y.

Helcon dentipes Brullé was bred from chestnut wood infested by a small Longicorn, supposed to have been *Callidium æreum*, also from wood from which were reared *Rhopalophora longipes* and *Curius dentatus*. These Longicorns belong to the same sub-family, the *Cerambycinæ* and the Hymenopteron might be parasitic on all three species.

Cenocælius rubriceps Prov. is an external parasite of *Liopus cinereus*. It was reared from the latter found breeding in the twigs of Locust

This species occurred with, but was not so abundant as, *Canophanes utilis* Cr., the parasite of *L. cinereus*, previously mentioned.

Meteorus orchesiæ Ashm. was bred from whitish cocoons in old dry wood of Birch (*Betula*), infested with the Cistelid, *Mycetochares binotata*. Imagos developed during the first week of May, Ithaca, N. Y. As a considerable number of individuals of both parasite and Coleopteron were bred, and no other insects were present in these twigs, I have no hesitation in placing *Mycetochares* as the host of this parasite, especially since the type of the species was bred from *Orchesia*—a genus of a very closely allied family—as recorded in an editorial article in *INSECT LIFE*, vol. III, p. 57.

Euphorus phlæotribi Ashm. is an internal parasite of the adult of *Phlæotribus frontalis*, having been reared from pieces of the wood of the White Mulberry (*Morus alba*) infested by this Scolytid. Although only a single example of the parasite was obtained this rearing is of much interest, for an examination of the galleries of the beetle resulted in the discovery of an empty, whitish cocoon and a dead beetle which had been parasitized, a circular hole near the end of its elytra showing where the Hymenopteron had issued. This species is thus shown to conform closely in habit to the congeneric *sculptus* Cr., a common parasite of the adult *Megilla maculata*, which has been treated by Dr. Riley in vol. I of *INSECT LIFE* (pp. 101, 338). It is probable, judging by the size of the species under consideration compared with its host, that the latter dies before or soon after the issuance of the parasite. Alexandria County, Va.

CHALCIDIDÆ.

Homalotylus obscurus How. was reared by me from three different species, representing as many genera of Coccinellidæ. Three examples were bred from larvæ of *Coccinella 9-notata*. The infested larva had attached itself for pupation about September 20, and the adult parasites emerged in October. Spring Lake Beach, N. J. A number of these parasites were also bred from the larva of *Psyllobora 20-maculata* taken with uninfested larvæ and the pupæ and imagos of the same at Ithaca, N. Y., October 3 on the European Ash. Adult parasites issued from April 24 to May 16 and earlier. Only a single parasite was bred from each Coccinellid larva as far as could be ascertained. A third rearing was from *Mysia pullata*, a ladybird confined almost exclusively to pine trees and other Coniferæ. Eleven examples, an exceptionally large number, were reared from a single larva, taken May 24, attached to a pine needle. Each of these eleven parasites had, as in the first case, issued from a separate hole in the body of the host. Other parasitized larvæ were also seen.

This insect was described from specimens bred by Mr. H. G. Hubbard from larvæ supposed to have been those of *Coccinella sanguinea* (Bulletin No. 5, Division of Entomology, p. 22). Subsequently Mr.

Hubbard reared specimens from *Hippodamia convergens* (Insects affecting the Orange, Division of Entomology, p. 74). As far as observed this species, the sole North American representation of the genus, infests only Coccinellid larvæ, but a congeneric European species has been found to prey upon Galeruca of the family Chrysomelidæ.

Eupelmus cyaniceps Ashm. was reared from the seed pods of the False Indigo (*Amorpha fruticosa*) which were inhabited exclusively by *Bruchus exiguus* Horn. Adults issued at Washington, D. C., during the early part of October. This insect is by no means rare and it seems a little singular that it, or an allied species, has not been recorded from the congeneric species, the Pea and Bean Weevils.

Another species of *Eupelmus* issued from apple twigs from which was also reared the injurious Fruit Bark-beetle, *Scolytus rugulosus*, the only other species bred. Port Richmond, Staten Island. This species seem to be extremely rare.

Catolaccus tylodermæ Ashm. A pair of these parasites, male and female, were reared in September from the pupal chambers of *Tylo-derma foveolatum*, but whether from the larvæ or pupæ could not be ascertained. In order to effect their exit they were obliged to cut through the stem which is of about the consistency of the average perennial of the same size, and about 0.10 inch thick at the point of exit. The cells of each could be readily distinguished by the exit holes, that of the male being appreciably smaller. District of Columbia. It is quite possible that this species may also parasitize the noxious *Tylo-derma fragariæ*, or Strawberry Crown-borer.

PROCTOTRYPIDÆ.

Anoxus chittendeni Ashm. was bred from *Polyporus*, a genus of tree fungus, inhabited by *Cis fuscipes*, and is without doubt parasitic on this beetle, since no other insects were present at the time of this rearing. Ithaca, N. Y.

Cephalonomia hyalinipennis Ashm. was reared under precisely similar conditions to the above from twigs of Fig (*Ficus indica*) growing on the grounds of the Department of Agriculture. These twigs were infested exclusively with the little Scolytid, *Hypothenemus eruditus*, which with the parasite occurred in abundance in burrows in the pith in October.

Quite a number of other species have been reared from wood, but under such circumstances that it has been found impossible to determine the host. Doubtful cases have not, therefore, been considered, and I feel reasonably certain that the rearings here mentioned are worthy of record, although the host insect has not been, in all cases, identified with absolute certainty.

In most cases the parasites under observation were kept under practically normal conditions, and the breeding dates given are therefore nearly as in nature.

The parasitic species mentioned in this paper were determined for me by Mr. W. H. Ashmead, and by comparison with types in the National Collection. Types of the new species are also in the National Collection.

**REPORT ON THE AUSTRALIAN INSECTS SENT BY ALBERT KOEBELE
TO ELLWOOD COOPER AND B. M. LELONG.**

By D. W. COQUILLET.

LOS ANGELES, CAL., *November 1, 1892.*

SIR: In accordance with your letter of October 11, 1892, instructing me to examine and report upon the condition of the colonies of beneficial insects sent from Australia by Mr. Albert Koebele to various persons in California other than myself, I submit herewith the following brief report.

Respectfully,

D. W. COQUILLET,
Special Agent.

Prof. C. V. RILEY,
Entomologist.

On the 21st of October I interviewed Mr. Koebele at his home in Alameda, and learned from him that besides sending insects to me he had also sent some to Mr. Ellwood Cooper and to Mr. B. M. Lelong. Those sent to the former had been liberated in the olive grove formerly owned by Mr. Cooper, near Santa Barbara, while of those sent to Mr. Lelong, colonies had been sent to each of the following localities: Alameda, Haywards, Santa Clara, San Gabriel (two), Orange (two), and Tustin (two), making nine colonies in all.

Mr. Koebele informed me that the colony sent to Alameda by Mr. Lelong was placed in Mr. Koebele's yard upon a pear tree thickly infested with *Aspidiotus perniciosus*. This colony was placed upon the tree about the middle of May, and consisted of about forty adult specimens of *Orcus chalybeus*, five *Orcus australasiæ*, and two specimens of an undetermined species of Rhizobius. In company with Mr. Koebele and two other entomologists, Messrs. Baron and Harford, I examined the tree upon which this colony had been placed, and also the adjoining trees, but none of us found any trace of the *Orcus chalybeus*, and Mr. Koebele informed me that he had never succeeded in finding it upon these or any of the other trees in that vicinity, although he had repeatedly searched for it, since his return from Australia in August. Of *Orcus australasiæ* we found two adults, two pupæ, and seven larvæ, and of the Rhizobius we found two adults and six larvæ. One of the Rhizobius adults was found upon a tree adjacent to the one upon which the colony had been placed, but all of the *Orcus australasiæ* were upon the original tree.

In the afternoon of the above-mentioned day I proceeded to Haywards, in Alameda County, and interviewed Dr. E. Kimball. From

him I learned that about the middle of May Mr. Lelong had erected a cloth tent over one of his lemon trees quite thickly infested with *Lecanium oleæ*, and had introduced about a dozen moths of *Thalpochares cocciphaga* into this tent. About the 1st of October the tent was removed, and at that time no trace of these insects could be found upon this tree. Dr. Kimball informed me that about two months ago Mr. Lelong liberated several of these moths in his orange grove, and that about the middle of May he had liberated several adults of *Orcus chalybeus* in the same grove. Mr. Koebele informed me that he had liberated in this grove the moths of *Thalpochares cocciphaga* brought with him from Australia in August. I did not succeed in finding a trace of any of these insects, and Dr. Kimball informed me that he has not been able to find any of them in any of their stages. While at Alameda, Mr. Koebele informed me that he had carefully examined this grove about three weeks previously, but had been unable to find any of the imported insects in any of their stages.

On the 22d of October I proceeded to Santa Clara, in Santa Clara County, for the purpose of investigating the colony of insects sent by Mr. Lelong to Mr. A. Block. Mr. Block was absent, but his foreman informed me that a colony of *Orcus chalybeus* had been placed upon one of his pear trees infested with *Aspidiotus perniciosus*. I was not able to find a trace of this *Orcus* upon any of the trees.

On the 28th of October I called upon Col. J. R. Dobbins, of San Gabriel, in Los Angeles County, and learned from him that about the middle of May he had received about a dozen adults of *Orcus chalybeus* from Mr. Lelong and had placed them upon one of his lemon trees thickly infested with *Aspidiotus citrinus*; but neither of us was able to find a trace of the *Orcus* upon this or upon any of the adjacent trees, and Mr. Dobbins informed me that he has never found this insect in any of its preparatory stages in any part of his or of the neighboring orange and lemon groves.

In company with Mr. Dobbins I next visited Mr. A. Scott Chapman, near San Gabriel, and learned from him that during the first half of July he had received from Mr. Lelong a colony of about one hundred and fifty adult specimens of *Orcus chalybeus* and a single specimen of *Orcus australasie*; these he had placed upon one of his lemon trees infested with *Aspidiotus citrinus*, but neither myself nor Mr. Dobbins was able to find a trace of them upon this or any of the adjacent trees, and Mr. Chapman informed me that he has never found these ladybirds in their early stages upon any of his trees.

On the following day I visited Mr. H. K. Snow, of Tustin, in Orange County, and learned from him that during the last half of February he had received from Mr. Lelong about forty adult specimens of *Orcus chalybeus* and two specimens of *Leis conformis*. These he had placed on one of his orange trees thickly infested with *Aspidiotus aurantii*; but neither of us was able to find a trace of the imported insects either

upon this or upon any of the adjacent trees, and Mr. Snow informed me that he had never found these insects in their early stages upon any of his trees.

From Mr. Snow I learned that a colony of about thirty adult specimens of *Orcus chalybeus*, received from Mr. Lelong at the same time that Mr. Snow had received his, had been placed upon an orange tree in the grove of Mr. S. W. Preble, near Tustin. Mr. Preble was absent, but his foreman showed me the tree upon which the colony of imported insects had been placed. I was not able to find any of these insects either upon this or any of the adjacent trees.

I next visited Mr. Hiram Hamilton, of Orange, in Orange County, and learned from him that he had received two colonies of imported insects from Mr. Lelong. The first colony was received during the last half of February, and consisted of six specimens of *Orcus chalybeus* and a single specimen of an undetermined Scymnid. These he placed in a glass jar and supplied them with *Aspidiotus aurantii* to serve as food, but they finally died without depositing eggs. The second colony reached him during the first half of July, and consisted of about seventy specimens of *Orcus chalybeus*, two *Leis conformis*, and six specimens of an undetermined Scymnid. These were placed upon an orange tree thickly infested with *Aspidiotus aurantii*, but neither Mr. Hamilton nor myself was able to find any trace of them either upon this or any of the adjacent trees, and Mr. Hamilton informed me that he had never found either the larva or pupa of any of the imported insects upon any of these trees.

This completed my investigation of the imported insects received and sent out by Mr. Lelong. Of the nine colonies of *Orcus chalybeus* thus sent out by him, not a trace of a single one of them can be found at the present time; and out of the entire number of colonies of insects, only one—that at Alameda—has succeeded in maintaining itself up to the present time.

On the 26th of October, in company with Mr. John Scott, the Horticultural Commissioner of Los Angeles County, I paid a visit to Mr. Ellwood Cooper, near Santa Barbara, and learned from him that he had received two colonies of the imported insects from Mr. Koebele. The first colony was received during the first half of June, and consisted of about two dozen specimens of *Orcus australasiae* besides a few specimens of an undetermined species of Rhizobius. The second colony was received during the first half of July, and consisted of about four hundred specimens of *Orcus australasiae* and *Orcus chalybeus*, principally the former, also a few specimens of the Rhizobius and a box containing the larvæ and chrysalides of *Thalpochares cocciphaga*. The latter was placed in an olive tree infested with *Lecanium oleæ*, the lid of the box having first been removed and a piece of wire-screen placed over the box, the meshes in this screen being large enough to admit of the escape of the moths. The remaining insects were liberated among some

olive trees infested with *Lecanium oleæ*. In company with Mr. Cooper, Mr. Scott, and Dr. H. Sidebotham, who has charge of this ranch, I examined a large number of the trees where these imported insects had been liberated, and together we succeeded in finding about fifty-four adults, twenty pupæ and three larvæ of *Orcus australasiæ*; thirty adults and eight pupæ of *Orcus chalybeus*; and about nine adults of the Rhizobius. No trace was found of the Thalpochares, and both Mr. Cooper and Dr. Sidebotham informed me that they have not been able to find this insect in any of its early stages.

This completed my examination of the insects sent over from Australia to Messrs. Cooper and Lelong by Mr. Koebele. Besides at Los Angeles, *Orcus chalybeus* is also established at Santa Barbara; and *Orcus australasiæ* and the Rhizobius at Santa Barbara and Alameda.

THE GENUS DENDROTETTIX.*

By C. V. RILEY.

At the meeting of the Entomological Society of Washington, June 2, 1887, I presented specimens of a tree-inhabiting locust which I had studied in all stages in Missouri, and for which I proposed the new genus *Dendrotettix* and the specific name *quercus*. I promised to describe the species at some future meeting, but pressure of other work has hitherto prevented my doing so, though the manuscript name I then proposed has been used and referred to on several occasions. At a subsequent meeting I exhibited specimens from Washington County, Tex., having a similar habit and belonging to the same genus, and which I proposed to characterize as *D. longipennis*. This name has also been used in print, and I therefore take the present occasion to present a characterization of the genus and a description of the latter species, more particularly because Mr. Lawrence Bruner has now issuing from the U. S. Department of Agriculture a bulletin in which he wishes to quote the description.

DENDROTETTIX, gen. nov.

Head moderately large, the face less receding than in *Caloptenus*, the occiput ascending less and more depressed between the eyes and between the antennæ, giving greater prominence to the median ridges; more deeply sunken into the flaring anterior edge of the pronotum; fastigium moderately depressed in the ♀ and more distinctly so in the ♂; rather deeply sulcate; lateral carinæ quite prominent, somewhat approaching between the upper extremities of the eyes and also in front, where they are continuous with those of the frontal costa which is shallowly sulcate until just below the ocellus where it suddenly becomes much narrower and superficial, gradually fading away; eyes ordinarily more prominent and bulging than in *Caloptenus*. Pronotum quite broad, slightly narrowed at anterior third, widened posteriorly; posterior margin nearly straight or slightly rounded, with a very slight excavation at the median ridge; front margin extending over the occiput; the transverse impressed lines are deep, distinct, and continuous, the anterior

* Read by title before the Entomological Society of Washington, March 9, 1892.

crossing at rather less than one-third of the space, the second more irregular, just behind it, and the third reaching not quite to posterior third of space. Disk of posterior lobe nearly flat and strongly granulate, the lateral angles rather sharp. Tegmina and wings of equal length extending, when fully developed, beyond the tip of the abdomen in both sexes, the former rather narrow at the base but broadening especially at their apical half, the apex being evenly rounded; edges of tegmina not meeting when at rest at base, in the ♀, but overlapping beyond basal third. Hind femora rather slender, not quite reaching the tip of the abdomen (♀) or slightly surpassing it (♂); the anterior and middle femora but slightly enlarged in the ♂; hind tibiæ rather slender, quite hirsute, and with the spines long, regular and sharp. End of male abdomen not enlarged, but very generally bent upwards; supra-anal plate subtriangular, with very pronounced depressions, which leave marginal ridges and a medio-dorsal anteriorly furcate ridge, also a transverse median ridge somewhat arched anteriorly; anal cerci flat, about twice as long as wide, the apical portion slightly twisted and the apex evenly rounded. Valves of the ovipositor short with the outer emargination of the upper pair slightly serrate. Prosternal spines stout, short, pyramidal, and directed but slightly backward.

The genus is noticeable, as genera are made in the Acridiidae, by the wide, greatly depressed and broadly sulcate vertex, the short and rather broad pronotum, the slender legs and tapering abdomen. These features, together with the rather bright coloring of the species, bring it near to some southern or subtropical forms like *Rhomalea*.

DENDROTETTIX LONGIPENNIS n. sp.—General color testaceous with slight olivaceous hue, varied with faint yellow and piceous bands and lines; face dull olivaceous brown; occiput, especially back of the eyes, darker. Pronotum olivaceous with more or less yellow; median carina and the transverse impressed lines on the lateral bands piceous, generally darkest and most continuous in the ♂. Tegmina dull olivaceous brown, the veins being testaceous and giving the basal half a decidedly lighter coloring. Wings rather dark, becoming somewhat pellucid near their base, the veins dusky, especially on their apical half. Posterior femora with their outer face dull olivaceous and marked with brown and black along their upper edges and crossing to the inner surface, which, with the lower sulcus, is bright sanguineous, this coloring showing through the somewhat transparent walls even on the outside; the apex black, preceded by a rather wide and very distinct lemon-yellow annulus; hind tibiæ with a wide post-basal annulus of the same bright color; anterior and middle legs, also the tarsi of the hind legs gamboge-yellow, with the spines and claws black; antennæ fuscous, olivaceous towards tip. Venter gamboge-yellow.

Average length ♂ 25^{mm}, ♀ 30^{mm}.

The short-winged forms agree in all other respects except that, as is the case with other genera, the tegmina do not ordinarily extend much beyond the second abdominal joint, and may be either perfectly rounded or slightly twisted at the apex. In some cases, however, they extend to one-half the length of the abdomen.

Described from 2 ♂♂ and 3 ♀♀ of the long-winged form, and 4 ♂♂ and 7 ♀♀ of the short-winged form. Received from Mr. E. H. Hill, Manor, Travis County, Tex., July 13, 1887, as injuring post oaks; also collected by Mr. Bruner.

Mr. Bruner gave an account of the habits of this species in 1887, under the name of the Post Oak Locust (Bull. 13, Ent. Div. U. S. Dept. Agric., pp. 17-19), from his observations in Texas. Dr. Packard quotes this account entire under the name *Dendrotettix quercus* Riley MS. (5th Rep. U. S. Ent. Comm., 1890, pp. 214, 215), while in a paper before the Association of Economic Entomologists (*Can. Ent.*, vol. XXIII, p. 191, Sept. 1891, and *INSECT LIFE*, vol. IV, p. 20, Oct. 1891). Mr. Bruner

refers to it under the name *D. longipennis*. The species which I have referred to as *quercus* and which was found in St. Louis County, Mo., in 1877, feeding on Oak, is considered specifically distinct by Mr. Bruner. Six females and two males are before me, and, while they show average smaller size and paler coloring and no long-winged specimens have yet been found, I should hesitate to consider this Missouri form more than a variety; so that I would designate it *D. longipennis*, var. *quercus*.

EXTRACTS FROM CORRESPONDENCE.

Color of a Host and its Relation to Parasitism.

I have conversed with a number of intelligent stock-raisers, who declare that color has nothing to do primarily with the attacks of flies of various kinds on cattle, and explain the curious fact by saying that animals with very thin skins are at once chosen by flies. We have two yokes of dark red oxen. One of these will be covered with flies, owing to his extremely thin skin, while his "yoke fellow" will be comparatively free. Second, some animals' nervous systems are more highly developed, therefore they are more susceptible to annoyance. Horsemen are all aware that sorrel horses are "higher strung" than any other color, and are much annoyed by insects. Third, wounds and abrasions at once attract hordes of flies. Horsemen have always told me that gray or white horses were, in jockey parlance, "tougher," than any other color. Still I have heard that white horses alone were subject to a kind of cancer called Melanosis. As to white chickens being more subject to gapes, I have never been troubled with diseases among my fowls. I have never raised many white chickens, but my neighbor, Mrs. Cosky, has raised white Leghorns for years, thousands of them, and finds them peculiarly hardy and healthy; not troubled with gapes at all.—[Mrs. M. E. Rice, Pennsylvania.]

Fowls and Toads vs. Garden Insects.

I see in INSECT LIFE, vol. IV, p. 76, a note concerning ducks and the Colorado Potato-beetle. Permit me to add my experience concerning fowls as insect exterminators. While it is true that ducks, under some circumstances, will acquire a taste for the beetle, still you can not "bet on it." They are just as apt to destroy produce to more than balance the account. My aunt having read in the *Rural New Yorker* a similar account, she placed about a dozen in her garden. Hearing her complain of something destroying her cucumbers, a careful examination proved that the ducks were the culprits.

In my own case, they destroyed all my water-cress, and pulled down a great deal of grain, wheat, oats, and buckwheat; were always soiling the spring and spring run and spoiling our neighbors' tempers; they will follow a run for two miles. This summer a neighbor's ducks, twelve in number, destroyed a good deal of buckwheat for us. There were plenty of potato-beetles handy, but they did not touch them. I have given up raising ducks unless I can have a good-sized fenced pasture for them near water. When the potato-beetles first appeared my husband scattered buckwheat between the rows and called the chickens after him as he shook down the beetles and tiny larvæ among the buckwheat on the ground, soon the fowls would pick off the insects for themselves.

As to chickens, one year we put our Early Rose potatoes near the barn. For fear of hurting the chickens we did not use Paris green, as usual. My husband soon discovered that our chickens kept the beetles in check (see note). I did not believe this, so I made careful examination of plot (an acre in extent); I did not find a

hundred beetles and very few larvæ, but did see the hens and chickens; the rooster, a fine Langshan, at their head, ate the tiny larvæ. To be sure, they did eat some potatoes, but who would mind such a trifle? Next season we put in a large patch of potatoes near the henhouse, adjoining a large cabbage patch. Now, early cabbage brings here five or six cents per pound. I had intended making my fortune that year on "Early Jersey Wakefields." They had begun to head very nicely. I noticed the rooster and his numerous family walking up and down the rows; my husband suggested that they were worming the cabbage. I investigated; they had not touched the potato beetles apparently, but had eaten the hearts out of over one hundred cabbages. I sold the fowls the next day, all but the roosters, whom I took real satisfaction in consigning to the pot. I was damaged to the tune of twenty-five dollars.

I have decided that turkeys and Guinea fowls are the only fowls that can be trusted in a garden. Turkeys sometimes damage grain, but can be watched; they destroy innumerable grasshoppers.

But toads are the birds, as our Irish neighbor says: I even think it would pay to put a 12-inch board around market and flower gardens and introduce toads, they make nice pets (we have a big black one that has lived under the porch for years) and destroy immense numbers of injurious insects.

By the way, sprinkling the ground with a solution of Paris green (level teaspoonful to 16 quarts of water) seems to materially reduce the leaf-hoppers, flea-beetles, etc., that infest our garden. But thorough cultivation and plenty of manure—commercial as well as barnyard manure, will place any crop beyond the reach of any but extraordinary insect depredation.—[Mrs. M. E. Rice, Pennsylvania.

Bisulphide of Carbon against Grain Pests; Additional Correspondence.

* * * The bisulphide of carbon vaporizes so rapidly that we do not understand how it can be effective for more than a few days at a time unless the crib is practically air-tight.

My experiment on the evaporation of the bisulphide of carbon at a temperature of 90° to 100° degrees F. are as follows:

I filled five one-ounce vials with the carbon, and placed them in a row in a warm room.

Vial No. 1. Without any covering. Fluid evaporated in three days.

Vial No. 2. Covered with two layers of fine muslin. Evaporated in six days.

Vial No. 3. Covered with four layers of fine muslin. Evaporated in 5½ days. May have been some defect in tying.

Vial No. 4. Tightly corked with a pipe-stem through the cork, running almost to the bottom of the vial. In half an hour the gas forced the fluid to the top of the tube, but never ran over. Evaporated in three days.

Vial No. 5. Covered with a thin sheet of gum elastic, and perforated once with a very fine needle. Evaporated in ten days.

In these experiments the evaporating surface of each vial was about three-fourths of a square inch. Of course, as the size of the surface is increased, there would be an increase of evaporation, a matter to be observed for practical purposes.

Experiment No. 5 has agreeably disappointed me, for I expected that the evaporation would be exhausted somewhat within the range of six days.

For weevils our remedy is fully reliable, but for the exclusion of mice and rats the vapor should be kept up, if not continuously, at least at short intervals.

I have concluded to treat this year my corn in the bin as proposed in my last letter, with half-pound bottles of the bisulphide of carbon, covered with two layers of very close texture of cloth, capped over with a wad of cotton tightly compressed. At least, I will test it shortly as above, with the expectation of prolonging the evaporation a full month, or even longer, within the bin. I would offer reasons to adopt

the plan if time and space would admit, for the subject would call for a great deal of theorizing. The compressed cotton would serve almost like a solid body, as I found a small feather cushion serve as a very efficient stethoscope and ear piece for the telephone. I have an idea that the transmission of the vapor through the cotton from a large bottle would give the best results.—[G. P. Hachenberg, M. D., to Division of Ornithology and Mammalogy, Texas, August 3, 1892.]

On Irrigation and its Effects on Insects.

Was much interested in account of effects of irrigation on insect life; as at present I am farming in an irrigated country, and can furnish a little evidence out of the speculative stage. I am at work breaking 320 acres of new land on the west side of Cole Slough. The soil is sedimentary, with clayey subsoil, and liable to crack; very level, a foot levee being sufficient to flood a strip one-half mile wide. When I turned the water on it filled the cracks ahead of the main current, and drove out a perfect horde of scorpions, centipedes, and pocket mice. The scorpions are not as large as those on the east side of the slough, in the sand, which are from four to six inches long, but are scarcely one-half inch long; while the centipedes may be found in all sizes up to six inches in length. These hunt the highest land, and are finally covered over, and as they can not swim, they die.

So much for getting rid of dry soil species; but water brings ten species to one it kills, the mosquito leading the list.

Nevertheless, if the wheat stubble be allowed to soak in it, there will be many grain destroyers held in check, if not kept entirely at bay.—[Alvah A. Eaton, California, February 2, 1893.]

A tropical Honey Bee.

I inclose specimens of a local honey-giving bee. Have you it in the States, and what is its name?

Its storehouse or hive is represented by section of trees, to which considerable attention is given. A considerable industry might be locally developed in wax. What are the prospects in the United States? Pray give me any notes or suggestions which may occur to you. Is there a prohibitive tax?—[Sir Alfred Moloney, British Honduras, March 3, 1893.]

REPLY.—* * * It is one of the stingless tropical bees of the genus *Melipona*, and corresponds exactly with Frederick Smith's description of *Melipona fasciculata*, from Para, Brazil, and may without much doubt be identified with this species. It is hopeless to attempt to colonize this bee in the States, as our temperature is too low for it. It will not stand a lower temperature than 50 degrees and, so far as I am informed, its honey is inferior to that of our common *Apis mellifica*. There is, however, no tariff upon wax or upon bees for breeding purposes.—[March 14, 1893.]

A honey-producing Ant.

Some very curious specimens of this pest, and its produce, have lately been sent to the writer, from a little known district in Western Australia, 330 miles inland from the Indian Ocean, and in latitude 27°. They inhabit cells or caves in the sand of the scrub-covered lands of this district. Several large females, or queen ants dwell together in seeming harmony, in each of these caves, never venturing from home to collect the honey, but leaving that duty entirely to the working ants, which bring in supplies from outside and hand them over to the queens, who store the substance away in large oval-shaped bags, or pouches, of the size of from half an inch to three-quarters. As yet no closer observations have been made, but the gentleman who sent the specimens intends to devote some time to the work and report progress. He states that the honey is taken by the working ants from flowers,

as by bees, but it is not improbable that this is only an inference, for since ants are well known to be very partial to the honey-dew secreted by various insects, the sweet substance may prove to be derived from that source.—[R. Allan Wight, Auckland, New Zealand, August 1, 1892.]

REPLY.— * * * The honey ant is very interesting. It differs from our *Myrmecocystus melliger* of Colorado. So far I am unable to identify it with the species previously described from Australia, of which, however, I have never seen specimens. Emery, in the Ann. Mus. Civ. Genova, 2, IV, 1887, describes a species from Australia which he calls *Myrmecocystus irridescens*, while I notice in the Gardeners' Chronicle, for November, 1880, that Sir John Lubbock has described a honey-producing species from Australia under the name of *Camponotus inflatus*. * * * Our American species is very similar in form, and the larva is probably practically the same. One form of the worker has its abdomen distended to the size of a currant and entirely filled with grape sugar or "honey." The honey-bearers are found clinging to the roofs of the chambers a few inches under ground and act simply as cells for the storing of the sweet substance, which is collected by the active workers from the exudations of a gall, *Cynips q. mellaria* Riley on *Quercus undulata*. In times of famine the honey-bearer or "rotund" regurgitates the honey drop by drop and it is transferred to the stomachs of the hungry individuals in waiting. In other respects, the economy of the colony does not differ materially from that of other species. It is supposed that the worker majors are transformed by the gradual distention of the crop and expansion of the abdomen into the honey-bearers and that the latter do not compose a distinct caste, although some of the majors may have a special tendency to this change by reason of some peculiar structure of the intestine or abdominal walls.—[September 14, 1892.]

The Jumping Bean again.

The inclosed seeds, from California, when held in the hand exhibit motions that have gained for them the name of jumping seeds. On piercing the shell a live caterpillar was found with seed gone. I would like to know the name of the plant and the insect. It would remain in a dormant state I suppose until the leaves of the same plant were large enough to furnish it food. Can I hope to rear it?—[Mrs. J. M. Hunter, New York, October 26, 1892.]

REPLY.—The specimen sent is one of the so-called "Jumping Beans" infested by the larva of a little Tortricid moth known as *Carpocapsa saltitans*. There are three species of plants belonging to the genus *Sebastiania*, viz, *S. bilocularis*, *S. palmeri*, and *S. pringlei*, the seeds of which are infested by this insect in the United States. The adult insect is a small, grayish moth, and if you keep the seeds you will probably be able to rear some specimens.—[October 27, 1892.]

A Corn Ear-Worm Crusher.

My Heliothis-crushing instrument is not yet made, and I dare not say whether it would succeed. It was (or rather is) to be two wooden butter-pat-like instruments, with a groove down each to admit the convexity of the stalk (but not too deep of course), and an arrangement so that they would lock together and give proper leverage.

I give you this information because you ask for it, but likely enough the thing would fail in practice. However, a corn-grower in the country here, to whom I first suggested it, thought it a very good idea. It would in some ways be simpler to have a hinge in front, but that would make it harder to see what one was doing.

The larvæ complained of (of which I received samples) were in the green tops (no ear formed as yet), which I understand they mainly affect. In my own specimens it would be easy to crush the larvæ by pressure which would not injure the corn,

but whether this would hold good in the field I can not tell. Rubber might be put in the grooves if thought advisable. * * *—[T. D. A. Cockerell, Jamaica.]

REPLY.—When you have given your Heliolithis crusher a practical test please notify me of the result. It really seems to me that one could use his unassisted hand to about as good an advantage. The pressure could certainly be graduated more accurately.

Wax Moths in a Cupboard.

FIRST LETTER.—I send a box of cocoons. I have never noticed them before, but this year they were found in abundance in a cupboard shelf where books and papers were kept. They seemed to have lived on the paper and in forming their chrysalides some gnawed into the hard covers of books and pasteboard boxes.—[Alda M. Sharp, Iowa, December 7, 1892.]

REPLY.—* * * The cocoons which you send are apparently those of the common Honey Moth or "Wax Moth" (*Galleria mellonella*), and I imagine that you may have kept honey in this same cupboard. You will find some account of the insect in Riley's First Report as Entomologist of the State of Missouri (p. 166), where it is mentioned under the name of *Galleria cereana*, by which name it is also treated in most of the works on the Honey Bee.—[December 14, 1892.]

SECOND LETTER.—When I sent you the cocoons I was not aware that honey or wax had been in the cupboard where they were found, but I have since learned that a jar of wax and honey from a hive killed out by moths had been stored there a few days, which solves the riddle.—[Alda M. Sharp, Iowa, December 21, 1892.]

On the Habits of some Blister-beetles.

On July 21 I noticed that *Lytta cinerea* and *Lytta marginata* were devouring the *Clematis virginiana*. The two species seemed to be about equally divided. I dusted the vine with Paris green mixed into lime, and the beetles disappeared.

On July 23, I noticed that they had attacked another vine, *Clematis coccinea*. On the 25th I prepared to try these with kerosene emulsion. After having sprinkled about half of them I noticed that the two kinds were mating indiscriminately. I then quit trying to destroy and began to observe. Three pairs while in copulation were bottled, one pair, male *cinerea* with female *marginata*; one pair, male *marginata* with female *cinerea*; one pair male and female *cinerea*. As many as eight cases of cross-mating were observed, with only one of *cinerea* with *cinerea* and not any of *marginata* with *marginata*. It is plain that crossing was preferred.

The Paris green and lime frightened all away from *Clematis virginiana*, and they never returned. The kerosene emulsion lessened the number on *Clematis coccinea*. It was the 20th dilution and killed those only that raised their wings so as to permit the spiracles getting wet. Others were simply knocked off the vine. On August 1 there were a few beetles on *C. coccinea*, some of each kind; but the beets, potatoes, tomatoes, cabbage, pig-weed, and black nightshade of the gardens and Silphium and Actinomeris of the woodland were being attacked by *marginata*. Two of these found in copulation on the potato were bottled. *Lytta cinerea* was found on nothing but *Clematis*, and all had disappeared by August 10.

The period of vigorous vegetation which precedes and accompanies inflorescence seems to determine what species of *Clematis* these beetles select as food-plants. They first attacked the late flowering species, as *C. virginiana* and *C. flammula*; these flower in profusion by the first of August, and were when attacked full of tender leaves and flower buds. Their second choice seemed to be those species that flower all summer, *C. coccinea* and *C. viorna*. The early flowerets, as *C. jackmani* and *C. candida*, were not touched, perhaps, because having long passed the flowering stage, the leaves of these species had become harsh and woody.

On August 15 *Lytta marginata* was everywhere abundant. By this time they had stripped the potato tops and were making skeletons of the cabbage leaves, I can safely say, all over Decatur County.

Thirty years ago *Lytta vittata* was the "potato-bug." They would attack a potato patch, say of one or two acres, in immense numbers and devour it in a day. Then for a generation it was the "Colorado potato-bug." Now the inheritance seems to have been suddenly handed down to *Lytta marginata*, a beetle that was not common, at least in this locality, ten years ago. However, the damage from *marginata* is not likely to be serious, for early varieties are now in favor and the potato crop is largely matured before the "black potato bugs" make their appearance. A few examples of *vittata* were seen along with *marginata* on the beets, potatoes, and tomatoes.

By September 15 *marginata* and *vittata* had entirely disappeared, and *Lytta murina* had become abundant, especially on the Golden Rod. The first example of *murina* was taken on *Silphium perfoliatum* August 7. On September 25 the golden rods were in their glory and the Black Blister-beetles were the commonest of the many insects that feed upon these flowers. Outliving the golden rods, they took to the asters, and by the middle of October they had entirely disappeared.

The cross-mating of *L. cinerea* and *L. marginata* is an evidence that they are one and the same species. The difference in length of life and in range of food-plants is an evidence that they are distinct species. Experiments are needed to determine the results of the cross-mating.—[W. P. Shannon, Indiana, November 25, 1892.]

NOTE.—As we have not received specimens of any of the species treated by our correspondent, we are unable to identify the species to conform to modern nomenclature with absolute certainty. But from our knowledge of the habits of these insects we may be reasonably certain that by *Lytta cinerea* and *marginata* are meant our two common color variations of *Epicauta cinerea*; *Lytta vittata* is *Epicauta vittata*, and *Lytta murina* is *Epicauta pennsylvanica*. We have had a precisely similar experience on the different species of *Clematis* (including all those mentioned) and found that no remedy other than shaking down and killing availed on account of the continued in-coming of specimens from other regions.—[EDS.]

The Sweet-potato Root-weevil.

For the last three or four years we can not raise any more sweet potatoes fit for market on account of worms. I send a specimen of sweet potato with some bugs. In my opinion the bugs produce the worms, as the vines are always full of those bugs and when there are no bugs there are no worms in the sweet potatoes. I would like to know the name of the bugs and have your opinion whether they could be kept off by some means.—[H. Meyer, Plaquemines County, La., December 22, 1892.]

REPLY.—* * * The sections of sweet potato have been carefully examined, and have been found to contain the larvæ of the Sweet-potato Root-weevil, *Cytas formicarius*. The green bugs have no connection with the larvæ in the potatoes. They are known commonly throughout the South as the Green Soldier Bug, *Nezara viridula*. The Green Soldier Bug frequently damages vegetation by inserting its beak and sucking the sap, the cotton crop and the fruit of the Orange being the most marked examples of this injurious work. The insect which does the damage in your case, however, is the Sweet-potato Root-weevil, and up to the present time no remedy has been found except to burn all potatoes which are found to be infested. If this should be carefully and thoroughly done throughout a neighborhood, the pest could be greatly reduced. It is a sub-tropical insect, and was first recorded as occurring in this country in 1875, when it was found in Louisiana. Three years later it made its appearance in injurious numbers in Florida. Where it has been abundant in Florida it has been practically stamped out by following the measures just recommended.—[December 31, 1892.]

A Weevil in Mullein Seeds.

While collecting seeds, September 29, I got some mullein seed which I put into an envelope without cleaning it. I noticed then that about half of the ovaries

contained either small flesh-colored larvæ or small bugs. While cleaning the seed this morning I found eight of these insects, some still alive. I send them in a quill, and would like to know what they are and something of their habits.—[S. C. Stuntz, Wisconsin, December 12, 1892.]

REPLY.— * * * The species is *Gymnetron tetrum* Fab., one of the true weevils of the family Curculionidæ. It has been previously recorded as having this habit of feeding in the seeds of the mullein plant.—[December 17, 1892.]

A new Enemy to Cypress Hedges in California.

A friend of mine from Contra Costa County has just sent me the accompanying insects, and a specimen of the work they are doing to the Cypress hedges in their neighborhood. They were first noticed a few months ago near Martinez, and they are gradually eating their way through the Alhambra Valley, leaving nothing but dead trees behind them. Around here all our hedges and windbreaks are Cypress, and I should be glad to know how to deal with the destroyer should he make his appearance in this section.—[John Dickie, California, February 8, 1893.]

REPLY.—This is one of the bark-beetles of the family Scolytidæ, and is known scientifically as *Phæosinus cristatus*. These insects are all very difficult to handle when they have gained economic importance. They normally breed in dead, dying, or diseased woody vegetation and only attack living healthy trees when they have increased so greatly as to overflow, as it were, from their normal food supply. Having once acquired the habit of feeding upon healthy trees and shrubs, however, they will continue it for some time. The question of remedies is a very difficult one. Such portions of the hedges as have been attacked should be immediately burned, as it will be impossible to save them. This burning, of itself, will reduce the numbers of the insects to such an extent that the damage for a short time at least will not compare with that which would result without the employment of this means. At the same time if dead or dying trees or woody plants exist in the neighborhood, these should also be destroyed by fire, particularly if upon examination they are found to be infested by this same insect. Thorough work of this character will result in the great lessening if not the entire cessation of the injury, and there is no easier or less expensive way in which this can be brought about. From the standpoint of the economic entomologist the case which you describe is one of considerable interest, and I should be glad to receive further details from you in case your friend can furnish them. I should like facts concerning the amount of damage which has already been done, how long the insects have been at work, and whether there are plenty of dead or dying trees or stumps in which they can breed. If, as you seem to anticipate, the insect should make its appearance in your section, heroic measures should be taken from the start. If your friend has correspondents in the Alhambra Valley it will pay him to urge them to destroy the dead trees which you state are so abundant. Left standing, such trees offer breeding places for the beetles and are constant menaces to the healthy hedges.—[February 17, 1893.]

Another vegetarian Mosquito.

I was very much interested in Mr. Longuemare's account of a vegetarian mosquito in volume IV of INSECT LIFE (p. 214). I have never seen a mosquito eating potato, but was somewhat diverted last summer at seeing one try his tooth (?) at biscuit. I was camping by Cole Slough, the artery connecting Kings and San Joaquin rivers, and the biscuit was broken and lying by my plate, or at least half of it was, while I was disposing of the rest. Mosquitoes were scarce. I think this must have been a pioneer prospecting before bringing her family. I thought at the time she was either a scientist or a fool; for she let me rest, which never one was guilty of before, and settled on the biscuit. I was preparing to make the best of my advantage and sweep her to mosquito limbo when I saw her settle her bill into the bread. This turn of

affairs interested me and I began to watch. She would run her bill in as deeply as possible and then draw it half way out and plunge it back in the characteristic way of mosquitoes when they are enjoying a sanguinary repast on an animal. She stayed about five minutes, but did not seem to fill up in the least, so I concluded she was having a dry time of it, and as I wanted the biscuit I tried to move her off, not wishing to kill her after her entertainment, but she did not seem inclined to go, and only did so by being forced.—[Alvah A. Eaton, California, February 2, 1893.]

The Cluster Fly Household Pest.

I send a few flies as specimens of a pest that has proven to be very troublesome to us for nearly fifteen years past. If the weather is favorable—which must be warm and sultry—they usually come out about the first of September and continue until the weather gets quite cool. They seem to prefer to occupy the rooms on the north side of the house and those that are used but little. They gather in large bunches in the corners and all along the edge of the ceiling of the room. They can not be driven out as other flies, but must be killed outright to get rid of them, and when you mash them the odor is like that of honey. We have tried nearly everything that we heard of that was recommended to us, with no effect. It seems impossible to get rid of them or keep them out of the house, for they crawl in through the smallest places in the windows. The fumes of sulphur or pyrethrum seem to have no effect upon them.

We would be glad to know something of the life-history and breeding places, and if there is any way to get rid of them.—[Mrs. A. E. Brunk, Lasalle County, Ill., October 21, 1892.]

REPLY.— * * * The insect is the common Cluster Fly (*Pollenia rudis*) so-called from the habit which you describe of clustering in houses in the fall. The early stages of this insect do not appear to be known, although we have found the puparia in the roots of grass about three inches below the surface of the ground. You can destroy the flies after they have entered the house by putting fresh pyrethrum powder upon them by means of a little bellows. The smoke of burning pyrethrum does not seem to avail against them. Of the different pyrethrum powders upon the market you will probably find "California Buhach" to be the freshest and best.—[October 25, 1892.]

Chrysanthemums and the Drone-fly.

On the back of the bulletin containing the Sugar-cane Borer article, you will see a letter by Mrs. S. Heaven, part of which relates to the non-seeding of Chrysanthemums here. It seems that if Chrysanthemums, which flourish well in our mountains, could be got to seed, a profitable industry might be carried on, the seeds being of high market value. It at once occurred to me that our want of *Eristalis tenax* might explain the non-seeding, and the question has arisen, Shall we import that fly? But there is some literature of the *Eristalis-Chrysanthemum* matter which I have not seen, and I have not learned that the pollenization by *Eristalis* is proved by experiment. I should be very glad to have your opinion on the matter. Do you believe in the alleged usefulness of the fly?—[T. D. A. Cockerell, Jamaica.]

REPLY.—There has been some discussion in American journals in regard to the cross-fertilization of Chrysanthemums by *Eristalis tenax*. You will find an article by Dr. John Hamilton in *Entomologica Americana* for May, 1890 (pp. 81-83), and shorter notes on pp. 126 and 218 of the same volume. An article by John B. Smith is printed in *Garden and Forest*, July 2, 1890 (p. 326), and another by J. G. Jack in the same journal for September 10, 1890 (p. 446). No careful and accurate experiments seem to have been made in this country, although it is a matter which could easily be settled by a few simple experiments. Certain Chrysanthemum growers consider this fly responsible for the cross-fertilization and consequent fertility and

good condition of their plants, while others destroy them on account of the fact that they injure the appearance of the flowers by ejecting a dark fluid upon the petals. There is no question that this insect is frequently found in greenhouses towards the end of the season, and as it works around in the flowers it undoubtedly bears the pollen from one to another and does some good work. Whether it is responsible for the seeding of this plant to the extent which has been claimed is very doubtful. It is certainly by no means exclusively confined to these flowers.

The Orange Fruit-fly in Malta.

For some years past the orange groves of these islands have been infested with the *Ceratitis citriperda* MacL., the ravages of which have produced so much damage to the orange industry here that his excellency the governor has just appointed another commission (of which I am a member) to inquire into the causes and to suggest remedies for the evil.

Of late years, too, it has been noticed that the number of insectivorous birds, indigenous and migratory, has greatly decreased. Do you think that this fact is in any way accountable for the unusual abundance of the orange-fly? Could you oblige me with any information as to whether insectivorous birds, the ordinary species, have any preference for the fly or its larvæ?—[John H. Cooke, Malta, January 1, 1893.]

REPLY.— * * * As you know, *Ceratitis citriperda* does not occur in this country, although an allied species affects oranges across our border in Mexico and an insect which we have identified as *Ceratitis capitata* Wied. (of which *C. citriperda* MacL. is a synonym) injures peaches in Bermuda. The fruit-infesting species of the dipterous family Trypetidæ are in fact rather scarce in the United States, and but one species has attained any great economic importance, viz. *Trypeta (Rhagoletia) pomonella* Walsh, the larva of which is known as the "Apple Maggot" in our north-western States. I think it altogether likely that the increase of the *Ceratitis* in Malta is to some degree consequent upon the reduction of the numbers of insectivorous birds, although there are no observations on record in this country with reference to the Apple Maggot which would support this conclusion, and I regret, therefore, that I can give you no information in direct answer to your question. I would call your attention, however, to an article upon *C. capitata* in volume III of INSECT LIFE (p. 5), and also to the excellent remarks on pages 469 to 477 of Dr. O. Penzig's "Studi Botanici sugli Agrumi e sulle Piante affini," published by the Ministero di Agricoltura, Italy, 1887. Is not your insect *C. hispanica*?—[January 19, 1893.]

Plant-Bugs injuring Oranges in Florida.

I send a few Hemiptera for identification.

Nos. 1, 2, 4, and 5 were found at Altoona, Fla. They were captured while puncturing the rind of nearly ripe or ripe oranges while still on the tree. They evidently insert the tongue to the "pulp cells" and feed upon the orange juice. I have observed them for several minutes remain perfectly still with their tongues thus inserted. They are easily frightened, and it is difficult to find them in the act of inserting the tongue or to watch them long while feeding. I succeeded in cutting the heads off from several with the tongue remaining in, and microscopic sections of the rind containing the tongue thus cut off show the penetration to reach to the pulp. How much damage they do, if any, I can not say. No apparent damage has been observed. Mr. Cunningham, of Altoona, who first called my attention to them as insects affecting the Orange, reports them as "quite common."

No. 3, Hubbard has described as an orange insect, I believe, possibly the others also.—[H. J. Webber, Florida, December 7, 1892.]

REPLY.— * * * The insects which you send are: 1. *Euschistus servus* Say. 2. *Nezara viridula*. 3. *Leptoglossus phyllopus*. 4. *Euschistus servus* (immature). 5.

Ranassa calva. You are right in supposing that Hubbard has already reported No. 3 as an orange insect, and the species which he figures upon page 160 is in all probability the same as your Nos. 2 and 4. It damages the orange crop occasionally, and also injures cotton bolls. No. 1 is not exclusively a plant-feeder, as it has been frequently found preying upon Lepidopterous larvæ, and is mentioned in the Fourth Report of the U. S. Entomological Commission as an enemy to the Cotton Worm.—[December 17, 1892.]

Fowls killed by Mole-crickets.

While residing in St. Vincent, one of the Windward Islands, I frequently heard of the destruction of domestic fowls by mole-crickets. The cricket is common about sugar plantations, where it burrows among the cane-roots, or conceals itself under stones and sticks. Where cane-patches adjoin plantation-houses, as is frequently the case, the fowls wander among them all day, no doubt delighting in the shade and concealment and finding plenty of insect food. They do not often discover the mole-crickets, because the latter keep well beneath the surface; but when they do find them, they swallow them eagerly. In doing so, they frequently bring about their own destruction; for the crickets finding the bird's crop uncongenial, at once proceed to burrow out; the insect escapes and the fowl dies.

One intelligent planter told me that he had given up fowl raising, because so many were lost in this way; others assured me of the truth of the story, and I have no reason to doubt it. I frequently requested these gentlemen to send me fowls which had been killed by the crickets, but was never able to obtain one. It would be interesting to know whether the insect burrows through the crop itself or through the sides of the gullet.—[Herbert H. Smith, New York, December 1892.]

Roaches in Brazil.

Cockroaches are so common in Brazilian country-houses that nobody pays much attention to them. They have an unpleasant way of getting into provision-boxes, and they deface books, shoes, and sometimes clothing. Where wall paper is used they soon eat it off in unsightly patches, no doubt seeking the paste beneath. But at Corumba, on the upper Paraguay, I came across the cockroach in a new rôle. In the house where we were staying there were nearly a dozen children, and every one of them had their eyelashes more or less eaten off by cockroaches—a large brown species, one of the commonest kind throughout Brazil. The eyelashes were bitten off irregularly, in some places quite close to the lid. Like most Brazilians, these children had very long, black eyelashes, and their appearance thus defaced was odd enough. The trouble was confined to children, I suppose, because they are heavy sleepers and do not disturb the insects at work. My wife and I sometimes brushed cockroaches from our faces at night, but thought nothing more of the matter. The roaches also bite off bits of the toe-nails. Brazilians very properly encourage the large house-spiders because they tend to rid the house of other insect pests.—[Herbert H. Smith, New York, December, 1892.]

Screw Worms and the man-infesting Bot in Brazil.

I was once called upon to attend a little Brazilian boy, whose nose, with the sinuses and apparently the upper part of the pharynx, were literally alive with large maggots. He could only breathe through the mouth and was in great pain. The maggots were introduced by a blow-fly (probably one of the common green flesh-flies) through the nostrils, while the boy was asleep.

Luckily, I had a piece of rubber tubing, with which I arranged a nasal douche; dilute carbolic acid was repeatedly passed through the nose, the maggots dropping out in great masses; in the end all were removed, and the boy speedily recovered.

I was told that he had had a previous experience of the same kind, but less severe, and on that occasion he got rid of the pests without any treatment. Cases of this kind are quite frequent in South America, and they are decidedly dangerous. I heard of several well-authenticated instances where death resulted, the maggots either working their way out into the brain or eating out through the sides of the cheek. An American physician, practising in Brazil, told me that an injection or rather spray of chloroform was the most effectual cure, though he indorsed my own treatment in the case mentioned above. Slight wounds on animals in the tropics are likely to result disastrously if they are exposed to the attacks of blow-flies. The common preventive and remedy is corrosive sublimate, but I have found carbolic acid better and less painful.

While on the subject of maggots I may mention the *Cestrid*, which frequently attacks man in the American tropics. I believe the life history of this insect, if, indeed, there be only one species, has never been traced. The maggots are first apparent by a little sore resembling a small boil, on any part of the body; if neglected, the sore enlarges somewhat, but without any extended inflammation; the worst result is generally an intolerable itching. A common and barbarous remedy is to squeeze the maggots out through the small air-opening on the surface. This is difficult and very painful, as I can attest from personal experience. A better way is to put a drop of strong carbolic acid on the sore and then leave it until the next day when the maggot can be easily squeezed out. Still better is the remedy discovered by the Brazilian country people. They tie a bit of fresh pork-fat tightly around the wound: the maggot is thus deprived of air, and in the effort to obtain it, emerges from the skin, burrowing into the pork.—[Herbert H. Smith, New York, December, 1892.]

NOTE.—The "Blow-fly" was probably *Lucilia macellaria*, our common "Screw-worm Fly," or some allied species, while the Bot-fly was probably *Dermatobia noxialis*, which has been frequently referred to in the pages of INSECT LIFE.—[EDS.]

The Chipping Sparrow and House Wren as Insect Destroyers.

I have seen the Chipping Sparrow hopping from one cabbage plant to another in my garden and deftly picking out of them the green larvæ of the Imported Cabbage Butterfly. I believe this common bird to be a great aid in keeping that great pest to gardeners in check.

I have also observed the House Wren very skillfully removing tent caterpillars from their webs. This little bird is remarkably industrious in the extermination of noxious insects.—[J. M. Keck, Ohio, December 12, 1892.]

The Clover Mite in Houses again.

I have been troubled the past three years with insects. They crawl on the inside of the windows and wall no matter how cold the day is in winter or how hot in summer; if the sun shines they are crawling about. I have collected a few to send you, and for fear anything should happen to them I will describe them. The young are small, barely visible with the naked eye and are fire red. When fully grown their body is brown, legs red, and are big as quarter the size of head of a pin. Some I killed leave a green stain, some yellow. Their haunts seem to be in the plaster or rough stone foundation to the house, or where there are rough boards. They are worse in a dry season. I have tried hot water and freezing them, alum, camphor, borax, insect powder, red pepper, turpentine and kerosene, but do not seem to get rid of them, so I write to see if you can give information that will exterminate them.—[Mrs. Eva Bashaw, Minnesota, December 21, 1892.]

REPLY.—* * * The creature which you find in your house so abundantly is the common Clover Mite (*Bryobia pratensis*) a full account of which is given in INSECT LIFE, vol. III, pp. 45-52. * * *—[December 27, 1892.]

A new Chicken Plague in Texas.

A new chicken plague appeared last summer and to some extent continues through the winter. It is caused by an animal, specimens of which I send in alcohol. This creature attacks the hens, sucks itself full of blood, falls off, retires into the walls of the chicken house, and comes for a new supply when it feels hungry. Pullets it kills by creeping in masses under their wings, under their shoulders, and actually sucks their lives out until they die. In this section of the country this animal is a new-comer, but is already known in a larger portion of this county, and I was requested to send specimens to your Department for inspection, comparison, and possible remedy. Soapsuds with carbolic acid have been tried but gave no satisfaction. I shall try in a few days a thorough smoking with burning sulphur, and if successful will report to you.—[Albert Turpe, Kinney County, Tex., February 14, 1893.]

REPLY.—The creatures which are damaging chickens in your vicinity belong to a rather rare species in this country known as *Argas americana*. They belong to the family of Ticks, so-called, and their nearest allies are the mites and spiders. The common Cattle Tick of Texas, *Ixodes* or *Boöphilus boris*, is not distantly related. Inasmuch as a rather strong kerosene soap emulsion has proved to be efficacious against the Cattle Tick, there is every reason to believe that it would be equally effective against this chicken parasite. You are therefore advised to make a strong emulsion according to the formula given upon page 3 of circular No. 1 of this Division, and to wash the infested poultry and spray the mixture thoroughly about the hen-coops and poultry yards. It is quite likely that the addition of a small quantity of flowers of sulphur to this mixture will render it more effective, but such an ingredient is not a necessity. You may reasonably expect relief by a careful and thorough use of this substance.

The Entomologist would be very glad to receive any further facts which may come to your notice respecting the spread of this insect, the time of its appearance, and the amount of damage which it seems to be doing.—[February 21, 1893.]

NOTES FROM CORRESPONDENTS.

The Cattle Tick affecting Horses.—The common cattle tick of the southwest (*Boöphilus boris*) has not been recorded as affecting horses in this country. It is therefore worthy of mention that one of our correspondents, Sir Alfred Moloney, Governor of British Honduras, has recently sent us specimens of this creature which were taken from a horse in that Central American colony.

The smallest Insect known to Entomologists.—We have recently received a communication from one of our correspondents asking the name, size, and locality of the smallest insect known to entomologists, and replied that so far as known the smallest true insect which has ever been described is *Alaptus excisus* Westw., a minute parasitic Hymenopteron which occurs in England. Its length is seventeen hundredths of a millimeter, or from six to seven thousandths of an inch, and it is of slender form. This little species is probably parasitic in the eggs of some bark-louse. It is quite likely that there exist other species still smaller, but if so, they have escaped the eye of the entomologist up to the present time.

The Rose Icerya on Lignum Vitæ.—Mr. T. D. A. Cockerell, of Kingston, Jamaica, reports that *Icerya roseæ* R. and H., is found abundantly at Kingston, Jamaica, under the bark of *Lignum vitæ*. He thinks it highly probable that this Coccid is a native of Jamaica, and that *Lignum vitæ* is a natural food-plant, from which it has spread to cultivated roses.

A naturalized Panchlora.—Our extract from correspondence in the last number, entitled "A Tropical Cockroach in a New Orleans Greenhouse," has fallen under the critical eye of Mr. S. H. Scudder, of Cambridge, Mass., who is kind enough to inform us that, in his opinion, *Panchlora surinamensis* may be stated to be naturalized in this country. He bases his very just opinion upon the fact that Mrs. Annie Trumbull Slosson has taken mature and immature specimens in different years at Puerta Gorda, in the extreme south of Florida, a barren spot, with but little vegetation and this mostly tropical.

Eucalyptus vs. Mosquito.—Apropos of mosquito remedies, Mr. Alvah A. Eaton, whose letter on the bread-eating mosquito we publish on another page, writes that in California and other places where the Blue Gum grows no other remedy need be sought for. No matter how plentiful the mosquitoes, a few twigs or leaves, so he writes, laid on the pillow at night will secure perfect immunity. This is that same *Eucalyptus globulus* which is now being extolled as a panacea for all ills and insects. We should be glad to learn more of its value as an insect repellent.

Damage by Locusts in Pennsylvania.—A correspondent in McKean County, Pa., states that during the summer locusts of at least half a dozen species literally covered the face of the earth. The damage to cut hay amounted to one-third of the crop. In parts of Clinton County much damage was done and dryer weather was never known. No rain to amount to anything fell from the first week in July to the 1st of December.

A serious Case of Bee Sting.—A correspondent writes that a child three years of age was stung about one hundred times in various parts of her body in September, 1892. She was very ill, suffering from severe pains, followed by faintness, vomiting, and stupor. No physician was employed and the only treatment consisted in bathing in spirits of camphor. The child was ill for some weeks and wherever stung a small pustule formed which was slow to heal. At the expiration of three months the child was still feeble.

The edible Qualities of Ants.—It has long been known that the formic acid present in ants in such quantity is normally of such strength that it is not disagreeable to the palate. As a boy Mr. Howard tried the experiment of crushing ants with sugar and water as a substitute for lemonade and recollects that it was drunk with relish by his companions. A correspondent writes us recently that one of her hired men is in the habit of eating large black ants found in rotten wood. She also states that her father, after eating a large section of railroad restaurant pie in the dark, and noticing an agreeable acid flavor found that the remainder was swarming with specimens of the little Red Ant (*Monomorium pharaonis*) and that he must have eaten some hundreds of individuals. He was satisfied with his experience, which he did not repeat voluntarily, but he vouches for the edibility of this species. What the original ingredients of the pie were is not stated, but the effect of the combination was to make it about as sour as rhubarb.

A new popular Name for the Blood-sucking Cone-nose.—Mr. J. B. Lambert, a California correspondent, writes us concerning an insect which, from his description, we take to be *Conorhinus sanguisuga*, and which he states is known in his vicinity as the "Monitor Bug." He says that it is found in beds, and that its bite is severe.

An Omission.—The Secretary of the Association of Economic Entomologists, Mr. F. M. Webster, writes us that in the list of members which he furnished for publication in *INSECT LIFE*, vol. v, page 131, the name of Mr. A. D. Hopkins, Entomologist Agricultural Experiment Station, Morgantown, W. Va., was inadvertently omitted.

Additional Damage by Walking-sticks.—Mr. T. D. A. Cockerell, of Kingston, Jamaica, apropos to our note on page 63 of No. 2, on reported damage by Phasmids, writes us that *Necrossia cyllarus* Westw. did considerable damage to a hedge (kind not mentioned) in Jamaica in 1891.

An Insect Enemy of Chocolate.—Dr. C. C. Beach, of Hartford, Conn., has sent us the larva of *Sitodrepa panicea* found living in commercial chocolate. They were

first noticed by a Hartford druggist who, upon applying to the wholesale dealer from whom he bought the chocolate, was told that the little white bits were not really alive but were only small lumps of chocolate.

Sitodrepa panicea again.—Shortly after receiving this insect in chocolate Judge Lawrence C. Johnson sent us from Pachuta, Miss., specimens of the old-fashioned shot-gun wads which had been riddled by this same insect. About a dozen wads were received, each one perforated from top to bottom by many holes, while between the upper and lower surface the substance of the wad was reduced to powder.

Dipterous Larvæ infesting a Turtle.—An Indiana correspondent, Mr. Wm. A. Riley, has lately sent specimens of a larva closely related to the Screw Worm (*Lucilia macellaria*) which was found beneath the skin of a turtle, between the hind legs. It is evidently a species of the genus *Lucilia*, and doubtless identical with the larva mentioned by Mr. F. W. True in *Science* (vol. iv, p. 511), also taken beneath the skin of a turtle. A somewhat similar instance is mentioned by Dr. A. S. Packard in the *American Naturalist* (vol. xvi, p. 598).

Injurious Snails in Bermuda.—One of our correspondents, a seed dealer of Philadelphia, sends us specimens of a snail, *Bulimus decollatus*, known as the Broken-tail Snail, with the statement that they were received from Bermuda, where they had recently appeared in great numbers on Amaryllis beds. Although these creatures are rather outside the province of entomology, we have been considerably interested in the accounts of the damage which they do in several of the West India islands, particularly in Bermuda, and we would suggest to such of our correspondents as are suffering from the inroads of these pests to apply for an interesting little pamphlet recently published by the Queen's Printer in Bermuda, Mr. G. V. Lee, under the auspices of the Board of Agriculture, entitled "Five Essays, etc., History of the Spiral Snails and the most expeditious, efficacious, and economical method of effecting their extermination."

On the Habits of three California Coleoptera.—Our agent, Mr. Coquillett, has sent us, under date of March 6, some interesting notes on three species of California Coleoptera. *Odonotota californica* was bred in September from larvæ mining the leaves of *Ceanothus integerrimus* collected August 22. We have also received specimens of a Chalcidid bred from these larvæ. *Copturus lunatus* was found in its burrows in the main stems of growing plants of a species of *Cnicus*, September 28, and these burrows also contained larvæ, evidently of this species. *Copturus adspersus* was taken from dead and dry stems of a weed, probably *Chrysopsis villosa*, January 20.

GENERAL NOTES.

AN ENEMY OF THE SCREW WORM FLY.

We are indebted to Dr. C. Hart Merriam, Chief of the Division of Ornithology and Mammalogy, for a vial containing a large number of the puparia of the well known Screw Worm (*Lucilia macellaria*) which had been sent to him by Mr. H. P. Attwater, of Rockport, Tex., with the memorandum that they were being scratched out of the ground and eaten by the Caracara Eagle (*Polyborus cheriway*). This eagle is a common subtropical carrion bird in that part of the country, which also feeds upon small mammals and lizards, and is abundant enough, in case this habit should be at all common, to do considerable good.

THE ARCHIPPUS BUTTERFLY EATEN BY MICE.

Dr. Merriam has also given us a box containing a number of wings of the common Archippus butterfly (*Danais archippus* = *Anosia plexippus*) which were sent to him by Mr. Attwater, above mentioned, with the following label: "Wings of butterflies, the bodies of which have been eaten by white-footed mice, from an island in Aransas Bay, four miles south of Rockport, Tex., collected November, 1892." This observation bears an especial significance. The Archippus butterfly is a migratory species, as has been frequently stated in these pages, and flies south on the approach of winter for hibernating purposes. It is, moreover, one of the species which is seldom or never attacked by birds on account of its nauseous taste and odor. Abundant evidence in support of this fact we brought out in an article on mimicry as illustrated by *Limenitis disippus* and *Danais archippus* in our Third Report on the Insects of Missouri. The former species bears a strong protective resemblance to the latter. Mr. Attwater's observation shows that, however exempt the Archippus may be from birds and other natural enemies, it is unquestionably destroyed by these little white-footed mice in considerable numbers when hidden away in hibernating quarters in the south. The box which he sent contained 43 hind wings and 50 front wings, and of the front wings there were 23 right and 27 left, representing the destruction of at least 27 specimens. The mouse referred to in the field note, Dr. Merriam informs us, is not a white-footed mouse, but one of the grasshopper or scorpion mice of the genus *Onychomys*.

NOTES ON SOME INSECT PESTS OF THE FIJI ISLANDS.

Our agent, Mr. A. Koebele, has lately sent us a small lot of specimens with accompanying notes of interest. The Sandwich Island Sugar-cane Borer, which was treated in volume I of *INSECT LIFE* (pp. 185-189) he states is also very destructive to cane in the Fiji Islands. A somewhat similar Calandrid was associated with this species under the same number and has doubtless the same or similar habits. Neither of these, it should be said, belong to the true genus *Sphenophorus* as at present restricted. A third species is also sent with the statement that it is destructive in the larva state to cane by feeding on the larger roots. It is a Scarabæid, bearing some resemblance to our *Lachnosterina*, and probably belongs to the genus *Anchylonycha*.

Mr. Koebele also sends a Tineid Moth, belonging, evidently, to the Plutellidæ, and found feeding in the stalks of the Sugar-cane, and a small, black Pyromorphid closely related to our *Acoloithus* and *Harrisina*. The latter is said to be spreading over the South Sea Islands where it is destroying the palm leaves by devouring the epidermis. He further says, writing under date of February 13, that all the cocoa-nut plantations in the Fijis are being ravaged, the trees bearing only a few green leaves at their tops. He has been informed that the insect first appeared some years ago at the Sandwich Islands, coming, it is

believed, from South America. If relief is not soon found it is probable that one of the most thriving industries of these islands will have to be abandoned.

ENTOMOLOGY AT THE IOWA STATE UNIVERSITY.

Volume II, No. 3, Bulletin from the Laboratories of Natural History of the State University of Iowa, published January, 1893, contains three entomological articles by Mr. H. F. Wickham. The first of these includes an account of the earlier stages of three North American Coleoptera, viz, *Dicælus splendidus*, *Epipocus cinctus*, and *Ellychnia californica*. The second is a report on an entomological reconnoissance of southern Alaska and adjacent portions of British Columbia, which contains an interesting account of his methods of collecting and an itinerary of the journey, concluding with a list of the species captured; the list is a rather long one, covering twenty pages of the Bulletin. The third article is a short one announcing the westward spread of the European *Aphodius fossor* to Iowa City and the finding for the first time in this country of the European *Rhinoncus inconspicuous*. The first article is illustrated by a plate giving structural details of the larva and pupa of each of the three species of Coleoptera. The figure of *Epipocus cinctus* corresponds fairly well with drawings which we had made of *E. punctatus* some six years ago from specimens which we mentioned in the Proceedings of the Entomological Society of Washington, volume I, p. 37.

LOCAL NAMES FOR COMMON INSECTS.

Several times in the columns of this journal we have solicited correspondence with regard to local names for our commoner insects, and a number of our correspondents have responded.

The most interesting information on this head has lately come to us from Mr. Alvah A. Eaton, who sends quite a list of names current between Newburyport, Mass., and Portsmouth, N. H. Some of them are entirely new, and are probably quite local. The Walking Stick (*Diapheromera*) is there known as "scorpion." The term "huckleberry bug" is used indiscriminately for a species of red mite and for soldier bugs, just as "red bug" is applied in the South to mites and the Cotton Stainer. May Beetles and the like are called Dor Bugs, an old English name for this class of Scarabæids. "Crackamire" and "Needle Ichneumon" are the names given the long, slender Ichneumon flies. The large Locustidæ, or long-horn grasshoppers, are very appropriately called "cradlers" from the resemblance of the ovipositor of the female to a grain cradle, but most singular of all is the application of the name of locust to the large Bombycid moths, such as the *Cecropia*, *Luna*, and *Polyphemus*, and of lady-bird for the Sesiid or Humming-bird Moths.

A New York correspondent writes us that the carpet beetle, *Anthrenus scrophulariæ*, universally but incorrectly called "Buffalo moth," is known in certain towns along the Hudson as "Russian moths."

The different names that have been proposed for the *Acanthia lectularia*, the insect which "has no wings at all," but which makes its presence felt notwithstanding, will fill several pages. Around Boston these torments are called "chintzes" and "chinchies," and from Baltimore we get the name "mahogany flats," but in New York they speak of them as "red-coats."

LEGISLATION AGAINST SPRAYING.

We notice an item in Garden and Forest for December 7, 1892, to the effect that the Ontario legislature passed an act at its last session forbidding the spraying or sprinkling of fruit trees while they are in bloom with any mixture containing Paris green or other substance poisonous or injurious to bees. This question has already received attention in the pages of this journal, and at the last meeting of the Association of Economic Entomologists a paper was read by Mr. F. M. Webster, which, taken together with the discussion, failed to prove that bees are injured by such spraying. Moreover, the legislation was hardly necessary, for the reason that at present it is not considered desirable to spray the fruit trees while in bloom in order to destroy any of our injurious insects.

AN EXHIBITION OF SPRAYING MACHINES.

An important exhibition of spraying machines for the application of Bordeaux mixture was held at Wevelghem, Belgium, the 21st of July, 1892. Numerous exhibitors from Germany, Switzerland, and Belgium took part, France being represented by Messrs. Besnard, Duru, Japy, Loumagne, Vermorel, etc. The first prize, a medal of the ministry, was awarded to the "Eclair" of M. Vermorel. The second and third prizes went to Belgian exhibitors.

ECONOMIC ENTOMOLOGY AT THE CAPE OF GOOD HOPE.

We have frequently quoted in these pages from the Agricultural Journal, published by the Department of Agriculture of the Cape Colony, and it may be inferred from the frequency of our notes that the farmers of South Africa are wide-awake to their own interests in fighting injurious insects. Prof. P. MacOwan, although not a trained entomologist, as he informs us in a recent letter, has been doing excellent work in the way of giving advice to the farmers in the columns of the Journal, and each number which has reached us of late has been of increasing interest. The issue for December 29, 1892, contains among other matter notes concerning the hatching of locusts in one of the Provinces; a lengthy review of the work done in North Africa by the French against migratory locusts; a letter upon the Orange Fruit-worm (*Ceratitis citriperda*) and upon the Grape Phylloxera, which we wrote at Prof. MacOwan's request; an editorial on the subject of protecting corn from weevils, in which a specially constructed air-tight building is advised; a letter on the value of hemp for preserving grain,

and an article on spraying for insect pests on fruit trees, by Mr. P. Rodbard Malleon.

PARASITES OF ANIMALS TRANSMISSIBLE TO MAN.

Prof. A. Railliet of Paris has just sent us an interesting pamphlet of some 50 pages devoted to a consideration of the parasites transmissible from animals to man, which is, for the most part, occupied with the treatment of intestinal parasites, but which also takes up certain insects. The latter comprise principally external parasites, and of these largely those which are free or temporary. The species principally mentioned under this category are the Stable Fly (*Stomoxys calcitrans*), the African Tsétsé Fly (*Glossina morsitans*), the common Horse Fly (*Hippobosca equina*), and species of *Simulium* and *Pulex*. These are all of importance on account of the fact that they may become transmitters of contagious diseases. Among the Arachnida, he mentions the species of *Dermanyssus* and *Argas*. Some attention is also paid to *Ochromyia*, *Sarcophaga*, *Hypoderma*, and *Dermatobia*, all of which occasionally infest human beings, while the Chigo of Tropical America (*Sarcopsylla penetrans*), the Dog Tick (*Ixodes ricinus*), the larval *Trombidium* and several species of the family *Sarcoptidæ* are also treated briefly.

FURTHER ILLUSTRATIONS OF THE ROSE SLUGS.

It was our intention in the article in the September number of *INSECT LIFE* on Rose Saw-flies in the United States to have presented figures of the commoner species *Monostegia rosæ*, which we had made some years ago. These illustrations are given herewith. Fig. 35 represents

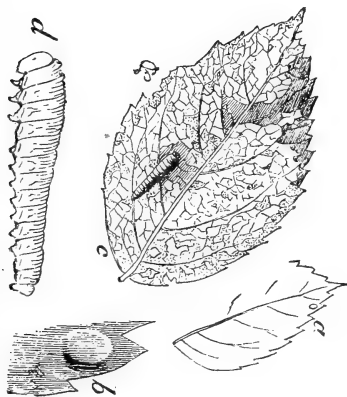

FIG. 35.—*Monostegia rosæ*: a, egg *in situ*, natural size; b, do., enlarged; c, skeletonized leaf with larva feeding, natural size; d, larva enlarged (after Riley).

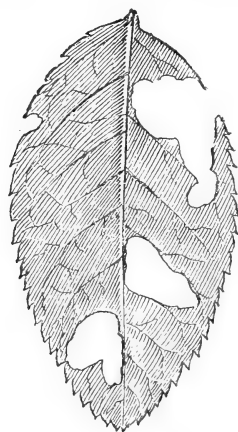

FIG. 36.—*Monostegia rosæ*: work of full-grown larva in rose leaf, natural size (original).

the early stages; the egg, natural size, is shown *in situ* at a, and considerably enlarged at b. The appearance of the larva on the leaf and

the characteristic skeletonizing of the leaf are shown at *c*, while a magnified lateral view of the larva is given at *d*. Fig. 36 represents a leaf

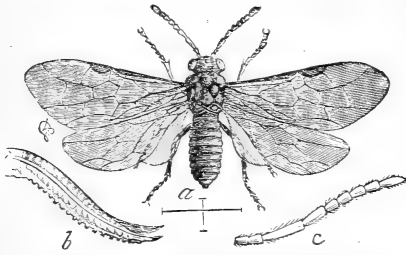

FIG. 37.—*Monostegia rosæ*: *a*, female; *b*, ovipositor of female; *c*, antenna of female, all enlarged (original).

eaten by a full-grown larva, in which none of the skeletonizing of the early larval stages is present. Fig. 37 is an enlarged view of the female fly, the natural size being indicated by the hair lines beneath. The ovipositor, by means of which the slit in the leaf for the insertion of the eggs is made, is shown at *b*, and the antenna at *c*. The first and last of these figures are reproduced from our account

of this insect in the *American Entomologist*, vol. III (new series, vol. I) page 115.

COCKROACH EGG PARASITES.

The commonest parasite of the cockroach egg capsule in Europe is the old Linnæan *Evania appendigaster*. This insect has been described in different parts of the world under a great many different names, and although an indigene in Europe, was found in Cuba as long ago as 1829. It has also been found in the United States by Dr. Packard, Mr. Ashmead, and others. The good which might be accomplished by this important parasite is modified by the fact that it has a destructive secondary parasite, which was described by Ratzeburg in 1852 as *Entedon hagenowi*. We should indeed be fortunate in this country if the *Evania* had been imported without its own particular enemy, but in a collection of micro-hymenoptera from the academy of Natural Sciences in Philadelphia, which has been loaned to this Division for study, Mr. Ashmead has found specimens of this *Entedon hagenowi* in a lot of Cuban micro-hymenoptera sent to Mr. Cresson many years ago by Dr. Juan Gundlach and Prof. Felipe Poëy. The larger species of this particular sending were described by Mr. Cresson in his paper on the Hymenoptera of Cuba in the Proceedings of the Entomological Society of Philadelphia for 1865. Mr. Ashmead also informs us that in his old Florida collection he has specimens of the secondary parasite collected in that State.

THE HYMENOPTERA OF AUSTRALIA.

Some two years ago Mr. W. W. Froggatt, of the Sydney Museum, published Part I of his "Catalogue of the Described Hymenoptera of Australia," carrying the list through the remarkable family Thynnidæ, a group in which the Australian fauna is wonderfully rich, not less than five hundred species having been listed.

We have recently received from him Part II of the Catalogue, which is a reprint from the Proceedings of the Linnæan Society of New South

Wales, Second Series, volume VII. In this part the author lists the Scoliidae, Sphegidae, Pompilidae (wrongly spelled with a double i), Laridae, Nyssonidae, Philanthidae, Crabronidae, Bembicidae, Masaridae, Eumenidae, Vespidae, Andrenidae, and Apidae.

The Catalogue is wisely published in small octavo, with blank leaves freely interspersed. The latter feature is one which will be appreciated by collectors.

THE GENUS MIRAX.

Mr. William H. Ashmead, in *Psyche* for January, 1893, describes five species of the genus *Mirax*, which is the first time this genus has been recorded in this country with the exception of the indication of three species by manuscript names in *INSECT LIFE*, vol. III, p. 15. The genus belongs to the Microgasterinae, and all of the species so far known are parasitic upon micro-lepidoptera. But one species is known in Europe.

AN IMPORTANT PAPER ON BUTTERFLIES.

Under the title "The Tropical Faunal Element of our Southern Nymphalinae systematically Treated," Mr. S. H. Scudder has published in the current volume of the *Proceedings of the American Academy of Arts and Sciences* (pp. 236-251) a paper of great interest to the student of faunal limits. He shows that nearly all the genera of the subfamily Nymphalinae, which are essentially tropical or sub-tropical and are represented on the extreme southern border of the United States by a very few species each (and some of these must be considered more or less accidental visitors), belong to a few tribes which directly follow one another between the Nymphalini and the Vanessini. In previous systematic arrangements they have not been as closely connected as they should be, on account of the great diversity of forms, and Mr. Scudder therefore gives a succinct treatment, with accounts of the early stages, largely drawn from Wilhelm Mueller's "Südamerikanische Nymphaliden Raupen," but supplemented from various sources.

THE TOBACCO SPHINX IN LOUISIANA.

Bulletin No. 20 of the Second Series, North Louisiana Experiment Station, just received, is devoted to the subject of tobacco-growing in Louisiana, with results of experiments at Calhoun. In a paragraph towards the end of the bulletin brief mention is made of the damage done by the larva of the Tobacco Sphinx, and the statement is made that the old remedy of injecting a few drops of sweetened cobalt into the tubular-shaped flower of the common "jimson weed" has proved quite effectual in Louisiana. The jimson weeds were transplanted to the margins of the tobacco fields for use in this way, and it is interesting to note that the farmers of Louisiana are so imbued with the desirability of clean culture that visitors to the station have been in the

habit of pulling up these jimson weeds so extensively that the Director has published a warning.

CANKER-WORMS IN CALIFORNIA.

On page 167, vol. IV, in reviewing a paper by Mr. Alexander Crow, we mentioned his identification of the Fall Canker-worm (*Anisopteryx pometaria*), from the larva alone, as open to doubt. The present season, however, Mr. Coquillett has reared the adult insects, and from good material which he has sent us we are able to decide that Mr. Crow's surmise was correct and that the species is identical with the eastern *A. pometaria*.

THE MEDITERRANEAN FLOUR MOTH IN CALIFORNIA.

We mentioned in the November number of INSECT LIFE the appearance of *Ephestia kühniella* in flour mills on the Pacific Coast. The *American Miller* of January 1, 1893, has a long article under the title "Flour Moths in California," in which it reviews the articles published by this journal, by Mr. James Fletcher, the Entomologist of the Central Experiment Farms, Ottawa, Canada, and by Miss E. A. Ormerod, of England, and states that the San Francisco *Call* has been investigating the occurrences of the insect in California. The result of this investigation shows that the *Ephestia* has already become an alarming pest, and that its work has resulted in the loss of thousands of dollars to a number of large establishments. The Pacific Coast occurrences have been carefully studied by Mr. W. G. Johnson, instructor in entomology at Leland Stanford, Jr., University, who is reported as stating that the disastrous effects of the insect's work will undoubtedly be very apparent in nearly all of the mills of the State before the end of another year.

We may mention in passing that M. J. Danysz has recently started a private "Laboratoire de Parasitologie" in Paris, and has studied the occurrences of this insect in France, and that after thoroughly considering all of the facts he is inclined to agree with our original supposition that the insect is not American in its origin, as has been claimed by European writers heretofore. M. Danysz, by the way, places less reliance on the use of kerosene emulsion or bisulphide of carbon as a remedy against this insect than upon a strong tobacco wash.

TENT CATERPILLARS IN MASSACHUSETTS.

The Massachusetts horticulturists, taking advantage of the liberal disposition of the State Legislature with regard to appropriations for fighting the Gypsy Moth, propose to memorialize this body for further appropriations to be used against the Tent Caterpillar which has become a great pest in certain of the New England States. At a meeting held in December a committee of the State Horticultural Society was

appointed to bring the matter before the legislators. It will be remembered that in an early number of *INSECT LIFE* we drew attention to the novel means in use in Connecticut for destroying similar tents which consisted in blowing them to "kingdom come" from a shotgun.

RESULTS OF CODLING MOTH LEGISLATION IN TASMANIA.

In the *New Zealand Farmer* for July, 1892, we find a long and interesting article under this caption, showing that the chief inspector of the Hobart Fruit Growers reports that there has been a decided diminution of the Codling Moth in Tasmania as the result of the work of the Board. The methods in use have been to destroy infested fruit and to spray with Paris green at the rate of one ounce to 20 gallons of water.

A VINE PEST IN AUSTRALIA.

Some of the South Australian newspapers have been publishing alarming items about a new insect which is attacking the vines in different parts of that Colony. It is particularly abundant at a place called Orroroo. Our correspondent, Mr. Walter C. Hackett, determines this insect as the larva of *Chærocampa celerio* and states that on account of its large size and conspicuous appearance it can always be kept in check by handpicking.

THE SUGAR-CANE PIN-BORER AGAIN.

The *Agricultural Record*, the official journal of the Central Agricultural Board of Trinidad, for November, 1892, contains on pages 151 to 156 certain correspondence upon sugar-cane borers, which is of great interest and importance. A letter from Mr. J. G. Coull, of St. Vincent, addressed to the Royal Kew Gardens, September 7, 1892, transmits specimens of canes the top portions of which have been injured by the Larger Sugar-cane Borer (*Diatræa saccharalis*) while the lower portions were infested by *Xyleborus perforans* and Mr. Coull claims that the observations of the season have set at rest the controversy as to whether the *Xyleborus* is the original cause of the damage to the canes, stating that it has been satisfactorily proved that Mr. G. W. Smith, of Grenada, and Mr. H. H. Smith, of Brooklyn, are correct and that the cane is primarily attacked by the "Moth Borer" and that when its health has been injured and acidity sets in, then the *Xyleborus* takes possession. He states that the main attacks of the moth-borer are at intervals of fifty to sixty days and that the proper time to destroy them is when they attack the young sprouts in May, June, or July. At this time all plants showing signs of disease should be cut out. Careful inspection in August and September and again in November and December and the burning of affected cane-pieces are recommended. Mr. Coull's letter and specimens were referred to Mr. W. H. F. Blandford whose report is appended. Mr. Blandford found the burrows of the *Diatræa* and of the *Sphenophorus* mentioned in *INSECT LIFE* by Mr. Cockerell, and

noticed that the burrows of the larger borers were all towards the summit of the cane, invariably destroying the terminal joints. The burrows of the *Xyleborus* on the contrary were in the lowest part of the stem and were recent compared with the tracks of the larger borers in the tops. The canes sent to the Kew Gardens, however, Mr. Blandford surmises, were selected for the purpose of exhibiting this state of affairs and he had no means of telling except from Mr. Coull's statement whether it was common. Mr. Coull, however, did not distinguish between the work of the *Diatræa* and the *Sphenophorus*, nor is it likely to be necessary except as regards periods.

Mr. Coull's observations coincide with what we have suspected to be the true state of affairs, although exceptionally healthy canes may be injured by the *Xyleborus*. The fact remains, however, that if the more normal nidus is destroyed in the cane fields the insects will either be reduced in numbers or will resort to other normal conditions away from the cane fields rather than take on a perfectly exceptional habit. It is interesting to note that the *Xyleborus* on arrival were found to have bored extensively into the soft deal boxes in which the sections of cane were sent.

THE MUSTARD BEETLE IN ENGLAND.

Our esteemed correspondent, Mr. Fred. Enock, has sent us a little paper published in the *Entomologist* for October, 1892, referring to the extraordinary abundance of *Phædon cochleariæ*, commonly known as the Mustard Beetle, in England the present summer. This insect is known as one of the greatest crop pests in England and for fifty years has been increasing and it would be a most undesirable species to introduce into the United States. Both brown and white mustard have been ruined. In one field of white mustard in which the plants were from nine inches to a foot high, every plant was found to be absolutely swarming with beetles. Mr. Enock, with his customary attention to minutiae, took the trouble to count the eggs on one plant. The top leaf held 85 eggs, the middle ones about 150 to over 500, while on the lower leaves were no less than 700. On reaching the thirty-fifth and last leaf he added up and found that one plant carried 9,234 eggs. It is needless to say that it was not long before the plants were completely skeletonized. The fields as a general thing were small and Mr. Enock suggests as a remedy the use of the sweeping or beating net. He himself collected the beetles by hundreds in this way and records the fact that a German saved his crop in this manner. It should be done, however, at the right time, when it will unquestionably pay.

NEW SPECIES AND GENERA OF RHYNCHOPHORA.*

Capt. Casey has recently published another paper of new species and genera of Coleoptera. It is entitled "Coleopterological Notices, IV,"

* Coleopterological Notices, IV. By Thomas L. Casey. Extract from Vol. VI, Annals New York Academy of Sciences, August, 1892.

and covers pages 359 to 712 of Vol. VI of the Annals of the New York Academy of Sciences, and with the exception of the last three pages, is devoted exclusively to two families of Rhynchophora.

The great tribe *Barini* is treated in monographic form, and in addition synopses are given of the following genera: *Dorytomus*, *Smicronyx*, *Promecotarsus* n. g., *Tychius*, *Thysanocnemis*, *Otidocephalus*, *Acampatus*, *Tyloderma*, *Phyrdenus* and *Zygops* of the Curculionidæ, and *Cactophagus*, *Calandra*, *Yuccaborus*, *Himatium*, *Allomimus*, *Pseudopentarthrum* and *Pentarthrinus* n. g., of the Calandridæ.

In *Calandra*, a genus which includes our Rice and Grain Weevils and others of the greatest economic importance, the author considers *remotepunctata* a synonym of *granaria*, and adds to our fauna *linearis* Hbst. and *rugicollis* n. sp. The occurrence of *linearis* in our southern states has been recognized for years past, but we should hesitate before including *rugicollis* in our faunal list, founded as the species is on a single Florida specimen, of probably accidental occurrence.

In the concluding chapter of the appendix the author suppresses twenty-two of his own species of *Stenus*, thus indicating a most praiseworthy disposition to change his views upon acquiring additional facts and material.

WESTWARD SPREAD OF THE CLOVER-LEAF WEEVIL.

We learn from an article by Mr. A. W. Butler, in the *Indiana Farmer* of January 14, that *Phytonomus punctatus* has been found the past season in northwestern Ohio in injurious numbers and also in the vicinity of Cincinnati. Anticipating its spread to southeastern Indiana the coming season Mr. Butler republishes our figures from the 1881-'82 report and gives a full account of the life history of the insect.

THE LARVAL HABITS OF THE ACALYPTRATE MUSCIDÆ.

Prof. C. H. Tyler Townsend, in the *Canadian Entomologist* for January, 1893, gives a most valuable summary of the known larval food-habits of this group of true flies. The list contains all of the facts already on record and a number of unpublished observations by the author. The grouping of the larval family habits in this way is of great interest. We notice that the author questions the parasitism of *Lestophonus* upon *Icerya* as well as of *Leucopis* upon plant-lice and scale-insects. There can be, however, no doubt as to the actual parasitism in both of these cases. Personal observations on the part of several entomologists besides our own, as already recorded, sufficiently prove this, and while skepticism is a good trait in a naturalist, it can serve no purpose when questioning well attested fact, upon no other grounds than generalization from group habit.

A BLOOD-SUCKING CHIRONOMID.

In *Psyche* for January, 1893, Prof. C. H. Tyler Townsend describes, under the name *Tersesthes* n. g. *torrens* n. sp., a minute gnat which he

has found in western New Mexico at an altitude of 7,000 feet, clustering in numbers upon horses and sucking their blood. The insect proved to be very interesting structurally and allied most closely perhaps to *Ceratopogon*, biting species of which are found throughout the northern states, and to *Cæcacta*, a small blood-sucking gnat inhabiting Cuba.

THE FAMILY APIOCERIDÆ.

We have just received from the author, Dr. S. W. Williston, a brochure extracted from No. 3, Vol. I, *Kansas University Quarterly*, in which he strongly defends his position in considering that the dipterous genus *Apiocera* and its allies, *Raphiomidas* and Coquillett's recent genus, *Apomidas*, are deserving of family rank and are not to be included with the *Asilidæ*, *Midaidæ* or *Therevidæ*. In this view he takes up cudgels against no less an authority than Baron Osten Sacken, who considers that the group should form a subfamily of the *Asilidæ*. The paper is a very thorough and, to us, convincing argument in support of the views of the author, in which, by the way, he is supported by Mik and Brauer, the family having originally been founded by Macquart. It is worthy of note that in this paper Dr. Williston adopts for the first time J. B. Smith's terminology of the mouth-parts, and consequently the author's views of the homologies of these sclerites. He does this, however, with some slight reservation in the statement, "I believe that his studies show a real advance in knowledge of the homologies of these parts, though in some instances his views may require modification or change." To this paper the author adds two notes, one describing a new genus of *Blepharoceridæ* under the name *Snowia* and containing the species *S. rufescens*, and the other on the American species of *Stylogaster*.

The *Kansas University Quarterly*, from which this paper is extracted, bids fair to become a journal of some prominence. Its general form is excellent and it will undoubtedly possess considerable importance to entomologists, since not only Dr. Williston, but Chancellor Snow and his son, Mr. Wm. A. Snow, as well as Mr. V. L. Kellogg, will undoubtedly use its pages.

THE CALIFORNIA REMEDY FOR THE SAN JOSÉ SCALE.

As we have occasionally mentioned, the remedy which is in most frequent use for the San José Scale or Pernicious Scale (*Aspidiotus perniciosus*) in California, is the lime, salt and sulphur wash used upon deciduous trees. The old method of cooking the mixture in iron vats resulted in a fair incorporation of the ingredients into a whitewash. Mr. H. P. Stabler, of Yuba City, Cal., in a paper read before the January meeting of the State Horticultural Society and reported in the *Pacific Rural Press* of February 4, gives the details of some extensive and important experiments in the use of this wash. By means of a 12-horse power boiler and attached pipes, vats and hot-water tank he

cooked by steam 1,500 gallons of spraying material, boiling it in every case more than two hours. Fifty pounds of lime and 100 pounds of sulphur were placed in one of the vats (capacity 300 gallons) and 100 gallons of hot water were run in from the tank. Then turning on the steam the contents began boiling almost instantly. After two or three hours 150 pounds of lime and 75 pounds of salt were added, after having been previously slacked. The steam was kept up and the contents of the vats boiled for half an hour longer, and water was then added to make 300 gallons. After this prolonged cooking the residue was very slight and the mixture approached a chemical solution in appearance. The use of this mixture resulted in a complete eradication of the San José Scale from a 100-acre orchard of 7-year-old trees.

INTRODUCTION OF THE LONG SCALE INTO CALIFORNIA.

We notice from the *California Fruit Grower*, of December 10, 1892, that no less than 22 carloads of Mexican oranges have been imported into California at Los Angeles, many of them infested by *Mytilaspis gloverii*, which up to the present time has not succeeded in getting a foothold in that State. The *Fruit Grower* is justly indignant over the supposed negligence of the quarantine officers in allowing this importation, as these oranges coming before the California fruit is marketable were widely distributed and liable to work great damage. That neither the Purple Scale, Long Scale, or Chaff Scale have as yet obtained a foothold in California, in spite of frequent accidental importations, is by no means an absolute argument against the possibility that they might ultimately become injurious on the Pacific Coast, although this is a point made by importers both of fruit and nursery stock against the necessity of disinfection.

IMPORTED SCALES IN CALIFORNIA.

In a paper read by Mr. Alexander Crow before the State Horticultural Society, December 30, 1892, he brings forward many important facts relating to the insect pests of foreign trees. He states with great positiveness that the Red Scale of California (*Aspidiotus aurantii*) was introduced upon Citrus trees from Australia, and that it is undoubtedly a native of that country. Inasmuch as it can be traced to four distinct importations of trees from Australia and its spread followed from those centers, the first of his statements is probably correct, but it by no means follows that it is an indigene of the island-continent, and of this we have serious doubts. The so-called "yellow scale" (*Aspidiotus citrinus*), which, by the way, we have as yet been unable to separate specifically from the Red Scale, but consider only a variety thereof, is stated with equal positiveness to have been introduced from Japan in the early '70's. The San José Scale is stated to be unquestionably of foreign origin and it is surmised on the authority of Mr. John Brit-

ton, of San José, that it was introduced into California upon trees received from Chile by the late James Lick. This last is an interesting point which has not before been made public. We may mention, by the way, the fact that this scale has made its appearance within the last year in Australia. Other imported pests which are specifically mentioned are the Purple Scale (*Mytilaspis citricola*) and the Long Scale from Florida (*Mytilaspis gloverii*); the Florida Red Scale (*Aspidiotus ficus*) from Florida, Cuba, and Japan; the Chaff Scale (*Parlatoria pergandii*) from Florida, and an allied species, *Parlatoria proteus*, from certain islands of the Pacific; the Wax Scale (*Ceroplastes floridensis*) from Florida, and the congeneric *C. rusci* from Japan; *Ctenochiton perforatus* from Australia, and *Dactylopius iceryoides* from the same locality; *Dactylopius destructor*, the common Mealy Bug, from Honolulu, and *Pulvinaria camellicola* from Japan; the common Orange Chionaspis (*C. citri*), the most abundant pest of the Orange in Louisiana, from Japan and also from Australia; *Lecanium depressum* from Honolulu.

THE MEMBRACIDÆ OF NORTH AMERICA.

We are pleased to notice that Dr. F. W. Goding, of Rutland, Ill., has published in the Transactions of the American Entomological Society, vol. XIX, a synopsis of the sub-families and genera of the Membracidæ of North America, upon which he has been at work for the last few years. His tables will be very useful to the student of the Homoptera, and we look forward with interest to the complete monograph which Dr. Goding has in preparation.

A NEW ENEMY OF THE TOMATO.

In November, 1892, we received from Mr. G. W. Caruthers, of Bexar, Tex., specimens of an insect which he stated was damaging his tomatoes, and which had been very destructive to that crop in the neighborhood of Bexar for the past three years. Upon examination the insect proved to be *Pthia picta* Dr., which occurs normally in the West Indies and has been but seldom reported from the Gulf States. This, in fact, is the first time it has been reported as of economic importance. The insect is not distantly related to the common Squash Bug and will probably be as difficult to control.

AN INSECT ENEMY OF LACE CURTAINS.

In a short paper, "Biologic Notes on New Mexico Insects," in the *Canadian Entomologist* for January, 1893, Prof. C. H. T. Townsend records the fact that *Ceuthophilus pallidus* Thomas, a wingless stone cricket has been found in New Mexico in houses eating holes in lace curtains and other fabrics, and is reported to cause much damage in this way. This is an entirely new habit for an insect of this group, and we should naturally suppose, were it not for the frequency of the

occurrence which Prof. Townsend reports, that it was entirely accidental and abnormal. We have observed a common species of this genus in recently built cottages in the Catskill Mountains upon and behind straw mattings used as dados, and have noticed that it had gnawed the straw to some little extent. This habit, however, was certainly accidental, and we imagine the same to be probably the case in New Mexico.

LOCUSTS IN SOUTH AFRICA.

The scourge of locusts still continues in South Africa. The *Agricultural Journal* of the Cape Colony, published December 1, 1892, contains a tabular statement indicating the exact condition of affairs in the seventy-six divisions of the colony, from which it appears that the western, north-western, southern, and midland provinces have generally escaped, while the south-eastern, eastern, and north-eastern provinces, Griqualand and the Transkei, are more or less afflicted. The natives have been occupied in destroying large swarms in these districts, and the divisional councils have in most cases made small appropriations which have been supplemented by the government of the colony on the £ for £ principle. The destructive work is purely mechanical, and is done with brush. Although it is generally conceded that the injurious species is migratory, no attempt seems to have been made to define the permanent breeding grounds. The present incursion has lasted three seasons.

NORTH AMERICAN SPECIES OF HIPPISCUS.

Mr. S. H. Scudder has just completed a careful monograph of the North American species of this genus of locusts, which comprise some of our more injurious species. The paper has been published in parts in *Psyche*, running from June to December of the past year. The author has studied more than five hundred specimens, which he finds to represent thirty-eight species grouped under the sub-genera *Hippiscus*, *Stictippus*, and *Xanthippus*. This is a difficult group of insects to separate, and Mr. Scudder has done a real service to working entomologists.

AN EXTREME CASE OF NORWAY ITCH.

The manifestations of the skin disease produced by *Sarcoptes scabiei* DeG., when especially severe, have been called by the medical profession *Scabies norvegicum* largely from the fact that the first case investigated by Hebra of Vienna occurred upon a Norwegian. An interesting case of this kind, occurring in this country, has just been described by Dr. Robert Hessler, of Indianapolis, in a paper read before the Indiana Academy of Science at its December meeting. The patient, a middle-aged white man, partly paralyzed, was admitted to the Indianapolis City Hospital, when it was found that his entire body was

covered with thick yellowish-white, leathery scales, the largest measuring over one inch in diameter, and over one-tenth inch in thickness. He was literally covered with scales like a fish. Upon cross-sectioning one of the scales itch-mites were found in abundance, and with proper treatment the mites were exterminated and the skin regained its normal character. An interesting calculation of the number of mites present on the host was made by Dr. Hessler. The estimate resulted as follows: Egg-cases and eggs 7,004,000; mites, 2,009,000. It seemed probable, however, that from one-half to three-fourths of the eggs had already hatched, while a comparatively small proportion of the mites were living at the time when the scales became detached. We are indebted to Dr. Hessler for some very fine microscopic mounts of cross-sections of the scales differentially stained with picro-carmin, which resulted in the epithelium taking the red color, the mites the yellow color, while the eggs remained unstained.

ON HARVEST SPIDERS.

Under the title "The Striped Harvest Spider" Dr. C. M. Weed gives an interesting study of specific variation in the December number of the *American Naturalist*, showing that *Phalangium vittatum* Say, and *P. dorsatum* Say, are inseparable upon structural details. After the study of nearly a thousand specimens Dr. Weed concludes that we have to deal here with a single very variable species in which natural selection has increased the size of the body and length of the legs in the south and shortened them in the north. The eggs of this species probably hibernate and the young of the northern form hatch in May and become mature the latter part of June or July. The young prefer the shelter of the grass, low herbage, and rubbish piles, and in Illinois are common upon corn, where, as Dr. Weed has surmised, they probably live upon the numerous small insects drowned in the moisture contained in the bases of the unfolding leaves as well as upon plant-lice. The article is illustrated by one page plate.

A CURIOUS PARASITE OF THE PELICAN.

Our correspondent, Mr. Alvah A. Eaton, of Riverdale, Calif., recently sent us specimens of lice which he had taken from the gular sac of the White Pelican, the accompanying note reading, "Bird killed this morning at 6:30. Laid in water with head under till 12:30. Lice alive and lively at the end of that time." The specimens were determined for us by Prof. Osborn as *Menopon consanguineum* Piaget. He writes us concerning the species as follows:

I have seen it a number of times collected at different localities, and have taken numbers of them from two pelicans brought here about two years ago. I formerly referred the specimens to *M. titan*, with which it is very closely related, but Piaget has seen fit to erect for it a new species and the characters are probably of sufficient importance to justify his action.

He says (Supplement to Les Pédiculines, p. 117): " Sur un *Pelecanus erythrorhynchus* (Muséum de Leide). La parenté avec le *M. titan* est frappante; les détails présentent cependant assez de différences pour constituer espèce nouvelle. Ces parasites paraissent infester de préférence l'intérieur de la grande poche et se fixer à la peau de manière à ne pouvoir en être détachés sans effort. Notre espèce a peut-être quelque rapport avec le *M. perale*, découvert par Leidy sur un *Pelecanus trachrrhynchus* (Proc. Ac. Nat. Sci. Phil., 1878, p. 100). Malheureusement la description est trop peu détaillée pour permettre une comparaison."

I have not seen the description by Leidy, but it seems quite probable that it may prove to be the same, and in that case his description should have priority.

It seems to me that the species shows close affinity to *titan* and that the difference may be due to the habit this form has assumed of living in the gular pouch, a habit which would quite naturally entail some modifications. It seems to me also that there is probability that this habit is comparatively recent, and that there may be expected a further modification of details of structure to accommodate the species more perfectly to this novel habitat.

To the popular mind the habits of parasites on the surface of the animal are disgusting enough. What would some of our "highly cultured" friends think of a louse living in the mouth?

PROCEEDINGS OF THE ENTOMOLOGICAL SOCIETY OF WASHINGTON.

Volume II, No. 3, of the Proceedings of this Society was issued December 31, 1892. It contains articles by Messrs. Ashmead, Bergroth, Doran, Gill, Howard, Hubbard, Mally, Marx, Riley, Stiles, and Webster, all of which have been mentioned by title, with short abstracts, in the notices of the meetings of the society which we have given from time to time on the final page of the consecutive numbers of *INSECT LIFE*. The present volume includes the proceedings from January, 1892, to June, 1892. A short No. 4 will be published immediately, containing the Proceedings of the Society for October, November, and December, 1892, which, with the index, will conclude Volume II.

The society is in a flourishing condition, and comprises 30 active members and 83 corresponding members.

OBITUARY.

On January 2 the death of Prof. J. O. Westwood, honorary life President of the London Entomological Society and Curator of the Hope Zoölogical Collection at the University of Oxford, was announced. Prof. Westwood, whose name is known wherever the science of entomology is studied in the civilized world, had reached the ripe age of nearly 87 and was fortunately able to continue his entomological work to the end. The list of his publications is exceedingly long, not only on account of his long life, but also his activity as a worker. The work by which he is best known is his *Introduction to Entomology*, published over fifty years ago. This work is standard to this day and has probably done more to encourage good work among English-speaking students of entomology than any other published treatise. His investigations covered the entire field of entomology, and in all directions

his work has been characterized by painstaking care, almost absolute accuracy of observation, and by a power of deduction and generalization characteristic of a broad mind.

Our old friend and correspondent, Dr. P. R. Hoy, of Racine, Wis., one of the early members of the Entomological Club of the American Association for the Advancement of Science and an old-time collector and observer of the habits of insects, died recently at his home at Racine, at the age of 76. To entomologists Dr. Hoy will be best remembered from his connection with the investigation of the northern food-plants of *Aletia xyliana*.

We have also to record the death of another distinguished English entomologist, Mr. H. T. Stainton, who died December 2, 1892, aged seventy. Among his many important contributions to entomology, the most notable are his Natural History of the Tineina, in four languages, with many plates, and his Manual of British Butterflies and Moths. He was a founder and to the end of his life one of the editors of the *Entomologists' Monthly Magazine*, besides being secretary for many years of the Ray Society, of the Zoölogical Record Association, and of Section D of the British Association. He was a fellow and at one time president of the Entomological Society, Fellow of the Linnean Society, and became F. R. S. in 1867.

THE MANNA SCALE.

At the meeting of the Entomological Society of France for December 28, 1892, Dr. A. Giard announced the discovery of specimens of *Gossyparia mannifera* Hardwick—the Tamarix scale-insect which furnished the manna of the Hebrews—in a sending of Prof. Trabut of the Medical School of Algeria. This is a wide extent of the range of this species, which had formerly been found only in Arabia, Russia, and Armenia. Dr. Giard considers the *Tamarix mannifera* of Ehrenberg to be probably identical with *T. gallica*, and calls attention to the fact that the name for the scale-insect suggested by Hardwick in 1822 having been *Chermes mannifer*, Signoret's adoption of the name *Gossyparia manniferus* was unjustifiable. He further states that the manna which Dr. Trabut has observed in abundance is certainly a production of the insect, and not a secretion of the parasitized plant.

A CURIOUS SEED-POD DEFORMATION.

Dr. Rose, of the Botanical Division of this Department, has handed us a herbarium specimen of an interesting leguminous plant from Mexico—*Desmanthus virgatus*—which normally gives off groups of from three to five narrow pods, averaging nearly three inches in length by one-eighth of an inch in width. We have found the seeds in these pods infested by *Bruchus bisignatus* and the *Bruchus* parasitized by a new

species of *Cænophanes*. The principal point, however, to which we wish to call the attention of the readers of *INSECT LIFE* is that certain of the seed-pod clusters are strangely modified by the work of a small Tortricid moth which we know as yet from the empty pupa shells only. Each pod is reduced in length to half an inch and swells out widely so as to produce a gall-like object radically dissimilar to the perfect pod. These pseudo-galls occur normally in clusters of five given off from a single stem and are well calculated to puzzle the botanist.

THE ZEBRA CATERPILLAR ON THE PACIFIC COAST.

According to Mr. J. B. Smith's "Revision of the Species of *Mamestra*" the common *Mamestra picta* of the vegetable gardens of the Eastern and Middle States is said to range west to Nebraska, and while the food-plants of the species have always been known to be rather general, it usually feeds upon annual plants like the Bean, Pea, Cabbage, Beet, Spinach, Aster, Honey-suckle, Mignonette, Asparagus, Clover, Lambs-quarter. Our California agent, Mr. D. W. Coquillet, however, received recently two colonies of larvæ indistinguishable from the Zebra Caterpillar, the one found on Apple and the other on Orange in southern California. From these specimens he reared a single male, which he forwarded to Washington and which we find to be identical with *M. picta*. We thus have not only a greatly widened geographical range, but two new food-plants from this observation.

ENTOMOLOGICAL SOCIETY OF WASHINGTON.

January 5, 1893.—The following new members were elected: W J McGee, J. B. Jones, and Frederick C. Pratt, active members; W. G. Johnson, Palo Alto, Cal.; J. W. Toumey, Tucson, Ariz.; C. H. Rowe, Malden, Mass., and Wm. H. Patton, Hartford, Conn., corresponding members. The distribution of No. 3, Vol. II, of the Proceedings was announced by the Publication Committee. Mr. Stiles opened the discussion of the president's address on parasitism, which was read at the previous meeting by Prof. Riley. He dwelt more particularly on Leuckart's classification of parasites and treated in detail parasitism by animals other than insects. General discussion followed on the address by Messrs. Fernow, Hubbard, Doran, Waite, Gill, Schwarz, Riley, and others. Under general notes and exhibition of specimens Mr. Schwarz spoke shortly on the food habits and distribution of *Silpha lapponica*. Mr. Hubbard remarked on the hibernation and food plant of *Chrysomela flavomarginata*. Mr. Ashmead exhibited a small Chalcidid representing a European genus not hitherto known to occur in the United States.

February 2, 1893.—The following persons were elected to corresponding membership: Rev. J. L. Zabriskie, Flatbush, L. I., and Mr. O. F. Cook, Huntington, L. I. A paper by Mr. Hubbard, accompanied by exhibition of specimens and entitled "Note on *Brathinus*," was presented by Mr. Schwarz. In this paper a new species from the Sierras of California is described as *B. californicus* and a synoptic table is given separating the three species now known. Mr. G. C. Davis, of Agricultural College, Mich., gave a general description of the character and extent of the insect collections of that institution. Mr. Howard presented a paper on a peculiar feature of

the Elasmīnæ in which he described minutely, with the aid of blackboard drawings, the peculiar arrangement of the spines on the hind tibiæ and tarsi of the Chalcidids of this subfamily. These spines, which are very minute, are so arranged as to make curious, but very regular figures which are of great value in the separation of species. Discussion followed by Messrs. Stiles, Ashmead, Schwarz, and others. Mr. Schwarz presented a paper entitled "A parasitic Scolytid," in which he described the galleries of an undescribed species of Crypturgus, which uses the galleries of another Scolytid as a starting point for its own galleries. The species will be described as *C. alutaceus*. The paper was illustrated by specimens and figures. Mr. Schwarz also exhibited a few northwestern Coleoptera, which have hitherto remained unidentified by American coleopterists. Mr. Stiles reported a case of spurious parasitism in a human subject. Before adjournment the Society was invited by Mr. Schwarz to examine three collections of Coleoptera of considerable local interest. These were made by Mr. Hubbard, at Lake Tahoe, Cal., in the Yellowstone National Park, and in the Bear Paw Mountains in northern Montana, and also by Mr. Schwarz and Mr. Hubbard in northern United States and Canada.

March 9, 1893.—Mr. Frank Benton presented a paper entitled "Curious defenses constructed by Meliponæ and Trigonæ," which was discussed at considerable length by various members. Mr. Riley presented by title, a descriptive paper on the genus *Deridrotettii*, with descriptions of *D. longipennis* and *D. quercus*. Mr. Schwarz presented a paper on the ovipositor in certain species of the Chrysomelid genus *Donacia*, illustrating his remarks by sketches and exhibition of specimens. The outer sheaths of this ovipositor were shown to be admirably adapted for the cutting or sawing of plant tissues, leaving little doubt that in the species provided with such ovipositor the eggs are inserted into the stems of aquatic plants. Mr. Schwarz exhibited samples of white and black insect pins made by Schlüter, of Baden, Germany, now on sale in this country, which he said were in his short experience a very superior article.

C. L. MARLATT,
Recording Secretary.

April 6, 1893.—Dr. George Marx read a paper entitled, "On Degeneration by Disuse of Certain Organs in Spiders," confining himself to a consideration of the disuse of two or four pairs of spinnerets in certain of the Drassid spiders which do not spin webs, and which need but two spinnerets for use in making the egg cocoon. Discussed by Messrs. Gill, Ashmead and Schwarz.

Mr. Ashmead presented a synopsis of the Spalangiinæ of North America, defining the sub-family and its component genera, remarking upon the distribution of species and host habit, and presenting in synoptical form the species which have hitherto been found in this country, together with a number of new forms. Discussed by Messrs. Howard and Smith.

Dr. J. B. Smith spoke informally concerning the Rabbit Flea, making some preliminary remarks upon an investigation which he had been conducting on the mouth-parts and male genitalia. His conclusions supported the view that the fleas do not form a family of the Diptera, but that the order Siphonaptera is justified. Discussed by Messrs. Stiles, Marx, Howard and Gill, the latter strongly supporting the conclusions of the speaker. Short notes and exhibition of specimens were introduced by Messrs. Stiles and Schwarz.

L. O. HOWARD,
Secretary pro tem.

U. S. DEPARTMENT OF AGRICULTURE.

DIVISION OF ENTOMOLOGY.

PERIODICAL BULLETIN.

Issued July, 1893.

Vol. V.

No. 5.

INSECT LIFE.

DEVOTED TO THE ECONOMY AND LIFE-HABITS OF INSECTS,
ESPECIALLY IN THEIR RELATIONS TO AGRICULTURE.

EDITED BY

C. V. RILEY, Entomologist,

AND

L. O. HOWARD, First Assistant,

WITH THE ASSISTANCE OF OTHER MEMBERS OF THE DIVISIONAL FORCE.

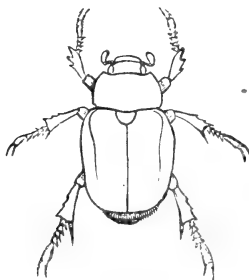

[PUBLISHED BY AUTHORITY OF THE SECRETARY OF AGRICULTURE.]

WASHINGTON:
GOVERNMENT PRINTING OFFICE.
1893.

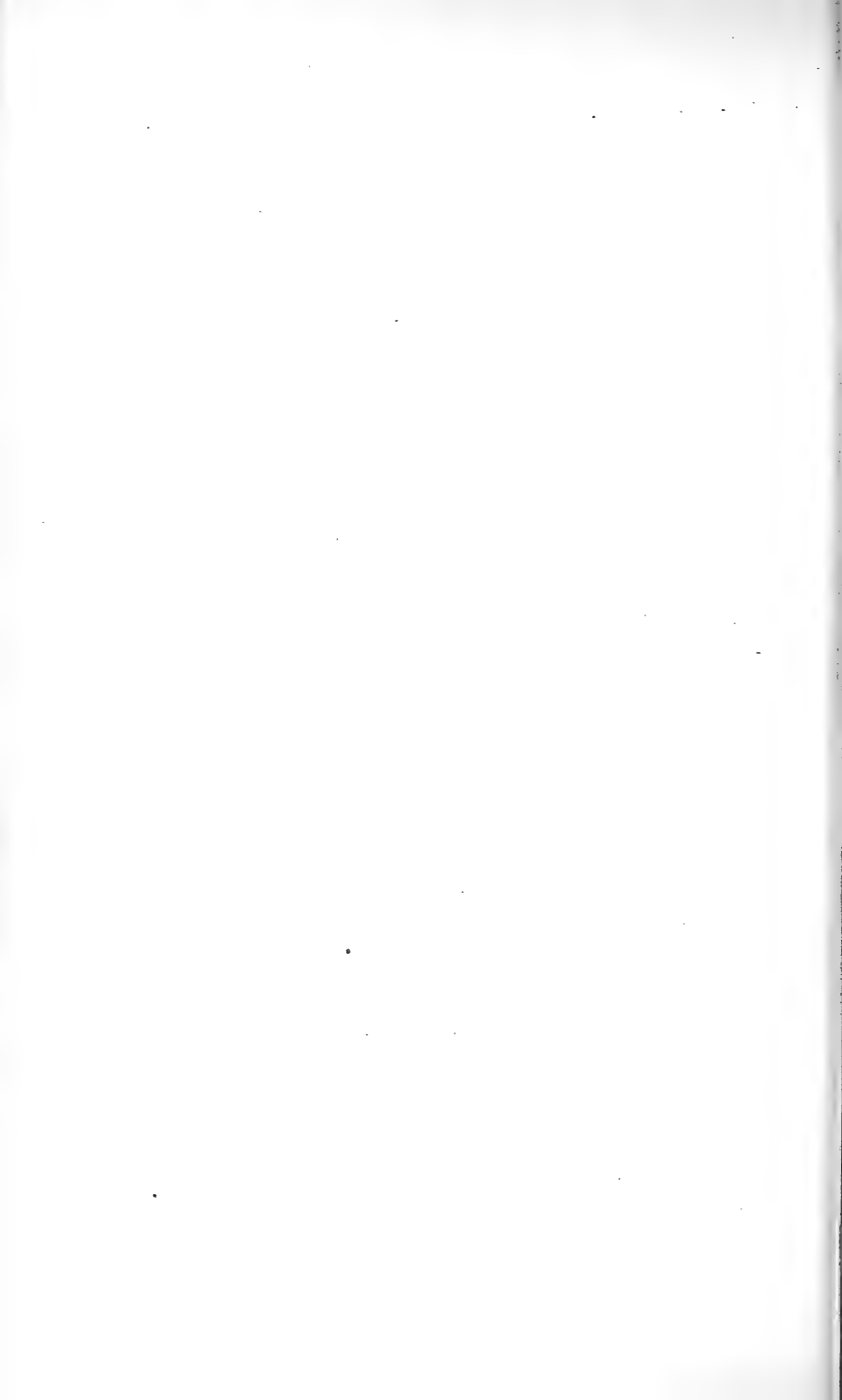

CONTENTS.

	Page.
SPECIAL NOTES	289
THE PRESENT YEAR'S APPEARANCES OF THE PERIODICAL CICADA	298
FURTHER NOTES ON YUCCA INSECTS AND YUCCA POLLINATION (illustrated)	300
..... <i>C. V. Riley</i> ..	
ON THE POLLINATION OF YUCCA WHIPPLEI IN CALIFORNIA	311
..... <i>D. W. Coquillett</i> ..	
THE COCOANUT AND GUAVA MEALY-WING (<i>Aleurodius cocois</i> Curtis) (illustrated)	314
FURTHER NOTES ON THE COTTONTAIL BOT WITH THE BREEDING AND IDENTIFICATION OF THE FLY	317
..... <i>C. H. Tyler Townsend</i> ..	
THE SUGAR-BEET WEB-WORM (<i>Lorostege sticticalis</i> L.) (illustrated)	320
REPORT ON A TRIP TO NORTHWEST MISSOURI TO INVESTIGATE LOCUST INJURIES	323
..... <i>Herbert Osborn</i> ..	
THE ANGOUMOIS GRAIN MOTH OR "FLY WEEVIL" (<i>Gelechia cerealella</i>)	325
..... <i>L. O. Howard</i> ..	
DESCRIPTIONS OF NOCTUIDE FROM THE DEATH VALLEY (illustrated)	328
..... <i>J. B. Smith</i> ..	
THE RED-LEGGED FLEA-BEETLE (<i>Crepidodera rufipes</i> L.) (illustrated)	334
EXTRACTS FROM CORRESPONDENCE	342
The Overflow Bug or "Grease Bug," a Plague in California—Is the English Sparrow instrumental in Suppressing the Horse Bot fly?—Notes on some Gall insects and Parasites—An Intruder in California Vineyards—Living Insects in the Human Ear—Eucalyptus vs. Mosquitos—Another vegetarian Mosquito—Insect Injury to Cactus Plants—Gapes in Fowls—The Clover Mite in Houses—The Utilization of Spider Silk—Further concerning the new Chicken Plague in Texas—Painful Spider Bites—Supposed Gall Mites on Blue Gum.	
NOTES FROM CORRESPONDENTS	349
GENERAL NOTES	350
The Cherry-tree Tortrix (illustrated)—An important Contribution to Insect Embryology—Insects said to Forecast the Weather—What Constitutes a Species—The Ravages of Book Worms—Further on Bee Stings and Rheumatism—The Mediterranean Flour-moth again— <i>Heliothis armiger</i> in Australia—Cut-worm damage to Grapes in California—On the transformations of the Saturniidae—The Tityrus Butterfly attracted to Light—A Banana Borer in Trinidad—The supposed Spread of the Gypsy Moth—Southern Range of the Colorado Potato-beetle—The Spotted Bean-beetle—The Palm Weevil in British Honduras—Alum for Rose Chafers—A Mosquito exterminator—The Horn Fly in Canada—Recent Studies upon <i>Lachnidium acridiorum</i> Gd.—Gall-making Coccidæ—The Egyptian <i>Icerya</i> in India—Carbon bisulphide for Hen Lice—The Long Scale not brought from Mexico to California—An enemy of the Oyster-shell Bark-louse of the Apple—An article on Scale-insects—North American Neuroptera—New Entomological Publication—Entomological Society of Ontario—A new patented Insecticide—Why insects infest Plants—Insect legislation in Massachusetts—Borers in Fig Trees—Food of a Tarantula in confinement—Entomological Society of Washington.	

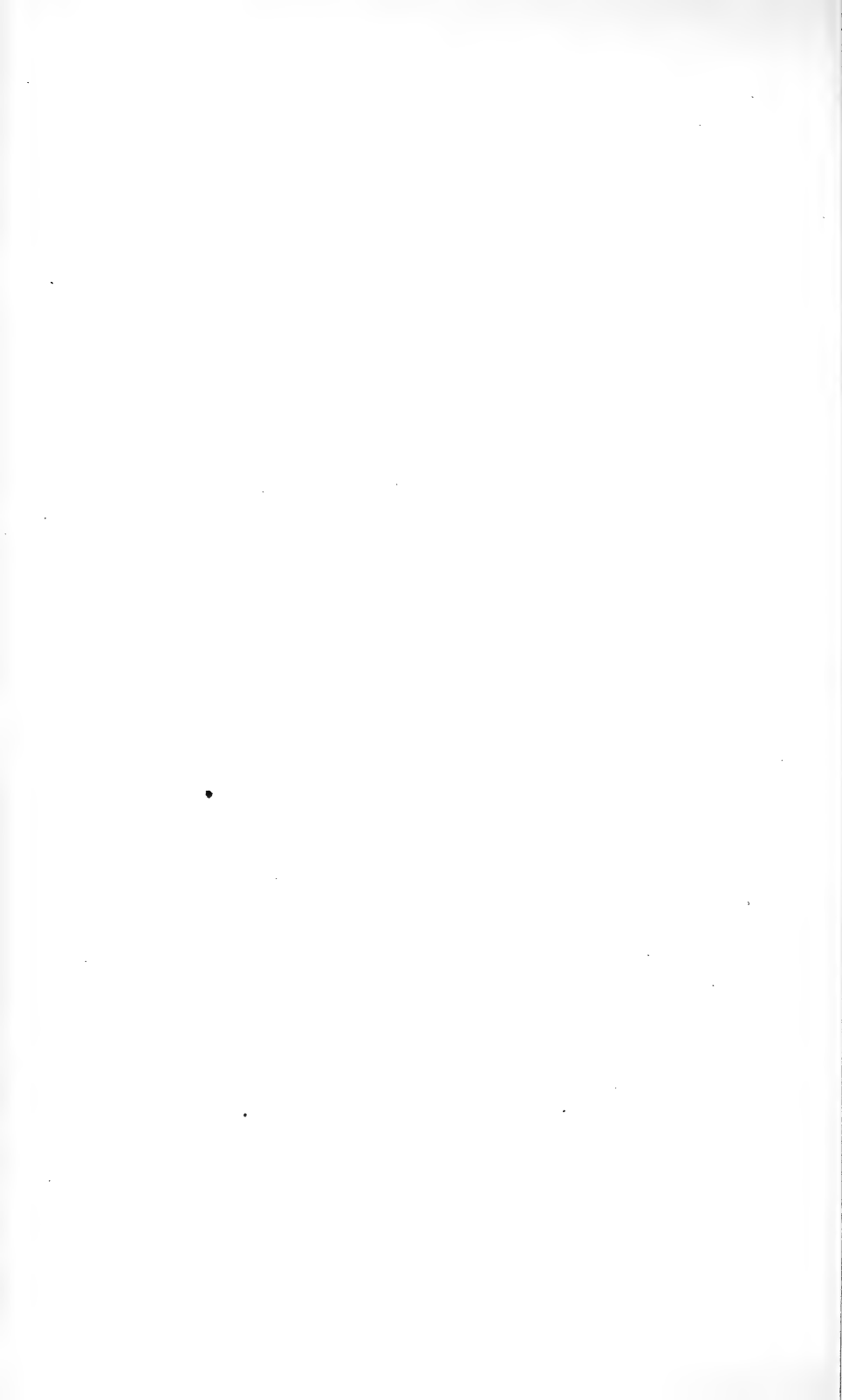

SPECIAL NOTES.

The 1892 Report of the Official Entomologist of Canada.—Mr. James Fletcher's report as Entomologist and Botanist of the Experimental Farms of Canada occupies pages 144-167 of the Annual Report of the Director and Officers, recently published. The entomological portion of the report is shorter than usual, but includes several articles of importance. After a summary of the insect outbreaks of the year, Mr. Fletcher gives detailed attention to the Hop-vine Borer (*Hydræcia immanis* Guen.), the Red Turnip Beetle (*Entomoscelis adonidis* Fab.), the Western Blister Beetle (*Cantharis nuttalli* Say), the Birch Bucculatrix (*Bucculatrix canadensisella* Chamb.), an egg-parasite of the Currant Saw-fly, and "some other useful parasites." The Hop-vine Borer, or "Collar worm of the Hop," is reported by certain Canadian hop-growers to be the most injurious insect in the hop yard, not even excepting the Hop Plant-louse. Mr. Fletcher's article on this insect is a carefully prepared summary of previous writings, but includes no suggestions of new remedies. The Red Turnip Beetle has done considerable damage during the past two years, in the northwest territory, and Mr. Fletcher gives a careful review of its life-history and recommends the Paris-green remedy. The Western Blister Beetle, together with other species of its family, did considerable damage in the northwest territory during 1892 and its extraordinary abundance is doubtless due, as in the United States, to the prevalence of locusts during the preceding year. The Birch Bucculatrix, which we treated on page 16 of the current volume, is reported to have been extremely abundant in the vicinity of Ottawa. The egg parasite of the Currant Saw-fly is a species of the genus *Trichogramma*, and the other parasites reported are: Another species of the same genus within the eggs of the Imported Willow Saw-fly (*Nematus pallidiventris*); *Pimpla eltopia*, Harr., reared from the chrysalides of the Vancouver Island Oak-looper; an undescribed species of *Telenomus* from the eggs of this last species; *Trichogramma pretiosa* and a new species of *Telenomus* from the eggs of the Zebra Caterpillar, and *Apanteles congregatus* from the larvæ of both the Tomato worm (*Protoparce ccleus*) and the Lesser Grape-vine Sphinx (*Ampelophaga myron*).

An Important Publication on the Mediterranean Flour Moth.*—M. J. Danysz, of Paris, to whose preliminary work on *Ephestia kuehniella* we have recently referred, has just published a completed account of his recent investigations of this destructive insect in the shape of a sixty-page illustrated pamphlet. Mr. Danysz's treatment of the subject comprehends a careful résumé of former publications, an extended discussion of the question of the origin of the species, and a most careful consideration of its life history and remedies. It will be remembered that European authors, with the single exception of Miss Ormerod, have hitherto considered that this insect is of American origin, and that it has been imported into Europe with American cereals. In our article published in vol. I, No. 6, of *INSECT LIFE* we protested against this haphazard conclusion, but with little effect upon European authors who have since discussed the matter. After a careful review of the arguments brought forth by European writers, Mr. Danysz concludes that it is unsafe to point to any one country as the original home of this insect. He is inclined to think that it was originally a very widespread species, and that it comes into prominence as a pest in flour mills at intervals when circumstances favor. He places no reliance upon the idea that it is being or has been imported in numbers from America into Europe. He calls attention to the fact that the first appearance of the insect in Germany in 1877 was at Halle, an inland town, and that its first appearance in France was also at a point far inland. Its first appearance in France, moreover, occurred prior to its first appearance in England, and he concludes that the natural course of an importation from America would have been exactly the reverse of what he shows to have been the case. Moreover, Mr. Danysz has collected two important bits of information from two practical millers, one of whom remembers that this same insect made its appearance in 1872 in large steam flour mills in Constantinople; that it was destructive for two years and then disappeared. The other individual states positively that he has known the insect in the vicinity of Paris for more than fifty years, and that he remembers having seen a serious case of damage as early as 1840.

We have given this evidence this attention for the reason that certain extremists have argued that it is necessary to quarantine American wheat before allowing it to enter France. The absurdity of such a regulation is shown by the fact that at the present moment this insect is known to exist in no milling establishments in the United States with the exception of one or two in San Francisco, and in these the insect was never known prior to 1892. The Canadian outbreak which we mentioned in our original article was the only one ever known in

**Ephestia kuehniella*, Parasite des Blés, des Farines, et des Biscuits. Histoire Naturelle du Parasite et Moyens de le détruire. By J. Danysz. Mémoires du Laboratoire de Parasitologie Végétale de la Bourse de Commerce, Vol. I, 1893. Paris, 1893.

North America prior to this appearance in San Francisco. The remedial measures recommended by M. Danysz are summed up as follows:

(1) Thoroughly to insufflate the mill with a powder composed of pyrethrum strengthened with nicotine, whenever the moths are seen, especially at these three times of the year: April-May, July-August, and October-November; that is to say, at the times when the moths issue from the cocoons in the greatest numbers.

(2) To whitewash the ceiling and walls of the mill, as well as the interior walls of the apparatus, at least once a year, in May.

(3) To clean regularly, or at least twice a month, the conduits of the elevators and especially those which carry the refuse away, by means of specially devised brushes.

(4) To disinfect the empty sacks by subjecting every one either to the action of heat or of bisulphide of carbon for at least twelve hours continuously.

Legislation Against Insects.—A summary of the laws which have been enacted by corporations at different times and in different countries for the enforcement of measures against destructive insects would furnish some very interesting comparative data. Still more interesting, however, would be an intelligent statement of the results which have followed such legislation. The paucity of beneficial results resulting from sound enactments may be due either to the inefficiency of the officers appointed to carry out the law, or to popular prejudice against the legal provisions and a consequent tendency to shirk and evade them where possible. Both causes almost invariably coöperate. The fact of comparatively poor success in the past, however, should not be used as an argument against wise legislation and an attempt to enforce it. We have frequently had occasion to advise restrictive legislation, and more frequently to urge coöperative work on a large scale, but regret to state that only in a comparatively few instances has this advice been followed to such an extent that the fullest good has been accomplished. Too often the *laissez faire* policy has intervened. Yet we continue our work, having faith in human nature and particularly in the intelligence of the average American citizen. We prefer active opposition to total indifference, but it is more discouraging still to have the merit of a suggestion accepted by intelligent persons who, nevertheless, refuse to assist in carrying it out for the reason that they fear that indifference and carelessness on the part of others will interfere with complete success.

As an instance in point, a prominent California horticultural and agricultural journal, after reprinting in full our article upon the Potato Tuber Moth (*Lita solanella*), in commenting on our advice relative to the necessity for strenuous efforts to stamp out the insect, goes on to state that it is not reasonable to suppose that the work will be done or that it is possible to accomplish it even if all potato-growers do their duty. The case is cited by the editor principally as an instance "of the little good that may be expected from the enforcement of anti-pest quarantine laws." It is true that the result of attempts at insect legislation in

California may justify this pessimistic view; but the horticultural and agricultural press should encourage rather than discourage all attempts to lighten the burden of the farmer. It is faulty logic to argue that because a thing has not been well done it can not be well done. Should this hasty expression of opinion on the part of the individual editor convince one or two persons critically situated that it is not worth while to attempt to stamp this pest out, it is quite within the bounds of possibility that an irreparable harm may be done to the entire potato-growing interests of the country. At the time of publication of our article this new pest was apparently limited in this country to a small area. Immediate energetic efforts would have at least retarded its spread and might have brought about its practical extinction. It was a matter for the town corporation of Bakersfield to take at once in hand, and it was important that every individual potato-grower in that neighborhood should at once do his best to destroy the insect. The carelessness or indifference of one, however, would vitiate to some extent the well meant and energetic efforts of many. Hence arises the desirability, in fact the necessity, of stringent local laws and their thorough enforcement.

The Codling Moth and Hop Louse in Oregon.—In Bulletin 25, of the Oregon Agricultural Experiment Station, published April 1893, Mr. F. L. Washburn publishes a short report of his work during 1892 with the Codling Moth and the Hop Louse. Experiments in spraying against the former pest were conducted with flour paste and Paris green, Paris green alone, I. X. L. and soap, I. X. L., Paris green, and soap. The flour paste mixture was found unsatisfactory, while the others were of a reasonable degree of efficacy. Mr. Washburn finds that the Codling Moth has three broods in Oregon, and publishes an interesting table of dates of transformations. The proper time for the first spraying in an average season in Oregon is the first week in June.

Under the head of the "Hop Louse" the author concludes that kerosene emulsion is not a safe insecticide in the hands of the Oregon hop-growers. This is contrary to the opinion expressed by the same author a year ago, and is based upon the fact that the average grower fails to make the mixture properly. A remedy which is unhesitatingly recommended is a solution of soap and tobacco, which is much cheaper than the quassia mixtures and less dangerous than the kerosene emulsion while almost equally efficacious. It may be well to mention in this connection that Mr. Koebele, one of the California agents of this Division, was sent to Oregon and Washington in May for the purpose of demonstrating the ease with which a satisfactory emulsion may be made, and of giving a practical illustration of the methods recommended by this Division for the destruction of the Hop Louse. It is as yet too soon to report results, but it may be stated that, so far as his experiments

have gone, Mr. Koebele confirms results obtained by the Division in the New York hop fields in 1887. While it is undoubtedly true that other mixtures may be applied more safely to the crop while in the burr, the enlightened hop-grower will never allow his yard to be infested as late in the season as this. Preventive work on neighboring plums should come first. Then, if by chance the yard becomes stocked from plum trees at a distance, all insecticide work should be done about the time of the disappearance of the migrating generation. Thorough work at this time will obviate the necessity for any further labor.

The insect portion of this bulletin is followed by some account of gophers and moles, with the remedies to be used against them. The remedies mentioned are exclusively in the line of traps and poisoned food, the excellent bisulphide of carbon treatment, which has been recommended for some years by the Division of Economic Ornithology and Mammalogy of this Department, and which forms the subject of a recent bulletin by Mr. Niswander of the Wyoming Station, being ignored.

Insects Injurious to Crops in England in 1892.—Our friend and correspondent, Mr. Charles Whitehead, in his capacity of technical adviser to the intelligence branch of the Board of Agriculture of Great Britain, has just published an interesting and well-illustrated report upon the insects and fungi injurious to crops in 1892 in that country. Most of the species treated are distinctively European, but American readers will be interested in what he has to say about the Grain Aphis (*Siphonophora granaria*), the Turnip Aphis (*Aphis brassicæ*), and the Cabbage Fly (*Anthomyia brassicæ*), as well as the Red Spider (*Tetranychus telarius*), although little or nothing new is brought out. The colored plates accompanying the report are especially good, that illustrating the Apple-blossom Weevil (*Anthonomus pomorum*) being particularly interesting to us at the present time on account of the striking similarity between the work of this insect and the work of our Strawberry Weevil (*Anthonomus signatus*).

The Bud Moth.—Mr. Slingerland has given us, in Bulletin 50* of the Cornell Station, an admirable summary of the facts concerning *Timetocera ocellana*, a well-known orchard pest of the northeastern States. He deals with its past history and classification, the indications of its presence, its general appearance, its life-history, its natural enemies, and the best methods of preventing its ravages. He shows from experiment that Paris green spray applied at the time the buds are begin-

* Bulletin 50, Cornell University Agricultural Experiment Station, Ithaca, N. Y., March, 1893. By Mark Vernon Slingerland.

ning to open will reach the insects so satisfactorily that no further remedy need be desired. The best proportions for central New York are one pound of the poison to 150-200 gallons of water.

The Cattle Tick.—Bulletin 24* of the Texas Agricultural Experiment Station, deals with the subject of the Cattle Tick, publishing in full a somewhat elaborate paper by Dr. Cooper Curtice, formerly connected with the Bureau of Animal Industry of this Department, upon the biology of the Cattle Tick, and following this with a short account of the preventive measures in use at the station, written by Dr. M. Francis of the station staff. Dr. Curtice's account is in the main a summary of investigations made while he was still connected with the Department, and is largely a repetition of a paper read before the Biological Society of Washington in 1891. It is an admirable summary of the literature and life-history of the insect, the latter from original observations, and it is illustrated by two plates drawn by Mrs. J. H. Comstock, of Ithaca, N. Y. Dr. Curtice sums up his conclusions under six heads, as follows:

(1) The ticks were probably brought with the cattle either from southern Europe or northern Africa.

(2) The life-history of the tick is, 1st, an egg; 2d, a six-legged seed-tick; 3d, an eight-legged asexual nymph; 4th, an eight-legged adult.

(3) Ticks dropping off where cattle are confined or spend the most time, more especially in their resting places, cause these places to be most infested with the young.

(4) Ticks are associated with a disease attacking cattle, and their removal has prevented the disease being communicated.

(5) By taking advantage of the climate and the use of remedies, cattle and certain pastures may be freed from the ticks.

(6) All cattle intended for transportation to northern fields and markets should be freed from ticks.

The recommendations of Dr. Francis consist in the application of any one of several patented sheep dips, diluted with 98 per cent water. He states, but without showing why, that the kerosene emulsion fails to satisfy the demands. The patented mixtures recommended are Cannon's, Hayward's, and Little's sheep dips. An apparatus for the easy application of the dip has been devised, and is figured. It consists in elevating a barrel of the mixture on a derrick 16 feet high. From the barrel runs a pipe which divides into five branches, each provided with a short piece of hose and a tin rose. Another hose for hand use is let into the main pipe above the branches. The derrick is built above a slanting platform, which collects the dip as it runs off the animal treated into a barrel sunk in the ground, whence it is pumped up to the elevated barrel for repeated use. The animals to be treated are successively driven under the derrick and the dip turned on, the hand-

* Bulletin 24, Texas Agricultural Experiment Station, Bryan, Tex., 1892.

hose being used to apply the liquid to the brisket, between the thighs, etc. With this apparatus about thirty animals per hour can be treated, at a cost, including material and labor, of five cents per head.

Injurious Insects in Cape Colony.—The March number of the Agricultural Journal, published by the Department of Agriculture of Cape Colony, contains what appears to be the first instalment of a series of articles upon insects injurious to fruit by Mr. S. D. Bairstow, whose name will be familiar to the readers of our reports as that of the gentleman who first discovered the helpful ladybird *Rodolia iceryæ*, the principal African enemy of the Fluted Scale, and sent it to England, where it was named by the late O. E. Jansen. In this instalment of this important series, Mr. Bairstow considers *Heliothis armiger* and *Carpocapsa pomonella*. The first of these insects is treated from an entirely new standpoint, that is, as an enemy to peaches. The popular name as given at the head of the article is "The Boll Worm or Corn Worm of the southern United States—the Peach Under-wing of the Cape." The eggs seem to have been laid in great abundance upon the young peaches in the town of Cradock in the fall of 1892. On one tree bearing 190 peaches no less than 73 larvæ were found. Each larva, not satisfied with tunneling and destroying the one peach upon which its attack commenced, made its exit upon the side opposite to that of its entry and then entered and destroyed a second and even a third young fruit. The species was determined by Mr. Roland Trimen, of the South African Museum, so that there can be no doubt as to the accuracy of the name. The remedies given by Mr. Bairstow are hand-picking and spraying with Paris green.

The consideration of the Codling Moth brings out little that is new. This cosmopolitan pest was found doing great damage to pear orchards at Graaff-Reinet during the past winter. We gather from the article that this is considered to be a new and more or less local occurrence of the Codling Moth in Cape Colony, and the importance of stamping it out at this point is insisted upon by Mr. Bairstow, who states that the fruit-growers there have a responsibility almost all their own in preventing a widespread calamity. The Codling Moth, however, as pointed out in Mr. Howard's article in our annual report for 1887, has been known in South Africa for a number of years, so that local work will have hardly more than local effect. The Paris green treatment and the banding methods are recommended.

Miss Eleanor A. Ormerod's Sixteenth Report.—The Sixteenth Report of observations of injurious insects and common farm pests of this well-known writer upon agricultural entomology has just reached us. It is

as usual from the press of Simpkin, Marshall, Hamilton, Kent & Co., Limited, London, and is on sale at eighteen pence, which barely covers the cost of publication. It comprises Miss Ormerod's observations on the injurious insects of the season of 1892, a remarkable summer on account of the abundance of many of the common insects. The principal damage was done by the Leaf-eating Pea-weevil (*Sitona lineatus*) upon Pea, the caterpillars of the Silver-Y Moth (*Plusia gamma*) on Clover, the Hop "Strig Maggot" *Cecidomyia* sp. on Hop, the Leaf Maggot on Mangold crops, the Corn Aphid (*Siphonophora granaria*) upon Wheat, and the Diamond-back Moth (*Plutella cruciferarum*) upon Turnips, and various root diseases of Cabbage and Tomato, several of the latter being figured in excellent photo-lithographic plates. A number of comparatively new insect attacks are mentioned. Considerable space is devoted to the Apple Sawfly (*Hoplocampa testudinea*) which was treated in her last report, the Cabbage-stem Weevil (? *Baridius* sp.), the Yellow-legged Clover Weevil (*Apion flavipes*), Mites (*Tyroglyphus longior* in Hay, the Currant-shoot and Fruit Moth (*Incurvaria capitella*), the Pigmy Mangold Beetle (*Atomaria linearis*), the Mustard Beetle (*Phadon betulae*), the Onion Fly (*Anthomyia ceparum*), Orchard Caterpillars (*Cheimatobia brumata*), Red Spider (*Tetranychus tiliarum*), Strawberry-leaf Beetle (*Galeruca tenella*), and sundry important eel worms receive detailed notice. The usual painstaking and accurate personal observations are recorded, and the whole is presented in Miss Ormerod's lucid style. The private publication of sixteen of these valuable reports is an instance of philanthropic work which is not equaled in any other country by any entomological worker.

Bulletins 45 and 46 of the Ohio Agricultural Experiment Station.—Prof. F. M. Webster has just published an author's edition of his portion of Bulletins 45 and 46 of the Station to which he is at present attached, and includes accounts of insects affecting the Blackberry and Raspberry and of underground insect destroyers of the wheat plant. The first of these articles is a complete résumé of our knowledge concerning the insects affecting these two plants and is fully illustrated. Mr. Webster's own observations are inserted here and there, and the compendium as a whole is a valuable one. Under the title of the second paper he gives accounts of wire-worms, white grubs, Southern Corn Root-worm (*Diabrotica 12-punctata*), and of the crane-flies, the latter article being extracted with some changes from his report as agent of this Division for 1891. The author's edition is printed on excellent paper, and the pamphlet is a creditable one.

Some Diseases of Cotton.—Bulletin 41 of the Alabama Agricultural Experiment Station reached us early in April. It bears the title "Some

Diseases of Cotton," and while none of the diseases treated are strictly entomological all who have studied the insects of cotton will find matter of interest in this pamphlet. Nine distinct pathological troubles are described and figured, the root gall produced by *Anguillulidæ* being the only one of animal origin.

Noctuidæ from the Death Valley.—We publish in this number some descriptions of new Noctuidæ from the Death Valley, by Prof. J. B. Smith, which were prepared too late for use in the general report on the insects of the Death Valley published in connection with Dr. Merriam's report. The plate accompanying this descriptive paper is from a photograph made by Prof. Smith, and is in the nature of an experiment in this line of illustrating. There is included in the photographs a very pretty species of *Antaplaga*, which we have named after Mr. Koebele, who did the insect collecting of the expedition, and a description of the species is therefore added to Prof. Smith's paper.

THE PRESENT YEAR'S APPEARANCES OF THE PERIODICAL CICADA.

We call attention to the localities in which this curious insect will doubtless appear the present summer. Two different broods, one a 13-year and the other a 17-year brood will appear and will have been making the woods resound with their peculiar song in their respective localities before this number of *INSECT LIFE* is received. We shall be exceedingly obliged to any readers or correspondents who will send us word of the occurrence of this insect in their own locality, or any facts additional to those here indicated, or any information that tends to confirm, correct, or amplify the records. We should like particularly to have exact data as to the limits of the appearance in any particular township or county.

BROOD XVI—TREDECIM (1880-1893).

In the First Report on the Insects of Missouri the senior editor established this brood solely on the testimony of Dr. G. B. Smith, from the single locality of southern Georgia. Since then he has obtained confirmatory proof of its existence not only in Georgia but in other parts of the south. It is now known from four States, but the special localities are much scattered and this fact is due, in all probability, to want of more careful observation, or to the incompleteness of reports. It is obvious, however, from the localities given below that this Brood XVI is confined to the southern States and does not extend into the Mississippi Valley.

It may be further noted that this brood is the forerunner of the largest 13-year brood known, viz. Brood XVIII (1881-'94), which occupies the Mississippi Valley, as well as the southeastern States. These two broods occupy, in fact, the same relation to each other as do the small 13-year Brood VI (1884-'97), and the second largest 13-year Brood VII (1885-'98), although Brood VI is confined to the southern part of the Mississippi Valley. The localities so far known for Brood XVI, which appears the present year, are as follows:

Alabama.—The following very definite statement was received in 1885 from Mr. William M. Garrett, Mount Willing, Lowndes County: The 13-year Locust will not make its appearance in this county until 1893. Your correspondent can remember their appearance in 1841, 1854, 1867, and 1880. There are no 17-year Locusts in this county.

Tennessee.—Mr. W. F. Rass, of Fayetteville, Lincoln County, wrote us as follows in 1885: "The Cicadas gave us a call in 1880, whether of the 13- or 17-year varieties I have no means of finding out, but I do know that they were very numerous." This locality is on the southern line of the State, and falls within the territory of this Brood and not within that of the 17-year Brood XV, which also appeared in 1880.

Georgia.—Cherokee County, according to Dr. G. B. Smith (not yet verified). Cobb County, as indicated by Mr. H. M. Hammett, of Marietta, who wrote us in 1885:

"In 1880 there was a considerable quantity of the Cicadas in this county. They made the woods ring and did some damage to fruit trees."

North Carolina.—Mr. F. B. Shuford, of Holly Springs, Miss., wrote us on June 18, 1885: "I recollect they (the Cicadas) were in Lincoln County, N. C., about 1828." This is an indefinite statement, which needs verification. Mr. D. B. McIver, Moore County, N. C., reported that Cicadas in 1880 were "in the piney woods of this county, but not in the oak woods."

BROOD XI—SEPTENDECIM (1876-1893).

This is an old-established and well-known brood, though much remains to be learned regarding its extent, and a few of the reported localities need verification. As in some of the other 17-year broods, and more especially Brood XXII (1885-1902), the present one occurs in two divisions or branches, the eastern branch (in North Carolina and Virginia) representing the bulk of the brood and the western branch being broken up into several well-separated detachments. Compared with other 17-year broods, Brood XI is of rather southern distribution, *i. e.*, its northern limit, so far as known at present, is the mouth of the Shenandoah River, the western detachments following nearly the same latitude (about along the 39th parallel). In its southern extension along the Alleghany Mountains it is only exceeded by Brood XXII, but it occupies a considerable area in North Carolina and Virginia well toward the east of the mountains which is not the case in Brood XXII. It always appears one year in advance of another well-known 17-year brood *viz.*, Brood XII (1877-'94), and there is evidently a relation between the two, for a glance at the territory occupied by both shows that Brood XII is the northward continuation of Brood XI, extending along the eastern flank of the Alleghanies as far north as Albany and Troy in New York. South of the Potomac the two broods do not exactly overlap, but run parallel with each other. Brood XI occupies the valley of Virginia west of the Blue Ridge and a strip halfway between the mountains and the ocean, whereas Brood XII occupies a rather narrow strip along the eastern flank of the mountains through Virginia to northern North Carolina. The following is the list of the localities known for Brood XI, the majority of them (already published in Bulletin No. 8 of this Division or previously) being here repeated without further comment:

North Carolina.—From Raleigh, Wake County, to the northern line of the State; also in the counties of Rowan, Davie, Cabarrus, and Iredell.

Virginia.—From near Petersburg, Dinwiddie County, to the southern line of the State; Bedford County; Valley of Virginia west of the Blue Ridge from the Potomac River on the north to the Tennessee and North Carolina lines on the south.

District of Columbia.—Noticed, the present year, early in June, in the woods north of Washington and along Rock Creek.

Maryland.—Southern half of St. Mary's County.

Kentucky.—Trimble County, in the northern part of this State, has been added to the localities occupied by this brood on the strength of the following communication by Mr. W. J. Parker, Bedford, Trimble County, dated June 25, 1885: "My first remembrance of the visitation of the Cicada was in 1855, when they were very numerous; then they appeared again in 1859 and again in 1872." The years 1855-'72 plainly

refer to the 17-year Brood VIII, while the year 1859 can only be referred to our Brood XI.

Indiana.—Counties of Sullivan and Knox. To these is probably to be added Posey and adjacent counties, since Mr. J. B. Elliott, of New Harmony, wrote us in 1885: "The Cicada appeared in great numbers over the whole of this (Posey) and adjacent counties in 1859." There is some doubt about these localities in extreme southwestern Indiana, for they come very close to the region known to be occupied by the 17-year Brood VII, which appeared in 1859.

Illinois.—About Alton, Madison County.

Kansas.—From this State, which was hitherto not included in the region occupied by this Brood XI, we received in 1885 the following statements, the first from Mr. E. M. McKinnon, Leavenworth, Leavenworth County, being as follows: "The only locusts I ever saw here appeared in 1859, and they destroyed a young orchard of mine which was one of the earliest set out here (in 1857)." The second communication is from Mr. John W. Robson, of Cheever, Dickinson County: "During the latter part of May, 1876, the Cicadas appeared in large numbers along the banks of the Smoky Hill River. They were so noisy and so numerous that the majority of the settlers were alarmed for the safety of their crops. These fears in some measure were allayed by two articles which I published in the county press." Both statements are quite definite and can only be referred to this Brood XI. Thus the counties of Leavenworth and Dickinson, Kans., have to be added to our list.

Colorado.—Cheyenne Canyon. We would have no hesitation in rejecting this locality, which is separated from the eastern forest region by a long stretch of open prairie land, if it were not based upon the authority of an experienced entomologist, viz, the late Mr. V. T. Chambers (see Amer. Entom., III, p. 77). Still we can not refrain from suspecting a confusion with some other species of Cicada.

FURTHER NOTES ON YUCCA INSECTS AND YUCCA POLLINATION.*

By C. V. RILEY, PH. D.

PRONUBA MACULATA.

Since the presentation a year ago of the communication on "Some Interrelations of Plants and Insects," in which I summarized what was then known of *Yucca* pollination and the *Yucca* moths, some further interesting observations have been made, and the facts which I have to present tonight should be looked upon as additional to those set forth in the previous paper (Proc. Biol. Soc. Washington, vol. VII, pp. 81-104). On account of the singular structure of *Yucca whipplei*, which was known to be pollinated by *Pronuba maculata*, I was quite anxious to obtain the facts in reference to this species. The long stamens, the sticky and abundant pollen, and the peltate stigma, are characters which would seem to facilitate ordinary pollination, though the restricted style would render this more difficult and the peculiarities of *Pronuba maculata* with its modified tongue, and maxillary tentacles very long and attenuated at tip, were, I felt quite sure, special adaptations to fit it for its work. This *Yucca* is not only one of the most interesting from the structure of its flower, but is one of the noblest of the cespitose species and placed in the subgenus *Hesperoyucca*. The flowers are borne in immense panicles on a stalk, which arises directly from a crown of

* Read before the Biological Society of Washington, May 20, 1893.

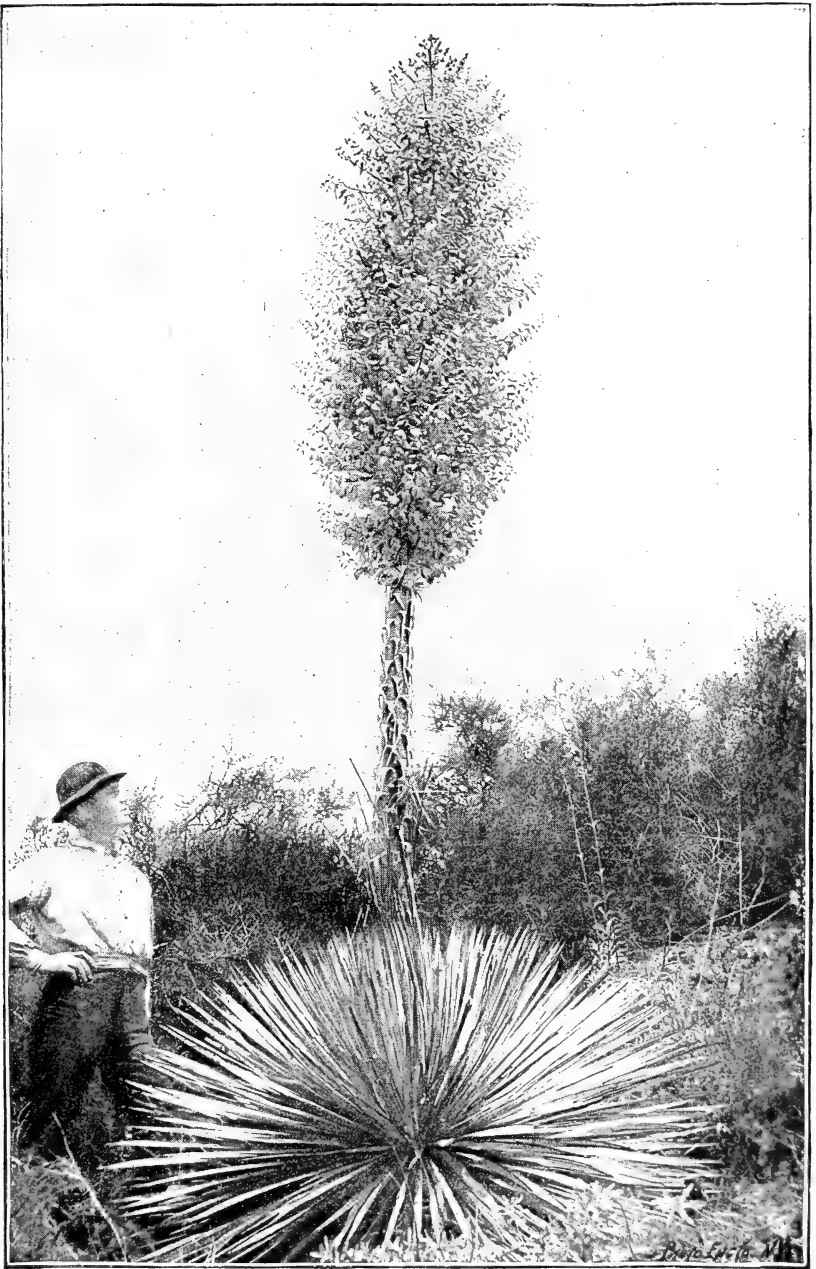

YUCCA WHIPPLEI.

leaves near the ground and reaches sometimes a height of twelve feet or more, and I present herewith a photograph which very well illustrates the magnificence of some of the larger specimens (Fig. 38). At my request Mr. D. W. Coquillett, of Los Angeles, Cal., made some special observations last year on the pollination of this species, and on the 12th of June he was able to witness the operations both of oviposition and pollination on a plant while yet the sun was shining brightly about forty minutes before setting. The act of oviposition does not differ in any particular from that which I have already described in detail for *Pronuba yuccasella*. The pollen is deliberately gathered and a mass nearly half the size of her head is held under the neck by the coiled tentacles. In pollinating, the tentacles are uncoiled and stretched so that the tips may be inserted into the upper part of the stigma. Mr. Coquillett describes the process of thus pollinating the stigma as lasting about half a minute, after which the insect that he watched descended the ovary and at once mounted to the top of one of the stamens. Here, with her tentacles, she removed both pollen masses (moving her head from side to side during the operation) and added the pollen thus gathered to the mass which she was already carrying. She went to two other stamens in succession, gathering a pollen mass from each. Mr. Coquillett in communicating his observations remarks that "it was indeed surprising to witness the evident intelligence which this insect displayed in all her actions wherever the pistil of the flower became pollinated solely through her own labors, and that she went through these maneuvers with the evident intention of pollinating the flower appears to admit of no doubt."

A number of insects have been observed associated with the flowers of *Yucca whipplei*, but none of them, as observed by Mr. Coquillett, acted in any way to produce pollination, either intentionally or by accident. As a check to prove the influence of *Pronuba* on the production of fruit, I desired Mr. Coquillett to inclose another panicle and exclude the moths. We were both somewhat surprised at the result, namely, that a certain number of the pods set on this panicle; and this would prove that (so far as a single experiment justifies conclusion) the species is capable of a certain amount of self-fertilization.

So far as they go, Mr. Coquillett's observations on the actions of *Pronuba maculata* agree very well with those of Prof. William Trelease, who made a special trip through the Southwest, in the spring of 1892, with a view of studying the pollination of those *Yuccas* which had not hitherto been studied in this connection. He has published a most interesting article in the Fourth Annual Report of the Missouri Botanical Garden, entitled "Further Studies of *Yuccas* and their Pollination." This is, in fact, a most valuable contribution to our knowledge of the subject, and is complementary and additional to my own paper published in the annual report of the same series for the previous year.

Mr. Trelease's life-studies of *Y. whipplei* have added materially to our understanding of its floral characteristics. The anther cells, on dehiscing, contract so as to expose the pollen freely, but the contents of each cell forms a "rather consistent, two-lobed moist mass, which is held by its lower part, but protrudes prominently from the open anther." The ovary is free from the longitudinal depressions which in the other *Yuccas* usually correspond with the appressed stamens. The capitate stigma is slightly indented at the center "and covered with long, hyaline, delicate papillæ, which are always moist with abundant secretion, that at length becomes almost gelatinous over the middle of the stigma." He found the nectar apparatus well developed, the septal glands though narrow reaching commonly to the base of the ovary, with a conducting groove of corresponding size. The glands are also, though smaller, more active than in most other species of *Yucca* studied by him. Prof. Trelease also notes that the characteristics of this flower would seem to make it easily self-fertilizable, and remarks on the exceptional occurrence in the lower part of the Cajon Pass of a few plants with more or less abundant, partly developed, but unusually diminutive capsules, in which no evidences of *Pronuba* action were to be found, and this, added to the experiment made by Mr. Coquillett, would seem to indicate that where *Pronuba* is absent *whipplei* has the same exceptionally limited power of fructification, whether by self-pollination or pollination by other agents, that we know to be possessed by *aloifolia* among the true *Yuccas*. Recognizing this possibility, Prof. Trelease was somewhat surprised to find that, with the single exception which he noted, no fruit, among all his observations, was discovered which did not clearly show the work of *Pronuba*.

From his account, as well as that of Mr. Coquillett, it appears evident that *Pronuba maculata*, in accordance with the greater tendency of the flowers of *whipplei* to open during the day, is more diurnal in habit than *Pronuba yuccasella*, carrying on the acts of oviposition and pollination during the day. Further, unlike the other *Pronubas* so far known, this species rests with the head toward the stigma, and when disturbed is very apt to drop suddenly from the flower and take wing. I can not do better than quote verbatim Mr. Trelease's interesting account of the act of pollination, that of oviposition being, as already stated, absolutely the same as in *yuccasella*.

When the moth is about to deposit an egg she usually moves about in the lower part of the flower much as the other species do, commonly dragging the tip of the ovipositor along the parts she walks on as if wiping off extruded secretion, but also seemingly using it as a tactile organ while she assumes the position best suited to oviposition, which is nearly the same as that taken while at rest. Standing on the side of the pistil, she then bends the abdomen sharply forward so as to bring the ovipositor to about the middle of the ovary, which she pierces at the thinnest part, namely, about 1^{mm} from the septal groove. As a general thing not more than six eggs are laid in a given pistil—one on either side of each septum—and frequently the number is smaller than this, so that even if they all hatch, which is not likely to be the case, there is rarely more than one larva to each tier of seeds, and con-

sequently a fair percentage of the seeds are allowed to come to maturity. In the very succulent white ovary the puncture made in laying an egg is usually seen easily immediately after the ovipositor is withdrawn, and a rather large drop of clear sap not infrequently exudes from it within a short time.

Having withdrawn the oviduct, in doing which she moves up so that her head is about level with the stigma, or even before this organ is entirely freed, the moth usually proceeds to pollination; but it is not infrequent for two eggs to be laid between each two visits to the stigma, and, owing to her peculiar alertness, she appears to be even more easily frightened into omitting pollination than are the other species of *Pronuba*. Standing with her head at about the height of the stigma, with the short tongue projecting out in front, she uncoils her long tentacles from the compact mass of pollinia—which she carries similarly to the other *Pronubas*—only that small part of her burden which adheres to the bases of the tentacles being removed from it, and, raising her body on tiptoe, she very slowly saws the tentacles back and forth across the top of the stigma, generally following one of the three shallow grooves, and very carefully working their slender tips into the more or less gummy exudation over the central depression. Sometimes the operation is interrupted long enough to admit of the tentacles being coiled back against the load of pollen and again extended; but the curious manner in which her head is held back from the stigma as a rule prevents any of the main load from reaching even the marginal papillæ.

On first witnessing this operation, I was impressed by the much slower motion of the moth than usual and the evident care which she took to run the ends of the tentacles into the central depression of the stigma, which I then supposed to be solid; the subsequent discovery of the styler canal, communicating with the ovarian cells, showed that it is into this narrow passage that she so carefully guides the tips of her tentacles with their modicum of pollen, and no doubt the abundant stigmatic secretion serves not only to foster the development of the nascent pollen tubes after pollination, but, wetting the tentacles, aids in the disintegration of her mass of pollinia. These, if really related to her work, would seem to have acquired their coherent structure as a means of facilitating their collection, rather than as an adaptation to their removal bodily from the anther to the stigma as is the case in orchids and asclepiads, where, however, special means of secure attachment to the insect accompany this aggregation of the pollen grains into a large mass.

A further interesting fact connected with the pollination of this species is that Prof. Trelease discovered a purely black variety (which he describes as *aterrima*) of *Pronuba maculata* connected with the variety *graminifolia* (Wood) of *Yucca whipplei*, common in San Bernardino county. The actions of this black variety are similar to those of the typical form, and it is also diurnal rather than nocturnal in its movements. The method of gathering the pollen mass is thus described:

Flying into a flower the moth runs about the bases of the stamens after the manner of other species, then quickly clammers upon the inner side of a filament, and, with the tentacles extended over the pollinia, drags first one and then the other out of the anther cells, pressing them together under the throat, and subsequently compacting the mass together, much as *yuccasella* does the powdery pollen of other *Yuccas*, so that the ball finally consists of as many as ten or a dozen pollinia. So quick and energetic are the motions by which the pollinia are removed that the stamens are often shaken quite violently, as I have before noted in the more nervous attempts of *yuccasella*.

PRONUBA YUCCASELLA ON THE PACIFIC COAST.

Of the fleshy-fruited *Yuccas*, among others, Prof. Trelease was able to study *Yucca baccata* Torrey, which is pollinized by *Pronuba yucca-*

sella. While he was not able to observe the acts of pollination, all the circumstances and the facts which he obtained would indicate that it is precisely the same as described for other species of *Yucca* that are fertilized by this moth, and the fertilized flowers show "conclusively that the pollen is thrust well into the stigmatal canal," or in some cases apparently even into "the top of the ovarian cells, which owing to the short style and the deep stigmatic notches, they [the moths] can reach easily with their long maxillary tentacles." The moths taken from flowers at Cabazon and San Diego are somewhat above the average in size, with the horny and chitinous parts somewhat darker than in the typical form, but specimens which he sent me can not be considered to have even varietal differences and find their counterparts in my cabinet in specimens from Dakota and Colorado.

Yucca rupicola Scheele, of southern Texas, and *Y. elata* Engelm., extending from southern Texas to southern Arizona, are both pollinated by *Pronuba yuccasella*, as Prof. Trelease ascertained.

PRONUBA SYNTHETICA.

Mr. Trelease was also fortunate enough to be able to study the operations of *Pronuba synthetica* on the flowers of *Yucca brevifolia*. This *Pronuba* is slower in its movements and slower to take flight than the other species observed, though he found it more active during the day than his *Pronuba yuccasella*. It takes wing less readily, and then merely sails down to the ground. This indisposition to leave the flower may be connected with the almost constant high winds on the Mojave Desert, where this yucca most abounds. The fertilized pistils of this *Yucca* are quite noticeable by comparison with those of other species by their symmetry and lack of constriction or indentation, so uniformly present in the *Yuccas* that are punctured by *Pronuba yuccasella* and *P. maculata*. The explanation is found in the fact that *Pronuba synthetica* pierces "the uppermost part of the style, conveying its eggs down to the ovary through the stylar channel, the course followed by the pollen tubes." This fact interested me very much, for I recollected very well in my first studies of *Pronuba yuccasella*, before the act of oviposition had been witnessed, that—puncturing for the purpose of oviposition being unrecorded and therefore quite exceptional among Lepidoptera—I was strongly of the opinion that the egg would be thrust through the stigmatic opening down the stylar channel. The instinct to oviposit only on the youngest flowers is particularly marked in *synthetica*, which Trelease frequently saw forcing itself into the narrow clefts between the rigid sepals of the opening bud, the flattened form of the insect facilitating the operation. This habit also suggests the cause of the looseness of the wing scales and the ease with which they are lost. Mr. Trelease's observations in detail on the actions of this *Pronuba* can not well be condensed, and I quote them entire:

When about to deposit an egg, having selected a suitable flower, the female of *synthetica* runs to the bottom of the stamens much as *yuccasella* does, makes a rapid

more or less complete circuit of their bases, and then quickly ascends to the very top of the pistil, her thorax rather higher than the end of the stigma, and with her short but strong ovipositor cuts through the thin wall into the stylar channel, rarely as much as 2^{mm} below the tip of the stigma, meantime holding fast to the pistil, the stamens being below her reach. The long extensile oviduct is then passed through the puncture, the egg being laid apparently within the ovarian cell, along the funicular end of the ovules. In removing the oviduct the moth not infrequently carries her body against the stigma, so that at first sight she appears to be withdrawing it directly from the mouth of the stylar canal; but I have never seen her make direct use of this canal. The operation consumes more time than does the oviposition of either *yuccasella* or *maculata* as I have observed them, and usually takes altogether from two-and-a-half to three minutes. Sometimes two or more eggs are laid before the stigma is pollinated, but commonly after laying each egg the moth retreats to the bottom of the flower and then again ascends the pistil until her head is brought even with the stigma, when she uncoils the large tentacles from their resting place against her load of pollen and passes them back and forth in the stigmatic chamber, with almost the same motion as the eastern species, usually making use of one of the stigmatic notches. While so employed she carries the rather short tongue almost straight out above the stigma, but I have never seen her make any use of it to force the pollen into the latter, nor has she been observed to attempt to feed on the slight stigmatic secretion nor to search for food at the base of the flower, where, if anywhere, the nectar of the septal glands should be found.

Prof. Trelease has not yet published anything upon the other species of *Yucca* insects which he has collected, and I take this occasion to present some few unrecorded facts in reference to some of the species of *Prodoxus* which he was kind enough to send me, as also some additional data from other sources.

THE SPECIES OF PRODOXUS.

Prodoxus coloradensis.—This was described by me from a single male taken in 1884 by Mr. H. K. Morrison in Colorado. In April, 1892, Mr. F. V. Coville, the present Botanist of the Department of Agriculture, gave me a few small pieces of the flower stem of a *Yucca*, infested by a *Prodoxus* larva. The plant was collected in the Charleston Mountains, Lincoln county, Nevada, the previous February, and was undoubtedly *Yucca baccata*. From these pieces of stem I reared early in the present month two imagoes, which proved to be *Prodoxus coloradensis*.

I have also received from Prof. Trelease four other collected specimens, rather battered and imperfect, which belong to this species, all taken from the flowers of *Yucca baccata* at Banning, Cal. These two bred specimens are constant, and agree thoroughly well with the type, except that there is no inclination to pale yellowish in the white scales of the head, and the thorax shows some black scales on the tegulae, a line of black around the collar, and, in one of the specimens, along the middle of the thorax; characters not noticeable except in well preserved specimens. The white portion of the antennae extends also in these two specimens beyond the basal third and fully to one-half the length of the organ. The four collected specimens from Prof. Trelease indicate considerable variation; in one specimen the outer arm of the transverse Y band across the posterior portion of the wing being absent,

while in another it is broken, as is also the basal portion of the median band. The same is true of the band across the middle of the wing, while the upper portion of this band is connected with the basal band. The larva shows no striking characteristics, but is very similar to most other *Prodoxus* larvæ, being uniformly yellowish white, the head and cervical shield anteriorly slightly darker, the ocelli black, and the mandibles brown and three-toothed.

Prodoxus reticulatus.—One of the specimens received from Trelease taken in flowers of *Yucca whipplei*, variety *graminifolia*, at Arrowhead Springs in California, would indicate that this species, which I described from three females from Los Angeles county, Cal., and the habits of which were not known, breeds in some part of this *Yucca*. The single female sent by Trelease is interesting, in that it shows some variation in the direction of *coloradensis*, especially by the separation of the basal half of the W-shaped band.

Prodoxus cinereus (Fig. 38).—A section of the flower-stem of *Yucca whipplei*, sent me by Mr. Coquillett last July, contained a number of different larvæ, and among them most numerous one which subsequently proved to be the larva of *Prodoxus cinereus*. We have known that this species breeds in the main stem of this *Yucca*, but none of the early states had been observed. The larva is remarkable in that it differs materially from the typical *Prodoxus* larva. It is first of all very much more elongate, with the sutures between the segments strongly impressed. It is, further, more uniform in diameter than the typical *Prodoxus* larva; but the most striking feature is the anal segment, which bears on its ventral plate two stout, brown, decurved horns resembling those of the larva of *Trogosita* in Coleoptera, except that these are curved in the opposite direction. I add a technical description:

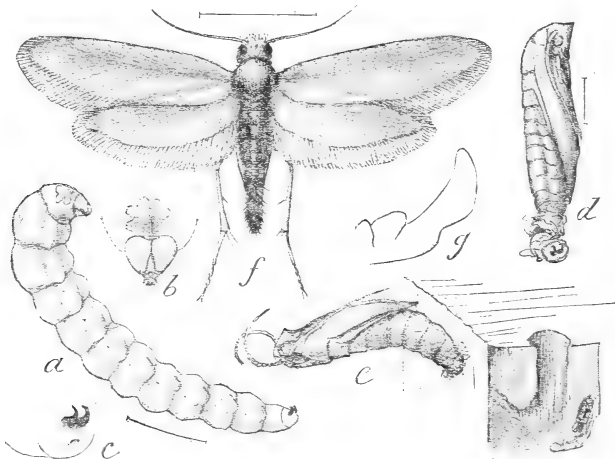

FIG. 38. *Prodoxus cinereus*: a, larva; b, head and first thoracic joint; c, anal hooks; d, pupa; e, pupa shell protruding from stalk; f, adult female; g, side view of clasper of adult male; a, d, e, and f enlarged; b, c, and g still more enlarged. (Original.)

PRODOXUS CINEREUS. *Larva* (Fig. 38a).—Average length when full-grown, 8.25^{mm}; body elongate, but slightly curved, the joints moniliform; head rather large, more horizontal, and more free than in other species, light brown in color, darker anteriorly; borders of clypeus almost white; pigment spot around ocelli, and the mandibles dark brown; the Y-shaped lines distinct and having exactly the outline of a rather narrow wine-glass; cervical shield pale, but fuscous around the borders and especially at the middle of the anterior border; sinuate laterally and cleft posteriorly by the pale mesial line; characteristic feature is a pair of decurved, dark, horny anal hooks, situated on the ventral apex; anal plate but faintly chitinous and with a fuscous mark upon it; a sub-ventral depressed line but faintly indicated, and more highly polished than the rest of the surface: spiracles extremely small, with a faint yellow annulus, the pro-thoracic pair situated on the sub-ventral depressed line, the others much higher up on the anterior third of the segments; no thoracic legs, but slight tubercles in place of them; general color faint bluish-green or yellowish-green, losing color, however, in alcohol.

Pupa (Fig. 38b).—Offering no peculiar structures of importance, but presenting the characteristics of the other species of the genus. Skin very delicate; the cephalic projection not very prominent and the anal tip absolutely smooth; dorsal spinules reduced almost to obsolescence. The shrunken larva skin with its two strong hooks remains attached to the tip of the body of the pupa, and doubtless serves to hold it secure when it pushes from the surface of the thin epidermis to give forth the imago.

The imagos issued from the 11th of April to the 8th of May, the antennal sheaths and leg sheaths of the pupa separating, the former curling very much as in other lepidopterous pupæ which have wood- or pith-boring larvæ.

Prodoxus ænescens.—Prof. Trelease has sent me a full account of the oviposition of this species upon *Yucca whipplei*, and it corresponds in every particular with the oviposition of *Prodoxus decipiens* in the east. In this case the species is not confined to one or the other of the forms of *whipplei* but occurs on both the typical form and the variety *graminifolia*.

Prodoxus intermedius.—This species was described from two female specimens taken in Texas and one taken in Colorado, in 1887. It is a most interesting form, bearing an even more deceptive resemblance to *Pronuba yuccasella* than does the much commoner *Prodoxus decipiens*. For though the female lacks the remarkable maxillary tentacles of *Pronuba*, the ovipositor is long and delicate, very much as in the latter species. I have been anxious, since publishing the original description, to obtain a male of this rather puzzling species, and, fortunately, Prof. Trelease sent me specimens associated with the females. On a superficial examination the males of this species would be separated with great difficulty from the males of *Pronuba yuccasella*; but upon denuding the genitalia the differences at once appear, and it is curious to note that while the form of the genitalia, though showing slight variation, corresponds with that of *Prodoxus decipiens*, yet the claspers agree more nearly with those of *Pronuba yuccasella* in having but the one large tubercle.

Prodoxus intricatus n. sp.—I recently received from Mr. J. T. Mason, who has been kind enough to observe and collect some of the *Yucca* insects for me, a number of specimens of a *Prodoxus*, which he found in the flowers of one of the tree *Yuccas* in Jalapa, Mexico. He sent also

flowers and sections of one of the leaves of the *Yucca*, which, from this material, appears to be, without much doubt, *Yucca guatemalensis*. The moths were found abundantly in the flowers, but unfortunately reached me in rather dilapidated condition. The species is of the same general size as *Prodoxus reticulatus*, and with a somewhat similar, but more varied and less distinct maculation. It is, however, a much darker species. I would simply characterize the species here by comparison with *reticulatus*, with a view of adding one more link in our knowledge of the Prodoxids associated with the different species of *Yucca*.

In size and general appearance most nearly related to *P. reticulatus*, the general color, however, more sordid, the lighter shades inclining to pale fulvous, with a slightly golden sheen. Primaries more acuminate at apex, and marked with black scales, taking on, in a very general and indefinite way, the pattern of those of *reticulatus*. Secondaries also more acuminate at tip, and blacker. Fringes of all wings black. Undersurfaces fuliginous, with the faintest trace of pale marks on the costa of primaries. Anal claspers of male short, recurved upward, with a rather angular production on the inferior margin, and with three minute, but distinct, black teeth. There is also a similar black tooth on the inner margin near the tip. Ovipositor of female similar to that of *reticulatus*.

Some of the darker specimens present an almost black appearance, the black marks inclosing narrowed, luteous spaces, which appear like so many spots.

Described from 20 males and 5 females, none of them in perfect condition.

CONCLUSIONS.

The additional facts which I have thus presented upon this subject of *Yucca* insects and *Yucca* pollination serve to confirm the generalizations which I have already indulged in. So far as variation is concerned they add still further links to the chain of alliances between the different forms of this interesting family, Prodoxidæ. The black form of *Pronuba maculata* presents us with the question of varietal or specific value that has arisen with the plant itself upon which it occurs, so far as regards the variety *graminifolia* of *Yucca whipplei*. Most specialists would be inclined, without any intermediate specimens, to characterize this black form as a distinct species, especially as it is dissociated from the other more typical forms and confined to one particular variety of *Yucca*. Yet in every other character but color it agrees precisely with the typical *maculata*, and I am strengthened in my view of considering it a mere variety by the well-known variation in the maculation of the typical species. It is a form that is differentiated as to color without having yet acquired any essential structural differences, though it may have lost the power to intercross with the typical form. Here, also, the color must be looked upon as of secondary importance to the species, and more or less fortuitous, as it is difficult to see what advantage the purely black has over the maculate form, especially in an insect essentially diurnal.

So it is in the variation of the banded species of *Prodoxus*. Some of

the specimens combine the characters of at least two different species, without being referable to either, satisfactorily, and in the present state of our knowledge most entomologists would be justified in describing them as distinct species; but there can be little doubt that when abundant material from different localities is obtained all these transversely-marked forms will be difficult to separate. Such, however, is the case in almost every genus, whether of plants or animals, and the Prodoxids simply furnish us with a rather marked illustration of the fact that the variation has gone on and is going on, so far as purely colorational characters are concerned, without any very definite and unchangeable differences having yet been acquired. How strikingly such facts compare with the permanency, even in colorational characters, of such well-established species in the same order as the cosmopolitan *Vanessa cardui*, which, with a most beautiful wing design and a most complex colorational pattern on the inferior surfaces, remains essentially constant in all its details in all parts of the world where it is known!

The decurved hooks in the larvæ of *Prodoxus cinereus* are also most interesting from an evolutionary point of view. Such anal hooks are extremely rare in Lepidopterous larvæ, being found in only a very few pith-boring or stem-boring species.*

We have in this structure, which is so exceptional in Lepidoptera, another illustration of a principle to which I have often referred in my writings, namely, that larval structure in insects has been modified independently of the ultimate structure and is, as a consequence, of very little taxonomic value. Thus we have in the same family the larvæ of a *Prodoxus* (*e. g.*, the typical *decipiens*), which remain in their short burrows, possessing no legs; while those of *Pronuba*, which quit their burrows and penetrate the ground, possess thoracic legs. Yet in the particular case of *Prodoxus cinereus* the larva approaches *Pronuba* in having thoracic tubercles which may be looked upon as either remnants of legs or the beginnings of the development of such. This larva burrows in the soft pith of *Yucca whipplei* much more freely than any of the other species of the genus so far studied, making much longer

*I have not had time to closely scan the literature for cases of this kind, but do not recall any. I am familiar, however, with three unrecorded instances, two of them of Pterophorid larvæ which bore the stems of *Solidago*. One is the larva of *Alucita kelicottii* Fish, which singularly departs from the typical Lepidopterous larva in its elongated body and in having a pair of supra-anal spines which give the anal plate an appearance characteristic of that of many Coleopterous larvæ. The second case is that of an undescribed species of the same family Pterophoridae, which has the anal plate obliquely truncate and fringed with a row of stiff hairs, and with a pair of small thorns at its ventral border, this modification also, recalling that possessed by several wood-boring Coleopterous larvæ. The third case is that of the larva of a Noctuid, *Hadena stipata* Morr., which burrows in the pith of young corn or maize. It has the anal plate obliquely truncate and flattened along the posterior margin, which is armed with a series of horny points, and thus again repeats the structure which recurs in certain Coleopterous larvæ, especially of the Elateridae, which inhabit burrows in the trunks of trees.

channels, the substance of the stem being less firm than that of the other species of *Yucca*. In so far, therefore, as this particular Prodoxus larva has peculiar structures we can trace their origin to purely dynamic influences, assisted by heredity and selection—a consequence, in other words, of environment—and repeated independently in larvae of different orders having no possible genetic connection.

The distribution of the genus *Pronuba* as exemplified in these additional observations is extremely interesting. *Pronuba yuccasella*, the typical species of the genus, not only occurs over half the continent, as I have previously shown, but extends to the Pacific coast, and is found as far south as San Diego, showing over this wide range absolutely no differences that would justify varietal designation. All the characters are absolutely the same, and the rather dark coloring of the horny and chitinous parts of the body in the California, Dakota, and Colorado specimens would indicate that the western forms have this peculiarity as compared with the eastern. This species is now known to pollinize all the true *Yuccas* so far studied, and accompanies them across the continent. It thus pollinizes *Yucca filamentosa* and its several forms in the northeast: *Y. gloriosa* and *Y. aloifolia* in the southeast: *Y. angustifolia (glauca)* in the Rocky Mountain regions; *Y. rupicola* and *Y. elata* in the southwest; and *Y. baccata*, which connects the territory of *Y. angustifolia* with that of *Y. brevifolia* and *Y. whipplei*. It thus occurs in the same territory as its two congeners, *Pronuba synthetica* and *P. maculata*, with its *aterrima* variety, while these last are restricted to their respective *Yuccas*. This fact, as Prof. Trelease has pointed out, strengthens the inference that *brevifolia* and *whipplei* are primary Pacific coast types, while *baccata* is an immigrant from the east. It remains yet to observe the pollinizers associated with *Yucca filifera*, *Y. australis*, *Y. treculeana*, and *Y. guatemalensis*, each of which will probably have a distinct *Pronuba*, while the other *Yuccas* not enumerated here will probably not have distinct species connected with them.

It would carry me too far to speculate further on the additional facts brought forth, but I would urge in conclusion that in all Mr. Trelease's interesting observations in his special studies of these different species of *Yucca*, and after having paid particular attention to the point, he has failed to see a single *Pronuba* in any species attempt to feed on either the stigmatic secretion or the septal nectar. He was also unable to convince himself that in any case the insect makes use of the tongue in pollination, as he once thought it might. In this and other respects he fully confirms the conclusions which I have drawn in my previous communication to the Society, while the additional data which I have indicated give further force to my remarks upon variation, as exemplified by these Prodoxids.

ON THE POLLINATION OF *YUCCA WHIPPLEI* IN CALIFORNIA.By D. W. COQUILLET, *Los Angeles, Cal.*

In *Yucca whipplei* all of the leaves are borne next the ground, and the flower-stalk, which sometimes attains a height of twelve feet, is naked except for the small, scarious bracts. The flowers are in a dense panicle, and are borne on the upper third of the flower-stalk. The flowers are pendulous, and of a pure waxy whiteness within, the outside being more or less tinged with green; the form is rotate-spreading, or somewhat saucer-shaped. The stamens are as long as, or slightly longer than, the deeply-lobed ovary, including the short, conical style and large stigma. The latter is hairy-papillose, and is of a deep green color, contrasting strongly with the pure whiteness of the other parts of the flower. The stamens are almost as spreading as the perianth, and each one is surmounted by a pair of pollen-masses inclosed in thin membrane, which finally splits in two and falls away, leaving the viscid pollen-masses still adhering to the top of the stamen. After pollination has taken place the ovary increases in size, the perianth and stamens wither and finally fall away, and as the ovary or seed-pod continues to grow it gradually turns around, so that from its pendulous position it finally becomes upright, and remains in this position until ripe, after which it splits open, allowing the seeds to escape. This *Yucca* has about the same distribution in California as *baccata*, but to the eastward it extends only as far as Arizona. The California Indians feed upon the juice of the young plants, and also roast them for food. With this species, unlike the two other kinds mentioned above, the entire plant dies after flowering, although before this takes place one or more young plants usually start out from the base of the old one. The flowering season usually extends from about the first of May to the middle of August.

As Dr. Riley has shown, the Tineid moths, *Pronuba maculata* and *Prodoxus pulverulentus*, live in the larva state, the former in the seeds and the latter in the seed-pods; while *Prodoxus marginatus*, *P. cinereus*, and *P. avescens*, live in the flower-stalks and petioles of *Yucca whipplei*. There are six other kinds of insects which I have observed to live at the expense of this plant. The largest of these is a showy red and black Cerambycid beetle, *Tragidion armatum*, the larvæ of which live in the dead and dry flower-stalks; the beetle is quite rare, but is occasionally met with in mid-summer, resting upon the green flower-stalk in the daytime. The largest weevil known to me to occur in California feeds upon the green flower-stalks of this *Yucca*, usually taking up its position low down upon the plant, where it is more or less hidden from view by the leaves; this is the *Scyphophorus yuccæ*. A much smaller weevil, the *Macrorrhyncholus protractus*, lives in the dry flower-stalks. The three remaining insects referred to belong to the Hemiptera, and I have thus

far found them only upon the leaves, the juice of which serves them as food. The first of these is a small brown Capsid known as *Haliicotoma valida*: the second, a curious Homopterous insect, *Ticida cingulata*, of a brownish color, banded with white: the third and last is a Coccid, *Pseudococcus yuccæ*, having the general aspect of the common mealy-bug of our hothouses.

Certain other kinds of insects, notably locusts, are occasionally found among the leaves of this *Yucca*, but as they have not been observed to feed upon this plant, their presence upon it appears to have been purely accidental, and not for the purpose of obtaining food.

The following is a list of the insects that I have observed within or among the flowers of *Yucca whipplei*:

Hymenoptera:	Coleoptera—Continued.
<i>Platylabus sp.?</i>	<i>Hippodamia convergens.</i>
Lepidoptera:	<i>Anthrenæus agarensis.</i>
<i>Laphygma frugiperda.</i>	<i>Carpophilus pallipennis.</i>
<i>Pronuba maculata.</i>	<i>Acmæops falsa.</i>
<i>Prodoxus marginatus.</i>	<i>Diabrotica soror.</i>
<i>Prodoxus ænescens.</i>	<i>Diabrotica trivittata.</i>
Diptera:	Hemiptera:
Genus? Species? Family Geomy-	<i>Aphis sp.?</i>
zidæ.	<i>Thamnotettix scutellata.</i>
Coleoptera:	Neuroptera:
<i>Aleochara sp.?</i>	<i>Chrysopa sp.?</i>

Of these, the *Laphygma* was present in three examples, but only at night, and may have been attracted by the light from my lantern, since they did not attempt to feed upon the flowers. *Diabrotica soror* was observed to feed upon the pollen-masses as well as upon the perianth. The Aphids were congregated upon the outside of the flowers. I did not observe a single butterfly or wild bee of any kind visit these flowers, although all of these insects were quite abundant in the vicinity where these observations were made. And the same observation also applies to humming-birds. *Pronuba maculata* and the two species of *Prodoxus* were present during the month of June and a portion of May and July: but none were observed after the 24th of July. The *Prodoxus* moths usually rested upon the inside of the perianth, but the favorite position of the *Pronuba* was resting upon the side of the ovary, her head turned toward but not reaching the stigma.

In 1892, at the request of Dr. Riley, I paid particular attention to the pollination of this *Yucca* and the actions of *Pronuba maculata*. After repeated watchings, both during the daytime and at night by the aid of a lantern, I was fortunate enough to witness the process of egg-depositing and pollinating. This was on the 12th of June of the present year. The sun was only about forty minutes high, but was shining brightly, and a cool breeze was blowing at the time. The *Yucca* plant was about eight feet high, and the flowers in the lower three-fifths of the panicle

alone were open. Upon approaching this plant I saw a *Pronuba* enter one of the opened flowers and take up a position on one side of the ovary, her head being directed toward but not quite reaching the stigma. She now pressed the top of her body against the ovary in the bottom of the groove over which she was standing, and appeared to be inserting her ovipositor into the tender ovary. She remained in this position for fully ten minutes, then she walked up the ovary and style until her head was slightly above the upper surface of the stigma, after which she stretched out her maxillary tentacles and repeatedly pressed their tips into the upper surface of the stigma, moving her head back and forth as she did so. Previous to this the tentacles had been held resting against a mass of pollen nearly half the size of her head, which was attached to the under side of her head. The process of thus pollinating the pistil lasted about half a minute, after which she descended the ovary and at once mounted to the top of one of the stamens until her head was slightly above the anthers or pollen-masses; then with her tentacles she removed both pollen-masses, moving her head from side to side during the operation, and added the pollen thus gathered to the mass already attached to the under side of her head. Next she ascended two of the other stamens in succession and in a similar manner removed a single pollen-mass from each of them, then took up a position on one side of the ovary and rested from her labors.

It was indeed surprising to witness the evident intelligence which this insect displayed in all her actions whereby the pistil of the flower became pollinated solely through her own labors. That she went through these maneuvers with the evident intention of pollinating the flower appears to admit of no doubt. She evidently did not gather the pollen to serve as food for herself. The small quantity of food which she requires during the few weeks of her existence could easily be taken direct from the stamens if she required pollen for food. Nor could the operation of pressing the tips of her pollen-besmeared tentacles into the stigma have any connection whatever with the taking of food, since these organs are no better fitted for taking up liquid food than her feet are, and the proboscis was not brought into use during this operation. The entire operation detailed above was evidently performed for the express purpose of providing food for her offspring which were to live in the seed-pods; and there also appears to be no doubt that she was in possession of the fact that unless she *did* thus pollinate the flower, there would be no seed-pods for her offspring to live in.

Wishing to ascertain if any other agency besides the *Pronuba* could effect the pollinating of the flower of *Yucca whipplei*, I inclosed the flower-bearing portion of five of these plants in thin muslin sacks on the 12th of June of the present year; none of the flowers on any of these plants had yet even partially opened, and I carefully removed all the insects from these plants before putting on the sacks. On the 24th of the following July I removed the sacks of two of these plants; one

of the plants bore four seed-pods, while upon the other were two dozen of these pods, each containing perfect seeds. The "march of progress" had obliterated the remaining three plants which I had inclosed in sacks, the plants having been uprooted and burned in order to give place to an olive grove. In the case of the two plants above mentioned, pollination had evidently been brought about by the repeated blowing of the sacks against the expanded flowers. In nature, of course, no condition like this exists, and it therefore seems very evident that, but for the kindly office performed by the Pronuba, *Yucca whipplei* could not exist.

THE COCOANUT AND GUAVA MEALY-WING.

(*Aleurodicus cocois* Curtis.)

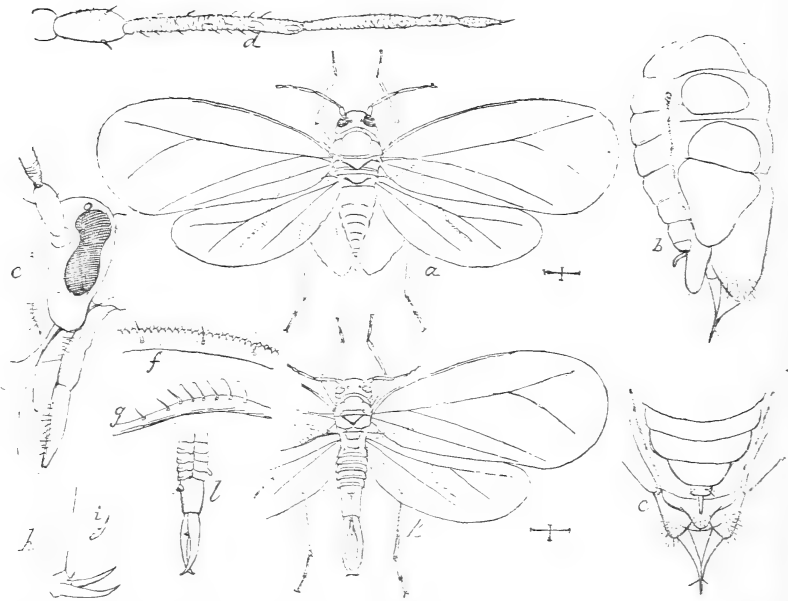

FIG. 39.—*Aleurodicus cocois* Curt.: a, adult female; b, side view of abdomen; c, dorsal view of same; d, antenna; e, head from side; f, costa of front wing; g, costa of hind wing; h, tarsus; i, pulvillus; k, adult male; l, claspers—a, k enlarged; others still more enlarged (original).

Under his well known pseudonym "Ruricola," John Curtis described in the *Gardeners' Chronicle* for May 2, 1845, a new Aleyrodid from the leaves of the Cocoanut trees in Barbadoes. The specimens were sent him by Sir Robert Schomburgk, who stated that to its work is attributed a widespread disease of the cocoanut which at that time threatened to destroy all of the trees on the island. The disease showed itself after the fatal hurricane of 1831, and at the time of writing there were few trees not affected by it. Cocoanut plantations which formerly yielded an income

of \$1,000 to \$1,500 per year had at that time not a single tree which bore fruit. The lower leaves die first and fall off, the flowers fall, or the nuts, if they have been formed, dwindle away and do not arrive at maturity. Ultimately budding leaves are attacked and the crown drops off, leaving the withered trunk. This work, however, was not to be attributed entirely to the Aleyrodid, since a bark-louse occurred also upon the leaves. Curtis described the former insect as *Aleyrodcs cocois*, and accompanied his description by a fairly recognizable figure of the larva and adult male and of the abdomen of the female.

In the *Entomologist's Monthly Magazine* for February, 1892, Mr. J. W. Douglas, in connection with an article by Mr. A. C. F. Morgan, erected for this and one other species, the genus *Aleurodicus*, the principal character separating it from *Aleyrodcs* being the bifurcation of the median nervure of the wings. The locality given is Demerara.

Up to the present time this insect has been found only upon cocoonut palm, but we have to record its recent appearance upon Guava in the Island of Trinidad. The cocoonut injury alone would have been sufficient to warrant the presentation of some account of this species in this journal, since the growth of the cocoonut palm as a fruit crop in south Florida is fast reaching considerable importance; but the fact that the species attacks Guava also adds to the insects importance. Several species of the genus *Psidium*, including a number of varieties of Guava of economic importance, are now grown in Florida and the industry is increasing. Up to the present time, as we notice from Mr. H. E. Van Deman's report on the condition of tropical and semi-tropical fruits in the United States, no insect enemies of the plant have been known in Florida.

The injury which this new insect is doing in the West Indies seems to be considerable, and its importation into Florida is probably only a question of time, if not already brought about. The Guava is even less fitted to withstand the attacks of a rapidly spreading species like this than is the cocoonut-palm; and there is, therefore, every reason to forewarn Guava growers of the appearance and habits of the insect.

The Trinidad specimens which we have received (through the kind-



FIG. 40.—*Aleurodicus cocois* Curt.: a, full-grown larval skin from below; b, same from above—enlarged (original).

ness of Mr. H. Caracciolo, of Port of Spain) were mostly dry and in their natural positions upon the leaves, so that we have not been able to trace the entire life history of the species. We have made out several of the stages, however, which we illustrate herewith. The insects cluster mostly upon the undersides of the leathery leaves and form dense masses along the ribs, the more advanced specimens being furnished with an abundant waxy secretion giving a general mildewy appearance to the surface, while the upper surface is frequently attacked by a smut fungus which is developed on the honey dew thrown down from the undersides of the leaves above. Cocoons of a species of *Chrysopa* appear frequently in the masses and two species of lady-birds of the Scymnid group have been found feeding upon the lice. The honey dew attracts numerous ants, and one species which Mr. Caracciolo has sent us has been determined by Mr. Pergande as *Prenolepis longicornis*.

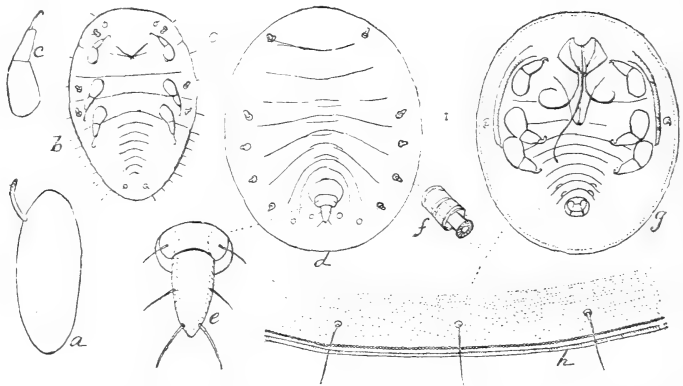

FIG. 41.—*Aleurodicus cocois* Curt.: a, egg; b, first larva; c, leg of same; d, intermediate larva, dorsal view; e, protrusile organ of same; f, secretory pore of same; g, intermediate larva, ventral view; h, margin of body of same—a, b, d, g, enlarged: c, e, f, h, still more enlarged (original).

ALEURODICUS COCOIS CURTIS.

The Egg (Fig. 41a).—We know the egg only from specimens taken from the bodies of gravid females. Length, 0.29mm ; greatest width, 0.11mm ; length of pedicel, 0.064mm . From these measurements it will be seen that the egg is broader in proportion to its length than that of *Aleyrodes citri*. The pedicel, instead of arising from the base of the egg, has its origin on the side, somewhat above the base, as shown at Fig. 41a. No sculpturing is observable.

Newly-hatched Larva—first stage (Fig. 41b).—What we assume from its size to be the first stage has been sparingly found in a more or less dried-up condition upon the leaves of guava received. It is 0.41mm long and 0.19mm wide, regularly elliptical, flattened, and smooth. Twelve hairs of medium length protrude from each side. Antennæ short, apparently five-jointed, joints subequal. Rostrum, one-jointed, arising from a point halfway between the middle of the body and the anterior extremity. The dorsal-anal pore is distinct, and the long conical organ protrudes.

Larva—intermediate Stage (Fig. 41d, g).—A stage intermediate between the newly-hatched larva and that which seems full grown has been found and carefully studied. It is flattened, of short oval form. 1.02mm long and 0.84mm wide. The legs are plain, and

are short, stout, and apparently three-jointed. The basal joint is very stout, nearly as broad as long; the second joint is slender, about twice as long as broad; the third joint is very short, and bears a single stout, curved hook. The rostrum is distinct, one-jointed, and three filaments protrude. Each abdominal segment bears laterally a large, complicated pore, from which protrudes a glassy filament, short in this stage, but very long in the following. A smaller pore is situated just laterad of the base of the antenna, and those on the anal and pre-anal segments are smaller than those on the others. Antennæ six-jointed. Joint 1 short, stout; joints 2 and 3 long, subequal in length, and each five times as long as 1; joint 4 one-half as long as 2 or 3; joint 5 one-half as long as 4, sharply pointed at tip. Dorso-anal pore large, distinct; protrusile organ conical in shape, supported by a tri-lobed chitinous framework. Entire dorsal surface of body finely granulate, the ventral surface granulate laterally to the large pores. Each ventral-abdominal segment bears a transverse row of eight small secretory pores, each of which seems to be tri-cellular.

Adult Larva (Fig. 40).—Closely resembles the preceding, except that it is much more convex, and has very long glassy filaments and an abundant secretion of white wax. Abdominal segments very distinct, arched antero-dorsally, with a median longitudinal ridge. The skin of this larva splits transverso-dorsally along the hinder edge of the thorax, and from the middle of this slit medially and longitudinally to the cephalic end of the body. From this double slit the pupa presumably emerges.

Adult Female (Fig. 39a).—Length, 2.1^{mm}; expanse, 4.1^{mm}. Color dull honey-yellow; eyes darker; abdomen, when swollen with eggs, much lighter, and bordered with abundant waxy secretions. Antennæ 6-jointed. Basal joint short, stout; joint 2 (scape) twice as long, equal to it in width; flagellum rugoso-annulate; joint 3 longest, more than twice as long as 1 and 2 together, and equal in length to 4, 5, and 6 together. In dried specimens it becomes especially constricted at two points. Joint 4 rather more than half as long as 3; joint 5 less than half as long as 4; joint 6 equal in length to 5. Joint 6 with a bristle at tip, the other joints with sparse, short bristles. Head conical when seen from above, the rostrum plainly 2-jointed, but perhaps with a basal joint; the apical joint acute, nearly as long as the preceding joint. Eyes pyriform, large. Two ocelli, large and conspicuous. Wings large, sub-opaque, median vein divided at two-thirds wing length. Costa of fore-wing finely crenulate to tip, furnished with sparse bristles arising below edge of wing. Costa of hind wing with 8 or 9 rather long bristles or hairs near base. Legs slender, moderately long, hind tibia with an internal row of bristles, tarsi 2-jointed, two large tarsal hooks, with a median basal hook-like appendage much smaller than the lateral hooks. Abdomen with 6 plain tergites, but 5 visible urites. Sixth tergite bearing a pronounced median curved papilla; ovipositor acute.

Adult Male (Fig. 39k).—Resembles the female except in being more slender and longer by virtue of the two large forcicular claspers, nearly as long as the entire abdomen and which give the average specimen a total length of 2.8^{mm}, as against 2.1^{mm} for the female. Between the two claspers is a short curved style rather more than one-third the length of the claspers. Sixth tergite bears a median papilla and the fourth urite a similar one. Color of abdomen much darker than in female, particularly at hind border of segments; claspers still darker.

FURTHER NOTES ON THE COTTONTAIL BOT, WITH THE BREEDING AND IDENTIFICATION OF THE FLY.

By C. H. TYLER TOWNSEND, *Kingston, Jamaica.*

In a paper in *Psyche* for August, 1892, the writer published a description of this bot. In the present paper some supplementary notes are presented on the larva of this species, followed by a description of the

adult flies bred from bots taken from cottontails in southern New Mexico.

On July 27, 1892, a young cottontail was shot near the G Bar Ranch, in the cañon of the Zuni River, Arizona. A large and nearly full-grown bot was taken from it on the dorsum at the root of the tail. After immersion in strong alcohol from that date until October 16, 1892, it was measured and found to be 26^{mm} long by 16.5^{mm} wide (6th segment).

On October 15, 1892, two cottontails were shot north of Doña Ana, N. Mex., and each one found to contain two bots. One of the cottontails was a young one. The bots in the younger rabbit were located, one in the left dorsal region and the other in the dorsal region of the spine; in the other rabbit, one in the left pectoral region and the other in the ventral region of the abdomen near the median line. Each lay in a separate cyst, which opened to the outside by a small round hole through the skin. The bots keep the anal segment inserted in this orifice, thus procuring air through the anal stigmata. Two or three of the bots seemed to be of nearly full size. After a ride horseback of about seven miles, during which time the rabbits were carried in the pocket of a hunting coat, they were taken out, and one bot was found to have escaped from each rabbit. These two escaped bots were found in the pocket of the coat. They measured, alive, from 28^{mm} to 30^{mm} or more in length and 13^{mm} to 14^{mm} in width (6th segment). As they were to all appearances nearly or quite full grown, a glass jar of earth was prepared and they were placed therein. Both bots immediately began to bury themselves in the earth and in the space of about ten minutes were entirely buried and out of sight. By placing the ear to the mouth of the jar it was distinctly evident that they were burying themselves still deeper. The earth in the jar was nearly four inches in depth, and the next morning, or about ten hours after they had begun to bury themselves, they were still heard to be moving. On the evening of this day one was found to have reached the bottom of the jar.

The other two bots, which had remained in the rabbits, were extracted and placed in alcohol. One of them was but little smaller than the above two, while the other was still smaller and of a general lighter more rufous color. The three larger bots were of a general blackish color, from the darker color of the numerous horny spined plates of the integument. The two smaller ones measured alive 27^{mm} and 22^{mm} long, by 13^{mm} and 11^{mm} wide (6th segment). It was noticed that these bots remained alive for a long time after immersion in alcohol. The lighter one was still alive and moving in the alcohol the next morning, ten hours afterward. After these two were about dead and curved into their usual position, they measured 25^{mm} and 20^{mm} long by 11^{mm} and 12^{mm} wide.

The jar of earth containing the two live bots was sunken in a wooden box of earth, and placed on the flat roof of an adobe house, where it

remained undisturbed through the winter. A piece of muslin was tied firmly over the mouth of the jar, and the latter was protected from heavy rains and snowfalls, when these occurred, by a tin lid or cover placed over it. The cover was left off during fine weather, which generally prevailed. In this manner very little moisture was allowed to reach the earth in the jar. On the 11th of May, 1893, two dead bot flies were found on the surface of the earth in the jar. They had issued sometime during the previous week or ten days, since that was the last time the jar had been examined. It was expected that they would probably issue about the first of June.

A study of these flies, which were in perfect condition, shows that they are, without doubt, *Cuterebra fontinella* Clark. This species was originally described from Illinois, where it was known to infest rabbits (see Brauer, Monogr. *Œstridæ*, p. 242). Since the description given by Brauer, which I take to be merely Clark's original description transcribed, is rather brief and indefinite, I present the following description of the above specimens:

Cuterebra fontinella Clk. ♀.—Length of body, 20.5^{mm} to 21^{mm}; width of abdomen, 9^{mm} to 9.5^{mm}; width of thorax, 9^{mm} or a little more; width of head, 8^{mm} to 8.25^{mm}; length of wing, 16^{mm} to 16.25^{mm}. Front about seven-sixteenths width of head at vertex, grayish black, scantily grayish hairy, with two whitish triangular markings on anterior eye margin, the lower one elongate and extended in a line nearly to base of antennæ; these leave two larger transverse glabrous shining black areas. Antennæ and arista grayish. Facial depression silvery, base with blackish lower border, the black of the latter descending in one specimen in a median line on the closely approximated and soldered facial ridges. Whole of sides of face, cheeks, oral region, in fact all of head below antennæ, covered with a yellowish white bloom and clothed with whitish hairs, the oral region especially hairy; two small black spots on cheeks, one next lower margin of eye, and the other well removed therefrom toward oral slit. Dorsum of thorax and scutellum grayish black, short, and finely black hairy. Whole under surface of thorax, with sides of thorax both above, below, and anterior to wing bases, and continued completely around edge of scutellum, thickly yellowish white hairy; three black spots on side of thorax, the upper one hairy. Abdomen black, with a bluish or purplish luster, rather thickly clothed with short and fine black hairs; inferior lateral edges with regions of grayish bloom containing blackish spots, in one specimen continued faintly on sides of abdomen in places. Restoring the color of the abdomen with chloroform shows this grayish bloom, with the circular black spots, to extend in both specimens upon sides of abdomen and dorsum of last two segments, or even in places on dorsum of second segment. Legs blackish, inferior surface with more or less of a grayish bloom, especially on femora and tibiæ. Wings, tegulæ, and alulæ fuscous or smoky, the alulæ very prominently approximated to sides of scutellum when wings are closed over abdomen.

Described from two specimens bred from larvæ taken from *Lepus artemisia* (?), the common cottontail of the lower Rio Grande region in New Mexico. A somewhat larger specimen of this species was sent to me from Colorado by Prof. Gillette. It is 22^{mm} in length, and the wing is 18^{mm}. It differs but little from the two bred specimens. The glabrous black areas on lower sides of front show more plainly, the posterior one extending back nearly to vertex. A wide frontal vitta is appar-

ent, and on each side of the shining black lower border of facial depression there is a velvet black drop-like marking, which is drawn out into a point above. The arista and antennæ are more blackish, with the third antennal joint brown. The dorsum only of segments 1 to 3 of abdomen is narrowly purplish black, the side of the abdomen and all of last segment being covered with the whitish bloom and circular purplish black spots.

Puparium.—Length, 23.5mm to 25mm; greatest width, 12mm to 13mm. Much the general form of the larva, black in color, consisting simply of the dried and very hardened larval skin, stouter in middle and posteriorly, in one specimen nearly as stout anteriorly as posteriorly, widest and thickest on sixth segment. Inferior surface almost straight from a side view, the upper surface showing a nearly perfect arc of a circle in outline. Surface roughened from the spur-like plates of the larval integument, which are in some places even spine-like.

In both cases the fly issued by the dorsum of first three segments becoming perfectly detached in a single piece or cap. This cap bears at its anterior end two prominent pale-colored short but column-like tubercles projecting from the integument, apically truncate and quite removed from each other, apparently representing the larval antennæ. Puparium lined inside with thin white silken membrane.

THE SUGAR-BEET WEB-WORM.

(*Loxostege sticticalis* L.)

In our Annual Report for 1892, just published, we devoted some space to the consideration of a new enemy to the Sugar Beet, which is also mentioned by Mr. Lawrence Bruner, on page 37 of Bulletin 30, Division of Entomology, which is also just published. It also receives brief treatment on pages 51–53 of Bulletin No. 36 of the Division of Chemistry, of this Department, and our article in the Annual Report is reprinted from advance sheets on pages 68–70 of the same bulletin. This insect, a Pyralid moth—*Loxostege sticticalis*—appeared in great numbers the third week in July in certain sugar-beet plantations in the State of

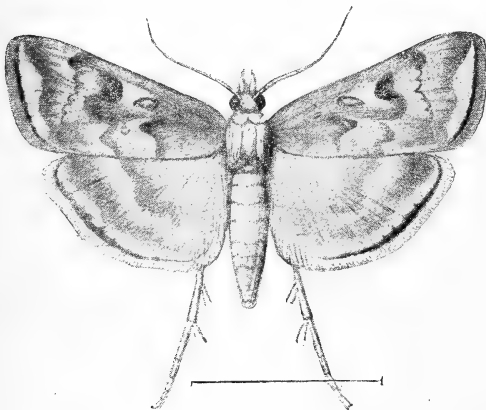

FIG. 42.—*Loxostege sticticalis*: adult, enlarged (after Riley).

Nebraska. Its larvæ partially defoliated the crop, transforming under ground in long, silken tubes. A second brood appeared a month later and there are possibly three annual generations. The best remedy

consists in the use of an arsenical spray. At the time of the submission of the Annual Report last fall we were unaware of the method of hibernation of the insect, and at that time were unable to give a good figure of the pupa. Recently, however, Mr. Walter Maxwell, the assistant in charge of the sugar-beet station of this Department at Schuy-

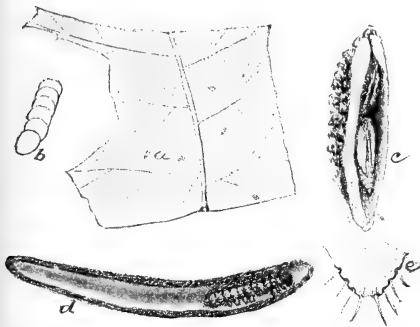

FIG. 43.—*Loxostege sticticalis*: a, eggs, natural size; b, eggs enlarged; c, cocoon; d, larval case; e, cremaster of pupa, enlarged (after Riley).

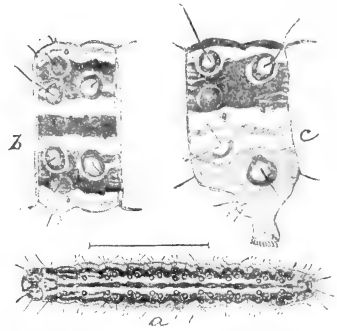

FIG. 44.—*Loxostege sticticalis*: a, larva, full grown, enlarged; b, dorsum of abdominal joint of same; c, same joint from side, still more enlarged (after Riley).

ler, Nebraska, has sent us a large number of over-wintered cases for the purpose of ascertaining whether the insect had successfully passed the winter and whether the outlook was favorable for a good crop of worms the coming season. At our suggestion last fall Mr. Maxwell harrowed the fields sown to beets last season, since it was supposed that this harrowing would bring the larval cases to the surface of the ground where they would be exposed to the frost and also to the attacks of insectivorous birds and mammals. He writes us May 15 that an examination showed that the cocoons which were exposed by repeated harrowings had been largely emptied by the birds—meadow larks, quail, and other species. Such as had not been rifled by the birds were chiefly dead, but occasional individuals still possessed a notable vitality. Upon ascertaining this fact he had them plowed under seven or eight inches deep and the soil compressed by rolling, considering that “their chances of seeing daylight were thus rendered extremely meager.”

The specimens which we received were collected November 12, 1892, and placed in a large box of earth which was placed under cover and kept through the winter, exposed to the out-of-door fluctuations of temperature, but protected from rain and snow. Examinations at this office May 16 gave the following result: Out of 141 larval cases 124 were

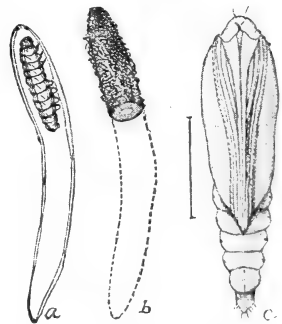

FIG. 45.—*Loxostege sticticalis*: a, larval case in outline; b, cocoon of parasite in larval case, natural size; c, pupa, enlarged (original).

found to contain living insects, 72 in the larva and 52 in the pupa state. Fifteen contained dead larvæ and 2 dead pupæ. Five of the larvæ had been parasitized.

We believe, as a result of this examination, that the great majority of the larvæ left undisturbed in the field will transform to adults with success, and that in all probability the beet plantations will be abundantly stocked with eggs, probably during June; since in our estimate of three annual generations we allowed for the probable normal occurrence of a June brood of caterpillars. If we are correct in this supposition the first brood last year must have been overlooked. This may seem astonishing in view of the great numbers of the destructive brood; but two thousand larvæ scattered through a field might well escape notice, and their immediate offspring, under favorable circumstances, would number nearly a million—enough to defoliate one hundred thousand plants.

All sugar-beet growers in Nebraska and adjoining States should, therefore, watch carefully for the advent of the worms in June, and on their first appearance should apply Paris green in solution at the rate of one pound of the poison to two hundred gallons of water. If they are not found in June careful search should again be made the third week in July.

We reproduce with this note the figures which illustrated our account of the species in the Annual Report, and have added at Fig. 45 a representation of the larval case in out-line at *a*, with the larva in the lower end. At *c* we show the pupa enlarged, ventral view, while at *b* is figured an interesting parasitized specimen. The dotted line indicates the outline of the entire case, the shaded portion showing the upper section occupied by the parasite, which, at the date of receipt, was still in the larval condition, although just ready to change to pupa. It had spun about itself a compact brown silken cocoon, the end of which is exposed at the point where the dotted line begins.

The pupa of the web worm is found close to one end of the larval case, its head applied to the extremity of the case, which, however, is entirely closed with silk spun by the larva before transformation. In making its exit the moth must undoubtedly moisten and pierce the silken fibers, as is the case with other cocoon-spinning Lepidoptera.

This insect did considerable damage during the summer of 1892, but it is a species which is easily treated, and with a little care no serious trouble need be anticipated.

REPORT ON A TRIP TO NORTHWEST MISSOURI TO INVESTIGATE GRASSHOPPER INJURIES.

By HERBERT OSBORN, *Ames, Iowa.*

In accordance with instructions received October 29, 1892, I started by first train for St. Joseph, Mo., that being apparently the most available point from which to work. No definite instructions further than "northwest Missouri" were received, and the only notice I had seen of grasshopper injuries was the following, which I had clipped from the *Daily Iowa State Register* at the time it appeared:

DAMAGE BY GRASSHOPPERS.

KANSAS CITY, *October 7.*—Myriads of grasshoppers have appeared in Buchanan and adjoining counties in Kansas and are rapidly destroying the winter wheat. The hoppers are not of the variety that appeared in 1879, but the common field grasshoppers that stay in one locality the entire season. The warm weather has hatched them out by the millions, and unless cold rains or frost comes immense damage will be done. Fourteen counties in Missouri also report them.

In Buchanan county, in the vicinity of St. Joseph, I was only out a few miles from the city, but the fields examined were doubtless fairly representative for the county.

I found *Melanoplus femur-rubrum* fairly plenty in the adult stage and noticed some of the adults copulating, which would not indicate a specially early deposition of eggs. *M. atlantis* also occurred here, but in less numbers than *femur-rubrum*.

No larvæ were seen, but a few specimens of *Pezotettix* were taken, and the strong resemblance of these to undeveloped *Melanoplus* could easily lead one, on superficial examination, to think they had young *femur-rubrum*. *M. differentialis* was also present, but very few living specimens remained. Other species noticed were *Dissosteira carolina* and *Oncoptolophus sordidus*, both in about the ordinary abundance. Larvæ that I took to be those of *Tragocephala viridis* and *T. infuscata* were quite plentiful, and it seems to me quite possible that larvæ of these species which hatch normally in late summer may, if seen in numbers, have been supposed to be the young of the more common species and given rise to the reports of the premature hatching of grasshopper eggs. These, if hatching at the usual time, would have been only large enough three or four weeks ago to be recognized as newly hatched grasshoppers. I could find no newly-hatched *Melanoplus*, not any signs of dead individuals, nor any indications of eggs hatching, and, though I had not facilities for extensive diggings, I could not discover any unusual number of eggs deposited.

Upon inquiry I was informed that no damage to winter wheat was known in the vicinity, but that some had been reported near Savannah in the next county north.

At Savannah I talked with several farmers from the surrounding country and made a circuit of several miles to the west, north, and east of the town to examine the fields.

A farmer who had recently been in Holt county said there had been some little damage a few weeks ago from grasshoppers working into the edge of the winter wheat, sometimes a strip a rod wide being injured: but the wheat had been retarded by dry weather more than by grasshoppers. No grasshoppers were there now, and there had been, he said, no young grasshoppers observed during the fall. None of the parties talked with had known of any damage to amount to anything. Some stated that grasshoppers were quite plenty in pastures and meadows a few weeks before and, with dry weather, had shortened the pasturage. I found in the fields practically the same conditions as in Buchanan county. Nearly all of the species noted there were observed. In one field of winter wheat I could see along the edges that the tips of the leaves had been eaten off some time before, probably when but little above the ground, but the wheat had evidently fully recovered from whatever check may have been caused by the clipping.

I was told that some damage had been reported in Nodaway county, and though it seemed probable that the conditions would prove the same there I thought best to stop there long enough to make sure of the situation. While en route for that county I talked with a man who owned a farm at Cawood, in Andrews county, who informed me that grasshoppers had been more than usually plentiful in his pastures some weeks before, but no young ones were seen. At Guilford the same story was repeated and hasty examination showed conditions to be the same as at preceding places. The fields of winter wheat seen from the cars in passing showed no damage, though some were quite uniformly thin, or the growth short.

At Conception I was told that grasshoppers had been very plentiful and had at one time done some injury to winter wheat adjoining grasslands, but they all disappeared some time ago. Only winged ones had been seen and my informant identified them as *femur-rubrum*, some specimens of which I caught and showed him. *M. differentialis*, which I also showed him, he said was not more common than usual, but he thought the red-legged one much more abundant than usual. I found both these species and *atlanis* common and observed numbers of dead ones in the grass along the roadside or in the grass and rubbish under fences. Here I found a single specimen of a rather young larva apparently *femur-rubrum* or *atlanis*, but nothing further to indicate any fall hatching of eggs.

Larvæ of *Tragocephala* here, as elsewhere, were rather common. *Dissosteira* was also present.

In addition to the territory visited I learned from a man in St. Joseph who lives in Clay county that grasshoppers injured clover and grass there, but no young ones were noticed, which evidently indicates the

same state of affairs as in the places examined, which really agree with the conditions in general for the northern Mississippi Valley this fall. As my examinations covered a strip about fifty miles in extent in Buchanan, Andrews, and Nodaway counties, running north and south directly through the region reported as suffering from the grasshoppers, it is probable that it represents fairly the conditions through all that region.

Evidently the common species, and especially *M. femur-rubrum*, and probably with it *atlanis*, have been more abundant than usual, pastures and meadows have suffered, and in some instances winter wheat has been attacked, but clearly with only a temporary check to its growth. There is no reason from my observations to think that eggs have hatched prematurely, certainly not in any large numbers, and, as it is probable that eggs have been laid in considerable numbers, favorable conditions for their development will probably show a plentiful supply of young grasshoppers the coming spring.

Where young hoppers were actually observed it seems quite probable that they were young of *Tragocephala* or some of the hibernating species.

Some statements made, and especially at Conception, lead me to suspect that *atlanis* might have been rather common and that some flights may have occurred, but I could get no positive data regarding this point.

THE ANGOUMOIS GRAIN MOTH OR "FLY WEEVIL."

(*Gelechia cerealella*.)

By L. O. HOWARD.*

The State of Virginia seems to be the original American home of this destructive grain pest. Originally, without doubt, a European insect, it was unquestionably imported by the early settlers of Virginia in their supplies of wheat brought from the old country. From this center it has spread in all directions through the country, but more extensively and injuriously towards the south than towards the north, since it does not thrive in a very cold climate. South of the wheat belt it is a very serious enemy to corn, reaching its maximum as a corn pest in Texas. In the extreme northern States it is frequently found in grain which is stored, for one purpose or another, in buildings which are artificially warmed, but although frequently carried north during the summer in grain, it dies out in course of time in cold storehouses or mills. It affects not only corn and wheat, but all other stored cereal products.

* Read before the Farmers' Institute of the Eighth Congressional district of Virginia, February 23, 1893.

The best of the early writings upon this subject are by Virginians. At the beginning of the present century it was investigated by Mr. Landon Carter, and later Mr. Edmund Ruffin, a well-known writer upon agricultural topics, and the man who first suggested the value of marl as a fertilizer, paid some attention to this pest, and wrote several very able articles upon its habits and the best measures to be taken against it. Since the war the literature upon this insect has been devoted to a consideration of its habits as a corn pest in the south, and only recently have its injuries to the wheat crop of Virginia and Maryland become so serious as to attract general attention. Prof. Riley published a general article upon the species in his report as Entomologist of the Department of Agriculture for 1884, and within the last year Prof. E. W. Doran, late Entomologist of the Maryland Agricultural Experiment Station, published a good account of the insect upon pages 437-441 of Bulletin 16 of the Station.

The farmers of Virginia are particularly concerned with the damage done by this insect to the wheat crop. Its habits need not to be dilated upon, since they are doubtless familiar to all concerned in its treatment. It may be stated briefly, however, that the parent insect is a small gray moth or "candle fly," resembling a clothes moth. This moth lays its eggs only upon hard grain. The eggs hatch into small, whitish, maggot-like caterpillars, which eat out the interior of the individual grains, and when full grown spin delicate silk cocoons from which the moths eventually issue. The insect passes the winter only in your barns and storehouses. It will breed uninterruptedly, generation after generation, in stored wheat. After the time of harvest the moth flies out from the granaries to the wheat fields and will lay its eggs upon grains of wheat in the shocks. The larvæ are not destroyed in the threshing and are carried back to the granaries again. From these facts it is plain that if the granaries of a neighborhood are kept free from the insect the shocks will not become infested in the fields. If an individual farmer, however, takes the trouble to disinfect his granary, his wheat shocks will be infested by moths flying from the barns of his neighbors, provided he does not thresh very soon after harvest. In such cases early threshing is very important. I realize the difficulty which frequently occurs in getting the thresher at the proper time, and where the wheat must be left in the field the individual farmer must disinfect his granary every year soon after the wheat is put in. There is an alternative, however, and it is a most desirable alternative, and upon its practice depends the diminution of the insect in numbers, if not its practical extermination, in any given neighborhood. Let all of the wheat growers of a neighborhood by concerted action disinfect their granaries thoroughly for one or two years. It is plain that if this be done all future damage will depend upon the importation of the insect in cereal products from some other locality. This is a plan which it is eminently fitting that a body of farmers like this should take into ear-

nest consideration, provided the amount of damage annually done by this pest would seem to warrant the trouble and expense.

How is the disinfecting to be done? A mal-odorous, inflammable liquid, known as bisulphide of carbon, is the agent, and its application is very simple. The simplicity of the operation depends upon the fact that the liquid is extremely volatile. When exposed to the air it evaporates with great rapidity, and its vapor is sure death to insect life. Prof. Doran, in the bullétin of the Maryland Agricultural Experiment Station above referred to, following earlier writers, recommends the use of this substance in tight bins, and when so used it is undoubtedly more effective, but there is no absolute necessity for a very tight receptacle, and it may be used to advantage in a reasonably close room of any dimensions. The method is to pour the liquid into shallow vessels, like small tin pans, and set them on top of the grain. The vapor is heavier than air, and will sink down through the mass of grain and destroy all insects. The amount to be used varies with the space to be treated. When used in bins, a pound and a half to a ton of grain is recommended by Prof. Riley. When used in a reasonably close room or in a nearly empty bin, one pound of the bisulphide should be evaporated for every one thousand feet of cubic space, or in a space 10 by 10 by 10 feet, $\frac{1}{3}$ of a pound in each of three shallow vessels for a space of these dimensions. For a space 10 by 10 by 20 feet, use 2 pounds in 6 vessels; for a room 10 by 20 by 20 feet, use 4 pounds in 12 vessels, and so on. Make the room as tight as is convenient. A good time to treat the grain is on Saturday afternoon. Place your pans of bisulphide in position, close the room up tightly before dark, and leave it closed until Monday morning. Then air the room thoroughly, and stir the grain to some extent. The vitality of the grain will not be injured in the least, nor will its edible qualities be harmed.

One point should be always borne in mind in using bisulphide of carbon, and that is its extreme inflammability; its vapor when confined is even explosive. No light nor fire should be brought into its vicinity. With care in this respect, however, it is easy and safe to handle, and it is not dangerous for a human being to inhale a reasonable amount of the vapor, in spite of its extremely offensive odor—to which, by the way, one soon becomes accustomed.

There is no need to insist before this Institute upon the value of concert of action in many farm operations, but in no way can the results of concert of action be made of more practical benefit than in the warfare against injurious insects. In regard to this specific pest I feel certain that following the plan outlined will result in the almost complete annihilation of the loss which it annually occasions.

It may be of interest to repeat here the excellent recommendations made by Mr. Ruffin against this insect as a wheat pest. He says:

Wheat, as soon as reaped, and perhaps sooner, is supplied from the granaries with a greater or less number of parent weevils to lay the earliest brood, and if it remains

in the straw until September, and when thrashed is left in small bulk, or often stirred, nearly all the grains may be weevil-eaten: but if wheat be thrashed and well fanned early in July, in this region, there will be no weevils worthy of notice. The eggs previously laid probably do not exist on the grains, but on the chaff or shuck in which they are inclosed, and, in hatching, the maggots must perish for want of food. As is the case with corn, the bulk of clean wheat is not exposed to subsequent layings, except on the grains at the surface of the bulk. Even if the eggs had previously been attached to and had remained with the grains instead of the chaff, as I infer to be the case, and then hatched in the interior of the bulk, the weevils could not escape from such close confinement, but would die without increase.

Seed wheat is usually kept spread out at least ten inches thick, in order to avoid any possible heating from remaining moisture, and by some farmers is frequently stirred, both of which conditions offer a greater opportunity for the depredations of these insects. Notwithstanding this, it is rare that they become numerous.

The bulking of early thrashed wheat without separating the chaff is also said to be sufficient protection from the weevil. Of this mode I have no experience. Its efficacy must depend, not on the removal of the eggs, but on the stifling of the maggots, and the inability of either the maggots or the moths to move in so close a mass.

Against this insect as a corn pest the practice is being generally adopted in some sections of the south, largely upon the recommendations of the Division of Entomology, Department of Agriculture, of growing only such varieties of corn as have a close-fitting husk, thus preventing the insects from laying their eggs upon the corn in the field, and of storing the corn in cribs without removing the husk. The damage done by the weevil is thus reduced to a minimum, although the storage space required is greatly increased.

It may be well to add that the bisulphide of carbon treatment above outlined is efficacious not only against the so-called Fly Weevil, or Angoumois Grain Moth, as it is sometimes called, but against all other insects which affect stored grain, and of these we have some five or six species in this country, all beetles in the parent stage. I may also add that this capital remedy was first suggested by Dr. C. V. Riley, in the columns of the *Farmers' Review* of Chicago, in March, 1879.

In the purchase of bisulphide of carbon, co-operation can be used to great advantage. It can be bought from wholesale chemists in 50-pound cans for 15 cents per pound. At retail it costs from 25 to 35 cents per pound. It is perhaps unnecessary to state that when not in use it should be kept in tightly closed receptacles, in which there is as little air-space as possible.

DESCRIPTIONS OF NOCTUIDÆ FROM THE DEATH VALLEY.

By Prof. J. B. SMITH, *New Brunswick, N. J.*

PERIDROMA DEMUTABILIS, n. sp. (Fig. 46, 1).—Ground color grayish white, with a more or less obvious luteous powdering. Head immaculate. Collar with a variously distinct luteous or smoky median line. Disc of thorax white, luteous or smoky. Patagiæ with luteous or smoky margins. Primaries strigate, the dark shadings luteous or smoky, the median line wanting. There is a basal black streak, above which the base is white and below which it is quite dusky; to this

streak is attached the long claviform, which extends beyond the middle of the wing, is somewhat paler in color, and defined by a very narrow black line which is usually incomplete. The ordinary spots are confluent, together irregularly gourd-shaped, inferiorly well defined by dark shadings, superiorly indefinite; the orbicular is paler than the ground, with a faint yellow tinge; the reniform is dusky centered. The s. t. line is marked by a smoky or blackish shade, interrupted below the apex, which may be either even and continuous, or invade and darken the terminal space, or may send in a spur over vein 5 to the lower edge of the reniform, joining the dusky shading beneath that spot. A very narrow dusky terminal line; the fringes white. Secondaries white, immaculate. Beneath white, the primaries with a dusky shading in the disk.

Expands 27-31^{mm}; 1.10-1.24 inches.

Habitat.—Granite Springs, San Bernardino County, California, April 6.

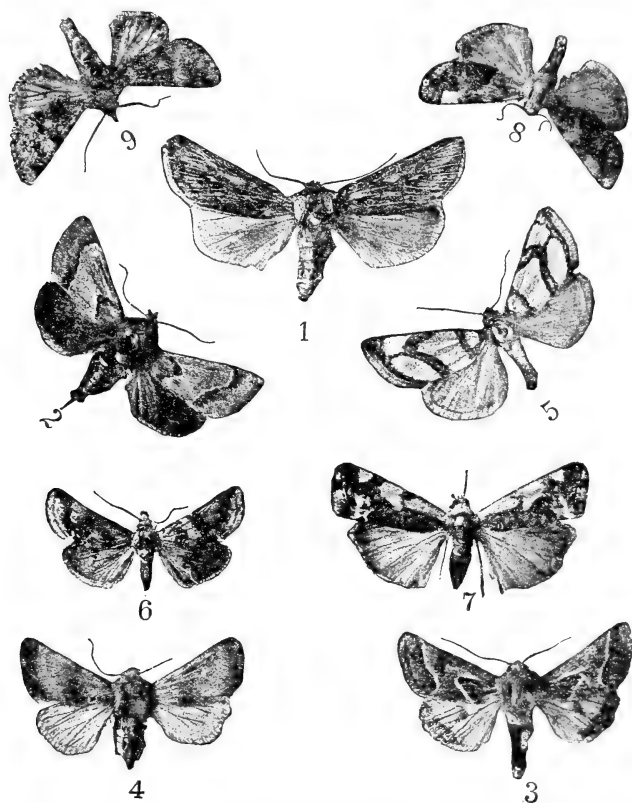

FIG. 46.—1, *Peridroma demutabilis*; 2, *Schinia ligeæ*; 3, *Schinia intrabilis*; 4, *Omia nesæa*; 5, *Antaplaga koebelei*; 6, *Tristyla alboplagiata*; 7, *Acontia lanceolata*; 8, *Acontia* (?) n. sp.; 9, *Oncocnemis flagrantis*.

Three specimens, 1 male, 2 females, are before me, no two exactly alike, and yet resembling each other closely. The species is unlike any other which has been referred to *Peridroma*, in the color and in the strigate character of its markings; but it agrees with the structural characters of the genus and has the pointed wings of the *saucia* group. The antennæ of the male have the joints slightly marked and ciliated. The tibial armature on all legs is feeble, and that of the anterior pair is scarcely more developed.

SCOTOGRAMMA DENSA, n. sp.—Ground color a sordid luteous gray, with fuscous powderings varying in density. Head and thorax immaculate save that there is

sometimes a paler central shade on the disk of the thorax. Primaries with all the ordinary maculation obscured by the dark powderings, and yet all of it traceable. Basal line geminate, wanting in dark specimens, fairly defined in the others. T. a. line geminate, the inner line vague, the outer outcurved between the veins, as a whole upright or very slightly oblique. T. p. line geminate, the inner line most evident, feebly crenulated, outcurved over the cell, and rather evenly oblique below. S. t. line a pale irregular shading near the outer margin, variably distinct in the specimens before me, and in one case well defined by a darker preceding shade. A series of dark interspaceal terminal lunules, followed by a pale line at the base of the fringes, the termination of the veins somewhat emphasized by the same color. There is an indication of a vague median shade line, most marked between the ordinary spots, where it darkens the cell. Claviform faintly indicated in some, wanting in other specimens. Orbicular round, concolorous, very feebly marked in most instances. Reniform moderate in size, upright, kidney shaped, sometimes defined by a narrow black line, sometimes only by a vague dusky shading, usually a little darker centered. Secondaries soiled whitish at base, smoky outwardly, with a fairly marked dark line at the base of the pale fringes, and a variably evident, never well-marked discal lunule. Beneath whitish, variably powdered with dark scales, forming a discal lunule on one or both wings, and sometimes an outer band as well.

Expands 26-30^{mm}; 1.05-1.20 inches.

Habitat.—Argus Mountains, April, 1891.

Four specimens, three of them males, are under consideration, and others not differing are in the National Museum. While all the specimens look very much alike in general appearance, no two agree in ground color nor in the distinctness of the maculation. It is one of those obscurely marked forms characteristic of the genus to which I have referred it, and which it is exceedingly difficult to characterize satisfactorily. It differs from the congeneric forms by the powdery luteous ground color and the fragmentary and obscure maculation.

ONCOCNEMIS FLAGRANTIS, n. sp. (Fig. 46. 9).—Ground color a peculiar rusty luteous, varying in shade. Head and collar immaculate. Thoracic disk with gray and black scales intermixed, the patagia margined with the same mixture. Primaries with the markings sordid black, the median space densely powdered with black scales, through which the ground color appears at irregular intervals. Basal line diffuse, single. T. a. line vaguely defined, geminate, the inner line consisting of irregularly disposed black scales, the outer indicated only by the dark median space as a whole. T. p. line defined by a series of irregular spots of the ground color to the submedian vein, up to which point the dark shading extends to the s. t. line; below this the contrast between median and sub-terminal spaces indicates the line. S. t. line irregular, marked by the difference between the s. t. and terminal spaces to the sub-median vein, below which it is obsolete to the inner margin where it is again indicated by a few black scales. A series of dark, interspaceal terminal dots, beyond which the fringes are cut by a dusky line. The fringes are long, of the ground color, with a dusky interline, and cut as above described in the interspaces. The claviform is traceable, centered with the ground color, margined by a somewhat more compact massing of darker scales. Orbicular small, round, distinct, of the ground color, with a dark central dot. Reniform large, of the ground color, undefined and sometimes black powdered. Secondaries a sordid yellowish white, the veins and an indeterminate outer band smoky or blackish. Beneath dull yellowish, powdered, sometimes with the disk of primaries darker, and on secondaries with an obscure punctiform outer line.

Expands 23-26^{mm}; 0.92-1.04 inches.

Habitat.—Argus Mountains, April, 1891.

Five specimens are under examination. The species belong to the *homogena* series and is perhaps nearest to *glennyi*, than which it is considerably smaller, differing also in color. It is not unlike a *Perigea* allied to *pulverulenta* at first sight, and except for the structural characters it would most naturally be referred there.

SCHINIA LIGEE, n. sp. (Fig. 46, 2).—Ground color a bright, though pale luteous, in some cases with an admixture of brown. Head and thorax immaculate, abdomen more smoky. Primaries with the median space white, or whitish with a yellowish tinge, else of the ground color. The darkest shades are those preceding the t. a., and following the t. p. lines, and these lines are marked only by the color contrasts between the spaces. T. a. line outwardly angulate, forming nearly a right angle. T. a. line very evenly and equally bisinuate. S. t. line faintly traceable in some specimens as an irregular white shade, but usually obsolete. Ordinary spots obsolete in most of the specimens, the reniform indicated in others. There is a series of terminal dots which is evident in most specimens. Secondaries smoky to blackish. Beneath, primaries smoky, the margins whitish, secondaries white.

Expands 23–28^{mm}; 0.92–1.12 inches.

Habitat.—Argus Mountains, April, 1891.

Eight specimens are before me, and others not differing in appearance are in the National Museum. The anterior tibiae are furnished with one inner and one outer short, stout claw at tip, and the nearest structural ally is *S. spinosa*. There is a considerable variation in size; but otherwise the specimens are very much alike and very simply marked.

SCHINIA INTRABILIS, n. sp. (Fig. 46, 3).—Ground color pale luteous, with an olivaceous shading in the darker parts of the wings. Head and thorax immaculate, the abdomen somewhat paler. Primaries with the median lines whitish, broad, the median space paler than the other parts of the wing, and with white powderings, which are most evident along the costa. The t. a. line starts from the base below the median vein, extends along it about half way to the end of the cell, makes an abrupt curve and thence runs inwardly oblique, to the hind margin; the pale median shade therefore extends above the median vein to the base of the wing. T. p. line from the costa a little before the apex, rigid to vein 5, then with a gentle incurve, reaching the hind margin a little before the anal angle. S. t. line broad, pale, straight, followed in some specimens by vague venular points. The reniform is indicated by a blackish shade, visible from the underside through the wing. Secondaries white with a yellowish tint, with a large black discal lunule, and a blackish outer border which is interrupted at the middle of the margin by a pale shade. Beneath whitish; primaries with a very large, prominent discal spot and sometimes an incomplete submarginal line; secondaries immaculate or with a discal spot, sometimes also with traces of an outer line.

Expands 23–24^{mm}; 0.92–0.96 inch.

Habitat.—Death Valley, April, 1891.

Three specimens, representing both sexes, are before me. Fortunately one of them boasts of one fore tibia, on which are 2 inner and 4 outer claws, the 4th shorter than the others, and the species is thus related to the eastern *S. rivulosa*, albeit quite different in color. The species should be easily recognized from the course of the t. a. line which does not cross the wing, but bends back abruptly and runs to the base before crossing the median vein from below. The t. p. line is also abnormal

in course, making it start close to the apex instead of about the middle or outer third of the costa. At first sight the species look like *separata*, but the tibial armature, and indeed the maculation also, when carefully studied, prove it to belong elsewhere.

TRISTYLA, n. gen.—Head distinct; eyes large, rather prominent, globose, naked; tongue well developed; palpi well developed, closely scaled, oblique, extending to or a little beyond the tip of the central frontal process; front produced into a flat plate which forms two short basal teeth to a long, pointed, central process exceeding the head by its own length. The thorax is moderate, the vestiture scaly, close, except that it forms a truncate, round, basal tuft. Abdomen somewhat exceeding the hind angles of the secondaries, rather slender and closely scaled, untufted. Legs moderately long, slender, with close scaly vestiture; tibiae unarmed except for the usual spurs on the middle and hind pairs. Wings moderate, rather broad for their length; primaries with the costa nearly straight, apex produced, acute, outer margin very oblique, convex; venation apparently normal, the accessory cell present; secondaries proportionate, the margins rounded, vein 5 as strong as the others.

This genus belongs to the Acontiid series rather than to the Heliothids, and its most distinctive character is the peculiar frontal structure. I recollect no other Noctuid with a similar pronged process.

TRISTYLA ALBOPLAGIATA, n. sp. (Fig. 46, 6).—Ground color white. Head with a very narrow black line at base; patagia with black scales toward their tip; dorsum of thorax luteous, posterior tuft white. Primaries with a narrow black basal line, extending only to the subcostal vein. T. a. line geminate, the outer line black, nearly upright, making three slight outcurves; inner line grayish, shading off into a mixture of gray and yellow scales which extends half way to the base. T. p. line single, black, interrupted, irregularly lunulate, with a deep incurve below the cell. The outer part of the median space is luteous gray except for a large, quadrate, white costal patch, and this dusky shade extends to the s. t. line, which is narrow and irregular, defined primarily by the contrast between the s. t. and the white terminal spaces. Apex grayish luteous. A broken dusky terminal line. Fringes white. The claviform is wanting. Orbicular indicated by a few black scales. Reniform marked by a large, quadrate, white blotch, which extends from the costa to the median vein, beneath which it is black margined, and from the middle or near it, to the outer fourth of the costal margin. Secondaries smoky, immaculate. Beneath, primaries blackish with narrow whitish margins; secondaries white with an extra median line and discal spot.

Expands 18–20^{mm}; 0.72–0.80 inch.

Habitat.—Argus Mountains, April, 1891.

I have three specimens, representing both sexes. This is a very pretty insect and easily recognizable, not by its structural characters alone, but by its markings as well. The base is white, limited by the grayish luteous band extending to the t. a. line; a broad band of white follows, and beyond this the dark color obtains to the s. t. line, except for the large white costal patch which occupies the outer part of the median space above the incurve of the t. p. line. The wing form and habitus is not at all unlike *Antaplagia* at first sight, while the truncate thoracic tuft and the close scaly vestiture implies *Acontia*.

OMIA NESÆA, n. sp. (Fig. 46, 4).—Ground color very pale whitish green. Head and thorax immaculate. Primaries immaculate, save that there is an oblique, broad, diffuse, darker green median fascia, and a deeper tinge of the same color at the

outer margin. In some specimens a pale t. p. line is visible, and in one case the reniform is indicated. Secondaries white, with a yellowish tinge, immaculate.

Expands 21–24^{mm}; 0.84–0.96 inch.

Habitat.—Argus Mountains, April, 1891 (Death Valley Exp.); Western Utah, Weidt.

I have seen 8 specimens, of which the one collected by Mr. Weidt is in the Neumoegen collection, the others from the U. S. National Museum. The species is so nearly immaculate that it is easy to describe it. There is, perhaps, a question as to the correctness of the generic reference, but the species agrees fairly well with the description of the genus, and has the shape, though not the color, of the European forms. The eyes are small, naked, round, and hardly retracted, though not prominent; the palpi are moderate, reaching to the middle of the front; terminal joint obtuse. Front with a prominent, navel-shaped protuberance. Thoracic vestiture hairy, loose, hardly divergent, forming no tufts. Primaries short, the costal margin somewhat depressed, the apex a little acute, outer margin oblique, a little convex, the fringes long. The legs are short and stout, clothed with rather long and fine vestiture, tibiae not spinose, the anterior unarmed at tip.

PLEONECTYPTERA FINITIMA, n. sp.—Ground color varies from gray to fawn brown. Head and thorax immaculate. Basal line wanting. Median lines marked at their inception on the costa by black triangular spots; t. a. line upright, even, consisting of a brown outer and a yellowish inner shading, the latter sometimes wanting, and the entire line sometimes reduced to a few dark scales; t. p. line yellowish, with a narrow, dark brown inner shading, which is sometimes wanting and sometimes punctiform; as a whole the line is evenly and not strongly bisinuate and only a little oblique inwardly. S. t. line irregular, very slightly paler, almost obsolete in some cases, preceded by dots or distinct blackish shades in others. Claviform and orbicular wanting. Reniform of good size, kidney shaped, black in most of the specimens, in one case almost obsolete. Secondaries soiled luteous, with a reddish-brown tinge, which intensifies outwardly. Beneath, reddish brown, powdery, the primaries with a discal lunule more or less evident, and occasionally the markings of the upper side faintly reproduced; the secondaries sometimes have an outer line and discal spot, but are as often immaculate.

Expands 22–23^{mm}; 0.88–0.92 inch.

Habitat.—Argus Mountains, April, 1891; Los Angeles, Cal., in October.

Four specimens are before me, but I have seen a number of others. Three of them are from the Argus Mountains. The species of *Pleonec-typtera* are extremely variable in many cases, and this species is no exception. I would not be much surprised if forms entirely immaculate occurred. There are several undescribed species referable to this genus, and I would not have named this at present were it not desirable to make the list of species taken as complete as possible.

ANTAPLAGA KOEBELEI Riley, n. sp.* (Fig. 46, 5).—Average expanse 22–25^{mm}. Ground color, silvery-white; markings ochraceous. Head with the ochereous scales predominating; frontal depression with a central conic elevation which extends well beyond the rim. Thorax with a broad ochraceous median band on the collar; brown behind the collar, and with a brown discal line extending to the base; patagium margined with ochereous: Primaries with the silvery-white broken only by the ordi-

* This species is described by me in this connection, because it was included in Mr. Smith's photograph.—C. V. R.

mary lines, which are as follows: From an ochereous spot at base, representing the half line, a band extends along the costa to the broad, even, upright t. a. line: The t. p. line is geminate, making it appear twice as broad as the t. a. line, the intervening space between the double line being yellowish; it is broad at costa and bent posteriorly, forming an acute but rounded angle beyond the cell, and a trifle incurved along its inner bend; a line extends from the elbow to the s. t. line, which runs very close to the outer margin, starting from the costa a little before the apex and gradually nearing the margin until upon the submedian vein it sometimes becomes coincident with it: there is also a narrow terminal line, and the space between it and the subterminal is also yellowish: fringes at the apex, with an ochereous interline: reniform spot indicated by a small blackish dot. Secondaries yellowish-white, glistening. Beneath, primaries smoky, with narrow white margins: secondaries white. Abdomen white, with a yellowish tinge.

Habitat.—Argus Mountains. Taken April, 1891, by Mr. Koebele.

Described from three specimens. The species is most nearly related to *dimidiata* in body structure and wing form, but quite different in ornamentation.

THE RED-LEGGED FLEA-BEETLE.

(*Crepidodera rufipes* L.)

ITS INJURY TO ORCHARD TREES IN MARYLAND AND VIRGINIA.

On April 11 of the present year the Secretary of Agriculture referred to the Division the following letter:

COLEMAN'S FALLS, VA., April 9, 1893.

SIR: I have had over 1,000 peach, pear, and plum trees entirely denuded of all blossoms and buds, both active and dormant, in less than forty-eight hours by a flea-beetle whose attack I have not been able to arrest up to the present writing. If you can send an agent to study habits and remedies in the interest of horticulture I will extend hospitality, force-pumps, labor, etc., necessary to his purpose.

Respectfully,

GEO. E. MURRELL.

No specimens accompanied this communication, but the insect attack therein described appeared to be of sufficient importance to call for further investigation. We therefore instructed Mr. E. A. Schwarz to proceed as soon as practicable to Mr. Murrell's place to learn all he could about the injury. This he has done and we append his report.

REPORT OF E. A. SCHWARZ.

Mr. Murrell's farm at Coleman's Falls is situated at the base of a high spur of the Blue Ridge Mountains. The numerous narrow valleys in this section of the country are separated from each other by rather flat-topped ridges, which are usually covered with a magnificent growth of chestnut trees. Black locust trees (*Robinia pseudacacia*) are very rarely met with in the chestnut forest on these ridges, though they are common to the valleys along the roads and fields as well as on the edge of the forest. If, however, the chestnut trees on the ridge be cut down, they are speedily succeeded by a dense growth of shrubbery mostly composed of Robinias.

The insect invasion presently to be described took place on the top of one of these ridges which years ago had been cleared, and where for a number of years oats and other field crops had been cultivated. Six years ago this cultivation had been abandoned, and the clearing was overrun with locust bushes. In the month of March, of the present year, Mr. Murrell had this shrubbery grubbed up, plowed the

land, and set out nearly one thousand young orchard trees, most of them being peach trees. This was towards the end of March, and in the first week of April, during the first warm days of the year, immense numbers of a small Flea-beetle, which proved to be *Crepidodera rufipes*, appeared on the young trees on which the first buds were just pushing out.

Long before the time of my visit (April 14) the beetles had done as much damage to the trees as can possibly be done by a phytophagous insect. Not a single green leaf or living bud was to be seen on the newly-planted trees. Yet the beetles were still very numerous on the trees, and this in spite of several applications of insecticides made by Mr. Murrell from April 8 to April 14. On one tree, which had not been recently treated with insecticides, I counted 52 beetles. Most other trees harbored a much smaller number of specimens, averaging about 15. The presence of the beetles at this time was at first glance difficult to account for, since there was apparently nothing left on the trees for the beetles to feed upon. Examination showed that those buds which at the time of the invasion were most advanced were attacked at the tip, and the beetles eat or burrowed their way through the center of the bud through its very base within the stem. The outer folds of leaves of such buds were left intact, quickly died and dried up, while within the buds almost always one or more beetles could be found with their heads deeply buried in the base of the bud in order to feed upon the exuding sap. The younger buds were devoured bodily and the beetles then crowded around the base to lick up the sap. Other beetles, for which there was no room on such places, were wandering up and down the trees in search of buds hitherto overlooked, many copulating pairs being seen among them. Other beetles driven by hunger were also seen eating the bark of the tips of the trees. In a few instances some of the older leaf buds had opened before the attack of the beetles commenced, but there was no crowding of beetles on the young leaf, though occasionally one or more of those oblong holes on the surface of the leaf, so characteristic of the feeding habit of Halticids, could be found. It was plainly to be seen that it was not so much the leaf substance as the sap of the trees the beetles were so eager to get at.

As a matter of course the damage done to the young trees must be very severe, and this the more so because the beetles do not give the trees the slightest chance to recuperate. My impression was that should the beetles remain in force on the trees for a week longer the trees would necessarily be killed.

Several choice varieties of peach trees are planted in this orchard, but all of them appeared to be equally subject to the attacks of the beetles. Some pear trees, however, had suffered less. Here only the tips of the young buds had been eaten, so that at least a few, though mutilated, leaves had made their appearance.

Another orchard, not far distant from that just described, and situated on the slope of the same ridge, presented a little more varied conditions. Here the lowest and most sheltered portion of the old clearing was plowed three years ago and planted with peach trees. Two years ago another portion of the clearing, higher up the slope of the hill, was added to the orchard, and then Mr. Murrell noticed first the appearance of the beetles. But this invasion, which took place also very early in the spring, was less severe than that of the present year, when the highest part of the clearing was plowed and set out with peach trees. The beetles attacked and injured the newly set trees as well as the two-year old trees in the same way as on the first-mentioned orchard; but the three-year old trees suffered much less. It appears that at the time of the appearance of the beetles the buds of these trees were considerably more advanced than those of the younger trees; they unfolded faster than the beetles could destroy them. Thus the trees were at the time of my visit in full foliage, although many beetles were upon them riddling the leaves with small holes.

As to other food-plants of the beetle, there was no chance of making any observation on the parts of the orchards just laid out, since besides the fruit trees there was not a single plant on the newly-plowed ground. The surrounding forest still presented a very wintery appearance, and not a single specimen of the beetle could

be found on the buds of the various trees and low plants. Along the edge of the forest, however, a few beetles could be seen on the buds of a dogwood (probably *Cornus florida*), and the buds themselves showed evidence of injury. On the older portions of the second orchard some beetles were found eating the young leaves of a blackberry (*Rubus*), and a solitary young shoot of a locust tree harbored many specimens. The leaves of a few wild cherry trees showed signs of injury, but the originator proved to be *Apion nigrum*. In the valleys where the vegetation was more advanced than on the ridges no beetles could be found except on the young shoots of black locust.

From analogy with the habits of other species of *Crepidodera*,* as well as from the ravenous appetite of the beetles, their sudden appearance in great numbers, and from their dark color,† it is safe to assert that they had hibernated in the imago state, and efforts were made accordingly to ascertain the place of hibernation. The insect sieve was brought into requisition, and after some failures I succeeded in finding a few specimens under a heap of old leaves and rubbish at the edge of the forest and close to the newly-plowed orchard. No specimens were found in the depths of the woods, although I chose for investigation places which from experience I knew to be favorable as hibernating quarters of insects, and where, indeed, many other Coleoptera (notably *Typhophorus canellus*) and Hemiptera were found by me. However, on the surface of the ground of the newly-planted orchard many beetles were seen crawling about, and many others were found under the clods of earth or within the loose soil, so that I was forced to the conclusion that the place of hibernation and the starting point of the invasion was the newly-made orchard itself, which, as stated above, had been covered with a growth of locust bushes up to March of the present year. It is to be regretted that no absolute certainty could be obtained regarding this point, for it has evidently an important bearing upon the means of avoiding future injury, as will presently be explained.

It may safely be asserted that the peach and other orchard trees are not the original food plants of the imago or larva of this *Crepidodera*. The consensus of all field Coleopterists in America is that the black locust (*Robinia pseudacacia*) is the favorite food-plant of the imago.†† But the beetles are also found on various other plants, and in my experience it is near Washington not rare on beech, the leaves of which it riddles with holes. I have never seen it feeding on any herbaceous plants. The true food-plant of the species *i. e.*, the food-plant of the larva, still remains unknown, but it is safe to say that if the larva were feeding openly on the leaves of some plant, or if it were a leaf-miner, it would have been discovered long ago, either in Europe or here. It appears to be almost certain that the larva of this as well as other species of *Crepidodera* and of the closely-allied genus *Epitrix* are root-feeders, and it is but natural to assume that the larva of *C. rufipes* is to be found within or at the roots of that plant, which is the favorite food-plant of the imago. Although I did not expect to find the larva of the *Crepidodera* at this season when the insect was in the imago state, I carefully exhumed and examined a clump of young locust shoots which grew between the three-year old peach trees of the second orchard, but neither the roots nor the rootlets showed the slightest sign of having been attacked by any insect larva. This is of course no convincing proof that the larva does not live on locust roots. Since no other wild leguminous plants were seen thus early in the season in the orchards or within the woods any further attempts to find evidence of the larva had to be abandoned.

Mr. Murrell first noticed the beetles on the orchard trees on April 7, and at once set to work to kill the invaders. Pure pyrethrum powder was first dusted over all

* Our common species of this genus, viz, *C. helvines*, *C. modeeri*, and *C. atriventris*, are well known to hibernate in the imago state.

† Of the many thousands of specimens seen by me, none had that bright-red color on head and thorax as seen in specimens found in summer time.

†† There are only two published records of this fact, viz, by Mr. Wm. Beutenmüller (*Ent. Amer.* VI, p. 177) and by Mr. F. H. Chittenden (*Proc. Ent. Soc. Wash.*, II, p. 206).

trees of both orchards and the application repeated the next day. From Mr. Murrell's observations it would appear that a great number of the beetles were killed (or perhaps only temporarily disabled?) thereby, but at any rate there was no diminution of the invasion. Then Mr. Murrell sprayed the trees of the first orchard with London purple water (2 oz. to 40 gallons of water) and repeated the spraying the next day, using a Nixon spray machine and a Japy knapsack sprayer which had been furnished by the Virginia Agricultural Experiment Station. Mr. Murrell was not certain whether or not any beetles were killed by this spraying; at any rate, the evil did not abate. On April 14 Mr. Murrell changed his tactics and commenced spraying with kerosene emulsion. The emulsion (milk and kerosene) was correctly and successfully made, diluted four times its volume with water, and applied to the trees by means of the Nixon pump, three men being necessary to carry on the operation. I witnessed myself the spraying, which was a very thorough one, and which progressed at a rapid rate where the ground was even. Most of the beetles jumped off the trees the moment they were touched by the liquid, and only a few—(especially those hidden within the dead buds) were caught and enveloped by the emulsion on the trees. These latter specimens did not recover and died; of those that had jumped to the ground I collected a small number in a tin box and found them all dead a few hours afterwards. It may be assumed, therefore, that most specimens that had been touched by the emulsion were killed. In the early morning hours of April 15 there was a heavy rain shower, and an examination of the trees treated the day before with the emulsion showed the presence of a small number of beetles. On the wet ground, however, many apparently healthy beetles were slowly moving about, apparently waiting to get dry before attacking the trees.

The invasion of *Crepidodera rufipes* has plainly a strong resemblance to that of the well-known *Macrodactylus*; in both cases thousands of newly-arrived specimens replace those that have been killed by the application of arsenical poisons or pyrethrum or kerosene emulsion. In the case of the *Crepidodera* the arsenical poisons evidently have very little or no effect whatever, since the young trees are mere naked slender shoots, without branches or leaves and with smooth bark. In short, the old method of jarring the beetles down is here plainly more effective, cheaper, and more time-saving than the other remedies just mentioned. To test this method I rigged up my "insect umbrella" (consisting of a piece of common cotton cloth one yard square and kept stretched out by means of two sticks). It was found that a *very slight* knock with a thin stick is sufficient to dislodge the beetles from the trees, excepting the specimens hidden within the dead buds. A stronger knock with the stick is liable to jar the beetles either in the wrong (opposite) direction or beyond the circumference of the cloth. It was further found that, if little judgment is exercised as to the most favorable side where to apply the jar and how and where to hold the cloth, all or nearly all the beetles can be knocked down onto the cloth; in other words, the beetles do not jump off, but simply fall down, following the impetus given by the shock. I convinced myself of this fact by counting in several instances first the beetles on the tree and then, after jarring, the beetles on the cloth. Finally, it was found that this operation can be proceeded with almost as rapidly as a man can walk, and I estimated that a single man could easily attend at least two hundred trees within one hour.

This remedy will be only effective, however, if the jarring is repeated as often as possible—say at least twice each day as long as the invasion lasts. A more handy contrivance than the somewhat clumsy insect umbrella could be easily and cheaply constructed, and from former experience I know that an old parasol which is lined on the inside with heavy cotton cloth does excellent service.

As a mode of prevention, Mr. Murrell suggested to inclose the upper part of the trees within gauze bags. If these bags are properly tied to the stem, they will no doubt protect the trees; but the great expense will no doubt prevent their use on a large scale. In order to be effective, these bags must be at least one foot long and of

a sufficient width not to interfere with the development of the buds. For the protection of single choice trees, however, such bags are no doubt to be recommended.

Should future observations corroborate the connection of the presence of the locust bushes on or near the orchard and the invasion of the Crepidodera, by far the most rational way of prevention would be the radical destruction of the locust thickets. This should, however, not be done as in Mr. Murrell's case, who, as stated before, grubbed up the locust trees in March and at once planted the peach trees on the new ground. The severity of the invasion is thereby evidently increased, for by the plowing of the ground the beetles are disturbed in their winter quarters and appear sooner above ground than they would under ordinary circumstances. The locust trees should be uprooted some time during the summer—*i. e.*, before the beetles have retreated into their winter quarters under the old leaves at the base of the trees or in the ground. The particular month when the beetles go into winter quarters has not yet been ascertained, but it is safe to say that this takes place before the cool season sets in, probably as soon as the month of August.

Besides the Crepidodera, only a single other species of insect was found on the newly-set trees—*viz.* *Apion nigrum*. I did not observe that it did any damage here, probably because there was nothing left to feed upon on the trees already denuded by the Crepidodera. It was more abundant on the three-year old trees, where it fed upon the leaves, but the amount of damage done was very insignificant. However, the presence of this little *Apion* on the peach trees is of special interest, since, like the Crepidodera, it belongs to the fauna of the Black Locust, the imago feeding on the leaves and the larva developing probably in the seeds of that tree.* Thus the assumption that there is a connection between the locust trees and the Crepidodera invasion is considerably strengthened.

On the three-year old trees a number of other insects were found, mostly Coleoptera (a few Coccinellidæ and Elateridæ, *Syneta ferruginea*, *Typhorus canellus*, and *Pandeletejus hilaris*), a few Capsidæ, and an Aphis, none of them abundant or of any special interest. But I utterly failed to find any insect that could be considered as an enemy of the Crepidodera. Mr. Murrell informed me, however, that in one instance he saw a brownish Hemipter spear a specimen of the Crepidodera. Being an excellent observer, he was able to draw from memory a figure of this Hemipter, and I had no difficulty in recognizing one of our Reduviids.

FURTHER EXPERIENCE.

We were anxious to follow up the further experience which Mr. Murrell had, both with the beetle and the experiments made to destroy it, and the following letters from him are sufficiently interesting and instructive to reproduce entire:

LETTER OF APRIL 29.

I was requested by Mr. E. A. Schwarz, while on his visit here, to write at a later date stating effect of kerosene emulsion diluted four times as affecting peach foliage. The trees so treated were about 75 in number, and were showing foliage from buds just opening to leaves about one-fourth developed. Four or five days after spraying the bulk of the lot were defoliated by beetles, and the few yet carrying leaves show no bad effect from emulsion. Six or seven hundred trees sprayed heavily, first with 2 ounces of London purple to 40 gallons of water and a few days later with one-half pound London purple, 2 pounds lime to 100 gallons water, show no difference in appearance or cessation of attack from trees untreated. The weather following both

* See Proc. Ent. Soc. Washington, II, No. 1, p. 76.

treatments of emulsion and poison was cloudy and moist to cool for a period of five or six days.

Mr. Schwarz advised my trying the jarring of the beetles on a cloth saturated with pure kerosene. Following this advice, I made a frame nearly of the shape of a palmetto fan, made by bending barrel hoops and fastening to a forked stick, leaving one prong long for a handle. I covered this with 14-ounce ducking. This gave me a shape that by passing the trunk of the tree into the crotch of the fork nearly surrounded the limbs with the canvas, which was 3 feet in diameter, and proved quite effective, although I would advise the use of a woolen cloth with nap as holding the oil better and preventing the jumping off of the beetles the instant they touch the surface, which fully two-thirds do. With this apparatus kept saturated the beetles can be kept in check during cool weather by passing over the orchard once a day. During warm weather it is nearly useless, as countless thousands are in the air, and two minutes after jarring, by actual count before and after and timing by my watch, I found nearly as many as the first time. Having the beetles between me and the sun, I could plainly observe their flight, and saw they were coming from out the edge of the woods close by, and especially did I notice them circling in large quantities around an old brush heap located just at the edge of the woods. Mr. Schwarz thought it possible that the clearing and fallowing of the land had caused the beetles to hatch earlier than usual. This theory would seem to be borne out from the fact that the trees surrounding a rocky spot nearly in the center of a large field of 1,000 trees have in the last few days been attacked with redoubled violence; but I do not consider this at all conclusive. The woods and locust trees are rapidly getting green, and while I have noticed some beetles on the latter trees both here and on adjoining farms, yet I see no tendency as yet in the beetles to abandon the peach for their natural food plant, and in the last few days they have been worse on my cherry trees than when the leaves were younger. I should be glad to learn the results of experiments with alkalis as affecting foliage. Soot is efficacious in treatment of masticating insects on squash vines, etc., when used dry, and I would be glad to know if it could be used in solution safely and with the same effect

LETTER OF MAY 12.

A few beetles are still on my trees, but the trees are fast growing out of their reach. Since May 5 the damage done is not noticeable. It is too early to state definitely the percentage of damage done. In a general way I can say that the pear trees show least ill effects. A number of plums have succumbed and several hundred peach trees are killed to the ground, but are putting up from below ground. The trees were planted somewhat deeper than they stood in the nursery, and it is owing to this fact that I will save a larger per cent than otherwise, as one or more buds were left covered by earth and escaped. None of the peach trees escaped with less than two months' set back, and many from twelve months to total destruction. For a period of three or four days the locust growth divided honors in attention from the beetles, but they are fewer now on both peach and locust, the proportion being about the same on both. One of my neighbors has been troubled with them on young apple trees, and I have noticed them on locust bushes in every portion of the neighborhood that I have visited lately.

CONCLUSIONS.

In spite of its small size—not exceeding one-tenth of an inch—the beetle is readily recognized, even without the aid of a magnifying glass, from its coloration and the sculpture of the upper side, in connection with

its leaping powers. It is oblong-oval in shape, shining and not pubescent; head, thorax, and legs bright red and impunctate; elytra usually bright blue, more rarely greenish-blue, and provided with regular striae of coarse punctures. The thorax has at its base a large and conspicuous impression which is sharply limited on each side.

Crepidodera rufipes, originally described by Linnaeus in 1758, is one of the numerous species of Coleoptera common to North America and Europe. In the latter country it is a common and widely distributed species, but does not appear to occur in the arctic regions. In North America it is known from the States of New York, Pennsylvania, Maryland and Virginia, and the District of Columbia. There are also two specimens in the National Museum marked "Texas," and Dr. Horn in his Synopsis of the Halticini says "it is now widely scattered over the Atlantic region as far west as Iowa." It seems to be absent, however, in the boreal region, and from this fact it may be assumed that the species does not belong to the circumpolar fauna but has been introduced by the agency of man. If this be so, it was imported at or before the beginning of this century, for it is enumerated in the old catalogue of Insects of Pennsylvania, by F. V. Melsheimer, published in 1806. Forty years afterward (in 1847) it was redescribed by the younger Melsheimer under the name of *Haltica erythropus* (Proc. Ac. Sc. Phila., vol. III, p. 165).

As in the case of many other flea-beetles the imagos of *C. rufipes* appear to feed upon several different plants which are not necessarily the food plants of the larva. Mr. Letzner, in his list of the Coleoptera of Silesia says (2d edition, p. 414) that the imagos are found "in deciduous forests, on *Lathyrus vernus*, *Malva silvestris*, *Vicia sepium*, etc.," while M. E. Olivier, in his "Faune de l'Allier" (II, pt. 1, p. 348) simply says, "on Malvaceous plants on dry meadows." Since in the United States the species feeds chiefly on Black Locust, which does not occur in Europe (except as an imported shade tree) it must be inferred that the beetle has changed its food habits upon its arrival in America. Whether or not a corresponding change has taken place in the food habits of the larva can not be ascertained, since the earlier states and the larval habits are still entirely unknown.*

* Mr. Ed. Perris found the larva of *Crepidodera lineata* feeding openly on the leaves and flowers of *Erica scoparia* in southern France, and gave a detailed description thereof in his "Nouvelles Promenades Entomologiques" (Ann. Soc. Ent. France, 1876, pp. 198-201), but he says, "Although the species of the old genus *Crepidodera* are pretty numerous and some of the species very common, yet not a single larva of this genus has ever been observed, and the failures of my efforts to find them induce me to believe that none of them save that just described live openly on plants. This peculiarity, in connection with certain structural differences in the imago of *C. lineata* appear to justify the erection of the genus *Arrhenocæla* Foudras for this species."

In the economic literature of Europe we find but a single notice of this *Crepidodera*, viz, by Kalténbach (*Pflanzenfeinde*, p. 141), where he briefly says: "*Sitones lineatus* and *Haltica rufipes* are injurious to young peas and field beans," but while a good deal has lately been written on the *Sitones*, especially by British economic entomologists, no further notice is made of the *Crepidodera*, and it is evident that this beetle is by no means a serious pest in Europe. As to the injury done in the United States, there are no records previous to 1887, when Mr. Murrell, on whose farm at Coleman's Falls, Va., the invasion of 1893 took place, sent specimens of the beetle to Prof. J. A. Lintner, who, in his Fourth Annual Report, pp. 101-103, devotes a short chapter to the insect, including Mr. Murrell's account of the invasion of that year.

One year afterward another invasion was reported to us by Messrs. Stover & Stover, Edgemont, Washington County, Md., in a letter dated May 15, 1888, which is published in *INSECT LIFE*, vol. I, p. 280.

Finally, the present year, a few days after Mr. Schwarz's return from Coleman's Falls, Prof. Van Deman, chief of the Division of Pomology, referred to us a letter from Mr. W. A. Powell, of Lexington, Va., in which complaints were made of the sudden appearance in injurious numbers of a small beetle on young peach trees. No further particulars were given, nor were there accompanying specimens, but there can be little doubt that the invaders were the same *Crepidodera rufipes*.

It will be noted that all these reports are from the slopes of the Alleghany Mountains, which is just the region where, in the experience of our field coleopterists, this *Crepidodera* is far more abundant than elsewhere.

It will be further noted that in all these instances the invasion took place early in the spring, and it would appear that later in the season, when the orchard trees have acquired their full foliage, these attacks cease and the beetles feed upon the leaves of the locust bushes. Similar attacks on the part of other flea-beetles are on record. Thus we recorded in *INSECT LIFE*, vol. I, p. 221, the appearance of great numbers of *Haltica ignita* on grapevines in the Salt River Valley of Arizona during the first part of April. The same species appeared toward the end of March in enormous numbers on strawberries at Orlando Fla., (l. c., II, p. 369).* A remarkable case of the early appearance of another flea-beetle is also recorded in *INSECT LIFE* (vol. IV, p. 401), where

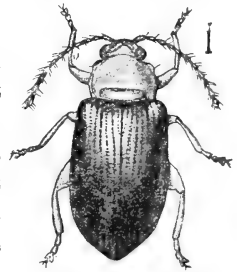

FIG. 47. *Crepidodera rufipes*—enlarged. (Original.)

* Prof. F. M. Webster's short note in *INSECT LIFE*, III, pp. 317-318, is of special interest, for he reports that this *Haltica* appears on the strawberry plants in the months of July and August, injuring the young foliage which appeared after the strawberry-bed fields had been burned.

Mr. C. H. Rowe, of Malden, Mass., reports that as early as March 25, when the weather was quite cold and snow to the depth of 6 inches was on the ground, swarms of *Haltica carinata* were found on his elm trees. In all these cases only the imagos of the Halticids were observed, and it is safe to say that the plants mentioned are not the food plants of the larvæ.

Whether or not the discovery of the food plant and habits of the larvæ of *Crepidodera rufipes* will materially add to the means at our command in dealing with the injury can not now be predicated. If the larva should be found to live on the roots of locust bushes the destruction of these would prove advantageous in the vicinity of young orchards. On the other hand, if the real food plant of the larva is scattered throughout the woods or meadows its discovery would be of little practical importance.

EXTRACTS FROM CORRESPONDENCE.

The "Overflow Bug" or "Grease Bug" a Plague in California.

I send you in the inclosed box a "grease bug," so called, I presume, from its disagreeable odor when crushed. They are among our worst pests about the house, coming in swarms so they sound like a rainstorm on the side of the house. They attack all kinds of food, eating holes into the interior of bread, etc., but preferring meats. I have had many bird-skins destroyed by their eating the lores and adjacent parts when drying. They stophere all summer, finding some damp place, where they congregate in immense numbers. I have seen at least a peck under one haycock in the field, and nearly every cock with them. They crawl up the sink-drain into the closet under the sink, and I have taken them from here by the double handful, dropping them on the hot sand, when they invariably kicked their last in less than half a minute.

I had thought they bred in the dead stock on the swamp, but the country about Wheatville is nearly free from them, and that is nearer the swamp than this place.— [A. A. Eaton, California, May 12, 1893.

NOTE.—A similar account of undue abundance of this insect (*Platinus maculicollis*) was given us some years ago by Mrs. A. E. Bush, another of our California correspondents, her letter being published by Riley in a note entitled "The Overflow Bugs in California," in the *American Naturalist* of August, 1882 (pp. 681-682).—[Eds.

Is the English Sparrow instrumental in suppressing the Horse Bot-fly?

I am sending you specimens of a fly, together with its larva, which is causing much trouble amongst our horses in this colony. There is a difference of opinion as to its identity, some asserting that it is the English Bot-fly, others that it is not. The nearest approach which I can find to it is at page 623 of Harris's *Insects Injurious to Vegetation* (Flinted.), where we find the brown farrier bot-fly "*Gasterophilus veterinus*." One fly darts on to the throat of the horse, depositing an egg on a hair at each operation. The animals frequently become frantic as these flies approach them. Farmers have adopted the remedy of tying a piece of sacking under the jaw, which prevents the fly from depositing her eggs on that particular spot. I notice that Dr.

Daniel Berry, Carmi, Ill., Mr. W. E. Dingman, of Newton, Iowa, and Prof. Charles Linden, Buffalo, N. Y., all agree that the Bot-fly has become much less troublesome in their several States of late years, and they appear to think that the English Sparrow is answerable for this good service, as they are supposed to capture the larva as it is ejected from the horse in his droppings. If you will kindly aid us in this matter by giving us your opinion as to the exact identity of the fly, we shall esteem it a very great favor.—[W. Murphy, Canterbury Agricultural and Pastoral Association, New Zealand, March 29, 1893.]

REPLY.—I am pleased to receive the specimens, since they indicate the presence in your colony of the old and well-known *Gasterophilus nasalis* Linn. You were perfectly correct in your identification, since *Gasterophilus veterinus* Clarke is simply another name for the same species. Your account of its habits is also correct, and quite as we find them in this country. I think it quite likely that the idea that the English Sparrow is of service in reducing the numbers of this insect is correct. It is a prevalent notion in this country, and it is claimed by a number of observers that the horse-bot has become almost unknown in certain localities since the advent of the sparrow. There is no proof of this statement, however, founded upon actual observation of stomach contents, nor, so far as I am aware, have sparrows been observed to feed upon the bots voided by horses. In an examination of the contents of 522 sparrow stomachs made in this office, some four years ago, no specimens of the bot-fly or its larva were found. The details of this examination are given by me in Bulletin No. 1 of the Division of Economic Ornithology, entitled, "The English Sparrow in North America, Especially in its Relations to Agriculture," by W. B. Barrows, published in 1889.—[May 29, 1893.]

Notes on some Gall Insects and Parasites.

Orthopelma diastrophii Ashm. was bred from galls of *Rhodites radicum*. If *diastrophii* be not a misnomer, is it not curious to find it in a *Rhodites* gall?

Rhodites (?) *utahensis* Bass. is the producer of a gall found on the roots of *Rosa blanda*—very distinct from *R. radicum*.

Orthopelma luteolator Gr. is a very common parasite in galls of *Diastrophus turgidus*, and has been so for the last twenty-five years.

Orthopelma luteolator Gr. is a very common parasite in galls of *Rhodites roseæ*, and has been so ever since the galls appeared here.

Entedon sp. is from galls of *Gelechia gallæ-solidaginis* Riley, the pupa of the parasite remaining within the pupa case of the moth all winter and the imago comes out the following spring.

Torymus rudbeckiæ Ashm. is from Cecidomyiid galls on stems of *Desmodium acuminatum*.

Catolaccus sp. is from galls of *Biorhiza forticornis* and is very rare.

Tetrastichus sp. is from galls of *Rhodites vernalis* and is also very rare.—[William Brodie, Toronto, Canada.]

An Intruder in California Vineyards.

Herewith please find a specimen of an insect called to my attention by a neighboring vineyardist which is alleged to be doing much damage to the young fruit buds and blossoms of the Muscat grape vine at this particular period. This insect has been recognized by many residents as a yearly visitor. It appears in spring, and was heretofore known as a pest infesting rose leaves and doing much damage to the young buds.

They are said to be very numerous on some vineyards, as many as hundreds to a single vine. In one case about three acres are reported to have been completely stripped of grape buds. Bordeaux mixture and Paris green in spray has been used on the infested vines without apparent benefit.

Vineyards in this immediate vicinity, $4\frac{1}{2}$ miles east of Selma, do not show any trace of the insect, but they are found in rosebushes around our dwellings.

Do you recognize the species and do you know a remedy?—[J. D. Power, Fresno County, Cal., May 17, 1893.]

REPLY.—* * * The insect which you send is a leaf-feeding beetle known as *Hoplia callipyge*. Since the Paris green has been tried without effect, you are advised to spray with dilute kerosene emulsion.—[May 24, 1893.]

Living Insects in the Human Ear.

In your last issue of INSECT LIFE I read your note on "Living Larvæ in the Ear." It is so like a case recounted to me yesterday that I feel like repeating it. A farmer said about one and a half years ago a small green fly—he thinks it was smaller than a house fly—buzzed around his head, and despite his efforts to drive it away it entered his ear. It caused him much discomfort, scratching against the drum of the ear. He tried to drive it out by slapping his ear; a friend worked in his ear with a double grass blade: at length the fly came out and flew away. That night about 2 o'clock he awoke with pain and terrible noises in his ear; he introduced a camel's hair pencil, moistened with oil, and found living maggots attached: after extracting he went to a doctor, who syringed the ear out with a decoction of tobacco, removing 19 small white larvæ of different sizes; he removed one dead one after he went home (27 in all). I called upon the doctor to-day, who confirms the story, tobacco juice and all: the larvæ or the treatments caused partial deafness for several months, but at length nature has restored the normal hearing capacity. I am sorry not to be able to give the name of the fly, as the farmer and his doctor paid no attention to that.—[Henry Shimer, Illinois, December 9, 1891.]

Eucalyptus vs. Mosquitoes.

I have the largest and oldest grove of trees of *Eucalyptus globulus* in this part of California, and have had fifteen years of opportunity to study these trees as insect repellants, and deem it my duty to respond to your request on page 268 of INSECT LIFE.

Thirty-three years ago I spent a portion of one summer with a Dr. McConnell, who had just returned from some years of residence among the Eucalyptus forests of Australia. We were in the Sequoia (*Sequoia sempervirens*) forest of the coast region of our State. The mosquitoes were so bad there it was nearly impossible to work during days when there was no wind. The doctor assured me that our common mosquito was never found in the Australian Eucalyptus forests and swamps, but added there's a "spotted mosquito" nearly as bad there in some places. He not being an entomologist, was unable to tell me whether the "spotted mosquito" was a species of the genus *Culex*, or of some allied genus.

The doctor being a reliable, close observer, I determined to test the anti-mosquito qualities of the Eucalyptus, so when I began to improve my house here nineteen years ago, one of the first things I did was to get a lot of Eucalyptus seed from Australia and plant out a grove of the trees. The tallest of them are now over 140 feet tall, and can be seen for 20 miles around. My house stands in the midst of these trees. My irrigating ditch, a dozen feet wide, of sluggish current, runs through the grove beside the house. There has never a single mosquito larva been seen in this ditch from where it enters the first shade of these trees to where it emerges from them 200 yards away; while above and below mosquito larvæ are plentiful—not immediately below, but some hundreds of yards away, where the water stands in pools and becomes stagnant among a growth of black walnuts and cottonwoods.

My live stock pasture in this timber, going into the walnuts and back again under the Eucalyptus shade at pleasure. Frequently when the cows come up at night they

bring a swarm of mosquitoes; occasionally some of them get into the house, but cause us so little annoyance that we scarcely notice them. Before this ditch reaches the Eucalypti it runs through a jungle of "fence bamboo" (*Arundo macrophylla*), where the mosquitoes are so bad that we avoid working there except on the windiest days. And, though the ditch has more currents there, the larvæ of mosquitoes are plentiful in the water till it reaches the Eucalyptus trees, below which point none are found, till it has become stagnant away below them.

People who have camped among the willows of Kings River, only a few miles away, have come here with faces so blotched and swollen from mosquito bites as to be hardly recognizable, and have camped in the shade of "Sanders' Gum Trees," as my grove is popularly called, for weeks, and declare that they never even heard a mosquito sing during that time.—[W. A. Sanders, California.

P. S.—To the non-botanical reader I may say this species of Eucalyptus is very tender as to frost. The coldest weather ever known here, 19° F. above zero, killed thousands of them.

Another vegetarian Mosquito.

Since writing to you last I have seen another vegetarian mosquito, possibly a descendant of the one I saw last year, as it was in the same place. I think this may be a new strain, or perhaps they belong to the total abstinence club. At all events let us hope they will continue to inherit acquired characteristics; it may be they will reform the race, as it were, and from mosquito bars and insect powder be combated with rose nozzles and Bordeaux mixture.

The mosquito in question settled on some apple sauce upon the table. She had a better time of it than the other one I saw, as she soon drank her fill of the juice and flew heavily away.—[A. A. Eaton, California.

Insect Injury to Cactus Plants.

I send you some bugs found on some Cactus plants. I have three species of *Opuntia*, which I am growing for ornament, namely, *Opuntia rafinesqui* (?), *Opuntia engelmanni*, and *O. leptocaulis* (*frutescens*). I had a patch of *O. rafinesqui* and *O. engelmanni* mixed, about twelve feet in diameter. It was a sight to look at when in bloom, but to-day they are all dead.

As a general thing the cactus family is looked upon as an enemy of mankind, but take away *Opuntia engelmanni* from portions of Texas and the rest of the cactus kind and there will be but little left to feed stock upon in case of protracted droughts. If this insect works all over the State as it does here it will be a very short time before all the *Opuntias* are exterminated. They are equally bad on the three named species, and since I have seen what they are doing I am killing every one I can get hold of. I do not know whether they attack such genera as *Cereus*, *Echinocactus*, or *Mamillaria*, for I did not have any of the above-name genera. If you receive these bugs in good condition you can experiment with them in your vivaria. Last year was the first time I observed them. They are out again in full force this year.—[F. W. Thurow, Harris County, Tex., March 17, 1893.

REPLY.—The bugs which you send as injuring *Opuntias* belong to the species known as *Chelinidea vittigera*. Your account of their habits is of considerable interest, as they have not before been found in such enormous numbers. You will find them very difficult to destroy, and while I have no experimental knowledge of the action of kerosene upon these cacti, I fear that an emulsion strong enough to kill the bugs will also kill the plants. However, if you are willing to sacrifice those plants which are most badly affected, you can certainly kill the insects at the same time, either by the use of pure kerosene or a strong emulsion. Should you think it worth while to conduct any experiments, I should be pleased to learn the result. The specimens which you sent arrived before your letter, so that all had been killed

and mounted before your suggestion as to experimentation was read. You are in position, however, to experiment very much more advantageously than we would be with living material which had been sent through the mails.—[March 25, 1893.]

Gapes in Fowls.

Poultrymen know that the disease known as "gapes" in fowls is due to a worm lodged in the windpipe, and some of them believe the worm to be a parasite of the common angle or earth-worm.

Is there any foundation for such belief? An answer through INSECT LIFE may gratify others as well as myself.—[George Wentz, Maryland, May 20, 1893.]

REPLY BY DR. C. W. STILES OF THE BUREAU OF ANIMAL INDUSTRY.—In reply to your letter dated May 22, 1893, inclosing a communication from Mr. George Wentz, of Catonsville, Md., permit me to state that the disease of poultry known as "gapes," "verminous tracheobronchitis," or "syngamosis," is caused by a nematode (round-worm) to which Siebold has given the name *Syngamus trachealis*. The parasite belongs to a family (*Strongylidae*) the members of which do not require any intermediate host for their development. Accordingly, we should not expect to find this worm as an obligatory parasite of the earth-worm. It is, however, beyond question that chickens may occasionally become infested with the parasite in question by swallowing earth-worms. This point will be evident from the following account of the life-history of the parasite.

The adult parasites are found in the trachea of poultry, the male being very firmly attached to the female. Numerous eggs are formed in the female parasite and in each egg a small embryo is developed. Females 20^{mm} in length have fully developed embryos in their uterus. According to Cobbold and Meginn these eggs with the contained embryos are not laid, but they escape from the adult worm only after a rupture of the body. This fact is easily understood when we recall that the male is intimately united with the female at the height of the vulva, so that the genital opening is practically sealed.

If the adult parasite is now coughed up by the affected chicken, or if it becomes liberated through the death of the fowl, the eggs will become scattered on the ground. They may remain unchanged for some time, or in a warm moist medium the embryo may escape. Should these eggs or embryos be swallowed by other chickens, they will gain access to the trachea and cause the "gapes." If an earth-worm should happen to swallow any of these embryos or eggs, the latter will retain their vitality for some time and will infect with gapes any chicken which happens to devour this particular earth-worm. Thus it is clear that the earth-worm may transmit gapes to chickens by acting as a carrier of the embryos or eggs, *but that the earth-worm is not a necessary factor in the transmission of this disease* is equally apparent.

The following experiments will undoubtedly be of interest to your correspondent:

Dr. Walker observed that the embryos of *S. trachealis* would retain their vitality when swallowed by earth-worms, and that birds contracted "gapes" upon swallowing these earth-worms. (For Walker's experiments see Second Annual Report, Bureau of Animal Industry, U. S. Department Agriculture, 1885, pp. 274-277.)

Mégnin infected a parrot with "gapes" by feeding to it some of the female parasites containing embryos. (For Mégnin's experiments, see a translation of his article in First Annual Report Bureau of Animal Industry, 1884, pp. 281-296.)

Ehlers fed eggs of *S. trachealis*, containing embryos, to birds, and after twelve days he found copulated parasites in the trachea.

From the account given above it is clear that fowls may contract "gapes" by any of the following means:

(1) By swallowing eggs or embryos of *S. trachealis* which happen to be in their food or drinking water.

(2) By swallowing the adult female parasite filled with eggs, which has been coughed up by some other fowl and which, on account of its reddish color, chickens might mistake for an earth-worm.

(3) By swallowing earth-worms, which may by chance happen to contain the *syngamus* eggs or embryos in their digestive tract.

The knowledge of these three possible modes of infection suggest several very practical means of preventing the spread of this disease:

(1) As soon as it is noticed that a flock is affected with gapes, *the infected chickens should at once be isolated* and the healthy members of the flock should be placed on other ground where no infection with eggs exists. The infected chicken-yard should not again be used for at least a year.

(2) *The bodies, or at least the entrails, including the trachea, lungs, etc., of all animals dying from this disease should be burned.* If the bodies are simply buried the earth-worms may bring the embryos to the surface and thus infect the rest of the flock.

(3) Poultry yards should be provided with drinking-troughs, so that the fowls will not be obliged to drink water from contaminated and stagnant pools.

(4) Poultry yards should occasionally be treated with lime in order to destroy the embryos of the parasite.

(5) During the season in which the disease appears chickens should be kept housed until after the sun is well up, say 8 or 9 o'clock.

The Clover Mite in Houses.

I send specimens of a pest which has caused me great trouble for three or four years. About the second week in February thousands of these creatures cover my window sills and panes. When they first appear they are about the size of a pin point. They are then a very bright scarlet. They are now fully grown. For weeks they have covered everything—windows, books, furniture, cushions, and pillows. They are not in sight in the evening. They travel constantly back and forth through the day. About the middle of June they disappear, leaving every crack and crevice filled with a line of white eggs. They often pack solidly in places, and then form a column and march up the casings of the windows. The matter is very serious. Is there any way to determine what they are, and how to be rid of them? If this pest becomes universal it will certainly cause great trouble.—[Mrs. Francis A. Smith, New York, May 26, 1893.]

NOTE.—The insect sent was the Clover Mite (*Bryobia pratensis*), a full account of which has been given in *INSECT LIFE*, vol. III, p. 45.—[EDS.]

The Utilization of Spider Silk.

I notice in *INSECT LIFE*, vol. v, No. 3, p. 210, a note relative to the silk of spiders, which sums up my experiments and attempts on the subject. The author of the note concludes by remarking that the most important desideratum is the means of obtaining or raising the spiders in large numbers.

Réaumur, in discussing the attempts of Bon, had raised the same objection. The difficulty now seems to be removed in the case of the large spiders of the genus *Nephila* of this country. Dr. A. Vinson, in his "Étude sur l'Arachnologie des îles de la Réunion, Maurice et Madagascar" (p. xxiv), remarks that these large spiders "may live in families," and I have myself observed that our "Halabe" of Madagascar (*Nephila madagascariensis*) multiplies rapidly and may be obtained in large numbers, living gregariously in the open air, without any care being taken of them. Not far from Tananarive, at Ambohips, the Catholic mission possesses the beginning of a garden of acclimatization and study, in which I lately counted about a hundred of the female "Halabes," already of good size, in the space of about a cubic meter.

In working with the large *Nephilas* it would be possible, if I am not mistaken, by taking some pains, to obtain, either in the open air or under covered sheds, a sort of spider magnanerie, in which the floss of the cocoons and the thread drawn from the living insect by the processes I have indicated or better ones, could be utilized.—[P. Camboué, S. J., Madagascar.

Further concerning the new Chicken Plague in Texas.

In No. 4, INSECT LIFE, I find your report to the Department on *Argas americanus*, a new chicken plague as you call it. Doubtless it will be of interest to you to hear more about it. I am well acquainted with this pest since the fall of 1888, when I for the first time found them infesting a chicken house on a neighbor's ranch, killing in a short time about 25 to 30 chickens. They are strictly nightly in their habits. I never saw one about in daytime, and alike numerous in summer as in winter, but they seem to appear in greater numbers in dry, hot years as 1892 has been. They spread very rapidly. Last year I built a new chicken house, but in eight days it was literally full. You state in your report "Pullets it kills by creeping in masses under their wings." This would suggest that the grown Argas does the work. Allow me to correct this. It is the young, apparently newly-hatched, that do this. Perhaps the eggs are deposited under the wings and along the neck of chickens. They are minute little fellows hardly as big as half a pin's head and fasten themselves like ticks, but in such numbers that the skin is perfectly covered. Chickens droop, refuse to eat and drink, in a few days they are unable to move and finally die. What becomes of the Argas after they kill their host I do not know, but will try to find out. The damage done is indeed great, not only killing old and young chickens but weakening them so that their laying qualities are greatly lessened. Kerosene oil emulsions seem not to have a great effect upon Argas. Lime and sublimate when the houses are whitewashed seem to do much better. Oil of sassafras kills them quickly, but is rather dangerous if put on little chicks.—[Ferdinand Hoehr to Albert Turpie, Kinney County, Tex., and transmitted by the latter to this Department.

Painful Spider Bites.

Referring to the letter from Dr. William P. T. Cook (INSECT LIFE, vol. II, p.255) in which he infers that spiders do not bite, I wish to add a mite of testimony. During the past year (1892) I have been twice bitten by spiders; in both cases experienced the bite and saw the spider.

Last summer while on a fishing excursion at Reservoir Lake, Saratoga County, N. Y., I experienced a sharp, stinging bite on my neck and on brushing off the biter discovered it to be a small spider of a silver gray color. A companion at once crushed his spidership, for which on afterthought I was sorry, as I should like to have sent the spider for examination. At the spot bitten a small red puncture was visible which was soon surrounded by a swelling somewhat similar to a bee sting. Sharp twinges of pain followed with stiffening of the cords of the neck and I was not a little alarmed, especially as I had not long before read some of the correspondence in INSECT LIFE relating to the subject. However, the pain soon left, swelling went down, and fishing was resumed. The only effects afterward noticed was a slight stiffening of the neck lasting for a few hours and once only on the following day a very sharp contraction or spasm of pain in the region affected.

The other bite spoken of was somewhat similar to a slight bee sting but with no effect of any consequence. Should anything further pertaining to the subject be noticed I will communicate if desirable.—[P. M. Van Epps, Schenectady County, N. Y., March 20, 1893.

Supposed Gall-Mites on Blue Gum.

I send some leaves of the Eucalyptus Blue Gum or the *Eucalyptus resiniferus* infested with scales out of a garden where *Aspidiotus aurantii* has been imported by the reckless transfer of a rose tree from a garden in Misoria infested with Red Scale. At least that is the decision that I arrived at, but the villagers are convinced that the disease on the orange and lemon trees has spread from the Eucalyptus. It is in a part of the island where up to the present Red Scale had been unknown, but strange to say I have not noticed this disease on the Eucalyptus in any other part of the island, neither is there any other Eucalyptus, but the two infested, within a radius of ten miles, neither have I noticed this particular disease on any other trees.

The village is situated about 300 feet above the sea and about one mile from the northern coast. * * * —[Alfred K. Bovill, Nikosia, Cyprus, February 6, 1893.]

REPLY.— * * * The Eucalyptus leaves have been carefully examined for both insects and fungi. Mr. B. T. Galloway, Chief of the Division of Vegetable Pathology of this Department, has carefully examined them for fungi and has been unable to find any trace of Mycelial or other fungus growths. We have sectioned and examined them for traces of insect work and can not find any evidence of such work. The larger of the spots are seen to contain, upon removing the epidermis, one or more minute pits, lined with a glistening amorphous substance resembling, to some extent, the pits occupied by the gall-mites or rust-mites of the family Phytomyzidae, although no trace of any mite or of a cast skin of one of these creatures can be found. The most likely hypothesis, however, is that the damage is done by some member of this family, but this can only be determined by an examination of fresh material, and that can only be done in Cyprus. If you have a compound microscope at your disposal you should be able to settle the question yourself. If this theory prove correct, the best remedy will be to collect and burn all fallen leaves and by a careful study to determine the period when the mites are not inclosed within their galls, at which time they may be destroyed by the application of a dilute kerosene emulsion to which a small quantity of flowers of sulphur has been added. This course is pursued against *Phytoptus pyri*, a similar creature, which damages pear trees in this country.—[March 17, 1893.]

NOTES FROM CORRESPONDENTS.

In Favor of the English Sparrow.—Good words for this important pest are so rare that it is almost a pleasure to record that our correspondent, Miss Jennie R. Bush, of San Luis Obispo County, Cal., finds it destroying a scale insect upon the climbing rose. The species of scale has not been determined.

The Tomato Worm in the Leeward Islands.—Mr. C. A. Barber, of Antigua, sends us specimens of the common *Protoparce cingulata*, with the statement that it is doing great damage to fields of sweet potato on the island of Antigua.

Early Locust Ravages.—Mr. F. A. Swinden, of Brownwood, Tex., informs us under date of March 21 that young grasshoppers are hatching out by the thousands in the vicinity of Brownwood, and that 200 acres of crops were destroyed last year and many eggs deposited. He has not sent in specimens, so that the species has not yet been determined.

The Indian Meal Moth.—In INSECT LIFE, Vol. II, pp. 170-171, we gave a long list of the substances upon which we had found the larva of *Plodia interpunctella* to feed. We add to this published statement the fact that we have recently received specimens from Mr. A. S. Fuller, of Ridgewood, N. J., which were found feeding upon stored seeds of the Salamander lettuce.

The Horn Fly in Southwestern Texas.—Mr. J. D. Mitchell, of Victoria County, Tex., sends us specimens of the Horn Fly, which, he says, made its appearance in that county in the fall of 1892. They are very abundant this spring, and reached

Texas, according to Mr. Mitchell, from Kansas and Indian Territory, and are known by the appellation of the "Third Party Fly." An interesting point in connection with this geographical distribution is that the slight wound made by the flies or by the cattle in their efforts to allay the irritation of the bite affords a spot of entrance to the Screw Worm.

A North American Chalcidid in England and the West Indies.—We have received from Mr. A. J. Tillson, of the Department of Agriculture of the Leeward Islands, St. Johns, Antigua, specimens of *Spilochalcis mariae* (Riley) which had issued from cocoons of *Attacus cyntia* received from England. The parasites must have attacked the larva in England and the species has undoubtedly been introduced into England by English entomologists (perhaps by M. Alfred Wailly), in their importations of American silk worms.

The Jamaica Ephestia.—In a previous number of INSECT LIFE we referred to the fact that the Mediterranean Flour Moth (*Ephestia kühniella*) had been found at Kingston, Jamaica, by Mr. T. D. A. Cockerell. Recently Mr. Cockerell has written us that he has sent specimens of the moth to M. Ragonot, of Paris, who determines the species as *E. desuetella* Walker, and that it is, therefore, not *kühniella* as Mr. Cockerell had previously supposed.

A New Enemy to Prune Trees in California.—Mr. D. W. Coquillett has sent us specimens of *Eurymetopon cylindricum* Casey, which he received from Mr. Geo. E. Stewart, of Nordhoff, Cal., through Mr. J. F. McIntire, one of the County Horticultural Commissioners, of Ventura County, and which Mr. Stewart states were found upon prune trees, the leaves of which they had eaten to some extent. This beetle belongs to the family Tenebrionidæ and this habit has not, we believe, been previously recorded.

A California Scarabæid on Plum.—Mr. Alva A. Eaton sends us from Riverdale, Cal., a specimen of *Serica anthracina* Lec., a small brown Scarabæid beetle, with the statement that it feeds on the foliage of Plum.

Larvæ supposed to have fallen during a Shower.—We have received from Mr. James Fletcher, Entomologist to the Dominion of Canada, Ottawa, specimens of a Carabid larva probably belonging to the genus *Patrobus* which he had received from Cleveland, Ohio, and which was said to have fallen in large numbers in a shower during the latter part of March or early part of April. This supposition was in all probability erroneous, as these larvæ, from their known habits, had probably issued from the ground during the rain storm.

Damage by May Beetles.—Mr. W. C. Brass, of Carlisle, Ark., writes us that April 7 and April 16 large swarms, comprising millions of May beetles, appeared in the vicinity of Carlisle. The nursery of Mr. Thomas Marson was completely stripped of leaves, while in a patch of woods south of the nursery the trees were entirely defoliated and presented a wintry appearance. The wood patch was a mile in length and one-fourth or one-half mile in width. The Oaks and Sweet Gums were most affected, although Elm, Maple, and Hickory were also attacked. Specimens received later from Mr. Brass show that the species were *Lachnosterna micans* and *L. nova*.

Birds Eating the Catalpa Sphinx.—Mr. Ben M. Hagey, of Paragould, Ark., writes us that the *Sphinx catalpæ* is very numerous the present season in his vicinity, and that the only birds which he has found feeding upon the larvæ are the common Catbird and Baltimore Oriole.



Wm. H. Cresson, N.Y.

THE CHERRY-TREE TORTRIX.



GENERAL NOTES.

THE CHERRY-TREE TORTRIX.

This common and widespread species, originally described by Fitch in 1856 as *Lozotania cerasivorana*, and now placed in the genus *Cacœcia*, is found all over the United States east of the Rocky Mountains and possesses the habit of feeding gregariously in the larval state, all of the caterpillars hatching from one lot of eggs and feeding in a community inclosing the leaves on the end of a branch in a silken web, which is extended to include more food from time to time. The blackish excrement is deposited in a large mass in the center of the web, and the larvæ when full-grown transform within this mass. When about to emerge the pupæ work their way partially out in order that the moths may easily escape. The caterpillars feed normally upon wild and cultivated cherry, but what is in all probability the same species has been found by Dr. Packard upon *Betula populifolia* and by Dr. Kellicott upon ornamental birches in Columbus, Ohio. We have recently received from Dr. F. W. Russell, of Winchenden, Mass., an interesting photograph of a series of webs of this insect which was extremely abundant in his vicinity during the summer of 1890. His accompanying statement is so interesting that we publish it with a reproduction of the photograph (see Plate IV).

I send you herewith some photographs of huge tents made by the larvæ of *Tortrix cerasivorana* F., during the season of 1890.

About fifteen years ago I found a single nest of this species and from it raised a number of the moths, one striking variety, two of ichneumons, and a rather handsome gray fly.

Year by year the number of these nests has increased, but I was hardly prepared for the wonderful increase of 1890. For a distance of 1,500 to 2,000 feet along one side of a country road there were thousands of these nests. I counted over 3,000 at one time. Many of them were over six feet high. I placed one of my attendants, a tall young fellow of over six feet, among them, and had their picture taken. The webs often spread over the smaller herbage at the base of the choke cherry bushes, then over the grass, and in great sheets out over the gravel, even to the wheel tracks, where they were torn to pieces by the passing teams. When riding by in the moonlight they presented a peculiarly weird appearance. They extended even to maple, wild cherry, and ash trees, though only rarely and where these trees happened to stand among their more normal food. I do not know that the caterpillars actually eat of these leaves.

I found quite a number of small camps in other localities about town where I had not previously seen them.

The next year, 1891, they were not common at all, even in the locality where they had been so excessively abundant in 1890, but even two years later great masses of leaves, frass, and web remained to disfigure the bushes.

AN IMPORTANT CONTRIBUTION TO INSECT EMBRYOLOGY.

Mr. William Morton Wheeler's inaugural dissertation for the degree of doctor of philosophy, as presented to the faculty of Clark University, the present spring, has been published in the *Journal of Morphology*

and the author's large reprint has just reached us. While we are not deeply versed in the subject of insect embryology, this work strikes us as a very able production. It covers 148 pages and is illustrated by six large folding plates. The subjects treated are: The embryonic development of the Locustidæ; Gastrulation in the Orthoptera; the indusium and its homologues in the Arthropoda; General considerations of the embryonic envelopes and revolution of the insect embryo; Neurogenesis in the Insecta; the development of the reproductive organs in the Insecta; the subœsophageal body in *Xiphidium* and *Blatta*; Technique; Bibliography. The species among the Locustidæ to which he has devoted his principal attention are *Xiphidium ensiferum* and *Orchelimum vulgare*, and certain biologic facts of interest concerning each species are placed on record incidentally to the main purpose of the work. He has made the Orthoptera a starting point in his studies, with a view of determining their relations to the Apterygota on the one hand and to the higher orders on the other; for, although the primitive and synthetic character of the Orthoptera has been recognized by comparative anatomists, the full importance of the group, according to Dr. Wheeler, has been but little appreciated from the embryological standpoint.

INSECTS SAID TO FORECAST THE WEATHER.

In reply to our suggestion on page 138 of the current volume our valued correspondent, Mrs. M. E. Rice, of Coryville, Pa., sends us the following local ideas concerning insects and the weather:

It is a common superstition here that the *black* markings on the *larvæ* of *Pyrrharcia isabella*, or "Wooly Bear" as it is commonly called, foretell the severity of the weather during the winter. If the black is longest on the head end the forepart of winter will be severest, and if *vice versa*, then spring will be coldest. Now some of the larvæ are *black at both ends*, some either one or the other end, while some are not *black at all*, or faintly marked. Whether this variation is owing to sex or food or environment I know not. A continuous flight of Dragon flies is said to portend a wet spell (I should say follow a dry spell). Observation shows that a sudden inroad of flies is a portent of rain. Spiders lie dormant in winter; before a thaw they liven up. An irruption of black ants in my house when the thermometer has for weeks hovered below zero, means to my mind an open spring. Such an one occurred last 20th of February and caused me to prophesy mild weather. I was derided, as we generally have "six weeks winter in March" here, but events proved that I was correct. Snails (spiral snails) crawl about only on the approach of wet or cloudy weather. You may expect rain in six hours from their appearance.

WHAT CONSTITUTES A SPECIES.

One of our correspondents who is just beginning the study of systematic entomology has recently written us inquiring what constitutes a species. To this inquiry we have made the following answer:

Your question regarding what constitutes a species is a broad one and not easy to answer in brief. In the abstract, a species is limited by the capacity of its individuals of both sexes to couple and produce fertile offspring, and to continue this indefi-

nately. The concrete proof of such capacity with species in entomology is seldom obtained, and we have, therefore, to rely upon an assemblage of characters which differ in their relative value in different groups. A character accepted with justice as of specific value in one group may have varietal weight in another and generic value in a third. The consensus of opinion among the best authors in a given group should decide the question of relative importance of any given character. You will gather from my writings in the past on the subject of classification that most of the definitions we are employing are purely conventional, and that we have, for the most part, in nature, but a series of alliances. The test of continuous perpetuation, whenever it has been made in different orders of insects, has always enlarged the conceptions of specific limit by showing a much greater variation than has been previously inferred; in other words, experience tends to what is known as lumping in specific characters, while the beginner is very apt to see specific characters in the minutest differences. The philosophical way of defining species is to allow value only to those characters which prove absolutely constant, and to denote as varieties or subspecies those differences which, inferentially, we are justified in believing to be non-specific.—[C. V. R.]

THE RAVAGES OF BOOK WORMS.

Science for March 24 (vol. XXI, p.158) contains under the above title an account of the ravages of three species of insects in books. Dr. Samuel A. Green, at a recent meeting of the Massachusetts Historical Society, exhibited two volumes that had been ruined by the so-called "book-worms," and made some remarks on the subject. His notes, together with a letter from Mr. Samuel Garman, to whom the insects were referred, are published in full. The species that wrought the mischief in this instance are common household pests and are identified by Mr. Garman as *Lepisma saccharina* (?), *Anthrenus varius*, and *Blatta* sp., the last mentioned being identified from its egg cases and excrement.

FURTHER ON BEE STINGS AND RHEUMATISM.

Mr. John Worthington, U. S. consul at Malta, has sent us a clipping from the *Malta Standard* of April 11, which states that the theory that the virus of the bee sting is an infallible remedy for acute rheumatism has received most unquestionable confirmation from the practices of the country people in Malta. Bees are said to be plentiful in the island and the virtue of the sting as a cure for rheumatism has been long established. It is, in fact, said to have been a common practice for generations past to resort to this remedy in all severe cases, the results being most favorable.

THE MEDITERRANEAN FLOUR MOTH AGAIN.

At the meeting of the Entomological Society of France, of December 28, 1892, M. Ragonot refers once more to the question of the origin of *Ephestia kuehniella*. He mentions the adoption of the name "Mediterranean Flour Pest" by the English, and the popular idea in Europe that the insect had been imported from America in flour or grain. Without wishing to discuss the merits of the question he called the attention of the society to the fact that a species of the family Phyci-

tidæ, discovered in the district of Wollombi, New South Wales, and described by Mr. A. W. Scott in the Proceedings of the Zoölogical Society of London, 1859, under the name of *Hyphantidium sericarium*, belongs evidently to the genus *Ephestia*, and closely resembles *E. kuehniella* from the description, but the plate shows two supplementary lines in the basillary space and another in the middle of the terminal space, the imperfect crossing being replaced by a round dot. This slight difference he is inclined to lay at the door of the artist, and thinks that the species may prove to be identical with *E. kuehniella*, the more particularly as its larval habits are precisely the same. For the present, however, he is content to let the species remain as *E. sericaria* (Scott). This communication we deem of considerable importance, as probably adding a new locality to the so-called Mediterranean Flour Moth, and in view of the fact that the species was known in Australia as early as 1859, as indicating, in case the identity is shown, that the species may be an indigene of that country.

HELIOTHIS ARMIGER IN AUSTRALIA.

According to the March number of the *Agricultural Gazette of New South Wales*, our old friend, *Heliothis armiger*, there called the Maize Moth, has done great damage recently in portions of New South Wales. No mention is made of the ear-feeding habit of the larva, and the principal damage is done by the destruction of the heart of the plant, the larvæ hiding between the coils of the young leaves. The species has long been known in New South Wales, but accounts of damage have been rare.

CUT-WORM DAMAGE TO GRAPES IN CALIFORNIA.

Through the kindness of Mr. J. R. Williams, Weather Bureau Observer at Fresno, Cal., we have been put in possession of particulars concerning a most interesting case of damage to vineyards by two cut-worms in Fresno county this spring. The district surrounding Fresno is essentially a raisin district, and at a number of points the cut-worms have appeared in such extraordinary numbers as entirely to defoliate the vines. Hiding under the surface of the ground during the day, as is their normal habit, they have issued at night, climbed the vines, and eaten off the leaves and young shoots. The specimens forwarded by Mr. Williams show that both species are identical with eastern forms. The most abundant is *Agrotis messoria*—the Dark-sided Cut-worm—a widespread species which has been locally known in New York state as the "onion cut-worm." The Variegated Cut-worm (*Agrotis saucia*) occurs in lesser numbers. The first of these species we have previously received from California through Mr. Koebele, but the latter we have not before known as an injurious species on the Pacific Coast. Mr. Williams informs us that ashes, sulphur, lime, and Paris green in powder have been used to no effect, but that the use of Paris green in solution has resulted successfully. Inasmuch as the worms are obliged

to feed upon the vines in order to get the poisonous dose where Paris green is sprayed upon the plants themselves, we have recommended the poison-trap system, urging that grass or alfalfa, sprinkled with an arsenical solution, be scattered at the bases of the vines.

ON THE TRANSFORMATIONS OF THE SATURNIIDÆ.

Dr. A. S. Packard has recently published in the Proceedings of the American Academy of Arts and Sciences [New Series, Vol. XX (?), pp. 55-92], a paper entitled "Studies on the Transformations of Moths of the Family Saturniidæ," in which he gives the results of a series of most careful examinations of the different larval stages of these insects. He believes from his studies of the larva that the family originated from some spiny group, undergoing a change in shape from a rather long, slender form to a thick, heavy body with a thin skin, perhaps as a result of an unusually stationary mode of life. He shows also that the adults have apparently undergone a process of degeneration, as seen in the total or partial atrophy of the maxillæ, and in the loss of the veins in the large but weak wings. The loss of strength of flight, however, he thinks is somewhat compensated by the remarkable development of the olfactory organs or antennæ. He believes the family to be a closed type, unless perhaps the Cochliopodidæ have descended from it. It appears to represent a side branch of the Bombycine tree, which grew apart late in geological history and reached a marked degree of modification, resulting in adaptive characters not transmitted to later forms. The type is probably Miocene-Tertiary which has lingered on in eastern America and eastern Asia, as well as in Africa, while it has become nearly extinct on the Pacific shores of North and South America. He describes most fully the larval stages of each of our common forms, summarizing at the end of each description under different heads the congenital characters and the evolution of later adaptational features.

THE TITYRUS BUTTERFLY ATTRACTED TO LIGHT.

In Excursus 10 of Scudder's "Butterflies of New England" it is stated that while several butterflies have been found attracted to electric lights since their general use in the country, but two instances are known of the attraction of butterflies to ordinary lights at night. These are *Apatura celtis*, reported by Miss Murtfeldt, and *Anosia pleurippus*, recorded by Dr. Merriam. At 9 o'clock on the evening of June 6, after a long continued rain, weather sultry, a handsome fresh male of *Eudamus tityrus* entered my study through the open window. It fluttered about with a heavy lumbering flight, quite unlike its usual active darting motion in the sunlight, and was evidently strongly attracted by the white curtains, upon one of which it finally perched and passed the night. The adjoining garden contains several old Black Locust trees, upon one of which it had probably fed in the larval

state. We believe that this is the first record of a nocturnal flight of this insect. The nearest locust tree is some fifty feet from the window.—
[L. O. H.]

A BANANA BORER IN TRINIDAD.

We notice an interesting article in the Journal of the Trinidad Field Naturalists' Club for February, 1893, by Mr. Thomas I. Potter, who has discovered that the larva of *Castnia licus* does serious damage to the Banana plant in Trinidad by entering at the base of the sucker and almost on a level with the soil and boring upwards almost into the heart of the plant. The larva is three inches long when full-grown, with light brown head, darker mandibles, and whitish body. Nothing can save the plant, according to Mr. Potter, when it has been affected for some time. The eggs are laid singly inside the dry and withered stalk at the base of the sucker. The insect is known locally as the "cane sucker." The species is not known as a pest in Florida, but with the extension of banana growing may make itself known.

THE SUPPOSED SPREAD OF THE GYPSY MOTH.

The director of the field work of the Gypsy Moth commission, Mr. E. H. Forbush, has recently written a letter for publication in the agricultural journals of New England, in which the statement is made that, notwithstanding all the statements to the contrary (and we have noticed one or two of them in *INSECT LIFE*), the Gypsy Moth has not been seen outside the region where it was found in 1891. During December last Mr. Forbush had an average of nearly thirty men at work searching for the eggs.

SOUTHERN RANGE OF THE COLORADO POTATO-BEETLE.

The Colorado Potato-beetle, as we have already noticed, has made its appearance in the northern part of Alabama in alarming numbers. While it may be that this is but a repetition of the occasional accidental introduction of this pest, which has frequently occurred of late years, and while it may die out after a season or two, the Department of Agriculture of Alabama has taken a very proper step in issuing a little bulletin entitled "Mode of destroying the Colorado Potato-beetle and Harlequin Cabbage-bug," which was published during April.

THE SPOTTED BEAN BEETLE.

Epilachna corrupta, a near relative of the so-called Pumpkin Beetle of the east, does a good deal of damage to the bean crop in the southwest. We have previously referred to this insect and its damage to the bean crop in New Mexico on the authority of our old correspondent, Judge J. F. Wielandy, and now notice a rather extended article in *The Prairie Farmer*, with a large illustration showing the different stages

of the insect and the damage which it does by gnawing the bean pods, The beetles not only destroy the bean pods, but feed also upon the leaves, and the larvæ do the same. The remedy to be used is Paris green or London purple in watery solution. The beetles of this genus *Epilachna* are anomalous in the vegetable-feeding habit, since all other ladybirds are, in the larval state at least, predaceous. The eastern species, *Epilachna borealis*, is treated by Mr. S. H. Scudder in a short article in the Twenty-third Annual Report of the Entomological Society of Ontario, published at Toronto the present spring.

THE PALM WEEVIL IN BRITISH HONDURAS.

We have published one or two short notes in the pages of *INSECT LIFE* on the subject of the ravages of *Rhynchophorus palmarum* on the Coconut Palm in Central America and the West Indies, and are greatly pleased to notice that Mr. W. F. H. Blandford, in the February-March number of the *Kew Bulletin*, has published an elaborate paper upon this injurious insect. The article was called forth by a government investigation which was started in British Honduras, the commissioners having forwarded specimens to England and solicited information from the experts at the Kew Gardens. A closely allied species, *Rhynchophorus cruentatus*, feeds normally upon the Palmetto (*Sabal serrulata*) in the Gulf States, and with the growth of the coconut palm industry in parts of Florida it is not unlikely that damage from *R. palmarum* will occur. Some attention is paid in Mr. Blandford's article to the other insects affecting the Palm, but only incidentally. No new points in the life-history have been brought out, but a careful consideration is given to the question of remedies; and the author's main article is followed by a short bibliography, together with careful descriptions of the different stages of the Palm Weevil, and the whole article is illustrated by two excellent lithographic plates, the one showing the larva, pupa, pupa-cell, and adult of *R. palmarum* and the other figuring *Rhina barbirostris* Fab., *Rhina nigra* Dr., *Megasoma elephas* Fabr., and *Æcodoma mexicana* Smith.

Under the head of methods of treatment, Mr. Blandford recommends care in the choice of sites for new plantations, thorough drainage, wide planting, and the destruction of felled trees and stumps. In the choice of a site, undue proximity to a cohoon ridge should be avoided. The trees should be left as far as possible in their natural state and unnecessary trimming avoided. All wounds should at once be dressed with tar mixed with fine sand. Holes should be probed with a hooked wire and then plugged with a tuft of fiber dipped in tar. The parts selected for egg-laying may be plastered with lime wash, to which may be added a small quantity of Paris green. Capture of the adult weevils seems to be practicable. They are attracted in great numbers to the fermenting sap of felled palms or to the split Cabbage Palm, and may then be caught by hand and killed with boiling water.

It has been suggested that the stumps of split Cabbage Palm be sprinkled with a Paris green solution, but no experiments have been tried to ascertain whether the application of the poison will vitiate the attractiveness of the bait. It seems to us, however, that this will probably prove a fairly satisfactory remedy. Mangoes and other fruit, crushed and allowed to ferment, will also prove suitable bait, and the cutting-down of wild palms in the neighborhood in order to catch the beetles visiting the stumps is also recommended. The latter plan, however, is a little dangerous, since these stumps and logs will become breeding places and will require constant watching. Mr. Blandford in his bibliography has overlooked our short notes on the subject in *INSECT LIFE*. (See vol. I, p. 14, and vol. IV, pp. 136-137.) Five years ago we recommended the plan of cutting off a palmetto plant, say one foot from the ground, and capturing the beetles on the stump. In Vol. IV we elaborated this plan to some extent in the following words:

There is, however, a preventive method, and this consists in cutting down or wounding several young trees of any wild species of palm growing in the vicinity of the cocoanut trees. The fermenting sap of the trunks of such trees, as you have yourself seen, attracts the beetles strongly, and a multitude of them can thus easily be captured and killed before they have oviposited. The trunks of the felled trees will soon be filled with the larvæ, and the infested portion should be sawed off and burned before the larvæ have matured. If concerted action on the part of owners of cocoanut trees could be obtained, this method would no doubt materially contribute toward a diminution in the number of the beetles and a consequent lessening of the damage to the cocoanut trees.

ALUM FOR ROSE CHAFERS.

There occasionally appears in the columns of the agricultural press an account of the successful use of an alum solution against the Rose Chafer. We notice, for instance, an article in the *Massachusetts Ploughman* of December 17, 1892, by James W. Gage, of Lowell, Mass., who sprayed his vineyard the previous spring with a solution of alum at the rate of one pound to four gallons of water. The application was made in the evening and the next morning the insects had disappeared. He is not of the opinion that the solution kills them, but that it is distasteful and drives them off. Such articles as these are liable to induce a considerable expense in experimentation on the part of other grape and rose growers and the remedy will be undoubtedly ineffectual where the insects are numerous. Accurate experiments have been made by Prof. J. B. Smith, of New Brunswick, N. J., which are recorded upon page 31 of his bulletin on the Rose Chafer. He found that at a strength of one pound to two gallons of water the mixture was perfectly ineffectual. It was so strong that a white deposit lasting several days was produced upon the plants, but the beetles were not kept off. Specimens of the insects dipped in the mixture were not in the least incommoded.

A MOSQUITO EXTERMINATOR.

The *Indian Medical Record* for March 16 says that a Bombay newspaper calls attention to the virtues of the castor-oil plant as a means of protection against mosquitoes. In Egypt it is planted about houses to drive the insects away. In towns a better plan is to have the growing plants in pots, and bring them into the house for a day or two at a time, but they must not be kept too long in the shade, for the *Palma christi* is a sun-loving plant. A writer is cited as saying that the mosquitoes are killed by a poison that they find on the lower side of the leaf, but it is stated that if a dozen leaves are placed about a room that swarms with mosquitoes they will disappear without leaving any dead ones lying about.—[N. Y. MED. JOURN., 1893, No. 10, p. 446.

THE HORN FLY IN CANADA.

Mr. A. F. Winn, in No. 5, Vol. v, of the *Canadian Record of Science*, publishes a short article on the subject of the Horn Fly, in which he compiles an interesting account of the habits and life-history of the species and publishes a well written letter from Mr. W. A. Oswald, of Belleriviere, Quebec, concerning the first appearance of the insect in his locality, which is about 20 miles from Montreal. It seems that the Horn Fly was first observed about the middle of July, 1892, although the probabilities are that it occurred in small numbers in that locality in 1891, since we have invariably found this to be the case on our side of the border. Young cattle seem to suffer more than older animals, and train oil was found to keep the flies away for from five to six days.

RECENT STUDIES UPON LACHNIDIUM ACRIDIORUM Gd.

Upon page 151 of Volume IV we reviewed the investigations of MM. Künckel and Langlois of the cryptogamic disease which sometimes attacks the Migratory Locust (*Schistocerca peregrina* Ol.) of Africa, giving the authors' conclusion that the prospect of exterminating the Migratory Locust in Algeria by means of this disease was not encouraging. The fungus in question was determined by M. A. Giard as *Lachnidium acridiorum* n. sp. We have received a pamphlet extracted from the *Révue Générale de Botanique*, Tome IV, 1892, p. 449, in which Prof. Giard gives the results of his latest studies of this question. It appears that the most extravagant statements have been made in the public press as to the usefulness of the disease in exterminating locusts, one writer declaring that the solution of the problem has been found not only for locusts, but probably for all injurious insects. M. Giard deplores these unfounded statements, since his investigations, as well as those of MM. Künckel and Langlois, show conclusively that the fungus is a purely superficial and not very malignant malady; that contamination takes place with difficulty between diseased and healthy individuals, even when placed in the same receptacle and uniting sexually;

and that it attacks particularly those individuals which have reached the end of their evolution. It does not penetrate the tissues like Entomophthora and Isaria, but vegetates superficially and only becomes dangerous to the insect when it invades the tracheæ and causes asphyxiation. Moreover, Lachnidium can only develop in certain conditions of humidity, which are rarely present in Algeria, and it is not proven, so far, that the cryptogam attacks the eggs of the Migratory Locust, even when these have been laid by infested parents. The premature glorification of Lachnidium as a specific for the Migratory Locust is not unlike the recent proposition of certain optimistic Californians to cease the spraying and fumigation of their citrus orchards for the Red Scale in the expectation that the new Australian parasites would do the work more effectually and cheaply. As M. Giard pointedly remarks, "In moments of public calamity, unfortunately, the people who suffer need no invitation to have recourse to the counsels of charlatans."

GALL-MAKING COCCIDÆ.

We have just received from Mr. Walter W. Froggatt, of the Technological Museum of Sydney, New South Wales, a brief but extremely interesting paper entitled "Notes on the family Brachyscelidæ, with some account of their Parasites and Descriptions of New Species," extracted from Vol. VII of the Proceedings of the Linnæan Society of New South Wales. These remarkable scale-insects form curious woody galls on plants of the genus Eucalyptus. The male galls are small tube-like excrescences, with the apex dilated into a bell or cup like form, generally bright red or yellow, and are always found upon the leaves or very slender twigs, except when they spring direct from the female galls. The female is usually cylindrical and grub-like in appearance, enveloped in a waxy secretion. She lies in a fleshy gall sometimes a quarter of an inch thick, the head downward and the anal end pointing outward. The active, two-winged adult males emerge from their smaller galls and by means of their slender pointed abdomen impregnate the imprisoned females through an apical orifice in the female galls. The young escape from an egg-mass within the body of the female and emerge through an opening in the gall, burying themselves in the bark or leaves and causing new gall growths around them. Mr. Froggatt is of the opinion that parthenogenesis occurs with this family, since he has found clusters of active larvæ in the same gall with the perfect and evidently unimpregnated female. Mr. Froggatt re-describes in the true genus *Brachyscelis* all the species described by Mr. H. L. Schrader in the Transactions of the Entomological Society of New South Wales for 1862, and adds eight new species from material obtained from various parts of Australia. These peculiar insects are of some economic importance, since, though they do not cause the death of the Eucalyptus, they stunt the young trees in Eucalyptus plantations and render them weak and unfit for transplanting.

THE EGYPTIAN ICERYA IN INDIA.

Mr. Robert Newstead, of the Grosvenor Museum, of Chester, England, a well known student of the Coccida, writes us that he has recently received from Miss L. E. Tomlin, of Nungumbalum, Madras, a number of specimens of *Icerya aegyptiacum*, which has hitherto been known only from Alexandria and Cairo, Egypt. The specimens when received by Mr. Newstead were swarming with minute parasites, specimens of which he forwarded to us. The finding of this scale-insect in India, and particularly the fact that it is so extensively parasitized there, creates a reasonable possibility that it is indigenous to that country, and we examined the parasites with great interest only to find that they belong to the genus *Tetrastichus*, all the species of which, so far as we know, are secondary in their habits. The presence of this insect, however, argues the existence of an important primary parasite in India, and we have written to our correspondent there, Mr. E. C. Cotes, of the Indian Museum, Calcutta, to search for the latter, and have also asked Mr. Newstead to request Miss Tomlin to do the same. No parasites of the Egyptian *Icerya* have been discovered in Egypt, and this fact partially accounts for the extraordinary spread of the species in the gardens of Alexandria and Cairo.

CARBON BISULPHIDE FOR HEN LICE.

A new use for the bisulphide of carbon has been pointed out by Dr. Schneider in the *Journal de l'Agriculture*, of Paris, of recent date. Dr. Schneider recommends tying a few small bottles of bisulphide of carbon to the perches in the henhouse, the bottles being unstoppered and the liquid allowed to evaporate. The hens roost over the bottles, and the vapor of the bisulphide kills the lice. The recommendation is founded upon careful experiment, as the following extract will show:

The very next day after using it I was agreeably surprised to find that the enemy had left, leaving none but dead and dying behind, and on the following day not a single living insect was to be found, while my birds were sitting quietly on the roosts, enjoying an unwontedly peaceful repose. This lasted for twelve days, till the sulphide had evaporated. Twenty-four hours later a fresh invasion of lice had put in an appearance under the wings of the birds in the warmest portions of the house, where there were no currents of air. I replenished the supply of sulphide, and the next morning only a few of these were remaining. The next morning every trace of vermin had disappeared. Since that time I have personally made a great number of further trials with the sulphide, with immediate and absolute success. I should recommend the sulphide of carbon to be put in small medicine vials hung about the pigeon house or poultry roost. When it has about three parts evaporated the remainder will have acquired a yellowish tinge, and no longer acts so completely as before, but if it be shaken up afresh it will suffice to keep the enemy at a distance.

THE LONG SCALE NOT BROUGHT FROM MEXICO TO CALIFORNIA.

On page 281 of the last number of *INSECT LIFE*, under the caption "Introduction of the Long Scale into California," we quoted from the

California *Fruit Grower* of December 10, 1892, the statement that 22 carloads of Mexican oranges infested by *Mytilaspis gloverii* had been imported into California at Los Angeles, rather emphasizing the indignation of the editor of the journal over the supposed negligence of the quarantine officers in allowing this importation. We recently received a letter from Mr. John Scott, Horticultural Commissioner of Los Angeles county, who states that the item upon which we based our note was incorrect. Mr. Scott states that not a single carload of Mexican oranges was brought to Los Angeles last year. A few boxes were sent from San Francisco, which were at once returned and not a single orange of this shipment was sold in the city of Los Angeles. We are very glad to make this correction, but the onus of the misstatement, if misstatement there was, lies upon the California *Fruit Grower*.

AN ENEMY OF THE OYSTER-SHELL BARK-LOUSE OF THE APPLE.

We have received from M. J. Lignières, assistant professor at the veterinary school at Alfort, France, a pamphlet extracted from the *Mémoires de la Société Zoologique de France*, 1893, in which he records the first discovery in Europe of *Tyroglyphus malus* (Shimer) in the scales of the Oyster-shell Bark-louse, *Mytilaspis pomorum*. In this country this species has usually been considered an enemy of the Oyster-shell Bark-louse, but the author's experiments, which have evidently been very carefully conducted, seem to prove that it is not. He finds that it does not feed upon the eggs of *Mytilaspis*, as supposed, nor does it suck the juices of the tree, but lives only upon the cast skins and egg shells of the bark-louse, and upon these only when they are somewhat moist. A full redescription of the species is given, with good outline figures and a more detailed anatomical account of certain parts of the body.

In the second part of the pamphlet, however, M. Lignières describes a new Acarian which is, he states, a true enemy of *Mytilaspis pomorum*. From its striking resemblance to the Sarcoptidæ he proposes for it the generic name *Hemisarcoptes*, with the specific name *coccisugus*. The species is described and figured, and a statement given of the differences in mode of life between it and *Tyroglyphus*. It attacks the eggs of *Mytilaspis* and is the most formidable enemy of the latter.

AN ARTICLE ON SCALE-INSECTS.

Mr. T. D. A. Cockerell, in the *Agricultural Record*, the official journal of the Central Agricultural Board of Trinidad for December, 1892, publishes a general article on the subject of Coccidæ, or scale-insects, which possesses more than passing interest. He defines the group, discusses their destructiveness, the methods of destroying them, the natural enemies, and how they are spread by human means. He considers that while those who have attributed the death of the Cocoa Palm to scale-insects have probably overestimated the influence of the

insects, in general their damage is frequently under-estimated. In case of small plants death may speedily ensue, and in the case of larger ones the vitality and consequent fruit yield are greatly reduced. To the objection that a drain on the fruit production is not necessarily harmful and that we are obliged to check exuberant growth by pruning, he replies that the purpose of pruning is not so much to check the energies of the plant as to divert them to fruit and flowers, while the Coccidæ attack not only the fruiting branches but the fruit itself, injuring the very parts it is desired to protect. Of the fourteen species which attack Citrus plants in the United States, he finds that eleven occur in Jamaica.

NORTH AMERICAN NEUROPTERA.

A most useful paper has just reached us in the shape of a Synopsis, Catalogue, and Bibliography of the Neuropteroid Insects of temperate North America, by Nathan Banks. It is an author's extra from the Transactions of the American Entomological Society, Vol. XIX, pp. 327-373. The key to families and genera will be found of considerable value in separating the forms of these insects, which have been little studied in this country except by Dr. Hagen, the forced cessation of whose labors will prevent the publication of a comprehensive work at his hands. The catalogue of species which follows is unexpectedly extensive and the bibliography seems full and accurate. In the grouping of the forms into super-orders, orders, sub-orders, and super-families, Mr. Banks gives expression to somewhat radical views, which may or may not be warranted, but which seem somewhat presumptuous following the careful study and philosophic treatment which the subject has received at the hands of such masters as Brauer and Packard. Thus the Plecoptera and the Corrodentia are made sub-orders of the Platyptera, the Plecoptera and Odonata sub-orders of the so-called order Subulicornia, while the Mecaptera are made a sub-order of the Neuroptera, on the same plane with the sub-order Planipennia, in which are included the super-families Sialina and Megaloptera. The whole group of Neuropteroid forms is made a super-order, Phyloptera. It is to be regretted that in proposing so radical a change in the classification of the higher groups, Mr. Banks has not stated more at length the reasons which have led him to adopt this course.

NEW ENTOMOLOGICAL PUBLICATION.

The recently-organized New York Entomological Society has published the first number of its Journal, which reached us early in April of the present year. It covers 48 pages of interesting matter, and is illustrated by a full-page plate. The appearance of the Journal is excellent, and the contributors include such well-known entomological writers as Mrs. Slosson, Dr. Packard, Mr. Angell, Mrs. Treat, Mr. Charles Palm, Messrs. Neumoegen and Dyar, Mr. Beutenmüller, and

Mr. William T. Davis. Mr. Beutenmüller is the editor, and is assisted by a publication committee, consisting of Messrs. Ottomar Dietz, Charles Palm, and Berthold Neumoegen. The most important article in the number is Dr. Packard's "Attempt at a New Classification of the Bombycine Moths," which he divides into fourteen families, the most revolutionary step in the proposed classification being the transfer of the old family Zygaenidæ as a whole to the Bombycine series. Mrs. Treat's "Some Injurious Insects of Orchard and Garden" is the only article of immediate economic importance, and consists of a series of local observations on the insect pests of the vicinity of Vineland, N. J.

ENTOMOLOGICAL SOCIETY OF ONTARIO.

The twenty-third annual report of this enterprising society has just reached us. It covers the year 1892, and is, as usual, published by order of the legislative assembly. It contains a number of most interesting articles, some of which have already been published in the *Canadian Entomologist*, while others are original here. Mr. James Fletcher's article upon the Horn Fly we have already noticed in its form as a bulletin of the Canadian Experiment Stations. The same author publishes an account of the clothes moths found in Canada, drawing largely from our article upon the same subject in a previous number of *INSECT LIFE*, but at the same time adding a number of interesting observations of his own. Perhaps the most striking article in the number is Mr. Scudder's "Songs of our Grasshoppers and Crickets," in which he passes in review what is known of our American species in this particular, beginning with the crickets and treating the species in systematic order. The songs are reduced to a musical notation, which is done simply for the purpose of illustrating intervals, since the pitch does not vary and, in fact, does not seem to have been determined. Mr. Scudder adopts arbitrarily the system of representing a second by a bar, a quarter-second by a quarter-note, a thirty-second of a second by a thirty-second note, etc. Musicians will thank him for the introduction of a new form of rest which we may describe as an obliquely truncate parallelogram and which indicates silence throughout the remainder of the measure. The subject is an interesting one and has been studied by Mr. Scudder for many years, his early contributions having been published in the *American Naturalist* a number of years ago. The annual address of the president, Rev. Dr. C. J. S. Bethune, covers some seven pages, and consists of an interesting review of the entomological events of the season.

A NEW PATENTED INSECTICIDE.

Among the many insecticides which are patented during the year is occasionally one which attracts considerable attention. The so-called "Brown's Insect Exterminator" as noticed in the *California Fruit*

Grower of November 19, 1892, was highly recommended by several experienced fruit growers at the State Fruit Growers' Convention at San José, and it was stated that the Commissioners of Santa Cruz County intend to use it extensively the coming season.

WHY INSECTS INFEST PLANTS.

Mr. John Saul, of Washington, D. C., read a paper before the Society of American Florists at Washington last summer. He shows that any check in the vitality of a given plant, either through unsuitable or undrained soil, too much or too little water, want of pure air or sunshine, or one or more of many other causes, is followed by the attacks of insects. He cites especially greenhouse plants which suffer from scale-insects. He believes it possible to grow plants and crops of such health and vigor that insects will not seriously damage them. Interesting instances in support of this rather old, but none the less plausible, and to a certain extent sound opinion are given; but the author's idea that the weakly condition of the plants generates the scale-insects is of course totally unjustified.

INSECT LEGISLATION IN MASSACHUSETTS.

According to the *New England Farmer* of April 22, the legislature of Massachusetts has enacted a law relative to the "extermination" of injurious insects. It is evident from the text, which we reproduce in full, that the law is directed particularly against the Gypsy Moth and Tent Caterpillar, although these insects are not specifically mentioned. The following is a copy:

SECTION 1. Cities and towns shall raise annually by taxation and appropriate such a sum of money as they may deem necessary, to be expended under the direction of the mayor and aldermen in cities and the selectmen in towns, in exterminating insect pests within the limits of the highways in their respective cities and towns, and the removal from said highways of all trees and shrubs upon which such pests naturally breed: *Provided, however,* That where the owner or lessee of real estate abutting on the highway shall annually exterminate all insect pests from the trees and shrubs along the highway where said real estate abuts thereon, such trees and shrubs shall be exempt from the provisions of this act.

SEC. 2. This act shall take effect in any city when accepted by the city council, and in any town when accepted at a legal town meeting called for that purpose.

BORERS IN FIG TREES.

The New Orleans *Times-Democrat* is authority for the statement that thousands of fig trees are being destroyed in the neighborhood of New Orleans by "the flat-headed tree borer." The species effecting all this damage is not known to us, but is possibly *Ptychodes vittatus*, a large Longicorn, the larva of which is said to girdle the twigs of fig trees. A number of remedies are recommended, but some sort of wash applied to the bark at the time that the female beetle deposits her eggs will be the most efficient. Such a wash as is used to prevent the attacks

of similar borers—namely, a strong soap solution to which has been added a small quantity of crude carbolic acid or a little Paris green—would, if applied at the right time, greatly reduce the damage.

FOOD OF TARANTULA IN CONFINEMENT.

Our old friend, Dr. J. M. Shaffer, of Keokuk, Iowa, has recently published in a local paper an account of the feeding habits of a "Tarantula" which was found at Keokuk in the fall of 1890 in a bunch of bananas. This large Theraphosid spider was kept by Dr. Shaffer and some interesting feeding experiments were followed out between the above date and October 20th, when the spider became torpid and was subsequently placed in alcohol. Dr. Shaffer found among the many things he experimented with that the spider fed upon Cockroaches, larvæ of *Apatela americana*, Dog Day Harvest Fly (*Cicada canicularis*), Red-legged Grasshopper (*Caloptenus femur rubrum*), Horse Fly (*Tabanus atratus*). The following were also placed in the box, but were not touched: Live mouse, raw beef, Colorado Potato-beetle, Cecropia caterpillar, Tent-caterpillar (*Clisiocampa americana*), larvæ of the Interrogation Butterfly (*Grapta interrogationis*), Five-spotted Sphinx (*Macrosila cingulata*), Crickets, Carolina Locust (*Dissosteira carolina*). The box in which Dr. Shaffer kept the specimen, and in which it made itself quite at home, was 8 by 12 by 16 inches and had a glass cover. When he placed in the mouse it did not seem to be in the least afraid of the spider, but ate corn and cheese, and eventually gnawed its way out.

ENTOMOLOGICAL SOCIETY OF WASHINGTON.

May 4, 1893.—A paper by Prof. C. H. T. Townsend entitled "Notes on the Coruco, a Hemipterous insect which infests poultry in southern New Mexico," was read by Mr. Schwarz. The author described the habits of the species which he identified as *Cimer inodora* Dugés and added a description of the nymph. Discussed by Messrs. Ashmead, Schwarz, and C. W. Johnson. Mr. Schwarz read descriptions of *Anchonus floridanus* and *Loganius ficus*, both representing genera new to the North American fauna. The following notes by Mr. Wm. H. Patton were read: Discovery of the male of *Pterochilus 5-fasciatus* Say; *Zethus aztecus* in Florida; Notes on Wasps No. 1. Mr. Ashmead presented a "Synopsis of the North American species of *Toxoneura* Say." Specimens were exhibited by Messrs. Heidemann and Schwarz.

June 1, 1893.—D. MacCuaig was elected an active member and H. H. Goodell, of Amherst, Mass., and A. L. Montandon, of Bucarest, Roumania, corresponding members. Dr. Marx read a paper entitled "Continuation of the life history of the Whip-tail Scorpion" in which he described the habits and growth of a specimen of *Thelyphonus giganteus* during the second year of its confinement. Discussed by Messrs. Schwarz, Marx, Howard, and Riley. Mr. Ashmead presented certain "Notes on the family Pachylommatoidea" of Foerster. He gave a historical review of the views of different authors as to systematic position of these insects and concluded that the group is a subfamily of the Braconidae. He erected a new genus *Eupachylomma* to contain two new North American species.

Mr. Frank Benton presented some "Notes on the Death's Head Moth in relation to Honey Bees" describing his personal observations with this moth in south Europe

and Syria and exhibiting specimens which had been killed by bees. He does not consider that it is a serious enemy to the honey bee. Discussed by Messrs. Stiles, Schwarz, Riley, Gill, Chittenden, Marx, and Howard. Prof. Riley exhibited a series of specimens of *Lachnosterna*, showing several which had exhibited a remarkable longevity when kept in an old weak cyanide bottle containing some moist blotting paper. Beetles placed in similar bottles containing no cyanide died in three days, while one of the former lived for thirty days. He found that there was no perfect succession of species this spring. Individuals of *L. hirta* were as abundant June 1 as they were May 1. Dr. Riley also referred to the hibernation of the Coccidæ and stated that he had recently ascertained that many forms hibernate not only in the egg and full grown condition but practically in all stages. Kerosene can not be used successfully during the winter upon full grown females of the Diaspinæ, but is effective upon the young. He spoke of the extraordinary traveling powers of the young of *Chionaspis euonymi* and mentioned the effect of the severe cold of last winter upon the Diaspinæ, stating that *Aspidiotus perniciosus* had been almost exterminated on the maple trees of this city. These several communications were discussed by Messrs. Doran, Schwarz, Marx, Howard, Ashmead, and Benton. Specimens were exhibited by Mr. Schwarz.

L. O. HOWARD,
Recording Secretary pro tem.



INDEX TO ILLUSTRATIONS.

- Acontia lanceolata*, Fig. 46, p. 329.
Acontia (?) n. sp., Fig. 46, p. 329.
Aleurodicus cocois, Figs. 39, 40, 41, pp. 314, 315, 316.
Aleyrodes citri, Figs. 23, 24, pp. 219, 221.
Amphizoa lecontei, Figs. 4, 5, pp. 19, 20.
Antaplaga koebelei, Fig. 46, p. 329.
Anthonomus signatus, Figs. 15, 16, p. 176.
Anthonomus signatus, with work of on strawberry, Figs. 13, 14, pp. 167, 171.
Archippus butterflies resting at night, Fig. 22, p. 206.
 Bee-hive, ancient Greek, Fig. 30, p. 231.
Belvosia bifasciata, variations in, Pl. I, opp. p. 238.
 Birch leaf showing work of *Bucculatrix canadensisella*, Fig. 3, p. 14.
Bittacus, maxilla of, Fig. 12, p. 162.
Bruchus pisi, first larval stage of, Fig. 21, p. 205.
Bucculatrix canadensisella, with work of, Fig. 3, p. 14.
Catolaccus anthonomi, Fig. 17, p. 185.
Cladius pectinicornis, Fig. 1, p. 6.
Cladius pectinicornis, work of, Fig. 2, p. 7.
Crepidodera rufipes, Fig. 47, p. 341.
Entilia sinuata, Fig. 25 (should be Fig. 34a), p. 244.
Erax, palpus and palpifer of, Fig. 12, p. 162.
Homalodisca coagulata, Fig. 10, p. 150.
Hypoderas columbæ, Fig. 7, p. 77.
Loxostege macluræ, Fig. 11, p. 155.
Loxostege sticticalis, Figs. 42, 43, 44, 45, pp. 320, 321.
Monostegia rosæ, Fig. 37, p. 274.
Monostegia rosæ, work of, Figs. 35, 36, p. 273.
Nemognatha, maxilla of, Fig. 12, p. 162.
 Non-swarming device, Langdon, Figs. 31, 32, 33, 34, pp. 231, 232, 233.
Omia nessæa, Fig. 46, p. 329.
Oncocnemis flagrantis, Fig. 46, p. 329.
Oncognathus binotatas, Figs. 8, 9, pp. 90, 91.
 Orange leaf infested with *Aleyrodes citri*, Fig. 23, p. 219.
 Pea, pod of, showing eggs and mines of *Bruchus pisi*, Fig. 21, p. 205.
Peridroma demutabilis, Fig. 46, p. 329.
Prodoxus cinereus, Fig. 38, p. 307.
Pronuba, maxillæ of, Fig. 12, p. 162.
Pronuba maculata, stalk of, showing pupa shell of *Prodoxus cinereus*, Fig. 38, p. 307.
Psylla pyricola, Figs. 25, 26, 27, 28, 29, pp. 226, 227, 228.
Rheumatobates rileyi, Figs. 18, 19, 20, pp. 190, 191, 192.
 Rose leaf, showing work of *Cladius pectinicornis*, Fig. 2, p. 7.
 Rose leaf, showing work of *Monostegia rosæ*, Figs. 35, 36, p. 273.
Schinia intrabilis, Fig. 46, p. 329.
Schinia ligeæ, Fig. 46, p. 329.
Schizocerus privatus, with work of, Fig. 6, p. 25.
 Strawberry, spray of, showing *Anthonomus signatus* at work, Figs. 13, 14, pp. 167, 171.
 Sweet potato, leaf of, with egg-sacs and larvæ of *Schizocerus privatus*, Fig. 6, p. 25.
Tristyla alboplagiata, Fig. 46, p. 329.

ERRATA.

- Page 18, thirteenth line from bottom, for "*trivittatus*" read *vittatus*.
Page 33, last line, for "*globularis*" read *globulus*.
Page 35, under CHRYSOMELIDÆ, first line of second paragraph, for "*Artemisia*" read *Artemisia*.
Page 38, under COLEOPTERA, first line of third paragraph, for "*Thryncopyge*" read *Thrincopyge*.
Page 39, line 31, under *Diabrotica tenella*, for "*peas*" read *pears*.
Page 53, third line, for "*7*" read *14*.
Page 62, second line from bottom of first paragraph, for "*reprinted*" read *referred to*.
Page 63, line 2, for "*Sixth*" read *Fourth Annual*.
Page 89, first article, fourth line from bottom, for "*or*" read *on*.
Page 135, line 18, from bottom, for "*albicornus*" read *albicornis*.
Page 139, third line of second note, for "*cardinallis*" read *cardinalis*.
Page 155, third line from bottom, for "*Dorchaschema*" read *Dorcaschema*.
Page 159, second line of footnote, for ♂ read ♀ ♀; third line of do., for ♂ read ♀; near middle of page (4), for "*Cavaliers, Pen.*" read *Cavaliers*.
Page 160, line 3, for "*Orthesia*" read *Orthezia*; line 15 (13), for "*green*" read *Green*; line 16 from bottom (18), for "*Merium*" read *Nerium*.
Page 165, line 25, for "*tosata*" read *tesota*.
Page 166, fifth line from bottom, for "*Canavalbia*" read *Canavalia*.
Page 176, in explanation of figures, for "*natural size*" read *enlarged*.
Page 182, line 3, for "*20*" read *8*; line 10, for "*June*" read *May*; line 18, for "*wolffi*" read *wolffi*.
Page 204, fourth line from end of "Notes from Correspondents," for "*glabberimum*" read *glaberrimum*.
Page 244, for "*Fig. 25*" read *Fig. 34a*.
Page 254, footnote, for "*1892*" read *1893*.
Page 259, for "*irridescens*," read *iridescens*.
Page 286, note on Manna Scale, fifth line, for "*extent*" read *extension*; last line, for "*section*" read *secretion*.
Page 288, second paragraph, fourth line, for "*Deridrotettii*" read *Dendrotettix*.

AUTHORS' INDEX.

A.

American Florist Company, letter, 201.

B.

Banks, Nathan, note, 210.
 Barnhart, P. D., letter, 136.
 Bashaw, Mrs. Eva, letter, 266.
 Beach, Wooster, letter, 199.
 Benton, Frank, article, 230.
 Blaisdell, F. E., article, 33.
 Bovill, Alfred K., letter, 349.
 Brodie, William, letter, 343.
 Brunk, Mrs. A. E., letter, 263.

C.

Camboué, P., letter, 347.
 Chittenden, F. H., articles, 167, 247.
 Cockerell, T. D. A., articles, 89, 117, 158, 245; letters, 259, 263.
 Coquille, D. W., articles, 22, 251, 311.
 Cooke, John H., letter, 264.

D.

Davitt, J. S., letter, 47.
 Dickie, John, letter, 262.
 Ducommun, C., letter, 197.

E.

Eaton, Alvah A., letters, 258, 263, 342, 345.
 Ellis, John P., letter, 49.

F.

Fletcher, James, article, 124.
 Forbes, S. A., address, 68.

G.

Giddings, H. J., letters, 137, 200.
 Goding, F. W., article, 92.

H.

Hachenberg, G. P., letters, 44, 257.
 Hettermann Bros., letter, 198.
 Hoehr, Ferdinand, letter, 348.
 Hopkins, A. D., article, 187.
 Howard, L. O., articles, 12, 90, 325; letter, 199; note, 355.
 Howard, L. O., (and C. V. Riley), editorial articles, 27, 41, 131, 150, 165, 189, 219, 226, 298, 320, 334.
 Howard, eds., see C. V. R.

Hoyt, John K., letter, 45.
 Hubbard, Henry G., article, 19.
 Hunter, Mrs. J. M., letter, 259.
 Hunter, William N., letter, 195.

J.

Jacobsen, R. C., letter, 134.
 Jones, John J., letter, 197.

K.

Keck, J. M., letter, 266.
 Keene, John Harrington, letter, 48.
 Kellicott, D. S., articles, 77, 81.
 Kellogg, V. L., article, 114.

L.

Lintner, J. A., address, 67; letter, 200.
 Loomis, H., letter, 194.

M.

Markham, Byron, letter, 44.
 Marlatt, C. L., article, 24.
 Meinert, Fr., article, 36.
 Meyer, H., letter, 261.
 Moloney, Sir Alfred, letter, 258.
 Morgan, H. A., letter, 138.
 Mullen, S. B., letter, 48; art., 240.
 Murphy, W., letter, 343.
 Murrell, Geo. E., letters, 334, 338, 339.
 Murtfeldt, Mary E., article, 155; letters, 135, 196.

N.

Neal, J. C., letter, 197.

O.

Osborn, Herbert, article, 111; report, 323.
 Osborn, Herbert, and F. A. Serrine, article, 235.

P.

Packard, A. S., article, 14.
 Palmer, Edward, letter, 196.
 Philips, C. G., letter, 196.
 Power, J. D., letter, 343.
 Price, R. H., letter, 137.

R.

Rice, Mrs. M. E., article, 243; letters, 202, 256, 257.
 Riley, C. V., notes, 208, 209.
 Riley, C. V., articles, 6, 16, 40, 127, 254, 300.

Riley, C. V., and Howard, L. O., editorial articles,
27, 41, 131, 150, 165, 189, 219, 226, 298, 320, 334.
Roberts Hardware Co., letter, 49.

S.

Sanders, W. A., letter, 345.
Schwarz, E. A., report, 334.
Shannon, W. P., letter, 261.
Sharp, Alda M., letter, 260.
Shelton, E. M., letter, 45.
Shields, G. O., letter, 201.
Sirrinc, F. A., and Herbert Osborn, article, 235.
Slingerland, M. V., articles, 86, 87, 100, 104.
Smith, Herbert H., letters, 265, 266.
Smith, John B., articles, 93, 161, 328.
Smith, Mrs. F. A., letter, 347.
Smith, W. C., letter, 138.
Southwick, E. B., article, 106.
Stiles, C. W., letter, 346.
Stuntz, S. C., letter, 261.

T.

Thurrow, F. W., letter, 345.
Townsend, C. H. Tyler, articles, 37, 78, 317.
Turpie, Albert, letters, 267, 348.

V.

Van Epps, P. M., letter, 348.
Van Riper, Paul, letter, 46.

W.

Walker, Ernest, letter, 200.
Walker, Thos. R., letter, 47.
Waring, P. C., letter, 48.
Webber, H. J., letter, 264.
Webster, F. M., articles, 89, 121, 128.
Weed, Howard Evarts, article, 110.
Wentz, Geo., letter, 346.
Wight, R. Allan, article, 163; letter, 259.
Williston, S. W., article, 238.
Wilson, J. S., letter, 202.
Wolcott, Robert H., letter, 136.

PLANT INDEX.

A.

- Abelmoschus esculentus, Diaspis lanatus on, 247.
 Abies nigra, Dendroctonus frontalis destroying, 187.
 Acacia filicina, Bruchus sp. on, 166.
 lophanthæ, Aspidiotus and Scymnus on, 128.
 Acer dasycarpum, Ægeria on, 84.
 negundo, Liopus variegatus on, 247.
 saccharinum, Ægeria on, 84.
 Achras sapota, Vinsonia stellifera on, 159.
 Actinomeris, Lytta marginata on, 260.
 Adenostoma sparsifolia, Haltica torquata on, 35.
 Akee, Aspidiotus and Planchonia on, 245.
 Pulvinaria cupaniæ on, 159.
 Alfalfa, insects of, doubtless checked by irrigation, 80.
 Stictocephala inermis on, 92.
 Almond, Ceresa bubalus on, 92.
 Polycaon confertus on, 34.
 Polycaon stoutii on, 33.
 Ambrosia, Entilia sinuata on, 92.
 Amorpha fruticosa, Bruchus exiguus and Eupelmus cyaniceps reared from, 250.
 Bruchus exiguus on, 166.
 Ampelopsis quinquefolia, Telamona fasciata et unicolor on, 93.
 Anacardium occidentale, list of Coccidæ on, 159.
 Anise, wild, alleged insecticidal properties of, 50.
 Anthurium lanceolatum, species of Coccidæ on, 159.
 Apeiba tibourbou, Aspidiotus articulatus and personatus on, 245.
 Apple, a new case-bearer of, 1.
 Anomala marginata on, 45.
 Chrysobothris californica on, 33.
 semisculpta on, 32.
 Haltica foliacea injuring, 39.
 insects on, 17, 18.
 Mamestra picta on, 287.
 Notoxus calcaratus on, 197.
 Plum curculio on, 94, 99.
 root-borers of, 216.
 rose-chaffer on, 95.
 Scolytus rugulosus and Eupelmus sp. bred from, 250.
 species of Membracidæ on, 92, 93.
 Termes flavipes (?) injuring, 201.
 Apples, analyses of sprayed, for arsenic, ref., 1.
 Apricot, Ceresa bubalus on, 92.
 Notoxus calcaratus on, 197.
 Schizax senex on, 39.
 Aralia guilfoylei, Aspidiotus personatus and articulatus on, 245.
 racemosa (?), Entilia sinuata on, 245.

- Arbor vitæ, bag worm on, 116.
 Arecha catechu, species of Coccidæ on, 159.
 Argyreia speciosa, Diaspis lantatus on, 247.
 Arrow leaf, Rhopalosiphum nymphaeæ (?) on, 236.
 Artemisia californica, Trirhabda luteocincta on, 35.
 Artocarpus incisa, Aspidiotus on, 159.
 Asclepias cornutum, Callipterus asclepiadis on, 236.
 Ash, Canker-worms on, 125.
 European, Psyllobora 20-maculata and parasite on, 249.
 Asparagus, Cricoceris 12-punctatus on, in New Jersey, 94.
 Homalodisca coagulata on, 152.
 Mamestra picta on, 125.
 Astragalus, Bruchus aureolus on, 166.
 obsoletus on, 30.

B.

- Banana, attacked by Castnia licus, 356.
 list of Coccidæ on, 160.
 Barberry, host-plant of wheat rust, 52.
 Barley, pearl, Calandra remotepunctata on, 62.
 stored, Calandra remotepunctata attacking, 62.
 Basswood, Canker-worms on, 125.
 Bean, Cerotoma caminea on, 110.
 Eudamus proteus destructive to, 196.
 species of Bruchus infesting, 165.
 weevil of, 27.
 Beans, Cantharis nuttalli injuring, 126.
 Beech, Bracon simplex reared from, 248.
 Heliria scalaris on, 93.
 Beets, attacked by Lytta marginata, 260.
 Bergamot, wild, Anthonomus signatus on, 175.
 Betula, Meteorus orchesiæ bred from, 249.
 Betula lutea, Bucculatrix canadensisella on, 15.
 populifolia, Bucculatrix canadensisella on, 14.
 cherry-tree Tortrix on, ref., 351.
 Bignonia magnifica, species of scale-insects on, 246.
 Birch, Bucculatrix canadensisella on, 14.
 Enchenopa binotata on, 93.
 Meteorus orchesiæ bred from, 249.
 Blackberry, Anthonomus signatus injuring, 168.
 Coleophora n. sp. on, 18.
 Diaspis rosæ on, 208.
 insects affecting, in Ohio, m., 296.
 insects on, in New Jersey, 95, 96.
 Thrips tritici injuring, 127.
 Black spot, fungus disease of Tasmania, 217.
 Bloodwood, Acrophylla tessellata denuding, 64.
 Blue fungus disease of chinch bug, 70.
 Blueberry, believed exempt from Anthonomus signatus, 175.
 Borage, Otiorhynchus ovatus on, 46.

- Botrytis tenella*, against white grubs. 70.
 recent work on. 69.
- Box elder, bag worm on. 116.
Cacœcia semifera on. 49.
Ephialtes irritator on. 247.
Proconia undata on. 204.
- Bread fruit, species of *Aspidiotus* on. 159.
Brunfelsia americana, Coccidæ on. 159.
Burgmansia, *Lema nigrovittata* on. 35.
 Butternut, *Carynota* and *Enchenopa* on. 93.
- C.
- Cabbage, *Entomoscelis adonidis* damaging. 2.
Homalodisca coagulata found on. 152.
 insects injuring. 64.
 insects on, in New Jersey. 94.
Lytta marginata damaging. 260.
 maggot. 136.
Mamestra picta on. 125.
 root-maggots on. 124.
- Cactus, Cochineal bugs on. 549.
 injured by *Chelinidea vittiger*. 345.
 plants, insect injury to. 345.
- Calotropis proera, *Aspidiotus* and *Diaspis* on.
 246.
- Canavalia, *Bruchus longicollis* on. 166.
 Cane, see Sugar cane.
- Cantaloupes, melon louse on. 97.
- Capri fig proposed introduction into Australia.
 ref. 63.
- Cassia fistula, species of *Aspidiotus* on. 159.
 marilandica, *Bruchus bivulneratus* on. 165.
- Castilleja, injured by herbarium pest. 41.
- Catalpa, locusts attacking. 116.
- Canliflower, insects on, in New Jersey. 94.
- Ceanothus, *Enchenopa binotata* on. 93.
integerrimus, *Odontota californica* on. 269.
- Cedar, bag worm on. 116.
- Celastrus scandens, *Enchenopa binotata* on. 93.
- Cestrum aurantiacum, *Lema nigrovittata* on. 35.
- Cherry, attacked by *Apion nigrum*, m.. 336.
Cryptophasa unipuncta on. 63.
Enchenopa binotata on. 93.
Notoxus calcaratus on. 197.
Myzus n. sp. on. 16.
Thrips tritici on. 127.
 wild, *Bucculatrix canadensisella* on. 15.
- Chestnut, *Atryna inornata* on. 92.
Telamona reclinata on. 93.
- Chilopsis saligna, *Aspidiotus* n. sp. on. 65.
- Chocolate (plant), Membracid damaging. 203.
- Chocolate, *Sitodrepa panicea* damaging. 265.
- Choke cherry, *Hyalopterus pruni* on. 236.
- Chrysanthemums, and the Drone-fly. 263.
 attacked by *Orthezia* and *Lecanium*. 121.
Lecanium and *Orthezia* on. 160.
 Thripidæ on. 125.
- Chrysophyllum cainito, list of Coccidæ on. 159.
- Chrysopsis villosa (l.), *Copturus adpersus* on. 269.
- Cineraria, Thripidæ attacking. 125.
- Cinquefoil, strawberry weevil on. 174.
- Citrus trees, red scale introduced from Australia
 with. 281.
- Clematis candida, not attacked by blister-beetles.
 260.
 coccinea, *Lytta cinerea* and *marginata* on. 260.
- Clematis flammula*, *Lytta cinerea* and *marginata*
 on. 260.
 jackmani, not attacked by blister-beetles. 260.
 viorna, *Lytta cinerea* and *marginata* on. 260.
 virginiana, *Cladius isomera* on. 6.
Lytta marginata and *cinerea* on. 260.
- Clover, attacked by Silver Y-moth in England.
 m.. 296.
 grasshoppers injurious to. 324.
 insects on, in Iowa. 112.
 locusts attacking, in Iowa. 112.
Mamestra picta injuring. 125.
- Cnicus, *Copturus lunatus* on. 269.
- Cocoa, Membracid damaging. 203.
- Cocoon, damaged by *Aleurodicus coccois*. 315.
- Coffea, *Aspidiotus articulatus* on. 245.
 Coffee, mealy bug damaging. 60.
- Coleus, injured by *Orthezia insignis*. 89.
- Corn, Angoumois moth on. 116.
 as trap crop for bollworm. 48.
Crambus caliginosellus on. 217.
Diabrotica 12-punctata and *longicornis* on. 116.
Diatraea saccharalis on. 48.
 grasshoppers damaging. 57, 58.
 insects injurious to. 75.
Luperus brunneus damaging. 47.
 preferred by boll worm for deposition of eggs.
 241.
 protecting from weevils. 272.
- Cornus florida, *Anthonomus signatus* on. 175.
- Cotton, *Aretia phyllira* on. 111.
Dactylopius virgatus on. 246.
Gortyna nitela damaging. 50.
Heliothis armiger on. 218.
 lost through grasshoppers. 57.
Luperus brunneus damaging. 47.
Monocrepidius vespertinus on. 47.
 sharp-shooter, attack of. 152.
- Cottonwood, leaf-miner of, remedy for. 80.
Proconia undata on. 204.
- Cow-pea, *Bruchus 4-maculatus* on. 105.
Cerotoma caminea on. 111.
- Cranberry, *Cacœcia* sp. on. 94.
 insects injurious to. 75.
 insects, remedy against. 73.
 Orthoptera affecting. 217.
- Creosote bush, *Gyascutus planicosta* on. 38.
Pyrota postica on. 40.
- Cryptoporus obvolutus, insects inhabiting. 133.
- Cucumber, *Aphis cucumeris* on. 116.
 melon louse on. 97.
- Cucurbitaceæ, insects on, in New Jersey. 96-98.
- Cupania edulis, *Aspidiotus* and *Planchonina* on.
 245.
Pulvinaria cupaniae on. 159.
- Currant, *Janus flaviventris* on. 18.
 red, *Janus flaviventris* boring. 134.
- Cycas media, *Diaspis lanatus* on. 247.
- Cypress, *Phæosinus cristatus* injuring hedges of.
 262.
- D.
- Dasyllirion wheeleri, *Rhizophagus* sp. on. 38.
Thrinopyge alacris on. 38.
- Datura, cultivated, *Lema nigrovittata* on. 35.
- Desmanthus virgatus, *Bruchus bisignatus* on.
 286.

- Desmodium acuminatum*, *Torymus rudbeckiae* from galls on, 343.
Dewberry, doubtful food-plant of *Anthonomus signatus*, 174.
 Die-back fungus, secondary in attack, 151.
Dogwood attacked by Red-legged flea beetle, 336. flowering, *Anthonomus signatus* on, 175.
Dolichos, *Bruchus 4-maculatus* on, 165.
- E.
- Echinocystis lobata*, *Melittia ceto* feeds on, 82.
Elm, *Bracon eurygaster* bred from, 248.
Cacæcia semiferana on, 49.
Gossyparia ulmi on, 51.
 parasite of *Ceratomia* on, 136.
Elymus canadensis, *Gortyna cataphracta* on, 125.
Empusa aphidis, against chinch bugs, 70.
Eragrostis, *Colopha eragrostidis* on, 235.
Erica scoparia food-plant of *Crepidodera lineata*, 340.
Erythrina umbrosa, *Aspidiotus* and *Ceroplastes* on, 245.
Eucalyptus globulus, *Polycaon stoutii* on, 33. vs. mosquitoes, 344.
Xylotrechus nauticus on, 34.
Eupatorium, *Archasia galeata* on, 93.
maculatum, *Acutalis colva* on, 92.
- F.
- Farfugium grande*, *Eristalis tenex* on, 200.
Ficus, species of *Aspidiotus* on, 160.
Fig, *Blastophaga psenes*, introduction of, 63.
Ptychodes trivittatus reported on, 18.
Smyrna, in Australia, ref., 63.
Fuchsia, *Thripidae* attacking, 125.
Fungi, do *Termites* cultivate, 134.
Fungus, inhabitants of a, rev., 133.
- G.
- Gaylussacia resinosa*, believed exempt from *Anthonomus signatus*, 175.
Genip, *Ceroplastes* and *Aspidiotus* on, 246.
Geranium, *Siphonophora geranii* on, 236.
Gleditschia triacanthos, *Spermophagus robiniae* on, 166.
Glycyrrhiza lepidota, *Pubilia* spp. on, 92.
Golden rod, coloring matter of plant-louse on, 49.
Lytta murina on, 261.
Gooseberry, *Cacæcia argyrosipila* on, 17.
Gortyna cataphracta on, 125.
Gossypium barbadense, *Dactylopius virgatus* on, 246.
Grape, *Anomala lucicola* on, 95.
Anomala marginata on, 44.
Anthonomus signatus on, 175.
Chionaspis minor on, 246.
Conorhinus variegatus on, 204.
Desmia maculalis injuring, 137.
Haltica foliacea on, 39.
Haltica torquata on, 35.
Lecanium oleæ on, 160.
Macroductylus uniformis on, 38.
Psoa 4-signata on, 34.
 rose-chaffer on, 95.
Scyphophorus acupunctatus on, 35.
 species of *Membracidae* on, 92, 93.
 various insects on, 17, 18, 19.
- Grapes*, analyses of sprayed, n, 3.
 damaged by cutworms, 354.
Graphiola phœnicis, fungus disease of *Phœnix dactylifera*, 246.
Grass, attacked by locusts in Iowa, 112.
 grasshoppers injurious to, 324.
 injured by *Drasteria erecta*, 87.
 insects on, 117.
 in Canada, 124.
 injuring, 75.
 species of *Membracidae* on, 92.
 timothy, a new enemy to, 90-92.
Grasses, *Ctenucha virginica* injuring, 125.
Gortyna cataphracta on, 125.
Hadena devastatrix on, 125.
Grewia rothii, *Ceroplastes floridensis* on, 160.
Guaiacum officinale, species of scale insects on, 245.
Guava, *Dactylopius longifilis* on, 246.
 damaged by *Aleurodium coccis*, 315.
Gum, blue, remedy for mosquito, 268.
Gymnocladus canadensis, *Sphingicampa bicolor* on, 204.
- H.
- Haw apple*, *Valgus canaliculatus* on, 53.
Hay, mites in, in England, m., 296.
Hazel, *Telamona coryli* et *tristis* on, 93.
Hedysarum torreyana, *Bruchus fraterculus* on, 165.
Helianthus globosus var. *fistulosus*, *Empretia stimulea* on, 203.
 sp., *Chrysonela exclamationis* on, 39.
Hemp, for preserving grain, 272.
Hibiscus, *Bruchus hibisci* on, 165.
Chionaspis minor on, 246.
esculentus, *Diaspis lanatus* on, 247.
purpureus f. *semi-plena*, *Aspidiotus articulatus* on, 245.
Hickory, *Doryctes radiatus* reared from, 248.
 species of *Membracidae* on, 92.
Hicoria alba, *Monella caryella* on, 23.
amara, *Monella caryella* on, 236.
Hippeastrum equestre, *Lecanium oleæ* and *hesperidum* on, 245.
Hollyhock, *Luperus brunneus* on, 47.
Hop, *Gortyna immanis* on, 125.
 tent-caterpillars on, 50.
Hop-tree, *Enchenopa binotata* on, 93.
Horn beam, hop, *Siphonophora* sp. on, 236.
Horse-mint, *Anthonomus signatus* on, 175.
Huckleberry, *Anthonomus musculus* on, 176.
 believed exempt from *Anthonomus signatus*, 175.
- I.
- Iambosa malaccensis*, *Vinsonia* and *Lecanium* on, 160.
Illicium floridanum, supposed insecticidal properties of, 50.
Indigo, false, *Bruchus exiguus* and *Eupelmus cyaniceps* bred from, 250.
Ipomea, *Bruchus discoideus* infesting, ref., 165.
Bruchus lucosomus and *compactus* (?) on, 166.
leptophylla, *Bruchus discoideus* on, 166.
Ironwood, denuded by *Acrophylla tessellata*, 64.
 tree, *Bruchus pruinus* on, 166.
Isaria densa, recent work on, 69.

- Iva xanthiifolia*, *Publilia bicinctura* on, 92.
Ixora coccinea, species of *Coccidæ* on, 160.
 sp., *Lecanium hemisphæricum* on, 160.
- J.
- Jasminum pubescens*, species of *Aspidiotus* on, 246.
 sambac, *Aspidiotus* and *Lecanium* on, 246.
- K.
- Karoo, *Ceroplastes* sp. on, 210.
 Kentucky coffee tree, *Sphingicampa bicolor* on, 204.
- L.
- Lachnidium æridiorum*, unsuccessful experiment with, 71.
Larrea mexicana, *Centrodontus atlas* on, 92.
Gyascutus planicosta on, 38.
Pyrota postica, on, 40.
Latania aurea, *Aspidiotus personatus* on, 245.
Lathyrus vernus, food plant of *Crepidodera rufipes* (adult), 340.
 Laurel oak, *Ophiderma* on, 93.
Lawsonia inermis, scale insects on, 246.
 Lemon, *Tetranychus n.* sp. on, 18.
Lignum vitæ, *Icerya rosæ* on, 267.
 scale insects on, 245.
 Lily, Japan, *Ceresa bubalus* on, 92.
 Lime, scale insects on, in Bermuda, 203.
 Linden, *A tymna inornata* on, 92.
Telamona monticola on, 93.
 Loco weed, *Bruchus* sp. on, 166.
 Locust, black, *Cecidomyia robinia* on, 136.
 honey, *Acutalis calva* on, 92.
Liopus cinereus on, m., 248.
 species of *Membracidæ* on, 92, 93.
Ludwigia alternifolia, *Bruchus alboscutellatus* on, 165.
 Lupine, *Mecyna reversalis* on, 111.
- M.
- Malva silvestris*, food plant of *Crepidodera rufipes* (adult), 340.
Malvastrum sp., *Chrysomela dislocata* on, 39.
Mangifera indica, *Ceroplastes floridensis* on, 247.
 list of *Coccidæ* on, 160.
 Mango, *Ceroplastes floridensis* on, 247.
 list of *Coccidæ* on, 160.
 Mangolds, leaf maggot on, m. 296.
 Maple, *Ægeria* on, 83.
Anisopteryx pomataria on, 125.
Cacœcia semiferana on, 49.
Melicocca bijuga, *Ceroplastes* and *Aspidiotus* on, 246.
 Melon, *Aphis cucumeris* on, 116.
 Mentha, scale insects on, 247.
 Merium oleander, species of *Aspidiotus* on, 160.
 Mesquite, *Coleoptera* on, 38, 39, 40.
 species of *Membracidæ* on, 92, 93.
Meyenia alba, *Lecanium olææ* on, 160.
Mimulus, *Thripidæ* on, 125.
Monarda fistulosa, *Anthonomus signatus* on, 175.
Muhlenbergia mexicana, species reared from, 132.
 Mulberry, *Aretia* injuring, 17.
 locusts attacking, 116.
 wild, *Homalodisca coagulata* on, 151.
 Mullein, *Gymnetron tetrum* on, 262.
- Murraya*, list of *Coccidæ* on, 160.
 Musa, *Aspidiotus palmæ* on, 245.
 list of *Coccidæ* on, 160.
 Muskmelon, *Melittia ceto* feeds on, 82.
 Myosotis, *Orthezia insignis* infesting, 247.
- N.
- Nectarine, *Notoxus calcaratus* on, 197.
 Negundo aceroides, *Liopus variegatus* on, 247.
 Nightshade, black, *Lytta marginata* attacking, 260.
Nymphæa odorata, *Rhopalosiphum nymphææ* on, 236.
- O.
- Oak, black, *Elaphidion villosum* on, 50.
Bracon erythrogaster reared from, 248.
Cænophanes dinoderi and *Dinoderus punctatus* bred from, 248.
Callipterus discolor on, 236.
Dendrotettix feeding on, 256.
 denuded by *Acrophylla tessellata*, 64.
Edema albifrons injuring, 136.
Ephialtes irritator reared from, 248.
 laurel, *Ophiderma* on, 93.
 live, California *Coleoptera* on, 33, 34, 35.
 species of *Membracidæ* on, 92, 93.
 Oats, *A tymna viridis* on, 92.
 grasshoppers damaging, 58.
Macrops porcellus on, 1, 2.
Stictoccephala inermis on, 92.
 (E)nothra sp. (?) *Haltica foliacea* on, 39.
Olea hispanica, *Aspidiotus personatus* and *articulatus* on, 160.
 Oleander, species of scale insects on, 160.
 Olive, species of *Aspidiotus* on, 121.
 Olneya tesota, *Bruchus pruininus* on, 165.
 probable food plant of *Bruchus pruininus*, 166.
 Onion, root maggots on, 124.
 thrips attacking, 127.
 Opuntia spp. injured by *Chelinidea vittigera*, 345.
 insect injury to, 345.
 Orange, *Aleyrodes citri* on, 219.
Homalodisca coagulata injuring, 151.
Mamestra picta on, 287.
 plant bugs on, in Florida, 264.
Pseudococcus n. sp. on, 202.
 scale insects on, in Bermuda, 203.
 various insects on, 17, 18, 19.
 Osage orange, *Pyralid* injuring, 135.
 insects on, 155.
Pyralid on, 155.
Ostrya virginica, *Siphonophora* sp. on, 236.
- P.
- Palmetto, *Caryoborus arthriticus* on, 166.
Panicum crus galli, *Macrops porcellus* on, 2.
 Parkinsonia, *Bruchus cruentatus* on, 165.
Bruchus ulkei on, 165.
 microphylla, *Bruchus amicus* on, 165.
 torreyana, *Bruchus amicus* on, 165.
 Parsnip, wild, webworm on, 106.
 Pea, choice food plant of bollworm moth, 242.
Diabrotica tenella on, 39.
Hylastes trifolii attacking, 99.
Mamestra picta injuring, 125.
 species of *Bruchus* bred from, 165.

- Peach, *Achæa chameleon* on, 4.
 attacked by Red-legged flea beetle, 335.
Ceresa bubalus on, 92.
Notoxus calcaratus on, 197.
 various insects on, 17, 18, 19.
- Pear, *Aphis n. sp.* on, 17.
 Arctiid injuring, 17.
 attacked by Red-legged flea beetle, 335.
Ceresa bubalus on, 92.
 Le Conte, *Homalodisca coagulata*, injuring, 151.
Lygus sp., injuring, 18.
Thelia acuminata on, 93.
Thrips tritici obtained on, 126.
- Peas, weeviled, germination of, ref., 1.
- Pelargonium, *Diaspis lanatus* on, 247.
- Pentstemon, injured by herbarium pest, 41.
- Persea gratissima*, see *P. persea*.
persea, *Aspidiotus* on, 160.
- Phalaris arundinacea*, *Gortyna cataphracta* on, 125.
- Phaseolus pauciflorus*, *Bruchus sp.* on, 166.
- Phoenix dactylifera*, *Aspidiotus articulatus* on, 246.
- Phragmites communis*, *Hyalopterus arundinis* on, 236.
- Picea marianna*, *Dendroctonus frontalis* on, 187.
- Pig-weed, *Lytta marginata* attacking, 260.
- Pine, *Bracon simplex* reared from, 248.
 pitch, *Dendroctonus frontalis* destroying, 187.
 scrub, *Dendroctonus frontalis* destroying, 187.
 white, *Dendroctonus frontalis* on, 187.
 yellow, *Dendroctonus frontalis* destroying, 187.
- Pinus echinata*, *Dendroctonus frontalis* destroying, 187.
inops, *Dendroctonus frontalis* destroying, 187.
rigida, *Dendroctonus frontalis* on, 187.
strobis, *Dendroctonus frontalis* on, 187
- Plant parasitism of insects, 68.
- Plum, *Anomala marginata* attacking, 45.
 attacked by *Serica anthracina* in California, 350.
Ceresa bubalus on, 92.
Hyalopterus pruni on, 236.
Lecanium n. sp. on, 17.
Notoxus calcaratus on, 197.
Phytoptus n. sp. on, 16.
Phytoptus pruni (?) on, 17.
 various insects on, 18.
- Polygonum dumetorum*, *Calothyssanis amaturlaria* on, 132.
- Pomegranate, *Ceroplastes floridensis* on, 247.
- Pond lily, *Rhopalosiphum nymphææ* on, 236.
- Poplar, *Homalodisca coagulata* on, 154.
 silver, *Saperda calcarata* injuring, 54.
- Populus candicans*, *Sciapteron tricincta* on, 82.
- Portlandia grandiflora*, *Aspidiotus articulatus* on, 160.
- Potato, applying poison to, ref., 5.
Ceresa bubalus on, 92.
Diabrotica tenella on, 39.
Entilia sinuata on, 92.
Epilachna hirta damaging, 4.
Lytta marginata on, 260.
Orthezia insignis on, 247.
- Potentilla canadensis*, strawberry weevil on, 174.
- Prosopis juliflora*, *Bruchus protractus* on, 165.
Bruchus prosopis on, 165.
Eupagoderes decipiens on, 40.
Gyascutus planicosta on, 38.
Pachybrachys atomarius on, 39.
Pandetelejus cinereus beaten from, 40.
 species of *Membracidae* on, 92, 93.
Sphænothecus saturalis on, 39.
pubescens, *Bruchus n. sp.* on, 165.
 species of *Bruchus* on, 166.
- Prune, *Notoxus calcaratus* on, 197.
Thricolepis inornata injuring, 18.
 trees attacked by *Eurymetopon cylindricum*, 350.
- Psidium guava*, *Dactylopius longitilis* on, 246.
- Ptelea trifoliata*, *Enchenopa trifoliata* on, 93.
- Puccinia granarius*, alternate host-plants of, 52.
- Punica granatum*, *Ceroplastes floridensis* on, 247.
 list of *Coccidæ* on, 160.
- Pyrus communis*, *Psylla pyricola* on, 228.
malus, *Psylla pyricola* on, 228.

Q.

- Quercus agrifolia*, *Coleoptera* bred from, 33, 34.
coccinea (?), *Callipterus bellus* on, 236.
dubiosa, *Lyctus striatus* on, 34.
palustris, *Ægeria rubristigma* on, 85.
undulata, *Cynips q. mellaria* and *Myrmecocystus melliger* on, 259.
- Quince, *Elaphidion villosum* and *Bracon eurygaster* bred from, 248.
Heliothis sp. damaging, 18.

R.

- Radish, root-maggots on, 124.
Entomocelis adonidis damaging, 2.
- Ragweed, *Entilia sinuata* on, 92.
- Rape, *Plutella cruciferarum* on, 112.
- Raspberry, "Black Cap," apparently exempt from
Anthonomus signatus, 174.
 insects affecting, in Ohio, m. 296.
 insects on, in New Jersey, 95, 96.
Thrips tritici injuring, 127.
- Red-bud, *Enchenopa binotata* on, 93.
- Rhus, *Anthonomus signatus* on, 175.
glabra, tannin in gall on, 145.
Chaetophloeus and *Pityophthorus* on, 36.
integrifolia, *Cymatodera ovipennis* on, 33.
Ipochnus on, 35.
laurina, *Ipochnus* on, 35.
- Robinia, *Lecanium n. sp.* on, 65.
neomexicana, *Anomala binotata* on, 38.
pseudacaciæ, *Cænophanes utilis* bred from, 248.
Cecidomyia robiniæ, 136.
 favorite food-plant of *Crepidodera spp.*, 336.
- Rose, *Iceyya rosa* on, 19.
 saw-flies of, 6.
- Rubus canadensis*, doubtful food-plant of *Anthonomus signatus*, 174.
 saw-fly, stem-borer of, 95, 96.
villosus, probably natural food-plant of *Anthonomus signatus*, 174.

S.

- Sabal**, *Caryoborus arthriticus* on, 166.
 palmetto, *Aspidiotus articulatus* and personatus on, 246.
 umbraculifolia, *Aspidiotus articulatus* and personatus on, 246.
- Sagittaria variabilis**, *Rhopalosiphum nymphææ* on, 236.
- Salix**, *Sciapterion tricincta* on, 82.
- Sambucus glaucus**, *Desmocerus auripennis* on, 35.
- Sassafras**, *Papilio troilus* on, 207.
- Schrankia uncinata**, *Bruchus schrankiæ* on, 166.
- Screw bean**, *Bruchus desertorum* on, 166.
- Sea-spurge**, *Deilephila euphorbiæ* on, 118.
- Sebastiania bilocularis**, *Carpocopsa saltitans* infesting, 259.
 palmeri, *Carpocopsa saltitans* infesting, 259.
 pringlei, *Carpocopsa saltitans* infesting, 259.
- Silphium**, attacked by *Lytta marginata*, 260.
 perfoliatum, "*Lytta murina*" on, 261.
- Solanum carolinense**, *Trichobaris trinotata* on, 135.
 Trypeta electa on, 135.
 douglasi, *Pseudococcus* n. sp. on, 202.
 tuberosum, *Orthezia insignis* on, 247.
- Sorghum**, *Diabrotica tenella* on, 39.
- Spikenard**, *Entilia sinuata* on, 245.
- Sporotrichum globuliferum**, in Canada, 126.
 recent work on, 69.
- Spruce, black**, *Dendroctonus frontalis* destroying, 187.
Bracon simplex bred from, 248.
Cacœcia semiferana on, 49.
Mamestra picta injuring, 125.
- Squash**, *Diabrotica tenella* on, 39.
- "Stink bush," local name of *Illicium floridanum*, 50.
- Strawberry**, *Anthonomus signatus* on, 167, 217.
Otiorynchus ovatus on, 46.
 rose-chaffer on, 95.
 slugs of, ref., 66.
Thrips tritici injuring, 126.
 varieties for trap crops, 183.
 various insects on, 17, 18.
 wild, strawberry weevil on, 174.
- Strobilanthes**, *Orthezia insignis* on, art., 89.
- Strombocarpus pubescens**, species of *Bruchus* on, 166.
- Sugar-beet**, *Loxostege sticticalis* injurious to, 320.
Loxostege sticticalis on, 55.
- Sugar-cane**, insects affecting, in Fiji Islands, 270.
Lepidota squamulata injuring, 45.
 pin-borer of, 51.
- Sugar-cane disease**, circular on, 51, 52.
- Sumach**, tannin in gall on, 145.
- Sunflower**, *Chrysomela exclamationis* on, 39.
Entilia sinuata on, 243.
- Sweet potato** attacked by Tomato worm, 349.
 Cassids on, 96.
Cylas formicarius on, 261.
Conorrhinus variegatus on, 204.
Nezara viridula on, 261.

T.

- Tephrosia virginiana**, *Apion segnipes* on, 30.
- Terminalia**, *Lecanium* on, ref., 140.

- Theobroma cacao**, Membracid damaging, 203.
- Thevetia nerifolia**, *Aspidiotus articulatus* and personatus on, 246.
- Thistle**, Canada, *Publilia concava* on, 92.
- Thorn**, *Thelia cratægi* on, 93.
- Tilia**, *Anthonomus signatus* on, 175.
- Timothy grass**, a new enemy to, 90-92.
- Tobacco**, *Lita solanella* destroying, 214.
- Tomato**, *Ceresa bubalus* on, 92.
 corn as trap crop to protect against boll-worm, 48.
Epilachna hirta damaging, 4.
Heliolithis armiger on, 94.
Lytta marginata on, 260.
Pthia picta on, 282.
- Turnips**, attacked by Diamond-back moth, m. 296.
Entomoscelis adonidis damaging, 1.
 root-maggot on, 124.
- Turpentine trees**, denuded by *Acrophylla tessellata*, 64.

U.

- Ulmus**, *Colopha ulmicola* on, 235.

V.

- Vaccinium** spp., believed exempt from *Anthonomus signatus*, 175.
- Verbena**, *Orthezia insignis* on, 247.
 hastata, *Archasia galeata* on, 93.
- Viburnum**, *Enchenopa binotata* on, 93.
- Vicia sepium**, food-plant of *Crepidodera rufipes* (adult), 340.
- Vine**. See Grape.
- Viola**, *Dactylopius virgatus* on, 247.
- Violet**, *Orthezia insignis* on, 89.
- Virginia creeper**, *Thelia uhleri* on, 93.
- Vitis vinifera**, *Chionaspis minor* on, 246.
Lecanium oleæ on, 160.

W.

- Walnut**, silk-covered nut of, 141.
 species of Membracidae on, 92, 93.
- Wheat**, *Calandra remotepunctata* on, 62.
 corn aphid on, m., 296.
 grasshoppers damaging, 58.
 insects injuring, 75.
 insects of, in Maryland, 2.
 insects on, in Kansas, 114, 115.
 joint-worm (?) attacking, 89.
Oscinis variabilis on, 216.
 rust, alternate host-plants of, 52.
Stictiocephala lutea on, 92.
 underground insects on, m., 296.
 winter, grasshoppers injurious to, 323.
- Willow**, *Mamestra picta* injuring, 125
- Micracis hirtellus** on, 36.
- Saperda** on, 82.
- Sciapterion tricincta** on, 82.
 species of Membracidae on, 92, 93.

Y.

- Yucca**, *Anthonomus signatus* on, 175.
Lecanodiaspis n. sp., on, ref., 65.
- Yucca angustifolia**, *Tragidion armatum* on, 39.
 whipplei, *scyphophorus yuccæ* on, 35.

GENERAL INDEX.

A.

- Acamptus*, synopsis of, ref., 279.
- Acanthia columbaria*, notes on, ref., 134.
hirundinus, notes on, ref., 134.
lectularia, local names for, 272.
pipistrellæ, notes on, ref., 134.
- Achæa chamæleon*, fruit moth of South Africa, ref., 4.
- Achorutes armatus*, swarm of, 202.
nicicola, swarming of, 202.
- Acidalia herbariata*, injuring herbariums, 40, 41.
microsaria, synonym of *herbariata*, 40.
pusillaria, synonym of *herbariata*, 40.
- Acridiine, divisional bulletin on, notice, 218.
- Acrophylla tessellata*, injuring forest trees in Australia, 63.
- Acutalis calva*, on *Eupatorium* and honey locust, 92.
dorsalis, on grape, mm., 92.
- Egeria acerni*, on maple, 83.
corni, biologic notes on, 83.
gallivora, compared with *Æ. rubristigma*, 85.
hospes, compared with *Æ. rubristigma*, 85.
nicotianæ, compared with *rubristigma*, 85.
querci, notes on, 85.
rubristigma, biologic notes on, 88.
n. sp., description, 84.
- Ægerians*, not attracted to lights, m., 86.
- Ægeriidæ* of central Ohio, notes on, art., 81-85.
- Agabus gagates*, killed by kerosene in water, 13.
- Gallia sanguinolenta*, in Iowa, 113.
- Agricultural college of Michigan, insect collection of, ref., 287.
- Agricultural Gazette of New South Wales, notices, 63, 214.
- Agricultural Journal, Cape Colony, rev., 272.
- Agrilus ruficollis*, in New Jersey, 95.
- Agriotes mancus*, account of, ref., 5.
- Agrotis messoria*, known as "onion cut-worm," 354.
ochreogaster, in Canada, 124.
spp., damaging grapes in California, 354.
- Alaptus excisus*, smallest known insect, 267.
- Aldrich, J. M., rev. of article by, 59.
- Aletia xyliua*, *Sarcophaga* infesting, 23.
- Aleurodicus*, note on genus, 219.
cocois, damaging cocoanut and guava, 315.
technical description of, 316.
- Aleyrodes*, orange = *A. citri*.
- Aleyrodes asarumis*, m., 219.
citri, *n. sp.*, article on, 219-226.
 description of different stages of, 220.
 habits and life history, 222.
 natural enemies of, 225.
 remedies for, 224.
sp., on *Punica granatum*, 160.
sp., on strawberry, m., 17.
spp., on *Lawsonia inermis*, 246.
- Allomimus*, synopsis of, ref., 279.
- Allorhina mutabilis*, irrigation against, 79.
 synonymical note, 38.
nitida, synonymical note, 38.
sobrina, synonymical note, 38.
sp., injuring fruits, m., 17.
- Alum for rose chafers, notes on, 358.
- Amer. Assn. Adv. Sci., abstract of proceedings of entomological club, 132-134.
- Ampelophaga myron* parasitised by *Apanteles congregatus*, 289.
- Amphizoia*, notes on larva of, art., 19-22.
insolens, notes on larva, 19.
josephi, note of specific value, 20.
lecontei, notes on larva, 19.
- Anasa tristis*, immersion against, m., 81.
- Anchylonycha?* *sp.*, damaging sugar cane in Fiji, 270.
- Anderson, James R., rev. of art. by, 66.
- Angoumois grain moth, see Grain Moth, art., 325.
- Anguillulidæ, root-gall on cotton, m., 297.
- Anisopteryx pometaria*, in California, 276.
 injuring maple, 125.
sp., on plum, 18.
- Anomala binotata*, on *Robinia neomexicana*, 38.
lucicola, biological note on, 95.
 on grape in New Jersey, 95.
marginata, vineyard pest, 44.
- Anosia plexippus* = *Danaus archippus*, 270.
 attracted to light, m. 355.
- Anoxus chittendeni*, bred with *Cis fuscipes*, 250.
- Ant, honey-producing, in Australia, ref., 259.
- Antaplagæ kœbeleï*, men., 297.
n. sp. descr., 333.
- Anthicid, reported injurious to fruit, 197.
- Anthomyia brassicæ* in England, m., 293.
ceparum in England, m., 296.
- Anthonomus musculus*, characters of, 176.
 not the strawberry weevil, 175.
pomorum in England, m., 293.
 similarity of its work to *A. signatus*, 293.

- Anthonomus signatus*, article on, 167-186; m., 293.
 covering beds as a preventive, 183.
 differences in individuals due to food-plants, 175.
 eggs of, 177.
 habits of adults, 180.
 injuries of, 167-170.
 injuries to strawberry, in Delaware, ref., 217.
 larva of, 178.
 life history of, 177, 181.
 on blackberry, 172.
 oviposition of, 177.
 parasites and natural enemies, 181.
 past history, 167.
 probably single-brooded, 179.
 pupa of, 179.
 remedies against, 182.
 trap crops for, 183.
 wild food-plants of, 174.
 work of, 170-174.
 work on different varieties of plants, 173.
- Anthrenus scrophulariæ*, locally called Russian moth, 271.
 varius, damaging books, 353.
- Ants, edible qualities of, 268.
 guarding *Entilia sinuata*, 244.
 house, of Mexico, 196.
 white, and fungi, 134.
 white, remedies for, 201.
- Apanteles congregatus*, parasitic on lesser grape-vine sphinx, 289.
 parasitic on tomato worm, 289.
glomeratus, abundance in Iowa, 112.
 n. sp., parasite of Japanese gypsy moth, 54.
 parasite of Japanese gypsy moth, 195.
 sp., bred from *Colias philodice*, 136.
- Apatura celtis* attracted to light, m., 355.
- Aphalara calthæ*, annual generations of, 227.
- Aphelinus diaspidis*, parasitic on red scale, 207.
- Aphid. on cucumber, 97.
- Aphides, destroyed by *Limax*, 128-129.
- Aphididæ, experiments on eggs of, 102, 103.
 notes on, art., 235-237.
- Aphids, congregated on *Yucca whipplei* flowers, 312.
- Aphis, melon = *Aphis cucumeris*.
 brassicæ, in England, m. 293.
Lipolexis rapæ reared from, 207.
 cucumeris, believed to have alternate food-plant, 98.
 on cucumber and melon, 116.
 n. sp., on pear, m., 17.
 rumicis, parasites bred from, 141.
- Aphodius fossor*, in Iowa, m., 271.
- Aphycus* sp., bred from *Dactylopius*, 207.
- Apiary, work of, simplified, 232.
- Apiocera, deserving of family rank, 280.
- Apioceridæ, rev. of paper on, 280.
- Apion flavipes*, in England, m., 296.
 nigrum, attacking peach trees, m., 338.
 attacking wild cherry trees, m., 336.
 segnipes, on *Astragalus*, 30.
- Apis mellifica*, honey of, superior to that of *Melipona fasciculata*, 258.
- Apomidas, deserving of family rank, 280.
- Appearance of the periodical cicada, art., 298.
- Apple-blossom weevil in England, m., 293.
- Apple sawfly in England, m., 296.
- Arachnida, transmitters of disease, ref., 273.
- Arachnoid, attacking cattle, 132.
- Araneidæ, New Zealand, ref. to art. on, 64.
- Archasia galeata*, food habits of, 93.
- Archippus* butterfly, eaten by mice, 270.
 swarming of, 197, 205.
- Arctia phyllira*, on cotton, 111.
- Arctiid caterpillar, injuring fruit trees, 17.
- Argas americanus*, chicken plague in Texas, 348.
 damaging chickens, 267.
 remedies, 348.
- Army worm, damage by, in Iowa, 112.
- Arsenic, in sprayed fruits, tests for, refs., 1, 4.
- Arsenicals, spraying with, 73.
- Arsenite of ammonia, useful insecticide, 73.
- Arsenites, analysis of apples sprayed with, ref., 1.
 vs. bees, art., 121-123.
- Arthropoda, African, ref., 134.
- Ash borer, remedies for, ref., 6.
- Ashmead, W. H., rev. of paper by, 275.
- Asparagus beetle, at Rochester, N. Y., m., 99.
 kerosene against, m., 73.
- Aspidiotus articulatus*, food-plants of, 159, 160, 245, 246.
 on olive, mm., 121.
 aurantii, m., 349.
 introduced from Australia, 281.
 new parasite of, 207.
 on *Areca catechu*, 159.
 on *Lignum vitæ*, 245.
 citricola, distribution of, 203.
 citrinus, attempt to colonize *Orcus chalybeus* on, 252.
 introduced from Japan, 281.
 ficus, food-plants of, 159, 160, 246.
 on olive, mm., 121.
 n. sp., on *Chilopsis saligna*, ref., 65.
 n. sp., on *Mangifera indica*, 160.
 palmæ, on *Musa*, 245.
 perniciosus, appearance in Australia, ref., 214.
 attempt to introduce other insects to destroy, 251.
 California remedy for, 280.
Chilocorus bivulnerus against, 53.
Scymnus lophanthæ preying on, 128.
 personatus, food-plants of, 159, 160, 245, 246.
 on olive, mm., 121.
 rapax, appearance in Australia, ref., 214.
- Aspongopus* sp. = *Oncoscelis sulciventris*, m., 1.
- Association of Economic Entomologists, See Entomologists.
- Astata*, monograph of genus, ref., 149.
- Atomaria linearis* in England, m. 296.
- Atropis pulsatorius*, ticking of, 60.
- Attacus cecropia*, breeding for silk gut, 48.
 cynthia, *Spilochalchis mariæ* from cocoons of, 350.
 luna, breeding for silk gut, 58.
- Atymna*, food-habits of species, 92.
- Aulacophora hilaris*, in Australia, ref., 214.
- Australian enemies of red and black scales, art., 41-43.

Australian *Scymnus* established and described in California, art., 127-128.

B.

- Bacteria?, attacking parsnip webworm, m., 108, 40.
- Bacterial diseases of insects, 70.
- Bag worm, injurious in Kansas, 116.
- Bairdow, S. D., on fruit insects, rev., 295.
- Baltimore oriole eating *Sphinx catalpæ*, 350.
- Banks, Nathan, Synop. Cat. and Bibliog. of Neuropteroid insects of N. A., rev., 363.
- Baridius? sp. attacking cabbage in England, u., 296.
- Bark-beetle, destructive pine, damage to forests by, art., 187-189.
fruit, parasite reared with, 250.
spruce, believed to have been destroyed by enemies, 188.
- Bark-louse, new, on orange, 202.
oyster-shell, in Tasmania, ref., 216.
- Bedbug, transmitter of contagion, 210.
- Bee, honey, a tropical, corr., 258.
- Bees, advantages in suppressing swarms, 230.
advantages of the Langdon non-swarmling system with, 234.
artificial swarming of, practiced by Greeks, 230, 231.
automatic swarm-hivers for, 231.
control of swarming of, 230.
desire to swarm removed, 232.
effects of spraying on, art., 121-123.
field-force of two hives work in one, 233, 234.
Langdon non-swarmler for, described, 233.
Langdon non-swarmling system tested, 235.
non-swarmling, strains of, 231.
number of colonies one can care for under Langdon system, 234.
parasitism of, 208.
preventing loss of swarms, 232.
preventing or limiting swarming of, 231.
removal of queen-cells to prevent swarming, avoided, 234.
selection of breeding-stock facilitated by non-swarmling system, 235.
self-hivers for, 232.
swarming disposition may disappear, 235.
"swarming-fever" of, removed, 235.
swarming of, how incited, 232.
wholly prevented, 234.
watching for swarms avoided, 234.
- Bee-hives, bars used by Greeks, 230, 231.
basket used by Greeks, 230, 231.
Langdon non-swarmling attachment for, 232.
- Bee-keeping, in South Dakota, ref., 5.
sting, curious case of, 268.
stings and rheumatism, 353.
stings, potassium iodide for, ref., 62.
- Beetles, myrmecophilous, note on, 143.
- Belvosia—a study, art., 238-240.
- Belvosia bifasciata, supposed sexes represent distinct species, 239.
leucopyga, characters of, 240.
- Bernardia hemisphericum, on Chrysanthemum, mm., 121.
hemisphericum, see also Lecanium.
- Berne, or bicho berne, hominivorous bot., 3.
- Bethune, C. J. S., rev. of address by, 62.
- Beutermüller, William, m., 336.
- Bibio sp., in wheat fields, 116.
- Bill-bugs, in Iowa, 112.
in Iowa bull., ref., 66.
- Biologic notes on New Mexico insects, art., 37-40.
- Biology of cattle tick, summary of, 294.
- Biorhiza forticornis, *Catolaccus* sp., from galls of, 343.
- Birch, Bucculatrix of, abundant near Ottawa in 1892, 289.
- Bisulphide of carbon against Angoumois grain-moth, 327.
against gophers and moles, 293.
against grain pests, corr., 257.
against hen-lice, 361.
- Blanchard, Dr. Raphael, rev. of article by, 2.
- Blastophaga psenes, introduction into Australia ref., 63.
- Blatta, sp. damaging books, 353.
- Blissus leucopterus, in Kansas, 115.
- Blister beetles, abundance during 1892, 127.
apparent cross-mating of, 261.
habits of, 260.
on beans, 126.
- Blister mite, pear-leaf, ref., 62.
- Blow-flies, attacking a boy, 265.
- Blue-bottle fly, transmitter of contagion, mm., 210.
- Blue-gum, supposed gall mites on, 349.
- Blue jay, enemy of boll worm, 242.
- Boll worm, cotton, bacterial diseases of, 70.
can be destroyed by irrigation, 80.
diseases of, 242.
divisional bulletin on, notice, 218.
food-plants of moth, 242.
habits of, 241.
hibernation of, 243.
host plants of, 241.
in Mississippi, observations on, art., 240-243.
in Oklahoma bull.; ref., 148.
natural enemies of, 242.
see also *Heliothis armiger*.
trap crop for, 48.
- Bomycid, curious chrysalis of, 131.
- Book louse, ticking of, 60.
worms, ravages of, 353.
- Boöphilus bovis, notes on, 267.
- Bordeaux mixture, as insecticide, 74.
in sprayed fruit, tests for, ref., 3.
- Borers in fig trees, notes on, 365.
- Bot-flies, infesting man, note, 2, 3.
- Bot-fly, infesting man, 58, 265, 266.
infesting the cottontail, 317.
is it preyed on by English sparrow? 342.
- Bot, horse, in Louisiana, ref., 5.
in necks of cats, ref., 66.
man-infesting, in Brazil, 265.
ox, cattle hides damaged by, 137.
in Louisiana, ref., 5.
rabbit, correspondence on, 137, 138.
- Brachyseleidæ, review of paper on, 360.
- Bracon anthonomi, parasite of *Anthonomus signatus*, 182.
sp. n., description of, 185.

- Bracon erythrogastrer*, reared from hickory infested with *Cyllene picta*, 248.
eurygaster, bred from quince infested by *Ela-phidion villosum*, 248.
simplex, reared from nests of *Rhagium linea-tum*, 248.
 sp., bred from *Aphis rumicis*, mm., 141.
 sp., bred from *Thalpochara cociphaga*, 141; mm., 207.
 sp., bred from *Tychius semisquamosus*, 141.
Braconidæ, species reared from Coleoptera, 248.
Brathinus, synoptic table of, ref., 287.
californicus, n. sp., ref., 287.
 British Columbia, Dept. Agriculture of, rep't by, rev., 66.
 Brown's insect exterminator, notice, 364.
Bruchus North American, food-plants of, art., 165, 166.
acupunctus = *B. obtectus*, 31.
alboscuteUatus, on *Ludwigia alternifolia*, 165.
amicus, on *Parkinsonia*, 165.
aureolus, on *Astragalus*, 166.
bisignatus, food-plant and parasite of, 286.
bivulneratus, on *Cassia marilandica*, 165.
breweri = *B. obtectus*, 31.
chinensis, bred from beans, 165.
cruentatus, on *Parkinsonia*, 165.
desertorum, food-plants of, 166.
discoideus, on *Ipomæa*, 165, 166.
exiguus, *Eupelmus cyaniceps* reared with, 250.
 on *Amorpha fruticosa*, 166.
fabæ = *B. obtectus*, 31.
 old name of bean weevil, 27.
fraterculus, infesting *Hedysarum boreale*, 165.
hibisci, on *Hibiscus*, 165.
irresectus = *B. obtectus*, 31.
leguminarius = *B. obtectus*, 31.
longicollis, on *Canavalia*, 166.
lucosomus, on *Ipomæa*, 166.
 n. sp., on *Prosopis pubescens*, 165.
obscurus = *B. obsoletus* = *B. obtectus*, 31.
obsoletus = *B. obtectus*, 31.
 compared with *B. fabæ*, 27.
 on *Astragalus*, 30.
obtectus, article on, 27-33.
 bred from beans, mm., 165.
 synonyms of, 31.
 the proper name for the bean weevil, 133.
pallidipes = *B. obtectus*, 31.
pisi, bred from peas, mm., 165.
 compared with bean weevil, 86.
 compared with *B. obtectus*, 32.
 first larval stage of, 204.
 on *Prosopis juliflora*, 165, 166.
prosopis, on *Strombocarpus*, 166.
protractus, on *Prosopis juliflora*, 165.
pruininus, on ironwood, 165, 166.
quadrifaculatus, in beans, 32.
 on bean and cowpeas, 165.
rufimanus, bred from peas, 165.
schranksiæ, on *Schranksia uncinata*, 165.
scutellaris, in beans, 32.
 spp., food-plants of, 166.
subarmatus = *B. obtectus*, 31.
subellipticus = *B. obtectus*, 31.
ulkei, on *Parkinsonia*, 165.
- Bruchus uniformis*, on *Prosopis* and *Strombocar-pus*, 166.
varicornis = manuscript name, 31.
 Bruner, Lawrence, notice of divisional bulletin by, 218.
Bryobia pratensis, in houses, 266, 347.
Bucculatrix canadensisella, in Canada, m., 289.
 on birches, art., 14-16.
Bud curculio, in Tasmania, ref., 216.
Bud moth, eye-spotted, in Canada, ref., 1, 62.
 (or worm), note on spraying, rem., 123.
 Paris green for, 293.
 rev. of bulletin on, 293.
 "Buffalo bug," *Otiiorhynchus ovatus* suspected to feed on, 46.
 gnat, new species of, 61.
 moths, lady birds mistaken for, 49.
Bufonidæ, dipterous larvæ infesting, 209.
Bulimus decollatus, injurious in Bermuda, 269.
 "Bull-heads," caused by *Gortyna immunitis*, 125.
Buprestid on strawberry, 17, 18.
 Burgess, Edward, work in natural science, 205.
 Burmeister, Hermann, obituary of, 211.
 Butterflies, important paper on, rev., 275.
 Butterfly larvæ, unusual abundance of, 207.
 "Buttoning," evidently due to Thrips, 126, 127.
- C.
- Cabbage-bug, harlequin, irrigation against, m., 81.
 paper on, ref., 117.
 parasites of, 138.
 butterfly, imported, Chipping sparrow de-
 stroying, 266; ref., 148.
Sarcophaga bred from, 23.
 fly in England, m., 293.
 lice, soapsuds for, ref., 5, 62.
 maggot, carbon bisulphide against, 136.
 hellebore against, m., 74.
 moth, diamond-back, ref., 214.
Plutella, remedy for, m., 73.
 root-maggot, in Canada, ref., 62.
 stem weevil, in England, m., 296.
 worms, arsenites against, 94, 99.
 corn meal against, ref., 62.
 green, in Nebraska, 195.
 immersion against, m., 81.
 Paris green used on, 94.
 remedy for, m., 73.
- Caccæia argyrosipila*, on apple and gooseberry, 17.
postivittana, mistaken for codling moth, ref., 215.
rosaceana, on osage orange, 155.
semiferana (probably) on box-elder, etc., 49.
 sp. on cranberry, 94.
- Cactophagus, synopsis of, ref., 279.
- Cænophanes dinoderi*, bred from *Dinoderus punc-tatus*, 248.
 n. sp., *Bruchus bisignatus* parasitized by, 287.
utilis, reared from *Liopus cinereus*, 248.
- Calandra*, synopsis of, ref., 279.
linearis, new to our fauna, 279.
oryzæ, in Maryland, ref., 2.
remotepunctata, attacking grain, refs., 62.
 considered a synonym of *C. granaria*, 279.

- Calandra rugicollis* n. sp., occurrence in our fauna doubtful, 279.
- Calandrids, injuring sugar cane in Fiji Islands, 270.
- California Indians, *Yucca* used for food by, 311.
- Callidium areum*, supposed host of *Helcon dentipes*, 248.
- Callipterus asclepiadis*, on *Asclepias cornutum*, mm., 236.
bellus, on *Quercus coccinea*?, 237.
 discolor, apparently identical with *C. asclepiadis*, 236.
- Callirhytes fruticola*, causing galls in acorns, 196.
- Calothyssanis amaturlaria*, ref. to paper on, 132.
- Calypus tibiator*, parasite of *Anthonomus signatus*, 181.
- Camponotus inflatus*, in Australia, ref., 259.
- Campylenchia curvata*, on bushes and weeds, mm., 93.
- Canada, entomological report of, rev., 1, 289.
- Canker-worms, in California, 276.
 in Canada, ref., 62.
 in Massachusetts, ref., 213.
 insecticides for, ref., 4.
 on ash and basswood, 125.
 on plum, 18.
- Cannon's sheep dip for cattle tick, 294.
- Cantharis nuttalli*, in Canada, 289.
 injuring beans, 126.
- Cape Colony, insects in, rev., 295.
- Capsus binotatus* = *Oncognathus binotatus*, 90.
- Carabidæ, possibility of rearing for use against noxious insects, rems., 68.
- Carabid larvæ, supposed to have fallen during shower, 350.
- Caracara eagle, enemy of screw-worm, 269.
- Caracciolo, H., ref. to articles by, 65.
- Carbon bisulphide, against cabbage maggot, 136,
 against hen lice, 361.
 against stored grain pests, 43, 257.
- Carneades messoria*, on sweet potato, 96.
- Carp *vs.* mosquitoes, in water tanks, 14.
- Carpet-beetles, different names of, 271.
- Carphoxera ptelearia*, compared with *Acidalia herbariata*, 40, 41.
- Carpocapsa*, acorn, parasite of, 135.
 pomonella attacking pears in Cape Colony, 295.
 irrigation against, 79.
 saltitans, species of *Sebastiania* infested by, 259.
- Carynota, food-habits of species, 93.
- Caryoborus arctoriticus*, on palmetto, 166.
- Case-bearer of apple, new, ref., 1.
- Casey, T. L., rev. of article by, 278.
- Cassids, single brooded in New Jersey, 96.
- Castnia licus*, injuring banana in Trinidad, 356.
- Castor-oil plant *vs.* mosquitoes, 359.
- Catbird eating *Sphinx catalpæ*, 350.
- Caterpillars, tent, Paris green against, m., 73.
- Catocala, Hulst collection of, 51.
- Catolaccus anthonomi*, parasitic on *Anthonomus signatus*, 182.
anthonomi sp. n., description of, 185.
incertus, parasitic on *Anthonomus signatus*, 182.
- Catolaccus incertus*, sp. n., descriptions of, 186.
 sp. from galls of *Biorhiza forticornis*, 343.
tylodermæ, reared from *Tyloderma foveolatum*, 250.
- Cattle, dark-colored, most subject to horn fly attack, 203.
 fly, in New Jersey, m., 111.
 tick, apparatus for application of sheep dip for, 294.
 bulletin of Texas station on, 294.
 preventive measures, 294.
 sheep dips for, 294.
 summary of biology of, 294.
- Cecidomyia chrysopsidis*, notes on, ref., 212.
 destructor, in Kansas, 114.
leguminicola, in Iowa, 112.
robiniaæ, on *Robinia pseudacacia*, 136.
serrulataæ, notes on, ref., 212.
- Cecidomyiid galls on *Cornus*, paper on, ref., 212.
- Cecidomyiidæ, of vicinity of Washington, ref., 212.
- Cecropia moth, remedies for, ref., 6.
- Cenocælius rubriceps*, parasite of *Liopus cinereus*, 248.
- Centrodontus atlas*, on *Larrea mexicana*, 92.
- Cephalonomia hyalinipennis*, reared with *Hy-pothemus eruditus*, 250.
- Ceratitis capitata*, probably identical with *citri-perda*, 264.
citriperda, in Malta, corr., 264.
 letter on, ref., 272.
hispanica (?) in Malta, 264.
- Ceratonia amyntor*, parasite of, 136.
- Cereopeus chrysorrhæus*, on grape, 18.
- Ceresa brevicornis*, on hickory, mm., 92.
 bubalus, list of food plants of, 92.
 diceras, food habits of, mm., 92.
- Ceroplastes cirripediformis*, on *Guaia-cum officinale*, 245.
floridensis, food plants of, 160, 245, 246, 247.
 introduction of, 282.
 on *Antharium lanceolatum*, 159.
 ? on *Brunfelsia americana*, 159.
 new enemy of, 140.
ruscii, introduced from Japan, 282.
 sp., on *Anacardium*, 159.
 sp., on Karoo bush, 210.
 sp., on *Lawsonia inermis*, 246.
utilis n. sp., new wax insect, in Jamaica, ref., 139.
- Cerotoma caminea*, injuring beans in Mississippi, 110.
- Ceuthophilus pallidus*, damaging lace curtains, 282.
- Chatocnema confinis*, on sweet potato, 96.
- Chatophleus hystrix*, on *Rhus integrifolia*, m., 36.
- Chalcidid, a N. A., in England and West Indies, 350.
 bred from *Odontota californica*, 269.
 parasite of *Lecanium*, ref., 140.
- Chalcididæ, bred species of, 249.
 remarks on, 146.
- Chambers, V. T., statement on Cicada, 300.
- Changes of address, 218.
- Cheese skipper, probably identical with ham fly 116.
- Cheimatobia brumata*, in England, m., 296.

- Chermes manifer*, see *Gossyparia manifer*.
oak, biological note on, 135.
- Cherry borer moth, in Tasmania, ref., 216.
- Cherry-tree borer, in Australia, ref., 63.
Tortrix, abundance of, in Massachusetts, 351.
- Chicken plague, new, in Texas, 267, 348.
- Chickens, destroying cabbages, 257.
destroying potato-beetles, 256.
- Chigo, transmitter of disease, ref., 273.
- Chilocorus bivulnerus*, good work of, 53.
- Chiloneurus albicornis*, parasite of oak *chermes*, 135.
- Chinch bug, diseases of, 71.
Empusa aphidis against, 70.
in Illinois, rev., 59.
in Kansas, 114, 115.
in Mississippi, m., 110.
in Nebraska, m., 195.
in Oklahoma bull., ref., 148.
- Chionaspis biclavus*, on orange, 19.
citri, distribution of, 203.
introduced from Japan and Australia, 282.
Tineid feeding on, 207.
minor? on *Punica granatum*, 160.
on *Vitis* and *Hibiscus*, 246.
orange, see *Chionaspis citri*.
- Chironomid, blood-sucking, 279.
- Chittenden, F. H., m., 336.
- Cherocampa celerio*, in Australia, 277.
- Chrysalis*, curious, art., 131.
- Chrysobothris Polychroma* sp. parasitic on, 141.
californica, injuring apple, 33.
femorata, on live oak, 33.
n. sp., on strawberry, 18.
semisculpta, bred from apple and live oak, 33.
- Chrysochus cobaltinus*, injuring peach, m., 17.
- Chrysomela dislocata*, on *Malvastrum*, 39.
exclamationis, on sunflower, 39.
flavomarginata, hibernation and food-plant of, ref., 287.
- Chrysopa*, enemy of scale-insect, ref., 140.
- Chrysops hilaris*, number killed by kerosene, 13.
- Cicada, periodical, irregular appearance of, 200.
present year's appearances of, art., 298.
reports of, wanted, 298.
ochreoptera, irrigation against, 80.
septendecim, brood XI, 299.
brood XI, localities of, 299.
brood XI, southern distribution of, 299.
tredecim, appearance of brood XVI, 298.
localities of brood XVI, 298.
unusual occurrence of, 50.
- Cigarette beetle (?), in Brazil and West Indies, 202.
remedies for, 198.
- Cigars, damaged by *Lasioderma* (?) in Brazil, 202.
- Cimbex americana*, in Nebraska, m., 195.
parasites of, ref., 5.
Sarcophaga bred from, ref., 23.
- Cis dichrous*, in fungus on live oak, 34.
fuscipes, *Anoxus chittendeni* probably parasitic on, 250.
- Cladius isomera* = *C. pectinicornis*, 6.
pectinicornis, descriptions of stages of, 8, 9.
habits of, 11.
on rose. art., 6-9.
- Clerus formicarius*, attempt to introduce into U. S., 146, 188.
rosmarus, possible enemy of *Anthonomus*, 182.
- Clisiocampa* sp. on hop in Washington, 50.
- Clover-leaf beetle, in New Jersey, 98.
weevil, destructive appearances of, 99.
mite in houses, 347.
root-borer, in Canada, refs., 1, 62.
in peas, 99.
seed caterpillar, in Iowa, 112.
remedy for, 74.
midge, in Iowa, 112.
Mammoth clover exempt from, 74.
Thrips, see *Phleothrips*.
- Cluster fly, a household pest, corr., 263.
- Clytanthus albofasciatus*, beaten from grape, 54.
- Coal oil, see Kerosene.
- Coccid notes, rev. of art., 64.
- Coccidæ, attacks by, 363.
food-plants of some, art., 158, 160.
gall making, notes on, 360.
Jamaican, food-plants of, 245.
- Coccinella 9-notata*, *Homalotylus obscurus* parasitic on, 249.
sanguinea, *Homalotylus obscurus* reared from, rev., 249.
- Coccinellid*, *Homalotylus* n. sp. reared from, 207.
- Coccirellidæ, importation of, mm., 71.
possibility of breeding for use against noxious insects, 68.
- Cochineal bugs, on Cactus, m., 49.
- Cochliopodidæ possibly descended from *Saturniidæ*, 355.
- Cockerell, T. D. A., rev. of articles by, 139, 140, 362.
- Cockroach, crop of, ref., 217.
egg parasites, note on, 274.
tropical, in New Orleans, 201.
in Brazil, 265.
- Cocoanut and Guava mealy-wing, 314.
Palm, death from scale-insects overestimated, 362.
methods of treatment, 357.
ravages on, 357.
- Codling moth, damage in Nebraska, 141.
expense of spraying for, 73.
experiments against, ref., 3.
increase in New Jersey, 93, 94.
in Australia, rev., 214.
in Cape Colony, 295.
in Missouri, 135.
in Nebraska, 195.
in Oregon, in 1892, 292.
in Tasmania, ref., 216.
irrigation against, 79.
lamp trap a failure against, 215.
legislation in Tasmania, 277.
proper time to spray in Oregon, 292.
remedies experimented with, 292.
remedies, ref., 1.
spraying against, ref., 213.
three-brooded, in Oregon, 292.
- Coleophora* n. sp., on blackberry, 18.
n. sp., on orange, m., 18.
sp., on peach, m., 17.

- Coleoptera, California, notes on habits of, art., 33-36, 269.
- hymenopterous parasites of, art., 247-251.
- Lake Superior, habits of, ref., 134.
- North America, rems., on, 132.
- Ohio, notes on, 53.
- Southwestern, biologic notes on, 48-40.
- Western, exhibition of, m., 288.
- Colias philodice*, *Apanteles* sp. bred from, 136.
- "Collar-worm," on hop = *Gortyna immanis*, 125.
- Colopha eragrostidis*, apparently identical with *C. ulmicola*, 235, 237.
- ulmicola, apparently identical with *C. eragrostidis*, 235, 237.
- Color of host in relation to parasitism, 256.
- Coloring matter of plant-louse on golden rod, 49.
- Colorado potato-beetle, ducks destroying, 256.
- southern range of, 356.
- Comstock, Mrs. J. H., illustrator, m., 294.
- Comys* sp., reared from *Lecanium*, 207.
- Cone-nose, blood-sucking, called "monitor bug," 268.
- variegated, habits of, 203.
- Conorhinus sanguisugus*, note on, 268.
- variegatus, habits of, 203.
- Conotrachelus nenuphar*, on apple, 99.
- Cook, W. P. T., on spider bites, ref., 348.
- Copper, oxide of, analysis of fruit sprayed with, 3.
- Copturus adpersus*, bred from *Chrysopsis villosa* (?), 269.
- lunatus, on *Cnicus*, 269.
- Coquillett, D. W., observations on *Yucca whipplei*, 301.
- Corn aphid on wheat in England, m., 296.
- ear-worm crusher, corr., 259.
- meal remedy for cabbage-worms, ref., 62.
- nitrate of soda vs. insects affecting, ref., 217.
- root-worm, in Nebraska, 195.
- Southern, in Kansas, m., 116.
- Western, in Kansas, 116.
- stalk-borer, larger, in Virginia, 48.
- stored, *Gelechia cerealella* injurious to, 325.
- Correspondents, notes from, 349, 350.
- Cotton, diseases of, m., 296.
- moth, *Sarcophaga* infesting, ref., 23.
- root-galls of *Anguillulidæ*, m., 297.
- stainer, remedies for, 52, 53.
- locally known as "red bug," 271.
- St. Andrew's, ref., 52.
- worm, anatomy of, ref., 205.
- Cottontail Bot, art., 317.
- Cottonwood leaf-miner, remedies for, 80.
- "Crackamire," local name for *Ichneumon* flies, 271.
- "Cradlers," local name for long-horned grasshoppers, 271.
- Crambus caliginosellus*, in Delaware, ref., 217.
- Crane-flies in Ohio, m., 296.
- robin eating, 148.
- Crapronis inæqualis*, remedies for, 47.
- Crepidodera atriventris*, hibernation of, 336.
- helxines, hibernation of, 336.
- lineata on *Erica scoparia*, m., 340.
- modeeri, hibernation of, 336.
- rufipes, art., 334.
- see also Red-legged flea-beetle.
- Cricket, margined, on Osage orange, m., 155.
- Cricket mole, life history of, ref., 134.
- in New Jersey bulletin, rev., 217.
- Crioceris asparagi*, at Rochester, N. Y., m., 99.
- 12-punctatus, advent in New Jersey, 94.
- spreading slowly, mm., 98.
- Crown-borer, Lepidopterous, on strawberry, 18.
- Cryptoglossa lævis*, in houses, 39.
- Cryptophasa unipuncta*, in Australia, ref., 63.
- Crypturgus alutaceus*, n. sp., MS., ref., 288.
- Cryptus nuncius*, parasite on *Cimbex*, ref., 5.
- sp., bred from *Thalpochares cocciphaga*, mm., 207.
- Ctenochiton perforatus*, introduced from Australia, 282.
- Ctenucha virginica*, injuring grasses, 125.
- Cucullia*, revision of genus, ref., 140.
- Cupes lobiceps*, on live oak, 34.
- Curculio*, bud, in Tasmania, ref., 216.
- plum, experiments against, ref., 3.
- exploded remedy for, 53.
- increase in New Jersey, 93, 94.
- on apple, 94, 99.
- remedy for, 62.
- scarcity in Iowa, m., 112.
- Curius dentatus*, supposed host of *Helcon dentipes*, 248.
- Current saw-fly, *Trichogramma* sp. parasitic on, 289.
- shoot in England, m., 296.
- Curtice, Cooper, on cattle tick, rev., 294.
- Cutereba fontinella* infesting the cottontail, 317.
- description of female, 319.
- description of puparium, 320.
- notes on the larva, 318.
- cuniculi, on rabbit, corr., 138.
- Cut-worms damaging grapes in Calif., 354.
- destructiveness in meadow and pasture, 137.
- eaten by striped gopher, ref., 5.
- in Canada, ref., 62, 124.
- in Oklahoma bulletin, ref., 148.
- nitrate of soda against, ref., 217.
- remedies for, ref., 6.
- Cylas formicarius* in Louisiana, 261.
- Cyllene picta*, *Bracon erythrogaster* vs., 248.
- Doryctes radiatus*, vs., 248.
- Cymatodera ovipennis*, breeding habits, 33.
- Cynips q. mellaria*, honey produced from, 259.
- Cyprus*, supposed gall-mites in, 349.
- Cyrtosia* spp. foodplants of, 92.
- D.
- Dactylopius*, *Aphycus* sp. bred from, 207.
- destructor, damaging coffee, 60.
- introduced from Honolulu, 282.
- iceryoides, introduced from Australia, 282.
- longifilis, on Mango, 160.
- on *Psidium* and *Gossypium*, 246.
- virgatus, on cotton, 246.
- on *Viola*, 247.
- Danaus archippus*, eaten by mice, 270.
- Danysz, J., on the Mediterranean flour moth, rev., 290.
- Datana angusii*, in Nebraska, m., 195.
- integerrima, spinning habits of, m., 141.
- ministra, in Nebraska, m., 195.

- Death Valley Noctuidæ, notice, 297.
 descriptions of Noctuidæ from, 328.
- Deceptive resemblances in nature, ref., 52.
- Deilephila euphorbiæ, on sea-spurge, 118.
 lineata, promiscuous feeder, mm., 118.
- Deltoccephalus debilis, in Iowa, 113, 114.
 inimicus, in Iowa, 113, 114.
- Deltoid moths, proposed monograph of, 60.
- Demodex sp., attacking cattle, 132.
- Dendroctonus frontalis, attempt to introduce
 European enemies of, 146.
 forests damaged by, art., 187-189.
 remedies against, 188.
- Dendrotettix, gen. nov., characters of, 254.
 paper on, ref., 288.
 the genus, art., 254.
 longipennis, description of, ref., 288.
 n. sp., description of, 255.
 var. quercus, characters of, 256.
 quercus, description of, ref., 288.
 MS. name for a tree-inhabiting locust,
 254.
 Riley MS., also called *D. longipennis*,
 refs., 255.
- Depressaria heracliana, article on, 106-109.
- Dermatobia, transmitter of disease, ref., 273.
 cyaniventris, note on, ref., 3.
 noxialis (?), bot of human beings, ref., 59.
 (?) in Brazil, 295, 266.
 (?) in necks of cats, ref., 66.
 under skin of man, 3.
- Derostenus sp., bred from Bucculatrix, 16.
- Desmia maculalis, remedy against, 137.
- Desmocerus auripennis, on Sambucus glaucus, 35.
- Diabrotica longicornis, injuring corn in Nebraska,
 195.
 in Kansas, 116.
 12-punctata, in Kansas, 116, m., 296.
 var. tenella, see *D. tenella*.
 soror, on Yucca whipplei, 312.
 tenella, food-habits of, 39.
 vittata, believed to have food-plant outside
 the Cucurbitaceæ, 98, 99.
 in New Jersey, 98.
- Diamond-back moth on turnips, m., 296.
- Diapheromera, locally known as scorpion, 271.
 femorata, damaging forest trees, mm., 63.
 Sarcophaga bred from, 23.
- Diaspis lanatus, food-plants of, 247.
 on Calotropis procera, 246.
 rosæ, Aphelinus diaspidis bred from, 207.
- Diastrophus turgidus, Orthopelma luteolator, in
 galls of, 343.
- Diatraea saccharalis, irrigation against, 80.
 on corn in Virginia, 48.
- Dicælus splendidus, earlier stages of, ref., 271.
- Dicopinae, revision of, ref., 140.
- Dilophogaster californica, reared from Lecanium
 oleæ, 207.
- Dimorphism, in Psylla pyricola, 227.
- Dinoderus punctatus, Canophanes dinoderi bred
 from, 248.
- Diplosis resinicola, notes on, ref., 212.
 sp., on ovisacs of scale-insects, 246.
- Diptera, palpifer in, 161.
- Dipterous larva in eye of toad, 209.
 infesting a turtle, 269.
 parasite of Melanoplus devastator, art., 22-24.
- Diseases of cotton, m., 296.
- Dissosteira carolina, in northwest Missouri, 323.
 longipennis, in Kansas, 116.
- Division of Entomology, publications of, notice,
 218.
- Dohrn, Dr. Carl A., obituary of, 211.
- Donacia, ovipositor of, ref., 288.
- Dor-bug, local name for May beetles, 271.
- Dorcaschema wildii, on Osage orange, 155.
- Doryctes radiatus, doubtless parasitic on Cyllene
 picta, 248.
- Dorytomus, synopsis of, ref., 279.
- Douglas, J. W., Aleurodicos, erected by, 315.
- Dragon-flies vs. mosquitoes, rem., 110.
- Drassid spiders, spinnerets of, rem., 288.
- Dræsteria crassiuscula, in grass lands, 87.
 distincta, supposed variety of crassiuscula, 87.
 erechtea, article on, 87-88.
 ochrea, supposed variety of crassiuscula, 87.
- Drone-fly, and the Chrysanthemum, 263.
 in greenhouses, 200.
- Dryops fastigiatus, supposed larvæ of, 54.
- Ducks, crops injured by, 256.
- Dysdercus andreae, in Jamaica, ref., 52.
- E.
- Eagle, Caracara, enemy of screw worm, 269.
- Earthworms not a necessary factor in gapes, 346.
- Eciton n. sp., in houses in Mexico, 196.
- Edema albifrons, on oak, 136.
- Edible insects, 268.
- Eel worms in England, m., 296.
- Elaphidion imbelle, on live oak, 34.
 villosum, abundance in Pennsylvania, 50.
- Elasminæ, paper on structure of, ref., 288.
- Elliott, J. B., statement on Cicada, 300.
- Ellopia somniaria, Proctotrypid parasite of, 126.
- Ellychnia californica, earlier stages of, 271.
- Elm leaf-beetle, kerosene emulsion against eggs
 of, 81.
- Embryology, insect, important contribution to,
 351.
- Emphytus, banded = Emphytus cinctus.
 cinctus, habits of, 11.
 on rose, art., 9.
- Empretia stimulea, on Helianthus, 203.
- Enchenopa binotata, food-habits of, 93.
- Encyrtinae with branched antennæ, ref., 140.
- Encyrtus sp., reared from Dactylopius, 207.
- Endogenetic species of insects, 120.
- Entedon epigonus, synonymical note on, 73.
 hagenowi, cockroach egg parasite, 274.
 sp., in galls of Gelechia gallæ-solidaginis, 343.
- Entilia sinuata, food-plants of, 92.
 notes on, art., 243-245.
- Entomological Club A. A. A. S., abstract of pro-
 ceedings, 132-134.
 News, reviews of, 61, 215.
 publication, new, rev., 363.
 publications U. S. National Museum, 140.
 Society of Ontario, annual meeting of, 62.
 report, rev., 364.

- Entomological Society of Washington, proceedings of. Vol. II, No. 3, rev., 285.
Washington, abstract of minutes of, 146, 212, 287, 366.
- Entomologists, Economic Association of, address of first vice-president, 68-76.
President's opening address, 67, 68.
Proceedings fourth meeting, 63, 67-130.
Revised list members, 130, 131.
- Entomology, agricultural, text-book of, rev., 147.
at Iowa State University, rev., 271.
economic, at Cape of Good Hope, 272.
notes on, 61.
recent publications on, 75.
newspaper, 144.
- Entomoseles adonidis, in Canada, 1, 2, m., 289.
- Epeira trifolium, correspondence on, 202.
- Ephestia desuetella, the Jamaica Ephestia, 350.
interpunctella attacking lettuce seeds, 349.
kübniella, important publication on, rev., 290.
new localities for, 141.
not at Jamaica, 350.
on Pacific coast, 276.
origin of, 353.
probably in New South Wales in 1859, 354.
see Mediterranean Flour Moth.
sericaria probably *E. kuehniella*, 354.
- Ephialtes irritator, parasitic on *Liopus variegatus*, 247.
- Epicauda cinerea, *Lytta marginata* and *L. cinerea* synonymous with, 261.
pennsylvanica, *Lytta murina* probably mistaken for, 261.
vittata, synonymous with *Lytta vittata*, 261.
- Epilachna borealis, carnivorous tendency of, 98; m., 357.
corrupta damaging beans, 356.
irrigation against, mm, 81.
hirta, in South Africa, ref., 4.
- Epipocus cinctus, earlier stages of, ref., 271.
punctatus, compared with *E. cinctus*, 271.
- Epirrita inclinata, number killed by kerosene on water, 13.
- Epurea monogama, on *Cryptoporus*, 133.
- Erax, palpifer of, 161.
- Ergates spiculatus, from roots of Coniferæ, 34.
- Eristalis tenax, cross-fertilization of *Chrysanthemums* by, 263.
in greenhouses, 200.
- Eucalyptus, description of galls on, 360.
globulus, remedy for mosquitoes, 268; letter, 344.
resiniferus, supposed gall-mites on, 349.
- Eucharidæ, entitled to family rank, rem., 146.
- Eudamus proteus, destructive to beans, 196.
tityrus attracted to light, note, 355.
- Eumenes fraterna, capturing *Depressaria heracliana*, 107.
- Eupagoderes decipiens, on Mesquite, 40.
- Enpelmus, reared from *Muhlenbergia*, 132.
allynii, check on *Isosoma tritici*, 11.
reared from infested wheat stems, mm., 90.
cyaniceps, reared with *Bruchus exiguus*, 250.
sp., reared from Tineid, 207.
reared with *Scolytus rugulosus*, 250.
- Euphorus phlebotripi, parasite of *Phlebotripius frontalis*, 249.
sculptus, parasitic on *Megilla maculata*, ref., 249.
- Eurycreon rantalis = *Loxostege similalis*, 55.
- Eurymetopon cylindricum on prune trees in California, 350.
- Eurytomid, parasite of wheat pest, mm., 90.
reared from *Muhlenbergia*, 132.
- Euschistus servus, on oranges in Florida, 264.
- Evania appendigaster, cockroach egg parasite 274.
- Exochomus tripustulatus, foe of oak Chermes, 135.
- Exogenetic species of insects, 120.
- Experiment against mosquitoes, art., 12-14.
- Experiment stations:
Alabama, bull. 41, rev., 296.
California, bull. 99, rev., 214.
Cornell University, bull. 44, abs., 226, ref., 226.
bull. 50, rev., 293.
Delaware College, bull. 14, rev., 217.
bull. 18, rev., 217.
Illinois, bull. 19, rev., 59.
Iowa, bulls. 16, 17, 18, rev., 66.
Louisiana, rept. for 1891, rev. of entomological matter in, 5.
Maryland, bull. No. 16, rev., 2.
Massachusetts, bull. 17, rev., 3.
bull. 20, rev., 213.
(Minnesota = University of Minnesota.)
Mississippi, bull. 21, rev., 64.
New Jersey, bull. 90, rev., 217.
Ohio, bulls. 45 and 46, rev., 296.
Oklahoma, bull. 3, rev., 148.
Oregon, bull. 25, rev., 292.
South Dakota, bull. 30, rev., 5.
Texas, bull. 24, rev., 294.
University of Minnesota, bull. 23, rev., 216.
Washington, bull. 4, rev., 4.

F.

- Fertilizers in combating insects, ref., 217.
- Ficus indica, *Cephalonomia hyalinipennis* and *Hypothenemus eruditus* reared from, 250.
- Fidia longipes, injuring grape, m., 18.
murina, injuring grape, m., 18.
- Fig, *Cephalonomia hyalinipennis* reared from, 250.
insect, introduction into Australia, ref., 63.
native Australian, ref., 63.
trees, *Ptychodes vittatus* attacking, 365.
- Fire-blight beetle, on fruit trees, m., 17.
- Flata conica, on Osage orange, 155.
- Flea-beetle, cabbage, kerosene emulsion against, m., 73.
grape-vine, ref., 62.
injuring grape, 19.
on apple, might be controlled by irrigation, 80.
on strawberry and peach, 17.
Paris green against, 257.
red-legged, art., 334.
tobacco against, m., 74.
- Flea, rabbit, structure of, rem., 288.
- Fleas, form a distinct order, 288.
- Flesh-flies, attacking a boy, 265.
- Fletcher, James, 1891 report, rev. of, 1.
report for 1892, rev. of, 289.

Flour moth, Mediterranean. see Mediterranean.
 Fluted scale in South Africa, m., 295.
 Fly disease, or Myiasis, 36.
 weevil, see Angoumois grain moth.
 Forbes, S. A., rev. of article by, 59.
 Fowls and toads *vs.* garden insects. 256.
 gapes in, 326.
 killed by mole crickets, 265.
 Francis, M., on cattle tick, rev., 294.
 Froggatt, W. W., rev. of papers by, 274.
 Fruit insects, article on, ref., 75.
 moth in England, m., 296.
 in South Africa, ref., 4.
 Fungicides and insecticides, bulletins on, rev., 3.

G.

Galeruca, parasitized by *Homalotylus*, m., 250.
 tenella, in England, m., 296.
 xanthomelæna, eggs of different broods, rem., 146.
 eggs of second brood at New Brunswick, N. J., 146.
 monogoneitic at New Brunswick, N. J., 132.
 polygeneitic at Washington, 132.
 Gall insects and parasites, notes on, 343.
 mites, supposed, on Blue gum, 349.
 remedies suggested, 349.
 plant louse, tannin in, 145.
 Galleria cereana=*G. mellonella*.
 mellonella, in a cupboard, 260.
 Galloway, B. T., on fungi, quoted, 349.
 Galls in Germany, note on, 140.
 on fruit trees and vines, rev., 214.
 Gamasid mite on cattle, 111.
 Gapes in fowls caused by *Syngamus trachealis*, 346.
 experiments upon, 346.
 how caused, 347.
 not necessarily transmitted by earthworms, 346.
 remedial measures, 347.
 Garrett, William M., statement on Cicada, 298.
 Gasterophilus nasalis probably lessened by English sparrow, 343.
 veterinus=*G. nasalis*, 343.
 Gelechia cerealella, early writings on, 326.
 in Kansas, 116.
 in Maryland, ref., 2.
 in Virginia, 325.
 natural history of, 326.
 remedies for, 327.
 gallæ-solidaginis, *Entedon* sp. in galls of, 343.
 Geometrina, Hulst collection of, 51.
 Georgia, Cicada tredecim in, 298.
 Giard, Prof., studies on *Lachnidium*, 359.
 Glassy-winged sharpshooter, art., 150-154.
 Glossina morsitans, transmitter of disease, ref., 273.
 Glyphe viridascens, found with eggs of Murgantia, 138.
 Gnathocerus cornutus, in cereals, 35.
 Goding, Dr. F. W., rev. of article by, 282.
 Goniops hippoboscoides, new Tabanid, 59.
 Gophers, in Oregon, remedies recommended, 293.
 striped, food-habits of, ref., 5.

Gortyna cataphracta, in Canada, 125.
 immanis, on hops, 125.
 immanis=*Hydrecia immanis*.
 nitela, not found in Ottawa, 125.
 on cotton, 50.
 Gossyparia mannifera, manna-producing scale, 286.
 ulmi, new locality for, 51.
 Gracilaria, *Simplosis dolichogaster* bred from, 136.
 Grain Aphis in England, m., 293.
 beetle, lesser, in Maryland, ref., 2.
 red, in Maryland, ref., 2.
 insects, bisulphide of carbon against, 257.
 moth, Angoumois, expts. against, 2.
 in Kansas, 116.
 in Maryland, ref., 2.
 pests, carbon bisulphide against, 43.
 stored, *Gelechia cerealella* injurious to, 325.
 Grape seed weevil, remedies for, 47.
 vine leaf-roller, in Texas, 137.
 Grapholitha interstinctana, in Iowa, m., 112.
 Graptodera chalybea, correction, 39.
 Grasshoppers, connection with blister beetles, 127.
 destroyed by turkeys, 257.
 injuries in Northwest Missouri, art., 323.
 in Canada, ref., 62.
 in New Jersey, 94.
 in New Jersey, bulletin, rev., 217.
 in the East, 57.
 kerosene against, 74.
 long-horned, called "cradlers," 271.
 Grass insects, further notes on treatment of, ref., 117.
 Graveyard bug, name of *Otiobryncus ovatus*, 46.
 "Grease bug" in California, 342.
 Gryllotalpa borealis, life-history of, 134.
 Guinea fowls *vs.* garden insects, 257.
 Gusano de mosquito, local name for human bot, 58.
 Gyascutus planicosta, biologic notes on, 38.
 Gymnetron tetrum, on mullein, 282.
 Gypsy moth, insecticide work against, m., 73.
 Japanese, and its parasite, 54, 194.
 not spreading in Massachusetts, 356.
 recent work on, 75.

H.

Hadena devastatrix, on grass, 125.
 Hæmatobia serrata, in Canada, 125, 144.
 in different States, 144, 145.
 in Florida, ref., 66.
 "Halabe" of Madagascar=*Nephila madagascariensis*, which see.
 Halisidota sp., on apple, 17.
 Haltica carinata, on elm, m., 342.
 erythropus=*Crepidodera rufipes*, m., 340.
 foliacea, damage by, 39.
 injuring grape, 19.
 might be controlled by irrigation, 80.
 ignita, injuring strawberry and peach, 17.
 outbreak of, m., 341.
 rufipes, m., 341.
 torquata, on grape and *Adenostoma*, 35.
 Halticotoma valida, on *Yucca whipplei*, 312.
 Hammer-handles, injured by *Lyctus*, 197.

- Hand-maid moth**, spinning habits, m., 141.
- Harlequin cabbage bug**, remedy, 61.
see Cabbage bug.
- Harpalus caliginosus**, on figure of larva of, 209.
pennsylvanicus, larva of, m., 209.
- Harvest-fly**, of New Mexico. irrigation against, 80.
spider, striped, rev., 284.
- Hawk moths**, injuring tomatoes, m., 195.
- Hayward's sheep dip** for cattle tick, 294.
- Heart-worm**, local name for *Heliothis*, 94.
- Helcon dentipes**, probable hosts of, 248.
- Heliothis armiger** attacking peaches in Cape Colony, 295.
divisional bulletin on, notice, 218.
in Australia, 354.
in Cape Colony, 295.
irrigation against, 80.
known as Maize moth in Australia, 354.
on tomato in New Jersey, 94.
= Peach Underwing of Cape Colony, 295.
crushing instrument, corr., 259.
sp., damaging apple and quince, 18.
- Heliria**, food-habits of species, 93.
- Hellebore**, as insecticide, 74.
- Hemiptera**, maxilla of, 161.
- Hemiptychus punctatus**, breeding note, 135.
- HemisarcOPTES coccisugus**, n. sp., attacking *Mytilaspis pomorum*, 362.
- Hen lice**, carbon bisulphide for, 361.
- Herbarium pest**, notes on, 40, 41.
- Hessian fly**, importation of parasites of, 72.
in Kansas, 114.
- Hessler**, Robt., rev. of article by, 283.
- Heterius hornii**, myrmecophilous, ref., 143.
- Heterophleps triguttata**, number killed by kerosene applied to pool of water, 13.
- Himatium**, synopsis of, ref., 279.
- Hippiscus**, North American species of, 283.
- Hippobosca equina**, transmitter of disease, ref., 273.
- Hippodamia convergens**, *Homalotylus obscurus*, parasitic on, ref., 250.
- Homalodisca coagulata**, art., 150-154.
description of, 153.
oviposition of, 152.
- Homalotylus obscurus**, hosts of, 249.
sp., reared from *Rhizobius ventralis*, 207.
- Honey bee**. See Bee.
dew, nature of, 104.
of *Aleyrodes*, 228.
secreted by *Psylla*, 101, 102.
moth, in a cupboard, 260.
producing ants of New Zealand, 258.
storing of, interrupted by swarming, 230.
yield under Langdon non-swarming system, 235.
- Hoplia callipyge** in California vineyards, 343.
remedies used, 344.
- Hoplocampa testudinea** in England, m., 296.
- Hoplophora 4-lineata** on oak, weeds, and bushes, m., 93.
- Hop louse** in Oregon in 1892, 292.
kerosene emulsion not a safe insecticide for, 292.
kerosene vs. quassia for, 61.
- Hop louse**, preventive work on plums necessary, 293.
soap and tobacco solution recommended, 292.
- Hop plant-louse** on, in Washington, 60.
"strig maggot" in England, m., 296.
vine borer in Canada, 289.
- Horicola?** sp., damaging *Theobroma cacao*, 203.
- Hormiga asqueles** in houses in Mexico, 196.
- Horn fly** abundant in Texas, 349.
different kinds of cattle attacked by, 111.
in Canada, ref., 62; rem., 111, 125, 144; notes, 359.
in different States, 111, 144, 145.
in Florida, ref., 66, 111.
in Kansas City, Mo., 116.
in Mississippi, 110.
in Oklahoma bull., ref., 148, 204.
known as "Third Party fly," 349.
newspaper account of, 144.
preferring dark-colored cattle, 203.
spread of, 49.
- Horse bot**. see Bot.
fly, transmitter of disease, ref., 273.
- House fly**, transmitter of disease, m., 210.
- Howard**, L. O., m., 295.
- Hoy**, P. R., obituary of, 286.
- Huckleberry bug**, local signification of term, 271.
- Hudson**, G. V., ref. to article by, 64.
- Hyalopterus arundinis**, notes on, 236.
= *pruni* Fab. (?).
pruni, on plum and choke cherry, 236.
- Hydreacia immanis**, in Canada, m., 289.
- Hylastes trifolii**, on peas, 99.
- Hymenoptera**, parasitic, notes on some bred species of, 140.
of Australia, catalogue of, rev., 274, 275.
- Hymenopterous parasites** of Coleoptera, art., 247-251.
- Hyphantidius sericarium**, probably *Ephestia kuehniella*, 354.
- Hyphantria cunea**, abundant in Canada, 125.
n. sp., injuring apple, etc., 17.
- Hypoderas columbæ**—a note, art., 77, 78.
- Hypoderma**, transmitter of disease, 273.
- Hypothenemus eruditus**, *Cephalonomia hyalini-pennis* bred with, 250.
- Hyria auroraria**, eating dry leaves, 41.
- I.
- Icerya**, Egyptian, in India, notes on, 361.
Lestophonus, parasitism of, 279.
Vedalia cardinalis, destroying, 142.
ægypiacum, parasites of, 361.
Vedalia cardinalis, destroying, 139.
purchased, in South Africa, ref., 4.
Ophelosia crawfordi, reared from, m., 207.
Vedalia n. sp., preying upon, rem's, 71.
rosæ, on *Lignum vitæ*, 267.
on rose, etc., in Florida, 19.
- Ichneumon flies**, local name for, 271.
subdolos, bred from *Gortyna immunis*, 125.
- Ichneumonidæ**, species parasitic on Coleoptera, 247.

- Incurvaria capitella* in England. m., 296.
 Indian meal moth in seeds of lettuce, 349.
Inglina, note on genus, 219.
 Injurious insects in Cape Colony. rev., 295.
 Insect collection. Michigan Agricultural College. ref., 287.
 eating birds, of Tasmania. ref., 216.
 embryology. important contribution to, 351.
 enemy of lace curtains, 282.
 to chocolate, 268.
 exterminator. Brown's notes on, 364.
 fauna of Mississippi bottoms. ref., 134.
 injury in New Mexico. influence of irrigation on. art., 78-81.
 to cactus plants, 345.
 legislation in Massachusetts. notes on, 365.
 Life. delay in publishing No. 4, 213.
 readers of, 149.
 parasites. exportation of, 72.
 of insects, 71.
 of insects. Australian, 207.
 benefits believed to have been derived from, 188.
 pests. methods of prevention. rev., 216.
 Tasmanian hand book of. rev., 216.
 pins, remarks on, 288.
 smallest known species, 267.
 transmitter of contagion, 210.
 Insecticide. a new patented, 364.
 machinery. for kerosene emulsion, 73.
 Insecticides and fungicides. bulletins on. rev., 3.
 expts. with, 72.
 refs., 147-148.
 use of, ref., 4.
 Insects affecting blackberry in Ohio. m., 296.
 raspberry in Ohio. m., 296.
 and the weather, 138, 139.
 aquatic. necessity for work on, 76.
 Australian. sent by Koebele to Ellwood Cooper and B. M. Lelong report on. art., 251-254.
 bacterial diseases of, 70.
 common. local names for, 271.
 contagious diseases of. rem., 68-71.
 cooperative work against, 291.
 directions for collecting and preserving. ref., 140.
 discussion on food-plants of, 93.
 eggs of. insecticides against. m., 81.
 irrigation against, 81.
 kerosene emulsion against, 102, 103.
 estimated number consumed by Swainson's hawk, 352.
 fungus diseases of, 69.
 injuring cabbage in Mississippi. rev., 64.
 injurious. abundance of. in England in 1892, 296.
 agricultural practices to control, 74.
 eaten by gopher, 5.
 in Canada. art., 124-126.
 in Cape Colony. rev., 295.
 in England. ref., 147.
 in England in 1892, 293.
 in Iowa. art., 111-114.
 in Nebraska, 195.
 of Fiji Islands, 270.
 of Kansas. rev., 215.
 Insects, injurious. of South Africa. rev. of article on, 4.
 quarantine against, desirable. ref., 216.
 to fruits. art., 16-19.
 instinct of. ref. to article on, 64.
 in the human ear, 344.
 irrigation and its effects on, 258.
 legislation against. in California, 291.
 necessity of stringent local laws, 292.
 list of. killed by kerosene emulsion, 73.
 number killed by application of kerosene to pool of water, 13.
 parasitism in. ref., 212.
 said to forecast weather, 352.
 toads and fowls destroying, 256.
Iphthimus levissimus, on live oak, 35.
Ipochus fasciatus, *Cymatodera ovipennis* in burrows of, 33.
 on *Rhus integrifolia*, 35.
 pubescens. habits similar to *I. fasciatus*, 35.
 Irrigation and its effects on insects, 258.
 influence on insect injury, art., 78-81.
Isocnatus vulgaris. bred from *Aphis rumicis*, 141.
Isosoma hordei. features of apparent attack. art., 89-90.
 tritici. in Kansas, 115.
 Itch, Norway. extreme case of, 283.
Ixodes ricinus, in Leeward Islands, 146.
 transmitter of disease. ref., 273.
 J.
 Jamaica Ephestia (*E. desuetella*) 350.
Janus flaviventris, borer in currant. ref., 134.
 in currant stems. m., 18.
 Jarring effective against red-legged flea-beetle, 337.
 Jasside. on grasses in Iowa, 113.
 Jigger. Mexican. or "tlanzahnate." rev., 211.
 "Jimpson weed." remedy for tobacco sphinx, 275.
 Joint-worm. some features of apparent attack. art., 89-90.
 Jumping bean. correspondence on, 259.
 June-beetle. green. irrigation against, 79.
Junonia caenia. on Block Island, 203.
 K.
 Kaltenbach. ref. to *Crepidodera*, 341.
 Kansas notes. art., 114-116.
 University Quarterly, vol. I, No. 3, rev., 280.
 Katydid, on cranberries. ref., 217.
 Kellogg. Vernon L.. rev. of art. by, 215.
 Kerosene. against blister mite, 105.
 against mosquitoes, 12-14.
 emulsion. against eggs of insects, 102, 103.
 against hop louse, 60, 61.
 against pear *Psylla*, 102.
 against *Thripidae*. m., 125.
 for animal parasites, ref., 5.
 for red-legged flea-beetle, 337.
 for rose-chaffer, experiments with, 94, 95.
 insects killed by, 73.
 not a safe insecticide for hop louse, in Oregon, 292.
 pan, against grass insects, 74.
 Kirby, W. F.. ref. to paper by, 65.
 Koebele. Albert. in Oregon. m., 292.

L.

- Lachnidium acridiorum*, notes on, 359.
Lachnosterna arcuata, in Iowa, mm., 112.
 dubia, in Iowa, mm., 112.
 fusca, plentiful in Iowa, mm., 112.
 gibbosa, in Iowa, mm., 112.
 grandis, in Iowa, mm., 112.
 implicita, in Iowa, mm., 112.
 spp., damage by, 350.
 spp., injuring corn, 195.
- Ladybird, Australian, colonized in Egypt, 139.
 bean, irrigation against, m., 81.
 local name for Sesiid moth, 271.
 twice-stabbed, good work of, 53.
- Ladybirds, mistaken for "Buffalo moths," 49.
 Langdon non-swarming device, art., 230-235.
Laphygma frugiperda on *Yucca whipplei*, 312.
 Larvæ in the human ear, letter, 343.
Lasioderma serricorne (?), in Brazil and W. I., 202.
 remedies for, 198.
Lasioptera, reared from *Muhlenbergia*, 132.
Lathridius filiformis, destroying herbarium snouts, 203.
Latreillia bifasciata, characters of, 239.
 Leaf-beetle, cottonwood, remedies for, ref., 6.
 eating pea-weevil in England, m., 296.
 hoppers, causing "silvertop," 124.
 hopper, grapevine, tarred board for capturing, 104.
 hopper, vine, irrigation against, 78.
 hoppers, kerosene against, 74.
 hoppers, Paris green against, 257.
 maggot, on mangolds in England, m., 296.
 roller, on shade trees in Colorado, 49.
- Lecanium depressum*, introduced from Honolulu, 282.
 hemisphericum, food-plants of, 160.
 on *Areca catechu*, 159.
 on *Chrysanthemum*, mm., 121.
 hesperidum, *Comys* sp. reared from, 207.
 mangiferæ, food-plants of, 160.
 on *Jasminum sambac*, 246.
 n. sp., on grape, 19.
 on peach, ref., 65.
 on plum, m., 17.
 oleæ, *Dilophogaster californica*, 207.
 food-plants of, 160, 245.
 parasite of, ref., 140.
 robinia MS., in New Mex., ref., 65.
 sp., on *Anacardium*, 159.
 on *Anthurium lanceolatum*, 159.
 on peach, m., 17.
 on strawberry, m., 17.
- Lecanodiaspis yuccæ* MS., on *Yucca*, ref., 65.
 Legislation against tinsects, 291.
 paucity of beneficial results, 291.
 Legislation against spraying, 272.
Leis conformis, attempt to colonize in California, 252, 253.
 in confinement, 42.
- Lema nigrovittata*, food-plants of, 35.
 Leopard moth, and its enemies, 204.
Lepidiotia squamulata, on sugar cane, 45.
 Lepidoptera collection at Rutgers College, 51.
 Geo. D. Hulst's collection of, 51.
 Lake Superior, habits of, ref., 134.
- Lepidoptera, new species, ref., 64.
Lepisma saccharina (?) damaging books, 353.
Leptoglossus phyllopus, on oranges in Florida, 264.
Leptops hopei, apple-root borer of Tasmania, ref., 216.
 robustus, apple-root borer of Tasmania, ref., 216.
Leptoterna dolobrata, abundant in grass and clover in Ohio, 92.
Lepus artemisia (?) infested by bot-fly, 317.
 Lesser grape-vine sphinx, parasitised by *Apanteles congregatus*, 289.
Lestophonus, parasitism of, 279.
 Lettuce seeds attacked by *Ephestia interpunctella*, 349.
Leucania albilinea, on wheat in Kansas, 115.
 unipuncta, damage by, in Iowa, 112.
Leucopis, parasitism of, 279.
 Lice affecting domestic animals, ref., 65.
 kerosene emulsion for, ref., 5.
 Lignières, M. J., extract from, 362.
Limax campestris, destroying Aphides, art., 128.
 flavus, lime against, 130.
 Lime, as insecticide, 74.
 for destroying snails, 130.
Limenitis disippus, resemblance to *Danais archippus*, 270.
Limneria, parasite of parsnip web-worm, 106.
 ferrugineipes, parasitic on *Cimex*, 5.
 fugitiva, bred from *Clisiocampa californica*, 141.
Liopus cinereus, *Cænophanes utilis* parasitic on, 248.
Cenocœlius rubriceps parasitic on, 248.
 variegatus, *Ephialtes irritator*, parasitic on, 247.
Lita solanella, m., 291.
 article on, 163-164.
 destroying tobacco, ref., 214.
Lithocolletis, n. sp., on peach, 17.
 Little's sheep dip for cattle tick, 294.
Livia maculipennis, dimorphism not present in, 227.
 vernalis, dimorphism not present in, m., 227.
Locust, local name for *Bombycids*, 271.
 migratory, parasitic fungus of, 71.
 misapplication of the term, 218.
 post oak, habits of, ref., 255.
 ravages, early, 349.
- Locustidæ, misapplication of the family name, 218.
Locusts, abundance in Algeria, 56.
 destructive, notice of divisional bulletin on, 218.
 in Africa, ref., 272.
 in Iowa, 112.
 in New Jersey bulletins, rev., 217.
 in South Africa, 283.
 injurious in Kansas, 116.
 non-migratory, in the East, 57.
Sarcophaga bred from, 23.
- London purple, against blister mite, 105.
 against strawberry slug, 66.
 for red-legged flea-beetle, 337.
- Long scale, introd. into California from Florida, 282.

- Long scale not brought from Mexico to California, art., 361.
not yet established in Calif., 231.
- Lophoderus triferana*, on Osage orange, m., 155.
- Loxostege macluræ*, earlier stages of, 156.
n. sp., article on, 155-158.
n. sp., description, 158.
similalis, injuries by, 55.
sticticalis affecting sugar-beet, 320.
hibernation of, 321.
notes on, and figures of earlier stages, 321, 322.
remedies, 321.
- Lozotænia cerasivorana*, abundance of, in Massachusetts, 351.
- Lucilia caesar*, common in Europe, 37.
hominivorax, in human nostrils, ref., 65.
not strictly *hominivorax*, 36.
macellaria, eaten by *Polyborus cheriway*, 269.
(?) in Brazil, 265, 266.
nobilis, parasitic on man, art., 36-37.
sp. found in toad's eye, 209.
- Luperus brunneus*, damaging cotton, 47.
- Lycus parallelopedus*, habits and remedies, 198.
striatus, habits and remedies, 198.
bred from *Quercus*, 34.
- Lygus* sp., injuring pear, 18.
- Lymantria dispar*=*Ocneria dispar*.
- Lytta cinerea*, habits of, 260.
marginata, habits of, 260.
murina, on golden rod, 261.
vittata=*Epicauta vittata*, 261.
on potato, 261.
- M.
- Macroductylus uniformis*, on grape, ref., 38.
- Macrops porcellus*, on oats, 1, 2.
- Macrorhyncholus protractus*, in dry flower stalks of *Yucca whipplei*, 311, 312.
- Madagascar, silk spider of, 347.
- Maize moth, in Australia=*Heliothis armiger* 354.
- Mally, F. W., notice of bulletin by, 218.
- Mamestra picta*, food-plants of, 125, 287.
on cabbage about Washington, m., 99.
on Pacific coast, 287.
parasites of, 126.
trifolii, on cabbage about Washington, m., 99.
- Man, attacked by cockroaches, 265.
by screw-worm, 265.
bot-flies infesting, n., 2; 58.
- Man-infesting bot, in Brazil, 265.
- Manna scale, note on, 286.
- Mantis, *Sarcophaga* bred from, 23.
- Maple-worm, green-striped, in Nebraska, 195.
- Masicera*, said to infest locusts, 23.
- Maskell, W. M., rev. of article by, 64.
- Maxillary tentacles of *Pronuba*, art., 161-163.
- May beetles, called "dor-bugs," 271.
damage by, 350.
damaging corn, m., 195.
- McIver, D. B., statement on Cicada, 299.
- McKinnon, E. M., statement on Cicada, 300.
- McOwan, P., rev. of arts, and notes by, 272.
- Mealy bug, damaging coffee in Mexico, 60.
introduced from Honolulu, 282.
- Mealy-wing, damaging cocoanut and guava, 315.
technical description of, 316.
- Mecynia reversalis*, injuring lupines, 111.
- Mediterranean flour moth known near Paris in 1840, 290.
important publication on, rev., 290.
in California, 276.
new localities for, 141.
not of American origin, 290.
remedies recommended, 290.
unnecessary to quarantine American wheat against, 290.
see also *Ephestia kuehniella*.
- Megasoma elephas*, mm., 357.
- Megastigmus*, evidence of phytophagic habit in, 146.
- Megilla maculata*, *Euphorus sculptus* parasitic on, ref., 249.
on cotton, m., 47.
- Megobrium edwardsii*, on live oak, 34.
- Melanoplus atlantis* in northwest Missouri, 323, 324, 325.
bivittatus, in Kansas, 116.
devastator, dipterous parasite of, art., 22-24.
differentialis, in Kansas, 116.
in northwest Missouri, 323, 324.
femur-rubrum in northwest Missouri, 323, 324, 325.
- Melanotus communis*, account of, ref., 5.
- Melipona fasciculata*, in Brit. Honduras, 258.
- Meliponæ*, curious defenses constructed by, ref., 288.
- Melittia ceto*, egg-laying of, 96-98.
notes on biology of, 82, 85.
- Melon aphid, see aphid cucumeris.
beetle, striped, in Oklahoma bull., ref., 148.
louse, in New Jersey, 97.
musk, *Otiorynchus ovatus* on, 99.
- Melsheimer, F. V., m., 340.
- Membracidae, N. A., food-plants of, art., 92, 93.
synopsis of subfamilies and genera of, 282.
- Menopon consanguineum*, parasite of pelican, 284.
- Merizus isosomatus*, parasite of wheat pest, 90.
- Meromyza americana* causing "silvertop," 124.
- Mesochorus melleus*, parasitic on *Cimbex*, 5.
- Mesquite, scale on, 65.
- Meteorus orchesiæ*, bred with *Mycetochares binotata*, 249.
- Metobates*, compared with *Rheumatobates*, 193.
- Meyrick, E., notice of article by, 64.
- Mice, eating *Archippus* butterfly, 270.
- Micracis hirtellus*, on willow, 36.
- Microcentrus caryæ*, on hickory and walnut, mm., 92.
- Microgasterin*, parasite of gypsy moth, 54.
- Microplitis ceratomiæ*, parasite of *Ceratonia*, 136.
- Migratory locust* attacked by *Lachnidium acridiorum*, 359.
- Milkweed butterfly, anatomy of, ref., 205.
- Mirax*, new species of, rev., 275.
- Mite, clover, in houses, 266.
local names for, 271.
on cattle, 111.
on plum, 16, 17.
pear-leaf blister, ref. 1; art., 104, 105.
in Canada, 125.

- Mite, undescribed, on lemon, 18.
 Mites, associated with scales on plants, 246.
 in hay, in England, m., 296.
 on pigeon, art., 77, 78.
 Mole cricket, see Cricket.
 fowls killed by, 265.
 Moles in Oregon, remedies recommended, 293.
 Monellia caryella, notes on, 236.
 Monitor bug, popular names for *Conorhinus sanguisugus*, 268.
Monocrepidius vespertinus on cotton, 47.
Monodontomerus montivagus, bred from *Xylocopa* sp., 141.
Monolepta rosea, in Australia, ref., 214.
 two-spotted = *M. rosea*.
Monomorium pharaonis, edible qualities of, 268.
Monostegia ignota, in Iowa, ref., 66.
 rosea, habits of, 10.
 illustrations of, 273.
 Morphology, Journal of, ref., 351.
Morrisonia, revision of, ref., 140.
 Mosquito, another vegetarian, corr., 262, 345.
 Eucalyptus, a remedy for, 268, 344.
 exterminator, notes on, 359.
 mistaken for parent of human bot., 58.
 remedies against, 143, 199.
 transmitter of disease, mm., 210.
 Mosquitoes, an experiment against, art., 12-14.
 castor-oil plant vs., 359.
 discussion of remedies for, 109.
 number killed by kerosene, 13.
 Multivorous subclass of insects, defined, 120.
Murgantia histrionica, irrigation against, m., 81.
 Muscidae, acalyprate, larval habits of, rev., 279.
 myiasis caused by, 36.
 Mustard beetle, in England, 278, m., 296.
Mycetochares binotata, probable host of *Meteorus orchesia*, 249.
 Myiasis, different forms of, 36.
Myodites nevadicus, supposed parasite of *Polistes*, 40.
Myrmecophilus beetles, note on, 143.
Myrmecocystus iridescens, honey ant. ref., 259.
 melliger, habits of, 259.
Mysia pullata, *Homolotylus obscurus* parasitic on, 249.
Mytilaspis citricola, introduction of, 282.
 on *Murraya*, 160.
 gloverii, introduction of, 282.
 not established in California, 281.
 pomorum, enemies of, 362.
 sp., *Aphelinus diaspidis* reared from, 208.
Myzus nov. sp., on cherry, 16.
- N.
- Necrossia cyllarus*, damage by, 268.
Nematus pallidiventris parasitized by *Trichogramma* sp., 289.
 ribesii, parasite of, 126.
Nemobius marginatus, destructive to Osage orange, 155.
Nemognatha, maxilla of, 161.
Nephila madagascarensis, experiments on silk of, rev., 210.
 silk spider, 347.
 Neuroptera, North American, rev. of paper, 363.
- New injurious insects of a year, art., 16-19.
 Newspaper entomology, note on, 144.
 New Zealand Institute, transactions of, rev., 64.
Nezara viridula, on oranges in Florida, 264.
 on sweet potato, 261.
 Nitrate of soda, preferable to potash as a protection against insect attack, ref., 217.
 Noctuidæ from Death Valley, notice, 297; descr., 328.
 Nomenclature and oviposition of bean weevil, art., 27-33.
 Non-swarmers, Langdon, patented, 232.
 opinion as to value of, 232.
 simplicity of, 232.
 test of, 235.
 Non-swarming device, Langdon, art., 230-235.
 system with bees, advantages of the Langdon, 234, 235.
Notoxus calcaratus, reported injurious to fruit, 197.
Novius wightii, name proposed for variety of *Vedalia cardinalis*, 142.
 Nymphalinae, rev. of article on, 275.
- O.
- Oak looper, Vancouver Island, Proctotrypid parasite of, 126.
 pruner, abundance in Pennsylvania, 50.
Oberea ocellata, on peach, 18.
 Obituaries, 211, 285.
Ochromyia, infesting human beings, ref., 273.
Ocneria japonica, attempt to introduce parasite of, 54.
 correspondence on, 194, 195.
 distinct from *O. dispar*, 195.
Odontota californica, mining leaves of *Ceanothus integerrimus*, 269.
Ocodoma mexicana, mm., 357.
Oeme gracilis, on *Quercus agrifolia*, 34.
 Estridæ, diseases caused by, 36.
 Oil, coal, see Kerosene.
 Olivier, E., m., 340.
 Olliff, A. S., rev. of arts, by, 1, 63, 214.
Oncocnemis flagrantis n. sp., 330.
Oncognathus binotatus, new enemy to timothy, art., 90-92.
Oncoplophus sordidus in northwest Missouri, 323.
Oncoscelis sulciventris, in N. S. W., ref., 1.
Onychomys sp., eating *Archippus* butterfly, 270.
 Onion fly in England, m., 296.
Ophelosia crawfordi, from eggs of *Icerya*, mm., 207.
Opheltes glaucopterus, parasitic on *Cimbex*, 5.
Ophiderma, food habits of species, 93.
 Orange Alelyrodes, article on, 219-226.
 bug, bronzy, in N. S. W., ref., 1.
 Chionaspis citri most abundant pest of, in Louisiana, 282.
 fruit fly, in Malta, corr., 264.
 fruit worm, letter on, ref., 272.
 Orchard caterpillars in England, m., 296.
Orchelimum vulgare, m., 352.
Orchesia, host of *Meteorus orchesia*, ref., 249.
Orcus australasiae, attempted colonization of, 251.
 in confinement, 42, 43.

- Orcus chalybæus*, as enemy of red scale, 41.
 attempted colonization of, 251.
 description of early stages of, 42, 43.
 spp. imported to America, mm., 71.
- Orgyia antiqua*, in Massachusetts, ref., 213.
 definita, in Massachusetts, ref., 213.
leucostigma, in Massachusetts, ref., 213.
- Ormerod, Miss E. A., rev. of article by, 147.
 16th report, rev., 295.
- Orthezia insignis* as a garden pest, art., 89.
 food plants of, 247.
 on *Chrysanthemums*, mm., 121, 160.
- Orthopelma diastrophii*, bred from galls of *Rhodites radicum*, 343.
 luteolator, common in galls of *Diastrophus turgidus* and *Rhodites rosæ*, 343.
- Orthoptera, crops of, ref., 217.
 mouth-parts of, ref., 217.
- Osage orange pyralid, art., 155-158.
- Oscinid, reared from *Muhlenbergia*, 132.
- Oscinis variabilis*, in Minnesota, rev., 216.
- Osmia leucomelæna*, *Stelis minuta*, parasitic on, 208.
- Otioccephalus*, synopsis of, ref., 279.
- Otiorynchus ovatus*, habits of, 46, 47.
 on muskmelon, 99.
- "Overflow bug" or "Grease bug" in California, 342.
- Ox bot, see Bot.
 warble, or Ox bot, see Bot.
- Oyster-shell Bark-louse, enemy of, notes on, 362.
 see Bark-louse.
- P.
- Pachybrachys atomarius*, on Mesquite, 39.
- Pachyneuron* sp., reared from *Scymnus flavifrons*, 207.
- Pachypsylla*, spring forms darker, 227.
- Packard, A. S., art., 364.
 on transformations of *Saturniidae*, rev., 355.
- Painful spider bites, 348.
- Palma christi* vs. mosquitoes, 359.
- Palm weevil in British Honduras, notes on, 357.
 trapping and destroying, 357.
- Panchlora surinamensis*, evidently naturalized in this country, 268.
 in New Orleans, 201.
- Pandeletejus cinereus*, on Mesquite, 40.
hilaris, ref., 338.
- Panorpidæ, mouth-parts of, 162.
- Papilio machaon* (?) in Japan, 194.
troilus, abundant in November, 207.
turnus, *Trichogramma* parasite of, 126.
- Parasite of Pelican, 284.
- Parasites, hymenopterous, of Coleoptera, art., 247-251.
 of animals transmissible to man, rev., 273.
 of gall insects, notes on, 343.
- Parasitism, case of spurious, ref., 288.
 discussion of, ref., 287.
- Parexorista* sp. (?), breeding in acorn *Carpocapsa*, 135.
- Paris green, against codling moth, 73.
 analyses of fruit sprayed with, 1, 4.
 best remedy for Bud moth, 293.
 combined with Bordeaux mixture, 214.
- Paris green for potato beetle, first use of, 44.
 for sugar-beet web-worm, 322.
 growers reticent on use of on cabbage, 94.
 recommended for red turnip beetle, 289.
- Parker, W. J., statement on Cicada, 299.
- Parlatoria pergandii*, introduction of, 282.
 proteus, introduction of, 282.
 sp., on *Anthurium lanceolatum*, 159.
- Parasit web-worm, article on, 106-109.
- Pastures, Grasshoppers injurious to, 324.
- Pea attacked by Leaf-eating pea-weevil in England, m., 296.
 weevil, first larval stage of, 204.
 in Canada, ref., 1.
- Peach attacked by *Heliothis armiger* in Cape Colony, 295.
 tree borer, irrigation against, 79.
 Under-wing of the Cape = *Heliothis armiger*, 295.
- Pear-blight beetle, in Tasmania, ref., 216.
 leaf blister-mite, in Canada, ref., 1.
 see Mite.
 midge, found in New Jersey, 94.
 slug, in Tasmania, ref., 216.
 tree *Psylla*, art., 226-230.
 = *Psylla pyricola*.
- Pemphigus attenuatus*, notes on, 237.
 rhois, tannin in gall of, 145.
- Pentaria trifasciata*, living on Chermes, 135.
- Pentarthrinus*, synopsis of, ref., 279.
- Peridroma demutabilis*, n. sp., 328.
- Periodical cicada, the present year's appearances of, art., 298.
- Periperus*, rediscovery of, 140.
- Perperus* sp., bud curculio of Tasmania, ref., 216.
- Perris, Ed., m., 340.
- Phædon betulæ* in England, m., 296.
cochleariæ, in England, 278.
- Phædrotoma sanguinea*, parasitic on *Trypeta electa*, 135.
- Phæsim, in insects, 61.
- Phalangium dorsatum*, synonym of *P. vittatum*, 284.
vittatum, habits of, rev., 284.
- Phidippus orpifex*, *Sarcophaga*, n. sp., feeding on eggs of, 24.
- Phlæodes diabolicus*, food habits of, 35.
- Phlæosinus cristatus*, injuring cypress hedges, 262.
- Phlæothrips nigra*, on clover in Iowa, 113.
- Phlæotribus frontalis*, *Euphorus phlæotribi* reared from, 249.
- Phora*, spp., parasitic on *Cimbex*, 5.
- Phorodon mahaleb*, destroyed by snail, 129.
- Phoxopteris, near *fragariæ*, on blackberry, 96.
- Phylloxera*, grape, letter on, ref., 272.
 in South Africa, ref., 4.
- Phymatodes obscurus*, on live oak, 34.
- Phyrdenus*, synopsis of, ref., 279.
- Phytonomus punctatus*, destructive appearances of, 99.
 in New Jersey, 98.
 westward spread of, 279.
- Phytoptus*, n. sp., on plum, 16.
 pruni (probably), injuring plum, m., 17.
 pyri, article on, 104; mm., 349.

- Phytoptus pyri*, in Canada, 125.
remedies against, 104, 105.
- Picus villosus*, feeding on parsnip web-worm, 107.
- Pieris*, native and imported, about Washington, 99.
rapæ (?), in Japan, 194.
in New Jersey, 94.
Pteromalus puparum checking, 126.
Sarcophaga bred from, ref., 23.
scarcity in Iowa, 112.
- Pigeon, parasite of, art., 77-78.
- Pigmy mangold beetle in England, m., 296.
- Pimpla ellopiae*, parasite on Vancouver Island oak-looper, 289.
- Pin-borer, sugar-cane, circular on, 51.
sugar-cane, ref., 53.
- Pionea rimosalis*, on cabbage about Washington, m., 99.
- Piophilæ casei*, bred from ham, 135.
in Kansas City, Mo., 116.
- Pityophthorus digestus*, on *Rhus integrifolia*, m., 36.
- Planchonia pustulans*, on *Cupania edulis*, 245.
- Plant-bugs, injuring oranges in Florida, 264.
fauna, notes on, art., 117-121.
lice, insecticides for, 73.
parasitism of *Leucopis* on, 279.
remedies for, 74; ref., 6.
- louse, coloring matter of, 49.
gall, tannin in, 145.
galls, on trees and vines, ref., 214.
hop, in Washington, 60.
new, infesting orange, m., 17.
new, on cherry, 16.
on strawberry, m., 17.
undeterminable, infesting orange, 18.
- Platinus maculicollis* in houses, 342.
- Platydemæ oregonense*, on *Cryptoporus obvolutus*, 133.
- Platypus compositus*, on orange, m., 17.
- Pleistodontes imperialis*, Australian fig insect, ref., 63.
- Pleonectyptera finitima*, n. sp. descr., 333.
spp., variability of, 333.
- Plochionus timidus*, enemy of fall web-worm, ref., 134.
- Plum Curculio*. See *Curculio*.
- Plusia brassicæ*, on cabbage about Washington, m., 97.
cabbage, in Oklahoma, bull., ref., 148.
gamma, on clover in England, m., 296.
- Plutella cruciferarum*, in Iowa., ref., 66.
in Iowa, 112.
in New Hebrides, ref., 214.
on turnip, m., 296.
- Podacanthus wilkinsoni*, injuring trees, ref., 64.
- Pæcilopectera pruinosa*, on Osage orange, 155.
- Polistes aurifer* supposed parasite of, 40.
habits of *Xenos* parasite of, 133.
- Pollenia rudis*, a household pest, 263.
- Pollination of yucca, art., 300.
- Polyborus cheriway*, enemy of *Lucilia macellaria*, 269.
- Polycæon confertus* on live oak and almond, 34.
stoutii, food-plants of, 33.
- Polychroma* sp., parasite on *Chrysobothris* sp., 141.
- Polygnotus*, reared from *Muhlenbergia*, 132.
- Polygraphus rufipennis*, believed to have been destroyed by enemies, 188.
- Porthetria japonica*, see Gypsy moth, Japanese.
- Potassium iodide, for bee stings, ref., 62.
- Potato-beetle, Colorado, disappearance of, in South Carolina, 50.
Paris green for, first use of, 44.
remedies for, ref., 6.
scarcity in Iowa, mm., 112.
scarcity in Missouri, 135.
- bug, different species known by this name, 261.
quails destroying, 143.
moth, destroying tobacco, ref., 214.
tuber moth, art., 163-164; m., 291.
- Potter, T. I., on banana borer, ref., 356.
- Potter wasp, see Wasp.
- Praon chenopodiaphidis*, bred from *Aphis rumicis*, 141.
- Prionus californicus*, on live oak, 34.
root-borer, ref., 39.
- Proconia undata*, cause of "Weeping tree," 204.
compared with *Homalodisca*, 151.
- Proctotrypid, parasite of *Ellopia somnariæ*, 126.
parasitic on *Mamestra picta*, 126.
- Proctotrypidæ, bred species of, 250.
- Prodoxus*, species of, 306.
ænescens, 307.
cinereus, 306.
technical description, 307.
coloradensis, description of, 306.
intermedius, compared with other species, 307.
intricatus, description of, 308.
pulverulentus, larvæ found in seed-pods of *Yucca whipplei*, 311, 312.
reticulatus, 306.
- Promecotarsus* n. g., synopsis of, ref., 279.
- Pronuba*, maxillary tentacles of, art., 161-163.
maculata, larvæ found in seeds of *Yucca whipplei*, 311, 312.
peculiarities of, 301.
pollinating *Yucca*, 300.
variety *aterrima*, 304.
var. *aterrima*, pollination by, 304.
Yucca whipplei pollinated by, 301.
synthetica, habits of, 304.
pollination by, 305.
yuccasella, occurrence of, 310.
on Pacific coast, 304.
pollination by, 304.
- Protoparcæ celeus*, parasitised by *Apanteles congregatus*, 289.
cingulata, on sweet potato, 349.
- Pseudococcus* n. sp., on orange, 202.
yuccæ, on *Yucca whipplei*, 312.
- Pseudo-galls, on *Desmanthus*, 286, 287.
- Pseudopentarthrum*, synopsis of, ref., 279.
- Psœa 4-signata*, on grape, 34.
- Psocidæ*, Edward Burgess's work on, ref., 205.
- Psylla*, pear-tree, art., 100-103; 226-230.
in New York, 200.
kerosene emulsion for, m., 73.

- Psylla argyrostigma*, considered the winter form of *Ps. simulans*, 228.
 pyri=*Ps. pyricola*.
pyricola, articles on, 100-103; 226-230.
 life-history of, 226.
 notes on, 200, 201.
 remedies, 101.
 seasonal dimorphism in, 227.
simulans, compared with *pyricola*, 201.
 supposed form of *pyricola*, 101.
 supposed winter form of *Ps. pyricola*, 227.
- Psyllidæ*, penis of, 230.
Psyllobora galbula, in confinement, 42.
 20-maculata. *Homalotylus obscurus*, parasitic on, 249.
- Pteromalid*, reared from *Muhlenbergia*, 132.
Pteromalus puparum, bred from *Pyrameis caryæ*, 141.
 check on *Pieris rapæ*, 126.
- Pthia picta*, new enemy of tomato, 282.
Ptychodes trivittatus, reported on fig. 18.
 vittatus, remedies against, 365.
- Publilia bicinctura*, on *Iva* and *Glycyrrhiza*, 92.
 concava, food-plants of, 92.
 modesta, food-plants of, 92.
- Pulex*, transmitter of disease, ref., 273.
Pulvinaria camellicola, introduced from Japan, 282.
 cupaniæ, notes on, 159.
 on *Bignonia magnifica*, 246.
 innumerabilis, injuring osage orange, etc., 155.
 kerosene emulsion against, 103.
- Pumpkin beetle, banded, in Australia, ref., 214.
- Pyralid*, Osage orange, art., 155-158.
 in Missouri, 125.
 paper on, ref., 134.
- Pyralidina*, Hulst collection of, 51.
- Pyrameis caryæ*, *Pteromalus puparum* bred from, 141.
- Pyrethro-kerosene emulsion*, ineffectual against rose-chaffer, mm., 94, 98.
- Pyrethrum* for Red-legged flea-beetle, 337.
- Pyromorphid* moth, on sugar-cane in Fiji Islands, 270.
- Pyrota postica*, on creosote bush, 40.
- Pyrrharctia isabella*, said to forecast weather, 352.
- Q.
- Quails vs. potato bugs, 143.
Quassia chips vs. kerosene emulsion, 61.
Quedenfeldt, F. O. G., obituary of, 211.
- R.
- Rabbit bot. see Bot.
 flea, remarks on structure of, 288.
- Ragonot, E., on *Ephestia kuehniella*, ref., 353.
- Railliet, A., rev. of paper by, 273.
- Ranassa calva*, on oranges in Florida, 265.
- Raphiomidas*, deserving of family rank, 280.
- Rascal leaf-crumpler, destructive in Texas, 50.
- Rass, W. F., statement on cicada, 298.
- "Raufo," *Lita solanella* on in New Zealand, 163.
- Rear-horse, female vs. male, 145.
- "Red bug," local signification of term, 271.
- Red-legged flea-beetle, art., 334.
 character of attack, 335.
- Red-legged flea-beetle, conclusions, 340.
 distribution, 340, 341.
 food-plants of imago, 340.
 injuring orchard trees, 334.
 jarring effective against, 337.
 literature, 340.
 outbreaks of, 341.
 Reduviid parasite of, 338.
 remedies used, 337.
- Red spider in England, m., 293, 296.
 turnip beetle in Canada, m., 289.
 Paris green recommended for, 289. =
- Reduviid, parasitic on Red-legged flea-beetle, 338.
- Rhagium lineatum*, *Bracon simplex* bred from nests of, 248.
- Rheumatism cured by bee stings, 353.
- Rheumatobates*, compared with *Metrobates*, 193.
 rileyi, article on, 189-194.
 description of imago, 190.
 description of larva, 193.
 remarks on, 146.
- Rhina barbirostris*, mm., 357.
 nigra, mm., 357.
- Rhinocnus inconspiculus*, reported in this country, 271.
- Rhizobius*, attempted colonization of, 251.
 debilis, Encyrtine reared from, 207.
 ventralis, *Homalotylus* sp. reared from, 207.
- Rhizophagus* sp., biologic note on, 38.
- Rhodites radicum*, *Orthopelma diastrophii* bred from galls of, 343.
 rosæ, *Orthopelma luteolator* in galls of, 343.
 (?) utahensis, gall-maker on roots of *Rosa blanda*, 343.
 vernalis, *Tetrastichus* sp. from galls of, 343.
- Rhopalophora longipes*, supposed host of *Helcon dentipes*, 248.
- Rhopalosiphum nymphæ*, food-plants of, 236.
- Rhynchophora*, new species and genera of, rev., 278.
- Rhynchophorus cruentatus*, attacking palmetto, 357.
 palmarum, 357.
 see Palm weevil.
- Rice, Mrs. M. E., quoted, 352.
- Riley, C. V., quoted, 352.
- Roaches in Brazil, 265.
- Robin, food of, rev., 148.
- Robinia pseudacacia* attacked by Red-legged flea-beetle, 334.
- Robson, John W., statement on Cicada, 300.
- Rodolia iceryæ*, m., 295.
- Roller-worm, destructive appearance of, 196.
- Root-borers, irrigation not useful against, 80
 knots on trees and vines, rev., 214.
 louse, woolly, in Tasmania, ref., 216.
 maggots, of cabbage, etc., 124.
 on cabbage and cauliflower, 94.
- Rosa blanda*, *Rhodites* (?) utahensis, gall-maker on roots of, 343.
- Rose chafers, alum for, notes on, 358.
 experiments on, in New Jersey, 94, 95.
 pyrethro-kerosene emulsion against, m., 94, 98.
- Iceerya*, see *Iceerya rosæ*.
 saw-flies, in United States, art., 6.

- Rose saw-flies, in United States, art., 6.
in U. S., mm., 117.
slug, American, habits of, 10.
illustrations of, 273.
worm, bristly, art., 6.
bristly, habits of, 11.
coiled, habits of, 11.
- Ruffin, Edw., quoted, 327.
- Russell, F. W., quoted, 351.
- Russian moth, local name of *Anthrenus scrophulariæ*, 271.
- S.
- Sabal serrulata food of *Rhynchophorus errentatus*, 357.
- Saddle-back caterpillar, on *Helianthus*, 203.
- Salt, as insecticide, 74.
- Sannina exitiosa, irrigation against, 79.
- Saperda calcarata, damaging poplar in Ohio, 54.
mœsta, on *Populus* and *Salix*, 82.
- Sapsucker, enemy of bollworm, 242.
- Sarcophaga, bred from *Pieris rapæ*, 23.
hosts of, 23.
transmitter of disease, ref., 273.
cimbicis, bred from *Cimbex*, ref., 23.
davidsonii, n. sp., description, 24.
helicis, bred from snail, ref., 24.
lineata, preying upon locusts, ref., 23.
opifera, n. sp., description, 22.
sarraceniæ, feeding habits of, 24.
sp., parasitic on *Cimbex*, 5.
wohlfarti, supposed parasite on man, 36, 37.
- Sarcopsylla penetrans, transmitter of disease, ref., 273.
- Sarcoptes scabiei, skin disease of, 283.
- Sarcoptidae, transmitters of disease, ref., 273.
- Saturnia arnobia, curious chrysalis of, 131.
- Saturniidae, believed to be a closed type, 355.
transformations of, rev., 355.
- Saul, John, paper, rev., 365.
- Saw-fly, a new sweet potato, art., 24-27.
imported currant, parasite of, 126.
imported willow, parasitised by *Trichogramma* sp., 289.
larva in currant stems, m., 18.
stem-borer on *Rubus*, 95.
willow, in Nebraska, 195.
willow, parasites of, ref., 5.
- Saw-flies in United States, mm., 117.
rose, illustrations of, 273.
in United States, art. 6.
remedies for, 11.
- Say, Thomas, life of, ref., 133.
- Scabies norvegicum, disease produced by *Sarcoptes scabiei*, 283.
- Scale, black, Australian enemies of, 41-43.
Thalpochares cocciphaga versus, 55.
chaff, introduction of, 282.
not yet established in California, 281.
Egyptian fluted, *Vedalia* against, 50.
Florida red, introduction of into Calif., 282.
greedy, in Australia, ref., 214.
long, introduced from Florida into California, 282.
not yet established in California, 281.
manna, note on, 286.
n. g. et n. sp., on Mesquite, ref., 65.
- Scale, pernicious=San José scale.
purple, introduced into California from Florida, ref., 282.
not yet established in California, 281.
red, Australian enemies of, art., 41-43.
new parasite of, 267.
on palms, ref., 159.
- San José, appearance in Australia, m., 282.
California remedy for, 280.
Chilocorus bivulnerus, against, 53.
said to be introduced from Chile, 282.
in Australia, ref., 214.
reported poisonous, 203.
Symnus lophanthæ, preying on, 128.
soft peach, in New Mex., ref., 65.
wax, introduction of, 282.
yellow, introduced from Japan, 281.
- Scales, imported, in California, 281, 282.
- Scale-insect, new, on grape, 19.
on Karoo bush, 210.
on orange, m., 19.
on strawberry, m., 17.
- Scale-insects, art. on, rev., 362.
- Australian parasites, reared from, 207.
from Antigua, ref., 52.
in New Mexico, rev., 65.
Jamaica, food-plants of, 158-160.
new enemies of, 140.
not poisonous, 203.
of California, ref., 75.
on orange in Bermuda, 203.
remedies for, 74.
parasitism of *Leucopis* on, 279.
- Schinia intrabilis, n. sp., 331.
ligæa, n. sp., 331.
- Schistocerca peregrina attacked by *Lachnifium acridiorum*, 359.
changes of color in, 56.
- Schizax senex, on apricot, 39.
- Schizocerus ebenus, on sweet potato, ref., 24.
privatus, on sweet potato, art., 24-27.
- Schlechtendal, D. H. R., von, rev. of art. by, 140.
- Schneider, Dr., quoted, 361.
- Schomburgk, Sir Robert, concerning disease of cocconut, 314.
- Sciapteron tricolorata, biologic notes on, 82.
- Scolytid, on sugar-cane, ref., 65.
- Scolytidae, parasitic, paper on, ref., 288.
biologic notes on, ref., 212.
enemies of, rem., 146.
- Scolytus rugulosus, *Eupelmus* sp. reared with, 250.
- Scorpion, local name of *Diapheromera*, 271.
- Scotogramma densa, n. sp., 329.
- Scott, A. W., m., 354.
- Scott, John, rem., 362.
- Screw-worm, attacking a boy, 265.
fly, enemy of, 269.
in Louisiana, ref., 5.
- Scudder, S. H., 283.
rev. of article by, 275.
"Songs of our grasshoppers and crickets," rev., 364.
- Scymnus, Australian, in California, art., 127.
fagus, compared with *S. lophanthæ*, 128.
flavifrons, *Pachyneuron* sp., reared from, 207.

- Seymnus lophanthæ*. established in California. 127.
 restitutor. importation of. ref., 127.
- Scyphophorus acupunctatus*. on grape. 35.
 yuccæ, on *Yucca whipplei*. 35, 311, 312.
- Seed-pod. curious deformation of. 286.
- Selandria rubi*. in New Jersey, 96.
- Semasia n. sp.*. on apple. m., 17.
- Semiotellus chalcidiphagus*. parasite of wheat stem pest. mm., 90.
nigripes = *Entedon epigonus*. 72.
- Serica anthracina*. on plum. 350.
- Sericaria mori*. silk gut from. mm., 48.
- Sharpshooter. glassy-winged. remedies for. art., 150-154.
- Sheep scab. kerosene emulsion. ref., 5.
- Shaffer, J. M., notes on tarantula in confinement. 366.
- Shimer, Henry. letter. 344.
- Shuford, F. B., statement on Cicada. 299.
- Silk-covered walnut. note on. 141.
 gut. from native silk worms. 48.
 of spiders. rev., 210.
 utilization of spider. 347.
 worms. native, silk gut from. 48.
- Silpha lapponica*. food habits and distribution of. ref., 287.
- Silvanus cassiæ*. in Maryland. ref., 2.
 rise in temperature of middlings caused by. 2.
surinamensis. in Maryland. ref., 2.
- "Silvertop." due to several insects, 124.
 due to Thrips. 127.
- Silver Y-moth on clover in England. m., 296.
- Simplosis dolichogaster*. a *Gracilaria* parasite, mm., 136.
- Simulium*. transmitter of disease. ref., 273.
 in New Mexico. 61.
 occidentale. dispersed by irrigation. 81.
- Sinea diadema*. feeding on *Lema nigrovittata*. mm., 35.
- Siphonaptera, a valid order. m., 288.
- Siphonophora *geranii*. apparently identical with species on *Ostrya*. 236.
granaria in England. m., 293.
 on wheat. m., 296.
rudbeckiæ. coloring matter of. 49.
 sp., on hop hornbeam. 236.
- Sitodrepa panicea*. damaging gun wads. 269.
 food-plants of. 33.
 living in chocolate. 268.
- Sitones lineatus* in England. m., 296, 341.
- Slingerland, M. V., bulletin 50, Cornell Station. rev., 293.
- Slug. Indexed under pear slug, dose slug, etc.
- Smicronyx*, synopsis of. ref., 279.
- Smilia camelus*. food-plants of. 92.
- Smith, G. B., statement on Cicada. 298.
- Smith, J. B., Death Valley Noctuidæ. notice. 297.
 on rose chafer. ref., 358.
- Smuts. in herbarium. destroyed by *Lathridius niliformis*. 203.
- Snail broken-tail. injurious in Bermuda. 269.
- Snow flea. swarming of. m., 202.
- Snowia*. notes on genus. ref., 260.
- Soapsuds for cabbage lice, ref., 62.
- Soldier bug. also called huckleberry bug. 271.
 Soldier bug as enemies of boll worm. 242.
 green. on sweet potatoes. 261.
- Southern corn-root worm. m., 296.
- Spalangia*. synopsis of. ref., 288.
- Span-worm. new. on apple trees. m., 17.
 on plum. 18.
- Sparrow. clipping, as insect destroyer. 266.
 English. favorable note on. 349.
 vs. horse bot-fly. 342.
- Sparthocerus diffusus*. on grape. m., 17.
- Species. what constitutes a. 352.
- Spermophagus robiniæ*. on *Gleditschia triacanthos*. 106.
- Spermophilus 13-lineatus*. insectivorous. 5.
- Sphænothecus suturalis*. on Mesquite. 39.
- Sphenophorus ochreus*. in Iowa. 112.
 in Iowa bull., 66.
parvulus. destructive in Iowa. 112.
 in Iowa bull., 66.
 sp., on sugar-cane. 277.
- Sphingicampa bicolor*. on *Gymnocladus canadensis*. 204.
- Sphinx tobacco. remedy for. 275.
 catalpæ. eaten by birds. 350.
- Spider bites. painful. 348.
 red. kerosene emulsion for. m., 73.
Sarcophaga davidsonii feeding on. 24.
 silk. utilization of. 347.
- Spiders. degeneration by disuse of organs of. rem., 288.
 silk of. rev., 210.
 tame. correspondence on. 202.
 web. remarks on. 212.
- Spilochalcis marizæ*. from cocoons of *Attacus cyathia*. 350.
- Spondylaspis*. note on genus. 219.
- Spotted bean beetle. note on. 356.
- Sprayed fruits. analyses of. refs., 1, 3.
- Spraying and spraying materials. in Tasmania handbook, ref. 217.
 article on. ref., 66.
 for fruit insects. ref., 273.
 legislation against. 272.
 machines. exhibition of. 272.
 pump. a cheap. ref., 5.
 see also arsenic. arsenicals. etc., 1.
 see also arsenites. ref., 1.
 with arsenites vs. bees. art., 121-123.
- Spring-tails. a swarm of. 202.
- Squash borer. egg-laying of. 97.
 notes on biology of. 85.
 see also *Melittia ceto*.
 bug. immersion against. 81.
 kerosene emulsion against. 81.
- Stable fly. as transmitter of contagious diseases. 273.
- Stagmomantis carolina*. female vs. male. 145
Sarcophaga bred from. 23.
- Stainton, H. T., obituary of. 286.
- Stalk-borer. tomato, damaging cotton. 50.
- Stelis minuta*. parasitic on *Osmia leucomelaena*. 208.
 parasitism of genus on *Osmia*. 208.
- Stictiocephala inermis*. food-plants of. 92.
 injuring peach. m., 19.
lutea. on wheat. mm., 92.

- Stictocephal* *marmorata*, on mesquite, mm., 92.
Stomoxys calcitrans, in New Jersey, m., 111.
 transmitter of disease, ref., 273.
 Stony acorn gall, caused by cynipid, 196.
 Strawberry crown-borer, *Catolaccus* possibly parasitic on, 250.
 crown girdler, name of *Otiorynchus ovatus*, 46.
 leaf beetle, in England, m., 296.
 weevil, m., 293.
 article on, 167-186, see also Weevil.
 Straw-worm, wheat, in Kansas, 115.
 "Strig Maggot" (*Cecidomyia* sp.), on hop in England, m., 296.
 Strongylidæ, parasitic family, m., 346.
 Stylogaster, notes on genus, ref., 280.
Syneta ferruginea, ref., 338.
 Syngamosis, see gapes.
Syngamus trachealis, cause of gapes in fowls, 346.
 Sugar-beet webworm, art. on, 320.
 cane borer, in Fiji Islands, 270.
 irrigation against, 80.
 small, ref., 65.
 cane pests, in West Indies, ref., 52.
 pin-borer, notes on, 277.
 relation of cane disease to, 51.
 Sulphur, as insecticide, 74.
 Sweet potato root weevil, in Louisiana, 261.
 sawfly, new, art., 24-27.
- T.
- Tabanidæ, new genus and species, 59.
Tachardia gemmifera, new lac insect, 140.
 Tachinidæ, four hundred and fifty genera of, 238.
 Tachytes, monograph of genus, rev., 149.
Tamarix mannifera, probably identical with *T. gallica*, 286.
 Tanner, J. Edward, ref. to article by, 65.
 Tannin in sumach plant-louse gall, 145.
 Tarantula in confinement, food of, 366.
 Telamona, food-habits of species, 93.
 Tenebrionid, injuring peach and plum, 18.
 Tenebrionidæ, myrmecophilous, ref., 143.
 Tent caterpillar, apple tree, in Nebraska, m., 195, ref., 213.
 compulsory destruction recommended, 213.
 expts. against, ref., 3.
 in Massachusetts, 276.
 on hop in Washington, 50.
 remedies for, ref., 6.
 Teras pastiana, on Osage orange, m., 155.
 Termites, do they cultivate fungi? ref., 134.
 in fruit trees, remedies for, 201.
 Tersesstes n. g. torrens n. sp., blood-sucking gnat, 279.
Tetraneura graminis, on *Leersia virginica*, 237.
 ulmi, notes on, 237.
Tetranychus n. sp., on lemon, m., 18.
 telarius in England, m., 293.
 tiliarum in England, m., 296.
Tetrastichus sp. from galls of *Rhodites vernalis*, 343.
 sp., probably a secondary parasite, mm., 135.
 Texas horn fly, erroneous name of horn fly, 145.
 flies, newspaper account of, 144.
 fly, erroneous name of horn fly, 145.
 Texas, further on chicken plague in, 348.
Thalpocharis ?, enemy of scale-insect, 140.
 cocciphaga, attempted introduction of, 252.
 Bracon sp. bred from, 141.
 Cryptus and Bracon bred from, 207.
 larval habits of, 55.
 Thelia, food-habits of species, 93.
 Thompson, E. H., rev. of art. by, 216.
Thricolepis inornata, on prune, 18.
 Thripidæ, in greenhouses, 124.
 Thrips, attacking onions, 127.
 clover=*Phleothripa nigra*.
 possibly causing "silver top," 124.
 tritici, cause of "buttoning" on strawberries, raspberries, etc., 126, 127.
 undescribed on orange, m., 18.
Thrinopyge alacris (?), biologic notes on, 38.
 Thymo-cresol, as insecticide, 74.
Thyridopteryx ephemeraformis, in Kansas, 116.
Thysanocnemis, synopsis of, ref., 279.
Ticida cingulata, on *Yucca whipplei*, 312.
 Tick, cattle. affecting horses, 267.
 remedy for, 267.
 dog, transmitter of disease, 273.
 in Leeward Islands, 146.
 Tiger, webworm, enemy of fall webworm, ref. 134.
 Timothy, damaged by thrips, 127.
 Tineid, on sugar cane in Fiji Islands, 270.
Tithorea flavescens, description of, ref., 65.
 Tityrus butterfly attracted to light, 355.
Tmetocera ocellana, rev., of bulletin on, 293.
 Toad, dipteran infesting eye of, 209.
 Toads and fowls. vs. garden insects, 256.
 Tobacco, as insecticide, 74.
 Sphinx, "jimpson weeds," remedy for, 275.
 Tomato worm on sweet potato in Leeward Islands, 349.
 parasitised by *Apanteles congregatus*, 289.
 Torcel, hominivorous bot, 3.
Tortrix cerasivorana, n., 351.
Torymus rudbeckiae, from *Cecidomyiid* gall on *Desmodium acuminatum*, 343.
 Townsend, C. H. T., rev. of articles by, 279, 282.
Tragidion armatum, biologic notes, 39.
 larvæ in flower stalks of *Yucca whipplei*, 311, 312.
Tragocephala infuscata in northwest Missouri, 323.
 viridis in northwest Missouri, 323.
 Trap crop, for bollworm, 48.
Trapezonotus n. sp., injuring fruit trees, 18.
 Trelease, Wm., quoted, 303, 305.
 report of Missouri Botanical Garden, 302.
 trip to study Yuccas, 302.
Trichobaris trinotata, bred from *Solanum carolinense*, 135.
Trichogramma pretiosa, parasitic in eggs of zebra caterpillar, 289.
 sp. parasitic on currant sawfly, 289.
 on *Mamestra picta*, 126.
 on *Nematus ribesii*, 126.
 on *Papilio turnus*, 126.
Trigona, curious defenses constructed by, ref., 288.
 Trimen, Roland, m., 295.

- Trinidad Field Naturalists' Club, journal of, rev., 65.
- Trioxa tripunctata*, annual generations of, 227.
- Trirhabda luteocincta*, on *Artemisia californica*, 35.
- Trissolcus murgantiae*, parasite of cabbage bug, 138.
- Tristyla*, n. gen., 332.
alboplagiata, n. sp., 332.
- Trombidium*, larval, transmitter of disease, ref., 273.
or Mexican jigger, 211.
- Trullula sacchari*, name proposed for cane-fungus, 52.
- Trypeta electa*, on *Solanum carolinense*, 135.
pomonella, apple maggot, m., 264.
- Tsété fly, transmitter of disease, ref., 273.
- Turkeys vs. garden insects, 257.
- Turnip aphid in England, m., 293.
beetle, red, injuries by, 1, 2.
moth, diamond-back, in Iowa, ref., 66.
- Tussock-moth, imported, in Massachusetts, ref., 213.
white-marked, in Massachusetts, ref., 213.
willow, in Massachusetts, ref., 213.
- Tychius* synopsis of, ref., 279.
semisquamosus, *Bracon* sp. bred from, 141.
- Tyloderma foveolatum*, *Catoloccus tylodermae* bred from, 250.
fragariae, possibly parasitized by *Catoloccus tylodermae*, 250.
- Typha angustifolia*, *Lita solanella* on, 163.
- Typhlocyba rosea*, on apple, m., 18.
vitifex, irrigation against, 78.
- Typephorus canellus*, hibernation of, m., 336; ref., 338.
- Tyroglyphus longior*, in hay, m., 266.
malus, in France, 362.
- Twig girdler, in Oklahoma bull., ref., 148.
- U.
- Univorous class of insects, defined, 120.
- Urquhart, A. T., ref. to art. by, 64.
- Utilization of spider silk, 347.
- V.
- Valgus canaliculatus*, notes on, 53.
squamiger, notes on, 53.
- Vancouver Island Oak-looper, parasitized by *Pimpla ellopiae*, 289.
by *Telenomus* sp., 289.
- Vanduzee*, food-habits of species, 93.
- Vedalia cardinalis*, colonization of, 139.
establishment of, in California, m., 127.
importations of, 142.
success in Egypt, 50.
wanted for use against mealy bug, 60.
n. sp., preying upon *Icerya purchasi*, 71.
- Vegetarian mosquito, another, 345.
- Ver macaque, local name of human bot., 59.
under skin of man, 3.
moyocuil, hominivorous bot., ref., 3.
- Vermineous tracheobronchitis, see Gapes.
- Vine, *Chaerocampa celerio* on, 277.
- Vineyards, an intruder in, 343.
- Vinson, A., on spiders, quoted, 347.
- Vinsonia stellifera*, food-plants of, 160.
on *Achras sapota*, 159.
- W.
- Walking-stick, damage by, 268.
damaging forest trees, ref., 63.
insect destroying forest trees in Australia, ref., 63.
locally known as scorpion, 271.
Sarcophaga bred from, 23.
- Walnut caterpillar, in Nebraska, m., 195.
- Washburn, F. L., on Codling Moth, and Hop Louse in Oregon, rev., 292.
- Wasps, fossorial, systematic work on, ref., 149.
potter, enemy of parsnip web-worm, 107.
- Water bug, an interesting art., 189-194.
- Wax moths, in a cupboard, 260.
- Weather, insects said to forecast, 352.
- Webster, F. M., bulletins 45 and 46, Ohio station rev., 296.
- Websteria tritici*, breeding habits of, 90.
- Web-worm, fall, abundance in Canada, 125.
enemy of, 134.
in Canada, ref., 62.
in Massachusetts, ref., 213.
might be controlled by irrigation, 80.
garden, damage by, 55.
eaten by striped gopher, ref., 5.
of the sugar beet, 320.
- "Weeping tree," *Proconia undata* causing, 204.
- Weevil, bean, American, rev., 133.
article on, 86, 87.
nomenclature and oviposition of, art., 27-33.
black, in grain, ref., 2.
clover-leaf, in Ohio, 54.
westward spread of, 279.
in mullein seeds, 261.
pea, compared with bean weevil, 86.
rice, in Maryland, ref., 2.
strawberry, article on, 167-186.
= *Anthonomus signatus*, 175.
covering beds as a preventive against, 183.
differences in individuals due to food-plants, 175.
egg of, 177.
habits of adults, 180.
in Delaware, ref., 217.
injuries of, 167-170.
larva of, 178.
life history of, 177, 181.
on blackberry, 172.
oviposition of, 177.
parasites and natural enemies, 181.
past history, 167.
probably single-brooded, 179.
pupa of, 179.
remedies against, 182.
trap crops for, 183.
wild food-plants of, 174.
work of, 170-174.
work on different varieties of plants, 173.
- Weevils, protecting corn from, ref., 272.

Western blister beetle, extraordinary abundance in Canada, 289.

Westwood, J. O., obituary of, 285.

Wheat-head worm, in Kansas, 115.
stem maggot, in Canada, ref., 62.
stored, *Gelechia cerealella* injurious to, 325.

Wheeler, W. M., dissertation on insect embryology, rev. of, 351.

White fly, local name for *Aleyrodes citri*, 224.
grubs in Ohio, m., 296.
article on, ref., 75.
fungus diseases of, 70.
pest of sugar cane in Queensland, 45.

Whitehead, Charles, insects injurious to crops in England, rev., 293.

Wickham, H. F., rev. of article by, 143, 271.

Wielandy, J. F., ref., 356.

Wilcox, E. V., rev. of article by, 148.

Williston, S. W., rev. of articles by, 280.

Willistonina bicincta, characters of, 239.
esuriens, characters of, 239.

Willistonidae, characters of family, 239.

Wireworms, arsenical poisons useless against, mm., 73.
in Ohio, m., 296.
plowing against, 74.
remedies experimented with, 74.

Woodpecker, hairy, feeding on parsnip web-worm, 107.
red cockatoo, enemy of boll worm, 242.

Wren, house, as insect destroyer, 266.
destroying tent-caterpillars, 266.

X.

Xenos, habits of, 133.

Xiphidium ensiferum, m., 352.

XO dust, as an insecticide, m., 73.

Xyleborus, males of, rev., 134.
dispar, injuring fruit trees, 17.
perforans, notes on, 277.
relation of cane disease to, 51.

Xyleborus "piceus" = *pubescens*, 51.
pubescens, correction, 51.

Xylocopa, *Monodontomerus* parasitic on, 141.

Xylomiges, revision of, ref., 140.

Xylotrechus nauticus, biologic notes on, 34, 35.

Y.

Yellow-legged clover weevil in England, m., 296.
fever fly, transmitter of contagion, mm., 210.

Yuca baccata, pollinated by *Pronuba yuccasella*, 304.
brevifolia, pollinated by *Pronuba synthetica*, 304.
clata, pollinated by *Pronuba yuccasella*, 304.
insects and yucca pollination, art., 300.
conclusions concerning, 308.
pollination, conclusions concerning, 308.
rupicola pollinated by *Pronuba yuccasella*, 304.
whipplei, capable of certain amount of self fertilization, 302.
description of, 301, 311.
distribution of, 311.
floral characteristics of, 302.
insects found upon, 312.
insects visiting flowers, 301.
on the pollination of, in California, art., 311.
pollinated by *Pronuba maculata*, 312.

Yuccaborus, synopsis of, ref., 279.

Z.

Zebra caterpillar, food-plants of, 125, 287.
in Canada, ref., 62.
on Pacific coast, 287.
parasitised by *Telenomus* n. sp., 289.
Trichogramma pretiosa, 289.

Zeuzera pyrina, not abundant in Europe, 204.

Zygana minor, phæism in, 61.

Zygops, synopsis of, ref., 279.

*LIST OF THE PERSONS ENGAGED IN GOVERNMENT ENTOMOLOGICAL
WORK.*

The following list embraces those now engaged in Government entomological work. The force of the Division of Entomology is more or less inconstant, as it consists of both permanent and temporary employés. Illustrations to this Bulletin, where not otherwise stated, are drawn by Miss Lillie Sullivan, under supervision.

DIVISION OF ENTOMOLOGY, U. S. DEPARTMENT OF AGRICULTURE.

Entomologist: C. V. Riley.

Office Staff: L. O. Howard, First Assistant; E. A. Schwarz, Th. Pergande, C. L. Marlatt, F. H. Chittenden, W. H. Ashmead, Assistants.

Field Agents: Herbert Osborn, Ames, Iowa; Lawrence Bruner, Lincoln, Nebr.; D. W. Coquillett, Los Angeles, Cal.; Albert Koebele, Alameda, Cal.; Frank Benton, Detroit, Mich.

DEPARTMENT OF INSECTS, U. S. NATIONAL MUSEUM.

Honorary Curator: C. V. Riley.

Aid: Martin L. Linell.

To bibliographers: Editorial or unsigned articles or notes should be accredited to Riley and Howard, where it is desired to give personal credit.

DATES OF ISSUANCE OF THE NUMBERS OF INSECT LIFE, VOLUME V.

No. 1 issued September 27, 1892.

No. 2 issued November 21, 1892.

No. 3 issued January 27, 1893.

No. 4 issued May 4, 1893.

No. 5 issued July, 1893.



