

241.6

HARVARD UNIVERSITY.



WHITNEY LIBRARY,

MUSEUM OF COMPARATIVE ZOOLOGY.

12,607.

Jan. 6. 1891

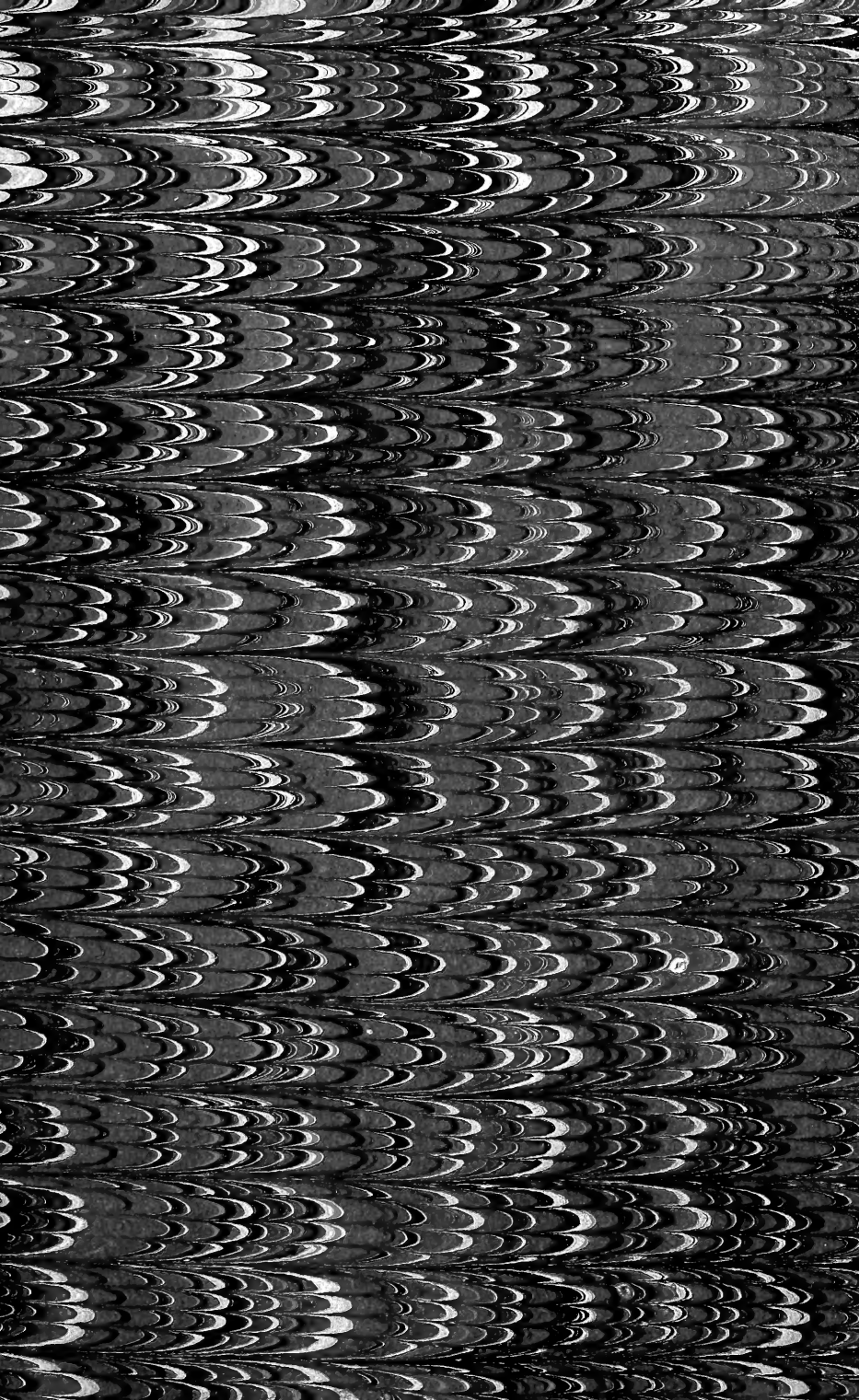



THE
INTELLECTUAL OBSERVER

REVIEW OF NATURAL HISTORY
MICROSCOPIC RESEARCH
AND
RECREATIVE SCIENCE

VOLUME X.

ILLUSTRATED WITH PLATES IN COLOURS AND TINTS, AND NUMEROUS
ENGRAVINGS ON WOOD



LONDON
GROOMBRIDGE AND SONS
PATERNOSTER ROW

Sms
MDCCCLXVII.

HARRILD,  PRINTER, LONDON

CONTENTS.

	PAGE
ALGIERS AS A WINTER RESIDENCE. By M. BETHAM EDWARDS. <i>With a Coloured Plate</i>	1
MODERN JEWELLERY AND ART. By WILLIAM DUTHIE.....	7
CHACORNAC'S SOLAR THEORIES	15
PHOTOGRAPHY AS A FINE ART	19
DECEPTIVE FIGURES; WITH REMARKS ON SATURN'S "SQUARE-SHOULDERED" PHASE. By R. A. PROCTOR, B.A., F.R.A.S.	23
ASCENT OF CADER IDRIS. By D. MACKINTOSH, F.G.S. <i>With a Coloured Plate</i>	27
NOTES ON FUNGI.—No. VI. By the Rev. M. J. BERKELEY, M.A., F.L.S. .	32
THE COMING METEOR SHOWER.—THE SPECTRA OF METEORS	38
DR. CURTIS'S PROCESS OF PHOTO-MICROGRAPHY. By R. L. MADDOX, M.D.	41
ANIMAL LIFE IN SOUTH AFRICA. By H. CHICHESTER, ESQ.	42
THE PLANET SATURN (<i>Continued</i>). By the Rev. T. W. WEBB, A.M., F.R.A.S.	49
ROSS'S FOUR-TENTHS CONDENSER	59
LARTET ON THE ASPHALT OF THE DEAD SEA	62
RESULTS OF METEOROLOGICAL OBSERVATIONS MADE AT THE KEW OBSERVATORY. By G. M. WHIPPLE	66
LADIES' SLIPPERS. By SHIRLEY HIBBERD. <i>With Coloured Plate of Cypripedium Veitchianum.</i>	81
HYPOTHETICAL CONTINENTS. By H. M. JENKINS, F.G.S.	88
THE PERSISTENCE OF LUMINOUS IMPRESSIONS. By the ABBÉ LABORDE ..	98
GOSSIP ABOUT FISH	99
LARGE BRITISH OAKS	107
ON THE GENUS FICUS. By JOHN R. JACKSON. <i>With a Tinted Plate</i> ...	112
RED STARS.....	119
HIGHLAND INSECTS. By E. C. RYE	124
PLANS FOR IMPROVING LONDON	136
THE PLANET SATURN (<i>Continued</i>). By the Rev. T. W. WEBB, A.M., F.R.A.S.	142
THE LAKE-DWELLERS OF SWITZERLAND	149
PRISMATIC SPECTRA OF THE AUGUST METEORS, 1866. By A. S. HERSCHEL. <i>With a Coloured Plate</i>	161
THE LINEATED PHEASANT OF BURMAH. By CAPTAIN R. C. BEAVAN ...	170
THE STREET ARCHITECTURE OF LONDON	174
THE BLACK POPULATION OF THE BRITISH COLONY OF NATAL, SOUTH AFRICA. By JAMES MANN, M.D., F.R.A.S. <i>With a Tinted Plate.</i> ..	184
THE PLANET SATURN (<i>Continued</i>). By Rev. T. W. WEBB, A.M., F.R.A.S.	194
THE FLORA OF IRELAND	202

	PAGE
CHACORNAC ON COMETS	209
A STRANGE PLACE FOR ROTIFERS. By HENRY J. SLACK, F.G.S.	211
FAMILY LIFE OF THE MIDDLE CLASS	213
THE STONE AGE IN CHINA. BY M. CHEVREUL	221
OSCURATIONS OF THE SUN. By M. ED. ROCHE	223
ON THE FORM, GROWTH, AND CONSTRUCTION OF SHELLS. By the late Dr. S. P. WOODWARD, F.G.S. <i>With two Plates, one Coloured and one Plain</i>	241
NOTES ON THE HABITS OF SOME LEPIDOPTEROUS LARVÆ. By the Rev. D. C. TIMINS, M.A., M.E.S., Lond. et Oxon	253
IRON AND STEEL IN THE CONSTRUCTION OF SHIPS AND BRIDGES, THEIR AD- VANTAGES AND DISADVANTAGES. By Professor MCGAULEY.....	257
DINOCHARIS COLLINSII; A ROTIFERON NEW TO SCIENCE. By PHILIP HENRY GOSSE, F.R.S. <i>With a Coloured Plate</i>	269
FROM KURRACHEE TO MOOLTAN. By FRANKLIN FOX	272
COMETARY LIGHT—NEBULÆ—OCCULTATIONS. By the Rev. T. W. WEBB, A.M., F.R.A.S.	281
WILD KAFFIR LIFE AND WILD KAFFIR INTELLIGENCE. By ROBERT JAMES MANN, M.D., F.R.A.S.	289
AIDS TO MICROSCOPIC INQUIRY.—No. VIII.—ORGANIC SUBSTANCES AND FORMATIONS	298
RESULTS OF METEOROLOGICAL OBSERVATIONS MADE AT THE KEW OBSERVA- TORY. By G. M. WHIPPLE.....	304
THE NEBULAR HYPOTHESIS OF LAPLACE EXPLAINED BY DELAUNAY	310
OBSERVATIONS OF THE CHANGES OF COLOUR AND MODES OF TAKING FOOD IN THE CHAMELEON. By JONATHAN COUCH, F.L.S. <i>With a Coloured Plate</i>	321
ON THE VARIATIONS OF CERTAIN CRUSTACEA IN RELATION TO THE THEORY OF THE ORIGIN OF SPECIES BY NATURAL MODIFICATION. By GEORGE S. BRADY, M.R.C.S., C.M.Z.S.	327
A NEW CHARR FROM BRITISH COLUMBIA. By JOHN KEAST LORD, F.Z.S. . .	338
PARASITICAL PLANTS—BALANOPHORACEA. By JOHN R. JACKSON. <i>With a</i> <i>Tinted Plate</i>	348
PHASES IN THE DEVELOPMENTAL HISTORY OF INFUSORIAL ANIMAL LIFE. By JABEZ HOGG, F.L.S., F.R.M.S., etc.	356
THE NOVEMBER METEORS. By HENRY J. SLACK, F.G.S.	373
FATIO ON THE FORMS AND COLOURS OF PLUMAGE.....	377
NEBULAR AND STELLAR SPECTRA—SOLAR OBSERVATIONS—RED STAR— PLANETS—OCCULTATIONS. By the Rev. T. W. WEBB, A.M., F.R.A.S. ..	386
ON SILK PRODUCED BY DIURNAL LEPIDOPTERA. By PHILIP HENRY GOSSE, F.R.S.	393
THE BELL-BIRDS OF AMERICA. By P. L. SCLATER, M.A., Ph. D., F.R.S. <i>With a Coloured Plate</i>	401
PARASITIC BEETLES. By E. C. RYE	409
BUDDHISM AND ITS LEGENDS.....	421
KAFFIR PROMISE AND CAPABILITY. By Dr. MANN, F.R.A.S., F.R.G.S., F.E.S.L., etc. <i>With a Tinted Plate</i>	428
LUNAR DETAILS—OCCULTATIONS. By the Rev. T. W. WEBB, A.M., F.R.A.S.	441
OSCURATION OF A LUNAR CRATER. By W. R. BIRT, F.R.S.....	444
SCHMIDT ON THE LUNAR CRATER "LINNE" AND ON THE NOVEMBER METEORS	448
THE NOVEMBER SHOOTING STARS. By the Hon. Mrs. WARD. <i>With an</i> <i>Illustration</i>	449

THE NOVEMBER METEOR-SHOWER AT GLASGOW. By A. S. HERSCHEL, B.A. <i>With an Illustration</i>	459
THE PLANET MARS. By RICHARD A. PROCTOR, B.A., F.R.A.S. <i>With an Illustration</i>	466
ARCHEOLOGIA	72, 225, 394
LITERARY NOTICES.—“Charles Waterton; His Home, Habits, and Handi- work,” 227; “On Force; Its Mental and Moral Correlates,” 229; “Tapeworms; Entozoa,” 231; “Electricity” 231; “Dictionary of Science, Literature, and Art,” 231 and 316; “Anthropological Review,” 231; “Date Stones,” 231; “Wayside Flora,” 232; “Handbook of the Stars,” 232; “Elementary Treatise on Physics,” 233; “Birds of Mid- dlesex,” 233; “Reliquiæ Aquitanicæ,” 315; “Brief Account of Scholar- ships and Exhibitions at Cambridge,” 316; “Scientific and Literary Treasury,” 316; “Chart of the Characteristic Tertiary Fossils,” 316; “Benedicite,” 476; “Origin of Species by means of Natural Selection,” 477; “Elementary Treatise on Heat,” 478; “Easy Introduction to the higher treatises of Conic Sections”	478
PROGRESS OF INVENTION	73, 156, 234, 317, 473
PROCEEDINGS OF LEARNED SOCIETIES	317, 396
NOTES AND MEMORANDA	71, 159, 239, 318, 398, 479





ILLUSTRATIONS.

ILLUSTRATIONS IN COLOURS.

	PAGE		PAGE
Scene from Algeria, Evening Prayer	1	Recent Shell Forms	241
Ascent of Cader Iris	27	Dinorcharis Collinsii	272
Cypridium Veitchianum	81	Chameleon	321
Prismatic Spectra of August Meteors	161	Naked-Throated Cotinga	401

TINTED PLATES.

Genus Ficus	112	Balanophoraceæ	353
Zulu Chiefs	185	Zulu Kaffirs	432

ENGRAVINGS ON WOOD.

Diagram of Deceptive Figures	23	Dog Whelk	247
Diagram of Herschel-Browning's Meteor Spectroscope	38	Common Whelk	248
Ross's Four-Tenths Condenser	59	Fresh Water Mussels and Melanias	248-9
Longicorn, <i>Astinomus œdilis</i>	129	Portion of Shell Wall	251
Bust of Kaffir	190	Cometary Light, Diagrams	282
Planet Saturn, Diagrams	197, 200	Head of Bell-Bird	401
Chiton Piceus	242	Lunar Details, Diagram	441
<i>Diceras arietinum</i>	243	Mare Serenitatis	447
<i>Requienia Lonsdalei</i>	243	Earth's Passage through the Stream of Meteors	456
Testacella	244	Ursa Major	463
Opercula and Sections of Spiral Shells	245	Tracks of Shooting Stars	464
<i>Carychium minimum</i>	247	Diagrams of Planet Mars	468
<i>Cyclostoma elegans</i>	247		



THE INTELLECTUAL OBSERVER.

AUGUST, 1866.

ALGIERS AS A WINTER RESIDENCE.

BY M. BETHAM EDWARDS.

(With a Coloured Plate.)

VERY few people are aware of the riches and beauty of the French colony that lies only two days' journey from Marseilles. To the artist, Algiers offers quite an unrivalled field for picturesqueness of costume and gorgeousness of colour; to the tourist, a diversified and wonderful country peopled by distinct races, each having a historic and romantic interest; and to the invalid, a climate which without any extravagance, may be called perfect during six months of the year.

The journey from London to Algiers is pleasant enough, occupying four or five days. To those who are fortunate enough not to suffer from *mal de mer*, nothing can be more agreeable than to skim across the blue Mediterranean in the light *Messagerie* steamer. One generally finds a company of talkative, genial French officers on board, and from them learns something in advance, of the country which has suddenly become the most interesting of all others. It is easy to see that Algeria is not a strong point in national vanity, and that by universal opinion the colony has no brilliant future before it. The country is fertile to a fable, the climate is superb, the situation of the port could not be better; yet all these advantages are as nothing weighed against such grievances as undue taxation, Arab incendiaries, the want of good roads, and so on, *ad infinitum*. It is, therefore with some sort of preconceived sympathy that one sees the first silhouette of the Libyan coast, thinking less of Dido and her story as we scanned it in our schoolboy days than of Abd-el-Kader, marauding Arabs, and French families striving to get a scanty living in the once-famed granary of Europe.

The first view of Algiers is sufficiently striking. Built upon a hill, its sunny green terraces of Moorish houses glisten

as if of marble against the bright blue sky. To the left of the city stretches a chain of olive-clad hills, plentifully dotted with white villas; whilst beyond, so pale in outline as almost to be mistaken for clouds, lie the far-off snow-peaks of the lesser Atlas.

Hotels are not too plentiful in Algiers; and for travellers who are spirited enough to venture upon oriental housekeeping, it is advisable to take one of the pretty furnished villas in the suburbs. Once established, the traveller will find ample distraction in wandering among the narrow streets of the old city, and studying the unalloyed element of oriental life that still prevails there. We see scene after scene out of the *Arabian Nights*—here a youthful Aladdin in crimson fez and orange-coloured vest, truanting with idle companions—there a dark-cheeked Morgiana bound on some special behest—now some veiled princess, accompanied by her negresses bound to the bath—or a gloomy door is opened by some grave Moor, and you catch glimpses of an airy court, planted with bananas, and having a fountain in the midst.

In the ugly French arcades which have been built upon the site of picturesque old streets are to be found all the civilizations of modern life, such as omnibuses, shops, and cab-stands. Indeed, but for the stately Arabs passing by, and the bronze skins of the negroes shining in the sun, you might fancy yourself in some small town of the provinces.

In the country, the two elements, French and Arab, are mixed in about the same proportion. You meet group after group of handsome, tawny-skinned fellows driving in donkeys laden with wood, oranges, or poultry; or a stately, well-mounted caid, leaning back in his embroidered saddle; or a camel from the interior, ridden by a wild-looking Ishmael, wrapped in white burnouse. It would be hard to say whether the town or the country offers most interesting matter for observation; both to the student of Arab or colonist life, the field is large and varied.

Alike striking and impressive is the spectacle of Mahometan worship, whether seen as we saw it, in the lighted Mosque during the Rhamadan, or out in the fields at sunrise, where a couple of solitary worshippers raise their hands towards the east, "out of which cometh our help."

The coloured plate prefixed to this article is from a sketch by Mrs. F. Le Bridell, and represents a scene of evening prayer.

Again, there are the ceremonies of the Mahometan Sabbath, when all the women betake themselves to the cemeteries, and pray to the souls of the dead. Nothing can be more oriental and picturesque than the groups of white-robed

figures among the palmetto shrubs. And whether the ceremonial has become one of mere custom or not, one can hardly help associating some sort of solemnity with it. Then there are religious festivals among the negroes by the sea-shore, which, for weird effect and wonderful show, surpass anything we have ever seen—dances of exorcists, sacrifices of calves, and cocks to the ginns, or evil spirits, celebrations in honour of Eysona, a lesser Mahomet, and, in fine, sufficient matter for speculation to all interested in the present and future of Islamism.

No one can refrain from a feeling of sympathy with French colonist life. As one travels from one French port to another, and rests for refreshment at little oases of civilization on the way, it is easy to learn a great deal both as regards the past, present, and future of the settlers. Things are certainly not promising; rich as is the country in natural resources, admirably as it is placed with regard to the mother country, and much as the Government has affected to take its interests to heart, Algeria offers no El Dorado for the poor or enterprising of the French people. And something is to be laid to the door of the people themselves. The French do not make good colonists. They do not carry their Lares and Penates with them, with the intention of founding a Latium, having lost Troy. They come over to Algiers with the hope of making a speedy fortune, and then returning to France.

Of course this sort of view has a deteriorating influence upon the moral and material influence of the colony, and upon the colonists also. They do not build and plant for posterity, but for the day, and having little interest in the adopted country except as a sponge to suck money from, it is hardly likely that they will serve her interests save as they fall in with their own. Yet we might apply Sidney Smith's speech regarding Australia to Algeria, "But tickle the soil with a hoe, and it laughs into a harvest." Anything, everything, can be done with it. And besides the sources of cereal wealth, are an infinity of others, as yet unworked and offering quite a new field for enterprise.

We are by no means disposed to overlook counterbalancing difficulties. The incendiaries of the Arabs alone have ruined many a hard-working farmer, and we, have only to glance at the *Rapport de la Commission d'Enquête* on this subject, published in Paris last year, to be sensible of the fatal antagonism still existent between Arab and Frank, Mussulman and Roumi.

Not entering upon this intricate and interminable subject, however, we will say a few words about Algeria from a tourist's point of view, and then speak more especially of the climate.

Place yourself within a day or two's journey from Algiers, and you are as completely out of the world as the most *blasé* tourist could desire. If you are a sportsman, there is plenty of game from the plover to the panther; quails, partridges, hares, gazelles, jackals, hyenas, filling the space between the Alpha and Omega of the list. To catch sight of the panther, one must travel a hundred and fifty miles from Algiers, and there having reached the snow-tipped Atlas Mountains, may, perhaps, find a lion too, if benighted in the cedar forests.

For an artist, there is such inland scenery as few people ever associate with "Afric's burning plains," as Bishop Heber has it; delicious orange gardens, sunny plains sprinkled with wild flowers, gorges of almost Alpine grandeur, olive-groves glossy green, rivers wandering amid a flame of oleander blossoms, mountain scenery vivid and varied as only African skies can make it; and lastly, the ever-picturesque element of Eastern life. Of course, we cannot enjoy such a feast of nature without some hardships. The traveller must make up his mind to ride over very rough roads, to sleep in caravansaries or in tents as the case may be, and not always in clean beds, to eat any dish that comes in the way, without too much inquiry as to the matter or manner of it, and not to expect much intelligence from such Arab guides as he may have to deal with.

With regard to the Algerian climate, there is not a doubt that it is in some respects incomparable from October till May. The air is soft and moist, and slightly bracing. When the sun would otherwise be too hot, there are refreshing breezes blown off the sea, and the nights are invariably clear and cool. On the hills, too—we are now speaking of the suburban part of Algiers—the weather is uniformly fresh and invigorating even when the summer is advanced, and the inhabitants of the town are suffering from the heat. Never shall we forget spending last Christmas-day in a Moorish villa at Mustapha Supérieure, one of the prettiest, healthiest, and most elevated spots within an hour's walk of the city. The skies were bright and cloudless, the hill sides were clothed with foliage and flowers, and ladies were plucking roses and violets in their gardens bareheaded. It was, in fact, a June day. And with the exception of rains, the winter of Algiers is uniformly mild, though every day is not, of course, like that just recorded. At night, one is glad of a little wood fire, and especially in the airy country houses, which are admirably built for coolness and air. In fine, we should say that for diseases of the chest and lungs, the climate of Algiers offers all the advantages without the drawbacks of other and more popular resorts. The fresh sea-breeze, the elasticity of the air, the absence of any depressing atmo-

spheric influences, are certainly arguments in favour of this statement, and there are other minor considerations not to be overlooked. The charming scenery, the agreeable English society, the moderate price of hotels, and the practicability of conducting a *ménage* on one's own account, the abundance of fresh vegetables and delicate game wherewith to tempt dainty appetites—all these things are so many items necessary to an invalid's comfort.

We only hope that any words of ours may induce those to whom east winds are emissaries of destruction, and fogs poisons deadly as Socrates' draught, to escape from both, and wing their way southwards with the nightingales and swallows. It is not pleasant to all to cross the Mediterranean, and not practicable to many, to quit England for six months in the year, but those who make the effort for health's sake will not do it in vain.

And we can hardly imagine any clouds that could not be dispersed from the mental horizon by a little sojourn in so lovely a land. Southern skies, oriental associations, majestic cedar-forests, sunny plains, snow-tipped mountains, and gold-green valleys—surely such combinations as these are seldom found outside the charmed circle of Algeria?

And the best of all is that as yet these things are unknown.

[NOTE BY THE EDITOR.]—A very interesting collection of pictures of Algeria, by Mrs. F. Le Bridell, and Madame Bodichon, was recently on view at the German Gallery, Bond Street, where, we believe, a few of them still remain. Mrs. Bridell supplied a series of figure pieces, and Madame Bodichon illustrated the landscape scenery of the French colony. Two pieces by Mrs. Bridell, one in water-colour, and another on a larger scale, in oil, illustrated one of the most pathetic and pleasing of Mahometan superstitions, and which is alluded to in the preceding article. It is believed that the spirits of the dead visit their tombs on the Sabbath (Friday), and are able to hold commune with their relatives and friends, who resort to the cemeteries for this purpose. In one of her pictures Mrs. Bridell represents with much beauty of drawing and colouring, and with a depth of expression rarely equalled, a young girl at the tomb of a relative, and addressing a departed spirit; while in the companion piece, the same girl is in an attitude of reverential attention listening to the answers which the spirit is believed to give. The figure-drawing in these pictures is excellent, and the landscape accessories bear the impress of fidelity, and harmonize admirably with the sentiment of the subject.

Amongst the other pictures by Mrs. Bridell, an "Arab Girl at an Embroidery Frame," the "Head of an Arab Girl, her hair Dyed with Henna," "Arab Musicians Chanting a Benediction on the House of a Bride," "Sidi Ben Cassim taking Coffee," and an "Arab Woman by the Sea Shore," possess a high degree of merit, and are likewise valuable as illustrating picturesque forms of life. By a resolute perseverance in overcoming difficulties, and with the friendly aid of the Duchess of Magenta, who highly appreciated her labours, Mrs. Bridell saw Arab and negro life in Algeria to an extent permitted to very few strangers, and she succeeded in obtaining sitters in cases where most artists who have made the attempt have failed. The result is that she has returned from Algeria with materials for very striking pictures, which our readers will no doubt find opportunities of seeing. Sacred and secular associations—the Bible and the Arabian Nights—give an undying charm to good delineations of Eastern life, and in Mrs. Bridell's pictures we see that combination of the actual with the ideal which proves the artist to have felt and understood her theme. Madame Bodichon's landscapes transport the spectator to the beautiful scenery of Algeria, and amongst many of much merit, one especially, a twilight scene, with a heron amongst tall rushes, is remarkable for its harmonious colouring, and its exquisite sensation of calmness and repose. In another piece, dark, weird-looking cedars stand in a rolling sea of rising mist, with very picturesque effect; while other sketches show us "Algiers from the Sea Shore," a wild romantic scene in Kabylia, etc. The coast of Algiers, with its red rocks, bears some resemblance to parts of South Devon, but a peculiar and striking character is given to the landscape by palms, cactuses, and other plants foreign to the English eye.

MODERN JEWELLERY AND ART.

BY WILLIAM DUTHIE.

ALTHOUGH the associations which connect jewellery with art are very strong, it does not necessarily follow that the connection itself is an intimate one. These associations are in part traditional, and in part the result of the charm which the materials of jewellery in themselves, by their natural beauty, exert over the mind in an æsthetic sense. Gems, gold, and silver suggest ornament, and ornament implies art, but the union between the two things—the harmonious blending of form and material—is often sadly imperfect. Perhaps no workman, in modern times, has employed the materials placed at his hand to so little advantage, in an artistic sense, as the jeweller. What art has done within the last quarter of a century in stone and wood, and the coarser, cheaper metals, is something admirable. It has moved the architect, the sculptor, the wood-carver, the modeller and founder in brass and iron, to efforts and results which will assuredly be remembered in future days ; and has helped on the nation in its great course of æsthetic progress and refinement. But nothing of this kind can be said of the jeweller, who has been content to produce lame, mongrel copies of ancient art productions ; has dealt in the slang and vulgarities, as it were, of daily life, epitomized into gold, and garnished with gems to serve as pin or brooch ; or who has gone to the ironmonger and the brass-founder for his newest patterns.

It is surely time that this cause of reproach should be removed. Something has already been done in the way of improvement in design in jewellery—not a word of fault-finding should be said as to execution—and it is only necessary to arouse the public themselves to the deficiencies of this branch of art, to ensure their correction. It is, in fact, the public who are chiefly to blame for the monstrosities which disfigure the jewellers' show-windows, and with which they, the public, esteem themselves to be adorned. The artizan must, as a matter of necessity, produce that which will sell, or the shopkeeper will not accept of it ; and the shopkeeper's chief art is to discover the idiosyncrasies of taste of his customers, and this he does with a wonderful aptitude. The jeweller may appear in some cases to lead the public taste, but he can only do so by pleasing it ; and if he make what in commercial phrase is a "hit," in the production of some grotesque article of jewellery—grotesque in its attempted originality, or vulgar in its imitation of something in ordinary use—it is the taste of

the customer which rules the market, and not that of the shopkeeper, who has simply detected the weak points of his patron's fancy.

It is not here asserted that the jewellery daily exposed for sale, or made to order, is not showy, pretty, and even handsome in one point of view; or that there are not meritorious efforts made to produce works of artistic skill, sometimes with considerable success. The better class of shopkeepers would not admit within their show-rooms the paltry, meretricious class of jewellery, upon the sale of which others again chiefly live; and it is by this better class, who claim to have a style of their own, and who do indeed collect together excellent specimens of tasteful combination and workmanship, that anything like a state of art is maintained in the manufacture of articles of personal ornament. But it is contended that there is an absence of real art, and of that knowledge of first principles upon which all true art is based, among those whose business it is, and whose assumption it is, to be the interpreters of æsthetic outseekings in the domains of personal adornment, in gems and in the precious metals. Great advances have doubtless been made in the general effect of the jewellery produced of later years, as compared with that of the times of the Georges, but this effect is attributable to other causes than artistic beauty of form, or even combinations of colour, and in too many cases the effect is a false one.

If we seek for examples of the styles of art produced at different periods since the mediæval ages, what do we find? Coarse, plump, and awkward outlines; little discrimination in the mingling of colours; and very inferior workmanship. Indeed, in our own country, since the reign of Elizabeth, there is scarcely a specimen of jewellery proper extant, which can serve as a model to us of the present day. There has been much good embossing and chasing throughout that period, and occasionally the enameller gives us glimpses of the best efforts of his art; but there are few works in which a unity and completeness of design, a refreshing contrast in the colours of the gems or enamels employed, and a harmoniousness of effect in details, which make up the perfect specimen, to win our praise or excite our emulation. There are not wanting, here and there, isolated details which are charming; as if all the materials for a perfect work were at hand, but that there failed the master-mind to select and mould them together. There are no evidences of the controlling taste of a Benvenuto Cellini, the tracings of a Holbein, or the minuteness and perfection of finish of the Brothers Müller, shown in many an example in the Grüne Gewölbe of the Zwinger at Dresden. Even on the continent, during this period, there is not very

much to boast of; and the best specimens of jewellery there, as at home, take the shape of pure diamond-work.

As was naturally to be expected, it was in the arrangement and manufacture of diamond *parure* that the best display of really artistic progress was shown. There the draughtsman and the modeller were thrown back upon their own resources; for, seeing that little was to be effected, as a rule, by contrast of colour, so much more devolved upon grace of form and boldness of relief, for ultimate effect. The diamond-workers were always a better trained, and better paid class of men, than the goldsmiths, and the costly material upon which they were employed permitted an outlay, and demanded a degree of attention, which the labours of the goldsmith could dispense with. But even the diamond-work made on the continent from the beginning of the sixteenth century, down to within the last fifty years, was heavy, inartistic, and, considering its value, ineffective. Perhaps the Venetian diamond-work was the best, and much of this excellence resulted from the manner in which the gems were cut, viz., rectangular, with deep, single facets, and a broad flat table. Venice then led the way in most of the arts, and it is not surprising that her diamond jewellery should excel that of all other countries. In England, till within the last half century, diamond ornaments, in common with all kinds of jewellery, were simply execrable. Perfectly flat, and although usually imitative of some kind of foliage, with no more relief or modelling (*movement*, the French call it), than a platter, the jewel was rather a rude mass of silver, in which diamonds were here and there set, than a piece of work with any traceable design. It was usually a cast block with a rounded back to each stone, and no gold whatever upon it beyond what was necessary as a means of fastening it to the dress. Where the pattern was not clearly floral, it was a mere jumble of grotesque shapes, not traceable to any original on the earth, or in the heavens.

The first real improvement in the design of diamond-work originated in Vienna, and from its very character led to new and more artistic development. It began in a *parure* of slender grass leaves, from which were pendent small stars, or dew-drops, and its best feature was a conscientious desire to follow closely upon nature. For a long time the simple field flowers and long grasses were the ruling models of diamond-work in the Austrian capital. The new fashion soon spread from Vienna to Paris, and thence, through French and German workmen, to London. At this time what is technically called "thread setting" was little used in London. The English workman prided himself upon his "grain setting," *i.e.*, his work, whether leaf, flower, or nondescript orna-

ment, was pared away on the edges, leaving long round-topped grains between, and on the side facets of the stones. All ornaments alike were subjected to this treatment, which gave a rounded appearance to the work, and destroyed all outline. This style of setting is described as "cut down," from the manner in which it is effected, and the Englishman was proud of his "cutting down." "Thread setting," on the contrary, preserves a fine *filet*, or line of silver on the outer edge of the portion of the leaf or flower, the sharp outline of which it is desired to preserve, and by a judicious use of the two methods, an admirable degree of relief is given to the whole ornament.

The advance of the Viennese in their search for art in the footsteps of nature led to most important results. The simple grass leaves were succeeded by foliage of a more ornate character; flowers of most complex construction were made the prominent features in the tiara, the brooch, or the stomacher, till no object was considered too difficult of imitation in the plastic silver, to be afterwards encrusted with diamonds so thickly as to leave little but a shell or skin of the original material to bind them together. It may truly be said that jewellery, in its employment of the diamond chiefly, attained perfection in these floral ornaments. The taste of the draughtsman and the modeller, and the skill of the workman, were combined to produce them, and the result was the creation of works of true art. Many of the best specimens of this class of workmanship were made in London, but, it must also be said, by foreign artizans, chiefly French and German. The style of the present day is no longer the same, but the skill and the taste remain, although scarcely employed so advantageously. The fashion of the moment runs in favour of a species of Arabesque or Byzantine interlaced work, to which it would be very difficult to give a name, but which is effective in so far that it allows of the massing of stones on a rounded surface, broken up by narrow interstices, and a few gems are made to produce the dazzling effect of many. Diamond-work finds a further development in simple five-pointed stars, placed at intervals on an interlaced band.

There is little to be said for the goldsmith's handicraft from the time of Elizabeth to within the last half century. The old skill and artistic aptitude of the workman, derived from Italy, and developed under the Tudors, did not immediately die out in England, but it was not likely to gain an accession of strength in the more prosaic and unsettled times of James and of the Charleses. There was doubtless plenty of work to be done for both jeweller and goldsmith in the latter part of the reign of Charles II., but it was more showy than

artistic, and has not lived. What did live, however, and give repeated signs of healthy vitality, was the art of chasing and embossing—in its result more often called repoussé-work—and many fine specimens of the art, executed at this and at a later period, are to be found. But repoussé-work is scarcely applicable to jewellery proper, and was chiefly employed on tazzas and other silver plate, but oftener still on the gold cases of watches, and the principal portions of chatelaines.

The eighteenth century was the age of snuff-boxes, etui-cases, bonbonnières, scent-bottle mounts, and a host of similar productions, in which great cleverness and some taste was displayed; and of paste waist-clasps, and shoe-buckles. What is more to our purpose, however, is the fact that at this period several kinds of finger rings of great taste, and very careful workmanship, were made. One kind is called the "Giar-dinetti" ring, and consisted of a sprig of leaves and flowers, formed of diamonds and garnets, the latter set to imitate rubies, but among which other stones are very often introduced. These rings are in endless variety, and often have an ease and grace which make them deservedly prized. There were also what are commonly called Queen Ann's rings, made of a single stone, an amethyst, a topaz, or a table diamond, in a close cramp setting, with a peculiarly light scroll shank, and an exquisitely fluted gold back. The double scroll on the shoulder of the ring was sometimes of silver, and held in its folds a small square cut gem, usually a ruby or a diamond. Then there were the crystal memorial rings, in which a single crystal, with a narrow faceted edge, was set over a gum-plait of hair, in the centre of which was a minute cipher made of twisted gold wire. The crystal was cut with a broad culasse, which rested directly upon the cipher, and allowed it to be seen clearly through. It must be especially noted that the pride of the setter at this period was that his work, whether of real gems or paste imitations, should be "sound," that is, capable of excluding air and water; which is much more than can be said of the setting of the present day. Some of the paste ornaments, in imitation of diamond work, of this time, although utterly devoid of beauty of design, were wonderful specimens of clean, close workmanship, and often retain their lustre untarnished after the lapse of a hundred years.

At the latter half of the eighteenth century, engine-turning was much employed to ornament large surfaces, and was made available as the ground-work for the enameller whereon to place his translucent glasses. The enamelled work of this period is very good, more especially the dead white and the purple, and a kind of dark puce (*pieuse?*) which has since been called mauve. Engine-turning was brought to great

excellence, but has now fallen into comparative disuse, together with another kind of machine tooling, at one time in great request for rings and ornamental edgings, called *nerling*. This *nerling* was the pressing of a pattern engraved on a small steel wheel, by means of a lathe, on to any metal wire or edge prepared to receive it. Then we come upon what may be called the garnet period, a distinct era in the history of jewellery, and which was of long duration. So far as design went, nothing could be more bald and tasteless than the single rows of round or oval garnets, or the occasional jumbling together of several stones in a cluster to give variety to the pattern. By this time the jeweller's art, as implying a knowledge of drawing, and the moulding of his materials into relief, was at its lowest ebb; but his garnets were of the finest claret colour, were carefully cut, and set and foiled to perfection. The diamond-jeweller still maintained his supremacy, and although his designs were flat and meagre in spirit, he managed to display considerable cleverness in small works, as in rings—*la bague marchise*, for example—and in ciphers; but here again the effect was in a great measure marred by the use of the cramp, or “cut down” setting, instead of the “thread,” which did not permit of the modelling, so to speak, of the letters. The garnet period only gave way to the period of filagree work, and the substitution for the garnet of the pink and yellow topaz, the jacinth, the chrysolite, the chrysoprase, the use of the zircon, or jargoon, instead of rose diamonds; the introduction of stone-cameos, set, in imitation of Roman work, in bright red gold, with yellow nerled edges; and last, though not least, the amethyst.

The filagree work which now came into fashion was simply a revival, under modifications; for this use of twisted and screwed wire dates from the oldest times. But it was a vigorous revival, and held its ground for some years. When at length it yielded it was to the superior attractions of a spurious Elizabethan, and an equally spurious Renaissance, scroll work. That taste dying out, there was awakened a passion, puffed into flame by a wind from Germany, for turquoise *pavé*, in balls, half balls, oval and round excrescences, perched upon and dropped into all kinds of uncomfortable places where they had no business to be. Conjointly with the turquoise *pavé*, came the fashion for large plain wire work—a sort of golden maccaroni, involved and knotted, but to what end no mortal could tell. Sometimes this wire work took the shape of simple round or oval rings, inexplicably interlaced, like a conjuror's puzzle; at other times it resembled most a huddling of earth-worms. The turquoise *pavé* and the plain wire work have still their admirers; and the latter was but the precursor

of a series of monstrosities. Among them came the horse-shoes, the straps and buckles, the jockey caps and whips, the screw-heads, the folded copies of *Bell's Life*, the padlocks, door-plates, bolts and bars, and cups and balls, which have long been the fashion. The jeweller's art in short fell among the pots, pans, and kettles of every day life, and, to a great extent, it is among them still. There has been, it is true, in the mean time, a Roman revival, here and there decidedly successful; and an Anglo-Saxon revival, which has somehow made rock crystal its principal medium of interpretation, and which has some very good features joined to its natural plumpness and heaviness; and a partial mediæval revival of a monkish character, which speaks in monograms and alphabetical puzzles. A great deal of good may be said for all these revivifications, unfaithful copies as they are of their quaint originals, but for the sporting, and what may be called the poker and shovel jewellery, there is only one word—it is simply despicable.

But cannot something really original be designed in our personal ornaments? Or, if we must be copyists, can we not choose good models, and copy faithfully and conscientiously? Is there no leaf or flower that may serve to give us new ideas of form or combinations of colours? It would appear as if the baser the material, the more was the artist drawn to rescue it from oblivion by his genius; and the more precious the matter to be dealt with, the less care was needed to embellish it. Our schools of design produce draughtsmen who furnish admirable patterns to be woven in wool and cotton; models to be executed in wood and stone, in iron and brass; elaborate compositions to be worked out in glass, and common potter's clay; and is there no cunning hand to devise forms of symmetry and beauty for the employment of gems, of gold, and of silver? What the sculptor has done, what the wood-carver has done, what the weaver and spinner have done, for their art, cannot the jeweller do for his? There are exceptions to every rule, of course, but we do not want the exceptions to monopolize the place of the rule; and that is practically the case with regard to the taste in composition of the most part of modern jewellery. A new pattern is simply a matter arising hap-hazard from something already in existence; it is scarcely ever an original conception; and the most commonplace objects are generally chosen as the base of the design, or as fit models, *pure et simple*, for illustration.

The fact is, the modern jeweller has allowed himself to be dazzled by the very materials among which he labours. With him all *is* gold that glitters. When the precious metals were scarce, and gems were rare, a Cellini could be found

who would build up a fairy fabric of graceful proportions and magic colours, to embalm jewels which were more prized for their names than for their beauty; or a Holbein to trace symmetrical outlines, and mingle brilliant colours in softening harmony, for the jeweller's behoof. But now that gold abounds, and gems were never so abundant or so beautiful, the artistic element is neglected, or allowed to fall through altogether; and the jeweller entrenches himself behind his dazzling store, and flashes their unassisted rays in the eyes of his customers. There is more skill, more talent, more appreciation of the beautiful even, among workmen now than at any time within the last century, if it were only turned to proper account. A true piece of jewellery should be as much a work of art as a picture, or a figure sculptured in marble; and there is no possible reason why it should not be so. There is no want of lovers of ornament, or of wealth to devote to its study; it is only necessary to place the fact clearly before one, viz., that the most beautiful materials for ornament in creation are only half utilized for their best purpose, or are degraded into meretricious imitations of commonplace objects. It is not so with the silversmith. All that refined art and delicate manipulative skill can perform is lavished upon our race-cups, our épergnes, our centre-pieces, our candelabras, to the delight of all beholders, and the permanent advancement of art itself. The material is comparatively valueless; it is the spirit breathed into it, the wonderful skill of execution which gives the vase, or the group of figures, its value. Whereas, in the case of a piece of jewellery, it is usually the cost of the gems, not the beauty of the design nor the delicacy of the workmanship, which is the subject of admiration.

The fault of this comparative lack of art conception in jewellery rests greatly with the public. So long as the taste of the public lies in horse-shoes, and straps and buckles, the jeweller is not likely to strive to anything much higher. The public should be the real teachers, not the slavish pupils of the manufacturer; and if gentlemen would devote the same study, and the same natural taste, to their family jewels—not necessarily in a spirit of costly outlay—as they do to the building of their mansions, the furnishing of their halls and studies, or the laying out of their grounds, the jeweller would be found an apt and willing scholar. A piece of jewellery would then become a real work of art, as it was in days long gone by; a series of models for cheaper ornaments being created, the general taste would be improved; and eventually the abortions and apish vagaries of modern jewellery would disappear, to the great comfort of all true lovers of art.

CHACORNAC'S SOLAR THEORIES.*

IN addition to the series of lithographed "*bulletins*" from the observatory of Ville-urbanne, M. Chacornac has just issued what appears to be the first part of an important essay, in which he arranges the facts which he has observed, so as to exhibit the theories he has formed.

He states, that an examination of the sun with a good telescope, even of small dimensions, enables the observer to see that the shining surface is not smooth, like that of a substance in liquid fusion; but that it is made up of luminous elements, matted together like meshes in a network composed of a viscous material, and not analogous to anything existing on the earth; although to a certain extent the appearances may be compared with threads of metal or melted glass, in a sufficiently viscous condition to solder them close together, to change their shape, and to enable them to disperse or assemble, like snow-crystals, under the influence of atmospheric currents. Conceiving the analogy between these solar phenomena and those of crystallization to be very strong, M. Chacornac speaks of "photospheric crystals," and defines the photosphere by saying that "it is composed of innumerable photospheric crystals united together." The shape of these crystals is not, as was supposed, uniform; and, though more often threadlike, they will be found to exhibit all the imaginable figures that a paste in a state of violent fermentation might be expected to offer.†

According to the definition given, the solar photosphere is not continuous, and behind (*au travers des*) the photospheric crystals a dark background is seen, on which all the strata of the envelope project themselves (*un fond obscur sur lequel se projettent toutes les formes des strates de cette enveloppe*).

Observation also shows that the vast agglomerations of photospheric crystals move independently of the fundamental stratum, as if the upper portions floated in an atmosphere, as clouds do in the air.

In the month of April, 1850, M. Chacornac states that he discovered that the spots or cavities in the photosphere were only formed by the dispersion of the photospheric crystals, and by a partial swallowing up or engulfing of the photo-

* "Notice sur la Constitution Physique du Soleil." Par M. Chacornac.

† Many observers will not agree with M. Chacornac in considering that the photospheric bodies bear an analogy to *crystals*, and there is little resemblance between forms produced in paste by violent fermentation and those which result from crystallization.

sphere. At that time he observed, and has since been confirmed in the opinion, that at certain points the photosphere seems to melt, and become like ice on the surface of a lake, which, under the influence of a considerable weight, slides obliquely into the liquid. In this way enormous photospheric fragments are engulfed while preserving their form, but losing their brightness as they sink. On the 3rd of December, 1858, he observed a luminous avalanche, larger than our earth, engulfed in this manner. During the interval between these meltings (effondrements) of the photosphere, he has observed a contrary action, like a condensation of the exterior atmosphere into luminous masses. This appearance he considers analogous to the formation of the "crystalline clouds," which we name *cirrus*.

As a provisional conclusion, M. Chacornac regards the sun as "a liquid incandescent mass, surrounded by a thick atmosphere, imperfectly transparent; and whose ultimate limits extend to great distances beyond the central body." This atmosphere he considers to extend not less than two or three times the length of the solar radius, and to its attracting power is due the difference in tint and splendour of the centre and margin of the disk. This immense atmosphere increases in density in its lower layers, which are near the surface of the liquid ignited mass. "After a series of photometric measures of the light of the penumbra, compared with the most considerable extinction of light which the photosphere experiences when it plunges by narrow isthmuses into the depth of the cavities, we come, with the help of depression measured in the *penumbra*, to the conclusion that the central body is situated at a depth about ten times greater than this depression." The lower layers of the solar atmosphere must acquire an immense temperature through contact with the incandescent mass, and the great pressure they experience; and from variations in their temperature perpetual movements arise. The liquid surface of the sun must vary in temperature from a variety of causes, such as ascending and descending currents, and variations in the diathermancy, or heat-transmitting power, of different portions of the atmosphere. A rapid and constant evaporation goes on from the liquid surface supplying the matter, which is precipitated in a crystalline form.

"When we examine the sidereal universe with reference to the probabilities which determine the incandescence of stars, we are convinced that the principal cause is the condensation of agglomerated masses of cosmical matter." M. Chacornac points out that, with a given pressure and temperature, vapours will have a density little below that of a liquid; and it is, therefore, reasonable to suppose that, at a certain distance

from the limit of the mass of solar vapours, they condense themselves into fluids at high temperatures, in which the laws of cohesion approach those of bodies in fusion. In admitting that temperature and pressure increase with depth, we may conceive that the central solar mass finally acquires the perfect condition of a body in fusion.

When solar vapours at high temperatures leave the surface, they rapidly ascend to a region in which radiation is energetic, and in the exterior regions of the solar atmosphere they are acted upon by the cold of celestial space. Under these circumstances condensation and crystallization occur, accompanied with the emission of light.

M. Chacornac calls particular attention to the fact, that in the phenomena of spots the gas that seems to escape from the central body dissolves the engulfed portions of the photosphere, just as crystals dissolve in a liquid; but "in certain cases, when the gaseous central emanations cease to disperse the photospheric matter, and to enlarge the openings in it, it may be seen that engulfed fragments of photospheric matter are augmented in volume, with loss of their incandescence, as if the luminous crystals had become transformed into nebulous vapour, reflecting only the light of the photosphere."

The gases of the absorbent atmosphere above the incandescent zone, or those which form aureoles during an eclipse, are not very luminous, as they reflect a large portion of polarized light. The incandescent zone limiting the photosphere presents an accumulation of incandescent matters in ignition, and terminating in flames like those proceeding from terrestrial substances burning in air.

During the eclipse of July 18, 1860, the first objects which M. Chacornac observed beyond the lunar disk were jets of vapour, like those represented by Mr. Poulet Scroope, but with this difference, that instead of exhibiting ascending masses of a globular form, they run like bands with luminous streaks, like *bouquets d'artificice*, and which spread out in their upper portions as if they had arrived rapidly in a lighter atmosphere. "These vaporous jets corresponded specially with groups of acute cones of incandescent matter, which constituted the purple zone surrounding the photosphere."

M. Chacornac regards the bodies he terms photospheric crystals as continually forming at certain elevations, and being recondensed into liquids, falling back on the sun as they descend below certain limits of pressure. He also considers that the central liquid mass of the sun, in addition to the emission of vapours, absorbs gases just as melted metals absorb oxygen or oxide of carbon, and that a sudden crystalliza-

tion of the incandescent matter is accompanied by explosive emissions of gas.*

To account for the appearance of spots, exceptionally, in the equatorial regions, M. Chacornac remarks that evaporation is most rapid when the atmosphere in which it takes place is least dense, and that the quicker it takes place the greater the local loss of heat. At the sun's equator, gravity being less than at any part of his surface, the pressure of his atmosphere is less than at the poles, and thus phenomena like our trade-winds must arise. Evaporation would be very rapid at the equator, and the rarefaction of the atmosphere would favour radiation. "If the liquid, incandescent surface cools itself more rapidly at the equator than in other zones, it must give rise to currents, as the difference of temperature in our seas between surface and depths occasions superficial and deep currents in opposite directions. If the cooled layers have a tendency to descend into the interior mass, the adjacent layers make a descending rush to fill up the void. This then is a superficial current, tending to carry matter from the poles to the equator. We mark also that this current transports fluid masses animated with a movement of rotation less rapid than that of the zones which they enter, and in virtue of this retardation, they seem to lag behind when compared with the fluid masses moving in zones of less latitude."

The currents resembling our trade-winds acting in a direction opposite to the accelerated movement of the external mass—for at the equator vapours rise more rapidly than at the poles—it results, from the combination of these opposite currents, that the central mass appears to have a movement of rotation more rapid than that of his photosphere. This difference of movement occasions the particular arrangement of spots, and the formation of groups elongated in a direction often parallel.

Referring to the "magnificent work of Mr. Carrington," showing, amongst other things, that the velocity of rotation of solar spots is a function of latitude, M. Chacornac remarks that it will be interesting to ascertain if a variation in the phenomenon of evaporation occasions deviations from this law.

In 1857, M. Chacornac states that he remarked a coincidence between the period of a revolution of Jupiter and two consecutive returns to a minimum of solar spots, as noticed by M. Schwabe, of Dessau, and he conceived a connection between the minima of the *radii vectories* of Jupiter and those of the

* M. Chacornac makes frequent reference to the theories of "surfusion and dissociation," by which M. Fournet and others have explained certain appearances in terrestrial geology, but we have not thought it necessary to cite these passages in detail.

solar spots. He considers the action of Jupiter in this matter to be established; and as we are now in the epoch of minimum spots, he asks whether we can recognize any influence analogous to that which M. Alexis Perrey, of Dijon, attributes to the moon over the volcanic eruptions of our planet. He thinks it probable, considering the immense mass of Jupiter, that he may cause an accumulation of solar atmosphere at the equator, augment its density and absorbing power, and thus lessen the rapid cooling actions which ordinarily take place in that zone. He likewise suggests that planetary attraction may collect some of the cosmical matter of the zodiacal light in the plane of the sun's equator, and thus mitigate both radiation and evaporation. M. Chacornac considers that the line of research followed by Messrs. Warren De la Rue, Balfour Stewart, and Loewy, is calculated to settle these questions.

In a note M. Chacornac says that since the text of his paper was written, other observations make him believe "that a central body may be clothed with an incandescent ocean, and that penumbra are craters of elevation." Our present object is not to criticise, but simply to give an account of the most generally interesting portions of M. Chacornac's important publication.

PHOTOGRAPHY AS A FINE ART.

THOSE who considered that the function of the artist was merely to copy natural objects with accuracy and fidelity, were (though erroneously) prepared to be satisfied with the operations of photography as soon as they were conducted with a sufficient amount of technical skill. There are certain cases in which art realizes all the conditions of deceptive imitation, and it is not very difficult to paint a butterfly, or a deal shaving so that a spectator might actually expect to be able to catch the pretended insect, or pick up the thin curly slice of wood.

When this mechanical fidelity is realized, there are many persons who conceive that nothing more is to be desired, and they form in their own minds a rude and inaccurate mode of estimating pictures according to the amount of realism which they exhibit.

A little more acquaintance with the facts of nature and the possibilities of art soon lead to the conclusion that realistic imitation is only possible to a very limited extent, and that in the main what may be called the imitative part of the artist's work consists in transposing, according to natural laws, the

facts of nature into the technical language of art. The painter can make no real imitation of the light which streams from the sun or the artificial fire, and his scale of light, shade, and colour is not only much lower, but in many respects different from that of nature. Only to a slight extent and under favourable circumstances can he, with any success, make the slightest attempt to imitate the strength of white light as seen in nature, and the art of the colourist is shown in his power of *transposing* what nature has composed in keys of actual light into corresponding, but not resembling, keys, such as his pigments enable him to provide.

The eye, as a living organism, does not remain in one and the same condition during any considerable portion of time in which an object is contemplated. Thus, if an object consists of parts in different planes, rapid focussing changes will occur in the eye, and the impression of vision is not the simple result of any one of these focussings, but a sort of average resulting from all. The perception of colour is not a simple affair. According to original sensitiveness and cultivation, the sensation of a colour is followed by another sensation of its complementary hue, and when two or more colours are simultaneously presented to the eye, very slight differences in the direction of that organ, and in the attention which the mind pays to its indications determine the precise result that is produced. The brightness of natural objects seen in full lights not being imitable by the artist, it follows that his productions cannot have the same power of summoning up complementary tints. Again, natural objects are more or less in motion, and more or less affected by motions of light and shade upon them, and the artist has to select and stereotype one out of many successive appearances presented to his view.

A few considerations of this kind will show how soon the limits of realistic imitation are reached, and it must also be remembered that even if accurate imitation were possible, it would not satisfy the human mind, which demands imagination, sentiment, emotion, as well as beauty in works of art. But it is generally supposed that photography comes to us with something like a perfection of imitative capacity. This is not the case. Instead of photography being necessarily right, imitatively considered, it is necessarily wrong. In the first place its focussing is a compromise, and if we take one of the best specimens of photographic landscape, its treatment of foreground, middle distance, background and greater distance, will never be found conformable either to nature, or to the impressions which, through the eye, the scene depicted makes upon the mind. In nature yellow light is the next in point of brightness to white light. Photographic machinery turns it into black.

The natural scale of brightness as connected with colour is constantly at war with the photographic scale; and the results of this conflict are seen in all photographic works which attempt to give a black and white version of a polychromatic object or scene.

The rise amongst us of the pre-Raphaelite school, and the modifications which that school, as represented by its leading artists, has undergone, has familiarized most minds with questions pertaining to detail or generalization. To paint a number of leaves and branches correctly, according to imitative notions, is not to paint a tree as any mortal ever saw it or could see it, when he looked at it as a whole. Too much detail for the conditions of a picture damage its verisimilitude as well as its art. Too vague a generalization is still more fatal, because it is wanting in particular truth. A drawing of a particular man so generalized as to be as much like any other man of the same race and clothing, would be an absurdity if it could be produced, and the true artist has to consider how far he is to generalize, and how far he must particularize in order to produce the best result—one of truth combined with beauty and with suggestive power.

If a number of good and bad photographs are examined, it will soon be found that, in addition to their merits or demerits, as attempts at imitation, they will vary in approaching to or receding from the kind of delineation which great artists delight to give. The artist imitates the appearance of nature in which delicately graduated lights and shades indicate the forms of objects seen in and surrounded by an atmosphere. Photography has a constant tendency to the child's blunder of making hard firm outlines where nature avoids them. The best of the orthodox school of photographers mitigate this mischief, but we are not aware that any one besides Mrs. Cameron has fairly attacked and vanquished it, and thus established a connecting link far stronger than any which previously existed between photography and fine arts. Mrs. Cameron has been engaged for several years in this labour, and her productions have been for some time before the public; but some of her most recent works have been the most remarkable, and have called forth from artists of the highest eminence a very enthusiastic, and, as we think, richly deserved praise. Mrs. Cameron has especially devoted her talents to two objects, both usually neglected in photography. The first is the realization of a method of focussing by which the delineations of the camera are made to correspond with the method of drawing employed by the great Italian artists. The second has been the introduction of an ideal pictorial element, by selecting good models and calling forth the kind of expression

which a judicious artist would desire to enshrine in his work. The results of Mrs. Cameron's labours may be seen at Colnaghi's, in a large collection of photographs, varying considerably in merit and interest, but all bearing testimony to originality of purpose and artistic skill. Here we have the head of a boy, full of fire and expression, simple and grand as a sketch by Correggio, which it closely resembles. There is no dead mechanism of mere photography here, but emphatically a work of art, instinct with life and motion. The hair flows freely, as if the breeze had caught it, the outlines are soft and melting, the play of light on the blooming features marvellous to behold. In another piece the same boy figures as *Love in Idleness*, a handsome mischievous urchin playing with his bow. An exceedingly well-managed group represents *May Day*; two other portraits are combined into an artistic and effective *Prospero and Miranda*. Other subjects of Mrs. Cameron's skill give us *Esther and Ahasuerus*, *Friar Laurence and Juliet*; while single figures, remarkably like drawings by great artists, are named, *The Mountain Nymph*, *Sweet Liberty*, *Adriana*, *Sappho*, *Clio*, *Christabel*, etc., etc.

In some of these cases we do not find ourselves able to follow the suggestions given by Mrs. Cameron in naming her pieces, the Greek ones especially seem to us, as a rule, to have much more of the character of mediæval Italy; but no one, free from professional photographic prejudice, can see them without being struck with the high degree of artistic merit which they possess, and the contemplation of works so original and so beautiful, leads to the conviction that photography need not remain in the lower stages of a mere imitative craft. Mrs. Cameron not only claims for it, but wins for it, the dignified position of a fine art, and we are glad to notice that copies of her works are offered for sale at very moderate prices. It is good for artists as well as amateurs that there should be this sort of competition. Ladies, like Mrs. Cameron, who break through the conventional nonsense which attempts to scorn industry the moment it seeks for profit, are doing good service in their day and generation. It is probably not of the slightest consequence to her whether she gains or loses by photographic pursuits, but, as her works are substantially good, and capable of multiplication, she is morally right in letting the public have the benefit of them, and economically right in accepting whatever legitimate profit they may produce.

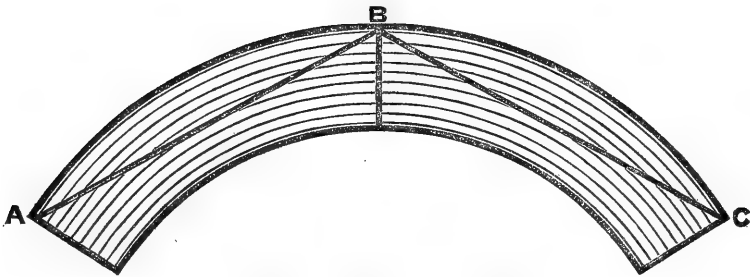

DECEPTIVE FIGURES;

WITH REMARKS ON SATURN'S "SQUARE-SHOULDERED" PHASE.

BY R. A. PROCTOR, B.A., F.R.A.S.

IN the April number of the *INTELLECTUAL OBSERVER*, p. 224, instances have been given of an optical illusion affecting our estimate of the relative *size* of figures placed in particular positions with respect to each other. In the figure accompanying this article a somewhat similar illusion affecting *shape* is illustrated; the lines A B and B C, which appear to have a decided curvature, being in reality straight lines.

In figures constructed on a larger scale, and with concentric circles closer together (in proportion), the deception is still greater; and it is remarkable that the illusion is increased by drawing equidistant lines radiating from the centre of the concentric circles. I notice, also, that a want of symmetry in the drawing seems to destroy the illusion.

The deception struck me as remarkably perfect in the case in which I first observed it. I had drawn the meridians and parallels for a polar star-map on the equidistant projection, to the scale of an 18-inch globe—the parallels to every degree, and the meridians, from the 20th parallel of N. P. D. to the bounding parallel (N. P. D. $37^{\circ} 23'$) of the map, also to every degree. Thus the map formed a circle $11\frac{3}{4}$ inches in radius, with 37 concentric circles crossed by 360 radiating lines, drawn with as much uniformity as possible. Now before marking in stars, I wished, as a matter of curiosity, to determine the exact figure on the *equidistant* projection of the spherical pentagon, which in my *gnomonic* maps appears as a true pentagon. I accordingly drew in, in pencil, first the inscribed pentagon, and then (through points determined by their known R. A.'s and N. P. D.'s) the five curved sides of the figure I required. Thus the sides of the true pentagon formed chords of the five sides of a curvilinear pentagon

outside the true one. But now I could scarcely persuade myself that I had not by mistake drawn the convexities of the curves the wrong way; in other words, that the curvilinear pentagon I had drawn was not a true pentagon, and its sides the chords of a curvilinear pentagon *inside* the true one. I had, in fact, to take a tracing of the curvilinear pentagon before I could form a satisfactory conception of its real shape.

This illusion seems to have a direct bearing on the question of the *square-shouldered* figure sometimes assumed by Saturn. We see that a series of concentric, similar, and symmetrically disposed curved lines, give to a straight line crossing them an appearance of curvature in a direction opposite to that of the curved lines. Hence a line drawn with a certain slight curvature in the same direction as the curvature of the concentric lines would appear straight, and a line with a greater curvature would appear to have its curvature diminished. Further, if such a line were continued beyond the concentric lines, the alteration of curvature would disappear at a short distance from the concentric lines. Hence H's observation of the flattening of Saturn's equator, and his determination of a maximum diameter and curvature at latitude 43° (not far from the apparent intersection of the ring's outer boundary with the outline of the disc) seems to be satisfactorily explained. Yet it cannot be denied that there are grave objections to the optical explanation of the phenomenon. One would expect that the illusion would be perceptible in pictures of Saturn; that it would be always observable, or, if it be supposed to depend on the extent to which the rings are open; that it would always be noticed when the rings are open to a particular extent; that it would disappear when the rings are closed; that it would not affect micrometrical measurement—or, if it affected such measurement in one case, that it would do so in all cases. A perusal of Mr. Webb's review of the evidence (pp. 250–252 of the May number of the *INTELLECTUAL OBSERVER*) will suffice to show that not one of these conditions is fulfilled.

I venture with great diffidence to offer some considerations which seem to point to a different solution of the difficulty.

If we assumed, either that the atmospheres bear any proportion to the masses of planets, or that any provision is made by increased depth of atmosphere for diminution of solar heat, we might fairly suppose that the height of Saturn's atmosphere is nine or ten times as great as that of our own atmosphere. Now the earth's atmosphere has been supposed to extend to a height of from 100 to 150 miles (Nichol's *Cyclopædia of the Physical Sciences*, Art. "Atmosphere"); but taking the more moderate estimate of 50 miles, the height of Saturn's atmo-

sphere might be assumed to be from 450 to 500 miles.* Our positive evidence is not, perhaps, very strong. The circumstance that the constitution of an atmosphere so far removed admits of determination by spectrum-analysis seems to indicate that the height of the atmosphere must be considerable. Mr. Grover's observation of a penumbra surrounding the planet's shadow on the ring (*Astronomical Register* for August, 1865, p. 212), "always noticed" even with the moderate telescopic power applied by this observer, also points to the existence of a strongly refractive atmosphere. Herschel's observation of a remarkable retardation of the occultations of Mimas and Enceladus has not been confirmed; but, perhaps, this is hardly to be wondered at. There are not ten telescopes in the world capable of following these two satellites up to the moment of their disappearance, and since the date of Herschel's observation there have only been five intervals, each of a few weeks only, during which the observation has been possible. It is true that where the further part of the ring appears to meet the disc at an acute angle, its outline should be distorted if the planet have a refractive atmosphere; but it is easy to see that the distortion would scarcely be appreciable even with the most powerful instruments, and Mr. Grover's observation above recorded is sufficient to show, that details observable with very moderate powers may for a long time escape observation. It will presently be seen that I am not here losing sight of the evidence pointing to a reflective power possessed at times and in certain latitudes by Saturn's atmosphere.

Now it has been observed by Professor Challis,† that the atmospheres of planets must have certain definite limits, since "the density continually decreasing with the height, a point must at length be reached at which the upward repulsive force of an atmospheric stratum is just equal to the force of gravity; in which case there can be no downward repulsive force, and therefore no further extension of the atmosphere." And he considers, that the effect of an atmosphere on our estimate of a planet's diameter will depend on "the relation between the gradation of density of the atmospheric strata and the curvature of the globe." This relation may be such that a ray would "pass through the atmosphere in a course which grazes, or is a tangent to, the interior globe;" or else, that rays could not reach "the surface of the globe in a direction making with it an angle less than" a certain limiting angle. In the first case

* Schröter estimated the height of the atmosphere of Ceres at 668 miles (!) ; a result which can hardly be considered as established.

† In an article on the "Indications, by Phenomena, of Atmospheres to the Sun, Moon, and Planets," *Notices of the Astronomical Society*, vol. xxiii., pp. 230—238.

the apparent diameter would "most probably not be sensibly increased;" in the second, "the increase would be the angle which the whole height of the atmosphere subtends at the earth." Now it is clearly possible that the atmosphere of a planet might in general exhibit one of these relations, but for a season might present the other, either over the whole planet or in certain latitudes only; and we have distinct evidence that Saturn's atmosphere is of variable refractive power, for whereas in nearly all pictures of Saturn, and notably in Mr. De la Rue's admirable engravings, the disc is darker at the edges than at the centre, so that this may be supposed to be the general appearance of the planet, the contrary appearance was presented in one instance to Bond II., and in another to Chacornac. Now it is perfectly clear, that if for a season the atmosphere over certain latitudes assumed the second state described by Professor Challis, while the remaining part was in the former—which we may perhaps be justified in calling the *normal* state—an apparent irregularity of figure would result. The outline of the disk would correspond in the former latitude to the upper limits of the atmosphere, in the latter to the limit of the interior globe; and we may suppose that in the intermediate latitudes the outline would pass from one limit to the other by indefinite gradations. There are reasons also for supposing that the "reflective state" would be more commonly assumed in Saturn's temperate zones than near his equator or poles. For the causes to which our trade-winds are due are exaggerated in the case of Saturn. Now Sir J. Herschel thus describes the circulation of our atmosphere:—"In each hemisphere inferior currents of air run in on both sides towards the equator, and superior ones set outwards, all around the globe, from the equator towards the poles. It is quite clear that neither near the poles nor near the equator, from or towards which these opposite currents tend, is it likely that there will be that tendency to stratification of the atmosphere into layers of variable density which favours the "reflective state." On the other hand, this state may be expected to occur—not commonly, indeed, but occasionally—in the temperate zones, where these currents attain their greatest velocity and steadiness of motion.

It need scarcely be remarked, that an apparent difference of level of 500 or 600 miles in latitude 40° or 45° , would be fully sufficient to account for Saturn's "square-shouldered" figure; but there are reasons for supposing that the height of Saturn's atmosphere in these latitudes exceeds the mean height. For it is found that barometric pressure attains its greatest value in the temperate zones; and although this phenomenon has never been fully accounted for, it appears highly

probable that it is due to the rotation and figure of the earth ; and therefore it seems probable that, in a planet of the figure, dimensions, and rapid axial rotation of Saturn, the excess of atmospheric pressure in the temperate zones would be still more marked.

It would be interesting to examine whether the square-shouldered figure seems to be connected with the occurrence of changes in the configuration of the Saturnian belts, or whether it is only assumed when the belts have remained for a long time in the same, or nearly the same position.

ASCENT OF CADER IDRIS.

BY D. MACKINTOSH, F.G.S.

(*With a Coloured Plate.*)

It is to be regretted that guide-book writers, in describing Cader Idris, should copy and perpetuate the errors of one another, so as to leave the tourist in ignorance of what he may really expect on making the ascent of this mountain. To supply, in some measure, this defect, I made a brief survey of the topography and surface-geology of Cader Idris in May last ; and it is but doing justice to the mountain to state that my expectations were far more than realized. If the attractiveness of a mountain is to be estimated by the number of abrupt and striking inequalities compressed within a small compass, Cader Idris is perhaps equal to any elevation in Britain ; and in the extent of its rocky cliffs and precipices it is certainly superior to Snowdon. It may be described as a long table-land, narrowing towards its eastern termination, and irregularly sloping towards the south. On each side of this table-land there is a range of rocky cliffs, which must strike the most ignorant observer as very similar to what may be seen on many sea-coasts. On the south-eastern, or Tal-y-llyn side, the cliffs are very picturesque, and often grotesquely shaped ; but, as this side is not likely to be very much visited in future,* and as one side is sufficient for a whole article, I shall at present confine attention to its northern front, and the neighbourhood of the peak.

The northern or Dolgelley side of Cader Idris is a continuous escarpment, extending like a rampart for a distance of at least eight miles ; the principal and most rocky part of this escarpment is about four miles in length. It commences on

* I was informed at Dolgelley that, owing to the completion of the Welsh Coast Railway as far as Penmaen Pool, the Machynlleth coach will in future be discontinued.

the west with a bold and striking headland called Tyrau Mawr. For some distance, in an easterly direction, it consists of a steep grass-covered slope, with frequent rocky projections. On the surface of a large flat stone on the side of this slope I noticed a distinct series of ice-grooves, only a little roughened by the weather during the time that has elapsed since they were imprinted. Further on, the escarpment graduates into a line of bare rocky cliffs, with debris or "screes" strewn along their bases. These cliffs are deeply indented with vertical rents and passages, which often ramify backwards so as to leave detached pillars. On approaching Llyn-y-Gader the cliffs become more massive, and rise to an almost appalling height. Here their bases are buried in screes, which run down into the transparent waters of the llyn. On the east, a continuous wall of rock extends to the headland which frowns over the town of Dolgelley; this headland terminates abruptly in a *cwm*, or inland cove, on the southern side of which it sends off a spur in the direction of the Arran range of mountains.

The principal screes are to be seen in the neighbourhood, and to the west of Llyn-y-Gader. They are partly derived from the breaking down of the cliffs, and here and there a large block has evidently very recently fallen; but a distinction must be made between debris, strictly so called, and the immense accumulations of stones to be found both at the base and on the summit of the mountain. The ridge-like buttresses, consisting of loose fragments, which, in many places, may be seen underlying large fissures in the cliffs, are chiefly the result of cataracts of stones which have tumbled down, not from the cliffs themselves, but from the heaps of loose fragments on the summit. These heaps, in many places several yards in depth, have been scattered, piled on each other, and apparently forced up the acclivity of the saddle-shaped eminence called Cyfrwy. They are generally columnar and pentagonal in shape, and are frequently made use of as gate-posts, lintels, etc. The number of stones on this part of Cader Idris would probably be sufficient to build a good-sized town. They are to be found in smaller quantities on other parts of the mountain. How these stones came there cannot be easily explained, even in the present advanced state of geological theory. The agency of land-ice is not applicable to a high and narrow table-land where no ice-shed could have existed. The action of the sea, assisted by ice-floes and coast-ice, at the time when the summit of Cader Idris was slowly sinking beneath or rising above the sea-level, would appear to offer the most probable explanation; and to this agency we may likewise attribute the stupendous accumulation of stones found lying beneath the mountain, in positions where they could not have fallen from the neigh-

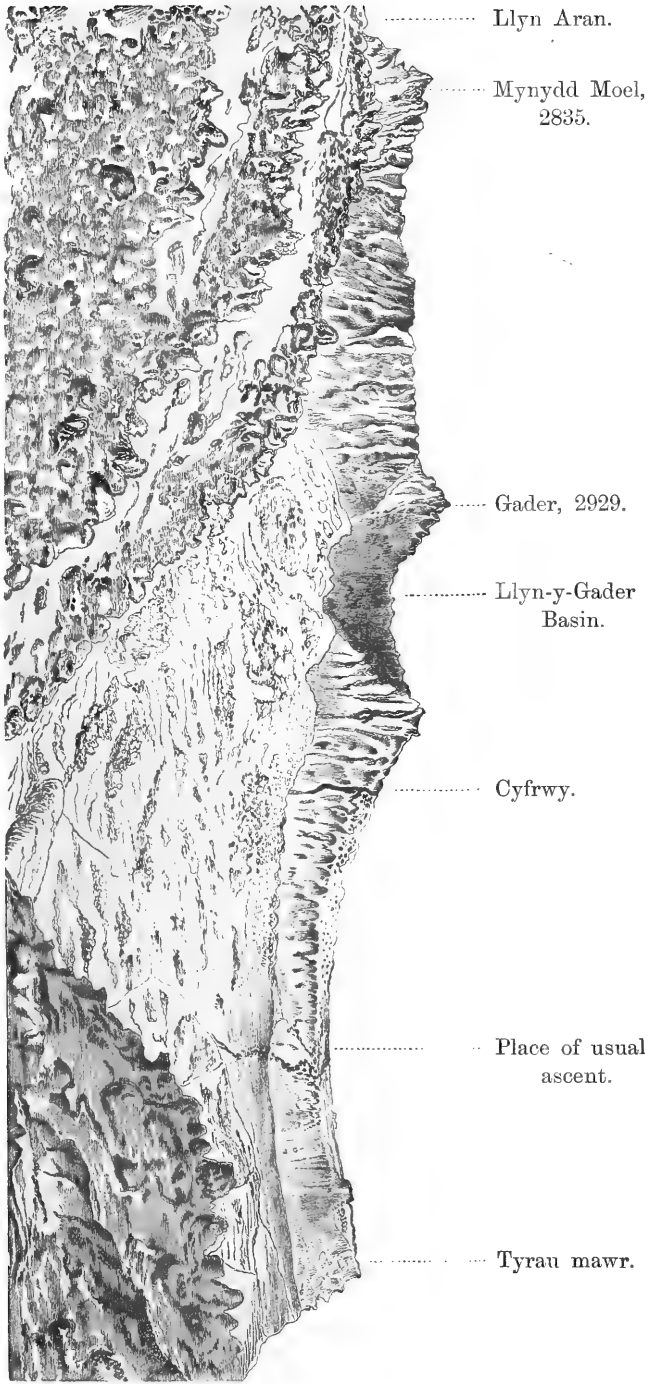

..... Llyn Aran.

..... Mynydd Moel,
2835.

..... Gader, 2929.

..... Llyn-y-Gader
Basin.

..... Cyfrwy.

..... Place of usual
ascent.

..... Tyrau mawr.

GADER IDRIS.

From a hill on the north of the Old Towyn road.

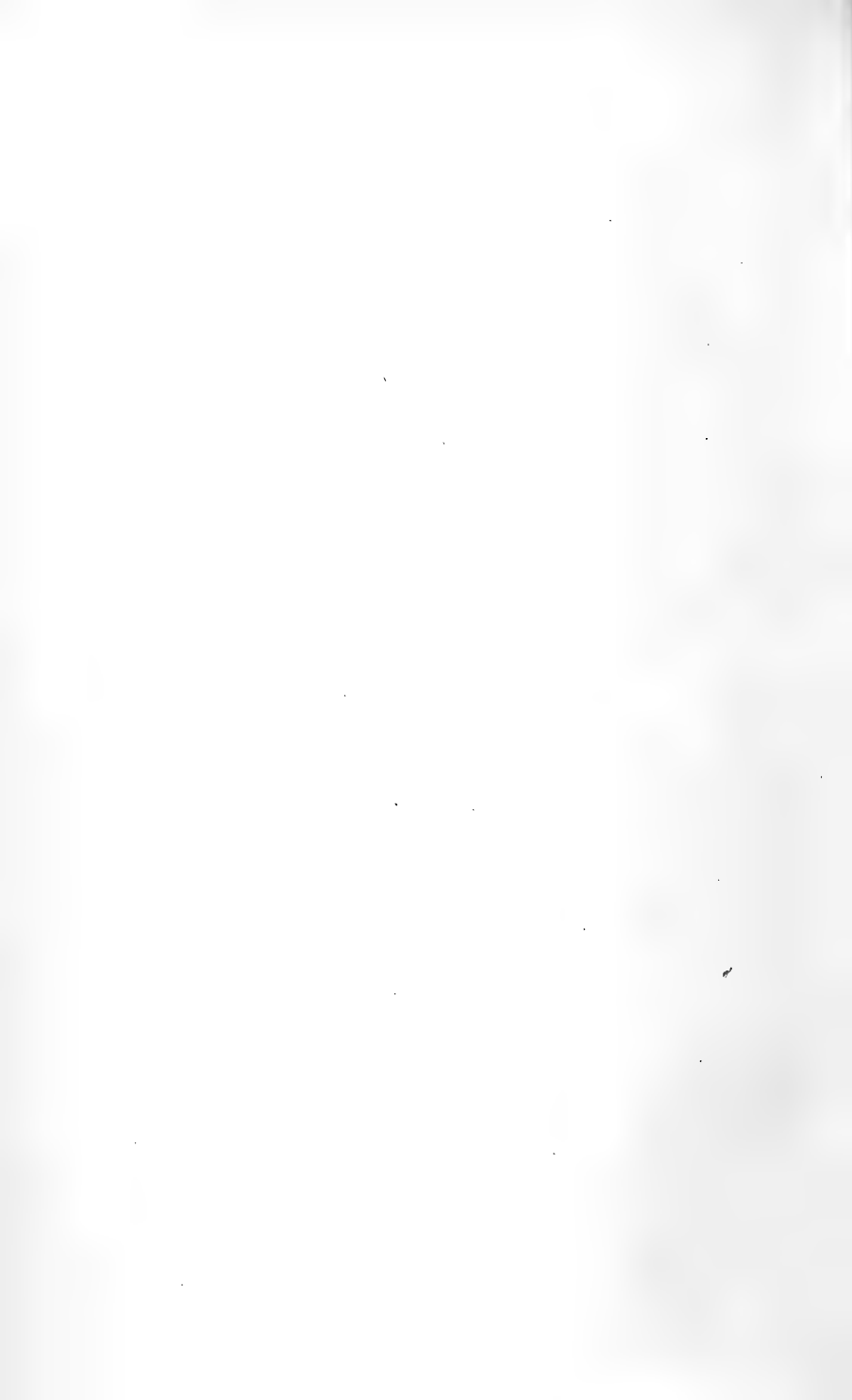

bouring cliffs. A scramble over the latter to the lake (Llyn-y-Gader) of which they form the western barrier, is about as severe an exercise for a pedestrian as can well be imagined; though the only real danger to be apprehended is a sprained ankle.

The small, round, and deep lake-basins form the most remarkable feature of the scenery of Cader Idris. The two best known are Llyn-y-Gader and Llyn Cae. The first may be found on the north side of the mountain, immediately under the Gader peak. It embraces about half a circle, and is bounded by high cliffs. The lake is dammed in by a ridge of stones, beneath which, in all probability, there is a solid rocky barrier, so as to give this hollow the character of a true rock basin. The water has no visible egress, though there can be little doubt that it percolates through the outer part of the stony barrier. It is not surprising that early travellers should have looked upon this basin as a volcanic crater formed by explosion, and that the neighbouring accumulations of stones, already mentioned, were the effects of the explosion. It is, however, to be regretted that the most modern guide-book writers should borrow their geology from the days of Pennant, and speak of pumice-stone, and other subaërial volcanic products, as being found on Cader Idris. In a certain extensively-circulated guide-book not only is this error perpetuated, but Llyn Gwernan, two miles from Dolgelley on the old Towyn road, is called Llyn-y-Gader, and the latter is left without a name; while Wilson is represented as having painted Llyn-y-Gader, whereas it is well known that Llyn Cae was the subject of his celebrated picture. It is a pity that guide-book writers should not take the trouble to visit the spots they attempt to describe. No geologist would now regard Llyn-y-Gader as a volcanic crater. It has evidently been scooped out of the alternating slaty and submarine volcanic rocks of which the mountain consists; but the cause of the excavation admits of difference of opinion. This basin, as well as Llyn Cae, may certainly have been deepened by ice, but its situation would appear to preclude the idea of a glacier having formed the whole of the crateriform hollow. The undermining action of a tidal current, at the time or times when the rocky rampart of Cader Idris was a sea-cliff, would appear to be the explanation most in accordance with our knowledge of the effects of recent geological causes. During the glacial submergence the excavation may have been completed, if not principally effected, and the sea may have been powerfully assisted by the action of coast-ice.

On proceeding along the usual route, and before you arrive at the base of the Gader peak, you suddenly behold the

black profile of the inner cliff of Llyn Cae, forming the gable end of a grass-covered ridge. The top of the cliff is almost perpendicular (that is, overhanging, in the phraseology of guide-book writers, but really at an angle of about 85°), and as you see the basin gradually deepen underneath, and the cliff assuming the shape of a peak, an impression never to be effaced is left on the mind. The rocky edge of this peak is so extremely sharp as to suggest the idea that it has buffeted the tempest and the waterspout since the sea last undermined its base.

There it remains, dark emblem of decay,
Revealing silently the wondrous way
In which the icy tide's tumultuous flow
Wore out the awful gulf that yawns below!

On making the ascent of Cader Idris, it is usual to proceed for about two miles along the old road from Dolgelly to Towyn. This road at first rises gradually to the level of an irregular terrace, which extends along the base of a high rocky outlier of Cader. You pass Llyn Gwernan, and soon leave the main road. You then take one of the zig-zag paths which act as torrent-channels in winter and pony-tracks in summer. You reach the summit of the Cyfrwy, or Saddle, with little difficulty, and then proceed in an easterly direction, skirting, and sometimes encountering, the accumulation of columnar stones already described, until you arrive at the base of the peak. This peak is a mass of solid rock, with projections, pillars, and intervening loose fragments. It is precipitous on *all* sides, and in this respect is superior to the summit of Snowdon. The tourist may here amuse himself in trying to make out the part of the mountain which mythologists have dignified as the chair of Idris. Do they suppose the giant to have reposed in the basin of Llyn-y-Gader, with his feet dangling down into Llyn-Gafr, and his head leaning back against the Gader peak? Or do they place him sitting in the more secure caldron of Llyn Cae, the inner cliff of which resembles the back of some of our old wooden arm-chairs? Or, contented with regarding him as approaching the size of an ordinary mortal, do they suppose a likeness between a chair and a certain rocky hollow near the summit of the peak? The latter would seem to be the true solution of the problem.

You have no sooner commenced the ascent of the peak than you begin to be struck and overawed with what at first seems an illusion, but is not long in being realized, namely, a gulf on each side of unseen profundity. You find yourself on a narrow ridge of fantastically-shaped rocks, between two precipices which slant down into apparently

bottomless pits. You can throw a stone with either hand over both precipices without stirring from the spot. The breadth of this isthmus (for an isthmus between two rolling seas at one time it must have been), from brink to brink of the two lake basins, is certainly not more than two hundred yards. By deviating a little to the right or left, and grasping a rocky projection, to give a sense of security and prevent a giddiness few can resist, you are enabled to see the water—on one side pellucid, on the other (Llyn Cae) dark and dismal—at an appalling depth below.* On reaching the apex, and leaning against the pillar of stones erected by the Ordnance surveyors, any previous sense of terror becomes replaced by delight on seeing Snowdon rearing its counterpart peak on the distant horizon, the hills on the opposite side of Cardigan Bay, the Breiddon Hills in Shropshire, the Black Mountains of South Wales, and (if the day be unusually fine) the distant coast of Ireland. After this the task of descending does not appear so hazardous. You take a last look at Llyn Cae, in its gloomy horror never to be forgotten; you proceed on your way rejoicing that you have made the ascent of the most remarkable, if not the highest mountain in Wales, and you soon find yourself among the habitations of mankind. Courageous and hardy pedestrians ascend and descend Cader Idris by a steep track almost immediately under the peak, and to the east of Llyn-y-Gader, and this is the only route mentioned in Black's *Picturesque Guide*; but it may be well to warn the majority of tourists against attempting this route, which, leaving danger out of the question, will be found to be more fatiguing than the one usually chosen.†

* The level of the waters of Llyn Cae must be at least a thousand feet below the apex of the peak.

† On the 28th. of last month (May), the body of Mr. James Smith, of Newport, Monmouthshire, was found at the base of the precipice on the Llyn-y-Gader side of the peak. His skull was fractured, neck dislocated, and one foot detached from the body. At the inquest held at Dolgelley it was agreed that he must have fallen from the summit. He had been missing since the 20th September last.

NOTES ON FUNGI.—No. VI.

BY THE REV. M. J. BERKELEY, M.A., F.L.S.

BLACKISH PURPLE, OR BROWN-SPORED MUSHROOMS, TOGETHER WITH THE BLACK-SPORED SPECIES.

THE first division, *Pratelli*, consisting of six subgenera, *Psalliota*, *Pilosace*, *Stropharia*, *Hypholoma*, *Psilocybe*, and *Psathyra*, contains our more important esculent Agarics. Many of the species are small and unimportant, while some in the first subgenus are amongst the largest and most noble Agarics. The spores in the more typical species are of a dark blackish purple, but in others they are of a dark or ferruginous brown. In some instances from imperfect development, they never acquire their proper colour, while in others the gills are absolutely barren, and in consequence assume a very abnormal appearance, a circumstance which occurs also amongst the dung Agarics or *Coprini*.

Psalliota (from *ψάλλιον*, a collar) is distinguished by the hymenium being absolutely distinct from the stem, the gills being rounded behind and free, and also by the presence of a ring. All the species grow upon ground more or less richly manured, and in some the spores seem to require to pass through the stomach of some graminivorous animal, to facilitate their germination, a circumstance which accounts for the occurrence of the common mushroom wherever horse manure is present.

It is difficult in this subgenus to say what is a species, what a variety, but some forms at least seem to stand out more especially above the rest.

Perhaps the most beautiful of British Agarics is one which occurred in Flintshire two years since, and which, from growing in the district of Elwy, was named *A. elvensis*. The pileus, which is six inches across, is fibrillose, and broken up into large persistent brown scales, the disk areolate, and the margin covered with pyramidal warts, and from its pleasant taste and smell is undoubtedly esculent. *A. cretaceus*, of whose esculent qualities little is known, is remarkable for the stem being deeply sunk into the flesh of the pileus, as in *Agaricus procerus*, and for the very pale gills and spores, in consequence of which, some doubt has occasionally been entertained as to its real affinities; and it has been sought for either in *Lepiota* or *Pluteus*. It occurs occasionally in hot-houses and about cultivated grounds, but generally in very small quantities, and is often solitary.

A. arvensis, the horse mushroom, or incorrectly, St. George's mushroom, is a large coarse species, in general occurring in rings, but sometimes in scattered groups, and is known at once from the true mushroom by its tendency to become yellow, and sometimes intensely yellow, when bruised, and its paler and at length more dingy gills. In its more normal state it is of a pure white, hemispherical and very fleshy, with a ring which looks as if it were made up of two, one within the other. Small conical varieties, however, occur, and others which are scaly and of a tawny yellow tint, as in *A. augustus*. To this, perhaps, the variety called *A. villaticus* in the *Outlines of British Fungology*, is referable, rather than to *A. campestris*.* Most of the varieties are wholesome, and while in Italy *A. campestris* is rejected, this has obtained the name of *A. exquisitus*, while in France it is well known under the name of *Boule de Neige*. Great prejudice exists in many parts of the kingdom against this species, which is rejected by most professed cooks and housekeepers on account of its turning yellow; but in some parts of England it is highly esteemed, while in London it forms far the greater part of the mushrooms which appear in the market. It is, however, almost universally used for ketchup, for which purpose it is far superior to many of the doubtful if not dangerous species which enter into that frequently questionable condiment. There is a variety mentioned by Mrs. Hussey, as the hedge mushroom, which grows in tufts under hedges, and though innocuous in ketchup, produces, when eaten, violent sickness. This never has the least tinge of yellow, and the pileus is regularly covered with small brown scales. Another form—much like it—mentioned by Mrs. Hussey, which grows on the borders of woods, and which turns of a yellow red when bruised, is, on the contrary, very highly valued. This, however, was considered by Dr. Badham, a form of *A. campestris*, and I am inclined to subscribe to his opinion. It was probably on this variety that a village schoolmaster, in Northamptonshire, who found it for many weeks in succession in an open plantation, nearly kept his family, without their experiencing the slightest inconvenience. I am not able to speak positively as to the species, as I never saw an individual, but his description and the locality pointed in this direction.

Of the merits of *A. campestris*, it is not necessary to say much, as every one, in this country at least, is pretty well satis-

* Dr. Badham writes respecting it:—"Do you meet with this scaly form of *A. exquisitus* in Northamptonshire? it is the first time I have seen it here, and but for the yellow tinge exuding from it when cut, and the grey gills, I should have supposed it a scaly specimen of *A. campestris*, which is often coated with similar brown scales." Brondeau's *A. villaticus* is vinous when bruised, in which character alone it differs from that of Dr. Badham.

fied on the subject. Variable as it is in colour, form, size, and sculpture, the peculiar pink gills, and the tendency to be pink when bruised if any change takes place, are in general distinctive characteristics. Many varieties of this occur both in the field and under cultivation, and it is a mistake to suppose that the brown pilose form is the only one that occurs in artificial beds. Several varieties were figured some years since in the *Gardeners' Chronicle*, and one at least, from its prolific nature, would have been an acquisition could it have been kept distinct.* The artificial formation of mushroom spawn was once considered a great mystery, and a powerful argument in favour of spontaneous generation, but the key to the mystery has been given above. At Belvoir Castle, where there is a great riding-school, the comminuted straw, which is collected from the pavement, when heaped up and occasionally turned, is used with complete success for the growth of mushrooms, without any artificial spawn. The stove mushroom, which is cultivated in enormous quantities in the catacombs at Paris, is almost the only one which is admitted into the Paris markets. A mode of cultivating the mushroom from the spores, by making them vegetate on glass under the influence of saltpetre, and then removing the young brood into artificial beds, was, a few years since, much talked of at Paris, and raised great expectations from the quickness of growth and the size of the supposed produce. The whole, however, came to nothing.

Mushrooms are subject to disease like other plants when cultivated. Not only do they become deformed without any apparent reason, but they are sometimes attacked by a minute fungus belonging to the genus *Hypomyces*, which obliterates the gills altogether, and entirely alters the texture. It would not be safe to consume such individuals, even in an early stage of growth without great caution, supposing their aroma not to be affected. It is scarcely necessary to add that such maladies are quite beyond control. In one instance, instead of mushrooms, a crop of shapeless dark bodies appeared, one of which, when coaxed into its complete development, proved to be an undescribed fungus of the genus *Xylaria*. A figure of this has lately been published in the *Transactions of the Linnæan Society*.

It is not easy to conceive why such a prejudice against *A. campestris* should exist in Italy. If the supposed cases of poisoning are really due to the species, and not to something mixed with it, which has sometimes happened in this country, we can only imagine that a larger quantity of amanitine is

* Some spawn which was prepared at Belvoir and sent to me by Mr. Ingram, produced exclusively a long stalked, pure white, nearly smooth variety of excellent quality.

formed in it than with us. There is not, however, the slightest evidence to show that this is the case, and we must wait for better information. *A. campestris* occurs in all parts of the world, and Mr. Drummond reported that a variety occurs in Australia which as far exceeds any European form in quality as our improved peas surpass those which were formerly in cultivation. He sent over samples of the spawn, but though great pains were taken by Mr. Henderson, the late talented gardener of Earl Fitzwilliam, it would not run. In addition to the distinctive characters given above of *A. arvensis* and *A. campestris*, a more subtle one, but one not liable to deceive a practised mushroom-gatherer, exists in the peculiar smell of the former, which is also possessed by the very abundant and deeply penetrating mycelium. I have seen in recently ploughed-up pastures, where rings of *A. arvensis* were abundant, large tracts of mould perfectly white with the spawn, and at once proclaiming what it was at some distance by its odour.

The quantity of mushrooms collected every year for ketchup is enormous. The ketchup is seldom made by the gatherers, who are not very particular what they put in their baskets so long as it yields a brown liquor; and as the contents are at once salted bad kinds cannot in general be detected by the mushroom merchant, if he is inclined to be scrupulous. They command from a penny to fourpence a pound, or very seldom a trifle more. The merchant does not always prepare the ketchup directly, but sometimes keeps the salted fungi in barrels for months. Good ketchup may be prepared from morels, *A. procerus*, *A. gambosus*, *A. prunulus*, *Marasmius oreades*, and some others, but all do not yield an equal quantity of juice. Mrs. Hussey recommends a way of preparing it without boiling—the clear juice, free from all sediment, being placed in small bottles and filled up to the shoulder, the remainder being filled with proof spirits, in which the requisite spices have been steeped. She adds, “all who try this plan fairly will acknowledge they never tasted ketchup before.” Ketchup made from the *Marasmius* is exceedingly strong, and like garlic requires to be used with caution.

It would not be right to leave this subject without mentioning *A. silvaticus*, which is not uncommon in woods, and which, though in some respects agreeing with *A. campestris*, has not the same pleasant odour, and is distinguished easily by the stem being stuffed with delicate threads. It is a species which should certainly be used with caution if not altogether rejected.

It remains only to notice a single species belonging to the subgenus, on account of its singularity, but certainly without any respect for its intrinsic value. *A. echinatus*, remarkable

for its dingy pileus, covered with smoke-coloured meal, and its blood-red gills which often yield only effete spores, occurs now and then upon peat in gardens. In all the species there is a universal veil, though not always distinct from the partial veil. In *A. echinatus* this is represented by the copious meal.

It is not necessary to dwell on the subgenus *Pilosace* (from *πίλος*, a hat, and *σάκος*, a shield), which is distinguished from *Psalliota* by the absence of a ring, as we have no British representative.

The subgenus *Stropharia* (from *στροφήιον*, a girdle) was formerly included in *Psalliota*, but has been very properly separated on account of its gills not being decidedly free as in *Lepiota*, *Volvaria*, *Pluteus*, and *Psalliota*. It does not seem to contain a single esculent species, though one has the reputation of being extremely poisonous. *A. aeruginosus* is sometimes a beautiful object when fresh from its verdigris-green pileus, clothed with white floccose scales. Both the green tint and scales, however, vanish with the first shower, and the beauty is gone. It has a peculiar smell like that of cerate, and is in all probability poisonous. *A. albo-cyaneus*, of which a figure (No. 3) is given in our second coloured plate of Fungi, published in the INTELLECTUAL OBSERVER, October, 1865, p. 184, occurs occasionally in meadows, and is distinguished by its more elegant form, and livid rather than green tint when young, in addition to other characters.

A. semiglobatus is one of the most common species, occurring everywhere on horse dung. Whether this or some other species was the cause of several deaths at Battersea when Sowerby was publishing the latter portion of his Fungi is not very clear, though he gave it, by way of indicating its supposed evil qualities, the name of *A. virosus*. It is, however, a species which could only be eaten by mistake, though it is very probable that it often gets with other dangerous species into the mushroom basket. Though in some cases the deleterious qualities of fungi may be diminished by evaporation and the free use of the salt in ketchup, there are cases on record where it has been fatal.

It will not be necessary to dwell long on the remaining subgenera.

Hypholoma (from *ὑφή*, a web, and *λῶμα*, a veil) is distinguished by the veil being woven into a fugacious web, which often adheres in fragments to the margin of the pileus. It does not form a ring upon the stem as in *Psalliota*. The species are mostly of a tolerable size, and are densely tufted. Either the taste of the primary species is bitter, or the texture tough, or the two bad qualities are combined so as to make them ineligible for food. *A. velutinus* is more tender, and is

sometimes an ingredient in ketchup. A large basket was once sent to me as a present, on the supposition that it was wholesome, but it is scarcely necessary to say that it was at once rejected.

A. sublateritius is often a great ornament in woods about the trunks of trees from its brilliant colours, but it is not always easily distinguished from similar species, and especially from the bitter *A. fascicularis*, which in its turn may be confounded with other kinds if attention is not paid to the spores. *A. capnoides* is at once distinguished by its mild smell and taste, but it is of too suspicious affinity to induce a trial of its esculent character, did it occur in sufficient abundance. *A. appendiculatus* (No. 4 in our second coloured plate),* which is a very abundant species, is readily distinguished by the abundant white fragments of the veil.

Psilocybe (from *ψιλός*, naked, and *κύβη*, a head), as the name implies, is destitute of a veil, except in one or two species, which grow on dung, while its incurved margin distinguishes it from *Psathyra* (*ψαθυρός*, brittle), in which the margin is straight. In either subgenus the species are, for the most part, insignificant, and often difficult to distinguish from the fugitive character of their colouring. We have given a figure of *A. bullaceus* (No. 5) in our second coloured plate,* more because it is interesting than from its being a very typical species.

The concluding division, *Coprinarii*, containing the species with black spores, consists of two subgenera only, *Panæolus* and *Psathyrella*. The former, *Panæolus* (from *παναιολος*, variegated), is distinguished by its rather fleshy pileus, which is never striate, and the margin extending beyond the gills, which are mottled. The species grow chiefly on dung, *A. separatus* being often very conspicuous from its shining, smooth, semi-ovate pileus and straight stem. *A. fimiputris* is often an extremely pretty object, from the edge of the pileus being adorned with little appendages which look like eyelet holes. None of the species are esculent, though they often enter into the composition of ketchup in consequence of their dark spores.

The remaining subgenus *Psathyrella* (a diminutive of *Psathyra*) has a membranaceous pileus, and the margin does not reach beyond the gills. The most abundant species is *A. disseminatus*, which springs up wherever wood is buried or on the wood itself in myriads, fading away almost as unexpectedly as it makes its appearance. This sometimes grows on plaster walls, and then springs from a dense mycelium.

The genus *Agaricus* comprises now at least 400 British

* October, 1865, p. 184.

species, to which undoubtedly many additions will be made. The present season has afforded several novelties. The study is undoubtedly involved in much difficulty, but this will be greatly diminished by a careful study of some typical species in each subgenus, for the determination of which good figures are absolutely necessary. Without some such previous discipline, it will be almost impossible to ascertain a species satisfactorily; and it is to facilitate this that the present series of notices has been prepared.

THE COMING METEOR SHOWER.—THE SPECTRA OF METEORS.

GREAT interest attaches to the composition of meteors, and though chemical analysis of the ordinary kind can lend its aid to the examination of meteoric stones, which fall in considerable masses upon the earth, it cannot avail with regard to the much more numerous class of shooting stars and bolides, which blaze for a moment in our atmosphere, and then disappear entirely, or leave for a few seconds the transitory traces of a luminous smoke. To learn something of the composition of these bodies, Mr. Alexander Herschel proposed the employment of a binocular direct vision spectroscope, fitted up with peculiar prisms designed by himself. This plan, which presents considerable difficulties of optical construction, has been very ably carried out by Mr. Browning; and the British Association Committee have ordered four of the instruments with a view to their employment in the coming November showers, when a maximum number of meteors may be expected.

The nature of Mr. Herschel's plan will be obvious from the following diagram. The thick dotted lines represent the path

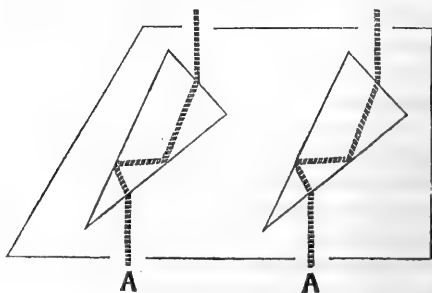

THE HERSCHEL-BROWNING METEOR SPECTROSCOPE.

of the light rays through the prism. When a pencil of light enters the prism, it is *refracted*, and then continues its course until it meets one side of the prism, which it strikes at such an angle that it cannot get out. It is therefore *reflected* to another side, also at an angle which prevents its egress; and accordingly it undergoes a second reflection, after which it is permitted to emerge in a position opposite, and parallel to, its line of entry.

In employing an ordinary spectroscope, it is necessary to limit the admission of light by a *slit*. But if the source of light took the shape of a fine line, no slit would be required, because the mass of light would not exceed the quantity with which the spectroscope could advantageously deal. With shooting stars and ordinary meteors this is the case, and hence the Meteor Spectroscope requires no slit. Observers furnished with the new instrument will direct it like an opera-glass to the part of the sky most favourable for the observation of the November shower, and as a shooting star makes a line of light in the sky, it will give one or more lines of light in the spectroscope. If, for example, we had a sodium meteor, it would give a yellow line in the sky, and a yellow line, occupying the sodium line place, in the spectroscope. If silver were present together with sodium, the meteor train would have a greenish tinge, and *three* lines would appear in the spectroscope—yellow, green, and blue.

Those who intend to take part in these highly curious inquiries should provide themselves in time with Meteor Spectroscopes, and should, with the help of an ordinary spectroscope, study in advance the spectra of the metals and other substances most likely to be seen when the meteors are in the field.

The study of meteors is already highly indebted to Mr. Alexander Herschel, whose labours are recognized as of the highest value by every physicist of eminence; and we have no doubt that his "Meteor Spectroscope" will contribute efficiently to the progress of our knowledge of shooting stars. To Mr. Browning belongs the credit of carrying Mr. Herschel's plans most successfully into operation, by the construction of prisms with an accuracy of angle and surface extremely difficult to obtain.

Mr. Alexander Herschel recently gave a lecture at the Royal Institution, "On the Shooting Stars of the year 1865—66, and on the Probability of the Cosmical Theory of their Origin." He commenced by adverting to the probability established by Professor Newton, of Yale College, U.S., "that in the current year, 1866, a prodigious flight of meteors, the most imposing of its kind, and visible over a large area of the

earth's surface, will make its appearance—perhaps for the last time in the present century—either on the morning of the 13th, or on the 14th November.”

The meteors should be especially looked for between midnight and sunrise, and may be expected in greatest abundance between three and four A.M. “They proceed, with few exceptions, from a common centre in some part of the Constellation Leo.” Mr. Herschel observes that “between the 13th of October and the 12th of November, during the years from A.D. 903 to 1833, not less than thirteen great star showers have been recorded. They are separated from each other by the third part of a century, or by some multiple of this period, and are periodical reappearances of one grand meteoric shower, viz., that seen by Humboldt in 1799, and by Olmsted in 1833, the star shower expected to return in the present year, and known by the name of the “great November shower.” Its contact with the earth takes place one day in the year at each of its principal returns. According to the exact calculations of Professor Newton, “the next passage of the earth through the centre of the meteoric group will take place two hours after sunrise at Greenwich on the morning of the 14th of November, 1866.” A watch on the morning of the 13th is recommended, “as the moment of greatest brightness may fall one day before the predicted time.” On the 13th of November, 1865, first-class meteors were seen at Greenwich at the rate of 250 per hour, and the “maximum display of the November meteors expected in 1866 is several hundred times greater than that observed at Greenwich on the 13th of November, 1865. Two hundred and forty thousand meteors are computed by Arago to have been visible above the horizon of Boston on the morning of the 13th of November, 1833.”

The average height of shooting stars at the middle of their apparent paths is not quite sixty miles above the earth.

Mr. Herschel points out a singular difference in the behaviour of shooting stars and aerolites, or meteoric stones. The meteoric stones most frequently fall after mid-day, between noon and nine P.M., while the shooting stars are most abundant after midnight; and only one stone has been known to fall on the 10th of August or the 13th of November, when shooting stars are most numerous.

A point of importance to be ascertained by means of the “Meteor Spectroscope” is, whether shooting stars and their luminous trains are composed of porous matter, or of solid matter, perhaps in a finely divided state, as is presumed.

The anticipated splendour of the November shower should not be permitted to divert attention from the smaller shower expected on the night of August 10.

DR. CURTIS'S PROCESS OF PHOTO-MICROGRAPHY.

BY R. L. MADDOX, M.D.

THE beautiful specimens of photo-micrography, tracings of which we were enabled, by the kindness of Dr. Maddox, to lay before our readers in our July number, have excited so much interest, that we are sure the following letter from Dr. M. explaining the process will be highly appreciated:—

“Through the kindness of Dr. J. J. Woodward, who has charge of the Medical and Microscopical Department in the Army Medical Museum, U.S., I am enabled to offer for the pages of your valuable journal a brief description of the plan adopted in taking the photo-micrographs alluded to, and published in your July number, and which becomes of more interest, as Dr. Woodward shows by a further number of prints of various objects, taken both by sun and artificial light, the excellency of the method.

“The difference in sharpness given to the $\frac{1}{50}$ th over the $\frac{1}{8}$ th, and achromatic concave amplifier, is attributed by him to the chemical process employed in rendering the albumen negative intense. The smaller prints were from the original negatives, and in the enlargement from these the solar camera was not employed.

“The diatom *Pleurosigma angulatum* was simply a dry mounted specimen, adhering to the cover of an ordinary slide, which was removed, turned, and then covered by the thin glass necessary for the $\frac{1}{50}$ th. The part alluded to as possibly a sun spot, was only due to a particle of adherent dust.

“The following plan is adopted by Dr. Curtis at the laboratory of the Museum—the lenses of the objectives in use being corrected for the violet ray, and the formula furnished by Mr. Lewis Rutherford, so well known for his astronomical photography; but in the $\frac{1}{50}$ th, the difference between the visual and actinic foci is so small as not to be noticed in the correction:—

“Outside the window is placed a Silbermann's Heliostat, which reflects the rays from a plane mirror, duly centred, through a brass tube, at the orifice of which hangs a large cell, with parallel sides of plate glass, filled with a saturated solution of the ammonio sulphate of copper, the other arrangements of the apparatus being properly disposed in a dark room, instead of using a camera: thus practically violet monochromatic light is employed. The sensitized albumenized plates being, in this case, placed about three feet from the object for the $\frac{1}{50}$ th, rather less for the $\frac{1}{8}$ th and amplifier, and seven minutes' exposure allowed. The condenser used was a pair of plano-convex lenses of about one inch combined focal length,

a large central stop being placed over the flat surface of the one nearest the object, thus illuminating it with only the oblique pencils. These lenses were not achromatic, as monochromatic light was employed. The value of these details will, I trust, prove a sufficient apology for again trespassing on your space !”

ANIMAL LIFE IN SOUTH AFRICA.

BY H. CHICHESTER, ESQ.

ALTHOUGH narratives of travel and of sporting adventure in Africa have of late become so numerous, the amount of information to be acquired through their medium respecting the peculiarities of the animal world in these regions, still beyond doubt the finest game countries of the older continent, is (with one or two exceptions) scanty indeed. We propose in the following pages to notice a few among the many points thus generally overlooked.

Commencing with the hugest specimen of nature's handiwork, the elephant, we have generally found two curious points overlooked or ignored by writers—one is the rapid and noiseless movements of this animal in the thickest cover ; the other, his capabilities of passing over ground for him apparently utterly unfeasible. The elastic noiseless footfall of the elephant has been frequently referred to by writers on Indian subjects, and has been rightly asserted to be the most agreeable feature in journeying on elephant-back. This peculiarity may be easily explained by an examination of the structure of the animal's foot ; but the silent stealthy way in which he will pass through the densest thicket, literally “*slipping away*,” when his acute senses of smell or hearing warn him of danger, has been generally overlooked, and appears to us somewhat difficult of explanation. Let any one unskilled in the mysteries of “bush ranging,” attempt to move even a few paces in an ordinary fox-covert without noise, and he will form some idea of the difficulties presented to the passage of so huge an animal as the elephant through the dense tangled undergrowth of a South African “bush.” Yet that the animal, despite his enormous bulk, will “draw off,” when within a few yards of his pursuer, without the slightest noise, and with the greatest rapidity, even in the thickest cover, is undeniable. We may, however, remark that this faculty or by whatever other term it may be described, is not peculiar to the elephant alone, for it has been observed to a marked extent in the moose or cariboo of North America.

Again, his powers of passing over difficult ground are often underrated even by hunters. When experiments were first made* in India in training elephants to draw the guns, it was observed with surprise that the animal's powers of ascending steep and rugged ground were far greater than had been anticipated. The gun, a light six-pounder, with which the trial was first made, was drawn up a slope so steep as to require the animal to crawl upon its four knees, without hesitation. On the other hand, hampered by the gun and harness, the elephant (a small female) showed unusual dread of soft and swampy ground. In Africa, marshes do not seem to possess the same terror for these animals in their wild state, for if they offer tempting pools, however uncertain the footing may be, the elephants appear to find a track across them.† In the river courses too, deepened as they are by the torrents of the rainy season many yards below the surface of the surrounding country, and having banks nearly perpendicular, small shady pools close sheltered from the sun's rays, often remain in the hot season when the rest of the stream has disappeared, and to these, should no other way be open, may be found tracts of the animals, leaving no doubt they have reached the coveted water by slipping down on their posteriors. In what position the hinder legs are placed during this operation we cannot tell, but the "spoor" leaves no doubt of its having been repeatedly adopted in places apparently inaccessible.

The elephants generally remain in the thickest part of the forest during day, making for the water, to which they often go long distances, shortly before midnight, and returning to cover some hours before dawn. We may here remark, that although these animals, owing no doubt to their acute sense of hearing and of scent, have never been surprised in a recumbent position, there is ample proof that the bulls at any rate, usually rest lying on their sides. The late Mr. Gordon Cumming was, we believe, the first to note this fact, which we can ourselves confirm. He remarked that the sides of the enormous ant heaps so common in this region, were apparently preferred, and that the ground was often distinctly marked with the impression of the under tusk as well as of the animal's body.

The influence of the particular tract of country in which they are found upon these animals, and the influence which

* About thirty years ago by a committee of Indian Artillery officers. Elephants, we may remark, had been previously used in assisting the gun teams by pushing with their heads, and aiding with their trunks, and not by drawing in harness.

† Elephants, like the generality of wild animals, take the water readily and swim well. Even baboons, though unwilling to do so, will on emergencies, swim with strength and rapidity, although with a queer and somewhat ludicrous action.

they, in their turn, like all other living creatures, exercise on their habitat, should not escape a short notice.

On the borders of the Cape Colony and Natal, we find the few elephants that remain large in size, but with comparatively small tusks of inferior ivory. As we approach the equator, although food is far more plentiful, we find the animals smaller in size, having far larger tusks, the latter too being of an ivory far superior in hardness and closeness of grain. Indeed, although naturalists have not recognized more than one species of the African elephant, the varieties of ivory exported from the north, west, south-west, south-east coast, and the Cape, have each marked differences of quality by which they are easily recognizable. The animals in their turn, however, likewise affect the economy of the country they inhabit. The damage done even by a single elephant in a very short time to a patch of cultivated ground is truly frightful, and having been once seen, would lead one to imagine that when these animals are herded together in vast troops such as the one seen by Dr. Livingstone on the banks of the Zambesi, consisting of over eight hundred, covering an extent of two miles of country, their course would be marked by utter desolation. The havoc thus caused is not however perceptible, a fact which that observant traveller has attributed, no doubt rightly, to the care shown by the elephants in the *selection* of their food—a point, as he justly remarks, often overlooked in estimating the *quantity* of food required by the larger animals.

Again, all these animals, rhinoceri and hippopotami included, are, as M. Krapf observed, the true pioneers, “the real pathmakers of the tropical forest, which without their tracks would be often utterly impenetrable to man.” Further, these paths leading as they most frequently do, to water, are often the *only* open channels for the surface-flow of the heavy rainfalls, and thus materially contribute to the continuance of the water supply of the district, to the very existence of which they owe their formation. While the elephant does not thus destroy vegetation which would ruin the shelter which appears indispensable to him, on the other hand he directly assists the production of new growths by his habit of searching for the many succulent bulbs to be found below the surface of the soil in every open space.

Mr. Gordon Cumming, in whose time elephants were more plentiful in the neighbourhood of the colonial frontier, than they are at the present, described large patches of many acres each in extent, as being thus ploughed up to a depth of several inches by the tusks of the elephants in quest of roots and bulbs; thus doubtless bringing to the surface germs of a fresh vegetation which would otherwise lie dormant. It is

curious to remark that Pliny was acquainted with this habit (generally overlooked by modern writers) and he describes the "Indians" (?) as sowing their corn in the furrows thus provided for them by the elephants.

We have already alluded to the influence of locality on the size of the elephant, and the same remark appears to hold good with other animals. Many of the so-called varieties of antelope are asserted by Dr. Livingstone in a note to his last work to be but local variations of other species already known. The same remark applies to the carnivora; the varieties of lion, the yellow and black, as they are styled by the colonists, thus appear to be one and the same animal at different ages and under the influence of different localities; the darker colour coming with age, and the thickness of the coat and the shagginess of the mane being apparently in a great measure dependent on the nature of the cover frequented by the animal.

Mr. Frank Buckland, in his interesting *Curiosities of Natural History*, Second Series, relates two curious circumstances showing the subtle occult influences of locality on animals when in confinement. Animals in travelling menageries, he informs us are, as a general rule, more healthy than those confined to one spot, as in the Regent's Park collection. This, too, is shown especially during gestation and parturition. Again, of several pairs of lions (from different places and kept always apart) which were successively placed in one particular cage in the Zoological Society's Collection, the lionesses in each case produced cubs with a singular malformation of the palate of the mouth, the cause being, it is needless to say, inexplicable.

We may here briefly refer to the effects instanced in the case of those two formidable foes of domestic animals the "fly," or tsetse, and the lung sickness or peripneumonia of South Africa, both of which appear so dependent on locality. The "tsetse" is a small active bee-like insect found in certain regions only, which sucks, in mosquito fashion, the blood of every creature it comes across. Its bite is harmless to man (even to the smallest children), to the mule, ass, and goat, to calves while sucking, and to all wild animals; yet it is certain death to the horse, ox, and dog; the symptoms, which last for months, pointing apparently to a strong poison introduced into the system. The localities in which this formidable pest is found are very circumscribed. Dr. Livingstone relates that although the south bank of the river Souta was a noted "fly" district, he found on the north bank the plague was unknown, the river being scarcely fifty yards wide, and tsetse being frequently carried across on the bodies of dead game by the natives.

Again, peripneumonia, known as "lung sickness" when it attacks the oxen, and "horse sickness" when it affects the horse, which is in fact the rinderpest of which we have of late had so much bitter experience, and which is equally fatal to domestic cattle and to the bovine antelopes and quaggas, appears unaccountably to be restricted to certain localities. In some parts of the Cape Colony there are very limited tracts of moderate elevation which appear to procure for horses while kept there a perfect immunity from the attacks of the disease from which they have acquired from the Dutch the name "Paarden bergen," or horse hills.* They appear to possess no peculiarities of soil, vegetation, elevation, or climate to distinguish them from other spots around, and the cause of the immunity they enjoy remains as obscure as when it was noticed by the Dutch traveller Sparmann a century ago.†

A remarkable instance of the influence of the animal on the vegetable world, occurs in the migrations of game which annually takes place, from the desert towards the Cape Colony and Natal. In some cases these may be due to the state of the herbage, which varies considerably at different elevations, but in the more marked cases as the migrations of the spring bok (*Antilope euchore*) this is not the case. These animals leave the desert at the time the grass is best, and track down towards the colony. The difficulty of estimating the numbers of a herd of animals in movement is always great; indeed, during the frontier struggles with the Kaffirs, it was always remarked that the number of cattle driven off or recovered, was in every case overrated by the most experienced stock keepers, even where no object was to be gained by misrepresentation. With these antelopes the difficulty is greatly increased by a certain quivering motion of their horns which they maintain, and also by the gleams of white from the beautiful fan like manes which extend along their backs, and which they invariably erect when moving; considering, however, the great numbers afterwards found in the colony when the main body has divided, it appears probable that the estimate which places the numbers at between

* There are certain localities in India which appear to be similarly endued in respect to cholera. These have long been known to the natives who suppose them to be under the protection of a "swamy," or deity. The credit of first having called attention to these spots, we believe belongs to Colonel Haley, H.M. 108th Regiment, who has recently referred to them in the *United Service Magazine*.

† This disease, which is endemic in a part of the Trans-Vaal territory, becomes annually epidemic throughout a considerable part of the Cape Colony and Natal. Horses which have once passed through the disease are termed "salted," and are supposed to be safe from future attacks, a security which in the case of oxen is sought to be attained by inoculation with a portion of the diseased lung of a dead ox inserted in the fleshy part of the tail, near the root.

thirty thousand and forty thousand at starting,* does not exceed the truth. On certain seasons, generally recurring about once in ten years, there is a vast increase in numbers which causes the movement to take some of the features of an American "stampede." We have ourselves witnessed instances on these occasions, when the animals hurried along and seemingly bewildered by the numbers round them have allowed themselves to be caught by the hand.

It is to these larger occasional migrations that the Dutch Boers more especially apply the term "trek bokkens."

A scarcity of food in certain seasons inducing greater numbers thus to migrate, is the cause usually assigned to these movements, but there is another which we think may have at least an equal share in producing them. These animals are polygamous, consorting in the proportion of four or five females to one male. Now it has been asserted with apparent truth, in the case of animals in a state of domestication that the proportion of the sexes born in different years varies considerably, and it is we think likely that these "trek bokkens" take place when the numbers have been increased by a large preponderance of females born a few seasons previously.

Dr. Livingstone assigns another cause, viz., the wary habits of the animals which induce them to leave the high and rank grass and choose more open feeding grounds, an instinct by the way, often displayed by domestic oxen.

Wherever the herds of antelope are found, whether the numbers be large or small, they appear materially to influence the herbage of the district they frequent. Their close, cropping bite resembling that of sheep, opens out a place for the young shoots, while their droppings not only fertilize the ground, but return to it the seeds in the form most suitable for fecundation.

Dr. Livingstone has related some instances where the game having been destroyed, the grass totally disappeared, being succeeded by a growth of mesembryanthemum-like plants, a change, which it is needless to say, would materially affect the water supply of a scantily watered country.†

* They have *never* been noticed returning to the desert.

† The difference in the quality of the flesh of different closely allied varieties of antelope feeding on the same herbage is noteworthy; while the flesh of some is tolerable venison (as the spring bok), that of others (as the rhei bok) is rank carrion. This reminds us that the Dutch colonists have a curious idea respecting the varieties of the common hare, which are very numerous. These animals, they maintain, feed on garbage, an idea certainly confirmed by the places they appear to frequent. To give an example of this habit in a herbivorous animal, the writer remembers many years ago in Lisbon, seeing the goats feeding in the vicinity of the city muzzled, which he was informed was done with a view to prevent their feeding, as they would, if possible, on the offal and impurities that fill the purlieus of that dirtiest of dirty cities.

The migratory habits of these animals also prevent the herbage, and consequently the water supply, of any particular district being affected by over-cropping. In the Cape Colony, near Graaf-Reinet (and, we have been told, in some of the Merino districts in Spain), the reverse of this picture may be seen. In these cases, by *over-feeding* certain of the sheep-walks, the herbage has first become impoverished, and in the end, like the water supply, has nearly disappeared.

The numbers of these animals are also kept in check by the large proportion of the carnivora. Lions, indeed, are getting scarce; but the various species of leopard and tiger-cat, known to the colonists under the general name of tigers, and of *hyænas* (called wolves), is still very great. The beneficent purpose these animals fulfil in the great scheme of nature, has been so admirably pointed out in the "Bridgewater Treatise" of the late Dean Buckland, that although our limits forbid our transcribing it, we cannot help begging the reader to turn to it.

It is, indeed, trite and superfluous to say that this intimate relation between every department of nature may be traced by the attentive observer upon every spot on the earth's surface, but in South Africa it possesses an additional interest from the consideration that while on the one hand (if the surmises of recent geologists as to the antiquity of the present state of the South African continent be correct),* there is no region we can point to where those relations AS THEY NOW EXIST, have been longer in force; there is on the other none where the retreat of animal life before the almost imperceptible encroachments of civilized man has been and is progressing in a more marked or obvious manner.

* See Sir R. Murchison's remarks on the South African continent.

THE PLANET SATURN.

(CONTINUED.)

BY THE REV. T. W. WEBB, A.M., F.R.A.S.

BEFORE we proceed to review the anomalies exhibited during the lateral presentation of the ring-system, we must take some notice of an idea to which Secchi was conducted by the singular disagreement of the measures which he obtained of it in its more open position. This eminent observer was induced by Σ II.'s suspicions as to the permanency of the ring, and the remarkable differences between the results of the first astronomers—Lassell, Encke, and Galle having given upwards of $1''\cdot5$ more than Bessel to the outer diameter of the whole—to use the micrometer largely himself. He found his values on any given evening very accordant among themselves, their discrepancies ranging within $0''\cdot3$; on different ones perplexingly the reverse, much more so than in the case of double stars; for instance, as the extremes of sixteen nights, 1855, Dec. 15, $41''\cdot443$; Dec. 27, $40''\cdot412$. A comparison of these variations, which he found in some respects corroborated by the observations of Lassell, Main, and De la Rue, led him to reflect whether the ring, as a whole, might be subject to periodical dilatation, or might be elliptical in form, with a rotation sometimes presenting to us its longer, sometimes its shorter axis. Of these two suppositions he thought the latter the more probable, suggesting a period of about $14\text{h}\cdot238$; but on the whole considered that there might be not merely ellipticity and rotation, but some actual variation in diameter; hence concluding that there is no reason to fear, with Σ II., a progressive alteration and final destruction of this “beautiful accessory” to the planet.

These last expressions of Secchi refer to a singular and impressive speculation of Σ II., who, from a careful comparison of the ancient drawings and measurements, such as they were, of the ansæ and the included space with more modern values, had been induced to believe that the ring-system, especially the inner edge of B, was in a state of such perceptible and rapid approximation to the planet that its ultimate disintegration was now not only a mere question of time, but, as it would seem, of a comparatively short interval. More recently, however, the improbability of this curious hypothesis has been shown by the measurements of Main (then Senior Assistant at Greenwich, now Radcliffe Observer at Oxford); and the ideas of both Σ II. and Secchi, though too interesting to be passed unnoticed in a recital like the present, have been so strongly

controverted by Professor Kaiser of Leyden that it may not be necessary to refer to them at greater length. We may, however, make the passing remark, the justice of which will be evident on more than one occasion, that the almost unapproachable mystery of the whole subject permits a latitude of speculation much more extensive than would be accorded in questions of a less obscure and perplexing character.

The want of symmetry which has led to these remarks is, as might be anticipated, not less evident during the lateral presentation of the rings. From an early period we meet with observations of anomalous appearances at these epochs, comprising not merely differences in the relative visibility of the two ansæ, but also other variations of aspect, all bearing similar testimony. As far back as Dec., 1671, the two Cassinis had seen Saturn attended by the blunted remainder of only a single ansa, and this not always on the same side.—1714, Oct. 1, 3, 5, 7, 9, Maraldi found the E. ansa rather the broader and more visible, while each, evidently from want of optical power, seemed reduced to one-half its usual length; 12, only W. was visible; 14, disappearance complete.—1715, March 22, a trace of W. only.—1743, Nov. 29, Heinsius found E. shorter than W.—1773, Sept. 24 to Oct. 4, Varelaz at Cadiz with three telescopes, one a 5-ft. reflector by Short, saw distinctly W. constantly brighter than E. ansa; he also remarked some more luminous points at the extremities; the first notice, it is believed, of an appearance frequently recorded in more modern times. Similar irregularities are stated to have been seen this year by Messier, who inferred much inequality of surface. Oct. 5, 6, W. only seen at Madrid.—1774, H_g is stated to have seen only one ansa for some time. Jan. 11, Messier observed E. longer than W. Previous to its disappearance W. was seen the longer and brighter for four weeks at Mannheim; at its reappearance, Wollaston thought he detected W. June 30; July 2, he was certain of the whole, but W. was the larger.—1789, August 30, Ussher at Dublin found E. the more visible; Oct. 1, E. only. At Cork, E. only latterly to Oct. 5. Schröter perceived only a few luminous points till after Oct.; but 1790, Feb., in frequent observations incomparably more of them, in part at least not satellites. During twenty days he and another saw W. much brighter than E., which was far more irregular, and had on it the last two days a fixed point of light. Hence he concluded, as Messier and others had done fifteen and thirty years before, that the S. was by far the more uneven surface. [We have already mentioned that the fixed points or knots of light, which will now repeatedly be mentioned, though supposed by Schr. to be mountains, one between 400 and 500 miles high,

are no doubt, as Olbers suggested, the perspective projection of the brightest portions of the ring enlarged by irradiation; or if we are looking on the dark side, light reaching us through its openings. But their frequent absence of symmetry is the point to which we are directing our attention.] 1803, Jan. (3?) 4, Harding found W. ansa reappear alone, with a large knot of light. 11, Schr., Harding, and another found W. more visible, and the knot unmoved. 14, ditto, Schr. detected two smaller knots on E.; they observed by turns for $8\frac{1}{2}$ h., and found them unchanged; during the latter days the W. knot began to lengthen westward; it continued visible and unmoveable for $4\frac{1}{2}$ months. June 10, all E. had disappeared except two points, W. was extremely thin and interrupted, with its great point or *mountain*. 16, Schr. saw W. with much difficulty; E. had for some time disappeared. It vanished at last, even in 27-ft. reflector, and reappeared on each side alternately as a fine interrupted line. Nov., ring knotty, E. white, W. fainter; the same three spots. Schr. considered that when we looked on the S. side, W. was the larger, and the reverse, and inferred that the rings did not lie in the same plane.

I have found no record of its aspect at its next disappearance, but in 1832 and 1833 we have several notices, especially by Schwabe,* the great observer of the sun at Dessau. Dec. 1, he saw one minute point on E. side, fixed for 3h. so as to show that it could not be a satellite. 12, E. ansa had a bright spot (near outer edge of ring B), and did not close up to the ball; W. uniform, rather the shorter, broader, less defined, and fainter; but vanishing later behind clouds than E. The dissimilarity continued through the spring of 1833, but the spot grew less obvious on the widening ring, and the E. ansa became continuous, though feebly so, to the globe. April 2, ansæ evidently unlike; E. fainter than W.; both feeble. 7, 15, E. the longer; no brighter spots. 17, E. obviously the longer, and somewhat the sharper defined; very faint or invisible near ball, while W. closes up to it. 25, W. the more distinct; E. seems discontinuous. 27, ditto; sometimes, perhaps, a bright spot on E. May 1, ring gone. June 8, 13, sometimes very minute point E. 14, first certainty, W. somewhat the more distinct, and closing up to ball; E. does not close, but has a bright spot. 18, spot so bright as to make E. ansa, though the fainter, the more conspicuous. 24, W. very obviously the shorter and fainter, but uniform; E. brighter towards extremity. 25, ditto; the spot seemed double. July 16, W. uniform; E. distinctly longer, and very faint next

* This name was erroneously printed *Schuzbe* in our last No.

globe; spot more extended. These observations were confirmed by others. Petersen at Altona found E. always considerably the brighter. April 22, 25, 26, a distinct bright point E.; another, not symmetrical, suspected W. At reappearing, June 16, Bianchi saw bright points in ansæ. 19, a point. 22, 24, several, E. Santini, 18, E. like a string of pearls, dissimilar to W. Mädler also saw a brighter point E. than W., and W. took the lead in the apparent shortening of the ansæ.

During the decrease of the ring in 1846, from Nov. 21, Schwabe found W. always rather fainter and less sharply defined than E.—1847, July 11 to Aug. 15, W. somewhat the more distinct, bright, and long, and its “lunule” more obvious, though not larger: from middle of Sept. both ansæ equal in all respects. At the ensuing edge-presentation in 1848, a greater degree of systematic attention was paid to these appearances, and the experience of Schwabe, the keen eye of Schmidt with the 8-foot Bonn heliometer, the unsurpassed vision of Dawes, and the extraordinary power of the achromatic at Harvard College, U.S., were all put in requisition. June 26, the dark side being turned towards us, the ring was visible in its whole length, but not continuous W. :* Bond II. Traces rather plainer E. as a multitude of the finest points: Schm.—June 30, 2 faint dots, E. the plainer, about the extremity of ring B: Dawes.—July 3, W. more distinct than E.: Bond I.—10, an interruption and two bright points on each side: Bond II.—11, three detached bright portions W., two E.: Bond I. Continuous, but brightest in four places, like satellites strung on the ring, only fixed: B. II.—14, 16, 17, breaks visible, B. II.—15, as before, Dawes.—18, composed of fragments, but more continuous, and broadest near ball W.: B. I.—21, 4 fixed points: B. II.—Aug. 29, W. the more easily seen; 2 spots on it; one only on E.: B. II.—30, W. best, with a spot: B. II.:—31, unequally illuminated: B. I. II.—Sept. 3, sun passed to S. side: ring perhaps beaded: B. I. II.; probably not equable, yet not dotted as June 26: Schm.—4, perhaps not quite equable, but prominences and interruptions not perceptible; thinnest next ball: B. II. W. somewhat the plainer; E. interrupted: Schw. W. seen without any difficulty interrupted in 2 places; E. less certainly so: Schm. [personal or instrumental equation must come in here]. E. decidedly longer than W.: Dawes.—5, ring a sharp line, thinning off from W. to E. end; W. most obvious, and joining globe; E. interrupted and not joining: 2 bright longish thickenings on W., one sharp point on E., all fixed: Schw. and Habicht. W. in

* *P.* in original, as in many other places.

3 portions ; E. in 2 : Schm.—6, much the same : Schw. One break on each side at place of Ball's division ; E. somewhat the longer : Schm.—7, the same : Schw. and Hab. E. the longer ; Schm. who saw one break E. 2 W., so Argelander, who did not think them quite dark.—8, W. and 2 spots plainer, E. and point weaker : Schw. and Hab. 11h. 15m., break in each ansa, near Ball's. div. : 12h. 15m., W. the broader as before, E. the longer with 2 breaks ; 14h. (very fine, power 600) W. in 3, E. in 2 parts, but all W. broader, brighter, and stronger, ; E. perhaps longer and very pointed : Schm.—9, W. very broad, points well divided ; E. narrower, but of sharper light, showing besides old point, 2 fainter ones nearer globe, from which to the nearest was an extremely faint line. It seemed as though both ansæ were not in one plane, but E. was a little sloped towards S. : Schw. One break, probably more, on each side ; proportions E. and W., as yesterday : Schm.—10, the same in all respects : Schw. and Hab.—11, W. only one longish thickening ; E. three points : Schw.—10, 11, break on each side ; E. the longer : Schm.—11, no prominences : B. II.—12, W. certain ; E. nothing but 2 extremely fine points : Schw.—13, Earth passed to dark side ; W. perhaps visible close to ball : B. II.—18, ring extremely delicate ; W. 2 fixed points : B. I.—Oct. 5, interrupted, especially W. : B. II.—6, 7, rather broken, especially E. : B. II.—12, disconnected, and 2 points : B. II.—20, 23, inequalities as in July : B. I. II.—28, the dark part across the ball uneven : B. I.—Nov. 3, symmetrically interrupted, but broader E. : B. I.—13, 29, dark part uneven : B. I.—1849, Jan 6, brightest E. : B. II.—19, after earth had passed to illuminated S. side, ring rough, broken and not joining ball and longer E. : B. I. ; these differences not perceived : B. II.—21, W. unquestionably the broader, but less defined and fainter, broadest at end, and with a knot of light ; E. carried 2, possibly 3 points : Schw. A strong point at end of E ; doubtful whether ansa touches either it or ball ; fainter and less distant point on W. which touches ball : Schm.—27, W. uniform ; points on E. doubtful. E. seems longer than W., and not joined to globe : Schw.—29, ditto ; greater length of E. obvious : Schw.—31, no points, but ansæ very unequal ; W. evidently the shorter, less defined, and fainter ; yellowish ; E. orange ; joined to ball by a feeble line : Schw. Günther in Breslau, 1848, Sept. 5, found ansæ disjoined from ball, and E. distinctly brighter than W.—Sept. 7, Busch at Königsberg saw a fixed point at the very end of E., one nearer ball on W. So Wichmann.—8, point on W. invisible ; on E. somewhat nearer ball.—9, 10, point at end of E.—11, W. brighter than E.

The observations at the last epoch of similar presentation,

1861-2, were, as far as I have seen them, of the same character. As the ring diminished, Secchi found, if the air was not good, E. ansa sometimes the shorter. Nov. 8, both were short, but especially W.; E. the fainter. 15, ansæ dotted; E. much the narrower. 19, E. "apparent" ansa (qy.: does not this mean the real W. in an inverted field?) certainly the shorter. [We must not forget that these differences in length which so repeatedly come before us, may be as fairly ascribed to eccentricity, as to deficiency in reflective power of the extremity of the line.] During the following observations by Schwabe, with 6ft. Fraunh. up to 360, the earth was on the sunny side of the ring.—Feb. 7—10, both uniformly smooth, E. growing brighter. 17, W. very blunt-ended; E. with 5 or 6 fixed knots, 2 strongest very near ball. 18, 19, W. the shorter; E. dotted and very pointed. 27, E. still dotted. March 1, 8, W. a little the more distinct. 10, both alike bright, long, and smooth. The dark spaces begin to appear as 2 very fine black lines. [This seems inconsistent with any appreciable thickness of C.] 12, ditto. Ring begins to be brighter than ball. 15, 16, 24, ansæ unchanged. April 1—8, W. less defined and shorter than E., which had a granular light. 10, E. obviously the longer. 14, E. very pointed and somewhat knotty. 15, E. certainly the brighter. 22, E. alone knotty. 24, E. so sharp that its termination is sometimes doubtful. 25, ditto; W. the more distinct. 29, E. end often vanishes. 30, 2 knots on E., and its end fainter. May 1, E. had 2 knots; it often vanished. 2, a third knot E. 3, E. the feebler; no knots. 4, 5, W. the plainer. Throughout these observations, from Feb. 7 to May 2, the ansæ preserved invariably a wedge-shaped aspect, tapering from W. to E., as Schröter had represented it in a "rough but very faithful" design; whence Schwabe infers that, whatever explanation may be given of the dots of light, rotation is impossible.—1861. Wray 7 in.: Dec. 17, line irregularly broken (looking on dark side); 26, 16h. 30m. E. scarcely, W. readily visible, and broken in 2 places; 18h. 30m., both equally bright; 19h., E. the brighter. Jan. 4, W. much broken, brighter than E. 5, 13h. 30m., W. much fainter and shorter than E.; 16h. 40m. equal in length and light; 17h. 15m. to 18h. W. decidedly the brighter. 18, ansæ equal.—1862. Huggins, May 2, 12, 13, two bright dots E. at inner and outer edges of ring. 16, ansæ steady; no dots.—Carpenter at Greenwich, May 5, E. $\frac{1}{10}$ the longer. 17, W. just visible; only one spot E. 19, W. the more visible.—Birt, May 13, with 2 achroms. by Slater, 3 beads W.; 4 (Slater 5), E., which was the longer.—Σ II. May 16, W. the longer as 5 to 4. 17, 18, 19, W. the more visible. June 3, perhaps the shorter.

The unvaried bearing of all this testimony is in favour of

the conclusion, already adopted by some of the very early observers, that, instead of the whole ring-system lying in an uniform plane, there must be a slight degree of mutual inclination in the surface of its subdivisions, and such an inclination as will occasion want of symmetry in its perspective projection.* This would not be the result of mere inclination, so long as the intersection of the planes, whatever might be their number, passed through the centre of the planet, because one half of each plane would be as much elevated as the other depressed on either side, like the ecliptic and equator in the sky, and symmetry would not be interfered with. We must, therefore, in order to explain the observed appearances, adopt the idea of planes whose intersection does not pass through the axis of Saturn—perhaps not even through any part of the globe, or ring-system itself; and whose varying inclination—for under the action of so many disturbing forces, their inclinations and nodes must vary—though symmetrical on either side of their own intersections, or *lines of nodes*, would not be so on either side of the centre of the planet. Such an arrangement would not involve any theoretical impossibility. It is not essential to the stable equilibrium of the whole system, that the centres of gravity of the several rings should coincide with that of the planet; so long as this is the case with the common centre of all, they would individually balance each other on opposite sides of it. And even a want of coincidence between the common centre of gravity of the rings, and that of the planet, would not produce disintegration of the system, provided each of those points revolved round an intermediate one, the general centre of gravity of the whole. The mutual attractions, however, of the rings, and the external influence of the satellites, while not of necessity causing any permanent derangement or ultimate collapse, would yet introduce a complexity of balancing, the result of which would probably transcend all human analysis, but which may *possibly*—more cannot be said—produce the peculiar variations which the foregoing details record, and which certainly are supported by too great a mass of evidence to be treated as mere optical deceptions. Theoretical inquiries, however, unless of the most superficial and familiar character, lie wide of our present object, which is simply to bring into one point of view the most accessible data, that the student may, as the result of a

* Bessel found by strict mathematical investigation that the times of the disappearance and reappearance of the ring were incompatible with parallelism in its opposite surfaces. But this, though harmonizing with the wedge-shaped form recorded by Schwabe, is scarcely an adequate solution of many of the recorded phenomena, and at any rate merely treats the system as a whole. Cassini II. had anticipated this conclusion.

careful comparison, ascertain for himself, what is pretty certainly known, and what is still ambiguous, in this wonderful subject.

To explain the variety of appearances, it would seem necessary to assume that Ball's is not the only actual division in the system, but that the minuter dark lines which have been often noticed, indicate its separation into many narrow concentric annuli. This is in every respect probable, and it is not impossible that the difference so frequently recorded in the visibility of these divisions on opposite sides of the globe, may be due to some of the perturbing influences to which we have alluded, and which may really, in the inscrutable arrangements of an all-wise Creator, be the source of preservation instead of ruin. Such at least was the opinion of Pierce, who considered that, without the compensation introduced by the influence and position of the satellites, not even the irregularities of the ring, to which Laplace had referred its equilibrium, would suffice to guarantee it from collapse and destruction.

The variation of inclination among the bright portions is obviously confined, as we must have remarked, within narrow limits, and disturbs the symmetry but in a small degree. But it may be questioned whether this may not be more the case with regard to the dark ring C, as well as whether it may not be of considerably greater thickness than its neighbours. Σ II. thinks both of these probable, from the visibility of what Maraldi called the equatorial belt during the disappearance of the ring in 1715. This, however, does not seem conclusive, unless it can be shown that he was not then looking upon the unenlightened side of the bright rings. But at the first discovery of C in 1850, Dawes remarked that it was always more plainly seen behind than in front of the ball, and that its projection upon the ball was then considerably too narrow to accord with that at the major axis; and more conspicuously so at that time, than at the end of 1852. These appearances, he says, might be satisfied by the supposition of a wedge-like form in C, the thick edge outwards, and a similar but reversed form of B: he preferred, however, the hypothesis of De la Rue of a different inclination for C, which would thus be tilted up, as it were, from behind towards the eye. De la Rue, in fact, in his first beautiful engraving, Nov. 1852, represents C as encroaching on the outline of B behind the ball; and in his second continues to show it wider there than in front:* he

* Lassell, on the contrary, at Malta, with 24 inches, found, 1852, Dec. 15, C so broad, and B so narrow, in front of the ball, that he thought the darkest part of the latter must have been merged in the appearance of the former.

considered, too, that its apparent ellipticity was not the same with that of the bright rings. Mitchell also, with the 12-in. achrom. at Cincinnati, noticed the disproportionate breadth at the major axis; and I thought it evident with $5\frac{1}{2}$ in. in June, 1865.

The very curious comparative indistinctness of the E. edge of ring B, observed by Schumacher and Dawes (INTELLECTUAL OBSERVER, ix., 371), struck Mr. Barrow, the companion of the latter, 1855, Dec. 19, as an indication of an inclination in the plane of C.—1857, Jan. and Feb. Morton, observing with Lord Wrottesley's achromatic of $7\frac{3}{4}$ inches, found the division of B and C never well marked, from the apparent overlapping of the latter, the opposite or inner edge of which was sharply seen. But still more curious are the observations of the eminent optician Wray and Σ II., in 1861-2, when the edge of the ring was presented to us. The former, using a 7-inch object-glass, distinctly saw, Dec. 23, 26, Jan. 4, 5, 11, 18, a faint, nebulous, bluish-white light, very different from the planet in colour, attending each side of the narrow ring-line for about $\frac{1}{3}$ of its length right and left of the ball. The latter, May 15, perceived luminous appendages like clouds of less intense light, lying on the S. side of the line, which was much sharper defined N.—19, they extended 0.6 *p*, 0.3 *f*, of the diameter of the ball; their colour very unlike that of the ring, being "not yellow, but more of a livid colour, brown and blue." 20, extent 0.65 *p*, 0.5 *f*.—21, 0.6 *p*, 0.4 *f*, on which side light much more feeble; breadth increasing towards limbs like sharp wedges.—22, 0.6 *p*, 0.5 *f*.—June 3, very bad image, yet appendages still distinctly visible. Winnecke concurred in these observations. Nothing of the kind, however, was noticed at Greenwich, May 17, 19, 20, June 3. During Σ II.'s observations the sun was nearly in the plane of the ring; more elevated during Wray's, when the earth, on the contrary, was much lower.

Our readers may have remarked that nothing has been said as to the period of the rotation of the ring, which, as is well known, was deduced by H , in 1789, from the luminous points of which such repeated mention has been made. He fixed it at 10h. 32m. 15.4s., and the dissentients from so high an authority have been very few. Schröter, indeed, from the unmoved position of certain protuberances; Schumacher, from the unvaried difference in sharpness of the inner edges of B; and Schwabe, from the unchanged direction of the wedge-like form of the lateral view, have not hesitated to express a doubt even as to the fact of rotation; but the generality of astronomers have acquiesced in H 's determination both of the fact and the period: and it would seem to involve no small degree

of hardihood, not to say presumption, for any but a great leader in science to call it in question now. But truth ought to be paramount to such considerations. It is not authority but fact with which we have to deal. It is not so much a matter of opinion as of evidence, and a circumstantial examination of the original observations seems to bring with it the inevitable impression that they are not adequate to bear out the conclusion which has been drawn from them. The lucid points which have been so often noticed, strung like beads, to use H_g's elegant illustration, upon the ring, may be referred to more than one cause. If fixed, the reasoning of Olbers and the measurements of Bond concur to prove that they are merely perspective foreshortenings or transmitted glimpses of the brightest portions of the ring, and their frequent want of symmetry offers, as we have seen, no insurmountable impediment to this explanation, in default of which they would be irreconcilable with any rotation whatever. It is only among such as are moveable that the indications of rotation can be sought; of these the greater number are confessedly merely satellites projected upon the line of the ring, and it remains to be inquired whether there are any others which cannot be accounted for in this way. Now, in 1789, after the discovery of the two innermost satellites, H_g found in the record of his observations that in 47 instances, extending through 20 nights, he had seen bright points not concurring with the position of any satellite at the time. The idea of their being mere results of perspective, or openings in the dark side, had then never been suggested, and he does not seem to have contemplated the possibility of their fixity: he therefore assumed the existence of 5 separate spots—which he preferred to consider as outbreaks of fire rather than as mountains—in different positions on the ring; and he proceeded to show that his observations might all be accounted for by a combined rotation of these hypothetical spots in rather more than $10\frac{1}{2}$ hours. This, it may be safely asserted, is a mode of proof which is entitled to little confidence. But, it will be asked, did he not actually witness their motion? That, it is obvious, would be the only satisfactory test. A point on a ring revolving with such rapidity would be carried through its whole apparent length in $5\frac{1}{4}$ hours, or through a space equal to the radius of the planet in about 1h. 10m., and, though considerable allowance must be made for the perspective foreshortening of the direction of motion, it is evident that among so many observations it ought to have been repeatedly perceived. But in two instances only is anything of the kind distinctly specified. Oct. 30, 20h. 53m. distance $\frac{1}{4}$ diam. of planet *f* (but this he is obliged to refer to a different hypothetical spot):—23h. 55m. $\frac{2}{3}$ ditto *p*, very near the end of the arm:—0h. 42m. a little nearer than before:—

0h. 47m. $\frac{3}{8}$ again.—October 31, 21h. 13m. $\frac{3}{8}$ p:—22h. 11m. drawn nearer; “flying clouds prevent estimations of the distance.”—23h. 13m. “no longer visible.” From such very limited and incomplete data it does not seem too much to say, with all due respect to the illustrious observer, that no exactness of period could be deduced. And nothing has since been added to them. In an accompanying diagram the imaginary spots are set nearer to or further from the edge of the ring, to make the calculations correspond with the appearances; but he expressly states that his period applied to the exterior ring A. Laplace had previously given about the same value, but for the *interior* ring.

(To be continued.)

A near appulse of the moon to Saturn during the evening of Aug. 16 will be an interesting spectacle, the distance, at Greenwich, being only 36'.

ROSS'S FOUR-TENTHS CONDENSER.

THE subject of achromatic condensers for the microscope is not yet exhausted, and although several forms of considerable merit are now before the public, there is still room for experiment and invention, both in the glasses employed and in the nature of the stops. Mr. Ross has added to the number of condensers one that especially deserves notice and commendation; and, we think, after giving it a considerable trial, that it will be regarded with great favour by practical microscopists.

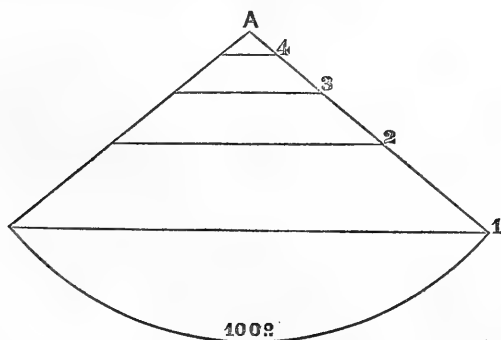

Before describing the new condenser, we must say a few words on the different results which proceed from employing combinations of different sizes and different degrees in angle of aperture. Let the microscopist draw two lines converging and making an angle of 100° , and then draw, at various dis-

tances from the angle, horizontal lines uniting the two lines that converge to form the angle. The figure will be like the preceding diagram, in which A represents the focal point of a series of lenses, 1, 2, 3, 4, of different sizes and focal lengths. Each lens, 1, 2, 3, or 4, can throw, through any transparent substance, appropriately situated, rays of light which converge at an angle of 100° ; but there will be a great difference in the total quantity of light which each lens can receive or refract, and also in the proportion which the marginal rays bear to the central ones. In 1, the marginal rays will be greatly in excess of the central rays; while in 4, as the marginal rays are fewer, and the central rays the same, the latter will be relatively much more important. This diagram distinctly expresses to the eye the fact that, when achromatic condensers are made with small lenses, the marginal rays do not exceed the central rays to anything like the same extent as when larger lenses are employed.

Suppose the diagram to be on such a scale, that the lens, whose diameter is represented by 2, will focus through the thickness of an ordinary glass slide, it is then plain that lenses of the same aperture, and so small as either 3, or 4, cannot possibly perform with their whole aperture, or anything like it, through the thickness in question. A lens of given aperture and of focal length greater than the thickness of a glass slide, may converge all its rays through any transparent object on the slide; and if the slide be much thinner than the length of its focus, all the difference is, that the thin glass will obstruct and refract the passage of the rays less than the thicker glass. If, however, we try to make a large-angled and small lens with a short focus work through a slide, the thickness of which exceeds the length of its focus, only the central rays, and those near them, can get through in the direction required. Thus, if a microscopist desires to have a large-angled condenser, for use with ordinary glass slides, as well as with thin glass, he must not take an optical combination of small lenses and very short focus, for if he does, a considerable portion of the slanting light he desires should reach his object will never get there at all.

It appears to us that two things should be required of achromatic condensers intended for general use and for *research*. First, that the optical combination employed should be adapted to a considerable range of power—say from an inch or two-thirds upwards to the highest; and, secondly, that it should be capable of working with a large aperture through ordinary glass slides. When low powers are employed, a pleasantly lit field can be obtained, by using a condenser a little out of focus, so that the rays cross before reaching the object; but a condenser for general use should be able to send

a sufficient quantity of its oblique rays, when in focus, through an object seen with very moderate magnification, and should be capable of giving a dark ground illumination with a half inch or two-thirds object glass.*

In Mr. Ross's four-tenths condenser, the principal desiderata are excellently provided. The optical combination is exactly the same as in his large angled four-tenths objectives, and the front lens has a diameter of one-fifth of an inch. In the best condensers the diaphragms are brought close to the lower lens, and this is the case with the instrument before us, which is provided with two revolving wheels of diaphragms. The upper one is pierced with eight round holes, or "circular apertures," as those who prefer learned phraseology may call them. One of these is, in point of size, a copy of its next door neighbour, and may be filled up with a polarizing slice of tourmaline, or may be made with a little rim, so as to receive any experimental stops the microscopist may wish to try the effect of. Omitting this stop, we have seven other stops, marked respectively 109° , 95° , 82° , 70° , 59° , 49° , and 40° . These stops allow the lenses to work with the angles of aperture named. In the wheel of diaphragms, below them, is another set of stops, which can be combined with the preceding. A, the first, is a large central stop adapted to 109° or 95° angles of aperture. B and C, smaller ditto; 3, 2, and 1 are *radial* stops—that is to say, they are pierced with slots, three, two, and one respectively, cut so as to converge towards the centre of the circle, but not carried as far as the centre. The single slot stop keeps out the central rays, and allows a radial beam, including its proportion of marginal rays, to illuminate the object. This can be used with the larger of the open stops. The two-slot stop gives passages to two such pencils of light, one at right angles to the other, a plan very effective with certain diatoms and other objects. The three-slot stop allows the transmission of three pencils, equidistant from each other. This gives the three readings of the *P. angulatum* beautifully. The arrangement for working the diaphragms in the condenser is very convenient, and the whole apparatus rotates with Mr. Ross' substage. The lenses are capable of adjustment to suit different thicknesses of glass.

Let us say a few words on the results. The proportion which, from the size of the front lens the marginal and central rays bear to each other is such, when the stop, allowing 40° of aperture is employed, that^a the two sets of lines, on *Pleurosigma hippocampus*, and *P. angulatum*, are distinctly shown with a one-fifth objective and first eye-piece. A slight change in

* With a two-thirds, we find it advisable to send the light through the four-tenths condenser with the *concave* mirror, when a dark ground illumination is required.

the position of the flat mirror makes this stop work excellently with the *podura* scale. Thus this arrangement enables an experimenter viewing a *new object* to see surface markings, and to obtain penetration with one and the same stop, an important gain in original investigation. For lined objects, other combinations will do better, but it is remarkable how well distance lines can be shown with only 40° aperture of the condenser, and no central stop at all. The slot stops have been found very useful in investigating unknown objects, as well as in displaying those that are known; and with the whole aperture and the two-slot stop many diatoms with double sets of lines are brought out very powerfully. The microscopist will find that from 40° to 59° angle of aperture will, in many cases, give the best results, when a one-fourth or a one-fifth objective is employed, though a larger aperture would be desirable to display the same objects if another condenser made of smaller glasses should be used.

LARTET ON THE ASPHALT OF THE DEAD SEA.

THE following paper of M. Louis Lartet will be found in *Comptes Rendus*, No. 26, 1866:—

“The ancient traditions concerning the appearance of bitumen on the surface of the Dead Sea bear testimony to the evident connection of this phenomenon with the persistent activity of the internal forces of the globe in this region, and which have given rise to profound dislocations of cretaceous and nummulitic rocks, to the flow of volcanic matter, and to thermal springs. In our own times, some travellers who, like the American missionary, Smith, had the advantage of knowing the Arabic language, have been able to obtain, from tribes actually stationed in this region, tolerably consistent accounts of the more recent appearances of bitumen in the waters of the Dead Sea. It seems that the appearance of this substance is always preceded by subterranean commotions. Thus, after the earthquake of 1834, a considerable mass of bitumen made its appearance at the southern end of the sea, and the Arabs detached about 220 quintals, out of which they made a good profit.

“In 1820, when another earthquake destroyed a great part of the city of Tiberias, and occasioned the death of more than 6000 inhabitants of the district, very violent shocks occurred in the direction of the great axis of dislocation of the basin; new hot springs uprose in the Tiberiad; and a few days after-

wards the Arabs saw a mass of bitumen floating on the Dead Sea, which they took possession of and sold in the bazaar in Jerusalem for 16,000 francs, being at the rate of 100 francs for a quintal.

“It is only along the western shore of the Red Sea that important deposits of bitumen occur. We know that Strabo mentions the existence, in the neighbourhood of Masada, of rocks distilling pitch. We think we have discovered the deposits to which the Greek geographer alluded, first in the ravine to the south of the hill of Sebbeh, whose summit is crowned with the ruins of the ancient Masada. We meet there with dolomitic rocks, the numerous cavities of which are partly filled with asphalt which must have been introduced in a fluid state, and gradually solidified, giving the rock the character of an asphaltic breccia. More to the south, and nearer the diggings of *sal gemmi* and gypsum of Djebel-Ussdom, if we ascend Wady-Mahawat to the height of about 300 metres, we find the same cretaceous formations strongly impregnated with bitumen, which runs from their fissures, and sometimes forms stalactites of asphalt. At certain points the bitumen has cemented together the ancient alluvium resting upon the calcareous rocks, and has formed bituminous pudding-stones, fragments of which are carried by torrents towards the Dead Sea.

“To the north of Masada we find traces of bituminous emanations at Ras Mersed; and lastly at Nebi-Musa, at the north-western extremity of the sea, the most considerable deposits of bituminous limestone are found, and where cretaceous fossils (*inoceramus*, *echinus*, etc.) are associated with the remains of fossil fish. This limestone contains as much as 25 per cent. of bitumen; and the cretaceous beds which have been impregnated with it contain also in the same vicinity salt, veins of gypsum, and traces of magnesia. It burns easily, and the Arabs call it Hajar Musa, or Stone of Moses, and make use of it to light their encampments. The Christians of Bethlehém make religious symbols out of it, which they sell, under the name of Dead Sea Stones, to the numerous pilgrims who flock every year to Jerusalem for the solemnities of the Holy Week.

“In the valley of the Jordan there exists, at the same level, other deposits of bituminous limestone. Such, without doubt, are those of Tiberias, from whence, according to Hebard, arise the Hot Springs of Hammon, the situation of which we could not verify.

“At Hasbeya, near the sources of the river, bitumen shows itself, as at Nebi-Musa, in fossil fish limestones, but it is less abundant, although it was the only deposit regularly worked at

the time of the Egyptian conquest, when shallow pits were sunk and a tolerably rich deposit arrived at, the *débris* of which we found on the margin of the pits.

“ Besides this series of bitumen deposits of which are ranged in *échelon* on the long axis of the basin of dislocation, as well on the western bank of the Dead Sea. As on reascending the course of the Jordan, we found considerable traces of it, at the same geological level, in the inoceramous limestones of Khalwet, in the Anti-Libanus, between Hasbeya and Rascheya, and even in the approaches to Damascus; but the alignments of these last deposits departed considerably from the direction of the axis of the basin of the Dead Sea to arrange itself along the chain of the Anti-Libanus, and to direct itself towards analogous deposits of Mesopotamia and Persia—as if they would serve to unite these last with the long series of bituminous emanations passing by the Dead Sea, the point of Sinai, and the mountain of L’Huile, in Egypt.

“ Much attention has been given to the origin of the fragments of asphalt which the Dead Sea throws up on its banks, and from its analogy with that of Hasbeya, it has been thought that it was brought down by the waters of the Jordan, forgetting that although bitumen is lighter than the water of the Dead Sea, it is much heavier than that of the Jordan, and that this river must have deposited it on its own banks in the course of so long a journey. It has also been supposed that vast sheets of bitumen, accumulated at the bottom of the Dead Sea, after hardening, have become detached and floated to the surface. This hypothesis is not justified by the numerous soundings made by the American expedition, nor by those of the Duke de Luines’ expedition in which we had the honour to take part.

“ Lastly, Dr. Anderson had a notion that under the bituminous deposit of Nebi-Musa there existed considerable layers of asphalt, intercalated with calcareous rocks, and the prolonged outlines of which stretched under the Dead Sea, and yielded to the erosive action of its waters the specimens which travellers noticed on its shores. This opinion does not appear to us more admissible than its predecessors. We do not see why the fragments of bitumen dispersed on the banks, and of which no trace is found in the ancient alluvium or the ancient deposits of the Dead Sea, should not come in part from the *débris* of these floating islands of asphalt, as well as, perhaps, from the disintegration of the bituminous rocks which the waters of the Wady-Mahawat and those of Wady-Sebbeh bring down at certain seasons.

“ As for the occurrence of bituminous emanations in the

bottom of the Dead Sea or on its shores, or along the Valley of the Jordan, we believe that they are connected with a system of thermal, saline, and bituminous springs which extend along the major axis of the dislocation of the basin. This conviction rests first on the alignment of bituminous deposits along the same axis on which we find the rare representatives of springs which seem to have been connected with extinct volcanic phenomena: secondly, on the presence, verified by M. Hebard, of bitumen in the limestones, from whence emerge the thermal and saline springs of the Tiberiad, in which Dr. Anderson found bromine associated with organic matter; thirdly, on the analyses of the water of the Dead Sea, which, according to M. Terreil, contains an organic matter having the characteristic odour of bitumen, and which is particularly abundant in the neighbourhood of Ras Mersed, whose odours of sulphuretted hydrogen are noticed by all travellers, and which is the place signalized for its bitumen by Strabo.

“As at Ras Mersed the bitumen has penetrated the fissures of the calcareous rocks on the banks, and is found in the saline deposits in a little grotto very near this point, everything leads to the supposition that there still exists one of those submarine springs which in former times emitted considerable masses of bitumen, and which now confine their operation to exceptionally enriching the water in bitumen, chlorides, and bromides, and so disengaging sulphuretted hydrogen gas.

“In thus unfolding the reasons which lead to the belief that the bitumen has been brought by the hot and saline springs, and that it has impregnated the limestones after their deposit, we do not intend to decide the question whether this bitumen has been brought up direct from the depths, or whether the hot springs met with carbonaceous matter in their course, and reacted upon it. It is known that there exists in the Lebanon, in the system of sandstones below the cretaceous rocks which are impregnated with bitumen, considerable masses of lignite, of which the analogues may have existed in the Anti-Libanus and in the Dead Sea. In this hypothesis, which supports the observation of traces of vegetation found by Dr. Anderson in Dead Sea asphalt, the heated waters may have been able to extract from the lignites their hydro-carbon products, such as M. Daubr e has been able to show in his beautiful experiments illustrative of metamorphism.

“However this may be, we see in the preceding facts a fresh confirmation of the laws of association, connecting deposits of bitumen with salt, gypsum, hot springs, and volcanic phenomena.

RESULTS OF METEOROLOGICAL OBSERVATIONS MADE AT THE
KEW OBSERVATORY.

LATITUDE 51° 28' 6" N., LONGITUDE 0° 18' 47" W.

BY G. M. WHIPPLE.

1866.	Reduced to mean of day.					Temperature of Air.			At 9·30 A.M., 2·30 P.M., and 5 P.M., respectively.		Rain— read at 16 A.M.
Day of Month.	Barometer, corrected to Temp. 32°.*	Temperature of Air.	Calculated.			Maximum, read at 9·30 A.M. on the following day.	Minimum, read at 9·30 A.M.	Daily Range.	Proportion of Sky clouded.	Direction of Wind.	
			Dew Point.	Relative Humidity.	Tension of Vapour.						
April 1	inches.	°	°	inch.	°	°	°	0—10		inches.	
2	29·435	38·2	36·4	·94	·248	47·4	35·8	11·6	10, 8, 7	N by E, N by E, N by E.	·006
3	29·637	39·7	35·8	·88	·261	49·3	38·5	10·8	9, 8, 9	NNW, N by E, NE.	·000
4	29·672	37·5	35·8	·94	·242	46·8	35·2	11·6	10, 9, 10	SSE, E by S, NE by E.	·031
5	29·881	42·4	38·6	·88	·287	51·5	34·8	16·7	10, 7, 3	E by S, E by S, E by N.	·067
6	30·014	45·1	40·7	·86	·315	53·2	42·0	11·2	9, 2, 3	E by N, E, NE by E.	·025
7	29·910	40·8	40·7	·99	·271	47·8	40·6	7·2	10, 10, 9	NE, NNE, NE by N.	·008
8	52·4	41·5	10·9	·010
9	29·903	38·9	39·2	1·00	·254	44·8	42·4	2·4	10, 10, 10	NE by E, NE, N.	·005
10	29·844	43·5	40·4	·90	·298	51·4	42·0	9·4	10, 10, 10	WSW, SW by W, SW.	·191
11	29·528	46·1	44·4	·94	·326	54·8	41·6	13·2	10, 10, 10	ESE, ESE, S by E.	·000
12	29·778	47·5	42·5	·84	·343	58·8	45·3	13·5	7, 9, 10	WSW, SW by S, SW.	·215
13	29·884	48·5	46·7	·94	·354	58·5	49·8	8·7	10, 10, 10	SW, SW, SSW.	·020
14	30·009	46·8	39·5	·78	·334	58·4	40·1	18·3	5, 8, —	WSW, W, W by N.	·021
15	58·3	39·7	18·6	·178
16	29·924	46·8	45·1	·94	·334	54·9	39·5	15·4	10, 10, 2	SSW, SW, SSW.	·104
17	29·948	50·7	37·6	·64	·382	58·0	45·7	12·3	9, 6, 3	W, WSW, W.	·033
18	29·976	52·2	33·4	·64	·402	61·8	38·1	23·7	0, 4, 3	SW, W by N, WNW.	·000
19	29·808	52·8	44·7	·76	·410	62·5	40·1	22·4	10, 5, 7	S, S by W, SW by W.	·000
20	29·886	47·4	38·9	·74	·341	57·8	43·1	14·7	6, 9, 4	W, W by S, W.	·000
21	30·136	51·1	40·3	·69	·387	60·6	43·9	16·7	6, 6, 4	NW by W, NE, W by S.	·031
22	55·8	38·2	17·6	·000
23	30·342	44·9	31·5	·62	·313	52·8	39·5	13·3	0, 0, 0	E by N, E, E by N.	·000
24	30·165	48·4	34·2	·61	·353	55·8	38·9	16·9	0, 0, 0	E, E, E.	·000
25	30·068	55·3	35·6	·51	·447	63·4	44·3	19·1	0, 0, 0	E, E, E.	·000
26	29·944	61·4	46·6	·61	·547	71·7	41·7	30·0	0, 5, 4	ENE, SE, SE.	·000
27	29·742	64·4	50·6	·63	·605	74·6	50·4	24·2	0, 6, 10	E, SSW, S.	·000
28	29·469	52·0	51·7	·98	·399	66·8	53·0	13·8	10, 10, 10	SW by W, WNW, NE.	·020
29	46·5	39·1	7·4	·717
30	29·738	39·1	24·7	·60	·256	46·3	35·3	11·0	7, 9, 6	E by S, E by N, ENE.	·040
Daily Means.	29·866	47·3	40·1	·80	·348	14·5	1·807

* To obtain the Barometric pressure at the sea-level these numbers must be increased by ·037 inch.

HOURLY MOVEMENT OF THE WIND (IN MILES), AS RECORDED BY ROBINSON'S ANEMOMETER,--APRIL, 1866.

Day.	Hour.												Hourly Means.																		
	1	2	3	4	5	6	7	8	9	10	11	12																			
	8	4	8	2	4	10	18	6	6	4	20	15	6	8	18	19	4	5	8	7	10	1	13	13	13	10	9	6	18	17	9.3
	6	2	10	2	5	10	19	8	4	4	18	15	5	8	19	17	5	2	7	10	1	13	13	12	10	9	6	15	18	9.0	
	3	3	9	1	3	13	20	8	3	4	22	14	6	8	18	18	5	2	6	10	1	13	12	8	6	6	5	14	16	8.6	
	4	5	10	1	3	18	23	11	4	5	19	14	6	8	18	19	5	1	9	10	1	11	14	8	4	5	5	19	8.9		
	3	8	8	1	7	17	20	12	4	8	17	16	3	6	19	18	4	1	8	8	2	13	11	9	5	5	6	10	17	9.1	
	3	8	6	2	9	17	18	10	2	10	12	16	3	10	19	19	5	2	8	6	3	13	12	11	11	5	5	10	17	9.2	
	5	1	9	1	11	16	18	8	0	8	16	16	3	11	21	20	6	2	12	8	6	8	28	15	11	5	5	10	16	9.7	
	3	3	3	2	10	12	14	7	1	10	12	14	11	12	21	23	6	2	13	8	11	32	22	12	9	5	5	15	20	11.5	
	7	7	12	2	10	17	17	7	2	11	17	21	15	14	21	24	8	6	16	16	11	32	27	14	9	5	5	16	19	13.4	
	4	11	10	3	14	19	17	8	4	18	20	18	13	14	22	22	7	8	18	10	12	27	27	16	9	8	9	18	22	14.1	
	5	4	13	4	16	25	17	11	2	11	17	23	14	17	24	20	9	15	20	12	16	27	31	21	13	10	10	19	25	16.1	
	4	11	10	3	14	19	17	11	4	18	20	18	13	14	22	22	8	15	17	12	16	27	27	21	14	10	11	17	22	16.0	
	10	11	13	6	16	25	16	22	6	16	17	21	16	18	24	21	8	20	16	8	18	34	30	29	11	12	10	19	25	17.1	
	11	12	13	5	17	28	16	19	6	16	17	21	15	18	24	21	9	18	20	7	20	30	30	26	14	12	13	17	25	17.2	
	12	15	11	8	17	28	14	10	8	19	21	15	22	20	22	14	8	18	20	7	18	30	29	23	17	10	13	20	25	17.3	
	1	5	15	11	11	19	29	16	6	20	18	22	15	18	24	21	10	17	16	7	18	30	29	29	20	14	11	10	25	17.4	
	2	15	11	11	19	29	12	16	8	19	21	15	22	20	22	14	9	17	16	7	18	30	29	29	20	14	11	10	25	17.5	
	3	13	10	8	17	28	12	16	8	21	18	16	13	24	19	23	10	17	16	7	21	29	29	23	13	11	17	21	25	17.6	
	4	11	13	10	17	28	12	16	8	21	18	16	13	24	19	23	10	17	16	7	21	29	29	23	13	11	17	21	25	17.7	
	5	11	13	10	17	28	12	16	8	21	18	16	13	24	19	23	10	17	16	7	21	29	29	23	13	11	17	21	25	17.8	
	6	11	13	10	17	28	12	16	8	21	18	16	13	24	19	23	10	17	16	7	21	29	29	23	13	11	17	21	25	17.9	
	7	11	13	10	17	28	12	16	8	21	18	16	13	24	19	23	10	17	16	7	21	29	29	23	13	11	17	21	25	18.0	
	8	11	13	10	17	28	12	16	8	21	18	16	13	24	19	23	10	17	16	7	21	29	29	23	13	11	17	21	25	18.1	
	9	11	13	10	17	28	12	16	8	21	18	16	13	24	19	23	10	17	16	7	21	29	29	23	13	11	17	21	25	18.2	
	10	11	13	10	17	28	12	16	8	21	18	16	13	24	19	23	10	17	16	7	21	29	29	23	13	11	17	21	25	18.3	
	9	11	13	10	17	28	12	16	8	21	18	16	13	24	19	23	10	17	16	7	21	29	29	23	13	11	17	21	25	18.4	
	9	11	13	10	17	28	12	16	8	21	18	16	13	24	19	23	10	17	16	7	21	29	29	23	13	11	17	21	25	18.5	
	8	11	13	10	17	28	12	16	8	21	18	16	13	24	19	23	10	17	16	7	21	29	29	23	13	11	17	21	25	18.6	
	5	10	4	10	9	20	28	10	10	6	16	13	14	22	12	10	5	11	9	1	13	28	15	14	15	12	4	15	17	20	11.8
	1	5	10	4	10	9	20	28	10	6	16	13	14	22	12	10	5	11	9	1	13	28	15	14	15	12	4	15	17	20	11.8
	5	10	4	10	9	20	28	10	10	6	16	13	14	22	12	10	5	11	9	1	13	28	15	14	15	12	4	15	17	20	11.8
	4	11	10	9	20	28	10	10	6	16	13	14	22	12	10	5	11	9	1	13	28	15	14	15	12	4	15	17	20	11.8	
	4	11	10	9	20	28	10	10	6	16	13	14	22	12	10	5	11	9	1	13	28	15	14	15	12	4	15	17	20	11.8	
	4	11	10	9	20	28	10	10	6	16	13	14	22	12	10	5	11	9	1	13	28	15	14	15	12	4	15	17	20	11.8	
	4	11	10	9	20	28	10	10	6	16	13	14	22	12	10	5	11	9	1	13	28	15	14	15	12	4	15	17	20	11.8	
	4	11	10	9	20	28	10	10	6	16	13	14	22	12	10	5	11	9	1	13	28	15	14	15	12	4	15	17	20	11.8	
	4	11	10	9	20	28	10	10	6	16	13	14	22	12	10	5	11	9	1	13	28	15	14	15	12	4	15	17	20	11.8	
	4	11	10	9	20	28	10	10	6	16	13	14	22	12	10	5	11	9	1	13	28	15	14	15	12	4	15	17	20	11.8	
	4	11	10	9	20	28	10	10	6	16	13	14	22	12	10	5	11	9	1	13	28	15	14	15	12	4	15	17	20	11.8	
	4	11	10	9	20	28	10	10	6	16	13	14	22	12	10	5	11	9	1	13	28	15	14	15	12	4	15	17	20	11.8	
	4	11	10	9	20	28	10	10	6	16	13	14	22	12	10	5	11	9	1	13	28	15	14	15	12	4	15	17	20	11.8	
	4	11	10	9	20	28	10	10	6	16	13	14	22	12	10	5	11	9	1	13	28	15	14	15	12	4	15	17	20	11.8	
	4	11	10	9	20	28	10	10	6	16	13	14	22	12	10	5	11	9	1	13	28	15	14	15	12	4	15	17	20	11.8	
	4	11	10	9	20	28	10	10	6	16	13	14	22	12	10	5	11	9	1	13	28	15	14	15	12	4	15	17	20	11.8	
	4	11	10	9	20	28	10	10	6	16	13	14	22	12	10	5	11	9	1	13	28	15	14	15	12	4	15	17	20	11.8	
	4	11	10	9	20	28	10	10	6	16	13	14	22	12	10	5	11	9	1	13	28	15	14	15	12	4	15	17	20	11.8	
	4	11	10	9	20	28	10	10	6	16	13	14	22	12	10	5	11	9	1	13	28	15	14	15	12	4	15	17	20	11.8	
	4	11	10	9	20	28	10	10	6	16	13	14	22	12	10	5	11	9	1	13	28	15	14	15	12	4	15	17	20	11.8	
	4	11	10	9	20	28	10	10	6	16	13	14	22	12	10	5	11	9	1	13	28	15	14	15	12	4	15	17	20	11.8	
	4	11	10	9	20	28	10	10	6	16	13	14	22	12	10	5	11	9	1	13	28	15	14	15	12	4	15	17	20	11.8	
	4	11	10	9	20	28	10	10	6	16	13	14	22	12	10	5	11	9	1	13	28	15	14	15	12	4	15	17	20	11.8	
	4	11	10	9	20	28	10	10	6	16	13	14	22	12	10	5	11	9	1	13	28	15	14	15	12	4	15	17	20	11.8	
	4	11	10	9	20	28	10	10	6	16	13	14	22	12	10	5	11	9	1	13	28	15	14	15	12	4	15	17	20	11.8	
	4	11	10	9	20	28	10	10	6	16	13	14	22	12	10	5	11	9	1	13	28	15	14	15	12	4	15	17	20	11.8	
	4	11	10	9	20	28	10	10	6	16	13	14	22	12	10	5	11	9	1	13	28	15	14	15	12	4	15	17	20	11.8	
	4	11	10	9	20	28	10	10	6																						

Meteorological Observations at the Kew Observatory.

RESULTS OF METEOROLOGICAL OBSERVATIONS MADE AT THE
KEW OBSERVATORY.

LATITUDE 51° 28' 6" N., LONGITUDE 0° 18' 47" W.

1866.	Reduced to mean of day.					Temperature of Air.			At 9:30 A.M., 2:30 P.M., and 5 P.M., respectively.			Rain— read at 10 A.M.
Day of Month.	Barometer, corrected to Temp. 32°.*	Temperature of Air.	Calculated.			Maximum, read at 9:30 A.M. on the following day.	Minimum, read at 9:30 A.M.	Daily Range.	Proportion of Sky clouded.	Direction of Wind.		
			Dew Point.	Relative Humidity.	Tension of Vapour.							
	inches.	°	°	°	inch.	°	°	°	0—10		inches.	
May 1	29.470	36.0	34.2	.94	.229	41.8	38.8	3.0	10, 10, 10	NE by N, NE, NNE.	0.000	
" 2	29.573	39.9	32.3	.76	.263	48.2	36.5	11.7	10, 3, 1	NW, WSW, WNW.	.140	
" 3	29.614	41.7	37.8	.87	.280	52.8	36.9	15.9	6, 7, 4	—, WSW, WNW.	.136	
" 4	29.843	46.1	29.1	.55	.326	54.8	31.4	23.4	1, 3, 3	NNW, W by N, W by N.	.024	
" 5	30.093	48.0	40.5	.77	.348	57.7	33.6	24.1	7, 9, 7	SW, SW, SW.	.021	
" 6	58.6	42.5	16.1036	
" 7	30.219	54.9	42.2	.64	.441	62.7	45.7	17.0	2, 3, 6	S, W by S, SW by W.	.000	
" 8	30.005	53.5	40.9	.65	.420	62.6	41.1	21.5	2, 7, 9	SW by W, W, WSW.	.000	
" 9	29.770	52.6	42.7	.71	.408	62.7	47.8	14.9	10, 6, 3	W, WNW, W.	.042	
" 10	29.973	51.0	38.3	.64	.386	58.7	45.2	13.5	8, 8, 8	W, W, W.	.000	
" 11	29.624	50.4	45.3	.84	.378	62.7	49.7	13.0	10, 9, 6	SW, W, W.	.360	
" 12	29.661	46.1	41.8	.86	.326	57.1	42.4	14.7	9, 8, 7	WNW, W by N, WSW.	.025	
" 13	51.3	39.1	12.2020	
" 14	30.151	45.9	32.1	.62	.324	53.7	38.3	15.4	7, 7, 9	—, E by N, ENE.	.000	
" 15	30.344	44.0	30.8	.63	.303	50.4	35.9	14.5	7, 8, 9	NNW, NE, NE by N.	.000	
" 16	30.363	47.3	35.8	.67	.340	56.2	38.1	18.1	10, 6, 10	ENE, ESE, ESE.	.000	
" 17	30.256	54.5	40.2	.61	.435	62.5	36.1	26.4	4, 6, 2	SW by S, SE by S, —.	.000	
" 18	30.162	56.5	42.5	.62	.465	65.5	34.5	31.0	4, 4, 0	SE by E, E, E by N.	.000	
" 19	30.159	59.4	40.5	.52	.512	67.0	41.0	26.0	1, 2, 0	E by N, E, ESE.	.000	
" 20	63.2	41.0	22.2000	
" 21	30.353	51.4	39.4	.66	.391	58.8	46.7	12.1	0, 0, 0	E, E, E.	.000	
" 22	30.263	50.3	31.9	.52	.377	57.7	42.2	15.5	0, 0, 0	E by N, E by N, ENE.	.000	
" 23	30.064	55.8	39.7	.57	.454	64.1	41.1	23.0	0, 2, 0	NE by N, NE, NE by N.	.000	
" 24	29.892	45.6	34.1	.67	.321	54.7	42.1	12.6	10, 7, 5	NE by E, E by N, NE by E.	.000	
" 25	29.747	49.0	30.8	.53	.361	56.7	42.3	14.4	4, 3, 2	E, ENE, E by N.	.000	
" 26	29.612	53.5	44.9	.74	.420	64.2	42.7	21.5	7, 9, 9	NE, NE by E, ENE.	.000	
" 27	63.7	45.3	18.4515	
" 28	29.806	60.0	43.7	.57	.523	68.4	43.7	24.7	0, 4, 4	SE by S, SW by S, SW.	.000	
" 29	29.811	55.0	40.1	.60	.442	64.0	41.7	22.3	0, 6, 8	NE by N, N by W, N.	.000	
" 30	29.882	52.4	33.7	.62	.405	61.7	39.1	22.6	3, 10, 9	E by S, NE, E.	.000	
" 31	29.690	54.7	45.8	.74	.438	63.6	49.4	14.2	10, 10, 10	SE by S, E by S. ESE.	.000	
Daily Means. }	29.941	50.2	38.4	.67	.382	17.9	1.319	

* To obtain the Barometric pressure at the sea-level these numbers must be increased by .037 inch.

RESULTS OF METEOROLOGICAL OBSERVATIONS MADE AT THE
KEW OBSERVATORY.

LATITUDE 51° 28' 6" N., LONGITUDE 0° 18' 47" W.

1866.	Reduced to mean of day.				Temperature of Air.			At 9:30 A.M., 2:30 P.M., and 5 P.M. respectively.			Rain— read at 10 A.M.
	Day of Month.	Barometer, corrected to Temp. 32°.	Temperature of Air.	Calculated.			Maximum, read at 9:30 A.M. on the following day.	Minimum, read at 9:30 A.M.	Daily Range.	Proportion of Sky clouded.	
Dew Point.				Relative Humidity.	Tension of Vapour.						
June 1	inches.	54.8	51.4	.88	.439	66.0	50.6	15.4	0-10		inches.
" 2	29.854	61.7	46.8	.60	.553	71.5	51.4	20.1	6, 10, 8	SE, E by S, ENE. SSW, E by N, ESE.	—
" 3	76.4	55.2	21.2000
" 4	29.838	57.8	55.5	.92	.485	68.7	55.4	13.3	6, 10, 10	SW, WSW, SW.	.424
" 5	29.874	52.2	49.4	.91	.402	62.5	51.7	10.8	10, 9, 9	S by E, S, S.	1.100
" 6	30.045	53.4	48.6	.85	.419	63.1	51.4	11.7	10, 9, 6	SSW, SW, S by W.	.039
" 7	30.125	59.1	54.7	.86	.507	71.8	53.2	18.6	10, 8, 8	SSE, SW, SW.	.004
" 8	30.217	66.2	55.6	.70	.642	75.2	49.9	25.3	5, 7, 3	SW by S, W by N, S by W.	.000
" 9	30.187	68.8	56.0	.65	.699	80.3	49.4	30.9	4, 4, 9	SSE, SSW, SW by S.	.000
" 10	78.6	58.9	19.7000
" 11	30.022	56.5	48.0	.75	.465	66.8	48.3	18.5	7, 8, 9	NW by W, SSW, SSW.	.000
" 12	29.631	52.2	50.7	.95	.402	62.5	53.6	8.9	10, 10, 10	SW by S, SW, S.	.000
" 13	29.771	51.3	49.1	.93	.390	60.1	49.8	10.3	10, 10, 10	W by S, WNW, —.	.019
" 14	29.969	56.7	50.3	.81	.468	65.7	46.7	19.0	10, 9, 7	W, W, W.	.196
" 15	29.910	56.3	54.0	.92	.462	66.8	47.2	19.6	10, 10, 10	SW, SW, SW by W.	.000
" 16	29.687	54.0	40.1	.62	.427	64.5	51.3	13.2	7, 7, 3	SW, WNW, W by N.	.000
" 17	60.7	41.7	19.0101
" 18	29.547	49.7	50.4	1.00	.369	62.8	45.1	17.7	10, 10, 9	W, S, SW.	.074
" 19	29.681	55.5	47.4	.76	.450	64.8	51.0	13.8	9, 8, 7	W, SW, W by N.	.038
" 20	30.038	55.9	52.0	.85	.455	71.3	43.6	27.7	10, 10, 10	S. SSE, S.	.014
" 21	29.863	66.2	55.8	.71	.642	76.1	54.0	12.1	7, 7, 8	SW, SW by S, S.	.004
" 22	29.933	61.7	49.1	.66	.553	71.6	56.8	14.8	3, 3, 2	W by N, W, WNW.	.861
" 23	30.118	64.0	53.8	.71	.597	74.8	49.7	25.1	10, 3, 3	SW, E by N, ENE.	.000
" 24	70.3	52.9	17.4000
" 25	30.081	61.9	57.4	.86	.557	72.2	50.5	21.7	10, 9, 5	NE by N, NE, NE by N.	.000
" 26	30.018	68.4	54.3	.62	.690	76.8	56.6	20.2	0, 1, 0	E by N, E by N, E by N.	.000
" 27	29.882	65.0	61.0	.88	.617	79.5	58.0	21.5	3, 5, 5	NE by N, W, —.	.000
" 28	29.948	68.6	56.1	.66	.694	80.8	58.9	22.9	1, 4, 8	—, —, —.	.257
" 29	29.960	62.8	57.4	.83	.574	74.3	58.8	15.5	10, 7, 7	NNW, NE, N.	.000
" 30	29.777	64.4	58.2	.81	.605	78.8	56.8	22.0	3, 9, 6	SW by S, N by W, NNW.	.000
Daily Means.	29.909	59.4	52.4	.76	.521	18.3	3.161

* To obtain the Barometric pressure at the sea-level these numbers must be increased by .037 inch.

HOURLY MOVEMENT OF THE WIND (IN MILES), AS RECORDED BY ROBINSON'S ANEMOMETER.—JUNE, 1866.

Day.	Hour.												Hourly Means.						
	P. M.						A. M.												
1	10	10	11	2	15	15	7	2	2	2	14	10	9	2	6	5	13	8	6.8
2	6	6	10	2	10	15	5	1	3	10	10	10	9	4	4	6	10	10	6.0
3	11	6	10	2	10	16	5	1	1	7	7	3	3	5	5	5	15	10	5.8
4	7	7	12	4	6	16	7	2	1	7	3	3	4	5	6	187	15	15	5.8
5	5	4	13	4	4	14	6	1	1	6	8	8	13	5	5	17	17	7	6.0
6	3	7	13	2	7	15	6	2	3	14	13	13	13	3	5	15	10	10	6.3
7	3	7	13	2	7	16	6	1	3	14	13	13	13	5	5	15	10	10	6.0
8	3	7	13	2	7	16	6	1	3	14	13	13	13	5	5	15	10	10	6.0
9	3	7	13	2	7	16	6	1	3	14	13	13	13	5	5	15	10	10	6.0
10	3	7	13	2	7	16	6	1	3	14	13	13	13	5	5	15	10	10	6.0
11	3	7	13	2	7	16	6	1	3	14	13	13	13	5	5	15	10	10	6.0
12	3	7	13	2	7	16	6	1	3	14	13	13	13	5	5	15	10	10	6.0
1	12	10	9	7	6	21	15	10	8	20	15	17	8	11	15	21	19	19	13.9
2	12	10	9	7	6	21	15	10	8	20	15	17	8	11	15	21	19	19	13.7
3	12	10	9	7	6	21	15	10	8	20	15	17	8	11	15	21	19	19	13.7
4	12	10	9	7	6	21	15	10	8	20	15	17	8	11	15	21	19	19	13.7
5	12	10	9	7	6	21	15	10	8	20	15	17	8	11	15	21	19	19	13.7
6	12	10	9	7	6	21	15	10	8	20	15	17	8	11	15	21	19	19	13.7
7	12	10	9	7	6	21	15	10	8	20	15	17	8	11	15	21	19	19	13.7
8	12	10	9	7	6	21	15	10	8	20	15	17	8	11	15	21	19	19	13.7
9	12	10	9	7	6	21	15	10	8	20	15	17	8	11	15	21	19	19	13.7
10	12	10	9	7	6	21	15	10	8	20	15	17	8	11	15	21	19	19	13.7
11	12	10	9	7	6	21	15	10	8	20	15	17	8	11	15	21	19	19	13.7
12	12	10	9	7	6	21	15	10	8	20	15	17	8	11	15	21	19	19	13.7
1	12	10	9	7	6	21	15	10	8	20	15	17	8	11	15	21	19	19	13.9
2	12	10	9	7	6	21	15	10	8	20	15	17	8	11	15	21	19	19	13.9
3	12	10	9	7	6	21	15	10	8	20	15	17	8	11	15	21	19	19	13.9
4	12	10	9	7	6	21	15	10	8	20	15	17	8	11	15	21	19	19	13.9
5	12	10	9	7	6	21	15	10	8	20	15	17	8	11	15	21	19	19	13.9
6	12	10	9	7	6	21	15	10	8	20	15	17	8	11	15	21	19	19	13.9
7	12	10	9	7	6	21	15	10	8	20	15	17	8	11	15	21	19	19	13.9
8	12	10	9	7	6	21	15	10	8	20	15	17	8	11	15	21	19	19	13.9
9	12	10	9	7	6	21	15	10	8	20	15	17	8	11	15	21	19	19	13.9
10	12	10	9	7	6	21	15	10	8	20	15	17	8	11	15	21	19	19	13.9
11	12	10	9	7	6	21	15	10	8	20	15	17	8	11	15	21	19	19	13.9
12	12	10	9	7	6	21	15	10	8	20	15	17	8	11	15	21	19	19	13.9
1	12	10	9	7	6	21	15	10	8	20	15	17	8	11	15	21	19	19	13.9
2	12	10	9	7	6	21	15	10	8	20	15	17	8	11	15	21	19	19	13.9
3	12	10	9	7	6	21	15	10	8	20	15	17	8	11	15	21	19	19	13.9
4	12	10	9	7	6	21	15	10	8	20	15	17	8	11	15	21	19	19	13.9
5	12	10	9	7	6	21	15	10	8	20	15	17	8	11	15	21	19	19	13.9
6	12	10	9	7	6	21	15	10	8	20	15	17	8	11	15	21	19	19	13.9
7	12	10	9	7	6	21	15	10	8	20	15	17	8	11	15	21	19	19	13.9
8	12	10	9	7	6	21	15	10	8	20	15	17	8	11	15	21	19	19	13.9
9	12	10	9	7	6	21	15	10	8	20	15	17	8	11	15	21	19	19	13.9
10	12	10	9	7	6	21	15	10	8	20	15	17	8	11	15	21	19	19	13.9
11	12	10	9	7	6	21	15	10	8	20	15	17	8	11	15	21	19	19	13.9
12	12	10	9	7	6	21	15	10	8	20	15	17	8	11	15	21	19	19	13.9
1	12	10	9	7	6	21	15	10	8	20	15	17	8	11	15	21	19	19	13.9
2	12	10	9	7	6	21	15	10	8	20	15	17	8	11	15	21	19	19	13.9
3	12	10	9	7	6	21	15	10	8	20	15	17	8	11	15	21	19	19	13.9
4	12	10	9	7	6	21	15	10	8	20	15	17	8	11	15	21	19	19	13.9
5	12	10	9	7	6	21	15	10	8	20	15	17	8	11	15	21	19	19	13.9
6	12	10	9	7	6	21	15	10	8	20	15	17	8	11	15	21	19	19	13.9
7	12	10	9	7	6	21	15	10	8	20	15	17	8	11	15	21	19	19	13.9
8	12	10	9	7	6	21	15	10	8	20	15	17	8	11	15	21	19	19	13.9
9	12	10	9	7	6	21	15	10	8	20	15	17	8	11	15	21	19	19	13.9
10	12	10	9	7	6	21	15	10	8	20	15	17	8	11	15	21	19	19	13.9
11	12	10	9	7	6	21	15	10	8	20	15	17	8	11	15	21	19	19	13.9
12	12	10	9	7	6	21	15	10	8	20	15	17	8	11	15	21	19	19	13.9
1	12	10	9	7	6	21	15	10	8	20	15	17	8	11	15	21	19	19	13.9
2	12	10	9	7	6	21	15	10	8	20	15	17	8	11	15	21	19	19	13.9
3	12	10	9	7	6	21	15	10	8	20	15	17	8	11	15	21	19	19	13.9
4	12	10	9	7	6	21	15	10	8	20	15	17	8	11	15	21	19	19	13.9
5	12	10	9	7	6	21	15	10	8	20	15	17	8	11	15	21	19	19	13.9
6	12	10	9	7	6	21	15	10	8	20	15	17	8	11	15	21	19	19	13.9
7	12	10	9	7	6	21	15	10	8	20	15	17	8	11	15	21	19	19	13.9
8	12	10	9	7	6	21	15	10	8	20	15	17	8	11	15	21	19	19	13.9
9	12	10	9	7	6	21	15	10	8	20	15	17	8	11	15	21	19	19	13.9
10	12	10	9	7	6	21	15	10	8	20	15	17	8	11	15	21	19	19	13.9
11	12	10	9	7	6	21	15	10	8	20	15	17	8	11	15	21	19	19	13.9
12	12	10	9	7	6	21	15	10	8	20	15	17	8	11	15	21	19	19	13.9
1	12	10	9	7	6	21	15	10	8	20	15	17	8	11	15	21	19	19	13.9
2	12	10	9	7	6	21	15	10	8	20	15	17	8	11	15	21	19	19	13.9
3	12	10	9	7	6	21	15	10	8	20	15	17							

ARCHÆOLOGIA.

ANOTHER example of the primitive CANOE has lately been found in WHETTALL MOSS, about three miles from Ellesmere, in Shropshire, in the course of some extensive excavations for agricultural drainage on the estate of Earl Brownlow. As the men were employed in cutting a main drain, they came upon this canoe, at about six feet below the surface. A large birch tree was growing over it. The canoe was found in tolerably perfect condition. It is eleven feet long by two feet five inches wide, and one foot four inches deep. A considerable number of similar canoes, usually about the same dimensions, have now been found in different parts of Britain, but never in such immediate connection with relics of known date as to enable us to fix the period or periods to which they belong. Our own opinion is that, for the most part, they are by no means necessarily of so remote a date as has sometimes been ascribed to them.

A rather interesting sample of a ROMAN TESSELATED PAVEMENT has been found in the churchyard of CAERLEON, the site of the *Isca Silurum* of the Romans. It was carefully taken up, and removed into the museum of the Caerleon Antiquarian Society, where it will be preserved. It offers a good specimen of the labyrinthine, or maze, pattern, of which other examples might be pointed out. This is not the only instance in Britain of a fine tessellated pavement being found under a churchyard, a position no doubt arising from the circumstance that at the time the church was first built, the builders selected a spot which had been occupied by a previous building of some extent, such as a Roman villa, the ruins of which furnished them with plenty of building materials ready at hand; and the ground covering the pavements of some of the larger rooms offered a clear space which would serve conveniently for the churchyard. This was the case with the principal apartment of the extensive villa at Woodchester, in Gloucestershire, the pavement of which lies under the modern church and churchyard, in consequence of which the mosaic work has been cut through and broken up in all parts by the sinking of graves.

Some ANGLO-SAXON ANTIQUITIES, found in excavations in Leicester and the neighbourhood, have recently been laid before the Leicester-shire Architectural and Archæological Society. The more remarkable of these relics were discovered in the parish of Glen Parva, some four miles from Leicester, in a grave containing a skeleton which is assumed, from the objects found with it, to be that of a Saxon lady. There were two bronze pendants, perhaps part of a sort of chatelaine which is often found in such graves, and appears to have been suspended to the lady's waist; three bronze fibulæ; part of an article made of bone, supposed to be an amulet; two flat pieces of bone, with corresponding rivet-holes, and one bone rivet remaining, apparently belonging to the handle of a knife; a drinking vessel of thin glass, which was broken to pieces in taking it out of the earth; two large finger rings; several beads, of glass and

other material; and a crystal ornament, cut in facets like a diamond, and drilled through, which measures in its horizontal diameter nearly two inches, and in its transverse diameter not quite an inch and a half. There was also found in this grave the claw of an animal, pierced through, evidently for suspension on the person.

T. W.

The Rev. W. Kilbride, vicar of Aran, and G. H. Kinahan, F.R.G.S.I., of the Geological Survey of Ireland, have recently discovered the sites of two ancient settlements on the Islands of Aran, County Galway. The settlement on Inish More, the largest of the islands, consists of eight Cloghauns, or dry stone cells with "beehive roofs;" fifteen Cnocāns, or dry stone beehive cells covered with clay; four Fosleac, or cells built of and roofed with flags; four Ointigh, or dry stone cells that had not beehive roofs; two Doons, and one Cashel. The settlement on Inish-Maan, the centre island, consists of thirteen Cnocāns and Cloghauns and one small Doon.

PROGRESS OF INVENTION.

NEW REGULATOR OF VELOCITY.—Motion is rarely obtained continuously from any source in such a state of uniformity, as the purpose for which it is destined requires. Hence ingenuity has devised a number of contrivances which, if they, in no case render the motion perfectly uniform, in most they regulate it with sufficient precision for the attainment of the intended object. The regulators used with chronometrical instruments give rise to periodical alternations of rest and motion; which though objectionable from the necessity of alternately destroying motion and overcoming inertia, is found to comply sufficiently with the conditions which are to be fulfilled. Such regulators, it is obvious, would be inapplicable where interruption of motion is inadmissible; and hence regulators, founded on different principles, are then indispensable. It might be supposed that friction would answer the purpose of absorbing the excess of motion which would produce augmented velocity; but such is not the case, as the circumstances which give rise to friction are so various, and so little under control; and hence it is never used as a means of regulation, when great exactness is required. The resistance of the air affords a more suitable mode of regulation. As the resistance offered by the air to any surface moving in it, is proportionable to the square of the velocity, it is clear that the resistance increases much more rapidly than the velocity; and that the velocity of any body having a large surface will be but little affected by slight variations in the power. It will, however, be affected; and hence absolutely uniform motion is unattainable when the regulator consists of revolving vanes. The happy idea occurred to M. Leon Foucault, of combining with the principle of revolving vanes that of the centrifugal governor used with the steam engine, etc.: and the result is a regulator of great simplicity, which affords a motion

that may be considered absolutely uniform. In this apparatus, the rods and balls of the centrifugal governor are replaced by oblong triangular thin plates of metal, constituting vanes, which are hinged by their vertices to the revolving upright spindle, and move in the same vertical plane. They are prevented from flying out to their full extent by slight increments in the velocity of rotation, by spiral springs which, being fixed to their centres of gravity, are the causes of no disturbing influence. When the velocity is that which is required, the resistance offered by these vanes, as they hang down along the revolving spindle suffices to absorb the excess of motion, so as to prevent the velocity from becoming accelerated; but the slightest increase of velocity causes them to fly asunder by means of centrifugal force, and to an extent which depends on the increase of velocity. As the distance of the vanes, and especially of their broader portions, from the axis of motion is increased, the resistance they experience from air, which has also been augmented by the increased velocity, is increased; and hence equilibrium is soon established between the disturbing and controlling agents. The velocity which this apparatus will permit is entirely under control; since it depends on the size of the vanes, the quantity of matter they contain, and the relative power of the springs. When one velocity is to be changed into a very different one from that previously required, it is necessary to change the springs; but when the desired alteration is inconsiderable, movable metallic masses, are merely slipped up and down along the vanes by means of screws, so as to alter their distance from the axis of motion, when the vanes fly apart. This affords an easy mode of regulation to any velocity desired. So accurate is the adjustment of velocity obtained by this contrivance that power may be taken for any required purpose from a clock regulated by it, without disturbing the accuracy of the rate of going.

A NEW AND EXTREMELY POWERFUL ELECTRICAL APPARATUS.—The production of electrical currents by means of magnetism, or electro-magnetism, is used by Mr. Wild of Manchester for the obtaining of enormous quantities of electricity, by means of a contrivance which, considering its vast power, is neither complicated nor expensive. He was led to the invention of this apparatus, by discovering a mode of utilizing the important fact ascertained a considerable time since by M. Seguin, that a very large quantity of electricity may be developed in an electro-magnet by a permanent magnet of very small power. As an electro-magnet possesses all the properties of a permanent magnet, the effect thus obtained can, of course, be multiplied to any extent, by successive elements added to the apparatus; but it was found that the principle repeated three times, that is by the use of three elements; afforded quantities of electricity quite as large as could be desired. Each element of this apparatus consists of one or more, either permanent or electro-horse-shoe magnets, and a kind of cylinder within which revolves an armature. The cylinder, or rather the cylindroid, which has four flattened sides, constituting a kind of quadrangular prism, having rounded corners parallel to its length,

consists of two plates of cast iron, placed opposite to each other, and united by two plates of brass. In the ends, which are of some non-magnetic substance, are small circular apertures, that allow an armature to revolve in the axis of the cylindroid. This armature is a cylinder of iron, down the two sides and across the ends of which are deep grooves, within which is wound a helix, formed of copper wire 0.03 of an inch in diameter, and about 160 feet in length. When the cylindroid is placed between the poles of a magnet, so that the latter are in good contact with the cast-iron plates, and the armature is made to revolve, it is evident that two opposite electric currents are formed in its helix during each revolution of the armature. All the currents may, by means of a commutator, be made to pass in one direction, and when the rotation is very rapid, the amount of electricity produced by even a single, permanent magnet, is very great; but every additional magnet placed on the cylindroid causes the addition of an equal effect. If the electric current thus obtained is made to excite one or more electro-magnets, the poles of which are in contact with a cylindroid similar to the first, and the two armatures are made to revolve rapidly, the effect becomes very considerable. And if the second current is transmitted through the helices of other electro-magnets, the poles of which are in contact with a third cylindroid, the third secondary current thus obtained is of great power. With four permanent magnets, each only one pound in weight on the first cylindroid, the armatures in the first two cylindroids being two inches and half in diameter, and that in the third cylindroid ten inches, a current was obtained which, with carbon electrodes, and a parabolic reflector, produced so intense a light on the top of a lofty building at night, that shadows were projected by the flames of street-lamps a quarter of a mile distant. The calorific power of the apparatus sufficed to melt an iron rod a quarter of an inch in diameter, and copper wire 0.125 of an inch in diameter; and to keep twenty-one feet of iron wire 0.065 of an inch in diameter at a red heat. This instrument seems applicable to lighthouses and numerous other practical purposes; since it is neither very large nor very costly, and the only expense its working entails is the rotation of the armatures, which should each make about 3000 revolutions per minute. Its effects at first sight would appear at variance with the ordinary laws of the conservation of force; but all difficulty will vanish if we remember that the machine is merely an apparatus for changing rotary motions into electricity. In many cases, the motion required may conveniently be obtained from a steam engine.

PEROXIDE OF HYDROGEN.—This curious compound, which is every day being applied to new uses, and is likely to become a very valuable agent in the hands both of the philosopher and the manufacturer, may, as Schönbein has discovered, be prepared with great facility, by agitating in a large receiver, into which the air has free access, amalgamated zinc in powder and distilled water. The oxygen of the air combines both with the zinc and water, oxide of zinc and peroxide of hydrogen being formed. The peroxide of

hydrogen does not contain a trace of either zinc or mercury; and being quite free from acid, it remains for a long time without decomposing.

IMPROVED ELECTROTYPE PROCESS.—Christofle and Bouillet, of Paris, have introduced three great improvements into the electrotype process. They add to the silver bath sulphuret of carbon, or an alkaline sulphuret, which produces a small quantity of sulphuret of silver; and this, for some reason not yet explained, causes the silver deposit to be, not dim and lustreless, but as brilliant as if it had been carefully burnished. They add to the sulphate of copper bath a moderate quantity of gelatine, which, for some reason, also as yet unexplained, causes the copper deposit to be as compact and dense as the very best rolled sheet copper. And lastly, they secure very great economy, by attaching plates of lead to the platinum wire, which forms the interior skeleton of the mould used for the production of articles in relief. The results produced by this modification of M. Lenoir's process affords products yet more perfect than those obtained by casting and chasing.

REPRODUCTION OF DESIGNS ON GLASS.—The decoration of porcelain with designs embracing every grade of excellence, and at a very trifling cost, compared with the beauty of the products, has long been practised in this and other countries. But, hitherto, glass appeared to be incapable of receiving any kind of ornamentation except by methods tedious, difficult, and expensive. It is likely, however, that such is now no longer the case, as a process has been invented in France, by means of which engravings are transferred to glass with nearly the same facility as they have hitherto been transferred to ceramic products. In the case of porcelain, fine lined copper plate engravings on tissue paper are applied to the surface of the article, the engraved side inwards; and the paper having been washed away, the lines of the engraving which still adhere to the porcelain are permanently attached by firing and glazing. In the case of glass, this process requires to be modified; a fine lined engraving would not answer, and hence, one having lines of sufficient depth is used. Also, stearates and oleates are added to the silicates and borosilicates, which are intended to support, or to fuse the coloured or colouring oxides, for the purpose of giving to the enamels the thickness which glass requires them to have; and a solution of resin in ether or benzine is added. The engravings on paper are produced by means of engraved rollers; and, after having been treated very much in the same way as with porcelain, the glass is placed in the furnace, and thus the most beautiful results are obtained with certainty, ease, and economy.

OXYGEN IN A DIFFERENT STATE IN DIFFERENT PEROXIDES.—Our knowledge regarding the different conditions in which oxygen may exist is receiving constantly new accessions. Not the least important of these is the fact recently discovered, that the oxygen in the peroxide of manganese is in a very different state from that in the peroxide of barium: a circumstance which is strongly confirmative of the theory of Schönbein, that oxygen may exist in two opposite states, which he has termed *ozone* and *antiozone*, oxygen in its ordi-

nary state being a combination of both. It has been proved by recent researches that the oxygen in peroxide of barium is in the form of ozone, and that in the peroxide of manganese in the form of antozone. The consequences which follow from these discoveries are of a most interesting description: since if the two kinds of oxygen enter into combination, it is probable that the elements with which they combine exist in two allotropic states; and the inference may indeed be extended indefinitely, so as to lead to a belief that also all the elements, and perhaps all their compounds, are capable of existing in two opposite allotropic states. The facts which demonstrate that the oxygen elements in the peroxides of barium and manganese are in very different states, are very remarkable, and are such as admit of no doubt. Thus the oxygen in the peroxide of barium has a less affinity for hydrogen than chlorine, since, when it is acted on by the latter, hydrochloric acid will be formed, oxygen being given off; while on the contrary, hydrochloric acid is decomposed by peroxide of manganese, chlorine being evolved. It is worthy of remark that the oxygen given off by the peroxide of barium is in the form of ozone. Again, if peroxide of barium is treated with hydrochloric acid, peroxide of hydrogen will be formed; but if peroxide of manganese is treated with the same acid, ordinarily, water will be formed, and chlorine evolved. Sulphovinic acid, if heated in presence of peroxide of barium, affords ether, bicarburet of hydrogen, and sulphurous acid; but if in presence of peroxide of manganese, aldehyde. Peroxide of hydrogen may be formed by means of either peroxide of barium or peroxide of manganese; but the two peroxides of hydrogen thus obtained are very different, since each will be decomposed by the peroxide employed in forming the other; and, what is still more remarkable, they will decompose each other.

MISCELLANEOUS.—*Damping Apparatus for Copying.*—In copying letters, the most troublesome portion of the process consists in damping the paper: this is greatly facilitated by means of a simple apparatus recently invented in Germany. It consists of a hollow perforated roller covered with linen, and rotating on a tube connected with the handle, which serves as a reservoir for water. When the roller is in use, the water flows from the handle into the tube, thence into the perforated roller, and thus the linen is kept wet while being rolled over the paper. When the instrument is not required, it is left in such a position as causes the water to flow back into the handle.—*Purification of Water.*—There is good reason to believe, from certain experiments recently made, that any kind of water may be freed, not only from the impurities it contains in suspension, but also those it holds in solution, and may thus be made fit for drinking, by adding to it a very small amount of a solution of permanganate of potash, and then filtering it through a layer of magnetic oxide of iron and carbon, a few inches thick. The required mixture may be obtained by heating in a close vessel red oligist ore and a small quantity of sawdust.—*Petroleum as Fuel.*—In the ordinary modes of using petroleum as fuel, there is very frequently produced a very large quantity of black smoke,

which not only is very offensive, but a source of great waste. This is entirely prevented by mixing superheated steam with the petroleum vapour, as has been done for some time past in America, and more lately at Woolwich Dockyard; which causes the smoke instantly to disappear, and the whole fire-place and tubes to be filled with a bright white flame. We need not remark that the decomposed water causes no addition to the total amount of heat, since water absorbs the same quantity of heat during decomposition as its elements afterwards give out during combination. The economy arises from the waste of a large part of the fuel, as smoke, being prevented.—*New mode of fixing Photographic Prints.*—Chloride of sodium (common salt) was one of the very first fixing agents employed; it was used by Daguerreotypists before Sir John Herschel's discovery that hyposulphite of soda is better suited for the purpose was generally known. A slight modification in the use of it renders it, however, all that can be desired as a fixing agent. The prints, when taken out of the frame, are to be placed for some time in a solution containing five per cent. chloride of it, and the solution is then to be raised to the boiling point, and left at it for about ten minutes. The prints may then be removed and washed, and the pictures will be found completely fixed.—*New Mode of Utilizing Combustible Fluids as Fuel.*—For this purpose a lamp is used in which the turpentine, or other combustible fluid, is reduced to a fine dust by an apparatus, which the inventor, a Russian professor, terms a "pulveriser." The flame produced by means of this is of great size and power, and of a whitish-yellow colour. The heat it emits is so intense as to melt steel. The contrivance is certainly not so economical as the ordinary furnace; but it is expected that, for many purposes, this will be far more than counterbalanced by its convenience and power.

NOTES AND MEMORANDA.

THE DHURMSALLA METEORIC STONE.—A paper in *Proceedings of Royal Society*, by Professor Haughton, states that on the 14th July, 1860, at 2.15 P.M., a remarkable meteoric stone fell at Dhurmsalla, and that the cold of the fragments that fell was so intense as to benumb the hands of the coolies who picked them up. A fragment they sent to the museum of Trinity College, Dublin, was analyzed by Professor Haughton, who found 100 parts to contain nickel iron 8.42, protosulphuret of iron 5.61, chrome iron 4.16, chrysolite (peridot or olivine) 47.67, and minerals insoluble in muriatic acid 34.14. The proportion of chrome is unusually large.

NEW MARINE WORM (*Phenacia pulchella*).—Mr. Edward Parfitt describes, in *Annals of Natural History*, No. 103, a new species of marine worm thrown up by the sea at Exmouth on 6th January during a heavy gale. It inhabits a thin, flexuous, horny tube, three inches long. The worm itself is two inches long, the body composed of forty annulations, the anterior of which were armed with two fascicles of yellow bristles of about three or four each, placed opposite to each other. The rest of the rings have about two each, but the numbers vary. Colour pale orange, red mouth with a purple cast. Buccal cirri twenty, white, beautifully

maculated with oblong spots of orange, red down the centre. Dorsal cirri reflexed purple, with faint reddish tinge.

IODINE DISSOLVES GOLD.—M. Nickles states, in *Comptes Rendus*, that if iodine, water, and gold leaf, are heated in a tube to 50° C. (122° F.) the gold is dissolved. Ether may be substituted for water, and the action will take place on exposure to strong sunshine. The filtered solution deposits a film of gold on evaporation, if the heat at the end of the operation is sufficient to decompose the iodide of gold which is deposited. Sesqui-iodides and bromides of iron likewise dissolve gold.

SIZE AND LIFE OF A MAMMOTH TREE (*Sequoia gigantea*).—M. A. De Candolle, giving an account to the French Academy of the recent Botanical Congress in London, stated that an exact measurement of one of the mammoth trees of California, the "old maid," which was blown down in a storm a few years since, had been made by Mr. Edmond De la Rue. It was found to be twenty-six feet five inches and nine lines, six feet above the ground. Mr. De la Rue traced the annual layers on a sheet of paper which M. de Candolle exhibited, and it was found that the layers amounted to 1234.

VOLCANIC EMANATIONS AND DISEASE.—M. de Corogna states to the French Academy that in districts towards which the winds blow the gaseous matter given off by the eruption at Santorin, inflammations of the eye, bronchitis, and digestive derangements have been frequent, while other districts have not suffered in the same way. Asphodels, and generally, plants of the lily tribe have been injured. He ascribes the human maladies of indigestion, etc., chiefly to sulphuretted hydrogen, and the vegetable disorders to hydrochloric acid vapours. The ophthalmia is traceable to volcanic dust.

THE ZODIACAL LIGHT.—M. Liandier has a note in *Comptes Rendus* stating that for several years he has watched the zodiacal light during the evenings of February and March. This year, for the first time, he saw it on the 19th of January, and watched it till the 5th of May. He considers it to have the shape of a perfect cone, varying in luminosity and colour from dull grey to silvery white, the changing aspect probably being occasioned by the condition of our atmosphere. In February the summit of the cone reached the Pleiades, and the Twins in May. Between January and May he found it to follow the zodiacal movements of the sun. He believes the luminous cone to be a fragment of an immense atmosphere enveloping the sun on all sides. If so, he says it may be expected to exercise an enormous pressure on the sun, with great development of heat; and if local variations occur, he thinks they may explain the occurrence of spots through the reduction of temperature that would follow diminished pressure.

EFFECTS OF INCREASE OF SUN'S MASS.—On the 1st September, 1859, Mr. Carrington and Mr. Hodgson witnessed a sudden blazing up in the sun, which is supposed to have indicated the fall of an extraneous body into our luminary, and a consequent accession to his mass. In *Monthly Notices*, vol. xxvi., No. 8, recently issued, will be found a mathematical paper computing the effects of the fall into the sun of such a body as our earth, which some persons suppose would produce such a blaze as to scorch up all the planets. Mr. Waterston finds that if the blaze so occasioned were persistent, the general rise of temperature would not exceed 10° or 15°, but he observes that as soon as the falling body had plunged below the atmosphere into the fluid incandescent body of the sun, the blaze would terminate, though the temperature of that part of the sun would be sensibly increased. If the whole potential radiating power of the sun were increased 1000°, he says, "even this is only one twelve-thousandth part of the potential temperature that sends heat to us sufficient to maintain a general average temperature over the surface of the earth of about 500° above the absolute zero of space. Now this proportion of 500° is only one twenty-fourth of a degree, and this is the extreme maximum effect that can be reasonably expected from such a planet fall." But increase of the sun's mass would shorten the year, and the addition of matter equal to our globe would effect this to the extent of 130", causing a difference in the longitude of the sun at the end of the first year equal to 5"·3.

PRISMS AND SILVERED FLATS FOR TELESCOPES.—A paper by Mr. Browning will be found in *Monthly Notices*, comparing the action of a prism and a silvered flat when used with the glass reflecting telescopes. The prism he finds to reflect more light, as might have been expected, and he found that when a prism and a flat, placed side by side, threw down two pencils of the light from a paraffin lamp, that the circle of light from the prism looked *white*, while the other was strongly tintured with a reddish chocolate colour. We have made experiments with prisms and flats fully according with Mr. Browning's results. The prisms, if accurate in form, are far superior to the silvered flats in light and colour, and quite equal to them in point of definition. Mr. Browning exhibited to the Astronomical Society a fine prism made for Mr. De la Rue.

FUNGUS IN A TREE.—The *Archives des Sciences* has an account of a paper by Signor Gasparini, in which he states that a fine *Acacia dealbata* from New Holland, when in full flower in a garden at Naples, was broken through its stem by a slight blast of wind. It was found that the heart wood was black and rotten, and microscopic examination revealed the mycelium threads of a fungus. The medullary rays, pith, and spiral vessels were not attacked, but the dotted vessels (*vaisseaux ponctués*) were so. Signor Gasparini considered that the spores of the fungus had introduced themselves through the rootlets. He states that when the spangioles have been broken in plants of the lily tribe, spores have found entrance, and occasioned damage.

STRANGE EFFECT OF LIGHTNING.—*Cosmos* states, on the authority of M. Saillant, that on May 15 an oak was struck by lightning in the forest of Vibraye (Sarthe) at about two-thirds of its height, at the origin of the large branches. The upper third, comprehending the crown and its branches, was not touched, but the remainder of the tree was split to shivers, and dispersed in all directions. No vestige was found of the bark, the root was partly torn up, and a heavy fragment hurled more than fifty paces. "The most curious thing is that the top of the tree was stuck in the ground, just where the original trunk was, so that the trunk and roots must have been swept away the time the tree-top took in falling."

ACHROMATIC EYE-PIECES FOR TELESCOPES.—For ordinary use the Huyghenian eyepiece will probably remain the favourite for achromatic telescopes, though for extent of field Horne and Thornthwaite's aplanatics are preferable. For reflecting telescopes, now coming into more general use since the success attained by Mr. With and Mr. Browning in making and mounting the silvered glass mirrors, the Huyghenian eye-piece scarcely works as well as it does with the achromatic. In the latter case the Huyghenian eye-piece corrects errors which do not exist in reflectors. Mr. Browning has constructed a series of achromatic eye-pieces to work with the silvered glass reflectors, and, after giving them many trials, they appear to us decidedly advantageous where smallness of field is not objectionable. If a good Huyghenian eye-piece is employed on Saturn or Jupiter, and then an achromatic of the same power, a noticeable improvement in definition is obtained. Thus the divisions in Saturn's ring can be seen with the achromatic eye-piece when the Huyghenian will scarcely indicate them. We recommend those who possess reflectors to try Mr. Browning's achromatic eye-pieces.



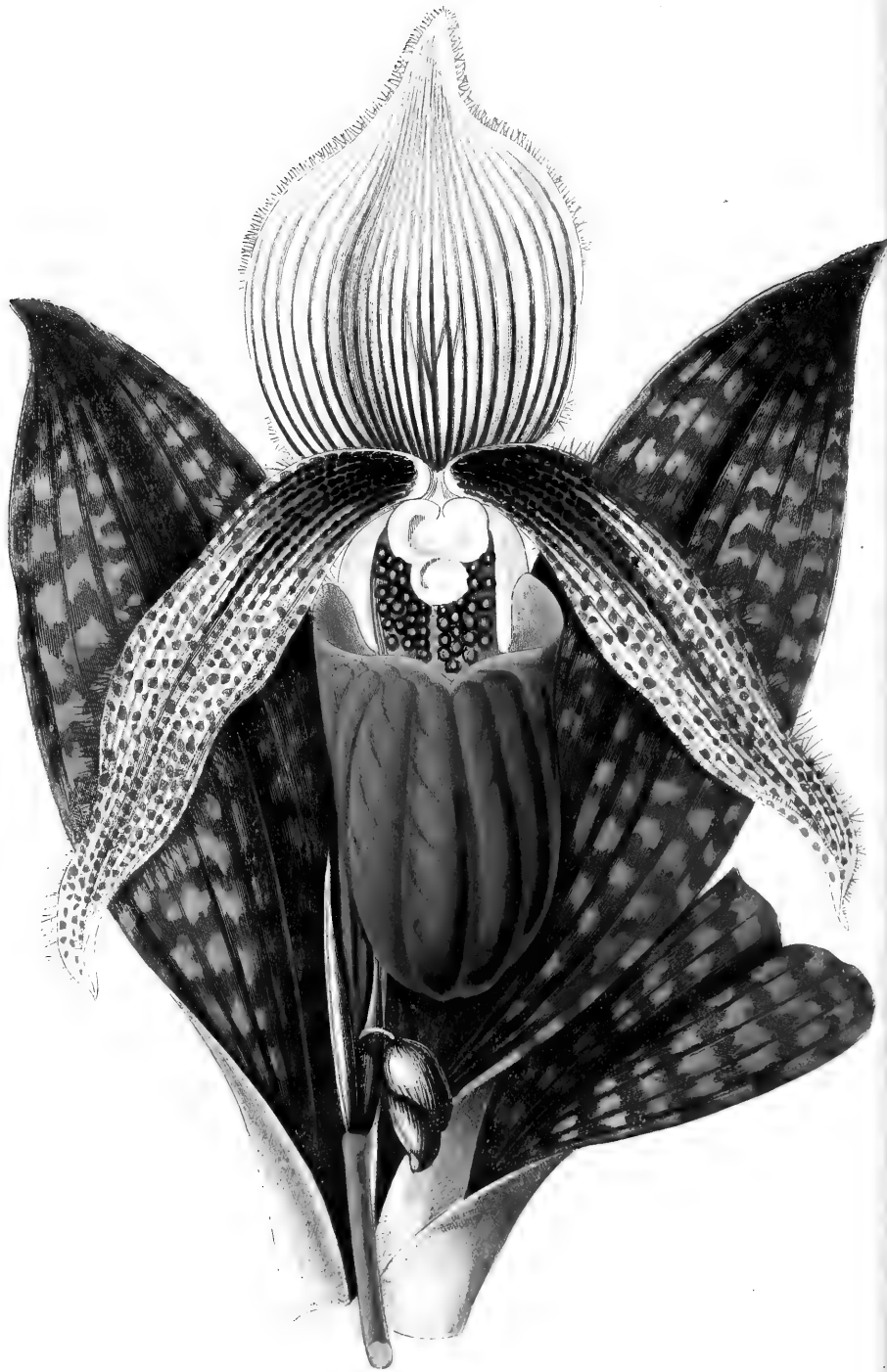

THE INTELLECTUAL OBSERVER.

SEPTEMBER, 1866.

LADIES' SLIPPERS.

BY SHIRLEY HIBBERD.

(With Coloured Plate of *Cypripedium Veitchianum*.)

THE ladies' slippers are at once the least interesting of all known orchids with those who cultivate solely with a view to their decorative uses, and the securing of special variations from types; but the most interesting to those who give attention to organic structure, and physiology, and botanical distinctions. While both parties rejoice in their exquisite beauty, the first is oftentimes wearied with their stubborn adherence to settled forms and colours, and the apparent impossibility of altering their forms by hybridization, the philosophic observer finds in them solutions of problems in phytology, and exceptions to the prevailing details of orchid structure that render them perpetually entertaining and attractive. In common with the majority of orchids now in cultivation, they have not long enjoyed the favour of cultivators, for the simple reason that until lately very few were known. One of them, the common ladies' slipper, *C. calceolus*, is a native of Britain, though very rarely to be found growing wild at the present day; and of all the rest it may be said that we have so recently become acquainted with them that very much pertaining to their history has the charm of novelty added to peculiarity of structure. In the *Hortus Kewensis*, of 1810, only six species of *Cypripedium* are entered as being then cultivated in the Royal Gardens, and they are all (with the exception of *C. calceolus*) hardy North American species, named respectively *parviflorum*, *pubescens*, *spectabile*, *humile*, and *arietinum*. In Sweet's *Hortus Britannicus*, 1830, eleven species are entered, and these again are all hardy English and American kinds, except two—namely, *C. venustum* and *C. insigne*, natives of India, and originally obtained from Nepaul—the first in 1816, the second in 1819. In Don's *Hortus Cantabrigiensis*, 1845,

there are thirteen entered, including *C. purpuratum*, introduced from the Malays in 1837, and the beautiful *C. barbatum*, from Mount Ophir, in 1841. Since that date the number has steadily increased, and within ten years past some very notable additions have been made by the introduction of such noble species as *Veitchianum*, *lævigatum*, *caudatum*, *concolor*, and others. It must not be supposed, however, that all the species and varieties recorded in the books are valued, or even known to cultivators. With the exception of *C. calceolus*, which is known by a few—very few—collectors of scarce and curious plants, the hardy species have no place in our gardens, success in cultivating and keeping them having proved so rare as to discourage the most ardent lovers of herbaceous plants. Now and then some spirited trader secures an importation of these plants, but it invariably ends, not in his finding customers for them, nor yet in growing them for his own amusement; he simply loses them, and there ends the speculation. But the majority of the tropical species are easily grown and multiplied; and as they are very various in character, some of them extremely curious, and all of them beautiful, so we meet with some of them wherever exotic orchids are cultivated, even if only on a small scale. The favourites at present are *C. insignis*, which will thrive in any warm greenhouse; *C. barbatus*, and its varieties; *C. villosum*, *C. Veitchianum*, *C. Stonei*, and *C. caudatum*.

The distinctive character of the *Cypripedium* must become immediately evident to the most casual observer who has an opportunity of seeing any of the species grouped with examples of other families of orchids. They are terrestrial plants; they neither produce pseudo-bulbs above the soil, nor send out snake-like aerial roots for prehensile or nutritive purposes. Instead of the great branching spike bearing hundreds of flowers, as in some of the *Oncidiums*; or the compact panicle towering high above our heads, as in some *Vandas*; or the whip-like, arching stem, bearing many great butterfly-shaped flowers, as in *Phalænopsis*; or the forest of flowers, making clouds of gold, and amber, and rose, as when the sun sets in glory, which the *Dendrobes* surprise us with; we have here flowers that are generally rather sober in colouring, and that are in many cases produced singly; or when more than one occurs on a stem, the spike is few-flowered. But as every genus has what may be called its accidental characters, by means of which it is identified without the aid of a botanical analysis, we may allow all this to pass in order to take note of the structural peculiarities of these plants. Comparing them with other orchids, it will be observed that the lip is neither like a frill, nor a banner, nor a tongue, nor a hood; but it is folded so as

to form a pouch, and in some of the species the pouch so nearly resembles a shoe as to justify the popular likening of it to a "lady's slipper." This pouch-like labellum is an essential part of the organic construction, and is directly related to the fertilization of the ovary, as Mr. Darwin* has very clearly shown by his original and painstaking researches. In other words, were the pouch modified or removed, the whole plan of the flower, as respects the disposition of the reproductive organs, would need to be modified also, the mechanical relationships of the several parts being matters of necessity, and every minute detail fitting properly into a complicated scheme.

But let us glance at the construction in order to obtain some distinct idea of the nature of the demarcation which lends so peculiar an interest to the study of the ladies' slippers. The plan of an orchid is *ternary*, and it consists in all of fifteen elementary parts. That we cannot very easily trace these out in any orchid is owing to the fact that some of the parts are commonly confluent, or peculiarly modified, or extravagantly developed, or nearly suppressed. There are three *sepals*, and these are usually determinable, because usually nearly equal; three *petals*, one of which usually gives the flower its most interesting feature, being modified into what is termed the *labellum*, or lip. There are three *stamens*, only one of which is commonly developed, and this is confluent with the pistil forming the *column*. In *Cypripedium* alone do we find three stamens, and by the aid of this genus, therefore, we obtain a key to one of the life mysteries of this mysterious order. Yet here again ordinary eyesight is baffled, for only two stamens can be found in *Cypripedium*, and these are placed right and left of the column; the third is in the customary place between them, but being sterile is not recognised until we have made a careful study of the flower. There are three *pistils*, but these again are so modified as to require to be discovered in the mind ere they can be traced in the flower. They are, in the first place, united, and confluent with the stamen; the upper stigma is modified into the extraordinary organ called the *rostellum*, which ordinarily presents no likeness to a stigma at all; and the two lower stigmas are confluent, and appear as one, and this one occupies a central position below the anther, and is *the stigma* to which reference is made in descriptions, and to which special interest attaches in respect of the process of fertilization. Lastly, the ovary consists of three perfect *carpels*, stationed alternately with the stamens opposite the petals, and bearing the placentæ in their axes, and of three other pieces, destitute of placentæ, and eventually

* *The Various Contrivances by which British and Foreign Orchids are Fertilized by Insects.* By Charles Darwin, M.A., F.R.S., etc. Murray, 1862.

separating from them when the fruit is ripe. The frequency of composite organs, and the peculiar individualities of development of certain parts, especially of the petals and the lip, result in that endless variety of form which render the orchids so strangely attractive and fascinating to botanists, florists, and sight-seers, all of whom are not the less charmed by their beautiful colouring and their exquisite odours.

In *Cypripedium* there are several exceptions to the prevailing type of structure, as will be seen on reference to the plate of *C. Veitchianum*. The topmost piece, which may be likened to a banner, and the striated colouring of which is beautiful beyond all description, that piece is a sepal; where are the other two? They are conjoined, and form one, corresponding in position to the one already likened to a banner. Right and left of the centre are placed two petals, like a pair of wings, and in the centre is the third petal in the form of a pouch or slipper. The elder Darwin saw in this arrangement of parts, and especially in the swollen pouch and eye-like anthers of *C. calceolus*, a resemblance to a spider, and in the figure of the plant in the "Botanic Garden" a very spider-like aspect is given to it—in fact, a *little* exaggeration, perhaps, to justify the fancy embodied in the passage in which the flower is celebrated:—

"So where the humming-bird in Chili's bowers,
On murmuring pinions robs the pendant flowers;
Seeks where fine pores their dulcet balm distil,
And sucks the treasure with proboscis bill;
Fair CYPRIPEdia, with successful guile,
Knits her smooth brow, extinguishes her smile;
A spider's bloated paunch and jointed arms
Hide her fine form, and mask her blushing charms;
In ambush sly the mimic warrior lies.
And on quick wing the panting plunderer flies."

CANTO IV. 501—510.

That stress should be laid upon the exceptional character of the orchids under consideration will not surprise any who have read the masterly treatise of the living Darwin. He says, "Lindley's last and seventh tribe, including only one genus, *Cypripedium*, differs from all other orchids far more than any other two do from each other. An enormous amount of extinction must have swept away a multitude of intermediate forms, and left this single genus, now widely disseminated, as a record of a former and more simple state of the great orchidean order." *Cypripedium* is destitute of a rostellum, all three stigmas being fully developed, but confluent. The anther, which is present and fertile in other orchids, is here rudimentary, sterile, and appears as a shield-like projecting body deeply notched on its lower margin. The two fer-

tile anthers producing pollen grains, which are not united into waxy masses, nor tied together by elastic threads, nor furnished with a caudicle as in other orchids, but are immersed in, and coated by, viscid fluid, which is so glutinous that it can be drawn out into threads. "As the two anthers stand behind and above the lower convex surface of the stigma, it is impossible that the glutinous pollen can get to this, the fertile surface, without mechanical aid. An insect could reach the extremity of the labellum, or the toe of the slipper, through the longitudinal dorsal slit; but according to all analogy, the basal portion in front of the stigma would be the most attractive part. Now, as the flower is closed at one end, owing to the toe of the labellum being upturned, and as the dorsal surface of the stigma, together with the large shield-like rudimentary anther, almost close the basal part of the medial slit, two convenient passages alone are left for an insect to reach with its proboscis the lower part of the labellum—namely, directly over and close outside the two lateral anthers. If an insect were thus to act, and it could hardly act in any other way, it would infallibly get its proboscis smeared with the glutinous pollen, as I found occur with a bristle thus inserted. . . . Thus an insect would place either the flower's own pollen on to the stigma, or, flying away, would carry the pollen to another flower. . . . We thus see how important, or rather how necessary, for the fertilization of the plant is the curious slipper-like shape of the labellum in leading insects to insert their probosces by the lateral passages close to the anthers." Glutinous pollen grains, so peculiar to the *Cypripediums* that they alone possess them, are equally essential to this scheme of fertilization, and thus Mr. Darwin winds up by remarking, that "there is no superfluity in the means employed."

The cultivation of *Cypripediums* is, generally speaking, a most easy matter. Indeed *C. insigne* is the best of all plants for beginners in orchid culture, as it at once furnishes a key to many of the peculiarities of orchids, and adapts itself to various degrees of good and bad treatment. A shady position in a warm greenhouse, the soil to be a mixture of peat, loam, and silver-sand, and plenty of water in the season of its growth, are the conditions most conducive to its well-being. The stove kinds require only the ordinary treatment of what are called Indian orchids—that is, a temperature varying from a day maximum of 65° in winter to a day maximum of 90° in summer, and a night minimum of 60° in winter to a night minimum of 70° in summer, to be kept moist at all seasons, and when in active growth to have abundance of water. The hardy species are so difficult to grow that even in botanic gardens, and in places where all the resources of art and fortune are at com-

mand for the purpose, it is but seldom any of them are seen at all, or if seen are far from presenting such an appearance of health, and vigour, and beauty, as they are described as presenting when found growing wild. I wish to speak with all possible modesty on this subject; but having something to communicate, I shall endeavour to combine the results of experience with the results of thought in offering a code for the management of these rare plants. The first new light that dawned upon me in connection with this subject came from a collection of hardy orchids, that had been obtained with great care, and were planted out in a border consisting of a mixture of peat, leaf-mould, loam, and nodules of chalk. They had the usual care, and made the usual return, some doing well, but the majority making but a sorry figure. Still the collection was kept up by supplying with new plants the places of those that perished; and in due time I was laid by through a long and severe attack of tic, and as the collection of hardy orchids was looked upon with contempt by all in the place except myself, the bed became a mass of weeds; and though it was scarcely possible to find the places of any of them by their leaves, which were mixed with much rough herbage, their flowers surpassed in strength, and abundance, and beauty, everything of the kind I had ever seen before. I began to reflect upon this, and soon came to the conclusion that as they invariably grow amongst grasses, sedges, patches of *Narthecium*, etc., etc., in their native wilds, so, when brought into the garden, they should be similarly accompanied. No doubt our customary mode of keeping the beds clean exposes these plants to an undue amount of evaporation, which is exhaustive to them, and deprives them of a share in that condensation of dew which goes on all night long where innumerable living vegetable sprays are associated together, each spray distilling its nutrient drop from the generous atmosphere. I thenceforth sought for suitable plants to "surface" the beds where the orchids were planted, and I never found any to surpass *Festuca ovina*, which rejoices in the same soil as an orchid bed should consist of, and is both elegant, appropriate, and marvellously active in the condensation of dew and its conveyance to the earth by means of its wiry leaves; equally useful for small growing kinds, such as *Gymnadenia*, *Ophrys*, *Habenaria*, etc., etc., is the neat mossy herbage of *Spergula saginoides*, or of *Saxifraga hypnoides*; and to make an end of this part of the disquisition, it may be said that hardy orchids should always be grown in the midst of herbage of some sort, and the best way to accomplish it is to select plants that are suitable in habit, and at the same time worthy to be associated with such beautiful subjects. Shade, moisture, and protection in winter, are points of some impor-

tance, but given the herbage, nearly all the difficulties of orchid-growing come to an end.

Among the hardy species the first, without doubt, is *C. spectabile*, with its huge, finely-formed, rosy-purple lip. Next to this we may place *C. calceolus*, which is still to be met with in certain spots in the county of Durham known to a few, and who happily have sufficient caution to abstain from publication of the names of the localities. *C. acaule*, with the lip split into two equal lobes, is both interesting and pretty.

Among the species requiring to be cultivated in the stove, *C. Schlimii* is at once rare and exquisitely beautiful. It produces spikes of five to eight flowers each, the sepals and petals are white and green, the lip mottled and striped with rose on a white ground; *C. barbatum*, and its varieties; *C. Veitchianum*, so superbly striped; *C. caudatum*, *C. lævigatum* and *C. Stonei*, are the finest of the "tailed" series; in these the petals are prolonged, so as to present, with the help of a little fancy, a resemblance to mustachios set on each side of a gaping mouth and extravagant chin—a burlesque altogether of humanity. *C. insigne* is beautiful, and as it does not need stove heat, is useful to persons who grow orchids in cool houses. *C. villosum*, *purpuratum*, *Farrieanum*, and *hirsutissimum* are essential in a collection. The last is indeed a remarkable species, producing flowers of great size. *C. concolor* is notable for the beauty of its variegated foliage; the flowers are yellow, with chocolate spots. If we halt here, it is not because the subject is exhausted, but because we cannot afford more space, even for any more of such elementary and superficial particulars as have been hazarded already.

HYPOTHETICAL CONTINENTS.

BY H. M. JENKINS, F.G.S.

THE present surface of the globe has admitted of division into several marine and terrestrial regions, each characterized by its inhabitants possessing, as a whole, more or less distinctive features; just as, on the principle of nationalities, we might divide Europe, Asia, and Africa into several natural kingdoms. This division has involved no theoretical considerations of any importance, and it is only when an attempt is made to explain the *origin* of the inhabitants of any particular area that the naturalist ventures to step beyond the region of unyielding facts, and addresses himself to the more pliant province of hypothesis. The palæontologist, also, frequently seeks to trace the origin of ancient faunas and floras, and finds assistance in comparing the population* of bygone periods with that now peopling the earth's surface in the same, or neighbouring, or distant areas. And as, in searching for the origin of things, we must necessarily go back to some previous period, his palæontological knowledge specially fits him for the task, on account of his being acquainted with those facts, the ignorance of which not unfrequently forces the student of recent nature into the wilderness of pure hypothesis, or even imagination.

Two theories are prevalent respecting the origin of organic beings in particular areas. The first of these is that the fauna and flora of each great area possess, as a whole, certain distinguishing characteristics which belong to that district alone, and have never been disseminated through other regions; and that the species composing the population of that area have been *created* from time to time, probably as representative species died out. The opposing theory is that of the derivative origin of every group of organisms, whether species, genus, etc.; in other words, that each species is the modified descendant of some other species of the same genus, until the successive modifications cause so wide a divergence from the type, that a modified form transgresses the conventional circle which we draw round the generic type, and thus causes us to refer it to another genus.

It is quite obvious that if the first theory be true, any attempt to trace the origin of the present and past faunas and floras must necessarily be completely futile; for have we not their origin sufficiently elucidated in the dogma that "they

* The use of the terms "population," "peopling," etc., is in this paper restricted to the animal and vegetable "population," and is not meant to include man.

were created on the spot"? How utterly aimless, then, is palæontology, reduced in this way to a leviathan catalogue of fossils!

It will, therefore, be necessary for me to assume as a postulate the truth of the doctrine of the derivative origin of species; but it is not my intention here to adduce any facts or arguments in its favour, or respecting the causes which have conspired to produce the necessary modification; it is enough for my purpose to mention that compulsory wandering, or "migration," as it is termed, is one of them, and the one that most concerns the subject of this article.

Granting the postulate I have mentioned, the palæontologist can frequently infer—with greater or less probability of its truth, according to the state of our knowledge on the subject—whence came the progenitors of any particular assemblage of animals and plants. In the case of marine organisms he can also indicate, by reference to the position of geological formations of the period, the route by which the ancient ancestors travelled from their own habitation to that of their more recent descendants; in fact, it is chiefly where terrestrial life is concerned that he meets with any serious difficulty, and then generally as to the route.

During the tertiary period, and probably through all geological time, organic life was subject to similar laws of distribution as at present, and as climatal, hydrographic, and other physical conditions changed, a corresponding alteration was produced in the faunas and floras of the regions affected. We may therefore consider that migration and emigration of animals and plants were as constantly taking place as elevations and depressions of the land.

During their wanderings the specific features of organisms became more or less changed; weak and tender species dying off or becoming modified, new forms thus coming in, and varieties of old ones being formed, and the representatives of the various faunas becoming entombed at their death in the localities where they had severally existed. Now the palæontologist has to contemplate the results of these changes and migrations; he has to "try back," and decipher step by step the order of proceeding, and to write a history of the life of each period—not a mere catalogue of names and list of peculiarities, like the foreign consular passports, but an intelligent record of the wanderings and fortunes, ancestors and descendants, of the different faunas, and even species, with which he has to deal.

As a few out of many known examples of the evidence of changes which palæontology has revealed to us, I may cite the correspondence in facies between the recent American flora

and the plants of American eocene deposits and of European (notably Swiss) miocene; between the shells of the Faluns and those which are now found in eastern seas; between the eocene mammals of Europe and the existing tapirs of South America; and, finally, between the eocene plants of Europe and the existing flora of Australia. Many other examples might be given, but we have selected these as specially bearing on the subject of this article. There are also instances of "isolated faunas," such as those of Australia and Madagascar, which present some very curious differences from the animal population of the nearest continents.

Now "hypothetical continents," the term I have chosen as the title of this article, have been invoked to account for both classes of phenomena, and in the following pages I shall endeavour to investigate the probability of their furnishing the true explanation of the facts in each case.

Of these "hypothetical continents," the most celebrated is the Atlantis, partly on account of its having been the first proposed to explain a natural history difficulty, and partly on account of its name and position giving it an appearance of truth, by resolving an ancient legend into a scientific fact. This great continent, or "sunken island," was used by Professor Unger to account for the similarity of the miocene flora of Europe to the recent flora of America; it has formed the subject of several essays by distinguished botanists and geologists, and has been popularly illustrated on more than one occasion;* its prominent features are therefore tolerably well-known.

A less known theory of Professor Unger's is that of a complete land-connection between Europe and Australia during the eocene period, an idea suggested by the affinity of the majority of European eocene plants to those now living in Australia, the remainder belonging to genera now exclusively Asiatic.†

A third theory is Dr. Sclater's hypothetical continent, "Lemuria," stretching from Hindostan through Madagascar to the West Indies.‡ Dr. Sclater believes that this continent must have existed on account of the affinity of some of the curious mammals of Madagascar to some now living in India, and to others existing in the West Indies; and on account of the entire distinctness of the Madagascarian from the South-African mammalian fauna.

Now these theories depend upon the principle that the

* See especially *Journal of Botany*, No. 25, January, 1865, p. 12; Lyell's *Elements*, sixth edition, p. 265; and *Natural History Review*, 1862, p. 149.

† *New Holland in Europa*, and *Journal of Botany*, No. 26, February, 1865.

‡ *Quarterly Journal of Science*, vol. i. No. 2, p. 213, 1864.

affinity of certain animals, or of certain plants, implies their common origin, and in the case of terrestrial organisms, an almost if not a quite continuous land-connection between the habitats of the allied organisms. This principle is perfectly sound, according to my notions, and of infinite value in palæontological reasoning; but the upheaval of these various hypothetical continents is by no means the only way of explaining known phenomena in accordance with it. It therefore seems reasonable to expect some physical evidence in confirmation of their former existence, and unless this evidence is forthcoming I should much prefer another explanation if supported in that way.

I shall now endeavour to make clear an explanation of the phenomena which have hitherto required the aid of an Atlantis and a Lemuria, treating them as belonging to one category. This hypothesis will also explain certain facts requiring elucidation by any theory framed to account for the peculiarities of the Swiss miocene flora, and will, I hope to be able to show, accord with others which have, apparently, no necessary connection with the subject.

I have stated that the Atlantis theory was founded on the similarity of the miocene flora of Europe to the recent flora of America. According to Dr. Oswald Heer, 186 species of miocene Swiss plants have their nearest allies living in the United States, 40 in tropical America, 6 in Chile, 58 in Central Europe, 79 in the Mediterranean region, 108 in Asia, 25 in the Atlantic Islands, 26 in the rest of Africa, and 24 in Australia. This analysis, by a strenuous and able advocate of the Atlantis theory, shows that there are other facts to be explained besides the preponderance of American types. Dr. Asa Gray, therefore suggested that the plants had travelled by way of Japan, Northern Asia, and Asia Minor to Europe, instead of across the Atlantic over a great island-continent, and this theory has been received with great favour by geologists like Sir Charles Lyell, and botanists like Professor Oliver. The latter gentleman, indeed, has ably seconded Professor Asa Gray in attempting to show that the plants travelled by the longer rather than the shorter route, and in comparatively high latitudes.* It will be unnecessary for me to do more than mention some of the chief features of his analysis of the three recent floras, namely, of Europe, Japan, and the Southern United States, in so far as they are allied to the Swiss miocene flora.

Of the miocene plants of Switzerland there are 76 genera common to the recent flora of Europe, 88 to that of the Southern United States, 77 to that of Japan, and 123 which occur in the united floras of Europe and Asia. The 77 genera

* *Nat. Hist. Review*, 1862, p. 149.

common to Japan include 26 not recent in Europe, and several of these are eminently characteristic tertiary types. Taking the orders of the Swiss miocene plants, 73 are common to the Southern United States, and 71 to Japan; but while 6 of the largest Japanese orders are represented in the Swiss miocene, there are only 4 of the largest American. The inference therefore appears natural and legitimate that the larger the group which is taken as the basis of the comparison, the smaller is the preponderance of American types; and considering the nature of many so-called species of fossil plants this fact has a remarkable significance. Professor Oliver also uses as a basis of comparison the proportion of ligneous species in each flora, and he finds that while about 40 per cent. of the Japanese flowering plants are ligneous, only about 22 per cent. of the American come into that category. The proportion of ligneous species in the Swiss miocene flora is even larger than in the Japanese, amounting to 60 per cent., and the former therefore corresponds more closely in this respect with the latter than with the flora of the Southern United States.

The foregoing facts seem to render reasonable the expectation that the true explanation of the affinity of the Swiss miocene plants to those of the Southern United States should, at the same time, account for its correspondence with that of Japan, and for the occurrence of allies of other species in different parts of the world. The Atlantis hypothesis does not answer this expectation; but a modification of the theory of an Asiatic route does. On natural history grounds, therefore, we should prefer the latter.

Another consideration to which I must direct attention, is the direction in which the migration took place. Hitherto it has been taken for granted, that the migration was *from* America to Europe during the miocene period, that is to say, the American flora being stationary, it spread during the miocene period as far as Europe. The Ex-President of the Geological Society, Mr. W. J. Hamilton, is, I believe, the only geologist who has ventured to dispute this assumption, and he has characterized the idea of a recent flora migrating to an ancient as a physical impossibility.*

I have just stated the assumption rather differently, and, put in that way, it does not seem impossible; still, I venture to support Mr. Hamilton's view, that the Swiss miocene plants emigrated towards America, and that during the emigration, many became dispersed to other regions; but, at the same time, I believe, on palæontological grounds, that they came from that continent at an earlier period.

In any area undergoing great physical changes, such as

* *Quarterly Journal of the Geological Society*, vol. xxi. p. 94.

Europe underwent during the tertiary period, there must also be great changes taking place in its fauna and flora. Consequently we find that the eocene flora of Europe is largely Australian in its character,* that the miocene flora is largely American and Japanese, and that the miocene shells are largely East Indian.† Respecting this last character, I have shown that the only legitimate inference to be drawn from it, is that the mollusca emigrated from Europe in a south-easterly direction; and this conclusion is borne out by the fact, that some still exist in the Mediterranean and Red Seas, having been left behind by the less hardy species, for the emigration was no doubt chiefly the result of the climate having become colder, in consequence of physical changes. This cooling of the climate of Europe began towards the close of the eocene period, for while the eocene fauna and flora were purely tropical, the miocene were scarcely more than subtropical, and the pliocene hardly more than temperate in some regions and much colder in others.

It is worth remarking, that the emigration of animals and plants from Europe seems to have taken place more constantly towards the east than in an opposite direction; witness, for instance, the affinity of the Australian mammals to those of our oolitic rocks, the affinity of the eocene European plants to the Australian recent, and the likeness of the European miocene flora to the recent American and Japanese. The tertiary character of the American cretaceous plants is notorious, as is the miocene (European) and recent (American) character of the eocene flora of that continent; I believe, therefore, that our miocene plants came from America during the eocene period, and that their progenitors were the plants of the eocene and cretaceous periods in America, from which have also descended the recent flora of that continent.

If these views be admitted, the large number of Swiss miocene species represented in America is naturally explained, for the American plants had a double chance of preserving their likeness to their descendants. Again, if the present flora of America (or that from which it has descended), has existed on that continent ever since the cretaceous period, we ought to find the remains of it imbedded in leaf-bearing strata of all succeeding periods in America, if such deposits exist. At present, this crucial test is not available for periods later than the eocene; but the evidence at our command bears out, as we have seen, the views I am advocating.

* Ettingshausen—*Ueber die Entdeckung des Neuholländischen Charakters der Eocenflora Europás*, 1862. Unger—*New Holland in Europa, and Journal of Botany*, No. 26.

† See *Quarterly Journal of the Geological Society*, vol. xx. p. 63.

At present, the miocene Atlantis theory has received no confirmation from students of physical geology; we have no evidence of such vast changes in the physical features of the Atlantic having taken place since so recent a date as the miocene.* On the other hand, the modifications of it which I have just enunciated are well sustained by known geological, as well as palæontological data.

In studying the distribution of the cretaceous and nummulitic strata of the Old World, one cannot avoid remarking their persistent east and west extension, in temperate and northern sub-tropical regions. We thus find them occurring in southern Europe from Portugal to the Black Sea; and, in Asia, from Asia Minor as far east as geological researches have been made. These and other facts, especially the east and west direction of the lines of volcanic disturbance of the same periods, induced Mr. Searles Wood, jun., to promulgate, in 1862,† his view of a land-connection between America and the then existing Europeo-Asiatic continents at the close of the cretaceous period and the dawn of the tertiary. We have seen that this hypothesis accords remarkably well with one section of the palæontological facts which it is our endeavour to explain; it now remains for me to show that other phenomena can likewise be explained by the same theory.

I have already stated, in general terms, the grounds on which Dr. Sclater was led to promulgate his theory of the ancient continent Lemuria. As instances of the peculiarities in the fauna of Madagascar, sought to be accounted for by this "hypothetical continent," I may mention, quoting Dr. Sclater,‡ that the Insectivora of that island are most nearly allied to the American genus *Solenodon*; that the frugivorous bats of Madagascar belong to the Indian section of the group, and not to the African; and that certain American forms of serpents and of insects are also found in Madagascar, while the characteristic members of the African fauna are entirely absent from the island. Dr. Sclater also states that the lemurs of Africa are abnormal when compared with those of Madagascar; but that those of India appear to form in some respects an intermediate group. The theory he has proposed, does therefore account for the facts he wished to explain; but the question to be solved is its admissibility on other grounds.

In the proceedings of the Zoological Society for 1863, Mr. H. W. Bates gave an analysis of the affinities of eleven families of the coleoptera and lepidoptera of Madagascar, and referred also to Dr. Hartlaub's analysis of the birds. The general

* See Lyell's *Elements*, 6th Edition, p. 267.

† *Phil. Mag.*, 4th Ser., vol. xxiii. p. 277.

‡ *Quarterly Journal of Science*, No. 2, pp. 213, *et seq.*

result is the same as that arrived at from a consideration of other classes of animals, namely, that there exists a large number of genera and species peculiar to the island, certain others common to it and to Africa, some allied to Asiatic types, and a few having tropical American affinities. The proportions differ, of course, in the different classes, owing to a difference in the powers of locomotion and other causes.

Dr. Hartlaub had previously hinted at the connection of Madagascar with South-Eastern Asia, rather than with Africa; but Mr. Bates rightly observed that if the Asiatic element justifies such a conclusion, the American ought also to be taken into account. This suggestion, as we have seen, has since received its complete development at the hands of Dr. Sclater.

Mr. Bates's own idea is "that the island (whether previously stocked with anti-African forms or not) was at one time much more closely connected with Africa than it now is, and that the time of connection was anterior to the date when the continent became peopled by *Simiidae*, and the bulk of its present mammalia; but posterior to the introduction of lemurs." With this opinion I entirely agree.

Palæontology is not yet in a position to furnish us with any complete evidence on the question; but some few facts are known which seem to bear on it. The mammalia which existed in eocene and miocene times include forms, such as *Didelphis*, that are now restricted almost entirely to America, with others now South African and Asiatic in their affinities; but these types, geographically distant at the present day, have a very striking stratigraphical distribution in the tertiary deposits of Europe. As examples I may quote the following: In the eocene strata we have the genus *Chæropotamus* most nearly allied to the peccari of America; a species *Didelphis*, the opossums being now confined to that continent; and such genera as *Coryphodon*, *Pliolophus*, *Hyracotherium*, *Palæotherium*, *Lophiodon*, *Anoplotherium*, etc., all tapiroid pachyderms more or less allied to the tapirs of South America.

Miocene deposits have also furnished the remains of some interesting mammalia. I may especially quote two genera of old-world monkeys from Eppelsheim, named respectively *Pliopithecus* and *Dryopithecus*, so that here we get the first indication of true eastern types. The *Macrotherium*, a gigantic sloth allied to the old-world genus *Manis* was also obtained from the same deposit. The genus *Dinotherium*, a miocene ally of the tapirs, has hitherto been recognized only in strata of that period; but great interest is attached to it from its having been obtained from a locality so far east as the Gulf of Cambay. The genus *Mastodon*, which appeared first in miocene times, has

a still greater geographical range, several species of it having been obtained from both hemispheres.

Unfortunately no species of lemur has yet been discovered in the fossil state, although it is in accordance with all analogy to infer that they existed during the tertiary period.* New-world monkeys of pliocene age have been found in South America, but not elsewhere; and old-world monkeys have been found in Europe, as we have seen, and in Asia in miocene and more recent deposits. So far as we know, therefore, new-world monkeys never have existed in the old world, nor old-world monkeys in the new; and we have no certain record of any quadrumana during the miocene period. Had the Atlantis existed during the miocene period, it would be strange to find the distinctive features in the distribution of the monkeys of the two hemispheres still preserved; but if the Atlantis was of eocene date—before monkeys lived on the existing continents—then the differences in the distribution and structure of the *Catarrhini* and *Platyrrhini* cease to be marvellous.

These facts show that it is possible to account for the American affinities of certain of the vertebrates of Madagascar by supposing their ancestors to have come to Europe from America by the eocene Atlantis, and to have travelled thence to India, Africa, and Madagascar at a later period. The affinities of the European tertiary insects are in favour of this view, which is also curiously confirmed by the fact that the lemurs, which are not known in the fossil state, are confined in the living state to the old world; and if they are ever discovered fossil, it probably will be in the eastern hemisphere; while most, if not all, of the Madagascanian animals having allies in the new world are known to have been represented, more or less closely, in eocene and miocene times.

There is no physical evidence in support of the hypothetical continent Lemuria, while, as we have seen, the eocene Atlantic continent was suggested by Mr. Searles Wood, junior, almost entirely on physical grounds. That India may have been connected at some not very remote period with the Mascarene Islands, Madagascar, and Africa, is, however, extremely probable. Such a connection no doubt existed when the *Glossopteris* flourished in South Africa, Central India, and Australia, and it may have continued to a comparatively recent period, or have been reproduced in tertiary times, or the connection may have been similar to what exists at present.

Our knowledge of the geology and palæontology of Mada-

* Prof. Rüttimeyer has announced the discovery of the remains of an eocene monkey allied to the lemurs; but although this fact would add considerably to the strength of my argument, caution forbids me to quote it until its truth has been placed beyond doubt.

gascar is so extremely scanty and indefinite that we cannot quote a single fact derived therefrom in support of either view; but doubtless future discoveries will prove the probability or the impossibility of the hypothesis I have here advocated. I will just venture to anticipate one element of uncertainty in future inquiries into this subject, namely, the probability of a great Pacific continent having formerly united the old and new worlds on that side, for we know that that great region is even now an area of depression. It seems probable, however, that this consideration would more nearly affect the relation which formerly existed between Australia and South America, than the regions which now concern us.

In the foregoing pages I have endeavoured to establish the following conclusions:—

1. That hypothetical continents belong to two categories; namely, first, those supported by physical evidence, and, second, those unsupported in that respect.

2. That while the miocene Atlantis and Lemuria come into the second category, the eocene Atlantis and the possible Pacific continent come into the first.

3. That the theory of a miocene Atlantis and that of Lemuria each explains only one portion of the palæontological facts that call for elucidation; while the theory of an eocene Atlantis explains the whole of the facts of both cases.

4. That for these reasons it is probable that the miocene fauna and flora of Europe came from America during the eocene period by way of the eocene Atlantis; and that since the miocene period they spread over Asia and Africa and the eastern seas, and that a part of the flora returned to America by way of Northern and Central Asia and Japan.

5. That the fact of American cretaceous and eocene plants uniformly occurring in older deposits than a European palæontologist would, *a priori*, consider possible,* is of itself a most remarkable confirmation of two theories; namely (1), that organisms have migrated from west to east (*e. g.*, from America to Europe in eocene times); and (2) that deposits in the old and new worlds should be treated as homotaxeous,† and not as contemporaneous.

* See Dana's *Manual of Geology*, p. 510.

† *Quarterly Journal, Geological Society*, Vol. xviii., p. 52; and *Quarterly Journal of Science*, Vol. ii., No. 8, p. 622.

THE PERSISTENCE OF LUMINOUS IMPRESSIONS.

BY THE ABBÉ LABORDE.

THE following paper is translated from *Comptes Rendus*, 16th July, 1866:—

“When a luminous point strikes the eye and suddenly disappears, the sensation which it produces does not become immediately extinct, and according to the researches of some physicists, it remains for about one-third of a second, from whence arises all the phenomena known and explained under the title of *persistent luminous impressions*.

“It occurred to me to inquire whether in white light all the component colours had the same degree of persistence, and to study this question I submitted the sensation of light to an experiment which revealed to me a very curious fact, which seems to demonstrate that in white light the most refrangible colours are more persistent than the others, and that they act in advance of the others, so that the organ of vision decomposes white light by dispersing its colours in different times, just as the prism decomposes it by dispersing in different places.

“I make this experiment: the light of the sun is received upon a mirror which throws it horizontally on to a slit made in the shutter of a dark chamber. This slit should be three millimetres* wide and six long. Close to this slit, inside the chamber, a disk of metal is placed, on the margin of which, similar slits are made, with wide interspaces between them. A clockwork movement turns the disk, and a clamp, which the observer can operate upon at a distance, allows the revolution to take place with greater or less velocity. In the line of the light rays, at a distance of about a metre, a screen of ground glass is placed, behind which the modifications of the light can be observed when the disk is in motion. At first the light is made to appear or disappear slowly, and is found uniformly white; but when the successive appearances are made to take place more rapidly, the margins begin to be tinted, and by progressively increasing the velocity, the surface of the image becomes successively affected by blue, green, rose, white, green, blue. After this last blue, increasing velocities restore the whiteness of the light.

“The whole of the phenomena depend, as will be seen, on the varying periods occupied by the revolutions of the disk.”

* In Darling's *Metric Tables* we find 3 mm = 0.118 of an inch.

M. Laborde does not give us any information on the rates of velocity which produce the different effects; but we apprehend those of our readers who wish to repeat his experiments will have little trouble in preparing the necessary apparatus, as the velocities required in the movement cannot be great.

GOSSIP ABOUT FISH.*

MR. COUCH'S great work on British Fishes has arrived punctually at its termination in the fourth and concluding volume, which contains no less than seventy-three beautifully executed coloured plates. The entire work is enriched by two hundred and fifty-two coloured plates and numerous woodcuts. The illustrations thus afforded by Mr. Couch are the more valuable from being, with very few exceptions, drawn by his own hand from *freshly* caught specimens, and thus they are characterized by a degree of fidelity rarely attained in natural history works. Another highly important and valuable peculiarity of Couch's *British Fishes* is the large amount of information which it affords concerning the habits of the creatures described. Some of the older naturalists, with considerable talent for observation, were not sufficiently careful in description, and hence it is often difficult, and sometimes impossible, to identify the objects of their research. Since their days a new school has grown up, very careful in descriptive accuracy, and, we might add, very careless as to modes of life, and relations of habit to structure, which really constitute the essence of natural history, properly so called. Those who write as Museum naturalists may add very valuably to the means of identifying species; but unless their labours are supplemented by the observation of the field naturalist, they eventuate in nothing better than a long catalogue of names. Inaccuracy of description destroys the worth of field labours, because it leaves in doubt to what particular creature they were directed; but accurate description is of little value until some observer of habit, or some deep-thinking tracer of structural relations, has built up the raw material thus afforded into something that may be fairly dignified with the name of science.

The different dispositions and capacities of men naturally cause them to view external objects, and especially living ones, from two distinct points of view. According to one, and the

* *A History of the Fishes of the British Islands*, by Jonathan Couch, F.L.S. 4 vols. Groombridge and Sons, 1862—1866. Vol. i., fifty-seven coloured plates; Vol. ii., sixty-three, ditto; Vol. iii., fifty-nine ditto; Vol. iv., seventy-three ditto, from drawings by the Author.

most popular, because the apparently simplest, method of observation and philosophizing, every animal, for example, is supposed to be gifted with a special structure, *in order* that it may live under particular conditions and perform particular acts. According to another method of reasoning, the structure is the result of general laws operating under special conditions, and each animal belongs to a group, the whole of which must be studied before the individuals composing it can be understood; while the entire group has definite relations to other groups, and so on throughout the whole round of nature, which forms one great unity, in which Creative will and intelligence are displayed in conformity with an all-comprehending plan. Which ever mode of reasoning the tendencies of particular minds may lead them to adopt, the relation of habit to structure, or of structure to habit, is equally important; the difference being that the more philosophical and wider of the two systems give a proportionately ampler signification to every fact that is ascertained.

The fish, the reptile, and the bird, at first sight so different in appearance, and so apparently separated by a great gulf in structure as well as in habit, are found to grow nearer to each other the better they are understood.

Professor Huxley divides the vertebrate animals into three ascending groups; (I.) the *Ichthyoids*, comprising fishes and amphibia, defined by the presence of branchiæ or gills at some period of existence, nucleated blood corpuscles, and certain other peculiarities; (II.) the *Sauroids*, which have no branchiæ or gills at any period of their existence, nucleated blood corpuscles, certain peculiarities in the skull, and other structures, and which comprise reptiles and birds; and (III.) the mammalia.*

It is by tracing points of resemblance of too technically anatomical a character to be referred to in detail in this place, that Professor Huxley expresses the decision of comparative anatomists, when he speaks of the class of birds as "an ex-

* The passage stands as follows:—"The vertebrata are capable of being grouped into three provinces: (I.) The ichthyoids (comprising fishes and *amphibia*) defined by the presence of branchiæ at some period of existence, the absence of an amnion, the absence or rudimentary development of an allantois, nucleated blood corpuscles, and a parasphenoid in the skull. (II.) The sauroids defined by the absence of branchiæ at all periods of existence, the presence of a well-developed amnion and allantois, a single occipital condyle, a complex mandibular ramus articulated to the skull by a quadrate bone, nucleated blood corpuscles, and no parasphenoid, comprising reptiles and birds; and (III.) the mammals devoid of branchiæ, and with an amnion and an allantois; but with two occipital condyles and no parasphenoid; a simple mandibular ramus articulated with the squamosal and not with the quadratum with mammary glands, and with red non-nucleated blood corpuscles."—*Elements of Comp. Anat.*, p. 74.

tremely modified and aberrant reptile type ;” and if the general reader will take for granted the connection between reptiles and birds, he will have no difficulty, from a slight knowledge of frogs in their tadpole and gill-breathing state, in carrying the argument further, and connecting reptiles, through the amphibia, with fish.

These considerations will serve to show that the fish are not so distinct and essentially different from other creatures as might have been supposed. The peculiarity of their abode marks them out with a certain conspicuous breadth of divergence ; but several fishes can live for a time on dry land, and do so occasionally, by choice, while the whales represent mammalian life in the water, and the amphibia show how, at different stages of existence, the same animal may comport itself as a land reptile or as a fish.

From a survey of Mr. Couch’s work, it becomes evident that the British coasts supply the naturalist with a great variety of species of fish, some occurring constantly in vast multitudes, and others, if not permanent inhabitants, visiting us sufficiently often to reward the attention of those who live near the sea.

The first volume of Mr. Couch’s work discourses of the sharks and rays which belong to us or visit us, and concludes with delineations of sturgeons, sticklebacks, perches, basses, etc. The second volume contains, among other fishes, the gurnards, to which additional interest has been excited by recent researches into their capacity for producing vocal sounds. Mr. Couch gives sketches of several of their air-bladders, which are concerned in their vocal utterances. In the case of the piper (*Trigla lyra*), he says, “Several of the fishes of this genus are known to utter obscure grunting sounds when newly taken out of the water, and they continue them at intervals as long as they are alive.” And, when speaking of the common gurnard (*Cuculus griseus*), he mentions its social habits, and tells us that “sometimes, in the fine weather of summer, they will assemble together in large numbers, and mount to the surface, over deep water, with no other apparent object than the enjoyment of the season ; and, when thus aloft, they move along at a slow pace, and rising and sinking in the water for short distances, and uttering a short grunt as if in self-gratification.” In fact, they have a sort of musical water-party ; and, possibly, if they heard some of the bipeds singing, they might not speak of the performance more respectfully than Mr. Couch does of theirs when he calls it “a short grunt.” These assemblies of gurnards, and other gatherings of certain fishes that might be adduced, certainly indicate the presence of a social instinct much more distinctly

than the progress of many fish in shoals, which may result from a community of impulse, quite distinct from companionable qualities.

In Mr. Couch's third volume, comprehending mullets, wrasses, rocklings, flounders, soles, etc., we find many illustrations of greater mental powers than fish are usually imagined to possess. Thus, the grey mullet is singularly watchful against restraint, and tries to leap over obstacles in preference to passing through them. Mr. Couch says, "In the port of Looe, in Cornwall, there is a salt-water mill-pool of thirteen acres, that is enclosed on the side of the river by an embankment, and into which the tide flows through flood-gates that afford a ready passage for fish to the space within. When the tide begins to ebb, the gates close of themselves; but even before this has happened, the mullets which have entered have been known to pass along the enclosed circuit within the bank, as if seeking the means of deliverance, and, finding no outlet, they have thrown themselves on the bank at the side, to their own destruction." Mr. Couch adds, all writers agree in ascribing to this fish great quickness of hearing, and it has even been supposed that it is capable of the perception of particular sounds. The Cornish historian, Carew, had formed a pond on a branch of the Tamar, in which mullets were fed at regular periods, and they were drawn together to the appointed spot at the sound made by the chopping of their food.

The carps (described in Mr. Couch's fourth volume), like the mullets, can be brought together by sounds intimating that their dinner is ready, and they seem to be fish of a highly intelligent character, with more than the usual fishy allowance of brain. "According to Professor Owen, the average proportion of the size of the brain to that of the body in fishes is one in three thousand; but in the carp, according to Blumenbach, it amounts to one in five hundred, which is the same as is found in the 'half-reasoning' elephant." Why the elephant should be called "*half-reasoning*" we never could understand, unless human vanity cannot bear the notion of ascribing reason to any other animal than man himself. Reasoning may be logically correct as far as it goes, and as far as the materials at its disposal allow it to go, and then it is as much *whole* reasoning in a fish as in a Newton, though the results may be less grand. The disciples of old Izaak are well acquainted with the cleverness of the carp, and when we regard him as a highly-organized specimen of the finny tribe, it is the more remarkable to find that he may—to use a Paddyism—be frozen to death, and yet come to life again.

Sir J. Franklin, cited by Mr. Couch, is the authority for this statement. He says that in his voyage to the Polar Sea,

“the fish caught in their nets became so frozen that in a short time they formed a solid mass of ice; and by a blow or two of the hatchet they were easily split open, so that their entrails might be removed in one lump. But if in this frozen state they were thawed before the fire they recovered their animation. This was particularly the case with the carp, and he has seen a carp so completely restored after being frozen for thirty-six hours as to leap about with much vigour.” Mr. Couch alludes to experiments of John Hunter, which had an opposite result, as the carp which he subjected to a freezing mixture was killed; and he observes, “if we are to suppose that the fish frozen by Sir J. Franklin were of the same time species as those of Hunter, the only explanation of the difference of result will be that the suddenness of the operation in the north prevented that exhaustion of vitality which was fatal in the other.” We are also told that carp can be kept alive for weeks in a cool cellar, if the body is kept moist and appropriate food supplied.

The minnows seem to possess their full share of piscine mother wit and natural politeness. When they have discovered some dead animal substance, “they arrange themselves in the form of a ring, which has been compared to that formed by the petals of a flower, with their heads lower than the level of their bodies, and in this situation no one jostles another. But however peaceable among themselves, the circle must not be broken into by a stranger, for on the approach of such, the most powerful of the company will quit his station to drive him away, while his place is kept vacant by his companions until his return to the feast.”

Fishes with filaments hanging from their heads have usually keen sensations of touch, and some species seem equally remarkable for fine scent, if, indeed, the fish sense residing in the nostrils be not a sort of taste. Thus Mr. Couch informs us that the loach has been seen to follow his food by scent, so as to have discovered it “when intentionally concealed from the mere influence of sight and feeling.” With reference to fish hearing, Mr. Couch states that a shoal of pilchards have been known to sink and disappoint the fishermen at the firing of a heavy gun twenty miles off.

Many curious instances will be found in Mr. Couch’s fourth volume of the skill evinced by the eel in surmounting obstacles in his migrations. It appears that he gets up rocks, climbs gate-posts in canals, and, as is generally known, occasionally takes a walk in the fields. “It is said to have been known to devour newly-sown green peas in a garden, and I have been credibly assured that one was found in a field of turnips at the distance of a quarter of a mile from a river.” An eel keeps one

of his five senses, that of touch, in his *tail*, and Dr. Marshall Hall discovered a sort of supplementary heart in that curious situation, and he noticed that "the vessels which issue from the caudal heart appears to have a particular distribution to the spinal marrow." The vertebræ of the tail allow of great flexibility. Thus, they not only use their tails to collect information by their superior sense of feeling, but also as bands to grasp any object round which they can be twined. The conger eel uses his tail in the same way. "When taken on board a boat, and left undisturbed, the sensitive powers of its tail are employed in searching out the nature and limits of its prison, and then this organ is stretched out to lay hold of the gunwhale, by fixing its hold fast on which a reversed muscular action is put in force, and the whole body is turned overboard." A small blow at the root of the tail disables the creature.

Among the curiosities of the fish world which attract the constant attention of visitors to the aquarium-room in the Zoological Gardens are the pipe-fish, remarkable for their slender, worm-like bodies, elongated snouts, and the exquisite motions of their dorsal fins. These creatures are no less remarkable for their domestic habits, as the males perform the functions of nurses—*dry* we cannot say, considering the watery situation in which the duty is discharged. The greater pipe-fish and the red-nosed pipe-fish are, like kangaroos, marsupial animals so far as the males are concerned. Mrs. Pipe-fish hands her eggs over to the male, who puts them in his pocket, and hatches them in due time. The slit, opening into the pouch, is closed by adhesion of its lips, and opens again when the time has arrived for the infants to get out and see a little more of the world. The males of the ocean pipe-fish (and some others) having no pockets, carry the eggs about cemented to the abdomen. Concerning the snake pipe-fishes, Mr. Couch says, "When on our coast their actions are amusing, as with their slender and prehensile tails they lay hold of some loose and floating object, with the aid of which, and the anterior portion of the body free, they steer their wandering course by the wavy action of the dorsal fin."

Little is known concerning the sleep of fishes. Mr. Couch supposes that some of them go to sleep, if we so phrase it, a piece at a time—that is, that certain portions of the brain rest while others remain at work. He thinks the pike may be asleep when he lies so quiet and stupid as to be caught by having a wire noose laid over his nose; and that great monster, the sun-fish, may be "enjoying a snooze" when it is found lying on the surface of the water, and allows itself to be seized. The shape of this fish is very queer. It is a sort of blunt oval, very obtuse at the tail end, at which it is furnished with two

great spear-shaped fins. If awakened from its slumbers, its usual mode of escape is along the surface of the water with great swiftness, so that, in a case which Mr. Couch mentions, a rowing boat could not overtake it. Mr. Couch gives a beautiful figure of it, and informs us that when seen shining in the water, it is found to merit its sunny name. Our readers will remember its portrait, drawn in a former number, to illustrate its capacities for playing the part of host to some of Dr. Cobbold's vermicular pets.*

Among the queerest of queer fishes are the lampreys. They are of worm-like form, with soft bones, and mouths rather vertical than horizontal, which can be expanded, and act as sucking disks. The sea-lamprey is often found tightly adhering by its sucker mouth to a ship, and it has been supposed by some that it mistakes the sides of the vessel for something good to eat; while others consider that, without studying Bishop Berkeley, it has a high opinion of the virtues of tar, and adheres to the ship for the sake of that substance. The sea-lamprey is described by Mr. Couch as dining off its fellow-creatures after a fashion more skilful than kind. "The whole of the interior arch of the mouth is studded with regular rows of teeth, each one of which, on a broad base, is furnished with one or two apparently reversed points; and the teeth which are the most distant and concealed are larger than the others, and more effectually crowded with these points. For simply biting, as in other fishes, they are useless; but when the breadth of the open mouth is brought into contact with the surface of a fish on which the lamprey has laid hold, by producing a vacuum, these roughly-pointed teeth are brought forward in a manner to be able to act on it by a circular motion, and a limited space on the skin of the captive prey is thus rasped into a pulp and swallowed, so that a hole is made which may, perhaps, penetrate to the bones." The victims of this singular "diner out" cannot succeed in throwing off their tormentor; but they seem to get well of their wounds, and are ready, like the Abyssinian cows, when one slice has been taken away, for their devourers to come again. A more amiable trait in the lamprey character is the aptitude for matrimonial felicity at the spawning season. Both sexes then combine to excavate a trench at the bottom of a river, in which their eggs are to be deposited, and when a stone of considerable size is in the way, the sucker-mouth seizes it, and it is thrust on one side. Stones of even ten or twelve pounds weight are said to be turned over by the zealous pair, who no doubt experience satisfaction in the performance of their task. The lamprey figures in heraldry, and is occasionally met with as a surname, though what resem-

* Vol. ii. p. 82.

blance our forefathers could have discovered between the man who first bore the appellation and the creature itself, history, as known to us, does not record.

As we come to the conclusion of Mr. Couch's work, we find ourselves passing out of the fish world altogether, through those singular transition links—the myxine, or borer, and the amphioxus, or lancelet. The myxine, Mr. Couch tells us, is scarcely rare in our northern waters, especially about Scarborough, and is no favourite with the fishermen, as it attacks the fish caught on their long lines as soon as they are dead. The myxine is worm-like in aspect, and breaths by means of little vesicles or chambers, the lining of which forms folds. The spine is a cartilaginous tube, and the nervous cords lie upon it unprotected by bone. This creature enters the bodies of larger fish through the gills when they are dead, and devours their muscular structure very much as the lamprey feeds.

Older naturalists took the myxine for a *worm*; and the lancelet, another of the lower fishes, was regarded as a *slug*. This very curious creature is of small size, the largest Mr. Couch has seen being two inches and three-tenths long, with a depth of about three-tenths of an inch, exclusive of the fins. Its gelatinous vertebral column exhibits separate joints; but it has no skull and very little brain. It has no true gills and no true heart.

In taking leave of the fishes, we strongly recommend those who wish to acquire a general knowledge of them in a very agreeable way to turn over the pages of Mr. Couch's splendidly illustrated volumes, and glance at his descriptions. For strangeness and variety of form and beauty of colouring, fish are not surpassed by any other animals, and we have no doubt Mr. Couch will tempt many to become real students of fish under his able guidance, whose original intention went no deeper than to amuse an hour by looking through his plates.

LARGE BRITISH OAKS.

MODERN discoveries have enlarged our notions on the size of trees as well as many other subjects, and it is now no longer a doubt that, in proportions of height and expansion, there are those both in the old and new world that can look down with dimensions of superiority upon our ancient standards, the cedars of Lebanon.

From time immemorial, the natives of the British Isles have justly boasted of their oaks; since the days of the Druids, who bore an identical name with them and abode beneath them, down to the present generation. The idea of them is associated with bulk, elevation, strength, durability, and stateliness: they are the monarchs of the forest. Until metal was substituted for wood, the universal testimony of ages concurred in assigning a decided preference to their employment in the most important services. To them, under Divine Providence, has been ascribed not only the feeling, but the actual existence of that national security that England has enjoyed from her "wooden walls." Iron, it is true, has recently waged war against oak in several ways—in the construction of our dwellings, as well as of those floating habitations or castles that, under various forms, have been applied, in conjunction with steam, to the circulation of commercial enterprise as well as to the protection of our shores.

Leaving speculation, however, and coming to matter of fact, while we consign the discussion of the *genus Quercus*, and the relative merits of its different species to the naturalist, and the comparative growth of other trees in other regions to the traveller, let us descend to some notable proof of what the English oak is capable of producing for our use, in justification of the ground of a preference cherished for a time, "whereof the memory of man runneth not to the contrary."

What has been remarked of the cow among the "beasts of the field," that it contains no part or property, living or dead, that is not in some way or other convertible to the use of man, may, with little exception, be fairly predicated of the oak among "the trees of the forest." Shelter and shade, and the acorn while living; bark, fuel, and material of the best and most enduring quality when the axe has laid it low. Whatever of it is undecayed is applicable to useful purposes. The term *materies*, by which the Romans designated timber in general, is eminently descriptive of the product of this noble and valuable gift of the Creator to man.

Of the particular value, variety, and extent of its application some notion may be formed by the selection, among

many others that might be made, of two striking examples. They consist of trees that grew in the county of Monmouth, a part of this island so abounding in them for ages that, even at a late period, they obtained the appellation of "the weed of the soil." Diminished in size and number by thinning out, and the facility of removal through railroad accommodation, they still flourish innumerable amidst the hills and valleys of that beautifully diversified region. Specimens, both here and elsewhere, may no doubt be found upon record that may have exceeded the largest to which we are referring; but they both appear so remarkable, on account of the ends to which they were applied, that they deserve to be rescued from oblivion. The first and smaller of the two was called

THE BRYNGWYN OAK.

Bryngwyn (signifying the White Hill) is a term of frequent occurrence in Wales and on the borders. In this case, the estate on which this tree was felled, in 1791, is near Raglan, and was then the property of William Morgan, Esq. Its price was forty guineas, and its dimensions and various distributions on dissection were thus minutely described by the purchaser:—

Bark, 3 tons, 17 cwt., 2 qrs.
Cordwood, 31 cords, 3 qrs.

Cooper's timber, from slabs, etc.

84 hogshead staves.
67 barrel staves.
106 kilderkin staves.
256 cooper's ends,
28 hogshead heads.
38 barrel heads.
49 kilderkin heads.

	FEET.
Butt-piece 31 feet long, when sided to upper piece of stem	330
From the two slabs, 216 feet of knees, sided square from the angle	216
1 branch, 29 feet long, siding 17 inches	58
1 ditto 24 ditto by 19	60
1 ditto 19 ditto by 17	38
13 sided knees	217
When converted	919

In the square state.		FEET.
One piece growing from the side, about 12 feet from the ground, squared in nine pieces		106
One piece damaged by felling		52
23 ends of crooks from different branches not less than 6 inches in girth		118
		<hr/>
Or 29 tons, 35 feet		1195

This account, somewhat irregular in its arrangement, though there is no reason to think inaccurate as to number, weight, and measure, appears by itself somewhat extraordinary, but is marvellously surpassed by the next example, that in gigantic proportions may be said literally to *cast it into the shade*. The ensuing statement, put into the hands of the writer of this article, some years ago, by one who was resident near the place where this enormous tree grew, is detailed in a different but more satisfactory form. Like the preceding, it stood on an estate from which it took its name of

THE GOLYNOS OAK.

Golynos is about four miles from the town of Newport, and is in the parish of Bassaleg. The tree was purchased by his Majesty's Purveyor of Plymouth Dockyard and Dean Forest, in the year 1810, for one hundred guineas, and was felled and converted in the same year. Five men were each twenty days stripping and cutting it down, and a pair of sawyers were constantly employed one hundred and thirty-eight days in its conversion. The expense of stripping, felling, and sawing, exclusive of superintending the conversion or hauling any part of it, was eighty-two pounds. It was felled in separate parts, and stages were erected by the workmen to stand on to cut down the valuable limbs. Previous to being felled it was divested of its brushwood, which was placed as a bed to prevent the timber from bursting in falling. The main trunk of the tree was nine feet and a half in diameter, and consequently no saw could be found long enough to cut it down; two saws were therefore brazed together. In cutting the main trunk through, a stone was discovered six inches in diameter, six feet from the butt, and three feet in a diametrical direction from the rind, round which the timber was perfectly sound. The rings in its butt being reckoned, it was discovered that this tree had been improving upwards of FOUR HUNDRED YEARS! and, as many of its lateral branches were dead and some broken off, it is presumed that it must have stood little short of a *century* since it attained maturity. When

standing it overspread *four hundred and fifty-two square yards of ground*. Its produce was as follows :—

	FEET.
Main trunk, at ten feet long	450
One limb	472
One ditto	355
One ditto	235
One ditto	156
One ditto	113
One ditto	106
Six smaller ditto	413
Dead limbs of the size of timber	126
<hr/>	
Total quantity of timber	2426

Its conversion was thus :—The main trunk was cut into quarter boards and cooper's stuff; the limbs furnished one upper piece-stem for a hundred-gun ship; one ditto, fifty guns; one rother (rudder?) piece, seventy-four guns; three lower futtocks, each one hundred guns; one fourth futtock, one hundred guns; one ditto, seventy-four guns; one ditto, forty-four guns; one floor-timber, seventy-four guns; one second futtock, one hundred guns; and about twenty knees, all of which were large enough for the navy. The heavy body-bark was three inches thick. When all its parts passed into the market, they produced nearly six hundred pounds! What compression, what expansion from a single seed, weighing probably less than a quarter of an ounce, and contained with ease in the hollow of the human hand!

The secret of the growth and magnitude of these and similar specimens is, that for the most part they were solitary beings, that spread out their limbs without any neighbouring opponent or control. Such as these, rearing their heads aloft on the wide common or wayside green, charm the eye of the lover of nature's beauties, who deplores the utilitarian feeling that imperils their lives. Their majesty and beauty conspire to seal their doom; the contractor and carpenter see nothing in them but pounds, shillings, and pence, and they are gradually disappearing by the railway at hand. All things must yield to traffic in a money-getting age; but the exertions of the poet and the painter will still survive the destruction wrought by man and time.

“Everything,” says Epictetus, “hath two handles.” Your readers, Mr. Editor, will be differently affected by the representation of the fate of these objects. There may be those who think they could not be appropriated to a better purpose; on the other hand, there are those who, if they had their own

way, would gladly have spared them till they perished by decay. All do not view the same object in the same light, and it is well for the general good that it should be so. Each has thus his share in it.

It happened to the writer many years ago that he was riding in company with several persons, among whom was the celebrated author of the *Essay on the Picturesque*, together with a simple country squire, whose ideas and admiration of forest scenery centred in trees as timber. "What a charming effect," said the lover of pictorial beauty, "do those masses of foliage produce!" "Yes," added the other, "but the trees are worth next to nothing in the market." The man of taste turned round with a glance of disapprobation, and was silent at the moment, but could not refrain from expressing apart his disgust and indignation at such an absence of feeling; and yet each in his own way was not far from right.

Sir Uvedale Price, Bart., the person alluded to, a man of taste and a scholar, was an enthusiastic lover of forest scenery, as his oaks at Foxley, near Hereford, bore ample testimony. He used to prune them regularly, in part, with his own hand, and had under him a set of pruners who worked beneath his own eye. On the loss of one of them he expressed his regret to the writer in the words employed by Priam on the death of Hector, "Ὅς δέ μοι ὄϊος ἔην (*Iliad*, Ω), such was his zeal for the care and cultivation of the oak.

A taste of this kind seems to have been inherent in the family. Colonel Price, a brother of the above gentleman, was a great and deserved favourite of George III. An anecdote is related of him that the King, intending to have a certain tree taken down, asked the Colonel's advice respecting it, at the same time expecting to meet with a ready acquiescence in the notion of its propriety. The Colonel, however, ventured respectfully to say that he was of a different opinion. "Aye," replied the King, somewhat hastily, "that's your way, you continually contradict me." "If your majesty," resumed Colonel Price, "will not condescend to listen to the honest sentiments of your faithful servants, you can never hear the truth." After a short pause, the King very kindly laid his hand upon the Colonel's shoulder, "You are right, Price, the tree shall stand."

J. W.

ON THE GENUS FICUS.

BY JOHN R. JACKSON,
Curator of the Museum, Royal Gardens, Kew.

(*With a Tinted Plate.*)

WE have before spoken of tropical forest trees, and in a previous paper in the *INTELLECTUAL OBSERVER*, we gave a brief account of some of the most noble of the Australian forms; we also, in that paper, made a passing allusion to the denizens of the oriental forests. We purpose now to conduct our readers into some of these forests, or rather to introduce them to some of their inhabitants. Amongst the finest trees of purely tropical scenery, of course still excepting the palms, the members of the genus *Ficus* hold a prominent place. This genus belongs to the natural order *Moraceæ*, and is that also to which our common fig belongs, besides *Morus* itself, which includes the mulberry, *Broussonetia*, the paper mulberry, *Dorstenia*, and others. Though the order is small, it is a most important one, both in an economic point of view, and also in botanical interest. The genus *Ficus* is especially rich in many varied forms of useful products, for besides the fig itself, we have caoutchouc, lac, etc. Whether any of the species are European is a question upon which our best botanical authorities have differed. Lindley says that none of the *Morads* are European, and that the mulberry and common fig have both been brought from the East; other writers consider the fig to belong originally to Asia Minor, Persia, South-Eastern Europe, and North Africa. We can only say, that if not truly indigenous, the plant has become thoroughly naturalized in all the countries mentioned above. The way in which many of the species adapt themselves to circumstances in their mode of growth is peculiar, and very striking to an observer. In many cases we find them twining, and almost enveloping, colossal palm trunks, though they are capable of forming very thick trunks of their own, which frequently bear an immense spreading crown. The magnificent wild fig-trees of the East, indeed, are always regarded as the true friends of the sun-scorched traveller, affording, as they do, such a cool retreat, and such a complete shelter from the sun. Lindley says the genus *Ficus* is one of those which travellers describe as most conducing to the peculiarities of a tropical scene; and, quoting from the "*Annals of Natural History*," he says, "Mr Hinds points out the complex appearance of the main stem of many species; their immense horizontal branches, their proportionate lowness,



2

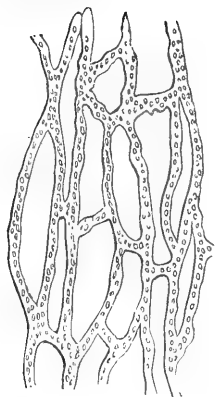

3

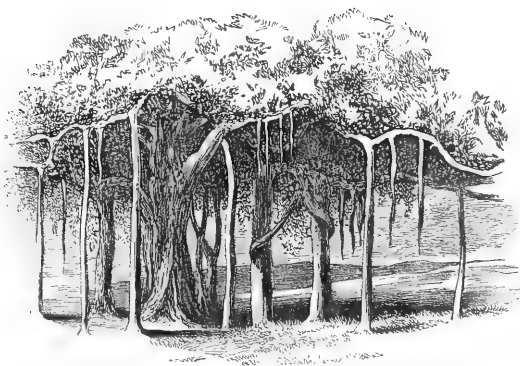

1

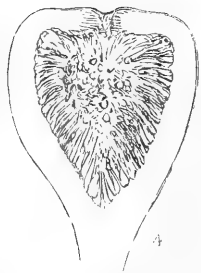

4



5

THE GENUS FIGUS.

- | | |
|--|---|
| <p>1.—Banyan tree, (<i>Ficus Indica</i>, L.)</p> <p>2.—Palm encircled by <i>F. Indica</i>.</p> <p>3.—Laticiferous tissue of <i>F. elastica</i>, Rox.</p> | <p>4.—Section of Common Fig, (<i>F. carica</i>, L.)</p> <p>5.—Open receptacle of <i>Dorstenia contrayerva</i>, L.</p> |
|--|---|

and the vast number of smaller stems in every stage of development—some just protruding from the horizontal limbs, others hanging midway between the leafy canopy and the earth, displaying on each thick rounded extremity an enormous spongiole, while many reach the soil, and, having attained strength and size, act as columns to sustain the whole structure.” The best example of this very peculiar provision for supporting so wide-spread a canopy is to be found in the Banyan-tree (*Ficus Indica*, L.) Fig. 1. This tree is certainly one of the most famous and interesting of all the East Indian forms of vegetation, and is the best type of the peculiar adaptability of the genus in forming irregular trunks, and that in a manner quite contrary to the usual mode of proceeding in the vegetable world. We all know that one of the laws of plant-life is to send its root downwards and its stem upwards, so that the former may take in from the earth the nutriment there stored, while the latter, developing itself by its natural appendages, performs the important functions of respiration. This, of course, in its infancy, is the case with the banyan; but after it has grown, and formed its crown of foliage by throwing out its branches, and while yet a young tree, these branches perform a double duty; for besides being the support of the leaves, they throw out again downward branches, which reach, and strike root in the ground, and then go on growing as true stems, thus forming a support for the spreading mass above. These trees are common all over the East Indies: and to such a size do they grow, that one tree forms a miniature forest in itself. The largest banyan-tree is said to be on the banks of the Nerbuddah river, where, for aught we know, it is still growing. Forbes, in his “Oriental Memoirs,” says the circumference of the tree at the time of writing the account, was nearly 2000 feet, and the overhanging branches which had not thrown down their props or supports, stretched over a much larger area. The tree had as many as 320 main trunks, and over 3000 smaller ones, and was capable of giving shelter to 7000 men. These dimensions appear almost fabulous; there is, however, another fine tree at Mhow, which has sixty-eight stout stems, and can give shade, even under a vertical sun, to an immense number of men; indeed, we are constantly told that a regiment of cavalry can conveniently take refuge beneath one. For large assemblies or meetings they form perfect natural tents. It is very certain that these immense trees must be of great age; and we should naturally expect to find a full description of so remarkable an object in the works of the old classic authors. Strabo’s description is both minute and accurate, as is also that of Pliny. The banyan has been the theme of poets in more recent times, as well as of travellers

and naturalists. Milton beautifully describes it in the following passage—

“Branching so broad and long, that in the ground
The bending twigs take root; and daughters grow
About the mother tree; a pillared shade,
High over-arched, with echoing walks between.
There oft the Indian herdsman, shunning heat,
Shelters in cool; and tends his pasturing herds
At loop-holes cut through thickest shade.”

And Southey, in his “Curse of Kehama,” says—

“’Twas a fair scene wherein they stood,
A green and sunny glade amid the wood,
And in the midst an aged banyan grew.
 It was a goodly sight to see
 That venerable tree.
For o’er the lawn, irregularly spread,
Fifty straight columns propped its lofty head;
 And many a long depending shoot,
 Seeking to strike its root,
Straight, like a plummet, grew towards the ground.
 Some on the lower boughs, which crossed their way,
Fixing their bearded fibres round and round,
With many a ring and wild contortion wound;
 Some to the passing wind, at times, with sway
 Of gentle motion swung;
Others of younger growth, unmoved were hung
Like stone-drops from the cavern’s fretted height.
 Beneath was smooth and fair to sight,
 No weeds nor briars deformed the natural floor;
 And through the leafy cope which bowered it o’er,
 Came gleams of chequered light.
So like a temple did it seem, that there
A pious heart’s first impulse would be prayer.”

Though habit has taught us to look upon the root of a plant as that part alone which is buried in the earth, we see there are such things as roots being given off from totally different parts. This occurs mostly, if not entirely, in tropical climates, and is effected greatly by the influence of moisture and shade, considering, of course, that the plants have a natural predilection for forming these aerial, adventitious, or secondary roots. The banyan is a good example of a plant producing aerial roots.

The structure of a true root, when fully developed, is very similar in all respects to a true stem. The epidermis, however, is without stomata, and the bark is always very thick, owing to the moisture it absorbs from the earth. Thus we find that stems of many plants are capable of forming roots, as is instanced by the growth of plants from cuttings, or by pegging a bent branch down to the ground. In the case of the banyan, so long as the roots are pendant, they derive their nourishment from the parent trunk, but so soon as they reach the ground,

the spongioles or absorbent parts of their roots become more developed, and strike into the earth, and then begin the necessary functions for increasing their diameter, and supporting the weight of the new foliage above. It is not at all uncommon to see the trunk of the talipot palm (*Corypha umbraculifera*), or the palmyra (*Borassus flabelliformis*), completely encircled by one of these figs. (Fig. 2.) This is caused by the seeds, which are very small, dropping into the axils of the leaves of the palm, where they vegetate, and send their roots downwards, embracing the trunk in their descent. In very old specimens, where these aerial roots have extended to a goodly diameter. the palm is seen emerging from the thickness of the fig, as if it was actually one and the same plant. These combinations are considered sacred by the Hindoos, who call them holy marriages. A white, glutinous juice exudes from the stem, which is considered a remedy in toothache; bird-lime is also manufactured from it, and an infusion of the bark is said to be a powerful tonic.

A small but very good specimen of the banyan-tree may be seen in the palm-house of the Royal Gardens, Kew, and a trunk of the talipot palm, encircled as described, is in the museum of the same establishment.

The *Pepul* (*Ficus religiosa*, L.) is also a native of the East Indies, and is remarkable for the long tapering points of its leaves, as well as the closely reticulated and strong vascular fibre. The Chinese make very pretty and effective ornaments of these leaves, by removing the cellular tissue or green pulpy matter, and covering the skeleton with a coat of varnish or gelatine, and then painting figures of birds, flowers, etc., on the surface. The ease with which the cellular tissue is removed by macerating, recommends the leaves of this species for the purpose of dissecting or skeletonising for leaf bouquets. Amongst the Hindoos, the pepul-tree is greatly venerated, their belief being that among the branches the goddess Vishnu first saw the light. The plants are, in consequence, frequently to be met with near houses, pagodas, etc., and the natives are very unwilling to cut them down. Birds devour the fruit with avidity; and in their flight, instances have been known of the seeds having fallen into the cracks of buildings, where they have germinated, and caused much damage. They are used in medicine by the native practitioners, as is also the bark. The leaves of the different species vary much in form, those of the pepul being heart-shaped, with the long slender point before spoken of, and seated upon long and slender petioles; they have a trembling motion in the air, very similar to that of the common aspen. They are a favourite food for silkworms.

Peculiar as the two species here enumerated are, the most

important of the Indian species, in an economic point of view, is *F. elastica*, Roxb. It is a tree growing some thirty or forty feet high, with large oval or oblong leaves, very thick and glossy, and is now well known as a common conservatory and parlour plant. The fruits are arranged in axillary pairs, sessile, or without stalks, not larger than an olive. From this species most, if not all, the caoutchouc or India rubber brought from the East Indies is obtained. We all know how abundantly a white milk flows from the least fracture occasioned to any part of this plant, the prick of a pin upon its stem or thick green leaf will cause it to ooze out, and by exposure to the air become thick and elastic. When collected in its native country for commercial purposes, deep incisions are cut through the bark nearly down to the wood, in a transverse direction, and about a foot apart. The juice flows from these wounds in large quantities, and, on coming in contact with the air, forms itself spontaneously into a solid elastic substance, from which a kind of whey or foetid fluid separates. After such a tapping as this, the tree is said to require but a fortnight's rest before it is ready for a similar operation. The presence of caoutchouc or milky juices in plants is a character of many natural orders. Some yield a pure milky fluid, which never hardens. The vessels that contain this fluid are called laticiferous tissue, or cinenchyma. They are very minute, the average diameter of one of them not exceeding $\frac{1}{1400}$ of an inch. One of the chief distinctions of these vessels is, that they lie in no regular or definite position to the other tissue, and consist of long branching tubes, as seen at Fig. 3. In their young state, they are very thin and hair-like, but as they get older, they become large, their sides thicken, and contract in some places, and swell in others. This has given rise to an opinion amongst some botanists that they are merely a series of cells, placed end to end, in which the partitions have become absorbed, as there are no divisions through their entire length. The contents of these tubes, called the latex, is not in all plants milky, but sometimes coloured, and at other times quite transparent and colourless. It is always of a granular nature, but its chemical composition varies in different plants; for while some give a perfectly harmless, and even a nutritious milk, others are acrid and narcotic. The cells which contain caoutchouc, and similar juices, must therefore not be confounded with the cells or vessels through which the ordinary nutritive functions of the plant are carried on, nor must the fluid itself be confounded with the sap.

The common Fig (*Ficus carica*, L.) is perhaps the best known of all the species, owing to its valuable fruit. As we have before said, its native country is doubted. The plant is,

however, now cultivated to a very large extent in Turkey, and on the shores of the Mediterranean. It is a tree growing in favourable situations to a height of twenty or thirty feet. The plant is so well known in our gardens and greenhouses, that it would be needless to describe it. We may, perhaps, however, be allowed to say a few words about the fruit, as it is a peculiar, though a common one. We hear people speak of the "seeds" of the fig, meaning those little granular sago-like things so numerous inside a fig. These are not seeds, which we should soon discover were we to examine them in a green fig. They are each of them a small individual fruit, which in this form is called an achene. The *Ficus carica* is not cultivated for the sake of its flowers, for though it does flower, and that profusely, we venture to doubt if there are many of us who have actually seen the flower. It is not showy, nor is it exposed, as most flowers are, to the air and light. In most of our common fruit-producing plants, we first behold the bud, then the expanded flower, which in time drops away, leaving the fruit to develop itself to the size limited by nature; but in the fig, what we call the fruit is not the produce of one flower, but of many. The fleshy part which we eat, is in botanical language called a receptacle. (Fig. 4.) There are, however, various forms of receptacles, and even in the same family to which the fig belongs; thus, for instance, in *Dorstenia* (Fig. 5), we have an open, somewhat irregular square receptacle, slightly turned up at the edges like a tray. In this genus the flowers are exposed, but are still numerous as in the fig. Another common example of an open receptacle is to be found in the sun-flower, and we have only to bring up the sides, and nearly unite them at the top, and we shall have the same form of receptacle as the fig, namely, a hollow one, with the inflorescence inside instead of out. This inflorescence is of both sexes, else fertilization could not take place; and it is worth noticing the provision of nature in placing the male flowers near the orifice, at the apex of the fruit, while the females are seated in the concave part below; by this arrangement, the pollen from the male flowers, in dropping, is more sure to fall on the stigmas of the females, as the figs themselves, in their earlier stages of formation, and when the flowers are fully expanded, are nearly always more or less upright upon the stalks which bear them, seldom drooping until after fertilization has taken place, and the receptacle has become swollen. It frequently occurs, however, that the stamens are imperfect and no pollen formed. A practice, called caprification, has been resorted to in the East to provide for this natural deficiency. A number of wild figs, which are often infested with a species of cynips, are strung on threads and hung above the

cultivated ones. When the insects escape from the former, they enter the latter by the orifice at the apex, and so, by carrying the pollen grains upon their wings or otherwise, fertilize the female flowers. This system, however, is not so generally adopted as formerly, as it is now considered to injure the quality of the figs. It appears to have been clearly understood and practised by the ancients, as it is fully described by Theophrastus and Pliny. The introduction of the fig into this country is by some writers attributed to the Romans, and by others not till the early part of the 16th century, on the return of Cardinal Pole from Italy. The very trees which he brought, and which were planted in the garden of Lambeth Palace, are said to have flourished for 300 years. There is, or at least was until very recently, several fine examples of very old fig-trees in the kingdom, some of them of very great diameter, proving that even in our climate the fig is capable of thriving, though a severe frost is liable to do it great injury. The south coast of England, however, appears to agree with it, and standard trees have been known to produce fruit in tolerable abundance.

There is yet another species of this interesting genus which we must just notice before taking leave of it, and this is the sycamine or sycamore fig (*F. Sycomorus*, L.). This is supposed by some to be identical with the tree into which Zaccheus climbed. If this is so, and the tree is to be identified with that mentioned in many passages of Scripture, it must have been of great importance among the Jews, though the fruit is small, and hardly worth eating compared with that of the common fig. The light wood of this plant is said to be almost imperishable, and served to make the cases of the Egyptian mummies. The genus includes about 200 species, but the few we have described are the most important in an economic point of view, the most peculiar, and the types of the genus generally.

RED STARS.

GREAT interest attaches to red stars, not only from their extreme beauty when seen through a good telescope in contrast with a dark clear sky, but also from the changes which many of them undergo. Our numerous readers who possess telescopes will therefore be gratified with the following abridged list of solitary red stars published by Dr. Schjellerup in the *Astronomische Nachrichten*, No. 1591. We have omitted all the stars he mentions below the eighth magnitude (except some of the variables), as ordinary telescopes cannot exhibit them satisfactorily; and in consideration of the wants of subscribers living in more southern lands, we have inserted many stars not visible in this country. Those who possess equatorial telescopes will find the red stars without difficulty, and those who are not so provided will be able to trace their position on a map, and thus learn where to point their instruments in search of them.

Dr. Schjellerup remarks on the general interest excited by red stars, and he observes that with few exceptions variable stars are reddish, either constantly, or at some period of their transition. When changes of colour occur at definite periods in variable stars we may expect that interesting information concerning them may be afforded by the spectroscope.

As the following list contains the great majority of the solitary stars mentioned by Dr. Schjellerup, it follows that the majority of these bodies at present known are of the eighth magnitude and upwards; and the reader will notice how large a proportion range between the seventh and eighth magnitudes. Sir J. Herschel mentions an 8.5 mag. star, R.A. 12^h 39^m 15 D. —58° 55' 7 as the "most intense blood red" of any star he has seen, and it will be found from the list that stars approaching this tint are rare. Observers who use reflectors for their observations will find the colours more exactly seen when a glass prism is used instead of a smooth mirror, and achromatic eye-pieces like those of Mr. Browning will (with reflectors) be more reliable than Huyghenian.

RA. 1860. h m s	Decl. 1860. ° ' "	Mag.	
0 51 41	— 6 38,2	8	Schj. 340: <i>red.</i>
1 8 27	+25 1,6	8	Bessel: <i>red.</i>
1 9 42	+46 57,5	7.5	Argelander: <i>very red.</i>
1 10 15	+ 8 11,5	var.	S Pisc. Hind: <i>reddish.</i>
1 13 47	+ 6 17,0	neb.	h. 101: <i>red star.</i> 7.5. 45° <i>s.p.</i> According to d'Arrest, in 1864, Sept. 25, this star was 9 mag.
1 20 32	—33 16,6	6	Cape Obs.: <i>most beautiful orange red.</i>
1 23 25	+ 2 9,5	v	R Pisc. Hind: <i>fiery looking.</i>

AR. 1860. h m s	Decl. 1860. ° ' "	Mag.	
1 45 24	+69 30,8	8	Argelander: <i>very red.</i>
1 59 35	+ 0 46,5	7	Cape Obs.: <i>very red.</i>
2 8 10	+24 24,3	v	R Arietis. Winnecke A. N. 1224: <i>orange in max.</i>
2 12 18	— 3 36,6	var.	o Ceti. Cape Obs. <i>Very full ruby; sang.</i>
3 9 1	—57 50,9	7·5	Cape Obs.: <i>high orange or brick red.</i>
3 9 26	— 6 14,8	7	Bessel: <i>red.</i>
3 37 1	—10 3,0	8	Schj. 1132: <i>red.</i>
3 45 13	+60 41,6	5·5	Conn. d. T. XV.: <i>red.</i>
3 48 31	—15 19,2	8	Schj. 1216: <i>yellow red.</i>
4 13 46	— 6 34,9	7·7	Schj. 1375: <i>yellow red.</i>
4 14 9	+20 28,9	6·5	Radcliffe Obs. XIX.: <i>pale red.</i>
4 20 38	+ 9 50,8	var.	R Tauri. Hind: <i>red.</i>
4 21 32	+ 9 38,0	var.	S Tauri. Hind: <i>reddish.</i> Winnecke A. N. 1224: <i>no colour.</i>
4 26 45	—11 5,1	6·7	Schj. 1462: <i>yellow red.</i>
4 27 53	+16 13,5	1	α Tauri.
4 36 45	+67 54,8	6·5	Argelander Zone 80: <i>very red.</i>
4 42 45	+28 16,9	8	Cape Obs.: <i>a very extraordinary ruby</i>
4 44 37	+14 0,9	5	Conn. d. T. XV.: <i>red.</i> [<i>coloured star.</i>]
4 46 5	+ 2 15,6	5·5	Conn. d. T. XV.: <i>red.</i>
4 48 14	+ 7 33,0	7	Conn. d. T. XV.: <i>red.</i>
4 51 22	+ 7 54,7	var.	R Orionis. Hind: <i>reddish.</i>
4 53 14	—15 1,2	var.	R Leporis. Hind's <i>crimson star.</i>
4 54 38	+ 0 30,9	6	Schj. 1615: <i>yellow red.</i>
4 58 10	+ 0 58,9	6·5	Hist. Cél. pp. 49 and 316: <i>red.</i> [<i>yellow.</i>]
5 2 55	— 0 44,5	7	Knorre Acad. Sternk: <i>red.</i> Schmidt: h. 350: <i>very ruddy, almost orange coloured.</i>
5 10 26	+39 11,5	7	Cape Obs.: <i>very remarkably red.</i>
5 11 35	+34 7,1	8	Schmidt: <i>very red.</i>
5 16 36	— 9 27,7	8	Schmidt: <i>very red.</i>
5 22 38	— 1 12,3	5	Hist. Cél. p. 251: <i>red.</i> Schmidt: <i>yellow red.</i>
5 24 1	+18 29,2	5·5	Conn. d. T. XV.: <i>red.</i> [<i>red.</i>]
5 29 18	+10 56,7	7·5	Hist. Cél. p. 311: <i>red.</i> Schmidt: <i>yellow</i>
5 34 0	— 3 55,2	8	Schj. 1878: <i>red.</i>
5 35 0	+ 2 17,6	7·7	Schj. 1888: <i>red.</i>
5 36 40	+24 21,4	8	Markree Cat. I. p. 76: <i>very red.</i>
5 39 19	—46 31,4	8	Cape Obs.: <i>vivid sanguine red, like a α Orionis.</i> [<i>blood drop.</i>]
5 47 36	+ 7 32,6	v	Hist. Cél. p. 142: <i>red.</i> [<i>2 Observ.</i>]
5 49 32	+45 55,1	6	Schmidt: <i>yellow red.</i> Schj. 2015: <i>red.</i>
5 55 15	— 5 8,5	7·7	A. N. No. 77, p. 73: <i>reddish.</i> Greenw. Obs. 1863: <i>very deep crimson colour.</i>
6 2 12	+26 2,3	8	Bessel: <i>red.</i> Cape Obs.: <i>vivid red.</i>
6 17 29	+14 47,7	8	Cape Obs.: <i>very intense ruby coloured.</i>
6 18 4	—26 58,7	8	Schj. 2236: <i>red.</i>
6 23 26	— 2 55,9	7·7	Hist. Cél. p. 208: <i>red.</i> Cape Obs.: <i>superb orange red, very rich colour.</i>
6 26 55	+38 33,2	6·5	Moesta Obs. p. 103: <i>reddish.</i>
6 35 17	—52 48,5	6	h. 411: <i>the chief * 8 mag. is red.</i>
6 41 0	—20 36,0	neb.	Struve Obs. Dorp. II. p. 60: <i>sub-red.</i>
6 49 59	+70 55,6	6	Moesta Obs. p. 111: <i>reddish.</i>
6 52 32	—48 31,6	5·5	Piazzi 320: <i>sub-ruby.</i>
6 56 8	—27 44,2	3·5	R Gemin. Radcliffe XV.: <i>red.</i> Auwers A. N. 1238: <i>pale red.</i>
6 58 55	+22 54,9	var.	Bessel: <i>red.</i>
7 0 9	— 7 20,7	8	

AR. 1860. h m s	Decl. 1860.	Mag.	
7 1 31	-11 42,6	7·5	Hist. Cél. p. 271: <i>red.</i> Argelander: <i>reddish.</i>
7 6 30	+59 9,7	7	Struve Obs. Dorp. II. p. 76: <i>red.</i>
7 7 11	+22 12,6	7·3	Radcliffe XV.: <i>very red.</i>
7 17 14	-25 29,7	7	Cape Obs.: <i>very intense fiery red.</i>
7 25 7	+ 8 36,8	var.	<i>S</i> Canis minoris. Hind 1856: <i>a fiery 8·5 mag.</i> Winnecke Astron. Nachr. 1224: <i>very red.</i>
7 34 33	+29 33,3	5	σ Gemin. d'Arrest: <i>reddish.</i>
7 34 38	+23 46,6	var.	<i>S</i> Gemin. Hind 1848: <i>bluish</i> , 1852: <i>reddish.</i> Winnecke Astron. Nachr. 1120: <i>deep orange.</i>
7 36 45	+28 21,6	1·5	β Geminorum.
7 40 54	+24 4,7	var.	<i>P</i> Geminorum. Hind 1848: <i>ruddy</i> , 1852: <i>bluish.</i> Auwers Astr. Nachr. 1238: <i>reddish or orange.</i> [orange.]
7 53 16	-49 36,7	8	Cape Obs.: <i>rich brick red, inclining to</i>
8 8 51	+12 9,2	var.	<i>R</i> Cancr. Auwers A. N. 1238: <i>bright</i>
8 14 54	+ 0 17,0	8	Bond p. 253: <i>red.</i> [orange.]
8 18 7	-37 50,2	6	Moesta Obs. p. 115: <i>reddish.</i>
8 27 45	+19 22,5	<i>v</i>	<i>U</i> Cancr. Winnecke A. N. 1224: <i>no colour.</i> Auwers A. N. 1238: <i>reddish.</i>
8 39 36	+ 0 9,3	8	Bond p. 245: <i>orange</i> : p. 255: <i>orange red.</i>
8 48 34	-10 50,4	8	Schj. 3282: <i>red.</i>
8 48 40	+20 23,0	var.	<i>T</i> Cancr. Bessel: <i>red.</i> Hind: <i>very red.</i> Winnecke Astr. Nachr. 1224: <i>blood red.</i>
9 1 54	-25 17,2	4·5	Argelander: <i>red.</i>
9 2 13	+31 32,1	6	Hist. Cél. p. 221: <i>red.</i>
9 28 42	-62 10,7	8	Cape Obs.: <i>very intense sanguine star, between scarlet and carmine red.</i>
9 37 10	+35 9,3	var.	<i>R</i> Leonis minoris. Schönfeld A. N. 1500: <i>yellow red.</i>
9 40 2	+12 4,6	var.	<i>R</i> Leonis. Greenw. Obs. 1861: <i>deep red.</i>
9 44 36	-22 21,8	6·5	Argelander: <i>red.</i>
9 49 44	-40 55,6	7·5	Cape Obs.: <i>scarlet; remarkably full rich colour.</i> Three Obs.
10 3 59	- 7 43,7	6	Hist. Cél. p. 152: <i>red.</i>
10 5 46	-34 38,0	7	Cape Obs.: <i>Scarlet.</i> Three Obs.
10 29 1	-38 50,6	6·5	Cape Obs.: <i>extreme orange, almost scarlet.</i> Two Obs.
10 30 12	-56 50,0	5·5	Moesta Obs. p. 117: <i>reddish.</i>
10 30 39	-12 39,5	6·5	Hist. Cél. p. 329: <i>red.</i> Bessel: <i>red.</i> Lamont Z. 316: <i>orange.</i>
10 34 41	+69 30,5	var.	<i>R</i> Ursæ majoris. Auwers A. N. 1238: <i>pale red.</i>
10 44 49	-20 30,5	6·5	Hist. Cél. p. 284: <i>decidedly red.</i> Argelander: <i>very red.</i>
10 52 36	-15 36,2	6	Argelander: <i>red.</i>
10 53 40	-17 34,4	8	Cape Obs.: <i>most intense and curious colour.</i> <i>Scarlet, almost blood colour.</i>
11 4 59	-81 1,9	8	Cape Obs.: <i>ruby, almost sanguine.</i>
11 10 55	+33 51,5	4·5	Conn. d. T. XV.: <i>red.</i>
11 33 55	+25 34,9	8	d'Arrest: <i>red.</i>
12 15 10	-74 44,0	8·5	Cape Obs.: <i>sombre red.</i>
12 23 22	-56 19,4	2	γ Crucis. Rümker: <i>red.</i>
12 25 4	+ 5 26,8	9·5	Ross Phil. Trans. 1861: <i>scarlet.</i>

AR. 1860.			Decl. 1860.		Mag.	
h	m	s	°	'		
12	37	48	+61	51,6	var.	<i>S</i> Ursæ majoris. Auwers A. N. 1238: <i>red or violet.</i>
12	38	32	+46	12,3	5.5	Hist. Cél. p. 385: <i>red.</i> d'Arrest: <i>red.</i>
12	45	24	+17	52,1	8	d'Arrest: <i>tawny (subfusca).</i>
12	51	11	+18	31,5	8	d'Arrest: <i>red.</i>
13	11	18	-22	25,8	3	Conn. d. T. XV.: <i>red.</i>
13	19	20	-11	58,7	5.5	Conn. d. T. XV.: <i>red.</i>
13	22	4	-22	33,4	var.	<i>R</i> Hydræ. Piazz: <i>ruby.</i>
13	25	42	-6	28,4	var.	<i>S</i> Virginis. Pogson, Radcliffe XV. p. 288: <i>vivid red.</i> Auwers A. N. 1238: <i>orange.</i>
13	42	44	+16	29,6	4	Argelander Abo Catalog: 1829 <i>Mari</i> 12, <i>noted as red.</i>
13	47	13	+41	1,8	7	d'Arrest: <i>tawny.</i>
13	57	40	+0	12,8	8	Bond p. 281: <i>reddish.</i> [<i>brick red.</i>
13	59	13	-59	3,5	8	Cape Obs.: <i>double equal.</i> <i>Both stars</i>
14	6	53	-59	15,6	7.5	Cape Obs.: <i>ruby, or high orange.</i>
14	9	17	+19	54,8	1	α Bootis.
14	17	25	+8	43,6	6	d'Arrest: <i>fulvous.</i>
14	17	53	+26	20,6	7.5	Cape Obs.: <i>vivid red; almost a bright ruby colour; fine.</i>
14	22	22	-5	21,4	8	Schönfeld Neb. Cat. pp. 66 and 68:
14	25	48	+31	59,3	4	Conn. d. T. XV.: <i>red.</i> [<i>reddish.</i>
14	28	55	+37	14,6	6	Hist. Cél. p. 164: <i>red.</i>
15	0	58	-69	32,8	6	Cape Obs.: <i>almost scarlet.</i> <i>Two Obs.</i>
15	9	19	-29	37,8	4.7	δ Lupi. Greenw. Cat. of 1439 stars: <i>very red.</i>
15	10	37	-75	25,1	7	Cape Obs.: <i>very high red, or ruby.</i>
15	15	6	+14	49,2	var.	<i>S</i> Serpentis. Winnecke Petersh. Bull. III. p. 176: <i>red.</i>
15	29	59	+15	34,0	7.5	d'Arrest: <i>red.</i> [<i>reddish.</i>
15	42	49	+28	35,3	var.	<i>R</i> Coronæ bor. Auwers A. N. 1238:
15	44	15	+15	33,7	var.	<i>R</i> Serpentis. Winnecke A. N. 1224: <i>remarkably red.</i> Auwers A. N. 1238: <i>not very red.</i>
15	59	56	+18	45,1	var.	<i>R</i> Herculis. Auwers A. N. 1238: <i>red.</i>
16	1	19	+22	12,1	7.5	d'Arrest: <i>reddish yellow.</i>
16	18	57	-12	5,9	8	Cape Obs.: <i>dull brick red.</i>
16	19	37	+19	12,8	var.	<i>U</i> Herculis. Schönfeld A. N. 1523: <i>red.</i>
16	20	50	-26	7,1	1.5	α Scorpii.
16	31	39	-32	5,8	8	Cape Obs.: <i>deep red, like a drop of</i>
16	43	57	-5	56,0	8	Schj. 5990: <i>red.</i> [<i>blood.</i>
16	45	31	+15	10,8	var.	<i>S</i> Herculis. Auwers A. N. 1238: <i>red.</i>
16	52	26	-4	0,4	8	Schj. 6046: <i>yellow red.</i>
17	8	16	+14	33,2	var.	α Herculis.
17	14	33	-28	0,2	6	Argelander: <i>reddish.</i>
17	30	31	-41	32,3	8	Cape Obs.: <i>beautiful ruby red.</i>
17	31	17	-57	39,0	8	Cape Obs.: <i>brilliant scarlet, or very high orange.</i>
17	36	43	-18	35,5	8	Cape Obs.: <i>remarkably red.</i>
17	51	2	+2	44,3	7.5	Cape Obs.: <i>a very fine orange star.</i>
17	59	7	+7	5,3	8	Schj. 6539: <i>red.</i>
18	1	41	-15	18,1	8	d'Arrest: <i>red.</i>
18	12	18	+0	47,3	8	Cape Obs.: <i>a very red star.</i>
18	21	59	+6	12,7	var.	<i>T</i> Serpentis. Baxendell Monthly Notices XXI. p. 68: <i>deep yellowish red colour.</i>

AR. 1860. h m s	Decl. 1860. ° ' "	Mag.	
18 14 59	+ 0 5,7	7.5	Bond pp. 39 and 309: <i>red.</i>
18 24 44	-14 57,6	6.5	d'Arrest: <i>red.</i>
18 25 40	- 5 15,7	7.5	Schj. 6803: <i>red.</i>
18 30 58	-13 53,8	8	d'Arrest: <i>red.</i>
18 35 8	+ 0 1,5	8	Bond p. 41: <i>red.</i>
18 52 9	+14 10,2	8	Lamont Z. 199: <i>red.</i>
[18 56 55	- 5 53,4		Knott: <i>fine crimson.</i>]*
18 59 38	+ 8 1,2	var.	<i>R Aquilæ.</i> Auwers A. N. 1238: <i>red.</i>
19 2 47	+23 57,6	7	Conn. d. T. XV.: <i>red.</i>
19 8 29	-19 33,0	var.	<i>R Sagittarii.</i> Auwers A. N. 1238:
19 23 20	- 3 4,7	7	Lamont Z. 258: <i>red.</i> [reddish.
19 26 17	-16 40,4	7	Cape Obs.: <i>high scarlet or good ruby colour.</i> Two Obs.
19 26 30	+76 16,9	6.5	Argelander: <i>very red.</i>
[19 33 4	+49 53,2	var.	<i>R Cyni.</i> Knott: <i>colour remarkably fine</i>
19 37 35	+ 4 37,8	8	Schj. 7572: <i>red.</i> [at times.]†
19 58 21	-27 37,3	7.5	Cape Obs.: <i>fine ruby coloured.</i> Two Obs.
20 3 27	-14 40,8	var.	<i>R Capricorni.</i> Hind: <i>reddish.</i>
20 8 55	-21 44,7	6	Hist. Cél. p. 174: <i>red.</i> Cape Obs.: <i>this is perhaps the finest of my ruby stars.</i>
20 19 0	+ 9 36,3	8.5	Lamont Z. 265: <i>red.</i>
20 19 23	-28 43,1	8	Conn. d. T.: <i>red.</i> Cape Obs.: <i>fine ruby coloured star.</i>
20 50 40	+15 42,9	8	Lamont Z. 204: <i>red.</i>
21 9 15	+59 32,2	8	Conn. d. T. XV.: <i>red.</i> Piazzzi 61: <i>ruby.</i> Argelander: <i>very red.</i>
21 11 31	-70 19,2	6	Cape Obs.: <i>ruby red, inclining to orange.</i>
21 36 54	+77 59,6	var.	<i>S Cephei.</i> Conn. d. T. XV.: <i>red.</i> Argelander: <i>very red.</i>
21 37 29	+37 22,6	8	Bessel: <i>red.</i> ‡
21 39 13	+58 8,4	var.	W. Herschel's <i>garnet star.</i> Argelander:
21 39 17	- 2 51,5	6.5	Hist. Cél. p. 183: <i>red.</i> [very red.
21 57 38	+27 40,4	8	Cape Obs.: <i>very ruddy orange.</i>
22 7 52	+39 1,3	4.5	Argelander Abo Cat. 511: <i>red.</i>
22 17 52	+55 15,4	6.5	Argelander: <i>very red.</i>
22 52 30	-25 54,6	6	Hist. Cél. p. 181: <i>red.</i>
22 59 37	+ 9 47,4	var.	<i>R Pegasi.</i> Hind: <i>red.</i>
22 59 57	+ 8 39,2	5.5	Conn. d. T. XV.: <i>red.</i>
23 11 16	+48 15,0	5.5	Argelander: <i>red.</i>
23 23 31	+ 0 6,4	8	Bond p. 107: <i>red.</i>
23 25 30	+23 4,4	8	Lamont Z. 223: <i>red.</i>
23 39 14	+ 2 42,6	6	T. Mayer, Piazzzi etc.: <i>sub-ruby.</i>
23 45 37	+ 74 45,1	6.5	Radcliffe Vol. XIX.: <i>orange.</i>
23 49 55	-27 24,2	5.5	Hist. Cél. p. 570: <i>red.</i>
23 51 19	+50 36,5	var.	<i>R Cassiopeæ.</i> Pogson Radcliffe XV. p. 294: <i>vividly red.</i> Auwers A. N. 1239: <i>bright red.</i>
23 54 9	+59 34,6	6	Argelander: <i>red.</i> A small bluish star following 7s55 on same parallel.

* Omitted by Schjellerup. In June, 1865, we saw it repeatedly as an orange star, flushed with intense crimson. It follows 12 Aquilæ by 2' 43", 2' 5" north of the parallel. Mr. Knott believes it slightly variable.

† We are indebted to Mr. Knott for pointing out Schjellerup's omission of this star.

‡ In September, 1865, Mr. Slack requested Mr. Knott's attention to the colour of this star, and he reported that on the 15th it was a fine coppery or orange red. On another night, at intervals, it was finely flushed with pale carmine, which was often seen by Mr. Slack.

HIGHLAND INSECTS.

BY E. C. RYE.

THE English Entomologist, confining himself for the most part to the productions of his native land, is at a great disadvantage, as regards mere variety and quantity of material, compared with continental workers; the late Dr. Schaum, when on a visit to this country, having indeed expressed astonishment that there should be *any* entomologists here, as there appeared such a "plentiful lack" of objects for investigation. Our insular position is, of course, in a great measure the reason of this comparative dearth of species; but, *en revanche*, it has the advantage of imposing upon our study a definite limit; and no one who has perused the works on the Atlantic fauna by our talented countryman, Mr. T. V. Wollaston, can deny the charm of working at island groups.

There are, however, more things in the British isles than are dreamed of in our philosophy, especially in the way of insects, and notably in the order *Coleoptera*, or beetles; and, strangely enough, it is from the more boreal parts of Great Britain that novelties are to be expected. The remote nooks and corners of the north are necessarily less investigated than the more easily accessible southern hunting-grounds; but the superficial observer would be inclined not to attach much weight to this point, as he would argue (and with apparent reason) that insects are most plentiful in the southern counties, and get gradually scarcer towards the midland and northern districts. Nevertheless, there are many parts of the south and west where beetles never abound, and from whence nothing entomologically good ever comes; and the geological formation and universal utilization of the soil of the midland counties account, in a great measure, for their want of insect-life,—the drainings of meres, and other "improvements," having especially exterminated many rarities. But when we get beyond the borders, and reach the mountainous districts of the Scottish highlands, a new insect-life, sub-alpine, and strange to southern eyes, greets us. Nor are the individual exponents of species rare, very many occurring in great profusion, and some of the forms being of considerable and unexpected size, curious development, and attractive colours.

Some years ago the little village of Kinloch-Rannoch, on the shores of Loch Rannoch, in Perthshire, about twenty-five miles west of Killiecrankie, was discovered (entomologically) by the late Mr. Weaver, a professional collector; and, subsequently to his time, has periodically been visited by many

pilgrims (including the writer of these notes), the result being evident in the addition of many species to our fauna, some of the most startling kind. About nine miles from Kinloch, on the south side of the loch, and stretching down to its shore, is a patch of thick pine-forest, about four miles square, known as the Black Wood, on account of the dark colour of the trees, some of which are of great age and size, being indeed occasionally so large, as to require the outstretched arms of two men to span their trunks. This forest must once have extended beyond the village of Camachgouran (*prononçez* "Camhouran," Gaëlicè), as the black soil is evidently composed of comparatively recent vegetable detritus, interspersed with knotted and gnarled stumps. Behind, is a wide-spreading flat of heather, *Sphagnum*, and pools, shut in by "Cross Craig," a mountain some three thousand feet high, its feet clothed with birch trees, and its top often snowy in summer, and nearly always wrapped in mist. To the west the view is closed in by more birch-scattered hills, at the foot of which a wide, steep, and rapid burn dashes along, with alternations of wavelets flashing over white boulders, black, sullen eddies, and leaping falls. This burn takes the drainage of the mountains on the flanks of Rannoch Moor, a vague, pathless tract, reaching to misty Glencoe, and is fed notably by a streamlet from "Grayvel" (Gaëlic for "rough," and well deserving the epithet), a mica-capped and white marble studded peak, with precipitous crevasses, higher than and behind Cross Craig. On this mountain, in mid July, with cloudless skies and unbearable heat, I have seen patches of snow, five feet deep, and more than a hundred feet long, evidently destined to remain unmelted until increased by the next winter's fall. Here, also, ptarmigan are found among the peaks, on the lichen level. It will be noticed that in this district the conditions for the production of insect-life are extremely favourable; the heat being intense while it lasts, and alternated by a period of undisturbed rest (not the undecided winters of the south, which often allow insects to come to maturity prematurely, or tempt them from their torpid condition to an unseasonable and self-destructive activity),—the supply of vegetable pabulum unlimited, and in all stages, from soundness to decay,—and the atmosphere tempered by an almost constant dampness, in itself a necessary to most insects.

The Black Wood—however it and its neighbourhood may abound in insect-life—is nevertheless no place for drawing-room entomologists. There is a road along part of its skirts, certainly, but with that one road ends all approach to civilization. Once having left it, the collector must shift for himself—knee deep in wet *Sphagnum*, stumbling over vast decayed and

moss-grown logs, crashing through underwood, leaping from boulder to boulder, wading the numerous rapid streams, and always panting up, or slipping down-hill. Unfortunately, also, the inner man will find little indigenous food to sustain the over-taxed powers. Meat is a myth; milk scant and skim; eggs are small and few; so that oatmeal alone is left as a staple. Happy he whose primitive digestion can assimilate it with comfort. The Southron stomach does *not* take to it kindly as the sole staff of life. Of course, the luxurious traveller can take potted and savoury meats, curious drinks, and other vanities with him; but the road to Camachgouran is not favourable to much luggage. Once settled in that village, where some of the hospitable Gaëls will, for a nominal consideration, and to their own great personal discomfort, cede half of a two-roomed stone shanty to the visitor, he can, when on the verge of starvation, walk his sixteen miles to Kinloch and back for dinner—a meal to be obtained, in a surprisingly good style (apart from the oatmeal antithesis), at the fishing inn there, under the needle-peak of Schehallion.

Although my notice has been chiefly directed to the *Coleoptera* at Rannoch, there are a few conspicuous species of other orders occurring there, to which brief allusion must be made. In the *Lepidoptera*, butterflies appear to be scarce; the Alpine forms, in which the continent is so rich, being represented in this country by a very meagre list. Still, such mountain species as we possess are found here, and in abundance; *Erebia Cassiope*, a sight not often vouchsafed to southern eyes, fitting gaily on the mountain sides, high up, and retreating from observation directly the sun is obscured; *Blandina* being more common, and *Davus* swarming on the lower levels. The latter species occurs plentifully on Carrington moss, near Manchester, under similar conditions. The gap between the two localities is rather wide, but the subject of geographical distribution, as regards British insects, comprises harder problems than this; a recent puzzle having been afforded by the discovery, in one of the wet ravines at the back of Wimbledon Common, of *Stenus Kiesenwetteri*, a large and conspicuous species, and which had not long before been described as new to science from specimens found in Spain.

At Rannoch, also, among the birches, occurs plentifully, at times, the handsome moth known as "The Glory of Kent" (*Endromis versicolor*), formerly only taken in the extreme southern counties. This is one of the *Bombycidae* to which the practice of "sembling" is so fatal; a virgin female being bred and taken into the woods, where she attracts numerous males, who insist upon being caught, as it were; but by what

marvellous keenness of perception they are directed to their unseen attraction we cannot divine.

A permanent variety of the Oak-eggar moth (also easy to catch in the way indicated above), or a species closely allied to it (for it has been described as separate), is very common here on the heather, over which its large chocolate-banded male may be seen, winging his rapid flight in the hot sunshine in search of his bride—who, larger still, and of lighter hue, reposes sluggishly near her birth-place. This insect must be dear to a believer in the Darwinian theory, as it halts between the two opinions of a species and variety; its larva feeding on a different plant to that of the type form, and differing slightly, and the perfect moth also differing slightly in colour, and coming out at a different period of the year.

Another fine moth, *Petasia nubeculosa*, first discovered here as British, is found on the birch-trees, when the snow is on the ground; for insects in Alpine situations seem less affected than their southern brethren by climatic influences: as an instance of this I may remark that I have seen *Bombus lapponum* flying and working here in the cold rain at five o'clock in the morning. Concerning the *Petasia*, its original captor adhered to the statement that he was materially aided in finding the moths by certain tree-creepers, which flew from birch to birch, chattering, and directing his attention to the insects on the trunks.

Parasitic upon some of these large moths must be a large and handsomely banded species of *Metopius*, one of the *Ichneumonidæ*, which I took flying on Grayvel; probably its larva is nourished in that of the above-mentioned eggar (*Lasiocampa callunæ*), which would be sufficiently bulky to contain it. Another very large and thin black species, allied to *Pimpla*, with exceedingly long three-bladed ovipositor, was often observed by me flying round the felled trunks at the woodman's saw-pit, Dall; and it was most interesting to watch the prying ways of the creature, as it peered into holes and crannies, delicately gauging the many galleries made by the larvæ of *Ionicorn* beetles, which its formidable weapon could scarcely fail to reach. A small species of *Spathius*, supposed also to be parasitic upon wood-beetles, used to occur plentifully in the wood work of my solitary bed-dining-and-drawing-room, which was riddled by *Ptinus* and *Anobium*, evidently its prey. The *Anobium* (a genus to which the well-known "Death-watch" belongs) kept me awake for some time by the frequency and persistency of its ticking, clicking call,—one beetle answering another by rapidly striking its hard mandibles against the sides of its gallery, and the result being very clear and distinct in the stillness of the night.

Of other *Hymenoptera*, our largest saw-fly, *Cimbex femorata*, and the large wood-ant, *Formica congerens*, were most conspicuous. The former, which flies sluggishly round the tops of young birches, could be taken by suddenly and violently hitting the trunk of the tree directly the insect was observed to settle on the top shoots, when it would often fall helplessly into the net; and the nests of the ants were to be seen, sometimes of huge dimensions, agglomerate masses of pine-droppings and sticks, swarming with their bellicose tenants. In these nests (not easy to examine, apart from the large size, great numbers, and sharp mandibles of their occupants, on account of their unusually copious and pungent exhalations of formic acid) lives a small species of *Tinea*—odd dwelling for a delicate moth,—also *Homalota parallela* and other myrmecophilous *Coleoptera*, and, notably, the larva of the Scotch rose-chaffer, *Cetonia cenea*, a species resembling, but duller than, our common rose-beetle.

Of the *Neuroptera*, some fine species of dragon-flies were not rare, *Cordulegaster annulatus* (found also in South Devon), being perhaps the most common, with the southern *Libellula A. maculata*, and the polar *Æschna borealis*, and *Cordulia arctica*. One cannot fail to be struck with the unusual circumstance (in England) of the large size of so many of these noteworthy insects, as, comparatively, but few of the southern forms are large; or, if so, are common species.

It is, however, to the *Coleoptera* that we must look for peculiarities of structure, novelties in appearance and habit, and additions to our lists. Here the wood-feeders, but seldom seen in the metropolitan district, play a conspicuous part, owing to the great abundance of their natural food. One of the most abundant at certain times is a *Longicorn* (*Astinomus ædilis*), which could scarcely fail to attract the attention of the most inveterate non-observer, owing to the extraordinary development of its antennæ, especially in the male. The accompanying wood-cut, in which the insects are life-size, will show to what a length horns can be carried, even in our temperate clime, unused to developments of frequent occurrence in more tropical regions. The female, readily distinguished by her long ovipositor (with which of course she lays her eggs in fitting chinks of the bark), has the antennæ much shorter than the male; a difference easily seen, even in the pupa condition, inasmuch as in that of the latter sex they are carried round in a complete circle, and again curved towards the front, whereas, in the female pupa (figured in the cut) each antenna is only just long enough to form a circle. The larvæ, which, like those of all wood-feeding insects, live for a long time in that condition, eat broad galleries on the surface of the solid

wood of the pine, beneath the bark, passing the winter in nests formed of chewed fibre, and eventually turning into pupa within a similar rampart. They seem to assume the perfect condition late in the summer or beginning of autumn, hibernating in their cell until the first hot days of the spring, when they gnaw a way to outer light with their powerful mandibles through the pine bark, which often looks as if it had served as a target for pistol practice, owing to the number, size, and neatly-cut edges of these escape holes.

Although lignivorous by nature, the males of this curious insect are excessively pugnacious; two of them settling on a tree-trunk being almost sure to fight, so that it becomes any-

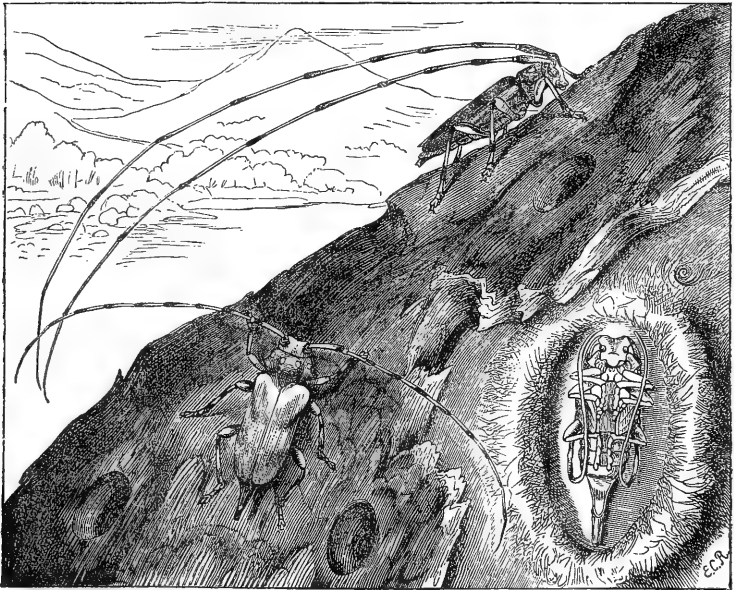

thing but easy to find specimens with their fragile appendages quite perfect. It is a fine sight to the untravelled coleopterist to see a male of this exotic-looking creature flying across a glade of the forest, with his long antennæ streaming behind like the pennants of a ship. The inhabitants of the village are quite familiar with the *Astinomus*, on account of its frequenting the wood-huts, timber-cutting yards, and even the door-posts of the shanties, usually settling and gravely walking about with its horns extended laterally like an open pair of compasses, from which habit, indeed, it derives its fanciful specific name of "*Ædile*," as if a surveyor of buildings.

It appears to be common in Sweden, where, from its wood-frequenting habits, it is called "timberman" by the country-people, according to Linnæus; and it is exceedingly curious that several of the dwellers in Camachgouran also call it by the very same name. The insect is not known to be found in any other part of Great Britain (save accidentally; as, for instance, when a live specimen—a very Triton among the minnows of London beetles—was found in the courtyard of the British Museum, whither it had been conveyed under the bark of a stout larch pole, brought with others for scaffolding); so that the coincidence of name is very curious, for I imagine that the works of the learned Swede have not yet become household words amongst an isolated community whose sole literary wealth (*crede experto*) consisted of a Gaëlic Bible and a copy of Bunyan's "Pilgrim's Progress" (original edition).

It should be observed, however, that the parallel between the Swedish and Highland fauna is so marked that the student derives great assistance, when working in this district, from the works of Gyllenhal and Thomson; a clue to many of the species recorded by those authors, and already recognized as British, though very rare, being afforded by their notes as to habits and times of appearance, which also assist in the discovery of species new to our lists.

Another common insect at Rannoch, *Trichius fasciatus*, a *Lamellicorn* allied to the rose-beetle, is interesting, not only on account of its excessive rarity elsewhere, but also through its mimetic analogy to the common humble-bees, *Bombus muscorum* and *B. lapponum*, found in its company. It is bright yellow, with interrupted velvety black bands on the elytra, and covered with dense long yellow downy hairs, and delights to settle on thistle flowers; being, indeed, known to the villagers as the "bee-beetle." This unwonted appreciation by common people of the peculiarities of animals usually so despised as insects, is doubtless owing to their familiarity with collectors, and is possibly tinged with the suspicion of attachment of a pecuniary value, as the first visitants to Rannoch were dealers, who obtained a large price in London for insects then considered of great rarity, and therefore could afford to employ all the "young barbarians" to collect these really common things for "bawbees." Another conspicuous beetle, *Lamia textor* (which derives its specific name from a recorded habit of weaving osier-leaves together, after the manner of a tailor-bird, as a nidus) was formerly common here, but has been nearly exterminated by the "penny a-piece" system of collecting, the insect being easily seen on the willow-trees through its large size, cumbrous build, and deep black colour. It occurs also near Bristol. Very different from this is the deli-

cate, flattened, beautifully reticulated, bright red *Dictyopterus Aurora*, first discovered here, and not as yet found elsewhere in Britain, where it has long been considered as one of the arcana of science. It is very plentiful among rotten pine-chips under logs, accompanied by its larva, which much resembles that of the glow-worm, and, delicate as it is, is voracious enough, for I found one feeding on the carcase of a deceased "Shard-born" beetle (*Geotrupes*): the perfect insect may also be seen flying feebly, towards evening, in the depth of the forest. Its foreign brethren delight in settling on flowers; but we have only another species here, *D. minutus*, found very rarely in the south, mostly in rotten wood.

In consequence of the prevalence of fungoid growth under the decaying bark of felled trees and stumps, the family of *Anisotomidæ* is well represented in the Black Wood by considerable numbers of *Liodes* and *Agathidium*, the species of which much affect such food. Three of our four species of the former genus (one of them occurring here only) are indeed to be taken in considerable numbers, gregariously haunting the black powdery residuum of certain fungoid excrescences on old bare pine stumps, in which they nestle, covering themselves as a sparrow does with road dust when water is not to be had. They are very little creatures, and, like the *Agathidia*, roll themselves up into balls, drop to the ground, and "scuttle" off when alarmed by the approach of the collector's fingers.

The *Agathidia* especially frequent a small dry, pink, puffy ball, growing on pine logs, and also damp, white layers of fungus under bark. Although small, they are of great interest, owing to their peculiarities of structure, not the least of which is the diversity in the number of joints of the tarsi between the two sexes. One species, *A. Rhinoceros* (Sharp), recently found here, and apparently new to science, is conspicuous from the great development of a sharp curved horn springing out of the left mandible of the full-grown males. In small examples of that sex the horn is much reduced, sometimes even entirely vanishing; and this reduction or absence of a strong sexual development is often found in the *Coleoptera*, where the most favourable conditions are required in many instances to produce the perfection of the type form, and especially in wood-feeding insects. So great, indeed, is the disparity frequently between the two extreme phases, that authors have been tempted to describe them as specifically distinct. The common stag-beetle exhibits a good instance of the possibility of increase of the sexual distinction of size of mandibles under favourable circumstances, in its earlier stages; as small male specimens often occur with very stunted jaws, when reared from willow, or stunted in proper food during the larval condi-

tion ; whilst a male from a full-fed oak-bred larva is of great bulk, and bears huge branching dentate mandibles. It is not, however, only the mandibles that are subject to this variation ; all sexual developments, such as cornuted processes on head or thorax, swelling of hind femora, dilatation of the head or front tarsi, spining and curving of the hinder tibiæ, etc., come under the same law.

A very marked instance of a frequently observed habit of insects—viz., that of their frequenting places similar in colour to themselves, was constantly forced upon my eye at Rannoch by *Rhagium indagator*, a Longicorn beetle apparently peculiar to this part of our country, and belonging to a genus very destructive to timber, the fat, flat-headed larvæ swarming under pine-bark in all directions, and committing great havoc. This insect is of a mottled grey colour, strikingly similar to the lichen-covered bark of the larch, on which tree (and never on the dark black pine) I constantly found it, beetle and bark being so precisely alike in hue and markings, that it was possible absolutely to sit on the log and yet not see the insect. On these logs, and under the bark, the very flat *Pytho depressus* (another species added to our catalogue from Rannoch) is occasionally to be found—a beetle which, although apparently bulky when viewed from the upper side, is most eminently adapted for slipping into the narrowest cracks. Its voracious, elongate larva, armed at the hinder apex of the upper side with two recurved hooks, for the purpose of obtaining a fulcrum, is found under bark, where it preys upon the larvæ of *Rhagium*, and other true wood-feeders.

Running about quickly, in company with *Pytho* and the fragile *Dircea*, *Clerus formicarius*, a curiously banded and variegated species, strongly suggestive of a large exotic ant, might often be seen ; its larva being of similar sub-cortical habits to that of the *Pytho*.

The freshly-cut stumps of fir-trees, fragrant with exuding turpentine, act as splendid traps for many beetles, *Astinomus* often settling on them, and a flattish, dull black Longicorn allied to it, *Asemum striatum*, called "the soft timber man" by the wood-cutters, being very plentiful. Ripping the bark off these and older stumps disclosed numerous colonies of Xylophagous *Coleoptera*, with their larvæ and attendants ; the species of *Hylastes* and *Hylurgus* being very abundant in deeply cut narrow channels worked in the underside of the bark, at the end of each of which the change to pupa takes place, the perfect insect drilling a neat round hole through which it escapes to the surface. Two species of *Ips* (one yellow, the other black, with red spots), and three or four of the linear *Rhizophagus*, abound also in these galleries ; syc-

phants of the true wood-feeders, among which they have hitherto been considered to rank (as far as selection of food goes), until M. Perris, a distinguished French entomologist, pointed out their true relations with regard to the *Xylophaga*. From his observations (which I have been enabled to corroborate in a great measure) it appears that the species of *Ips* and *Rhizophagus* enter the holes made in the fir-trees (either in chinks of the bark, where there is the thinnest space between the inner and outer coatings, or, in the case of felled stumps, at the junction of the bark and wood) by the *Hylastes*, and lay their eggs in the galleries made by the latter, on whose larvæ their larvæ feed. M. Perris has observed the larvæ of the common *R. depressus* with half their bodies plunged into the larvæ or pupæ of *Hylesinus* or *Hylastes*, devouring them; and I have myself seen the same species half immersed in a sickly specimen of a perfect *Hylurgus piniperda*.*

At the junction of the bark and solid wood in freshly-cut stumps, the female of *Pissodes pini*, a large and very prettily marked northern species of weevil, may be constantly seen, laboriously drilling round holes with its rostrum, in which to deposit eggs. Its fat, full-grown larva, or the pupa in a gnawed out cell, may often be found near the ground, to which it has eaten its way under the bark; where also its ally, the still larger *Hylobius abietis*—a clumsy, dull black, delicately yellow marked *Curculio*, of very clinging habits as to its tarsi—undergoes its changes, and may be found copiously. The latter insect has been imported in Scotch timber (in the larval state) to the south, where it is not uncommon.

These species, though constantly wood-feeders, exhibit a great difference in structure to certain other tree-frequenters; their heavy bulk being strongly contrasted by the thin, flat, elegant, long-limbed, *Dendrophagus crenatus*, a very rare sub-cortical species, which I found coursing rapidly, towards evening, over a bare stump; and by the cylindrical *Xyloterus lineatus*, which undergoes its changes deep in the solid wood, drilling a small, neat shot-hole through to the surface at right-angles from the centre, and lurking at the mouth of its burrow, into which it retreats backwards on the least alarm. A similar, but larger, hole is drilled in the very hardest pines by the larva of *Hylecætus dermestoides*, which nothing but a woodman's axe can circumvent. The exceedingly flimsy material of which this curious elongate *Malaco-*

* Certain species of *Epuræa*—small flat testaceous beetles, often seen in flowers and fungi, or at the exuding sap of trees—are also attendants upon the larvæ of the small wood-feeders; one especially, *E. pusilla* (conspicuous through the arched middle tibæ of its male), thronging the galleries. I imagine that they are attracted by the wet frass and sappy exudations caused by the operations of the *Xylophaga*.

derm is constructed causes its burrowing operations to appear the more wonderful. In the male, usually much darker than the other sex, the maxillary palpi are of great size, assuming the appearance of a fan, on account of the third joint (which is much developed) having numerous bronchial appendages.

The southern naturalist can hardly fail to be struck by the great prevalence of certain conspicuous species of *Elateridæ*, or "skip-jacks,"—a family with which he cannot make much acquaintance in his own district. Here many of them abound, and they are often of large size and bright colours, from the very rare banded and lovely *Athöus undulatus* to the shining black *Elater nigrinus*, beaten off birches; the very stones on the sandy shores of the loch covering little families of the jerking *Cryptohypnus*. Their long, vermiform larvæ abound in rotten wood; and some bright shining *Oteniceri*, with strongly-serrated antennæ in the male, fly about in the hot sunshine, often settling on timber with a metallic clang. The females of these are more sedentary and much rarer, occurring under stones, etc., and having the antennæ much smaller and more simple.

Of the *Phytophaga*, so abundant in the south, perhaps the most abundant of the few species to be seen is (at its proper season, and in its right locality) a most beautiful and variable species of *Cryptocephalus* (first discovered here in Great Britain in 1865), the *10-punctatus* of Linnæus; which, in its normal form, is clear yellow, with black spots—the male being darker and banded—and both sexes "sporting" into a deep black variety (*bothnicus*, Linn.). This elegant creature defies the net, and has to be absolutely "stalked" in its native dwarf sallow beds; it drops hopelessly into the wet moss if a shadow fall on it, and in the hot sunshine flies as readily as the common green Tiger-beetle (*Cicindela campestris*), which abounds in the hot paths. Of the latter a black form occurs, but exceedingly rarely; dark forms, also, are to be found of many bright insects (a circumstance often observed in marshy places), so glistening and coppery a species as *Anchomenus ericeti* being here taken of a dull, deep black colour.

Want of space prevents me from entering upon the numerous fungus-feeders abounding here, from the gregarious and minute species of *Cis* to the large Cassidiform *Thymalus*—also found in the New Forest; or upon the many Coprophagous Lamellicorns, or the very numerous species of *Brachelytra* or *Staphylinidæ* (of which Scotland is the metropolis), from the lustrous but rapacious bandit *Quædius lævigatus* under bark (whose crooked yellow pupæ are often to be seen) to the many *Tachini*, living in *stercore*—insects of an apparently puzzling uniformity, but a close observation of whose diversely

sculptured anal plates has resulted already in the addition of two species from Scotland new to us. It is in the *Brachelytra* that the most numerous novelties have been, and will for some time continue to be, found. But a few words must be given to the beetles found upon the absolute mountain-tops and sides, which are of different habits and forms to those on the lower levels. On the topmost peaks, among the mist, the rare *Miscodera arctica*, a huge *Dyschirius* in show, occurs under stones; where, also, *Otiorrhynchus maurus* (oftener dead and fragmentary than alive) may be seen; and the Alpine *Nebria Gyllenhali* (not seldom with lurid red elytra) replaces the closely allied *N. brevicollis* of the lowlands; the common *Patrobis rufipes* being in like manner superseded by *P. septentrionis* and *P. clavipes*. Here in moss, and under mica slabs, occur *Calathus nubigena* (apparently a mountain form of the common *C. melanocephalus*), *Anthophagus alpinus* (the males with strongly-cornuted heads, and long apical joint to the antennæ), *Arpedium*, *Geodromicus*, and hosts of other *Staphylinidæ*. This pure mountain work has great charms, apart from the adjuncts of scenery and the bracing results of the toil; for the species found are of strange aspect, the chances numerous of obtaining novelties or observing unrecorded facts, and the problems of arrested development (exemplified by apterous conditions, short elytra, etc.) and mutation of species appear to be undergoing solution under one's eyes.

In a paper of this limited length it is, of course, impossible to note more than the general features and most salient forms of so extensive a subject as the entomological productions of a rich district; indeed, a mere enumeration of all the new and rare species that have been found at or near Rannoch alone would occupy too much space—in spite of the fact that only two orders, the *Lepidoptera* and *Coleoptera*, have been as yet worked with any energy. Enough has been done to show that for many years the English naturalist need not travel out of his own country to find novelties.

PLANS FOR IMPROVING LONDON.

THE present year, A.D. 1866, marks a period of exactly two centuries since the great fire of London, an event at that time naturally considered as a great national calamity, but which might have tended to a great national good, if firmness and sound common sense had been allowed to prevail over prejudices and self-interests. The little mind and short-sightedness were unfortunately as common in those days as at the present time, and Sir Christopher Wren's noble plan for rebuilding the destroyed portions of the metropolis was rejected in the same obstinate manner as the proposed principal lines of our railways were in our own days, when first brought before the public. In 1766, exactly one hundred years after London's great conflagration, John Gwynn published his *London and Westminster Improved*, illustrated by some admirable plans, in which more than one hundred improvements are mapped and described. In the present year, after the lapse of another century, the Engineer and Surveyor to the Commissioners of Sewers for the City of London brings forward a most able and elaborate report on *The Traffic and Improvements in the Public Ways of the City of London*.

It may, perhaps, be interesting to take a glance at these centenary productions. John Gwynn was a bold man in his way; expense to him was a matter not to be thought of. The title of his work states that his illustrated plans were prefixed by "A Discourse on Publick Magnificence," and in 132 pages of letter-press he contended for his several suggested improvements with all the ardour and ability of the Préfet Haussmann. Gwynn proposed two royal palaces—one in Hyde Park, with a circular road of one mile in circumference to enclose it, and another to fill up the space from the Green Park to St. James's Street, with one end towards Piccadilly and the other on the site of the present St. James's Palace. The Houses of Parliament he proposed to rebuild; and not having the fear of the mediævalists before his eyes, he desired to make a clear sweep of Westminster Hall, in order that the site might be raised to a proper and higher level above the river. And although at the first sight we may be astounded at so audacious a proposal, yet, in so large an outlay as there has necessarily been in the construction of the Palace of Westminster, the additional amount in raising the ground floor—the *piano nobile*—of the whole structure some fifteen feet, and rebuilding Westminster Hall on its present site, raising the roof, and making every portion of it a strict restoration of the present venerable pile, would have been at a cost justified by the national importance

of the structure, and adding immensely to the grandeur and dignity of what ought to have been the most magnificent work of architecture in the metropolis.

Gwynn's veneration for Westminster Abbey stayed his hand of demolition in that sacred quarter; but the Dean and Chapter had no doubt smiled at his suggestion, that "*an elegant light Gothic dome*" be raised from the nave of the Church, and "the whole inside of the building *painted of an uniform clean stone colour*, in the manner that St. Paul's Church is, it would then become a most beautiful pile, and be deservedly esteemed one of the finest things of the kind perhaps in Europe." St. Paul's also was to come in for a share of suggested improvement, by the lead-work of the cupola "*being painted in stone colour.*"

We may smile at these well-intentioned suggestions, but in Gwynn's long list of improvements there are many which are entitled to great praise, and some have been since acted upon. We will just run through some of the most salient.

"Bedford Row is opened into Holborn, and the line continued to Lincoln's Inn Gardens."

"St. George's, Bloomsbury, is detached and disencumbered from the buildings, and streets opened north and south."

"An opening sixty feet wide is made through Leicester Square from Piccadilly, and continued into Long Acre. The west end of Queen Street, called the *Devil's Gap*, is here opened equal to the breadth of that street obliquely from Long Acre."

The opening into Leicester Square from Piccadilly has been done; the "*Devil's Gap*," it is feared, still remains.

"From the opening at the north-east corner of Leicester Fields before-mentioned, a street of fifty feet in width, making an acute angle with Long Acre, is carried through St. Martin's Lane into New Street." This improvement has also been effected, although not quite in the order described. Garrick Street is even better than Gwynn's line of street, and the Club House on the south side presents a striking façade.

"The Haymarket is continued to St. James's Park, where a triumphal arch may be erected as a termination to the view."

"A spacious opening is made at Spring Gardens from the Park, and continued to Charing Cross, opposite the Strand."

"A direct line from Northumberland House is drawn to Whitehall, and two considerable streets are formed which run down to the Thames, one of them directly fronts the Admiralty." It is to be hoped that the proposal for an opening from Charing Cross, which has of late been seriously entertained,

may still be accomplished, and that even the ducal Northumberland Palazzo may not be allowed "to stop the way."

"A new bridge is designed from the Savoy across the river Thames."

By referring to the plan it will be seen that three radiating straight lines of streets diverge from a crescent at the foot of the bridge, the centre one leading to Bow Street and Long Acre, the westward one to Southampton Street in the Strand, and that to the east to Catherine Street in the Strand. The situation thus marked out for St. George's Bridge by Gwynn one hundred years ago, has, in our times, been very nearly adopted in the construction of Waterloo Bridge by a public company, but unfortunately without the radiating streets Gwynn laid down. That this bridge, an important entrance to London, should be allowed to continue a toll bridge is most degrading to a great nation; indeed it ought to have been a national work in the first instance, and suitable approaches made at both ends of it, with buildings of character and importance, instead of the mean and wretched tenements in Wellington Street, and the abominable common lodging-houses on the Surrey side. With the successful completion of Somerset House, Wellington Street ought to be rendered worthy of the name it bears and of the bridge it leads to.

"Carey Street is continued into Vere Street, and widened at the end next Chancery Lane." This alteration has been effected, and there is hardly any part of the metropolis which of late years has been so much improved as the south end of Chancery Lane. The widening of Carey Street, the new Union Bank, and other commercial buildings, have all tended to make this an important thoroughfare; but with all the large outlay with which this has been effected by the City of London, the north approach from Holborn is only of sufficient width for *one* carriage, and the corner house was allowed to be rebuilt upon the old site only a few years since.

The above are only a few of the numerous improvements in Gwynn's first and second plates. The third map relates to the City proper, in which many alterations are suggested about the Mansion House, the Royal Exchange, and Moorfields, some of which have been adopted entirely, and others with modifications; but as it would occupy too much space in this paper to describe them fully, we will pass on to the present century, and take a rapid view of what has been done since Gwynn produced his *London and Westminster Improved*. The Houses of Parliament have been rebuilt, Victoria Street, Westminster, is in the course of completion, Buckingham Palace has been rebuilt, the new and extensive quarter of Belgravia formed upon swamps and open fields where snipes have been shot in the memory of living Londoners.

Kensington is now united to the metropolis by rows of splendid terraces overlooking Hyde Park, and has extended to the south, forming a new quarter, which will probably ere long be devoted to the fine arts. On the other side of Hyde Park, the humble Bayswater, and the culprits' spot of doom, now stand forth a district of palaces and villas, known as Tyburnia. Marylebone fields have been converted into a charming park, where the horticulturist spreads forth his treasures, and the professors of zoology find a home for natural history. The master-hand that originated the park also designed a noble street from Portland Place to Pall Mall, as well as Trafalgar Square, and widening the Strand. The Victoria Park and Battersea Park are also new creations; the latter, one of the happiest and most successful works of the able hand now attached to the Woods and Forests' department.

In the City of London a new street has been formed from Finsbury to the Mansion House, another from the Mansion House to London Bridge, and a third from London Bridge to St. Paul's; besides sundry widenings, lopping off of corners, setting back houses, and obtaining additional width to streets. These, for the most part, have been well done. A great portion of them were due to the energy of Mr. Lambert Jones, an influential member of the Corporation. He was for a time master of the situation; but he unfortunately was too careful of the City purse, and instead of forming a bold plan in making a good line of thoroughfare from Guildhall to the Post Office, made so tortuous a line, as to occasion the remark, that "Crooked Lane (close by London Bridge) was removed to Gresham Street." London Bridge and Westminster Bridge have both been rebuilt, and the Southwark, Waterloo, Hungerford, Lambeth, and Vauxhall bridges are all new erections. A noble street has been formed on the Surrey side, leading from London Bridge to Blackfriars; there are several fine piles of warehouses erected in this important thoroughfare—one in particular, on the south side, belonging to the Hop Planters' Company, which has a *portone* worthy of the old Italian architects. With this rapid notice of works *de facto*, we will take Mr. Haywood's plan, and see what he has *in petto* for us, premising that his report being an official one, connected with his appointment under the Corporation of London, is principally confined to the City proper. "But, in order," says Mr. Haywood, "to take the broad and comprehensive view which the subject demands, I must refer to the whole metropolis, for I shall be enabled to show that a large portion of its inhabitants have the most direct interest in the City of London, going to and from it daily, spending within its limits the largest portion of their active life, earning therein their livelihood, and forming the bulk of the traffic which encumbers its streets.

“The population of the metropolis was, in 1801, 958,863; in 1861, 2,803,989—thus having trebled itself in sixty years. In 1865 the population was computed to be, in round numbers, *three millions*; therefore, in forty years hence it may be expected to be *six millions*; and it is for the wants of this future, as well as for those of the present community, in respect of highways, that provision must now be made.”

Mr. Haywood introduces in his report several most useful and valuable tables, showing the vehicular and pedestrian traffic, the areas of various thoroughfares, the number of persons entering into the City on certain days, and proves incontestably how enormous the amount of the to-and-fro population is to the sleeping population. The following paragraph will no doubt astonish some of our old, retired City tradesmen of twenty-five years ago:—“As the traffic has increased since 1860, it may be computed that there now pass into the City of London daily three quarters of a million of human beings, and that the same number pass out at night, leaving but its residential, or sleeping population of 113,387; and this vast daily influx is equal to *one-fourth part of the whole metropolitan population.*”

“This enormous amount of in-comers and out-goers comprises all classes of society, from the highest to the very humblest in the social scale. Thus, there are 68 Members of Parliament who have offices within the City, and of that large class who are directors of the commercial undertakings which must have a home in the commercial centre, there are 56 Peers of the realm, 132 Members of Parliament, and altogether as many as 589 titled and distinguished personages, whose directorial duties bring them frequently within its precincts.”

Of the vehicular traffic, it would appear, that during twelve hours in June, 1865, 19,405 vehicles passed over London Bridge, and 11,972 through Fleet Street by Temple Bar, being about fifty-one per cent. above the traffic in 1850.

After an able exposition of the immense and daily-increasing amount of civic traffic, both pedestrian and vehicular, already producing the greatest inconvenience from the crowded state of the streets, Mr. Haywood boldly states, “*There is but one complete remedy for this, which is the formation of a new bridge, or a tunnel, with suitable approaches, lower down the river than London Bridge.*”

This is certainly a startling proposition at the first view, and Mr. Haywood really exceeds his rival, Mr. Gwynn, in the boldness of his projects; but a little calm consideration of the following paragraph may convince us that Mr. Haywood’s boldness is the result of sound judgment. He says:—

“I am aware of the great interests which would be interfered with by the construction of this bridge; I am aware of the large sum of money which would be required, although I believe that the cost is exaggerated in the minds of most; but whatever the interests may be, and whatever the cost may be, sooner or later a bridge or a tunnel must be built lower down the river. Nothing else will effectually relieve London Bridge at the present day, and nothing else will satisfy the requirements of the vast population which will exist east of London Bridge; and it is to be hoped that this necessity will be boldly faced at once, and not be postponed until the period when it will cost double the outlay now needed, however great that outlay may be.”

This is followed up by some very sensible remarks as to the width of streets and bridges, showing clearly that the author of the report is not led away by projects of grandeur or magnificence, but that the useful is what he has always in view. The following is the extract from the report to which we allude:—“It is, however, fundamentally an error to make streets and bridges of very great width; large streets are more costly; they are also in one respect inconvenient; they lead to concentration of traffic, and if stopped or impeded (as at times they must be) the public inconvenience is very great. *Diffusion*, and not *concentration* of traffic should be the object in devising the thoroughfares of large towns. Alternative lines give the most convenience; and, as a principle, it may be said that it is far better to have two bridges, each of fifty feet in width, than one of 100 feet in width, even if the cost were greater for the two than the one.”

Our space will not permit us to cull any more of the wise saws and interesting statements abounding in this able report. We cannot, however, conclude without a view of the map in which Mr. Haywood lays down a projected new street leading from the east end of the Holborn viaduct to a point in Whitechapel, High Street, where the Metropolitan Board of Works propose a continuation of it to the Docks. This fine line of thoroughfare takes a gentle curve to the northward; it passes close in the rear of Christ's Hospital and crosses Aldersgate Street, Wood Street, Aldermanbury, Coleman Street, and Moorgate Street, Broad Street, and Bishopsgate Street, and debouches at Whitechapel, as above shown. This would afford an immense relief to the traffic of Newgate Street, Cheapside, the Poultry, Cornhill, Leadenhall Street, and Aldgate.

The curved line of the street is so gentle that it will scarcely be perceived in so long a distance; indeed, in some cases, such as the High Street, Oxford, curved lines are more

picturesque and beautiful than straight ones. We cannot conclude our notice upon this able report without one more quotation from it, and bestowing our sincerest congratulations to the Commissioners of Sewers for the City of London upon possessing so accomplished and efficient an officer in the Surveyor and Engineer:—

“That looking to the future as well as the present necessities, and having regard to the fact that the cost of present improvements will probably be in a degree cast upon a future generation, they should be planned and carried out upon the broadest and most comprehensive scale, that no obstacle should be allowed to interfere with this principle; and that such course is true economy.

“It should be held in mind that where the need for public improvements arises from the increase in the numbers, business, and wealth of the population, it may generally be inferred that the population is able to pay for them.”

THE PLANET SATURN.

(CONTINUED.)

BY THE REV. T. W. WEBB, A.M., F.R.A.S.

IN our last No. attention was drawn to the insufficiency of the evidence by which the period of rotation of the ring has hitherto been considered to be determined. It will be at once understood, that no idea is entertained of throwing doubt upon the fact of rotation. The reader is in possession of the means of showing the insufficiency of the objections of Schröter, Schumacher, and Schwabe; and if such a motion is not a necessary condition of equilibrium, it would be entirely beyond the power of the writer to show it to be otherwise.* What has been said amounts merely to this, that the period must still be considered as unascertained, so far as observation is concerned: even its theoretical value is rather uncertain, for Secchi has given 14·238 hours as the period of a satellite revolving a little within the external ring, A. One thing is evident, that it must differ, theoreti-

* There are some curious observations by De-Vico which are worthy of mention. On several successive nights in 1840, an extremely minute point of light, like one of the smallest satellites, was seen in the E. ansa, immovably attached to the edge of the ring (B), then widely open. A similarly-situated pretty bright point was again seen 1812, Oct. 17, Ball's alone among the divisions being visible, but that very distinct. It is difficult to explain this in connection with rotation.

cally, according to the 3rd law of Kepler, for every point in the breadth of the ring—and that it must differ, practically, for every zone of the ring that has a separate existence; the width of each zone being probably determined by the relative proportion of the forces of cohesion and gravity, or, in other words, by its power of resisting the strain to which it is subjected by a rotation, the uniformity of which must necessarily be too rapid for its outer, too slow for its inner edge. From this cause Laplace perceived that the ring must be multiple; and Pierce considers that it may be divided into at least twenty annuli, each having a period of its own.

The rotation of the dark ring, C, seems to be shown by the varying colour of its ansæ; but nothing definite has been ascertained with respect to it.

There are observations which seem to indicate that the general plane of the rings is not always coincident with that of the equator of the globe. We have already mentioned a want of parallelism between the belts and ring observed by H₂ and De-Vico (INTELLECTUAL OBSERVER, ix. 254). The same was noticed by Schwabe, 1828–29–30, when the ring-shadow and the belts converged W., though not always equally.—1833, Dec., he saw the elliptic outline of the planet very obviously inclined to the ring.—1848, Sept. 30, shadow not exactly in direction of equatorial belt.—Schmidt, the same on several nights, Sept., proved by divided object-glass. 14, belts inclined to line of satellites.—1862, May 22, Secchi proved by measurement that the black shadow was not parallel to the belts. Nothing more, of course, could be inferred from a single observation of this kind, than the probability of an oblique current in the atmosphere of the ball; but a little consideration will show, that if the obliquity is maintained through a series of observations, when rotation has brought all parts of the ball successively under the eye, it can only be explained by a temporary deviation of the ring-plane from that of the equator—a very curious feature, if it can be established.

Another deviation from symmetry is implied in certain appearances, which, if not illusory, may be ascribed either to unequal curvature in the two hemispheres, or to an anomalous position of the ring-plane, not dividing the ball exactly in half. This construction might be put upon the observations of H₂ and Gruithuisen, about to be cited under the head of refraction; and the following may be added: Valz at the disappearance in 1833 saw N. hemisphere much more considerable than S.—1848, July 11, Bond II. saw ball most flattened at N. Pole.—Aug. 29, it seems not symmetrical; flattest at N. Pole: Bond I.—Sept. 9, Busch and Luther thought centre of ball somewhat S. of that of ring.—Oct. 10, ring and shadow to

the eye nearer S. than N., Bond II: *by micrometer*, $8''\cdot5$ and $9''\cdot4$.—1852, Sept. 29, Bond II. found the ball projecting somewhat more over the edge of the ring in front (S.) than behind it. Dec. 1, distance between intersections of outer edge of A with ball greater to the eye S. than N.: *by micrometer*, $10''\cdot68$ and $9''\cdot11$ (exceedingly fine definition). It is conceivable that the two hemispheres may be unequal in density; and the singular irregularity in terrestrial attraction which has recently been discovered round Moscow furnishes an analogy which might possibly find its counterpart in Saturn on a much larger scale, so as to dissociate the centre of gravity from the centre of figure of the ball; but unfortunately such an explanation would only be applicable if the deviation were always in the same direction.

Whether the whole ring-system may be encompassed by any perceptible amount of atmosphere is an enquiry worthy of attention. **H** considered it probable, not only because even the smallest satellites appeared distinctly protuberant on either side of the thin ring-line, but because in June, 1807, when the ring crossed the S. hemisphere so as to leave only a segment of $1''\cdot3$ or $1''\cdot4$ in breadth visible, that portion seemed curved or bulged outwards, while the opposite N. pole retained its usual flattened appearance. This observation, which was frequently repeated, was confirmed by his son, as well as by Professor Wilson with another telescope. A refraction of $\frac{1}{2}''$ would, he thought, be adequate to the effect. The same appearance was remarked by Gruithuisen, 1817, and in the same direction. It may be questioned, however, whether this is anything more than an optical deception, the counterpart of the quadrilateral figure of the ball. Were it a reality, its effect would increase with the decrease of the outstanding segment, till the last visible portion of the latter would exhibit an unmistakable amount of distorted elevation. Nothing of the kind, however, is on record. On the contrary, Bond II. noted, 1853, Dec. 15, that the N. pole was invisible, when the S. limb just touched the outer edge of A: circumstances under which refraction round either ball or ring would surely have made itself known.

The idea, however, of an atmosphere is not without support from evidence of another nature. 1828, Jan. 22, Kater was led to the same conclusion, by noticing that during an observation of several hours, in a perfectly favourable evening, he could find no trace of the subdivisions upon A which had struck him so much on a former occasion.

Other phenomena also may be referred to the presence of such an envelope. But before describing them we must obtain some idea of the cause of the multiform aspect of the ring

where it crosses the globe. Various cases of projection and degrees of illumination arise from the changing, and sometimes opposite positions of the sun and earth with regard to the ring-plane. When this stands nearly edgewise to both, the ring and its shadow may be alike invisible (1848, Dawes, Sept. 1, 13. Schm: Sept. 6, 14, 17, 18). If the sun and earth are both on the same side, and equally elevated, the ring will hide the shadow, but may be itself perceptible as a grey stripe from the duskiess of C, and the greater part of B, to which possibly the enfeebling of the solar light through the "horizontal misty air" of its own atmosphere may contribute (see Schwabe's observation *infra* of the progressively fading ring, 1845). If the sun is higher than the earth above the ring-plane, the shadow will be visible beneath it, and A and B will be relieved upon the ball between two unequally dark borders,* C on the one side, and the true shadow on the other—a beautiful sight. If the earth be the higher, the shadow of A and B will be lost sight of behind C, the nearer part of which it ought to render deeper in shade. I do not know that it has been seen to do so; but in this position Dawes failed to distinguish the shadow of C from C itself across the ball. If the sun and earth are on opposite sides of the plane, and each sufficiently removed from it, the ring and its shadow will come out as two dark lines crossing the ball, with an extremely narrow bright streak, a portion of the ball's surface, between them. This extremely minute object, though repeatedly seen,† has not been always visible when we might have expected it; the difference might arise from a change in the position of the plane of C (we may here remark, by the way, that if C were materially thicker than the other rings, it is scarcely conceivable that this streak of light should be ever visible); or it might be referred to the presence of an atmosphere; some possible indications of which we shall now be better able to appreciate.

During the decrease of the ring in 1845, Schwabe found it gradually diminishing in reflective power, till from being in July always brighter than the ball, it had become equal in September, and by Oct. 11, a trifle fainter, and at the same time more of an orange-grey. This went on increasing, and he could only exceptionally note the colours alike, though the ring was always the fainter. After Nov. 21, it was always much the darker, especially on the W. side.—1848. June 30,

* 1851, Oct. 26. Dawes saw both equally black, but in consequence of their falling on very unequally reflective parts of the ball.

† INTELLECTUAL OBSERVER, ix. 381, where it is erroneously stated never to be mentioned by the American observers. See Bond I., 1848, Nov. 22. To the instances of visibility there given, should be added 1861, Dec. 4, Jacob.—1862, May 13, Talmage.

Aug. 9, Dawes found the unenlightened ansæ with $6\frac{1}{2}$ in. not quite invisible on the sky, of a deep coppery tinge like the eclipsed moon. On many other evenings the visibility of the dark side is noted, just as by Bond and others; but Dawes differs from them in thinking that what was seen was not the edge, or light through openings, but the whole surface feebly illuminated, more probably by atmospheric twilight than by reflection from the ball (an idea which had occurred to H₁): The ring across the globe appeared less dark than its shadow when it was possible to distinguish them; a difference which was also noted by Schmidt, Sept. 19, with the addition that these details were much less distinct towards W. limb. 20, 21, nearly the same. Oct. 12, while ring invisible, he and Brunnow at Bilk saw shadow plainer and sharper E. Dec. 3, Schm. the same again.

During this season Bond II. found, July 10, the band across the ball not quite black; 18, it was darkest near *f* limb, B. I. II. 21, ditto, B. II. Aug. 29, growing less dark, B. I. II. [as the light fell more horizontally upon it]. Sept. 18, Oct. 6, not black, B. II. Nov. 13, perhaps a twilight illumination upon it, B. I. 22, not by any means black, B. II.—1849, Jan. 26, Schm. saw the re-appearing shadow faint, and in places very indistinct.—1852, Nov. Lassell at Malta saw on two nights the shadow not black, but like C., and not sharply defined. 1861, Nov. 8, Secchi found the ring decidedly reddish across the ball, though we were looking on the sunny side. 15, violet on ball, darker than he could have supposed possible, almost black, “truly surprising,” but not well defined, whence he inferred an atmosphere. 23, much the same; the earth not till now passing to the dark side. 1862, April 25, ansæ on sky ruddy. Hence, he says, encompassed by a strong atmosphere, if there is any solid part to encompass. May 13, Birt saw shadow darker than ring on ball. Carpenter, at Greenwich, found the ring of a dirty copper colour. June 3, fancied it very faintly illuminated. 1862, May 17, when the shadow of Titan, the largest satellite, was crossing the disc,—a very interesting sight, which I was permitted to witness,—Dawes could find no trace of the shadow, which he had expected to see with $8\frac{1}{2}$ inches in beautiful air; the ring was like a very dark pencil line, but not inky black like the shadow of Titan, and there was a very faint coppery gleam, much more plainly seen on several subsequent evenings, in the place of the ansæ on either side: these appearances he was disposed to refer to refraction through a pretty dense atmosphere producing a twilight on the dark side, and diluting the shadow on the ball. About the same time Huggins saw the ansæ of a deep bluish purple,—May 20, a beautiful dark blue, scarcely

distinguishable from that of the sky.—16, to June 10, he searched in vain, like Dawes, for the shadow of the ring, which ought to have become visible in consequence of the sun's passage to the side opposite to the earth about 17.—May 17, Σ II. considered the light of W. "of the colour of rose copper." (Edgewise that day to sun.)

The reader who has had the patience to examine and compare the mass of details which has been laid before him, in an accumulation which must have appeared more than ordinarily tedious to those not specially interested in the subject, will be disposed, we think, to view it in a two-fold light. Some part of it he will consider sufficiently intelligible on the principles of analogy and the known laws of the universe; other portions he will find so puzzling, that he would take refuge in the supposition of instrumental or personal error, did it not seem precluded by the character of the testimony. But what shall we say when we find that a number of observations which remain, are still less capable of explanation upon known principles, and at the same time are so well established by the consent of astronomers, that they cannot fairly be got rid of by any supposition of illusion? To explain them aright is most difficult; to explain them away may suit the taste of those who choose to magnify the attainments of human knowledge, but they would scarcely have escaped the censure of Aristides of old, in thus adopting a course which, however expedient, would not be just. The true philosopher, on the contrary, deems such outstanding phænomena of peculiar interest and value. They have continually recurred during the extension of physical knowledge, and have furnished invaluable tests of the truth of theories, which, but for them, might have found unchallenged but erroneous acceptance. And though those to which we are now referring do not seem weighty enough to overthrow any received hypothesis, yet they are such as, steadily kept in sight and diligently pursued, may lead to interesting investigations and valuable conclusions.

We have indulged in very little speculation as to the possible materials of the ball and rings. Their nature is indeed involved in so much mystery that the reader will not be disappointed if we enter into no lengthened discussion upon the subject. The very slight density of the globe is well known. It has been given at only 0.132251 (the earth being 1), or $\frac{3}{4}$ that of water, so that it would float high out of a terrestrial ocean large enough to give it sea-room. And if, as may be expected from analogy, its density increases towards the centre, the value already specified being the average of the whole mass, the exterior shell must be considerably lighter still, and we can hardly form an idea of solid materials suf-

ficiently attenuated to take their place on its surface. If fluid existed there in any quantity, Beer and Mädler have supposed that it would be raised up in a gigantic and permanent equatorial tide by the attraction of the ring: of this, however, there is no appearance.* Mädler observes that the planet is far brighter than accords with its distance from the sun (whence Gruithuisen had previously inferred the existence of native light); but this, from the analogy of Jupiter, would be due to the highly reflective power of the vapours suspended in its atmosphere.† The density of the ring has been valued by Bessel at $\frac{1}{118}$ of that of Saturn. The aspect, at least of its brighter parts, is undoubtedly that of a solid, but at such a distance the mere evidence of sense is fallacious—a terrestrial thundercloud similarly situated would undoubtedly give as bright a reflection, as hard an outline, and as black a shadow. Secchi, in fact, has become convinced that the whole appendage is of a gaseous nature, and consists of opaque clouds suspended in an imperfectly transparent atmosphere, which renders itself visible in the dusky ring, and fills up Ball's division with feeble light. Theory, as has been stated, is entirely against its continuous solidity. Professor Maxwell (of Aberdeen) has investigated the question with great ability in an essay which gained the Adams Prize at Cambridge. He has shown that Laplace's result was imperfectly worked out, and that instead of concluding that the rings were irregular solids of unequal thickness, he should have inferred that since if solid and uniform their motion would be unstable and they would be destroyed, the fact that they are stable and permanent shows that they are either not uniform, or not solid. He then proves that so great a degree of irregularity as Laplace's theory would require, being equivalent to a *load* upon the ring, is not consistent with the observed structure,‡ and that therefore, though a rigid ring is not impossible, it is impossible that the rings of Saturn can be such. A continuous fluid ring would in theory suffer such perturbation as to break it up; and he therefore concludes that the rings are "composed of an indefinite number of unconnected particles, revolving round the planet with different velocities according to their respective distances," and that these are probably arranged in a series of

* B. and M. thought otherwise. They interpreted in this way, curiously enough, the aspect of ring C upon the ball, and imagined a corresponding determination of all the fluid in the ring to its inner edge, causing its more dusky light.

† 1848, Schmidt watched the gradual removal northward of the central zone, which is usually the most luminous part, till, Sept. 17, the whole of it had passed into N. latitude.

‡ Schr's 100 miles, in p. 379 of our June No. being German, should have stood as 460. Yet, had this been a real elevation, it seems that it would not have been large enough to ensure stability.

narrow rings, affected by waves of transversal displacement, as well as of condensation and rarefaction. To obtain ocular proof of the accuracy of this remarkable theory, to which so much publicity has recently been given by the ingenious and elaborate treatise of Mr. Proctor, may never perhaps be granted to us; we must not forget that even under the most favourable circumstances, we have to contend with 700 millions of miles of space! It remains to be seen what may be effected by persevering examination; hitherto it must be admitted that instead of removing, it has increased the difficulties of the subject. This will sufficiently appear from the ensuing part of our prolonged recital, in which we shall see whether any information as to the structure of the rings, or indeed of the ball, can be deduced from the appearance of their respective shadows. The reader has already met with some puzzling matter; he must now be prepared for statements still less intelligible.

So great is the variety presented to us in this marvellous planetary system, that we are again obliged to postpone our conclusion.

OCCULTATIONS.

Sept. 26, ξ Arietis, $5\frac{1}{2}$ mag. 9h. 42m. to 10h. 37m., B.A.C. 755, 6 mag. 10h. 28m. to 11h. 31m.—28, γ Tauri, 4 mag. 8h. 17m. to 8h. 42m. (well worth looking for). 75 Tauri, 6 mag. 11h. 40m. to 12h. 41m.—29, 111 Tauri, 6 mag. 9h. 58m. to 10h. 43m. 117 Tauri, 6 mag. 11h. 20m. to 12h. 13m.

THE LAKE-DWELLERS OF SWITZERLAND.*

In our fifth volume we published an interesting paper by Mr. Henry Woodward, *On the Ancient Lake Habitations of Switzerland*, and illustrated it by a plate containing a series of drawings of implements and ornaments obtained from the Swiss lake explorations, and now deposited in the British Museum. We must refer our readers to that paper for general views on the subject, and for sketches of objects belonging to various dates. Our present purpose is to call attention to a very valuable and beautiful work by Dr. Ferdinand Keller and Dr. J. E. Lee. Dr. Keller is the author of a series of papers on the lake dwellings, and Dr. Lee has, with his consent,

* *The Lake-Dwellings of Switzerland, and other parts of Europe.* By Dr. Ferdinand Keller, President of the Antiquarian Society at Zurich. Translated and arranged by John Edward Lee, F.S.A., F.G.S. Author of "I-ca Silurium," etc. Longmans.

rearranged and translated them, with additions and alterations made by Dr. Keller, or with his approval, so as to make the book an invaluable treasury of facts known up to the present time. The illustrations are of a very high order of merit, and occupy no less than ninety-six plates, comprehending an amazing variety of objects, elucidating the mode of life and state of art amongst a most interesting set of men during the many generations that they adopted a sort of amphibious life.

To settle with tolerable approximation to accuracy the earliest period illustrated by the relics of the lake-dwellers is a difficult task for the geologist, but to the antiquarian belong the later periods in which the influence of Roman civilization is distinctly seen. That in Switzerland, in Ireland, and in various parts of the earth, tribes should have lived surrounded by water on artificial islands, is not in itself to be wondered at. Fishing must have been a source of subsistence almost as universal as the water in which the aquatic vertebrates dwell. Hence the vicinity of rivers, lakes, and seas must have been favourable to the multiplication of the human race, and to their aggregation into communities. Nor are we astonished that the water should be turned into a means of defence. An island, whether natural or artificial, is, by its position, more or less protected from the attacks which rude savages can carry on; and a tribe of people living in a village sustained upon piles, only accessible from the mainland by a single causeway, or rude bridge, supplied with fish from the adjacent water, and never lacking the fluid most essential for quenching thirst, might be regarded as in a condition of considerable security and comfort.

The researches which Dr. Lee has now rendered accessible to English readers, seem to show that the custom of living on pile-supported villages in lakes, was by no means confined to a peculiar race distinct from the inhabitants of the adjacent land, nor limited to such times of barbarism as might have been supposed. The earliest lake-dwellers must, if we consider them to have been the parents and progenitors of the later lake-dwellers, have already started on the road to civilization. Their implements may have been rude, their wants few, and their means of supplying them small; but they must have been in a very different state from those races of savages which remain stationary or die out, as circumstances change. In the earliest lake-dwelling period, rude huts, resting on piles, and made in a rough fashion, something like the "wattle and dab" construction of Australian settlers at the present day, with clay floors, and roofs of bark, straw, and rushes, seem to have been aggregated into villages of considerable size. Fishing nets, and hooks made of boars' tusks, have been found in some

of the earliest settlements, and organic remains likewise show that the lake-dweller was a hunter as well as a fisherman, and chased the land animals as well as caught the finny tribes. Any bone containing marrow seems to have been dexterously split lengthwise, to get at what Professor Rüttimeyer calls a "miserable pittance," but which the old lake-dwellers, agreeing with many moderns, may have considered a tit-bit. The work before us says: "The investigation of the bones which are found in such great numbers amongst the piles of all the lake-dwellings, has shown that, together with the remains of the beasts of the chase, those of domestic animals are met with, especially of the dog, which even in the oldest settlements is found as man's companion, and, moreover, of cows, sheep, goats, and pigs." If this was the state of things with the earliest lake-dwellers, they must have been considerably in advance of the mere hunter stage of existence; and it is, moreover, found that they were agriculturists as well as keepers of cows and other animals. A sort of scratching or tearing of the ground with tools of stags-horn, or wood, seems to have been an anticipation of ploughing, but their produce was of good quality, and considerable in amount.

Professor Heer divides the plants hitherto found in the lake dwellings into—1, cereals; 2, weeds of the corn-fields; 3, culinary vegetables; 4, fruit and berries; 5, nuts; 6, oil-producing plants; 7, aromatic plants; 8, bark and fibrous plants; 9, plants used for dyeing; 10, forest trees and shrubs; 11, mosses and ferns; 12, fungi for kindling fire; 13, water and marsh plants. The cereals comprehended the small-grained six-rowed barley, a small variety of wheat, a beardless compact wheat, and two kinds of millet. Masses of manure from domestic animals indicate that heaps of such materials were systematically collected. The fruits comprised crabs, apples, pears, strawberries, raspberries, cherries, plums, etc.; a cake of poppy seeds, pressed, probably for oil, was found at Robenhausen, and also carraways, which may have been a condiment. As lake-dwelling existed for many generations, the state of agriculture must have changed, and that of the earliest times may be presumed not to have comprised all the articles in the list. "The inhabitants of the lake-dwellings," do not, according to Professor Heer, "appear to have had any close connection with the people of eastern Europe, for they, at least in the bronze age, cultivated rye, with which the lake settlers must have been acquainted if there had been any extensive intercourse. On the contrary, all the cultivated plants show a connection with the countries of the Mediterranean." Thus, their agriculture seems to have come from the basin of the Mediterranean, and Professor Heer remarks concerning celts of

nephrite, found in the lake-dwellings, "The presence of what is called noble nephrite, which is only known in the east, is not more strange than the appearance of the Egyptian wheat, the Cretan cattle fly, the oil-yielding poppy, and the glass beads found at Wauwyl, which were either of Egyptian or Phœnician origin. Professor Heer does not assign a very high degree of antiquity to the lake-dwellings, but thinks it probable that they extended back to one or two thousand years before the Christian era. Professor Rüttimeyer, who has examined the remains of the animals that co-existed with the lake-dwellers, observes, "I cannot, however, refrain from expressing my conviction, that even the oldest lake-dwellings do not by any means exhibit to us the primitive population of our country. I must, indeed, regard them as 'autochthones,' or, at least, as very ancient inhabitants of these districts, for they possessed, as domestic animals, a number of those that undoubtedly were indigenous here, particularly the urus and the marsh swine; but the fact that from the beginning they had the sheep and the dog, the indigenous origin of which is, to say the least, highly improbable, indicates their having descended from a still earlier people. For my own part, therefore, I have little doubt of the existence at one time of a genuine primitive population throughout Europe. This appears to have been proved, as far as France is concerned, by the latest discovery at Aurignac." In another passage the Professor adds, "The discovery at Aurignac places the age of our lake-dwellings at a comparatively late period, although almost immediately under our peat-beds, with their rich treasures, similar antiquities are found: nay, still older remains are met with, only a little deeper, in the slaty, brown coal of Dürnten, perhaps forty feet under the bed of the Lake of Pfäffikon, than those of Aurignac, which have been gnawed by hyenas after having been despoiled of their marrow by human hands."

A very important part of the work before us refers to the settlements on the mainland, which corresponded with the lake-dwellings, and were contemporaneous with them. At Ebersberg, Burg, Uetliberg, and Windisch, settlements have been discovered in which "the stone celts, flint knives, what are called corn-crushers, tools of bone and bronze, as well as implements of bone and bronze, all appear perfectly identical with the antiquities of the lake-dwellings on both sides of the Alps. And in the presence of this fact, the correctness of the conclusion cannot be doubted in the slightest degree, that the settlements of the same people who erected the lake-dwellings were also spread over the mainland."

The manufactures of the lake-dwellers exhibit an advance from rude periods to the time when Roman civilization exerted

some influence upon them. "The whole of the pottery," say our authors, "may be divided into two classes, according to the nature of the material, one, a coarser sort, made of clay mixed with a large quantity of grains of stone; and a finer kind, made of washed loam, in some cases mixed with a small quantity of charcoal powder. The shape of the vessels in the older settlements does not vary to any great extent. Urns with a large bulge and thin sides are rare, very few flat vessels are found in the shape of plates; as a general rule, the form approaches that of a cylinder. With respect to ornamentation, . . . it consists only of bosses or impressions made either with the finger or a little stick. On some specimens, worked with greater care, a commencement of the zigzag ornaments may be seen; and some also are painted with graphite and ruddle. It is very certain that many of the large pots were used for cooking, for they are covered on the outside with soot."

The writers of this work very properly reject the theories which endeavour to mark out the "stone" and "bronze" ages as sharply defined. They see that improvements came gradually in old times as they do in new, and that transitions were gradual as they are now. But as the lake-dwellers learnt to cast bronze, and finally to work iron, they improved their various arts, and the pottery associated with bronze implements bears marks of augmented skill and increasing tact. "Still, at this period no vessels are found artificially formed with long narrow necks, like bottles, flasks, or jugs, which are so abundant in Roman times." The numerous plates with which this volume is illustrated contain a great many sketches of potter's vessels, wrought by hand, not by a wheel, and exhibiting the progress from rude shapes to elegant forms.

A very curious kind of pottery was ornamented with plates of tin, as thin as paper, which seem to have been pressed into the earthenware while it was soft, and contrasted with the black ground of the vessel so decorated. One of the plates gives a picture of a round dish of this sort found at Cortaillod. "The (tin) ornamentation consists of a rosette in the middle, formed of quadrangles, which is surrounded by a band of a pattern similar to that called the meander. . . . The material is dark grey, blackened by graphite."

In textile fabrics the lake-dwellers, evinced considerable skill, and they arrived at the art of working by means of some kind of loom. As the weaving together of twigs for basket work bears a close resemblance to the weaving of softer materials into cloth or net, we shall commence with the former, and we learn that ropes or basket handles of twisted willow twigs have been discovered. Mats have likewise been found of bark, varying in the complexity

of their manufacture. A simple cross plat under and over making a square pattern is represented in one of the plates. In other patterns (also depicted) "the warp is made of twisted strips of bark, and the woof of flat bands." Other patterns are still more complicated. Many articles made of flax have been discovered, and in some of them the famous "weaver's knot" appears. Fishing nets were made of flax, and many specimens of linen cloth, which, though rude as compared with the productions of civilized races, yet evince considerable skill, and are pronounced by persons in the trade to have been made in some kind of loom.

When specimens of linen cloth of a complicated pattern were first obtained, it was thought that they might have become accidentally associated with earlier fabrics, but investigation convinced the Swiss antiquaries that "these questionable specimens are the actual relics of the lake-dwelling settlers, and belong to the same age as the implements of stone and bone."

The lake-dwellers were acquainted with some mode of dressing and preparing the skins of animals they killed, but the remains of their industry in leather have been very imperfectly preserved, and little more than the fact of its existence seems to have been ascertained.

Our plate in vol. v. gives illustrations of the bronze work of the lake-dwellers, and the volume before us contains an immense number of engravings fully illustrating this very interesting subject. From a chemical analysis made by Professor Fellenberg, of Berne, it appears that the bronze of many of the weapons and implements discovered in the western part of Switzerland, consists of pure tin mixed with copper, containing a little nickel, "while not a trace of this metal is to be found in bronze objects met with elsewhere." Copper of this kind is afforded by the ores of the Valais, and it is conjectured that the lake-dwellers worked these ores, and obtained their tin from the Cornish mines.

No definite line of demarcation separated the "stone age" from the bronze period, but as metal implements became more plentiful the stone ones gradually disappeared. Considerable skill was attained in the manufacture of bronze articles, and in many cases the form and the ornamentation is of a pleasing kind. The lake-dwelling of Nidau-Steinburg, lake of Bienne, has supplied very numerous illustrations of bronze manufacture, including sickles, knives, celts, spear-heads, pins, rings, hooks, etc. Many of the pins were of an ornamental character (see our plate, vol. v.), and it would appear that armlets of the same materials, engraved with elegant angular patterns, were also in vogue.

At Marin a great many objects of iron have been found, swords, lances, rings, brooches, etc., etc. Other localities have likewise afforded iron articles, but Marin has yielded the richest supply. Professor Keller says, "The following facts result from the investigation of the arms and implements of Marin, and their comparison with the specimens found in England, Alesia, and Berne:—The form of the swords and lance points, the ornamentation on the sword sheaths, the marks on the sword blades, the numerous Gallic coins found with them, and the wide-spread district where they occur, show that all the Marin antiquities have come from some of the workshops of Gaul, perhaps situated amongst the Belgæ." In another instructive passage Professor Keller observes that, "in looking over the specimens from Marin what strikes us most is the fact that the weapons, and other implements, differ so essentially, both in material and form, from the products of the older settlements; not only has iron taken the place of bronze, but the form and ornamentation are so different, that one is tempted at first sight to attribute their origin to another nationality and another district. But when we carefully consider this phenomenon it appears less striking. For if we compare the relics of a pure bronze station, such as Wangen or Mooseedorf, that is, of simple bronze implements, with those of stone, wood, and bone, the difference between them in whatever is necessary for sustaining life is found to be much greater. It is certain that these are passages or transitions from the stone to the bronze period. On the one hand, we find a number of stations in which stone or bronze objects are mixed together in different proportions, and which reveal to us the gradual diffusion of metal tools. On the other hand we can follow up the development of the art of bronze casting, and see how at first implements of this material took the form of those of the stone age."

When the Marin objects were made, iron had full possession of the field, and the forms of the object had undergone a change, partly from the peculiarities of the metal, and partly, no doubt, from a considerable alteration in wants and modes of thought.

That people should continue to occupy lake-dwellings after they had acquired possession of iron implements made with great skill, does not appear as surprising to us as it does to some other observers. In our own day the conservative element which resists progress, perpetuates practices and processes long after better ones are known, and we are usually driven to improvements by the force of competition. Amongst a barbarous people the conservative element dominates their entire lives, while a semi-civilized race retains enough of the

same spirit to resist innovations with a steady and powerful force. Besides, the lake-dwellings may have been favourite abodes for a fishing and semi-aquatic population, long after they ceased to be desirable on the score of defence. Possibly a diminution in the quantity of fish easily procurable had more to do with the abandonment of these villages than anything else. When fish abound, and a family can secure a dinner by the simple expedient of suspending a few hooks and strings in the water, the temptation to live close to, or on the water, must be very strong.

Many interesting questions concerning the lake-dwellers remain to be worked out, but enough is known to warrant the belief that in certain stages of human progress—not necessarily coincident in point of actual time—the same mode of living has been adopted by different races in various countries. The crannoge of Ireland bears some resemblance to the pile-dwellings of Switzerland, and our own fen districts will most likely show that we had our population of lake-dwellers, when much of the land, now artificially drained and dried, was permanently submerged.

PROGRESS OF INVENTION.

PHOTOGRAPHY WITH DRY PLATES.—Photographers have never ceased to look for a process by means of which dry instead of wet plates might be used. Many such processes have been proposed; but though some of them have answered tolerably well, the greater length of time required for exposure, and generally a want of delicate graduation, and therefore of truth, in the tints and shadows obtained, has prevented any of them from being generally adopted. A want of complete success is the more unfortunate as the necessity for using a wet plate involves a very large amount of trouble and annoyance; especially when mountainous and other places accessible with difficulty, are to be visited. This inconvenience which has so long been felt, is now overcome; at least so far as perhaps it is possible to overcome it; since a wet must ever be superior to a dry plate in sensitiveness. The improved process, which is due to Mr. W. England, consists in adding to each ounce of ordinary bromiodized collodion, two grains of bromide of cadmium and two grains and a-half of common resin, then shaking the bottle well and allowing it to rest for a couple of hours. After this it may be used for coating the plate, which is sensitized by being placed for a few minutes in a silver bath that contains forty grains to the ounce, and four drops of nitric acid to the pint. The development is effected, after running a little varnish round the edges of the plate to prevent the film from becoming loose, and slightly washing, by ordinary iron solu-

tion, to which when it is poured off the plate two or three drops of a thirty-grain solution of silver are to be added, after which it is to be poured on again. Should it be found that the exposure in the camera has been too short, the development may be continued by a gelatino-iron solution. The fixing is effected in the usual way. The resin is supposed to act mechanically; and employed in this manner, the developer need not be pyrogallic acid. Only double the time required for exposure with a wet plate is necessary when this process is employed, and the pictures obtained by means of it are quite satisfactory. It involves, however, one inconvenience: fogging begins to take place after a certain number of plates have passed through the bath. But the addition of a few drops of ammonia or solution of carbonate of soda, and a few drops of solution of cyanide of potassium, placing for a few moments in the sun, filtering, and slightly acidifying with nitric acid, not only renders the bath as good as before, but suits it admirably for use in the wet process.

NEW BLEACHING PROCESS.—Until a comparatively recent period the process of bleaching was extremely tedious; it is still both troublesome and expensive. As it is carried on to an enormous extent, any improvement in it is a matter of the highest importance. It has been greatly simplified by MM. Tessié du Mothay and Rousseau, without being rendered less effective or less generally applicable. The article to be bleached is immersed in a solution of permanganate of soda, which has been rendered slightly acid, and is stirred about in it for a few minutes with a glass rod. It is then plunged into a solution of sulphurous acid, which removes the violet brown oxide of manganese deposited upon it in the first bath. After the successive immersions in the two fluids have been repeated two or three times, it is found to be beautifully white, without its fibres being in the least impaired in strength. In this, as in all the processes which have been used for bleaching, oxygen is the agent which destroys the colouring matters; but it is here applied in the form of ozone, which is disengaged from the permanganate by the organic matters. Permanganate of soda, is at present, somewhat costly, but MM. Du Mothay and Rousseau have discovered a method of producing it that is extremely economical.

SUBSTITUTE FOR SODIUM AMALGAM, IN METALLURGICAL OPERATIONS.—The gold set free in extremely minute particles from crushed quartz, etc., is covered with an impalpable powder which protects it from the action of the mercury intended for its separation, and thus a considerable amount of gold is lost. In addition to this, the mercury thrown into a state of minute division by the agitation employed, being covered by the same impalpable powder, is incapable of reuniting: a considerable portion therefore assumes the appearance of a fine powder, and is carried off with the refuse; and thus a large amount of mercury is wasted. These two sources of loss have caused a great diminution of profits. It was, however, fortunately ascertained that the brilliancy of the mercury is restored, so that it will run together freely, and unite with the gold with the greatest avidity, if a minute quantity of sodium amalgam

is added to it. Hence sodium amalgam is now an important article of commerce. It is considered highly explosive, and therefore very dangerous: but such is not the case, the explosive property of pure sodium on coming into contact with water is lost almost entirely when it is associated with mercury, so as to form an amalgam. But sodium amalgam is now likely to be superseded by a far less expensive, and it appears not less useful material. Caustic soda has not only been found quite as effective as sodium amalgam, but it is contested that the sodium in the amalgam actually assumes the form of caustic soda before producing its effect. A very simple experiment will show the efficiency of the soda. If a finely pulverized metallic powder is thrown into water, no amount of stirring will cause it to fall to the bottom of the vessel; it is rendered specifically lighter than the fluid by the coating of air which adheres to it. But if a very small quantity of caustic soda or potash is added it will soon descend from the surface to the bottom. It is supposed that the minute particles of mercury also, and of gold, are prevented from coming into contact by a coating of air, which the alkali removes in a way which has not yet been ascertained. This, if the real, is perhaps not the only effect produced by the alkali. The potash of soda must not be allowed to lose its causticity by exposure to the air during transport, etc., or it will be ineffective: it may have become a carbonate, without those who use it being aware of the fact.

NEW APPLICATION OF TUNING-FORKS.—An instrument has recently been constructed at Paris which possesses great power and sweetness. It somewhat resembles a piano, but is far more simple, as the strings are replaced by tuning-forks, one for each note. The sounds are produced by hammers, and are very persistent unless brought to an end by removing the fingers from the keys, and thus allowing the dampers to act.

DISSOCIATION OF GASES AT HIGH TEMPERATURES.—Some interesting researches on this subject have recently been made by M. L. Cailletet, in developing the discovery of M. Sainte-Claire Deville, that at a high temperature the constituents contained in a mixture of gases will separate. As it is necessary to cool the dissociated elements rapidly, it was necessary to devise an apparatus suited to the purpose. By means of this apparatus some important facts were observed. Thus, that oxygen has no action whatever on hydrogen, carbon, or carbonic oxide, placed within a mass which is at a temperature higher than the melting point of platinum; and the conclusion arrived at was that all bodies would most probably be dissociated by a temperature sufficiently high.

APPLICATION OF A NEW PRINCIPLE TO FIRE-ARMS.—The inertia of the projectile causes a certain time to elapse before it is set in motion. A certain amount, therefore, of the force of the gunpowder is wasted, and the more rapid the explosion the greater the loss, from this cause. M. Galant, of Liege, has invented a breech-loader which meets this difficulty. The force of the charge is first communicated to an elastic body which is easily set in motion, and the force which in ordinary cases is wasted, but in this is stored up, is gradually

communicated to the ball, after it has begun to move. The charge is ignited by a needle, the explosion commencing at the end next the ball, but between the latter and the powder, are placed five pads of felt, those next the ball having been for the sake of lubrication, moistened with a fatty matter. This arrangement altogether changes the nature of the explosion. A white smoke escapes from the muzzle, instead of flame, and the penetrative effect is so great that with a charge consisting of 6·5 grammes of powder and a cylindrical-spheric steel ball weighing fifteen grammes, a plate of steel twenty-nine millimetres thick was perforated at the distance of one hundred metres. Omitting any of the pads causes a proportionate increase in the recoil.

NOTES AND MEMORANDA.

THE WORM PHENACIA PULCHELLA.—We are indebted for the following remarks to Mr. Jonathan Couch, F.L.S.:—"The INTELLECTUAL OBSERVER, No. 55, informs us, in a note copied from the *Annals of Natural History*, No. 103, that this has been described as a new species, which it may be to the generality of naturalists, but it is far from new to myself or to Mr. W. Laughrin, A.L.S., who long since sent them to the British Museum, and who has lately dredged a considerable number from sandy ground off the coast of Cornwall, at a depth of about forty fathoms. They appear to be not attached to the bottom, or to any substance at that depth; and that they are even capable of rising high in the water by their own action, appears from a note that I made long since, of one which was obtained, in its case, high in the water over a considerable depth. From the thinness and transparency of the case with the marks of rings, I have supposed that it was formed from an exudation from the surface of its body. This worm readily quits its case, or shrinks into it when afraid."

SPECTRUM OF APATITE.—Mr. W. G. Lettsom writes to us from Monte Video (12th June, 1866): "With reference to the letter of Professor Church, contained in No. 52 of the INTELLECTUAL OBSERVER, I beg leave to remark that the apatite which occurs in Spain, I believe at Villa Rica, in nearly colourless transparent crystals, exhibits the absorption bands as distinctly as zircon does. Five of these bands are very clearly defined. One, the second from the red end of the spectrum, is nearly as dark as the black zircon band."

THE RAPID INCREASE OF THE STAR IN CORONA.—Mr. Lynn, of the Greenwich Observatory, noticing, in *Astr. Nachr.*, a letter from Herr Schmidt, of the Athens Observatory, stating that between half-past eight and half-past nine, Athens time, on the 12th May, he was surveying the heavens near Corona, and must have seen the so-called "new star," if it had been as large as 5 mag., applied, through Mr. Huggins, to Mr. Birmingham, of Tuam, to know at what hour on the same night he saw this remarkable variable as of the 2nd mag. The reply was, not later than 11.45 p.m., local time, whence Mr. Lynn draws the important conclusion, that at 8 p.m., Greenwich time, the star must have been less, and may have been much less, than 5 mag., and that it increased to the 2nd mag. in four hours, either suddenly or with great rapidity. This star was noticed, on the 4th May, by Mr. Barker, of London, Canada West, as brighter than ϵ Corona. He thinks he saw it one or two years ago.

NEW PLANETS.—Mr. Pogson discovered a new planet, 11.5 mag., on the 16th of May. Professor Peters, of Hamilton College, United States, also discovered one on the 20th of June of the same size. The numbers will be (87) and (88). They are named Sylvia and Thisbe.

NEW PARASITIC CRUSTACEAN.—*Annals of Natural History* contains a translation of a paper by M. Hesse on a parasitic crustacean living in a small tumour often noticed in young green wrasses,* not far from the eye and the bronchial aperture. This tumour is formed by the entrance of a young crustacean of the order Lernæida under the fish scales, which it displaces as it grows, and eats a hole in the flesh. The body is fusiform; head small, rounded at the apex, bearing above a median eye, a proboscoidiform process with denticulated jaws, and three pairs of prehensile footjaws.

DIALYTIC ACTION OF INDIA RUBBER AND METALS ON GASES.—A paper by Mr. Graham will be found in *Proceedings of the Royal Society*, 86, on this subject, in which it is stated that a thin film of caoutchouc has no porosity, and is really impervious to air or gas; but the same film is capable of liquefying the individual gases of which air is composed, while oxygen and nitrogen, in the liquid form are capable of penetrating the substance of the membrane (as ether and naphtha, etc.), and may again evaporate into a vacuum, and appear as gases. When thus acting on air, oxygen is absorbed two and a-half times more abundantly than nitrogen. The penetration by hydrogen of platinum and iron tubes, discovered by M. M. St. Claire Deville and Troost, is supposed by Mr. Graham to be connected with "a power resident in these and other metals to absorb and liquefy hydrogen, possibly in its character as a metallic vapour." Palladium foil at 100° C. condenses 643 times its volume of hydrogen, but has no absorbent power for oxygen or nitrogen. Mr. Graham observes, "It is believed that metallic pores, and indeed all fine pores, are more accessible to liquids than to gases, and in particular to liquid hydrogen."

CONGELATION AND DEATH OF ANIMALS.—Dr. Davy, finding that a statement made by him many years ago, to the effect that a leech might be frozen without loss of life, was contradicted by more recent experiments of M. Puget, has repeated his investigations on leeches, frogs, etc., and he arrives at the conclusion that "the thorough congelation of an animal is incompatible with life." It is still, however, not certain to what extent congelation may be carried without death necessarily ensuing. What, for example, are we to make of the story of the frozen carp told by Sir J. Franklin, and cited by Mr. Couch. The amount of freezing in these cases may have been nearly complete. Dr. Davy's paper is in *Proceedings of the Royal Society*, 86.

MAGNETIC ACTION OF THE MOON.—*Proceedings of the Royal Society*, 86, contains a paper by Lieut.-General Sabine, F.R.S., on the lunar diurnal variation of the magnetic declination, and of the horizontal vertical components of the magnetic force, derived from seven years Kew observations, and from comparison with observations in other parts of the world. The paper states that "a magnetic variation shown to be thus obviously dependent upon the moon's position relatively to the terrestrial meridian, and agreeing in its principal features in such various localities, is urged by the author as being ascribable, with great probability, to the direct magnetic action of the moon."

CRYSTALLIZING CARBON.—M. Lionnet gives the following process in *Comptes Rendus*:—Take a long thin leaf of gold, or better of platina, and wind round it a helix formed of a similar tin leaf, so that the covered and uncovered portions of the platina shall be about equal. With the metallic couple thus formed a spiral is made, and plunged into sulphide of carbon. The sulphide is slowly decomposed, the sulphur combining with the tin, and the carbon being precipitated in crystals.

* For an account of the wrasses, see Couch's *Fishes of the British Islands*.



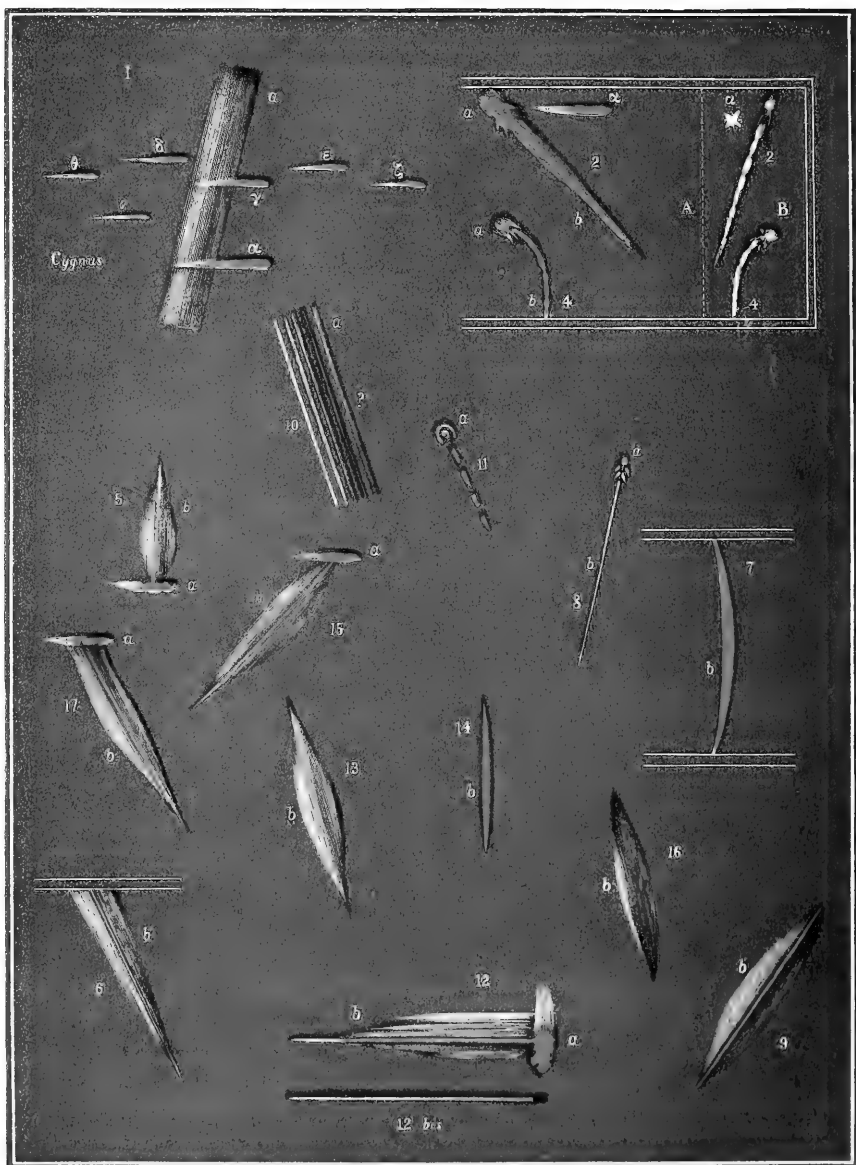

PLATE V. A. Hesse.

THE INTELLECTUAL OBSERVER.

OCTOBER, 1866.

PRISMATIC SPECTRA OF THE AUGUST METEORS, 1866.

BY A. S. HERSCHEL, B.A.

(*With Coloured Plate.*)

AN instrument for observing meteors was described in the August number of this journal, which had for its—certainly very unique, if not indeed for what must have appeared its impossible—object, to examine the colours, or other peculiarities of the prismatic spectrum produced by a ray of light emitted from the luminous streak, or from the nucleus of a shooting-star. A wide field of view; great facility of direction,—or in other words direct vision; the means of pressing two quick eyes into the service,—or, in other words, binocular arrangement; and, last of all, great power in the prisms, are the characters without which an instrument for viewing meteor spectra will be comparatively useless. A peculiar construction of prisms, described in a former volume, and a binocular arrangement of the same prisms, figured in the last-mentioned number of this journal, and answering all the above conditions, was invented as early as the year 1864 by the writer of these pages; and a meteor spectroscope, of the pattern now made by Mr. Browning, was presented by the writer to Mr. Babinet, at Paris, in August, 1864; without any attempt having hitherto been made, so far as the writer has been able to learn, to examine the peculiarities of meteor spectra, either by this or by any other means. If the problem of chemically analysing the substance of luminous meteors, by means of their light spectra, is not yet fairly solved, it is at all events pretty certain, from the following observations, that the metal *sodium* produces the most enduring light of the much-admired trains of the August meteors; and that at least one other mineral substance (either potassium, sulphur, or phosphorus) lends its aid, but in a much less remarkable degree, to produce the same luminous trains. Observations renewed

on the 13th of November will, doubtless, show a different result. The streaks of the November meteors are quite as enduring as those left by meteors on the 10th of August; but their colour is white, verging to blue, while a glance at the brightest and most enduring meteor-streaks left on the 10th of August generally shows their *yellow* cast of colour. The first, or rudimentary colour of the August meteor-streaks is, like that of the November streaks, white or bluish; and some few continue of this colour until they disappear. The effect is owing to the ignited vapour of the other mineral substance (potassium, sulphur, or phosphorus) to which allusion was just made, playing a principal part in the production of the streaks. Although glowing for a much shorter time, and with less intensity than the vapour of the metal sodium, it nevertheless in some instances forms the entire light of the meteor-streaks seen on the 10th of August. White, bluish, or "phosphorescent" streaks are most prevalent among the November meteors, and the light of this element, whatever it be, by which this bluish kind of phosphorescence of the streaks is produced, will probably appear more highly developed, and its spectrum will be more easily identified in the streaks of the meteors on the 13th of November, than it could be (from the brightness of the sodium-line) in the enduring streaks of the meteors of the 10th of August last. It extends between the red and the blue; and is that portion of the visible train-spectrum which is called "diffuse" in the following observations:—

The meteor spectroscope, as already described, presents to the view a pretty considerable extent of the star-spangled surface of the sky. The spectra of the well-known "seven stars" of Ursa Major, may, for example, be seen together in the instrument at a glance. Each bright star is converted into a line of highly-coloured light, nearly three-quarters of a degree in length; and horizontal, when the instrument is held in its natural position. Fifth magnitude stars are obliterated, and fourth magnitude stars appear only as a greyish line of light of no decided tint or colour. Prismatic hues are first perceptible in stars of the third magnitude and upwards. When the spectroscope is turned to a given part of the sky, the stars, through it, appear as if a gigantic wet brush had been applied to them in that part of the sky, and their light had been partially washed out in a particular direction. The effect is produced by the dispersion of the light of each star in passing through the prisms. Its single beam is spread out, as it were, into a fan of different coloured rays, called its "prismatic spectrum," and its light is proportionately enfeebled; but the stars appear to occupy very nearly the same relative positions

in the field of view of the meteor spectroscope as that which they occupy in the sky to the unassisted eye. In this manner the instrument is well adapted for analysing the light of any bright object presenting itself for a moment in the part of the sky under examination, as, for example, the light of a shooting-star, or of its bright, fast-fading luminous train.

A flame of mono-chromatic light, or of light possessing only one degree of refrangibility presents, when viewed in the meteor spectroscope, a striking aspect. The flame of a common spirit-lamp, for example, possesses a faint and hardly distinguishable spectrum. Its light, when viewed through the instrument, is so dispersed, in a horizontal direction, as to be almost washed out, or obliterated; but if salt be introduced into the wick, the flame at once becomes conspicuous, and the homogenous character of its light is perceived by the sharpness of the definition, every flicker of its outline being visible, as perfectly and as brightly as it appears to the naked eye. The example of the spirit-lamp with a salted wick illustrates the streaks of some of the August meteors, which, when examined optically by the meteor spectroscope, reveal their chemical character from the composition of their light. Seventeen spectra were observed, in eight of which the sodium line, for the most part brilliant, and in some cases forming the entire spectrum of the streak, was plainly visible. Its position relatively to the rest of the spectrum, "on the side towards the red" (Nos. 9, 12, and 14), its golden yellow colour (Nos. 7, 8, 12, 14), its extreme brightness (Nos. 7, 14), and its single or isolated appearance (Nos. 8, 14) perfectly agree with the well-known appearance in the spectroscope of the yellow sodium flame; and at the same time with the spectrum of no other elementary substance, sodium only excepted, with which the spectroscope has made us acquainted. That the element sodium should be the first detected in the meteor spectra is by no means surprising, when the well-known brightness of this line of the spectrum is considered, wherever a trace of sodium exists in the outer luminous envelope of a flame. Nevertheless the fact, that the sodium line has been observed in the spectrum of lightning, is no proof that the meteor-streaks owe its presence in their light to the existence of the vapour of sodium in the atmosphere. No lines of nitrogen, or of any other known gas, accompany the sodium flame in the train spectra of the August meteors; but on the other hand the great intensity of the sodium streaks makes it almost certain that the meteors contain this element as a part and parcel of their chemical composition.

To obtain the spectra of meteors, a night must be chosen when they are more than ordinarily plentiful (such as, for

example, the 10th of August, or the 13th of November), and the attention should be directed below the radiant point, to that portion of the sky where the meteors will, in all probability, appear to fall vertically towards the earth. Near (*but not too near*) the radiant point, their course is also foreshortened, and their apparent motion is comparatively slow. Their course in the spectroscope will in this case appear parallel to the refracting edges of the prisms, which is an essential point to be kept in view in the arrangement of the spectroscope, so as to obtain the prismatic spectra of meteors. Some resolution, in the next place, is required to fix the attention constantly within the stipulated bounds; for the sky meanwhile is alive with meteors; and some few are of a startling kind, perhaps even calculated to shake the nerves of any but a cool observer. Paying attention to these precautions during the hours from midnight until sunrise on the morning of the 13th of November next, no difficulty, it is apprehended, of any kind will be experienced in obtaining the spectrum of a shooting-star; and as the necessity of the case seems to require it, notes should be made of their most peculiar features.

All the necessary preparations having been made, and with the prospect of a considerable meteoric shower at hand, a watch for meteors was commenced, in order to observe their spectra, on the night of the 9-10th of August last. Expectation on the first night was not destined to be disappointed, and six meteors were observed to pass across the field of view. Notes of the peculiarities were made, and of the general appearance of their spectra, and are briefly as follows:—

August 9th.—No. 1; 8h. 40m. p.m. About equal to a fourth mag. star. Passed across the body of Cygnus, in half a second; leaving no streak. The spectrum exactly resembled that of a fourth mag. star (α Cygni) close to which the meteor passed, the conclusion being that *the meteor might be a solid body, heated to ignition.*

August 10th.—No. 2; 0h. 27m. a.m. Nearly as bright as Sirius. Commenced near Polaris (in the field of view), and shot 15° or 20° (beyond the field of view) along a line directed from Cassiopeiæ, leaving a streak on its whole course for four seconds. The latter part of the meteor's course was seen with the naked eye. In the spectroscope two images of the meteor and of the streak were visible, one refracted, and one accidentally reflected at the side. These two images of the meteor and of its streak could not be distinguished apart, at least in their general appearance, the conclusion being that the light both of the nucleus and of its luminous streak was homogeneous, and that *its luminous substance was a gas.*

No. 3; 0h. 42m. a.m. A very brilliant fire-ball, with a flash

like lightning, burst overhead, leaving a streak from θ Cygni, half-way to α Lyra, for twenty seconds. A cloud unfortunately dimmed the streak. In the spectroscope, as far as cloud would permit any judgment of the streak to be formed, its aspect was the same as to the unassisted eye. The light of the streak was therefore probably homogeneous, and *the streak itself probably a luminous gas.*

No. 4; 1h. 15m. a.m. About equal to a second mag. star. Shot in three-quarters of a second, from θ Cassiopeiæ half-way to \circ Honorum, and then turned round the quarter of a circle, to u Honorum, where it vanished, leaving a streak for half a second on its course. In the spectroscope the general appearance of the meteor, and of the streak in the field of view, was the same as that of the purely reflected image by the side; the conclusion being, as before, that the light, both of the meteor and of the streak, was homogeneous, or that *the luminous substance of the meteor was a gas.*

No. 5; 1h. 40m. a.m. About equal to a second mag. star. Passed slowly through a short path near β Tauri, directed from Cassiopeiæ; duration, one second; leaving a streak at the place for three seconds. The spectrum of the meteor and streak was quite equally diffused over a space about $\frac{1}{4}^\circ$ in width; its colour greyish white; the diffuse train-spectrum vanished without further change, the conclusion being that in this case *the train might, like the nucleus, be composed of heated sparks.*

No. 6; 2h. 15m. a.m. Equal to a first mag. star. Shot on the same course as No. 2; duration, one second; leaving a bright streak for four seconds. The spectroscope was turned towards the streak before it disappeared. The train was widened by the prisms to a greyish-white band, somewhat greater than a quarter of a degree in breadth. It faded from sight without further change; the conclusion in this case also being, that *the train might possibly be composed of heated sparks.*

Three spectra in the foregoing observations appeared homogeneous, like that of a luminous gas (Nos. 2, 3, 4); and three were continuous, or diffuse (Nos. 1, 5, 6), like that of an ordinary spark. The question, accordingly, whether luminous meteors might or might not contain solid substance, remained undecided, when daylight beginning to appear, put a stop to further observations.

The following night, observations could fortunately be resumed, and the perplexing appearance of the meteor spectra on the previous night, received a truly surprising and most satisfactory explanation, in the repeated appearance in the spectra of the streaks of a yellow line, *unmistakably that of the metal sodium in combustion.*

Two observers being engaged to watch on this night, one checked the observations of the other with the naked eye. The troublesome reflected image in the spectroscope could accordingly be dispensed with, and it was kept out of sight; so that the views obtained of the meteor spectra came as nearly to perfection as could be wished.

August 10th, continued.—No. 7; 4h. 22m. p.m. Equal to a first mag. star. Shot from γ Cephei to ι Draconis in three-quarters of a second; leaving a bright streak for five seconds on its course. The meteor first appeared in the field of view, and passed out of it. The brightest portion of the streak, however, was brought into the middle of the field of view; where it occupied an excellent position, parallel to the refracting edges of the prisms, for viewing its prismatic spectrum. A slight effect of distortion (produced in the prisms) caused it to appear bent, like a bow, across the field of view (Fig. 7). The spectrum presented the appearance of a narrow line of light, exceedingly brilliant, of a golden-yellow colour, and not more than 5' in width. It faded gradually along its whole length, and disappeared in about two and a half or three seconds. Its description, noted in the register, kept for the purpose at the time, was—"neither double, triple, nor multiple, nor continuous, but purely and positively mono-chromatic."

August 11th.—No. 8; 0h. 15m. a.m. Equal to a third mag. star. Shot from β Cephei to δ Draconis, in three-quarters of a second; leaving a luminous streak for two seconds. The spectrum of the streak was a remarkably slender, orange-yellow line of no appreciable breadth, without any continuous spectrum near to it, or any other neighbouring bands, or lines. It was very bright, remaining in sight two seconds; and it gradually faded away until it vanished. The spectrum of the nucleus appeared to be undistinguishably the same as that of the streak.

No. 9; 0h. 20m. a.m. Equal to a third mag. star. Shot from α Cephei to 33 Cygni (Fl.), in three-quarters of a second; leaving a streak for one second and a half. The spectrum of the streak was dull grey, diffuse, about $\frac{1}{4}^{\circ}$ in width, with a yellow line included in it, *on the side towards the red*. The yellow line and the diffuse band disappeared together. The spectrum of the nucleus, appeared to be appreciably the same as that of the streak.

No. 10; 0h. 33m. a.m. Equal to a fourth mag. star. Shot from ρ Cassiopeiæ to σ Honorum, in half a second; leaving no streak. The spectrum of the nucleus appeared to be concentrated into a few faint lines with wide intervals between them, but this description is very uncertain.

No. 11; 0h. 33m. a.m. Equal to a third mag. star. Re-

turned about half way along the course of the preceding meteor, in half a second; leaving no streak. The spectrum of the nucleus was a concentrated point of yellow light, having all the appearance of some yellow shooting-star.

No. 12; 0h. 42m. a.m. Equal to Sirius; colour white. Shot from α Trianguli to η Piscium, in one second and a quarter; leaving a streak for four seconds on its course. In the spectroscope the meteor slowly crossed the middle of the field of view, on a course directly parallel to the refracting edges of the prisms, producing a very superb spectrum. The spectrum of the nucleus was red, green, and blue; extremely brilliant. The train-spectrum was diffuse; $\frac{1}{4}^{\circ}$ in width; in which a thin bright orange-yellow line was plainly seen *on the side towards the red*. The diffuse portion of the train-spectrum faded in about two seconds, apparently following the nucleus. The sodium-line remained extremely bright for not less than two seconds longer, and faded gradually along its whole length, when it also disappeared. The singular characters of this spectrum were most distinctly and beautifully seen, and the long endurance of the sodium line, after the rest had disappeared, was leisurely watched.

No. 13; 1h. 23m. a.m. Equal to a third mag. star. Shot from P Camelopardi to α Draconis in half a second; leaving a streak for two seconds on its course. The train-spectrum was a diffuse band of greyish light, $\frac{1}{4}^{\circ}$ wide, somewhat brighter on the side towards the red, and it so vanished.—The spectrum of the nucleus was appreciably the same as that of the streak.

No. 14; 1h. 55m. a.m. Equal to a first mag. star. Shot from σ Custodis to 3° below Polaris, in three-quarters of a second; leaving a bright streak for three seconds. The meteor first appeared in the field of view, and passed out of it. The spectrum of the early portion of the streak, behind the nucleus, was a greyish diffuse band, $\frac{1}{4}^{\circ}$ in width. The spectrum of the nucleus was appreciably the same. The brightest part of the streak, before it faded, was brought into the field of view, well situated parallel to the edges of the prisms, and in the middle of the field for about two seconds. Its appearance was that of a golden-yellow line of light, about 5° in length, some $4'$ in width, tapering gently towards the ends; and perfectly sharp and well defined. It was unaccompanied by any continuous spectrum, or any bands, or other lines; and it so disappeared from the ends towards the centre.

No. 15; 2h. 15m. a.m. Equal to a second mag. star. Shot from μ to α Andromedæ in three-quarters of a second; leaving a streak for two seconds. The train-spectrum was a diffuse, greyish-white band; $\frac{1}{4}^{\circ}$ in width, and about 6° or 7°

long; and faded away without any further change. The spectrum of the nucleus showed prismatic colours.

No. 16; 2h. 16m. a.m. Equal to a second mag. star. Shot from θ Cassiopeiæ to β Andromedæ, in half a second, leaving a streak for two seconds and a half. The meteor was seen with the unassisted eye. The last-fading portion of the streak was examined in the spectroscope, where it appeared more widely diffused than when seen with the naked eye. Its colour in the spectroscope was a dull greyish white.

No. 17; 2h. 27m. a.m. Brighter than a first mag. star. Shot from α Cassiopeiæ to σ Honorum, leaving a streak for two seconds and a half. The train-spectrum was a diffuse greyish-white band, $\frac{1}{4}^\circ$ in width, not sensibly brighter in any part; and it so faded. The spectrum of the nucleus was bright,—red, and green.

Daylight at this time began to appear, and observations were obliged to be discontinued; the streaks of the August meteors might, however, already be plainly divided into two classes. In the majority of cases, a bright yellow line, having the unmistakable appearance of the sodium line, was clearly visible in the spectrum. In a smaller number of cases the spectrum was merely a diffuse and greyish light band, or ordinary spectrum of weak intensity, resembling the spectrum of the glowworm's light. It will be interesting to observe this form of meteoric spectrum, should it be more common among the "phosphorescent" streaks of the November meteors than it was in August last; when only five such purely "phosphorescent" streaks were noticed, entirely free from sodium light.

The spectra of the meteor-nuclei were seen in a few cases only with distinctness; as they were in general overpowered by the brightness of the sodium light, whenever that was present. When the streaks were phosphorescent only, and free from sodium light, the nuclei in general presented highly-coloured spectra, like the spectrum of solid matter at a glowing white heat, or like the spectrum of an ordinary gas flame containing white-hot solid particles of carbon. A better night for observing nucleus-spectra would be the 12th of December, when meteors leaving no trains are plentiful; and they are for the most part very brilliant, radiating from some part of the constellation Gemini.

That which spectral examination of the August meteors has most certainly brought to light, is the existence of an extraordinary quantity of the vapour of sodium in their luminous streaks; so that many of the streaks, especially the most conspicuous, and the most slowly-fading amongst them, consist of nothing else but soda flames for a great propor-

tion (that is to say the latter portion) of the time that they continue visible. Their condition is then exactly that of a flame of gas in a Bunsen's burner, freely charged with the vapour of burning sodium; or of the flame of a spirit-lamp newly trimmed, and largely dosed with a supply of moistened salt.

It is difficult to believe that the vapour of the metal sodium exists, in such considerable quantities, at the confines of the atmosphere. It is much more reasonable to suppose that it is brought into the atmosphere by the meteors themselves, so as to be deposited in the luminous trains that mark their course. The material of the August meteors is, therefore, probably a mineral substance, in which sodium is one of the chemical ingredients. Such is the rather satisfactory termination of an experiment, which it will be very easy to repeat, whenever an abundance of meteors on the night of the 10th of August offers an equally favourable opportunity for examining their spectra by the aid of the meteor spectroscope.

The connection believed by adherents of Chladni to exist between shooting-stars and aërolites is now shown, at least in August, to extend itself in some measure to their chemical composition. The meteorites of Aumale, which fell on the 25th of August, 1865, were found, on analysis by Mr. Daubrée, to contain *soluble salts* (chloride and carbonate) of sodium. A circumstance so uncommon in the composition of aërolites, allies the meteorites of Aumale very closely with the sodium-bearing streaks of the meteors of the 10th of August.

In this manner each new acquisition of knowledge, however unforeseen may be its origin, tends to support the theory of Chladni, and to confirm the belief that shower-meteors and shooting-stars are actually aërolites of small dimensions. In whatever manner aërolites and shooting-stars are related to each other in their astronomical and other peculiarities, they will certainly require a vast number of further experiments to unfold their real source.

EXPLANATION OF THE PLATE.

The meteor spectra are numbered in the plate, after the description in the text, in the order of their appearance; *a*, represents the spectra of the nucleus, and *b*, the spectra of the meteor trains. Double white lines indicate the boundaries of the field of view.

Figs. 1, 10, represent the persistent luminous impressions of the *nucleus* only, and the meteors left no streak. 1, a meteor in *Cygnus*; 10, a meteor spectrum, conveying a faint

impression of interruptions; 11, the meteor could be followed by the eye, but it left no streak.

Figs. 2, 4, refracted and reflected images, viewed together (A refracted, B reflected), of *Polaris* (*a*); and of two meteors.

Figs. 5, 6, 13, 15, 16, 17, diffuse train-spectra.

Figs. 9, 12, ditto containing the *sodium* line.

Figs. 7, 8, 11, 14, purely mono-chromatic, or *sodium* meteor spectra; similar to Nos. 2, 4, but better defined.

Fig. 12, *bis.*, represents the appearance of No. 12, two seconds after the disappearance of the meteor. Total duration of the streak, four seconds.

Note.—The distortion or curvature of the streak by the prisms, was plainly seen in No. 7, but not in the remaining spectra. The meteor spectroscope was generally held nearly horizontally; but in No. 12 the instrument was held almost vertically, and the meteor moved in a nearly horizontal direction. The effect of producing the prismatic spectrum was the same as in the other cases.

THE LINEATED PHEASANT OF BURMAH.

BY CAPTAIN R. C. BEAVAN.

SYNONYMS. *Gallophasis lineatus*, Auct. Jerdon's *Birds of India*, vol. ii., part 2, pp. 531 and 535. *Euplocomus lineatus*, Belanger, who has figured it in his voyage, plate 8 of *Birds*. *Phasianus lineatus*, Latham. *Phasianus reynandii*. Lesson. GENUS, *Grammatoptilus*, of Reichenbach. Mason's *Burmah*, edit. 1860, pp. 230 and 687. Burmese name "Yeet" or "Yit."

Dr. Jerdon, in his famous work, the *Birds of India*, describes the group of the Kallege Pheasants, amongst which he includes the species under review, as one which leads from the true pheasants (of which *Phasianus colchicus*, Linn., the Common Pheasant of the British Islands, is a type) to the Firebacked Pheasants and Jungle Fowl of India and Malayana; and as the group in question partakes of the characters of both the true pheasants and the jungle fowl, so in its geographical distribution it is found to range from the Himalayas, the head quarters of the pheasants, to the Burmese provinces, where jungle fowl and their allies take their place.

The genus *Gallophasis*, of Hodgson, or that of the Kallege Pheasants, as they are more popularly termed, embraces at least four species—two from the Himalayas—a third from Assam and Arracan, and the fourth, our species, from the

Tennasserim provinces of Burmah. They are birds about the size of a fowl, with glossy black and white plumage in the males, the females being invariably of a sober brown hue; the fleshy orbits, or naked skin round the eyes, is bright red in both sexes, and both have a well-developed crest. The tail is moderately long, of sixteen feathers, raised in the centre as in the domestic fowl, and held demi-erect, the feathers drooping and curving outwards. Essentially hill birds, they live at various elevations of from 1500 to 7000 feet above the level of the sea, and in places where they occur abundantly, are for the most part the only species of pheasant found, at the comparatively low elevations frequented by them.

The male of the species under notice has the colouration of the neck, back, and upper parts generally, almost exactly similar to that of the domestic guinea-fowl. The two arched central tail feathers are of a pearly grey white, much more so than the rest: the throat, breast, and underparts are black, with the sides of the throat and flanks longitudinally striated with white. The head is pure black, with a long pendent crest; the orbital skin bright red, beak greenish, horny, legs duller and strongly spurred. Length, about 27 to 28 inches, and weight about 3 lbs. The female is a smaller bird, of a light brown colour throughout, without a trace of black; the orbital skin as in the male, but she has no spurs, and the crest is smaller. The irides are reddish brown in both sexes.

In 1865, when the last list of vertebrated animals, living in the gardens of the Zoological Society of London, was published, there were two pairs of this species flourishing there, besides hybrids, and in the same year I brought up two fine males with me from Burmah, which have since been forwarded, and I hope ere this been safely received by the Society.

Whilst in Burmah, I had several opportunities of seeing this handsome bird in a state of nature, and as hardly anything regarding its habits or economy has as yet been recorded, I proceed to give briefly in detail the results of my own observations, and of information procured on the spot from intelligent natives who were in the habit of capturing them, either for their own use, as food, or for sale in Moulmein.

They breed in the month of "Tagoo," that is, about the month of May, or beginning of June. The nest is always built on the ground, and the female lays from five to seven eggs of a brownish olive colour, like those of the English pheasant, but perhaps somewhat smaller; the young male is at first like the female in colour, but apparently begins to gain his proper plumage after the first moult, and has it perfected by the end of a year. The general habitat of the species may be defined as the thick bamboo and forest jungle, which

clothes the foot and lower slopes of all the hill ranges in the Tennasserim provinces of Burmah. The elevation above the sea cannot be great, but the vegetable productions of this tract of country agree well with those found at an elevation of about 2000 feet in the Himalayas.

Their food consists chiefly of white ants, but they also pick up the roots of plants, young shoots, and when ripe the *toungyar* paddy, or hill-grown rice. In the dry season they are found about the foot of the hills, wandering somewhat as water becomes scarce, but in the rains return to the hill-sides, from which I imagine they never at that time of year move far. In fact, judging from the habits of their congeners in the Himalayas, I should say they were inclined, unless compelled to move by necessity, to keep very much to the same spots on the particular hill-sides they most like. I have found the Sikkim kallege invariably returns to the same bough every night to roost, in spots where seldom disturbed.

The Burmese bird seems to be more gregarious than the Himalayan kalleges. My informant tells me he has seen as many as twenty to twenty-five together, but I should think that this was an unusual occurrence; four or five—perhaps a family of the previous year—would apparently be more usually met with.

Mr. Blyth, a well-known authority on such matters, mentions that some varieties of this bird are scarcely distinguishable from the Assam species of kallege, *Gallophasis Horsfieldi*, Gray, the probability being that where the two species meet in Arracan, individuals of hybrids will be found to occur, in every intermediate phase of plumage; since we know that such are common, where, as in Nepaul, the white-crested bird of Simla meets the black-crested one of Sikkim.

I was lucky enough, during a short stay at Thatone, a town in the Martaban district, some forty miles to the north-west of Moulmein, to see the way in which the Burmese capture the species.

A tame male bird, for which, if a good decoy, as large a sum as twenty-five rupees is sometimes given, is taken and pegged down to the ground in an open space, between three or four clumps of bamboos, on the hill-side frequented by the wild birds. The birdcatcher is led to the choice of a good spot by the recent signs of fresh droppings, or lately upturned soil. The tame bird has a range round his peg of a diameter of about four feet only. In a circle round him, at the distance of about six feet, a row of upright running nooses are fixed in a continuous line, while further off, at the distance of some ten or twelve yards, all likely openings between clumps of bamboos are guarded by other lines of nooses. Half an onion is

then administered to the call-bird, and his ire being aroused by shaking the hand near him, when the bird-catchers retire behind some bushes within thirty or forty yards, and there await the result. If a wild bird is within hearing of the tame bird, the latter will make a peculiar drumming sound with its wings. Jerdon mentions this noise as being also made by the male of the Simla kallege, *Gallophasis albocristatus*, Vigors, but was not aware of the cause which led to its production. "The male often makes a singular drumming noise with its wings, not unlike the sound produced by shaking in the air a stiff piece of cloth. It is heard only in the pairing season, but whether to attract the attention of the females, or in defiance of its fellows, I cannot say, as I have never seen the bird in the act, though often led to the spot where they were by the sound."*

Each wild male is apparently "cock of the walk" of a particular portion of jungle, and on hearing this insult offered to him in his own domain, quickly pushes for the spot, in order to inflict speedy punishment on the daring intruder. By following the direction of the looks of the tame bird, who gets much excited, the wild one is seen to approach quickly until within a short distance of his adversary, whose looks he measures with no friendly eye, as he marches round and round, with feathers puffed out, until he looks twice his usual size, and gives utterance at intervals to angry notes of defiance. Nearer and nearer he comes, and if he does not, in his eager haste, get noosed whilst approaching, terrific is the battle that ensues, and feathers fly in all directions. The wild bird gets so excited that he speedily becomes absorbed, so intent is he on killing his adversary, in which he would doubtless succeed, did not the hidden Burman, anxious for the safety of his pet, throw a stone, which, dropping into a bush, scares the wild bird, who runs off in a hurry through the nearest opening, and gets caught in a noose.

In case the decoy does not begin to drum of his own accord, the birdcatcher imitates the sound with some feathers tied on a stick, which he rapidly twirls between the palms of his hands, so as to cause a humming sound. The effect of this is increased by the voice, and the result is an exact resemblance to the humming sound produced by the quick vibration of the wings of the bird. The sound immediately sets off the decoy, or brings the wild bird to the spot.

The sport is carried on by two men—one carries the decoy about, carefully muffled up in a cloth until wanted; and the other takes charge of the bundle of nooses, and a dhar, or heavy Burmese knife, with which to clear away the brushwood. If

* *Birds of India*, vol. ii. part 2, p. 533.

after an interval of from ten minutes to a quarter of an hour no response is met with to the drumming of the decoy, the bird-catchers move off to try another spot. They are at times very successful, and catch three or four birds near one place, where plentiful. Of course, males are most frequently taken by this method; but females, also, turn up sometimes, and in paying a friendly visit to the decoy, get captured. They appear to be much more difficult to keep in confinement than the stronger sex.

The method of capture here described is practised in Burmah all the year round but with most success during the pairing season.

THE STREET ARCHITECTURE OF LONDON.

In our former article we feel strongly that due justice has not been done to Gwynn, for his *London and Westminster Improved*, in 1766; or to Mr. Haywood, for his admirable report made in the present year 1866; but we must not forget that we have undertaken to note down a few remarks upon the street architecture of our metropolis as now existing; in attempting which we have the advantage of the observations of a young Parisian architect, who has lately been consigned to us by letters of introduction, and to whom we felt it both our duty and pleasure to act as cicerone. It occurred to us that we could not better commence our duties than by taking our young friend Alphonse Fontaine to the summit of St. Paul's, for a bird's eye (*coup d'œil*) of our metropolis. There is always a great charm in a general view from an elevated position, and—*malgré* the smoke from those abominable and reeking shafts in Lambeth—our friend was delighted with what he saw, and his first observation was, "What a charming effect from your atmosphere. With us on the Continent, everything is marked out clear, crude, and distinct; but here you have an atmospheric medium, which gives an effect to objects most agreeable and enchanting. It is what your celebrated Turner has obtained in his pictures—there is a medium between the spectator and the objects—an aerial effect, adding to the perspective and to the *chiaro oscuro* of the scene. But where are your domes beyond the one I am standing on? In the distance I see two gems at Greenwich; but those on what you term your National Gallery, your London University, and Bethlehem Hospital are mere *pimples*. In Paris we can boast of several noble domes, and hence the

magnificent appearance of our city when viewed from any of the environs."

We had no excuse to offer, and contented ourselves with the apologetic reply that formerly there was a charming cupola upon the church of St. Benet Fink, and another very picturesque dome close by us over the College of Physicians, both of them the works of Sir Christopher Wren, and both lately demolished. There were two others to the westward, which we had no little difficulty in explaining to him were called "the Brompton boilers," but which the good sense of Parliament ordered to be taken down.

The young French architect, seeing our chagrin on the paucity of domes, good naturedly replied, "Well, but you compensate for them in your spires and steeples. What charming forms are those of Bow, St. Bride's, St. Magnus, St. Vedast, St. Dunstan's in the East, and even that humble one close upon us, St. Martin, Ludgate!" and when we informed him that they were all the works of Sir Christopher Wren, he exclaimed, "He was, indeed, an architect!"

The interior of St. Paul's did not excite so much surprise or approval from our companion, beyond being astonished at the aerial effect of the dome, and its *apparent* over its *real* magnitude. Of the embellishments and decorations now in progress he was silent, although it was explained to him they were the works of *foreign* artists. A shrug only was expressive at this announcement. The exterior excited more of our friend's praises than the interior, and the picturesque towers at the west end of the Cathedral, and the circular porticos at the north and south sides he greatly commended.

Instead of adopting the usual plan of dividing the metropolis, guide-book fashion, into certain districts, it was thought better to take the buildings according to their several dates, commencing with the early English and mediæval, then the classical, and finish with the Italian and Palladian. According to this arrangement, the Tower of London first excited the deepest interest in our young friend; Westminster Abbey he thought finer than Notre Dame, but in parts inferior to Amiens or Beauvais; he rejoiced to hear of the intended restoration of the Chapter-house. The Temple Church, and that of St. Bartholomew the Great, in Smithfield, completed the list of ancient ecclesiastical structures. Of the modern, in mediæval fashion, we pointed out to him the Catholic Apostolic, in Gordon Square; All Saints, in Margaret Street; and St. Alban's, in Baldwin's Gardens, as three of the most important of a legion in this style. The first and last of these he considered of the highest merit, and was somewhat surprised that mass had not yet been performed in them, and that they were not

already under the jurisdiction of a Roman Catholic Bishop of London.

Of modern mediæval works, the Palace at Westminster of course stood in the first rank. Alphonse was some time before he hazarded the remark that the enrichments and ornamentations were laid on with too lavish a hand, and that, if some plain surfaces had been preserved, those portions which were enriched would, by contrast, have had an additional value. The Victoria Tower he considered as a *Capo d'Opera*. The buildings at the Broad Sanctuary he found most picturesque, and admirably adapted to the site, and the Crimean Memorial a most successful performance. The numerous attempts at mediævalism springing up so plentifully in all parts, excited the young French architect's greatest astonishment. He was told that by some it was called the Victoria school, to which he replied that it was well named, as it seemed to "*règne partout.*" Many shrugs of the shoulders were given as he passed these specimens of incongruous forms and elaborate workmanship rapidly in review, considering them generally as great monstrosities. The *Music Hall* in the Strand is said to be the crowning triumph of this school. My friend observed that its claims as to being a *chef d'œuvre* might be a question, but that, at all events, the architect had endeavoured to make it characteristic, and had shown his knowledge of the science of *thorough base*. There are, however, some specimens of this style which are deserving of praise; for instance, the schools in Endell Street, St. Giles's; some buildings on the west side of Bishopsgate Street; a house built for Messrs. Alexander, in Lombard Street; and more especially a house on the east side of Mincing Lane, near the south end.

Of Greek and classic buildings, we brought forward St. Pancras Church, in the New Road; the Propylean entrance to the North-Western Railway; the British Museum; and the Post Office in St. Martin's le Grand. The beautiful little façade and entrance to Melbourne House, Whitehall, may be added to the list.

We now approach the Italian and French school, and first of all stand the churches of Sir Christopher Wren, the several towers and spires of which had so delighted our young architect in his panoramic view from St. Paul's. With the interior of these churches he was equally delighted; the ingenuity displayed in adapting the buildings to old sites; the cleverness with which they are lighted; the appropriateness and freedom of the enrichment. The interiors, especially of St. Stephen's, Walbrook; St. Bride's; St. Laurence Jewry; and, more particularly, St. James's, Westminster, all impressed him with admiration at the genius of our great architect, and

with utter astonishment that fashion and false taste unfortunately prevail so much at the present day, that some of these beautiful interiors have been martyred at the hands of the mediævalists. Our friend, we think very justly, remarked upon the bald and incomplete appearance of the exterior of St. James's Church, Piccadilly; surely, in so wealthy a parish and royal neighbourhood, the necessary funds might readily be subscribed for the properly facing the walls with stone, and the raising a glorious tower and spire, to become as great an ornament to this quarter of London as the matchless spire of Bow Church is to the City. The church of St. Mary-le-Strand, and the glorious portico of St. Martin's, both by Gibbs, made a most favourable impression on our visitor; but, on proceeding to Whitehall, the view of the Banqueting House raised his enthusiasm to boiling heat. He jumped and clapped his hands for very joy, and pronounced it to be one of the finest works he had ever seen, either for the grandeur of the pile or the refinement and exquisite delicacy of the detail. From this fragment, judge what the effect would have been if the whole of the intended palace had been completed! Both the Escorial and the Louvre would have been inferior to it! The National Gallery and Trafalgar Square of course formed the subject of some criticism; and when it was asked how long the pedestal *vis-à-vis* to George IV. had been without its equestrian termination, and Nelson without his guardian lions, we pretended a little deafness, and hurried on to Pall Mall; here we felt more at ease, and took some little pride and pleasure in pointing out the several palatial clubs. This is certainly London's first street for architectural effect, occasioned very much by the buildings being insulated, and not mere *façades*, and the lines of some (the War Office, for instance), being set back with a *cortile* in front. The "Travellers'," the "Reform," and the "Carlton" were particularly pointed out; the former seemed to bear away the palm for grace and beauty. St. James's Palace was regarded more historically than architecturally interesting; but, as for Buckingham Palace, I don't know how many shrugs of disappointment our friend made, and, when he saw the equestrian statue in the distance, high in air, and heard that it was the Duke, he was appalled at such an outrage. He recovered somewhat in being shown Bridgewater House, and Lord Spencer's, adjoining; the one quite Palladian, the other of Rome's best period. A long discussion ensued as to their rival merits, resulting perhaps in favour of Spencer House as being the more graceful of the two.

The Marble Arch, in Hyde Park, was the next object we viewed, and our young friend was so jocose in his criticisms upon this work that we were positively ashamed that he should

have seen it. "What!" he exclaimed, "all this expensive material of marble, and no Quadriga, no statues, no inscriptions—nothing upon the columns but those wretched scrolled blocks which I believe are called trusses? If you are at a loss for a subject, send to Birmingham foundries for a car with a Victory riding over *Mayne force*. You need not wait till Sir Edwin and the Baron have finished Nelson's lions; for, as you prefer employing foreigners, we can spare you a corps of sculptors who would turn them out for you presto-presto."

Our companion, in his walk down Oxford-street, was much struck with the meanness of many of the houses at the south side of it, and suggested what a fine boulevard might have been formed when Oxford Road was converted into a street of shops. The Paris boulevards are about the most pleasing and agreeable thoroughfares of that most magnificent of all European cities, and our humble London does not produce one—a want which is ever to be deplored, as Tottenham Court Road, the Marylebone Road, the City Road, the Borough Road, and the thoroughfares leading from the Elephant and Castle to Lambeth, would all have been most applicable for the formation of boulevards. A detour from Oxford Street into Hanover Square was much to our tourist's taste. He considered the view of the Square and George Street, with the Church, as one of the most scenic in London; the street not being parallel, and several of the houses being built of red brick and stone dressings, in a quaint Queen Anne style, renders this part of London very picturesque. A ride from the Regent's Park down Portland Place and Regent Street elicited many remarks and shrugs of the shoulders from our observant companion. The first shrug was at the Lilliputian statue of the late Duke of Kent, at the termination of a spacious avenue. The new Langham Hotel could not be passed by without an observation of its gigantic size, putting all around into shade, and thoroughly extinguishing its neighbouring church and spire. The Circus and Regent Street were considered worthy of a much better class and style of house than what prevails. The Quadrant is not altogether a disagreeable feature, although it has been shorn of its colonnades.

Victoria Street, Westminster, now in progress, was seen by our young friend, who thought that in this case the houses were rather too high for the width of the street, and that at times we should feel it dark and gloomy. The buildings at the Grosvenor Place end, now being erected, are very superior in design to those in Victoria Street. They are quite French in character, with *Mansard* roofs, terra cotta enrichments, and ornamental zinc-work on the curbed roofs. Our friend thought that one of his countrymen must have been employed; but

we believe that the Marquis of Westminster entrusted his London architect with the work with the request that the style should be Parisian in character. When completed, the Marquis will have every reason to be proud of his estate as being one of the most attractive in London. Montague House was much to our young friend's taste. The new Foreign Office and the *façade* of the Treasury elicited no favourable expression. The screen of the Admiralty especially delighted him, but he complained sorely of the removal of the columns to form side entrances. We do not think our young architect agreed with our boastful expression that Trafalgar Square was "*the finest site in Europe.*" It possibly might have become so had a Visconti been engaged on it; but with its National Gallery, College of Physicians, its puerile fountains, its pedestal without an equestrian figure, and the base of Nelson's Column still bare of the joint productions of the pet painter and the titled Italian sculptor, made us quite ashamed of our position as *cicerone*. Our friend saw our distress, and adroitly expressed his admiration of the statue and pedestal of Charles the First, and the fine portico of St. Martin's Church. The latter, he remarked, from its skilful arrangement of plan appeared to him infinitely larger than its real dimensions would warrant. The Charing Cross Hotel was found rather too *prononcé*, and the erection of the Eleanor Cross only to be excused on archæological grounds. Somerset House was next pointed out, and greatly delighted our friend by its grandeur of outline towards the Strand, and the exquisite detail of its enrichments; the *cortile* and *façade* towards the river he did not so much approve of, but the new portion in Wellington Street he considered as most successful. *En route* to the City, Temple Bar he thought inferior to the Porte St. Denis, but at the same time clever and picturesque. Fleet Street displeased him, and he asked us to compare a pretentious example of the fashionable Victoria style, exhibited in the Crown Insurance Office, next to St. Dunstan's Church, and a little architectural gem, the London and Provincial Law Assurance Office, on the opposite side—the one protruding in boldness of deformity,* the other retiring in delicacy and beauty worthy of a Peruzzi. Turning into Chancery Lane, young Mansard was quite charmed with the exquisite *façade* of the Law Fire Office, which, in his opinion, had more of the refinement of Vignola than any building he had seen in London. The Law Institution did not produce any favourable criticism, but the

* Our Critic will find many who dissent from his strictures on the Crown Life Office; but, having long made Architecture a profound study, and being the Author of one of our most beautiful recent buildings he is well entitled to be heard.—ED.

Union Bank, at the corner of Carey Street, he considered of great merit, and somewhat Parisian in character. Ludgate Hill was pronounced as a picturesque approach to St. Paul's, particularly in respect of St. Martin's Church, with its elegant and unpretending spire. The Railway Bridge was abominable, and we believe there was an expression of something very like *sacre* when it first came into view. St. Paul's has been already remarked upon. The neighbouring Hall of Christ's Hospital was much approved. The Post Office and Goldsmith's Hall were both striking; Guildhall by no means worthy of the first city of the world—the Continental Hotels de Ville eclipse it entirely. The *façade* of Mercers' Hall detained our young friend for some time, and we felt somewhat humbled at not being able to inform our inquirer the name of the architect. The Mansion-House he thought noble and striking. The Portico of the Royal Exchange met his approval, but the pretentious gigantic erection immediately opposite, and soaring above it, produced an exclamation which was anything but that of approval. Why the Bank itself should be so low a structure surprised him, but the circular end of the Bank, at Princes Street and Lothbury, excited the greatest delight; he considered it perfectly unique—a choice specimen of taste and genius. Adjoining Lothbury we found the New Auction Mart, quite Venetian in character, evidently by a master hand—the same, we believe, that has given us the noble *façade* of Munt and Brown's warehouse in Wood Street. The new Insurance Office, on the site of the former Auction Mart, was passed in silence; but the noble erection, the Sun Fire Office, at the corner of Bartholomew Lane and Threadneedle Street, was recognized as one of the most successful works of the most accomplished architect the present century has produced. Our young friend hardly knew which most to admire—the beautiful effect of the mass, or the exquisite taste of the ornamentation, the proportion of ornament to plain surface, and the character and suitableness of the ornaments themselves. Proceeding along Broad Street, a number of modern erections, mostly in stone, present themselves. They are not generally of great merit, save and excepting the Imperial Fire Office. The large pile opposite the City Club quite enraged our French visitor that so golden an opportunity should have been lost. “*Detestable!*” was all he muttered. The new National Provincial Bank, in Bishopsgate Street, put our friend in good humour. It is by the same talented hand that produced the Imperial. This is certainly one of the best attempts at classic architecture that we have in the Metropolis, and the liberal application of appropriate sculpture in the design gives an appearance of Roman magnificence.

We must not neglect Lombard Street, which has been more changed of late by the architect than almost any other street in London. The London and County, Robart's, and Barclay's Banks are all solid and important structures, but why stone was not employed throughout in the two last we are at a loss to discover, for we feel quite certain that no question of expense interfered. The Royal Insurance at the corner of Nicholas Lane is a design that has evidently been carefully studied, and the enrichments are in a great measure Greek in character and feeling.

In Fenchurch Street, Mincing Lane, Mark Lane, Seething Lane, Billiter Street, Tower Street, many new buildings of importance have been built of late years, and many are still in progress; in their style it appears to be a race between the mediævalists and the Italian. The first revelling in colour, red, black, white, and yellow, with a superfluity of carving, in which the London sparrows will build many a comfortable abode; the other, the Italian, also indulging in much ornamentation, and looking rather to Venice than to Rome for examples. With the exception of polished granite, the sober colour of Portland stone appears to satisfy the designers.

We must not quit the City without a glance at the National Provident Office at the corner of Eastcheap, designed by the Professor of Architecture to King's College. It is a very striking building, and courts approval; the principal entrance is well and ably designed. The monument with its noble pedestal and happy termination excited much more attention from the Paris architect than the column and lionless pedestal in Trafalgar Square. We were glad to take boat after our long pedestrian exercise, and with an approving glance at Fishmonger's Hall. We had an opportunity in our voyage to observe the magnificent span of the centre arch of the Southwark Bridge, and what engineers are attempting to do with the *square* instead of the *arched* openings at Allhallows and Blackfriars; we observed also with much regret how much the Railway Termini next the banks completely crush and dwarf all the surrounding buildings. The embankment in progress of course was a source of great interest, and we agreed that from what we could judge, the work was poor and tame, and more suited to the banks of the Cam or the Isis than to the shores of old father Thames. The architect of York Gateway and Stairs would have adopted a bolder and more characteristic wall of masonry, and with a nobler parapet than the ill constructed one at Westminster Bridge Stairs. Landing on the Surrey side we had a good opportunity of observing the superb effect arising from the great width of the new bridge at Westminster and although the City Engineer, as a utilita-

rian, considers that two bridges of a moderate width would be preferable to one wide one, we decidedly gave our vote here in favour of the broad guage principle. On looking over the parapet we hope we were mistaken as to a feeling of vibration.

The site for the new St. Thomas's Hospital was pointed out to our visitor, and the plan of the buildings explained to him. We believe he was more engaged in thinking of "Les Invalides" on the Seine, than the proposed pavilion hospital on the Thames, for "he made no sign." We returned by London's "silent highway" to London bridge, noticing a large stock of warehouses on the Surrey side with a Venetian façade next the river, and the fine old Tower of St. Mary Overys rose in far greater dignity than more recent piles. We completed our days' lionizing by taking our places from Moorgate Street in one of the comfortable carriages of the Metropolitan Railway, and our *underground* works, and particularly the station connecting the line with the Great Northern, were considered by our young friend as being of far superior merit to many of our works *aboveground*; the admirable plan and arrangements, the excellent and careful construction, and the good taste of the architectural features impressed our visitor with a strong feeling of admiration for the talent displayed by the engineer of this most important work.

Upon our return home in the evening we chatted over what we had seen; and with regard to the architecture of cities, I think we came to a cordial agreement that for the general view from the environs, domes, and towers, and spires are most desirable, as witnessed in the beautiful effects produced in the large eastern cities from the outlines of the domes of mosques and by the minarets. Our next point was that open spaces are indispensable, and that they should intersect or be in close continuity with long lines of thoroughfare, as in Regent Circus and Cavendish and Hanover Squares, in respect of Oxford Street. Perhaps the finest open space in London is Lincoln's Inn Fields, disgraced by three of the most inferior entrances, and the inlets from Holborn by *two turnstiles*.

That streets should not always be laid out at right angles, but that diagonal streets should be introduced as being favourable to the traffic, and as giving variety to the different points of view must be conceded. Nothing we conceive can be more monotonous than the laying out of New York in square blocks, *ad infinitum*. Lines of thoroughfare need not always be straight. The width of streets should not exceed eighty feet. Pall Mall appears to us perfection for a street with important buildings; an excess of width occasions the buildings to look low, and dwarfed, and are most inconvenient for passengers to

cross. Paved covered ways, as in Paris, are most desirable. Having agreed upon these points, we now, to our dismay, approached the subject of public fountains, and our companion inquired why we had not pointed out in our rambles some of the many which he understood had lately been erected; we never felt more ashamed in being obliged to reply that we could not point out a single one deserving his notice, and that we had purposely avoided what we had hoped he had overlooked. Our friend saw our chagrin, and referring to the architecture of our recent buildings, he observed that he thought our mediævalists had run wild in their productions; that buildings of that style when carefully studied and not caricatured were most picturesque, and formed a pleasing contrast with the classic and Italian; that in respect of our Italian designs they were in most instances wanting in the careful study, which is expected from the hands of a travelled and accomplished architect.

The last day of our friend's visit was reserved for a *bonne bouche*; a *déjeûné à la fourchette* at Richmond; a visit of course to the Tunnel, and a white bait finale at Greenwich, with a previous two hours round the Hospital, followed by a glorious sunset, completely smoothed down all the little disappointments he had met with in our street architecture. We made our adieux at the London and Dover Railway Station, with a promise on our parts to make the return visit to Paris next year at the great National exposition.

THE BLACK POPULATION OF THE BRITISH COLONY
OF NATAL, SOUTH AFRICA.

A PRELIMINARY SKETCH.

BY ROBERT JAMES MANN, M.D., F.R.A.S.,
Superintendent of Education in Natal.*(With a Tinted Plate).*

THE British Colony of Natal lies on the south-eastern coast of Africa, about eight hundred miles beyond the Cape of Good Hope, and reaches upwards to within a little more than two hundred miles of the southern tropic. It is a strip of land included between the high Drakenberg step of mountains, which forms the threshold of the great continent, and the Indian ocean. Its sea-board is one hundred and fifty miles long, and its depth from the sea to the mountains, an extent varying from one hundred to one hundred and forty miles.

Natal, thus placed, is the very middle of what Dr. Livingstone and the geographers have termed the "Kaffir zone" of climate, as distinguished from the Bechuana and Namaqua zones beyond the mountains. This zone was inhabited, before the land was visited by Dutch, Portuguese, or Englishmen, by a distinct race of people, whose direct descendants now form the black population of the Colony. The land was first seen by European eyes on the 25th of December, 1497, when the renowned Portuguese navigator, Vasco de Gama, touched at it on his first voyage to India round the cape, and named it the "Terra Natalis," in honour of the day. The soil was first trodden by British feet in the year 1683, when a crew of men who had been shipwrecked further north, near the spot now known as Delagoa Bay, made their way through it to the Cape of Good Hope. Three years subsequently a Dutch ship was wrecked where the Port of Natal is now established, and the stranded crew spent twelve months on the shore, and at last built a small vessel from the fragments of the wreck, and sailed away for the Cape of Good Hope, leaving, however, three Englishmen and a Frenchman behind. These were finally taken away, after a longer residence, by a Dutch vessel visiting the coast; but they carried with them reports of the place which led to the Dutch forming a settlement there in the year 1721. The settlement, however, was maintained for only a brief period, and then abandoned. In the year 1823, Lieutenant Farewell of the Marines in the progress of a surveying voyage, visited the site of the old settlement. On the following year he led

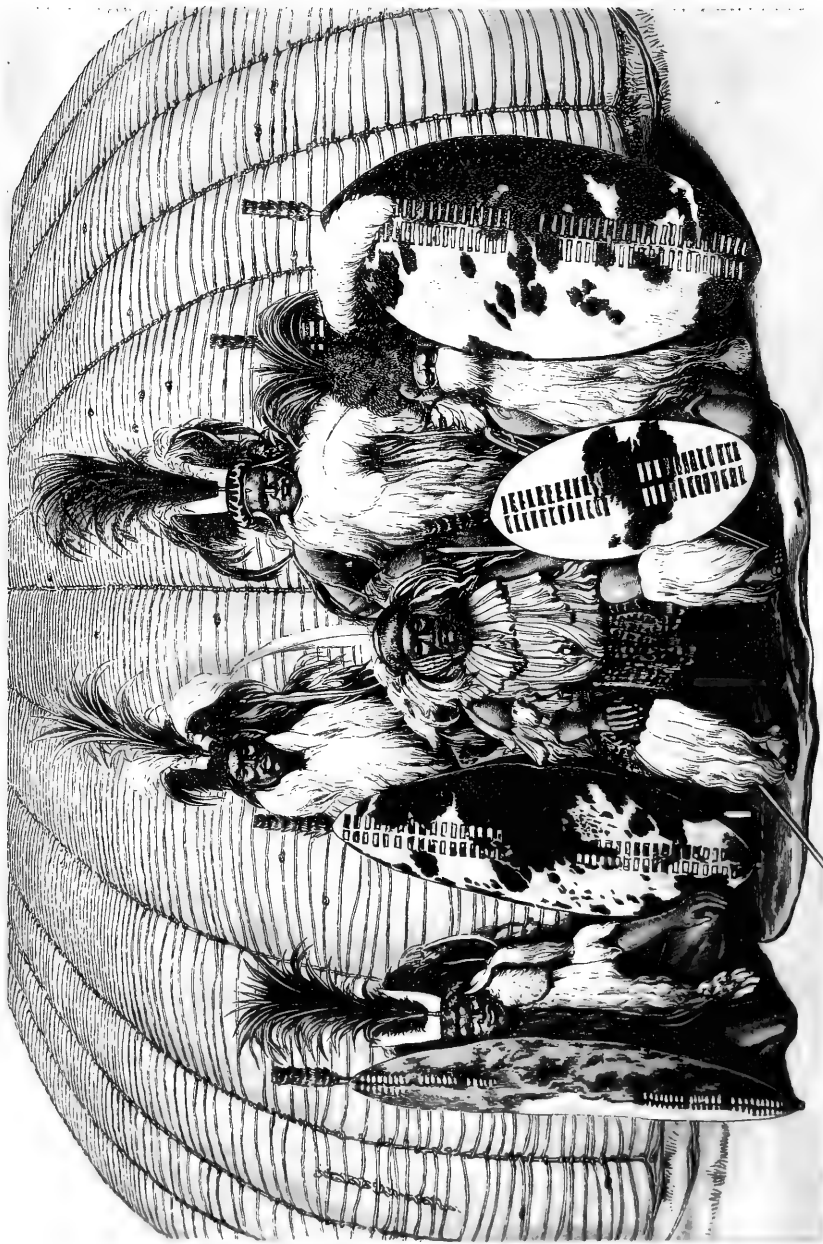

ZOOLU CHIEFS.

back a band of twenty Englishmen, who proposed to acquire territory there, through friendly negotiations with the native chiefs. These pioneer settlers maintained varying relations with the natives in the subsequent years, sometimes retiring southwards to avoid the consequences of disagreements, at others returning to the neighbourhood of the Bay now known as the harbour of Durban. Twelve years after their first arrival a party of Dutchmen came down from the mountains in the interior and joined them. Their successors founded the towns of Durban and Maritzburg in the year 1839, and from that time until the year 1842, there was a period of dispute and strife between the Dutch immigrants and the British Government, which claimed allegiance from them in consequence of their being emigrants from the Cape Colony. The dispute was finally adjusted in this year, and in the year 1845, the first British Lieutenant-Governor was installed in Natal.

When the Portuguese and Dutch first visited Natal they found the land thickly peopled by a black race of friendly and gentle temper. The race was divided into separate communities, which lived in a quiet orderly way under distinct chieftains. When Lieutenant Farewell came to Natal, in 1824, matters were greatly changed. A warlike chieftain to the North had drawn together many separate clans under his dominion, and formed them into an army of aggression. With this army he had moved down towards the south, subjugating the land, and either carrying away the remnants of the conquered tribes, to incorporate them among his followers, or driving them before him as scattered fugitives. The tribe which first began this career of conquest and absorption, was a small clan located some distance to the north of the Tugela. It was then known as the Zulu tribe, and accordingly in its aggrandized state it still kept the designation of Zulu. The warlike chief who struck out the bright idea of extended rule bore the name of Chaka, a name which remains a potent spell among the Kaffirs even at the present time. Wherever there was black mail to be levied, or an independent clan to be eaten up, this warlike chieftain led the short javelins and stealthy steps of his disciplined warriors, until by degrees his sway extended from Delagoa Bay in the north to the great river of St. John in the south, and Zululand became a wide kingdom five hundred miles across. When Lieutenant Farewell landed his small expedition in Natal, Chaka was at the summit of his power, and had a large military kraal on the banks of the Umhlali, twenty-five miles within the boundary of what is now the colony. A few fugitives of the original Kaffir tribes lurked in concealment in the bush, as the sole representatives of the once teeming population; culti-

vating small patches of maize in hidden ravines, or living upon wild roots and shell-fish. Beyond the military posts of the Zulu conqueror the entire country was a desert.

After some preliminary negotiation, Chaka gave the English settlers permission to occupy territory at the Bay, and promised them his protection. One of the settlers, Mr. H. Fynn, was raised to the dignity of subordinate chieftainship. In the year 1828 Chaka's term of power came to a violent end. He was murdered at the instigation of his brother Dingaan, who thereupon proceeded to throw the royal skin over his own shoulders, and as one of the first acts of his rule, summoned all chieftains, who had shown fidelity to his brother, to appear before him. Mr. Fynn knew too well what this meant, to obey the summons; and retired with his followers beyond the Umzinkulu, until he was able to come to an understanding with Dingaan. He returned in 1831, and was then recognized by Dingaan as the "Great Chief" of the Zulu Kaffirs.

So early as the year 1827, refugee Kaffirs had commenced to return into Natal under the guarantee afforded by the presence of the pale faces. Some of these refugees came from the north, and some from the south. The influx now increased. In 1836 there were 1000 adult male Kaffirs in Natal, able to bear the shield and assegai, and paying allegiance to the English. Two years subsequently the white chiefs could muster a following of 2100 armed Kaffirs. The Kaffir population at that time numbered 10,000 individuals, men, women, and children.

It was in this year, 1836, that the party of Dutch emigrants, under the guidance of Jacobus Uys, Hendrick Potgieter, and Pieter Reiteif, descended into Natal by a central pass which Reiteif had discovered through the Drakenberg Mountains. From this time fresh accessions of Dutch rapidly flowed down, and a period of conflict between these Dutch pioneers, and the Zulu chieftain ensued; which, after a series of vicissitudes, ended finally in the year 1839, in the destruction of Dingaan, after a signal defeat of his regiments, and in the establishment of Umpananda, the brother of Dingaan, who had been for some time a fugitive in the Natal territory, as supreme chief of the Zulus. Umpananda assumed his seat on the principles of white alliance, and in the interests of peace. He paid a subsidy of 36,000 head of cattle to the Dutch when he began his reign.

The Dutch settlers in their turn became involved in disputes with the British Government, as has already been stated. When, in the year 1842, the Dutch flag finally went down before the British, and the Dutchmen within the Natalian territory became subjects of the British Crown, the friendly

allegiance of the peaceful chief Umpanda was transferred to the new masters.

Umpanda still sits in his big royal kraal beyond the Tugela River, which has been established as the boundary that separates the British territory from independent Zululand, surrounded by his wives and children, and by his flocks and herds; and sends ambassadors over from time to time to confer with the Colonial authorities, and get their advice on matters of delicacy and difficulty. But Umpanda's days have not been altogether roseate ones. Umpanda is now a very portly potentate, and a martyr to gout. He has to be dragged about upon wheels, and when he enters upon a journey his attendants take off the front wheels of his travelling waggon, and slide the royal body up; and then lift up the waggon by sheer force to re-insert the wheels upon the axle. Now, an invalid and obese king, thus absolutely dependent upon the care of his people, is very convenient and satisfactory to peaceable neighbours, but, in another sense, not altogether qualified to fulfil the cravings of a glorious tradition. Umpanda and his cart do not glitter in young Zulu eyes, when young Zulu ears have heard of the stride of the conquering Chaka, at the head of his light-footed legions. Since Chaka's time it has been the custom to band all male Zulus above adult age into regiments, and to bring these regiments in succession to the royal kraals for service. The ordinary service consists mainly in building huts and fences, and in milking and herding the cows belonging to the king. The captains and chief men of the regiments reside in huts appointed to them by the king, but receive their daily food from their own people. They have a claim, however, to certain gratuities of cattle as a guerdon for the service.

In Chaka's time there was no difficulty about these gratuities; there was then constant war, and the spoils of the vanquished readily furnished the royal pay. Umpanda, on the other hand, has no extrinsic supply of this character to draw upon. He rules in the interest of peace, and has to rely entirely upon his own internal resources to meet the expenses of his state. Consequently, the chief men assembled at his place, commonly return to their kraals empty-handed, at the end of their terms of service. Some time since, as a measure of state economy, the king gave his eldest sons permission to found kraals of their own, and to go to reside in them. A natural result of this combination of circumstances has been that these kraals have come to be the resort of dissatisfied and disaffected men, who attach themselves to the persons of the young chieftains, and encourage them to set up on their own account. This is technically termed "living

under the tiger's tail." Through a series of years the parties of the young chieftains have been waxing in strength, and the old king has been left more and more to his gout and his old councillors. The young chiefs have, of course, been growing more jealous of each other as they have waxed in power, and more especially as it has come to be known that Umpanda has inclined to favour his younger sons in preference to his first-born. In the year 1856 there was a great fight between the party of the elder son, Ketchwayo, and that of the younger brothers, in which Umbulazi and five others of the younger sons were slain. Since then the fortunes of Ketchwayo have been in the ascendant. The person of the old king is respected, and he continues to live, surrounded by his old men, at his kraal; but it is understood that he is now too old "to move," and is only to do "the thinking." Umpanda is "the head" of the tribe, but Ketchwayo is its "feet." Two others of the younger sons of Umpanda escaped with their mothers from Zululand at the time of the great fight, and are now living as refugees in Natal under the British ægis. The brothers who remain on the Zulu side of the Tugela are considered to be adherents of Ketchwayo.

One important consequence of this curious passage of Zulu history is, that the 10,000 Natal Kaffirs of 1836, have grown into 200,000 Natal Kaffirs in 1866. Year after year, more and more of the men who had primarily sided with the younger brothers, and more and more of the middle-aged and sedate Kaffirs who have longed for quiet and peace, have passed over the border as opportunity served them, and settled themselves down among the black subjects of the British Queen. These refugees are required to enter upon three years' term of service, whenever their presence is recognized; but sooner or later they all become absorbed into the following of one or other of the petty chieftains who are distributed over the land. There are certain districts set apart as reserves for these clans, where they are allowed to live under the condition of paying a small yearly hut tax to the Government, and yielding obedience to the magistrates and laws. But many of them have built their kraals on the lands held by private proprietors, or on the lands yet in possession of the crown. In the former case they pay a small rent to the landlord, or furnish an equivalent in the form of personal service.

The black population of Natal thus consists of numerous small tribes, living under their own separate chiefs, and scattered abroad over the face of the land, either in reserves which are set apart by the Government for their occupation, or as squatters upon the crown land and private estates. These tribes are primarily formed of the original natives of the

district, who were driven away from their hill-sides at the time of the Zulu invasion, but who returned when the colony came under the protection of European occupation and British rule, and have since been largely reinforced by successive additions of refugees from Zululand, who were themselves for the most part, it will be remembered, originally drawn from the same aboriginal source. These people are now all liege subjects of the Queen of Great Britain, and already partake in a large measure of the advantages of British rule. But they are nevertheless still barbarians in the mass; and here, therefore, arises the most momentous and deeply interesting question, What is to be done with their black bodies and barbarous minds? what is to become of them in the future? There can be no doubt they will not remain where they are as barbarians. Nature herself, and the immutable laws of human existence, have decided that this cannot be; civilization and barbarism cannot continue to look into each other's eyes at close quarters. Whenever they have been brought face to face by circumstances, one of two things has always taken place—either the barbarians have disappeared from their place upon the earth, or they have been drawn within the civilized pale, and turned to account. Which of these fates is it, then, that is in store for these black tribes of Natal? Are they to find, under the altered circumstances of their land, and after their escape from the thralldom of a savage tyranny, extermination or a new life?

In endeavouring to catch the first faint whisperings of the answer to this question, the inquirer is met by a stubborn fact, which undoubtedly has its meaning. Up to this time the results of the meeting certainly has not been in the direction of the extermination alternative. The 10,000 Natal Kaffirs of 1836, are 200,000 Natal Kaffirs in 1866! Under the ægis of British protection, and in the face of European civilization, the black race of Natal has increased twenty-fold in thirty years. This certainly looks very much indeed as if there is no early extermination to be thought of. It looks, indeed, as if the other alternative is the thing that is in progress, and must be brought about.

Before entering further upon the consideration of what indications there are that the civilization and utilization of the Natal Kaffirs, are possible and in progress, it is absolutely essential here to get some clear notion of what the uncivilized Kaffir is, upon whom the civilizing operation has to be performed. We must pause for a passing glance of scrutiny at the raw material before we entangle ourselves too deeply in the processes of the manufacture.

The Kaffir who is found in Natal, is, upon the average, of

somewhat lower stature than the Englishman ; but he has a well-proportioned and well-developed frame, of slim rather than robust dimensions, and, as a rule, more fitted for the exertion of activity than of strength. There is more of the Mercury than of the Hercules about him. He has black wool upon his head in the place of hair, and very commonly he has the large protruding mouth, thick lips, and broad flat nose of the negro type of organization, as shown in the accompanying very characteristic portrait taken from the life. But occasionally he has the narrow aquiline nose, straight lip, long beard, retiring chin, and square prominent forehead of the European.



BUST OF KAFFIR.

His eye is for the most part dark, soft, and twinkling with merry humour, and his face stamped with an open, gentle, and amiable expression. The few observers who made his acquaintance before the days of Chaka's military despotism always spoke of him as being gentle and amiable in character.

The small-boned and slender limbs of the Kaffir, already alluded to, at once distinguish him from his cousins of the negro variety of the dark skinned African family. In young individuals and among the boys, the tapering, delicate arms and hands, slim legs, and slight feet are so remarkable that they catch the attention of the most careless observer. In all probability he has some substratum of the coarse-grained,

light-hearted, and grotesque negro in his organization; but this organization obviously vibrates between that fundamental and some nobler type. His habits and tastes point to this conclusion as forcibly as his frame. His propensities are pastoral and nomadic. He loves to have fat oxen and grazing goats about his kraal, and to wander from hill side to hill side. A stroll of fifty miles is pastime to him in a fine season. He has an inherent impatience of constraint in any form. Chaka could never have made his invading and conquering armies out of negroes.

In his wild, free state the Kaffir goes entirely naked. He has no other garment than a bunch of strips cut from the skin of a sheep, a wild-cat, or a goat, and suspended from a slender girdle as a kind of diminutive apron. He wears, however, an apron behind as well as in front, and indeed deems the posterior one the more essential covering of the two. If he has had the good fortune to win distinction in the eyes of his chief, he puts on a collar of merit upon his neck, composed of the teeth and claws of the lion and leopard, or of the claws of the eagle, and circlets of bright brass upon his arms. In some instances a necklace of fragments of certain kinds of roots takes the place of the teeth and claws. He pierces the lobes of his ears with wide gashes, which he then ornaments with knobs carved out of fragments of bone, or uses as the depository of his snuff boxes constructed from tubes of reed. He hardly ever moves from his hut without having his buckler of ox-skin upon his arm, and a bundle of five or six assegais, and a knobbed stick, or club of hard wood in his hands. Most probably this habit was primarily due to the risk he was exposed to of having to encounter some fierce wild animal at any instant. At night he lies down on the floor of his hut, and there wraps himself in a well-greased ox-skin, now often exchanged for a woollen blanket of English manufacture.

Although the wild Kaffir has so scanty a wardrobe for the ordinary purposes of life, it must not, however, be supposed that he is indifferent to the graces of personal adornment. He has plumed and furred robes of considerable complexity for ceremony and for war. Our plate gives a portrait, from the life, of the Natal Government chief Ngoza, with four of his men, in heavy war costume, in front of his hut. Ngoza is sitting in the middle. His head-dress is made of circlets and pendants of furred skins, with a crane's feather on the crest; his breast-plate is a tippet of tails of monkey-skins. His apron is mingled goat-skin and monkey-skin, and his greaves are fashioned from the skin of the white ox. The tall plumes of the attendants are of the feathers of the crane. The shields are dried ox-skins very artistically stretched on wooden frames,

and diversified by the natural white, black, and brown patches of the hide. Ngoza has a plume of scarlet ostrich feathers in his wardrobe, which he prepared on the occasion of the visit of Prince Alfred to the colony, at a cost of thirty pounds. Ngoza is not an hereditary chieftain. He has won his spurs by faithful service to the British Government. He was placed over a heterogeneous assemblage of refugees some years ago, and now lives in a large kraal within sixteen miles of Maritzburg, and assembles a considerable following under his command whenever any special service is required by the Government. He appeared before Prince Alfred with four thousand armed men, and entertained him with an exhibition of the native ceremonial dance on a very imposing scale.

The Kaffir women are certainly of inferior organization to the men. Occasionally young girls of a comely presence are encountered. But as a rule they are far more coarse and repulsive in their aspect than the men, and they always shrivel and wither at a very early age, unless when they take to the scarcely less objectionable proceeding of turning themselves into unwieldy bundles of fat. I incline myself to think that the life of inferiority and drudgery to which the native woman is born acts through successive generations upon her frame, and brings about a real degradation in her physical organization. The Kaffir is fond of his women, but he is fond of them in very much the same fashion that he is fond of the cows, for which he barter them away. The men reserve their thews and their energies for war and for the chase. They take care of the cattle, milk the cows, build the huts, and cut down timber with the axe. But with the exception of these light tasks, which are all honourable and dignified occupations in their eyes, they engage in no kind of labour. The women do all the real work of life. They till the ground, and sow and reap the grain; prepare the food; fetch the wood and water; keep the house in repair; and carry all the burthens. It is a matter of quite common occurrence in the open country of Natal to meet a young lord of the black creation marching along the path with an erect head and a jaunty step, his ankles encircled with little fringes of white skin,—that look as if they must necessarily soon bud with winglets to establish beyond all cavil his kinship to the messenger of the old classic Olympus,—and his hands filled with assegais, while immediately behind him march in single file three or four naked women bearing on their heads the load of his household gods; rolls of his sleeping mats; pots filled with beer; bundles of tobacco, and other prime necessaries that need to be transported in his steps. The young girls in their wild state go even more naked than the men. At festive times they are adorned with necklaces and

anklets of beads, and with broad fringed belts of beads that are arranged not untastefully across their hips. When they become wives and mothers they adopt a matronly costume, which consists of a short petticoat extending from the waist to the knee. With advancing years the petticoated wives and mothers pass rapidly into petticoated hags.

Such, in general outline, is the nature of the raw material; such is the Kaffir of Natal in his wild state, and in his simple bodily aspect. There is something more to be said of what lies a little deeper than the outward skin, for barbarian as the wild Kaffir naturally is, he is nevertheless subjected to the influence of a certain kind of culture and training even in his most savage condition. His education properly begins even before he falls within the sphere of the white man's operations. This topic, however, must be reserved for a future occasion.

EXPLANATION OF PLATE.

The engraving represents the group of Ngoza and four of his attendants, alluded to at page 191. The background is formed of the chief's principal huts, in a large kraal near the Maritzburg Table Mountain. The engraving is made from a photograph by Mr. Bowman, of Natal, and is therefore a very exact representation of Kaffir military costume. The tails of the dress are formed of strips of furred skin, often spirally curled after they have been cut. The feathers have necessarily lost some of their distinctness and splendour in delineation, in consequence of movement communicated to their light pinnæ by the wind. The greaves on the chief's legs are not altogether up to the mark. The right thing is that they should be formed of the actual tails of white oxen! It is probable that oxen are not now slaughtered upon quite so large a scale in Natal as when hostile raids and war were more the order of the day; and hence even wealthy chieftains are put to some shifts to keep up a due appearance in the altered state of affairs. Ngoza has, as mentioned above, one head-dress, which he provided, on the occasion of Prince Alfred's visit, at a cost of £30. It is principally composed of ostrich feathers, dyed crimson. He did not chance to be wearing this particular piece of costume when the group of the engraving was taken.

THE PLANET SATURN.

(CONTINUED.)

BY THE REV. T. W. WEBB, A.M., F.R.A.S.

FROM an early period, irregularities have been remarked in the form of the shadows which the globe and ring mutually cast upon each other. As far back as 1792, Dec. 26, when Schröter was first trying his 13 ft. reflector, he noticed a jagged outline to each of these shadows, which was confirmed, Jan. 18. —Next we find Lassell, during an “unequaled view,” 1849, Aug. 3, describing the shadow on the ball as “evidently knotted or notched,” as though there were mountains on the ring intercepting portions of the shadow, and “almost breaking it up into a line of dots:” an appearance which he again noticed with a similar opening of the ring, 1861. He had also seen it serrated, 1850, Nov. 21. So did De la Rue, repeatedly in the spring of 1861, and very distinctly April 7, with his 13 in. reflector and a very fine $4\frac{1}{8}$ in. achromatic; the “very irregular” outline was however figured by him as belonging to the edge of the shadow, not of the ring, as Lassell. So did Jacob several times, 1861, especially May 19, with $3\frac{7}{10}$ in.; he thought it might be an illusion from the apparent projection of parts of the shadow darker than the rest; an idea even more unintelligible than the difficulty which it professes to remedy. Lassell also at Malta, 1862, Jan., found the shadow a rough line. The little roughnesses, it is true, which Huggins suspected, 1862, especially May 18, on the S. edge of the dark side of the ring, always entirely disappeared, leaving a perfectly smooth edge, under powers of 600 to 950. But this, though it suggests caution, does not negative the previous testimony. The fact is sufficiently clear, and sufficiently perplexing. Such irregularities could only, it would seem, be occasioned either, 1, by corresponding unevennesses on the ring; or, 2, by a fretted and honeycombed structure of the surface of the globe; or, 3, by very great irregularity of refraction through the ring’s atmosphere (that of the ball not being distant enough). Now, if the ring were studded with mountains of sufficient size, they would be very visible in its edgewise projection upon the sky, and, unless rotation is given up, would be distinguishable by their rapid motion from the lucid points so often mentioned. If a highly irregular surface of the globe were suggested, still our eye is never sufficiently far removed from the direction of illumination to see any marked effect in the form of the shadow; and the supposition of

irregular refraction seems too extravagant to be admissible on such slender data.

But if we pass over this difficulty as insoluble, we have yet to encounter a still more obstinate one in accounting for the abnormal character of the shadow of the ball projected upon the ring. If the latter, considered as a whole, were an uniform plane, the shadow on it would have an elliptic outline, deviating more or less from parallelism with the edge of the globe, according to the greater or less difference between the direction of illumination and that of vision (an angle never exceeding a small amount), but invariably curved in the same direction as the limb, and perfectly smooth. That the ring is not an uniform plane we have seen reason to believe, and we are so far prepared to expect some slight deviations, but only such as would be consistent with the extreme thinness, not only of the ring, but even of its apparent protuberances, at the epoch of lateral presentation. Now for the facts.*

We have already seen that, as long ago as 1792, Schröter perceived an unevenness in the shadow, not only upon the ball, but particularly, he says, upon the ring, where it was especially distinguishable by a projecting portion of the light of A. The next mention seems to be by H, 1806; June 9, whose description of it does not, however, specify that feature of his diagram which would now be thought most curious—the reversed curvatures of the limb and its shadow. Then after a long interval, 1850, Lassell, Dawes, and Secchi saw the outline of the shadow slightly concave towards the ball. Dawes thought that it might be an illusion from contrast with the limb, or B might be wedge-shaped, though then it would be hard to account for its edgewise disappearance. Secchi referred it to a slight convexity of B, experiment proving that a very slight one would suffice; or in some degree, possibly, to difference of planes.—1851, Sept. 5, Bond I. found the outline straight, or a little concave. 9, Lassell ditto. 10, slightly concave. 25, Dawes found the shadow on A irregular.—1852, Oct. 5 to middle, Lassell (Malta) saw a “remarkable sudden projection” of the shadow in crossing Ball’s div., and an elongated spot on B on the opposite (*f*) side, close to the limb, sometimes, but not generally, extending to the division; this, he afterwards perceived, was the germ of the coming shadow on that side, as our eye travelled across the direction of illumination at the opposition. 22, shadow on both sides ball: Bond II. 28, ditto; 2 wings on B also fancied: Bond II. Nov. 3, shadow on both sides; “what can this mean?” C. W. Tuttle; also B.

* Secchi alludes to Cassini and Messier as having inferred, from observation, a curved surface for the ring. I am not able to say whether this may signify anything more than the irregularities of the edge-view.

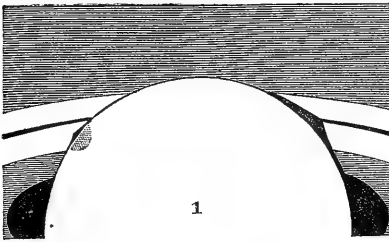

1

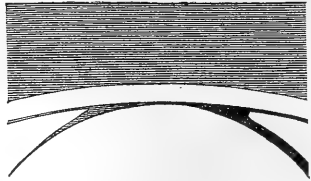

2

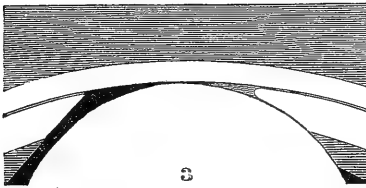

3



4

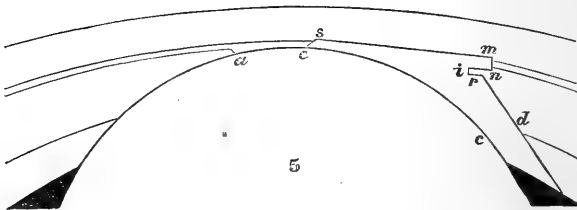

5

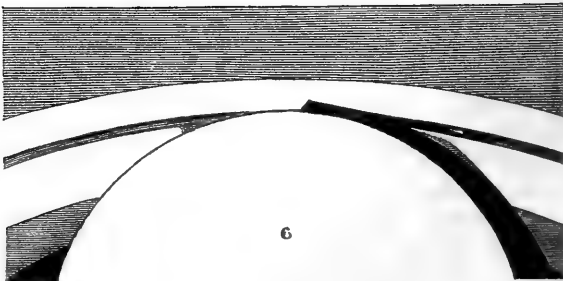

6

II., and Nov. 4. 15, Lassell, the shadow had changed sides, and the "sudden projection" lingered as a similar spot *p*, so that there was shadow, though on B only, on both sides of the ball. In this month De la Rue drew the shadow *f*, with a strong discontinuity at the division, as though A lay above B (inverted). 29, on both sides, much plainer *f*; "This is very remarkable, but there can be no question as to the fact:" both like objects seen by mirage: B. I. See the diagram, Fig. 1. The American memoir contains no less than 40 views in which some peculiarity of the shadow is represented, from which Figs. 1, 2, 3, 5, 6, 7 have been selected, with regret at the omission of many others equally curious, especially as the work is very little known in England. Dec. 1, *p* shadow seems to adhere to and partially overlap limb; in continuation of a dusky belt, but much darker: B. II.—1853, Jan. 8, a singular dusky spot adhering to *p* limb, as often before; *f* shadow almost makes a corner opposite to it, at Ball's div.: B. II. Oct. 24, 25, Nov. 2, Dawes saw little triangular spot *f*, just within division, considerable breadth of shadow *p*, concave to limb on B, convex* on A, and much further out on B than A, so as to make a notch at division, as though in two planes. [His drawing singularly like our Fig. 1, but reversed, and placing the small spot close to the division.]—1854, Feb. 12, and later, Hippisley observed the shadow on B conspicuously concave towards the ball, so that it should have passed over much of A, if in the same plane; this ring, however, was untouched: it seemed as though B had a convex surface. From computation and experiment he found that, allowing for polar flattening (which is material), the shade on A would have been hidden by the ball, especially if A were in the least above B. But he does not allude to the reversed curvature. Sept. 26, *p* shadow on B nearly straight; 29, a little recurved, with a small projection *f* close to division: Dawes. Nov. 23, S. region of globe (now coinciding with Ball's div.), or adjoining part of ring, singularly distorted. On each side of globe a slight shading on B, turning out right and left in 2 corners along division, which is quite flat between them: B. II.; Coolidge, with 5 ft., ditto. Nov. 26, Dec. 7, angular projection on both sides, up to Ball's div., something like our Fig. 2, but equally black and blunted on either hand. A unshaded: Dawes. 9, flattening of S. regions very evident: B. II. Later, and much finer air, a new distortion; *horns* of the two shadows certainly concave: S. edge of shadow (or Ball's div.) between them straight, and ball at S. edge encroaching in a protuberance

* The terms are occasionally interchanged by observers, the outline being sometimes referred to the enlightened, at others to the shaded part of the ring. The latter is always preferred here.

upon A: S. C (oolidge), and another. 26, *f* corner decidedly darker than *p*, at times almost black; Fig. 2: B. II. *f* much stronger and blacker than *p*; *p* projects very little; ball seems to project upon A, which is a shade darker between the two corners: B. I. Mouse-coloured shading on A from horn to horn; ball less projecting upon A; *p* shadow less dark and visible; *f* increasing every way; black: S. C.—1855, Jan. 25, a nearly black spot in the *p* shadow [now much smaller than *f*]: B. II, S. C. Mouse-coloured shading of Dec. 26 not now to be seen: S. C. Feb. 28, *p* shadow scarcely discernible; *f* angular on A, encroaching on Ball's div., and "giving to the outline of that part seen on ring A and division of rings the appearance of a roof with broad projecting eaves:" S. C. Corner juts over upon division (but not on rings) like eaves of a roof: B. II. March 29, *s f* limb of ball straight in front of shadow; *s* sliced off; vision not very good: S. C. Spring, shadow across B straight or concave; different observers and artists differed as to form: Secchi. Nov. 9, shadow above S. limb "much less dark on the upper and right hand portions than on the left hand:" B. II. 13, *p* shadow straight; a faint shadow *f*, (Fig. 3): S. C. 26, both shadows concave near division, *f* most so; *p* straight everywhere else, even on dusky ring; adjacent limb also straight and distorted from inferior definition: S. C. [Ball overlapping A a little: S. C. 27, on the contrary, evidently not reaching division: Lassell. This seems to be the greatest amount of opening.] Dec. 6, both concave; *f* very narrow, and not so dark as *p*, which alone is seen on dusky ring, and seems to have a penumbra along outer edge; S. limb not distorted; encroachment of ball on middle of shadows may cause apparent concavity: S. C. 6, 12, a kind of "cornering:" Lassell.—1856, Jan 8, 10, outline reversed with low powers, yet illusion suspected [much as Fig. 2, but each side equally black and blunted]; "I am quite unable to imagine any section for the bright ring (compatible with its ascertained thinness) that would give such an outline to the shadow;" 22, 23, shadow convex all round S. limb, but with 2 *ears* where it crosses Ball's div.; exact form could not be made out, but rather triangular; seen distinctly crossing division, which was much paler than shadow, brown instead of black, and from form of shadow would seem below level of rings: Jacob (Madras). Feb. 4, shadow has *not* the reversed beak, and seems to extend upon A: Secchi. 28, outline changed since Dec. 6; more regular, and a slight projection upon A, but still corners at division; *p* faint and very small; *f* plainly seen on C: B. II. March 14, trace of *p* shadow at *a*, (Fig. 5); at narrowest part, *c d*, *f* is wider than C at minor axis; its "roof" overlaps division, and is projected on A; it

slopes rapidly from *s* to *e*; "to the right the 'roof' protrudes over the shadow as it did last year; but now it overlaps both rings at *m* and *n*. The whole of this upper part of the *f* shadow is black, and darker than the rest, though the lower part is darker than the ring C, and well projected on it. Near its E. edge the shadow seems to be separated from the 'roof' by an *inlet*, *i n*, equal in depth to $\frac{2}{3}$ of *c d*, or even more." Ball does not seem to encroach upon division: S. C. [18, not at all: S. C. At greatest opening, division never seen in full breadth beyond S. limb: Dawes.] 17, roof less prominent, encroaching very slightly on A; point *r* fainter than rest of shadow: S. C. 18, roof decidedly blacker than shadow below it, but edge *m n*, till now abrupt and well-defined, seems to blend more gradually with division. *p* corner rather darker than before: S. C. 20, inlet seems rounded off on N. side; roof blacker than rest of shadow; *m n* again as sharp as ever; *p* shadow seems less prominent: S. C. 25, roof-like appearance noticed; *p* well seen: B. II. 27, limb appears straight across B, probably from its dark shade there; inlet rounded off and shadow faint at *r*; outline on B [by diagram] bent at an angle with that on dusky ring: S. C. 27, 29, De la Rue's second engraving brings *s* (Fig. 5) down to *e*, and makes *s m* a little convex; an *ear* like Fig. 2. projection on division not shown, the latter being black; shadow on B slightly concave, on C straight, and in a fresh direction; general effect, however, very similar. 31, curve of shadow expressly reversed; ring appears not plane: Secchi. April 1, never so perfectly defined before; powers to 1561; a narrow shadow over S. pole unites faint shadow *p* to black *f*; it is not the division unless refracted, because the two make an angle upon A at their junction. Roof concave to shadow near division in which it gradually disappears, without overlapping A or B; inlet rounded off, with some faint shade adhering; see Fig. 6: S. C. 2, "*L'ombre est assez curieuse, elle est renversée et ondulée*;" Fig. 4: Secchi. 4, curve reversed; a little shadow on A: ditto. 5, *p* shadow darker than division into which it blends; roof does not appear to project; is darker than rest of shadow, as black as open ansa; *f* follows regular curve of limb on B and C; inlet quite narrow, but deep as ever, and seems not rounded off: S. C. 19, shadow irregular. 25, remarkable discontinuity at division: Secchi.—1857, Jan. 1, almost exactly in opposition, no shadow visible except projecting ears crossing division, one on each side: Jacob. Jan. 13, shadow on B not black: B. II. 30, *f* shadow black, covering A except a narrow line: B. II. *p* concave and very faint; *f* black, pretty regularly curved on A, straighter on B and C; Feb. 11, *f* follows curve of ball on B and C, turns off abruptly on A: S. C. 12, faint shading *p*,

fainter than division, probably not reaching across B; *f* black, regularly curved on B and C, and not projecting at division as last year [opening of ring less]: S. C. 14, *p* very faint; *f* black, broadest at division and changing direction there, with a corner or notch, close to which division is darker: B. II. *p* seems darker and larger than Feb. 12, crossing B; *f* pretty regularly curved, a perfectly black spot in it where it meets division, not so dark elsewhere; this has the effect of breaking the curve. S. limb undistorted: S. C. Mar. 4, *p* very faint, all across B, slightly concave, and broad at division, which is plainly seen above it [and darker, in diagram]. *f* pretty uniform, but a small break at division, and 2 near apex. On this side of B "something that I cannot make out to my satisfaction. It seems as if there were a faint penumbra partly adhering to the division of rings, and partly to the shadow:" S. C. *f* black and more regular than usual; *p* a very narrow ghost-like shade, of the usual outline, all across B, broadest and darkest near division. "I was much impressed with the fact that the outline was preserved perfectly, while the intensity of the shadow was very

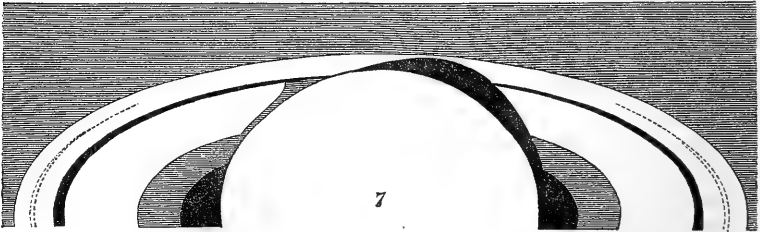

feeble:" B. II. See Fig. 7. 16, *p* darker than before; *f* not perfectly regular: S. C. *p* by no means as dark as *f*, which is black: B. II. 26, *p* unaltered, *f* extends further E; its junction with division clear and sharp: S. C. Apr. 16, distortion of *f* on B suspected, but definition bad: B. II. 18, atmosphere bad, but *f* seems to be becoming concave on B again: B. II. 25, *p* distinctly visible over further half of B; *f* slightly concave on B; its breadth at division equals that of A at axis minor; at the crossing there seems a dark spot: B. II.*

Thus far extend our facts. Whall shall we say in explanation of them? Can we charge them upon personal or instrumental equation? It seems not possible, since, in the main, they are agreed upon in England, and Italy, and Malta, and India, and the United States. Some of the most singular statements, it is true, come from America alone. But as they

* Schwabe during this spring, noticed a strong convexity of the shadow on both A and B: meaning, apparently, the reversal of the outline.

have often the concurrence of more than one observer, so the optical capacity of a telescope, which in favourable air would bear distinctly a power stated to be 1561 upon Saturn, leaves small chance of appeal. In fact, it is a remarkable circumstance that the mystery of the subject has increased under closer, more powerful, and more extended scrutiny. Some of the phenomena may admit of a more or less probable solution. For instance, the apparent concavity of outline might be explained as a deception, similar to those optical perversities so ingeniously illustrated by Mr. Proctor in our August Number; and a deficiency of shadow upon A would naturally follow from its lying in a different plane. But the "ears," projecting even when the true shadow was invisible,—the two shadows when, even after allowing for the planet's latitude, one only should have been seen,—the "roof," and "inlet,"—and the varying depths of shade in different parts, are alike too clearly attested for doubt, and too incomprehensible for explanation. We might take refuge to a certain extent in the idea of varied curvatures in the shadowed surfaces; and in order to meet the objection arising from the evanescent thinness of the lateral view, we might add a speculation as to the possibility of some force emanating from the sun, which might disturb the level of the surface, in proportion as its inclination exposed it to his influence. But even after we have ventured this daring effort, we find other features as intractable as ever. Some things look like effects of an atmosphere very irregularly distributed round the ball, and possessed of properties greatly dissimilar to those of ordinary gases; but this is undiscoverable, just where it ought to be most apparent, at the concurrence of outlines very obliquely inclined to each other.

We must therefore close this subject, already protracted to a wholly unexpected length—not, however, in despair of some better solution, but as commending it earnestly to the study of those who have the means and leisure for further investigation. It was not by recoiling from apparent impossibilities that the earlier inquirers won their way to such brilliant discoveries. It was not thus that the genius of Kepler carried him forward into the unknown, or guided him in "feeling the walls of ignorance, ere yet he reached the brilliant gate of truth." Or even if disappointment in one sense should wait upon such researches, they will bring with them in another respect their own recompense: "The works of the Lord are great; sought out of all them that have pleasure therein."

The object of the foregoing papers being to bring before the student, for his own comparison, as many original data as were accessible to the writer, the following additions and corrections may be permitted for completeness sake:—

1788, Aug. 2, H suspected a little equatorial flattening.—1790. Feb. 1, ring

reappeared brightest E: Cassini.—1792, H^l had occasionally noticed very small variations in the breadth of Ball's div. and the ring itself.—1840. De-Vico saw and measured excentricity.—1841. Schwabe saw Encke's div. 5 times; July 26, Sept. 11, on both ansæ. Ball's div. almost always plainer, or broader if less sharp and dark W. Sept. 21, indistinct, with a beautiful sharp image. His observations seem in some instances to connect its greater breadth W. with larger excentricity of ring E, as though A remaining unmoved with respect to the ball, B were somewhat displaced at those times: e. g. Aug. 19, div. only distinct W.; very large dark ansa E.: 20, div. plainer E. than W.; less difference of ansæ than 19.—1842. Sept. 2, De-Vico, Ball's more distinct W. 5, do. E. 30, Oct. 1, best W. 17, very distinct, no subdivision whatever. 25, best W.—1843. July 14, Encke's plainest E. Aug. 6, do. W. July 19, Aug. 6, 8, Ball's broadest E. July 19, 29, two subdivisions broadest E. Aug. 6, 9h. 43m. three do. plainest W.; 10h. 18m. best E. 8, three do. best E. [Is it impossible that a careful collation of the positions of the satellites, especially Titan, at any given epoch, with these features of the ring, should lead to the discovery of some connection? A friend has suggested that the closest satellite, especially, must raise a wave in A, which, however, would hardly be visible to us.]—1848. July 11, both poles brighter than equator: Bond II. Sept. 11, 12, S. belt like clouds: Schmidt.—1850. Nov. 22, Lassell suspected Encke's on both ansæ; 23, 25, Dawes do. and 29, especially *f*. Nov. 23, Secchi and others saw C brightest W., without divining its real nature; and 1851, Jan. 19, slightly broader W.—1850. Dec., when Hind first saw C, it was very narrow, and much plainer E.—1851. Oct. 26, Dec. 6, B and C not divided; 30, C broadest and most distinct W.: Secchi.—1852, Aug. 31, C fades away, so that its half next B is invisible: Tuttle. Nov., De la Rue's fig. shows shadow of A very faint on N. ball. 29, ball nearer outer edge of C, *p* than *f*; to eye; by microm. 4''26, 5''25, B. I. Dec. 15, div. on *p* side of B: Breen and another.—1855. Some nights in spring, Ball's broader before than behind globe; Secchi.—1856. Mar. 27, Apr. 5, 1857, Feb. 14, faint penumbra on *s f* limb: S. C.—1857. Jan. 30, do. either on S. limb or on ring in close contact: B. II.—1861. Nov. 15, blackish irregular patch on ball: Secchi.

THE FLORA OF IRELAND.*

THE British Association for the Advancement of Science, at the meeting held in Bath, appointed seven gentlemen as a committee, for the purpose of investigating the distribution of the Irish Flora, with £25 at their disposal. This sum has been judiciously applied towards the publication of a work, entitled *Contributions towards a Cybele Hibernica*, under the editorship of Dr. D. Moore and Mr. A. G. More.

This royal octavo volume of 460 pages, which has just appeared, will excite some amount of interest in botanical circles, for our knowledge of Irish plants has greatly increased since the publication of Mackay's *Flora Hibernica* in 1836, and not only have many species been added, but others have become better understood, whilst the range of many has been greatly extended.

In the introduction to this work we are favoured with

* *Contributions towards a Cybele Hibernica, being Outlines of the Geographical Distribution of Plants in Ireland.* By David Moore, Ph.D., F.L.S., and Alex. Goodman More, F.L.S. Dublin, 1866. Royal 8vo., 460 pp.

some details as to the climatical condition of Ireland; the mean annual temperature of the whole island is stated to be above 50° Fahr., being about the same as that for the south of England. But this moist and equable climate, and the comparatively low range of temperature does not give rise to such a diversity of forms as occurs in a like area in Great Britain. And though the ripening of corn and fruit is later and more uncertain in Ireland than in England, and wheat often a precarious crop, yet, on the other hand, many plants thrive and flourish there which would be killed by the cold dry frost of an English winter.

We regret to find that in the work before us no attention has been given to the physical features of the island in their relation to the distribution of plants; and the reader is simply informed in a few lines of the general character of the surface of the country.

Lists are given, enumerating the species which belong to the several types of vegetation in Great Britain, thus:—

I. Of the Hibernian type, *Helianthemum guttatum*, *Saxifraga Geum*, *S. hirsuta*, *S. umbrosa*, *Erica mediterranea*, *E. Mackiana*, *Arbutus unedo*, *Dabeocia polifolia*, and *Pinguicula grandiflora*, ally the flora of the S.W. and W. of Ireland, to that of the West and South of Europe, and range, under an exceptional climate, to a higher northern latitude than on the continent. With these are associated *Erica ciliaris*, *Sibthorpia europæa*, *Euphorbia hyberna*, *Simethis bicolor*, *Adiantum capillus-veneris*, and *Trichomanes radicans*, which occur also in Britain.

Sipiranthès gemmipara, *Sisyrinchium anceps*, *Naias flexilis*, and *Ériocaulon septangulare*, the latter being also British, “point to a former connection with North America.”

In addition to the above-mentioned species, which occur in Ireland, but not in Great Britain, the following make up a total of 22:—*Arenaria ciliata*, ? *Saxifraga Andrewsii*, ? *S. hirta*, ? *S. affinis*, *Inula salicina*, *Neotinea intacta*, *Potamogeton longifolius*, *P. sparganiifolius*, *Carex Buxbaumii*, and *Asplenium acutum*.

II. Of the plants classed by Mr. Watson under his Atlantic type, 41 out of the 70 are also Irish.

III. Of the species belonging to the Germanic type of vegetation, 18 only out of 127 have been found wild in Ireland. The majority of these are confined to the eastern counties, but *Monotropa Hypopitys*, *Astragalus Hypoglottis*, *Teucrium scordium*, and *Bromus erectus*, occur also in the west; *Orchis pyramidalis* being distributed sparingly over a large portion of the island.

IV. The Alpine type of flora is represented by 40 species, only a little more than a third of the 113 of Watson's Highland type, most of which occur in the west and north.

"Some of the species, as *Draba incana*, *Dryas octopetala*, *Galium boreale*, *Arbutus uva-ursi*, *Sesleria cœrulea*, *Lycopodium selaginoides*, and *Isoëtes lacustris*, occur in many places at, or a little above the sea-level, so that they cannot be termed highland species in Ireland. It is probably in consequence of the vaporous atmosphere, and the less amount of sunlight, that these plants are found at a lower level than in Scotland."

V. The northern plants, namely, those belonging to Watson's Scottish and Intermediate type, amount to 66 out of 117. Of these, *Trollius europæus*, *Geranium sylvaticum*, *Ligusticum scoticum*, *Melampyrum sylvaticum*, *Lamium intermedium*, *Salix nigricans*, *S. ambigua*, *S. laurina* and *Equisetum umbrosum* are confined to the north; whilst *Helianthemum canum*, *Potentilla fructicosa*, *Gentiana verna*, and *Ajuga pyramidalis* are species of the west, and *Allium scordoprasum* is met with only in Kerry and Cork.

Mr. Watson represents the flora of Great Britain as amounting to 1425 species, which has been increased, say, to 1435; of these Ireland claims about 950, to which are to be added the 22 species which occur in Ireland without reaching Great Britain, and "with the addition of *Hieraci* and *Rubi*, the whole flora may be computed at about 1000 species, thus amounting to little more than two-thirds of the plants found in Great Britain."

The authors then proceed to point out the deficiencies of the Irish flora, amongst which we notice such common British plants as:—*Genista anglica*, *Galium cruciatum*, *Helianthemum vulgare*, *Ranunculus hirsutus*, *Ononis spinosa*, *Plantago media*, *Paris quadrifolia*, *Valeriana dioica*, and many others of an extended latitudinal range in this country.

The island is divided into twelve districts, as shown by a map, particulars of which, such as the elevations of the highest mountains, and the more remarkable plants in each, are given. The districts are as follows:—

- I. Kerry and South Cork.
- II. North Cork, Waterford, South Tipperary.
- III. Kilkenny, Carlow, Queen's County.
- IV. Wexford and Wicklow.
- V. Kildare, Dublin, Meath, Louth.
- VI. Limerick, Clare, East Galway.
- VII. North Tipperary, King's County, Westmeath, Longford.
- VIII. West Galway, West Mayo.
- IX. East Mayo, Sligo, Leitrim.

X. Fermanagh, Cavan, Monaghan, Tyrone, Armagh.

XI. Donegal and City of Londonderry.

XII. Down, Antrim, Derry.

The introduction concludes with a table, showing the distribution of the plants in the districts.

The *Contributions towards a Cybele Hibernica* present the features of a good "Local Flora." The materials are arranged somewhat after the plan of Mr. Watson's *Cybele Britannica*—whence the title. The natural system is followed; the technical and popular names of each species are given; as also the districts in which it occurs; its habitats, time of flowering, and when known, its altitudinal range; in the case of rare plants localities are enumerated.

The body of the work is interspersed with observations on the many species discarded as Irish, either because they are not considered natives, or have become extinct, or because about which no authentic information or specimen has been obtained.

There are good indices to the Latin and English names.

From a glance at pp. vi.—xv., we gather that the editors have had a paucity of material at their command, and perhaps they have experienced a reluctance on the part of authors and correspondents to avow errors of determinations. These circumstances have clearly entailed on them much field investigation.

Too much praise cannot be accorded to Dr. D. Moore and Mr. A. G. More for the successful issue of their meritorious labours. They are, however, aware of the incompleteness of this production, and appeal to the botanists of Ireland "to assist them in the preparation of a more complete work," adding that "there is an ample field yet open in the exploration of the flora of their native country."

One interesting branch of study is recommended—"The upper and lower limits of the elevation of plants," regarding which, it is very properly observed, "that little is gained by the statement, that a species descends to sea-level in *one* district, while it ascends to 3000 feet in *another*; it is only by comparing both upper and lower limits in each different range of hills, or at least in each of the chief groups, that any useful results can be expected."

Cybele, as employed by Watson to express the distribution of plants upon the earth's surface, and adopted in the present work, is somewhat misapplied. The volume "is merely a revised list of the wild plants of Ireland, with a classified summary of their localities;" it deals in no generalizations, and is inferior in many particulars to some of our good Local Floras.

The association of plants with certain kinds of soil is not even alluded to, although the way has been led by Mr. Foote,* who has shown that in "The Burren," county Clare, as in most districts, there is a close connection between botany and geological strata; and Mr. Tate† has pointed out the peculiar attachment of many species in the north of Ireland to certain rocks and soils. As the *Cybele* is but the sum of all the local floras, so we may reasonably expect that facts of this kind should have been collated, and some general law have been deduced.

If some regard had been paid to this department of the *Cybele*, the parcelling out of the island into districts would have been made more in accordance with the physical and petrographical features of the surface than has been done. Such an investigation has led the writer to differ from the authors who attach the county Down to the counties of Derry and Antrim to form their District 12. Now, geologically, Down is very differently constituted from Derry and Antrim; in the former palæozoic rocks prevail, yielding light and warm, and, in a few localities, calcareous soils; whereas the basaltic rocks occupy the greater portion of the surface of Derry and Antrim, with keuper marls and liassic shales beneath the escarpments of the volcanic masses. The soil of this area is cold and heavy, excepting here and there along the coast, where sand and gravel are met with, in which case a marked group of plants accompany the same. Much of the district is, moreover, elevated above the agral zone, and is greatly encumbered with wet peat bogs; in the county Down, this is not much the case, and the surface is varied by the occurrence of swamps.

In the *Cybele* I find that 112 species are recorded in the counties Antrim and Derry, which are unknown in Down, and that 25 species met with in that county are wanting in Derry and Antrim; the number of species in common being about 650. This partial incommunity of species between Down and Antrim is real, and cannot be reasoned away on the grounds that the latter county has been better worked; it is due to physical features, soil, and geographical position. For it is significant that the county Down is richer in species of the Germanic and English types of vegetation, whilst Antrim and Derry contain a superior number of Scottish and Highland plants; some of which, however, though eminently characteristic of the northern counties, pass into Down, and *vice versa*. As, for example, *Lamium intermedium* (the frequency of the occurrence of this plant appears unknown to the editors), which occurs from Magilligan, county Derry, along the coast

* *On the Distribution of Plants in Burren.* Trans. Roy. Ir. Acad. 1862.

† *Flora Belfastiensis.* 1863.

line to Belfast, and inland at Bellaghy, county Derry, is met with on the light sandy soils of the county Down, in the immediate vicinity of Belfast, but extends as far south as Newtonards.

The incongruity of including Down in District 12 is manifest; it should—at the very least, its southern half—form part of District 5; or, with a portion of Antrim, and with Armagh and Louth, constitute an additional district.

It appears objectionable to separate the S.W. shore of Lough Neagh from District 12; the basin of the lough, and the area drained by the Lower Bann constitute a natural district; and if it be impracticable to unattach it, the whole of it should certainly form part of District 12. By this arrangement, such a restricted plant as *Calamagrostis stricta* would belong to one district, as it naturally does, and not to two, as now.

The *Cybele Hibernica* is remarkably deficient in generalizations; there is no comparison with neighbouring floras, and no allusion is even made to the late Prof. Forbes's *Origin of the Flora of Ireland*. This certainly is a disappointment, inasmuch as doubt had been raised as to the correctness of Forbes's premises, whereon he established that masterly essay on the sources whence the flora of Ireland, as well as of Great Britain, was derived; and it is not unreasonable to suppose, considering the care the editors of the *Cybele* have bestowed on the thorough investigation of the plants that have come under their notice, that they are in a position to test the soundness of Prof. Forbes's conclusions.

Another edition will be required, if the workers, which this publication will undoubtedly raise up, will respond to the solicitations of the authors, who repeatedly direct the reader's attention to the paucity of species in Districts 7 and 11. The labours of the writer during a few weeks of the summer of this year, have added *Medicago sativa*, *Helminthia echioides*, and *Myriophyllum alterniflorum* to the list of District 12, and have furnished new localities of species thought to be rare. He offers the following few remarks by way of addenda and corrigenda:—

Is *Ranunculus pseudo-fluitans* not merely a state of *R. pel-tatus*? The two grow in the Bann, at Coleraine; the former in the rapids, and therefore without floating leaves; the latter in still water, where floating leaves are developed.

It is stated that “the two sub-species, *Fumaria pallidiflora* and *F. confusa* have not been sufficiently distinguished, but appear to be about equally distributed.” The latter is generally distributed in Antrim and Derry, but always on light soils; the latter is rare, and has occurred to me at the Curran of

Larne, Carnlough, Cushendall, and Toome Bridge; all the localities in Antrim.

Lavatera arborea occurs in many stations on the east coast of Antrim, always by houses, and has no claim, in District 12, to rank as a native.

Geranium pratense grows at Dunluce and Port Ballintrae, and not *G. sylvaticum*, as suspected in the *Cybele*.

Myriophyllum alterniflorum is common in Antrim. *M. spicatum* is rare.

Arctium intermedium is a common plant on the Antrim coast; *A. minus* was not seen.

Orobanche rubra is not confined to the basalt in District 12. It was gathered on White Limestone, at Ballintoy, and at Ballyvoy, near Ballycastle.

Helminthia echioides grows wild on Island Magee, District 12.

Calamagrostis stricta, confined to the shores of, and islands of Lough Neagh, was discovered in profusion on the shores of Lough Beg, county Derry.

There is no value in retaining localities whence species have long since been eradicated, and where there is no possibility of their reappearance; preserve the record, but do not confuse collectors by the insertion of erroneous references. In the volume before us are too many examples of this kind, which, we presume, have been inserted through ignorance of the present unfitness of the locality for the growth of the species. *Typha angustifolia* does not now grow near Belfast. The ditch near the Belfast Linen Hall, where, in the last century, *Lemna gibba* grew, has many years been filled up.

In several instances the locality of a species appears under two or three names. This is decidedly objectionable, for not only is the bulk of the volume increased, but an erroneous impression as to the frequency of its occurrence is produced. Thus, the locality for *Rosa Hibernica*—"hedges on the shore near Holywood, Belfast Harbour"—positively includes "hedge-rows half way between Holywood and Belfast" of one, and "Hedge, Tillysburn" of another author.

Despite the aid rendered by two eminent London botanists in the revision of the proof-sheets, there are very numerous errors, both of omission and commission, in the volume.

R. T.

CHACORNAC ON COMETS.

THE following is a translation of a paper for which we are indebted to M. Chacornac. It forms part of the *Recherches d'Astronomie Physique*, which he issues from time to time:—

“Since the great comet of 1811, it has been known that the nuclei of comets as they approach the sun dilate into vaporous atmospheres, to a certain limit, uniformly round the nuclei, since if that limit is passed, these atmospheres are compelled, by the action of an unknown force, to flow back on a level surface, in the prolongation of the *radius vector*, with a velocity nearly equal to that of light.

“In seeking to interpret this grand phenomenon of nature with the aid of simple physical laws, we are led to the following conclusions. If no repulsive force emanated from the sun, and opposed their dilatation, these cometary atmospheres would extend in all directions, at least as far from the nucleus as the extreme length of the tails, since the dilatation of a gas in a vacuum appears to be indefinite. The rapidity with which these atmospheres are developed is such, that even at a temperature such as that of the earth's surface, it would be considerable.

“The aigrette of the comet of 1862 extended through a length equal to four times the diameter of the earth in an inappreciable time, since the first trace of this jet, though weak, was observed throughout the whole extent the moment it was perceived. This fact shows that the expansive force of the gaseous matter is great enough to produce effects like those repulsions which arise from elevation of temperature, and we are naturally led to conceive of similar actions in the solar photosphere.

“If we consider what must occur at the limits of the pressure of the exterior atmosphere, where the force of gaseous expansion exceeds the attraction of the solar mass, it would seem that the gaseous matter heated by the photosphere would overflow into the vacuum of space. The behaviour of the sun's external atmosphere appears in perfect accordance with this consequence of the physical causes in operation. Thus above the purple zone (*zone pourprée*), which appears contiguous to the photosphere during total eclipses, a zone of dense atmosphere is constantly noticed which reflects a brilliant light, and on this account has frequently been confounded with the reappearance of the disk on its emersion. It is from the external surface of this atmosphere that those rays of the solar aureole spring, the configuration of which indicates the expansive force of gases projected violently into planetary space.

“If we calculate the velocity of outflow with which a gas precipitates itself into a vacuum, we find that at the pressure of our atmosphere, and at a temperature of zero, it is greater than that of a cannon-ball; and, in fine, it is demonstrated that the pressure is insignificant in determining the velocity of the flow of different gases, which depends on their density only, and is greater as the density is less.*

“If these considerations are applied to the question of the limitation of planetary atmospheres, it will be seen that it is possible that at the temperature of planetary space there may be an equilibrium between the weight of the external atmospheric layers and the elasticity of those below them, but this cannot be the case with a vaporous atmosphere exposed to a temperature of many thousand degrees. Moreover, for an external layer to press inwards from its weight, we must conceive that it can no longer dilate itself in the vacuum of planetary space, that is to say, it must be more dense than what is beyond it. This last consideration affords mathematical ground for regarding the external layer as *crystalline*,† in order to comprehend how any atmosphere—like that of the earth—can be limited.

“At the surface of the sun such an hypothesis is not admissible, and, moreover, in the phenomenon of re-incandescence, seen in the photosphere, there must evidently be a repulsive force acting upon gases, and producing violent dilatation according to laws which are not known. We do not know what forces of dilatation would be developed at such enormous temperatures, but it is incontestable that the radiating aureoles of the sun point to a projective force acting outwards, and shooting forth perpendicularly to the solar periphery masses like innumerable and very dilated aigrettes of comets.”

M. Chacornac appends sketches of aigrettes formed by the comet of 1862.

* “Et enfin on demontre que la pression est insignifiante pour la vitesse d'écoulement des differents gaz, que celle-ci est dependante de le densité des gaz seulement, puis-ce-qu'elle est autant plus grande que la densité est moindre.”

† We have before had occasion to notice the peculiar sense in which M. Chacornac uses the words crystal and crystalline. We must either suppose the elasticity of the atmosphere to be limited, or we must imagine such an arrangement of its particles as to give rise to, or be acted upon by, opposing forces. Why this should be called a crystalline state we do not see.

A STRANGE PLACE FOR ROTIFERS.

BY HENRY J. SLACK, F.G.S.,

One of the Hon. Secs. of the Microscopical Society of London.

In the writer's garden hangs a Mason's hygrometer, or wet and dry bulb thermometer. The supply of water to keep the wet bulb moist is held in a small glass vessel about one inch in diameter, and rather more than that in height, and having a short neck, just wide enough to allow some threads of lamp cotton to hang freely through it. It may therefore be described as a small glass, squat bottle, loosely stoppered with lamp cotton. Every two or three days in warm dry weather, and every two or three weeks in wet weather, this vessel requires replenishing, which is usually done by holding it under a tap, and suffering the stream not only to fill, but to give a good washing to the cotton and to the vessel. When the cotton is dirty it is removed, and fresh supplied. No green matter of any kind has grown in the vessel, and very little atmospheric dust could find access to it. Under these circumstances it could not be expected to be a favourable place for any kind of infusoria, but in August the cotton fibres became slimy without getting discoloured, and this circumstance led to a microscopic examination. There was no decay in the cotton fibres, and very little extraneous matter adhering to them, but the slimy matter resulted from the presence of a considerable number of infusoria, among which were many rotifers of small size and of the common sort.

The chief infusoria in point of numbers were monads of minute dimensions, some swimming freely with a jerking motion, and others jumping violently without much change of place. With the help of Smith and Beck's one-twentieth and first eyepiece, giving a magnification of 1000 linear, it was seen that these little objects were provided with single tails or filaments, and were able to adhere to the glass by the extremities of these organs, and being thus moored fast to a fixed point, they executed a series of jerking jumps in all directions, with great liveliness. The body of these little monads was white and pear-shaped, about 1—8000" in greatest diameter, and more or less filled with smaller cells. The tails or filaments were exceedingly fine, and four or five times the length of the bodies. A few small ciliated infusoria were also present. The rotifers were numerous and very lively, though apparently stunted in growth by the limited supply of food.

Part of the cotton was transferred to a Preston salts bottle filled with cistern water, and left uncovered, so as to catch

floating dust. The consequence was that in a week or two much more organic matter was present than had been in the hygrometer vessel, but this did not lead to increase in the rotifers, which on the contrary decreased, although some new animalcules (trachelius, etc.), made their appearance, and one very delicate round, empty test—probably of a diffugia—was observed. This was curious on account of its being covered with what appeared to be microscopic crystals of carbonate of lime.

As it cannot be supposed that clean undecayed fibres of cotton were devoured as food by any members of the colony, they must all have lived on the very minute quantity of other organic matter present, and either in decomposition or growth. The monads were probably vegetable, though possibly animal. They appeared to form the food of the rotifers, and had nothing noticeable to live upon.

This accidental experiment affords an illustration of the fact that very minute quantities of organic matter in decay are sufficient to lay the foundation of, and for a time support, a numerous infusorial colony, which may include objects of comparatively high organization. The wind may have carried small rotifers, or their eggs, on to the cotton; or, which is more likely, one may have been imported in the cistern water with which the hygrometer vessel was filled; and, notwithstanding the limited supply of food, the creature and its progeny flourished for many weeks.

FAMILY LIFE OF THE MIDDLE CLASS.

THE good qualities of the English middle class, as developed in their family life, are amply recognized; indeed, an exaggerated estimate of them too often occasions a blindness to very striking, if not perilous, defects. The term "middle class" usually designates those families whose income is, wholly or chiefly, derived from personal exertion in trade, commerce, or a so-called "learned profession," and this description will be sufficient for the purpose of this paper. The family income in this great section of the community may be supposed to range from two or three hundred to as many thousands a year; but there are many whose resources are smaller, and others who are able to rival and exceed the expenditure of the wealthiest houses of the aristocracy. Social custom divides the middle class into several grades, partly on the ground of diversity of wealth, and still more on that of occupation. As a rule, retail trades are held to be inferior to those that are wholesale, and it is thought to be "genteel" to sell goods in a warehouse, and comparatively "vulgar" to sell them in a shop. The greatness of London tends to swamp many minor distinctions, and hence the popular estimate of the dignity or inferiority of occupations has less action in the metropolis than in smaller towns. The fashionable world rigidly excludes from its private assemblies all who are known to be guilty of the serious offence of dispensing articles in small quantities. Mr. Jones, who sells cotton in the bale, is admissible; Mr. Thompson, who will accommodate his customers with a skein, could not possibly be tolerated. This exclusion of retailers is more or less broken into when the shop is in the city, and the family reside in a villa a few miles off.

In small towns the artificial distinction of social grades has more rigidity and completeness. One or two successful professional men are allowed to visit "county families," and the same high powers will sometimes look benignly upon a local merchant, if his transactions are large. In such towns it frequently happens that the most intelligent and useful man for rendering service in public questions, local or national, keeps a shop, and he is thus placed in an awkward intermediate state. His talents and services compel a certain amount of consideration from those above him; but as they cannot condone the shopkeeping, they do not freely admit his family into their circles, and probably those of his own precise rank are not sufficiently cultivated to be his natural companions. In many little towns social visiting is well nigh impracticable, except amongst relations, as every man in the

place is a little too high, or a little too low, to be socially civil to anybody else.

In country towns there are other peculiarities, as, for example, the position assigned to manufacturers, which is chiefly, though not entirely, dependant upon the style in which they live. The great manufacturer ranks as an important man in the county as well as in the town, while the smaller maker of the same article is held in little estimation. This is also noticed in such businesses as brewing. Those upon whom the vats and coppers have, in Johnsonian phraseology, conferred "a potentiality of becoming rich beyond the dreams of avarice," are freely welcomed by great landed, or noble families, while those whose vats and coppers are of smaller dimensions would be snubbed if they attempted any intercourse of the kind. In agricultural districts the precise position of farmers' daughters is often difficult to settle, and we remember serious conflicts of opinion in a little town, as to whether certain young ladies of this description might be invited to public balls. The general opinion of the young men was in favour of the girls, whose beauty was admired; but the puzzle was how to admit them without their brothers, who were voted too rough.

It is not our purpose to inquire into the complicated rights and wrongs of these social divisions; but their existence materially affects the conditions of middle-class family life. They make the co-operation of large bodies of the middle class very difficult, and they tend to prevent the best manners and the wisest opinions from spreading throughout the mass.

As a rule the education of middle-class families is bad; on the whole that of the richer sections, though still bad, is the best, while that of the poorer sections is not equal to that which the working class enjoy in the *best conducted* British or National schools. All through, there is a deplorable want of any species of culture that tends to enlarge the mind. Physical science is woefully neglected; political economy and social sciences usually ignored, though remarkably well taught, as part of the instruction supplied for sixpence a week, in the famous Peckham School, founded by Mr. Ellis, and conducted by Mr. Shields. Only the dry bones of geography are usually imparted in the shape of names of places and rivers, with their latitudes and longitudes, and history figures as a dull catalogue of battles and dates. Very rarely does any school-teaching develop a capacity for enjoying or understanding the great literature of our own or any other country, and many a boy is cured for life of any fancy for poetry, by its being made an instrument of torture in Latin or Greek.

It would not be fair to the schools if we were to forget that

their profit depends upon their supplying what their customers demand, and until the heads of families entertain more worthy ideas on the subject of education, or are willing to be led by those whose judgment is enlightened, it will only be in rare cases that a schoolmaster or mistress can get a living by doing justice to the pupils. At the present moment there are many schools in advance of the average requirements of their supporters, and the best schoolmasters evince a laudable anxiety to improve the system of instruction. We must also recollect that it is very hard work for a schoolmaster to be continually engaged in pulling his pupils upwards, if the family life to which they are periodically remitted pulls them down again.

The composition, habits, and education of middle-class families leads to a general deficiency in taste for intellectual pursuits. It is the exception, not the rule, even for a single member of the family to have a decided taste for science, literature, or art, or to cultivate it so as to reach any considerable degree of proficiency or knowledge. Taking the whole of our middle class, with its vast numbers, it is, of course, easy to select some thousands of persons to whom these remarks do not apply; but they are unfortunately applicable to the great majority of those who are rich, as well as of those who are comparatively poor. The number of families in which any member has attempted to make a study of Shakspeare, Milton, or Bacon, is—relatively—very small; and still smaller the number of those who systematically study, for pleasure, a science or an art. One conspicuous proof of this may be found in the absence of demand for lectures of a high class, and in the small number of copies of first-rate books that any publisher can sell. Many excellent works are with difficulty pushed through a sale of five hundred copies, and few first-class books reach a sale of a thousand copies, except after years of recognition, and strenuous efforts on the part of the bookseller. Rubbishing books, on the contrary, often enjoy a large immediate sale.

The ordinary middle-class family is not much given to the purchase of books. If somewhat feeble in intellect, it will have its Tupper; if stronger, its Longfellow or Tennyson: but what thousands of homes in which the upholstery is excellent, the comestibles costly, and the grand piano unexceptionable, both for cabinet work and tone, in which not a readable book is to be found in secular literature, and in which, if any question arises on points of history, science, or art, it is in vain to appeal to the "library" for a reply! England is, in this respect, far behind the New England States of America. The close of a school career leaves "young ladies and gentlemen" as euphuism always describes them—boys

and girls, as we prefer—at an age when help to continue old studies, or enter upon new ones, is peculiarly desirable; and, as a rule, nothing of the kind is provided. Some years ago, in the metropolis, there were in full activity, the Royal Institution, the London Institution, the City of London in Aldersgate Street, the Mechanics in Southampton Buildings, and some others, which were thronged by the members of middle-class families, who attended considerable courses of lectures on important subjects by eminent men. Classes were also common for the further pursuit of the same branches of knowledge. Now, the Royal is in full vigour, the London in genteel decay, the Mechanics in doleful dirt, and others have disappeared. Only the Royal Institution in London, and less than half a dozen other institutions in the three kingdoms, can attract an audience for a course of first-class lectures on any subject whatever. Eight hundred or a thousand institutions exist throughout the country, of which many neither have lectures nor form classes; while nearly all in which lectures figure confine them to subjects that are trivial, or to graver ones treated in the most useless and flimsy way.

Even in London, if any family of more than common intellectual ambition would like its boys and girls, when their school time has passed, to acquire a reasonable knowledge of any physical science, or to get help in the more difficult branches of literary or artistic study, they are not encouraged by facilities, but staggered by difficulties. A district in which five or ten thousand families of moderate means live, ought to be able to co-operate and provide the necessary machinery of lectures, classes, and libraries; but nothing of the kind is done. The social demarcations to which we have adverted, no doubt, constitute a serious difficulty, but the chief obstacle is the absence of desire.

Much drudgery falls upon many members of the middle class, but in cases where pecuniary means are sufficient to preclude the necessity for over-toil, the dignity that should belong to home-life is damaged by idleness and frivolity. In too many cases, if the young men are not in business, they may be found in the billiard-room of a public house; and if the girls are not required for household duties, their hours are passed in the idle gossip of morning calls, or evening parties. Thousands of families, which do not fall into these special errors, set up for their standard, propriety, not excellence; and if they escape the blame of doing mischief, they are still open to censure, as they contribute nothing to the active forces by which society is prevented from running to decay.

Young men, prematurely emancipated from parental authority, usually take to their own courses, while girls, perhaps of finer tastes and more sense, are subjected to too

much control. A possibility of isolation at fitting times, liberty in the choice of pursuits, facilities for gratifying them—these are requisites for the best development of girls. If their home-life is always passed in the common sitting-room of the family, if at years of discretion they cannot buy a book, obtain an instrument, and take a walk to look at a picture, or pick a flower, without interference and supervision, their characters are dwarfed, and their faculties have no fair play. The “fast young lady” may be an unpleasant symptom of social disorder, but the tame young lady is a more hopeless product of social disease.

The want of tastes is a serious family evil, as well as an individual fault. A life without excitement is impossible for many, and objectionable for all. Good honest tastes form the springs of useful exertion, and in the endeavour to gratify them a wholesome excitement is to be found. Exclude the tastes for good things, and tastes for bad things will spring up; because some human faculties will be active, and if the finer elements of our nature are enfeebled by want of exercise, lower propensities and passions are left in sway. There are painfully respectable natures, incapable of any but cheap virtues, and without the vigour needful for great defects; but they are not objects to be contemplated with any approval. There should be something heroic and dignified in every life, and no human being should be permitted to grow up without throbs of aspiration towards that which is noble, beautiful, and true.

Tastes for good things are, in the higher natures, so strong as to command their means of cultivation, even under adverse conditions; but in ordinary mortals they must be cultivated, or they will never exist. Even in childhood, the family atmosphere, or the influence of some special person, determines for the major part of mankind whether they shall grow up with or without strong tastes for something useful and elevating. If circumstances hinder, or fail to favour, such cultivation and growth in early years, it becomes exceedingly difficult or impracticable afterwards. Parents often wonder why the young man of sixteen or eighteen is headstrong and dissipated, when the seeds of such conduct and character were sown in his childhood, through the inaptitude of the family life to stimulate a higher sense of duty, or cultivate a taste for worthier pursuits.

Family life presupposes the daily meeting of the same persons, often with a very moderate allowance of intercourse with outsiders. The male part of a quiet family, through their occupations, usually get most change, while the women suffer, like greenhouse plants under a bad gardener, who keeps the doors and windows shut. Even frivolity of admixture with other fellow-creatures is better than the damp, mildewy influence of isolation, with nothing elevating to do. But a family

ought to contain within itself no small share of the elements of happiness and growth; and with anything like proper education and cultivation, it would be difficult to find three or four people, even of the same parentage, without a wholesome diversity of character and tastes. If the various members of a family have their own occupations and pursuits, some from the necessities of business, others from the promptings of choice, and each does his own work well, the meeting together will neither be tame nor tiresome, nor will the only bond that keeps them together be a notion of duty, or a mere instinct of affection.

There can be no greater contrast than exists between two sections or orders of middle-class families—the larger one, in which there are no particular tastes or pursuits of a high character; and the smaller one, in which they exist in force. To the smaller category, public events, and social movements, scientific discoveries, the labours of art, the appearance of noteworthy books, supplies daily food of an intellectual and exciting kind, upon which each comments with earnestness and intelligence. In the larger class, the mental food is scarce or bad, the mental appetite languid, and the digestion weak. The women, as the weaker vessels (and brought up to be so), accept the situation as they find it, while the young men too often seek^d in dissipation for an excitement which domestic emptiness does not afford.

“ — Winds blow and waters roll,
Strength to the brave.”

So says Wordsworth. And if our middle-class families can summon up courage enough to assail the evils we have pointed out, they will find abundant help from the cultivated minds within their own ranks. Let us endeavour to sketch a few of the changes to be desired. In the first place, every member of a family ought to be able to read aloud either prose or verse sufficiently well for the performance to be intelligible and pleasurable, while in many instances a considerable degree of artistic skill should be attained. This demands practice in acquiring power over the voice, accurate and critical knowledge of the thing to be read, and such aid as can be obtained through hearing really good (not clap-trap) professional performers. Each family ought to be able, with certainty of response, to address one or more of its members, and invite him or her to

“ Lend to the rhyme of the poet
The beauty of thy voice.”

It is exceedingly difficult for any one to appreciate the blank verse of Shakspeare, with its wonderfully-varied rhythm, or the grand, though less flexible, verse of Milton, without hearing it well read; and the same remark may be made of the finest prose passages, such as those which abound in Bacon,

Jeremy Taylor, or Sir Thomas Brown. The foundation of a fine taste in literature is often laid by good reading, and good family reading does not require the acting style in which certain favourite public performers over-indulge. Boys as well as girls ought to learn music, if they have any aptitude for it, otherwise the time so spent is wasted; but whoever pretends to learn music should not be satisfied with playing or singing the fashionable pieces of the day. Some knowledge of music as a science should be acquired. This involves a little thorough bass, and a little accoustics; and music should further be studied as a fine art, and some notion obtained of the peculiarities of the leading schools of the great composers, and the methods by which their effects were produced. If music is worth learning at all, it should, like all other things, be learned properly, whether the study be elementary, or carried to a great extent. Drawing and painting should be studied on the same broad principle, whether the time devoted to them be more or less. A study of drawing and painting would be useful to thousands who could never be proficient in either art. It assists the comprehension of what great artists have accomplished; and those who have paid no attention to perspective, colour, and shadow, have not learnt to see. The beauty of form, and its idealization, will be brought within the mental grasp of those who have learnt how to look at a fine figure-piece, while the landscape artists (and especially Turner) will teach those who study them how to enjoy the aspects of nature in all the gorgeous subtleties of atmosphere and light.

Some elements of science, such as physics, chemistry, geology, and astronomy, should be deemed essentials in any system of education, and also the rudiments of physiology and natural history.

No family that can afford the money ought to consider its house furnished if it does not contain a telescope and a microscope, neither of which need be very expensive for general purposes; and there should be a fair collection of books, for reference on all the leading topics likely to interest rational persons living in a civilized country. Diversities of taste would make some tend more to art, some more to science, and some more to literature; and, although certain elementary information on a variety of topics ought to be communicated to all, it would be a grave mistake to endeavour to force all to pursue the same career of study without regard to difference of mental constitution. Let us suppose a family of half a dozen persons. It is most probable that all will like, at times, to be well read to, and most, if not all, will enjoy the good music that those most proficient in that art can give at leisure intervals. If one has a fancy for observational astronomy, all are sure to

like to take a frequent glance at solar spots, lunar mountains, and double stars, if accompanied by such explanations as will enable them to understand what they are looking at. If another works with a microscope, all will be glad to see any new object of remarkable beauty or curiosity, provided its nature is explained. A geologist can always interest ordinary mortals, if they are not in a state of præternatural stupidity, by showing and explaining appropriate objects; and so can a botanist, or any other student of special matter. Each member of a family should be expected to contribute something to its intellectual life, as well as to its moral excellence, and no child should be brought up to be an uninteresting and mentally unprofitable member of the circle. Lectures ought to be made systematically available for what they are worth; they can never replace class teaching or private study, but they are admirable introductions and stimulants, and useful for keeping up knowledge already gained, and bringing it up to date.

In addition to such larger combinations as may be necessary for the support of public institutions, why should not a few families combine for the general encouragement of intelligent pursuits. With mutual help, the study of difficult subjects might be facilitated, and very interesting gatherings might advantageously replace many dolefully stupid and sorely afflicting parties, in which nobody has anything useful or entertaining to say.

We do not want to flatter our readers, but we do look upon them, and upon those like them, who *ought* to be our readers, as the leaven that is to leaven the lump. Progress takes place when superior minds, or better cultivated minds, come into frictional contact with, and excite less advanced minds. It is for families who have learned to rejoice in the fulfilment of those intellectual duties which devolve upon human beings endowed with noble faculties, and placed in a noble universe for their exercise, to lead others in the same path. Let them exclaim, with Wordsworth—

“————— What we have loved,
Others will love, and we will teach them how;
Instruct them how the mind of man becomes
A thousand times more beautiful than the earth
On which he dwells: above this frame of things
(Which, 'mid all revolution in the hopes
And fears of men, doth still remain unchanged)
In beauty exalted, as it is itself,
Of quality and fabric more divine.”*

* This grand passage, which forms the conclusion of the *Prelude*, is a *pons asinorum*, or donkey's bridge, for bad readers, who are sure to break down before getting through it. We recommend families to have a try at it, each member at a time, and the one who can bring out its full sense and majestic rhythm, will deserve at least as much credit as the boy or girl who gets over the famous proposition of Euclid, to which we have likened it.

THE STONE AGE IN CHINA.

BY M. CHEVREUL.

THE following paper is translated from *Comptes Rendus*, 13th August, 1866 :—

“It is now the custom to designate by the expression ‘age of stone’ those pre-historic times when men, not acquainted with metals and the methods of working them, fashioned out of hard stones implements such as hammers, chisels, knives, hatchets, etc. A passage from the life of Confucius, by Père Amiot, printed at Paris in 1788, shows that the Chinese passed through the stone age.

“Confucius, so states his biographer, being in the kingdom of Tchen, stayed at the house of a sage named Tcheng-Tsee, when the king of Tchen perceived on the terrace of his garden a bird of prey which seemed to have *three wings*, and a strange mode of flight. The king ordered that the bird should not be lost sight of, and should be brought to him alive or dead. The bird soon fell lifeless on the steps before his palace. The bird had only two wings, but the feathering of an arrow that transfixed its body explained how it appeared to have three; and the extraordinary fact was that the arrow, quite different from those then in use, was armed with a hard-pointed stone instead of with iron, and its wood was peculiar. Tcheng-Tsee, the friend of Confucius, was commanded by the king to explain the matter, but being unable to do so, he spoke of Confucius as one capable of fulfilling his majesty’s desire. Confucius, having recognised the bird as a *sun*, a kind of hawk, whose peculiarity it is not to chase the birds it feeds upon, at their love season, or when they are incubating, said, ‘This kind of bird of prey is a native of the land of Sou-chin, to the north of Tartary; it never comes to our climate. Inasmuch as the arrow is armed with a piece of hard stone instead of an iron point, it resembles that which Ou-ouang presented to the prince in whose favour he erected into a kingdom the country of Tchen, when, having extinguished the dynasty of Chang, he gave the fiefs to his chief assistants in that glorious expedition. This arrow was thirteen inches long, without reckoning its stone armature, and was given as the sign of sovereignty of him who was created King of Tchen. Seek, Sire, in your armouries, and perhaps, in spite of the different revolutions which have happened since the creation of your kingdom, the arrow may still be preserved. If it can be found, let us compare it with that which has occasioned the death of this bird, and we may conclude from it that heaven favours your majesty,

since it allows the authentic sign of the sovereignty of the kingdom to fall into your hands.'

"The text adds that the king caused search to be made amongst his antiquities, and that an arrow was found precisely similar to that in the bird of prey.

"Does it not appear from this passage that at the succession of Ou-ouang to the empire, the date assigned to which is 1122 B.C., iron-pointed arrows were used, but that tradition preserved the reminiscence of sharp, stone-pointed arrows, and that Ou-ouang availed himself of this tradition, and gave a sacred sanction to the kingdom of Tchen by an imperial gift of a weapon used by the ancient Chinese?"

To this paper of M. Chevreul is appended a note by M. Stanislas Julien on the "Age of Stone in China." He quotes the dictionary *P'ing-tsen-loui-pien*, printed in 1726, to the effect that stone arrows were found in digging the earth in the district Sin-thou-hien, where in old time there was a tower and a camp. In the *Annals of Song* (biography of Tchang-sun), soldiers are spoken of as fighting with stone arrows. These annals were composed under the Youen dynasty, which lasted from 1260 to 1341. The *Annals of Northern China*, composed under the Thang dynasty, founded in 1618, states that 'in the country east of Fo-ni all the arrows have iron points.' In another passage in *P'ing-tsen-loui-pien*, arrows are spoken of 'pointed with bluish-black stone.'

"The Chinese have a particular character, *nou*, signifying a stone, from which arrow-points are made (*Dic. du P. B. de Glémona*).

"We read in *Koue-yu* (a Discourse on Kingdoms), a work anterior to our era, this passage, relating to the kingdom of Lou, the land of Confucius, 'When Confucius was in the kingdom of Tchin, a hawk rested on the palace of Prince Tchin, and was killed (or died?) there. It was pierced with a stone arrow-point fixed to the wood of Khou. This arrow was twenty inches long. Hoi-kong, Prince of Tchin, ordered a man to carry the hawk to Confucius, and inquire of him concerning it. The philosopher said, this hawk comes from afar. The arrow which has killed him is an arrow of the country of So-tchin.'

"In *P'ing-tsen-loui-pien*, vol. xlii., fol. 38, we read, 'In days of yore Wou-wang (who mounted the throne in 1122) having conquered the dynasty of Chang, opened a way in the midst of the country of nine barbarous tribes, and ordered them to bring tribute of the produce of their land. Then the inhabitants of the country of So-tchin offered arrows made of the wood of Khou, and pointed with stone. These arrows were twenty inches long.'

“I omit other passages of the same kind. In the *Annals of the Dynasty of Thang*, founded in 1618, I find mention of stone hatchets; and in other passages a stone knife, a stone sword, and a stone agricultural implement for stirring the soil are spoken of.”

OBSCURATIONS OF THE SUN.

BY M. ED. ROCHE.

THE following paper appears in *Comptes Rendus* for 27th August, 1866 :—

“The term obscuration has been applied to transitory diminutions of solar light not connected with eclipses by the moon. Historians have recorded several phenomena of this kind; and Humboldt notices a certain number in *Cosmos*, doubtless selecting those which seemed to him the most important and the best established. He admits, without hesitation, that at certain epochs the disk of the sun was momentarily obscured, and the light so weakened, that stars were visible in daytime. Arago, in his *Astronomy*, has reproduced the same assertion. An obscuration of the sun, therefore, is analogous to a total eclipse, but longer in duration, and resulting from abnormal conditions.

“Having had occasion to examine the texts cited by Humboldt, I perceived the necessity for rectifying the interpretation of several, which have led me to very different conclusions. The greater part of these phenomena of obscurations were veritable eclipses, badly observed, or inaccurately described. Thus, to cite only one example, the obscuration which took place on the 28th February, 1206, is nothing else than the eclipse of the sun of 28th February, 1207, seen in Spain, France, and Italy; and if certain historians of the time referred it to 1206, this was because the year then commenced on the 25th March, and not on the 1st January.

“Except at the periods of eclipses due to the interposition of the moon, the sun has never diminished in splendour, so as to produce a kind of night, and allow the stars to appear. The small number of authentic cases in which stars seem to have been visible in full day, lose their marvellous character when subjected to a searching examination. These pretended apparitions of stars are usually thus reduced to some planet which was visible in the daytime during an obscuration.

“One of the most remarkable of these facts is that of

April, 1547. According to a tradition reproduced by Kepler from a passage of the *Cosmo-Critico* of Cornelius Gemma, the sun was so enfeebled for three days, that the stars appeared. In a note on this subject (*Comptes Rendus*, t. lx., p. 653), M. Faye has shown the unlikelihood of such a phenomena. Nevertheless, the recital of Kepler rests on something real, and by research amongst contemporary witnesses, the explanation is discovered. There was certainly, about the 24th April, 1547, the day of the battle of Muhlberg, an obscuration—that is to say, a mist of fog obscuring the sun and the moon, according to Gemma Frisius.* As for the appearance of stars, Cornelius Gemma does not say that he or his father saw them, which would have given his assertion great value. He appears to have borrowed the statement from *De Meteoris*, of Frytsch, of Lanbach, who first mentioned it.

“According to Frytsch, it was on the 12th April that the stars were seen, and it was exactly on this day that the planet Venus was at her maximum of illumination, and up to the end of the month she remained under conditions favourable to her being seen in full day. The unusual appearance of Venus, close to the time of the obscuration which occurred a few days later, seems to have been the veritable foundation of the story, which Kepler accepted the more readily, as it tended to confirm his theories.

“I have studied various phenomena of obscuration, and a comparative view of them leads us to refer them to a particular state of the atmosphere, known as a *dry fog*. The origin of these fogs is quite uncertain. They are commonly ascribed to volcanic exhalations, and they may likewise be due to meteoric dust suspended in the air, and diminishing its transparency. But, whatever may be their cause, the connection between them and the obscurations is not doubtful; and to explain the latter we need not have recourse to gratuitous hypotheses, such as perturbations in the photosphere, occultations of the sun by a cosmical mass, or by a cloud of asteroids.”

* Reinier Gemma, the father of Cornelius, so called from his birth-place, Friesland.

ARCHÆOLOGIA.

THE Kent Archæological Society has issued the sixth volume of its collection of papers, published under the title of *Archæologia Cantiana*, the contents of which do great credit to the management of the Society. The most remarkable of these is Mr. Brent's account of the researches in the early ANGLO-SAXON CEMETERY AT SARR. Mr. Brent has already opened a hundred and eighty-three graves in this cemetery, and we believe that much still remains to do. The very numerous objects found in these graves present a singular and almost perfect picture of Anglo-Saxon life. We have the arms of the warrior sufficiently complete, the ornaments of his personal attire, and especially the various ornaments of the person of the Anglo-Saxon lady, and the articles of her toilette. We have the characteristic pottery and glass which loaded the Saxon festive-board, and the various domestic implements of the household, the money the Saxon spent, and even the dice with which he gambled. The contents of one of the graves were very remarkable—it was that of a man. Near the feet, and about two feet three inches from the surface, was a small black earthen vessel; on the left side lay the umbo of a shield, and near it, all together, as if the contents of a bag or purse which had undergone decay, about fifty small circular counters of bone or ivory, one or two apparently made of the teeth of an animal. A sword, thirty-seven inches long; a spear-head eight inches and a quarter, and the ferule of the shaft; a small brass coin of the Emperor Magnentius; some rivets, a knife, an iron ring, and a small bronze buckle, were also taken from this grave. All these objects are characteristic of the pagan Saxon gentleman, and it may be remarked that he seems to have placed his implements of gambling under the protection of his shield. Such draughts or counters have been found in several instances in Saxon graves. They vary a little in size and shape; but they are all circular and flat-bottomed, and some nearly conical, while others are but slightly convex. A pattern of little double circles, with a dot in the centre, appears on the upper side of most of them. Some of them had decayed, and it was judged that the original number had been about sixty. In a grave opened subsequently, a second set of similar counters was found, the number of which was about forty, and there were with them two dice, which leave no doubt of the use of the counters.

The contents of another of these graves were equally interesting, the more so, as similar objects have been found in other Anglo-Saxon cemeteries. Near the skull of the occupant of the grave lay the umbo of a shield, and on the left side a spear. On the breast a fine buckle, brightly plated, and what appeared to be the mounting of a purse. On the left side were some iron keys, and an iron lock, with a bronze plate containing a hole for its lock, no doubt the remains of a box. At the left foot lay a small BALANCE AND SCALES, WITH NINETEEN WEIGHTS. The other contents of the grave were a knife or dirk, with a smaller knife in one doubled sheath of wood,

a circular iron plate, another knife, and a pair of shears. In the case above alluded to, the Saxon had been a warrior; in this he was evidently a dealer in some articles which required weighing, as well as cutting and dividing. The beam of the balance was about five inches long, and slightly chased; the end of the thread or silk which suspended the scales remained still adhering to its end, and some of it was found attached to the scales, which were an inch and seven-eighths in diameter. The weights, in number about twenty, were formed of Roman coins, rubbed to the exact quantity, and most of them were marked by dots, which seemed to indicate a multiple of weight. The lock had a bolt made to ascend diagonally into the bronze plate, which was rather more than six inches long, and one and a quarter wide, and was very like such a plate on our own door-posts. The double sheath with two knives, an object which has never been found in an Anglo-Saxon grave before, presented the exact type of the Highland *scian*, or dirk and knife in a double scabbard. The whole of these discoveries are of a very remarkable character, and furnish a satisfactory evidence of the utility of our local archæological societies.

Among some ROMAN INSCRIPTIONS recently found at MESVE in France, there is one of peculiar interest, as giving us the name of a goddess previously unknown, Clutonda—no doubt a local divinity, but as proving that the village of Mesve, on the right bank of the Loire, is the site of the *Masava* of the Romans indicated in the Peutingerian table. The inscription, which is read as follows, informs us that one Medius Acer, the son of Medius Annus, gave to the statue of *Masava* "a wall between two arches, with its ornaments:" *Augusto sacrum, deæ Clutondæ et Vicaniæ Masavensibus: Medius Acer, Medii Anni filius, murum inter duos arcus, cum suis ornamentis, de suo dono dedit.*

A few days ago, at SUTTON HILL, in Corve Dale, Salop, some excavations were made which, though as yet of little extent, are of some interest. It may be remarked that Sutton Hill—which is the property of Charles Powell, Esq., a gentleman who has for some half a century held the office of Chairman of the Board of Magistrates—is composed of limestone rock, with a rather shallow covering of earth. A part of the summit is uncultivated, and has been long quarried for the purpose of obtaining stone for making lime; and, in the course of this process of quarrying, many human skeletons, according to the information given by the labourers, have been found at different times, and with them objects of various kinds, some of them of iron. The accounts of these former discoveries are so circumstantial and apparently truthful, that they cannot reasonably be doubted, although all the objects discovered have long been dispersed, and no sufficiently scientific account of the discoveries has been preserved. In the earlier part of the present month, at the suggestion of Mr. T. Wright, an attempt at more careful exploration was made, under his immediate direction, which resulted in the discovery of a skeleton, laid on its back, with the head to the west and the feet to the east, and of some of the bones of a second skeleton, apparently a secondary interment, at a slight

elevation above the other; but the inclemency of the weather prevented the continuation of the excavations for the present. No objects of any kind were found to help us to fix the people or date to which these interments belong; but there can be no doubt that they were of very great antiquity; and they probably still remain undisturbed over some part of the top of the hill, which has never been quarried. The occurrence of implements made of iron would lead us to suppose that this was an early ANGLO-SAXON CEMETERY, in which case, it would be the first discovery of Anglo-Saxons found on the Welsh border; and, as the Mercians (Angles) and the West-Saxons met and appear to have overlapped each other in this district, the objects found with the bones would perhaps enable us to decide which of those two divisions of the Teutonic settlers in our island first established itself in South Shropshire. The graves appear to have been cut into the decomposed and soft upper part of the rock, in the same manner as, in Kent, they are dug into the chalk.

Further explorations have been made among the SEPULCHRAL TUMULI on the YORKSHIRE WOLDS, some account of which has been given in the contemporary papers. From these descriptions, which do not appear to us to be entirely satisfactory, it appears that the objects found consisted of human skeletons, of broken pottery, and of flint flakes, and presumed flint implements, with nothing to suggest any decided opinion as to their date. The tumuli opened were three in number, situated on the Sherburn wolds, near Scarborough. In each of them, bones were found, thrown together very confusedly, and independent of the entire skeletons; and it is assumed, we think rather unnecessarily, that these are the results of the practice of cannibalism among the race who are buried in these tumuli. It must not be forgotten, that all these tumuli are described as having been much crushed and broken down by the process of tillage, and that the bones may therefore have been, at some former period, dug up accidentally, and reinterred in this confused manner.

T. W.

LITERARY NOTICES.

CHARLES WATERTON: HIS HOME, HABITS, AND HANDYWORK. Reminiscences of an Intimate and most Confiding Personal Association for Thirty Years. By RICHARD HOBSON, M.D., Cantab., Leeds. With Sixteen Illustrations. (Whittaker & Co.)—Dr. Hobson has produced a very pleasant, rambling, but readable collection of reminiscences of Charles Waterton, and of his famous residence, Walton Hall, a large mansion, built on an island in a great pond, or lake, in which all kinds of water-fowl found a happy, undisturbed home, while land creatures were equally cared for and protected in the adjacent park. The house was full of stuffed specimens, exemplifying its owner's remarkable skill as a taxidermist, and justifying, according to the general opinion of those who were

fortunate enough to see the collection, the peculiar methods which Mr. Waterton adopted. Mr. Waterton belonged to a class of eccentric characters, found more often in out-of-the-way country places than in towns. When, as was the case with him, these singular specimens of humanity are remarkable for benevolence as well as for intelligence, no one has a right to criticise their peculiarities harshly. The manners and modes of thought of our age tend too much to destroy individuality, and we ought to be thankful that a few persons stand out from the monotonous ranks, winning respect for their substantial goodness, and reminding us that humanity in a civilized country need not be reduced to a series of mechanical imitations of a few favourite types. Doubtless Mr. Waterton would have been a greater naturalist and a greater man if something like a crack or craze had not run through his character, but his life was a useful and valuable one, and he had the great and rare merit of being true to himself. With great physical courage, and that sort of moral courage which enabled him to pursue his own course in defiance of what Mrs. Grundy, and even more rational authorities might think expedient, he was nevertheless in bondage all his life to superstitious ideas, and he had not the slightest notion of the way in which free political and religious systems contributed to human advancement. His mind was mediæval rather than modern, and new processes and improvements in agriculture seem to have been viewed by him as heresies to be avoided rather than as practices to be pursued. His body he called his "ass," and he took care that it should never be pampered. An old suit of clothes, a "shocking bad hat," with ventilating apertures worn in its crown, and a plentiful coat of dirt adhering to its surface, formed his regular costume. He slept on a board, with a log for a pillow, and a rough wrapper for a covering. When very ill, he would, under medical orders, betake himself to a sofa, but a bed he would not enter, as he considered that would be indulging the body more than was necessary for good health. Ordinary visitors were rigidly excluded from his domains, but he would admit large parties to occasional picnics in his park; and if persuaded that any one really wanted information on natural history or taxidermy, he was happy to afford it, on condition of the recipient's repaying his teacher with an abundance of reverence and faith. He was rigid in all the fasts which the Roman Catholic Church ordained, and his favourite remedy for any kind of illness was copious bleeding from the arm. That he should have survived this treatment to extreme old age is a proof of the wonderful strength of his constitution, and, indeed, in all physical matters he was an extraordinary man.

"Mr. Waterton," says Dr. Hobson, "during his long life, never partook of either wine, spirit, or malt liquor. In addition to simple water, a cup of excessively weak black tea was his favourite, indeed his only, beverage, on all occasions, into which he put a large quantity of sugar, but no cream." He went to bed about nine o'clock, and rose at half-past three, when he lighted his own fire, which had been laid for him the previous evening, and began some

natural history work. Great benevolence, not restricted by conditions of creed, and a habit of incessant Latin quotation (in which his friend, Dr. Hobson, participates), and a strong perception of humour, were other characteristics of the "old squire;" and it is no wonder that he should have conciliated much affection while living, and that his friends should delight to honour his memory now that he is dead.

Many of the stories told by Dr. Hobson are highly amusing, including the famous rattlesnake scene at the doctor's house. An assembly of professional friends was arranged to try the comparative effects on rabbits of the rattlesnake bite, and the wourali poison which Mr. Waterton obtained in South America. An American showman, with a collection of the dangerous reptiles in glass cases, was invited to the party, and Mr. Waterton astonished them all by the boldness with which he put his hand into the cases and caught any snake that was wanted by the neck. One of the reptiles nearly escaped; the doctors fled pell-mell and helter-skelter down stairs, some rushed hastily into the street and did not return, but Dr. Hobson pressed the lid of the case door so as to obstruct the complete exit of the snake, and Mr. Waterton quietly took hold of it and remitted it to its prison. Mr. Bartlett of the Zoological Gardens, and Dr. Günther of the British Museum, handle venomous snakes with equal confidence and impunity; but Mr. Waterton's performance caused him to be looked upon as little less than a conjuror by those who were not acquainted with the character of reptiles, and the circumstances under which they may be safely seized.

The Waltonian mode of stuffing animals consisted in soaking the skins in a solution of corrosive sublimate, and moulding them from within before they dried to the exact form of the living object. A few mechanical supports were used while the skins dried, and they retained their shape for ever after.

ON FORCE: ITS MENTAL AND MORAL CORRELATES; and on that which is supposed to underlie all Phenomena with Speculation and Spiritualism, and other Abnormal Conditions of Mind. By CHARLES BRAY, Author of the "Philosophy of Necessity," the "Education of the Feelings," etc. (Longmans.)—Mr. Bray commences his work by reviving the proposal to dispense with the belief in matter, and confine our credence to "centres of force." The objection to such a proposal is that we cannot get on without the idea of matter, however incomplete, and possibly incorrect that idea may be. The one term centre of force will not carry us far, either in the description of phenomena or in reasoning upon them. Let us take one of Mr. Bray's sentences and see if we can make it fit his philosophy. He says, "It is a limited quantity of force that is derived from the food, and the mode of its action depends upon its distribution over the body while digestion is going on the powers of thinking and feeling are proportionably increased." Are we to say it is a limited quantity of force which a man derives from eating centres of force for breakfast. While he is digesting centres of force, his powers of thinking and feeling, themselves consisting of other centres of force, are proportionably decreased, and so forth? Most persons will

find it difficult to conceive of a force without its resulting from some substance in action ; and whether the term spiritual or physical is applied to a force, it is equally supposed to be the effect of a something acting, and not a self-existent entity. With many of Mr. Bray's speculations we agree, but we think he sometimes fails to see the bearing of his own words. For example, he says, "As all actions are the necessary result of pre-existent force, they are *morally* alike in themselves—right and wrong, virtue and vice, having no existence but as they affect the well-being of the sentient creation." The introduction of the word *morally* is surely a mistake. All actions may be alike, in that they are the results of pre-existent forces, but the morality of an action involves questions of obligation, duty, etc., and hence the moral likeness of a set of actions will depend upon circumstances quite distinct from the physical cause of the actions themselves. Again, Mr. Bray says, "Truth, justice, and wisdom are only relations to *finite* things, and cannot therefore be infinite, or absolute in their own nature." Surely if these be infinite things, there may be truth, justice, and wisdom concerning them. Infinite truth would be truth concerning all existing or possible things. A particular truth relating to a particular thing, has no claim to be called infinite, and this may be all that Mr. Bray intends. Mr. Bray quotes with approbation Bentham's dictum, that an immoral action results from a miscalculation of self-interest ; but, with great admiration for Bentham, we must agree with those who think his notions of moral philosophy defective. It is possible to make the term "self-interest" comprehend a devoted promotion of the interest of others ; but by such an enlargement of the scope of the term we destroy its special meaning, and leave it like an algebraic symbol, the significance of which is determined by its position. Man has self-regardant faculties, and extra regardant faculties, and it tends to confusion to designate the happiness which springs from self-sacrifice by the same term as that which denotes self-seeking. We do not see that Mr. Bray in anywise proves his assertions that "there is nothing underlying phenomena—phenomena are correlatives of force, and force is all." After having demolished matter, Mr. Bray still finds his *force* as "one infinite substance," "force changing into life, and life into sentience," etc., and he endeavours to explain what are called "spiritual phenomena," as resulting from modifications of mental force. For those who are fond of metaphysical speculations—carried often into the regions of the unknown, Mr. Bray's new work will provide ample suggestions, but before undertaking to reduce the so-called "spiritual phenomena" to some sort of cohesion with general philosophy, we must learn exactly what phenomena really occur in table-turning, spirit-rapping, etc., etc. Under all ordinary circumstances no obstacle is placed in the way of applying physical science tests and methods to alleged physical effects, but the spiritualists demand faith at the wrong end, and their tables will not rap, and their sideboards will not walk across the room, if sceptical persons with experimental modes of verification or disproof happen to be present. Mrs. De Morgan's recent book, written in

manifest honesty, shows, as other works have shown, that an anti-scientific believing frame of mind is essential to what is called spiritualistic success.

TAPE WORMS; HUMAN ENTOZOA: THEIR SOURCES, NATURE, AND TREATMENT. By T. SPENCER COBBOLD, M.D., F.R.S., Lecturer at Middlesex Hospital. (Longmans.)—We suppose Mr. Cobbold hopes to tempt readers by this little volume to study his large work on Entozoa. We should not have thought it worth while to publish the present small treatise, which is little more than a portion of the larger work.

ELECTRICITY. By ROBERT M. FERGUSON, Ph.D., of the Edinburgh Institution. (Chambers.)—This volume, which forms part of "Chambers' Educational Course," is a compact and well arranged treatise on the subject indicated by its title. Magnetism, Frictional Electricity, Galvanism, Electro-dynamics, Electro-magnetism, Magnetic Electricity, Thermo-Electricity, and Practical Applications of Current Electricity, are treated of in separate chapters, and praiseworthy pains seem to have been taken to bring the whole fairly down to date.

A DICTIONARY OF SCIENCE, LITERATURE, AND ART. Comprehending the Definitions and Derivations of Terms in General Use, together with the History and Descriptions of the Scientific Principles of nearly every branch of Human Knowledge. Edited by the late W. T. BRANDE, D.C.L., F.R.S.L. and E., of Her Majesty's Mint, and the REV. GEORGE WILLIAM COX, M.A., late Scholar of Trinity Coll., Camb. Part X. (Longmans.)—The present number, finishing "Radiant Heat," and progressing as far as "Rules," contains many excellent papers supplying the information most likely to be needed by those who resort to a Cyclopædia.

THE ANTHROPOLOGICAL REVIEW. Journal of the Anthropological Society, and Popular Magazine of Anthropology, Part XIV. (July, 1866). (Trübner.)—Contains some interesting papers; and though we should, in a detailed review, repeat some of our old objections, we think this magazine is improving, and it certainly deserves credit for calling popular attention to a highly important and neglected class of subjects.

DATE STONES; OR, MNEMONICS OF GENERAL AND CONSTITUTIONAL HISTORY AND OF LITERATURE. By NEUENHAM TRAVERS, B.A., formerly scholar of Lincoln College, Oxford. London.—This book, small in dimensions but important in contents, is published by the Author at his own residence, 25, Tolmers Square, N.W.; we suppose he has not published it in the usual way because he has especially designed it to assist in a short series of lessons of which we find a notice accompanying the book. Mr. Travers is well known to hundreds of young men educated at University College School, in which he was for many years a remarkably able teacher. The subject matter of his "Date Stones" is well selected, both for general students and for those who desire to pass examinations for the civil service or for university certificates. The mnemonic plan is substantially the same as that employed by Dr. Grey, but worked out with much originality. Mr. Travers dissents from Dr. Pick's

view that real words should always be employed, but in his artificially compounded words he preserves a suggestive portion of the name of the person or incident to be remembered. At the close of each chapter are some hexameter verses, in which the chief incidents with their several dates are mnemonically epitomized, and though, like all similar combinations, they look as if they would distress the jaws that utter them, we cannot doubt their utility after many proofs that have reached us that Mr. Travers' pupils really do use them with success.

WAYSIDE FLORA; OR, GLEANINGS FROM ROCK AND FIELD TOWARDS ROME. By NONA BELLAIRS, Author of "Hardy Ferns," "Going Abroad," etc. (Smith, Elder and Co.)—The inexorable requirements of society compelled Miss Nona Bellairs to go to Rome, and being fond of wild flowers, she provided herself with the necessary apparatus for collecting and drying them. She enjoyed her trip, and describes it in a pretty volume, giving the names of some of the flowers that took her fancy, and of the pictures and buildings that pleased her eye. A good-tempered reviewer—and those who are admitted to our columns are all of that happy character—does not know what to say of books of this kind. There is not enough in them for especial praise, or description, and yet it would be hard to blame them because they do not reach some ideal standard of which their author's never dreamt. Miss Bellairs certainly merits commendation for having a taste and a purpose, and her books, though slight, may help other young ladies to acquire similar good things.

THE HANDBOOK OF THE STARS; containing the places of 1500 Stars, from the first to the fifth magnitude inclusive, upwards of 200 of which are noted as Double, Multiple, or Variable: a list of Star Names; a Table for determining the position of the Constellations on the celestial concave at all hours and seasons; and other Useful Tables. With an examination of the properties and projections used in mapping, and hints on the selection, use, and construction of Star-Maps. By RICHARD A. PROCTOR, B.A., F.R.A.S., late Scholar of St. John's College, Cambridge, and King's College, London. Illustrated by maps and diagrams. (Longmans.)—The voluminous title of this little book amounts to a catalogue of its chief contents, and, from the merit of Mr. Proctor's previous works, the scientific public will be prepared to receive this with favour. Some of the chief topics have been recently discussed in our pages, so that all we need say now is, that the explanations of star maps and their principles will be found compendious and valuable. The sixth of the tables supplied by Mr. Proctor strikes us as particularly useful. It is easily understood, and gives by simple inspection the names of the constellations occupying the zenith, and other parts of the heavens, at any hour for any day of the year. As a guide to a knowledge of the constellations, and to their changes in position, according to the time of the year, this book will be found remarkably useful. The list of double-stars, though not going below the fifth magnitude, will also be of service. In a few instances, we think, an error has been made in giving their distances. Thus, the

components of Castor are put down as between two and three seconds apart, while Engelmann's measure gives $5''526$; δ Herculis and *comes* are given as between seven and eight seconds apart, which is surely much too little.

ELEMENTARY TREATISE ON PHYSICS, EXPERIMENTAL AND APPLIED. For the use of Colleges and Schools. Translated and Edited from *Ganot's Eléments de Physique* (with the author's sanction), by E. ATKINSON, Ph.D., F.C.S., Professor of Experimental Science, Royal Military College, Sandhurst. Second edition, revised and enlarged. Illustrated by a coloured plate, and nearly 700 woodcuts. (Ballière). Part II.—In a notice of the first part of the new edition of this excellent work we expressed a decided opinion that it is the best book of the kind which has appeared. To that opinion we adhere, though there are some minor points in which Professor Atkinson ought to have improved upon the original. Thus, at p. 447 we are told that the new silvered glass mirror telescopes “are much shorter than the old ones, their focal distance being only about six times the diameter of the mirror.” The celebrated Short made his ‘dumpy’ metallic telescopes with focal lengths as short as have been given to any successful glass ones, and it is incorrect to say that the usual focal length of fine glass silvered telescopes is only six times the diameter of the mirror. The figure given of the mounting (p. 448), though pretty looking, is bad—very inferior to Mr. Browning's pattern, and students will be misled who suppose from M. Ganot's work that a $6\frac{1}{2}$ inch mirror should only bear a magnification of 150 to 200. One of that size in our possession, the mirror by With, and the mounting by Browning, bears from 600 to 700 well on bright objects. The microscope in this part fares worse than the telescope. Instead of figuring a good instrument by one of the great English makers, a very poor one by Chevallier is represented, giving no idea of the best constructions, and nothing is said concerning the formula of the best objectives. These, however, are trifles in comparison to the general merit of the work, but they ought not to be passed over.

THE BIRDS OF MIDDLESEX; a Contribution to the Natural History of the County. By JAMES EDMUND HASTING, F.Z.S. (Van Voorst.)—A very pleasantly written work, giving accounts of the birds habitually living in, or visiting Middlesex. Mr. Hasting has judiciously left technical descriptions and systematic information to be obtained from well-known ornithological works. His remarks are thrown under heads corresponding with the principal divisions of birds into orders and families, and frequently enlivened by good anecdotes. For example, a very interesting account is given of a black-backed gull, caught and tamed by the author:—“A curious fact with regard to this gull is that he catches sparrows for himself very dexterously, and the way in which he does it is this. About the time that the fowls are being fed, he makes his way to the poultry-yard, and mingling with the hens, walks very slowly about with his head drawn in so as to make his neck look very short, and as if, in fact, he were trying to look as much like a fowl as possible. As soon as the general rush for grain is over, the sparrows drop

down one by one, and then it is that the gull, drawing gradually within reach, suddenly darts out his long neck, and seizes an unfortunate sparrow by the head. So rapidly is this done, that escape for the unsuspecting sparrow is hopeless, and in another second he is crushed and devoured." On one occasion this same bird seized a young kitten, which the cat had brought out on the lawn, and tried to swallow it whole. He was discovered with the kitten's head down his throat, making frantic efforts to swallow the body, and was greatly disappointed when the little creature was rescued by one of the family. This book is illustrated by musical notations of the song of many of the birds, and by a frontispiece in a deplorable style of art. A very tolerable engraving of Kingsbury Reservoir is quite spoilt by printing a dingy rhubarb tint all over it!

PROGRESS OF INVENTION.

IMPROVEMENT OF THE HYSOMETER.—The boiling points of fluids depend on the pressure of the air. The greater the altitude of any place above the ordinary level of the earth's surface, the lower the boiling point of a given fluid, because the less the barometric pressure in that place. And hence the height of any place may be found by means of the boiling point of water in that place. With this object a peculiar kind of thermometer, termed a *hypsometer*, or more correctly, a *hypo-thermometer*, has been constructed. It is marked, not with degrees of temperature, but with barometric pressure corresponding to these degrees, or, better still, according to the latest improvements of M. Abaddie, with the altitudes corresponding to the temperatures, supposing them to be the boiling points of water. The boiling point of a fluid can be accurately determined by placing the thermometer in the escaping vapour; but unfortunately the results are liable to vitiation, on account of the tendency which the zero of thermometers almost invariably has to alter spontaneously. The danger of error from this cause is, however, greatly diminished, if two or three hypsometers are used in each experiment, and the mean of their indications is taken. The hypsometer is, for several reasons, more suitable for the purposes of travellers than the barometer. It is more easily carried, it is less easily injured; and it requires, not an observation, but an experiment which is made with greater facility, and is less subject to error.

MAGNESIUM AND ITS SALTS AS ILLUMINATING AGENTS.—The complication necessary when the magnesium wire is fed by means of clockwork, has been hitherto a great obstacle to the use of the magnesium lamp for the purposes of illumination or photography. This difficulty has, however, been obviated by the lamp exhibited in operation at the recent meeting of the British Association at Nottingham. The magnesium passes down in the form of a very fine powder from a reservoir, through two small tubes, the lower aper-

tures of which are placed opposite to, and at a small distance from, each other. To dilute the magnesium powder, and thus render the feed more gradual, and the light more diffused, it is mixed with fine sand before being placed in the reservoir. And to prevent the tubes through which the mixture of sand and magnesium issues from being choked with magnesia, on account of combustion of the magnesium taking place within them, coal gas is transmitted through them with the mixture, and burns along with the magnesia. Finally, to remove the small quantity of magnesia which, forming at the aperture of the tubes, might ultimately stop them up, the sand, after separating from the magnesium during the combustion of the latter, falls into a small receiver; and this, tilting over every few minutes, on account of the weight of the sand, gives motion to a wire to which are attached nippers that seize the magnesia and separate it from the tubes. When the sand has fallen out of the receiver, it again assumes its ordinary position. The cost of this lamp is, however, very considerable. The amount of coal-gas used with it is, indeed, very trifling, but the magnesium is very expensive, and will probably continue so. This very serious objection is likely to be got rid of by the use of the oxide of magnesium, which M. Carlevaris, of Geneva, has found to answer, in conjunction with the oxy-hydrogen flame, as well as the metal itself. Oxide of magnesium is in this case volatilized, though to a very small extent; but this minute quantity of vapour imparts a pure white light that may be used either for ordinary illumination or for photography, having all the properties of solar light. The effect is due to oxide of spongy magnesium, and this may be conveniently produced from several of the magnesium salts, especially from chloride of magnesium or carbonate of magnesia. For this purpose a small piece of chloride, for example, is placed on a prism of gas-retort graphite, and the flame of the burning gases is thrown upon it. The use of pure oxygen is not indispensable; common air and hydrogen answer extremely well. Also, the chloride, after having been compressed into the form of a prism or cylinder, may be merely introduced into the flame, no graphite being employed.

PREVENTION OF THE SPARK PRODUCED BY THE EXTRA CURRENT.—In electro-magnetic experiments, the oxidation caused by the sparks due to extra currents, is highly inconvenient, as it prevents perfect metallic contact, and thus greatly diminishes the electro-magnetic effect. There are two kinds of *extra* current. One of them is opposite in direction to the battery current, and is produced when connection with the battery is established. It is perceptible chiefly by its neutralization to a greater or less extent of the battery current. The other, which is in the same direction as the battery current, is produced when connection with the battery is interrupted. It retards the demagnetization of the electro-magnet, and causes oxidation so as to prevent perfect metallic contact between the different portions of the conductor. The latter evil is prevented by a very simple means, due to Dr. Dugardin, of Lille. He provides a separate conductor for the extra current. For this purpose he permanently connects the poles of the electro-magnet

with a small helix of wire, which, however, offers so little resistance to the ordinary galvanic current, on account of its low intensity, as to divert but a very small amount of it from the helix belonging to the electro-magnet. Were the wire of the resistance coil, thus introduced, of any considerable length, the effect produced upon it by induction would be very mischievous. But its resisting power is derived, not from its length, but from the material of which it is formed. This being a very thin wire of iron, or, better still, of mallechort, an alloy of zinc and cobalt. A helix containing only one metre of the latter will produce as much resistance as many kilometres of telegraphic wire, and thus the interposed helix may, for the largest electro-magnet, be extremely minute.

PHOSPHORUS A METAL: THE SO-CALLED AMORPHOUS PHOSPHORUS CAPABLE OF CRYSTALLIZATION.—Certain properties of phosphorus lead to the conclusion that it is a metal very similar to the other metals arsenic, antimony, and bismuth, belonging to the group in which it is found: but the supposition is strongly confirmed by recent experiments, in which the property possessed by lead of dissolving phosphorus is applied to the production of phosphorus in the crystalline form. The phosphorus is put, along with the lead, into a thick tube of hard glass, the interior of which is next exhausted of air, and hermetically sealed. The glass tube is then placed in an iron tube, capable of being closed at the ends; and the space between the tubes is filled with magnesia, after which the apparatus is kept at a high temperature for eight or ten hours. On cooling, the surface of the lead is found covered with crystals of phosphorus, which, like those of arsenic, antimony, and bismuth, are rhombohedral. They have a metallic appearance, and are black by reflected, but red by transmitted light. Their specific gravity is greater than that of the ordinary and even of the amorphous phosphorus, being 2.34, while that of the others is 1.82 and 2.14. The volatilities of these three different kinds of phosphorus differ in a similar way.

The so-called amorphous or red phosphorus can now be easily crystallized. For this purpose, M. Blondlot, who discovered the fact, draws out the neck of a matrass in a lamp until it is about the size of a quill. He then fuses phosphorus under water in glass tubes capable of passing through the contracted neck, and introduces two grammes of the cylinder thus obtained into the matrass, having previously wiped them with filtering paper: after which he hermetically seals its neck, keeping it during the process wrapped in a moist cloth to prevent the phosphorus from igniting. It will, however, emit light while combining with oxygen, and this combination will be complete in twenty-four hours, after which its temperature is to be raised to that of fusion, solar light being excluded by covering the matrass with a truncated cone formed of cardboard. After a few hours, brilliant points will make their appearance in the upper part of the matrass, and after two or three days crystalline arborisations will have covered its whole surface. The crystals thus formed are cubes, sometimes octohedrons, and sometimes in the form of long projecting needles. As long as they are kept from light they are colourless, but even diffused daylight

changes them very quickly to red, without, however, diminishing their brilliancy or transparency. That, in becoming red, the phosphorus has not changed its properties is evident from the fact that if heat is again applied, it will be covered with the white crystals. The latter, as might be expected from the eminently electro-positive properties of the phosphorus, rival the diamond in brilliancy.

SIMPLIFICATION OF THE SODA MANUFACTURE.—Sulphide of sodium is, in the ordinary process of manufacture, changed into sulphate of soda, by means of nitrate of soda, which involves considerable expense. It has been found, however, that the oxidation of the sulphide may be effected by far less costly means. For this purpose it is only necessary to utilize the oxygen of the air, which is effected in the following way:—The crude liquor is placed in a vessel with a false bottom, having a great number of small holes. Into the centre of this false bottom has been inserted a pipe, the upper end of which projects over the top of the vessel, and terminates above by a funnel-shaped throat. Steam of about forty pounds pressure being made to issue from a jet, which is situated a little above the throat, in rushing into the funnel it carries along with it a large quantity of air: and this issuing through the holes of the false-bottom, and passing into the fluid in a finely-divided state, so as to come in contact with a very large surface, all the oxidisable matters present are oxidized, and thus a considerable quantity of sulphite is changed into sulphate in a very short time. The manufacture of alkalies is carried on at present on so vast a scale that any improvement of the processes used in it must be productive of an immense saving.

IMPROVEMENT OF GLASS FOR OPTICAL PURPOSES.—Great refractive power is the chief desideratum in glass for optical purposes. This is obtained by means of great density, which hitherto has been due to lead. It has been found, however, that replacing the potash or lead, and especially the former, with thallium, affords a highly refractive glass of the finest description. 300 parts sand, 200 parts peroxide of lead, and 335 parts carbonate of thallium give a glass which has a greater specific gravity and a higher refracting power than any other known, its specific gravity being 4.235, and its index of refraction for the yellow rays, 1.71. It is perfectly homogeneous, and has a slight yellow shade which is very pleasing. It may, perhaps, be found useful to makers of artificial gems. A much greater specific gravity and higher refractive power may be attained by altering the relative amounts of the ingredients.

NEW ELECTRIC ALARM.—An electric alarm of extreme delicacy, the invention of M. Robert Houdin, is formed by soldering together a blade of copper and another of steel, fixing one end of this compound blade to a board, along which it lies parallel, something after the manner of a knife used in chopping, but not in contact, that friction may be avoided. Near the free extremity of the blade is a metallic knob, which is capable of being moved to different distances from it, and is in conducting communication with one pole of a galvanic battery, the free end of the compound blade being in connection with the other. When the temperature of the surrounding air is increased, the compound blade becomes curved,

on account of the metals of which it consists being unequally expanded; and coming in contact with the metallic knob, battery connection is completed. This causes a small bell, similar to that used to attract the attention of the attendants in telegraph offices to ring; and thus notice is given of any undue rise of temperature in the place containing the instrument. Information of fire having broken out may thus be obtained, and the necessary means for its extinction may, in consequence, be promptly taken. The temperature at which the bell will ring may be regulated by adjusting the metallic knob: and the apparatus is so sensitive that a lighted cigar or taper placed within a very few inches of it will cause the bell to ring.

THERMO-ELECTRIC PROPERTIES OF IRON.—The small quantity of carbon which causes the difference between malleable and cast iron produces so considerable a modification of thermo-electric properties, that, while a thermo-electric battery of malleable iron and bronze causes the needle of the galvanometer to be deflected to the left, a similar battery of cast iron and bronze causes a deflection to the right. The discovery of this curious fact led M. Arnould Thenard to make experiments with a battery consisting of malleable and of cast iron; and the results he obtained indicated other anomalies which could scarcely have been anticipated. Thus, with a battery consisting of malleable iron and bronze, the deflection was found to be $+ 23^\circ$, and with a battery of cast iron and bronze $-11^\circ 5$; and it might be supposed that with a battery of malleable and cast iron the deflection would be $23 + 11.5 = 34.5$. Such, however, was not found to be the case; the deflection actually produced being only 27° . The electro-motive force of the three kinds of battery was in accordance with what might be expected: that of malleable iron and bronze, cast iron and bronze, and malleable iron and bronze being represented respectively by the numbers 691, 263, and 953: the last being very nearly the sum of the other two taken together.

OXYGEN OBTAINED FROM ATMOSPHERIC AIR.—Our ordinary modes of obtaining oxygen for experimental and other purposes are very costly or very troublesome. It may, however, be procured with great facility through the medium of permanganate of soda, which, as it may be used over and over again, for the purpose, will entail but a trifling expense. Atmospheric air is passed over a solution of the permanganate, which, after a while, becomes saturated with the oxygen it has absorbed, the nitrogen having passed off. To separate the oxygen from the solution, a current of vapour at a proper temperature is substituted for the current of air, this, almost without producing any change in the permanganate solution, further than dilution, causes the oxygen to be evolved. Concentrating the solution by heat renders it again fit for use, especially if a very small quantity of the permanganate is added to it.

MISCELLANEOUS.—*Substitute for Amalgamated Zinc in the Galvanic Battery.*—M. Zaliwski-Mikorski has recently informed the Academy of Sciences that if the zinc of a galvanic battery, instead of being amalgamated, is moistened all over with oil, or even with ether, or any of the liquid hydro-carbons, the duration of the current

is greatly increased.—*New Textile Fibre*.—If, as soon as its flowers have been gathered, the stalks of the hop-plant are made into bundles, and well steeped in water, then dried in the sun, and beaten like hemp, a fibre will be obtained which, after being combed, is admirably adapted to being spun into thread, that furnished by the larger stalks being well suited for cordage or twine. This is very important as the flower is not in any way interfered with.—*New Application of Cork*.—Springs of India-rubber, used in the buffers of railway carriages, etc., under the influence of great pressure soon lose their elasticity. Cork, which may be of an inferior kind, has been found an excellent substitute for them. To render it soft and permanently moist, it is soaked in a mixture of molasses and water. It is then cut into discs which have a central hole, and are placed in a cylindrical cast-iron box, and over them a flat iron disc. Being then subjected to great hydraulic pressure, their thickness is reduced to one half, after which a bolt is run down through the metallic and cork discs, and the bottom of the cylindrical box, and is fastened by a nut. This, when the pressure is removed, prevents the cork from regaining its original dimensions. The apparatus is now ready for use. Cork discs about eight inches in diameter are found to exhibit extraordinary elasticity under a pressure of 20,000 lbs.

NOTES AND MEMORANDA.

CHEMICAL POISONING.—M. Melsens states, in *Comptes Rendus*, that chlorate of potash and iodide of potassium may be administered in considerable quantities *in succession* to dogs, without injuring them, while if they are given simultaneously, the animals are poisoned, apparently by the formation of iodate of potash. He observes that the two salts do not react in this way under ordinary circumstances, but they do so in strong acid solutions, or when in fusion, and when mixed and decomposed by the electric pile.

MEDICAL PROPERTIES OF THE TEAZLE.—M. Beullard informs the French Academy that the leaves of the teazle, *Dipsacus sylvestris*, pounded, and applied to wounds and bruises, has a powerful action in the prevention and cure of gangrene. He removes mortified flesh, washes the wound in chlorurated water, and then applies a poultice of the leaves. He states that he used this remedy with success for fifteen years.

BOLIDE AT VICHY.—M. Veriot describes a bolide, seen at Vichy on the 21st August (20th?), at 7h. 20m. P.M., as like an enormous fusee, and brighter than the moon. It was visible for ten seconds, passing from N.W. to S.W. in a line making an angle of 20° or 25° with the horizon.

SHOOTING STARS NEAR THE EARTH.—In *Astronomische Nachrichten*, No. 1606, is a communication from C. Behrmann, of Göttingen, stating, that on the 30th of July, about 9½h. P.M., shooting stars appeared to come out of a thick cloud, about 15° above the horizon, and vanished in about four-tenths of a second, having a visible path of five or six degrees. The cloud covered the entire sky, and was so thick, that a bright meteor could not have been seen through it; hence he concludes "that the shooting-stars were manifestly driven on this side of the cloud." He thinks these stars must have come within 0.1 mile of the earth.

NEW FRESHWATER POLYZOA.—Mr. C. Parfitt describes, in *Annals Nat. Hist.*, two new freshwater polyzoa he found in Devonshire, *Plumatella lineata* and *Limnas*. The first is characterized by eight or ten dark brown longitudinal lines running the whole length of the tubes. The polyp cells are barrel-shaped, and hyaline, the mouth entire, each having five or six dark brown annulations, slightly constricted at each annulus. Tentacles sixty-two; statoblasts dark reddish brown, elliptical, with a broad yellow margin. It was found on the underside of water-lily leaves, in a pond in Mr. Veitch's old nursery, Topsham Road, Exeter. The other (*P. limnas*) belongs to that section of the genus which includes *P. emarginata*; "but the line of demarcation between the diaphanous portion of the tube in this species and the thick opaque walls of the inferior half, gives it even at first sight a very distinct and marked appearance. Another striking peculiarity is that the tubes grow mostly in pairs, and are very closely adherent to the matrix, except the polyp cell, which stands up conspicuously near the end of the tube." The lower half of the tubes are opaque, and coated with grains of reddish-brown matter. The opaque walls are white inside, and made up of pentagonal cells. Tentacula fifty to fifty-four; calyx festooned. "Statoblasts elliptical, yellow, with a narrow blackish ring dividing the cell from the narrow purple rim or annulus which surrounds it." The orifices are conical, not quite at the end of the tubes, and stand at right angles to the tubes, being raised by three or four folds or rings.

SILVERED OBJECT-GLASSES FOR SUN-VIEWING.—M. Foucault proposes that, for the special purpose of viewing the sun, large achromatic objectives should have their outer sides silvered by chemical precipitation. He finds that a silver film, such as that deposited on the silvered mirrors for telescopes, does not interfere with the definition of an object, like the sun, bright enough to be seen through it.

THE SPONTANEOUS GENERATION CONTROVERSY still occupies the French Academy. Recently, M. Al. Donné, who formerly took the opposing side, adduced experiments on the affirmative side. He punctured the shells of eggs with a red-hot wire, enveloped the eggs in cotton that had been heated, with a view to destroy germs, and then immersed them in hot ashes. In the course of three weeks or a month he found moulds growing on the organic matter of the egg. M. Pasteur pointed out that the precautions to exclude germs of small organisms were by no means sufficient, and hence the experiment must be rejected.

THE CHOLERA MIST.—Should the blue mist described by Mr. Glaisher still appear in any part of the country, it is most desirable that the organic particles it may contain should be accurately examined by the aid of the microscope. Mr. Glaisher and other observers have detected some small bodies of a blue colour, the nature of which has not, we believe, been thoroughly investigated. Microscopists should endeavour to ascertain whether such particles exist in sufficient quantities to account for the colour, and whether they represent known forms of sporules.

AN APPLE CONGRESS.—The French Pomological Congress began its eleventh session at Melun on the 14th September. Its object is to induce the rejection of all mediocre and bad sorts of apple-trees, and to promote the cultivation of the finer and more profitable kinds. It is expected that the export of French apples will be extended by these measures; and we have need, as Mr. Roach Smith has pointed out, of something of the sort in this country, where the supply of good apples is below the wants of the population.



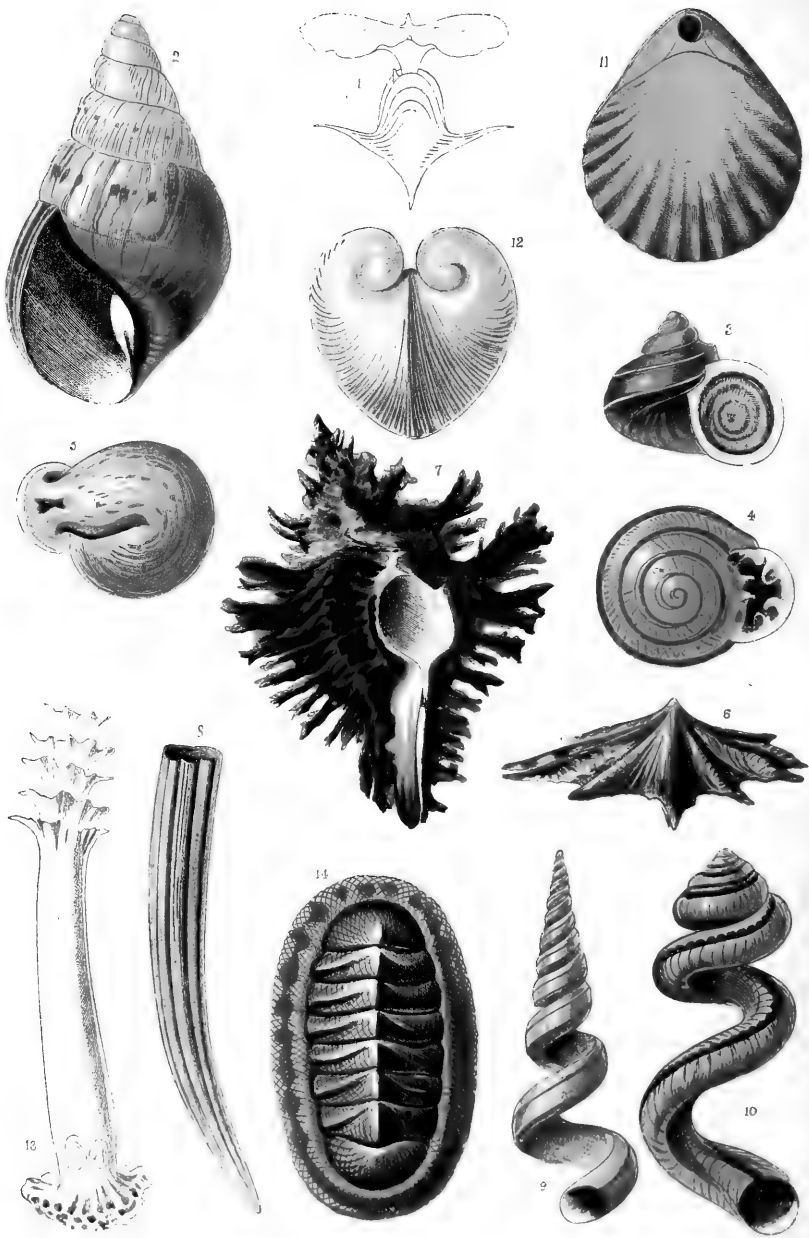

RECENT SHELL-FORMS.

- | | |
|-------------------------------------|------------------------------------|
| 1. <i>Cleodora pyramidalis</i> . | 8. <i>Dentatum elegans</i> . |
| 2. <i>Bulimus regina</i> . | 9. <i>Vermetus lumbricatus</i> . |
| 3. <i>Tropidophora carinata</i> . | 10. <i>Sinquaria angusta</i> . |
| 4. <i>Helix Anastoma tuberosa</i> . | 11. <i>Waltheimia australis</i> . |
| 5. <i>Helix</i> (small shell). | 12. <i>Iscaerata cor</i> . |
| 6. <i>Lacuna</i> (small shell). | 13. <i>Apandium var. dentata</i> . |
| 7. <i>Hydrobia</i> (small shell). | 14. <i>Clavus squamosus</i> . |

THE INTELLECTUAL OBSERVER.

NOVEMBER, 1866.

ON THE FORM, GROWTH, AND CONSTRUCTION OF SHELLS.

BY THE LATE DR. S. P. WOODWARD, F.G.S.

Edited from his MSS. by Henry Woodward, F.G.S., F.Z.S., of the British Museum.

(With Two Plates, one Coloured and one Plain.)

SHELLS are often called the "habitations" of fishes, or of marine animals, or snails. Every one has seen the device of a snail, with the motto, "always at home," on juvenile letters. The quarrymen of the Cotteswolde Hills go so far as to call some fossils "snail-houses," the same epithet which they apply to empty shells of the common garden snail. The term is not quite correct, for they are more properly *skeletons*, and we do not "inhabit" our bones, though Byron calls the *skull* a "tenement," and "the palace of the soul." Nevertheless, the expression is sufficiently indicative of the sense in which it is popularly used, and may pass muster without any further challenge on our part.

One afternoon last summer we visited the fish-house of the Zoological Gardens, and paused to watch the manœuvres of a hermit crab housed in a whelk-shell. Just then a lady of distinguished appearance called the attention of her friends to the same truculent animal, and expressed her lively satisfaction at having thus become acquainted with *the creature which made that kind of shell!*

We hope before long to introduce our readers to a better acquaintance with the original fabricator of that common object of the shore, and to show how the forms and patterns of shells are suited to the wants and welfare of their proper owners. But at present we intend to look more especially at certain specimens put together to illustrate the structure of shells in general, and to show their architectural rather than their physiological peculiarities.

It may be seen at a glance that many shells are *bivalve*, like the oyster and cockle (see Coloured Plate, Fig. 12, *Isocardia*);



FIG. 1, *Chiton piceus*,
(side view).

while a few, called "Chitons" (see Coloured Plate, Fig. 14, *Chiton squamosus*, and Woodcut (1) of *Chiton piceus*) are *multivalve*; but the great majority are *univalve* (see same Plate, Figs. 1—10), and sometimes tent-shaped (Fig. 6, *Patella*), or tubular (Fig. 13, *Aspergillum*; Fig. 8, *Dentalium*; Fig. 9, *Vermetus*; Fig. 10, *Siliquaria*), but for the most part spiral (Figs. 2, 3, 4, 7, 9, and 10), though exhibiting an endless diversity in their proportions, as well as in their sculpturing and colour.

All insects, crabs, and other articulate animals are symmetrical, having the organs in pairs, *i.e.*, the right side like the left. In corals and star-fishes the bilaterality is usually disguised by a radiate arrangement of the parts. But in snails the symmetry of the eyes, tentacles, and other organs of the head, is lost in the body of the creature. Instead of a double heart, and two series of gills, these organs are single, and placed on one side. When on the left side, the growth is from left to right, to provide space; but in shells which are symmetrical, like the pearly nautilus, the keyhole limpet, and the *Ampullaria*, the gills are developed symmetrically on each side, or nearly so.

The tendency to grow in a *spiral form* is very characteristic of the class Mollusca. Some writers have accounted for it in a very matter-of-fact way. "Molluscous animals are long and worm-like; therefore Nature has coiled them up, that their tails may not be an incumbrance to them."

It is easily ascertained that the snail has a small spiral shell when it first quits the egg, and the young whelk may be examined while still a prisoner in the same capsule with its brothers and sisters.

The convenience of the arrangement is obvious, and that may be sufficient for us at present, but the time is coming when naturalists will desire to look more closely into these things.

How happens it that the embryo-snail coiling itself up closely in its narrow cell, almost always takes a direction from left to right, following the course of the sun, and forming a dextral spiral, or *right-handed* shell, like an ordinary screw? Such a course is not absolutely necessary, neither is it accidental. A few whelks and garden-snails—perhaps one in ten thousand—are *left-handed*; and certain kinds of whelks and land-snails (see Coloured Plate, Fig. 2) are as frequently reversed

as right. The greater part of the genus *Clausilia* (numbering upwards of two hundred species) is reversed. The species of the genera *Physa* and *Triforis* appear to be all reversed. All the specimens of *Fusus contrarius*, Sby., so abundant in the Red Crag, and also found living in Vigo Bay, on the coast of Spain, are left-handed. But, after all, these latter are the exceptions. Every one familiar with garden plants will have noticed that the hop turns round its pole in one direction, going to meet the light, while the scarlet-runner takes an opposite course, as invariably as the sun it follows.*

The tendency to *spirality* is observable in bivalve shells, especially in *Isocardia*, whose separate valves resemble two spiral univalves—one right-handed, the other left-handed (see Coloured Plate, Fig. 12), with small spires and large apertures.

In this shell, as in the common cockle, one valve is placed on each side of the shell-fish, which is usually symmetrical, and lives in a vertical position as regards the plane of its valves.

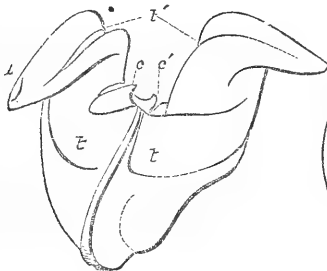

FIG. 2.

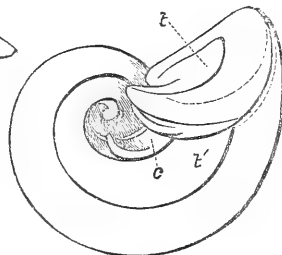

FIG. 3.

FIG. 2 represents the internal cast of *Diceras arietinum*, Lamk. Coral Rag, France, $\frac{1}{4}$ nat. size, *a*, point of attachment; *c, c'*, casts of dental pits; *t, t, t', t''*, furrows produced by muscular ridges.

FIG. 3, internal cast of *Requienia Lonsdalei*, Sby. sp., $\frac{1}{2}$ nat. size, Lower Greensand, Bowood, Wilts. From *Quart. Journ. Geol. Soc.*, 1855, Vol. XI. p. 53, Figs. 28 and 29.

To this there are some exceptions; for example, the oyster and scallop, which, like the turbot and sole among fishes, lie, the former on its left side, and the latter on its right side, and fatten at their ease.

The valves of the cockle are united by an elastic ligament, and articulated by projecting teeth, which form a very complete hinge. It is obvious that the valves of a shell cannot grow so freely along the hinge, as on the rest of the margin, but it may shoot out to a great length, as in the "razor-shell" (*Solen*), or in three directions, as in the "hammer-oyster"

* Unluckily the botanists have chosen to reverse the terms employed in mechanics, and call the spiral of the hop right-handed.

(*Malleus*), while in the "heart-cockle" each valve takes a spiral (see Coloured Plate, Fig. 12).

There are some fossil shells called *Diceras*, in which the two valves resemble horns, and others called *Requienia* (see Woodcut, Figs. 2 and 3), with one valve produced into a horn. In *Chama* the *umbones* are also spiral.

In many bivalves the beaks are turned *forwards*, towards the head of the animal (*not always*, as stated in some big books). But the oyster is again an exception in this respect; and if among the exotic or fossil species you find some with spiral growth, the spiral is turned *backwards*; indeed, the number of exceptions is so great, that one fears to make any general assertion. *Anomia*, when it grows inside other shells, may have its umbo a little removed from the margin, and the fossil genera of *Hippurites* exhibit every condition between a marginal ligament and a spiral beak, like *Chama*, and a patelliform valve, with a ligament wholly internal, and a central umbo.

The shell, considered *as a defence*, is most complete in those bivalves, like the oyster, which shut up close (see Coloured Plate, Figs. 11 and 12), and in those univalves which have an *operculum*, or door, to their houses (same Plate, Fig. 3).

Many *bivalves* gape a little at the sides (or ends), where the foot and the respiratory tubes are accustomed to be pushed out; and many *univalves* are too large and bulky, in proportion to their shells, to be completely housed and protected in them.

The cowry owes the glassy polish of its whole exterior to the amplitude of its mantle, whose folds meet over its back, and ordinarily conceal the shell entirely.

In the shining Marginellas and Olives, and some Volutes, the shell is partially glazed by the same envelope.

One sort of garden-slug, the *Testacella* (see Woodcut,



FIG. 4. *Testacella haliotideae*, side view; *s*, shell; *b*, end view of a specimen which has been disturbed from its winter sleep, showing the mantle partly expanded round the shell.

Fig. 4), has a small, shield-like shell on its tail, while the rest appear to have no shell at all, it being always rudimentary, and usually internal. Such is also the case in *Aplysia*, the "sea-hare," in which the shell is entirely concealed by the mantle. On the other hand, *Cyclostoma elegans* (see Woodcut, Fig. 6), a snail found in hedgerows and thickets of the chalk districts, covers the aperture of its shell with a close-fitting, shelly plate,



Fig. 1. Operculum of *Turbo fluctuatus*;
a, outside.

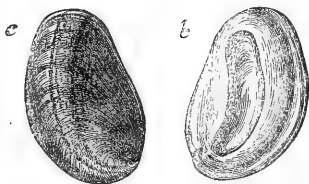

Fig. 2. Operculum of *Imperator olivaceus*;
b, outside; c, inside.



Fig. 5. *Conus tessellatus*,
transverse section.

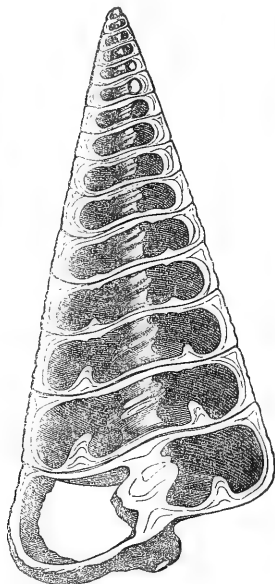

Fig. 8. *Cerithium telescopium*,
longitudinal section.

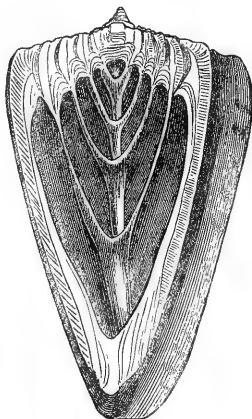

Fig. 4. *Conus tessellatus*,
longitudinal section.



Fig. 6. *Marginella glabella*,
longitudinal section.

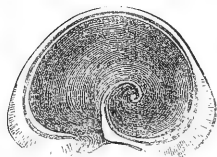

Fig. 7. *Cypræa Turdus*,
transverse section.

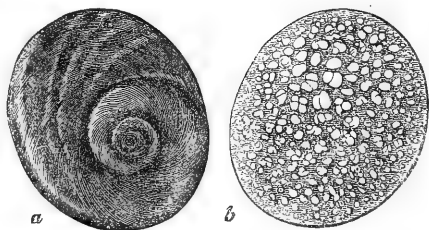
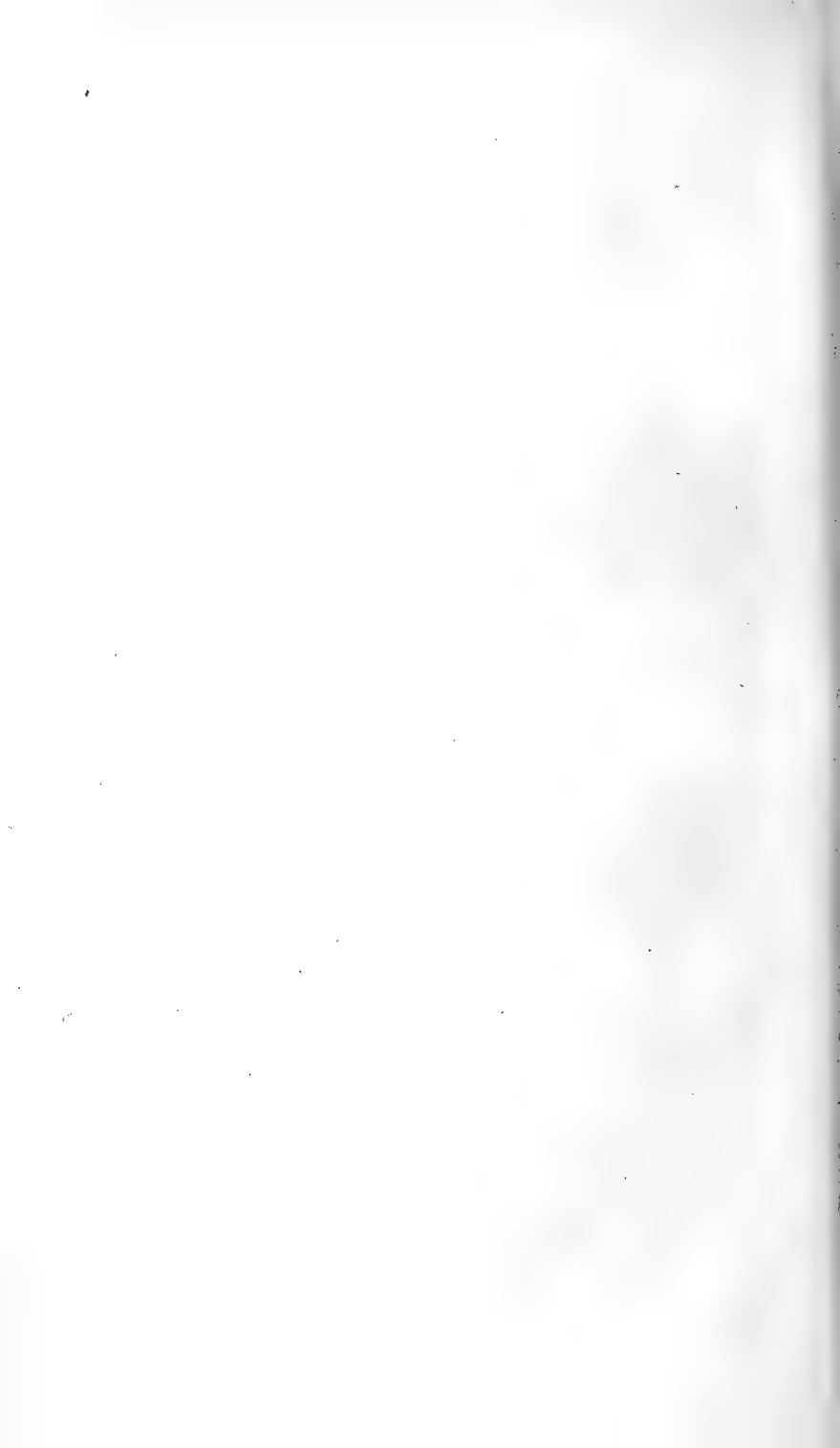

Fig. 3. Operculum of *Turbo Sarmaticus*—b, exterior surface; a, interior surface.

OPERCULA AND SECTIONS OF SPIRAL SHELLS.



which enables it to resist the summer drought, and exclude all enemies.



FIG. 5. *Carychium minimum*, highly magnified. FIG. 6. *Cyclostoma elegans*.

In the Coloured Plate, at Fig. 3, is represented a specimen of the foreign land-snail, *Tropidophora carinata*, presented to the author by that indefatigable traveller, the late Madame Ida Pfeiffer, which was brought *alive* by her with other specimens from the Mauritius. It was perfectly lively and well after six months' close confinement, wrapped up in an old sock in a tin pot.

The periwinkle has a similar operculum, of a horny consistency and spiral structure; but the exotic Turbos have a solid, shelly operculum (see Plate, p. 245, Figs. 1—3), coated inside with rich brown, and spirally marked with lines of successive growth; while the exterior is smooth, or corrugated, like the tufa of a dripping well (same Plate, Fig. 3, *b*), or variously carved.

In the great pearly *Turbo marmoreus*, so often used for a sideboard or mantelpiece ornament, the operculum frequently weighs several ounces. A specimen in the shell-gallery of the British Museum weighs more than half a pound.

The whelks and all their tribe have horny *opercula*, and the pattern is often characteristic of the genus; the operculum of



FIG. 7. The Dog-whelk, *Nassa reticulata*.

FIG. 8. The Dog-whelk, *Purpura lapillus*, and a small cluster of its egg-capsules.

the whelk is *never spiral*. (See Woodcut, Fig 9.) Gregarious animals, such as the whelk and periwinkle exhibit malformations more frequently than others; thus we have whelks with double opercula, others with shells repaired after injury or curiously contorted. Mr. W. H. Rich, of No. 14, Great Russell street, Bloomsbury, W.C., has devoted much time to the collection of anomalous forms of British shells. He will be

happy to gratify any of the readers of this article with a view of his collection, which is well worthy of inspection. There are also several cases for the exhibition of abnormal shells in the gallery of the British Museum.

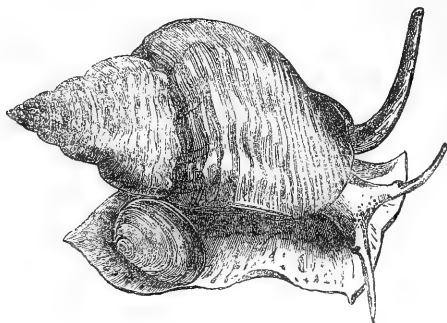

FIG. 9. The Common Whelk, *Buccinum undatum* (British).

The *Epidermis*.—The exterior of the shell of the whelk (see Woodcuts, Figs. 7—9) is invested with a thin, straw-coloured membrane whose existence is scarcely recognized. Shells from a quiet soft sea-bed often have a coat like brown velvet. Many exotic Tritons are remarkable for their rough cuticle. Arctic shells, also, such as *Modiola*, *Astarte*, *Cyprina*, have, when taken alive, a very dark-brown epidermis, entirely covering their surfaces. Fresh-water mussels and melanias (see Woodcuts, Figs. 10—12) are also conspicuous by their olive or chesnut-coloured skin.

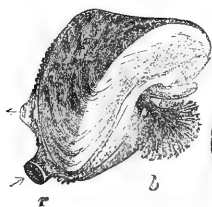

FIG. 10. *Dreissena polymorpha*, showing foot, byssus (*b*), and respiratory siphons.



FIG. 11. Three *Dreissenas* attached to Caspian Cockle.

This living membrane extends beyond the margins of the valves in a fringe or sheath, and protects the shell from decomposition by chemical action.* The mollusca inhabiting fresh water are especially exposed to corrosive action, either from

* In fact, it fulfils exactly a similar office to the human scarf-skin, having life without sensation, it protects the shell whilst the animal lives.

carbonic acid in solution, or dilute sulphuric acid from the decomposition of iron pyrites. But the action is especially manifested in those stagnant waters where the first probe of the collecting-rod disengages from the mud an abundant stream of bubbles of sulphuretted hydrogen. In such situations the spiral shells—for example, *Bithynia*—have lost the ends of their spires, and the discoidal shells, like *Planorbis*, have been found with a small hole caused by the dissolution of the inner whorls.

The great and ponderous mussels of the American rivers, and even the fresh-water unios and anodons of our own streams (see Woodcut, Fig. 12) are often externally eroded, and the cause has been the subject of much speculation. The umbo is the part first formed, and consequently that where the epidermis is thinnest and has been longest exposed to the action of the elements, and it is this portion of the shell which is most corroded. The epidermis of *Trigonia* is formed of a layer of nucleated cells, difficult to detect, however, in the state in which they are usually sent home (*i. e.*, well cleaned).

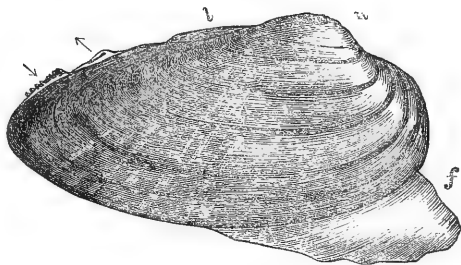

FIG. 12. *Unio tumidus*—River Lea. *u*, the umbo of the right valve; *l*, the ligament; *f*, the foot; the arrows indicate the respiratory currents.

Dr. Bowerbank wrote a paper to show that the epidermis was a very highly-organized structure, not only endowed with vitality like our cuticle, but furnished with vessels appropriate for and capable of repairing any injury it might sustain (*Micr. Soc.*, 1843). These observations, however, have not been confirmed.

Shell-structure.—Shells are composed of carbonate of lime, with an animal basis. There is no appreciable amount of phosphoric acid, so that shells or shell-sand have no chemical value as fertilizers. The French chemist, M. E. Fremy, found that the composition of shell was carbonate of lime, with not more than one or two per cent. of phosphate of lime. When treated with hydrochloric acid, there was left a brilliant felt-like organic residue, not soluble in hot water, like horn or gelatine, and insoluble in alcohol and ether.

This substance, which is isomeric with *osseine* in bone, he named *conchioline*. It sometimes exists in such large proportions that, like the animal basis of human bone, the lime may be dissolved out with weak acid, and the film of conchioline will remain with its peculiarities of structure.

This substance, which is isomeric with *osseine* in bone, he named *conchioline*. It sometimes exists in such large proportions that, like the animal basis of human bone, the lime may be dissolved out with weak acid, and the film of conchioline will remain with its peculiarities of structure.

Formerly, shells were supposed to have a merely crystalline structure; in fact, that they were a mere inorganic exudation. Look, for example, at the exterior of the operculum of *Turbo sarmaticus* (see Plate, p. 245, Fig. 3, *b*) how exactly it resembles tufa formed by spray on a limestone rock (the mantle of the animal does not continuously cover it, on the contrary, it is the door which, when closed, shuts in and protects the mantle; but at times it certainly does cover it, for it deposits on each little eminence an additional layer of shell-matter); or at the broken tube of the great *Teredo* (*Furcella*) of Java, which is more than two feet in length, and half an inch in thickness; or at the shell of the fossil Belemnite and recent *Pinna*, they have a fibrous structure, which might easily be mistaken for mineral. Drs. Bowerbank and Carpenter have advocated the views taken by botanists and anatomists, namely, that the hard tissues of shells are formed by deposits of lime in cells, or upon layers of membrane. Mr. G. Rainey, having observed that when salts crystallize in syrup, they assume a globular or other concretionary form, not geometrical, was led to imagine that a close imitation of shell-structure might be produced by causing carbonate of lime to deposit in minute concretions, which, coming in contact, become polygonal in the course of their growth. We have every reason to believe that the cells are formed *first*, and then that lime is deposited in them afterwards, just as the hard tissues of seed-vessels, the albumen of the vegetable ivory, and the silicious cuticle of grain is formed.

Dr. Bowerbank, however, has been misled in the attempt to compare the shell and the formation of shell too closely with that of *bone*, a highly vascular structure capable of absorption and internal repair, being permeated by canals in which the blood circulates.

If we examine any immature shell, we shall find the lip, or growing margin of the shell, much thinner than the rest of the shell, and, indeed, quite soft. The mucus of this soft, growing edge is found to contain granules, which are, in fact, incipient cells destined to unite and form the calcareous matter of the future shell-wall. The gradual formation of shell may readily be traced in all its stages.

There is an intimate connection between the mantle of the mollusk and its shell. The oyster, as we see it on the supper-table is much smaller than its shell, and adheres only by its glistening shell-muscle; but when alive, its *mantle*, extended to the very edge of the valves, lining the whole interior, and having a slight adhesion, especially at the edge of the valves, which is speedily ruptured, however, when the poor animal is forcibly invaded.

The "carrier-shell" (*Phorus*) cements other shells, and stones, and fragments of coral to the growing lip, and they remain firmly attached, forming a spiral round the suture. In this case, the hold of the mantle must be strong, or the animal must remain quiet for a while every time it adds a fresh bit to its grotto.

The section of any pearly shell exhibits an immense succession of fine and smooth layers. If polished or worn ever so little, these laminae will be cut through, and their edges will present a series of parallel lines. In the nacreous shell of *Haliotis*, the layers are corrugated, so that a single layer might serve to give the pearly effect. In porcellanous shells, the entire structure is composed of layers of cells, much metamorphosed, arranged in three distinct strata, the direction of each of which is different (see Plate, p. 245, Fig. 5, transverse section of *Conus tessellatus*, Born). When seen in section, each stratum is found to be composed of many vertical plates arranged sometimes transversely, sometimes lengthwise, according to the genus. Pearly shells and fibrous shells, such as *Pinna*, are like aragonite, biaxial, and prismatic, when examined with the polariscope. Porcellanous shells, like calcite, are rhombohedral and uniaxial.

The prismatic structure of certain shells is well illustrated by the fossil *Hippuritidae* from the cretaceous beds; the annexed Woodcut (Fig. 13) taken from the author's paper on Hippurites (Quart. Journ. Geol. Soc., 1855, vol. xi., p. 47, Fig. 12), represents part of the rim of *Radiolites Mortoni*, of Mantell, from the lower chalk of Sussex. (Traced from the original specimen in the Museum of the School of Mines, Jermyn Street.)

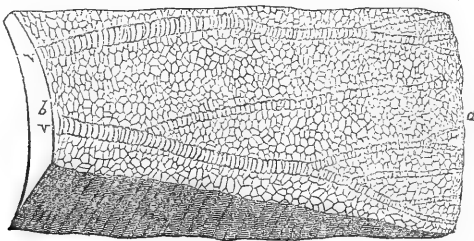

FIG. 13. Portion of the shell-wall of the lower valve of *Radiolites Mortoni*, Mant. Lower Chalk, Sussex. *a*, the outer edge; *b*, the inner edge; *v, v*, dichotomous impressions.

A structure analogous to the chambered shell of the cephalopod occurs in the thorny oyster, or *Spondylus*; in aged specimens, the shell, instead of increasing in size, becomes thickened in its interior by the addition of inner layers of shell,

which are distinct from the outer, and from each other. The cavities thus formed are found to contain water, which, however, evaporates after the specimens have been placed in a dry situation for a long period: but the water is again absorbed by immersing the specimens for a sufficient number of hours. This reduction of the inner space appears to be effected in order to counteract the continued increment of the shell (by deposits of new shell-matter, along its margin from the border of the mantle) at a greater rate than is required for the accommodation of the soft parts of the animal.

The tubes of *Vermetus* (see Coloured Plate, Fig. 9), and *Magilus*, and the apices of *Triton*, *Turritella*, and *Euomphalus* become either partitioned off or filled up solid, in the continued growth of the animal.

Shells owe their variations in form to a number of circumstances. Those which assume a spiral, vary in being either turbinated or discoidal in their growth, and again, in the infinite gradations between the extremes of these two. The shape of *Conus* (see Plate, p. 245, Fig. 4), is an inverted triangle, that of the telescope shell (*Cerithium telescopium*, Fig. 8) trapezoidal, and so on. The turbinated shells again merge into forms in which the whorls become detached with age as in *Vermetus* (Coloured Plate, Fig. 9), and *Siliquaria* (Fig. 10), or a nearly straight tube like *Dentalium* (Fig. 8). The discoidal shells graduate into forms having fewer and fewer convolutions, and wider and simpler mouths, until at last, in forms like *Patella* (Coloured Plate, Fig. 6), all spirality is lost, and we have only a tent-shaped cover.

DESCRIPTION OF COLOURED PLATE.

Fig. 1, *Cleodora pyramidalis*, L., Atlantic; Fig. 2, *Bulimus regina*, Fer., Amazon; Fig. 3, *Tropidophora carinata*, Mauritius; Fig. 4, *Helix* (*Anastoma*) *globulosa*, Lam., Brazil; Fig. 5, ditto (under side); Fig. 6, *Patella longicosta*, Lamk., West Indies; Fig. 7, *Murex adustus*, Lam.; Fig. 8, *Dentalium elephantinum*, Red Sea; Fig. 9, *Vermetus lumbricalis*, Gm. sp., West Africa; Fig. 10, *Siliquaria anguina*, Linn., New Guinea; Fig. 11, *Waldheimia australis*, Quoy, Port Jackson; Fig. 12, *Isocardia cor*, Lin., British; Fig. 13, *Aspergillum vaginiferum*, Lam., Red Sea; Fig. 14, *Chiton squamosus*, Linn., West Indies.

DESCRIPTION OF PLATE (PAGE 245)—OPERCULA AND SECTIONS OF SPIRAL SHELLS.

Fig. 1, Operculum of *Turbo fluctuatus*, Mazatlan—*a*, external surface; Fig. 2, Operculum of *Imperator olivaceus*,

also from Mazatlan—*b*, external surface, *c*, interior; Fig. 3, Operculum of *Turbo Sarmaticus*, L., from the Cape of Good Hope—*b*, exterior, *a*, interior; Fig. 4, Longitudinal section of *Conus tessellatus*, Born., to show the thinning of the internal whorls; Fig. 5, Transverse section of the same shell; Fig. 6, Longitudinal section of *Marginella glabella*, Canary Islands, showing four spiral ridges on the columella; Fig. 7, Transverse section of a Cowry (*Cypræa Turdus*); Fig. 8, Longitudinal section of telescope-shell (*Cerithium telescopium*, L.), from Indian rivers, showing one spiral ridge on the column, and a second on the wall of the shell.

(To be continued.)

NOTES ON THE HABITS OF SOME LEPIDOPTEROUS LARVÆ.

BY THE REV. D. C. TIMINS, M.A., M.E.S. LOND. ET OXON.

THE processionary-moth (*Bombyx processionea*) is tolerably abundant in European collections, but the very singular habits of its larva seem to have escaped the notice of writers on entomology. I have never met with a detailed description, so venture to note the following facts, results of personal observation.

The larvæ of *B. processionea* lives in society; fifty or sixty individuals uniting to spin a common "nest." These "nests" are generally spherical, or nearly so, and are composed of very coarse network of hairs spun together. Their colour is a dull brownish grey, and they are extremely dangerous to handle, the hairs of which they are composed being highly irritating, producing very painful swellings, attended with inflammation. Within these nests the larvæ spend their days, issuing forth toward evening for the purpose of devastating the neighbouring trees. Most species of pine and fir are exposed to their ravages; but the picturesque "umbrella pine," so common along the coast of Provence, sometimes escapes without injury, *B. processionea* preferring any other species of pine if accessible. I have sometimes met these larvæ feeding during the day, but for the most part they are certainly night-feeders. They march forth in a long line, single file, one after another, each touching the one in front. They go wherever the individual who leads chooses to take them, and it would be a subject of curious speculation to imagine *how* these larvæ elect their

leader, and *why* they follow him so obediently; and by what means one individual obtains authority over his fellows. The line marches along until a suitable tree is reached, then the larvæ dispersing among the branches, commence their work of destruction. It is probable that they return in the same order in which they set out, but I have never had the good fortune to see them re-enter their nests. When they are on the march, if you knock the leader away, the whole line halts and remains stationary until the chief has resumed his place. If you kill the leader, the line at first remains quiet, then after a little time falls into confusion, various individuals going hither and thither, apparently bewildered, possibly searching for their leader. Presently they reform line under a new chief, whose direction they obey as they obeyed his predecessors, and continue their march. If you knock some individuals out of the line, their fellows will halt and wait until they have resumed their places, but if you kill or disable any, the remainder, after waiting for some little time, will close up their diminished rank and proceed on their way. They march straight on, heedless of danger, and well they may, for you had better not touch them without gloves. The hairs with which they are covered are so poisonous that it is said death has followed upon handling these larvæ; this, however, I should think due to a very diseased state of the blood. Birds, those enemies of the insect tribe, do not seem to prey upon these larvæ, which appear thus to increase unmolested. The ravages which they commit among the firs and pines near Hyères and Cannes are very great; I have often counted 100 nests in the course of a single ramble. I am at a loss to account for the very poisonous nature of these creatures; I have subjected their hairs to careful microscopic investigation; they are certainly formidable looking weapons, jagged and barbed on each side; but this is the case with the hairs of other species, which are harmless (*e. g.*, our common *Bombyx pudibunda*). There is a long bulb at the root of each hair, which I have conjectured to be a poison-bag, similar to that found in venomous serpents. This is merely a conjecture, however, as the bulb in question *may* be only the usual root of the hair, but I give it here as being the only way of accounting for the poisonous nature of these hairs which has occurred to me.

When about to assume the pupa state, about the month of April, these larvæ quit their nest in the usual order, and often traverse very considerable distances before finding a place suited to their purpose. They bury themselves, and form a rough cocoon of earth, hair, etc., at a depth of an inch or two below the surface. Hence the choice of a proper locality is a matter of importance, as the larvæ cannot form their cocoons

in stony ground, nor among the rocks of mica schist which abound in Provence. Accordingly they wander about, still under the guidance of their leader, until a suitable place is reached; then, as if by common consent, the line breaks up, and each larva proceeds to bury himself, near his fellows, so that where one cocoon is met with by digging, others are sure to be found close at hand. I may mention that I have never succeeded in rearing the perfect insect, all my pupæ having died, probably from not having the choice of ground when in captivity.

Another larva, whose habits are worthy of note, is that of the magnificent *Charaxes Jasius*, the prince of European butterflies. This glorious insect is very local in Europe, occurring only in Provence, near Hyères for the most part; and, it is said, in one or two localities in Spain. The larvæ I have found pretty commonly near Hyères: at Cannes none were to be seen, nor were any met with in the Estrelle mountains, although the food plant (*Arbutus unedo*) abounds there. This larva is of a curious shape, the middle segments being very thick, and those toward the head and tail gradually tapering. The head has a species of mask with four horns, corresponding quaintly enough with the four tails on the wings of the perfect insect. This larva feeds only in the sunshine, and must of course be looked for only on those leaves which are exposed to the sun's rays; all attempts to induce it to feed in the shade prove fruitless. The creature would sooner die than eat except in the bright sunshine! It forms a slight silken web, very soft, and of a brilliant white colour on the leaf, not for a covering, strangely enough, but for a couch. This is, as far as I know, the only instance of silk being produced by a member of the diurnal *Lepidoptera*. The larvæ being of a bright green colour, similar to that of the food plant, are very difficult to find, and often are overlooked, even by sharp-sighted entomologists. They adhere with wonderful tenacity to the leaves on which they feed. No amount of shaking or beating will dislodge them; in order to obtain them it is necessary to examine each leaf carefully (that is, of course, each leaf on the south side of the plant). The larva grows very slowly, being hatched about July, and rarely attaining its full size until the following May. Before each change of skin it suspends itself from a branch by the tail, and when the change is effected, the skin of the head is left behind, horns and all, like a mask! This insect is exceedingly difficult to rear, a very slight touch will kill the larva or pupa; and to rear it in England is next to impossible, first, on account of the scarcity of its food plant; secondly, because we have so little sunshine during the spring; thirdly, because our summers are not warm enough to bring

the pupæ to maturity. However, I have managed to rear a *very few* out of a large number of larvæ; several emerged crippled in the wings, and the experiment altogether was almost a total failure, as we only obtained *two* good specimens out of twenty-three healthy larvæ, which we brought from Hyères in April last. Feeding them during the journey was of course very difficult, and the change from a hot climate to a cold one did much mischief. When this larva is full fed, it suspends itself by the tail, the head curled round towards the tail in the usual manner of diurnal lepidopterous larvæ. In this position it remains for ten or fourteen days, during which time the *least* touch is fatal. At the expiration of that period the skin cracks at the fourth segment, and the bright green pupa emerges, the old skin shrivels up (leaving the pupa free) the "mask" alone remaining. The pupa state lasts but a few days, the markings on the wings soon appear, and are rapidly developed, the antennæ and legs assume their proper colours, and the perfect insect emerges (always, it is said, at *noon*) about the first week in June, sometimes earlier. The perfect state is usually of very short duration; for the young larvæ are found in July and August, the parent insect disappearing about the same time. Occasionally, however, the perfect insect survives until the winter; indeed, *once* I saw it on the wing in December, but this was considered by French entomologists as quite an abnormal appearance. *C. Jasius* flies with amazing rapidity, and it is very difficult to catch on the wing, taking alarm at even the distant approach of the entomologist, and flying off at a marvellous speed.

IRON AND STEEL IN THE CONSTRUCTION OF SHIPS AND BRIDGES: THEIR ADVANTAGES AND DISADVANTAGES.

BY PROFESSOR MCGAULEY.

A GREAT revolution has taken place in two of the most important branches of construction: the "wooden walls of Old England," which for ages were justly considered its impregnable bulwarks at home, and the infallible means of asserting its superiority abroad, have been discarded; stone and brick, which were relied upon as affording a power of crossing rivers, since the progress of civilization enabled mankind to be independent of fords, inflated skins, and other such rude, inconvenient, and unsafe appliances, are now almost equally fallen into disuse for such purposes. The transition has been, in many respects, so sudden, and iron and steel, which have supplanted wood in the building of ships, and stone and bricks in the erection of bridges, are so different in properties from the materials hitherto employed—while, at the same time, so brief has been our experience with regard to them—that we may be considered as, in a great measure, working in the dark, as far as they are concerned. This is a circumstance the more serious, as on the proper construction of our ships depends even the safety of our country, and on the proper construction of bridges the security of our lives, when passing on or beneath them.

It is certain, such are the inducements held out to the use of iron and steel, both for ships and bridges, that a return to the materials formerly employed is out of the question. A wooden ship would be exposed to almost certain destruction by the projectiles employed in modern warfare. And such are the spaces now, in so many cases, to be spanned in bridge-building, that the erection of the structures indispensable to our present system of engineering would be, not only very expensive, but often impossible, with either stone or brick. The widest stone arch in existence, that over the Dee, near Chester, is only 200 feet in span; the main spans of the Menai tubular bridge are each 460 feet wide.

That iron should be so generally used for almost every purpose, is but the natural consequence of its abundance, its cheapness, and its great strength. Comparing the cost of its production at present with what it was in former times, it is evident that it could not be employed, until now, on the present enormous scale of consumption. Many circumstances contributed to limit its use, until a recent period. From the method adopted in smelting, it could be obtained only to an

amount that was practically limited; and such was the imperfection of the machinery employed in moulding it to the forms it was subsequently required to assume, that it could be worked only in masses of a size which at the present day would be considered utterly insignificant. The possibility of using it on the present immense scale supposes a combination of circumstances which did not formerly exist, and which could be brought about only by long-continued exercise of enterprise and ingenuity.

Iron is the most generally diffused of all the metals. This, looking to the ordinary economy of Providence, evidently points to its wide-spread application. It is, however, one of the metals most difficult of reduction. This arises from its powerful affinities, which also cause it to be so extremely perishable. The difficulty which attends the extraction of iron from its ores prevented its use until long after mankind had attained a considerable amount of civilization. Hence in pre-historic, and even in the earlier portions of historic times, recourse was had to metals which are still both scarce and dear. Bronze was the universal substitute for iron; but, though great hardness was imparted to it—greater, perhaps, than is possible to us—its attendant brittleness, in some cases, and a limited supply in all, placed very narrow bounds to its application. Iron possesses a combination of good qualities which, taken in connection with its abundance, causes it to leave every other metal far behind, when there is question of utility.

One of the most valuable properties of iron—its capability of being cast in moulds—and one which it still retains in its best form, that of steel, was most probably unknown, and most certainly was unapplied in former times. Cast iron, with us, is far cheaper than malleable, and for a great variety of purposes answers at least as well. But, by the modes of manufacture anciently practised, it could not easily have been obtained; and were it even attainable with facility, the methods of manipulating it, now employed with such success, were then undiscovered. Casting iron is, with us, a very simple operation: it could not have been so in former times, on account of the difficulty of forming suitable moulds. This difficulty has been entirely overcome, within a comparatively recent period, by the adoption of sand, an improvement due to a Welsh shepherd boy. The use of sand for the purpose had been previously attempted, but without success: its general application to this most important purpose afforded facilities in the manufacture of cast iron which had been until then unknown.

The exclusive use of wood in the manufacture of iron, in

former times, imparted to the product qualities which it now rarely possesses, but set very narrow limits to its production. When the value of that metal began to be properly understood, and the demand for it, in consequence, became considerable, the rapid destruction of the forests which ensued had so injurious an effect upon its manufacture, that the quantity of iron made in this country fell to one-fourth of what it had previously been.

A mode of escape from this embarrassment, also, was soon devised. It might be supposed that mineral coal, in the form of coke, would be universally employed as a substitute for wood, when its applicability to the purpose was once ascertained. Such, however, was not the case. The use of coke is attended with difficulties which were not suddenly overcome—which were not, indeed, entirely surmounted before the power of the blowing-machine was augmented by the invention of the steam engine: until then blowing had been effected by that clumsy and imperfect contrivance, the bellows. When steam power came into use, the bellows gave place to the cylinder and piston, the capabilities of which were, practically, unlimited.

The progress of the iron manufacture towards perfection, once begun, was very rapid. It was again almost revolutionised by the introduction of the hot blast. Though the saving effected by this may, at least plausibly, be disputed, there can be no doubt that it is accompanied by peculiar advantages. Thus it renders possible the employment of coal, and even anthracite, and it enables us to utilize inferior ores. The adoption of coal instead of coke leads to an immense saving, on account of the gases, which are the most valuable portions of the fuel, and which formerly were wasted, being economized.

There are, it is true, certain serious objections to the use of coal in the smelting of iron. Thus, the sulphur it usually contains, and from which even coke is not free, causes the iron made with it to be *red short*—that is, to have the very objectionable property of being brittle under the hammer at a red heat. So little as 0.03375 sulphur destroys the property of welding, and a still smaller amount of it renders the metal utterly unsuitable for armour plates. The phosphorus, which also is likely to be present in coal, causes the iron to be crystallized—that is, renders it *cold short*, or brittle when cold. It is worthy of observation, that phosphorus, to a certain extent, counteracts the effect of sulphur; it sets free carbon, which combines with and removes the sulphur. It is possible, however, to get rid of all these mischievous ingredients: but the hot blast cannot yet be entirely depended on for the production of superior iron.

Numerous other improvements of great importance have been introduced into the iron manufacture, and valuable machinery connected with it has been invented. As an example of the former may be mentioned the process of *boiling*, and of the latter the *steam hammer*, without which it would be impossible to mould the enormous masses of iron required for ship-building and other purposes. But, of all the modifications which the manufacture of iron has undergone, that of Bessemer is probably the most valuable. It enables us to obtain excellent steel at a cost little higher than that of iron; and when the great difference between the strength of iron and steel is considered, the advantage of this will easily be understood. We may observe that, while the tensile strength of pure malleable iron is only 18,000 lbs. per square inch, that of good steel is 130,000 lbs. As with the hot blast, so with the Bessemer process, there are some difficulties yet to be overcome, since, when steel for very important purposes is required, it must be made by the old method.

In considering the fitness of iron as a material for ships and bridges, and particularly for the latter, one most dangerous defect to which it is liable must be taken carefully into account, namely, its tendency to crystallize, and thus to lose a very large portion of its strength. It appears from Mr. Fairbairn's experiments, that with constant changes of load, or with the same load, but with constant disturbance of the metallic molecules, from vibration, fracture will, in time, certainly ensue of itself. And it has been ascertained that an iron girder will break with about 400,000 changes of load, accompanied by vibrations: a fact which but too clearly shows that the spontaneous destruction of our iron bridges is but a question of time, and not even of a very long one. The explanations of this very alarming fact, the danger from which is, unfortunately, not even confined to bridges, but extends to the axles of locomotives and carriages, and to the various portions of machinery, which from time to time so unexpectedly give way, is found in the restoration to their primitive form of the crystals which had been elongated and mutually entangled by the hammering to which the iron is subjected during its manufacture.

It might be supposed that steel, from its tensile strength, being so much greater than that of iron, would be, in every instance, far preferable to iron. Such, however, is not the case. If, for example, steel is used in the formation of a girder, its thickness may be much less than if iron were used. But this very circumstance, as it is almost equally liable to oxidation, causes its strength to be impaired with much greater rapidity. Thus, a plate of iron half an inch thick is much less weakened by oxidation to the depth of the sixteenth of an inch than a

plate of steel, which at first is only a quarter of an inch thick. In the one case, the strength of the plate is diminished only to the extent of one-eighth: in the other, with the same amount of oxidation, to the extent of one-fourth. In the former case the plate would stand, when in the latter it would be sure to give way. Again, it might be supposed that steel would answer, best where violent concussions are to be withstood, and that, therefore, it would be an excellent material for armour plates. The reverse is, however, true. Steel is strong only when exposed to a force that is slowly applied. A cannon-ball which would cause only indentations in iron, or, at the worst, merely pass through it, would dash a plate of steel to pieces, dealing destruction, most probably, to all those in its vicinity.

The construction of ships and bridges of iron, and especially of the former, supposes the power of producing iron bars and plates. As the mode of forming these, except on a very limited scale, and in a very imperfect way, was unknown until near the close of the last century, iron ships and bridges must necessarily be of very modern invention. There has been by consequence very little experience regarding them: it is, therefore, the more necessary that we should bring to bear on so important a subject, everything we know regarding it.

In comparing the fitness of iron as a material for ships with that of wood, it is requisite to know their relative strength. The tensile breaking strain of iron greatly exceeds that of the very best wood. That of malleable iron is to that of dry English oak as about four to one; and, taking into account the weakness caused in the case of plates by riveting, as two and three-tenths to one. If, however, the riveting diminishes the strength of the iron, on the one hand, it increases the strength of the ship, as a mass, on the other; since, by means of it, the plates are united firmly in every direction. Considering the injuries to which ships are liable, it is not enough to bear in mind mere tensile strength. A compressing strain is often a great source of danger to them. The resistance of malleable iron to such a strain is to that of dry English oak, as seven to one. On the whole, however carefully constructed, a ship of timber is greatly inferior in strength to one properly made of iron.

Iron may be used either partially or exclusively, in the construction of ships. Each mode of proceeding has its peculiar advantages and disadvantages. Thus an iron vessel, timber-sheathed, and copper-fastened is greatly superior to one of iron, as far as fouling is concerned, and it is considerably lighter. But these advantages would be at an end, if a means were discovered of preventing the adhesion of animals or vegetables to the bottom of iron ships, and if steel were to

become so cheap as to be applicable to the ordinary purposes for which iron is now used.

Whatever the materials of which merchant vessels shall still be constructed, we have scarcely a choice with regard to ships of war. Our wooden walls belong to the past. We must henceforward depend on our walls of iron. The rams and improved projectiles at present in use would soon send the largest vessel of timber to the bottom. The contest between projectiles and armour is still undecided. It may, perhaps, be admitted that the projectiles already in use would, under favourable circumstances, penetrate any armour a ship could carry. But in battle such circumstances can scarcely ever exist. A projectile fired against a certain plate in a direction exactly at right angles to it may penetrate it without difficulty, while impinging at a less angle, it will glance off, after having done little or no mischief. The chances are many to one that in battle the angle of incidence will not be a right angle. There is, therefore, no well-founded reason for hesitating about the use of armour, and this can scarcely be applied with effect except to an iron ship.

Our only considerations at present are the comparative strength and durability of timber and iron ships. We have nothing to do with their form or armament, their sailing power, or their capability of efficient ventilation; though all of these must be more or less modified by the use of iron in ship-building. The superior strength of an iron ship is derived, not only from the nature of the material, but from the forms which may be given to it. The ponderous beams of the timber ship have been replaced by a much lighter, and at the same time stronger combination of plates and angle iron, so arranged as to afford the greatest amount of strength with the least expenditure of material. The resistance to fracture in every direction, afforded by a hollow iron beam or girder, consisting of plates judiciously arranged so as to prevent a yielding in any direction, is marvellous to those who have not studied the subject. Of all the forms which have been given to the ribs and other portions of a ship requiring enormous strength, the cellular is the most effective. It has the additional advantage of affording spaces for the stowage of water, without its occupying any otherwise disposable room, a circumstance of great importance on board a ship.

There is, however, one objection to the use of iron in ship-building, which has often caused serious doubts as to the propriety or even the possibility of continuing to employ it for the purpose. Iron is the most perishable of the common metals, not even excepting zinc, which, though more strongly electro-negative, is more durable, being to a greater or less extent

protected by a coating of oxide, which in ordinary cases soon forms upon it. The pecuniary loss caused by the rapid corrosion of iron ships has given rise to very serious anxiety both to our own and to foreign governments. This loss is so enormous that about twenty years ago the government of this country determined to abandon the use of iron ships of war. The evil is of the greater magnitude, as iron ships cost nearly four times as much as those of timber formerly in use in our navy.

Few persons have any idea of the rapidity with which iron ships are eaten away under the action of sea water. Large holes have been produced in two or three years, plates and rivets have been destroyed over a large surface, so as to put even the safety of the ship in peril. The vast number of the patents taken out for paints and other protective compounds, shows the seriousness of the difficulty, and at the same time proves the futility of the efforts which have been made to grapple with it.

The rapid destruction of the ship is not the only serious evil that accompanies the use of iron in shipbuilding. Iron ships are peculiarly liable to fouling, and this to an extent which is not only a cause of great delay, but often of imminent danger. When copper sheathing is used with wooden ships, the slight galvanic action which attends its slow solution in the sea water completely prevents the adhesion of marine plants and animals. This trifling corrosion formerly gave rise to considerable annoyance on account of the loss it entailed, and efforts were made, not without success, to prevent it. The sagacity of Sir Humphrey Davy suggested to him as a protecting agent the use of a metal at once more strongly electro-negative and less costly. Such a metal was found in zinc, which, in suffering the electric action, would save the copper. But the removal of such action from the sheathing led to an amount of fouling which soon caused all attempts to preserve the metal to be given up, and it was even considered very fortunate that at the expense of the copper, fouling could be prevented.

A sheathing of copper having been found so advantageous with wooden ships, it might be supposed that it would be equally useful with those of iron. But, instead of the copper protecting the iron, the iron would but too effectually protect the copper, and an enormous galvanic battery being produced, the destruction of the vessel would proceed with fatal rapidity. Were it possible entirely to prevent contact between the iron and the copper, the destruction of the former might be averted, but all attempts in that direction have been vain, so many circumstances are liable constantly to occur which render every precaution that may be taken unavailable.

Neither can the iron be protected by paint, or any other similar composition. All those compounds hitherto tried have failed, the corrosion, commencing in points, and spreading under the paint in every direction. Indeed, in proportion as they are successful in preserving the iron, they are mischievous in giving rise to fouling, large quantities of barnacles and weeds accumulating rapidly on the protected portions. The retardation thus caused is a source of serious additional expense. A comparatively small deposit would give rise to a loss of speed to the extent of one knot an hour, and the additional cost of fuel, seamen's wages, etc., consequent on this, is a matter of very simple calculation. Thus, supposing, for example, the average speed of the vessel to be ten knots an hour, the expense would be increased by one-tenth.

Fouling can be averted only by a clean metallic surface, on which electricity is constantly developed. It is vain to attempt the destruction of marine plants and animals by poisonous substances, the only way to prevent their adhesion is to present to them such a surface as will afford them no means of adhesion. This is best effected by the slow removal of the surface itself, on account of gradual corrosion, and the washing off of the resulting compound.

We may, therefore, conclude, that with iron, as with wooden ships, some metal must be sacrificed, and the only question that remains for solution is what that metal shall be. It is fortunate that in considering the important subject of the electro-chemical preservation of iron ships, we are not confined to the use of copper, on the contrary, a far less expensive and a thoroughly effective substitute for it is in our hands. If iron perishes in presence of copper, because it is electro-negative with reference to the copper, to preserve the iron as completely as the iron would preserve the copper, we have only to place in contact with it a metal which bears the same relation to it that it bears to copper. Such a metal is zinc, and it is the better suited to the purpose since its conductivity and other properties only just permit that amount of corrosion which is enough to secure a surface sufficiently clean to prevent fouling.

The efficiency of zinc, as a sheathing for iron ships has already been tested, and the experience of several months at a time has shown that its surface remains perfectly clean, under the ordinary conditions of immersion in the sea. The necessity for the substitution of zinc for copper as sheathing is fortunately not accompanied by increased expense, but rather the contrary. The cost of zinc is, indeed, only about one-third that of copper, but as sheathing it costs very nearly the same as copper.

There is no reason why only the outside skin of an iron ship should be carefully protected. It is true that this portion is corroded, if unprotected, with great rapidity, but every part, especially if exposed to the action of bilge or other water, rapidly decays. This general destruction might be, at least in a great degree, prevented by a judicious application of zinc, which when dissolved, or otherwise rendered ineffective, might be easily replaced. Experiments recently made at Portsmouth show that when the zinc sheathing and the iron of the ship are in perfect metallic contact, the zinc remains clean, and free from a coating of any kind. The interposition of felt, or any other imperfectly conducting material, as might be anticipated, has been found injurious. Complete contact of the metals is no more than sufficient to secure just enough galvanic action to preserve the one metal and keep the other clean.

The advantage of protecting iron ships from corrosion, is evident from the immense numbers of them annually constructed in the United Kingdom. The tonnage of the iron ships built on only six of our large rivers, during last year, amounted to nearly half a million of tons. The value of all those at present in use must, therefore, be enormous; and their preservation from a decay which has been found alarmingly rapid must be a question of the highest importance. The application of zinc to the protection of iron, especially after its having been employed long since for the protection of copper, is a proceeding so obvious that we can only wonder it has not been long ago, and universally, adopted with iron ships; its use in that way being rather the application of a well-known principle, than a novel discovery in science. And, indeed, as Sir Edward Belcher observed at the recent meeting of the British Association at Nottingham, its application to this purpose is not new.

Among the important advantages which accompany the use of zinc as a protection for iron ships, not the least is the absence of the necessity for insulation. If copper or "yellow metal" is employed as sheathing, it must be perfectly removed from conducting communication with the iron: or it will, so far from protecting the iron, cause its destruction to be far more rapid; since the least contact between the metals will not only transfer the chemical action to the iron, but render it far more intense than it would have been had the iron been merely left to its fate. The effect on iron of contact with copper is very great. The accidental dropping of a copper coin into the bilge-water, so as to come in contact with the iron of a ship, has more than once given rise to the formation of large and dangerous holes. In the attempts made to use copper sheathing with iron ships various means have been vainly used to

secure its insulation. Thus plugs of ebonite were inserted in the iron skin, and over the latter was spread, first sheets of felt, and then sheets of india-rubber. But unforeseen and accidental circumstances have rendered every such attempt to preserve insulation unavailing.

It may be asked, Why, if zinc is so much cheaper than copper, and at the same time so effective, it did not supersede copper as a sheathing even for wooden ships. The reason is very satisfactory: it would not have prevented fouling, since the condition which is secured by its contact with iron—namely, galvanic action—would not have been sufficiently secured by its contact with wood.

There is one rather serious difficulty that attends the use of zinc as sheathing for iron ships—its attachment. The drilling of numerous holes in the iron skin would be, not only expensive, but very objectionable for other reasons. This, however, has been obviated, and by very simple means. The edges of the plates forming the skin of the vessel are kept asunder by a slight interval, which is filled up with compressed teak, and into this are driven the zinc nails which are used to attach the sheathing, and which are rendered more secure by their points being, where they come in contact with the iron rib, turned back by it into the teak. The sheets of zinc can thus be nailed to the iron skin as easily as if it were wood, and the insertion of the nails in the teak serves to wedge it more tightly in the joint. In forming the latter, it is obvious that the edges of the iron plates may be left as they come from the forge, dressing of any kind being superfluous—a circumstance which considerably lessens the expense.

Iron supplies to the engineer a most excellent material for the construction of bridges. Not only is it cheaper for the purpose than stone or brick, and more durable than wood, but it allows the construction of bridges of immense span. It may be in the form of cast iron, wrought iron, or steel. Cast iron answers well enough within certain spans, but the soundness of the casting can never be entirely depended on. In the form of voussoirs or ribs, engineers have ventured to employ it in spans of 240 feet. Malleable iron is most generally used, and invariably with very large spans—almost always in plates varying from less than a quarter to little more than five-eighths of an inch in thickness. Looking to the rapidity with which iron is corroded, even in the atmosphere, how short is the period during which these plates will retain any amount of strength, without a degree of care which no one thinks of bestowing upon them. The danger from this source is not imaginary. The best constructed and most carefully preserved of our iron bridges are, as it were, melting away perceptibly.

Very recently more than *forty tons* of rust were removed from the Menai tubular bridge; but, large as this quantity was, it does not represent anything like the entire corrosion which has taken place in this bridge during the few years it has been in existence, since it consisted only of the rust which had formed on the exterior. How many additional tons would the interior and inaccessible portions have furnished, places where corrosion may be going on with an unsuspected but most dangerous rapidity. A very small extent of surface deeply corroded would suffice to endanger the stability of the largest constructions of iron, and might at any moment give rise to its sudden destruction.

The effect of air and moisture upon iron bridges must be greatly increased when, as is but too often the case, not only no effective means are taken to preserve them, but they are wantonly exposed to the most injurious influences. How long can they reasonably be expected to last, when moist clay and gravel are kept constantly heaped up against and in immediate contact with them, or when the pillars on which they, at least partially, rest are immersed in salt or brackish water. Experiments have shown that cast iron is rapidly changed, by the action of salt water, into a friable mass, closely resembling plumbago in both texture and weakness.

Independently of the danger which must arise to the public from the rapid decay of so many iron bridges, their renewal within a comparatively very short period, which, under the circumstances, will be unavoidable, must hereafter entail a most serious expense and inconvenience on railway companies, and indeed, indirectly at least, on the public. This consideration should lead to the adoption of a more rational treatment of iron bridges, and even to some attempt at a retardation of that decay which seems almost inseparable from them. Protection from moisture, with the exception of that contained in the air, is, in many cases at least, possible. But our electro-chemical knowledge might, perhaps, if properly employed, supply us with the means of imparting to iron constructions a degree of permanency almost without limit. Why do we not avail ourselves of the principle which is now being applied to the protection of iron ships—the transfer of the corrosive action to zinc. The cost of the metal which would thus be consumed, especially taking into account the ease with which it could be replaced, would bear no proportion to the expense and trouble which the frequent renewal or extensive repair of so many iron bridges must necessarily entail.

The subject of iron as a material for ships and bridges is one of the most important that can be considered. There is not one whom it does not, in some way or another, concern.

The owner of an iron ship is seriously interested in its preservation; the shareholder in a railway company ought to be anxious that the bridges on his line should last as long as possible, since the cost of their repair or renewal must be effected with money which otherwise would be his. The traveller, whether by sea or railway, is also deeply concerned, as there is the question of his safety. The general public is concerned, since it is impossible to proceed in any direction without passing under one or more railway bridges; and this, if they are allowed to corrode as rapidly for the future as at present, cannot but be attended with peril.

Iron and steel as materials for ship and bridge building possess advantages which will render their use for these purposes still more general than it is. We never can return to the materials they have supplanted. It behoves us, therefore, to make every effort to lessen or remove the inconveniences by which their use is at present accompanied. Science, if it does not now, will certainly hereafter supply us with the means for effecting this. But future safety, and a large saving in the time to come, must not be sacrificed to a trifling advantage in the present. The precautions that are taken must be wise and not specious ones. It is not unusual, for example, to contract for iron-work by weight, in the hope of securing the required amount of strength; but this important object is not to be attained in such a way. For the strength of iron and steel depends not only on their massiveness, but their quality; and the contractor may exactly fulfil his bargain as to weight, while at the same time he supplies what is vitiated by dangerous weakness.

DINOCHARIS COLLINSII; A ROTIFERON NEW
TO SCIENCE.

BY PHILIP HENRY GOSSE, F.R.S.

*(With a Coloured Plate.)*Class *Rotifera.*Fam. *Euchlanidota.*

Gen. DINOCHARIS (Ehrenb.). "Eye single, cervical: foot forked: lorica closed ventrally, with the lateral margin sharp."

Sp. *D. Collinsii* (Gosse). Lorica about as broad as long; furnished with four spines at the posterior edge, and four longer ones in the centre of the back: front and lateral margins denticulate.

Description:—Total length, when extended in swimming, .008 inch; length of lorica along dorsal line, .0032; *ibid.* to tips of posterior spines, .004; breadth of lorica, .0038. The lorica, viewed dorsally, has a somewhat square outline, with rounded angles; the front hollowed, the posterior edges nearly even, but set with four spines directed backwards, of which the dorsal (and inner) pair slant diagonally upwards and outwards, the ventral (and outer) pair are nearly in the line of the body. The dorsal surface is much arched longitudinally, particularly the anterior half (See Fig. 3), the highest point being about one-third from the frontal excavation. From this highest point spring two stout, long, rigid, slightly decurved spines, rather wide apart, and point backward almost horizontally. Another pair, very similar, arise from a more central point, close together, but diverge towards their tips. The lateral margins of the lorica are beset with small spines, about twenty-five on each side, like the teeth of a circular saw, the seventh, eighth, ninth, and tenth being larger than the rest. The frontal excavation is similarly toothed, but much more minutely. The whole ventral surface is delicately punctulate; the dorsal surface only in the central region, where the punctuli have a tendency to run in convergent rows. The ventral surface is wholly closed, so that the lorica is testudiniform. It is strongly convex in transverse section (See Fig. 4).

The head is quite retractile, thick, and massive in form, sub-cubical, with rounded angles; the lateral edges appear to become shelly, carrying two or three rows of small spinous teeth. The occiput forms a shelly projection, also edged with rows of teeth (See Fig. 1); this, though nearly lost in the general outline, when the head is fully extended, yet is often

left isolated when it is suddenly retracted. The front is set with strong cilia, which in action produce a vigorous vortex on each side.

The foot consists of four joints, of which the first is thick, and carries at its extremity on the dorsal side a pair of divergent spines; the second joint is very short, and slenderer; the third is longer, but still further attenuated, expanding slightly at the tip; the fourth consists of two straight, slightly decurved, moderately long, spine-shaped toes.

An eye of conspicuous size, transversely crescentic in form, and of rich ruby hue, is seated just in front of a large globose mastax, which displays the ordinary structure. I have not been able to discern the cerebral mass on which the eye, doubtless, rests. The alimentary canal is ample, commonly filled with the digestive secretions, of a clear yellow-brown hue, and with granular food. The viscera are difficult of exact definition, from the complex nature of the integument, and its appendages; but seem to present no remarkable feature.

This very attractive form was brought under my notice nearly a year ago by Francis Collins, Esq., M.D., Assistant Surgeon in the Royal Military College, Sandhurst. He kindly communicated specimens to me, from which the preceding description, and the accompanying figures were prepared. As the species appears to be hitherto unrecognized, I honour it with the name of its discoverer. Dr. Collins favours me with the following notes concerning it:—

“The new species of *Dinocharis* is [found] in the parish of Sandhurst, in Berkshire, and as yet only in one small pool in a fir wood between the Royal Military and Wellington Colleges, about two miles from the former and one from the latter. The pool is not more than eight feet in length by five in breadth, and from four to five in depth. It receives the surface drainage of a very small portion of the wood. The drains are open, and are almost choked with moss, and it is chiefly in one of these, close to the pool, that this interesting and curious species has been found. Both the pool and the drains are peculiarly rich in rare species of *Rotifera*. They contain also many varieties of Diatoms, Desmids, Infusoria, and indeed microscopic objects without number.

“The history of our little creature is rather curious. In September, 1864, a lady (Miss S.) was staying with me. On leaving my house she took away a bottle of water from our favourite little pool, which proved to contain specimens of our new *Dinocharis*. It was not until the autumn of last year that I for the first time saw a specimen, but then I found it in abundance. In the winter it disappeared entirely. In April

of the present year, Miss S., who had been spending a few weeks with us, again took away a bottle full of the water from the same pool. We had searched it well while she was here, but could find nothing of particular interest. After she had kept this bottle of water, however, for more than four months, she suddenly found it swarming with these interesting creatures. I may add that about three weeks ago [at the end of July] I obtained water from the same place, but could not then find anything of interest. Some of the drains leading to the little pond had been cleaned out during the course of the summer, which may possibly account for the absence of the *Rotifera*."

In captivity our little *Dinocharis* is active, rarely still, rooting among the sediment, or swimming with a smooth, gliding motion, of no great speed. If I may judge of its behaviour in freedom from what is seen while under our notice, it seems to be specially a bottom-frequenting form; for, in a phial, the pocket lens never detects it roaming freely through the water, while a pipette thrust down to the sediment invariably captures several specimens. I am not acquainted with any other form in the class with which this well-armed species can possibly be confounded, unless it be the *Polychaetus subquadratus* of M. Perty, figured (without any description) in Dr. Arlidge's *Infusoria*, Plate xxxviii., figs. 31, 32. To this species there is certainly much resemblance, but at the same time much dissimilarity, particularly in the shape of the lorica, the number of long medial spines (eight in *Polychaetus*) and in the situation of these, which are represented on the ventral surface. This, however, may be mere inaccuracy of observation. Indeed, considering all things, I would not be quite sure that this form of Perty's was not founded on our *Dinocharis*, very carelessly and untrustworthily delineated. Should it, however, prove to be so, M. Perty's name cannot be retained, since there can be no doubt of the generic affinity of our species with the other members of *Dinocharis*. Dr. Leydig, indeed, supposes Perty's *Polychaetus* to be a crustacean; but in this he is certainly mistaken.

EXPLANATION OF THE FIGURES.

Fig. 1. *Dinocharis Collinsii*; dorsal aspect. Fig. 2. Ibid. ibid. (the armature of the lorica omitted, in order to a clearer display of the viscera). Fig. 3. Ibid., lateral aspect. Fig. 4. Ibid., outline of transverse section of lorica.

POSTSCRIPT.—I subjoin a list of *Rotifera*, which Dr. Collins has detected in the tiny pool above-mentioned, remarkable, not only for the number, but for the rarity of the species, as will

be apparent to those who have made this beautiful class of animals their special study:—

Floscularia cornuta	abundant.
" campanulata	scarce.
" (an undescribed species)	very scarce.
Melicerta (an undescribed species) ...	rather scarce in this pool, but abundant in the neighbourhood.
Æeistes crystallinus	scarce.
Megalotrocha velata	scarce.
Microcodon clavus.....	abundant.
Notommata aurita	
" centrura	
Furcularia cœca	common.
Plagiognatha felis	
Lindia torulosa	abundant.
Monocerca bicornis	
Dinocharis tetractis	scarce.
" Collinsii	abundant.
Salpina mucronata	
Colurus caudatus	abundant.
Stephanops muticus	
" (an undescribed species)	
Rotifer (several species)	common.
Actinurus Neptunius.....	
Philodina (several species)	common.

FROM KURRACHEE TO MOOLTAN.

BY FRANKLIN FOX,

Superintendent Oriental Inland Steam Company, Limited.

THE monotonous chant of the Lascars calling the soundings in feet, as they dip their coloured bamboos to the river's bottom from the flatly-built steamer's bow, warn us in our gradual and winding passage up the Indus, when we may look for the grounding bump that stops our progress for a time.

"Bonée paunch poot!" "Sara char poot!" quarter less five, and a-half four feet, hint that we have not very much water to spare under us. In the dry season, from November to February or March, though the journey up the Indus is formidable from the time it occupies, the channels of the river being shallow, winding, and comparatively dried up, the climate is cool and invigorating, and the trip from Kotree to Mooltan, affords to those making it, a not by any means unpleasant experience of Indian life. But to begin at the beginning, one must "take a departure" from Kurrachee, a seaport close to the creeks forming the delta of the Indus, and which presents to us, on arrival, an appearance different from any other harbour in the world.

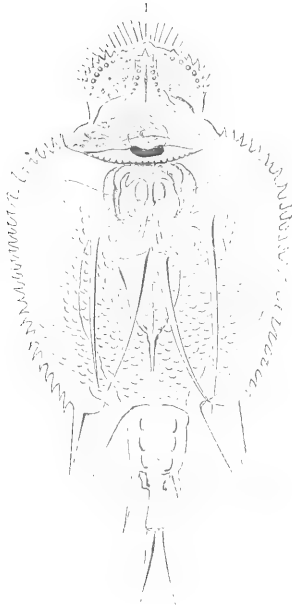

P. H. Gosse, ad viv.

DINOCHARIS COLLINSII.

Mag. 400 diam.



The shore, as seen approaching it, is a flat tract of yellow haze-covered sand, looking as heat-radiant as the desert itself: an intensely blue sky, of course, over it. On the right of the harbour-inlet's mouth, a cluster of dark rocks of fantastic shape, half pyramid, half ninepin, stand boldly out against the yellow beach, and on the left another mass of rock, the top of which is fashioned into a light-house, and flag-staff, has a Robinson Crusoe looking aspect. Rough stone winding steps cut out in the rock, show it to be accessible by water at all events, if not from the promontory of land which joins it, and forms the inner part of the harbour. This is the establishment of the harbour-master, and the sandy beach adjoining, devoted to ship-yard and river-steamer work, is called Manora.

The entrance to the harbour is obstructed by a bar, on which there is at high water but nineteen feet, rendering the port inaccessible to vessels of large draught, and a very uncomfortable place for ships of lighter burden when the south-west monsoon, to which it is exposed, thunders, in heavy seas and stormy squalls, at its mouth.

Large government works have been undertaken, and about three hundred thousand pounds expended for the purpose of clearing away the bar, partly by narrowing a creek called Chinee Creek, which joins the upper part of the harbour, and partly by the construction of a groyne on one side of it, extending into the sea, by which it is intended to increase the rapidity of the tide in the harbour, and thus, it is hoped, sweep away the obstruction at the entrance.

The water of Kurrachee harbour, or some creature peculiar to it, so affected the plates of an iron steamer's hull in the course of eighteen months she had lain there, that a pen-knife could be thrust with ease through her plates at places, some a few inches, some farther, apart, as if the iron were rotten wood. The appearance of the iron at these places, indicated by little circular spots, being also like rotten or rust stained wood. To test whether this is the work of an animal, or of the water, or in consequence of the plates being defective, the authorities have, I believe, sunk plates to the bottom of the harbour to try the effect upon them.

The landing at Kurrachee is at a wooden pier or jetty, and facing you, mounting its steps, is a wooden building marked "Post-office." A drive of a mile or two along a narrow causeway-road, bordered by Chinee Creek on one side and the harbour mud the other, brings you to a stone arched gate and building, the Custom House. Here you enter the town, which is laid out in square blocks of buildings of stone, of rough construction, but solid, and nearly all standing in square inclosures (compounds), surrounded by rough stone walls. Far-

ther on, past the houses of business and banks, you reach the camp, divided into civil and military lines. In the centre, nearly, is Trinity Church, with a square, stone-built tower for its steeple. Close by is the flag-staff, on which a red pendant announces once a fortnight the advent of the English mail and home news.

The train from Kurrachee to Kotree—the terminus of the steamers on the Indus, now that the railway has superseded the tedious navigation of the creeks, or the passage by the mouth of the Indus, by which formerly the water passage from Kurrachee to Kotree was made—starts at half-past six every morning, and its whistle is sounding impatiently, otherwise I might pause and dwell a little on the lions of Kurrachee—its Government Gardens, its Government House (the Commissioner's residence), its Cutcherry, and its Rere Hall, lately built, its Library and Museum, its evening drive, where an enormous rifle-target and a "blasted heath," appear to have suffered as much scorching as no doubt the reputations discussed there do: its sea-view at Clifton, and last, not least, its famous picnics and drives to Muggerpoeer,* that shady abode of priests and muggurs (or crocodiles), held equally sacred in the native eye. There are some three hundred crocodiles here in about as many yards of shallow muddy streamlets, bordered with muddy grass, in which these brutes wallow. Close by is a hot sulphury spring, said to be of great medicinal power. A shady grove of trees covering in this spot renders it a pleasant retreat for visitors as well as residents, and part of the amusement of the day is supplying the resident muggurs with a live kid or goat to see the summary way in which it is disposed of; a stock of these animals for sale is kept on the spot by the natives. Occasionally a child is carried away, I suppose when a dearth of visitors (and consequently kids) make the muggurs unusually voracious, and then the Government threaten to "put down" that sort of kidnapping. But there it exists at present, and a famous old temple, and shrine, and tombs of holy men also to look at, make a visit to the shady oasis not by any means an unpleasant day's trip.

The man who, as Sterne says, travelled from Dan to Beer-sheba, and found "all barren," would certainly not find much to notice from Kurrachee to Kotree except an "embarras" of barrenness, which the total want of water during part of the year imparts to the level, monotonous tract of sand and stunted shrub that Lower Sind is at the delta of the Indus. A few dry water courses spanned by railway bridges that look now in the

* Sometimes spelt Muggæ Poer.

“dry” season absurdly long, tell of the rushes of water that in the rains flood these plains.

Kotree, or Little Cairo as it is sometimes called, presents an agreeable contrast when you reach it full of the sand of Sind internally and externally. The shady road from the railway station, overtopped by bright green trees, arching over head till they meet, the beautiful flower-gardens round the houses, the placid river, the white-painted steamers and flats moored to the bank, recall Cairo and the Nile to one’s mind’s eye; and also suggest what the other parts of Sind might be with the aid of the water that makes Kotree so bright. A shady road runs parallel to the river, leading to a fort-like building and the steamers depôt where we embark for Mooltan. There is nothing in the width or appearance of the Indus here to indicate its real size and grandeur, as the father of the five rivers of the Punjaub. “Paunch” signifies five, and “aube” waters, in Hindustanee, and refer to the five rivers, the Jhelum, the Sutlej, the Chenaub, the Ravee, and the Beās, joining each other, and eventually the Indus, after running through the north-west provinces of India.* On the arrival of the morning train from Kurrachee (which has been all night on the road), and generally a few days after the mail from England *viâ* Bombay, a steamer starts for Mooltan. Each steamer takes a flat lashed on each side of its paddle-boxes (for cargo), and with these encumbrances, and little more than four feet of water to depend upon at times, the reader may imagine the navigation is peculiar and not without its difficulties. A train of barges or flats joined to the steamer and each other, so as to form a serpentine tail, of which the steamer was the head, was a plan tried, but the windings of the river are so abrupt, the stream so rapid and shallow, that this did not succeed, and it is found now the more the steamer and her barges are assimilated together to move rapidly and in unison, the more successful they are in combating the obstacles the river opposes. To the energy and enterprise of the Oriental and Inland Steam Company are due the experiment alluded to, and the merchants of Sind and the Punjaub are indebted (although the experiment failed) to the same company for having placed the new and fast steamers on the river, where there were only the old vessels of the moribund Indian navy, since replaced with some additions by the Indus Flotilla Company.

* Thornton says in his *Gazetteer of India*, “With respect to the propriety of the designation, it is, however, to be observed that there are in fact six rivers,—the Indus, the Jhelum, the Chenaub, the Ravee, the Beas, and the Sutlej; but as the Beas has a much shorter course than the others, it seems to have been disregarded when the name of the country was bestowed.”—ED.

November 5th, 186—. Shook myself down on board the river steamer! Reached the first wood station, Onapere, at dark, here we lash to the bank, and take in wood fuel. All sleep on deck on account of mosquitoes taking charge below.

The river's bank here is a low sandy plain, patches of sandy islets intersect the river course frequently, and now and then the bank is a bluff of muddy sand, with trees of larger growth than the shrubs which appear to border it. The course of the stream is apt to vary through the sand it carries with it, which, lodging on these islands, in time changes the channel. We take a pilot at every wood station. The great guide in the navigation (in addition to local knowledge) appears to be the eye; the pilot is constantly on watch, altering the vessel's course where little peculiar ripples on the smooth, muddy surface of the river indicate shallow water. Our steamer draws only four feet of water, and we keep sounding with bamboo poles, marked to feet, on her and on the flats all day, the Lascars constantly chaunting the depth they have. The pilots are Sindians—intelligent fellows, who have worked in the Bherrie, or large river boats, up and down the river, all their lives. They are organized by Government, and under the control of the Conservator of the Indus. Each one wears a red sash, with a brass plate on it, as a badge of office; and they get about eighteen rupees (twenty-six shillings) a month as pay.

November 6. Passing the same sort of scenery as yesterday, all day. A line of trees in the far distance shows the difference between the river's breadth to-day and in the floods. Sometimes it is so capricious in its direction, that villages originally on one bank are discovered, when the floods subside, to be on the opposite side to where they were before; and it not unfrequently happens they are washed away altogether. At night we reached Gopang, the second wood station. Went on shore; found a fine beaten road, and a village of mud huts. During the latter part of the day we had passed some small forests blossoming with yellow flowers; at other places groups of breeding camels and their little ones, watering; and some picturesque native boats being tracked up stream by their crews, the towline being led from the top of the boat's mast. At places, as you pass, the stream comes with a rush, and you see large masses of sandy bank crumbling into the river bodily. They said, a man on horseback, riding by here, was suddenly engulfed in this way, and his body picked up fifty miles down the river.

November 7. The same sandy shore, with here and there small forests. Current very strong, so we did not reach the wood station.

November 8. Reached Bembra (the next station) at half-past ten A.M. Went to see the village mud huts, and two seedy-looking plaster mosques. At night, pulled up at the bank. Went for a walk through a real Sind wood; startled a lot of grey partridges roosting on trees overhead; gathered some cotton flowers and pods in various stages of maturity.

November 9. Approaching the first town of any importance, Sehwan, by name, eighty-four miles from Kotree only by land; stuck in the mud for an hour as we near it; passengers set to at whist, catch mosquitoes, and drink beer; captain, crew, and steam-pipe all roaring, and very busy till she comes off again. At Sehwan you observe a chain of hills—the Lukkee Range—extending the length of Beloochistan down nearly to the sea, and originating far off in the Hala Mountains. Every turn and winding of the river seems to bring us near to their base, though of course in reality they are a long way off. Went to see “the lion” of Sehwan, which is a magnificent tiger, kept in a rattle-trap bamboo cage. The town is composed of streets of mud houses; but there is a fine mosque, into which, after taking off my shoes, I was allowed to penetrate, across an inner square court of stone, to the tomb, where, amid crowds of worshippers, and tom-toms, reposed (which was more than I could have done) the remains of some great departed. Backsheesh, of course; and back to the steamer, hoping the tiger would not break out of his cage that evening, as he seemed pretty certain of doing some time or other soon, if he felt inclined.

November 10. Left Sehwan at daylight. The next station is called Kukan; then Seta, then Jumalli, then Baradera, then Suliana, and then Sukkur, the great place between Kotree and Mooltan. Here we arrived November 16, having passed through a continuous tract of vast sandy plain, day after day, following a winding course wherever clayey strata in the bed of the stream altered its course through the soft sand. Where there is no clay the banks of the stream are soft and yielding, crumbling away trees and all under the wash of our paddles as we pass. At intervals we passed numbers of native boats, employed in carrying the produce of the country, though many are lost in their passages. It occupies them generally about six months to get up from Kotree to Mooltan, partly sailing and partly tracking, though the passage down stream is comparatively easy. Some are employed conveying wood to the fuel station on the river, large quantities being used by the steamers.

The sails of some of these boats are as peculiar as their shape, those from Ferozepore and the Sutlej River being different to the Mooltan and Kotree ones. Some have sails laced to a

boom, making them set like a board—a “wrinkle” our yachtsmen took out from the “America’s” canvas.

We now begin to find blankets on deck acceptable at night, but prefer the cold to facing the mosquitoes below. At Seta I saw large quantities of cotton growing, and came across, in my walk, a lot of green parrots, some wood-peckers, and some enormous orange-coloured bees, having honeycombs in a tree hard by. Persian wheels for irrigation are at work, everywhere there is vegetation, on the river bank, and the results show the marvellous effect even of these partial supplies of water.

As we approach Sukkur and the Sukkur Pass, the country becomes more picturesque; the usually flat banks of the river change to hill; and getting a glimpse of the town as we approach, one sees in the setting sun square buildings, with deep pillared porticoes, looking like the pictures of ancient Greece; but the massive-looking structures prove to be mud when one comes a little closer. Nevertheless, Sukkur is the most remarkable place on the passage up. The river narrows to a gorge formed by steep, rocky shores; in the centre is a fortified island, looking like a miniature Malta in its yellow clay construction, which somewhat resembles the yellow-white stone of that place in colour. This is called Sukkur Fort; and past this place the river, pent up in narrow limits, rushes with great force. This is called the Sukkur Pass, and steamers often find it hard work here to get through.

Sukkur is near Jacobabad, where the famous Sind Brigade hold their head-quarters, and keeping a line of frontier videttes, the looting Belooches are kept in check. Here our whist party was broken up; it had been composed of a Sind horseman, a post-office inspector, about to commence his tour on relays of camels and elephants, and other wild animals, and an agreeable Italian gentleman.

November 17. At evening reached Rhoda, the first wood station after leaving Sukkur. We get now out of the jurisdiction of the forest ranger of Sind in wood supplies, and depend on our own arrangements, instead of those of Government, for that necessary article.

November 18. Reached Ghobla. Here we wooded from boats.

November 19. Passing sandy islets, with armies of birds, pelicans, storks, cranes, sandpipers, swarms of geese and ducks. Here and there an alligator appears, and occasionally a white porpoise. We have a bluff sandy mud cliff on one side, a shallow sand spit on the other, and a winding channel in and out. Did not reach the station to-night, the current being very strong—not that there is much difference here between the bank

anywhere and "the station," except that at the latter there are a few stacks of cut wood on a small clearance, and at the former it is all jungle. A puttywallah, or watchman, keeps guard on the wood, and the pilots are here obtained for the next day's run.

November 20. Reached Kordrewallah at breakfast-time; a few miles from here we pass the boundary line between Sind and the Punjaub; and here also ends the patrol line of the Jacobabad warriors (Sind Horse).

November 21. Found the river a little slacker in its currents. At one o'clock reached Mulochwallah; saw some jackalls, some grey partridges, and some tiger tracks.

November 22. Getting on faster, the stream being slack, but winding amid large patches of sand-banks, much more numerous than lower down stream; the sand-patches are tenanted by alligators, looking like logs of wood with pointed ends, which, when they are startled, prove to be very ugly heads, with large jaws and fishy eyes. Their teeth are not large, but there are plenty of them. The natives don't seem to mind them a bit; and when any one—say the pilot—wants to return down the river after a day's run, or some one wishes to cross at a bend of the river, they inflate their goatskin (or mussick) with air, stream it, and jumping astride, away they go down the road cheerily! To-day we had a fine breeze, and set sails on the steamer and flats. We reached Essanpore at two P.M., and started off again at four P.M.; but there was a shoal in the river just off the wood station, which brought us up—bump, oh!—and there we stuck for an hour. The pilot, in awe of the captain's wrath, fled into the woods; and I afterwards saw him mount his mussick and ride off. After a time the steamer was got off, and the current, very strong here, spun her round, with her flats, at a marvellous rate, like a teetotum. After this, we pulled up at this station for the night.

November 23. Started again, and stuck again until the steamer was lightened, by putting what cargo she had, and her fuel, into the flats. Just as we began to get on again, smoke is observed down the river. A steamer sent with a party of surveyors for the Indus Valley projected line of railway is known to have left Kotree after we did, and it is supposed to be she. The vicinity of another vessel stimulates our crew, apparently, for we steam away at a greater speed to-day.

November 24. At daylight, up steam and away, our rival after us. At seven A.M. passed Mittenkote, now six or seven miles inland, but which last year the river washed so close, it used to be the station of the Punjaub Flotilla steamers. Here we turn eastward, entering the Chenaub River, which at this point joins the Indus. Navigation becomes now more intri-

cate, sand-banks more frequent, the current stronger, and the alligators larger. After breakfast, reached Chercha, five stations from Mooltan. Wooding here is performed very rapidly, the steamer astern stimulating every one to increased exertion. We are off again in a very short time; but it is quite plain, in spite of every effort, our friend astern is overtaking us; and when we stop for the night one of the river steamers passes, and makes fast close to us.

November 25. Very slow work; boat sent away sounding for the passages constantly. Reached Tibbee, the next station, as our rival left it. Wooded, and went on for Buckree. At night, an alarm, caused by a native deck passenger, who was sick, ending his sorrows by stepping quietly into the river in the dead of night, and drowning himself. Despatched a boat in vain to save him, the river sweeping by like a sluice. At Buckree the Sutlej joins the Chenaub; up the Sutlej to Ferozepore the water is shallower even than the Indus at this time of year, there being only about two feet six inches as a reliable depth.

November 27. Reached a narrow part of the river at Sultawgoshawur, only thirty-five miles from Mooltan; and here our steamer, our rival, and two others coming down stream from Mooltan, were all stuck at a dead-lock for some time. I began to despair, and sending for camels, made preparation to finish my journey in that way, when at last one of the steamers (our rival) was with difficulty got over the bad place, and ignominiously abandoning my vessel; I transferred myself to the rival; and on the 29th reached a part of the river's bank called Shershah, where there was a painted board announcing the Punjaub Railway premises, and where there was a house called a railway station; and, what was more, a railway for the rest of the twelve miles to Mooltan, which enabled me to finish my jaunt from Kurrachee to Mooltan in as comfortable a manner as could be expected.

Two facts strike me forcibly—the length of time occupied in doing six hundred miles, and the wonder that steamers can't be devised to go without barges, and still carry enough cargo to pay; and the other is the contrast between the country where there is water near, and where there is not. That the irrigation of India must be fairly considered as a question by which its future prosperity will be affected in no small degree, no man in his senses who has travelled through Sind and the Punjaub can deny. The point to decide appears to be, who is to do it?—whether it is to be left to the enterprise of the age, or whether the Government will undertake what must necessarily be more or less a Government work, under any circumstances.

COMETARY LIGHT.—NEBULÆ.—OCCULTATIONS.

BY THE REV. T. W. WEBB, A.M., F.R.A.S.

It is curious to remark the occasional revival, perhaps in a modified form, of speculations which have for a time been laid aside. At the period when much attention was drawn to the "Nebular Theory" of Laplace, and the condensation of luminous mists into blazing suns was commonly spoken of as the probable history of the universe, an idea was entertained by Sir W. Herschel that comets might be detached portions of nebulous matter attracted to our sun from the depths of space; and though his speculation was not announced in terms corresponding with the requirements of mathematical accuracy, yet it was in itself sufficiently remarkable, and would be rendered additionally probable by what he did not refer to in this instance, though he himself discovered it—the proper motion of the sun through space, which would be still bringing fresh portions of nebulous material within the sphere of his attraction. The doubt subsequently thrown upon Laplace's theory by the real or supposed resolution of certain nebulæ into stars with increased optical power, of course restored the comets to their independent rank. But the researches of later times, without giving countenance to Laplace's speculation—for the materials of the gaseous nebulæ do not appear capable of being condensed into suns like our own—have yet tended to re-establish the connection between these two most mysterious classes of bodies. Our readers are acquainted with the great fact that Huggins has obtained evidence of the gaseous nature of the nucleus of Tempel's comet (I. 1866); or at least of the identity of its constitution with that of the "planetary nebulæ" of H. This was the first precise intimation that had ever been obtained as to the real composition of these wandering members of our system. It is true that as a spectroscopic investigation it had been anticipated by Donati at Florence, in the case of Comet II. 1864, but his results are more equivocal, as he was less distinct in his interpretation of what he saw; nor could this be wondered at in any one who neither had the extraordinary experience of eye and hand which distinguishes our great observer, nor was previously aware of the peculiarity of the nebular spectra. At first Donati says that he perceived distinctly two dark bands in the comet's light; but he adds that the spectrum resembles that of the metals, the obscure being broader than the luminous spaces; and that it might be equally said to consist of three light bands. Hence, little more, indeed, could be inferred with safety than that it was elementary

and not reflected light, but even this was a long step in advance, and afforded great promise of future discovery. His very curious diagram is but little known in England, and we shall therefore give a reduced copy of it, which will be the more intelligible and interesting since, chiefly through the enterprise and perseverance of Mr. Browning, the spectroscope bids fair to become a more popular instrument amongst us; as it well deserves.

The uppermost portion of the diagram is the spectrum of the comet, exhibiting the three bright bands; the lower is the corresponding portion of that of the sun, showing the four dark lines, and close groups of lines, named by Fraunhofer D b F and G; D, the "sodium-line," being to the right-hand. From this it appears that the light of the comet, being coincident with the blue and green spaces of the spectrum, must have had that hue. It may be presumed, however, that though

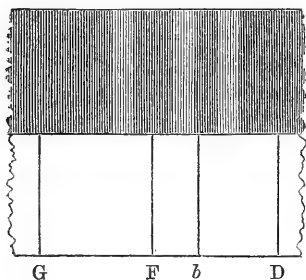

this comet did not reflect solar light, in which case a more continuous spectrum would have been produced, yet its composition, however analogous, could not have been identical with that of our recent visitant. Mr. Huggins has spoken of the bright lines in the spectrum observed by him as resembling those of some of the nebulae, and taking those of 37 H^{II} IV. as a specimen (see INTELLECTUAL OBSERVER, vi. 402), we find their magnitude and arrangement very different, the whole of the nebular spectrum being comprised within the left-hand half of the space between *b* and F, and consisting of extremely narrow stripes, perhaps not exceeding one-fiftieth of the breadth of the bands in Donati's figure. Unless, therefore, there were some essential difference in the two instruments or modes of observation, it must be inferred that there was a wide dissimilarity in the composition of these two comets. This, of course, might have been expected. A very little attention to the descriptions of former comets would convince us that with complete identity of type there is considerable variety in detail; and some of these differences are such as to indicate diversity of materials, not merely as between different comets, but as co-existing in the same individual. One very remarkable feature of this kind is the combination of a straight with a curved tail; the one streaming right out into space, and piercing the ether, as it would seem, without resistance; the other swept backwards and condensed at its advancing edge, according to Kepler's striking comparison, like the corn in the winnowing-

floor. From such a division Bessel was led to the idea of a heterogeneous composition in 1807; and in 1858, though the pale thin narrow beam which preceded the grand flowing train of "the Donati" was totally missed in England, and found few spectators anywhere, yet its existence is too well established to admit of doubt, and inevitably leads to a similar conclusion.

Diversity of colour, too, points strongly in the same direction. This has always been a recognized peculiarity among comets; not only in ancient and less accurate, but in our own careful, modern days. Virgil's beautifully picturesque description—

"liquida si quando nocte cometæ
Sanguinei lugubre rubent,"

would lead us to suppose that since the epithets would hardly apply to the majority of cases, he must have witnessed some such portent of an unusually deep and fearful hue; and the Chinese record of Ma-tuon-lin, compiled in the thirteenth century, vague as it is in some respects, yet careful and precise in this, speaks not only of red, but white, blue, yellow, and violet comets. In our own times, no one who recollects the different aspect of the two great comets of 1858 and 1861 could doubt of the fact; while, as far as I can remember, the orange tint even of the last was exceeded by the very fiery and angry aspect of that of 1854, the sabre-like precursor of the Russian war. Even between the different parts of the same comet a curious difference of tint has been noticed. In 1811 *H* remarked the very peculiar greenish or bluish-green colour of the head, while its central point had a pale ruddy tinge; and in 1858 the very feeble and wide-spread nebulosity surrounding the head was thought by Winnecke and Fearnley to be of a light-blue colour, while the head and tail were yellow. Here the reflected light, which was probably concerned, seems to speak sufficiently of diversity of material; but with the native light of the nucleus the case is still more evident, for spectrum-analysis teaches us that in all such instances a difference of colour, at least at corresponding temperatures, indicates the presence of a different element. We have no reason therefore for surprise at the contrast between the two spectra, one figured by Donati, the other described by Huggins.

In one respect, however, the comparison is not fully satisfactory. It does not appear how Donati's spectrum was obtained. Huggins, on the contrary, examined separately the nucleus and the coma, and hence possibly succeeded in obtaining more decisive evidence of its gaseous nature than can be deduced from Donati's figure. One great fact comes out in

both—the existence of elementary or unborrowed light. This indeed was nothing new; it had been maintained by H₁ and Schröter in 1807 and 1811, though subsequently discredited by other authorities. But the very curious distinction between the light of the central body and its envelope, though previously indicated by polarization experiments, was reserved to be demonstrated by the spectroscope of Huggins. Schröter, the strenuous assessor of electric light in comets, was so unsuspecting of this distinction that some of his chief proofs were drawn from the rapid changes and coruscations of the tail. On the other hand, Arago, the great advocate of reflected light, was somewhat less confident. His examination of the comet of 1819 with a doubly refracting prism showed two images of somewhat unequal intensity indicating polarization, and consequently reflected light; and at the return of Halley's comet in 1835 he obtained more decided evidence by the interchangeably red and green colours of the images in his polariscope, and thus he satisfied himself that the light of the body was not, at least in general, native, though he is very cautious in his conclusion, candidly admitting that the whole light might be partly intrinsic and partly reflected, since bodies becoming incandescent do not thereby lose the power of reflection. From this, however, it appears that he had less idea of the really native character of the light of the nucleus than of its becoming enkindled by its approach to the sun. In the same manner Bruhns at Berlin in 1858, and Murmann at the Vienna Observatory in 1862, found that the light of the great comets of those years, taken as a mass, was polarized, and therefore reflected.

In 1861 Secchi had obtained a better result from the magnificent apparition of that summer. He found the polarization of the tail and rays near the nucleus very strong, but no trace of it in the nucleus till July 3 and following days, when it presented decided indications of it, notwithstanding its very minute size (hardly 1", July 7). This he thought a fact of great importance, as showing that the nucleus had possessed native light on the former days, being perhaps rendered incandescent in its perihelion. The following year brought us a less brilliant but curiously developed comet, which has been described at length in one of our earlier volumes, and in this again he could detect no polarization in the nucleus, except a feeble trace on the last day of observation, while the aigrettes, or jets, unpolarized at their origin, became more so as they passed into the strongly polarized condition of the surrounding nebulosity. Non-polarization, however, is no conclusive evidence of native light, though polarization is a test of reflection; and hence Secchi supposed that the nucleus and aigrettes, if not incandescent, which he thought a less probable

idea, might consist of vapour in a vesicular state, like our clouds, which do not polarize, while the coma and tail were in a gaseous and polarizing condition. Huggins, however, by his more refined and critical mode of analysis, may be considered to have decided this question. An important remark of his should not be omitted here. He thinks that the dark spaces which so frequently intervene between the multiple envelopes of comets, may represent an intermediate condition of the matter originally derived from the nucleus, when it has ceased to be self luminous, but, from still retaining its gaseous state, is capable of reflecting but little light in its transition to a more visible condition, analogous to fog or cloud. Many curious questions of detail, however, remain to be considered, and it is to be hoped that before long the near approach of some magnificent and fully-developed comet, such as that of 1744, which nearly rivalled the splendour of Venus, and was visible to the naked eye at noon-day, may give full scope to the employment of his extraordinary means of investigation. Even before the arrival of such a phenomenon, some out of the ordinary profusion of smaller comets may furnish materials for keeping us on the alert. Eight of them, of very various sizes, were recorded in 1858, and the recent scarcity may be fairly considered the precursor of renewed abundance.

The comet whose light Huggins so successfully analysed, though not a brilliant, is in some respects a remarkable one. D'Arrest observes that it is the sole instance hitherto known of retrograde motion combined with shortness of period. The latter he fixes at $3930\frac{1}{3}$ days, the course all lying within the orbit of Saturn. Pechyle has given 53 years, Oppolzer about 30, but D'Arrest considers the elements very uncertain. At its first discovery, by Tempel, its motion was so rapid that it passed in 5h. through 2° , or about four times the breadth of the moon. D'Arrest remarks that its present orbit may be of modern date, and that it is more and more probable that comets of short period have not long pertained to our system, and are rapidly tending to dissolution. This he thinks is indicated by the unquestionably decreasing brilliancy of Encke's and Faye's comets, and notices Kepler's anticipated description of the fate of that of Biela, when he suggests the possibility of their division and dissipation.

The total loss, as it would seem, of the latter comet, though not an unprecedented occurrence, as that of 1770 never appeared again according to computation, is an event of considerable significance. It is an additional proof that the stamp of mutability has been impressed upon all created matter. From the comparatively small dimensions of its orbit, and the known character of the space which it had to traverse and the

perturbations which it would undergo, such a termination was not to be foreseen. But, considering the multitude of minor planets (now amounting to 89), and the probability that their number is by no means exhausted, there is no extravagance in the supposition that it may have encountered some such member of our system, and may thus have changed alike its mode of existence and of motion; destroyed, possibly, in the ordinary sense of the word, but, in the design of an omniscient and omnipotent Creator, merely transmuted into some newer form, not less valuable in itself, nor less conducive to the well-being of the great whole.

NEBULÆ.

We will proceed to some additional details on the subject of nebulæ, which could not be included in our former paper.

Up to October, 1864, Prof. D'Arrest had carried on the Copenhagen Review of Nebulæ, begun in the autumn of 1861, to upwards of 2500 objects, and looked forward to its completion after a year or two more. Of his 215 new nebulæ, a few, he found, had been anticipated by H and the E. of Rosse. 32 out of them he classes as B(right), though generally recurring as F(aint) in some of his revisions. 3 are of H's first class. He speaks of 2 great groups of Nebulæ in R. A. 11h. 58m. D. N. 21°, and R. A. 12h. 53m. to 56m. D. N. 28° to 29° (in *Coma Berenices*), neither of which had then been investigated by Lord Rosse, where, under particularly favourable circumstances, he has seen an extraordinary number of unknown nebulæ. They are, especially in the second group, "incredibly numerous and crowded, and, though extremely small, of a diversity of which no idea could have *a priori* been formed. Occasionally, in the most favourable moments, I have had the very exact impression, as though the nebulæ, often containing only a few seconds in diameter, though intermixed with larger ones—round, longish, stellar, or comet-like—lay packed together like oysters in a barrel."

Of Rosse's 35 "nebulae not found," D'Arrest had seen 12, and confirmed the invisibility of 4 others. He had repeatedly seen that most curious object, 55 *Andromedæ* (INTELLECTUAL OBSERVER, vi. 448) quite clear of nebulosity subsequently to Aug. 1862; and, still later, Huggins had found its spectrum similar to that of other stars. "This instance," says D'Arrest, "is one of the few which deserve especial attention in future." It will be readily found a little way *sp* γ , being of $5\frac{1}{2}$ mag., and the nearest star of that magnitude in that direction.

He has given a catalogue, up to the beginning of 1861, of 50 of those most singular and suggestive objects, Double Nebulæ, including about $\frac{1}{3}$ of the whole number visible with

the Copenhagen telescope. Of these 11 or 13 are new. On his No. 1—R. A. $8^{\circ} 2'$ (*not* 8h. 2m) D. N. $0^{\circ} 2'$, both equally bright, *p* longish, *f* round, distant $3'$, he remarks, "What has been observed in this place by W. and J. Herschel and by Bond, cannot be brought into sufficient accordance either with one another, or with the existing sky. It is triple." He thinks proper motion possible in 2 members of a triple group; R. A. $137^{\circ} 50'$, D. N. $34^{\circ} 19'$.—113 H. I. H. 581. (These, however, are not identical in Gen. Cat.—582 may be meant, but the locality is very puzzling.)

The interesting question of Variable Light still continues to attract attention, as well it may. Of the 3 supposed variable nebulæ in *Taurus*, we have recently heard very little. Hind's was just caught with Mr. Gurney Barclay's 10 inch achromatic at Leyton, in the winter of 1863-4. I am inclined to think that the nebula in the *Pleiades* (No. 6 of our list) is fainter than it was in 1863-4. In looking for it with 5.5 inches of aperture, on a transparent night, 1866, Feb. 12, I could scarcely perceive it with a power of 30 or 65, while the eye was in its usual position, or turned sideways to the left, but when twisted sideways to the right, in one of those contortions to which the possessors of achromatics are occasionally subjected, I saw its *f* border—or thought I saw it—distinctly crossing the field of 65, just like the edge of a faint comet's tail. Possibly it may be found that a varied position of the eye may be of use in detecting extremely faint phenomena. The lovers of scenery well know how curious and beautiful an effect is produced upon a landscape by viewing it with the head inclined to one side.

D'Arrest had previously remarked how singular it was that 3 variable nebulæ should be found only 9° and 8° respectively apart, and in a portion of the sky where nebulæ are rare; all of them becoming invisible, or nearly so, about the same time. Contrary to his idea that the list of such objects was nearly exhausted, a fourth has since been added to it, and, strange to say, in the same region. In April, 1863, Chacornac perceived a nebula a few minutes of arc distant from ζ *Tauri*; in Sept. it had become invisible in the achromatic at Copenhagen. And now that the fact of variation may be considered established, and does not rest upon a solitary or doubted instance, older observations and drawings, as our authority remarks, acquire an importance which would by no means have been accorded to them a few years ago. Other suspicious cases have been mentioned. Schmidt, at Athens, had recorded, in 1864, 4 nebulæ surrounding M. 49 (G. C. 3021, R. A. 12h. 22m. 39s. N. P. D. $81^{\circ} 13' 44''$). They were extremely small and faint, even in his lovely sky. This, unfortunately, is no

matter of surprise, as he informs us that his dialyte is so injured by the deterioration of its polish, that it may be considered "a wholly ruined instrument;" an announcement which all lovers of astronomy will hear with sincere regret, and earnestly wish that so diligent an observer may soon be armed with a larger achromatic of English glass, which is not subject to decomposition, or with one of the silvered reflectors which are now attaining such perfection. On the contrary, D'Arrest found 3 of these nebulae bright and pretty large, but one decidedly invisible at Copenhagen, and only 2 minute stars in its place. This struck him the more, as he could see without the smallest difficulty a feeble nebula, which neither Schmidt nor any one else had perceived except its discoverer, Struve II. It is singular, too, that H_2 , in 1785, had pointed out a faint nebula (498 H_2 II.) very near the site of Schmidt's missing object, which, as nothing could subsequently be found there, was supposed to be a mistaken double entry of 18 H_2 II.

Rümker, at Hamburgh, with nothing more than a 5ft. achromatic, found that 68 H_2 IV. (G. C. 1888), R. A. 9h. 32m. 18s. N. P. D. $30^\circ 31' 15''$, instead of being, as H_2 called it, "considerably faint, very small," might be better described as "very bright, large," and he remarked, on two occasions, that a companion star, 11.2 mag., seemed surrounded with faint nebulosity.

We must return to this subject at a future opportunity.

OCCULTATIONS.

Nov. 11, B. A. C. 6287, 6 mag. 5h. 7m. to 5h. 23m. B. A. C. 6292, 6 mag. 5h. 16m. to 6h. 31m. (This will be a noteworthy observation, from the near coincidence of the immersions. The conditions also will be favourable, the moon being a crescent, $5\frac{1}{2}$ d. old).—12th, ρ^1 Sagittarii, 4 mag. 5h. 22m. to 6h. 34m.—14th, 9 Aquarii, 6 mag. 5h. 9m. to 5h. 45m.—15th, B. A. C. 7620, 6 mag. 6h. 12m. to 7h. 26m.—16th, 67 Aquarii, 6 mag. 5h. 16m. to 6h. 19m.—20th, ξ Arietis, $5\frac{1}{2}$ mag. 6h. 58m. to 7h. 58m. B.A.C. 755, 6 mag. 7h. 48m. to 8h. 50m.—22nd, 75 Tauri, 6 mag. 6h. 43m. to 7h. 38m. B.A.C. 1391, 5 mag. 7h. 39m. to 8h. 15m. α Tauri, 1 mag. 9h. 58m. to 10h. 52m. (But for the nearly full moon, a night of especial interest: it also includes a near appulse to θ^1 Tauri, $4\frac{1}{2}$ mag. at 7h. 8m.)—24th, 26 Geminorum, $5\frac{1}{2}$ mag. 9h. 29m. to 9h. 57m.—27th, \circ Leonis, $3\frac{1}{2}$ mag. 11h. 13m. to 12h. 9m. (The reader will be struck with the curious *run* of the hour-numbers in this unusually full list.)

WILD KAFFIR LIFE AND WILD KAFFIR INTELLIGENCE.

BY ROBERT JAMES MANN, M.D., F.R.A.S.

Superintendent of Education in Natal.

AT page 188 of the October number of the *INTELLECTUAL OBSERVER* it is stated that the 10,000 "Natal Kaffirs" of 1836 have grown into 200,000 Natal Kaffirs in 1866; and the inference is drawn that the native race in that colony is increasing in numbers rapidly, and not dwindling away, under the presence of British enterprise and rule, and that therefore the question of the capabilities of that race is an important one. It may be necessary to explain that the Natal Kaffirs thus alluded to were Kaffirs who acknowledged English authority, and came within the sphere of civilized observation at even that early period, or very soon afterwards. The Kaffirs spoken of by Mr. Fynn as "Natal Kaffirs" were natives who had gathered round his settlements at the Bay. The rapid increase in numbers was, in all probability, due to the addition of more and more resident clans to the white man's following, as well as to the return of exiles, and the influx of refugees. The Secretary for Native Affairs in Natal has recently ascertained by direct investigation, that there are at the present time forty-three distinct clans, or tribes, within the colony, which were aboriginal tribes of the district, and which have never dwelt elsewhere, excepting for any brief period that they may have been compelled to remove themselves into concealment during the Zulu invasion and occupation. There are also twenty-two other native tribes in Natal, of which nine are composite and made up of a fusion of the fragments of aboriginal tribes, and of which seven are Zulu tribes which have removed themselves from the territory that is still under Zulu rule.

Before the rise of the Zulu power these aboriginals were neither warlike, nor aggressive. Disputes occasionally arose, both between families and between tribes; but such disputes were always speedily settled. There was no attempt at military organization. The several tribes were, for the most part, on friendly terms, and intermarried with each other. They possessed cattle, sheep, and goats; and cultivated the ground, and drew the principal portion of their subsistence from their gardens. They were, indeed, to a considerable extent what the Natal Kaffirs are now seen to be in the colony. The notion of Zulu-Kaffir ferocity, which has become

prevalent in late years, does not properly belong to these people. It has come from an accident in their history; the development of the Zulu military despotism under Chaka, which has been already described.

The chiefs of these aboriginal tribes ruled as patriarchs, and possessed absolute and uncontrolled power over the lives and property of their people. There was no other check to this irresponsible power than that which arose from the necessity, even in this state of affairs, of conciliating public opinion.

At the present time the several chiefs of the sixty-five tribes of Natal Kaffirs retain only the shadow of their old authority. They are allowed to settle disputes between their people, and to punish petty offences, but all criminal cases are now tried by the magistrates and the Supreme Court of the Colony; and even in cases adjudicated by the chiefs, an appeal can be made to the magistrates, to the Secretary for Native Affairs, and to the Lieutenant-Governor in Council. All supreme power has been transferred from the petty chief to the proper head of the State; and the chiefs now only consider themselves lieutenants, responsible to the Governor for the management of their tribes. They can no longer assemble their people in arms, unless under the order of the Governor. The attempt has been made, and with a considerable measure of success, in Natal, to turn the natural and inherent sentiment of respect for the patriarchal chiefs into a means of orderly government. By leaving a show of authority, and a harmless jurisdiction in the hands of the chief, his dignity has been saved from the evil effects of rude shock, while, at the same time, he has been made the direct link which connects his people with the institutions of the Government. The tribes themselves are divided into territorial districts, villages or kraals, and families. The chief presides over the tribe with a head-man, or Induna, under his authority. Each territorial division of the tribe has also its own proper head-man, or Induna; and there are also heads of groups of kraals, heads of kraals, and heads of families. Each head is practically responsible to the one immediately above him; and in the ascending series the chief of the tribe is responsible to the resident magistrate of his county; and the magistrate to the Secretary for Native Affairs, who is the head-man, or Induna, of the Governor, *par excellence*, the great chief. This organization is so complete, that any order emanating from the Governor can be at once made known to every native hut in the land, although the communication has necessarily to be made without the intervention of written or printed documents.

The huts of the native Kaffirs are nearly always grouped

together into villages, which are technically named "kraals." The huts are planted upon sloping ground, whence the water can run away easily, and are ranged in circles larger, or smaller, according to the number that has to be accommodated. The head of an ordinary family will have perhaps from six to ten huts in his kraal. The chief Ngoza's kraal near Table Mountain, to which the hut of the Tinted Plate at page 185 belongs, has some eighty or ninety huts in it, and is a pretty long walk across. Old Umpana has a royal kraal at Nodwengu in Zululand, containing six hundred huts arranged round the circle in triple ranks. The huts are fenced in with stakes and wattle, which thus form an outer wall to the kraal. But there is also within the circles of huts, an inner wall of similar construction, which encloses a kind of court-yard, that is entered by a single opening, and that is employed for herding cattle at night. The huts thus stand in a clear, ring-shaped enclosure of their own. The interior space of the kraal of Ngoza, to which the hut of the Tinted Plate belongs, is so spacious, that upon one occasion, when it contained the wagons and travelling oxen of the writer, and of the Lieutenant-Governor, with the tents of their encampment, in addition to the very large herd of oxen belonging to the chief, it still looked like a large and nearly empty field.

A very good idea of the appearance and size of the Kaffir hut may be gleaned from the plate, where Ngoza and his men are seen at the back of his own immediate dwelling. This structure is not very unlike a squat bee-hive, large enough to hold men, instead of insects. It is unquestionably a rude affair, when compared with the dwellings of an older and higher civilization. But there is another point of view from which it may be contemplated. Taken as a structure made almost out of nothing, by hands that are almost innocent of instruments, it is really a surprisingly ingenious and complete contrivance. In order fairly to understand this, the reader must conceive a man, just in the state in which nature has made him, planted down on a piece of wild pasture, with nothing but a rudely-fashioned lance in his hand, and told that he must fabricate there for himself a structure that shall at once be both clothing and house, and that shall efficiently shelter him through day and night, through storm and sunshine, through summer and winter. If the reader himself could be made the actual hero of the situation, he would be better able to comprehend what the task is that the wild Kaffir has accomplished, when he has made this straw house, than he can be without the experience. In constructing the hut a frame-work of wattle is first bent into a hemispherical shape. A thatching of dried grass is then laid over the

wattle, and bound compactly down upon it by fibres. A low arched door, very much like the bee's door, is left at one point, through which passage is made horizontally, either for ingress or egress. The correct position is something even more abject than that which is familiarly known as on all fours. This doorway is closed at night by a frame of wicker-work. The floor is a smooth, hard, and almost polished pavement, constructed of beaten earth and cow-dung. If the hut is of large dimensions, it has four or six posts inside; but if of small size, these internal supports are not used. There is a saucer-like and rimmed depression in the middle of the floor, to serve as a hearth in cold weather, and the smoke and air permeate the grass with just sufficient freedom to secure ventilation, but not one drop of water enters from the sky. Round the walls, in the interior, the scanty Lares and Penates of the master, consisting principally of beer pots, milk pots, mats, skins, and shields and assegais, are distributed. Upon the floor with rush mats unrolled beneath them, the dusky household squat to gossip by day, and lie outstretched to sleep at night. Each hut affords sleeping-room for several individuals. The chief, or head-man of a kraal has a principal hut for himself, where his visitors come to gossip and feast with him, and also a hut for each of his many wives, whose families dwell therein with them until the children attain a certain age. In most kraals there is also a hut set apart for the use of young men.

The Kaffir is eminently a creature of sunshine. In cold or wet weather he keeps himself close within the shelter of his hut, and gossips and doses away his time. When the sunshine is genial and warm he sits outside squatting upon the ground, surrounded by his dogs and his children, and fashioning some article for household use, for employment as a weapon, or for personal adornment; or with a small shield upon his arm, and a bundle of short light assegais, and a knob-headed stick in his hand, he strides off over the hills bent upon some business of gossiping or feasting. The cattle are principally tended and herded by the young boys, roaming free over the pastures by day, and being driven into the inner enclosure of the kraal for protection at night. In some convenient nook on a hill side, or in a sheltered ravine near to the kraal, a space is rudely fenced in as a garden, and here crops of the Indian corn, the millet, the sweet potato, and occasionally of the pumpkin, a wild sugar-cane (*Impheè*), and wild hemp, and tobacco for smoking, are grown. The ground of the garden is broken and tilled by the women, working with a curious kind of hoe, now imported largely into Kaffir lands for native use. The Indian corn and millet are produced in large quantities, and ordinarily form the staple of a Kaffir's food. The grain is stored, after

harvesting, in pits dug in the ground, with only a narrow opening left at the top, which is carefully and skilfully closed by placing a flat stone over it, for protection against the rain. The food is prepared by the women, sometimes aided by the children and young lads. The Indian corn is roasted, when green, upon the cob; when ripe the grain is crushed by hand, between stones, and the meal converted into a kind of porridge. The milk from the cows is chiefly consumed in a half sour and clotted state by the children. The millet is ground between stones, and made into a sort of infusion or decoction, which undergoes spontaneous fermentation, and so becomes converted into a liquor that is known as Kaffir beer (Tywala). In its choicest state, as it is found in the cellars of distinguished men, this liquid is limpid and clear, and possessed of considerable inebriating power. It is unquestionably very nourishing. In more common-place households it bears a considerable resemblance to a mixture of bad gruel and table beer. The beer drinking is the most ordinary form of native carouse. When there is a good brewing ripe, the men assemble and drink the liquid in rotation out of capacious gourds or pots, made of closely and thickly-woven grass, or more rarely of hardened clay. The beer is kept during fermentation in these vessels, which stand in the interior of the hut, opposite to the doors, something like the jars of the Forty Thieves, in a long row. The milk is held in similar vessels. The beer pots and milk pots are carried by the women and girls, very skilfully balanced upon their heads. A jovial spark, off on a visit, may be sometimes met, with a string of women or girls, each with a full beer pot balanced on her head, behind him. The water for household use is brought in by the women from the nearest stream, in gourds.

Under ordinary circumstances the gardens furnish a fairly ample supply of food for the daily wants of the household. But occasionally from some accident of season, or from some other cause, the supply runs short, and periods of great privation have to be endured. One of the first benefits which the barbarian reaps from the neighbourhood of civilized men is the alleviation of this unavoidable misery of barbarous life. So soon as he has white neighbours within reach of his kraal, he is pretty sure to have some additional resource to draw upon in seasons of dearth and famine. In olden times, and still in remote districts, the Kaffirs occasionally die of famine in great numbers; and those who survive subsist to a large extent, even for weeks at a time, upon wild roots dug up out of the ground.

Animal food, among the Kaffirs, is entirely a matter of carouse and feasting. If a distinguished visitor comes to a

Kaffir village, or kraal, the principal man makes a present to the visitor of a goat, or of an ox, as the case may be. The animal is graciously received, and turned over to the attendants of the guest for slaughter: some choice part is retained by the guest, and the rest is handed over to the inhabitants of the kraal, to be eaten in honour of the visit. Animals are also killed and eaten upon certain other ceremonial occasions, when set invitations are given, and set feasts made. Upon such occasions, if it is an ox that is to be eaten, it is taken near to the entrance of the kraal, and stabbed behind the shoulder with an assegai, wielded by some expert hand. A fire is kindled near, and almost before the animal is dead it is hewn to pieces, and the selected portions being removed, the rest is divided in what seems to the uninitiated observer to be a sort of scramble; but it is in a scramble that has in itself some underlying order of accepted etiquette and custom. The fragments of meat are just laid for a brief interval upon the embers of a wood fire that has been prepared close at hand, and are then rapidly transferred to the throats and stomachs of the feasters. The eagerness for the unusual, and rare, gorge is far too keen to allow any refinement of culinary art to be either learned or exercised. A couple of hours is pretty well enough, in Kaffir handling, for the conversion of a living ox into a remnant of stripped skin and bare bones.

Well-to-do Kaffirs rejoice in a multiplicity of households. In the kraal of a chief, or of a wealthy patriarch, each hut near to his own, contains a wife, and that wife's offspring, and the more distant huts are appropriated to the other members of the family or clan. Polygamy is an institution among the Kaffirs, that is intimately and inseparably interwoven with the privileges of wealth and the rights of property, and that will therefore be very difficult to eradicate. The Kaffir has strong natural instincts of affection for his wives and his children, as a rule; but the peculiar position which he holds as a polygamist, of necessity introduces some relations and characteristics into his domestic life and social history that are not calculated to awaken interest or respect. In all probability some of the incidents and occurrences that arise out of these relations are but imperfectly understood by European censors and critics. Kaffir men do not acquire wives until they are able to pay a stipulated number of cows to the father of the bride for the privilege. These cows are differently viewed by the different authorities who speak of Kaffir practices and customs. By some they are held to be an actual purchase price paid for the girl. By others they are considered to be a sort of deposit made in her interest to her family. In case of a wife leaving her husband within a limited period, he is allowed to have some

claim against her parents for cow-restitution ; but matters are held to be in some way changed when she has bestowed female offspring upon her husband. In some instances a family of girls confers a measure of freedom and independence upon the mother, because the value of the cows, price or deposit, is thus restored. At any rate the women are looked upon as possessing material and substantial value in a household, because they bring girls, who in due time turn into cows ; and because they perform hard and productive drudgery. The children of any particular wife speak in common of all the other wives of their paternal parent as "mothers ;" and, as a general rule, there is a surprising amount of harmony maintained in the household under the circumstances. According to the old and time-honoured custom of the Kaffirs, the father's property in his daughters was so absolute and complete, that his sole will determined all matrimonial arrangements, and he possessed, and not unfrequently exercised, the right of punishing a refractory child who refused to obey his commands with death. Since the subjection of the Kaffir chiefs to British supremacy and rule, all coercion of girls to an unacceptable marriage has been generally forbidden, and in any case where an appeal is made against parental authority upon this ground, the magistrates discountenance, and even punish, its exercise. It is the intention of the colonial government, at the earliest possible opportunity, to introduce some arrangement which shall make a full and clear declaration of a woman's personal consent indispensable to the legality of a native marriage. In the meantime two very important alterations in the old Kaffir practice have already been brought about. Every marriage now consummated is held to be irrevocable and final, so far as the parents of the woman are concerned ; and a widow is now free to marry any one that pleases her without reference to the opinion or will of her natural guardian. These important modifications have been made by the Lieutenant-Governor, acting in his capacity of supreme chief, and have received the general assent of the natives on the ground that they admit them to be just and reasonable. It is obvious that some caution and judgment is required in the introduction of changes that are directly aimed at the root of a practice which is intimately bound up with the customs, habits, ideas, and laws of a race, and which the people believe to have been created with them.

Mr. Crawford considers the negro to be a very unmanageable and unpromising piece of humanity. He remarks of him that he has no literature, and no architecture ; that he cannot tame elephants ; that his religion is nothing but witchcraft, his wars merely the incursions of savages, and his government only a brutalized despotism. Without at present meddling with the

inferences which Mr. Crawford draws, it must be admitted here that these allegations apply as accurately to the Kaffir as they do to the pure negro. It is a very remarkable fact in human history, that the Kaffir, with such inherent capabilities, should have remained utterly savage so long; that even, after seeing with his own eyes the wonders that are worked by his white cousins, in matters that come so immediately home to him, as flocks, herds, and food crops, he should still be willing, if left alone, to lead the indolent, unproductive, and unprogressive life that has been described. Whatever may be the case in regard to the principle that Sir S. W. Baker enunciated so prominently at the last meeting of the British Association for the Advancement of Science, namely, that all negro races would infallibly fall back into barbarism, if left to themselves; there can be no doubt, at any rate, that these races will not advance out of barbarism, if so left. But here there occurs one consideration, that perhaps has not yet received all the attention it deserves, and that really carries with it much important and practical suggestion. Mr. Crawford argues, "The negroes are uncivilizable, or nearly so, for, after years of social existence, they have no literature." May it not be that the negro races have not advanced into civilization *because* they have no literature? A race which is incapable of originating a literature, may, nevertheless, be quite capable of being deeply and permanently influenced by a literature that is brought to them from without. This literature may indeed ultimately prove to be the very panacea and influence that makes progress possible and advance permanent. It is by no means an unheard of thing in human history, that races have received and benefited by a written and recorded language, although they had failed to contrive the instrument for themselves.

It is a very curious, and certainly a most noteworthy fact, bearing indirectly but instructively upon this view, that the wild Kaffir, even when quite removed from the influence of white men, and from civilized appliances and practices, has, nevertheless, *an education* of his own. This becomes strikingly apparent to even the most careless and most casual observer, when the young men and the old men of the race are compared. The young men are all wild, impulsive, restless, and full of savage fire, which generally burns itself out in howling, dancing, boasting, and laughing, but which is quite capable, as proved in Chaka's experience, of being turned to less desirable account. The old men are all quiet, astute, thoughtful, and full of "wise saws and instances." The countenances of the young men are commonly savage and furtive, even when good humoured. The countenances of the old men are constantly dignified, grave, and intelligent. In Zululand, at this

present hour, the young men are nearly all turbulent, quarrelsome, boastful, and aggressive; the old men are nearly all quiet, peaceful, and full of admiration and friendship for their Dutch and English neighbours. There is a very simple and obvious reason for this difference. The young men are all of the raw material of barbarism; the old men are all *educated!* The education of the Kaffir race is talk. The remark of Sir S. W. Baker and others, that the negroes acquire their full intellectual development at a very early period, and are incapable of subsequent advance, certainly is not true in regard to the Natal Kaffirs.* The wild Kaffir leads a life of indolence, and puts the amount of drudgery that is requisite to provide for the absolute essentials of this indolent life upon his women. But he also leads a life of *gossip*; he talks incessantly, and much of his talk concerns the doings of his relatives and neighbours, and the general relations of his social state. When he walks forth over the sunny hills to pay his visit to some neighbouring or distant kraal, he carries with him matters that have to be made there the theme of patient discussion and grave deliberation. It is not possible for men to gossip through long years without doing some thinking as well, and, wherever there is thinking, there is also intellect and progress. But, in the case of the wild Kaffir, the progress is individual, and not collective. Each man has to go through the same process for himself, and the result dies when the man dies. Tradition may carry on some very small shadow of the sum total and gain to the next generation, but the main bulk of the personal advancement and experience must disappear. And can it be said that it would not be the same, even in England, if there were no permanent and recorded accumulation to be transferred on from generation to generation? if there were no books and no formal teaching? Men may say that the negro races cannot be raised much, or at all, above their present stand points, and they may be right; but, at any rate, an appeal necessarily lies from such judgments to events and time; and, not until it has been seen what the modifications are, that a formal, a designed, and a well considered training and education can introduce, can the question of Kaffir civilization be held to have received a practical settlement. It yet remains to state, indeed, that something has already been actually achieved in Natal, which does give promise of a higher capability in the native race than the theory of unprogressive stagnation and ready retrogression would allow. This is reserved for another opportunity.

* There is no satisfactory ground for believing it true of the negro. The balance of evidence is on the other side.—ED.

AIDS TO MICROSCOPIC INQUIRY.—No. VIII.

ORGANIC SUBSTANCES AND FORMATIONS.

IN a former paper of this series, entitled *Notes on Organic Chemistry*, vol. vi. p. 428, some illustrations were given of the general principles upon which the elements of living bodies are combined, and we shall now consider the nature of some of the principal substances found in organic beings.

It astonishes a pretty young lady to tell her that, chemically, she consists of a pail of water, a few gases, some charcoal, lime, iron, phosphorus, and a few et ceteras; but the statement is, nevertheless, very near the truth. Organized beings are composed of very similar materials whatever may be their zoological rank, and they do not differ so much from vegetables in mere composition as was formerly supposed. They contain, for the most part, hard structures and soft ones—the former being for supports, frame-work, etc., and the latter constituting the more vital portions. In man, the hardest material is the enamel of his teeth, and among the softest are his nerves and brains. Human bones, and bones in general, are composed of a soft material, which when extracted from them is known as *gelatin*, and a hard one strengthening the former, consisting almost entirely of phosphate of lime. It is interesting to compare a hard firm bone of one of the higher vertebrates with the soft bones of cartilaginous fishes, sharks, etc., the magnates of the fish world, whose elevated position is demonstrated to the satisfaction of naturalists by their superior power of devouring their brethren, to which end they are elaborately organized. A terrestrial beast of prey with the soft bones of the shark would not be a successful animal, and should any morbid condition turn out a lion as a gristly monster, “Natural Selection” would take no steps for his preservation, but his days would be soon finished in the stomach of a more earthy-boned brute. In the water, things are different, and the lightness of the shark bone more than compensates for its slighter strength, while its pliability is no doubt convenient.

The combination of phosphorus, a soft highly combustible solid, of oxygen, the gas that gives its life and fire-sustaining qualities to atmospheric air, and of lime the well-known earthy mineral, results in *phosphate of lime*, to which bones owe their hardness and solidity; and which meets us again as one of the constituents of wheat flour, and many other substances used as food. The animal derives his phosphates from the vegetable, and when the animal has done with them, and

passes them away in secretions, or lays them down with his bones to rest in their mother earth, fresh plants catch them up again, and bring them once more within the circle of organic life.

The simplest animals are composed wholly or chiefly of *sarcode*, the soft stuff of which the infusoria are made, and which with a little modification constitutes the bodies of the polyps. As it occurs so commonly as a chief constituent of the lower kinds of animals in their adult form, it is not surprising that it is found in the larval or embryonic stages of higher ones, including man himself. One of the best ways of getting a notion of the appearance and properties of *sarcode* is to look at an *amœba* through a microscope. Chemically it has a close relation to the muscular tissues of higher animals, as it belongs to the *proteic*, or *albumenoid* group of bodies. The principal substances composing albumen, the type of this group, are, carbon, hydrogen, oxygen, and nitrogen, but small quantities of sulphur, and some saline ingredients are always present. Albumen is easily studied in its well-known form, white of egg. Albumen, and its near relative *fibrin*, can exist in two conditions, soluble and insoluble. The white of egg readily coagulates on the application of heat, and fibrin, which the blood holds in solution coagulates on being withdrawn from the vessels of a living animal. Substances closely resembling, or identical with albumen and fibrin, exist in the vegetable world, and especially in seeds, which are found useful for food. The albumenoid group are essential to animal life, and probably to organic life, though their quantity in many plants may be infinitesimal, and they are remarkable for the facility with which they undergo chemical changes. They give its chief nutritive value to milk, to the meal of peas, beans, and other bodies standing high as food.

As the object of the present paper is solely to help beginners and those who are not special students of chemistry, we shall not introduce any of the complicated questions relating to the chemistry of the constituents of animal bodies, but add a few words on some important compounds, beginning with *muscular tissue*. It consists chiefly of coagulated fibrin, "but being highly vascular, and containing nearly three-fourths of its weight of water, it is permeated with a fluid consisting partly of blood and partly of substances secreted from it, independently of a small portion of nervous and adipose matter."*

The portion of muscle which is soluble in cold water consists of albumen, salts of the blood, and two crystallizable animal principles named *kreatine* and *inosite*, several acids, and

* Prof. Miller's *Elements Chem.*

a peculiar red colouring matter. All kinds of flesh contain an immense quantity of water, and unless the chief animal tissues and substances are very moist, active life appears impossible, though some creatures may be very nearly dried without being killed. In such a condition they are torpid, from suspended functions. By drying animal substances their susceptibility to chemical change is destroyed, as is illustrated by the fact that in some parts of the Andes, and in other very dry, cold places, the bodies of the dead shrink into natural mummies, and suffer no decay.

Ready susceptibility of chemical change is the condition of those substances on which life mainly depends, and the nerve materials exhibit this quality in a high degree. The human brain contains in one hundred parts, about seven of albumen,* five of peculiar fatty acids—one of which, cerebrie acid, contains phosphorus—and about eighty of water. Cerebrie acid contains no less than five bodies, carbon, hydrogen, nitrogen, phosphorus, and oxygen, and many other important animal compounds are equally complicated. As might be expected from the complex character of the substances we have mentioned, blood, from which they all spring, is remarkable for its numerous and complicated components. Chemists recognize in it four kinds of fatty matter, fibrin, albumen, common salt, and other soluble salts, together with other materials, amongst which iron is conspicuous. We have seen that the chemical composition of animals and vegetables is substantially the same, but the proportion of the various compounds entering into both, vary very much, the animal series being remarkable for the quantity of their highly complex nitrogenous elements, while the hydro-carbons with oxygen prevail in plants. A comparison of fibrin with wood may be interesting and instructive. The former contains more than half its weight of carbon, about 6 per cent. of hydrogen, about 15 per cent. of nitrogen, about 23 per cent. of oxygen, and small quantities of sulphur and phosphorus. The latter varies a little according to its kind, but a piece of oak will contain about 49 per cent. of carbon, about 6 per cent. of hydrogen, about 43 or 44 per cent. of oxygen, and, in some cases, a little nitrogen, say 2 per cent.

The essential part of wood is its fibre, called in chemical language *cellulose*. This contains 36 definite portions of carbon, united to 30 definite portions of oxygen, and as many of hydrogen. In a very delicate form, cellulose is digestible and nutritious, but as soon as it concretioned into firm fibres like hemp, cotton, etc., it is no longer fit for the food of human beings.

* See Miller.

The horse can digest cellulose in a more compact form than man, the camel perhaps still more so, and certain wood-devouring insects possess additional faculties of the same sort. A clean cotton fibre is nearly pure cellulose, and so is that elegant material erroneously called "rice paper," and made by the Chinese from the pith of the *Aralia papyrifera*.

The hair, hoofs, horns, and feathers of animals are very similar in chemical composition, and silk is very like them, and belongs to the same series. Speaking generally, we may say that these substances are rather more than half carbon, about one quarter oxygen, about a sixth nitrogen, and they contain about 3 per cent. of sulphur.

The solid parts of insects, such as the elytra and hard skin of beetles, their jaws, ovipositors, etc., and the shells of certain rotifers, etc., are composed of *chitin*, a substance chemically resembling the preceding, but with a larger allowance of oxygen. This substance is also found in the organic matter of the shells of crustaceans—those of water fleas (*Entomostracea*), for example, contain little else.

Professor Miller says "sugar appears to be the basis or foundation of organic matter in general, and from it all the varieties of organized products might be obtained by the addition or subtraction of water, oxygen, and ammonia."* This is cited not to convey the impression that all organic bodies do actually arise out of such a mode of treating sugar, but to illustrate the relation which different organic compounds bear to each other.

Organic compounds placed under appropriate conditions are susceptible of endless changes and modifications, first by simple addition of definite quantities of materials they already possess; secondly, by removals of certain constituents, wholly or partially, but always in definite proportions; thirdly, by *substitution*, that is, by taking away certain elements in definite proportions, and adding new elements in *equivalent* proportions. Living beings take matter into their system in one condition, and change it by processes of this kind. The plant is remarkable for the extent to which it can convert inorganic matter into organized combinations, and the animal with some power of this sort is chiefly occupied in receiving from plants, or from other animals, materials belonging to the organic series, and modifying them according to its needs.

The chemical processes carried on by organized beings range from comparatively simple ones to others that are highly complicated. A vegetable cell, such as a yeast cell, is able through its delicate walls to allow a certain intercourse between its internal contents and the matters which the fluid in which

* *Elements of Chemistry*, vol. iii. p. 723.

it grows contains. It takes from the fluid or solution what it requires for its development and reproduction, and in so doing determines certain decompositions and recompositions, which are termed fermentation, and which give rise to special products. In more complicated organic beings a great series of processes, more or less similar, are going on, and every organ is engaged in a series of transactions with fluids and gases, one result of the whole being the orderly building up, and the equally orderly taking to pieces, of the various parts which make up the entire structure.

Starches and sugars are among the most interesting products of vegetable life. Common starch consists of carbon, oxygen, and hydrogen (the proportion being $C_{12} H_{10} O_{10}$); and if the elements of water (oxygen and hydrogen) be added, starch sugar is the result. There are many varieties of sugar, and many substances allied to sugar, and belonging chemically to the same group. They consist of the same elements combined in different proportions. Cane sugar crystallizes in four or six-sided rhombic prisms; grape sugar in cubes or square tables; sugar of milk in four-sided prisms. Fruit sugar is not crystallizable. Gums are much like sugars in composition, and abundantly found in plants. Gum arabic has the same composition as cane sugar, $C_{12} H_{11} O_{11}$, and may be converted into sugar by the action of dilute sulphuric acid, which first removes one equivalent of water, and turns it into *dextrin*, a substance in properties between gum and starch.

Vegetable jelly (pectin) gives their gelatinous character to the juice of many fruits, and *pectose*, which may be converted into it, abounds in carrots, turnips, etc.

Silica, or flint, pure in white quartz crystals, is often met with by the microscopist in vegetable bodies, such as wheat straw, the glazed surface of canes, the spicules of certain sponges, and so forth. In these cases it has been deposited by organic agency in an organic structure. Silica is composed of silicon and oxygen, and is one of the most abundant constituents of the earth's crust. Silica or silicic acid crystallizes in six-sided prisms, terminated by six-sided pyramids. It requires an intense heat to melt it, and is insoluble in all the acids except hydrofluoric. One of its modifications is slightly soluble in water, and it may be precipitated in a gelatinous form from solutions of silicates of soda and potash. Diatoms, and many other organized beings, can separate from water the minute quantity of silica necessary for their hard structures. When the microscopist is in doubt whether a substance is silica, or carbonate, or oxalate of lime (the last common in plants as raphides), he should apply a drop of muriatic acid. If lime it will be dissolved, if silica not. Oxalate of lime crumbles to an

opaque powder when heated red hot. Silica, if pure, remains unchanged in form, and keeps its transparency, or it becomes white, if minute portions of other earths are present. In sponge spicules an animal substance is present, and this blackens with heat.

Silica is contained abundantly in common minerals, agates are chiefly composed of it; the opal has it for its chief constituent; sharp sand is mostly composed of particles of silex, and sandstone contains it in large quantity.

The few hints given in this paper, and in the preceding one on *Organic Chemistry* will, it is hoped, give young microscopists some help, but they must make a special study of chemistry if they wish to do more than approach the threshold of many very interesting questions in the growth and decay of living beings on which the microscope is able to throw light, but which without chemical knowledge must remain more or less unintelligible.

304 *Meteorological Observations at the Kew Observatory.*

RESULTS OF METEOROLOGICAL OBSERVATIONS MADE AT THE KEW OBSERVATORY.

LATITUDE 51° 28' 6" N., LONGITUDE 0° 18' 47" W.

BY G. M. WHIPPLE.

1866.	Reduced to mean of day.				Temperature of Air.			At 9:30 A.M., 2:30 P.M., and 5 P.M., respectively.		Rain— read at 10 A.M.	
Day of Month.	Barometer, corrected to Temp. 32°.*	Temperature of Air.	Calculated.		Maximum, read at 9:30 A.M. on the following day.	Minimum, read at 9:30 A.M.	Daily Range.	Proportion of Sky clouded.	Direction of Wind.		
			Dew Point.	Relative Humidity.						Tension of Vapour.	
July 1	inches. ...	° ...	° ...	inch. ...	66.8	53.5	13.3	0—10	...	inches. 0.857	
" 2	29.375	54.0	46.8	.78	64.6	49.7	14.9	10, 7, 5	WSW, WSW, W.	.064	
" 3	29.367	53.7	47.6	.81	62.9	50.0	12.9	9, 8, 9	W, WSW, SW by S.	.010	
" 4	29.478	55.5	49.4	.81	65.8	50.7	15.1	10, 8, 9	SW, W by S, SW.	.160	
" 5	29.508	55.4	47.6	.77	64.7	51.1	13.6	6, 7, 8	SW by W, SW, SW.	.116	
" 6	29.626	56.6	47.9	.74	67.2	49.7	17.5	9, 7, 4	WSW, NW by N, W.	.106	
" 7	30.009	56.5	41.8	.60	64.8	48.5	16.3	7, 5, 4	W, NNW, NW by W.	.096	
" 8	66.1	48.6	17.5000	
" 9	30.184	65.3	58.4	.79	62.3	57.7	17.1	10, 7, 7	W, W by S, SW by W.	.004	
" 10	30.287	70.9	57.6	.65	7.48	79.7	58.0	21.7	0, 3, 2	WSW, WSW, NW by W.	.000
" 11	30.277	70.4	57.6	.66	7.36	77.5	56.7	20.8	1, 2, 7	—, NW by W, E by N.	.000
" 12	30.163	74.9	61.4	.64	8.51	84.3	56.3	28.0	0, 4, 1	—, SE, SE.	.000
" 13	30.058	75.0	59.8	.61	8.54	82.7	60.2	22.5	0, 1, 7	S, W by S, W by S.	.000
" 14	30.125	71.0	59.8	.69	7.50	80.6	57.9	22.7	4, 6, 4	—, SW, SSW.	.000
" 15	79.2	58.0	21.2000	
" 16	30.079	63.5	54.9	.75	5.87	72.9	59.0	13.9	7, 4, 5	E by NE, ENE, E by S.	.000
" 17	30.022	61.0	52.5	.75	5.40	68.8	58.6	10.2	10, 9, 9	NE, NE, NE.	.000
" 18	29.963	61.6	47.0	.61	5.51	70.6	48.7	21.9	4, 4, 2	NE by N, NE, NE.	.000
" 19	29.894	60.0	51.6	.75	5.23	69.7	49.3	20.4	1, 8, 7	NE by N, NE, NE by N.	.000
" 20	30.051	59.3	46.4	.64	5.11	69.6	47.5	22.1	9, 3, 0	NW by N, NE by N, NW by N.	.000
" 21	30.057	67.4	51.8	.60	6.67	77.3	48.5	28.8	0, 1, 3	—, W, W by N.	.000
" 22	66.8	52.2	14.6000	
" 23	30.006	57.6	48.1	.73	4.83	67.8	47.5	20.3	9, 1, 2	N by W, NE by N, N.	.000
" 24	30.047	56.2	46.7	.72	4.60	67.7	52.8	14.9	10, 10, 9	NE, NE, NE.	.000
" 25	30.213	56.0	48.6	.78	4.57	65.9	52.3	13.6	9, 9, 10	NE by N, NNE, N by E.	.000
" 26	30.098	60.1	50.3	.72	5.25	70.1	48.7	21.4	9, 10, 10	—, SW by S, SSW.	.000
" 27	29.767	58.3	56.7	.94	4.94	66.7	55.0	11.7	10, 10, 10	S, S by W, S.	.034
" 28	29.642	60.2	55.9	.87	5.26	69.5	53.5	16.0	7, 10, 10	ENE, SE by E, SE by S.	.050
" 29	67.7	58.1	9.6424	
" 30	29.795	58.1	42.2	.58	4.91	65.4	50.1	15.3	7, 8, 5	NW by N, NW by W, NW.	.005
" 31	29.666	50.1	48.0	.93	3.74	58.4	45.6	12.8	10, 10, 10	WSW, WNW, NW by W.	.004
Daily Means. }	29.914	61.1	51.4	.73	5.51	17.5	1.930

* To obtain the Barometric pressure at the sea-level these numbers must be increased by .037 inch.

HOURLY MOVEMENT OF THE WIND (IN MILES), AS RECORDED BY ROBINSON'S ANEMOMETER.—JULY, 1866.

Day.	Hour.												Total Daily Movement.	Hourly Means.
	P. M.						A. M.							
1	16	11	7	5	16	7	5	6	12	6	6	12	285	9.1
2	16	10	10	7	18	7	3	3	12	6	7	12	2900	
3	10	10	10	8	18	7	2	1	2	2	2	2	312	
4	12	11	7	8	16	6	3	3	3	3	3	3	330	
5	10	11	9	9	10	4	4	4	4	4	4	4	363	
6	8	13	9	9	13	4	3	3	3	3	3	3	128	
7	12	14	9	10	13	4	8	8	8	8	8	8	185	
8	12	14	9	9	13	3	10	10	10	10	10	10	279	
9	10	15	16	12	16	5	15	15	15	15	15	15	289	
10	8	15	17	14	18	5	16	16	16	16	16	16	192	
11	10	10	17	14	19	8	10	10	10	10	10	10		
12	13	13	17	16	15	8	11	11	11	11	11	11		
13	15	14	15	15	19	4	12	12	12	12	12	12		
14	15	14	15	15	19	4	12	12	12	12	12	12		
15	16	15	20	20	16	7	16	16	16	16	16	16		
16	14	10	18	20	19	8	10	10	10	10	10	10		
17	17	16	26	18	19	10	15	15	15	15	15	15		
18	15	14	18	14	17	6	14	14	14	14	14	14		
19	17	17	18	16	14	5	12	12	12	12	12	12		
20	9	10	13	8	16	4	11	11	11	11	11	11		
21	6	9	10	9	16	4	10	10	10	10	10	10		
22	8	13	14	11	15	5	9	9	9	9	9	9		
23	10	10	16	12	12	6	8	8	8	8	8	8		
24	9	10	13	10	13	4	7	7	7	7	7	7		
25	10	10	14	11	14	5	8	8	8	8	8	8		
26	9	9	14	11	14	4	9	9	9	9	9	9		
27	8	10	13	10	13	4	8	8	8	8	8	8		
28	6	9	10	9	10	4	7	7	7	7	7	7		
29	5	8	9	8	9	3	6	6	6	6	6	6		
30	6	10	12	9	12	4	5	5	5	5	5	5		
31	4	9	10	8	10	3	3	3	3	3	3	3		
	4	9	9	6	10	4	6	6	6	6	6	6		
	6	9	9	6	10	4	6	6	6	6	6	6		
	10	10	10	8	10	4	6	6	6	6	6	6		
	11	10	10	8	10	4	6	6	6	6	6	6		
	12	10	10	8	10	4	6	6	6	6	6	6		

RESULTS OF METEOROLOGICAL OBSERVATIONS MADE AT THE
KEW OBSERVATORY.

LATITUDE 51° 28' 6" N., LONGITUDE 0° 18' 47" W.

1866.	Reduced to mean of day.				Temperature of Air.			At 9.30 A.M., 2.30 P.M., and 5 P.M., respectively.			Rain— read at 10 A.M.
	Day of Month.	Barometer, corrected to Temp. 32°.*	Calculated.		Maximum, read at 9.30 A.M., on the following day.	Minimum, read at 9.30 A.M.	Daily Range.	Proportion of Sky clouded.	Direction of Wind.		
			Temperature of Air.	Dew Point.						Relative Humidity.	
Aug. 1	29.901	59.5	50.3	.73	.514	69.3	50.6	18.7	10, 6, 4	W by N, S, S.	0.127
" 2	29.566	60.9	56.9	.87	.539	70.7	55.9	14.8	10, 9, 10	SW by W, WNW, NW by W	.084
" 3	29.744	62.0	54.6	.78	.559	71.2	55.2	16.0	10, 7, 9	SW by W, SW, W.	.065
" 4	29.704	57.3	42.8	.61	.478	66.0	50.7	15.3	9, 8, 5	SW by W, WSW, SW by W.	.000
" 5	64.5	51.1	13.4000
" 6	29.715	52.0	50.8	.96	.399	...	49.3	...	10, 10, 10	SW by W, SW, SW.	.472
" 7	29.446	55.5	50.0	.84	.450	66.6	5, 6, 4	SW by S, W, W.	.111
" 8	29.653	55.8	43.5	.78	.454	64.8	50.3	14.5	7, 7, 6	SW, SW by S, S by W.	.147
" 9	29.564	58.0	42.7	.59	.489	66.1	51.2	14.9	6, 6, 5	W, W by N, W by N.	.002
" 10	29.721	54.3	44.8	.72	.432	64.6	48.2	16.4	5, 8, 7	WNW, W, SW by W.	.134
" 11	30.083	58.0	46.8	.68	.489	67.9	49.3	18.6	6, 7, 9	WNW, W, W.	.316
" 12	65.7	51.4	14.3051
" 13	29.918	55.4	...	9, 10, 10	NE by N, —, —.	.050
" 14	29.777	58.5	53.7	.85	.497	66.7	10, 9, 6	SW by S, NNW, NW.	.005
" 15	29.950	55.6	46.4	.73	.451	64.0	52.1	11.9	10, 10, 8	W, W by S, W.	.000
" 16	29.694	55.3	48.9	.80	.447	63.7	52.1	11.6	10, 9, 6	SW by S, SW, WNW.	.060
" 17	29.788	56.2	43.0	.64	.460	64.4	49.2	15.2	8, 8, 8	W, W by S, WNW.	.001
" 18	29.946	58.5	46.9	.67	.497	63.8	45.9	22.9	5, 6, 2	W, WSW, S by W.	.000
" 19	70.8	42.2	28.6062
" 20	29.691	62.1	54.4	.77	.561	70.6	54.8	15.8	7, 5, 5	NNW, N, N by W.	.010
" 21	29.830	58.5	55.2	.89	.497	67.7	56.0	11.7	10, 8, 8	NW by N, N by W, W by N.	.000
" 22	29.979	60.9	54.3	.80	.539	70.4	55.7	14.7	10, 7, 5	SW, —, —.	.000
" 23	30.010	61.8	56.9	.79	.555	73.5	51.7	21.8	10, 7, 2	E, E by N, E.	.000
" 24	29.996	63.2	61.9	.96	.581	69.7	56.8	12.9	10, 10, 10	E, W, E by S.	.070
" 25	30.059	62.8	57.4	.83	.574	71.7	50.4	21.3	4, 8, 8	WSW, S, SSW.	.008
" 26	75.7	54.2	21.5000
" 27	29.804	63.8	52.8	.69	.593	72.9	59.4	13.5	8 7, 3	SW by S, SW by W, WSW.	.000
" 28	29.514	59.7	54.9	.85	.518	68.8	53.2	15.6	9, 10, 9	SE, ESE, S.	.096
" 29	29.308	51.7	53.0	1.00	.395	59.5	52.3	7.2	10, 10, 10	SE by S, WNW, WSW.	.500
" 30	29.716	56.0	46.0	.71	.457	65.7	52.9	12.8	1, 10, 8	NW, W, S by W.	.064
" 31	29.860	60.0	48.2	.67	.523	69.4	46.5	22.9	1, 5, 3	SW by S, SSW, WSW.	2.435
Daily Means. }	29.776	58.4	50.8	.74	.498	16.2

* To obtain the Barometric pressure at the sea-level these numbers must be increased by .037 inch.

HOURLY MOVEMENT OF THE WIND (IN MILES), AS RECORDED BY ROBINSON'S ANEMOMETER.—August, 1866.

Day.	A.M.												P.M.												Hourly Means.							
	Hour.	1	2	3	4	5	6	7	8	9	10	11	12	1	2	3	4	5	6	7	8	9	10	11		12						
1	12	15	13	9	11	6	23	16	13	7	9	6	7	8	8	8	7	7	7	7	7	7	7	7	7	8.2						
2	11	13	10	11	12	7	25	14	12	7	8	8	7	7	7	7	7	7	7	7	7	7	7	7	7	8.0						
3	9	13	7	7	11	6	19	10	12	6	8	6	8	8	8	8	5	5	5	5	5	5	5	5	5	7.3						
4	8	12	5	10	11	11	6	10	11	11	6	9	10	7	7	7	6	6	6	6	6	6	6	6	6	7.3						
5	6	10	9	13	12	7	19	11	12	7	5	12	7	7	7	7	4	4	4	4	4	4	4	4	4	7.0						
6	10	10	7	17	10	10	6	12	10	9	5	11	8	8	8	8	7	7	7	7	7	7	7	7	7	6.5						
7	10	10	10	18	10	10	6	14	10	14	6	10	8	10	10	10	8	8	8	8	8	8	8	8	8	7.6						
8	8	13	13	21	13	10	17	13	17	10	11	9	9	9	9	9	10	10	10	10	10	10	10	10	10	8.6						
9	6	8	15	22	14	14	14	14	14	13	8	8	8	8	8	8	8	8	8	8	8	8	8	8	8	9.4						
9	9	19	32	10	16	16	20	17	17	13	13	13	13	13	13	13	13	13	13	13	13	13	13	13	13	10.3						
10	9	17	29	16	16	16	19	17	17	13	13	13	13	13	13	13	13	13	13	13	13	13	13	13	13	10.8						
11	5	9	17	25	14	15	15	15	15	11	11	11	11	11	11	11	11	11	11	11	11	11	11	11	11	11.1						
12	5	10	19	24	12	12	15	15	15	12	12	12	12	12	12	12	12	12	12	12	12	12	12	12	12	11.8						
1	8	6	11	18	16	16	18	18	18	15	15	15	15	15	15	15	15	15	15	15	15	15	15	15	15	11.2						
2	7	11	18	20	14	14	20	20	20	16	16	16	16	16	16	16	16	16	16	16	16	16	16	16	16	11.9						
3	4	11	18	20	15	15	21	25	30	17	13	13	13	13	13	13	13	13	13	13	13	13	13	13	13	12.8						
4	3	12	13	11	20	15	22	22	27	13	13	13	13	13	13	13	13	13	13	13	13	13	13	13	13	12.6						
5	5	19	12	22	23	15	22	22	27	13	13	13	13	13	13	13	13	13	13	13	13	13	13	13	13	10.2						
6	6	17	10	19	19	12	12	12	12	12	12	12	12	12	12	12	12	12	12	12	12	12	12	12	12	9.9						
7	8	12	9	14	13	7	25	20	25	11	4	4	4	4	4	4	4	4	4	4	4	4	4	4	4	10.2						
8	10	10	10	14	14	5	24	19	21	9	6	6	6	6	6	6	6	6	6	6	6	6	6	6	6	8.6						
9	10	10	9	12	13	6	25	17	17	7	7	7	7	7	7	7	7	7	7	7	7	7	7	7	7	8.2						
10	10	10	10	13	13	7	22	14	14	6	6	6	6	6	6	6	6	6	6	6	6	6	6	6	6	8.0						
11	10	10	10	13	13	10	22	14	14	6	6	6	6	6	6	6	6	6	6	6	6	6	6	6	6	8.0						
12	12	15	13	9	11	6	23	16	16	6	6	6	6	6	6	6	6	6	6	6	6	6	6	6	6	7.7						
Total Daily Movement.	226	243	324	435	269	380	468	414	284	204	199	133	145	230	175	275	328	173	158	86	140	96	223	126	132	183	242	164	190	275	104	9.4

RESULTS OF METEOROLOGICAL OBSERVATIONS MADE AT THE
KEW OBSERVATORY.

LATITUDE 51° 28' 6" N., LONGITUDE 0° 18' 47" W.

1866.	Reduced to mean of day.				Temperature of Air.			At 9.30 A.M., 2.30 P.M., and 5 P.M. respectively.		Rain— read at 10 A.M.		
	Barometer corrected to Temp. 32°.*	Temperature of Air.	Calculated.		Maximum, read at 9.30 A.M. on the following day.	Minimum, read at 9.30 A.M.	Daily Range.	Proportion of Sky clouded.	Direction of Wind.			
			Dew Point.	Relative Humidity.							Tension of Vapour.	
Sept. 1	inches. 29.871	60.2	48.0	.66	inch. .526	67.6	51.6	16.0	0—10	2, 6, 4	SW, SW, SW.	inches. 0.000
" 2	64.1	54.3	9.8082
" 3	29.849	56.2	43.2	.64	.460	64.7	45.5	19.2	1, 2, 2	WNW, W, W.138
" 4	29.609	58.8	58.8	1.00	.502	66.4	51.9	14.5	10, 10, 10	SSW, SSW, SW.061
" 5	29.403	61.0	55.9	.84	.541	68.4	61.4	7.0	10, 6, 3	SW by W, SSW, SW by W.447
" 6	29.574	57.9	54.8	.90	.487	65.4	54.8	10.6	5, 10, 10	SW, S, S.025
" 7	29.604	58.7	53.9	.85	.501	65.6	57.2	8.4	8, 9, 10	WSW, W, SW.655
" 8	29.688	54.0	53.5	.98	.427	60.9	55.0	5.9	10, 10, 10	E, NNE, —.007
" 9	65.0	53.1	11.9248
" 10	29.525	58.1	51.7	.81	.491	66.3	55.6	10.7	8, 4, 2	SW, SW by S, SW by W.130
" 11	29.535	54.1	49.2	.85	.429	61.8	52.3	9.5	10, 7, 7	SW by S, SW, W.143
" 12	29.923	49.0	44.3	.85	.361	57.8	49.3	8.5	5, 10, 10	W, SW by W, SW.007
" 13	29.799	55.4	47.0	.75	.448	63.4	49.7	13.7	10, 6, 10	SW by W, WSW, W.026
" 14	29.548	54.4	45.9	.75	.433	63.3	52.9	10.4	8, 6, 8	SW, W, W.367
" 15	29.713	53.1	47.1	.82	.415	63.5	47.3	16.2	2, 7, 8	SW by S, S, S by W.022
" 16	59.9	47.4	12.5079
" 17	29.737	54.0	42.7	.68	.427	61.5	48.3	13.2	4, 6, 6	NW by W, W by N. N.204
" 18	30.053	53.0	47.1	.82	.413	60.1	38.5	21.6	3, 10, 10	SW by S, S, SSW.012
" 19	29.929	55.1	51.7	.89	.444	64.1	53.9	10.2	9, 10, 9	SW, SW by W, WSW.005
" 20	29.930	52.6	47.6	.84	.408	59.8	47.5	12.3	10, 10, 9	W by S, SW by W, SW by W.052
" 21	29.608	52.1	43.1	.74	.401	59.5	52.3	7.2	7, 8, 7	W, WSW, SW by W.140
" 22	29.278	47.0	45.0	.94	.337	54.1	46.1	8.0	10, 10, 9	NNW, W by S, SW.449
" 23	57.1	44.8	12.3009
" 24	29.701	52.4	43.7	.88	.405	59.0	46.1	12.9	9, 8, 3	S by W, WSW, SW.081
" 25	29.971	53.4	44.8	.74	.419	60.9	34.7	26.2	0, 1, 4	S, S, SSW.047
" 26	29.936	55.8	53.7	.93	.454	62.5	50.9	11.6	10, 7, 1	S, W by S, WSW.017
" 27	29.925	55.5	50.3	.81	.450	63.7	50.2	13.5	10, 4, 1	W, WSW, W by N.502
" 28	29.793	58.9	55.1	.88	.504	69.1	49.3	19.8	9, 10, 8	E by N, ESE, ESE.021
" 29	29.892	58.5	56.1	.92	.497	66.5	56.2	10.3	9, 10, 8	W by S, —, —.000
" 30	64.6	56.5	8.1007
Daily Means.	29.756	55.2	49.6	.83	.447	12.4	3.588

* To obtain the Barometric pressure at the sea-level these numbers must be increased by .037 inch.

HOURLY MOVEMENT OF THE WIND (IN MILES), AS RECORDED BY ROBINSON'S ANEMOMETER.—SEPT., 1866.

Hour.	A.M.												P.M.												Total Daily Movement.	Hourly M.ans.			
Day.	1	2	3	4	5	6	7	8	9	10	11	12	1	2	3	4	5	6	7	8	9	10	11	12					
1	4	10	8	5	18	28	3	2	17	17	14	8	14	10	10	16	16	3	20	8	23	9	2	2	2	13	9-9		
2	6	10	10	5	15	27	2	4	18	12	14	8	16	11	9	16	3	3	18	7	25	11	1	1	2	9	9-6		
3	8	10	9	7	12	27	1	3	17	16	12	9	19	11	8	13	5	20	3	18	8	21	1	1	6	5	9-5		
4	8	11	10	6	14	30	1	2	13	16	12	11	15	8	9	13	4	22	7	17	7	17	6	2	5	8	9-4		
5	6	16	7	6	15	26	2	2	10	14	10	8	13	8	11	11	3	19	6	10	7	10	7	2	2	6	8-6		
6	6	16	8	5	10	34	1	2	9	13	10	6	10	6	10	9	3	12	9	10	10	10	5	2	2	4	8-5		
7	9	15	11	7	12	37	2	4	9	17	10	9	13	8	10	9	2	12	7	12	11	11	11	1	1	11	9-3		
8	12	16	14	10	15	43	4	2	10	22	11	12	12	10	15	10	5	13	7	12	12	13	2	2	2	0	10-4		
9	12	16	17	17	15	47	3	5	11	23	12	11	19	12	16	10	5	20	11	11	13	12	4	1	4	1	12-0		
10	13	17	17	16	14	34	3	3	8	23	12	14	22	16	18	13	10	17	11	11	20	12	2	2	14	4	13-4		
11	15	17	18	19	15	32	8	8	12	21	12	13	19	18	21	10	10	17	12	13	16	13	4	1	17	7	14-0		
12	16	17	17	17	16	18	7	7	16	24	10	10	23	15	20	13	13	18	18	19	15	16	12	4	15	5	14-4		
1	19	14	18	17	16	20	8	9	16	24	10	10	28	17	21	10	10	17	11	11	16	12	7	7	16	7	15-5		
2	20	14	16	16	18	22	7	11	18	25	13	10	25	17	25	10	15	22	15	21	11	11	4	7	16	6	15-5		
3	21	15	15	15	23	18	5	14	19	25	10	12	22	18	18	11	16	22	15	17	10	10	7	7	12	8	14-3		
4	19	15	18	18	25	19	4	15	23	22	10	14	19	13	13	9	17	18	16	16	11	10	4	4	15	8	13-5		
5	21	15	17	17	26	11	5	13	19	22	10	12	11	22	16	12	18	19	19	19	15	16	2	2	15	7	13-6		
6	16	13	8	13	23	26	7	14	15	24	9	11	19	14	17	10	17	18	18	18	17	10	10	2	15	9	13-0		
7	15	11	9	9	20	30	5	12	15	21	7	8	12	13	18	6	19	19	15	16	16	8	3	3	9	7	11-7		
8	12	11	8	8	27	25	5	12	17	20	6	11	12	6	12	3	20	11	17	17	13	8	8	4	4	6	10-4		
9	13	12	9	9	23	25	5	14	17	19	4	11	13	6	10	4	20	11	11	12	12	5	5	4	5	8	10-7		
10	10	8	7	7	20	25	2	14	13	19	2	13	10	8	11	4	19	10	11	24	13	6	6	4	6	9	10-9		
11	8	8	8	8	25	24	4	11	13	19	2	13	13	8	4	3	18	10	10	23	13	5	5	4	4	6	9-8		
12	9	10	10	10	18	24	6	14	17	16	5	10	13	11	9	3	18	10	10	27	11	4	4	3	3	9	10-4		
1	9	7	8	8	17	31	3	14	15	12	8	10	13	9	11	4	19	9	9	25	11	3	3	2	2	10	10-4		
Total Daily Movement.	303	310	293	422	458	465	101	209	359	471	233	248	379	278	328	223	285	385	338	371	214	87	223	203	135	55	211	305	10-9

THE NEBULAR HYPOTHESIS OF LAPLACE
EXPLAINED BY DELAUNAY.

RECENT investigations into the nature of nebulæ have strongly revived public interest in what is called the "Nebular Hypothesis," and as fresh facts, which we may expect to be made known by further research, promise to supply arguments for and against this theory of the origin of suns and planets, it is well that clear ideas should be entertained concerning the views which Laplace held. Professed students of astronomy are sufficiently acquainted with them; but to the general scientific reader, the following explanation, given by M. Delaunay, in his *Cours Élémentaire d'Astronomie*, 4th edit., will be acceptable. He tells us that "in adopting the ideas of Herschel concerning the progressive condensation of nebulæ, and their transformation into stars, and in applying these ideas to our planetary system, Laplace arrived at the most satisfactory mode of explaining their formation. No peculiarity that observation has disclosed relative to planets or their satellites, has escaped the ingenious explanation which he has developed at the close of his *Exposition du système du Monde*, of which we shall proceed to give an idea."

"Laplace supposes that in the beginning, the sun, and all the bodies circulating round him formed a single nebula, animated by a movement of rotation about a line passing through its centre, and extending to the orbit of the most distant planet, or beyond it. He further conceives that by reason of a progressive cooling, larger and larger portions of nebulous matter were condensed at its centre, so as to form a nucleus, the mass of which gradually enlarged. Starting from this supposition, he demonstrated that in the course of time the nebula would be reduced to the state in which we actually find the planetary system."

"In proportion as the cooling caused the condensation of new parts of the nebula, the materials so condensed would fall towards the centre just as drops of rain fall through the condensation of the vapour contained in our atmosphere. But this fall of condensed matter could not take place without occasioning an acceleration of the velocity with which the entire nebula turned upon its axis. Matters condensed and falling towards the centre of the nebula would acquire a movement of rotation about its axis more rapid than that of the rest of the mass. Then the friction of different parts of the nebula, one against another, would accelerate the motions of those turning less rapidly, and would lessen the rapidity of those moving with greater velocity, and after a certain lapse of

time, the entire mass of the nebula would revolve with an angular velocity greater than that which it had in the beginning. Thus the progressive condensation of the primitive gaseous matters of the nebula, and their agglomeration about its centre, necessarily produces a continual augmentation in the velocity of the nebula's rotation about its own axis."

"A nebula such as we have imagined, animated with a movement of rotation about its axis, cannot extend itself in the plane of its equator beyond a certain limit, the position of which depends on the velocity of its motion. Any molecule situated in the plane of the nebula's equator, and participating in its movement, must be subjected at one and the same time to the attraction which the entire mass can exert upon it, and also to the centrifugal force resulting from its rotatory motion. The dimensions of the nebula cannot remain such as would cause the second force to prevail over the first even at any part of its equator, for should this happen, and any molecules be impelled by centrifugal force beyond the control of gravitation, they would cease to form part of the nebula, and move off, independently of it, with the velocity that they possessed at the instant of their starting away."

"The progressive condensations of different portions of the matter forming the nebula would, as we have said, accelerate its rotation, and by consequence give rise to a corresponding augmentation of centrifugal force for any point situated at a given distance from its axis, and thus the limit beyond which the nebula could not extend and cohere would become more and more restricted."

"If at a certain epoch, this limit, measured from the centre, terminates at the surface of the nebula, the condensation to which this further cooling will give rise must cause the limit to fall within the surface, and then the outside molecules of the nebula surrounding its equator will be beyond this limit, and consequently this excess of matter beyond that which the nebula can retain by means of its attraction, will cease to be a portion of the mass, and will separate in the form of a ring, rotating in its own plane about its own centre with the velocity which it possessed at the moment of its detachment. It is only about its equator that the nebula can abandon portions of the matter composing it; for in no other place, except in the plane of this circle, can a molecule be acted upon by the attractive force in the same line as that in which the centrifugal force operates. These two forces compose a resultant force,*

* For those who are unacquainted with this term as used in mechanics, we may explain its meaning by stating, that if one force impels a ball straight forward, and a second force of the same amount impels it exactly across, or at right angles to, the line of the first force, the two forces will combine into a *resultant* force, sending it in an intermediate direction..

which tends more and more to make the molecule approach the equator, in proportion as the centrifugal force is increased. The increase of angular velocity in the rotation therefore causes the surface molecules to move from all parts towards its equator, and then to be abandoned into space as we have described."

"It will be understood that our nebula, in its process of cooling, has thus abandoned successively, in the plane of its equator, divers rings of nebulous matter, which continue to revolve in the same plane, and about a common centre. The central mass to which successive condensations have reduced the nebula, is no other than the sun; and the concentric rings of nebulous matter thrown off in succession in the plane of its equator will give rise to planets, as we shall proceed to show."

"Each ring must be perfectly regular, in order to preserve its annular form for an indefinite time. This regularity can only exist under exceptional circumstances, and it is natural to suppose they are wanting in the case before us. Thus the matter belonging to each tends to assemble about certain centres of attraction, and their partial condensation divides the ring into fragments, which continue to move separately very much as they did when united. The velocity of the various parts which once formed one ring not being rigorously the same, either because they were not equal at the moment of separation, or were subsequently changed by the perturbing action to which the whole system is exposed, it follows that the different portions can rejoin each other, and end in forming a single mass, circulating round the sun in an orbit nearly corresponding with the circumference of the ring from which it originated, and this mass condenses itself into a planet. It may, however, happen that the various fragments into which a ring was decomposed will continue to revolve as separate bodies, and give rise to many distinct planets moving in almost the same orbits, and it is thus that the planetoids between Mars and Jupiter may have resulted from the fragments into which one nebulous ring may have been divided."

"Let us now see what becomes of the materials of an entire ring, united together about one point of its circumference as we have supposed, and let us endeavour to understand how the mass thus formed has been able to produce a planet turning upon its own axis, and accompanied by satellites, as is generally the case in our planetary system. In the progressive condensation of such a mass, the molecules most remote from the sun have approached nearer to that body, and the molecules which were nearest have become more remote; the first having a greater, and the latter a smaller velocity, than that of the mean portions towards which they are moving by the

process of condensation, and hence must arise a movement of rotation round a centre, and in the same direction as the revolution of the whole mass round the sun. Henceforth the materials of a ring abandoned by a nebula become a system analogous to the nebula, but of much smaller dimensions. They have given rise to a new nebula moving round the centre of the original nebula, and in the same direction. This new nebula would, by successive condensations, throw off in succession different rings of nebulous matter, and would at last form a planet turning on its own axis, and revolving in the same direction round the sun. The abandoned rings of matter would behave just as those thrown off by the original nebula, and give birth to the satellites of the planet. Some rings may preserve an exceptional regularity, and thus, as in the case of Saturn's appendages, be able to retain their original form."

"The matter united at a certain distance from a planet to form a satellite, would elongate itself in the direction of a line joining the planet, just as the action of the moon determines an elongation of the sea in the direction of a line joining the earth and moon. This elongation of a satellite while in its fluid state—much greater than in the comparison just made—would give it a tendency always to turn the same points of its surface towards the centre of the planet; and thus may be simply explained this remarkable fact with reference to the moon, which, as Herschel thought, was also exhibited by Jupiter's satellites."

"We see that the hypothesis of Laplace on the origin and formation of our planetary system takes due cognizance of all the peculiarities by which it is characterised. Almost complete coincidences in the planes of the orbits of the planets, slightness of the eccentricity of their orbits, identity of direction in the movements of rotation and revolution throughout the system—all is explained in the most natural manner, and in conformity with the laws of mechanics."

"In this hypothesis the body of a planet formed by condensations such as we have described, would at first be a liquid mass affecting the form of a spheroid flattened in the direction of its axis of rotation, and surrounded by an atmosphere the residue of the nebula from which it sprung. This liquid mass, continuing to grow cooler, would solidify little by little over its whole surface. The solid crust thus formed would be gradually altered in shape, and at last would split in several parts, by reason of the progressive diminution of the liquid volume in its interior, as the temperature was lowered. In the mean time if the atmosphere contained a great quantity of aqueous vapour its condensation would form enormous masses of water, which would occasion degradations of the surface,

and a transport of matter which would be deposited in horizontal layers at the bottom of the vast basins in which the waters would congregate. These phenomena would continually be reproduced through the successive evaporations and condensations which the water would experience through the high temperature of the surface of the globe, and through the continual refrigeration of the atmosphere. Thus the successive formations on the terrestrial globe, which it belongs to geology to elucidate, would arise naturally out of the circumstances we have considered."

"The comets which from time to time pass near the sun cannot be regarded as arising from the nebula which we have supposed to be the origin of the sun and planets, and of their satellites. These comets must be regarded as small *nebulæ* moving in immensity, and which on approaching our system are drawn into it by the sun's attraction, and which after coming near him, recede, often never to return. When a comet thus journeys near our sun and planets, their actions upon it may modify the line in which it moves, so as to convert it into an ellipse with a major axis not extravagantly great; and thus the comet may become periodic, and an integral part of our system. Four known periodical comets seem to be in this condition, but it may happen that the disturbing actions of the planets, near which they pass, may so modify their orbits as to elongate them indefinitely from us, without absolutely preventing their return; and there are instances of comets whose movements have been effected by actions of this kind."

"The zodiacal light is readily explained according to the hypothesis of Laplace. It cannot be regarded as due to the atmosphere of the sun, as it extends beyond the orbits of Mercury and Venus, and thus exceeds the limits within which the solar atmosphere must be circumscribed through the velocity of the sun's rotation; but we might conceive that some of the matter successively abandoned by the nebula which formed our planetary system, might not be totally condensed into the various masses out of which the planets were formed. Small quantities of this matter might remain and form a very diffuse lenticular nebula, such as the zodiacal light. Many examples of such elongated nebula are found in the heavens. It may also happen that nebular matter diffused in the space surrounding the sun might be condensed into an immense number of little planets, and in this way we may explain the origin of shooting stars, whose periodical return gives some countenance to such a theory."

LITERARY NOTICES.

RELIQUIÆ AQUITANICÆ: being Contributions to the Archæology and Palæontology of Périgord, and of the adjoining Provinces of Southern France. By EDWARD LARTET and HENRY CHRISTY. Part III. (Baillièrè.)—The present part of this important and remarkably handsome work, commences by describing the mode in which the Indians of California fashion their stone arrow-heads; and cites from Sir. E. Belcher the way in which the Esquimaux of Cape Lisburne manage, by pressing the hard points of reindeer-horn upon fractured pieces of chert, to produce saw-like edges, which it might be supposed required the agency of metallic tools. The caves of Dordogne then form the subject of remark, and it is stated that, besides ossiferous deposits which may have resulted from water action, others must have been accumulated when the caves were the abodes of wild animals or of men. "Some have been the resorts of beasts alone, and some only inhabited by men. In the comparatively few in which they have been tenanted by both, there are usually indications that the earlier occupancy has not been that of man." "It is especially in the valley of the Vezère, a tributary of the Dordogne, which is an affluent of the Garonne, that these remains are in great abundance, and are indisputably contemporaneous with the remains of animals extinct in that country before history or tradition." The cave deposits are composed of broken bones, pebbles, nodules, and chips of flint of various sizes, intermixed with charcoal in dust and in small fragments. Besides these, a multitude of implements of deer-horn have been discovered, some finished, and others in process of formation. "These consist of square chisel-shaped implements; round, sharp-pointed, awl-like tools, some of which may have also served as the spikes of fish-hooks; harpoon-shaped lance-heads, plain or barbed; arrow-heads with many and sometimes double barbs, cut with wonderful vigour; and lastly, eyed needles of compact bone, finely pointed, polished, and drilled with round eyes, so small and regular that some of the most assured and acute believers in all other findings, might well doubt whether, indeed, they could have been drilled with stone, until their actual repetition, with the very stone implements found with them, has dispelled their honest doubts. More than this, all but two of the many deposits explored, have given more or less examples of ornamented work; and three of them (Les Eyzies, Laugerie Basse, and La Madeleine) drawings and sculptures of various animals, perfectly recognizable as such." Thus it appears that these early inhabitants of France were considerably removed above what is ordinarily meant by the savage state. They had, as the remains clearly show, abundance and variety of food, they could make implements requiring considerable skill, and they amused themselves with rude, though by no means despicable works of art. To estimate the date of their existence is extremely difficult, and indeed sufficient means for estimating the precise geological time, and converting that into common time, do not exist. Not only have animals

then living become extinct, but, as the following passage shows, there is reason to believe that considerable changes of climate have taken place. The writers say, "In addition to the presumption of a once colder climate, which is furnished by the fauna, it is difficult to suppose that, at the period when these remains were left, the climate was the same as it now is; for, though we may have examples in the habits of the present Esquimaux, that in their cold climate it is possible to live, without detriment to health, amid an accumulation of animal remains, the case would be very different in the south of France, where, at the temperature of the present day, such accumulations would, except in winter, speedily become a decomposing mass. That the inhabitants of that day had no such difficulty to contend with, may be inferred from their having almost invariably chosen a southern exposure, and the warmest and sunniest nooks for their residences." The plates given with this number continue the depiction of stone, bone, and horn implements, and are very well executed.

A DICTIONARY OF SCIENCE, LITERATURE, AND ART. Comprising the Definitions and Derivations of the Scientific Terms in general use, together with the History and Descriptions of the Scientific Principles of nearly every branch of Human Knowledge. New Edition. Edited by the late W. T. BRANDE, D.C.L., F.R.S.L. and E., of Her Majesty's Mint; and the Rev. GEORGE WM. COX, M.A., late Scholar of Trinity College, Oxford. Assisted by Gentlemen of Eminent Scientific and Literary Acquirements. To be completed in Twelve Parts. Part XI. (Longmans.)—This part commences with "Rules" and ends with "Sigurdr." The various articles appear well adapted to give the information required for all ordinary purposes. Some subjects, such as "Screw-propeller," "Shooting-stars," "Siege," etc., are treated at considerable length.

A BRIEF ACCOUNT OF THE SCHOLARSHIPS AND EXHIBITIONS OPEN TO COMPETITION IN THE UNIVERSITY OF CAMBRIDGE; with Specimens of Examination Papers. By ROBERT POTTS, M.A., Trinity College. (Longmans.)—The title, which gives the contents of this little book, will show persons intending to become students at Cambridge the useful information they may derive from it.

THE SCIENTIFIC AND LITERARY TREASURY. By SAMUEL MAUNDER, author of the "Treasury of Knowledge," "Biographical Treasury," etc. etc. New edition, thoroughly revised and in great part re-written, with upwards of One Thousand New Articles by James Yate Johnson, Esq., M.Z.S. (Longmans.)—This popular work was well worth revising and improving. In its present state it is a very compendious little encyclopædia, admirably adapted for family use. To get an enormous quantity of matter into a brief space the print is very small, but it is clear; and after referring to a good many of the articles, we feel justified in recommending it.

CHART OF THE CHARACTERISTIC BRITISH TERTIARY FOSSILS, Stratigraphically Arranged. Containing upwards of Eight Hundred Figures. Compiled and Engraved by J. W. LOWRY. (Tennant.)—This beautifully engraved chart of British Tertiary Fossils will be invaluable to students and fossil collectors. It consists of a series

of folding plates, which commence with the newer and post pliocene fossils, and finish with the lower eocene. In columns on the right hand side of each plate, information is given concerning the various strata in which the organic remains are found, and the nature of the principal fossils. Many of the figures are drawn in their natural size, and in other cases their proportion is given. Mr. Lowry's name is a guarantee that due pains have been taken in all the details; and it must be admitted that he has rendered an important service to students of tertiary geology.

PROCEEDINGS OF LEARNED SOCIETIES.

MICROSCOPICAL SOCIETY OF LONDON.

THROUGH the zeal of the President, Mr. Glaisher, assisted by his council, a royal charter has been obtained for this Society, and the patronage of the Prince of Wales. Fellows will use the letters F.M.S.L. The first meeting of the season took place on the 10th October, when the charter was read, and other business transacted. The President, in the name of the Society, presented an elegant silver inkstand to T. W. Burr, Esq., F.R.A.S., F.S.C., in acknowledgment of his gratuitous services in the legal steps necessary for obtaining the charter. Mr. Slack read a paper describing a new diaphragm eye-piece, which is described in our *Notes and Memoranda*. Mr. Suffolk exhibited some metal rings, made according to his directions by Mr. Collins, and adapted for microscopic cells of various sizes and depths.

PROGRESS OF INVENTION.

THE TERRESTRIAL DARK LINES OF THE SPECTRUM.—From the moment that Wollaston observed that certain rays are wanting in the solar spectrum, their places being occupied by dark lines or bands, philosophers have been occupied in attempting to investigate their origin. These attempts have been in a great degree successful. They arise from a cause which, applied to spectrum analysis, enables us not only to detect the presence of elements so minute in quantity as to elude the most careful researches of the chemist, but to pronounce with certainty regarding the elementary substances of which the most distant stars are formed. But there is one great source of uncertainty in the application of spectrum analysis to the purposes of astronomy, the difficulty of determining whether the dark lines in the spectrum of a heavenly body belong to the light emitted by that body, or have been caused during the passage of that light through our atmosphere. This difficulty is now in a fair way of solution, if it is not already resolved. M. Jansen has

proved by the most satisfactory experiments, that a large portion of the dark lines of the solar spectrum are terrestrial, and are due to the vapour of water. When, in 1864, he ascended the Faulhorn, he found that these dark lines became feeble in proportion to the height above the level of the sea; while, on the contrary, when the light of firewood, which affords a continuous spectrum, was made to pass through several miles of air in contact with the Lake of Geneva, and therefore saturated with its watery vapour, all the dark lines of the solar spectrum were produced. And he ascertained, that with a given altitude of the sun above the horizon, the higher the dew point, the more distinct the dark lines produced in the spectrum, scarcely any being perceptible on very dry days. He verified these facts by a very effective apparatus. Having placed an iron tube of considerable length, in a box, and filled the vacant space round the tube with sawdust, to prevent radiation of heat, he transmitted the light of sixteen gas-burners, placed in a line which was a prolongation of its axis, through this tube, and a continuous spectrum was thus produced. But when he filled the tube with vapour, supplied by a steam boiler, and then transmitted the light, nearly all the dark lines were reproduced, the spectrum obtained corresponding with that formed by sunlight when the sun is very near the horizon. A detenuation of the lines produced by the earth's atmosphere renders observations regarding the constitution of the heavenly bodies founded on spectrum analysis more reliable. It also enables us to find the amount of moisture in portions of the atmosphere inaccessible to us. The solar lines predominate in the green, the blue, and the violet portions of the spectrum; the atmospheric in the red, the orange, and the yellow, being ten times more numerous than the solar lines in the same places.

NOTES AND MEMORANDA.

LIGHT OF NEBULÆ.—The *Philosophical Transactions* contains a very important paper by Mr. Huggins on the spectra of some of the nebulæ, in which estimations of the amount of light emitted by some of these bodies is given. Mr. Huggins took for his standard of comparison a sperm candle of the size known as sixes. This was placed at a certain distance, and its light reduced by a neutral tint glass to $\frac{1}{27}$ of its original intensity. It was then found that nebula No. 4628 gave a light equal to $\frac{1}{135}$ of that emitted by the unshielded candle, the annular nebula in Lyra was equal to $\frac{1}{3012}$, and the dumb-bell nebula to $\frac{1}{13500}$ of the same standard.

PLUMULES OF THE PIERIS OLERACEA (CANADA).—These "plumules" are peculiar scales found only on males. They occur under the ordinary scales, and Mr. Watson considers that when inflated they raise up the other scales. Those of the *P. oleracea* most resemble those from *P. rapæ*, figured in *Microscopical Dictionary*, but they are not of exactly the same shape. The form is something like that of a battledore, with a pear-shaped hole at the thick end, and the handle terminating in a fringe. From the centre of the pear-shaped recess springs a peduncle with a round bag at the end of it. By this bag or bulb it is attached to the wing. A paper by Mr. John Watson on these plumules will be found in the *Entomologist's Monthly Magazine* for June, 1865. We are indebted for our

Canadian specimens to one of our Canadian subscribers, who signs himself "J. J. B.," and dates from Napanee. We beg him to accept our thanks. He compares the plumules, which he rightly designates "puffy," to a "boxing-glove with two fingers or thumbs." Mr. E. C. Rye was kind enough to compare this Canadian butterfly with others. He tells us that it is closely allied to the American *P. cruciferorum*, and that both are most likely localized forms of our common green-veined white.

STAR MAGNITUDES.—In the *Transactions of the Manchester Philosophical Society* will be found a paper by Mr. Knott on the Comparative Magnitudes assigned to Stars by Admiral Smyth in the *Bedford Catalogue*, by Struve in the *Mensuræ Micrometrica*, and by Argelander in the *Bonner Stern-verzeichniss*. "It appears that the scales of the *Bedford Catalogue*, of the *Bonner Stern-verzeichniss* are practically identical down to the 9th mag., and assuming with M. Pogson that the 13 mag. of Argelander's scale corresponds with the 16 mag. of Admiral Smyth, we may tabulate the results below the 9th, thus:—

MAG. SM.	MAG. A.
10	9·6
11	10·1
12	10·7
13	11·3
14	11·9
15	12·4
16	13·0"

So far as Mr. Knott's observations go, this proportion is found to hold good. He says further, "The coincidence between the scale of the *Bedford Catalogue* and that of the *Mensuræ Micrometrica* ceases practically with the naked eye magnitudes. At the 6th mag. the scales diverge, and the 11th mag. of the one corresponds with the 13th mag. of the other. Five magnitudes of Admiral Smyth's scale, below the 11th, are represented by only one magnitude in the scale of Professor Struve."

MR. SLACK'S DIAPHRAGM EYE-PIECE.—At the October meeting of the Microscopical Society of London, Mr. Slack exhibited a microscopic eye-piece which he had devised, and which was made by Mr. Ross for the purpose of protecting the eye against the glare of a large and strongly-lit field. It has four shutters, each capable of separate motion, and enables objects of any form to be exhibited in a field of any dimensions required, and bounded by straight lines. This field may be long or short, broad or narrow, as the object may require, and it is found that the exclusion of unnecessary light makes the objects more distinct, and avoids fatigue to the eye. The shutters are moved by small milled heads attached to the flange of the eye-piece. A similar eye-piece will probably be found convenient for astronomers when viewing the moon, or the solar disk.

SPIDERS AND EARWIGS.—An illustration of the tact and skill of the spider in dealing with a dangerous foe, may be obtained by putting an earwig into the web of the *Epeira diadema*, common in all gardens. On perceiving the earwig, the spider advances cautiously, and when near the creature turns her abdomen towards it, and shoots out a sheaf of threads which immediately adhere to the earwig. She then pats him round and round as if she were roasting him on a spit, and in the course of a few seconds he is effectually rolled up in a silk mummy cloth, from which there is no escape.

SOAP BEANS OF CHINA.—*Comptes Rendus* contains a paper by M. Payen on the beans of a plant belonging to the genus *dialium*, which are used instead of soap in many provinces of China. The Chinese remove the outer skin with a knife, and then rub the bean against wet linen which they wish to wash. A rinsing completes the process. The pericarp, which is dry in most beans, is of a fleshy character, and contains *saponine*, besides many other substances. M. Payen, also found in these beans a gelatinous substance, differing from pectin, pectose, etc., and which he calls *dialose*.

EARTHQUAKE IN FRANCE, SEPTEMBER 14, 1866.—M. Rovet describes the particulars of this earthquake to the French Academy. It occurred about ten minutes past five, a.m., and there were two oscillations, the first from west to east, the second south to north, and with an interval of a few seconds between them.

The spots at which the shocks were felt might be enclosed in a polygon, of which Paris, Auxerre, Tournus, Montbrison, Bordeaux, Nantes, and Rouen would form the principal summits. The west-east shock was particularly felt in Dordogne, Haute Vienne, and Charente on one hand, and Loire Inférieure and Orne on the other. The south-north shock was chiefly felt in Indre, Indre et Loire, Loire-et-Cher, Eure-et-Loir, Seine-et-Oise, and Seine, being most violent in Indre-et-Loir and Soir-et-Cher. In Paris it was slight. At Périgueux the west-east shock damaged many houses, and at Luche people at work were obliged to lean against the walls to prevent their being thrown down. At St. Marc, near Orleans, two persons were thrown down, the windows broken, and doors opened. Heavy noises were heard at various places.

FLINT CORES FROM THE INDUS.—The *Geological Magazine* for October has a plate of remarkably neatly worked flint cores discovered by Lieut. Twemlow three feet below the rock in the bed of the river, near Shikapoor, Upper Scinde, and described by Mr. John Evans, who remarks that further details of the rock must be obtained before their age can be determined. From their form alone he would refer them to the neolithic rather than to the palæolithic period of India. The cores are composed of fawn-coloured flint, and flakes were struck from them so as to have a regular polygonal pattern.

THE "GLASS ROPE" OF THE HYOLONEMA.—Dr. Gray has a paper in the *Annals of Natural History* on the structure of the sponge *Hyolonema Sieboldi*, and he considers that the researches of Professor Borboza du Bocage, who has found the "glass ropes" with attached polyps off the coast of Portugal, show that the long glass, or silica spicules do not, as Schulze and some other observers have thought, belong to the sponge, but are formed by the polyps, as he affirmed long ago. M. de Bocage did not find any object attached to these spicules, and as it is plain they must have had some support, the evidence is inconclusive. We shall shortly publish a paper on this subject, and therefore say no more now.

FIELD ADJUSTMENT FOR OBJECT FINDING.—A "Subscriber" writes:—"When the position of a good specimen in a slide of Diatomaceæ has been marked, the recovery of the view is more difficult than would appear at first sight, owing to the smallness of the marking, or indicating circle, and the size and propinquity to the slide of the end of an object-glass such as Smith, Beck, and Beck's one-eighth. If, however, the observer will incline the body of the microscope towards the horizontal position, and set the *plane* side of the mirror to give an easy and convenient view of the end of the object-glass, the slide may be put in exact position at once."

THE 90TH PLANET was discovered by Dr. Luther, of Bilk, near Düsseldorf, on the 1st of October. It is of 11 mag. 2 Oct. R.A., 0h. 8m. 42s. 07 D—2° 35' 42"·7. Daily movement in R.A. 44s. in D—4'·2.

POROSITY OF CAOUTCHOUC.—M. Payen states in *Comptes Rendus* that a microscopic examination of thin sheets of caoutchouc discloses minute holes or pores, which are rounded, and communicate with each other. Contact with liquids makes these pores more distinct. Vulcanized indian rubber exhibits narrower cavities and concentric circles spreading from one pore to another, showing successive zones of diminishing action of the sulphur. By exposure to water the caoutchouc becomes whiter and opaque through absorbing the fluid. M. Payen considers this porosity to be concerned in the dialytic action of indian rubber on gases discovered by Professor Graham.

SILVERED OBJECT GLASSES FOR SUN VIEWING.—M. Le Verrier describes in *Comptes Rendus* successful experiments made with an object-glass of 25 centimetres aperture. The silvering allowed excellent views of the sun to be made with magnification up to 300. It is found that the blue tinge of light that has passed through the silver film results from an elimination of the extreme red rays; nearly all the other rays passing through.

METALLIC FILM SPECTACLES.—M. Melsens states in *Comptes Rendus* that having suffered from an accident, by which his eyes were rendered exceedingly averse to light, he found the greatest relief by employing spectacles containing glasses covered with gold leaf, through which he could see the contour of bright clouds.





CHAMELEON.

THE INTELLECTUAL OBSERVER.

DECEMBER, 1866.

OBSERVATIONS OF THE CHANGES OF COLOUR AND MODES OF TAKING FOOD IN THE CHAMELEON.

BY JONATHAN COUCH, F.L.S.,

Corresponding Member Z.S., etc.

THE chameleon has ever been an object of curiosity, and in the times of great ignorance of natural history it was a special subject of wonder, as well as of much fable, in consequence of its frequent and unaccountable changes of colour, and its supposed faculty of living without food: its only diet being the air, of which it drew within itself a large abundance, and from which it was believed to acquire a considerable increase of size. But its habits in these respects were differently represented, even by those who appeared to be careful observers; and it was therefore with much pleasure that I had an opportunity of observing them in an example which was presented to me, and which was embarked on board of a ship at Cadiz, with several others, the larger number of which died on the voyage to England. It came to my hands about the end of the month of July in perfect health; and when presented to me the only caution given with it was, that I should be careful to provide it with water; and, it was added, that those which had died on the passage had refused it, whilst such as drank freely remained alive. To this observation and recommendation, however, I paid no attention; as a Mr. Jackson, who studied the habits of this creature in its native country, in his *Account of the Empire of Morocco*, had asserted that the chameleon was not accustomed to drink.

The example which thus came into my possession measured ten inches in length, of which the tail was four inches and a half. The head compressed, jaws of equal length, furnished with slight cartilaginous teeth. From above the upper jaw commenced on each side a ridge, which passing

backward formed an elevated crest of a triangular shape, the posterior edges of which passed down, one on each side, to the hindmost angles of the jaw. The eye large, projecting, conical, covered with the common skin; the pupil deeply seated in a hole scarcely larger than would be made with a pin. It is black and lively, and encircled with a gold coloured iris that is not wider than a thread. The projecting eyeball is capable of very extensive movement, and the movements of each eye are independent of its opposite; so that they are rarely seen directed to one object, except when this creature is intent on seizing its prey. The body is usually much compressed, but on the inhalation of air it becomes greatly distended; and it may be readily supposed that the difference in its appearance from this cause was what led to the opinion that air formed the material portion of its diet. The back is ridged, and, on account of the tubercles on it, slightly serrated; the belly also has an obscure ridge. Above the hind legs the body is slender; the tail flattened at its origin, round and tapering through its posterior half; the legs long, those behind longest and with a very extensive motion at their articulation with the body: the claws sharp, five on each leg, and united in sets; that is, on the anterior legs two of the toes are joined together on the outward side and three inward; on the hind legs three are joined together on the outward side and two inward. The body is covered with slight papillous elevations.

This creature moves slowly and with much apparent deliberation, especially when on the ground; but its favourite place of resort is a bush or branched stick, along which it proceeds with great care, never losing its grasp with one hand—as its singularly formed feet may well be termed—until it has secured a firm holdfast with the others; and the tail at the same time is employed in keeping itself safe by twisting round the branch on which it is to advance. This last named expedient is especially needed, in order to keep the body erect when on a slender twig; since for this purpose the feet alone appear to be of comparatively small service.

The colour of the chameleon is subject to continual change; but if a creature that rarely retains the same hue for ten minutes together can be said to possess one which may be termed its own, it is dusky brown, or almost black, nearly approaching to the darkness of soot. This it is which it assumes when it compresses its sides, and places its body with the plane of its surface to be exposed to the direct beams of the sun, so as to receive the full benefit of its rays: of which, as we shall have further to remark, the light is of more importance to its health and comfort than the heat. And when thus enjoying itself even the mouth is extended to receive the influence, although

at other times it is kept closely shut. It was noticed also that as a dingy black was the common colour when enjoying itself in the usual habit of basking in the sun, a light, or whitish yellow prevails when it is asleep; during which time it never changes its position.

Desirous of obtaining a knowledge of the temperature of its body, at nine o'clock of the evening of the 18th of August, when a thermometer in the room stood at 64° , this instrument was moved carefully to the side of the chameleon, when the colour changed from yellow to greenish, and then to deeper green, followed by purple spots, and it expanded itself by inhaling air, an action which sometimes is accompanied with a rushing or hissing sound, the lungs appearing to occupy the lower portion of the belly. While the thermometer lay in contact with its side, in a few minutes it rose to 68° ; and a few hours afterwards, when the animal was still asleep and distended with air, with the colour a light yellowish green, and the thermometer in the room stood at 63° , on its being applied to the side it again rose to 68° . At this time, although the touch of the thermometer did not cause it to awake, two rows of purple spots made their appearance on the former ground; and it was observed that whenever two rows of spots were produced they were large, and in one situation and direction.

On another evening, at eleven o'clock, when the thermometer stood at 62° , and the chameleon was asleep, with the colour light yellow, although the touch of the instrument did not cause it to awake, yet the colour changed to darker, and it became covered with numerous purple lines; and then, in a few minutes the colour was dark green with obscure purple spots. But both sides do not always adopt the same colours; for while basking in the sun with the side towards the light a very dark brown, the shaded side was lighter, with green tints and two large rows of purple spots, and yet sometimes spots in the same order are altogether white. When asleep at night the colour was light yellow, with two rows of white spots, on holding a lighted candle at only a sufficient distance to communicate warmth, the side thus acted on became of a uniform brown, while the other side continued of the former light yellow. Afterwards, while still asleep, and the colour was yellow with two rows of white spots, when a candle was held within the distance of three inches, the side exposed to the candle became brown with a row of deeper brown spots, and the other side continued with the unchanged light yellow and white spots; the change when it took place not requiring more than a minute, and within a minute afterwards, on removing the candle both sides were of a greenish yellow with

two rows of large purple spots. When the stick on which it rested was touched gently, without waking it, it became instantly covered all over with minute brown spots. On another occasion, when the colour was altogether yellow, a book was held so as to cast a shade on the anterior part of the body, while a candle was held within four inches of the hindmost portion; and then presently the illuminated part changed to a light brown, while the shaded portion remained as before; and when the screen was removed the exact limit of the shade was visible. When again the colour was yellow with two rows of white spots, in breathing on it so gently that nothing beyond the warmth of the breath could have been perceived, it immediately became covered with minute brown spots on both its sides; and at all times it was discerned by examination with a lens, that the colours existed entirely in the very small tubercles with which the body was covered, and not in the skin which lay between them.

I had hitherto paid no attention to the question whether it was necessary to its health that it should be supplied with drink; but it was not long before an opportunity was afforded for removing all doubt on that subject. Whilst the chameleon was near me at a window, basking in the sun, I was engaged in drawing the figure of a fish; and in order to preserve it alive, it had been wrapped up in sea-weed that was charged with salt water. Having removed the weed, some fresh water was poured on the fish, on perceiving which the chameleon immediately left its station at the distance of about a foot, and hastened with unusual speed to the place; where it scrambled into the vessel, and began to lap the water by repeatedly placing its tongue in contact with the fish, in which action the fleshy portion of its tongue being thrust a little beyond the lips, and then lifting its head, it swallowed the water in repeated efforts. When the fish was removed to different parts of the vessel, the chameleon followed it, without being alarmed, as it usually was, at my meddling with it. In order to ascertain whether it was the salt that might be still on the fish which attracted its attention, I sprinkled a portion of the fish with salt; but when it touched this part with its tongue, it turned away to where the water was fresh; but having lapped it for a moment it returned and applied its tongue to a portion of the fish which I had newly turned up; and it was from this manner of proceeding that I concluded its habits to be to quench its thirst by taking moisture from some fixed surface rather than by drinking from a pool or floating liquid. At this time the quantity of water swallowed appeared to be equal to a tablespoonful, and when satisfied its sides had become very much distended. From the 23rd of August this

chameleon did not again drink until the 12th of September; and I afterwards observed that it required water once in about a fortnight. As the opinion that the chameleon does not drink was thus proved an error, so it seemed equally clear that the popular opinion of its assuming the colour of any substance on which it rests is equally so. It has passed over and rested on carpets variegated with different colours—a large green cloth, a large growing myrtle, with other coloured substances, without my being able to discern that there was ever any connection between the colour of its surface and that of the material on which it rested. On one occasion, indeed, there appeared something like this; for when it had made its escape to the outside of the window, it became so much like the stones on which it rested—black and white—as to escape observation for a considerable time; but it has been known to assume precisely the same appearance under other circumstances, and when surrounded with substances very different in colour. It was not kept in greater restraint than was afforded by a large room; but after continuing for several hours on a green or scarlet cloth, or on green vegetables, it was not seen to assume these colours; nor, indeed, was it ever seen to assume the colour of scarlet.

It was only after it had been a fortnight in my possession, that I had an opportunity of seeing it take a fly; but after this it not only took all that came in its way, but would seize them as fast as children would bring them; and it even became so familiar with the act as to take them repeatedly from the hand. It was thus easy to measure the distance to which it was able to dart its tongue in seizing its prey, which was found to be six inches—or rather more than the length of its body; but the more usual distance was about three inches, and it was very rarely seen to miss the mark. In approaching a fly, the motion at first was slow and cautious, and within a favourable distance the mouth opened and the tongue protruded slowly to the extent of about an inch, beyond which it darted swiftly, although not as has been represented, for it has been described as more sudden and swift than human sight could follow it. The extremity of the tongue is usually flat and pointed; but when darted forward to its prey, the end is formed into the shape of a (large) pea, the middle being the most projecting part. To this the fly adheres by means of the tenacious mucus with which it is covered, and it is instantly conveyed into the mouth. But it is necessary to the success of this operation that the fly should be on some fixed substance, and almost, if not entirely, at rest; for if otherwise the chameleon will not attempt to take it, and repeatedly it has been observed to protrude a portion of the tongue,

and then withdraw it as the fly has been in motion, until at last it has either secured the prey, or given up the attempt.

About the middle of September, when the weather had become moist, and the thermometer had ceased to stand at 60° at noon, its activity was greatly lessened, scarcely moving when awake, and sleeping the greater part of the day; but the appearance of sunshine restored some degree of activity. It was noticed also that when asleep at night, with the thermometer below 56° , the colour had ceased to be yellow or whitish, as was formerly the case under these circumstances of rest, but pea green. But the greatest changes were in the first week of December, when, with the thermometer at about 50° , it ceased to take the flies presented to it; and when the thermometer was at 46° it had become so torpid as, although taken in the hands, it seemed unable to move or open its eyes. As the coldness of the air appeared to be the cause of this insensibility to impressions which at one time effected visible alterations in its actions, as well as in its changes of colour, it was often brought within the influence of artificial heat; but this appeared to produce little effect, and it never spontaneously sought the aid of the fire; whereas the faintest sunbeam was a source of enjoyment, in which it would bask, and for the sake of which it would change its position as the gleam moved in the room. Its breathing at this time appeared distinctly to be counted; the portion of its body presented to the sunbeams was darker than the rest, and when, on the 5th of December, it was found dead, the general colour of the surface was dark.

From later and extensive observation of the change of colour found in fishes, it seems certain that there is no physiological analogy between what occurs in them and in the chameleon, but that the circumstances, as well as the causes, are altogether different.

ON THE VARIATIONS OF CERTAIN CRUSTACEA,
IN RELATION TO THE THEORY OF THE ORIGIN
OF SPECIES BY NATURAL MODIFICATION.

BY GEORGE S. BRADY, M.E.C.S., C.M.Z.S.,

Secretary to the Tyneside Naturalists' Field Club.

DARWIN'S theory of the origin of species has outlived the virulent abuse of an extreme school of scientific, or one might more correctly say, of unscientific opinion, and has entered upon a second phase of existence. It has now to undergo the ordeal of a searching comparison with the phenomena of nature; with phenomena not only old and familiar, but with many others which have been brought to light since the publication of Mr. Darwin's treatise, and with a still greater multitude which must before long reward the efforts of such laborious students as are now engaged in the pursuit of natural history. The time must come, though we do not yet see it, in which educated men will be willing to receive new truths of biological science, however much these may conflict with preconceived ideas, in a temper as calm as that with which they now contemplate those revelations of geology and astronomy which a past generation counted no better than damnable heresies.

It is obvious that the lower orders of animals present a field on which the many details of descent and variation can be examined with much greater facility than amongst more highly-organized beings. The great numbers in which members of many of the lower groups may be obtained, both in a recent and fossil state, their excessive fecundity, their curious metamorphoses, and other circumstances, render it highly probable that amongst them we shall look with the greatest chance of success for information regarding the true relationships of species, and the modes in which they have originated.

There is, doubtless, at the outset, a considerable difficulty in accurately defining what we mean by a *species*. This must, in the long run, be left to the discretion of each observer in the department which he specially cultivates. We can lay down no recognized rule by which one nearly allied species may be absolutely, and without fear of contradiction, separated from another, and the practice of different naturalists varies in this respect very widely. Thus while "M. Grenier enumerates only twenty-three roses for the whole of France, M. Dèsegliè describes or mentions one hundred and seven in his elaborate monograph of the French Roses; and M. Boreau, in the last edition of his Flora, gives seventy-four for the

Central Departments only.”* Our common bramble, *Rubus fruticosus*, is a parallel example. By some botanists it may still be, as it used to be, considered as one very variable species; by others it is divided into a multitude of distinct species: that these are “good” species, according to any possible morphological or physiological test, I cannot believe, though their distinction by specific names may be very convenient to the botanist. But suppose a few links in different parts of this chain to be lost, then there would be no question as to the “goodness” of the several species. And this continuity is equally apparent in the animal kingdom. Dr. Carpenter’s conclusions with respect to the *Foraminifera* are that their range of variation is so great as to include, not merely the differential characters which have been accounted specific, but also those upon which the greater part of the genera, or even in some instances the orders, have been founded; that the ordinary notion of species as assemblages of individuals marked out from each other by definite characters that have been genetically transmitted from original prototypes similarly distinguished, is quite inapplicable to this group; since even if the limits of such assemblages were extended so as to include what elsewhere would be accounted genera, they would still be found so closely connected by gradational links, that definite lines could not be drawn between them; that any arrangement of genera and species which may for convenience be adopted, must be regarded merely as assemblages of forms characterized by the nature and degree of modification of the original type, which they may have respectively acquired in the course of genetic descent from a common ancestry; that even as to the family types it may fairly be questioned whether analogical evidence does not rather favour the idea of their derivation from a common original than that of their primitive distinctness.†

My object, however, in the present paper, is to give a brief account of some recent researches of two German naturalists, Dr. Müller, and more particularly Dr. Claus, the Professor of Natural History at Marburg. The work of Dr. Fritz Müller, *Für Darwin*, I know only by some extracts given about a year ago in the *Annals and Magazine of Natural History*. These are especially interesting, inasmuch as the author conducted his investigations on a deductive, instead of on the usual inductive plan; that is to say, instead of in the first instance ascertaining a number of facts, and then looking for some general explanation of them, he, to begin with, set before himself Darwin’s theory of descent, and said, “If this theory be

* J. G. Baker, *Review of the British Roses*.

† Dr. Carpenter, quoted by Mr. Grove, Address to British Association.

true, we ought in such and such a case to find such and such peculiarities." He then set to work to investigate on this basis, and the following is a very striking example of his results.

Crabs are divided into several natural families, so grouped because all the species of each family possess certain characters in common which distinguish them from those of neighbouring families. This, according to Darwin's hypothesis, is the natural result of their descent from one common ancestor. Then the species of all these families, which we may call A, B, and C, present certain ordinal characters common to all, and due to the fact that the families A, B, and C, descended from a more remote type X. This may be more plainly shown as follows :—

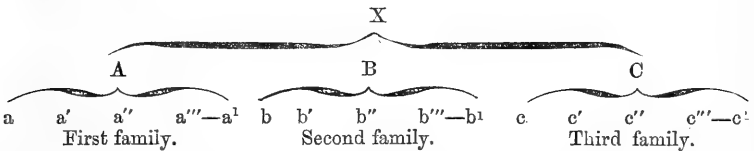

Now it is remarkable that in each of these families we find, as exceptions to the normal mode of life of the crabs, certain terrestrial species. It is permissible to suppose, *a priori*, that these must present certain modifications of the respiratory apparatus, enabling them to breathe air, and if each terrestrial species has gradually renounced, for itself, the aquatic mode of life, there is every probability that each would present a modification, *sui generis*, very different from those presented by others. If, on the contrary, observation proved that all these terrestrial species present the same modification of the respiratory apparatus, the Darwinian theory could only account for them by assuming that these terrestrial species belonging to various families, which we may distinguish as a¹, b¹, c¹, descended from a common type, O, which had already acquired the organic conditions of aërial respiration. But then the theory would contradict itself; for while the study of the respiratory organs would compel us to make a¹, b¹, c¹, descend from O, the distinctive characters of the families to which they belong lead us to assign to them a different origin, namely, from X through A, B, and C.

The details of the organization of the respiratory apparatus in the land crabs have hitherto been unknown; and thus a fine field of investigation was open to Dr. Müller. If he found in the terrestrial species of different families the same arrangement for effecting aërial respiration, the Darwinian theory would be irrevocably condemned, but if he should discover differences so complete as not to be reducible to the same type,

this would certainly furnish a strong argument in favour of the theory, and the latter alternative has proved to be the true one.

In an *Aratus* which climbs upon the branches of the mangroves, and in a *Grapsus* which runs about the rocks of Santa Catharina, the air finds entrance to the branchial cavity by a fissure situated above the last pair of feet. These crabs open the respiratory fissure by elevating the posterior extremity of the carapace. This aperture is consequently at the extremity of the branchial cavity opposite to that by which water enters and issues; for the apertures for the ingestion and egestion of water are in the same position in all crabs.

The genera *Sesarma* and *Cyclograpsus*, belonging, like the preceding, to the family *Grapsidæ*, contain species living in holes on the shore. These possess the same posterior respiratory fissure: but it is difficult to see the gaping, as the animals rarely open it, indeed only when they have been a long time out of the water. This is due to a very curious arrangement, which does not exist in the preceding species, and which enables these animals for a long time to respire the air dissolved in the water that bathes the branchiæ. The region which separates the aperture for the reception and emission of water is, as it were, reticulated, and bristles with small recurved hairs. The water issuing from the egestive orifice spreads in an instant over this network of hairs, and becomes saturated with air, after which it is conducted by a special arrangement into the ingestive aperture. The same portion of water may thus pass through the branchial chamber a great many times, carrying always a fresh supply of oxygen with it. In moist air this circulation of water may be maintained for a very long time, but when the provision of water is evaporated, the crab has recourse to the posterior aperture for aërial respiration.

The arenicolous *Ocypodæ* have been so completely estranged from an aquatic mode of life that a stay of one day in sea-water is sufficient to kill them. It has long been observed that in these animals the third and fourth pairs of feet are exceedingly close together. Their contiguous surfaces are clothed at the margins with a dense coat of hairs. It has been supposed that these hairs were intended to diminish the friction of the surfaces, but this is evidently a mistake. Dr. Müller has discovered between the bases of these approximated legs an aperture leading into the respiratory cavity. This arrangement exists in several species of the family, particularly in certain *Gelasimi*, some of which inhabit the mangrove swamps, whilst others run about upon the sand in open day. It might, perhaps, be said that this arrangement was necessary

to protect the respiratory cavity from the entrance of the sand in which the creatures live, but a species of *Gelasimus*, which lives far from the sands, in the mangrove forests, in company with several *Grapsidæ*, nevertheless has the respiratory orifice concealed between the third and fourth pairs of feet.*

The limits of this paper do not permit me to follow Dr. Müller in his investigations into the development of various crustacea. The metamorphoses which these animals undergo are amongst the most wonderful in the whole range of natural history, fully equalling, and perhaps, from their significance even exceeding in interest, the more generally known changes of the *Lepidoptera*. The phenomena of embryonic development in all kingdoms of nature lend very strong support to Darwin's theory, and are indeed perfectly inexplicable without recourse to some such hypothesis, and Dr. Müller has, by his recent investigations, added considerably to our knowledge of these amongst the crustacea, and given additional reasons for belief in the theory of transmutation. For the details of his researches I must refer the reader to the translation from which I have already quoted largely.

The *Ostracoda* belonging to the families *Cyprinæ* and *Cytherinæ* have been hitherto divided into genera and subgenera on the strength of characters taken in great measure from the carapace, or outer shell of the animal, and more particularly from those of the hinge-joint. This mode of classification must in time give place to one founded on the structure of the animals themselves; but these are often so difficult to obtain in a living or un mutilated state, and are withal so difficult to examine thoroughly and minutely without the aid of a large supply of specimens, that a thorough knowledge of their organization must involve the labour of a lengthened period. Meantime, a good beginning of the work has been made by Dr. Zenker, Professor Lilljeborg, G. O. Sars, and other naturalists. But by far the greater number of *Ostracoda* hitherto described are fossil species, which can be known only by their shells; or recent species, which have as yet only been examined in a dry state. In these cases the characters of the hinge-joint are very valuable, exhibiting peculiarities which seem to coincide pretty definitely, so far as we at present know, with certain differences of the animal organization.

When I began the study of the *Ostracoda*, I supposed that every species (I refer now to those of the families *Cytherinæ* and *Cyprinæ*, which comprise a vast majority of the British species) might unhesitatingly be placed, by virtue of the peculiarities of the hinge and external shell-surface, in one or other of the established genera. What I wish now to show, is that

* *Annals and Magazine of Natural History*. Third Series; vol. xv.

no such arrangement is possible without leaving numerous intermediate forms—evidently, as it appears to me, links in a chain of descent—which cannot be referred with certainty to any genus. Up to a very recent period, the recognized genera of these two families, founded upon characters of hingement, were as follows:—(1) *Jonesia**, the hinge of which is perfectly simple, the edge of the valves being quite straight, and held in opposition by ligamentous tissue; (2) *Cytherideis*, in which the edge of one valve projects sharply at each extremity, and articulates with corresponding excavations or notches of the opposite valve; (3) *Cytheridea*, bearing on the right valve two knurled or crenulated elevations, which are received into shallow fossæ of the opposite valve; (4) *Cythere*, which, instead of knurled elevations, bears two strong projecting teeth, articulating with corresponding fossæ of the left valve, and between the two teeth a bar which is received into a furrow of the opposed valve; (5) *Cythereis*, similar to the foregoing, except that the bar and furrow are obsolete; (6) *Bairdia*,† in which the left valve is much the larger, overlapping considerably the edge of the right valve, which is received within it.

But between the typical forms of *Jonesia* and *Cytherideis* there are many gradations of hinge character, no two species being exactly alike in this respect. Many species, instead of having margins either absolutely straight or angularly notched, have more or less pronounced curvatures. In this category may be placed *Cythere variabilis*, Baird, *C. contorta*, Norman, and other species. The genera *Cythere* and *Cytheridea* are not, so far as we at present know, so closely interwoven; still there are several species which are intermediate in character. One of the commoner littoral species, *Cythere lutea*, Müller (*C. reniformis*, Baird), has hinge-processes which are distinctly crenulated, and many species possess a crenulated bar between the two terminal teeth. *Cythere* and *Cythereis* are so inextricably united that it is impossible to draw any line of separation which at all takes into account the character of the hinge, and even if we look to more general peculiarities, the task of discrimination is scarcely more practicable. The genus *Bairdia* is very distinct indeed in its most strongly marked forms, the great inequality in the size of the two valves, and the peculiar overlapping of the left hinge-margin being unmistakable characters. But besides that the tendency to a

* The genus *Jonesia* was proposed by myself (*Trans. Zool. Soc.*, vol. v.), but appears to be equivalent to *Bythocythere*, G. O. Sars, a genus founded on exclusively animal characters. When my paper was written, I was not acquainted with the valuable memoir of M. Sars, which indeed was probably not printed at the time.

† The genus *Bairdia* is related to *Cypris*, belonging to the family *Cyprina*, and not *Cytherina*, with which it has been hitherto classed.

slight inequality of the valves is very general amongst the *Ostracoda*, there are some species which possess this character strongly developed, and are at the same time not at all referable to the genus *Bairdia*. *Cythere convexa*, Baird, is a well-marked example, the carapace having the general form of *Bairdia*, and also the unequal and overlapping valves, but exhibiting at the same time the strongly-developed hinge-processes of *Cythere*.

It may also be noted as a most interesting fact that there exist several genera of marine *Ostracoda*—not hitherto described as British*—which are distinctly intermediate, in the character of the contained animals, between the (chiefly) marine ambulatory genus *Cythere*, and the purely fresh water, natatory genus *Cypris*. These intermediate genera are—*Bairdia*, *Pontocypris*, *Paracypris*, and *Argilloecia*. The first-named group is represented in the British seas by several species, *B. inflata*, Norman; *B. acanthigera*, Brady; *B. intermedia*, Brady; *B. obtusata*, G. O. Sars; *B. minna*, Baird. Of *Paracypris*, we have one British species, *P. polita*, G. O. Sars; of *Pontocypris* two species, *P. semilata*, G. O. Sars; and *P. trigonella*, G. O. Sars, while the genus *Argilloecia* seems to be unrepresented on our shores.

The object which I have now more especially in view is to give a brief abstract of a memoir recently published by Dr. Claus† on the *Copepoda* of Nice. This paper has not, so far as I know, been yet translated, or even noticed, in England. The object of the author, besides the description of new species, was to give an account of some remarkable variations which have come under his notice during a long study of this tribe of animals, and I propose now to notice, very briefly, some of the facts which he describes.

The *Copepoda* of Nice, are, as might be expected from geographical considerations, much more nearly related to those of Messina than to those of the North Sea, but the following particularly northern forms are found likewise at Nice:—*Anomalocera Patersonii*, an Atlantic *Pontella*, *Cetochilus septentrionalis*, which forms the chief food of the Arctic whales, but attains in that northern region to a much greater size; also *Tisbe furcata* and *Eutерpe gracilis*. Other species occur less commonly, such as *Ichthyophorba denticornis*, of which the Nice variety is of strikingly slender form, and has, in the male, remarkably small clasping feet. The variations noticed in *Dias longiremis* are also remarkable.

* Some of these species have been described from the external shell characters by British authors, but of the animals themselves nothing has been published in this country.

† “Die Copepoden-Fauna von Nizza : ein Beitrag zur charakteristik der formen und deren Abänderungen im sinne Darwin’s.” Marburg und Leipzig, 1866.

Some northern species are, at Nice, represented by very nearly related forms. Thus the northern *Dactylopus Stromii*, gives place to *D. similis*; the northern *Harpacticus chelifer* to *H. niceensis*. Similar differences may be noted between the *Copepoda* of Nice and Messina, the species and genera of which places are for the most part the same, and, in many cases, of invariable form, e.g., *Euchaeta Prestandreae*, and *Candace melanops*. But there is a constant deviation observed in *Calanus mastigophorus*.

The most important distinctive characters met with amongst the *Copepoda* are in the size and colour of the body, the form and length of the tail, the form and number of joints of the upper antennæ, the character of their appendages, the character of the eyes, etc. The colour of a species may, however, be due to the distribution of pigment in various form through the external tissues of the body, or it may result merely from masses of food lodged in the alimentary canal, or from the natural colour of organs such as the ovaries. Indeed, it is often very difficult to decide how far in particular cases variations of colour may depend upon outward conditions, such as those of food and temperature.

It is worthy of remark that some very common species have a large and a small variety, and that we do not find intermediate sizes. These may, perhaps, exist, but they are seldom seen. Thus a large form of *Dactylopus similis* is 1.2 mm. in length, the small variety only 0.7 mm. *Tisbe furcata* also varies at Nice from 1.4 mm. to 2.3 mm., and there is a form of *Antaria mediterranea*, in which some of the middle segments are wholly, or in part, wanting. As connected with this part of the subject, I may note that I find a variety of *Dias longiremis* in brackish water at Burgh Marsh, Cumberland, also in similar situations at Hartlepool and Alnmouth, the length of which is only one-thirty-fifth of an inch, that of the normal form being one-twentieth of an inch.

The characters of the tail setæ, and the joints of the antennæ are of great specific importance amongst the *Copepoda*, and there are many striking variations in these respects, as, for instance, in *Cyclops serrulatus*, *Antaria mediterranea*, and various *Corycei*. Differences in the size of the various joints of the antennæ are very common. In *Harpacticus niceensis* the third and fourth joints are often much elongated; in a large variety of *Tisbe furcata*, the size of each joint is subject to much variation; and there is also a variety of this species which bears a very large secondary branch on the lower antenna; the terminal joint being excessively elongated. In *Dactylopus similis* the fifth and sixth joints are very variable,

and the nearly related *D. Stromii*, of Heligoland, likewise shows a similar tendency to variation. Circumstances of this kind prove that closely-allied species are subject to changes of a similar nature. *Dactylopus Stromii* seems especially liable to great divergence. The seventh antennal joint is of very uncertain length, and is even sometimes divided into two joints. This Dr. Claus has observed only in one instance, the antennæ having nine, instead of eight joints, and in their relative size simulating those of the allied genus *Thalestris*. Of thirteen known species of *Dactylopus*, far the most have eight-jointed antennæ, two species have ten joints, one has seven and one five. Nine-jointed antennæ are not met with normally in any species of *Dactylopus*. Thus it appears that through individual alteration characters may be acquired which one is accustomed to regard as being even of generic importance. In the same way, the Mediterranean species of *Harpacticus* have nine-jointed antennæ, the northern species being eight-jointed. Greater and smaller individual differences may occur in all parts of the body, and these often occur in such wise that though there may be no intermediate forms, it is quite impossible to regard the animals as belonging to distinct species. We must in such cases allow the influence of "time's effacing fingers." Highly interesting and important in this view are the variations in the length of the third and fourth antennal joints of *Harpacticus nicaensis*. The stronger, and, on the average, the larger form, has a heavy, strong body, ill-bred apparently, inactive and wanting in mobility, the antennæ clumsy, with their third and fourth joints short and thick, the second joint very long; the second foot-jaw ends in a strong, massive, clasping hand; the first pair of feet are armed with doubly-curved claws; the feet, especially the last pair, are strong and clumsy, all the setæ showing a tendency to become plumose. The smaller and slenderer breed has longer antennæ, the third and fourth joints of which are much elongated; the prehensile apparatus of the foot-jaws and first pair of feet more slender, and there is also a much slimmer, slenderer form of the limbs. In general structure and conformation of body, in the peculiar arrangement of setæ, the serration of the abdominal segments, in short, in those points where distinct species mostly diverge, there is here a striking agreement. "After diligent inquiry," says Dr. Claus, "these differences remained unexplained, and I was inclined to consider them as mere individual variations. But further investigation of all portions of the body convinced me that two distinct forms, with qualities diversely useful, had originated two separate races, one slender, swift, and agile; the other, clumsy in figure, but robust and powerfully armed. The two

racés are so far separate, that intermediate individuals, partaking of the characters of both, are not met with. The upper antennæ, however, in each case, show a tendency to similar variations. At the same time, these variations are not so profound that they might not have been acquired singly or in combination. The differences in the relative size of the claws and prehensile organs may be traced back to the youngest stages of growth. . . . Many species may, no doubt, have been founded on characters no more distinct than these, and on mere deviation of character in the joints, which a critical investigation would prove to be worthless."

When the advocate of immutability urges the absence of forms intermediate between distinct species, he forgets that between acknowledged *varieties* it is mostly impossible to obtain connecting links.

Besides forms, varieties, and nearly allied species observed in places near to each other, Dr. Claus notes examples of variation depending on influences of climate and other external conditions. He lays little stress on varieties of colouring, but much upon difference of size, instancing the *Cetochilus septentrionalis* as found at Nice, which is only one-third of the normal size of the species. The little *Calanus mastigophorus* which he distinguished at Messina by the long, whip-shaped, antennal setæ, occurred also at Nice, but without these setæ. Very remarkable also are the differences of form in the male prehensile foot of *Dias longiremis*. While the fifth feet of the females of Nice and Heligoland are in all essential respects the same, that of the Nicæan male has a stronger claw and appendage, to allow, as it seems, of a stronger grasp. We have here, as in the case of *Orchestia Darwinii*, two different males in the same species, and can only explain the deviation as the result of natural causes connected with different localities. The difference of the feet is indeed so striking as to have led to the supposition of the two forms being distinct species. An instance of concurrent variation of different parts of the body occurs in the *Ichthyophorba denticornis* of Nice and Heligoland. The former is not only smaller than the northern species, but has proportionally far more slender armatures of the antennæ, and a much less marked angular projection of the last segment of the body, and in the males much weaker prehensile apparatus of the fifth foot. It thus stands, in size and conformation, between the northern *I. angustata* and *denticornis*, the distinctions, indeed, are here so sharply defined that according to some schools of naturalists they might properly constitute species rather than varieties. "The opponent of the origin of species by descent," continues Dr. Claus, "asks to see forms of an intermediate character. When we succeed in showing

these, which, from the requirements of natural selection, must be but seldom, he immediately answers that the two extreme forms are not good species, but only varieties. This is a vicious style of argument. Darwin rightly says that facts seems to prove the fruitfulness or sterility of animals *inter se*, to be a criterion of no value whatever, but his opponents maintain that the descendants of varieties are fruitful, and of species sterile, *inter se*. So when Rouy in Angoulême obtained many successive generations of a breed between the hare and the rabbit, they directly affirm that these animals had been hitherto misunderstood, and that they are evidently only varieties of the same species. In the same way, however, as we discriminate species by characters occurring either singly or in combination, we are entitled to believe in the general unfruitfulness together of animals belonging to those forms which we designate by the name of species—a peculiarity imparted to them along with many other characters, and having in itself nothing requiring separate explanation.”

A great many people fear to believe in the derivative origin of species, because they vaguely fancy that the doctrine leads to materialism, and even worse phases of belief or unbelief. They charge its advocates with inability to appreciate whatever cannot be weighed and handled, with a want of reverence for the spiritual and unseen. And, indeed, it is obvious that material organisms must be subject to the laws which regulate *matter*, just as much as spiritual entities must obey the laws of spirit. But though we believe that the phenomena of origin and creation are the result of the operations of immutable law, no less as regards species and races than as regards the individual; we believe likewise that these laws are at once an expression of the will, and a revelation of the wisdom of the Eternal, and that through them “the whole round earth is every way bound by gold chains about the feet of God.”

A NEW CHARR* FROM BRITISH COLUMBIA.

BY JOHN KEAST LORD, F.Z.S.,

Naturalist to the North American Boundary Commission; Author of "The Naturalist in Vancouver's Island and British Columbia."

SP. CH.—Scales minute. Head and body rather compressed; the height of the head equals the length of the head, and is two-ninths of the total (without caudal); the length of the head is one-half the distance between the snout and the vertical from the origin of the dorsal fin. Snout very obtuse, scarcely longer than the diameter of the eye, which is three-fourths of the width of the interorbital space. The lower jaw is a little shorter than the upper; maxillary of moderate length, scarcely reaching to the vertical from the margin of the orbit. Teeth of moderate strength; those along the medium line of the hyoid are very small. Præoperculum with a very distinct lower limb. Fins rather small; the length of the pectoral is less than that of the head (without snout), or one-half of the distance of its root from the ventrals; caudal fin slightly emarginate. Back and sides reddish olive; sides with numerous round light-coloured spots. Belly whitish powdered with reddish olive; paired fins and anal colourless; caudal immaculate. Pyloric appendages very long and wide.

"This is one of the smallest species of charr, both our specimens having the abdomen filled with mature ova."

It would be of no practical use to give a lengthy description of the specific differences which separates the charr from the rest of the *Salmonidæ*. The charr we are familiar with, as tenanting British waters, are as a rule resident in deep lakes. Yarrell, in his *History of British Fishes*, vol. ii., p. 125, tells us "The charr generally inhabit the deepest parts of those lakes, in which they are found, and afford but little amusement to the angler." The charr are very seldom known to wander into any of the streams, by which these lakes are either supplied or drained, except at the season of spawning, and their decided partiality for clear water and a hard bottom is then very conspicuous. The spawning season is in November and December.

I must ask my readers to forget for a short time the beautiful lake scenery we are all so justly proud of, to leave the haunts of the British charr (with which, if the reader is a disciple of the "gentle art," he is pretty sure to be familiar), and to visit with me, in imagination, its near relative, a dweller in the

* *Fario Lordii*, Nov. Sp., Gunther, Brit. Mus. Catalogue of Fishes, vol. vi., p. 148.

wild regions of North-western America. Let us suppose ourselves to be entering the Fraser River, which, I need hardly say, is the principal navigable stream flowing through British Columbia; it heads from the Rocky Mountains, drains a large extent of country west of the Cascade Mountains, and empties into the Gulf of Georgia, about six miles north of the British and American boundary line, the 49th parallel of N. lat.; the entire length of the river may be roughly set down as 1000 miles.

A small steamer conveys us so far as New Westminster (which is the capital town of British Columbia), a small straggling place built on a steep wooded slope, about fifteen miles from the mouth of the Fraser River. Here we charter a canoe, and provide a stout crew of Indians, and if we start early, we may manage to reach Fort Langley by sundown. This so-called fort is a trading station belonging to the Hudson's Bay Company, whereat in salmon-time immense numbers of these lordly fish are salted and barrelled, to be eventually disposed of at the Sandwich Islands and San Francisco. Putting up cranberries also, at one time, formed a large item of the trade done at this station. The berries were bartered from the Indians, then headed into casks made at the fort, these casks were lastly filled with water, through a hole in the head bored for the purpose, and then plugged up. We sleep at Fort Langley, and paddle away again early in the morning. On either side of the stream (which in this, the month of August, is swift and turbulent), rise steep sharp-pointed hills, deeply cleft into ravines, and densely clothed with massive pine-trees, from the water's edge to the very topmost pinnacles of their craggy rocks. Here and there some tributary stream makes its way from amidst the trees, and, as we pass, little clusters of Indian lodges are revealed, resembling hillocks, but from which many columns of white smoke are stealing up through the trees, and but for such tell-tales we might have gone by the village fifty times, and have been none the wiser. Suddenly, as we round a sharp bend in the river, we come into a wide expanse of water, tranquil as a lake (these lake-like stretches of water are peculiarly characteristic of the scenery on the Lower Fraser) green grassy banks like verdant meadows extend for some distance from the water's edge to meet the bases of the hills, to be at last absorbed amidst their timbered slopes. These banks are favourite camping-grounds for the fishing Indians, and we can make out, as we paddle slowly past, little fleets of canoes, laying bottom uppermost on the grass, whilst behind them are lodges of all sizes: many camp-fires are burning brightly, and round about them groups of dingy savages loll lazily or squat on their heels. A-head of us are four canoes, each of

them manned by two nearly nude savages, the one paddling is seated in the stern, the other, standing in the bow, is armed with a spear seventy feet in length. These Indians are sturgeon-spearing—sturgeon five hundred, and sometimes as much as seven hundred weight, are speared and landed with these frail canoes, that the slightest inequality of balance would upset in a moment. We land in the evening on the "Sumass spit," a large sand-bank at the junction of the Sumass and Fraser Rivers. Here we find a regular Indian town, not very large as regards the number of its houses, but each house contains from nine to twelve families. The houses are built like sheds, with cedar planks, a small part of the interior is apportioned to each family, who sit or lie on the bare ground round the fire, every family has its own fire, and the smoke from the whole of them finds its way out as best it can. A stockade about twelve feet high, constructed of small trees and stout poles, encircles the village; this defence is pierced with small apertures, through which arrows or bullets, if need be, can be fired at an enemy. About three miles higher up the river lives another tribe, we shall not see their village, because it is situated inside a small island, and, thus craftily hidden from sight, any one going up or down the river, would not know of its existence. The owners, the Chilukweyuk Indians, are dire enemies of the Sumass tribe, hence the latter, being the weaker, need a stockade to prevent their foes from pouncing upon them unexpectedly. These Indians live in a great measure upon white fish (*Coregonus quadrilateralis*) and salmon, fresh and sun-dried.

We have fifty miles more to accomplish ere we reach Fort Hope, our destination. The river above Sumass gets swifter in its course, rapids are more numerous and difficult to ascend, and what is most astounding, heaps of drift timber, each heap containing many thousands of immense trees, are piled up at nearly every bend, or wherever rocks, a point of land, or a sand-bank, has offered any obstruction to their onward course. These trees are washed down by the floods, which commence in May, and are at their highest during June and July, at which time the sun rapidly melts the snow from off the hills. If one did not previously know that the river rises quite forty feet during the summer freshets, it would be a puzzle to conceive how such gigantic trees could be piled one upon top of another; as the canoe glides along beneath their shadow, it is precisely like looking up at a cliff composed of huge trees. Two living things only are to be seen on this chaos of wood; one of these, the dipper (*Cinctus Americanus*) hunts busily on the submerged stumps for aquatic insects and larvæ, sometimes quite under water, at others only half immersed; whilst the

other, the "store keeper" squirrel (*Tamias quadrivittatus*) scampers along from tree to tree, chattering, whistling, and scolding, as if in angry remonstrance at so impudent an intrusion into its solitudes. It is ticklish work getting up some of the rapids; paddles are of no avail, and the canoe has to be propelled with light poles (poling a canoe up a swift rapid is a feat I have never seen a white man perform with the same skill as an Indian, not even the oldest and most skilful voyageurs belonging to the Hudson's Bay Company are equal to the red-skins; the art of holding the canoe with the pole, and whilst propelling her against the current, preventing its sweeping her round, is an art Indians, and only Indians, know how to manage) the slightest slip and over we go, with the water running like a mill-race, rocks, boulders, and snags everywhere, and eddies, and whirlpools strong enough to suck down a boat; why, a man would not have the slightest chance of saving himself from drowning, even if he could swim like a beaver; but somehow the red-men get us through in safety. Now and then we pass beneath a rocky cliff, the splintery points of which knock the water into spray as it hurries on its way; then coaxing the frothy current into clefts and hollows, whirls it round in countless eddies. Here in these dark retreats salmon love to linger, as they toil on against every obstacle in search of some gravelly stream, wherein to make a nest and bury their eggs; and we may count these noble fish by the thousand, and then fail to arrive at a fair estimate of the numbers which every year ascend the Fraser and its tributaries. Stages suspended by ropes of twisted bark dangle over these gloomy whirlpools, frail are they in construction, being simply light poles tied clumsily together, one shudders even to look at the fearless savages, as kneeling or sitting on their heels they ply a small round net affixed to the end of a long handle, and one by one land goodly salmon on the treacherous platform. It is no easy feat to lift a heavy fish, flapping and struggling in the full vigour of superfluous health, on to a stage swinging in mid-air, or to knock it senseless with a single blow when it is there; and yet these untutored men manage to do it, every day and all day long. To fall from off the stage must be certain death, and yet they are compelled by hard necessity thus to imperil life and limb in order to obtain food, on which to exist during the biting cold of a six months' winter.

We need not linger to describe all our different camping-places, but we will pass them by as offering little worthy of particular notice. Fort Hope, our destination, is visible a-head, perched upon a bluff some height above the river. The scenery is grand and massive beyond description; lofty

mountains, some of them crowned with perpetual snow, completely shut the river in on both sides. A dense impenetrable forest of pine-trees seem to rise from out the water, and in a series of green slopes end only at the sky-line. But this mass of dark green is so broken, divided, and grouped, if I may so express it, by craggy masses of rock, deep ravines, and narrow valleys, through which streams rattle noisily, that all idea of monotony vanishes, and on every side is a magnificent natural picture, wherein are all the elements requisite to make a landscape beautiful, but on such a scale of immensity, that it fairly staggers one to gaze upon it. The river sweeps past Fort Hope with great velocity, then making a sudden bend to the right, is suddenly lost amidst the jutting points of land and the dense foliage of the forest.

Fort Hope is but a small place, consisting of the Hudson's Bay trade post, some scattered log houses, and a kind of street facing the water, made up of stores, groggeries, billiard saloons, and barber's shops. This town, since the period of which I am writing (being the head of steamer navigation) has grown to be a place of some importance, because one of the routes to Cariboo is *via* Fort Hope and Lytton. A steamer in old days did occasionally come up to Fort Hope at certain periods of the year, in order to take away the furs collected there during the year, and at the same time to bring goods for barter with Indians, which goods were destined for the supply of the frontier trading posts.

We are now near the home of our new charr, and I shall continue this imaginary journey, because it will the better enable me to describe the character of the river in which the fish lives, and the kind of country through which the stream flows, matters of importance, as showing how the charr of British Columbia differs in habit and habitat from its better known British brethren.

The distance to our fishing-ground is rather too great to walk comfortably, and the hills are steep, so we will mount our mustangs, and ride. Our route is along a flat at first, covered with shingle and large rounded boulders, which were brought here, in all probability, on the shoulders of the ice king, for in no other way could masses of rock, differing entirely from the rocks comprising the encircling mountains have been transported from a distance. Water power could never have rolled them; their weights must be calculated by tons, not pounds. The flat we are traversing was, most likely, the bed of an ancient lake. The best evidence obtainable respecting the age of these vast accumulations of water-worn stones is at best but very imperfect. Whether this huge continent has been depressed in the mass, or whether the

upheaval in the centre has greatly exceeded that along its margins are speculations for geologists to decide.

These terrace formations, as they are styled, must strike the most obtuse traveller as being unlike anything he has seen before in other parts of the world. There is hardly a valley between the Rocky Mountains and the Pacific coast lower than 4000 feet above the sea in which these shingle terraces are not met with. Two miles across the shingle, which is but sparsely covered with timber, brings us to a beautiful stream, the Qua-que-alla, clear as crystal, and cold as ice. It has a swift rocky course, and as we look into the glass-like water, brigades of salmon (*Salmo lycaodon*) are seen toiling on, all with their heads up stream, literally crowding one another against the rocks and banks, the bright scarlet stripe marking the sides of every fish; the worn noses and large ulcerous wounds that have eaten holes into the living fish, tell their own tales of hardships, difficulties, and privations, endured in obeying an instinct ever prompting them to deposit their eggs as high up in the mountain streams as they can get. Neither can we be blind to the fact that another purpose is fulfilled by the bountiful hand of God, thus directing myriads of fish to quit the sea, and enter rivers intersecting the interior of a continent or an island. This obedience to an unalterable law is a simple means by which heat-yielding materials, and meat requiring sunshine only to cure it (salmon sun-dried will keep sound for years), are floated, free of all freight, to the dwellings of the aborigines who live far inland, and have to endure a rigorous winter and six months snow.

It is not at all overstating the fact to say, that four out of every six of these salmon we are watching, will die as they struggle onwards, and drift back again in rotting masses, towards the ocean from whence they came.

We only follow this stream for a short distance to reach its junction with a second stream, up the course of which we ride by following a narrow trail. Where the forest is a little open we can look upwards through the trees and discern the water-shed of the Cascade Mountains. The waters of the eastern side find their way into the Columbia, whilst these on the west flow into the Fraser. The hill we are ascending is steep, and the river tumbles from rock to rock with tremendous force; a louder roar than we have been listening to, directs us to a waterfall, where the river plunges over a vertical wall of rock, and puts an effectual stop to the salmon's further ascent (bear this fact in mind).

We by-and-by reach a kind of plateau, where the water has a slower course; now we will tether our mustangs, put our fishing-gear into working order, and commence work.

The flies we must use are small, and of bright, gaudy colours. My first cast results only in a rise; my second is attended with better success—a fine speckled trout, the Oregon-brook trout (*Fario stellatus*) lies flapping on the grass. The next throw is into a comparatively still pool; with a gentle splash a small fish seizes the fly, and finds itself suddenly in the hands of a naturalist; I examine it carefully, and discover that I have a charr; more than this, it was a female fish, and she was full of eggs, others were soon taken; but in all the roe and milts were near to maturity, the largest charr did not exceed six inches in length, and there could be no doubt the fish were adult, and fully grown. I had frequently fished in the lakes on Vancouver's Island, as well as in other lakes and streams (I may mention the Sumass, Chilukweyuk, and Swelza, as examples; these are mountain lakes, with streams flowing out from them), at lower levels along the spurs of this, the Cascade range of mountains; but in no single instance did I ever catch a charr.

The three lakes I have named fulfil every condition of the Cumberland, Swiss, and other lakes in which our charr (*Salmo salvelinus*) are usually taken, and one would have naturally supposed that if charr were to be found at all, they would have been in localities similar to those they favour and frequent in other countries. Not so, however; here is the only place (as far as my experience goes) where charr are to be obtained in British Columbia. The first thing which occurs to us as being unusual as regards this charr is, that there is no lake, nor even still water, near to where it resides, and not far above the spot on which we are standing, is the source of the river (about 7000 feet above the sea level), owing its origin to the melting snows, of course the water is at all times intensely cold. In the second place, we have tracked the river courses from the sea, and it is quite clear this tiny charr could never have come from the lower part of the river; it must have quitted its egg near to where I caught it, and have lived there to a mature age, and in its turn is now ready to deposit eggs for the production of another family. Even supposing this small and delicate charr risked a plunge over the cascade we peeped at, and survived the tumble, it is hardly conceivable that it would escape the thousand and one dangers which would beset it; and if it did, by no possibility could it ever return again to this part of the river. In the third place, the habit of leaving the lakes at the spawning time common to all our charr (according to Yarrell) can never be indulged in by this British Columbian species, because it is completely imprisoned in a few miles of river. The barrier on one side is a waterfall; on the other the source of the stream.

The stomachs of all the charr I opened were crammed with the remains of winged insects, and in a few of them I observed portions of the wings, together with other parts of the larger dragon-flies (*Eshna*), an insect that in size nearly equalled its devourer. I did not see any remains of aquatic larvæ intermixed with the other contents of the stomach, hence I am disposed to think these charr during the summer take the greater part of their food on the surface of the water. They are the most greedy little gluttons conceivable, I could see them dash at my flies two or three at a time, fighting and struggling to get the first chance to seize it.

The British Columbian charr is a particularly handsome little fish. The body is more slender than is that of the trout, and in colour olive-green, blushed with pink; the sides are densely covered with minute white spots, as if the fish had been sprinkled with whitewash; all the fins are of a pinkish hue, whilst the fish is alive, but turn to a dingy white immediately after death. The lower jaw being a little shorter than the upper, gives the head and snout (if I may use the word for want of a better) a snubby appearance. As the eggs of the female fish were nearly mature, there can be but little, if any, doubt that these charr spawn in August, although I had no opportunity to watch them as to their modes of depositing the eggs; and, singular to say, I never obtained a male fish. It is a somewhat remarkable difference, as regards the *Salmonidæ* of North-western America, when compared in habits with our own, that the former spawn in summer and early in the autumn, whereas our salmon generally deposit their eggs in December. But then we must not forget that during the summer the North-western rivers are at their highest, from the enormous inflow of water caused by the rapid melting of the snow, and also that the temperature of the water is never, in the hottest weather, more than a degree or two above the freezing point. If the salmon did not ascend the rivers during the flood time, they could not leap over the falls, or twist their way against the rapids, that everywhere occur to intercept their progress towards the spawning grounds. What are obstructions only when the rivers are high, become impassable barriers when the waters are at their lowest level.

There is another curious feature in the habits of North-western American salmon, one is at once struck with, which is, salmon never take a bait of any kind after quitting the sea; whereas their near relatives, the charr, trout, and salmon-trout, greedily take anything offered to them. My own opinion is, that the salmon in North-western rivers never feed after they abandon the salt water until they either perish or again reach the ocean, and I say, without fear of contradiction, that four

out of every six salmon die which ascend the river for the purpose of spawning in its tributaries. So vast, during the winter months, is the accumulation of dead salmon in the small streams, that to live anywhere near to them is next to impossible. Rotting fish hang from every spray that dips into the water; rotting fish lodge in every eddy, and jam against the irregularities of the rocks and boulders; rotting fish lie stranded on every sand-spit; and rotting fish are day and night drifting onwards towards the sea. Why such a waste of valuable food is permitted by the all-wise God who bountifully sent it, no one can tell; but that it is intended to serve some wise and useful purpose, although to us inscrutable, is indisputable.

To return to our little charr, it is equally puzzling to me to account for the presence of this member of the *Salmonidæ* in a mountain stream, shut in betwixt two barriers, and, as far as I know, it is not to be found in any other part of British Columbia. I am almost afraid to venture a suggestion, lest some geologist pounce down upon me. It is disagreeable, to say the least of it, to find oneself tumbled over, and sent floundering amidst the fragments of a pet theory, by some person who happens to be more learned in matters geological. I have my own opinions, however, and I mean to state them, and if I am snuffed out and utterly extinguished, so to speak, then so be it; there must be a right side and a wrong side to this question as there is to every other, and if I am groping my way along the latter, why the sooner somebody comes to the rescue the better.

I cannot help thinking this isolated charr might possibly have lived in a lake at some remote period, the bottom of which, now high and dry, we rode across when we left Fort Hope. Upheaval of the land drained the lake of its water, and as the mountains were tilted up higher and higher, a few charr might have either followed up the course of this stream, then a tributary to the lake, or they may have been lifted up bodily by a sudden convulsion, such as caused the cliff of rock over which the stream now finds its way, and constitutes an impassable barrier to the ascent or descent of fish. The other charr, after the lake was drained, perished, it may be, suddenly; or if they escaped, have given place, during the course of ages, to some stronger race of fishes "in the struggle for existence." Only in this way can I account for so singular a case of isolation as shown us in this British Columbian charr. Bearing upon, and in some degree, too, confirmatory of this theory, is another fact. Near by this stream wherein the charr live, rhododendrons grow, and in no other part of the Cascade Mountains were these plants discovered. How, then, can we account for this? Here we find a group of flowering shrubs completely islanded, if I may so express it, on a small spot of

ground in the very midst of a vast mountain-range. I can see no other way to solve the problem save that of admitting that some geological change has so modified and altered the general conditions requisite for the growth of this plant in the surrounding district, as to cause its extinction, whereas the small spot of land on which it thrives remains unchanged.

Perhaps I had better stop my theorizing, lest I get inextricably entangled. "Fools rush where angels fear to tread," says the adage. Dr. Gunther for some time imagined the specimens of this charr, which I brought home to the British Museum, to be the young of one of the species of salmon common to the rivers of British Columbia; and it was not until he examined them carefully, and discovered the fish were females containing fully-matured eggs, did he decide they were charr, and the smallest known species. In compliment to the discoverer, Dr. Gunther has named the new charr *Fario Lordii*.

I have given briefly a sketch of the general features of the Fraser River, the stream in which I caught the charr, and of the district through which it flows. How far my speculations as regards this fish's isolated position may accord with the opinions of those more conversant with the changes which have from time to time altered the earth's surface than I am, I do not know; of the charr itself I have not deemed it necessary to say more than was sufficient to put any reader in possession of its most prominent characteristics. Minute descriptions of structural peculiarities, by which it was known to be a species new to science, would prove anything but amusing, and of no practical value to any but the scientific ichthyologist. My end was to place its habits, and the singularity of its position, in a pleasant guise, for I fully believe the general reader, though looking upon a fish as only a fish, feels a pleasure in knowing what it does, and how and where it lives in far away lands. Whether or not I have succeeded in my endeavour my reader must decide.

PARASITICAL PLANTS.—THE BALANOPHORACEÆ.

BY JOHN R. JACKSON,

Curator of the Museum, Royal Gardens, Kew.

(With a Tinted Plate.)

THE structure and habits of parasitical plants are so peculiar and anomalous to those of other branches of the vegetable kingdom, that they have not only claimed the particular attention of learned and acute observers, but are also of great interest to all lovers of nature; indeed one of the most popular plants, the mistletoe, belongs to this class, as well as the largest known flower in the vegetable world, namely, that of *Rafflesia Arnoldi*. It is to the class of parasites to which the *Rafflesia* was formerly considered to be allied—the *Balanophoræ*—that we wish to direct the reader's attention; *Balanophoraceæ*, *Cytinaceæ*, and *Rafflesiaceæ* were included by Lindley under the head of *Rhizanthæ*, which constitutes one of his five divisions of the vegetable kingdom. The plants so classed are all destitute of true leaves, but having instead cellular scales they do not partake of any of the appearances of other plants, having no indication whatever of green colouring matter about them, but are either brown, purple, yellow, or a pale, livid pink. They have short amorphous stems; that is, they are without regular or definite form, and are always parasitical on the roots of other plants. They have true flowers, with stamens, pistils, etc., but these flowers vary considerably in their form and structure; so much so, indeed, as to induce some botanists to consider them widely distinct, and to place them widely apart in botanical classification. Dr. Hooker is of opinion that the *Balanophoræ* have no affinities whatever with *Rafflesia*, but are nearly connected with *Halorageacæ*, to which the *Trapás* belong.

Numerous papers have been read from time to time at the various learned societies both here and on the continent, on the structure and affinities of the various genera and species of the *Balanophoræ*, but no one has devoted so much attention to the whole group as Dr. J. D. Hooker, the present Director of the Royal Gardens, Kew, who by the aid of his extensive correspondence, as well as by his own travels, has secured an unrivalled collection of these peculiar vegetable forms for the Kew Museum.

These plants rise not more than a foot above the ground. They are all natives of hot countries, in the tropical and subtropical mountains of Asia and South America, where they

probably occur in nearly equal proportions. The rhizome, or rooting portion of *Balanophorous* plants is usually in the form of a simple or branched tuber, seated flat upon the root of the plant, to which it is attached. In very young plants the appearance is nothing more than a mass of cellular tissue, united with the tissue of the root. Dr. Hooker says, "It offers at first no trace of a vascular system, nor any distinction of parts, but before it has reached the cambium layer of the bark, and before its upper extremity has attained any considerable size, an opaque line of white cellular tissue, different from the rest, may be found in the centre of the mass, or beneath each of its lobes, in which vascular tissue makes its appearance. Shortly afterwards the wood of the root upon which the parasite grows appears to become affected, its annual layers are displaced, and at a still later period vascular bundles, enclosed in a cellular sheath, are found in the axis of the rhizome, and are continuous with those already found in it. Some genera do not present the appearance of any vascular bundles communicating with those of the root stock, but their own vascular bundles may be traced descending to the line of union between the root and the parasite, where they become closely applied to the vascular system of the former, without, however, forming any interlacement or organic union."

The roots or rhizomes of these plants are of comparatively slow growth, but vary much in the several species. This may in some measure be referred to the different forms of attachment or union with the roots upon which the parasites grow, for it would appear that there are three distinct modes of attachment in the several distinctive forms or genera, and these have been suggested as lines by which to divide the *Balanophoræ* into three sections; firstly, where the vascular tissue of the parasite and nourishing plant is apparently merged in one, or continuous; secondly, where the attachment is alone effected by means of the cellular system; and thirdly, where the termination of the vessels from the root into the parasite are definite or distinct. The most perfect examples of the first of these divisions are to be found in the genera *Rhopalocnemis* and *Balanophora* itself, where also the most perfect vascular system exists, the woody tissue being present throughout the whole plant. Fig. 1 shows a transverse section of *B. involu-crata*. The formation of the tissue in *Helosis Mexicana* illustrates the second division, Fig. 2; while that of *Langsdorffia* illustrates clearly the third, Fig. 3.

In the cellular tissue of many of the *Balanophoræ*, wax is secreted in large quantities. A view of one of these cells, burst open, and discharging its waxy granules, is shown at Fig. 4. The wax is found mostly in *Balanophora* and *Langs-*

dorffia, while in *Lophophytum*, *Cynomorium*, and *Sarcophyte* in particular, as well as in other genera, starch grains are found in the place of wax.

The plants are either monœcious or dicecious. The flowers in some species are arranged in a capitulum, or head, varying in shape, being either round, oblong, ovoid, etc., and in other species they are in compound spikes or panicles. The individual flowers also vary considerably in the different species; they are most perfectly developed in *Mystropetalon*, and the least so in the female of *Balanophora* and the male of *Lophophytum*. The flowers are either with or without a perianth, but when present it is usually dimorphous. In the genus *Rhopalocnemis* it is tubular, while in *Thonningia* it is composed merely of three very minute scales. The styles, stamens, etc., are very variable in number, as well as in form, but though they are always present, they are in many species so imperfectly developed as almost to warrant a very low position in the arrangement of flowering plants; but, on the other hand, "if we disregard imperfection, and inquire what organs are wanting in the order, we shall find that, with the exception of terrestrial roots, all are present which are necessary to justify their being placed among phænogamic plants."

Of the whole of the genera of the *Balanophoraceæ*, *Mystropetalon* is the most perfect, or highly developed. In the capitulæ, or flower-heads of this genus, the male flowers are always seated at the top, and the female flowers below. This does not occur as a rule through the other genera, the males in many instances being lowest. *Cynomorium coccineum*, Michx. is the *Fungus melitensis* of the old writers. From its old name one might be led to expect that it is alone indigenous to the Island of Malta, but its range extends to the Levant, the Canary Islands, and Northern Africa. The plant grows to about a foot in height, it has a deep pink or reddish tinge, and a very fleshy appearance. The flowers are unisexual, but sometimes hermaphrodite flowers are likewise found on the same head. The parts of the perianth, or floral coverings, are always in sixes. The whole plant is covered with small scales. This plant was formerly much valued in Malta as a medicine for the cure of dysentery, and the places where it grew were carefully guarded to prevent its being stolen. The plants were, even up to a recent date, protected and gathered under the supervision of an officer appointed by the British Government. They formerly had a great reputation for stopping the flow of blood, and it is said that the celebrated styptic used by the Crusaders to stanch their wounds was none other than this plant. Mr. P. B. Webb, who travelled in the Canaries, tells us that it is eaten for food there, and much esteemed. Of the genus

Sarcophyte, *S. sanguinea*, Sparrm. is the only species known. It is found only in South Africa, principally on the roots of species of *Acacia*. The male flowers are paniced, but one of the characters by which this genus is distinguished from *Balanophora* is that the filaments and connectives of the stamens are free, while in *Balanophora* they are united. The male flowers have a three-lobed perianth, and the female flowers are arranged in globose heads, and have no perianth. The arrangement of the tissues in the stem of *Sarcophyte* do not differ essentially from other species of the order, though in the peduncle the vascular bundles are very irregularly deposited. The roots of the plant upon which it grows are connected by stout, woody branches with the rhizome of the parasite, and there seems to be a complete fusion of the vascular tissues of both. The stems of *Sarcophyte* contain innumerable starch granules.

Two species are enumerated of *Langsdorffia*, *L. hypogæa*, Mart., and *L. rubiginosa*, Wedd., but Dr. Hooker, who is undoubtedly the best authority on *Balanophoræ*, doubts whether there are sufficient characters to distinguish the latter from *L. hypogæa*. They are both natives of South America, the first being distributed through Mexico and Brazil. The remarkable parasitism of *Langsdorffia*, Dr. Hooker describes in the following terms:—"The dichotomously branching rhizomes appear most frequently to corrode, as it were, the back of the roots they encounter, which they even sever, and then enclose the end that remains attached to the parent plant. The root swells considerably at the junction, and appears to send prolongations of wood into the rhizome of the parasite, which run along its axis for several inches, and though there is an intimate union between the wood of the root and the cellular tissue of the parasite, there seems to be no blending of their vascular systems." The fruit-bearing receptacle after flowering dilates very much, which causes the scales to spread open, and when fully expanded the whole has a similar appearance to the involucre of a thistle (Fig. 5). The rhizome of this species is highly charged with wax, and it will burn freely with a clear flame. The secretion is contained entirely in the cellular tissue where it appears as a large opaque mass in every utricle. This wax is collected to a large extent by the people of New Grenada, who make candles of it, while in Bogota the stems themselves are collected and sold in all the markets without any preparation, for use as candles on Saints'-days. On the Tolima range of mountains around Bogota the plant is known by the names of "Belacha" and Melonsita, and the soft receptacle, when ripe, is eaten and considered stimulating and refreshing.

Thonningia sanguinea, Vahl., is found in Western Tropical Africa, on the roots of trees. Its root-stock is of a dingy

brown colour, and the flower-stalks are covered with closely-imbriated scales of a bright red colour. The only difference between the female flower of this plant and that of *Laingsdorffia* is that in *Thonningia* it has a more complete tubular 3—5 toothed perianth, the stamens are united into one column, at the base of which are a few scales. Specimens of these plants were first brought to Europe by Thonning in 1804, Vahl examined them, and described the genus, naming it after its discoverer. So far as is known they have no economic uses.

Of the genus *Balanophora*, eight or nine species are enumerated, but in bringing them down to this number, some varied forms or varieties are included as one species. Quoting Dr. Hooker upon this point, it appears these varieties are so numerous that neither colour, form, nor the sexuality of the capitula are constant characters. In the same woods wherein the Doctor gathered *B. involucrata* var. *gracilis*, growing upon the roots of oak, he also gathered var. *flava*, growing on those of an Araliaceous shrub, and differing from the var. *gracilis* only in its more robust habit. *B. involucrata*, Hook. fil, grows in the Himalayas at an elevation of from 7000 to 9000 feet. It is, however, common in Sikkim up to 8000 or 10,000 feet. The capitula of this species, as well as the stalks, are of a very bright colour, either red, a rich deep crimson, a brightish yellow, or of a purplish tinge.

Balanophora dioica, Br., *B. indica*, Wall., and *B. polyandra* are all East Indian species. The first is very common in Eastern Himalaya and Khasia, and is also very variable in form, according to the localities in which it is found. "Specimens of all sizes may be found, from an inch to a foot high, of all degrees of robustness, and of all colours between blood red, yellow and white, or brown." *B. polyandra* is very abundant on the Khasian and Himalayan mountains, at an elevation of from 4000 to 6000 feet. It varies from two inches to six inches in height, and differs from some of the other species in having the capitula always short and sub-cylindric or conical, but like *B. dioica* it varies much in colour and robustness. It flowers during the months of August, September, October, and November.

B. elongata, Bl., is an inhabitant of the mountains of Java, where it is found at an altitude of from 5000 to 9000 feet. It is also found in Ceylon, and on the mountains of the East Indian islands. It has been found in flower in the months of March, May, and August. *B. globosa*, Jung., is found in Burmah, and *B. alutacea*, Jung., in the Philippine islands. They both flower in April. The first of these two species in general habit much resembles *B. indica*. The rhizome has a peculiar, crumpled appearance, covered with small tubercles, or





1

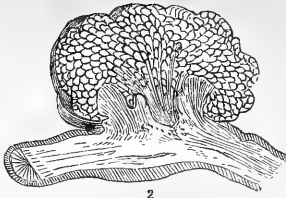

2

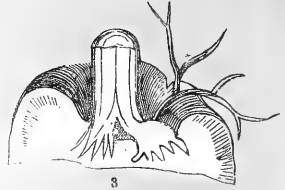

3

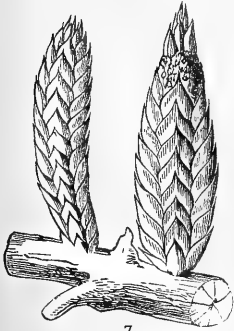

7

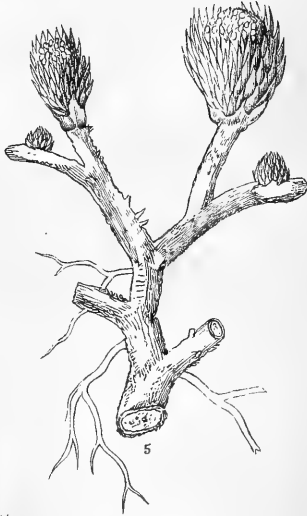

5

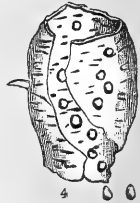

4

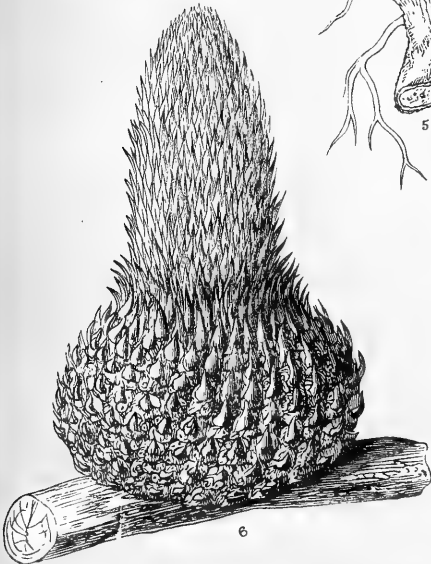

6



8

ALANCO

ALANCO

1. Transverse section of rhizome of *Alanco* sp. n. involucreta. H.f.
2. Vertical section of *Helosis Mexicana* showing its attachment to the root.
3. Vertical section of *Langsdorfa* root showing its attachment to the rhizome.

4. Transverse section of rhizome of *Alanco* sp. n. involucreta. H.f.
5. Vertical section of *Alanco* sp. n. involucreta. H.f.
6. Vertical section of *Alanco* sp. n. involucreta. H.f.
7. Vertical section of *Alanco* sp. n. involucreta. H.f.
8. Vertical section of *Alanco* sp. n. involucreta. H.f.

warts. The whole mass appears highly charged with wax. Wallich says that it is sold in the Burmese bazaars for medicinal purposes.

B. fungosa, Forst., is peculiar, as being the only Australian species. The following description of the arrangement of the tissues in this species is so clear that we cannot do better than quote it entire:—"The most curious point in this species is the tendency of the tissues forming each vascular bundle in the rhizome to arrange themselves rudely into the form of an exogenous stem, the wood forming a zone of wedges round a central pith, enclosed by a cellular zone that communicates with the pith by broad medullary rays. The total absence of pith in the root, with whose wood these bundles communicate, would thus seem to indicate that the wood of the rhizome belongs to itself, though it has all the appearance of being solely produced by the root; the root, in short, supplies the nutriment from its own vascular tissue, but the parasite organizes it."

The several species of *Balanophoræ* are found on the roots of such trees as oaks, maples, vines, etc., but *B. involucrata* has also been found growing on the exposed aerial rootlets of oaks in damp or humid forests. This species, when growing upon subterranean roots, appears to affect them much more than any other, as it produces large knots from two to four inches in diameter. These are much prized by the natives, who make from them very neat wooden cups, which are in general use throughout the Himalaya and Thibet. Some of them are esteemed antidotes for poison, and for this purpose fetch a high price. This and the Java species, *B. elongata*, which furnishes a wax from which candles are made, are the only species of any importance in an economic point of view. In *Lophophyllum Weddellii*, Hf., the root-stock is a somewhat spherical fleshy mass, covered on the upper part with long overlapping scales. From the top of this mass springs the flower-stalk, very much in the form of a pine cone, and covered likewise with imbricated scales. On the upper portion of this stalk small regular branches are given off, upon which the flowers are closely packed. A better idea of this singular plant will be obtained from Fig. 6 of the plate. It is a native of New Grenada, in moist woods. It is said to be used by the natives as an article of food. Two other species have been described, viz.:—*L. mirabile*, Schott and Endl., and *L. Bolivianum*, Wedd. Both of these are South American, the first being found in Brazil, the other in Bolivia.

Ombrophytum Peruvianum, Poeppig and Endl., is another of those peculiar plants which Poeppig has described as being eaten by the Peruvians, who boil it, and treat it similar

to fungi. The generic name is derived from the Greek, *ombros*, a shower, and *phyton*, a plant; in reference to the sudden way in which they are said to spring up after a shower of rain. The genera *Scybalium* and *Sphæronhizon* follow here in the order of classification. *Scybalium fungiforme*, Sch. et Endl., a native of the forests of Brazil, being the only described species of the first genus, and *Sphærorhizon curvatum*, H. f., the only species of the second. This plant, from the fact of its roots penetrating only the last year's wood of its prey, and producing no effects in the layers below, would seem to be only of annual duration.

Phyllorcorhiza Jamaicensis, H. f., is found in the savannahs of Jamaica, as its specific name indicates. It is the only West Indian species, and is commonly known in Jamaica as John Crow's nose, but whence the derivation of such a singular vernacular we are unable to tell. The plant is found in flower from January to July. The rhizome or root-stock is branched or lobed, a transverse section of which shows "a thick brown cellular cortical layer, formed of hexagonal cells full of starch granules and chlorophyll, with occasional masses of hard, woody, or sclerogen cells." From this root-stock numerous flower-stalks arise, covered all the way up with closely imbricating scales. These flower-stalks bear large cylindrical or oblong flower-heads. (Fig. 7).

Rhopalocnemis phalloides, Jung., is undoubtedly the most noble, if we may so speak, of all the *Balanophoræ*. It is found at the roots of trees in the mountains of Java, at an elevation of 7000 feet, as well as in the Khasian and Himalayan mountains, Nepal and Sikkim, at 6000 to 8000 feet. It grows in shady woods in large masses, and has a very pretty appearance, with its pale yellow brown heads only showing above the ground. The rhizomes are of various sizes, from that of an egg to masses as large as the human head. The flower-buds, which spring from the rhizome in their earliest state, appear like swellings, which presently burst forth and reveal the most magnificent flower-heads. "Both males and females expand at the same time, throwing off their cohering bracteal scales in large masses, and exposing a velvety pile of style, and a dense mass of subjacent articulate threads. There are several crops of male flowers which expand successively, and in the dense humid woods in which this genus grows, insect agency is probably necessary to impregnation." A representation of this plant will be found at Fig. 8.

Three species of *Corynæa* are enumerated, namely, *C. crassa*, Hook. fil., *C. spherica*, H. f., and *C. Purdiei*, Hook. fil. The first of these is the most imposing plant of the three, frequently weighing many pounds. It attacks the roots of its prey in all

directions, swelling over stems, and completely encircling them. It has a thick, fleshy flower-stalk and dense flower heads; the male flowers much resemble those of *Rhopalocnemis*, it is a native of New Granada, at an altitude of 8000 feet. *C. spherica* is also a New Granada species, and is found at a similar elevation. Like the former, the rhizome completely encircles the root of its prey; though the plant itself has a very different appearance to *C. crassa*, the flower heads are more globular and regularly formed. *C. Purdiei* is a native also of the same country, growing chiefly on the roots of *Cinchona*. The capitula and the flowers themselves are very similar to those of *C. spherica*.

Helosis Guyanensis, Rich., is a very remarkable plant, and has been described and written about by several illustrious botanists. It is found in Guiana, as its specific name indicates. Its range, however, appears to be in "damp woods on the East coast of South America, from Trinidad to south of the equator." The rhizome, or root, runs underground for a great distance, adhering to any roots which come in its way. Dr. Hooker has shown that the arrangement of the tissues in a transverse section of this rhizome closely resembles that of many menispermaceous plants, and that the vascular system of the peduncle consists of scattered bundles that run free, and unbranched from the rhizome to the capitulum, where they partially anastomose, forming a plexus within the circumference, from which bundles are given off with great regularity towards the base of each scale. The plants vary much in size from an inch to about a foot high. The flower-stalks are numerous, with globose or ovoid heads of flowers, the males and females being on separate heads. From close observation it would appear that the female flowers are seldom, if ever, fertilized except through insect agency. The native country of *H. Mexicana*, Lieb., is also indicated by its specific name. It is found on the Mexican mountains, at an altitude of 3000 to 5000 feet. It does not differ considerably in form or structure to *H. Guyanensis*, but it is not so variable. Plants of this genus are of little or no economic value, though they are sometimes used as styptics in their native countries.

Though the *Balanophoræ* are of no value or importance in a commercial or economic point of view, they are most interesting in a scientific point. Popularly little is known about them, or even of the existence of such plants. This is easily to be attributed to the fact that no living plants have been seen in this country, and they are certainly less attractive to a general observer in a dried state than when arrayed in their bright colours. But even with a slight acquaintance of their habits and modes of growth, they cannot fail to excite some interest.

PHASES IN THE DEVELOPMENTAL HISTORY OF
INFUSORIAL, ANIMAL LIFE.*

BY JABEZ HOGG, F.L.S., F.R.M.S., ETC.

THE elucidation of the mystery which surrounds the beginnings of organic life, and the discovery of the living principle which exerts so powerful an influence on all animated creation, has often and long been sought for by philosophers as well as physiologists, from the earliest ages down to the present time; but all their efforts have been in vain, and we stand in precisely the same position in regard to this subject as that occupied by the first philosopher who entered upon its investigations. Although we have not been able to throw much light on the nature of life, we find that the degree of vitality possessed by an animal is to a great extent in proportion to the degree of its organization, and we may conclude from this that there is an intimate connection between life and organization. Not that organization can create life; of this we have no instance at all, but that the principle of life, which exists in and has been given to any organic germ is only brought to maturity in accordance with the original law of its organization; and by means of this *principle of life* it is enabled to pass into a state of greater perfection, constituting what has been called, and is now recognized as the *law of progressive development*. First, let me say that I do not purpose to enter upon any inquiry into the precise nature of life, such as I have just hinted at, but rather let me on this occasion direct attention to some points of interest in the developmental history of infusorial life.

On the threshold of this inquiry a remarkable theory, and one which cannot be passed over without discussion, stares us in the face, "Whether among the smallest, and apparently the most elementary forms of organic life, the phenomenon of spontaneous generation obtains?" This question has quite recently formed the subject of careful experiment and animated discussion on the continent; the *general* opinion, however, seems to be that the lowest forms, in common with the highest, are generated by reproduction from preceding forms.

Aristotle found no difficulty in believing that worms and insects were generated by dead bodies; and to the mind imperfectly acquainted with the results of modern investigations, spontaneous generation is as easy of belief as it was to Aristotle.

* Being the substance of a lecture delivered to the Old Change Microscopical Society, September 27th, 1866.

Do we not constantly see vegetable mould covering our cheese, our jam, our bread? Even our air-tight vessels cannot be kept free from plants and animals, where neither plant nor animal could be seen before, and where it appears impossible that their seeds could have penetrated. Where do those parasitic animals come from which are to be found in the blood, the brain, the liver, and the eye? How got they there? These questions are more easily answered on the supposition that generation can take place spontaneously; nevertheless, the weight of scientific evidence has been year after year accumulating against such a supposition, and the majority of physiologists have come to the positive conclusion that no generation whatever can occur except by direct parentage.*

And yet how difficult at times to divest the mind altogether of some such theory, when asked to account for the apparently sudden appearance in a most unlikely place, of some such extraordinary creature as that of Mr. Crosse's *acarus*. This, as you are aware, was found in a solution of silicate of potash, through which an electric current was passing, and after every care had apparently been taken to free the apparatus from every particle of dust and foreign matter; or that noticed by Dr. Maddox on the surface of a nitrate of silver bath, which had been set by for some time. The several bright spots in motion proved to be well-developed, highly-organized acari, looking like "miniature fat sheep."†

These, and other like remarkable instances were at one time regarded as good evidences of spontaneous generation, and afforded a simple and easy mode of getting rid of a difficulty.

The first formidable assailant of the doctrine of spontaneous generation was the celebrated Italian naturalist, Redi. In his work *On the Generation of Insects*, he proved that the worms and insects which appear in decaying substances, are really developed from eggs designedly deposited there by the mature animal. But it was thought preposterous to suppose that putrefaction could produce an insect, and this explanation was for a time rejected. But driven from the insect world, where such an hypothesis could have no chance of success, the upholders of it sought refuge in the world of infusorial and parasitic life.

Any one acquainted with the writings of Leuwenhoek will see how steadily this father of microscopy set his face against spontaneous generation, because even his imperfect instrument showed him that many of the most minute animals produced eggs, and were generated like the larger ones. Since his time

* Lewes.

† *Quarterly Journal of Microscopical Science*, vol. ii. p. 96.

hundreds of observers have brought their contributions to the general stock, and the modes of development of plants and animals have been more and more clearly traced; and each extension of knowledge in this direction has had the effect of narrowing the ground on which the spontaneous hypothesis could possibly find a footing; and the question now comes to this: "Is it more probable that a law of generation which is well nigh universal in the organic world, should have an exception; or that our researches have as yet been so faulty that we have not as yet been able to bring this seeming exception under the law? One after another, cases which seemed exceptions have turned out to be none at all. One after another, the various obscurities have been cleared away, and it is therefore the dictate of philosophic caution which suggests that so long as we remain in positive ignorance of the actual process, we must assume that a general law prevails."*

Positive evidence would at once settle the dispute, and I take this opportunity of directing ardent and aspiring microscopists to the question, as one well worthy any amount of time and trouble; but I must tell them beforehand that every one who has hitherto made any experiments, or attentively followed those of others, has found it exceedingly difficult to devise any experiment which shall be conclusive. This arises, first, because the facts elicited admit of very different interpretations; and secondly, from numerous sources of error. "For it is quite true that there are organic beings of which we can as yet only say that there is the strongest presumptive evidence against their being exceptions to the otherwise universal law to which I have alluded. As an instance, we do not know how the *Amœba* arises, no one has even seen its eggs, or ever been a witness of its mode of reproduction; and yet we find the *Amœba* in almost every drop of rain-water, and most vegetable infusions, so that we may be perfectly certain that its ova are carried about by every breath of air." Schultze, of Berlin, devised an experiment which might have been thought to settle the question. This experiment proved that an infusion of organic substance, supplied with air driven through a strong acid, could be suffered to remain for three months without either any animal or vegetable life becoming apparent. At the end of that time atmospheric air was allowed to enter freely, and in three days the infusion was found to be swarming with animalcules.

It will be at once observed that the essential condition in such an investigation is to be quite certain that no organic germs are introduced into the liquid from without, and that there should be secured a free supply of air, carrying no

* Lewes.

organic germs; on the hypothesis that animalcules, like other animals and plants, are produced from germs or eggs, which might be in the water and yet so excessively minute as to be easily overlooked, and only awaiting the proper *conditions* for their speedy development; or, on the other hand, supposing them to be floating about in the air, they would fall into or enter any vessel containing organic matter in a state of decomposition and there develop. Schultze's experiment, then, looked very like a conclusive one, for no sooner were measures taken to destroy the germs, supposed to be suspended in the air, than the infusion was kept free from animalcules; and no sooner was the air allowed to enter in the ordinary manner than both animal and vegetable life abounded. It was thought, however, by M. Morren, that air in its passage through sulphuric acid underwent some alteration which affected its power of supporting life; and upon putting this to the test, he found that air passed through sulphuric acid was incapable of sustaining life. We have then, M. Pouchet's experiments, which are of a most imposing character. He announced that there was nothing in either Schultze's test or Morren's correction, for he declared that in following the former's experiment in every particular, and also in repeating it with fresh precautions, he could constantly find both plants and animals in an infusion in which every organic germ had been previously destroyed, and to which the air only had access after passing through concentrated sulphuric acid, or through a series of porcelain chambers kept at a red heat. M. Pouchet even goes farther than this. He determined to substitute for atmospheric air, *artificial air*; this he introduced into a flask containing an infusion of hay, the *hay* having previously been subjected for twenty minutes to a heat of 212° F. He thus guarded against the presence of any germs in the infusion or in the air. The whole was then hermetically sealed; but in spite of all these precautions, both plants and animals appeared in the infusion. He repeated the experiment with pure oxygen gas instead of common air and with similar results.

Professor Wyman instituted a series of thirty-three experiments, prepared in different ways, in which solutions of organic matter, some of them previously filtered, having been boiled at the ordinary pressure of the atmosphere for a length of time varying from fifteen minutes to two hours, were exposed to air purified by heat. In only four were the contents of the flasks unchanged when opened; in all the rest *Bacteriums*, *Vibrios*, *Ferment-cells*, *Monads*, or *Kolpoda-like* bodies were seen, some of them having ciliary movements. In nearly every instance their presence was indicated by the formation of a film, which appeared in some, on the second, and in others not until the

nineteenth day. The result of these experiments is, that the boiled solutions of organic matter made use of, exposed only to air which has passed through tubes heated to redness, or enclosed with air in hermetically sealed vessels, and exposed to the heat of boiling water, became the seat of infusorial life; but such experiments throw no light on the immediate source from whence the organisms in question were derived. I have shown repeatedly, as well as numerous other observers, that the air contains many kinds of organic matter, spores of cryptogams, starch granules, and other vegetable fragments, and probably also the eggs of many animalcules, all of which are floating freely about.

Milne-Edwards objected to the conclusions of Pouchet, saying, there is no proof that the hay itself had been subjected to the temperature of boiling water, it being very probable that although the furnace was at that heat, the hay, which was in a glass vessel and surrounded with air at rest, was not at anything like that temperature. On the other hand, granting that the temperature may have been reached, that would not suffice for the destruction of all the germs if they were perfectly dry; the power of resistance possessed by vegetable silicated cylindrical tubes, as hay and straw, is well known. The observations of M. Doyere prove that the *Tardigrada*, "water-bears," when thoroughly desiccated, preserve the power of reviving even after having been subjected to a temperature of 316° F. The *Vibrio tritici* will maintain its vitality for many years through all the vicissitudes of heat and cold. I have kept wheat for ten years, and still find these animals easily resuscitated; and Mr. Deane mentions a remarkable fact, "that on a particular piece of land whenever wheat is grown it is always infested with *Vibrio*, no matter what the length of time since the previous wheat crops, nor what crops have been sown in the meantime." If, therefore, animals of so complex a structure as these *Tardigrada* and *Vibrios* can resist the action of time and temperature, there is no reason for supposing that the germs of the simpler animalcules would be destroyed by them.

The Rev. Lord Sidney Godolphin Osborne, in a letter filled with interesting remarks on "Cholera and its germs," which appeared a few weeks ago in the columns of the *Times*, writes—"I know from experiment that there are 'germs' containing a principle of life, that will stand very strange usage, and yet not have that principle destroyed. Many years since I applied a certain matter to a piece of glass about four inches square. This has another very thin piece cemented close over it on three sides, leaving a space just sufficient for a thin stratum of water between the two. It has been exposed for days to

the action of the direct rays of the sun, it has been kept in the dark, and sometimes has been for a year or two in a very dry place without a particle of water touching its surface. To amuse friends I have again and again allowed a little water, sometimes filtered, generally of the coldest *spring* nature, to fill up the space between the two glasses—water I had previously tested for any living organisms. I have never failed to produce, in a few hours, a most beautiful exhibition of one of the most interesting species of Infusoria, having beforehand sketched the exact creature I would produce. With the same water, in another glass tank of the same nature but not so prepared, I fail to produce anything at all until it has been left for some days, and then the creatures seen are not my old friends. I have read, not seen, that these organisms retain their vitality even when the glass has been made red hot. I don't say I believe, but from what I have seen I think it quite possible."

I have myself found, upon subjecting the spores of *Penicillium* to the action of boiling water, twice over, that they remain uninjured, their vitality is so little impaired that on placing some of them in saccharine solutions and other substances, carefully excluded from the air, a very short time sufficed to show the presence of the characteristic mould growing up from the spots where the spores rested, and microscopic examination confirmed the character of the growth.

M. Quatrefages says, that he examined the dust remaining on the filter after ignition from some observations on rain-water, and found that the organic elements presented a confused assemblage of particles, and this continued to be the case for a few minutes after their immersion in water; but in a few hours he detected a great number of vegetable spores, infusoria, and those minute spherical and ovoid bodies familiar to microscopists, which inevitably suggest the idea of eggs of extremely small size. He also declares that he has frequently seen monads revive and move about after a few hours immersion.*

M. Pouchet's reply is, that if the air is filled with animalcules and their eggs, they will, of course, fall into any vessel of water, and as water is their natural element, will there exhibit their vitality. But if half-a-dozen vessels of distilled water, perfectly free from animalcules, be left exposed to the air beside one vessel of distilled water containing organic matter in decay, the half-dozen will be free from animalcules and eggs, but the one will abound with them. Now it is perfectly intelligible that inasmuch as organic matter is said to

* Mr. Samuelson examined the dust shaken from rags brought from Alexandria, Trieste, Tunis, Peru, and Melbourne, and found in all germs of *Monads*, *Bacteria*, and *Kolpoda*.

form the indispensable condition for the development of the eggs, it is only in the vessel containing such matter that the eggs will develop; but why are they not also visible *as eggs* in the other vessels? Why are not the animalcules themselves visible there as they were in the water examined by M. Quatrefages?

My reply to Pouchet's question is, that in all the vessels ova had probably been deposited, but for lack of nourishment, in five, they had quickly died. It is well known that in all organized structures, disorganization rapidly sets in, unless either some vegetable matter or a well-oxygenated medium be ready at hand to carry the ova on to maturity. And as to their not appearing in all the six vessels, I can only say that this does not accord with my experience; for upon exposing any number of bottles to the same atmospheric influences, all have given positive results, and I can only suppose that M. Pouchet either made a very imperfect and cursory examination, or his microscopic manipulation must have been greatly at fault.

A few years ago an observation made by Cienkowski, the botanist, seemed finally to settle the question of spontaneous generation, and to place the matter beyond doubt, because it caught nature in the act, so to speak, of spontaneously generating. Cienkowski's statement is as follows:—If a slice of raw potatoe be allowed to decompose in a little water, it will be found, after some days, that the starch cells have a peculiar *border*, bearing a strong resemblance to a cell-membrane. This shortly turns out to be a real cell-membrane, and is gradually raised above the starch grain, which then occupies the position of a cell-nucleus. Thus, *out of a grain of starch a cell has been formed under the observer's eye*. Inside this cell little granular masses are developed, which begin to contract. Finally, minute eel-like animalcules (a species of *Anguillulidæ*) are developed there, which bore their way through the cell-wall into the water.

Franke, in his report of this observation, which he says he has verified, asks, "how is it possible to deny spontaneous generation here? Before our eyes a grain of starch becomes a cell, in that cell are developed living forms, which bore their way out." Again, Professor *Nægeli* stated that he had been baffled at first in the attempt to verify this observation, but that after nearly a hundred trials he had succeeded; he appears to have confirmed all the statements made by Cienkowski; but if the phenomenon was of such rare occurrence, surely there must have been some other explanation than that of spontaneous generation.

It seemed probable that error had crept in somewhere. Cienkowski himself at length discovered the source of his own

error: the membrane which seemed to form itself round the starch granule had quite another origin. He observed the little *Monads* swimming about, and noticed one of them adhere to a starch grain, spread its elastic body round it, and finally envelope it, just as the *Amœba* does its food. Thus was explained how the starch grain came to be inside a cell; and as this process was never suspected, and as the starch-grain was within a cell-wall, the idea of natural formation was inevitable, the more so as the wall seemed to grow larger and larger.

M. Pasteur, who has been the leading and most determined opponent of the spontaneous generation theory, contrived a series of experiments which met many of the arguments brought forward by Pouchet, and he thought it was possible to obtain, in some place, atmospheric air so pure that it would not produce any change whatever in a putrescible liquid. M. Pouchet, Joly, and others, in their desire to meet this idea, ascended the glacier of La Maladetta, in the Pyrenees, taking with them a number of flasks, each one third filled with an infusion of hay, which had been previously filtered and boiled for more than an hour. The air was then exhausted, and the flasks hermetically sealed. Four were then afterwards filled with air on the surface of the glacier, and four in a crevasse. The examination of four of the flasks, three days afterwards, gave specimens of *Bacteria*, *Monads*, *Vibrio*, *Mucidinea*, and *Amœba*. The conclusion drawn from this was that even the air of high mountains did not fulfil the conditions which M. Pasteur predicated of it. Nevertheless M. Joly said that he believed that M. Pasteur was quite right in his statement that all that was required for the production of animalcules was "air and a liquid susceptible of putrescence," and that in his opinion there is no such thing as "spontaneous generation."

M. Pasteur goes on to state that the doctrine of spontaneous generation may be expected to be constantly turning up, since it maintains a hold over us, unknown to ourselves, from its relation to the impenetrable mystery of the origin of life upon the surface of the globe. Gay Lussac's report of his examination of the method of preserving provisions for the army, was not without its influence on the minds of men on the subject now under consideration. He proved that when the air in the bottles in which substances have been well preserved is analyzed, it no longer contains oxygen, and consequently that the absence of that gas is a necessary condition for the conservation of animal and vegetable substances. He also found that grapes crushed under mercury do not undergo fermentation unless brought into contact with pure oxygen, or with common air, even in a scarcely perceptible quantity. Such experiments, made with so much exactness and care by so great a master of

chemistry, have never been disputed, and other observers, following in his footsteps, have extended their researches to the organisms which arise in vegetable infusions; and all, whether partisans or opponents of the theory of spontaneous generation, admit that the smallest possible quantity of atmospheric air is sufficient, when brought into contact with a suitable infusion, to produce in a short time such changes, that there appears an incredible number of minute forms of animal life. The character of the infusion most decidedly exerts an influence over the ultimate results; as for instance when any kind of albuminous material is added to the saccharine fluid, the spores of a fungus, *Penicillium glaucum*, cover the surface in a few days; the infusions are also affected by the atmospheric conditions, whether summer or winter, by locality, whether placed inside or outside the house, in town or in country.

To sum up, and in a few words, after having carefully considered the arguments used by disputants on *both* sides of this question, I believe I am perfectly right in saying that the balance of experiment is certainly very much against the spontaneous generation theorists; but so much has been said and written on this subject, that we might if space permitted, greatly extend our remarks. There is, however, another point deserving of notice, which appears naturally to follow an inquiry into the source of living organisms, namely, the order of their successive appearance in vegetable infusions. This point in the life history of the infusoria has already occupied the attention of many investigators: and one in particular I wish to direct attention to,—Mr. Samuelson, whose researches were carried on in conjunction with Dr. Balbiani of Paris, and confirmed by him. As might have been expected of this gentleman, he starts by asserting his utter disbelief in spontaneous generation, and then goes on to tell us that when a carefully prepared infusion of vegetable matter in distilled water is exposed to the air, the *Protozoa* which first appear in it are *Amœba*: these in a few days disappear, and are succeeded by ciliated infusoria, such as *Kolpoda*, *Cyclidium glaucoma*, and sometimes *Vorticella*, and these in their turn by what we have looked upon as higher forms, as *Oxytrichum*, *Euplotes*, *Kerona*, etc., consequently Mr. Samuelson thinks that *Monads* are but the larval condition of the ciliated infusoria. He also noticed the constant occurrence of *Monads* belonging to the species *Circomonas fusiformis*, or *acuminata* of Dujardin, etc., in pure distilled water after a certain exposure to the air, and this without the previous admixture of vegetable matter of any kind in the water. The same results were obtained upon shaking rags, from various and distant parts of the world, over the distilled water; other experiments were also tried, and in all cases in

about three weeks he invariably obtained forms of ciliated infusoria. "The fusiform body of the *circo-monas* bears a long whip-like cilium at its anterior end, and a short seta at its caudal extremity: this finally drops off, and when exposed to undue heat and light, the animal is transformed into an *Amœba*."

Mr. Samuelson's results do not very materially differ from my own, save in one or two particulars. I have not seen the succession of generations take quite the same course, and the animal and vegetable bodies generally appear simultaneously, or so soon after each other, that it is at times difficult to decide the priority of appearance; but as my experiments have been chiefly confined to collections of rain and distilled water, *without* the addition of vegetable matter of any kind, this will materially affect the results. We are, however, quite agreed as to the wide and general distribution and great tenacity of life presented by these infusorial germs. With regard to the supposed purity of rain-water, at no time can it be taken without the numerous matters floating in the air being brought down with it, and, consequently, within a few hours after it is caught, *Protococcus pluviialis*, *Amœbæ*, and *Circomonas*, may always be found in great numbers. It is somewhat remarkable that the purest snow water, caught in a clear glass vessel, and allowed to remain well corked, will, in the course of two or three weeks, be found to contain *Amœbæ* and *Circomonas*, but it rarely presents other forms of animal life; the vegetable matter completes its growth very slowly, gradually passes to confervæ, and for a time no other change is seen to take place; so that it is painfully apparent that the atmosphere in which we live and move and have our being is something more than a mixture of gases, as apparently determined by chemical analysis.

Mr. Glashier's "*blue mist*," which he believes to be in some way associated with our cholera visitations, certainly does not depend upon the presence of any unusually large number of spores floating about in the air. Although spores, etc., exist, as I have shown, in the atmosphere, in greater abundance about the period of such visitations, they also exist when the public health is good. And therefore it should be regarded as a mere coincidence, if certain bodies prove to be more abundant during the prevalence of epidemic disease. But this "fungus-spore" theory is no new thing, for it is upon record that rusts and mildews have sprung up so rapidly upon articles of food and clothing, as to have appeared to herald approaching plagues. A so called "blood-rain" is said to have been the forerunner of the plague of Rome. It has been noticed, however, that the present year (1866) has been especially characterized by the prevalence of all kinds of moulds and mildews upon vegetation generally; we consequently

find the air thoroughly charged with the germs of *Uredo* (smut) and *Penicillium*; and we may readily believe that the same depressing influences that render the human family subject to epidemic disease also affect vegetable life, and the weakly and sickly plant equally with the higher human creature, goes to the wall, and may ultimately furnish the nidus for a colony of parasites.

In all my collections of rain, snow, and distilled water, animal and vegetable life proceeds to one definite point, and then recedes. I have never found any go beyond *Euglena*; and unless some vegetable matter be added to the solution, no higher form of life appears; on the contrary, a retrograde condition takes place. If some kind of vegetable matter, as hay or lettuce-leaf, be added, then I find, with Mr. Samuelson, rotifers make their appearance—not otherwise. But here, again, we get no further, and the infusion requires a something more to give it a start in life. As might be predicted, these changes are all modified, accelerated, or retarded by the action of light, heat, season, and so forth, and by the presence of any albuminoid material. If fresh-caught rain water be filtered and excluded from atmospheric influences, the appearance of both vegetable and animal life is very much delayed; but when fresh and clean rain water is exposed to the air, *Protococcus* quickly makes its appearance, and with it *Amœba*; the cells of the *Protococcus* soon throw off zoospores, and the *Amœba* take possession of the cells and feed upon the zoospores. I mention this latter circumstance, because some observers, both before and since Cienkowski, having doubtless seen the same occurrences, have stated their belief in the conversion of the contents of the cells of the *Protococcus* or *Chlamydococcus* into a free moving mass of amœboid bodies.

Mr. Carter, well known for his valuable contributions to microscopical science, was one of the first to notice and promulgate this apparently impossible transitory condition of the volvox-zoospores; but he afterwards saw fit to change his opinion, and in place of looking upon it as the conversion of the vegetable protoplasm into that of an animal, he now believes that the germ of the *Amœba* must have been included in the vegetable cell, or as a parasite made its way into its interior; and remarking upon his first statement, that *Acitenæ* are thrown off by *Vorticellæ*, he writes thus: "Seeing, then, the great analogy, if not real identity, that exists between the nature of these organisms, I would suggest that the germ of the *Acitenæ*, like the egg of the *Ichneumonidæ*, becomes encysted in the *Vorticellæ*, and lives upon its host." *

* Carter. *Note on Organization of Infusoria*. *Ann. Mag. Nat. Hist. Series 3*. Vol. viii., p. 207.

To my mind this view scarcely admits of a doubt, and it is clear that the young of the *Amœba* in some manner find their way into the cell, just as it is on the point of breaking up, and so become developed in a situation where they are at once provided with a due amount of nourishment for the support of their earliest state of existence. I must not, however, omit to say that no less an authority than Dr. Hicks still holds to the former opinion, and fully believes, after many careful observations, that these bodies, which move freely about in the cell, ever changing their position, protruding and retracting portions of their membranous walls, exactly as the *Amœba* do, are really and positively what they appear to be, animals belonging to the class of *Rhizopoda*. He further observes, that after the amœboid bodies have begun to shift about in the cell, for every such moving body there was a corresponding empty space; and he cannot suppose it possible that any parasite could enter the cell from without, but that every examination tends to confirm his opinion that the amœboid organism is really the product of the metamorphosis of a mass of vegetable protoplasm.

Another careful observer, Mr. Archer, of Dublin, has also recorded the development of amœboid bodies in the cells of *Stephanosphaera pluvialis*; he looks upon the phenomenon as analogous to that which is known as occurring in one of the stages of development of the *Gregarinida*, the encysting stage; the central nucleus and vesicle disappear, and after a certain time "the mass breaks up into a series of rounded portions, which become elongated and slightly pointed at each end, constituting a little body which has been called a 'pseudo-navicella,' from its striking resemblance to the Diatomaceous navicula; the capsule next bursts, and the pseudo-navicellæ are scattered, and pass out of the body of the creature which they inhabited." *

Dr. Hicks believes that he has seen the young volvox pass into an amœboid state; in other words, the conversion of the protoplasm of a vegetable cell into an animal. He says, "Towards the end of the autumn the endochrome mass of the volvox increases to nearly double its ordinary size, but instead of undergoing the usual subdivision, so as to produce a *macrogonidium*, it loses its colour and regularity of form, and becomes an irregular mass of colourless protoplasm, containing a number of brownish granules." †

* Huxley.

† I have continuously had the volvox under the microscope during the past summer and autumn, and made more than a hundred examinations without having once seen anything approaching to the form of an *Amœba* in the interior of the cell.

The final change and ultimate destination of these curious amoeboid bodies have not yet been made out; but from Dr. Hicks's previous observations, made on similar bodies developed from the protoplasmic contents of the cells of the roots of mosses, "which in the course of two hours become changed into ciliated bodies," he thinks it very probable that this is designedly the way in which these fragile structures are enabled to retain life, and to resist all the varied external conditions, such as damp, dryness, and rapid alternations of heat and cold. "The philosophic mind," observes Mr. Carter, "takes up this line of argument." No one can at first sight witness the changes which take place, almost like a dissolving view, in the protoplasm and chlorophyll of *Chlamydococcus*, *Eudorina*, and in that of the cells of the *Algæ* generally, and during which they pass from their original form into that of a rhizopod, without inferring that the form produced is merely another one of that which preceded it, and not an absolute change. Hence my description of the fancied passage of the vegetable protoplasm into *Actinophrys*.*

Passing on to the consideration of another stage of this inquiry, we must be struck with "the remarkable powers of multiplication by fission and gemmation which many of the group exhibit; within the last few years the investigations of Müller, Balbiani, Stein, and others have shown that these minute creatures possess a true process of sexual reproduction, and that the sexual organs are those which have been hitherto denominated the 'nucleus' and 'nucleolus.'"[†] And ultimately it will be found that the infusoria have a life history as important as that of the higher classes of animals. Dr. Grant in 1851 recorded the presence of ova in one of the marine sponges (*Tethya*), thus showing that the Protozoa formed no exception to the other sub-kingdoms of animals in the possession of these essential elements. Five years later his observations were corroborated by Lieberkuhn, in the case of one of the fresh-water sponges. Even then the existence of the generative elements still remained to be demonstrated in the Infusoria. Ehrenberg, it is true, had drawn particular attention to the "nucleus," and some others took note of certain minute filaments, but there these observations rested. Now, however, the whole aspect of this subject is changed, and for the vagueness which, four or five years ago, charac-

* The circumstances under which the moss-roots should be placed to show these phenomena, are to float any common moss on a glass of water in the shade; and when the radicles thrown out are of a considerable length, they may be removed to the slide and examined. Care must be taken not to expose them to too much light and heat.—Dr. Hicks's *Quarterly Journal of Microscopical Science*, 1862, p. 103.

† Huxley.

terized all attempts to explain anything like a generative function in the Infusoria, we have substituted, by Balbiani, a clear and complete survey of their leading phenomena. The Infusoria have long been known to multiply by spontaneous fissure, gemmation, and the production internally of various formed bodies, which many observers have described under the name of "embryos." The phenomena of "encysting," "conjugation," etc., which these minute bodies frequently exhibit, and the relation, real or supposed, between such processes, and their various modes of propagation, have from time to time afforded matter for no little controversy. M. Balbiani's investigations, however, derive additional interest from the very complete manner in which they have been carried out. As an instance of this, he states that in his examination of *Paramœcium aureliæ* he could not look upon them as conclusive until he had succeeded in extracting uninjured some of the eggs from the parent body, and had subjected them to the action of the surrounding water; when he saw each egg resolve itself into two portions, the smaller being enclosed within the larger, then by employing reagents, acetic acid and iodine, he produced the changes more rapidly; and in this way again and again obtained abundant proofs of the truth of each observation. So much then for Dr. Balbiani's researches on the phenomena of reproduction among the Infusoria, which have added most valuable information to our former meagre knowledge of these interesting forms of organic life.

The case of the Infusoria is, in some respects, comparable to the fertilization of Orchids, which Darwin has investigated with so much care, and rendered doubly interesting by showing how highly complicated are the contrivances by which among this beautiful and extensive group of hermaphrodite plants, fertilization is accomplished, and that, save in a few exceptional instances, self-fertilization is almost impossible. Comparing the Infusoria with Orchids, we may see that their fecundation is effected by constant dissimilar elements produced in different individuals; and in both cases the details of the process are curiously varied in their several tribes.

In 1819 Chamisso detected the mode of reproduction of the *Biphoræ*, and coined the term, "Alternation of Generations."* He found that the isolated *Salpæ* only produced chained-salpæ, and then only by gemmation; whilst the chained-salpæ produced isolated ones, and only by ova. The discovery of the now well-known life history of the *Medusæ* was next made by Saars and Siebold; it was shown that the *Medusa aurita* deposits an egg, which gives rise to a polyp,

* This term is more generally associated with the name of Steenstrup, the well-known author of a learned and valuable treatise on the subject.

which grows by gemmation and fissuration, and produces from a single individual several small medusæ, which again in their turn produce ova. Other phenomena were soon collated with these, as the fissiparous generation of Annelidæ, the various processes exhibited by certain Spongidæ and Infusoria. In 1845, T. Müller described the remarkable larvæ of the *Echinodermata*, from whose viscera the future perfect being is thrown off by a process of gemmation; and the researches of Kuchenmeister and Van Beneden afterwards fully illustrated the remarkable migrations and metamorphoses of the Helminthoid worms. "In the *Distoma* the embryos have at first the form of ciliated monads, these are metamorphosed into Gregarina-form worms, and in the interior of each of the latter, numbers of *Cercariform*, or tailed animalcules, are developed, which ultimately become true *Distomata*."

Quatrefages and Professor Goodsir, however, look upon all this as simply a part of the process of growth, comparable to the growth of a lost or mutilated limb in the Crustaceæ. The gemmation of the Hydra, the medusification of the Polyp, the peculiar virgin-propagation of the Aphis, the segmentation of the Nais, the gradual development of the Echinoderm within its Phitean larva, and all similar instances, are regarded as mere phenomena of *growth*, and not as illustrations of the *Parthenogenesis* of Owen. And this view is now held by nearly all biologists. We might even go a step further and point out that recent investigations have established the wide spread existence of *polymorphism*. One of the fungi has been known to possess six different kinds of fructification; the *Uredo* exhibits four, and others might be named, which were formerly looked on as distinct species.

In some of the gemmiparous animals new creatures are at times multiplied to an almost incredible extent by simple mechanical division. I have seen, after breaking away an Actinia from the side of my aquarium, a number of small pieces of the foot-stalk left adherent to the sides of the vessel; all of which fragments became in a few days perfectly-formed young Actiniæ. The *Hydra viridis* may, as we know, be divided longitudinally, or transversely, into several parts, and each part will become a perfect polyp; or if a wound be made in the body of the animal, a new one sprouts from the site of the injury.

"The gemmiparous form of generation is met with in a large variety of animals. It exists in the Infusoria, Entozoa, Polypi, Medusæ, Annulata and Tunicata. In the *Nereis* a constriction first appears in the tail of the animal, immediately behind which the head of a new *Nereis* is developed, and the posterior division becomes separated from the anterior, or parent, as a

perfect animal. In this form of reproduction animals are formed, not from ova, or from the fission of primary reproductive cells, but from secondary or derivative germ-cells, placed in reserve in the tissues of these animals. The same process occurs in the *Triton* or the lobster, when a broken-off claw or tail is replaced, the new formation springs from derivative germ-cells placed in the claw or tail—that is, a reserve of derivative germ-cells, not wanted for use in the general development, is deposited in these different parts of the body.”*

Professor Goodsir believes that “the regenerative faculty does not reside at any part of the claw of the lobster indifferently, but in a special locality at the basal end of the first joint. This joint is almost filled by a mass of nucleated cells surrounded by a fibrous and muscular band.”

With respect to the *Hydra*, its reproduction is indifferently by gemmation or by true ova. The young *hydra* from the egg is identical in structure and character with that produced by budding. Nearly all writers now regard gemmation and generation by ova as two essentially distinct processes; nevertheless, the identity of the results is clearly seen in Mr. R. Crouch’s observations on the Sertularian Polyps. “At certain seasons of the year,” he says, “they produce cells much larger than those of a more permanent character. These are at first composed of the granular pulp of the stem, afterwards the pulp becomes furrowed, and finally formed into cells. After a short period they separate from the parent, and undergo the process of development. If these cells attain a certain size they are developed into eggs: if, on the other hand, they are stunted by cold, or otherwise interfered with, they are formed into polyps, while, if from further unfavourable circumstances they are rendered still smaller, they grow into branches, and thus we see that, according to circumstances, different organs are capable of being eliminated from the same structure.”

It appears, then, that there are three forms of reproduction, fission, gemmation, and generation by ova; in other words, “*Fissiparous*, when a cell spontaneously divides into two or more: *Gemmiparous*, when a plant or animal sends forth young branches from its stem; *Oviparous*, when the young are produced from seeds or eggs.” If we endeavour to arrange the known facts of reproduction, proceeding from the simple to the more complex, we must begin with a very simple process; namely, that of a single cell spontaneously multiplying itself by subdivision. In all the albuminous, starchy, or gelatinous matter called *protoplasm*,* a single cell appears, it assimilates

* Huxley’s *Lectures on Comparative Anatomy*.

† *Protos* (πρῶτος) first, *plasma* (πλάσμα) formative substance.

more and more of the fluid portions of the protoplasm, and then divides into two parts, perfectly symmetrical; these two quickly divide into four, eight, or sixteen, and so go on multiplying until a number of cells is produced, each cell being attached to its fellow by its wall, but capable of a separate existence. By this process of subdivision, a single cell of *Protococcus nivalis* (Red snow plant) has been known to redden in a single night vast tracts of snow, and the *Bovista giganteum* is estimated to produce in one hour no less than four thousand millions of cells. Ehrenberg computed the increase of the infusorial animalcule, *Paramœcium*, at two hundred and sixty-eight millions in a month. This simple mode of reproduction is certainly identical with that of growth of both plants and animals of a higher type.

If we ascend a step we reach the second form of reproduction, namely, the union of two *similar* cells, termed by botanists "*conjugation*." This consists in the coalescence of two similar cells to form a new starting point from which multiplication may proceed. Instead of two cells in the same filament we may have two cells in contiguous filaments coalescing, but in each case it is the union of two similar cells. From the fission of one cell into two, and the conjugation of two similar cells, we pass to the third mode of reproduction, namely, *generation by ova*, or the union of two dissimilar cells, and for the production of the more complex organisms, the union of germ with sperm-cells is indispensable.

By these several separate modes of reproduction we must admit that there is nothing more marvellous in an animalcule producing several millions of its kind, than in a plant constructed by as many cells, each produced by a process identical in every way. In the development of the tissues of the animal body, the newly-formed cells increase by division: and become determined in their growth by the character of the secretion elaborated within the walls of those previously existing. The formation of the more complex animal tissues takes place in the same way as that already noticed in plants, with this difference, that the mother cell contains a nucleus, within which is seen a very minute body called a nucleolus. The nucleus has the power of appropriating, or drawing in, a certain portion of the surrounding material—protoplasm—enlarges, and ultimately divides into two perfect cells. From the aggregation of such cells we have the animal body built up in all its complexity.

We have thus far traced the development of organic life through some very curious and highly interesting stages, and we have seen that life, in all cases, whether in the highest or lowest forms, depends upon perfection of organization for

development and maintenance ; but it must not therefore, as we said before, be supposed that it is altogether the result of organization, for death may occur without any trace of organic lesion to account for it. Nevertheless, the extent of organization necessary to the enjoyment of life is apparently very small indeed. A simple cell constitutes the entire organism of such plants as the *Chlamydococcus* or the *Palmella cruenta*, or even an animal, as the *Amœba*, and in these and such like simple structures resides a vital principle on which its integrity depends. But whatever the *extent* of organization may be, its perfection is essential and necessary to the maintenance of life ; for, as we now know, the seed which has been dormant a thousand years will, if its organization be perfect, spring into activity when planted ; but if crushed, its living principle is destroyed, and it will no longer germinate. Thus it is exemplified that to those minds familiarized with the phenomena of life, as manifested by the simpler organisms, the microscope "is not the mere extension of a faculty, it is a new sense."

THE NOVEMBER METEORS.

BY HENRY J. SLACK, F.G.S.,

Hon. Sec. Royal Microscopic Society.

ON the night of the 12—13th November the anticipated meteors were magnificently seen from my house in Camden Square, N.W. Occasionally mist and cloud drifted across the clear sky, but no large portion was obscured at any time between 11 p.m. and 3½ a.m., and when the interrupting vapours came, they were generally thin enough to allow the stars to peer through. At just about 11h. 8m. p.m. a magnificent fire-ball as bright as Jupiter passed over Betelguese and under Bellatrix in a nearly horizontal path. It had a beautiful greenish train, with undulating smoke-like edges. At (about) 11.37 a reddish meteor shot upwards under Mars, with a train lasting half a second. At (about) 11.41 another meteor shooting upwards, vanished near Castor ; and at (about) 11.48 a very fine one appeared under Rigel, slightly sloping to the south, and displaying a yellow and green train ; the train of this meteor was of a character frequently seen later in the night. The margins were like fine gold dust, and the centre a singularly beautiful pale emerald green. The golden yellow might be called between three and four of Admiral Smyth's scale, and the green though more emerald in hue, between the same numbers of his greens.

At (about) 11.51 two meteors shot from under Pollux and vanished beyond Orion; these had yellowish red trains. At (about) 11.54 the train of one west of Capella lasted from two to three seconds, and three minutes later the train of another exhibited the aspect of a narrow shower of closely packed sparks. At (about) 12.8 a meteor with a similar train, but red, appeared below Capella. At (about) 12.13 one shot up from below Mars towards Betelguese: the ball was orange and the train bluish green. At 12.13 I looked at a meteor moving towards Castor, through a Herschel-Browning spectroscope, and it exhibited all the colours; its train lasted about three seconds. About 12 p.m. my wife joined me, and while I looked from Leo to Orion, she watched a sky space from Orion to the S. W. Towards one o'clock the meteors came thicker and thicker, and from 1 to 1.30 it is scarcely an exaggeration to say that all the heavens were a blaze with fiery balls and long streaming tails of coloured light. The long trains stretched from 40, 50, to 60, 90°, and possibly greater lengths. In these cases a large proportion of the whole length of the trains was in a highly lustrous condition at the same moment of view. The effect was that of a continuous stream of burning particles left behind by the meteors in their course, and quite different from any luminous appearance that might arise from mere compression of the air in the fire-ball's flight.

Looking towards Leo it seemed as if a celestial rocket battery had been established in that constellation. A few meteors went downwards from γ Leonis, and many more upwards from the same star; but the majority had a more central radiant point. Upwards they shot by dozens, scores, and hundreds; now pelting past Procyon and through Orion, now bombarding Castor, then up to the zenith and down again: then through the Great Bear, under and over the pointers. Occasionally a little to the south of γ Leonis, meteors burst, and disappeared immediately, showing no trains. Probably their tails were behind them, and invisible from the foreshortening of perspective. At the same time the meteoric shower went on in descending curves west of the zenith point, and by 2.15 we had counted 1,400, excluding at least a hundred more seen before they came thick and strong, and our attempts to number them began.

At 1.22 my wife saw one perform a zigzag below Orion. The ups and downs of the ∇ it made, were shorter than is usual with forked lightning.

In addition to the long tailed meteors, we saw many with short fan tails. None of these reached any great height above the horizon, perhaps not more than 45°, and their tails exhibited glowing rainbow tints. These came from Leo. My wife saw some with light blue trains, and some with purple.

Catching meteors in a spectroscope is not an easy task. It is a sort of celestial snap-shooting in which there are more misses than hits. From the luminous glow which filled the whole atmosphere, and which was heightened by the London gas-lights, it was hopeless to spectroscopize trains, except at their brightest. Out of a dozen or two I saw through the instrument, the best defined spectra were yellow and green from the trains, and with all the colours when the nucleus or ball was in the field. My wife compared one she saw of a ball, to the spectrum of Sirius, but brighter.

I tried, ineffectually, to catch some of these shooting stars in my six and a half inch telescope, but they evaded me. I put on a large, low, eye-piece—an aplanatic of Horne and Thornthwaite, —which, with my instrument, gives a field of 4m. 15s, and pointed it at stars near which meteors were flashing, but although fresh supplies came in the expected direction, they provokingly went a little too high or too low.

The great majority of the meteors were as bright as first magnitude stars, such as Vega and Sirius; some as bright as Jupiter; others rivalled Venus, but few, if any, exceeded her. One of the largest I saw shot horizontally in the N. E, and burst with a irregular flame at (about) 2.38. A shower of sparks came from one near γ Leonis.

At the height of the shower the meteors came in batches and volleys. Sometimes two or more travelled close together, and at others, sets of four or five flashed in diverging courses from various parts of the heavens.

Near two o'clock I marked the paths of a good many on one of Herschel's British Association maps. Most of them seemed to converge to a point between α and ι Leonis, but the courses of several that passed through Gemini and Canis minor would, if continued straight backwards through their points of first visibility, have converged in Leo minor. The radiant point of the great majority was undoubtedly in Leo, and we must wait for Mr. Herschel to compare the various observations, and give us an accurate estimation.

The duration of the trains is probably underrated from their tendency to be lost prematurely in the general luminosity of the sky. Mr. J. Symons saw some for two minutes through a two and a half inch telescope. We saw several flashes like lightning, but whether they were really electrical discharges, or the light of meteors bursting out of sight, I cannot tell.

From the impossibility of two persons seeing and counting all the meteors, the total number must be set down as considerably in excess of our enumeration. We counted 1500 by about 3 a.m., and adding 100 or so seen earlier, this makes 1600—a portion only of the entire display. If these bodies are

regarded as microscopic planetoids, one night has consumed—burnt up—many thousand little worlds, and their remains are diffused in our atmosphere, or scattered unnoticeably on our earth. To meet and burn up a shower of these little bodies and convert them into most glorious fireworks is a pleasant incident in the journey of our earth-ball through celestial space, and perhaps the most enthusiastic advocate of the habitability of the planetary worlds does not consider that we have brought to a fiery ending the lives of microscopic populations on these tiny globes.

These shooting-stars, periodically met with in swarms, appear to be circling round the sun like larger planets, and it happens at recurring intervals that their orbit crosses ours when we are near enough to attract them into our atmosphere, which they enter with velocities of thirty or forty miles a second, and get burnt up through the heat which the friction engenders. A cannon-ball moves at about 1600 feet per second at its greatest velocity, and when we consider how insignificant this motion is when compared with thirty miles a second, we may imagine the intensity of the heat developed by friction even against the particles of highly attenuated air.

From the small size of the bodies of the shooting-stars their bombardment of our earth is unable to do any harm or produce any visible effect on its surface, but if there be swarms of bodies as big as the great meteoric stones, and likely to get in our way, future astronomers may not find watching a meteor shower so agreeable an affair as those of this generation found their labours on the famous November night in 1866.

We may add an interesting observation of the Rev. E. L. Berthon of Romsey, who says—"One most brilliant, rose coloured globe, which passed through Gemini below Pollux, left a long train of blue light, which continued like a comet 16° long for three minutes, and then gathering itself gradually into a wisp, remained in sight for six minutes and twenty seconds." Between one and two o'clock Mr. B. Scott, F.R.A.S., saw from Weybridge two meteors in the west, which he describes in the *Morning Star* as "revolving, like partners hand in hand in a country dance, round each other, describing spirals of light."

Papers already published in the INTELLECTUAL OBSERVER will supply much information for which we have been asked, and we shall resume the subject in our next number, supplying full answers to inquiries for popular expositions. A general account of *Falling Stars and Meteorites*, by Professor Ansted, will be found in vol. iv., p. 157. In vol. i., p. 217, is a paper by Mr. A. S. Herschel, on the *Observed Heights of Meteors*, illustrated by a diagram. In vol. iii., p. 31, is a translation from M. Quetelet's *Physique du Globe*, containing much valuable information on shooting stars, with a diagram, showing the

frequency of these meteors in different months. The meteor of Nov. 22, 1862 (with a sketch) is described by Mr. E. J. Lowe, vol. ii., p. 422. *Remarkable Detonating Meteors* of Feb. and Nov., 1865, are described by Mr. Herschel, vol. ix., p. 99. The "Herschel-Browning Spectroscope," is figured in the article called *The Coming Meteoric Shower—Spectra of Meteors*, Aug. number (1866), p. 38. In the last paragraph but one of this article, read *gaseous* matter instead of "porous." This paper contains important extracts from Mr. Herschel's lecture at the Royal Institution. The October number (1866) commences with a most important paper by Mr. Herschel on the *Prismatic Spectra of the August Meteors*, illustrated by a coloured plate.

FATIO ON THE FORMS AND COLOURS OF PLUMAGE.

M. VICTOR FATIO has kindly sent us a copy of his important paper on "*the Different Modifications in the Form and Colouration of Plumage*,"* of which we shall proceed to give an account, with extracts from the more important passages.

Speaking of the down first developed in birds, M. Fatio says, "In the thickness of the skin, on a growing bulb, and in the place of the future feather, the down grows and developes itself in a manner analogous to that which we shall presently study in the feather. It moves on little by little as it grows through the cutaneous layers, and at last pierces the surface in the form of a hairy looking material, ordinarily composed of eight to twelve, and sometimes of as many as twenty-four distinct filaments. This down does not always possess a stem and central axis like the barbs of a feather, and resembles those barbs which are held together by the extremity of a small special sheath. Down not only belongs to a young age, for we find it as a protecting covering of adult birds, whether garnishing the base of the stems of nearly all feathers, as a material without axis, at the base, and in the middle of the principal stem, or lastly when arranged on a separate stem, isolated and developed in the single tube of the principal feather, and lining to a greater or less extent its internal surface. This arrangement constitutes the double feathers of our Gallinaceous birds, and of our birds of prey, and is seen in the triple feather of the cassowary of the Indian Archipelago."

M. Fatio enumerates three sorts of down—cutaneous down, basilar, and feather down. The first is directly attached to the skin, the second confined to the basal portion of the feathers, and the third to the principal stem at the sides of downy feathers. The barbs in these downs vary a little in form, but

* *Des Diverses Modifications dans les Formes et la Colouration des Plumes*, par Victor Fatio. (Tiré du Memoires de la Societé de Physique a d'Histoire Naturelle de Genieve, tome xviii, 2me. partie.)

still more so the barbules in different groups of birds, or in different positions of growth. Down is often coloured: sometimes by the irregular diffusion of an internal pigment, in its barbs and barbules, and sometimes by pigment deposits in regular order and definite positions, and in parts swollen out, like the antennæ of certain insects.

“After a greater or less lapse of time the feather, which has followed the path prepared for it by the cutaneous down, drives before it the latter and its sheath, and at last thrusts out its downy termination. The great quill feathers, whether wing or tail, generally appear first, and a feather generally consists of a *stem*, or central axis; *barbs*, or secondary axes, lateral or branching from the former; *barbules*, tertiary axes implanted in the barbs, or between them on the stem; *hooklets* (*crochets*), appendages of the barbules, or quaternary axes.” These parts exhibit an *epidermis*, formed of flat, irregular cells, and below this a larger *cortical substance*, formed of elongated cells, or their fibres; and in the centre a *medullary axis*, continuous or segmented, formed of regular pigment cells, polygonal or rounded. Besides down and feathers, most birds have, on the nostrils or feet, piliform feathers, which, as their name intimates, resemble the hair of animals. They are stems without barbs. Some birds, like the wax-wing (*Bombycilla garrula*), have horny and coloured developments at the end of some of their feathers, which, as we shall show, are probably barbs conglomerated together. Other species have defensive spines composed by the union of several feathers, united by extravasated pigmentary matter, and strongly reminding us of the formation of rhinoceros horn, by the coalescence of hair.

In studying feathers, M. Fatio says we must distinguish in the hooklets between those which have true quaternary axes and those which are merely outlying portions of the cortical matter. The first feather of a young bird is not always constructed exactly like that which succeeds it. Its barbs are lower and more distant, and its barbules have fewer hooklets.

In a young bird still in its shell, Engel has shown the existence of definite spots and rows of mother cells from which the feathers arise. “The primary cell divides into smaller cells, some of which accumulate in a basilar bulb, and then range themselves round the circumference, and others occupy the centre. The sheath which envelopes these primary materials, has at its base an orifice, commonly called the *inferior umbilicus*, and through it pass blood vessels, which convey to all parts the elements necessary for their progressive development. The plastic pigment-bearing matter forms gradually, and the cells which it produces, and as they take up their places they elongate

the rudimentary feather, which, furnished with its envelope, advances obliquely under the epidermis. The constituent pigmented cellules, polygonal, round, and nucleated, arrange themselves in series, composing the barbs, barbules, and axis of the feather."

"As the cellules which constitute the cortical portion develope and group themselves, their nuclei disappear in part, and they elongate themselves and assume a fibrillose form."

When the end of the growing feather has become firm enough to pierce its sheath, it puts forth the terminal barbules of the perfect feather, at first rolled round their axis, but soon developing into a tuft by the elasticity they acquire in drying. "They are coloured as the extremity of the adult feather should be, and have received already all the pigment which they will obtain." As the growth proceeds, each part receives on emerging from the sheath all the elements of colour which it will afterwards exhibit. At a later period the blood vessels are obliterated, the inferior umbilicus closed, and the sheath thrown off, and the pulp which constitutes the life of the feather dries up.

In a chapter on "true moults," M. Fatio explains that each bird, whatever its species, receives in its first feathers a certain dose of pigment, and after its first moult the new feathers are supplied with a fresh dose of new pigment, which, being differently elaborated, causes the bird to assume a different livery. M. Fatio regards the autumn moult as the true and most complete one, while the spring moult is more or less complete as the existing feathers are capable or incapable of modification. The special decorations which appear on the head and neck at the love season arise from local irritation. When a feather has gone through its course of growth and modification, it gradually dies, and is usually thrust out by a new feather growing at its base. M. Fatio cites on the authority of M. Linnel, the case of a goldfinch which had two complete sets of wing feathers, resembling a double set of teeth; the new ones having emerged a little out of their true direction, and not having thrust the others out.

"We have seen," says M. Fatio, "that when a feather has reached its natural size, and has thrown off its external sheath, the internal marrow dries up, and an operculum closes the inferior umbilicus. This drying up and closing are most complete in the longest feathers, but in no case is there any further supply of blood. The researches which I have been able to make on this subject, in many birds, as well as the observations of many authors, like those of M. Martin at the *Anas nigra*, demonstrate that the skin at the base of a dried feather does not exhibit the local inflammation or sanguine turgescence

noticeable at the base of a growing feather. A feather once dried, receives no more blood or pigment, because it no longer grows from its base."

Besides variations of colour produced by moults, other colour changes occur in most birds, taking place gradually from the end of the autumn, and in some cases going on rapidly at the approach of spring. Two principal phenomena are exhibited in these colour changes: "the interior pigment dissolves and spreads, while the extreme parts of each feather fall and allow the new colouration to appear, which has been formed below them, and thus showing suddenly a new livery which had been concealed."

M. Fatio describes the latent colour as residing in pigmentary granules, not dissolved, isolated, or grouped, and usually confined to the centres of the different parts of the feather to which they are to impart a new colouration. The colour which is seen is spread through the cortical substance of the same parts, and arises from an anterior colouration of other pigment granules, or of a subsequent solution of latent pigment deposits. Light, atmospheric moisture, and temperature are agents influencing these changes, operating in conjunction with food and the sanitary conditions of the bird.

"Here," exclaims M. Fatio, "are two feathers from the same part of the same bird—one an autumn feather, uniform, or variegated, with clear tints, dark, but comparatively feeble and not lustrous; the other, a spring feather with more definite and brilliant colouring. I place the autumn feather under the microscope, and, studying it with magnifications of from 80 to 300, I notice in its tissues the two conditions just spoken of; the colouration more or less strong, transparent, and diffused: and also its internal deposits somewhat diminished, or disappeared, from the extreme parts, such as those of the barbs and barbules. The pigment in the axis has been dissolved in, and spread abundantly through, the surrounding cortical substance; some parts being largely developed in their proportions."

After citing the opinions of other observers, M. Fatio describes his own experiments, and states that by exposing the feathers of the starling and linnet to the influence of moisture by immersing some in water, and floating others on the surface, they soon exhibited a sensible development of their cortical substance in the barbules of the starling, and in the barbs of the linnet. At the end of twenty days the pigment was not dissolved, or only so imperceptibly.

In another experiment M. Fatio moistened feathers with water, and gradually heated them on a plate of glass. He noticed at first a slight extension of colour in the tissues, and

when the moisture was evaporated, a perfect sketch of the barbs and barbules was traced upon the glass by a deposit of greasy matter.

In another case he wetted the feather with alcohol, but still obtained the sketch in greasy matter, which he considered to demonstrate that besides the coloured pigment, most of the tissues contained a little colourless grease.

Having satisfied himself that this diffused and colourless grease did not act as a solvent of the pigment granules, to which he ascribed a greasy nature, he made further observations thus described:—"I set to work to study and compare under the microscope the basilar tubes (quills) of different feathers in process of colouration, and I noticed always many greasy colourless cellules in the tissue of the tube, in its inside, and in the cortical substance of the parts nearest the stem, close to the spot where many of the feathers exhibited a marked strangulation. I could not, however, make out the channels this grease must follow, and I endeavoured to dissolve it on the field of the microscope. Having introduced a drop of ether between the two glasses that enclosed the feather, I saw like a circular canal, opening at the base of the stem, and probably able to conduct the grease between the remains of the subcutaneous sheath and the external wall of the tube; and I noticed within, a possible direct communication, between the hollow of the tube and the broad layer of cortical substance which looked like a channel of porosity. I speak now of small feathers, in which a less complete internal desiccation may more easily allow this internal circulation of greasy matter than the large feathers, in which the cortical substance becomes more opaque and horny with lapse of time."

To test these suppositions, M. Fatio dipped the quill ends of two small feathers in solution of carmine, having left one intact, and stripped the barbs off half the stem of the latter. At the end of twenty-four hours he found the carmine had ascended either externally between the sheath and the quill, or internally through the diaphragms formed by the cortical substance. In the first feather the fluid had ascended comparatively little, because it was carried off laterally by the barbs; but in the second it rose up to the point at which the barbs were left.

M. Fatio in further pursuit of his analysis, "procured a linnæus whose breast feathers already showed a little of their spring colours, and having delicately applied to them the grease contained in the bird's oil-glands, soon perceived a more intense colouration, which was increased by heat. This colouration was not fugitive like that which grease or water will

produce on any feather, but remained intense and brilliant after many washings with alcohol and complete drying." The same experiment succeeded with the feathers of a finch (*Fringilla cœlebs*) and similar results were obtained in a few minutes by the use of olive oil.

With reference to the large feathers, M. Fatio remarks that birds in preening their feathers pass their beaks all along each wing and tail feather, regularly taking a supply of grease from the oil-gland. He adds, "if a change of colour does not begin regularly at the extremity of a wing feather, as is usual with the smaller feathers, it is because it is much more exposed to the action of the air than the latter. And if sometimes the colouration does not proceed regularly in a small feather from the periphery towards the centre, it is for the accidental reason that some parts have been more exposed to moisture and light, or more readily penetrated by the grease." He further observes that the oil-gland becomes larger at the approach of the love season, and that fat birds usually exhibit the most intense colours.

"The external grease is absorbed by the barbs and barbules, and penetrating by endosmose or capillarity the more or less porous tissues fills the empty spaces, and finding its passage facilitated by dilatations occasioned by moisture, it gradually dissolves the fatty pigments they contain."

"Thus under the influence of moisture, alternately absorbed and evaporated, as a preparatory developing agent, afterwards of the grease of the body as a solvent, then of temperature and light facilitating chemical action, the feather colours itself, and changes and augments its tints."

Referring to the labours of other observers, M. Fatio employs the divisions of Bogdanow, but adds to his "ordinary feathers" others which he calls mixed, and to his "optical feathers" others which he calls enamelled (*emailées*). "Ordinary feathers," although often brilliant, do not exhibit metallic reflexions, and they show by their transparency an internal pigment resembling the colour they exhibit by incident light. The "optical feathers" exhibit reflexions, and show by their transparency an internal pigment of a different shade to the colour they assume in incident light. The linnet furnishes "ordinary," and the starling "optical feathers." "From their first appearance out of their sheaths, I see," says M. Fatio, "essential differences between the ordinary and the optical feathers which grow after the autumn moult on the breast of these two birds. I perceive, it is true, on all those parts which are about to fall, that they are grey or brownish in the linnet, or white or yellowish in the starling, but I notice in the former, barbules slender and slightly coloured, while in the latter the

extreme barbules are already large, well coloured, and even showing metallic reflexions. As these feathers finish their growth, as well as after their complete moult, they show the same difference—an inferiority of development and colour in the barbule of the ordinary feather as compared with an optical one. If I look at the feathers of the same birds in spring, I am struck by a series of differences which multiply more and more between the ordinary and the optical feathers, as I enter more minutely into their details of development, structure, and colouration. In the first place to the naked eye merely, the linnet's feather is shortened through the loss of its brown extremities, and has become red by a more complete solution of its internal pigment, whilst the starling's feather which has lost its white tip, and the ends of its upper lateral barbs has taken a more thread-like aspect (*effilée*) whilst its reflexions are much more brilliant and extensive. Under the microscope, in the ordinary feather, the barbule, instead of developing, is seen in many places to have fallen off, whilst the barb or secondary axis is enlarged and coloured, especially at its extreme portions. In the optical feather of the starling the barb has slightly changed, while the barbules, or tertiary axis are much developed both in size and colour."

"The barbs, or branches of the single stem, are in general formed of superimposed segments, more or less persistent, and the barbules constructed on a similar plan, are implanted in the barbs by their basilar segments. This base of the barbule is larger and stronger according to the period, and the nature of the feathers; but internal communications appear always to exist, which may render possible a mingling of pigments between the two axes of optical feathers, and between the same parts of ordinary mixed feathers. All the barbules are, like the barbs, composed of larger or smaller segments, arranged end to end and enveloped in a common epidermis; but as their segmentation has much more importance than that of the barbs, let us see the chief differences which exist between them in spite of their unity of structure."

"1. The lines of demarcation between the segments of optical barbules are much more decided than in ordinary barbules; or, to speak explicitly, separating diaphragms of these different parts are stronger in the former than in the latter. 2. The granular pigment deposits ordinarily diffused in the central nucleus of the segments, are always more abundant and more regularly distributed in the first than in the second. 3. We distinguish around these dark nuclei a layer of parallel or longitudinal fibres, much thicker in the optical barbule than in the ordinary one. 4. The lateral hooklets of the optical barbules are in general more developed in autumn than in spring, and their function

is, as we shall see, different from those of the ordinary barbules."

"Moisture develops each part in proportion to its supply of cortical substance. In the optical feathers the barbules, only augment in diameter, and as each segment swells into a little cylinder, more or less regular, we sometimes see the lateral hooklets swallowed up (*noyés*) in the distended mass, and disappear more or less completely. In the ordinary feather, the barb possesses the most cortical substance and becomes most developed. Possessing all the qualities of the optical barbule, it becomes swollen and coloured, sometimes immersed in its own matter, but usually expelling its useless barbules."

"The ordinary barb becomes much dilated like the optical barbule; but instead of increasing like it, the proportions of its segmentation and separating diaphragms, it loses in its development the character which is associated with the persistence of the barbules in mixed feathers.

"The ordinary barb is simply a fibrous mass. It is at the moment of extreme dilatation of the cortical substance that the pigmentary matter, often extravasated, proceeds to unite and sometimes solder together adjacent barbs, to form certain masses which have a horny appearance, and which we have spoken of in the wax-wing. I have seen several of these accidental solderings in the red frontal feathers of the goldfinch. This enormous dilatation of the barb is only exhibited in those ordinary feathers which are destined to acquire a certain splendour or lustre, and there are many others which exhibit a mean development, and these we call *mixed*."

"*Mixed feathers* comprise all the feathers which undergo little change of form; they constitute a great part of the plumage of ordinary birds: they never exhibit metallic reflexions, are often dull, and though sometimes of a certain lustre, rarely show that brilliance which belongs to the ordinary feathers."

"The barbules of mixed feathers are persistent and in direct communication with the barb that bears them. These barbules dilate and colour themselves at the expense of the barbs, without exhibiting the regular form or the pronounced segmentation of the latter."

"In certain mixed feathers the colouring matter accumulates at the ends of the barbules, which often break at these points, and assume the truncated appearance of optical cylinders. I call these feathers mixed, because they resemble the optical feathers in their mode of development, and the ordinary feather by their mode of colouration."

"Those feathers which owe their colour entirely to the light, whether optical or enamelled, do not change their internal pigmentation, and only acquire their colours by changes

of form; but it is not so with the ordinary or the mixed feathers. They modify their colours either by augmenting the intensity of their original tint, or by replacing an old colour with a new one. In the first case there is a more complete solution of the internal pigments, and in the second an extravasation of the old colouring matter which disappears as an external dust, while a new solution is made of another pigment latent in the barbs. In this case it is rather difficult to obtain a complete solution by operating from without; and I think that since those birds which entirely change the colours of their great wing and tail feathers, modify their little feathers much less, it is probable that a particular grease developed in the body, and reaching the feather internally, may be necessary to a solution of the new pigment, which, as we have seen, is already deposited in the interior of the feather."

"The feathers I have called *enamelled*, comprise all the blue feathers without metallic reflexions, and some of the most brilliant green feathers which are without these reflexions. . . . These enamelled feathers always exhibit in the interior of their barbs at their birth as well as after a complete moult, large polygonal cells with coloured nuclei. Below the colourless epidermis and on the dorsal or upper face of new feathers, the microscope always shows a layer of elongated vertical cells, and their thickness gradually diminishes in advancing towards the lower surface. These cells constitute what I call the *enamel*.

"This transparent enamel is differently coloured and variable in thickness. Its tint gives the appearance of green or blue, and its thickness gives a greater or less fixity to the colours which often change from the finest blue to the finest green, and sometimes to a tint of delicate yellow. A very thick layer gives the appearance of an opaque colour. In spring the colouration increases, the barbs develop a little, and many barbules disappear, while in the meantime the dark internal pigment gradually dissolves, passing through transitive tints. The enamel only seems to be slightly soluble in the dissolving material in the axis."

M. Fatio gives the following summary of these various actions:—

"1. Of two successive axes the first develops always at the expense of the latter.

"2. In ordinary feathers, properly so called, the secondary axis predominates over the tertiary, and the chief changes take place in the barbs.

"3. In optical feathers, properly so called, the tertiary axis predominates, and the chief modifications are effected in the barbules.

“A. In mixed feathers the barbs undergo some changes, and the persistent barbules are much less modified than in optical feathers.

“B. In enamelled feathers the barbs though optical in pigmentation, swell and colour themselves; the barbules fall.”

We must, on a future occasion, return to M. Fatio's important paper.

NEBULAR AND STELLAR SPECTRA.—SOLAR OBSERVATION.—RED STAR.—PLANETS.—OCCULTATION.

BY THE REV. T. W. WEBB, A.M., F.R.A.S.

THE return of the glorious Orion Nebula to our evening skies will always be a source of pleasurable anticipation to the astronomical student: and now that its gaseous composition is fully recognized, the possibility of change will be a fresh inducement to its attentive examination. It must still remain a matter of strange and perplexing mystery, by what agency such changes of figure or intensity can be produced in free space; but it will be admitted that there is less difficulty in conceiving their existence in such a filmy mass, than among an innumerable host of stars, where the presence of mutual gravitation renders derangement of figure almost inconsistent with permanency of existence: and hence the alterations of figure and brightness already recorded or imagined, do not now appear so incredible as they might in earlier days, nor so probably if not certainly due to differences of instruments or climates. We have already on several occasions* referred to the opinions of eminent observers on this head, and we have now to add that renewed investigations have been in active progress on the other side of the Atlantic. A considerable time has elapsed since the late W. C. Bond published, in the *Memoirs of the American Academy*, a finely executed figure of this nebula, with a catalogue of the involved and adjacent stars, which has been thought open to some exception. Otto Struve, in particular, gave it as his opinion in 1857, that the latter was “crowded with errors, and worked without any system,” and that the author had “expended more care on the graphical representation of the nebula,” without, as it should seem, intending to rate even the diagram very highly. In consequence of these remarks, a careful review was undertaken with the noble instrument previously employed, an achromatic, by Merz,

* See INTELLECTUAL OBSERVER, iv. 258; v. 58; vii. 139; ix. 177.

of 14.95 inches aperture, and 22.5 feet focus, under the direction of G. P. Bond, the worthy successor of his father; and at his death, Feb. 17, 1865, we are informed that he left a MS. containing a thorough and systematic examination of the nebula; a work which continued to occupy his thoughts until a few days previous to his decease.

The Report of Harvard University, dated in the following month, states that "during the winter and early spring of 1864-5, minute observations were made on 59 nights, resulting in the discovery of many new features." The astronomers engaged assert that "it will require a long series of observations to determine whether there are variations of the form of the nebula, or of its light. It will also require many observations to get more precise results about the variability of the stars in the nebula." They think it a question whether the three apparently well-defined groups of stars represented to the naked eye as ι , ρ , and ϵ *Orionis*, may not be associated with the nebula itself, rather than barely superposed, a point deserving of notice being that many of the stars have nebulous envelopes. It seemed to them highly probable that these three clusters are coincident with three centres of aggregation of nebulosity; and they therefore extended their fresh survey $1\frac{1}{2}^{\circ}$ N, and as far S of θ , preserving nearly the same limits of RA, $16^{\circ} 52''$ * each way. Within this area they have determined the places of 1143 stars; the number in H's and Σ 's catalogues having been 155, a difference arising in part from the enlarged extent. "It has been found hardly possible to confirm Σ 's supposed discovery of variable stars, except in one or two instances. The special difficulty arises from the fact that a bad state of the atmosphere, and the consequent blending of the nebula with small stars in its immediate neighbourhood, renders the latter invisible." They have found 6, not identical with Σ 's, which show marked signs of change. They mention among their other results, the tracing of the connection of ϵ , and ι , *Orionis*, with θ , especially the great loop uniting ι with θ , one of the finest features of the whole nebula: the association of the nebulosity with stars by general aggregation round the three clusters—by wisps of nebula attached to certain stars—and by larger numbers of small stars in bright nebulous areas, contrary to the natural optical effect of a brighter ground: the spiral structure of the parts surrounding θ : and the comparative permanency of the form and aspect of the nebula, in contradistinction to the rapid variations supposed by Otto Struve.

These observations, so far as respects the extent and connection of the whole nebulous mass, are in exact correspondence

* There seems to be some mistake in these figures, which I am unable to rectify.

with those of Secchi (INT. OBS. vii. 139); and the possessors of the large silvered specula which are now coming into use will find it an interesting task to ascertain how far they may be able to confirm them. We have already mentioned the full recognition of the gaseous character of this marvellous phenomenon, which cannot be discredited after the accordant results of Huggins and Secchi; but it is gratifying to add that the resolution which has for twenty years been usually ascribed to the reflector of the E. of Rosse, has been disclaimed by its noble maker; his lordship having authorized Mr. Huggins to state "that the matter of the great nebula in Orion, which the prism shows to be gaseous, has not been resolved by his telescope. In some parts of the nebula he observed a large number of exceedingly minute *red* stars. These red stars, however, though apparently connected with the irresolvable blue material of the nebula, yet seem to be distinct from it." This alone was wanted, to set that most curious inquiry definitively at rest. One singular fact, however, may be noted here. The spiral arrangement ascribed to part of the nebulosity by the American observers is also a well-known characteristic of many clusters and groups of stars, and should its existence in the Orion nebula be confirmed, it will form a curious bond of connection between objects of a nature apparently most dissimilar.

An examination of former observations with the great reflector, for which we are indebted to Lord Oxmantown, leads to the important conclusion, that no object to which prismatic investigation has ascribed a gaseous nature has shown a stellar composition in the telescope; the widest discrepancy being that 6 nebulae giving a gaseous spectrum, had been considered "resolved, or resolvable?" at Parsonstown. The indications of the two very distinct and dissimilar modes of analysis seem therefore to be rapidly and satisfactorily converging. Our readers will be interested in knowing what results the spectroscope of Huggins has given with respect to the objects already enumerated in our list of clusters and nebulae. The following were all found to exhibit a continuous spectrum: by which is meant, in contradistinction to the insulated bright lines given out by incandescent gases, a spectrum similar to that of such stars as are bright enough for examination, and to that of our own sun.

No. 19 (INT. OBS. vi. 115). 11 M. 4437 Gen. Cat. "The continuous spectra of all the brighter stars were separately visible. When the clockwork of the equatoreal was stopped, an interesting spectacle was presented by the flashing in rapid succession of the linear spectra of the minute stars of the cluster as they passed before the slit. In no part of the

cluster was any trace of bright lines [*i. e.*, the indication of gaseous matter] detected."

No. 20 (INT. OBS. vi. 117). 13 M. 4230 Gen. Cat. "Spectrum ends abruptly in the orange. The light of the brighter part is not uniform; probably it is crossed either by bright lines or by lines of absorption."

No. 25 (INT. OBS. vi. 347). 56 M. 4485 Gen. Cat. "Suspicion of unusual brightness in the middle part of the spectrum."

No. 26 (INT. OBS. vi. 348). 81 M. 1949 Gen. Cat. "The red end of the spectrum wanting or very faint."

No. 27 (INT. OBS. vi. 348). 82 M. 1950 Gen. Cat. "The absence or great faintness of the red portion of the spectrum more marked than in the spectrum of No. 1949."

No. 29 (INT. OBS. viii. 207). 51 M. 3572 Gen. Cat. "A suspicion that some parts of the spectrum [of each of the bright centres] were abnormally bright relatively to the other parts."

Such is the result of prismatic analysis applied to nebulae and clusters with which we have been made familiar. In a very remarkable and suggestive note the author states that the peculiar appearance of the continuous spectra of some of the nebulae and clusters has suggested to him, from his first examination, that possibly the luminous points into which the telescope resolves some of them, may not be of the same nature as the true stars. The spectrum of the great nebula in Andromeda and its small companion was recorded in August 1864 as ending abruptly in the orange: and throughout its length not uniform, but evidently crossed, either by lines of absorption, or by bright lines. The same characters, he adds (as we have already seen), have since been found in several of the brighter nebulae and clusters: it would be possible to explain the absence of the less refrangible rays by absorption through vapour; but the apparently *complete* want of light at that end, and the unequal, mottled appearance of the brighter parts suggest rather a gaseous source; and that the spectrum consists of numerous *bright* lines: they are too faint, however, to admit of a sufficient contraction of the slit to determine this point. But some quite recent observations (June, 1866) not yet complete, appear to support the view that the bright points of some clusters may not be similar in constitution to the sun, or the brighter stars.

Thus it would seem that a new and unsuspected, and most singular field of inquiry is opened to the view of those whose instrumental means admit of its investigation. Such means, indeed, are rare. But if, where they exist, they were pushed to their full capability, much valuable aid might be given to

one whose name must ever stand foremost as the leader of the prismatic analysis of the starry heavens.

Another eminent observer, Secchi, has been diligently prosecuting spectroscopic, or, as he calls them, "spectrometric" inquiries, and has arrived at conclusions differing in some respects from those of Huggins. He has formed a classification of stellar spectra according to distinctly-marked types:—1. That of the bluish-white stars, such as Sirius and Wega, with dark bands in the blue and violet, including nearly one-half of the stars examined:—2. That of the red, or orange stars, with broad zones, such as Betelgeuse and Antares:—3. That of the yellow stars, comprising Capella, Arcturus, etc., marked by fine lines, and resembling the spectrum of our sun. To these are added a type the inverse of the first, found only as yet in γ Cassiopeæ and β Lyræ, and a type peculiar to Orion, distinguished by the intensity of the green. He has also observed in other regions the separate and special predominance of some one type of light. All this is certainly very remarkable, but is only given by himself as the result of a few evenings' work preparatory to a more general and detailed research. Before, however, any fully satisfactory conclusion can be attained, a question will have to be decided as to the nature of many of the bands towards the red end of the solar spectrum, the origin of which, as will be seen in our last number (p. 317), has been largely referred by M. Jansen, of Paris, to the presence of aqueous vapour. As to some of these confessedly delicate and obscure points, further investigation and the labours of many observers are obviously desirable. In such stellar spectra as are crossed by numerous dark bands, a difficulty has been pointed out in ascertaining whether certain intervening luminous spaces may not assume the deceptive aspect of bright and gaseous lines from contrast alone, and here the finest instruments will be required for the decision. As to nebulous material, it is frequently so deficient in luminosity as to elude all known means of analysis. Up to the beginning of the present year Secchi had discovered fourteen very feeble nebulae which had escaped all former observers; and has found occasionally large spaces where the sky has a milky aspect—the "diffused nebulosity," no doubt, of the Herschels. In the latter case there seems no impossibility in the idea of a vicinity to our own system, which, if it could be estimated, might perhaps surprise us. According to the Roman astronomer the nebula of Orion extends through all the space from ζ southwards to 49 and ν , two 5 mag. stars nearly on the parallel, and somewhat less than 2° apart, forming the bottom of the sword.

One of the most curious observations of this nature, for

which we are indebted to Secchi, relates to a singular convolution of nebulous streaks, RA. 17h. 55m. 18s. DS. $24^{\circ} 21' 15''$. This is M 8*, or Gen. Cat. 4361. He says (1865, Aug. 8) that this object "se trouve notablement changée. La portion qui divisait ses ovales a disparu, et les ovales ne sont qu'un canal presque continu." The ovals are three included spaces, one entirely, two others comparatively dark, which were, when figured by H. at the Cape (1837, June 27), divided by two streaks of irresolvable haze. There is, indeed, some difficulty in reconciling H.'s description and drawing (semi-inverted, it must be remembered, owing to his front view) with the expressions of Secchi. If I interpret the former aright, his three ovals thrown into one would not form a continuous canal, but an opening bent back at an acute angle, and Secchi seems to be referring to another opening described by H. as a larger and more ill-defined basin distinct from the ovals, and lying in the same straight line with two of them. But whether this conjecture may or may not be right, there seems strong evidence of change. H. observes that the nucleus (which is in the p streak) is not stellar, and greatly resembles that of the nebula in Andromeda. Secchi finds that under the spectroscope it exhibits "la raie ordinaire," the usual bright band of gaseous matter. To a suspicion that the great aperture of H.'s reflector ($18\frac{1}{4}$ inches, front view) might reveal interruptions of continuity which Secchi might not perceive, it might be replied that the former was on the other hand unsuccessful in tracing any connection between the principal mass of the Orion nebula and that surrounding the star c . 8 M is not included in the *Bedford Catalogue*; it has now left our evening sky, but may form an interesting object of search in another year, when Sagittarius is in a suitable position.†

SOLAR OBSERVATION.

The "Solar Caps" or dark glasses which have hitherto been adapted to the eye-pieces of telescopes to intercept the heat, and as much as is unnecessary of the light of the sun, are all more or less objectionable as giving a tint to the solar image which might interfere with the real colour, and in some cases perhaps affect the visibility of the more delicate details. A very ingenious contrivance has lately been introduced by G. and S. Merz of Munich to obviate this defect. It is well

* M 1 in the *Astronomische Nachrichten*, from a misreading of the Cape Observations.

† It should have been noticed before that subsequent investigation has shown the relative fixity of the nebulous star 45 μ iv. and its companion: so that the suspicion of proper motion advanced in INT. OBS. vii. 188, and derived from earlier measures, must be abandoned.

known that the rays of light, when reflected at a certain angle from a surface of glass, become polarized, and consequently will be either transmitted through, or reflected from, a second similar surface, according to the angle under which the latter receives them. In Merz's new solar eye-piece, 2 pairs of plane glass mirrors (of course, un-silvered), are so arranged as by the rotation of one pair relatively to the other, to intercept at pleasure the whole, or any required part, of the light transmitted through the telescope. Secchi's opinion of this contrivance is decidedly favourable. He says, "your helioscopic polarizing ocular is preferable, because it shows the sun of its true colour; thus films which appeared blue in the ordinary oculars with blue glass, are seen with yours of a rosy hue, the same tint as the protuberances which are seen during eclipses. This is an important fact." It is to be hoped that Mr. Browning or some other skilful optician will turn his attention to this construction in our own country, where the solar phenomena are at present attracting so much notice.

RED STAR.

In an extract from the Memoirs of the Astronomical Society, Vol. iii. p. 187, I find the following statement on the authority of H. "No. 895 (Σ) R.A. 6h. 12m. P.D. $84^{\circ} 12'$ [=D. N. $5^{\circ} 48'$] L full ruby red, or almost blood colour. S fine green, which it loses when the large star is concealed." This object from its double character may possibly have been intentionally omitted from the catalogue of Dr. Schjellerup, of which an abridgment was given in our Sept. number; but it seems likely to repay the search. It will be found near the nose of Monoceros.

PLANETS OF THE MONTH.

MARS is now rapidly approaching the earth, and becoming a telescopic object of much interest. As the opposition, which occurs on Jan. 10, will be somewhat more favourable than the last, as well as those for some years to come, we trust that all available telescopes will be employed in the scrutiny and delineation of his features.

The following remarks, by one so pre-eminent in the art of design as De la Rue, are too valuable not to find a place in relation to this subject. Speaking of the disagreement too frequently observable in astronomical drawings, he says, "These discrepancies no doubt arise in some measure from differences in the aperture and defining power of the telescopes employed; in other instances, much is attributable to the state of the atmosphere at the places of observation. The discordances

arising from the foregoing causes, would, however, not present so many difficulties, were astronomers, as a rule, able to delineate what they see with anything like an approach to accuracy of detail. Much confusion is created by the exaggeration of certain details which happen to strike forcibly the mind of particular observers, who give undue prominence to those features both as regards size and intensity. But astronomers are not responsible for the whole of the difficulties placed in the way of those who undertake the task of reducing observations; the steel-engraver, the lithographer, and the wood-engraver, are answerable for a great share of the confusion engendered by their very free translations of the drawings placed in their hands to be copied."

Mr. Banks, to whom we owe a beautiful series of drawings of this planet in 1864, published in the *Astronomical Register*, remarks that a considerable change will be found in the position of the poles, the N., which was then beyond the limb, coming more and more into sight, while the spots near the equator will be projected further from the centre of the disc, and follow a course much more curved upwards (as seen inverted) so as to render their identification more difficult.

URANUS will be very well situated for observation this month; at the commencement of it lying very near the *sf* edge of the fine cluster near *Propus* (INT. OBS. v. 54) and reaching at its opposition on the 27th, a station between 2° and 3° *sp e* *Geminorum*, a 3 mag. star standing about $\frac{1}{3}$ of the way from Pollux to Aldebaran.

OCCULTATION.

20th. B.A.C. 1526, 6 mag. 5h. 11m. to 5h. 59m.

ON SILK PRODUCED BY DIURNAL LEPIDOPTERA.

BY PHILIP HENRY GOSSE, F.R.S.

THE Rev. D. C. Timins, in his interesting paper *On the Habits of some Lepidopterous Larvæ* (INTELLECTUAL OBSERVER, Nov., 1866) says at p. 255, after describing a silken couch spun across a leaf by the caterpillar of *Charaxes Jasius*—"This is, so far as I know, the only instance of silk being produced by a member of the *diurnal Lepidoptera*."

The expression is too strong; for I need not remind Mr. Timins, I am sure, that the pupæ of the *Vanessadæ* and similar dangling forms hang from a dense conical button of silk spun by the mature caterpillars, while those of the

Papilionidæ and *Pieridæ* have, besides, a thoracic girdle of silk.

But my object in writing is not to correct this little oversight of phrase, but to mention a case very curiously parallel to that recorded by Mr. Timins, of a reposing couch of silk spun by the caterpillar of another showy butterfly, the Tiger Swallow-tail of North America (*Papilio Turnus*). Nearly twenty-seven years ago I thus announced the fact in question in my *Canadian Naturalist* :—

“September 1st. I have lately taken several of the fine green velvety caterpillars of the Tiger Swallow-tail, with violet spots on the body, and two eye-spots. It spins a bed of silk so tightly stretched from one edge of a leaf to the other as to bend it up, so that a section of it would represent a bow, the silk being the string. On this elastic bed the larva reposes, the fore parts of the body drawn in so as to swell out that part, on which the eye-spots are very conspicuous. I have taken it from willow, poplar, and basswood, but chiefly from brown ash. Before it spins its button and suspending girth, it gradually changes colour to a dingy purple.”— (*Op. cit.* p. 293.)

ARCHÆOLOGIA.

DISCOVERIES of considerable importance to English history were made in the latter part of the last month in the CATHEDRAL OF ROUEN, under the care of the well-known Norman antiquary, the Abbé Cochet. It is well known that, as far back as 1838, some well-directed excavations brought to light the original effigy, or statue, of Richard Cœur-de-Lion; the Abbé Cochet has discovered that of Richard's elder brother, HENRY COURT-MANTEL, the turbulent son of Henry II., who, as it is well known, was crowned during his father's life. Contrary to the statement of Montfaucon, who said that Henry's effigy was sculptured in white marble, the material was found to be the hard lias of Créteil, as was the case of that of Richard I. It is unfortunately much mutilated, and the body cracked through the middle. Still it presents many points of great interest. It represents a king of England and Duke of Normandy, and offers a faithful representation of the royal costume of the time. The young prince wears a tunic, or long robe, fastened under the throat by a handsome circular fibula. A girdle, buckled on the loins, is ornamented in its own length with St. Andrew's crosses, and other devices, in a very graceful pattern. The body of the Prince is enveloped in the royal mantle, which is fastened at the shoulders by means of two clasps in the form of quatrefoils. The effigy is without a sword, as was the case in that of his brother

Richard; a broken sceptre is supported on the left arm, and an extremely elegant awmônîère is suspended to the girdle. After this discovery the explorations were continued, and other objects of interest were brought to light, by far the most important of which was a leaden coffin, which there can be no doubt was that of John of Lancaster, Duke of Beaufort, the brother of our Henry V., and Regent of France under Henry VI. This had evidently been originally enclosed in a strong coffin of oak. The bones of the great duke were found inside undisturbed; the body had been embalmed with some aromatic substances, the nature of which could not be satisfactorily ascertained, except that mercury had entered largely into them. Drops of mercury which fell from it almost formed a stream. The hair of the head was found perfectly preserved. The hands were crossed over the abdomen. On the breast lay a cross formed by a fillet of a stuff which resembled silk, or fine linen. It was the only object of art found with the body. The Abbé Cochet deserves the greatest praise for the skill and energy he has displayed in carrying out these interesting explorations.

The city of **HEREFORD** ought to feel flattered in its character for antiquarian interest, for it appears that the three great archæological institutions, the British Archæological Association, the Archæological Institute, and the Cambrian Archæological Association, had each, unknown to the other, chosen Hereford for its place of meeting next year. The Cambrian Association, having been the first to publish its choice, remains in possession, and will hold its meeting in Hereford in the month of August, 1867. The Archæological Institute is understood to have changed its place of meeting to Hull. The British Archæological Association has resolved upon holding its meeting next year at Ludlow, and has elected for its president Sir Charles H. Rouse Boughton, of Downton Hall, near that town. Its week of meeting is to be that beginning on Monday, July 29, and ending on Saturday, August 3. No town in England could, by the beauty of its scenery, and by the multitude of objects of antiquarian interest scattered in and round it, offer so many attractions to the archæologist as Ludlow.

A correspondent at **NORHAM** has sent us a drawing of an **ANCIENT SWORD** which was found protruding from alluvial deposit, on the Tweed banks, near that place, after a severe flood, some feet below the surface of the land. The blade, he informs us, is thirty-two inches long; it tapers gradually to a point, and the handle is formed by two lunette cross-bars, the convex sides turned towards each other. It is a very rare type, but Mr. Roach Smith, in his well-known Museum of London antiquities, had one closely resembling it, which was found in the bed of the Thames. He considered it as belonging to a date not older than the thirteenth century, but perhaps even a little later, and this opinion is probably correct.

The excavations at **SILCHESTER**, on the site of the Roman town (*Calleva*), have been carried on with vigour during the summer and autumn, at the expense of the Duke of Wellington, and under the direction of the Rev. J. G. Joyce, and are becoming every day more interesting. Lines of streets have been already traced, and houses

have been opened, presenting somewhat varied examples of hypocausts, and remains of tessellated pavements, all throwing new light on the condition and manners of the inhabitants of this island during the Roman period. One of the hypocausts recently uncovered is unusual in character: the ground has been first cut into channels radiating from a centre, and afterwards perforated, and faced with tiles, instead of the ordinary arrangement of supporting columns of tiles. The part on which Mr. Joyce is now at work, is supposed, from the appearance of the buildings and from the various objects found in it, to have been the forum of the Roman city. Some of the houses present the appearance of having been altered more than once from their original plan, as though through restorations and adaptations after they had been destroyed. This is not uncommon in the remains of Roman buildings in this island.

An ancient PYRAMID has been recently discovered in the vast plains between New Mexico and California, through which the Rio Colorado flows. It has been originally about 130 feet high, with a platform of a few feet square at the top. It presents the appearance of having at some period suffered from an earthquake. The resemblance of these curious monuments of a primitive Mexican civilization to those of Egypt is very remarkable.

A ROMAN INSCRIPTION has been found on the shore near the now small town of Skinburness, on the coast of Cumberland. Formerly a town of some importance stood at Skinburness, but it was destroyed by a great irruption of the sea so long ago as 1301. It is a fragment of an altar dedicated to the deities addressed on it as *MATRIBVS PARCIS*. The worship of the *deæ matres*, usually represented as three females seated, and holding fruit, was extensively spread over the north-western provinces of the Roman empire. Here they are identified with the three *Parcæ*, or Fates. The discovery of this stone would seem to show that the old town of Skinburness had occupied a Roman site.

T. W.

PROCEEDINGS OF LEARNED SOCIETIES.

GEOLOGICAL SOCIETY—November 7.

The following communications were read:—

ON SOME REMAINS OF LARGE DINOSAURIAN REPTILES FROM THE STORMBERG MOUNTAINS, SOUTH AFRICA. By Professor T. H. Huxley, F.R.S., V.P.G.S.—The specimen more particularly described in this paper is a portion of a right femur, twenty-five and a half inches long, so that the entire femur may be safely assumed to have exceeded thirty inches in length. The peculiar form of the bone, and the characters and position of the trochanters, leave no doubt of the Dinosaurian affinities of the reptile to which it belonged, which must have been comparable in point of size to its near allies, the *Megalosaurus* and the *Iguanodon*. To the former of these it possesses the closest affinity, but differs in the proportional size and

form of its trochanters, and in its much heavier proportions; and the author proposes for it the name *Euskelosaurus Browni*. A portion of the distal end of a femur indicating another genus of large-sized Dinosaurian reptiles was also described, the characters yielded being sufficient to prove that it belongs to another genus than *Euskelosaurus*. The discovery of these remains in the Stormberg rocks was stated to be by no means decisive of their geological relations, as Dinosaurian reptiles lived throughout the Mesozoic period, and may have existed during the Permian; but it is interesting to observe that the Stormberg rocks conformably overlie the Karoo beds, which have yielded the Dicynodonts, and so many other remarkable reptiles and Labyrinthodonts.

ADDITIONAL NOTES ON THE GROUPING OF THE ROCKS OF NORTH DEVON AND WEST SOMERSET. By J. Beete Jukes, Esq., M.A., F.R.S., F.G.S.—Commencing with the country around Wiveliscomb, near which place Sir H. De la Beche had indicated an east and west fault of small extension on the maps of the Geological Survey, Mr. Jukes described the rocks of the district reaching from that place north-west to the Brendon Hills, and westwards to Dulverton, including the valley of the Tone, more to the south. From Dulverton he examined the country towards Simonsbath, and then, proceeding to Barnstaple, made traverses from that place to Challacombe and to Bittadon. Similarly, after examining the neighbourhood of Combe Martin, he proceeded along the north coast in an easterly direction, through Countisbury, Porlock, and Dunster, and across the Williton valley to the Quantock Hills. The observations made during these several journeys were given in detail by the author; and the principal conclusions at which he had arrived in consequence were stated to be the following:—(1) There are three areas of old red sandstone in this region, namely, *a*, the Quantock Hills; *b*, the Porlock, Minehead, and Dunster area; and *c*, the Morte Bay and Wiveliscombe ridge. (2) Each of these masses of old red sandstone dips under a great mass of carboniferous slate. (3) The coal-measures, the carboniferous slate, and the old red sandstone of Devon are contemporaneous with the coal-measures, the carboniferous limestone, and the old red sandstone to the north of the Bristol Channel. (4) That if the great fault which the author believes to exist be proved to be absent, his other conclusions will not be altogether vitiated, for the red rocks of Porlock and Dunster may then be taken as the top of the true old red sandstone lying underneath a great thickness of carboniferous slate.

ROYAL MICROSCOPICAL SOCIETY—Nov. 14.

A letter was read containing Her Majesty's command that this society, which recently obtained a charter of incorporation, shall be a "Royal Society." Fellows will use the letters F.R.M.S. The bye-laws of the society were revised, and one of them referring to the term of office of the president was suspended with a view to the re-election of Mr. Glaisher, whose term of office would normally expire in February.

Mr. Wenham described a modification of his plan of combining two prisms for binocular vision with high powers, designed by Mr. Abren ; and Mr. Jabez Hogg exhibited the spring clip described in our *Notes and Memoranda*. Mr. How showed his new student's microscope, which is described in our *Notes and Memoranda*.

NOTES AND MEMORANDA.

MEASURING SMALL INTERVALS AND COUNTING METEORS.—The Rev. N. J. Heineken has sent us two letters on the above subjects. He says that an ordinary spring tape measure—one yard—drawn out and suddenly released, springs back in a quarter of a second, and it may be arrested so as to mark smaller divisions. He says that although the velocity is not strictly uniform, it is near enough for ordinary purposes. By attaching a weight to the tape, and allowing it to spring vertically, he thinks the motion might be regulated. In counting the meteors in the late splendid display, he used “one of Perkins's old pedometers.” Each step is registered in this instrument by pulling a string, and Mr. Heineken holds it in one hand, and pulls the string with the other, each time a meteor appeared.

HOW'S NEW STUDENT'S MICROSCOPE.—When a number of respectable firms compete in the construction of cheap microscopes, it naturally happens that they distribute the inevitable expenditure in different directions, and it would be impossible to do justice to Messrs. Beck, Pillischer, Baker, Collins, etc., without instituting an elaborate comparison of their several patterns. Mr. How now comes forward with a new pattern, which deserves a high place amongst cheap instruments. The brass-work is very good, the stage has a new arrangement for facilitating its motions, which is one of the best we have seen. The upper part is held to the lower one with springs, offering a convenient resistance, and it can be moved backwards, forwards, up and down, or in slanting directions. Its action resembles that of the magnetic stage in smoothness, etc., but it is far more reliable. A dividing object-glass is supplied with this instrument, giving with ten inches of tube and a Ross A eye-piece, powers of about 45, 100, and 130. The eye-piece employed by Mr. How is of higher power, bringing the magnification to about 200 with the whole combination. Still deeper eye-pieces can be used satisfactorily. The powers are very well finished and corrected. They are of English make, and differ from higher-priced ones in having much smaller angles of aperture. This is a legitimate mode of lessening cost, and small-angled powers being much more easy to manage, and having great penetration, are the best fitted for beginners. All the ordinary objects (excluding lined tests, for which the apertures are not sufficient) are beautifully shown with Mr. How's cheap objectives, and as his student's microscope is made with the universal screw, other objectives may be added when required.

THE WIRE SPRING CLIP FOR MICROSCOPIC OBJECTS.—Mr. Curtis (of Mr. Baker's establishment), has improved upon a clip for holding down the covering glass when preparing microscopic objects, which was originally devised by Dr. Maddox. It is made by bending an elastic brass wire, so that it will open and shut like the common letter clip. The cover is pressed down by a small cork, and held in its place while cement is applied and allowed to dry, or Canada balsam allowed to insinuate itself by capillary attraction. Mr. Jabez Hogg informs us that he has found it “extremely useful in mounting algæ, tongues of mollusca, etc., in glycerine jelly, or similar preparations.” We can also speak well of it from personal use, and its price per dozen is very small.

THE PORTABLE HORIZONTAL SLIDE CABINET AND COVERED OPAQUE SLIDE.—These two excellent inventions of Mr. J. Piper, a member of the Old Change Microscopical Society, will, we believe, be sold by the principal makers and dealers in microscopes. The “Cabinet” is a neat box, containing six strong

cardboard trays, lined with white glazed paper. Each tray is divided into six compartments, to hold six slides in a horizontal position. When the box is closed, and the lid held down by an elastic band, each slide is retained safely in its own place, and the whole can travel without injury. As these very excellent cabinets can be sold at a very moderate price, they will, no doubt, come into general use. Mr. Piper's covered slide is exactly what is wanted for opaque objects, which it is desirable to view without the intervention of covering-glass. It consists of a mahogany slide with the usual central cavity, over which a cover is fastened by a small brass pin. When the object is to be viewed, the cover turns on the pin on one side, and can be rotated back again as often as required.

PSEUDOSCOPIC APPEARANCE OF THE MOON.—Most observers are annoyed more or less frequently with the tendency of hollows in the moon to appear in the telescope like elevations, and elevations to look like depressions. Mr. R. Hodgson, in a communication to the *Monthly Notices*, ascribes these effects to the "position of the shadows being the reverse of what we usually see," and he states that by using a reflecting diagonal eye-piece he can change the appearances from reliefs to intaglios or *vice versa* by revolving the whole eye-piece 180° . We do not feel satisfied with the explanation, as we are accustomed to see shadows in all directions; but we recommend our telescope-using readers to try the experiments Mr. Hodgson suggests.

PECULIAR DISENGAGEMENTS OF GAS.—M. Babinet states in *Comptes Rendus* that when cold water is poured on the powder of roasted coffee, a considerable quantity of gas is disengaged. This gas, he adds, is probably common air, and equals in volume the mass of coffee employed. If a bottle is half-filled with coffee-powder, and cold water poured in up to the place of the cork, which must be inserted, an explosion takes place, by which the cork is driven out, or the bottle broken. The roasted coffee-powder acts like charcoal in absorbing air, and the water drives it out again.

SECCHI ON DOUBLE STARS.—In *Astronomische Nachrichten*, Father Secchi gives the following positions, measurements, and dates:—For 36 Andromedæ, 1866, 052 P 349°51 D 1°314. ζ Cancri AB, 1865, 213 P 245°30 D 0°641. Do. 1866, 285 P 234°62. D 0°40. ϵ Bootis 1865, 482 P 324°70 D 3°292. η Coronæ 1863, 592 P 23°26 D 0°827. Do. 1865, 504 P 26°26. D 0°792. Do. 1866, 538 P 33°13 D 1°122. μ Bootis 1866, 578 P 180°30 D 0°3. ζ Herculis 1865, 55 P 86°± single "Position of a little prominence (?)." ρ Libræ (ξ Scorpii) A B he could not well separate in 1864, he now gives them 1866, 519 P 161°00. D 0°4± "well separated."

HUMAN REMAINS IN THE RHINE VALLEY.—Mr. Faudel describes in *Comptes Rendus* the discovery of portions of a human skull at Engisheim, near Colmar, in the formation termed *lehm Alpin*, and in conjunction with bones of the *Elephas primigenius* and *Bos priscus*. He considers these remains to show that man lived in Alsace and in the Upper Valley of the Rhine at the period when the loam (*lehm*) was deposited, and before the country had reached its existing form.

PAPER SUBSTITUTE FOR LINT.—The Italian *Medical Gazette* states that the Viennese surgeons employ a white blotting-paper, locally known as *papier de soie*, as a cheap and efficient substitute for lint.

A MONSTER AEROLITE.—Marshal Vaillant informs the French Academy that Marshal Bazaine has found a Mexican aerolite, weighing not less than 860 kilogrammes. It is on its way to France, and will figure in the exhibition of 1867.

NINETY-FIRST PLANET.—M. Le Verrier informs the French Academy that another planet, the ninety-first, has been discovered at the observatory, Marseilles.

A LIGHT FOR PHOTOGRAPHERS.—*Cosmos* states that M. Sayers recommends twenty-four grammes nitrate of potash dried and powdered, seven flowers of sulphur, and seven red sulphurate of arsenic as giving a light with great photographic power.

THE GLASS ROPE OF THE HYALONEMA.—In our last number we mentioned some remarks of Dr. Gray on this subject to which Dr. Bowerbank replies in

Annals of Natural History, and promises shortly a paper to show the "organic unity" of the basal mass of sponge tissue, the spicular axis or rope, and its coriaceous envelope.

DEEP SEA LIFE.—*Annals of Natural History* contains a report by Mr. George Jeffreys on *Dredging among the Hebrides*, in which he states that Professor Sars is of opinion that Dr. Wallich's deep sea star fish is an *Ophiocantha spinulosa*, a well-known Greenland species, found usually from 20 to 190 fathoms depth. He states that Professor Sars has enumerated fifty-two species and distinct varieties of animals found by himself at a depth of 300 fathoms—sponges, rhizopods, actinozoa (anemonies), polyzoa, true mollusks, and worms. The Swedish deep sea dredgings, in the expedition to Spitzbergen (1861), sounded depths of from 6000 to 8400 feet (1000 to 1400 fathoms), and the sea bottom at these depths was covered with a fine greasy-feeling material of a yellowish-brownish or grey colour, rich in diatomacea; and polythalamia, annelids, crustacea, and mollusca were found at these depths.

MR. PEARSON'S PHOTOMICROGRAPHS.—Mr. Pearson has published, through Mr. Frederick J. Cox, a series of photographs of microscopic objects taken with the lime light. Most of those we have seen are exceedingly good; salicine and cinchonidine under polarized light, sections of sarsaparilla, pepper, cherry-tree wood, coal, lime-stone from the Himalayas, and oolite are very beautiful specimens of this ingenious art, excellently displaying the peculiarities of the several objects. A slide of foraminifera seems to be less successful, and the *trichina spirales* have not come out with sufficient distinctness. Others, which we have specified, occupy a high place among works of this kind, and show how valuable the photographic process is to give accurate delineations of objects extremely troublesome to draw anything like as well.

NEW EDITION OF "THE HEAVENS."—A subscriber calls our attention to Mr. Bentley's advertisement of a new edition of *The Heavens*, with "sixty illustrations," and asks what number the last French edition contains. On referring to our French copy we find 40 plates, and 192 engravings incorporated in the text. We can give no information as to what Mr. Bentley includes in the "sixty" he announces, but we observe that he wants as much money for his edition as the complete French one costs.





NAEED-THROATED COTINGA.

Chasmodon naeeditarsis (Aud.)

THE INTELLECTUAL OBSERVER.

JANUARY, 1867.

THE BELL-BIRDS OF AMERICA.

BY P. L. SCLATER, M.A., PH.D., F.R.S.,
Secretary to the Zoological Society of London.

(With a Coloured Plate.)



It is only within the last few months that the Zoological Society of London have succeeded in adding to their large collection of living birds examples of the species belonging to the great fruit-eating family of Cotingas (*Cotingidæ*), which plays so conspicuous a part in the ornithology of Tropical America. Birds that in a state of nature subsist almost entirely on ripe fruit are, as might have been naturally expected, difficult creatures to provide for in a state of captivity, especially during the voyage home, and consequently rarely reach our shores alive. Recently, however, several forms belonging to the different frugivorous families of the tropics of both hemispheres have been successfully imported, and amongst them examples of the Cock-of-the-rock of Guiana (*Rapicola crocea*), and the Bell-bird of Brazil (*Chasmorhynchus nudicollis*), two of the most striking members of the above-mentioned family. It is to the latter of these birds and its allied species, which are

alike remarkable for very curious peculiarities in structure and habits, that I now propose to call attention.

The genus *Chasmorhynchus* of naturalists embraces four species of birds, each inhabiting a distinct region of tropical America, of about the same size as the missel-thrush of Europe, but essentially different in structure. Their general form is much the same as that of the typical Cotingas, but they have a more depressed bill and wider gape, and their nostrils placed further forward. The wings are long and pointed, indicating extensive powers of flight. The feet and legs are moderately strong. The tarsi are covered in front with a series of six or seven horny shields; behind with numerous much smaller reticulated scales. The outer and middle toes are united together at their bases to the end of their first phalanx. These two last characters, together with the possession of ten well-developed primaries in the wings, are marked features of the family *Cotingidæ*, to which this genus belongs. But the most special external character which distinguishes the Bell-birds from other genera of the same family is the development in the adult male of naked skin and fleshy wattles in various parts of the head and neck. In all of the known species the adult male is either wholly or partly of a pure snowy white, with more or less of these cutaneous developments, and the female of a dull green above and yellowish below, without any of the peculiar excrescences of the head and neck which distinguish the male sex. Having said thus much about the general features of the genus, I will now say a few words about each of the four known species of this curious group, commencing with the Brazilian *Chasmorhynchus nudicollis*, of which a coloured illustration is given, drawn from the adult male in the Gardens of the Zoological Society.

In the naked-throated or Brazilian Bell-bird, the adult male is wholly of a pure snowy white. The space round the eyes and throat are covered with a naked fleshy skin, which is very sparingly clothed with minute black feathers, only distinguishable on close examination. In the breeding season this naked skin becomes of a fine green colour, which disappears during the rest of the year. The female, as has been already stated, is a very different-looking bird—being of a dull green above, with a blackish head, and yellowish, flammulated with green, below. Nor has she any trace of the naked throat and face which are the characteristics of the male sex.

This Bell-bird was first made known to science by the French naturalist Vieillot,* in 1815, from specimens in the collection of the Jardin des Plantes at Paris. But the best, and, in fact, only good description of it in a state of nature is

* *Nouv. Dict. d'Hist. Nat.*, viii., p. 164.

that given by that excellent and observing naturalist Prince Maximilian of Neuwied, in his *Contributions to the Natural History of Brazil*.* Prince Maximilian tells us that this remarkable bird is one of the most singular features in the fauna of the wooded coast-region of Brazil, and attracts the stranger's notice as well by its brilliant white plumage as by its clear ringing voice. It seems to be very generally distributed through the woods, resorting especially to the thickest and most secluded parts of them. Hence it resulted that the Prince and his party, during their expeditions in the neighbourhood of Rio de Janeiro, became well acquainted with its singular notes some time before they obtained specimens of the producer of them. Prince Maximilian describes these notes as resembling the sound of a clear-ringing bell, sometimes repeated at intervals, sometimes following each other in quick succession. In the latter case they are more like the sound produced by a blacksmith when he strikes a piece of steel upon an anvil, whence the bird has obtained its Portuguese name *Ferreiro* (*smith* †). The song is heard at all hours of the day, and when, as often happens, several of these birds are in the same neighbourhood, and begin singing against and answering each other, a most wonderful vocal concert is the result. The *Araponga*, as this bird is also called in Eastern Brazil, often takes up its station at the highest withered summit of a colossal forest-tree, and pours forth its loud metallic notes out of the reach of gun-shot, at the same time presenting with its lovely white plumage a fine contrast to the clear blue sky. It is, however, easily disturbed by anything unwonted making its appearance. Its food, as ascertained by dissections, appears to be exclusively fruit. Nothing was ascertained by Prince Maximilian respecting its nidification, nor have subsequent observers added to our knowledge on this point.

Of this extraordinary bird a living specimen was first acquired for the aviaries of the Zoological Society of London in May last. It was an adult male, and was purchased from a well-known London dealer in living animals for the sum of £10. Shortly after this bird had arrived in the Society's gardens it commenced its song, and continued to pour forth its peculiar notes at intervals of more or less frequency for several weeks. These notes have been described by an accurate observer in the following manner:—

“The first note is a loud, harsh, and somewhat grating noise; this is followed by six or eight fine, clear, metallic, ringing notes, with an interval of about a second between each of

* *Beiträge zur Naturgeschichte von Brasilien*, 3 vols., Weimar, 1830.

† Professor Burmeister (*Syst. Ueb. d. Thiere Brasiliens*, ii., p. 426) says the Portuguese name is *Ferrador*, not *Ferreiro*, but the meaning is the same.

them. The resemblance of these to the sound of an anvil is most extraordinary. The clear metallic ring, repeated at about the same rate that a blacksmith strikes upon the anvil, is so perfect that many persons upon hearing it are unwilling to believe the sound could be produced by the delicate organs forming the vocal apparatus of so small a bird."

I may add that the bird also makes the most extraordinary gesticulations when producing these sounds. When commencing its song it usually stands upright with its bill aloft, as represented in the coloured plate herewith given. Subsequently it lowers its bill and throws itself violently forward and downward, seeming to assist itself in this manner to pour forth its final notes.

The *Araponga* lost the brilliant green colour of its face and throat at the conclusion of the love-season, and those parts became of a dull grey or lead-colour, as they now remain. Later in the summer a second example of the same species was purchased for the Society. It was a young male, which, as is usually the case with young birds, was clad in the plumage of the female, but is now gradually assuming its adult dress. We are in great hopes, therefore, of having both these birds in full song during the ensuing summer.

In the forests of Cayenne, British Guiana, and Surinam, the *Araponga* is replaced by a second bird of the same genus, the "*Campanero*," or *Chasmorhynchus niveus* of naturalists. In this species the adult male is pure white, as in its Brazilian representative, but there is no deficiency of feathers on the throat, and a long straight caruncle issues from the base of the bill, which at once distinguishes it from the preceding. This curious caruncle in a specimen of a young male in my collection is about three and a half inches long, but is often longer in adults. It is scantily clothed with small feathers throughout. In the breeding-season it is probably carried erect, as figured by Buffon in his *Planches Enlumonnées*, No. 793, at any rate when the bird is in song. The female has no caruncle, and much resembles the same sex in the preceding species. The Bell-bird of Cayenne was well-known to the older authors, but our best account of its habits is derived from the *Wanderings* of the late Mr. Waterton, who, speaking of the Cotingas, of Demerara, says:—

"The fifth species is the celebrated 'Campanero' of the Spaniards, called 'Dara' by the Indians, and 'Bell-bird' by the English. He is about the size of the jay. His plumage is white as snow. On his forehead rises a spiral tube, nearly three inches long. It is jet black, dotted all over with small white feathers. It has a communication with the palate, and when filled with air looks like a spire; when empty it becomes

pendulous. His note is loud and clear, like the sound of a bell, and may be heard at the distance of three miles. In the midst of these extensive wilds, generally on the dried top of an aged mora, almost out of gun-reach, you will see the *Campanero*. No sound or song from any of the winged inhabitants of the forest, not even the clearly-pronounced 'Whip-poor-Will,' from the goat-sucker, causes such astonishment as the toll of the *Campanero*."

"With many of the feathered race he pays the common tribute of a morning and an evening song; and even when the meridian sun has shut in silence the mouths of almost the whole of animated nature, the *Campanero* still cheers the forest. You hear his toll, and then a pause for a minute, then another toll, and then a pause again, and then a toll, and again a pause. Then he is silent for six or eight minutes and then another toll, and so on. Acteon would stop in the mid chase, Maria would defer her evening song, and Orpheus himself would drop his lute to listen to him; so sweet, so novel, and romantic is the toll of the pretty snow-white *Campanero*. He is never seen to feed with the other *Contingas*, nor is it known in what part of Guiana he makes his nest."

Proceeding a little further northwards in the forests bordering the northern coast of Venezuela, we meet with a third Bell-bird, the *Chasmorhynchus variegatus*. In this species the adult male has again a white body-plumage; but his wings are black and his head is brown, so that he cannot easily be confounded with either of the former species. His bare throat is sparingly clothed with small black feathers, as in the *Araponga* of Brazil, but besides this there are numerous small fleshy caruncles dependent from the lower part of the throat, which in adult birds attain a considerable length. The female, however, is very like the female of the Brazilian species. This Bell-bird extends along the coast of Venezuela into the forests of Trinidad, where its existence is well known to the colonists.

To find a fourth, and in some respects still more wonderful, species of Bell-bird, we must go further northwards across the isthmus of Panama into Chiriqui and Costa Rica. Here is the abode of the Three-wattled Bell-bird, *Chasmorhynchus tricarunculatus*, the male of which exhibits several very marked differences from those of its three southern congeners. In the first place the head, neck, and breast of this species are alone of the glossy white which is so characteristic of the genus, the whole hinder portion of the body, including the wings and the tail, being of a deep chesnut red. Besides, not content with a single caruncle springing from the base of the bill which distinguishes his brother of Cayenne, the male of this Bell-bird throws out two additional elongated wattles from the

angles of its mouth. These are thinner and narrower than the *Araponga's* single horn, and attain a greater length—the medial caruncle in a young male bird in my collection measuring nearly $4\frac{1}{2}$ inches in length, and extending, when recumbent, down beyond the middle of its back. The female of the Costa-Rican Bell-bird again hardly differs materially from the females of the other species.”*

It appears, therefore, that there are four rather widely separated districts in tropical America, each of which is tenanted by a distinct species of this group of birds. The intelligent mind naturally proceeds to inquire why this is so. Why should the Bell-bird of Brazil be different from the Bell-bird of Cayenne, and the Bell-bird of Venezuela from that of Costa Rica? What is the meaning of these four birds, each having a special abode into which the others never intrude? Why are the males of each of them all so different, and the females all four so much alike? Not many years ago it would have been thought rather irreverent to ask such questions as these. We should have been informed in reply, that it was for the same reason that “dogs delight to bark and bite”—because Divine Providence “hath made them so;” and it would be, therefore, no use inquiring into the matter. And this is the theory (if theory it can be called) of the supporters of “special creation” to the present day. They say that each species of organic beings was created to perform certain functions over a definite area, and there is an end of the matter. But it is not easy to satisfy the inquiring spirit of the present age in so summary a manner. Let us try, therefore, if by adopting Mr. Darwin's views of the derivative origin of species and “natural selection,” we can invent a theory of any sort which would account for the present state of things as regards the case of these four Bell-birds, and numerous other cases of the same description.

Let us suppose then, that these four Bell-birds, now so distinct, are all descended from a common progenitor—a certain “*Chasmorhynchus priscus*” we will call him. This would at once account for the females of the four species being all alike. Let us suppose that in bygone ages *Chasmorhynchus priscus* lived in a small area (*a, b, c, d*, Fig. 1) occupying the centre of the extended area *A, B, C, D*. Let *A, B, C, D* represent the “generic area” of *Chasmorhynchus* at the present period, that is the whole of the areas now occupied by the four known species of the genus, together with the intervals between them which are not now tenanted by any species of *Chasmorhynchus*.

* Both sexes of this very singular bird are figured in the *Ibis* for 1865, Pl. iii., where Mr. Salvin has likewise given many interesting remarks on this and the allied forms.

It may be easily imagined that *C. priscus* finding a country suitable to its habits and mode of life, gradually extended its range northwards and southwards, until, instead of its original "specific area" (*a, b, c, d*, Fig. 1), it became occupant of the larger area (*A, B, C, D*, Fig. 2), *i. e.*, the whole of the present "generic area" of *Chasmorhynchus*. Now, so long as the area *A, B, C, D*, remained united and homogeneous it is probable

FIG. 1.

FIG. 2.

FIG. 3.

FIG. 4.

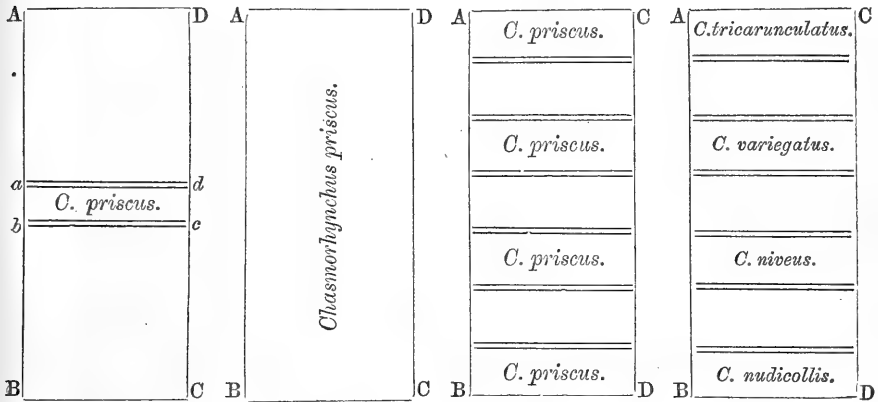

that, in spite of the innate tendency to perpetual variation, there would be but slight modifications in the structure of our *C. priscus*, as the different varieties would to a certain extent neutralise each other by interbreeding. At all events the changes introduced by progressive variation would be similar or nearly similar over the whole area, and would be such as would, perhaps, enable us to distinguish the extreme northern and southern forms from one another, as is usually the case with species spread over a very extended area, but not of sufficient importance to necessitate the recognition of more than one species.

But now let us suppose that the slow course of secular variation which is constantly altering every part of the surface of our globe, operates upon the area *A, B, C, D*, where the vacant intervals are placed in Fig. 3, and renders these portions unfit for the habitation of *C. priscus*. This might take place either by the submergence of the vacant tracts, and division of the extended area into four islands, or by their elevation, or simply by the failure of certain trees on the fruit of which *Chasmorhynchus* subsists within the vacant areas. *Chasmorhynchus priscus* would, after this event took place, occupy four different areas, completely cut off from one another, as shown in Fig. 3. The tendency to variation would now act

upon the individuals located in each of these four separate areas in a different manner, according to the different natural influences (such as food, weather, climate, etc.) affecting them. Communication being cut off between them, there would be no neutralization of the variation occurring in one area by a contrary variation occurring in the adjoining area. The four isolated colonies of our *C. priscus* would therefore, in process of time, become a series of four distinct species, as represented in Fig. 4.

It will be remarked in the present case that the variation which has taken place has mainly affected the male birds. The females of the four species of *Chasmorhynchus* are still nearly identical. There has been manifestly a much greater "struggle for existence," as Mr. Darwin calls it, amongst the males than amongst the females of these birds. And it is not difficult to see how this has occurred. The very object of the structures that have altered in the present instance is to render the male agreeable to its mate, so that we have here an influence that would work forcibly upon the male sex, and cause it to vary, while it would leave the female untouched.

It appears, therefore, that if we adopt Mr. Darwin's theory, a few simple hypotheses will enable us to give a reasonable explanation of the mode in which the present distribution of the four species of the Bell-bird may have been brought about. Similar hypotheses will explain hundreds and thousands of other cases in which groups of animals and plants offer corresponding phenomena as to their geographical distribution. What the exact influences were that divided up the area formerly occupied by the common progenitor of the four *Chasmorhynchi*, it would be impossible at present to say; but it will be seen at once that when the geological structure of the earth is more perfectly known, great light will necessarily be thrown on problems of this nature. Such problems, in our present state of ignorance of the formation of the greater part of the earth's surface, it would be vain to attempt to answer in a decisive way. But it seems better, even under present circumstances, to attempt some sort of explanation of these and similar phenomena, than to remain content with the *deus-ex-machina* theory of "special creation," which is in fact no theory at all, but only a periphrastic way of confessing our ignorance of the subject.

PARASITIC BEETLES.

BY E. C. RYE.

OUR *Coleoptera*, or beetles, exhibit none of those pre-eminently social or constructive instincts which have attracted the earliest exercise of human observation to certain of the *Hymenoptera* (bees, ants, etc.). It is true that in some cases their habits are gregarious; but their associations are for the most part apparently devoid of purpose, beyond the procuring of food, and are usually to be accounted for on the most easily intelligible grounds, such as (in the case of the *Phytophaga*) the occurrence of their food-plant in isolated spots, or the incapability of much motion attendant upon the structure of the larvæ of many species, which usually causes the produce of one batch of eggs not to get dispersed until they arrive at the perfect state. Their labours, also, which seem never (except in the case of certain *Necrophori*, commonly known as "burying-beetles") to be undertaken in concert, are limited in their earlier stages to the construction of the most rudimentary hybernacula, cells, galleries, or pits, or to the erection of protective cases (*Clythra*, *Cryptocephalus*)—in all of which operations they exhibit less ability than the caterpillars of the more lowly organized order *Lepidoptera*, and, in their perfect state, to the exercise of the most ordinary instincts for the protection of their future offspring; such protection being in the majority of instances confined to depositing the eggs in convenient and proper situations, though some species, such as the above-mentioned burying-beetles, certain of the *Rhynchophora* (*Rhynchites*, *Pissodes*, *Balaninus*, etc.), and some of the indigenous Coprophagous representatives of the sacred-beetle of the Egyptians, exhibit considerable ingenuity, and are compelled to use much physical force, in their preparations for the welfare of their descendants.

There remain, however, certain (as it were, morganatic) alliances constantly contracted by beetles with other insects, for which as yet no satisfactory explanation has been given; and it is to these that the present paper refers. There are even some associations of *Coleoptera* with animals out of their own class, such as that of *Haploglossa nidicola* (one of the *Aleocharidæ*, a large family of small *Brachelytra*, of which section the common "Devil's coach-horse," *Ocypus olens*, is the most gigantic and the best known exponent) with the sand-martin, and *Drilus flavescens* with certain species of *Helix*; but these and their like are readily capable of interpretation. The former insect, which has received its specific name from its nest-hunting propensities, is a parasite upon the bird for

the sake of its droppings, and possibly for such crumbs as fall from its table. I am not aware whether the sand-martin employs much (if any) dried twigs, grass, or leaves as a pad at the bottom of its burrow; if such be the case, however, it would be of use in assisting to solve the question of the alliance between bird and beetle, as another of the latter's genus, *Haploglossa prætexta*, sometimes swarms in twigs, etc., at the bottom of neglected hay-stacks. Another of its intimate allies, *Haploglossa gentilis* (hereafter mentioned), is a parasite upon ants; so that sycophancy seems to run in the family. *H. nidicola*, being very small, is doubtless in some of its stages unwittingly transported by the birds from one nest to another; I have never heard, however, of its being found in the nests of any bird but the sand-martin, under banks perforated by which it may be found in profusion. The nests of birds, on account of their warmth, damp, etc., often serve as a home for beetles, which in many cases may be originally introduced with the substances of which they are built. A curious instance of this, and somewhat entomologically akin to the accounts so often to be read in provincial journals of birds building in unusual or much frequented situations, is to be found in the capture by Mr. E. Waterhouse of several specimens of the rare *Dendrophilus punctatus* in sparrow's-nest rubbish stuck in a water-pipe of the British Museum. Another species of *Dendrophilus* (*D. pygmæus*) is a true ant-parasite, and *D. punctatus* has itself been taken in nests of *Formica rufa*; so that the parallel between it and *Haploglossa* is, oddly enough, somewhat close.

Drilus flavescens is constantly found in the vicinity of snails (*Helix nemoralis*, etc.), for the simple reason that its larva feeds upon those molluscs. It is, however, noteworthy on account of the males only being known in this country (in certain chalky parts of which, near Dover, Dartford, etc., it is not uncommon); but the non-appearance of the other sex is not due to the same cause (whatever it may be) as that which baffles us in the endeavour to discover the males of certain abundant species of *Cynips* (gall-insects). In the latter case persistent but unsuccessful endeavours have been made (by breeding, etc.) to solve the enigma; but, as to the *Drilus*, failure is owing simply to a want of sufficient experiment: for if any one assiduously collected snails in the localities where the male occurs, the female would assuredly be detected, as I have found the full-grown female larva at the base of Shakespeare's Cliff, running very quickly among empty snail-shells in the hot sunshine. The two sexes—as in the glow-worm (*Lampyrus noctiluca*), to which it is closely allied, and which is equally rapacious and mollusc-devouring, *malgré* its poetical reputation—are very dissimilar in appearance; the male having wings and brown

elytra, with conspicuous and strongly pectinated black antennæ, and the female being apterous and slug-shaped, having, indeed, been described as belonging to a separate genus, *Cochlæoctonus*, founded upon it, and named in allusion to its habits. As also in the glow-worm, the resemblance between the perfect female and full-grown female larva is considerable.

The ordinary associations of beetles with other insects are purely for the purposes of preying upon them or their leavings; but some few are sufficiently interesting to be noticed. The most frequent and unvarying alliances of this class are, perhaps, those of certain of the *Nitidulidæ* (e.g., *Epuræa* 10-guttata, *Soronia* grisea and *S. punctatissima*, *Cryptarcha* strigata and *C. imperialis*, and, I suspect, the very rare *Thalyera* sericea) and *Aleocharidæ* (*Homalota* cinnamomea and *H. hospita*) with the goat-moth (*Cossus ligniperda*); in and about the burrows made in the solid wood by the large naked red fleshy larva of which insect most of them may be readily found, and sometimes in profusion—no matter in what tree, be it oak, elm, willow, or poplar, the Lepidopterous devastator may be ploughing its deep tracks. The exudation of sap and quantities of wet woody excrement, caused and left behind by this caterpillar, strongly impregnated, moreover, with its peculiarly rancid odour, seem to act as a never-failing attraction to the above-mentioned beetles (as the collector well knows), and to many others; amongst them being the very rare *Quedius dilatatus*, a large black *Brachelytron*, formerly only known to occur in the nests of the common hornet (*Vespa crabro*), under the protection of whose sting (by what means diverted from itself we cannot tell) it may readily be believed that it was safe from capture. M. Chevrolat, a distinguished French entomologist, has, however, recently detected it haunting the burrows of the goat-moth larva, coursing rapidly in and out of the galleries by night; and it has since his discovery been taken under similar circumstances in this country. There can be little doubt, from the habits of certain other *Quedii* (*Q. lævigatus*, *cruentus*, *xanthopus*, *scitus*, *longicornis*, and *truncicola*) frequenting trees, that this beetle merely exhibits a preference for such localities in consequence of the number of other insects also attracted to them, upon which it preys.

Many other beetles also found under or about bark are predeceously parasitic upon insects either of their own or another order. Of these, *Ips* and *Rhizophagus*, attendant upon the genuine wood-feeders, *Hylesinus*, *Hylastes*, and *Hylurgus* (as mentioned in No. LVI., p. 133), are notable examples; and with them may be classed two very rare species, *Nemosoma elongata*, one of the *Trogositidæ*, and *Colydiium elongatum*, the type of the *Colydiadæ*, both of which are of an elongate tere-

brant form, and have hitherto been considered as true wood-feeders; but the former is a parasite upon some of the genuine *Xylophaga*, and the latter preys upon *Platypus cylindrus*, to whose attenuate shape it bears some resemblance. *Opilus* and *Clerus*, predaceous Malacoderms, follow *Anobium* and other dry-wood eaters, upon the larvæ of which their larvæ feed: *Anthribus* and its allies, sedate and massive, and, on account of their belonging to the peaceful section of *Rhynchophora*, long unsuspected of such appetites, are now known to prey in their larval condition upon *Coccus*; a habit for which fruit-growers would doubtless thank them; the beetles are, however, so exceedingly rare here that no practical good can result from their operations. Of a similar class to these relations is the companionship of *Dyschirius* with *Bledius*, members of which two genera are constantly found together—often in profusion—burrowing in sandy places on our coasts and elsewhere. Both are of elongate and cylindrical shape, eminently adapted for their sphere of existence; *Dyschirius* (the wolf) being clothed with more continuous and solid armour, and possessing two very strongly arched, thickened and spined front legs, eminently fitted for fossorial purposes, and representing the structure of the fore paws of the mole; and *Bledius* (the lamb) having a flexible and somewhat loosely articulated body, and often (in the male) acute, stout, projecting horns on the head and thorax, doubtless also of service in digging.

Another—and the largest reputed British—member of the *Geodephaga* (to which section *Dyschirius* also belongs), *Calosoma sycophanta*, has received its specific name from its parasitic connection with the gregarious larva of the processionary moth (*Cnethocampa processionea*), upon which it gorges its fill, both in its own larval condition and as a perfect beetle. It is an exceedingly handsome and large insect, being of a violet-black colour with golden, green, and coppery reflexions, and has for a long time stood its ground in our lists of indigenous species (of which, from mere beauty's sake, it forms one of the chief glories) on the strength of its periodical occurrence, chiefly on or near the coast-line. There seems little doubt, nevertheless, that it is merely an accidental visitor from some of the continental districts where it abounds; as its especial pabulum, the processionary caterpillar, is not found at all in England, and the beetle is not only possessed of stout wings, and, from its strong build, evidently capable of considerable exertion, but has even been taken actually floating on the sea near our shores, suggesting the idea of its dropping nearly exhausted after a long flight.

The numerous recorded instances of butterflies and other equally delicately organized insects being seen at greater

distances from land than the *Calosoma* would have to travel, quite warrants this supposition. We have, however, another undoubtedly British species, *Calosoma inquisitor*, of smaller size and less beauty, which constantly frequents oaks for the purpose of promiscuous feeding on the many Lepidopterous larvæ frequenting those trees. This habit of tree-haunting is very rare among the large and predaceous *Carabidæ*, which usually prowl about on the ground, except occasionally at night, when they have been observed investigating tree trunks for their victims. Another of the *Geodephaga*, *Zabrus gibbus*, a large, heavy, clumsy, black species, departs from the habits of the members of that group so far as to be often seen climbing up the shoots of young wheat and other plants. This has been so frequently observed that it has been strenuously urged that the beetle, unlike all its sectional allies, is a vegetable feeder; but the more reasonable view appears to be that it frequents the plants for the purpose of preying upon the numerous small insects of all orders found upon them. A similar explanation accounts for the constant occurrence of one of the burying-beetles, *Silpha quadripunctata*, upon young oak-trees, where it finds a ready meal on plant-feeding larvæ. I have never found this insect in any other place than upon an oak-tree; though the other *Silphæ* (except, perhaps, *S. atrata*) constantly occur in carrion.

All the above cases of companionship, therefore, readily admit of explanation, as also do certain of those hereafter mentioned, of some of which the entire life-history has, indeed, been accurately chronicled.

It will be observed that, in all the following instances, the insects with which the beetles are associated belong to the order *Hymenoptera*; and it is in connection with the social members of this order that the most constant and perfect—though hitherto unexplained—cases of beetle-parasitism occur.

The bees, to begin with, are affected by species of at least three different genera, viz., *Trichodes*, *Melœ*, and *Sitaris*.

The first of these, one of the *Cleridæ*, has two reputed British exponents, *T. apiarius* and *T. alvearius*, whose names sufficiently indicate their propensities. Both of them are, however, of exceedingly doubtful British origin, though abundant on the continent; they are of moderate size, elongate, bright blue with red bands, and very pubescent. *T. apiarius* lives in its larval condition in the combs of the honey-bee (*Apis mellifica*); whilst *T. alvearius* at a similar stage of its existence inhabits the nests of mason-bees (*Megachile muraria*, and others), though it has also been found under pine bark. Both of them feed upon the larvæ of the legitimate owners of their temporary residences, and, in their perfect

state, are found in flowers, where it is possible that they may deposit their eggs, which would be readily (inadvertently) carried to their nests by the visiting bees.

Melœ comprises the well-known "Oil-beetles"—huge, clumsy, wingless, fat, blue-black insects, with short overlapping sytra, and of feeble development—frequently seen crawling heavily in early spring on commons and waste lands, especially among butter-cups, and conspicuous for their nasty peculiarity of exuding a clear yellow oil from their joints when handled, which has in bygone times (with many more nauseous remedies) been in favour for the purposes of medicine. The female deposits separate batches of small yellow ova, thousands at a time, but on a diminishing scale after the first laying. These ova are agglutinated, and dropped into small holes in the ground previously dug by her; and from them, after a period of from three to six weeks, as the heat of the weather varies, the young larvæ are hatched, being then long, flat, yellow, with longish legs and four hairs at their hinder apex, resembling, in short, small bird-lice. For a time they keep torpid; but, on being sufficiently roused by increased warmth, course about certain low plants, (chiefly *Ranunculaceæ*) with wonderful rapidity of motion. From these plants they fasten, sometimes in great quantities, on the hairy bees that are busy about the flowers: at times, also, getting attached in error to some equally hairy species of *Volucella* (Dipterous insects superficially much resembling bees), that also settle on their temporary lodgings. Of course, in the latter case, the attachment is not a lucky one for the parasite: as the fly makes no nest to which it can be transported, and it must perforce starve. It is probably the chance of this, added to the numerous lucky combinations that *must* take place before the *Melœ* larvæ can reach its destined haven, that causes the parent beetle to deposit so large a number of ova; and there can be no doubt that the produce of one female would, if it all came to maturity, outnumber vastly all the perfect insects that would be seen by any one observer in his lifetime.

Supposing that the larva has been carried by the unconscious bee to its nest, it devours the egg of the latter therein contained, and changes into a second form (not unlike the larva of a small Lamellicorn beetle, being cylindrical, arched, and possessing stout legs and toothed mandibles), subsisting on the food laid up by the bee for its own young. After some time the second condition of the larva changes its outer skin, which is not, however, entirely shed, but remains wrinkled up at the hinder extremity of the body; it is then arched, composed of thirteen segments, contracted at each end, and motionless. This is called the *false pupa*, and from it (pro-

bably after a winter's interval) a third form of the larva appears, similar to the second. Here, however, ceases all direct record of the extraordinary metamorphoses of this insect; the most unaccountable part, viz., the passage of the heavy, full-grown, bloated beetles from the bees' nest to the commons where they are usually found, not having been hitherto observed.

The transformations, however, of *Sitaris muralis*, the third above-mentioned bee-parasite, throw some light upon the final changes of its ally *Melœ*. This insect, which, unlike the latter, has ample wings, though its elytra are of imperfect development, is, during all its existence, parasitic upon mason-bees of the genus *Anthophora*, which are common in old brick-walls. Here the larvæ undergo fewer vicissitudes than those of *Melœ*, as the eggs are deposited by the parent at the entrance of the bees' burrow, near which it stays; and the young larvæ, after passing through the above-mentioned stages, and taking no food in their third condition, change to the ordinary Coleopterous pupa, from which the imago is produced after about a month's interval; the whole metamorphoses covering a space of about two years.

Mr. Newport has given particulars of his discoveries as to this species in the *Linneæan Transactions*, vol. xx., p. 297, and vol. xxi., p. 167. M. Fabre, also, in his "Mémoire sur l'Hypermétamorphose et les mœurs des Méloïdes," in the *Annales des Sciences Naturelles*, sér. 4, vol. vii., 1857, p. 299, goes into considerable detail with reference to the abnormal nature of the above-mentioned changes.

In connection with these beetles, mention must be made of certain interesting insects variously considered as a separate order, under the name of *Strepsiptera*, or simply as a family of the *Coleoptera*, under the name *Stylopides*. As there exist strong reasons to suppose that the latter view is incorrect, and as the details of their structure and habits are too voluminous and interesting to be hurried over in a paper of this kind, it may be sufficient to remark that they are parasites chiefly upon the females of certain *Andrenidæ*, a family of wild bees; the female *Stylops* remaining enclosed between the abdominal rings of the *Andræna* during all her stages, and the male until his perfect condition; when he acquires wings, exhibits great activity in his search for the other sex (which is, of course, carried about in its living prison), and dies within a day of arriving at maturity. Our countryman, Kirby, was the discoverer of these marvellous insects.

Of other—and undoubtedly Coleopterous—bee-parasites, *Leptinus testaceus*, a species of considerable rarity in this country (I once found it in a nest of the large black wood-ant, *Formica*

fuliginosa, at Mickleham), has recently been detected on the continent, living in the nests of one of the larger white-tailed humble-bees (probably *Bombus terrestris*). Herr Eichhoff, who records this occurrence, states that there were but two or three nests in which he did not find the beetle, out of thirty that he examined, and that some contained twenty or thirty specimens each; there can, therefore, be little doubt that the true residence of this interesting Acaroid little creature has been now discovered. Other beetles, also occurring (though comparatively rarely) in this country, have been observed on the continent to be parasites upon humble-bees, such as *Cryptophagus setulosus* (in great plenty) and *C. pubescens*, *Antherophagus nigricornis*, *silaceus*, and *pallens*.

Nor are the dwellings of the allied genus *Vespa* without their illegitimate tenants. The hornet (*V. Crabro*) fosters (or is compelled to tolerate, whichever be the true interpretation) *Quedius dilatatus*, as above-mentioned; and the common wasp (*V. vulgaris*), apart from *Cryptophagus pubescens* (which has been observed on the continent to be more abundant with it than with the humble-bees) and, occasionally, *Onthophilus* (one of the true Coprophagous *Histeridæ*), lodges in its structures a most curious beetle, *Rhipiphorus paradoxus*, one of the *Mordellidæ*, in which the body is broadest and convex on the upper side, but shelves down to a mere ridge beneath, and a certain degradation in the development of the parts of the mouth commences. This insect undergoes its transformations in the cells of the nests, the larger larvæ (from which the females are produced) being found with, and feeding on, the female wasp grubs. The perfect insect, which is also sometimes found in the nests, varies considerably in the two sexes, the female being the largest and usually having blue-black elytra, which are of imperfect development, being attenuated and gaping, so as to allow the wings to be seen. In the male the elytra are reddish testaceous, and the antennæ have the third and following joints divided into double fan-like rays. It will be remarked that the parasitic habits of this insect, as in *Melœ* and *Sitaris* above-mentioned, are accompanied by a lessening of the usual development of certain parts of the body. Our countryman Mr. S. Stone has accurately observed the economy of these parasites on the *Hymenoptera*.

Lastly remain to be noticed the most interesting of all the alliances of the *Coleoptera*, viz., those with the ants. So numerous and constant are these alliances that the epithet "*Myrmecophila*" has been coined to express the beetles that contract them; and they have formed objects of study to eminent entomologists in all European countries, Aubé, Chevrolat, Grimm, Janson, Kiesenwetter, Mörkel, Mannerheim,

Motschulsky, and Schiödte being conspicuous among them. In spite, however, of the numerous observations that have been made, and of the extension among British Coleopterists of acquaintance with these beetle-ant connections through collecting operations, no satisfactory explanation has been given for them. It has, indeed, been suggested that the *Coleoptera*, and especially those of the section *Brachelytra*, resorting to the nests may be in some way conducive to the welfare of the communities, in all probability yielding secretions which serve as food to the young brood. But this view appears to me to reverse the case. It is surely more likely that the beetles find in the secretions of the ants or in the materials of which they form their nests, or in the food which they procure for their young brood, a sufficient attraction to induce them, as free agents, to take up their abode with the latter. On the other hand, in two instances, at least, viz., *Claviger testaceus* and *Atemeles*, there can be no doubt that their landlords are as careful over them as their own young, bearing them rapidly, but with an excess of care, away from the approach of danger, and exhibiting as much anxiety on their account as some of their species do for the *Aphides*, to whose secretions, so agreeable to the ants, it is possible that those of the beetles may be similar. It is certain that the larger *Brachelytra* frequenting ants' nests acquire a most peculiar and pungent odour, and that they often distil an iodine-coloured fluid on the cards on which they are mounted, and retain a like smell for a considerable period. This, evidently (from its similarity of smell) derived from constantly dwelling in a vapour of exhalations of formic acid, may, on the principle of "similia similibus," be acceptable to the ants, whose ingenuity may succeed in "tapping" the internal supply, though there is no visible outlet as in the *Aphides*. Apart from this interpretation, there remains no solution for the enigma but that of sentimental attachment, which is rather too absurd for such work-a-day folk as the *Formicidæ*. No verbal expression could, nevertheless, sufficiently depict the evident trouble and anxiety with which a *Formica fusca* carries away *Atemeles emarginatus* in its jaws, tenderly bearing it; and there is something ludicrous in the complacency of the beetle, a great, angular *Brachelytron*, as it submits to be thus dandled; the absurdity of the thing being more apparent when one compels the ant to drop its nurseling, which straightway opens out its long legs and antennæ, and, considerably larger than its late porter, scuttles away with straggling gait.

The British ants which have hitherto been observed to harbour beetles in their nests are *Formica rufa*, *F. congerens*, *F. fusca*, *F. fuliginosa*, *F. flava*, *F. sanguinea*, and *Myrmica rubra*.

The first of these, *F. rufa*, commonly known as the wood-, hill-, or horse-ant, is of large size and red colour, with darker abdomen; it builds heaped up nests of a conical shape, composed of twigs or any light rubbish not too bulky for transportation. Sometimes these nests, when undisturbed, are quite two feet high; and they are often constructed inside the trunks of hollow trees or piled up against the outsides. The cells appear to be formed in the ground, and the heap acts merely as a shelter.

Associated with this ant—which is a most pertinacious, pungent, and pugnacious creature, holding on by its mandibles, and allowing its body to be torn away, leaving the head and jaws attached, rather than relinquish its bite; and which, moreover, has a pleasing habit of bringing its abdomen forward between its hind-legs, and therefrom projecting an acrid juice to some distance—are found some twenty species of beetles in this country, the majority belonging to the *Brachelytra*. Of these, perhaps, the most typical is *Myrmedonia humeralis*, belonging to the genus of myrmecophilous beetles *par excellence*, as all its members are either positively or by reputation ant-parasites, one of them, indeed, *M. canaliculata*, being found with nearly all ants, though also in other situations. The two exceptions are *M. Haworthi* and *M. collaris*, both considered myrmecophilous, but I think erroneously; the former is so rare both here and abroad that there is no sufficient evidence of its true habitat, all that have been found having occurred in sandpits or among dead leaves; and the latter is certainly a wet-moss insect, occurring in the Norfolk Fens and on Wimbledon Common in *Sphagnum*. Our countryman, J. F. Stephens, who first described the former of them, separated them both from *Myrmedonia*, and formed two separate genera (not now recognized) on their behalf. It is somewhat amusing to notice the revolutions that take place in a few years both in nomenclature and collections. At the time of publication of that author's manual, the secret of ant's nest hunting was either not known or not appreciated in England; the result being that the claim of divers species (now in every novice's cabinet) to a place in our lists depended upon single specimens, found "under a stone," or "flying," or under similar accidental circumstances.

In the nests of *F. rufa* are also found the following *Brachelytra*:—*Thiasophila angulata* (and sometimes *T. inquilina*), *Dinarda Mærkelii* (a small form of which occurs also with *F. sanguinea*), the exceedingly rare *Lomechusa strumosa*, *Oxypoda formiceticola* and *O. hæmorrhœa*, *Homalota anceps* and *H. flavipes*, *Quediis brevis* (some of whose congeners are above-mentioned as either direct or indirect parasites on other insects), *Lepta-*

cinus formicetorum and *Xantholinus ochraceus* (which, though found in the nests, is probably not truly attached to the ants). Of the *Histeridæ*, *Saprinus piceus* and *Dendrophilus pygmaeus* (and perhaps *D. punctatus*); and, of the *Colydiadæ*, *Monotoma conicicollis* and *M. angusticollis* frequent these nests, where also the larvæ of the common rose-chafer, *Cetonia aurata*, occasionally live, and those of *Clythra 4-punctata* seem to have their natural habitat, though the perfect insects of both these species would never be suspected of such an origin. Another unsuspected visitor is the rare and delicate *Prionocyphon serri-cornis*, which has, on more than one occasion, been taken in these nests.

In the nests of *Formica congerens*, a species closely allied to *F. rufa*, and occurring in Perthshire, the larva of *Cetonia ænea* has its dwelling; the perfect beetle having been observed to fly down and disappear, burrowing in the huge mounds of nests until it reaches a place judged fit for the deposit of its eggs. Here also is found the little *Homalota parallela*.

With *Formica fusca* cohabit *Atemeles paradoxus* and *A. emarginatus*, *Dinarda dentata*, and the quaint pigmy *Heterius sesquicornis*, with uni-articulate club to its antennæ. The nests of this ant are very unlike those of the preceding, being merely cells connected by intricate passages and galleries, excavated beneath the surface of light warm banks, and usually having their entrance under a stone. The *Heterius* seems to be an object of great care to the ants. Near the nests of this species (and also with *F. rufa*) the large and handsome *Aleochara ruficornis* has been captured. *Homœusa acuminata* was, also, first introduced as British on the authority of a specimen taken in a nest of *F. fusca*; but subsequent investigation has shown, that its true haunts are the runs or beaten paths worn by the thin lines of scouts ever on the tramp near nests of *F. fuliginosa*, a large jet-black ant usually building in decaying trees, from and to holes near the roots of which hundreds of its shining workers may be seen constantly hurrying.

With the latter *Myrmedonia humeralis* and *Quedius brevis*, at times so abundantly associated with *Formica rufa*, are very rarely found; but other *Myrmedoniæ* in plenty supply their place, no less than five species of that genus (*funesta*, *laticollis*, *lugens*, *cognata*, and *limbata*) evincing a partiality for the chewed woody fibres ejected from their galleries by the ants, and deposited near the mouths of the burrows in moist fermenting heaps. The first of these beetles, *M. funesta*, is often exceedingly abundant, running about rapidly amongst the troops of its friends, from which, on account of its similar stature, equally shining mail, and deep black colour, it is not readily to be distinguished. All these *Myrmedoniæ* have a

curious habit of packing themselves up when not in motion; the head being deflected, the abdomen rolled up over the thorax and elytra, and the antennæ and legs cramped together; so that, when they suddenly stretch their body and limbs to their fullest extent, the difference in size is very conspicuous. They also readily counterfeit death; and scamper off with marvellous celerity on the approach of danger. Many other *Brachelytra* are found in *fuliginosa* nests; *Haploglossa gentilis*, *Oxypoda vittata*, *Homalota confusa*, *Thiasophila inquilina*, *Omalium pygmæum*, and *Falagria thoracica* (the latter, however, being often seen in other situations) constantly occurring in them, with beetles of other sections, such as *Amphotis marginata*, *Batrissus venustus*, *Abræus globosus*, *Atomaria ferruginea*, etc. I have taken the rare *Leptinus* (above mentioned as a *Bombus*-parasite) with this ant; and the very rare *Oxylæmus variolosus* has been recorded on the continent as also dwelling in its nests. This is not unlikely to be the case, as I have found *Cicones variegatus*, one of its close allies, in the sodden wood-dust at the mouth of the burrow; but in both these instances it is probable that the visits are only accidental, for *Cryptophagus scanicus*, and other certainly non-myrmecophilous species, may be often found in these places. In the runs near the nests above alluded to, and which are from time to time changed by the ants, a new and conspicuous species of *Oxypoda* (*O. glabriventris*, mihi) has recently been discovered at Mickleham.

The little yellow ant, *Formica flava*, abundant all over the country, appears, in the construction of its nests, to adapt itself to circumstances; for in woods or green meadows it raises little mounds to keep the rain away from its cells, having, indeed, been remarked to utilize mole-heaps for this purpose; but in hilly or chalky districts it simply constructs passages and cells under large stones. These latter are the residences of that most curious little yellow beetle, *Claviger testaceus*, which, on account of its want of eyes, and otherwise general debasement of structure, is usually placed at the end of the *Coleoptera*, being the opposite extreme to the highly organized *Cicindelidæ*, or tiger-beetles. There can be no doubt, from the number of times that *Formica flava* has been observed to evince the greatest care over this beetle, hurrying it away to the inmost recesses of the burrows, on the surface stone being lifted, that it is an object of importance to the community; for to suppose that the somewhat similar appearance of beetle and ant in size and colour deludes the latter into taking these precautions, under the supposition of the *Claviger* being one of the family, is not only an insult to its intelligence, but is not warranted by usual practice, for the ants only carry away their

larva or pupæ, which are of a different shape and hue to themselves. With this ant *Myrmedonia limbata* and the rare *Trichonyx Mærkelii* also occur sometimes.

From the above account it will be seen that the bond of persistent connection between certain *Coleoptera* (chiefly of the section *Brachelytra*) with some of the Heterogynous *Hymenoptera* remains yet to be fully explained; and rural observers of insect economy, who desire a change from the study of the habits of the honey-bee, will find a new field in the endeavour to supply this explanation.

BUDDHISM AND ITS LEGENDS.*

A religion which at the present day represents the feelings and guides the thoughts of at least three hundred millions of the human race, which had its origin some centuries before the Christian era, and which is more or less associated with the highest existing forms of Oriental civilization, is, of necessity, a very remarkable object of contemplation; and there are peculiarities about Buddhism which make the extent of its diffusion an almost unique phenomenon. From the stationary tendencies of Eastern life, we can imagine that any set of opinions once adopted would be tenaciously preserved; and, had it not been for occasional extensive conquests, the Oriental mind could have had few tendencies to change impressed upon it for a long series of generations. The causes why the civilization of Oriental nations ceased to be progressive are no doubt complicated; but, if we look to the way in which society progresses in Europe, we may arrive at the conclusion that no people continue to advance except they are stimulated by contact and competition with other people equal with, or superior to, themselves in some important particulars of knowledge, aptitude, or skill.

In former ages there was more vitality in the East, and, about six hundred years before our era, in the days of the Prophet Daniel, Mr. Spence Hardy invites us to imagine ourselves "in an appanage of Rajagaha, the capital of Mágadha, where the lord paramount of the Aryan race holds his court." He pictures the intellectual culture as resembling that of Athens in the days of its earlier philosophers; the commercial activity well developed, and "a freedom of manners and constancy of intercourse between the different grades of society

* *The Legends and Theories of the Buddhists compared with History and Science.* With introductory notices of the Life and System of Gotama Buddha. By R. Spence Hardy, Hon. M.R.A.S. Williams and Norgate.

like that seen now among the nations of Europe." "A general opinion seems to prevail that some great personage is about to appear, who will make all one, from being gifted with unerring intelligence and unbounded power . . . and men are waiting for some event to decide whether future ages are to be ruled by a Chakrawartti, a universal monarch, or guided by a Buddha, or all-wise sage."

On Sunday, the day of the full moon in the month of May, and in the year B.C. 623,* a prince of the house of Sákya was born in Kapilawastu, a city supposed to have been on the borders of Nepal, and on the following day his mother died. As he grew up, his preceptors foretold that he would become a recluse, and his father endeavoured to entice him into a more regal mode of living by the pleasures of the chase and the glories of war. At the age of sixteen he was married to the princess Yasodhora, "peerless in excellence and in grace"; but his character seems to have had few capacities for domestic enjoyment. The sight of a leper, and afterwards of a decomposing corpse, encouraged his brooding and introspective propensities. He came to the conclusion that all existence was vanity, and he determined to exchange his princely rank, with all its luxuries, for the position of a wandering mendicant, carrying an alms-bowl to receive the gifts of the charitable. He put this intention into practice on the very day on which his wife presented to him his first-born child. He looked at the infant and its sleeping mother, felt no compunction at leaving them, and rushed off into the forest with an attendant, whom he soon dismissed.

When he carried his beggars' alms-bowl through the town, the beauty of his person and the grace of his manner caused many to take him for a celestial personage. He accepted the morsels of food that were given to him, and eat them under a tree; their uncleanness reminding him of the vileness of man's body. His austerities nearly cost him his life, but he recovered, and spent six years in mental anguish and ineffectual search for absolute truth, and the means of extinguishing all human desire. Again he carried the alms-bowl, and, being deserted by his companions, continued his struggle alone. "Taking with him," says Mr. Spence Hardy, in his graphic narrative, "as much food as would support him during forty days of additional trial, he retired to the spot that was afterwards to become of world-wide renown. There, under a bo-tree, he was assaulted by innumerable demons, and the contest was fiercely

* The dates of Gotama's birth and death are variously given; the latter being, according to some authorities, 2422 years B.C., others place it at 544 B.C., and Westergaard as late as 370 to 368 B.C. Spence Hardy is a high authority on all questions of Buddhism, and we give his in the text.

prolonged ; but he resisted with like success the menaces of frightful fiends and the allurements of beauty, under all the forms that licentiousness could devise, until, before the setting of the sun, he was the acknowledged victor ; and, before the light had again dawned, the great end of his toil was accomplished, and he stood forth before all worlds a supreme Buddha, 'wiser than the wisest, and higher than the highest.' "

His first intention was to keep his newly-acquired wisdom to himself, but, on second thoughts, he resolved to commence preaching the Dharmma, unfolding the principles of his religion. Five Brahmins, who had been the associate of his first ascetic wanderings, were chosen as his first hearers and disciples. He taught them that sorrow is connected with every mode of existence, and that its cause is desire or attachment to sensuous objects, from which, by right conduct and mental tranquility, man may be relieved. Perfect freedom from desire would constitute the nirwana, or state of final perfection.

The King of Mágadha became a convert "on hearing the stanza so often found in monuments" now existing in India, "All things proceed from some cause : this cause has been declared by the Tathágato : all things will cease to exist : this is that which is declared by the great Sramana (Buddha)." It is, perhaps, impossible for any member of the modern Western world to understand how such maxims or dogmas could be accepted as the results of a supernatural exaltation to the highest medium, or how the metaphysical system of the ascetic sage could so readily obtain its marvellous sway. Mr. Spence Hardy considers that, at the period when the new religion was introduced, the popular theology was in a transition state between the Vedantic and the Brahminical systems, but with a tendency towards the latter, which developed its cumbrous mythology at a later date. In times when wealth and power are concentrated in few hands, an ascetic religion is sure to exercise a fascination over those who are hopelessly shut out from luxurious enjoyments, and it also comes as a relief and contrast, needed by those who repent of licentiousness when they are satiated and nauseated with its evanescent delights. The power of self-renunciation for a good object must likewise, in all stages of society, exercise a charm over the human mind, and Sákya-Muni, the "Penitent," must have appeared, in the eyes of his followers, elevated far above the earthly dignities which he abandoned in his resolute and arduous, though misguided pursuit of truth.

Were any one now to profess to be "wiser than the wisest," his pretensions would be tested according to the positive methods of physical science ; but pre-scientific times were of necessity times of credulity, in which there were no means

of disproving the most preposterous assertions, and when the world was prepared to accept teachers more from the vigour of their egotistical assertions, than from the evidence they might adduce. We may suppose Sákya-Muni to have come as a religious reformer, opposing certain growing and mischievous errors of Brahminism, and their hateful doctrines of *caste*; supplying a void in the popular faith, manifesting his integrity by his self-denial, and propounding a philosophy plausible enough for the vulgar, and subtle enough to exercise the deepest minds. Miracles were, of course, not wanting, in the belief of his disciples, to the attestation of his powers; but after several wonderful and supernatural escapes from danger, he finished his career, at the age of eighty, by a most unromantic attack of diarrhoea, brought on by eating pork.

To despise forms, to avoid evil, to think kindly of enemies by dwelling on their good qualities, and to put aside revenge by reflecting that its object is only a lot of bones, a skin covered with hair, and a mass of blood-vessels, and to meditate on the perfection attainable by subduing desires, seem to have been the chief teachings of Buddhism, as apprehended by the mass of its early followers; but for the more speculative due provision was made. Gotama Buddha affirmed that a sentient being depended upon, or was composed of, five essentials, called Khandas: "1. Rupa, the organized body; 2. Wedana, sensation; 3. Sannya, perception; 4. Sankhara, discrimination; 5. Winyána, consciousness." Mr. Spence Hardy remarks, "This system tells man that he is a heap, a collection, an accumulation, an aggregation, a congeries, an increment, and nothing more. To develop light, there is the lamp, the wick, the oil, and the flame; and to develop the man, there must be an organized body, and the five Khandas. When the flame is extinguished, the light ceases to be; when the Khandas are broken up, the man ceases to be;" but this negative result is not accepted by all the followers of Sákya-Muni, and is repudiated by the Llamas in Thibet.

Through the operation of Upádána, or cleaving to existence, a new being is produced at the dissolution of the old one, and to this, the Karmma, or aggregate of all the actions and responsibilities of the original being, is transferred. Mr. Hardy gives the following very curious passage on the Buddhist doctrine of continued existence: "On account of awijja, ignorance, sankháro, merit and demerit, are accumulated; on account of these accumulations, winyyánán, the conscious faculty is produced; in consequence of the faculty of consciousness, námarúpa, the sensitive powers, the perceptive powers, the reasoning powers, and the body, are produced; on account of the námarúpa, the body and sensitive faculties, the sadáya-

tanán, the six organs of sense (the eye, the ear, the tongue, the nose, the body, and the mind) are produced; on account of the six bodily organs, phassa, contact (the action of the organs), is produced; on account of contact, wédaná, sensation, is produced; on account of sensation, tanhá, desire, is produced; in consequence of desire, upádána, attachment, is produced; in consequence of attachment, bhawa, existence, is produced; in consequence of a state of existence, játi, birth, is produced; in consequence of birth, decay, death, sorrow, weeping, grief, discontent, and vexation are produced. Even this is the origin of the complete catenation of sorrow."

The Buddhists recognize three phases of being—1. Kama, in the worlds belonging to which (places of punishment included) pleasures and pains result from the exercise of the senses; 2. Rupa, worlds in which are organization and intellect, but no senses; 3. Arupa, worlds in which there are no bodily forms, but sensation, perception, discrimination, and consciousness. There are four of these worlds, the last being a sort of dreamland, in which consciousness is imperfect, there being neither consciousness nor unconsciousness. "Were a sentient being to pass through all these states of existence, in all these worlds, the period would extend to 231,628 maha kalpas, and 12,285,000,000 years."

The nirwána is the state of freedom, from wána, attachment, or desire. "The great rishis (prophets) who are free from wána, desire, call that nirwána which is achutan, that from which there is no going (no transmigration); achchantán, that which has no boundary (neither birth nor death); asankhatán, that which is not affected by cause or effect; anuttara, that to which there is not anything superior; and padán, that to which there is nothing to excel it in advantage."

In Ceylon the nirwána seems to be synonymous with annihilation, and Buddhism is described as atheistic, from its not recognizing any one paramount and supreme self-existing being. It must be a weary soul that can long for the eternal cessation of all sensation and activity, as its hoped for rest; and a religion which inculcates the destruction, instead of the regulation and right direction, of desire, must oppose a tremendous obstacle to social progress; but Buddhism has more theistic aspects in Cochin China, Siam, and Thibet, at least among the more cultivated classes; and as they become gradually acquainted with European science, their implicit credence in numberless absurdities must pass away.

From Mr. Spence Hardy's book, which was originally published in Ceylon, we find he is engaged in a most important controversy with the Buddhists. He assails their religion with all the weapons of rationalistic criticism, and the native priests,

assisted pecuniarily by the King of Siam and a local chief, use the printing press in their defence. Thus we have a very remarkable collision of the western and eastern minds, from which beneficial effects of the highest moment may happily arise.

The Buddhist views of the universe indicate their origin in a pre-scientific period, when mystical imaginations took the place of accurate observation. Boundless systems of worlds, Sakwalas, scattered through space in groups of twos and threes, can all be seen by Buddha, who can tell what is transacting in any one if he wills to know it. "In the centre of each system is a mountain called Sinéru, or Maha Meru. It is 1,680,000 miles from its base to its summit, half of which mass is below and half above the surface of the ocean. On each side it is of a different colour, being like silver towards the east, and like a sapphire towards the south. . . . It is supported on the three-peaked Trikuta rock, like a vessel upon a tripod." It is also said to be firmly clasped by them as by a pair of pincers. The three rocks rest upon a world of stone. On the summit of Maha Meru is the heaven of Sekra; in the body of the earth are eight places of suffering. Between Meru and the Sakwala ridge are seven circles of rocks, with seven seas between them, and the waters of the seas do not evaporate, and no rain falls in them. The first world is 2,400,000 miles thick. At its base is a stone world, impervious to water, 1,200,000 miles thick, and above it is the world of the earth, which has the same thickness, and below it is the world of water, 4,800,000 miles thick, and below that the world of wind, 9,600,000.

Each Sakwala has a sun and moon. The sun is 500 miles in height, length, and breadth, and its circumference is 1,500,000 miles. The moon is 490 miles in height, length, and breadth, and its circumference 1470 miles, etc., etc.

Buddhist astronomy, physical geography, and natural history proceed in this absurd style, offering an easy victory to real science wherever members of the Buddhist faith can be induced to study it, and to apply its teachings fairly and honestly to the correction of this preposterous legend.

Eclipses are occasioned by a monster nearly 50,000 miles high, who sometimes hides the sun and moon in his mouth, and sometimes covers them with his hand.

It is supposed that Buddha has passed, and will pass through endless forms of existence, for the benevolent purpose of teaching sentient beings the way to permanent peace—the nirwana which we have described; but, as might be expected, the recorded sayings of Buddha are not consistent with the pretensions of such enormous and varied experiences.

The Buddhist method of arriving at truth is one which necessarily passes out of public favour, as scientific and industrial civilization ensue. Solitary meditation in lonely places, carried to a certain point, is expected to bring comfort to the devotee ; but he still retains reasoning and investigation, which a continuance of the ascetic process takes away and replaces by a condition of pleasurable intuition. A third process of solitary meditation, if successful, removes joy, gladness, and sorrow, and diffuses through the whole system a perfect tranquillity ; and after a fourth process of the same kind, all reasoning, and all attachment to sensuous objects being removed, purity and enlightenment of mind engross the Buddhist saint, like a garment that covers him from head to foot. That those who can sustain the physical discomforts of this route to "perfection," arrive at the most complete and egotistic self-satisfaction, is evidenced not only by Buddhist devotees, but by the ascetic mystics of all ages and of all creeds ; but whatever may be the precise dogmas of the superstition that sanctions such practices, they usually lead to the same result, the degradation of the individual, and his withdrawal from the performance of all the duties and obligations imposed upon man as a social being. The ideal of perfection held up before a community that accepts any of the varieties of such a faith is of the most mischievous kind. It renounces duty as well as enjoyment, and looks to annihilation or inactivity as its ultimate reward !

Mr. Spence Hardy attacks the Buddhists by scientific criticism. He tells them that the personal existence of Gotama himself is open to doubt ; that all the notions ascribed to him concerning the physical condition of the universe are provably incorrect ; that the books in which the legends and opinions of Buddhism are set forth cannot be historical, because they state things which are impossible, and were not written till long after the events they pretend to describe. So far as they are able, the Buddhists reply, and thus the controversy goes on.

Railways, irrigation works, better pay for labour, and the opening prospects of personal advancement to those who are intelligent and industrious—these are the circumstances which seem likely to raise the Oriental mind when they can be brought to bear upon it. The superstitions of Buddhism and Brahminism belong to particular conditions of society, and experience seems to show that extensive changes in speculative thought can only be effected when other changes have prepared the way. The difference between the Oriental and European point of view is enormous, and hitherto no European race has succeeded well in governing and improving Orientals, though

occasionally some gifted individual, like the late Sir C. Napier, in Scinde, has been of wonderful use. Perhaps the industrial development of India may lead the natives to do their part towards reforming themselves. No amount of European benevolence can be a substitute for self-action, and the conservatism of Eastern nations can only be overthrown by movements that develop new interests and create new wants.

KAFFIR PROMISE AND CAPABILITY.

BY DR. MANN, F.R.A.S., F.R.G.S., F.E.S.L., SUPERINTENDENT
OF EDUCATION IN NATAL.

(*With a Tinted Plate.*)

IN a recent number of the INTELLECTUAL OBSERVER an allusion was made to the curious fact that there is a kind of education going on even among the wild Kaffirs, in consequence of the lives of gossip and of incessant talk that the men lead; and that this becomes at once apparent when the features of the young men are compared with the features of the old men, the countenances of the young men being commonly wild, furtive, and unintelligent, and the countenances of the old men being as commonly gentle, astute, and sagacious. This fact is illustrated in the plate of *Types of Zulu Kaffirs* that accompanies the present number. Figure 3 is the portrait of a young man of Ngoza's people, taken by photography at the chief's kraal, near the base of Table mountain, within sixteen miles of the city of Maritzburg; and Figure 4 is the portrait of Umshiyane, an old man of the same clan, taken by photography at Maritzburg. Figure 3 may be deemed a fair type of the young wild Kaffir of Natal, and Umshiyane is a fair specimen of what the young wild Kaffirs of Natal become after they have gossipped together for half a century.

Figures 1 and 2 of this same plate illustrate another scarcely less interesting fact in connection with Kaffir features, namely, that there are two very opposite types occasionally developed with great distinctness even in the same families—the one having the flat nose, projecting jaw, thick lips, and low cerebral development of the pure negro race; and the other having the small jaw, sharp features, prominent nose, and full capacious foreheads, that must be referred to some higher form of organization. It is not possible to have any extended acquaintance with the Kaffirs of Natal, without feeling that they have much in them that is common to themselves and to the negro. But it is equally apparent that they have

also much that the true negroes want, and that at times comes out in sufficient force to entirely mask the negro organization and blood. There can scarcely be a doubt that the Kaffirs of Natal and its neighbourhood are a composite people, formed by the engrafting of some nobler organization upon the negro stock, and that there is continually a developing out of the leading characteristics of both the lower and the higher element in different individuals. Figure 1 may be taken as a pictorial representation of the lower type, although without the full development of jaw that is often encountered. It is the portrait of a man of the Amabaca tribe, a people who originally dwelt between the site on which Maritzburg now stands and the Umgeni river, and who were driven from that position, at the time of the Zulu invasion, to the river Umzimkulu, at the south-western frontier of the colony, where they now dwell, partly within and partly beyond the British territory. Figure 2 illustrates the higher type of Kaffir organization. It is the portrait of Umkalipa, a subordinate chieftain, who is often seen at the seat of the Colonial Government, and who not infrequently proves a useful man to the authorities. Both these portraits are from photographs taken in Maritzburg by the author of this paper, and both have been very admirably and exactly copied by the engraver.

It is matter of familiar observation that the leading characteristics of the negro organization are very much more softened on the eastern side of the great African continent than they are on its western side. This seems to indicate that the modifying influence is in some way connected with geographical position—that it lies in the east, or more exactly in the north-east. Professor Huxley believes that the Kaffirs are a composite race, mingling distinct elements in their blood, and is of opinion that there has been a migration from the north-east. It looks very much indeed as if some people of higher organization than the true negro, but not disinclined to amalgamate with them, had come from the north, possibly somewhere among the highlands of Abyssinia, and passing through the equinoctial region of this side of the continent, the natural seat of the negro, had mingled with them there, and sent a mixed offset towards the south, where the Kaffir tribes are now found. It is not unworthy of note that Mr. W. C. Palgrave, the great modern authority on Arabian matters, found a people in the province of Oman who present many points of resemblance to the Kaffirs of the highest type. Mr. Palgrave considers that the inhabitants of the central and northern provinces of Arabia are Ismaelitic, and of true Asiatic origin; but that the inhabitants of the southern province and Oman are of different extraction, and come primarily from the high-

lands of Abyssinia. The southern and eastern Arabs, or Kahtanic variety, manifest a remarkable sympathy towards Africans, and readily admit the negro races to social fellowship, not unfrequently intermarrying with them. The emancipated negro in Oman commonly gives his sons and daughters to the middle or lower class of Arab families, and the mixed race springing from these unions are called the "Benoo-khodeyr," or "Sons of the Green one." Mr. Palgrave states that it has been his fate to be honoured by the intimacy of more than one handsome "Green-man," with a silver-hilted sword at his side, and a rich dress upon his dusky skin, but denominated sheykh, or emir, and who was humbly sued to by Arabs of the purest Ismaelitic or Kahtanic pedigree. In reading his description one is almost induced to think that Othello must have been a "Benoo-khodeyr." The Arab town of Riad is full of "Green-men" shopkeepers, merchants, and officers of government. The Ismaelitic Arabs are reserved, self-contained, and of gloomy temper, and narrow and concentrated intellect and will. The Kahtanic Arabs are frank, impulsive, light-hearted, and of social instincts and habits, like the Kaffirs. It must also be added, that so far as the brown, olive, or yellow hue of the skin is concerned, there are unquestionably "Green-men" among the Kaffirs.

In considering the capabilities and possible future of the Kaffir races of Natal, there very naturally arises, first and foremost, the question of hard work. What are they worth, or likely to become worth, as beasts of burthen, and as "sons of toil." They do not take to bodily labour naturally; there can be no doubt about that. But when impelled by circumstances to waive their personal inclinations and predilections in this particular, they can do hard work, and do it well. In the agricultural districts of the colony, Kaffirs are now hired, as field labourers, in considerable numbers. They go to work under monthly engagements, and receive from six to ten shillings per month, and rations, for their service; their food being principally Indian corn, which costs about ten shillings per month for each man. They need to be looked after carefully, and also require, in most instances, to be shown exactly what they are to do. They work very well in gangs, headed by white men. Most of the public works in the colony are carried out by Kaffirs in this way. The roads are made by them. Considerable numbers of them have been employed in the harbour works at Durban for some time; and perhaps in this particular labour their powers of endurance and performance have been more fairly and fully tested than in any other instance. Mr. Arnold Taylor, the agent of the contractor for the construction of these works, had between three hundred

and five hundred Kaffirs in his employment during a term of four years. The men were the rudest and wildest specimens of the race, and were sent to him under the orders of the magistrate for six months' term of service. Most of them, when they arrived, were entirely without a conception of a shovel, a pickaxe, or a lever. Mr. Taylor found that, for rough labour, one of these Kaffirs was equal to two of the very best Indian coolies; and he estimated that one Kaffir was worth about a fourth part of a good English labourer, who would receive four shillings a day in England for his work. These Kaffir labourers required one English leader to look after a gang comprising from twenty to thirty individuals. They took kindly to earth-work with shovel, pick, and barrow. Some made excellent sawyers, in pits with white men at the top, and some became very handy as assistants to English smiths. They were always free to leave after six months' service, and were then replaced by new recruits. One remark made by Mr. Taylor is well worth record and attention. He invariably found that the men who came to him wild, raw barbarians, went away at the end of their service altered beings. Their countenances had become perceptibly brighter and more intelligent. Regular discipline and steady industry seemed to exert the most beneficial influence over their characters. There can be no doubt that well-ordered and well-arranged work, carrying with it the proper remuneration, and bringing in its train new cravings to be satisfied by new efforts of industry, would prove among these people the most certain and most potent civilizer that could be employed in their behalf.

Work on the sugar plantations is, in the main, popular among the Kaffirs for two reasons. The climate is warm and genial on the coast, where the sugar is grown, and treacle is a thoroughly appreciated addition to the daily fare. The chief drawback to the employment of Kaffirs in industrial enterprise up to the present time has been the uncertainty of their labour. It has been found hitherto impossible to induce them to take any long term of engagement. They will work while the humour is on them, but they will reserve to themselves the right to start off to their kraals whenever the humour changes. They are as fitful and capricious as children, and look with ready jealousy and suspicion upon all attempts to impose obligations and constraints upon them. On this account a considerable number of Indian coolies have been introduced into the colony to work upon the plantations, with fixed terms of service. The mail which has just reached England from the Cape brings the most welcome intelligence, that one of the enterprising coast planters in Natal has recently succeeded in inducing the Kaffirs to undertake to clear ground intended for

the cultivation of coffee upon contract by piece-work, the contract for clearance being at the rate of thirty shillings per acre. This is unquestionably a step onwards towards civilization.

With the sole exception that refugee natives who come into the colony from beyond the border are registered and apprenticed out to white masters for three years' service, and that men are supplied to the Government works under requisition from the magistrates, no pressure of any kind is put upon the Kaffir population to induce them to work for European settlers. The affair is entirely one of free inclination under the temptation of wages. Kaffirs living in native villages, either in their own reserved locations, or upon the property of the Crown, or of private holders, come of their own accord to the employers of labour, and make their own terms for remuneration and period of service. The average number of Kaffirs engaged in the service of white men in the colony last year was nearly seven thousand. The terms of service are generally short. This number, therefore, did not by any means represent the sum-total of native men that came under the civilizing influence of labour and personal communication with white masters during the year. The exact number of the black people from whom these supplies of service are drawn is not certainly known. The estimate is made from the number of huts that pay taxes to the Government, and it is assumed that each hut accommodates a certain number of inhabitants. The return made to the Government upon this estimate in recent consecutive years varies between 136,000 and 175,000. It is probable that the latter number is not very far from being correct as the tally of the native subjects of Queen Victoria, residing at the present time under British protection and rule in the colony of Natal. Assuming that one in eight of the Kaffir population is of man's estate within the years suitable for service, the number actually engaged in work is not a very contemptible proportion under all the circumstances of the case. It has yet to be seen that there are many more than those actually engaged in service to white masters, who are steadily within the pale of civilizing influences. It will be inferred from what has been said in a preceding article on the subject of polygamy that, as a rule, Kaffir women do not engage in service to white mistresses or masters. Their service is jealously and exclusively reserved for their own black lords.

Kaffir children manifest a very remarkable facility for the acquisition of book-learning. Children of tender age learn to read with great readiness, and soon become expert with all the simple rules of arithmetic. They are quick with mental arithmetic when well taught. The boys make excellent compositors



1



2



3



4

and printers. There is a little monthly Kaffir periodical called the *Ikweze*, issued at the American Missionary station, at Esidumbine, which is principally printed by a Kaffir boy. A native lad, named Magema, is the Bishop of Natal's principal printer, and during the bishop's recent absence in England, used to correct the proofs of his work as well as to print them. This lad is very clever indeed, in his vocation, and it is no inapt illustration of the change which the light of civilization can work in these people, that the birth-name of the skilful Magema was "skellum," which, in the Dutch patois, means "rascal."

The missionaries of various denominations in Natal have all been for some time engaged in creating a "literary Kaffir Language," which is printed in books, and in some measure taught in schools by the aid of dictionary and grammar. The chief argument which the missionaries employ in advocating this proceeding is their urgent desire that every Kaffir shall be able to read the Bible. This argument would have considerable weight in it, if it were the fact that the general Kaffir population of the land can read the Bible when it is printed in the Kaffir language. This, however, is not the case. When the Bible is printed in Kaffir, the Kaffirs still cannot read, unless the further labour has been performed of specially teaching them to do so. But in practice it is found that it is really quite as easy to teach Kaffirs to read English, as it is to teach them to read a new written language manufactured out of their own rude tongue. There therefore remains the very important consideration, whether when they are taught to read, it would not be better at once to teach them to read in the English language, which would immediately bring them so much more within the pale of white influences. There are many who think that if one-fourth part the labour which has been given to create a new definite and formal language out of the Kaffir elements, and which the wild Kaffirs do not all understand when it is so created, until they are painfully and gradually taught to do so, had been devoted to teaching them to speak, read, and write English, a tenfold larger result in the way of education would have been gained than is now being realized. Kaffir children who are well taught learn to read and understand the English language much more quickly than to speak it. The faculty of speaking it comes slowly, and with a little difficulty at first; but when mastered, it is spoken well. No doubt the English language seems to them at first a very barbarous one to have to articulate, being so free as it is from clicks and from guttural explosives. The author once asked a young, clever Kaffir girl, who had acquired a fair understanding of English in a school, but manifested a

pertinacious determination not to speak it, for an explanation of her reason. The young lady informed him that she did not like to speak it because she was sure it would make her tongue crooked! The difficulty was entirely removed by the author pledging himself that if such a result ensued, he would set the crooked organ straight by a surgical operation, and by his showing the instruments with which he proposed to effect the rectification. It is, of course, very important that missionaries and teachers should themselves so far understand the Kaffir language as to be able to speak it with facility. The facility is needed, indeed, to enable them to teach English to Kaffirs. Their object should, however, be colloquial rather than literary. It is one thing to speak a rude language familiarly, according to the custom of, and in the idiom of, the people, and another thing to convert that rude language into a written and printed one, to be perpetuated in a fixed and definite form for special teaching.

The Kaffir men manifest a very great eagerness to learn to read and write. They look upon the art as a sort of magic which the white man employs in carrying on the wonderful operations of his strange life, and they think it a very desirable thing to qualify themselves for similar performance. This is strikingly, although somewhat ludicrously, illustrated by the way in which young Kaffir men may be seen striving to effect their purpose in the principal large towns of the colony. Evening after evening gatherings may be seen of young Kaffirs who have been at work all day, and who then assemble round some wall tablet, and repeat simultaneously, with stentorian energy, B-a, ba; B-e, be; B-i, Bi, as one of their number points to the printed characters with a wand. It is almost painful to note the patient and resolute way in which these young fellows pursue the exercise hour after hour and night after night, in the faith that they are rapidly becoming adepts in wielding the white man's instruments. If the public income were sufficient for the work, the Government would experience scarcely any difficulty in establishing native schools for English instruction, even among the wildest and most retired natives. It once occurred to the writer to receive a visit, in a wild part of the country, from a powerful young barbarian chief, who came with a company of his old councillors to offer to build a school hut at his kraal, if the Government would send him a teacher to instruct the children of his people there. He explained that the principal ground of his request was his desire to be able, in case of need, to communicate with the head of the state by means of a messenger carrying his words in a written document. In consequence of the extreme youth of the colonial community, and the great demand that there is

for the employment of the public revenue in works of general utility, the Government is not yet able to devote any large sum to the furtherance of the work of native education. The expedient course has therefore been taken of giving small grants in aid from the public funds to the various missionary establishments already having a footing in the land, upon the condition that the English language and industrial pursuits are taught to the native children of the neighbourhood. It would unquestionably have been better for the immediate prospect of success if the Government could have taken the work of secular native instruction entirely into its own hands, because among the wild native people the influence of prestige is in favour of the Government and against the missionaries. The wild natives are generally suspicious of the missionaries, because they are so very zealous in their work, and because they preach energetically against polygamy. The natives think it is quite impossible for men to be so personally eager about making converts, unless for their own purposes and for their own gain. The alternative plan, which has been adopted on economical grounds, of using the agency already established on the field by missionary spirit and enterprise will, in the meantime, produce very decided results in the right direction, until more energetic and costly measures can be added. The system alluded to has only been in force three years, and there are, at the present time, as a first instalment, 1700 Kaffir children learning English at the various schools, of which one is a central training school, where the most promising native pupils from other schools are received to complete their education as pupil teachers. The cost to the Government of the common native schools is a trifle in excess of £900 per annum, and, in the last year, contributions were made in ten of these schools by the Kaffirs themselves in aid of their support, amounting in the whole to £205 12s. 9d. The Colonial Government also furnishes £1000 a year to these schools, for industrial training of natives. The amount is expended in the payment of salaries to skilled labour masters or mistresses. Last year about 120 boys and girls were benefiting by these industrial grants, of whom several were under regular indenture for fixed terms. The lads in these industrial schools are trained as carpenters, cabinetmakers, waggonmakers, brickmakers, stonemasons, builders, thatchers, tailors, and shoemakers. They readily attain fair proficiency in all these arts. Most of the extension of the buildings on the principal stations is now performed entirely by the boys; and, in some of the most advanced schools, the boys are beginning to go out as hired workmen to settlers living in the neighbourhood.

There is no more interesting subject of observation and

thought than the proceedings of Christian missionaries in wild lands. In the small and young colony of Natal, there are thirty-six stations occupied by resident missionaries, of which nearly one-third belong to the American Board of Missions. There are several Norwegian missionaries residing in Zulu Land, far beyond the British territory. As a rule, these missionaries settle down in remote wild districts, and build themselves houses there, where other objects and influences do not yet bring civilized men to dwell. Some few of the wild natives gather round their dwellings, fix their huts upon the missionary grounds, attend the missionary religious services, and send their children to the missionary schools. There are altogether about 3000 native people attending the services of the thirty-six missionary stations in Natal. Some of these go for curiosity and amusement; some for what they can get; and some are serious converts to the Christian practice and creed. Whatever may be thought of the actual economy of missionary work, on comparing results with outlay; or of the question whether from Christianity to civilization, or from civilization to Christianity, is the natural and appointed progress for barbarous man, there can be no doubt of the fact that these missionary stations, scattered through the wilderness, do serve as most valuable outposts in the attack of civilization upon barbarism. The most careless and casual comparison of a wild native kraal, with a missionary native village in Natal, serves to establish at once this fact. In the wild kraal the Kaffir is a naked savage, squatting in the sunshine, or skulking in his straw bee-hive, amidst equally naked women, whenever *they* find intervals from the bodily drudgery of drawing his water, bearing his burthens, or delving his ground. In the missionary village the Kaffir is a clothed man, living in a square house with a wife and a family of children, who derive their daily bread from the sweat of his brow, and beginning to understand the dignity of labour, the responsibilities of rational existence, and the value of temporal possessions. In many instances he is a curious creature in his new-fledged state, and bears his unaccustomed graces with a very manifest expression of self-complacency. Deference to the white man is a striking and constant feature in the character of the wild Kaffir. He is even slow to follow the example which civilized life sets before him in social things, because he looks upon the white man as a being of an altogether higher order than himself, and as the proper inheritor of special gifts and arrangements in which he can have no part. One of the answers occasionally made to missionary appeal by wild Kaffirs is, "Oh, yes; that is all very true. There is no doubt a great Spirit who looks after,

and cares for the white man. But He has nothing to do with the black men. The black man has no protector of that kind." When the missionary has just succeeded in getting so far with him as to lodge skin deep the idea that he has been mistaken in this, and that the Great Spirit of the white man does care for him, and that he is a "man and brother," it can hardly be matter of surprise if he begins to think rather better of himself than he did before, and if his natural deference and modesty gives place to self-assurance and personal conceit. There is no doubt that the phase is but a transitional one, and that a prolonged experience of the conditions and working of civilized and Christian life will assuredly bring its own remedy for the evil. Still the tendency is well worthy of note, because it points to one obvious precaution which missionaries may easily make a part of their programme when they prepare themselves to deal with the raw material of barbarism.

It is also deserving of remark that the missionary stations in Natal, which are so placed as to afford an industrial career for the natives resident at them, are those which are manifesting the surest signs of vitality and success. Wherever townships, or fairly prosperous settlements of white people have grown up in the close neighbourhood, so that there is transport work to be performed by waggons and oxen, and a ready market for such articles as the Kaffir can make, or such produce as the Kaffir can rear, or where there is a sugar-mill at hand to manufacture such cane as he may be able to grow, there the native Christian communities thrive and enlarge quickly. Upon the whole the most successful missionary station in Natal is that of the Umvoti. This station was established by Mr. Aldin Grout, one of the fathers of the American Mission, in the year 1844. A few years since the Colonial Government erected steam machinery for the manufacture of sugar at this station, with a view to encourage the growth of the cane among the natives. One half the sugar manufactured is taken by the Government to cover the cost of manufacture, and the other half belongs to the native planters. At this station there are now sixty-seven square European houses inhabited by native sugar-planters, who for the most part employ their own native waggon-drivers as hired servants. Many of these men are estimated to have property belonging to them at the present time of the value of not less than £800 a-piece. Mr. Grant believes that two of them are worth £2000 each. These planters have built a large brick church, capable of accommodating a congregation of 500 individuals, at their own cost, and they contribute £75 yearly for the maintenance of a school for the education of their children.

The most remarkable instance of the industrial capability of the Kaffir that has come within the writer's own personal experience yet remains, however, to be given. At the missionary station of the Amanzimtote, on the southern coast, and sixty miles away from the Umvoti station, there lives a Kaffir named Nembulo. This man, having heard of the wonders which the sugar-mill at the Umvoti was working, one day took his staff, and walked off to look into the matter with his own eyes. He returned home from the Umvoti, pondering upon what he had seen. When he had completed his deliberations, he went to a native intimate, named Uncaijana, living close by, and proposed to him that they two should buy a sugar-mill for themselves, and grow and manufacture sugar at the Amanzimtote! His overtures being well received by his companion, he next visited a white planter, Mr. Sidney Platt, residing near Durban, and bargained with him for the purchase of a small steam-mill, that Mr. Platt was wishing to replace by a larger one, the exact terms of the bargain being that Nembulo was to begin to pay for the mill one year after he had commenced operations, that all the sugar made was to be devoted to the payment until the debt was cleared, and that the price was to be £500. In the year 1864, the writer chancing to hear of this spirited proceeding when he was in the neighbourhood, sent for Nembulo, and questioned him about his plans. The only doubt about them seemed to be whether the Kaffir would be able really to get his mill fairly started, to make the money which was to pay the debt. After due consideration of all the features of the case, the writer brought the affair under the notice of the Lieutenant-governor, and procured a loan of £100 from the Government, to be expended in removing the mill to Nembulo's place, and in setting it to work there. In the month of June, 1865, the writer again visited Nembulo, to see how he had succeeded in his enterprise. He found the Kaffir stripped to the waist, driving the steam-machinery of a pretty little mill, the rollers of which were being fed with cane by the women of his family. There was no white man near him. He was "monarch of all he surveyed," and master of the position. When questioned, he gave the writer a very lucid explanation of the safety-valve, and some other parts of the machinery. He had just manufactured five tons of very excellent sugar. His Kaffir neighbours had already planted a considerable stretch of cane, and he stated that he expected to be able to pay off his entire debt, which then, including the advance from the Government, amounted to £700, within two or three years. He found that he was able to manufacture twelve hundred-weight of sugar (worth from £12 to £15) per day. His first year's crop was estimated at about seven tons. The history of

his proceedings since the previous year was, that he had procured an engineer from Durham to remove and erect the mill for him. He had then retained the man three days to give him a lesson in managing the machinery, and at the end of the three days dismissed him with a payment of £95 for his services, and immediately afterwards carried the £5 which remained of the Government loan to Mr. Platt, as the first instalment of the purchase-money. Having settled this piece of business, he filled up his time until the crushing season arrived, by going about from mill to mill to perfect his knowledge of the machinery; and when the proper time did come, he started his own machinery single-handed, without a single mishap, and worked it with entire success.

One other fact is all that can now be added to the arguments and illustrations of this paper. It is a trifle in itself, but it is a trifle that is full of meaning and promise, and therefore well worthy of record. Not very long since the writer was riding on horseback in Natal, quite alone, and in a wild part of the country, when greatly to his surprise he came suddenly upon a large surface of the open ground, unmistakably traced by the familiar furrow of the plough-share. There was a wide horizon round, and no sign of human life in sight, and no other token of the neighbourhood of civilized appliance. He was quite aware that there was no white man's house within many miles. At the end of the day's ride he found the solution of the enigma by learning that the wild Kaffirs of that district were in the habit of sending twenty miles to a settlement of their more advanced brethren which possessed draft oxen and ploughs, to get one of the fraternity to bring up the magic implements and break up the ground for their grain-crops.

It will be seen from the several statements contained in the preceding pages of this paper that an interesting social problem is in process of practical solution in Natal. Certain important questions, that relate to the future destinies of a large race of mankind are being there put to the test of actual experiment under eminently favourable circumstances. The contingency is the work of what is ordinarily termed accident, rather than of design. A black race, under the immediate influence of a reign of tyranny and terror, is flocking in to the midst of an industrious English community settled in an exceptionally fine and congenial climate. In order merely to put some check to the rapidity of this black exodus from beyond the Tugela, the colonial authorities have found it essential to enact an ordinance providing that all cattle brought into British territory by refugees shall be given back to the Zulu chiefs on formal demand, and that the refugees themselves

shall be registered, and apprenticed to English masters for a term of three years. The English rule is already more popular with the great majority of the wild Zulu people beyond the border than their own government. The smile of Queen Victoria has more power on the banks of the white and black Umfolusi in Zulu land than the frown of the shade of Chaka. Mr. Shepstone, the Secretary for Native Affairs in Natal, is of opinion that the instant the two restrictions alluded to above are relaxed, or withdrawn, the remaining fragments of the Empire of Chaka and barbarous Zuludom will crumble into pieces. Within the last few months, since the writer of these pages has left the land that he is speaking of, the Basuto chief Moshesh, beyond the north-western frontier, has sent a special messenger to the British High Commissioner to say how ardently he desires that his people, another division of the great Kaffir family, should be enrolled among the black children of the British Queen. The race that is concerned in these movements of contemporaneous history combines in itself the docility of the negro, with certain mental qualities that are of a higher order than those of the negro. Therefore, no theory that can be shown to affect the true negro, and no experience that has been reaped from the true negro, can be relied upon in reasoning upon its future destinies. The final issue of the Natal experiment is yet in the obscurity of time. But this much at least is known—so far as the British territory is concerned this interesting aboriginal people must either be converted into an industrious and civilized community, serving the interests and co-operating in the objects of their white and more highly gifted brethren, or their places on colonial ground must become vacant. Civilization and barbarism cannot long stand side by side, or face to face. In such a state of affairs the few notes that have been placed on record in these pages cannot be held to be without deep interest, both as indications and as suggestions—as indications of what may fairly be hoped for, and as suggestions of what may possibly be done.

LUNAR DETAILS.—OCCULTATIONS.

BY THE REV. T. W. WEBB, A.M., F.R.A.S.

INCREASING evidence is constantly adding to the conviction, already sufficiently strong, that in proportion as more powerful telescopes and more careful attention are brought to bear upon our satellite, the inadequacy of existing representations will become more apparent; and that, without a more minutely

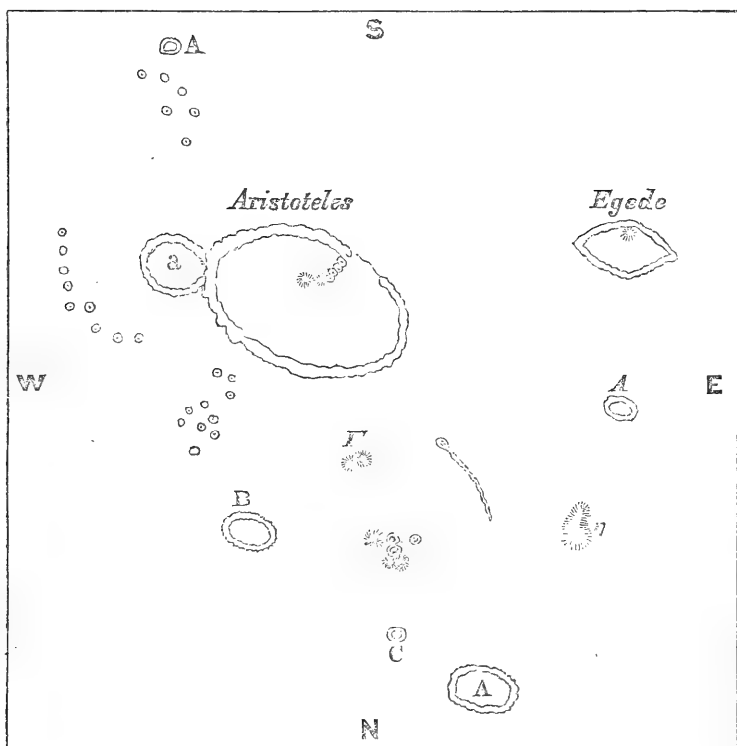

accurate delineation of the surface, the majority at least of our conclusions as to continuance of physical change are insecure. Our readers may be interested in becoming acquainted with an instance of this, which came before the writer not long ago. In our number for February last, a diagram was given of the great crater *Aristoteles* and its immediate neighbourhood, pretty accurately copied from the map of Beer and Mädler; and from its character, as well as that of their accompanying description, it would appear that they paid much attention to this curious

region. Yet a view of the vicinity, which I subsequently obtained on April 21, enabled me to add a few features, some of which, at least, it is strange that they should have overlooked. It is now to be regretted that the sketch in the February number did not include a wider area, so as to give room for a more interesting comparison; our purpose, however, will be sufficiently answered by the accompanying diagram, in which the lettered objects only are to be found in the map of B. and M.

With a power of 212, and very good definition in my $5\frac{1}{2}$ -inch achromatic, I distinctly perceived that the upper part of the ridge running down into the interior of *Aristoteles*, from the peak close to the breach in the S.W. wall, was really a chain of small craters, probably four or five in number. This, however, was of course an object of such delicacy, as to form no ground of inference. One of the lava-currents (?) issuing N.E. appeared as a very minute furrow, beginning at about $\frac{2}{3}$ of the diameter of the great ring from its summit as a little crater, probably broken down outwards, and running in a slightly curved direction for about an equal distance, with an aspect of irregular depth, as though it might possibly prove, under more favourable circumstances, to be a confluent chain of craters. Between B. and M.'s A (at the bottom of the diagram) and their two hills Γ is a curious group, consisting of a conspicuous pair of little contiguous craters, the larger N, with a smaller companion E, two unequal hills N. and another W. The ring B, of B. and M. has some irregularity within it, unnoticed by them. S.W. of it, about $\frac{1}{3}$ of the distance to the ring of a, but W. of the line, is a minute but conspicuous crater: between this and the wall of *Aristoteles* are several others still smaller, of which a mere idea is given in the sketch, as well as of a number of others to the S.W., the grouping of which seems to point to a, as their focus of action. N. of *Eudoxus* A (the most southern crater in the sketch) were several others; and on the whole the neighbourhood of *Aristoteles* was more like that of *Copernicus* than would have been imagined from B. and M.'s map. The W. of their two hills marked Γ either is a regular crater, or has a cavity on its summit.—April 23, 24, 25, the furrow could still be seen, though with decreasing visibility: the group of three craters between A and Γ remained conspicuous. April 23, I could still see the pit on the summit of the western Γ . All these objects therefore are confirmed, and the group of little craters in particular is shown to be an object of persistent visibility under varied illumination.

This assemblage of three craters and three hills had been previously discovered, together with several other very minute

craters near *Aristoteles* and *Egede*, Jan. 23, and reviewed Feb. 22, by Mr. Leigh, then of Birkenhead, with a very fine $9\frac{1}{4}$ -inch silvered speculum by With, but I had not at that time before me the sketch with which that gentleman had favoured me, nor any other than a very general recollection of its nature. I have no doubt the larger crater might be perceived with much less powerful instruments.

Now, are we to suppose that these objects did, or did not, exist at the time of B. and M.? In the face of their own drawing and description, it cannot be pleaded that this is an out-of-the-way region, which a selenographer might perhaps be pardoned for scrutinizing with less care. Nor can the admitted inferiority, as to light, of their optical means be alleged, when a portion of the objects, at least, are so very readily and persistently seen. A reference to Lohrmann's map shows us one of the twin craters, and so far tells against his contemporaries. But the question, it would appear, admits as yet of no completely satisfactory answer; and the same inquiry might be made, with the same ambiguous result, in examining many other parts of the lunar hemisphere. There must evidently be greater precision in detail before we can form safe conclusions as to the present condition of the moon.

OCCULTATIONS.

Jan. 8th, 18 Aquarii, 6 mag. 4h. 4m. to 5h. 2m.—9th. B.A.C. 7774, 6 mag. 6h. 2m. to 7h. 10m.—16th. θ Tauri, $4\frac{1}{2}$ mag. 4h. 1m. to 4h. 39m. 75 Tauri, 6 mag. 4h. 4m. to 4h. 50m. θ^2 Tauri, $4\frac{1}{2}$ mag. a near approach. B.A.C. 1391, 5 mag. 4h. 47m. to 5h. 48m. ALDEBARAN, 7h. 26m. to 8h. 37m.—17th. 130 Tauri, 6 mag. 11h. 59m. to 13h. 6m.—18th. 26 Geminarum, $5\frac{1}{2}$ mag. 7h. 44m. to 8h. 48m. (The night of 16th will be marked by especial interest, though too near the Full Moon to admit of the visibility of the dark limb; or give any chance of the optical phenomenon of "projection.")

OBSCURATION OF A LUNAR CRATER.

BY W. R. BIRT, F.R.A.S.

ALTHOUGH the disappearance of a crater on the moon's surface may not possess such an amount of interest as the sudden outbreak of a star, or a shower of meteors, as the earth plunges into a congeries of minute bodies, circulating around the sun—the two leading astronomical facts of the year 1866—yet, as giving us, inhabitants of the earth, intelligence that some change is taking place on the surface of our nearest celestial neighbour, every circumstance indicating that a portion of that surface is not in *precisely* the same condition as it was a few months since, must be regarded as extremely interesting; especially when we consider that “change” is the principal means by which we become acquainted, in a more intimate manner, with the physical constitution of bodies.

On the extensive lunar plain known as the *Mare Serenitatis* (INTELLECTUAL OBSERVER, vol. viii., p. 292) stands a crater named “Linné,” in W. longitude, $11^{\circ} 32' 28''$ and N. latitude, $27^{\circ} 47' 13''$. The crater, which is 5·6 English miles in diameter, is situated upon one of those low ridges, described by Mr. Webb, and is perfectly isolated, according to our maps; neither Lohrmann, nor B. and M. give any other in its locality, nor does Schröter; but it is not a little remarkable, that when observing the *Mare Serenitatis*, on the 5th of November, 1788, he saw in the place of “Linné” a dark diffused, but not sharply bordered spot, of not more than $\frac{1}{2}^{\circ}$ of light. Lohrmann saw the crater very distinctly, and measured its position. B. and M. also saw it distinctly, and made seven measurements for position. The indefatigable astronomer Herr Julius Schmidt, the Director of the Observatory at Athens, who has devoted much of his attention to the study of the lunar surface, for more than a quarter of a century, has known the crater since the year 1841, and never found it difficult until October, 1866, when instead of seeing the well known object, he could perceive nothing but a glimmer, a small whitish cloud in its place, and this was repeated in November, so that for upwards of one month, this somewhat conspicuous object must have been under a cloud.

It is hardly likely that this phenomenon can be any other than a *concealment*, and it would be interesting to know, if such were the case, when Schröter recorded the dark spot in its place. This is very probable, as the crater is distinctly shown *on the ridge* in Riccoli's map, published 1653. The most recent observations, December, 1866, show that the

extent of the whitish spot in the place of "Linné," is *greater* than the diameter given above. Upon comparing "Linné" with the standard spot, "Dionysius"—the diameter of which as given by Lohrmann, is 13·8 English miles, and also as measured on Rutherford's photograph—the magnitude—that is, the ratio in size, which "Linné" bears to "Dionysius," reckoned as unity—is 0·40; while on Dec. 15, 1866, its magnitude was 0·79, this will give 10·9 English miles for the extent of the whitish spot *over the crater*, which is exceeded by 5·3 miles. Lunar observers will doubtless watch the locality with great interest, especially as at the time when the terminator was near the spot, it was quite invisible. Whatever the cause of the obscuration may be, it is to be hoped that the first indication of the returning visibility of "Linné" may be made public, so that the period of its concealment may be well determined.

Closely allied to the observations of Herr Schmidt, is a series by the writer of this paper. Between the years 1858 and 1863 when the Sun had attained a considerable altitude above the *Mare Crisium*, a white ill-defined cloudy patch was regularly observed a little W. of the well known crater "Picard," but it was not seen about the time of sunrise or sunset at Picard. Nothing appeared to throw any light upon this appearance until the year 1863, when in the neighbourhood of the cloudy patch, a little before sunset, a small pit-like marking was noticed. In the year 1864 the attention of Mr. Ingall was arrested by a spot 6° or 7° of brightness in this locality, and towards the end of the year, the cloud-like patch had nearly faded out. On December 12, 1864, Mr. Knott, at his observatory, Woodcroft, Cuckfield, Sussex, examined the locality with his 7 $\frac{1}{3}$ -inch Alvan Clark, and discovered two minute craters, I C^{mu} 2 and I C^{mu} 5 of the new nomenclature. It was some time before this discovery was confirmed, as the smaller crater I C^{mu} 5 was very difficult to catch; at length, towards the end of 1865, Mr. F. Bird of Birmingham, saw the pair with his silvered glass mirror, the writer having previously seen them at Cuckfield, in October, 1865.

It is extremely difficult to say if these craters were really new, still the facts are sufficiently interesting to induce a very careful scrutiny in the neighbourhood of "Linné," especially as from the observation of Schröter there is reason to believe that the crater has suffered two obscurations within a period of 80 years.

Upon receipt of Herr Schmidt's letter to the writer, a translation of which we give below, the Moon Committee of the British Association issued a circular, calling the attention of astronomers to the interesting fact recorded in it. It is

probable some valuable observations will result from the adoption of this course.

P.S. Since the preceding was in type, we have received a note from Mr. Birt, with the following additional information:—

“Mr. Buckingham of Walworth, has obtained several photographs of the Moon, in October and November, which I have examined. In almost all I find the place of ‘Linné,’ but the object is very faint. I have one which he took on November 18, 1866, at 6·30 S.M.T. In this ‘Linné’ is visible, but its light I estimate, by comparison with the ground around Copernicus, to be only 2°. I have collected all the recorded brightnesses and compared the photographs which I have in my possession. The results are as follow:—

“Variations of brilliancy of the crater ‘Linné,’ since the year 1788.

Observations.		W.R.B.
1788, Nov. 5.	Schröter	0·5
1823, May. 28.	Lohrmann	7·0+
1831, Dec. 12, 13.	B. and M.	6·
Photographs.		
1858, Feb. 22.	De la Rue	5· glass.
1865, Oct. 4.	„ „	5· print.
	Rutherford	6· „
1866, Nov. 18.	Buckingham	2· „

“The above values for the photographs have been estimated, and may be considered as a continuation of the series, W.R.B.; except Rutherford’s, which is brighter than any degree of this scale. There is some uncertainty in the determination of the brightness on the prints, but the difference between 6° and 2° is, I apprehend, too great to be attributed to differences arising in the printing.

“The crater appears to have been brightest in 1823; Lohrmann always saw it brighter than Conon, which he records at 7°·0.

“From these records, it appears that Lohrmann and B. and M. observed ‘Linné’ to be *brighter* than any degree of the scale you have—*i. e.*, brighter than the surface around Kepler. Schröter’s observations give about the eighth of a degree of my scale; but De la Rue’s photographs give a brightness of about that of the surface around Kepler; and Rutherford’s brighter—probably the same as B. and M.’s. Buckingham’s series is so far accordant with Schmidt’s observations as to indicate, very strongly, that the crater has really undergone a change of some kind.”

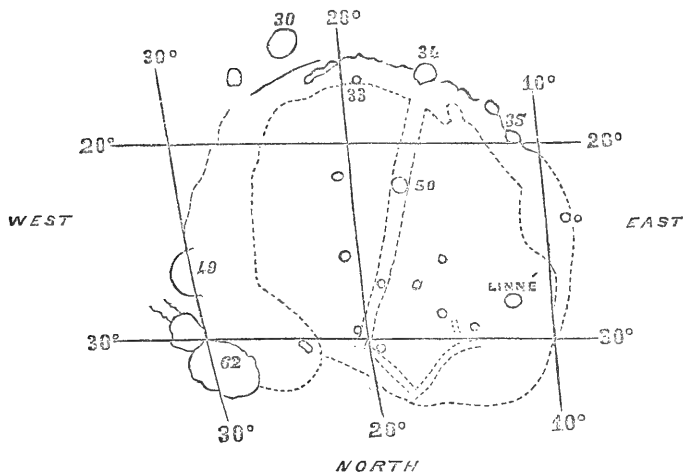

THE MARE SERENITATIS, FROM MADLER'S SMALL MAP.

References.

No. 30	Plinius.	49	Le Mounier.
" 33	Taquet.	50	Bessel.
" 34	Menelaus.	62	Posidonius.
" 35	Sulpicius Gallus.		

The interior dotted line, shows the boundary of the dark border of the *Mare*. The exterior of the *Mare*, on the N. is not shown, as it is not so well marked as the S.; the white streak, part of a ray from Tycho, across the *Mare*, is indicated by the double dotted line, from Menelaus to the N. border.

RECORDED OBSERVATIONS OF LINNÉ.

1788, Nov. 5. Schröter.

Dark spot in place of the Crater.

1823, May 28. Lohrmann.

1 Measure. Always saw it brighter than Conon in the Apennines.

1813, Dec. 12, 13. Mädler.

7 Measures. No remarks on its appearance.

1866, Oct., Nov. Schmidt.

Obscured; only a little whitish cloud visible.

SCHMIDT ON THE LUNAR CRATER "LINNÉ," AND ON THE NOVEMBER METEORS.

THE following is a translation of a letter from Herr Julius Schmidt, the Director of the Observatory at Athens, to Mr. W. R. Birt, from whom we have received a copy of the original:—

"For some time past I find that a lunar crater situated in the plain of the Mare Serenitatis has been invisible. It is the crater which Mädler named Linné, and is in the fourth section of Lohrmann, under the sign A. I have known this crater since 1841, and even at the full it has not been difficult to see. In October and November, 1866, at its epoch of maximum visibility, *i.e.*, about the time of the rising of the sun on its horizon, this deep crater, whose diameter is 5·6 English miles, had completely disappeared, and in its place there was only a little whitish luminous cloud. Be so kind as to make some observations on this locality.

"At Athens, I observed the great meteor shower on the night of the 13-14th November. On the nights of the 12th and 14th, the sky being partially clear, the hourly number of meteors was very small. On the night of 13-14th the sky was perfectly clear, and we found the meteors very scarce between 6 and 12 o'clock; but later the hourly number became enormous, and the spectacle was very brilliant and magnificent by reason of the great number of bolides. From observations made between 6 and 14 hours, and from 16 to 18 hours, and from an approximate calculation, I found the maximum, on November 13th, 14h. 15m., Athens mean time, and the number per hour for one observer = 1055. Almost all the meteors—that is to say, 343 out of 345—came from a radiant point in the vicinity of γ Leonis."

This letter has been communicated to the Lunar and Luminous Meteor Committees of the British Association.

THE NOVEMBER SHOOTING STARS.

BY THE HON. MRS. WARD.

(With a Woodcut Illustration.)

TRUE to astronomical prediction, the great November shower of meteors arrived on the night of November 13th, and continued to stream in radiant succession during the early hours of the 14th. Those observers who for years have devoted close attention to luminous meteors, hailed this opportunity for ascertaining fresh facts with regard to their distance, velocity, and physical properties, and for becoming acquainted even with their chemical nature, by the wondrous process of spectrum analysis.*

Some of the results of such observations will probably be laid before the readers of this periodical. My remarks in this paper are intended merely to afford answers to such questions as are likely to be asked by intelligent observers, to whom the whole subject of meteors is new, but who have felt interested by the beautiful display on the morning of the 14th of November; and, secondly, I wish to describe the scene for the benefit of those who, with considerable vexation, are constrained to own that they forgot to look out, and have missed the sight altogether.

For my own part, I narrowly escaped a similar fate. I knew the ordinary November meteors only by hearsay, having watched for them vainly, on the nights of the 12th and 13th in two or three former years; and my attention had not been much attracted by the notices given in the *INTELLECTUAL OBSERVER*, and elsewhere, of the probability that the flight of meteors *this* November was likely to be of imposing appearance.

But now—the morning of the 14th has passed—I have seen the November shooting stars in all their beauty and grandeur, a phenomenon unequalled since 1833, and my thoughts turn to the hundreds of observers who probably saw them also, and who inquire with newly-awakened curiosity, What are they? Whence do they come? What possible reason can be given for their appearance on a fixed day in our calendar? And what grounds were there for supposing that a more splendid display than usual would be seen in 1866?

What are they? And whence do they come?—These are questions difficult to answer; but for the answering of them a vast quantity of evidence has been collected within the last few years, and all observations seem to confirm the theory,

* See *INTELLECTUAL OBSERVER*, August and October, 1866.

that they do not belong to this earth or its atmosphere, but that on the contrary they are *from afar*; and that they circulate round the sun in definite orbits.

On almost any fine night a few shooting stars will be seen; such is the experience of those who have watched for them in various parts of the world. A bright object, looking like a star, is suddenly seen moving a little way through the heavens, and then disappearing. They are common at all times, and, to use Professor Ansted's words, "they are as little exceptional as clouds." These are the ordinary shooting stars, which I have seen hundreds of times, though generally not more than three or four of them during one evening: but we have now to speak of those which are known to be *periodical* in their displays, and by the pre-concerted observation of which, some knowledge has been gained respecting the shooting stars in general.

On several occasions these wanderers have appeared, not few and far between, but in astonishing numbers, conveying the idea of a shower of rockets, or of snow-flakes falling. Observers have noted the dates of such appearances, and the very remarkable fact has been established, that the greatest displays of the kind have uniformly happened on the night between the 12th and 13th, or on that between the 13th and 14th of November. Time out of mind those identical days, or those directly corresponding to them have been occasionally signalized by such exhibitions.

They appear likewise on the 10th of August, and more or less on the 9th and 11th also. The display is less brilliant than in November, but more *certain*. The November show is often interrupted for a number of years, but on those three days in August shooting stars are almost sure to be seen. Other epochs have also been, to a certain extent, established.

And here our third question must be answered—"What possible *reason* can be given for their appearance on a fixed day in our calendar?" A reason *has* been given; and it is so well stated by Sir John Herschel, that I shall give his remarks *verbatim*.* "It is impossible," he says, "to attribute such a recurrence of identical dates of very remarkable phenomena to accident. Annual periodicity, irrespective of geographical position, refers us at once to the place occupied by the earth in its annual orbit, and leads direct to the conclusion that at *that* place the earth incurs a liability to *frequent* encounters or concurrences with a stream of meteors in their progress of circulation round the sun. Let us test this idea by pursuing it into some of its

* *Outlines of Astronomy*, Art. 901. (1859.)

consequences. In the first place, then, supposing the earth to plunge, in its yearly circuit, into a *uniform ring* of innumerable small meteor-planets, of such breadths as would be traversed by it in one or two days; since during this small time the motions, whether of the earth or of each individual meteor, may be taken as uniform and rectilinear, and those of all the latter (at the place and time) parallel, or very nearly so, it will follow that the relative motion of the meteors referred to the earth as at rest, will be also uniform, rectilinear, and parallel. Viewed, therefore, from the centre of the earth (or from any point in its circumference, if we neglect the diurnal velocity as very small compared with the annual) they will all appear to diverge from a common point, *fixed in relation to the celestial sphere*, as if emanating from a sidereal apex."

Here Sir John Herschel refers us to his very interesting remarks in an early chapter on the subject of "celestial perspective"—"that branch of the general science of perspective which teaches us to conclude, from a knowledge of the real situation and forms of objects, lines, angles, motions, etc., with respect to the spectator, their apparent aspects as seen by him projected on the imaginary concave of the heavens; and *vice versa*, from the apparent configurations and movements of objects so seen projected, to conclude, so far as they can be thence concluded, their real geometrical relations to each other and to the spectator." He then proves that in celestial perspective "every straight line (supposed to be indefinitely prolonged) is projected into a semicircle of the sphere, *that*, namely, in which a plane passing through the line and the eye, cuts its surface. And every system of parallel straight lines, in whatever direction, is projected into a system of semicircles of the sphere, meeting in two common apexes, or vanishing points, diametrically opposite to each other." This digression is to explain what is meant by a "sidereal apex." And here let me anticipate. On the morning of Nov. 14th, when I saw the meteors emanating from a point at some distance above the horizon, when I observed many of them mounting overhead, and the whole display retaining the form of a canopy, while tending as if to some point far below the opposite horizon, I felt that *perspective* had in some way a great deal to do with their aspect, and that I should not think of them as of sky rockets shot in real curves *over the house*; but it required the luminous words of Sir John Herschel to place the matter in an intelligible form. Let us now take up the thread of his argument.

The shooting stars, he says, ought to appear to diverge from a common point; and he proceeds to tell us, "This is precisely what actually happens. The meteors of the 12—14th

of November, or at least the vast majority of them, describe apparently, arcs of great circles, passing through or near γ Leonis. No matter what the situation of that star with respect to the horizon, or to its east or west points may be at the time of observation, the paths of the meteors all appear to diverge from that star."

The exact position in the heavens from which the meteors appear to radiate, technically known as the "radiant point," is one of the subjects to which the attention of observers has been of late years much directed, and the spot which it occupies in Leo has probably been ascertained with great precision on the present occasion.

And now to sum up the theory, so far. We suppose the earth in its orbit, A, around the sun, to encounter a ring of meteors, B, at the point marked "Nov." There, and there only, we are led to believe, the orbit intersects the ring. At the opposite point, marked "May," the ring falls a little

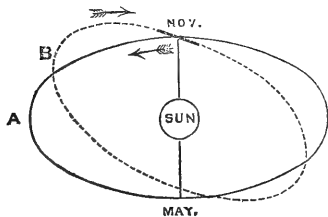

instead of cutting through it. A display of the meteors in this ring can therefore occur only in November. Now if the ring were *uniform*, *i. e.*, an unbroken stream of meteors through its whole circle or ellipse,* the earth's encounter with it would take place every revolution—

we should see an exactly similar star-shower every November 13 or 14.

But "if the ring be broken,"—here again I quote Sir John Herschel—"if it be a succession of groups revolving in a period not identical with that of the earth, years may pass without a rencontre; and when such happen, they may differ to any extent in their intensity of character, according as richer or poorer groups have been encountered." A *blank* part of the ring will occasionally occupy the point of intersection just as the earth arrives there—then there will be no November meteors visible that year. Again, a *rich* part of the stream, the *jewel* of the ring, of which we shall presently have much to say, may come to the point of intersection when the earth is there—then we shall have a glorious display, as in the year 1866.

Or, let us suppose we meet a thinner part of the ring, then we have an ordinary November star-shower, such as those which occurred in 1822, 1823, 1832, 1833, etc.; or, to take

* It is believed to be nearly circular.

more recent years, a display of them seen from Malta on Nov. 13th, 1864, when clouds obscured the sky in England, and in 1865, when a considerable number (250 per hour) were observed from Greenwich.

A ring of meteors in space, large almost as this earth's great track round the sun—what a wonderful idea, when one comes to consider it, or to represent it in a diagram! *One* ring! there are probably *several*, belonging to the various periodic groups of these strange bodies which up to the present time have been detected. The August meteors are as well-marked a group as those of November; they, too, have a sidereal apex always the same at each return, but it is far away from Leo, being close to the small star B Camelopardali. Certain other star-showers, also proved to be periodical, have also their points of radiation; and though in some cases these are not actually to be described as *points* but rather as *regions* of radiation (implying perhaps a want of parallelism in the movements of the meteors), astronomers still hold that it is highly probable that all shooting stars are grouped according to some law, and may form a number of rings, some nearly circular, some of a lengthened elliptical form, like those of comets; and that those which appear to be not periodical may be out-liers of such rings.*

Nor are the positions or dates of appearance the only distinctive features of the various groups of shooting stars, they have their own individuality—"The meteors of particular showers vary in their distinctive characters, some being larger and brighter than others; some swifter, and drawing after them more persistent trains than others."†

Two well-marked groups—probably *rings*—of meteors,—several others more or less known—their nearest approach to the earth estimated at an average of sixty miles, and their ordinary velocity supposed to be somewhere about twenty miles in a second, hastened as they approach the earth's attraction to nearly forty miles—so much being granted, have we yet answered the question "what are they?" Are they solid or gaseous, are they large or small, perpetually luminous or only exceptionally so?

The late observations which have succeeded in subjecting their fleeting light to the process of spectrum analysis will probably clear up some of the difficulties respecting their nature.‡ But even before this clue was given for their investigation, the learned had arrived at the conclusion that all shooting stars are "assemblages of fragments, finer or

* *British Association Report*, 1865, p. 131.

† *Ibid*, 1864, p. 101.

‡ See Mr. Alexander Herschel's paper on the *Prismatic Spectra of the August Meteors*, 1866, INTELLECTUAL OBSERVER, October, 1866.

coarser," that they are *not* luminous as they travel through space: but that as they near the earth, the friction of our atmosphere ignites them, and they are entirely consumed in a few moments. This description applies to meteors such as we see in general, and during the periodic displays; but occasionally we encounter bodies of greater density, which cannot be so readily consumed, sometimes entire, and at other times in a fragmentary condition. Samples of such meteors are to be found in various mineralogical collections.

The subject of these metallic stones which have really "fallen from the sky" is most curious, but must not be pursued here; we have made a sufficiently long digression from our fourth question, "What grounds were there for supposing that a more splendid display of meteors than usual would be seen in 1866?" To answer this, I revert to the INTELLECTUAL OBSERVER for August, 1866. It contains (p. 39) extracts from a lecture given at the Royal Institution, by Mr. Alexander Herschel, *On the Shooting Stars of the years 1865-66, and on the probability of the Cosmical Theory of their origin.*

The lecturer stated that Professor H. A. Newton, of Yale College, U.S., had calculated that in the current year, 1866, a prodigious flight of meteors, the most imposing of its kind, and visible over a large area of the earth's surface would make its appearance—perhaps for the last time in the present century—on the morning of the 14th of November. Professor Newton had searched in ancient records, and observed that between the 12th of October (O.S.) and the 13th of November (N.S.), during the years from A.D. 902 to 1833, not less than thirteen great star-showers have been recorded. When he had made the requisite corrections for the change of the earth's position, astronomically known as the precession of the equinoxes, he was able to compare the dates with exactness,* and became convinced of the fact that there are periodical re-appearances of the November-shower in extra grandeur, at intervals separated from each other by nearly the third part of a century, or by some multiple of this period. This shower was observed from Cumana in South America by Humboldt and his companion Bonpland, on the morning of November 12th, 1799, and was a spectacle of extraordinary grandeur. Nothing comparable to it appeared till the morning of the 13th of November, 1833, when another magnificent display was seen in the United States of America.

Professor Newton proposed the following theory to account for these returns of the phenomenon, that there is a *condensed*

* See *British Association Report*, 1863, p. 325.

part in the November ring of meteors,—which I have ventured to call the *jewel* of the ring,—and that each meteor in the whole ring, and in this condensed part or *cloud*, moves in a nearly circular orbit round the sun in a period which may be about eleven days less than that of the earth. The earth (for example) encountered the densest portion of this cloud in November, 1833; but the next year this portion passed eleven days before the earth returned to that point of its orbit; the following year the difference amounted to twenty-two days; so that at the end of about thirty-three years it must gain one entire revolution, and return nearly to the position where it must encounter the earth. (See diagram on page 452.) Professor Newton shows that the same result would follow by supposing the period of the ring eleven days *longer* than the earth's, but seems on the whole to incline to the former theory.

I have taken some of these explanatory details from a letter lately written to the *New York Times* by Professor Loomis, of Yale College; also from the *American Journal of Science*, as quoted in the *British Association Report* for 1864, p. 96, containing Professor Newton's data and theories as given by himself. In referring to past recurrences of the phenomenon, he remarks that, "a want of punctuality of one, two, or even three years in the return of the display may be accounted for by the revolution of the earth on its axis, by which observers were deprived of a view of the spectacle during a part of its existence;" but ends his communication by predicting with considerable confidence, a "maximum display on the morning of the 14th November, 1866."

The morning of the 14th of November came—and now let us make an essay in celestial perspective, and see what had happened. Let us divest our minds, if possible, of the idea of a canopy of sky-rockets, and "from the apparent configurations and movements of objects as seen projected on the imaginary concave of the heavens, conclude, so far as they can be thence concluded, their real geometrical relations to each other and to the spectator." What were the real bearings of the earth and the stream of meteors on that memorable morning when this "terrestrial ball" had been for some short time plunged in the current? Somewhat, I think, like this. Never mind, reader, if I have made the earth a little too large in proportion, or the stream too narrow, or too defined in outline. The inclination of the two paths is, or should be, 17° : the course of the meteors is retrograde, as stated by Professor Newton: and the shaded appearance of the stream is meant to indicate the sudden transitions of richness which occurred in the star-shower, causing the meteors to come at the rate some-

times of a hundred per minute, then only fifty, then a hundred, and so on.*

The reflection will probably occur to our readers, were the meteors really like that, a dark, formal stream? How much more beautiful was their actual aspect as seen by us! Truly it was so, as indicated by Mr. Herschel's heartfelt words, describing how they travelled to all parts of the sky "with a swift and stately motion most beautiful to behold, if not almost

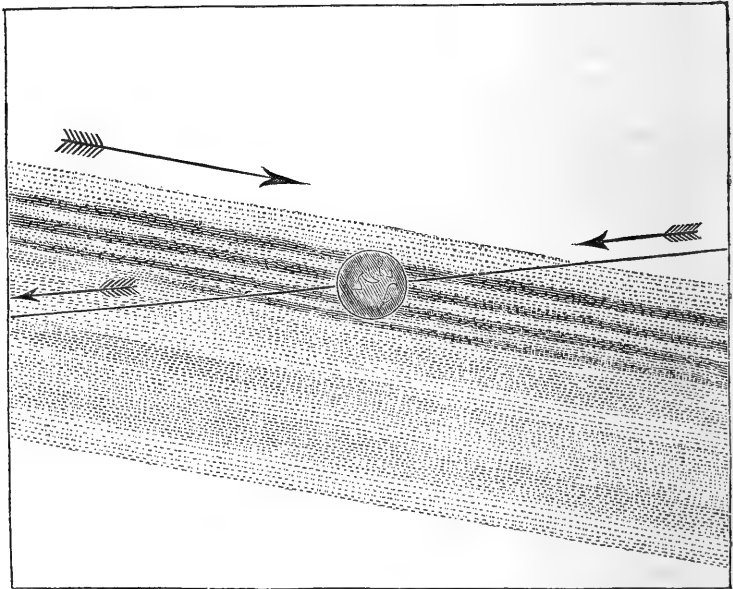

IDEAL REPRESENTATION OF THE EARTH'S PASSAGE THROUGH THE STREAM OF METEORS.

too wonderful and too surprising to describe."† I was roused from sleep to look at them. My informant told me that an old railway porter had just said, "God has sent us fire-works to-night;" and I appreciated the remark when I saw them. My thoughts had, on that day, been unavoidably fixed on the concerns of this earthly ball, rather to the neglect of the affairs of space; and I shall long remember how much I was cheered and uplifted by the sight of the November meteors, and how I felt that they were indeed *given* by Him who gives us richly all things to enjoy.

I intended to have attempted a sort of *resumé* of the observations of others, but will leave the task to abler hands,

* The attempt to introduce this circumstance into my drawing was suggested to me by the Rev. F. Howlett, F.R.A.S.

† Letter to the *Times*, November 17, 1866.

and merely tell my own story of what I saw, copied from a narrative which I wrote on that morning before daybreak.* It will be seen how conspicuous was the fact of the meteors radiating from a point in Leo—a circumstance of which I had doubtless read in books, but had little or no recollection of it.

On the evening of the 13th, at eleven o'clock, I looked out from my house at Seapoint, near Dublin, to see whether anything unusual were occurring, and observed that all was still—Mars glowing near Castor and Pollux; Sirius calmly accompanying Orion. "Good night to the stars," thought I; but it was not to be so. At a few minutes after twelve, Dublin time (say 12:30, Greenwich time), I was called up with the information that the shooting stars were chasing each other with wonderful rapidity. I hastened to look at them, and the first idea suggested was indeed that of an exhibition of fireworks, but how much more beautiful they were! Their occurrence was almost incessant. From 12:40 to 1:30, and later,† it would have been difficult to find a moment in which none were visible in some part or other of the sky. Sometimes three or four fine ones could be seen at once.

There was a marked difference in their appearance as seen from a window facing the east, and from a bow window commanding a view of the north, west, and south; and I set myself to find out in what this difference consisted. I first viewed them attentively from the bow window; the shooting stars invariably moved *downwards* there. Each commenced with an outburst of brilliant white light, like *one* of the many stars of a rocket; and this bright star travelled a second or two, and then disappeared, not very rapidly, but remaining visible four or five seconds as a beautiful spindle-shaped track of white light, the general straightness of its form being very remarkable. These spindles tended almost perpendicularly downward in the west, downward from left to right in the south, and downward from right to left in the north. Sometimes a wonderfully bright star appeared, with a long, thread-like track of extraordinary length, nearly from the zenith to the horizon. The stars, or *nuclei*, of these meteors were generally white, but occasionally one appeared blue, or red, or bright yellow. My impression is, that in these cases the train or track of light was sometimes of a different colour from the star.

The shooting-stars in the *east* were in general smaller than those observed in the north, south, and west; but they soon riveted my attention even more than the others had done.

* Mr. Slack's spirited account of the display is already in the hands of my readers. See No. for last month. [The reader is requested to correct the date in Mr. Slack's paper to 13-14th. Ed.]

† Greenwich time, which will be henceforth used in this description.

For I presently perceived that *their* course was not invariably downward. I could see some move perpendicularly upward, some darting quite horizontally towards the left, some moving upward in a sloping course, and some also downward like those seen from the bow window. These latter, sloping downward, were those nearest to the north and to the south; and, having ascertained this, I soon observed that there was a point in the heavens from which they actually started in all directions—I do not mean at random, or crossing each other, but in an invariable course, like the railroads from a great city. The meteors *at that spot* (close to the position of the star γ in Leo) were not of very frequent occurrence, but I observed all the different directions described, probably in the course of ten minutes, during one part of the morning; and more than once I saw with great interest two shooting stars at the same moment moving away from this point at right angles to each other. Numerous meteors commenced at points quite distant from γ in Leo; but wherever they commenced they seemed to travel with regularity, as if from about that point.

With respect to the size of the meteors in the east, I am certain I saw none which were long or threadlike, anywhere near γ ; at one time, on the contrary, I saw strangely small and even crooked ones near that spot.* They increased in magnitude as observed towards the north or south. Several fine ones passed above and across Orion, and always downward from left to right. Their *nuclei* were, in my opinion, much brighter than Sirius. Many meteors went *as if* over the house, like sky-rockets; and twice, meteors of extraordinary brightness came, lighting up the whole landscape, but I cannot give a description of their form, as in neither case had I happened to look in the right direction at the moment they appeared. These bright flashes occurred at about 1.45.

I saw one or two exceptions to the straight form in the long meteors. There was one decidedly crooked, or waved. Several of the meteors indeed were curved, as an effect of perspective, from their great length, if seen in the south or north. A few *nuclei* appeared without trains, merely showing a second or two as bright moving stars; but these were exceptions to the general rule.

Towards half-past two o'clock I began to notice that the phenomena were decreasing; at a quarter to three the meteors were rarely visible; and at half-past three they had almost entirely subsided. At 4.25 I remained on the watch for about ten minutes, and no meteors whatever were visible.

* Mr. Slack, it will be remembered, makes the following remark on similar meteors, "Probably their tails were behind them, and invisible from the shortening of perspective."

THE NOVEMBER METEOR-SHOWER AT GLASGOW.

BY A. S. HERSCHEL, B.A.

THE cloud-stratum of the second capital of Scotland affords coolness in summer and warmth in winter, and a protection from the unequal radiation of night and day. It would surprise persons unacquainted with the abnormally elevated temperature of climates on western coasts, to be informed that the mean temperature of Glasgow is three degrees warmer than the mean temperature of a place situated, like Birmingham, in the centre of the island; yet such, from the neighbourhood of warm streams of the Atlantic Ocean, is actually the case. The substantial advantage thus derived from the breezes of the sea has, however, its corresponding disadvantage of a more refined, aërial nature; for the watery vapours wafted with the wind do not always reveal at night, in the words of Byron—

“ — in the sky that clear obscure
So deeply dark, and darkly pure,
Which follows the decline of day,
Ere twilight melts beneath the moon away.”

Fine nights, when they occur at this season of the year, are, however, unexceptionally good observing nights; and the morning of the 14th of November, 1866, when the predicted shower of the November meteors was expected to appear, was one of these, which might be reckoned among the most fortunate events of an observer's diary.

The skies were attentively watched to catch the first signs of their appearance, and many, like myself (among the number of four observers, consisting of Professor Grant and his assistants at the Glasgow Observatory), sat up, determined “for once in their lives” to make a night of it.

To witness the successful issue of an altogether novel kind of prediction was a small satisfaction, compared to the advantage which co-operation with Professor Grant afforded me in noting the particulars of the shower. The detailed description which Professor Grant published in the *Glasgow Herald* of the following day, shows his personal interest in the phenomenon, whilst his assistance enabled me to complete a set of observations which, alone, it would not have been possible to carry out.

A violent gale of wind blew from the 4th to the 8th of November; when the wind abated, and a fine double arch of the aurora was visible in the evening, about seven o'clock, spanning the north-west verge of the horizon. It resembled a cap-and-plume, the upper arch being only a fragment, which

joined the lower arch at its extremity close to the west point of the horizon.

Auroral glare in the north, but not so bright, was seen again at about ten o'clock on the evening of the 10th of November. Between three and five o'clock on the mornings of the 9th, 10th, 12th, and 13th, half-hour watches were kept up at intervals when the sky was clear, and the greatest number seen was six meteors in half an hour, on the morning of the 12th of November. These were the preliminaries of the display. From Professor Grant's description we learn that "The early part of the night of the 13th did not promise well—heavy rain and drenching showers alternating with clear views of the sky and the stars." And again, that "between midnight and one o'clock the sky on the whole was not favourable for observation, but occasional views of the heavens showed unmistakably that we were on the track of the meteoric shower, for the meteors were obviously shooting athwart the sky with increasing frequency." During this hour my share of the spectacle began.

At about midnight, an orange-coloured meteor, nearly as bright as Jupiter, shot overhead, with a slightly wavy motion, from Capella to near the head of Aries—a space of 45° or 50° —in about a second and a half of time; leaving a bright streak for a few seconds on its course. This was the first brilliant shot seen, and for the early hour of its appearance, when the phenomenon did not exceed an ordinary display on a fair 10th of August night, it was indeed startlingly bright. At a later stage of the night, when a few of the superlatively large meteors, or "ring-tail roarers" of the shower (to use an Americanism), made their appearance, and multitudes, unnumbered, of its compeers thronged the sky, it would not have arrested attention for a moment. Expectation was gradually raised, when, toward 12h. 30m. A.M., three meteors near together first appeared simultaneously, and drew the eye irresistibly to the locality in *Leo*, from whence they appeared to diverge, and whence a whole fleet of similar craft might shortly be expected to arise above the horizon, like argosies in full sail from foreign parts.

A cloud from the north-west now overspread the sky, and threatened us with showers of a different kind, likely, in fact, to leave us, at the end, but little wiser, and on the whole much wetter for our watch. It passed, however, quickly, and in the clear space which it left behind it, the next meteor was observed. At 12h. 33m. a meteor fully as bright as Venus shot in one second from the right hand of Andromeda to β Pegasi, leaving upon the first part of its course a bright train in separate links, which rapidly faded away. The remaining portion,

6° or 8° in length, continued visible four minutes, at first bowing itself, leech-like, and afterwards contracting itself into a globular nebula, which advanced southwards some 16° or 12° as far as α Andromedæ, where it disappeared. Its width, and ragged edges prevented any conclusion being drawn in the spectroscope regarding the nature of its spectrum.

Ten or fifteen meteors might now be counted by one observer in a minute. Flights of three meteors occasionally appeared together, and a powerful flash, like prolonged lightning at no great distance, drew our attention to every part of the horizon, in the vain attempt to see the residue of some large meteor.

At 12h. 41m. a dazzling object, two or three times as bright as Venus, passed in a second from midway between the "pointers" to the nose of the Lesser Bear, leaving a bright streak, divided like the last into two parts; but the first part in this case remained in sight the longest. The end-half afforded a decided spectrum, appearing as a single bright band in the spectroscope, no broader than if looked at through an ordinary piece of glass. It faded rapidly and disappeared, whilst the first half collected itself into a ball, and grew brighter, exactly as a row of gas-lights, seen one behind the other, look brighter than a single flame. In nine minutes it could no longer be traced, as it gradually vanished between the "pointers" at the place where the meteor first began.

The number of streaks now visible in the sky gave an opportunity for using the spectroscope. "Nov. 14th, 12h. 54m. A.M.; equal to Sirius; from β Canis Minoris to β Eridani. Left a streak for five seconds. The streak appeared as an extremely fine line in the spectroscope."

A more powerful spectroscope was now employed, consisting of the central portion, only, of a Herschel-Browning spectroscope, containing two prisms, and producing, therefore, twice the dispersion of a single prism. My assistant, Mr. Macgregor, looking at the streaks with the unassisted eye, whilst I watched the same streaks in the spectroscope, we each called out "gone," when the streaks appeared to us to vanish.

"12h. 56m. A.M.—Equal to a first magnitude star. Left a greenish blue streak for three to four seconds. We differed in our vanishing moments two-tenths of a second.

"12h. 57m. A.M.—Equal to a first magnitude star. Left a greenish blue streak for three to four seconds. We differed in our vanishing moments one-tenth of a second.

"1h. 0m. A.M.—Equal to Sirius. Left a greenish blue streak for four seconds. We spoke together."

The result shows that some of the streaks were composed of mono-chromatic light, altogether undimmed by its passage through the prisms.

The object of disposing of the radiant point at the early stage of the shower so as to leave the remainder of the night, and the principal part of the shower for the more important observations, put an end for the time to the experiments with the spectroscope, which it was intended to have renewed if the shower had not exhausted itself before a sufficient number of meteor tracks for the purpose of fixing the radiant point had been recorded. The shower increased in intensity until about ten minutes and twenty minutes past one o'clock, at which time fifty-six and fifty-seven meteors were counted by one observer, or almost exactly double the number counted at one o'clock, and at half-past one o'clock; the display then ceased as suddenly as it began; and an interval of three minutes occurred from 1h. 57m. 30s. to 2h. 0m. 31s., in which no meteor as bright as a second magnitude star (so far as my own tolerably open view of the sky extended) made its appearance. At 2h. 30m. the number counted by one observer was also very small, being only one per minute, and long before this time the "Great November shower of 1866" had obviously passed away, and was gone for ever from the field of calculation and prediction into the domain of history!

At 2h. 14m. A.M., a meteor, three times as bright as Jupiter, shot in the southern sky from between α and θ Geminorum to 2° above Aldebaran, leaving a streak, which like previous bright streaks was divided into two parts. The end-half, extending from ι Tauri to Aldebaran, curved itself northwards at the ends, and then collected itself into a knot, which drifted southwards to the three head stars of Orion, where it disappeared. The total period of visibility of this streak was five minutes.

Another meteor, which must have been a large fire-ball, but which the Observatory buildings unfortunately hid from our view, appeared at 2h. 41m. A.M. Shortly afterwards we perceived its streak, bent in the form, and with the appearance of a red hot horse-shoe suspended in the sky, between the stars ϵ , χ of the Great Bear. The open ends of this singular footprint (for so it appeared) of the meteor gradually widened out for fifteen minutes, (during which the streak continued visible) and the apex of the shoe became pointed, and drew off towards the south. Just before disappearance the stars forming the square of Ursa Major appeared clipped by a gigantic calipers of which the point or hinge was at the stars ν ξ upon the Bear's hind-foot.

A number of matters yet remained to be decided regarding the white, yellow, and purple colours of the meteor-streaks, the prevailing yellow or orange colour of the heads, and other important characters of which the use of the spectroscope might

have offered some solution. The want of observations on these points, unavoidably left un-made by the cessation of the shower, a paper by Mr. John Browning, which follows, most opportunely

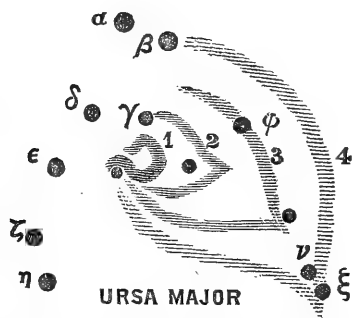

Changes of a Meteor-streak, Nov. 14th, 1866.—1st, 2h. 42m. A.M. 2nd, 2h. 44m. A.M. 3rd, 2h. 48m. A.M. 4th, 2h. 52m. A.M. Disappeared at 2h. 56m. A.M. Duration, 15m.

supplies ; and the present November shower may happily not be regarded, from this circumstance, as a most invaluable opportunity of examining the spectra of the meteors totally thrown away.

A point about midway between γ and μ Leonis is marked by the projection of the meteor tracks upon a map, in a more distinct and positive manner than could possibly be the mere result of accident. The point so prominently shown is evidently the “vanishing point of straight lines seen in perspective” (Olmsted’s expression), either parallel to each other or else converging to a point. If the latter were the case, and the bombardment of meteors proceeded from a local centre, of which the precise place could be determined, observers at distant stations would differ among themselves as to the position of the radiant point,—some placing it north and others south, some east and others west of the average place of its apparent situation,—by the effect of parallax, according to their various geographical positions upon the earth. The frequent appearance of stationary meteors at the very place, or centre in some part of the constellation Leo, from which they appear to diverge, arises from their line of motion, in that direction, been seen “end on,” or foreshortened by perspective, to a point. Of such meteors not a few were recorded in the map projection (see Plate) of the tracks of eighty-three meteors noted at Glasgow during the time—from 1h. 15m. A.M., to 2h. 40m. A.M.—of the greatest intensity of the shower, and one such meteor was observed close to the position of the radiant point obtained from a complete *chevaux-de-frise* of meteor tracks taken from

TRACKS OF 83 SHOOTING STARS OBSERVED AT THE GLASGOW UNIVERSITY OBSERVATORY, 1866, Nov. 14th, 1h. 15m. A.M., to 2h. 40m. A.M., by A. S. Herschel and A. Macgregor, showing the position of the radiant point in R. A. 149°, N. Decl. 24.°

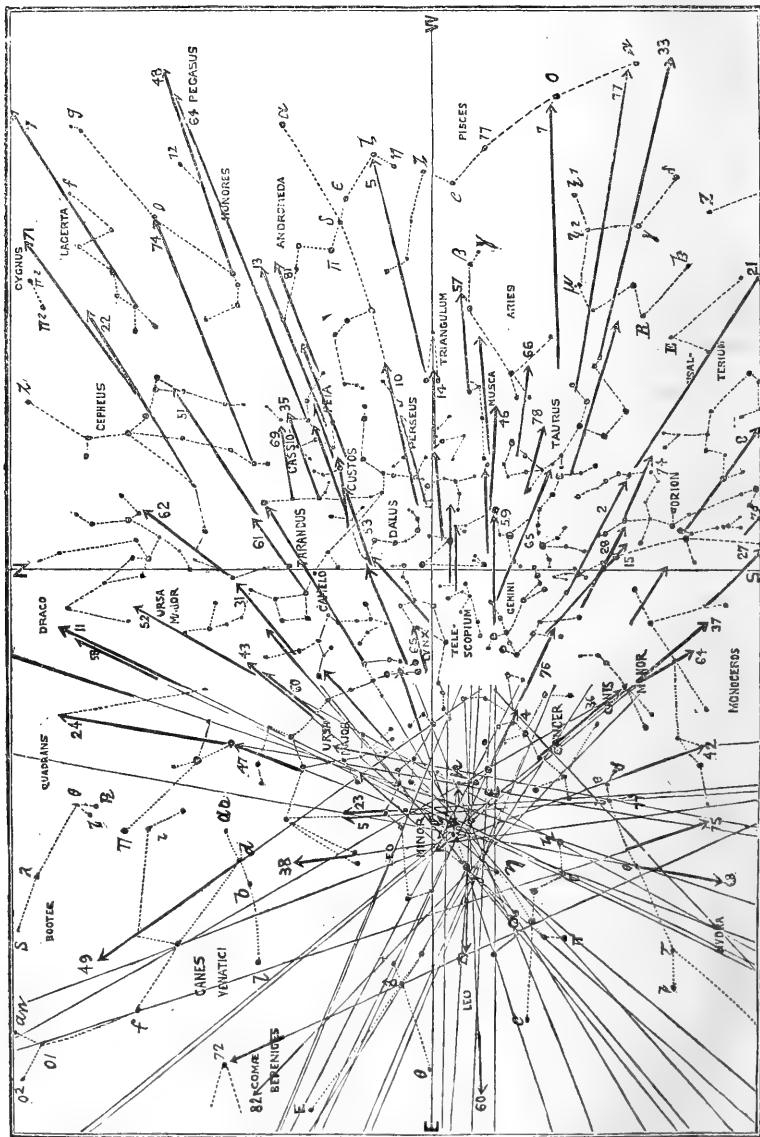

A. S. Herschel, del.—(NOTE.—A stationary meteor, shown thus \star , was seen very near the radiant point.) For the sake of greater clearness our engraver has not given the whole of the intersecting lines shown in Mr. Herschel's large map, or in Mr. White's excellent photograph from it.

the surrounding regions, at all distances from the point of radiation of the shower.

For the use of directing a telescope towards its place on the morning of the 14th of November next, a future page will be taken up with a list of twelve places of the radiant-point obtained by observers at Glasgow, and at other places in the "Great November shower" of 1866; together with the heights and distances from the earth of some of the larger meteors so favourably observed at Glasgow in that shower, and, fortunately, also at the same time at other places.

The following is the extract of a letter, to which reference was made above. For this, as it contains valuable notes on the spectra of the meteoric bodies, the reader of the paper is indebted to the successful endeavours, which characterize the use of the spectroscope, in every observation to which it has been applied by Mr. John Browning, F.R.A.S. :—

"ON THE SPECTRA OF SOME OF THE METEORS OF THE NOVEMBER SHOWER IN 1866. BY JOHN BROWNING, F.R.A.S.

"On the night of the 13th of November, I chose for my place of observation the Observatory of Mr. Barnes at Upper Holloway, which is situated on the highest ground in the immediate neighbourhood of the observatory.

I began observing at 9h. 30m. P.M., and continued my observations until 4h. A.M., on the morning of the 14th. The spectra I obtained were of four kinds.

"1st. Continuous spectra; in which the whole of the colours of the spectrum, except violet, were visible. In even the most uniform of these, however, I am inclined to think that the yellow was strongly predominant.

"2nd. Those which gave a bright orange-yellow line of light; or only a faint continuous spectrum in addition to this yellow line. Such spectra have been clearly described in the INTELLECTUAL OBSERVER, Number for October, 1866.

"3rd. Those consisting apparently of only a single line of green light of nearly the same colour as that shown by *Thallium*. Of this kind I only obtained the spectra of two meteors. In one of these I thought I detected a trace of a very faint continuous spectrum, nearly obscured by the brilliancy of the green line.

"4th. The spectra of the trains. The light from green trains appeared continuous in the prisms. Those which were of a blue colour appeared as a line of lavender colour, with a still fainter trace of a continuous spectrum. In some few instances, no continuous spectrum could be detected."

The occurrence of bright green light in some of the nuclei, is a very remarkable result of these observations; pointing,

possibly, to the existence of *Thallium* in the meteoric bodies ; as is also the existence of strong lavender light in some of the blue-coloured meteor-streaks occasionally without any continuous spectrum. The morning of the 14th of November next will present an opportunity for verifying the striking variety of colour so unexpectedly revealed by the spectroscope in the light ; and hence also, probably, a corresponding diversity in the chemical composition of the November meteors.

Mr. Browning adds :—

“On account of the great difficulty which attends these observations, I cannot be at all positive of the accuracy of these results, except in the case of those which I have called the first class of meteor-spectra (*i. e.*, uniform continuous spectra of the nuclei).

“At about a quarter to two, a large meteor, of a greenish-yellow colour, shot from near Regulus through the belt of Orion. This meteor left a train of a steel-gray colour, which was visible for nearly three minutes, although the end of its path was partially obscured by fleecy clouds.”

THE PLANET MARS.

BY RICHARD A. PROCTOR, B.A., F.R.A.S.

My object in the present paper is to exhibit to the readers of the INTELLECTUAL OBSERVER the true relations under which the planet Mars will present himself at the opposition which takes place during January, 1867.

There is a marked variation in the circumstances under which Mars is seen at successive oppositions. The other superior planets vary chiefly as respects the altitude at which they cross the meridian (or culminate) while in or near opposition. Mars partakes of these changes*—in fact we shall presently see that they are exhibited in a somewhat exaggerated form in his case ; but there are other and more marked

* A superior planet coming to opposition in midwinter attains an altitude about equal to the sun's midsummer altitude ; near the equinoxes a planet in opposition has a mean altitude about equal to the sun's altitude at either equinox ; and, lastly, a planet coming to opposition in midsummer attains an altitude only equalling the sun's altitude in midwinter. The reason is obvious—for the sun is always on the ecliptic, while the planets all travel near the ecliptic, and the ecliptic must be high by night when it is low by day, and *vice versa*. These changes produce a variation of 47° in the meridian altitude of a planet, a range of change which is yet further increased owing to the inclination of the planetary orbits to the ecliptic. The effect due to the last cause is small, however, except in the case of Mars.

variations presented by Mars, which the other superior planets do not exhibit, or at least not to any noteworthy extent. These peculiarities will be understood when we come to examine the nature of Mars' orbit.

The planetary orbits it is well known, are elliptical. But although several of these orbits differ very appreciably from circles *concentric with the sun*, yet their difference from the circular *form* is always very small indeed. For instance, the orbit of Mars, which is one of the most eccentric, yet differs so little from the circular form that if it were accurately traced down as an ellipse having a greater axis one foot in length, a circle described around this ellipse would nowhere separate from it by a distance exceeding one-eightieth part of an inch; though on the same scale, the distance of the sun from the centre of the ellipse would be represented by a length of more than half an inch (almost exactly $\cdot 56$ of an inch). Again, the inclination of the planetary orbits to the ecliptic, though quite sufficient to make the absolute distances by which the planets may be separated from the plane of the ecliptic very considerable, is yet so small in itself, that a representation of the orbits *in plano* is not unsatisfactory—save only in the case of Mercury, and some of the minor planets. It appears, then, that circles traced on paper may be taken to represent approximately the orbits of planets, if only these circles are properly *centred*.

In Figs. 1 and 2, parts of the orbits of Mars and the earth are traced down as accurately as possible, on the scale of one-eighth of an inch to 4,000,000 miles. S is the position of the sun, C is the centre of the earth's orbit. C' the centre of the orbit of Mars. The position of the earth at the time of winter-solstice is at W. Sol., while in Fig. 2, the position of the earth at the time of vernal equinox is at V. Eq. The two figures must be supposed to be parts of a single delineation of the orbits, the scale of which would be somewhat too large for our pages. The reader is recommended, however, to describe such circles on a larger sheet, taking the centering from Fig. 1. He will then be able to appreciate what is only partially indicated in Figs. 1 and 2, the remarkable variation in the distance separating the two orbits. He will find, indeed, that at the point of nearest approach (nearly in direction C' S) the distance separating the orbits is little more than half the corresponding distance on the opposite side—that is, in direction S C'.

The orbit of the earth is supposed to lie in the plane of the paper, while the plane of Mars' orbit must be supposed to cut the plane of the paper, in the line S Ω the part of the orbit which appears in our figures lying above the plane of the paper.

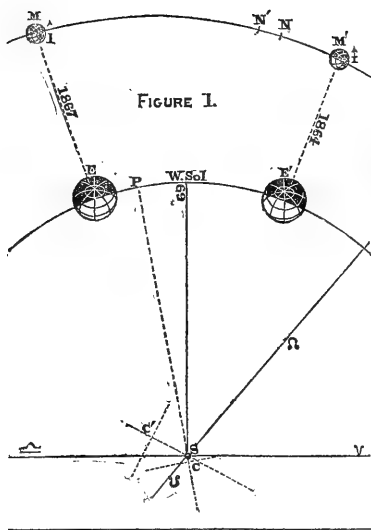

FIGURE 1.

FIGURE 2.

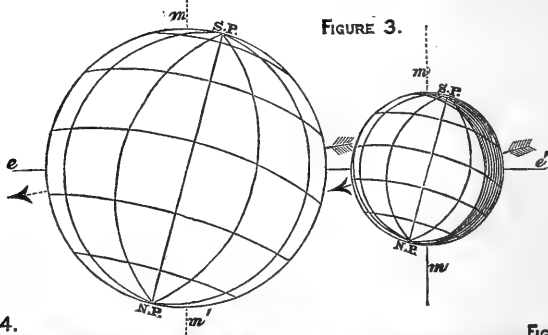
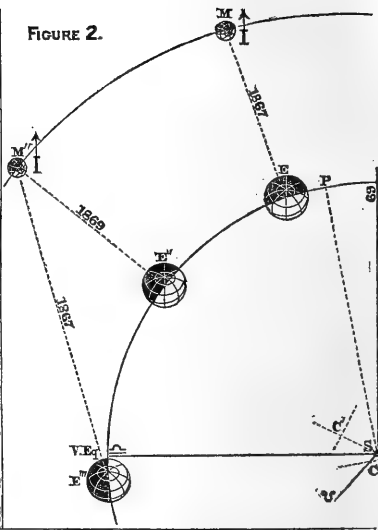

FIGURE 3.

FIGURE 4.

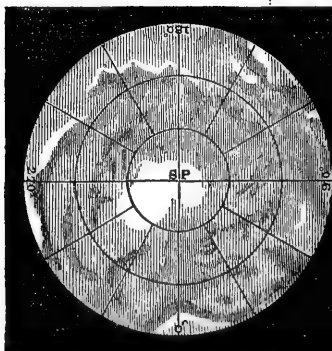
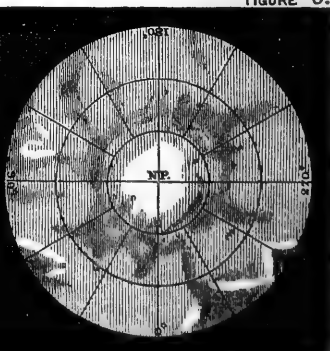

FIGURE 5.



The short lines surmounted by arrow-heads, represent the distance at which different parts of the orbit lie above the plane of the ecliptic.*

The figures representing the earth and Mars, are not drawn to scale, but purposely enlarged. The meridian lines upon them serve to indicate the position of the polar axes of the two planets. They are such that whereas the earth, when at V. Eq., has its polar axis square to the line from the sun, Mars is similarly circumstanced when near N or N'. The axis of the earth must be supposed to be inclined at an angle of $66\frac{1}{2}$ degrees to the plane of the paper; that of Mars, at an angle of about 60 degrees.

The two planets move round their orbits in the same direction (E' E E'' or M' M M'') at different rates; the earth taking one year to complete her circuit, Mars taking 1 year 321 $\frac{1}{2}$ days to complete his. Thus if they start together, the earth will go twice round, while Mars has gone little more than once round; and *on an average* the earth will make up this small arc by which Mars is in advance, in $49\frac{1}{4}$ days. Thus the interval between successive oppositions is on an average 2 years $49\frac{1}{4}$ days. But the rate at which Mars travels is so variable, owing to the eccentricity of his orbit, that this interval of $49\frac{1}{4}$ days is sometimes largely exceeded, at other times as largely fallen short of. For Mars in perihelion travels nearly half as fast again as he does in aphelion: the earth also moves at a variable rate, though her variation is much less marked than that of Mars; it happens, further, that the earth is moving at a rate less than her mean rate, when opposite that part of Mars' orbit in which he travels fastest, and *vice versa*. Hence it is that the intervals between successive oppositions differ so noticeably, For example: in 1860, Mars came to opposition on the 17th of July; in 1862, he was in opposition on October 5th, 80 days later; in 1864, on December 1st, 56 days later; in 1867, he will come to opposition on January 10th, only 41 days later; in 1869, on February 13th, only 33 days later; and in 1871, a yet smaller number of days will separate the date of opposition from that of 1869.

A word or two as to the absolute dimensions of the two orbits. The mean distance of the earth from the sun, is 91,650,000 miles; her greatest and least distances 93,190,000 miles, and 90,110,000 miles, respectively; thus the eccentricity, or C S, is 1,540,000 miles. The mean distance of Mars from the sun, or the distance C'M, is 139,650,000 miles; his aphelion and perihelion distances being, respectively, 152,670,000, and

* Only the part of such lines between the two cross-lines is to be taken as representing this distance.

126,620,000 miles; his eccentricity, or C'S, is 13,025,000 miles. The rising node of the Martial orbit, is in longitude $48^{\circ} 27'$, measured from S V in the direction of the planet's motion. Mars reaches his greatest distance from the ecliptic plane, near M'' (Fig. 2), when his distance from that plane is no less than 4,850,000 miles.

The point at which the two orbits approach nearest lies nearly in direction C'S, but somewhat *precedes* that direction, owing to the eccentricity of the earth's orbit. Here the orbits are separated only by 34,140,000 miles, whereas, in direction S C', they are separated by no less than 61,860,000 miles. Hence the planet Mars appears much larger when he is in opposition near perihelion, than when he is in opposition near aphelion. He is also more brilliantly illuminated when in the former position. Hence, when in opposition near perihelion, he shines with a brilliancy comparable to that of Jupiter and Venus; and his appearance at such a time has caused alarm to the uneducated. In August, 1719, for instance, when he was only $2\frac{1}{2}^{\circ}$ from perihelion, at the time of opposition, he created the same sort of panic that brilliant comets are apt to produce. His ruddy aspect, which gained for him among the Greeks the epithet $\delta \pi\rho\upsilon\beta\acute{o}\epsilon\iota\varsigma$, tended to increase this effect.

Since Mars, when he comes to opposition near perihelion, is south of the equinoctial, he attains but a moderate altitude on the meridian, and on this account he is less favourably seen. He is in fact thrown much further south at this time than he would be if he travelled in the plane of the ecliptic. For, although the plane in which he moves is inclined at an angle of only $1^{\circ} 51' 5''$ to the plane of the ecliptic, yet, seen from the earth in opposition, when nearly at his greatest distance south of the ecliptic (which happens if he is in opposition near perihelion), he is thrown nearly $7\frac{1}{2}^{\circ}$ south of the ecliptic. This will be clearly understood if we refer to Fig. 2 to exhibit the corresponding projection of Mars *north* of the ecliptic; for it will be very evident that Mars, being raised above the plane of the paper at M or M'', would appear much more elevated above that plane to an eye placed at or near the centre of E or E'', than he would to an eye placed at S. The greatest possible meridian altitude of Mars in our latitude is about 66° , his least scarcely exceeds 10° . Those who are in the habit of using the telescope will know very well what this means, and will readily understand that perihelion oppositions of Mars lose much of their superiority, through the comparatively low altitude of the planet on the meridian. Hence far better views of Mars were obtained in 1862 and 1864 than in 1860, though he was farther off slightly in 1862, and very considerably in 1864, than he had been in 1860. The approaching opposition is

exceedingly favourable as respects altitude ; but the planet will be yet further removed from us than he was in 1864.

Some misapprehension, by the way, appears to prevail respecting the apparent diameter of Mars in 1867. We find it stated by some of our best authorities that the planet will appear larger than he did in 1864. This is a mistake, though the *Nautical Almanack* appears to countenance the supposition. In 1864, Mars came to opposition when situated as at M' in Fig. 1, the earth being at E' ; this was on December 1st, 1864. In 1867 Mars in opposition will be situated as at M, the earth being at E. If now the distance E M (measured of course from centre to centre) be measured, it will be found to exceed the distance E'M' by more than one-seventh. I would not be understood as placing the accuracy of my figures against the calculations of the *Nautical Almanack* computers ; though I may note in passing that much more may be learned from carefully drawn diagrams than is commonly supposed.* As a matter of fact, however, the increased diameter given in the *Nautical Almanack* results from a change in the assumed value of the planet's actual diameter, and a reference to the columns in which the distance of Mars is noted will at once show that the planet is farther off, and therefore must present a smaller apparent diameter. The actual distance of the planet will be about 58,500,000 miles on January 10, 1867, against less than 50,000,000 miles on December 1st, 1864. At the opposition of February 13, 1869 (see Fig. 2), Mars will be yet further off than in 1867. In fact the next three or four oppositions will be very unfavourable ones as respects the distance of Mars, and will be successively less and less favourable as respects his meridian altitude. At the approaching opposition the planet will attain an altitude of $64\frac{1}{2}^{\circ}$ when in opposition.

But, if we would rightly understand the physical peculi-

* It seems to me that most works on popular astronomy fail in this respect ; it is as easy, or nearly so, to give diagrams correctly representing the relations to be illustrated, as to give incorrect drawings, and it is surely far more instructive. The mind apprehends much more readily, and retains much more certainly, what is presented to the eye, than what is stated verbally. Many of the most marked features of the solar system, or of astronomy generally, admit, too, of being fairly exhibited in diagrams. Occasionally, indeed, it becomes necessary to exaggerate dimensions ; in such a case it is sufficient to call the attention of the reader to the want of proportion in the drawing. But often (almost always, in fact) incorrect drawing is admitted where the just proportions could be easily presented. Take, for instance, the eccentricity of Mars' orbit. In Guillemin's *Heavens* we find a figure representing the orbits of the earth and Mars, in which no attempt whatever is made to exhibit this feature, though it is one of the most remarkable and most easily illustrated in the solar system.

Singularly enough, in the *Bridgewater Treatises*, Whewell remarks that all readers of works on popular astronomy are familiar with the appearance of the solar system, represented as it is in such works by a number of slightly eccentric ellipses. Where are we to find such works ?

arities presented by this interesting planet—the only one whose true surface we are able to examine satisfactorily—we are not to content ourselves with observing him in this or that position among the signs. For then we should only know of his appearance at this or that Martial season. We must examine him at every opposition, and endeavour, if possible, to connect the appearances presented at different oppositions with the seasonal changes which may fairly be assumed to be taking place upon his surface.

The seasons on Mars are due to an axial inclination not differing greatly from that of our own earth. From a series of observations by Sir W. Herschel it would appear to follow that the point of Mars' orbit corresponding to our vernal equinox (northern hemisphere) is at present in longitude 78° ,—N in Fig. 1. He made the inclination of the axis to the plane of Mars' orbit $28^{\circ} 42'$, to the plane of the elliptic $30^{\circ} 35'$. The determination of these elements is not a problem which we can expect to have exactly solved. Accordingly, we find that Dr. Oudemans, applying observations taken in 1830—1837 by Bessel, with the Königsberg heliometer, obtained results differing appreciably from Herschel's. He assigns an inclination $1\frac{1}{2}^{\circ}$ less than that given by Herschel, and he places the Martial vernal equinox as at N', Fig. 1. We learn also that this determination does not correspond quite accurately with some pictures of Mars taken by good observers.*

Fig. 3 indicates the polar presentation of Mars (supposed to be seen in an inverting telescope) at opposition, on Dr. Oudemans' assumption as to the inclination of the axis. The arrow represents the direction in which the planet is actually moving, while mm' represents a declination-circle through his centre, and ee' a declination-parallel, so that the apparent motion of Mars across the field of the telescope will take place in direction $e'e$. The polar presentation will gradually diminish as the planet retrogrades (that is, until the middle of February), and then gradually increase. In the beginning of April, when Mars has nearly reached his maximum phase of gibbosity, he will appear as shown at Fig. 3. At this time he will nearly have reached the summer-solstice of his northern hemisphere, so that the southern polar snows may be expected to be much more extensive than they had been three months before. The planet will, of course, appear much smaller his distance being so much greater—see in Fig. 2 the longer line marked 1867.

* It appears to me that the two pictures by De la Rue, reproduced in Guillemin's *Heavens*, require a somewhat larger inclination than that assigned by Dr. Oudemans.

Figs. 4 and 5 represent the features of land, water, snow-caps, etc., which have been seen by Dawes, De la Rue, Lockyer, Phillips, and others of our best observers on the southern and northern hemispheres of Mars, respectively. It need hardly be said that Mars never presents either pole *directly* towards the earth: nor, if he did, would he appear as in Figs. 4 and 5. These must be looked upon as *maps*, and they are intended to enable the student to fill in tracings or copies of Fig. 3 with suitable details—the upper half (or rather the part above the equator) from Fig. 4, the other part from Fig. 5; the bounding circles in Figs. 4 and 5 representing the Martial equator. When this is carefully done, the student will recognize the well-known features given in works on popular astronomy; and the observer, having made several such maps corresponding to different stages of rotation, will be able to interpret or correct the results of his own telescopic observations of the planet during the first three months of 1867.

PROGRESS OF INVENTION.

ECONOMIC PRODUCTION OF ANILINE.—The importance of aniline and its derivatives, in a commercial point of view, has become so great, that any improvement which tends to facilitate its production is of great value. It is obtained, as our readers are aware, by means of benzine, which hitherto has been procured only by a somewhat complicated process. M. Bobœf has been able greatly to simplify this. He dissolves the heavy oils contained in coal-tar with soda, at ordinary temperatures. They are thus separated from the benzine, which floats on the surface, and may be obtained quite pure by mere decantation and rectification. The residue, after decantation, is a product of some value. It is a combination of coal tar and alkali, which constitutes a kind of soap, and has been termed by M. Bobœf phenate of soda. He considers that it possesses all the useful properties of phenic acid.

DELICATE TEST FOR ACIDS.—Hitherto blue litmus paper has been the most sensitive test possessed by the chemists for the presence of an acid. Unfortunately, however, it has been found that its not being reddened by a given fluid affords no absolute certainty of the absence of acids. It is even inferior in delicacy to the reddened litmus paper used as a test for alkalies. M. Schönbein has, however, furnished us with a test for acids of remarkable sensitiveness. It indicates the presence of the very smallest amount of an acid, being so delicate that it shows the presence of carbonic acid in distilled water that has been merely breathed upon. It is obtained in treating cyanine blue with soda; dissolving one part of the product in one hundred parts alcohol, and adding twice its volume of water to the solution. The cyanine blue is formed by

acting on iodide of amyl with lepidine. Schönbein's test fluid is applicable also to the detection of bases, and is of extraordinary delicacy when used to that purpose, enabling us to ascertain the presence of the exceedingly small amount of oxide of lead, which is dissolved by water, and which is not to be rendered perceptible by sulphuretted hydrogen. That used for acids is adapted to alkalies by merely reddening it with an acid.

PROPULSION OF BOATS ON CANALS.—Great as has been the extension of the railway system, and numerous as are the advantages it possesses over every other mode of conveyance, canals, at least those already constructed, would retain a large portion of their utility, and of their superiority, in point of economy, could steam be employed generally upon them. But such has not been found the case, notwithstanding the many efforts which have been made for the purpose. The great disturbance caused in the water, not only by every form and application of paddle-wheel, but also by every adaptation of the screw propeller, causes a ruinous effect on the banks. A trial is, however, being made in France of a mode of using the paddle-wheel, which is found to be free from objections of this kind, and which will, if not accompanied by others peculiar to itself, most probably give a new impulse to canal navigation. Only one paddle-wheel is used, and it works in the centre of the boat, in a space which is enclosed on all sides, except at the bottom. The lowermost paddles project below the keel, and are so effective as to produce, it is said, a velocity equal to that obtained with any other arrangement that has been tried.

SIMPLE MODE OF RENDERING RESINS SOLUBLE.—Certain resins, such as Calcutta copal, are not, in ordinary circumstances, soluble in spirits of turpentine, benzine, petroleum, and other hydrocarbons; but they are rendered so by the application of heat. This, however, is objectionable, among other reasons, from the loss of one-fourth of the weight which occurs. It has been found by M. Violette that this loss may be avoided by heating the resins in close and strong vessels to a temperature between 350° and 400° Cent., and after this cooling them. They are then soluble, even at ordinary temperatures, in the above-mentioned fluids, forming excellent varnishes, which may be used for even the most delicate purposes. They undergo no loss of weight, and the effect produced on them is due to the conjoined action of both heat and pressure. There is one circumstance, however, which, at first, may be a source of difficulty, when the manufacture is carried on upon the large scale. The vessel in which the resin is heated must be able to support a pressure of about twenty atmospheres. The resin may be heated, and the varnish made by a single process. For this purpose it is only necessary to heat to the required temperature a mixture consisting of one part by weight boiled linseed oil, four parts spirits of turpentine, and one part Calcutta copal.

PRECIPITATION OF METALS FROM THEIR SOLUTIONS BY MAGNESIUM.—Magnesium, for a long period after its discovery, remained a mere chemical curiosity. It was then applied to the production of a light, suitable not only for ordinary illumination, but, which is of far

more importance, to the purposes of the photographer; and in such a way as that, to him, the day was practically rendered twenty-four hours long, and the darkest cavern became as well adapted to his art as the most brilliantly lighted studio. A new, and scarcely less important use of magnesium has now been discovered. It is found to precipitate metals from their solutions, and in such circumstances as to afford valuable aid to the toxicologist in medico-legal investigations regarding cases of supposed poisoning. Sometimes it gives rise to precipitation in the metallic state. Thus it throws down iron and zinc from slightly acidulated solutions of their proto or sesqui salts; and cobalt from a similar solution of its protoxide. In these, and other cases, a very remarkable circumstance occurs—hydrogen is evolved. The evolution of this gas, however, prevents arsenic, or antimony, from being precipitated in the metallic state; since each of these metals combines with the hydrogen, and passes off with it. The iron, zinc, and cobalt thus precipitated assume a brilliant metallic appearance if they are well-washed, and then compressed—a very slight pressure being sufficient with the zinc. Iron, cobalt, and nickel obtained in this way are highly magnetic. These are not the only metals which are thrown down by magnesium. It precipitates also gold, silver, platinum, bismuth, tin, mercury, copper, lead, cadmium, and thallium. Other important circumstances are the consequence of the great solubility of magnesium. Thus it decomposes water with great rapidity, if a very small quantity of chloride of sodium or sal ammoniac is present; and the hydrogen thus evolved when the magnesium contains no silicium, is quite pure. The great tendency of magnesium to become oxidized also renders it highly effective as a battery element. If a plate of magnesium, only 0.1 gramme in weight, is immersed, with a very small plate of copper, in a glass tube which has a capacity of six cubic centimetres, and is filled with water which has been acidulated, a galvanic current will be produced that will suffice to keep a small electro-magnetic apparatus, or to afford with a Geissler tube an illumination ten centimetres in length for about ten minutes.

NEW APPLICATION OF COLLOID DIAPHRAGMS.—A mode of dialysing gases by means of colloid diaphragms has recently been discovered. It has long been known that even a thin pellicle of caoutchouc is totally impervious to gases, as such. But it has been found that it is capable of liquifying certain gases, which then pass through it, and are again restored to the gaseous form, or reaching the other side of the pellicle. Atmospheric air is one of these gases; but its constituents are not transmitted with a velocity proportioned to their relative amounts; the whole of its oxygen, but only half of its nitrogen is allowed to pass through. We are thus enabled to obtain oxygen sufficiently pure to rekindle incandescent wood. To render the pellicle as effective as possible, the air to be dialysed must have free access to one side of it, and a partial vacuum must be maintained at the other. Colloid membranes are not the only simple means of liquifying gases. Platinum, palladium, and iron condense hydrogen into a liquid which, possibly,

is metallic. Palladium is especially effective in this way. And iron absorbs carbonic acid in still larger quantities than hydrogen—a circumstance which seems to explain certain facts connected with the manufacture of steel. These metals have no effect whatever on either oxygen or nitrogen. The necessity for the liquification of gases, previous to their passage through caoutchouc, is due to certain peculiarities of that substance. Though it refuses to transmit gases as such, it is very pervious to fluid. It will absorb water to such an extent, as to become opaque; and its pores are so much opened by this fluid, that the latter will pass through, and be evaporated at the other side. The pores, indeed, are visible under the microscope.

PROJECTILES AFFECTED BY THE EARTH'S ROTATION.—The discovery of the effect of the earth's rotation on the path of a projectile is not new; but the practical consideration of it has only recently engaged attention. The flight of projectiles, from their imperfection, and that of the fire-arms then in use, was formerly so uncertain, that the small deviation produced by the rotation of the earth was considered unworthy of any attention. Such is not the case at present; and hence the subject has been of late carefully studied. The deviation depends on the latitude: being greatest at the poles, and zero at the equator. In our latitude a shell, about twelve inches in diameter, with a range of four thousand yards, would deviate to the extent of eight yards. The direction of deviation is different in the different hemispheres; in ours it is, whatever the azimuth of the vertical plane in which the path of the projectile lies, always to the right. A deviation is caused also by the rifling; and as this depends on the direction of the latter, it may, according to circumstances, either augment, or, to a greater or less extent, diminish that caused by the rotation of the earth. In our latitude, with a Whitworth gun, half the deviation arises from the earth's rotation; a proper system of rifling would therefore prevent any deviation whatever. But it must not be forgotten that a rifle without any deviation in one hemisphere would have a very considerable one in the other: as it would become equal to the sum of the deviations caused by both the rifling and by the earth's rotation.

LITERARY NOTICES.

BENEDICITE; OR, THE SONG OF THE THREE CHILDREN. Being illustrations of the Power, Wisdom, and Goodness of God, as manifested in his Works. By G. CHAPLIN CHILD, M.D. In two Volumes. (Murray.)—The canticle known as the "Benedicite," and commencing "Oh all ye works of the Lord, bless ye the Lord: praise him and magnify him for ever," supplies Dr. Chaplin Child with a series of texts on which he has written elegant little dissertations of a scientific character. The book is beautifully got up,

with good print, pleasant cream-coloured paper, well-designed headings, and tail-pieces to the chapters. The verses of the "Benedicite" carry the doctor through a wide range of subjects, from astronomy to natural history. Dr. Chaplin is strictly orthodox—more so than is common with scientific men—but his pages are free from anything like cant, and they will be welcomed in many families which more elaborate treatises would not reach. The "Benedicite" is a very favourite hymn, both on account of its literary merit, and from its adaptability to music, and it is certainly desirable that those who use it for the expression of their devotional feelings should have some idea of the way in which "all the works of the Lord do praise Him," in the thoughts which they excite in intelligent minds.

THE ORIGIN OF SPECIES BY MEANS OF NATURAL SELECTION; OR THE PRESERVATION OF FAVOURED RACES IN THE STRUGGLE FOR LIFE. By CHARLES DARWIN, M.A., F.R.S., etc. Fourth edition, with additions and corrections. Eighth thousand. (Murray.)—No book of modern times has contributed so much to philosophical thinking on the subject of natural history as the *Origin of Species* of Charles Darwin. A considerable allowance of abuse from those whose minds were ossified with old-established prejudice, did more to call attention to this masterly work than to obstruct the reception of the truths which it conveys, and if its author has to complain of some ill-treatment on the part of those who know no better, he has the satisfaction of being more or less supported by the greatest thinkers of the day. Gross mistakes have been often made in treating the doctrine of "natural selection" as if it were merely a hypothesis capable of being entirely overthrown; whereas the exposition of the doctrine is simply a statement of facts; and the scientific doubt pertaining to it, concerns the extent of its action, and not the question of its existence. That living beings succeed in hereditary series is one fact; that progeny are subject to variations from the parent type is another fact; and it is a third fact that some of these variations are transmissible in long succession. Man, by careful breeding, transmits peculiarities in horses, dogs, cattle, pigeons, etc., according to his wants, or according to his whims. In nature, the permanence, or long duration of a transmissible peculiarity must, as Darwin shows, depend upon its adaptability to the circumstances in which the modified creature finds itself. If it lessens the power of the individual to fight the battle of life, it dies out, while if it assists in that conflict, it remains. The hypothetical part of Darwinism consists in the inferences which he draws, or suggests, as to the *extent* to which these causes have operated in past times. If we suppose their extent of action to be no greater than we can *prove* it to have been, it will not account for the descent of a vast multitude of divergent forms from one, or from a few parent forms; but if the positive evidence in this matter is incomplete, the negative evidence is palpably afflicted with the same defect to an enormous degree. If we had cause to suppose that geology and palæontology displayed to us a fair and unbroken sequence of organic beings from early times to our own, the negative evidence against the hypothesis would be

very strong indeed; but an immense deal has been done of late years, not only to show beyond all doubt that our palæontological record is incomplete; but that it is imperfect to such an extent that it may be likened to a book from which whole chapters of unknown size, and unknown contents, have been cut out. How many of these chapters we may be able to recover no one can guess, as only a small part of the earth has yet been subjected to accurate examination. We are likewise profoundly ignorant of the physiological causes of hereditary transmission, with or without variation. Darwinism, therefore, stands in the position of an array of facts, proving the operation of certain principles, but leaving room for conjecture as to the extent of that operation, and its consequent capacity of evolving new forms. Whether, therefore, it be accepted or rejected, the mind should still have its "philosophic doubt," and avoid bigotry with its antagonism to reason, on either one side or the other. As for the religious questions which have been mixed up with this, as with all former innovations upon received modes of thought, they must be subordinated to the love of truth, and to the conviction that whatever method it may have pleased the Creator to adopt in peopling his world, that method must necessarily be one which, when understood, will excite the love and admiration of his rational subjects. The testimony of all science is conclusive as to the infinitely small proportion of nature which we can either observe or understand; but there is much to lead us to believe that all parts of the vast whole are bound together by a unity of design, as well as by a unity of origin from one ultimate source of intelligence and power. From the vastness of the *Cosmos*, human speculation is necessarily imperfect, from insufficiency of information, or from the complexity of the system baffling men's powers of analysis. The readers of Darwin will find many beautiful and amazing instances of the interdependence of objects that might have been supposed disconnected; and no one in whom the religious spirit is active can rise from a perusal of his pages without higher conceptions of the evidence which Natural Theology offers to the mind.

AN ELEMENTARY TREATISE ON HEAT. By BALFOUR STEWART, LL.D., F.R.S., Superintendent of the Kew Observatory, Examiner at the Universities of Edinburgh and London. (Oxford: At the Clarendon Press, MDCCLXVI.)—This is by far the most compendious and well-arranged treatise on heat which we have seen, and the best adapted for class-teaching, or private study. It contains an immense amount of well-arranged information, and a clear exposition of the most recent theories and facts pertaining to its subject.

AN EASY INTRODUCTION TO THE HIGHER TREATISES OF THE CONIC SECTIONS. By the Rev. JOHN HUNTER, M.A. (Longmans.)—This little book, as the author tells us, has resulted from practical experience of the difficulties pupils feel in the study of conic sections, and we have no doubt it will be found of much use to the class of students for whom it is intended.

NOTES AND MEMORANDA.

NORMAN LOCKYER ON THE SPECTRA OF SUN SPOTS.—The *Proceedings of the Royal Society*, No. 87, contain an account of experiments by Mr. Norman Lockyer to test the opposing theories of Faye, and De La Rue, Balfour, Stewart, and Loewy. The former regards the interior of the sun as a nebulous mass of feeble radiating power at a temperature of dissociation, and the photosphere as of high radiating power, lower temperature, and chemical action. A sun spot he supposes to be an exhibition of the interior mass through rents in the photosphere made by ascending currents. The latter refer sun spots to a downward current of the cooler atmosphere, producing condensation and absorption in the photosphere. Mr. Lockyer in an experiment, which he hopes to repeat on a larger spot, did not find the spectra of the umbra give the character required by M. Faye's hypothesis.

MAXIMUM PERIOD OF NOVEMBER METEORS.—M. Coulvier-Gravier gives a diagram in *Comptes Rendus*, showing the proportions of meteors seen on the 12th and 13th November, from 1830 to 1866. The maximum was in 1833, the minimum in 1860, and he expects the next maximum to be in 1867, which would be in accordance with the prediction of Olbers. He says that, unfortunately, there will be a full moon at the time. There has been, he states, a progressive augmentation from 1862 to 1866, and he expects this will continue and culminate in 1867.

DISENGAGEMENTS OF GASES FROM THEIR SUPERSATURATED SOLUTIONS.—M. Grenet has a paper in *Comptes Rendus*, No. 21, on this subject. Solutions of gases in liquids are made under certain pressures, and the temperature of the fluid is then raised, and if, as is usually the case, the gas is less soluble in a warm fluid than in a cooler one, it will remain for a time supersaturated. If any rod of solid matter is then introduced, it becomes covered with gas bubbles, which escape freely if the liquid is stirred by the rod. After a time the immersed part of the rod loses the power of promoting the formation of gas bubbles; heat will also destroy this power, and solid bodies which have not been in contact with air do not possess it, and it is the air, or gas, adhering to the solid body which excites the action.

POISON IN WHALE FISHING.—In *Comptes Rendus*, No. 22, will be found an account by M. Thiercelin of the employment of small explosive shells to shoot whales, and kill them by conveying strychnine and curare poison into their systems. He states that a mixture in powder of soluble salts of strychnine, with one-twentieth of curare, will kill any animal if discharged into a wound. The animals require a five-thousandth of a gramme of the poison to each kilogramme of their bulk, or less if they are extremely large. He estimates whales to weigh, according to the sort, from 50,000 to 90,000 kilogrammes, and he mentions several instances of whales killed in a few minutes by his poison shells. The animals exhibit symptoms of tetanus, followed by death.

THE ICONOSCOPE.—M. Javal describes in *Comptes Rendus* the above named instrument as taking its place between Wheatstone's pseudoscope and the telestereoscope of Helmholtz. He says, by an optical combination identical with that employed in the binocular microscope of Nachtet, and the binocular ophthalmoscope of Giraud-Teulon, the two eyes cease to receive different images of external objects. It results that if, under these conditions, a large picture is examined, the eyes preserve the same state of convergence towards whichever part of the canvas they are directed, and the spectator having no means of assuring himself concerning the plain form of the surface he examines, it assumes an appearance of relief in proportion to the time it is observed.

YEAST OF BEER.—M. Herman Hoffman states (*Comptes Rendus*) that if a little beer yeast is placed in a weak solution of honey that has been boiled, bubbles of carbonic acid rise for a few days from the liquid, but not directly from the yeast cells; after which the acid which is developed stops the fermentation. A pellicle of yeast cells and baciliform cells, frequently in chains composed of several

members (? bacteriums), this pellicle fructifies in the form of *Penicillium*. Many yeast cells fall to the bottom, and they can be made to fructify as *Mucor* or *Penicillium*, if placed on pieces of potato. Heating the liquid to 60° or 74° (C.) arrests the fermentation for some days, after which it takes place feebly, and many of the cells fructify in the bacillar form. After exposure to a still higher temperature the yeast loses its faculty of inducing fermentation, but can still produce a pellicle. 84° (C.) destroys its vitality altogether, unless it is heated in a dry state, when it can survive a temperature not exceeding 150°, and still produce a feeble fermentation. At 215° it loses this property, but still produces the pellicle. Similar results followed the application of creosote, chloroform and sulphuric acid in appropriate doses.

A NEW GLOW-WORM, WITH TWO FIRES, has been found in the Grand Chaco, Argentine Republic. Wm. Perkins, Esq., F.R.G.S., writes from Rosario, October 20, 1866, to Wm. Bollaert, Esq., F.R.G.S.:—"I think I have made a discovery in natural history, and which you may make known to the scientific world. I found the female of the most extraordinary *Elateride* ever heard of, at least that I know of. It is a most brilliant glow-worm, one inch and a half long, with TWO FIRES. The body emits a most vivid flame of the ordinary greenish phosphorescent colour, while the head presents the appearance of a bright glowing red coal of fire. The reflection on a piece of paper is also of the two colours. I never saw anything so beautiful." Mr. Bollaert adds: "This is doubtless one of the *Cocuyos* family. One, the *Pyrophorus noctilucus*, is described as the South American *Cocuyo*, or glow-worm. Mr. Bollaert has noticed glow-worms in the West Indies, North and South America, but never in such abundance and beauty as in the wilds of Western Texas, still he never observed but the one light, the green."

GEOLOGY OF THE PARANA.—Mr. Perkins writes also to Mr. Bollaert: "You know how completely alluvial is all the littoral to the west of the Paraná. From Santá Fé up to the Bermejo, the right side of the Paraná is bordered to a strip of low alluvial land from two to five leagues in breadth. Then come the high *barrancos* of the Chaco, also alluvial, not a stone to be found from Rosario to the Bermejo; no clay neither. Well, I found, running in a direction S.E. and N.W. across the low lands mentioned, a large formation of conglomerate of agates and red clay, the latter of a brilliant colour, soft and homogeneous. The formation, where I found it, crossed the San Javier river, in latitude 29° 11' S. At the town of San Javier, where the river of the same name approaches, the high banks (80 feet high) of the lowlands, I found, at the depth of 90 feet, a bright red coarse sand that was going through the process of hardening into stone. I also found large numbers of old oyster shells, with very brilliant colouring inside. They seemed to me so similar to the pearl oysters I have seen at Paraná and the Gulf of Guaymas, that I made minute inquiries of some old Indians in the town of San Javier. They said that *little stones* had been found in the shells in former times. I had to take the information for what it was worth. The wonderful shell formation at Paraná, where we found them in the gradations from a perfect shell to a finished formation of fine limestone, does not leave us any room for surprise at finding them a couple of degrees further north."

μ^2 BOOTIS AND ζ AQUARI, SECCHI'S MEASURES.—Our attention has been called to the probability that the distance of the first of these stars as lately given by Secchi is too much. Mr. Webb finds it easier to divide than γ^3 Andromedæ, which he ascribes to the size of the disks. In 1864, Mr. Knott's measure of μ^2 Bootis was 0".5; and in 1865, Mr. Dawes made it 0".48. We are asked, but cannot tell, what Secchi means by the note he makes against this star, "*Non è ben certo, qual sia delle due pare \approx 1938.*" Mr. Knott thinks there may be a misprint in Secchi's position of ζ Aquari, which he makes 347° 83. Mr. Knott finds it 337° 01 D. 3" 644.



INDEX.



ACHROMATIC condensers, 60.
Achromatic eye-pieces for telescopes, 80.
Acids, delicate test for, 473.
Aerolite, a monster, 399.
Aids to microscopic inquiry, 298.
Albumen, 299.
Algiers as a winter residence, 1.
Amalgamated zinc in the galvanic battery, substitute for, 238.
Amœboid bodies, development of, 367.
Amorphous phosphorus, 236.
Ancient settlements in Ireland, 73.
Ancient sword at Norham, 395.
Anglo-Saxon antiquities in Leicester, 72.
Anglo-Saxon cemeteries, 225, 227.
Aniline, economic production of, 473.
Animal life in South Africa, 41.
Antelopes of South Africa, 45.
Anthropological Review, 231.
Ants, 416.
Apple congress, 240.
Aquarii and Bootis, Secchi's measures, 480.
Archæologia, 72, 225, 394.
ARCHÆOLOGIA.—Canoe in Whettall moss, 72; Roman tessellated pavement, 72; Anglo-Saxon antiquities, 72; ancient settlements, 73; Anglo-Saxon cemetery at Sarr, 225; balance and scales, 225; Roman inscriptions, 226; excavations at Sutton Hill, 226; sepulchral tumuli, 227; Reliquiæ Aquitanicæ, 315; flint cores from India, 320; Cathedral of Rouen, 394; City of Hereford, 395; ancient sword at Norham, 395; excavations at Silchester, 395; ancient pyramid, 396; Roman inscription, 396.
Archæological Societies of Hereford, 395.
Ascent of Cader Idris, 27.
Asphalt of the Dead Sea, 62.

Astinomus, species of, 129.
ASTRONOMY.—Chacornac's solar theories, 15; deceptive figures, with remarks on Saturn's square-shouldered phase, 23; coming meteor shower—spectra of meteors, 38; planet Saturn, 49; ring system of Saturn, 49, 143; rotation of Saturn's ring, 57; Dhurmsalla meteoric stone, 78; zodiacal light, 79; effect of increase on sun's mass, 79; prisms and silvered flats for telescopes, 80; achromatic eye-pieces for telescopes, 80; red stars, 119; planet Saturn, 142; spectrum of appetite, 159; rapid increase of star in Corona, 159; new planets, 159; magnetic action of the moon, 160; prismatic spectra of August meteors, 161; meteor spectroscopy, 162; monochromatic light, 163; spectra of meteors, 163; material of meteors—planet Saturn, 194; Chacornac on the comets, 209; obscurations of the sun, 223; hand-book to the stars, 232; shooting stars near the earth, 239; silvered object-glasses for sun viewing, 240; cometary light, 281; nebulae, 281; occultations, 149, 288, 393, 443; nebular hypothesis of Laplace explained by Delaunay, 310; terrestrial dark lines of the spectrum, 317; light of nebulae, 318; star magnitudes, 319; ninetyeth planet, 320; November meteors, 373; nebular and stellar spectra, 386; solar observations, 391; red stars, 392; planets, 392; Orion nebula, 386; measuring small intervals and counting meteors, 398; pseudoscopic appearance of the moon, 399; Secchi on double stars, 399; monster aerolite, 399; ninety-first planet, 399; the heavens, 400; lunar details, 441; obscuration of lunar crater, 444; Mars Serenitatis,

- 444; Schmidt on the lunar crater "Linne" and November meteors, 448; celestial perspective, 451; November meteor shower at Glasgow, 459; spectra of meteors, 465; planet Mars, 466; orbit of Mars, 467; seasons of Mars, 471; Norman Lockyer on the spectra of sun spots, 479; maximum period of November meteors, 479; Bötis and Aquarii, Secchi's measures, 480.
- BALANCE** and scales, ancient, 225.
- Balanophoracæ, 348.
- Banyan-tree, 113.
- Bee parasites, 414.
- Beetles, 130.
- Beetles or coleoptera, 409.
- Bell-birds of America, 401.
- Benedicite, or Song of the Three Children, 476.
- Birds of Middlesex, 233.
- Bitumen on the Dead Sea, 63.
- Black population of the British Colony of Natal, 184.
- Black wood, Forest of Kinloch, 125.
- Bleaching process, new, 157.
- Bolide at Vichy, 239.
- Bötis and Aquarii, Secchi's measures, 480.
- BOTANY**.—Notes on fungi, 32; blackish purple or brown-spored mushrooms, 32; mushroom diseases, 34; size and life of a mammoth tree, 79; fungus in a tree, 80; ladies' slippers, 81; cypripedium, species of, 84; Miocene plants, 91; Eocene flora, 93; large British oaks, 107; Bryngwyn oak, 108; Golyos oak, 109; genus ficus, 112; banyan tree, 113; poplar, 115; India-rubber tree, 116; fig tree, 117; sycamore tree, 118; plants found in the lake-dwellings, 151; flora of Ireland, 202; Hibernian plants, 203; wayside flora, 232; medical properties of the teazle, 239; apple congress, 240; parasitical plants, 348; rhizomes of parasitical plants, 349.
- British Columbia charr-fishing, 339.
- Bronze work of lake dwellings, 154.
- Brown-spored mushrooms, 32.
- Browning's spectroscope, 161.
- Bryngwyn oak, 108.
- Buckland's Curiosities of Natural History, 45.
- Buddhist astronomy, 426.
- Buddhism and its legends, 421.
- Burmah pheasants, 170.
- Butterflies of the Highlands, 126.
- CADER IDRIS, ascent of, 27.
- Canoe, found in Whettall Moss, 72.
- Caoutchouc tree, 116.
- Cape Colony elephants, 44.
- Capturing pheasants, 173.
- Carnivora, South Africa, 48.
- Cathedral of Rouen, 394.
- Celestial perspective, 451.
- Cellulose, 301.
- Cerebric acid, 300.
- Chacornac on comets, 209.
- Chacornac's solar theories, 15.
- Chameleon, 321.
- Charaxes jasius, 255.
- Charles Waterton, 227.
- Charr-fishing, 339.
- Charr from British Columbia, 338.
- Chart of the characteristic British tertiary fossils, 316.
- Chasmorhynchus priscus, 406.
- Chemical materials of man, 298.
- Chemical poisoning, 239.
- CHEMISTRY**.—New electrical apparatus, 74; peroxide of hydrogen, 75; oxygen in a different state in different peroxides, 76; electrotype process, 76; purification of water, 77; petroleum as fuel, 77; utilizing combustible fluids as fuel, 78; iodine dissolves gold, 79; new bleaching process, 157; substitute for sodium amalgam in metallurgical operations, 157; dissociation of gases at high temperatures, 158; dialytic action of India-rubber and metals on gases, 160; crystallizing carbon, 160; electricity, 231; magnesium and its salts as illuminating agents, 234; amorphous phosphorous, capable of crystallization, 236; electric alarm, 237; thermo-electric properties of iron, 238; oxygen obtained from atmospheric air, 238; substitute for amalgamated zinc in the galvanic battery, 238; chemical poisoning, 239; peculiar disengagements of gas, 399; economic production of aniline, 473; delicate test for acids, 473; simple mode of rendering resins soluble, 474; precipitation of metals from their solutions by magnesium, 474; colloid diaphragms, 475; heat, elementary treatise on, 478; disengagements of gases from their supersaturated solutions, 479.
- China, stone age, 221.
- Cholera mist, 240.
- Climate of Algeria, 4.
- Coleoptera or wood-feeder, 128.
- Colonial life in Algiers, 8.
- Colour of chameleon, 322.

- Colloid diaphragms, new application of, 475.
- Cometary light, 281.
- Comets, 209, 314.
- Condenser, Ross's four-tenths, 59.
- Confucius, passage from the life of, 221.
- Congelation and death of animals, 160.
- Conic sections, easy introduction to the higher treatises, 478.
- Copepoda of mice, 333.
- Copper sheathing for iron ships, 263.
- Cork, new application of, 239.
- Coryncea, 354.
- Cotingas, 401.
- Couch's British fish, 99.
- Crustacea, 327.
- Crystallizing carbon, 160.
- Curtis's process of photo-micrography, 41.
- Cyprapediums, 82.
- Damping apparatus for copying, 77.
- Date stones, 231.
- Deceptive figures, 23.
- Deep sea life, 400.
- Developmental history of infusorial, animal life, 356.
- Dhurmsalla meteoric shower, 78.
- Dialytic action of India-rubber and metals on gases, 160.
- Diamond-work, 9.
- Diaphragm eye-piece, 319.
- Dictionary of science and art, 231.
- Dictionary of science, art, and literature, 316.
- Dinocharis Collinsii; a rotiferon new to science, 269.
- Disengagements of gases from their supersaturated solutions, 479.
- Dissociation of gases at high temperature, 158.
- Double stars by Secchi, 399.
- Down, three sorts of, 377.
- Dragon-flies, 128.
- Dr. Curtis's process of photo-micrography, 41.
- Drinking habits of chameleon, 324.
- Dutch settlers in Natal, 186.
- EARTHQUAKE** in France, 319.
- Economic production of aniline, 473.
- Education of the Kaffirs, 296, 433.
- Electricity, 231.
- Electric-alarm, new, 237.
- Electrical apparatus, new, 74.
- Electrotype process, improved, 76.
- Elementary treatise on physics, experimental and applied, 233.
- Elephants of South Africa, 42.
- Enamelled feathers, 385.
- Eocene flora, 93.
- ENTOMOLOGY.**—Tsetse, 45; highland insects, 124; butterflies of the highlands, 126; glory of Kent moth, 126; oak-egg-moth, 127; petasia moth saw-fly, 128; wood ant, 128; notes on the habits of some lepidopterous larvæ, 253; processary moth, 253; charaxes jasius, 255; spider and earwigs, 319; worms and insects generated by dead bodies, 356; generation of insects, 357; silk produced by diurnal lepidoptera, 393; parasitic beetles, 409; coleoptera, 409; oil beetles, 414; bee parasites, 414; ants, 416; nest of ants, 418; new glowworm, with two fires, 480.
- Epidermis, 248.
- ETHNOLOGY.**—Algierenes, 2; lake dwellers in Switzerland, 149; Kaffirs of Natal, 184, 289, 428; human remains in the Rhine-valley, 399; Kaffir promise and capability, 428.
- Excavations at Silchester, 395.
- Excavations at Sutton Hill, 226.
- FAMILY** life of the middle class, 213.
- Fatio on the forms and colours of plumage, 377.
- Feathers, 381.
- Ficus, on the genus, 112.
- Field adjustment for object-finding, 320.
- Fig trees, 116.
- Filagree work, 12.
- Fire-arms, application of a new principle, 138.
- Fishing-nets and hooks of the lake-dwellers, 150.
- Flint cores from the Indus, 320.
- Flora of Ireland, 202.
- Food of the lake-dwellers, 150.
- Force of the mental and moral correlates, 229.
- Form, growth, and construction of shells, 241.
- Four-tenths condenser, 59.
- Fraser river, 343.
- From Kurrachee to Mooltan, 272.
- Frozen fish of the Polar sea, 103.
- Fungi, notes on, 32.
- Fungus-feeding beetles, 134.
- Fungus in a tree, 80.
- GAS**, peculiar disengagements of, 399.
- Gemmiparous animals, 376.
- Generation of insects, 357.
- Genus ficus, 112.
- GEOLOGY.**—Surface geology of Cader Idris, 27; bituminous deposits of the Dead Sea asphalt, 64; calcareous rock, 65; hypothetical continents,

- 88: new parasitic crustacea, 160; British tertiary fossils, 316; variations of crustacea, 327; remains of Dinosaurian reptiles, 396; rocks of Devon and Somerset, 397: geology of the Parana, 480.
 Geological society, 396, 397.
 Glashier's blue mist, 365.
 Glass, improvement of, for optical purposes, 237.
 Glass rope of the Hyalonema, 320, 399.
 Glory of Kent moth, 126.
 Glow-worm, new, with two fires, 480.
 Goldsmith's work in the time of Queen Elizabeth, 10.
 Golynos oak, 109.
 Gurnards, 101.
 Gossip about fish, 99.
 Gotama Buddha, 422.
 Government of Kaffirs, 290.
- HABITS of North-western American salmon, 345.
 Habits of lepidopterous larvæ, 253.
 Head of the chameleon, 321.
 Heat, elementary treatise, 478.
 "Heavens, the," new edition, 400.
 Helosis Guyanensis, 355.
 Herbage of South Africa, 47.
 Hibernian plants, 203.
 Highland fauna, 130.
 Highland insects, 124.
 Hippopotami, 44.
 Hotels of Algiers, 2.
 Human remains in the Rhine valley, 399.
 Hunting at Algeria, 4.
 Hunting in South Africa, 43.
 Hydra, 371.
 Hypsometer, improvement of, 234.
 Hypothetical continents, 88.
- ICHTHYOIDS,, 100.
 Iconoscope, 479.
 Implements of the lake-dwellers, 152.
 Increase of sun's mass, effects of, 79.
 India-rubber trees, 116.
 Infusorial animal life, 356.
 Insect life in the Highlands, 125.
 Iodine dissolves gold, 79.
 Iron manufacture, 259.
 Iron and steel in the construction of ships and bridges, 257.
 Iron-work of lake-dwellers, 155.
 Italian and French architecture, 176.
- JEWELLERY, modern, 7.
 Jewellery work of 18th century, 11.
 Journey from London to Algiers, 1.
- KAFFIR huts, 291
 Kaffir families, 292.
 Kaffir food, 293.
 Kaffir labourers, 431.
 Kaffir life and intelligence, 289.
 Kaffirs of Natal, 189.
 Kaffir promise and capability, 428.
 Ketchup, mushroom, 35.
 Kurrachee to Mooltan, 272.
- LADIES' slippers, 81.
 Lake-basins of Cader Idris, 29.
 Lake-dwellers of Switzerland, 149.
 Lampreys, 105.
 Laplace's Nebular hypothesis, 310.
 Large British oaks, 107.
 Lartet on the asphalt of the Dead Sea, 62.
 Lepidopterous larvæ, 253.
 Light of nebulæ, 318.
 Lightning, strange effect of, 80.
 Lineated pheasant of Burmah, 170.
 Literary Notices, 227, 315, 476.
 Lunar crater, 444.
 Lunar crater "Linné," 448.
 Lunar details, occultations, 441.
- MAGNESIUM and its salts as illuminating agents, 234.
 Magnetic action of the moon, 160.
 Mahometan worship, 2.
 Mammalia, 95, 100.
 Mammoth tree, size and life of, 79.
 Mare serenitatis, 444.
 Marine worm, new, 78.
 Mars, 466.
 Marriages among the Kaffirs, 295.
 Material of meteors, 168.
 Maximum period of November meteors, 479.
 Measuring small intervals and counting meteors, 398.
 Medical properties of the teazle, 259.
 Mediæval works of London, 176.
 Metallic film spectacles, 320.
 Metallurgical operations, substitute for sodium amalgam, 157.
 Meteors in November, 373.
 Meteor shower, 38.
 Meteor shower at Glasgow, 459.
 Meteor spectroscope, 162.
 Meteorological observations at Kew Observatory, 66, 304.
 Microscopic inquiry, 298.
 Microscopical Society of London, 317.
 MICROSCOPY. — Dr. Curtis's process of photo-micrography, 41; Ross's four-tenths condenser, 59; aids to microscopic inquiry, No. VIII., organic substances and formations, 298; Microscopical Society, 317; Royal Microscopical Society, 397; How's

- New Student's Microscope, 398 ; wire spring clip for microscopic objects, 398 ; Mr. Pearson's photomicrographs, 400.
- Middle-class family life, 213.
- Migrations of animals, 46.
- Migrations of the eel, 103.
- Miocene plants, 91.
- Missionary work among the Kaffirs, 436.
- Modern jewellery and art, 7.
- Monads, 363.
- Mono-chromatic light, 163.
- Moult, 379.
- Movements of chameleon, 322.
- Mushrooms, black-spored, 32.
- Mushrooms, diseases, 34.
- Myxine, or borer, 106.
- NAKED-THROATED, or Brazilian bell-bird, 402.
- Natal, black population, 184.
- Natal elephants, 44.
- Natal Kaffirs, 289.
- NATURAL HISTORY, including ZOOLOGY.—Animal life in South Africa, 42 ; elephants, 42 ; hippopotami, 44 ; rhinoceri, 44 ; antelopes, 45 ; Buckland's Curiosities of Natural History, 45 ; migrations of animals, 46 ; carnivora of South Africa, 48 ; gossip about fish, 99 ; Highland insects, 124 ; congelation and death of animals, 160 ; lineated pheasant of Burmah, 170 ; capturing pheasants, 173 ; the birds of Middlesex, 233 ; dinocharis collinsii, 269 ; chameleon, 321 ; head of chameleon, 321 ; movements of chameleon, 322 ; colour of chameleon, 322 ; drinking habits of chameleon, 324 ; new charr from British Columbia, 338 ; charr fishing, 339 ; habits of North-western American salmon, 345 ; plumage of birds, 377 ; deep-sea life, 400 ; bell-birds of America, 401 ; cotinga, 401 ; naked-throated bird, 402 ; chasmorhynchus priscus, 406 ; beetles, 409 ; bees and ants, 414 ; origin of species by means of natural selection, 477 ; poison in whale fishing, 479.
- Nebulae, hypothesis of Laplace explained by Delaunay, 310.
- Nebular and stellar spectra, solar observation, red star, planets, 386.
- Nests of ants, 418.
- New charr from British Columbia, 338.
- New planets, 159.
- Ninety-first planet, 399.
- Norman Lockyer on the spectra of sun spots, 479.
- Note of the bell-bird, 404.
- Notes on fungi, 32.
- Notes on the habits of some lepidopterous larvæ, 253.
- November meteors, 373.
- November meteors, maximum period of, 479.
- November meteor-shower at Glasgow, 459.
- November shooting stars, 449.
- OAKS, large British, 107.
- Obscuration of a lunar crater, 444.
- Oak-egg-moth, 127.
- Obscurations of the sun, 223.
- Observations on the changes of colour and modes of taking food in the chameleon, 321.
- Occultations, 149, 281, 293, 386.
- Oil-beetles, 414.
- Ombrophytum Peruvianum, 353.]
- Orbit of Mars, 467.
- Orchids, 84.
- Organic substances and formations, 298.
- Orion nebula, 386.
- Origin of ancient faunas and floras, 88.
- Origin of species by means of natural selection, 477.
- Oxygen obtained from atmospheric air, 238.
- Oxygen in a different state in different peroxides, 76.
- PAPER substitute for lint, 399.
- Palæontology, 89.
- Parasitic beetles, 409.
- Parasitic crustacean, 160.
- Parasitical plants, 348.
- Pathmakers of the tropical forests, 44.
- Pepul, ficus religiosa, 115.
- Peripneumonia, of Africa, 46.
- Persistence of luminous impressions, 98.
- Peroxide of hydrogen, 75.
- Petasia moth, 127.
- Petroleum as fuel, 77.
- Phases in the developmental history of infusorial, animal life, 356.
- Pheasant of Burmah, 170.
- Phosphorous, a metal, 236.
- Photography with dry plates, 156.
- Photography as a fine art, 19.
- Photographer's light, 399.
- Photographic prints, new mode of fixing, 78.
- Photo-micrographs, 400.
- Photo-micrography, 41.
- Phyllorcoryne tamaicensis, 354.
- Pictures of Algeria, 5.
- Pipe fish, 104.

- Plans for improving London, 136.
 Planets, the ninetyeth, 320.
 Planet Mars, 466.
 Planet Saturn, 49, 142, 194.
 Plants found in the lake dwellings, 151.
 Plumules of the pieris oleracea, 318.
 Plumage, forms and colour of, 377.
 Poison in whale fishing, 479.
 Polar insects, 128.
 Polyzoa, new freshwater, 240.
 Porosity of caoutchouc, 320.
 Pottery of the lake dwellers, 153.
 Portable horizontal slide, cabinet, and covered opaque slide, 398.
 Precipitation of metals from their solutions by magnesium, 474.
 Prevention of the spark produced by the extra current, 235.
 Prismatic spectra of the August meteors, 161.
 Prisms and silvered flats for telescopes, 80.
 Proceedings of learned societies, 317, 396.
 Processionary moth, 253.
 Progress of invention, 73, 156, 234, 317, 473.
 Projectiles affected by the earth's rotation, 476.
 Propulsion of boats on canals, 474.
 Pseudoscopic appearance of the moon, 399.
 Purification of water, 77.
 Pyramid at Mexico, 396.
- RAPID** increase of the star in Corona, 159.
 Red star, 392.
 Red stars, 119.
 Refugee Kaffirs, 186.
 Regulator of velocity, 73.
 Reliquiæ Aquitanicæ, 315.
 Remains of large dinosaurian reptiles from Stormberg Mountains, South Africa, 396.
 Reproduction of designs on glass, 76.
 Recherches of Dr. Müller and Dr. Claus, 328.
 Resins soluble, simple mode of rendering, 474.
 Respiratory apparatus of land crabs, 329.
 Results of meteorological observations at Kew Observatory, 66, 304.
 Rhinoceri, 44.
 Rhizomes of parasitical plants, 349.
 Rhapalocnemis phalloides, 354.
 Ring system of Saturn, 49, 143.
 Rocks of North Devon and West Somerset, 397.
 Roman inscriptions, 226, 396.
- Ross's four-tenths condenser, 59.
 Rotation of Saturn's ring, 57.
 Rotifers, strange place for, 211.
 Royal Microscopical Society, 397.
- SATURN**, 194.
 Saturn's "square-shouldered" phase, 23.
 Saw-fly, 128.
 Sauroids, 100.
 Schmidt on the lunar crater "Linné" and November meteors, 448.
 Scholarships and exhibitions in the University of Cambridge, 316.
 Scientific and Literary Treasury, 316.
 Seasons of Mars, 471.
 Secchi on double stars, 399.
 Sepulchral tumuli, 227.
 Settlers in Natal, 185.
 Shells, form, growth, and construction of, 241.
 Shell structure, 249.
 Ships and bridges, iron and steel in the construction of, 257.
 Shooting stars near the earth, 239.
 Shooting stars of November, 449.
 Silica, 302.
 Silk produced by diurnal lepidoptera, 393.
 Silvered object glasses for sun viewing, 240, 320.
 Sleep of fishes, 104.
 Soap beans of China, 319.
 Soda manufacture, simplification of, 237.
 Solar observation, 391.
 Solar theories, Chacornac's, 15.
 Spectra of some meteors in November, 1866, 465.
 Spectra of meteors, 38, 163.
 Spectrum of apatite, 159.
 Spiders and earwigs, 319.
 Spiral form of shells, 242.
 Spots on the equatorial regions of the sun, 18.
 Spontaneous generation controversy, 240.
 Spontaneous generation, 362.
 Stag beetle, 131.
 Star magnitudes, 319.
 Starches, 302.
 Stars, Handbook of, 231.
 Stone-age in China, 221.
 Stones on Cader Idris, 28.
 Strange place for rotifers, 211.
 Street architecture of London, 174.
 Sun, obscurations of the, 223.
 Sun spots, Norman Lockyer on spectra of, 479.
 Swedish fauna, 130.
 Sycamore tree, 118.

- T**
- TAPE-WORMS, human entozoa, 231.
 - TERrestrial dark lines of the spectrum, 317.
 - TESsellated pavement in the churchyard of Caerleon, 72.
 - TEXtile fibre, new, 239.
 - TEXtile fabrics] of the lake-dwellers, 153.
 - THERmo-electric properties of iron, 238.
 - TSETSE of Africa, 45.
 - TUNing forks, new application, 158.
- U**
- UTILIZING combustible fluids as fuel, new mode, 78.
- V**
- VALVES of shells, 243.
 - VARiable light, 287.
 - VARiations of certain crustacea in relation to the theory of the origin of species by natural modification, 327.
 - VERtebrates of Madagascar and America, 96.
 - VIEnnese jewellery, 10.
- V**
- Volcanic emanations and disease, 79.
 - VOYage from New Westminster to Fort Langley, 339.
- W**
- WAYSide flora, 231.
 - WHale fishing, poison in, 479.
 - WHELKS, 247.
 - WILD Kaffir life and wild Kaffir intelligence, 289.
 - WIRE spring clip for microscopic objects, 398.
 - WOOD-feeding beetles, 132.
 - WOOD-ants, 128.
 - WORM Phenacia pulchella, 159.
 - WORMS and insects generated by dead bodies, 356.
- Y**
- YEAST of beer, 479.
- Z**
- ZINC protections for ships, 265.
 - ZODiacal light, 79.
 - ZULU Kaffirs, 429.
 - ZULU tribe, 185.







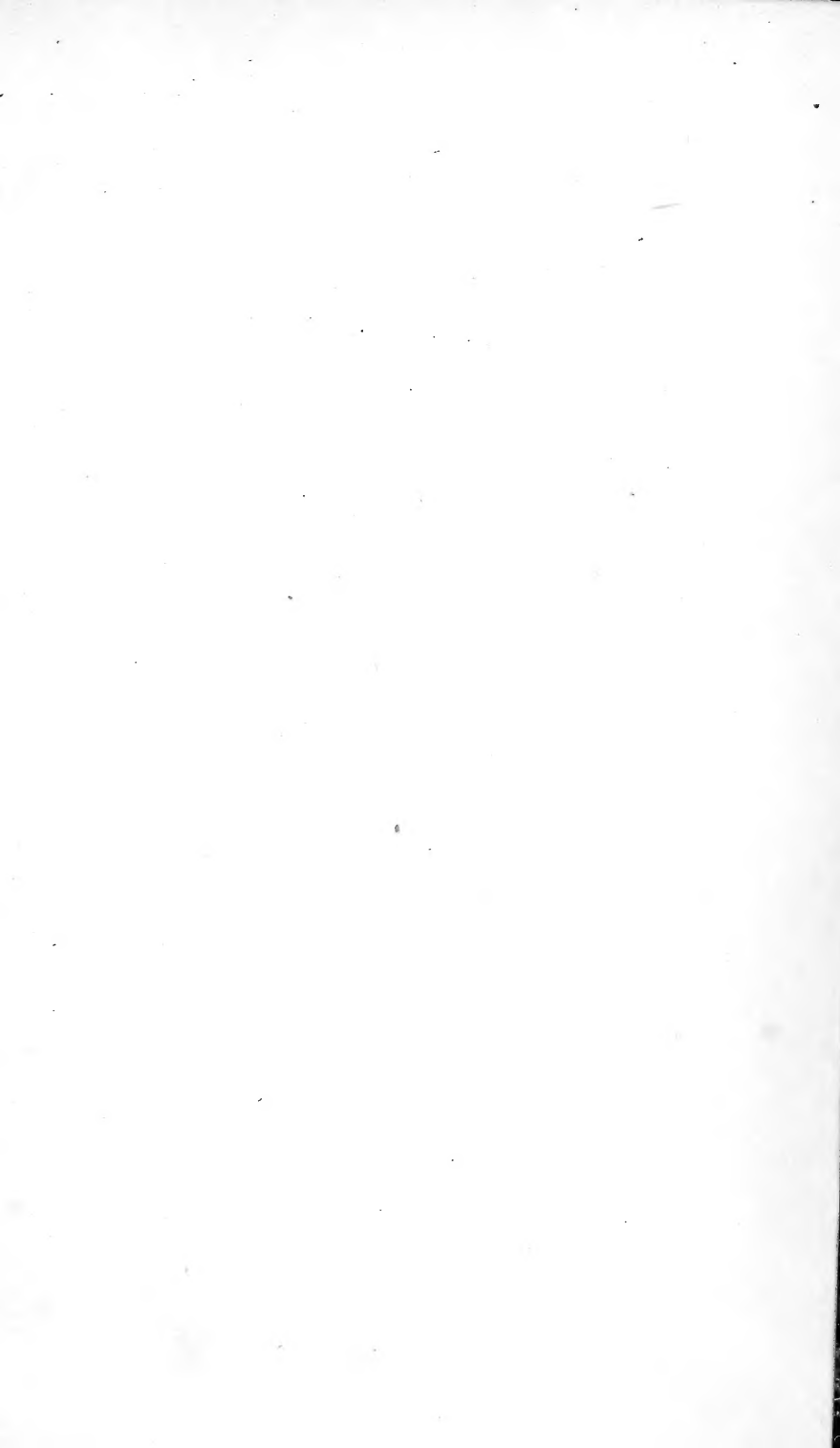

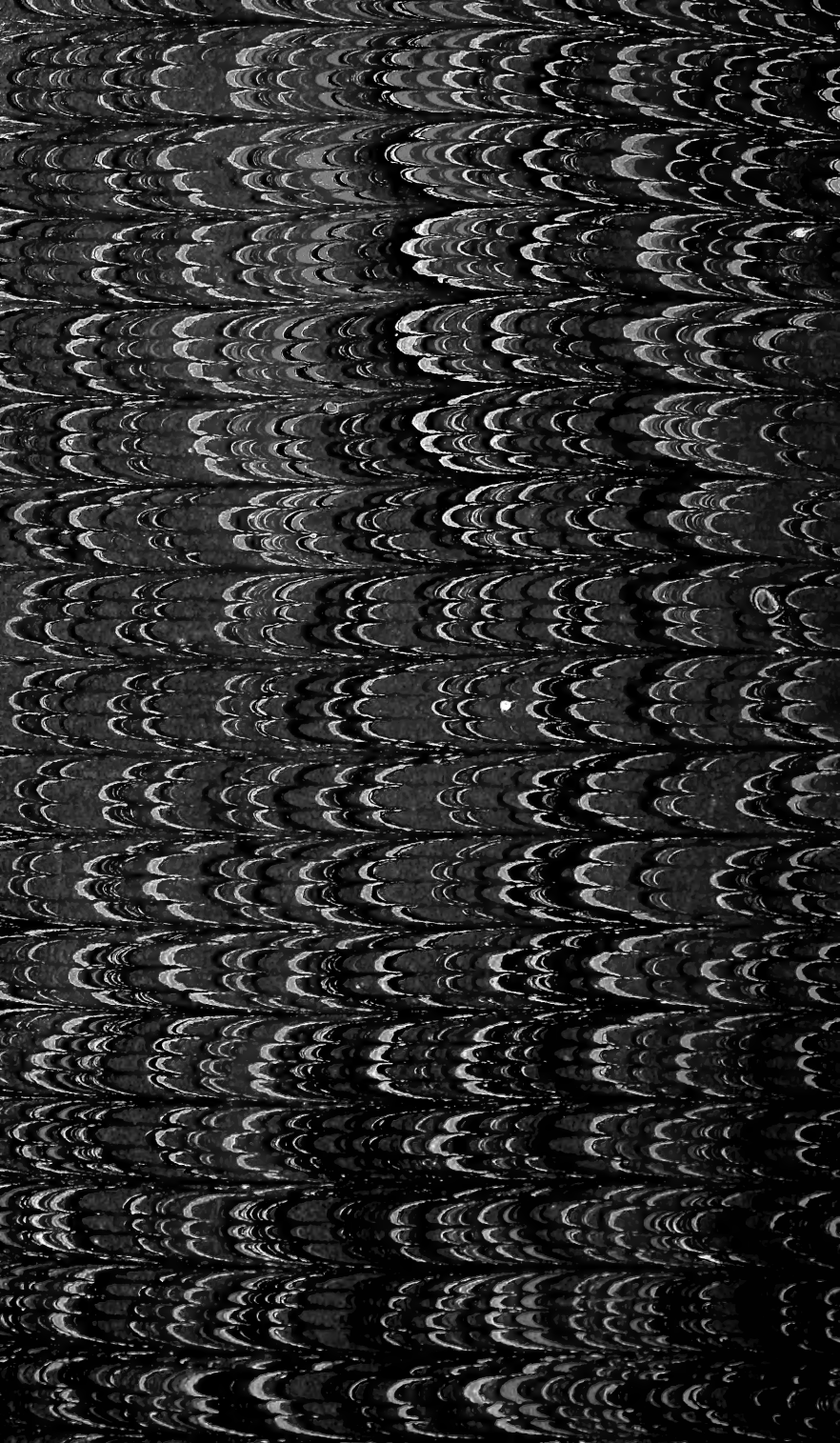



3 2044 106 188 923

MUSEUM OF COMPARATIVE ZOOLOGY.

WHITNEY LIBRARY,



HARVARD UNIVERSITY.

