

INTRODUCTION TO

Genetics and
Cytogenetics

HERBERT PARKES RILEY



Marine Biological Laboratory Library

Woods Hole, Mass.



Presented by

ESTATE OF HARRY L. WEIMAN
October, 1964

MBL/WHOI

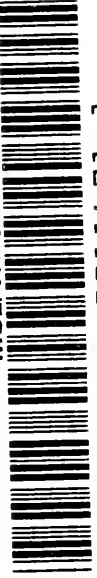

0 0301 0011671 1

INTRODUCTION TO
GENETICS AND CYTOGENETICS

I N T R O D U C T I O N T O

Genetics and Cytogenetics

BY HERBERT PARKES RILEY

Head, Department of Botany
University of Kentucky



JOHN WILEY & SONS, INC., NEW YORK
CHAPMAN & HALL, LIMITED, LONDON

P R E F A C E

In this book I have endeavored to state and to explain the basic principles of biological inheritance and to show the importance of those principles to man, to the improvement of plants and animals, and to organic evolution. I have attempted to present this material in a simple fashion so that any reader can grasp the fundamentals of heredity in spite of limited biological training. However, I have also included some of the data that support these principles so that the student who wishes can acquire an adequate background for further studies in heredity, and I have added a fairly extensive bibliography so that the more serious student will have a diversified list of some of the items of the research literature should he wish more information on a subject than a book of this size can offer.

Throughout this book I have stressed general principles rather than practical applications and have drawn my illustrations from both the Plant and the Animal Kingdoms. For the reader who is interested in human biology, references to inherited traits are numerous, and Chapters 3 and 19 should be of especial importance. The emphasis on principles and the variety of the illustrations should make this book of value to students of agriculture, psychology, and sociology. It should serve also as a foundation for advanced work in genetics and cytogenetics.

The book is readily divisible into four parts. The first five chapters provide a survey of general biological information which must be understood before progressing into the field of genetics itself. In Chapters 6 through 13 I discuss the fundamental principles of the transmission of genes. In discussing the method by which genes are distributed from generation to generation, I have used the cytological approach, describing chromosomes and their behavior at cell division and reproduction. Chapters 14 through 23 make up the third part of the book. They deal with the nature and physiology of genes and also include some topics of practical and of general interest.

Chapters 24 through 30, the fourth and last part of the book, deal with what are frequently called "chromosomal aberrations." If we accept an ideal concept of chromosomal behavior during cell division and reproduction and if we accept the $2n$ number as the ideal number of chromosomes in the animal soma or in the plant sporophyte and the n number as ideal in the plant gametophyte, any departure from these ideal conditions represents an aberration. The various types of aberrations are described in this section, and their bearing on problems of evolution is discussed. This material is often called "cytogenetics," although any correlation at all between genetic data and cytological observations should properly bear this designation.

Throughout I have tried to avoid being dogmatic on all or most controversial issues. Sometimes I have attempted to present all the important theories concerned in the explanation of certain data without expressing any preference, and on some points where I have favored one theory I have presented other theories for the student to consider.

Because of its scope, I have had to restrict the bibliography somewhat. Many important papers have had to be omitted entirely and where an author had published a series of papers on the same subject, I have listed only a few. Although I did not adhere rigidly to any rule, I frequently listed the first paper of the series and the most recent. I usually, also, included papers that contained extensive bibliographies or summarized information and those that were especially outstanding for the theories or conclusions that they presented. Even though a paper was referred to in more than one chapter, I included it in the bibliography only once.

Several persons have read all or part of the manuscript, and to them I wish to express my deepest appreciation. However, I must emphasize that they are in no way responsible for any of the errors that may appear in the book. Professor George H. Shull of Princeton University has read and criticized the entire text in manuscript, and I am very grateful to him for many suggestions. I also wish to thank Professor P. W. Whiting of the University of Pennsylvania for his kindness in reading and criticizing the manuscript of parts of Chapters 16 and 29. Doctor Alexander Wiener of Brooklyn, New York, read the manuscript of most of Chapter 19 and made many suggestions

that I greatly appreciate. I am grateful also to Doctor Edgar Anderson of the Missouri Botanical Garden for reading the page proof and for an important suggestion.

Many of the diagrams and illustrations are original, but in any book of a general nature it is necessary to borrow from the published works of others. I am indebted to Professor R. A. Fisher, also to Messrs. Oliver and Boyd, Ltd., Edinburgh, for permission to reprint Table III from their book *Statistical Methods for Research Workers*. I also wish to express my appreciation to the University of Chicago Press for permission to use Figure 10, which had previously appeared in the *Botanical Gazette*, to the *American Naturalist* for permission to borrow Table 20, and to *Scientific Agriculture* for permission to reproduce Table 23. I wish also to express my sincerest thanks to all the numerous journals which gave me permission to use their material, to the many geneticists and cytologists who kindly lent me original drawings or cuts, and to those who gave me permission to redraw their published figures or to reproduce their data. Individual acknowledgments have been made in the legends of the figures or tables.

HERBERT PARKES RILEY

University of Kentucky
Lexington, Kentucky
November, 1947

CONTENTS

1	Genetics, Cells, and Chromosomes	1
2	Chromosomes and Genes	16
3	Genes and Characters	30
4	Reproduction and Meiosis	47
5	Special Chromosomes and Sex Inheritance	68
6	The Genetic Distribution of a Pair of Alleles Located in Autosomes	80
7	The Genetic Distribution of Genes in the X and Y Chromosomes	95
8	Probability	108
9	The Distribution of Two or More Pairs of Alleles in Two or More Chromosomes	124
10	The Genetic Distribution of Two Pairs of Genes on One Pair of Chromosomes	147
11	Locating Genes on Chromosomes	171
12	Chromosome Maps	186
13	Miscellaneous Linkage Topics	202
14	The Nature of and Changes in Genes	219
15	The Nature of Gene Mutations	230
16	The Induction of Gene Mutations	243
17	Radiation, Evolution, and the Position Effect	263
18	Multiple Alleles	271

19	Blood Groups	282
20	Gene Action	301
21	Interaction of Genes	320
22	Quantitative Characters	342
23	Inbreeding, Selection, and Heterosis	367
24	Intrachromosomal Aberrations	390
25	Aneuploids and Nondisjunction	414
26	Haploids and Autopolyploids	433
27	Allopolyploids	456
28	The Origin of Polyploids	470
29	The Determination of Sex	480
30	Cytogenetics and Evolution	516
	General References	545
	Specific References	547
	Author Index	571
	Subject Index	577

Chapter 1

GENETICS, CELLS, AND CHROMOSOMES

Genetics is one of the numerous branches of the biological sciences. It attempts to discover the laws which determine why certain individuals related by descent resemble one another or why they differ from one another. It is the science of heredity and it attempts to discover how and why certain resemblances "run in families" and why many differences are also found among members of the same family. It is one of the biological sciences for it includes both plants and animals in its investigations, and, especially in its more recent aspects, it borders upon physics and chemistry. It is, furthermore, a relatively new science, not established on a scientific basis before 1900.

The science of genetics is intimately related to another biological science, *cytology*. Cytology is a study of those minute living units, the cells, of which plants and animals are constructed. Among the many structures found in cells are certain bodies, the *chromosomes*, which have been shown to be of the greatest importance to students of genetics because in them are located the hereditary units. In other words, the physical basis for the laws of heredity is to be found in the chromosomes; therefore, a knowledge of cytology or at least of chromosomal cytology is absolutely necessary for an understanding of the principles of the science of genetics.

The intimate relationship between the sciences of genetics and cytology was not realized during their early development. However, as more information became available in both fields of knowledge, a striking parallelism became evident which soon suggested that they were in reality not two separate studies but merely two phases of one. Further experiments only served to corroborate this unity until it became evident that the close relationship between genetics and cytology was incontrovertible.

During the earlier years of scientific investigations into the field of heredity, data were obtained by methods that are con-

sidered purely genetical. When the physical basis of genetic phenomena was realized numerous studies were undertaken using the methods of both genetics and cytology and correlating data obtained by genetic procedures with observations determined by cytological techniques. This dual approach to the problems of heredity has given us the term *cytogenetics*, a term which emphasizes the correlation of information obtained by the two diverse techniques. Many of the methods of cytogenetics make use of chromosomal aberrations, for it is by an intense study of exceptional chromosomal behavior that we obtain our best information in regard to the normal conditions. Although cytogenetics is frequently concerned with aberrations, the term is a broad one and includes all situations in which data from cytology and genetics are studied with reference to each other.

A study of the chromosomes and of their behavior in related species and genera has sometimes aided in a better understanding of the evolutionary relationships of taxonomic groups. Many difficult problems of classification and of relationships have been clarified in whole or in part by supplementing taxonomic studies with those of chromosomal cytology. A study of phylogenetic relationships by the methods of both systematic botany or zoology and chromosomal cytology is sometimes called *cytotaxonomy*.

Resting Cells

As part of the biological background for a study of heredity we must realize that all living organisms are composed of minute structures called *cells*. In the higher animals and plants the body is made up of many cells which may differ greatly in both shape and function.

When a cell is not dividing, it is usually referred to as a *resting* or, more properly, a *metabolic cell*, and it is in this condition that most of the cells of both plants and animals are to be found.

The living part of all cells, whether in the resting stage or dividing, is a very complicated mixture of a number of different chemical substances, known as *protoplasm*. Under the microscope, protoplasm, while alive, appears as a colorless, optically homogeneous fluid containing granules, crystals, and droplets; but, when killed, fixed, and stained, it appears to have a finely

granular nature. In the living condition protoplasm is generally considered to be an emulsion type of colloid consisting of a watery background in which are many tiny globules of an immiscible substance, giving it the appearance of milk that has been shaken up. In the watery part may be suspended many extremely small particles or granules, which may be arranged so as to form an interlacing network. In the liquid part also are various dissolved substances such as salts and sugars. Although protoplasm is generally fluid and has a specific gravity only slightly higher than water, it may sometimes be firmer in consistency than water and more like a jelly.

Protoplasm in all typical living cells can be differentiated into two parts, the *cytoplasm* and the frequently more jelly-like *nucleus*. The outer region of the cytoplasm is firm and membranous and forms the *plasma membrane*. This is of great importance physiologically as it permits some substances to enter and leave the cell and prevents others from doing so. In most plant cells a *cell wall* surrounds the plasma membrane, but this structure is not concerned with the passage of materials into and out of the cell. In young plant cells this wall may be very thin, but in most older cells a thicker secondary wall is also present. In some types of specialized cell this secondary wall becomes very thick.

In the embryonic plant cell (Fig. 1), the space inside the cell wall is occupied by protoplasm. When the cell is not dividing, the nucleus, usually centrally located, is a round or ellipsoidal mass of protoplasm separated from the cytoplasm by the *nuclear membrane*, a barrier that may separate nuclear and cytoplasmic material. In the mature, unspecialized type of plant cell known as a parenchyma cell, a large *vacuole* is present in the center of the cell and the cytoplasm is mostly restricted to the periphery. In the cytoplasm may be found living structures, such as the *plastids* and *chondriosomes* or *mitochondria*, and many non-living substances, including starch grains, protein granules, droplets of fat or oil, and various crystals.

In a typical animal cell there is no large central vacuole, and in the cytoplasm are chondriosomes and secreted granules, but no plastids. Lying in the cytoplasm to one side of the nucleus is the centrosome, a structure intimately connected with cell

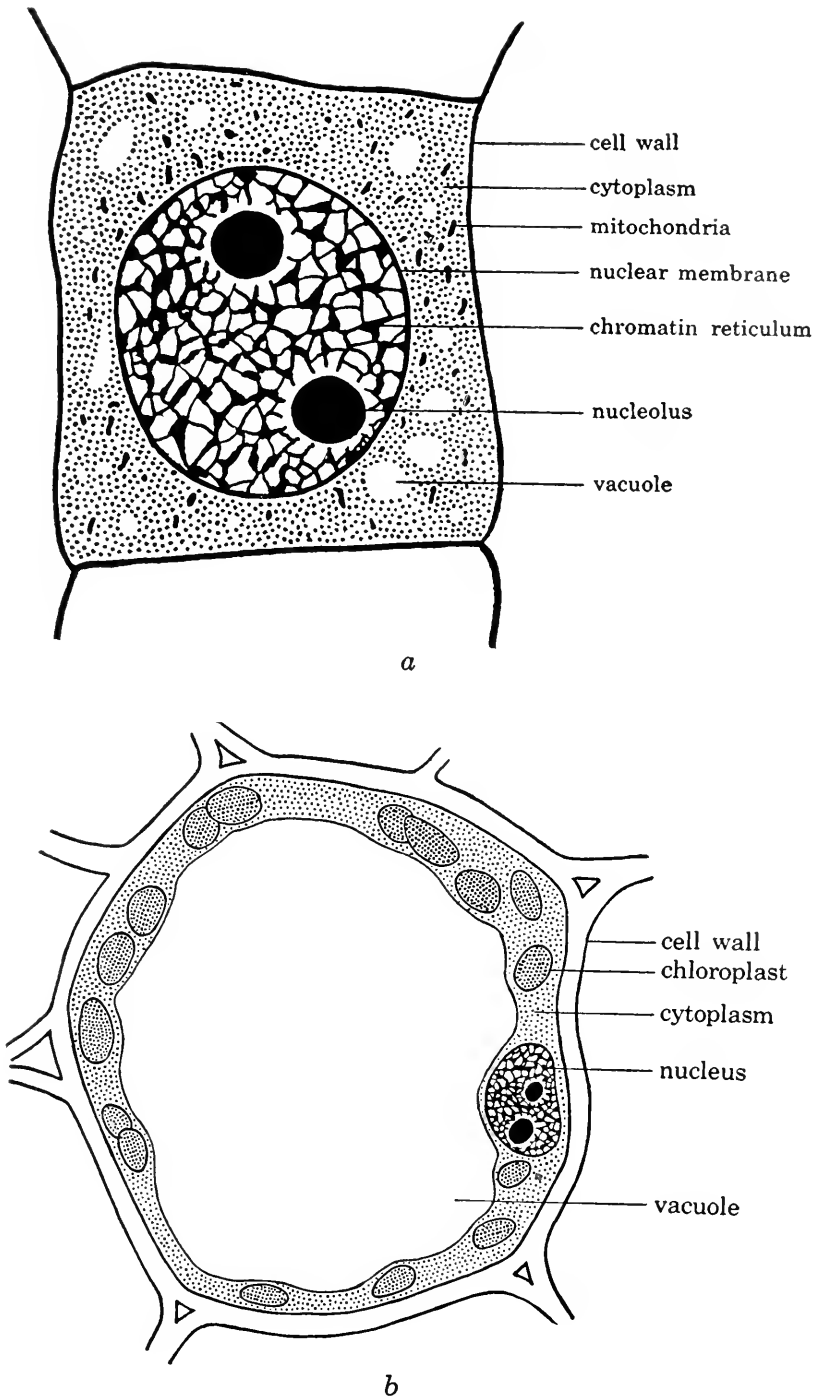

FIG. 1. Plant cells. (a) An embryonic cell from the root tip of an onion. $\times 2800$. (b) A parenchyma cell from the mesophyll of a leaf of English ivy. $\times 1400$. Camera lucida drawings.

division. This structure, characteristic of animal cells, is also found in some of the lower plants. The centrosome consists of a minute granule, the *centriole*, surrounded by a small mass of protoplasm, the centrosphere; the protoplasm of the centrosphere is often denser than the surrounding cytoplasm. During some stages of division, star-like radiations extend outward from the centrosome into the cytoplasm, forming the *aster*.

Another structure characteristic of animal cells is the *Golgi apparatus*. It is found in the cytoplasm and frequently appears to be a system of connecting canals, but it may sometimes have a more dispersed aspect. Its function is unknown and, although it is characteristic of animal cells, it may, according to some botanists, also be present in some plant cells. No cellulose wall is present in animal cells.

Resting Nucleus

For a geneticist, the most important part of a cell is the nucleus, because in the nucleus are found the genes which determine the characteristics of the organism.

The nucleus is separated from the cytoplasm by a definite membrane, the *nuclear membrane*. The reality of this structure has been shown by microdissection studies. There is good evidence that this membrane is differentially permeable, as is the plasma membrane. If so, the substances to which it is impermeable may be very different from those which will not pass through the plasma membrane.

The structures inside the nuclear membrane are not easily observed in the living condition. Living nuclei generally appear clear and homogeneous, but sometimes seem to consist of many fine granules. Discerning definite structures in the nucleus is difficult because, while alive, most of the structures of a cell are colorless and have almost the same indices of refraction. Also the threads which we know to be present in the resting nucleus are extremely fine and attenuated and are, therefore, more difficult to see than during division stages, when they are many times thicker.

The structures of the nucleus are best observed if the cell is killed, fixed, and stained. By "fixing" is meant treating the cell with certain chemicals that not only kill it but also preserve the cell structures in a condition resembling a living cell. A cell

treated in this manner is readily stained by certain dyes, some of which stain one part of the cell and not others. The parts so stained stand out in marked contrast to the rest of the cell, and their structure is much more easily observed than it is in the living condition.

In the resting nucleus is always found the *karyolymph* or *nuclear sap*, a clear fluid consisting mainly of proteins. In fixed and stained nuclei, the nuclear membrane is generally stained but the nuclear sap appears as an unstained or very lightly stained background inside the membrane. Superimposed on this background are the *chromatin reticulum* and one or more *nucleoli*, both generally stained very deeply.

In fixed and stained slides, the chromatin reticulum has the appearance of a network and is composed of numerous very long and extremely thin threads, in loose coils. These threads are the *chromonemata*. When the cell divides another substance, the *matrix*, condenses on these threads and the chromonemata and matrix together form the *chromosomes*, the most important nuclear structures for the geneticist as they contain the genes.

In the resting nucleus, the chromosomes are individually not distinguishable, but they become identifiable as the cell divides. During cell division it is clear that they exist in definite numbers which are the same not only for all the cells of a given plant or animal, excluding certain reproductive cells, but also, with certain exceptions, for all the individuals of the same species. For example, all the *somatic* (that is, body or nonreproductive) cells of the fruit fly, *Drosophila melanogaster*, normally have 8 chromosomes, whereas those of man have 48. Similarly, cells of all normal maize plants have 20 somatic chromosomes, cells of the garden pea have 14, and those of the onion have 16.

Division of Plant Cells

All cells come from preexisting cells by division. The term *cell division* includes the division of both the nucleus and the cytoplasm, either of which may divide even if the division of the other does not occur. The division of the nucleus is called *mitosis* or *karyokinesis* and the division of the cytoplasm *cytokinesis*, but the use of *mitosis* for the entire process is not unknown. It is customary to divide mitosis into four or five steps which mark definite turning points in the process. Accordingly,

these five steps are frequently recognized: prophase, prometaphase, metaphase, anaphase, and telophase.

Prophase. During the resting or metabolic stage, the chromosomes are so long and thin and so intertwined that they cannot be counted, and there is evidence that each is a single thread until the cell is about to begin to divide (Fig. 2). With the beginning of mitosis, however, a series of profound changes in the nature of the nucleus is begun. There are a shortening and thickening of the chromosomes and a probable loss of water and increase in staining capacity of the individual threads, and if the chromosomes in the resting nucleus are connected by branches or anastomoses, as is frequently believed, these anastomoses are withdrawn at this time. As the result of these changes the individual chromosomes are more readily seen than in the resting nucleus and are no longer joined together in a reticulum. One marked feature of the chromosomes in early prophase is that they are *double* rather than single threads. They appear as two long threads lying parallel and close to one another, each of which contains a specialized region known as the *centromere*, *kinetochore*, or *spindle fiber attachment point*. In early prophase, the chromosomes are still long and slender and still wind about in a number of loose coils.

As prophase progresses, the chromonemata uncoil and become thicker. The matrix begins to condense on the threads, and the chromosomes at this stage frequently have a fuzzy outline as the result of the irregular accumulation of this deeply staining matrical material along the length of the chromosome.

The two threads that constitute the prophase chromosome are the *chromatids*, each consisting of a chromonema and matrix. The two chromatids are generally visibly uniform throughout except for the centromeres, and the parts on either side of the centromeres are called the *arms*. The region of the arm nearest the centromere is the *proximal region*; the part farthest away is the *distal region*. As prophase progresses, the matrix continues to collect around the chromatids until each chromatid is now a long, rod-like body lying next to its sister chromatid and apparently identical with it in every way. The two centromeres lie side by side and in close contact. As these changes occur in the chromosomes, the nucleolus or nucleoli get smaller and smaller and at about the end of prophase have usually com-

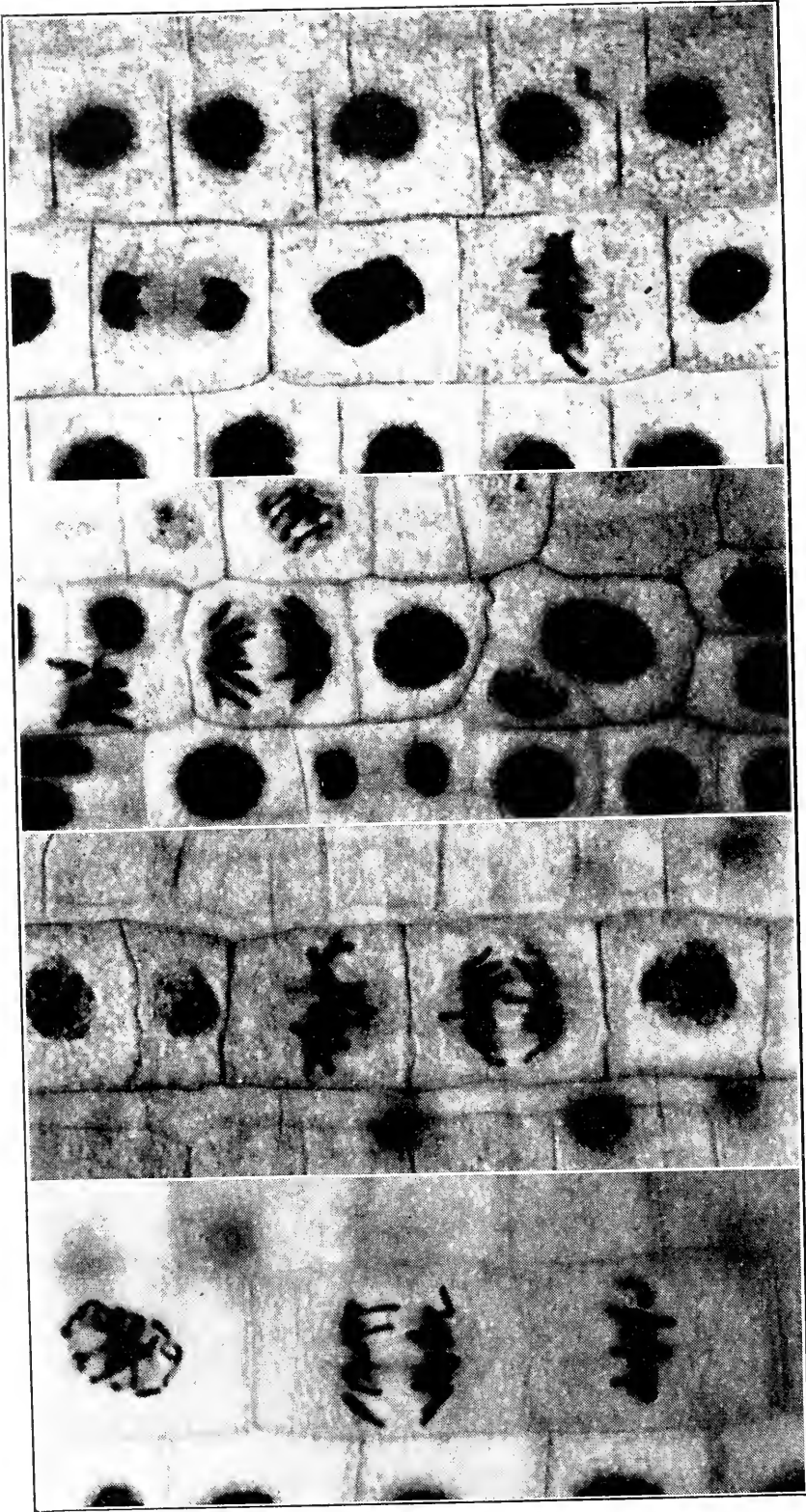

FIG. 2. Photomicrographs of mitosis in onion root tips. *Left*, a typical prophase above, an anaphase in center. *Left center*, typical metaphase in center, anaphase below. *Right center*, late anaphase above. *Right*, early telophase above, metaphase below. (Courtesy Carolina Biological Supply Co.)

pletely disappeared. Towards the end of prophase, the chromosomes have become much shorter and thicker and stain much more deeply than in the earlier stages. They also tend to move towards the outer part of the nucleus. At this time the nuclear membrane dissolves, and with the disappearance of this boundary between the nuclear sap and the cytoplasm, prophase comes to an end.

Prometaphase. When the nuclear membrane disappears, the nuclear sap and cytoplasm are brought into direct contact, and the cytoplasm appears to act upon the nuclear sap so as to cause it to form into a long, spindle-shaped structure known as the *spindle*. In living cells, this structure is not easy to see, but in many fixed and stained cells it appears as a number of fine lines converging to two points. Earlier cytologists believed these lines to be fibers and regarded the spindle as composed of a number of such fibers, which were fairly widely separated in the center of the spindle but converged at the ends. This may be the correct interpretation, but the microdissection studies of Chambers have tended to show that these so-called fibers are not solid.

Whatever is the correct nature of the spindle, it is a firmer, more rigid structure than the cytoplasm in which it is embedded. If the living cells are detached from one another and mounted on a slide, the spindle is crushed only with difficulty, and the cells generally lie so that the spindle is parallel rather than perpendicular to the surface of the slide. The spindle is of great importance in cell division and, if it fails to function properly, mitosis will be abnormal.

The spindle tapers at each end and may or may not come to a sharp point. The ends are called the poles, and the region equidistant between them, the equator. When the spindle has formed, the chromosomes released by the breakdown of the nuclear membrane move towards the equator.

Metaphase. At metaphase, the chromosomes are seen to lie on the equator of the spindle. They frequently arrange themselves so that they lie on the outer part of the spindle with only the centromeres on the equator but sometimes, especially when they are small and numerous, the chromosomes are found in the center as well as in the outer region of the spindle (Fig. 3). The centromeres always lie on the equator, forming an *equatorial*

plate, and the arms often extend away from the equator and may frequently project into the cytoplasm.

The metaphase chromosomes are thick, deeply staining structures. They frequently appear as rod-shaped, V-shaped, or J-shaped bodies, and their particular appearance depends upon the location of the centromere. If it is at the end (*terminal attach-*

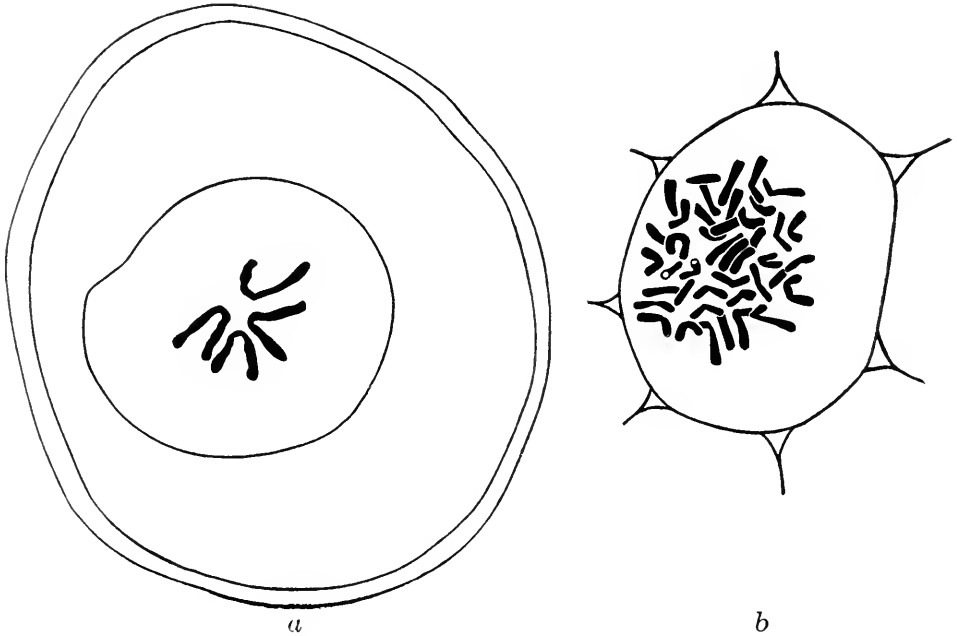

FIG. 3. Polar views of metaphase. (a) In the egg of the animal, *Ascaris megalcephala*; $\times 775$. (b) In cells of the root tip of *Iris fulva*; $\times 1500$. Camera lucida drawings.

ment) the chromosome will appear rod-shaped; if it is at or very near the center (*median or submedian attachment*) it is V-shaped; and if it is near but not at the end (*subterminal attachment*) it has the shape of the letter J. The centromere appears in the metaphase chromosome as a constriction. In addition to the centromere, secondary constrictions may be present near the end and may be very long and deep, so that the end of the chromosome appears as a little knob, called a *satellite* or *trabant*. The function of these secondary constrictions is not well known, but on some chromosomes they are regions at which the chromosome is attached to the nucleolus during the resting stage and from which the nucleolus begins to form at telophase. Each metaphase chromosome still consists of two chromatids but they are very close to one another

and may be twisted about one another. They may be so close together that the separation is not visible except at the end, and the chromosome may appear as a single structure forked at the ends.

It is at metaphase that the form of the individual chromosomes is most easily seen. In some plants, as the onion, all the chromosomes are practically alike in size and shape, but in many other plants this is not so. In plants in which the chromosomes are not all alike, however, every chromosome is never different from every other one, for there are always two of each type. Thus they are always in pairs, and the two members of any pair are called *homologues* or *homologous chromosomes*. The chromosomes occur in pairs because one member of each pair has been received from the male parent and the other member from the female parent, and these two chromosomes are identical as far as visual means can detect. In the onion, for example, where all chromosomes look alike, pairs still are present but are not readily detectable because of the general morphological similarity of all the chromosomes. The onion has 16 chromosomes, but, since the chromosomes occur in pairs, it is equally accurate to say that the onion has 8 pairs. This method of designation is frequently used. Similarly, maize has 20 chromosomes or 10 pairs, rye has 14 chromosomes or 7 pairs, and cabbage has 18 chromosomes or 9 pairs.

In general, we may say that a plant has n pairs of chromosomes, or $2n$ chromosomes, where n is a specific number, such as 10 for maize and 7 for some wheat species. In mitosis in most organisms, all the chromosomes are spread out at random on the equatorial plate. Even though the chromosomes exist in pairs, any one chromosome can ordinarily lie next to any other, and there is absolutely no tendency for the two members of a pair to lie near one another. This is a general rule, although there are some outstanding exceptions.

Anaphase. After the chromosomes have become arranged on the equator, the two chromatids of each chromosome move apart from one another, each going towards its nearest pole. How this movement is brought about is still a puzzle, but possibly it is initiated by a repulsion of perhaps an electrical nature between the two centromeres. The centromeres are the active force in the separation of the daughter chromosomes, and the arms are

dragged along passively by the centromeres. After the chromatids have begun to pull apart, they are referred to as *daughter chromosomes*.

Anaphase begins as soon as the centromeres begin to move to the poles and ends when all the centromeres have arrived at the poles. Although the initial movement is probably always due to the repulsion of the centromeres, the final movement is sometimes accomplished by an elongation of the central part of the spindle after the two groups of daughter chromosomes have progressed part of the way towards the poles.

Telophase. As soon as the two groups of chromosomes, with the centromeres in advance, have arrived close to the poles, a nuclear membrane begins to form around each group and finally completely encloses it. At this stage, the cell has two new nuclei, but the remains of the spindle still persist between them. At the equator, each spindle "fiber" begins to liquefy, and finally a thin fluid area is found extending completely across the cell. This plate cuts the cell into two complete halves, and where the cytoplasm comes in contact with this liquid plate, a plasma membrane is formed. The cytoplasm is now divided into two parts, and each part has a new nucleus.

The changes in the nucleus during telophase are practically the reverse of those during prophase. After the nuclear membranes have formed around the groups of daughter chromosomes, the chromosomes themselves become extremely long and thin, and are consequently less deeply stained. Part of this process is due to a loss of the matrix which had collected during prophase around the threads. The nucleolus or nucleoli reappear and become large as telophase progresses. After these changes are concluded, each new daughter nucleus resembles the resting nucleus of the original cell.

Significance of Mitosis

If the plant we were studying was the onion, there were 16 chromosomes in the resting stage of the cell before division. At prophase, each chromosome consisted of 2 chromatids so that there were 32 chromatids. As anaphase separation took place, the 2 chromatids of each chromosome became new chromosomes so that, during anaphase, there were 32 chromosomes, 16 of which went to each daughter cell. Therefore, each new cell has

16 chromosomes, or the same number as the parental cell. As the result of this mechanism, each cell of the body has the same number of chromosomes. These body cells, as distinguished from the reproductive cells, are called *somatic* cells, and ordinary mitosis of body cells is frequently called *somatic mitosis* to distinguish it from the type of mitosis which forms reproductive cells and which will be described in a later chapter.

Mitosis in Animals

Mitosis in the onion root tip is frequently studied in both botanical and zoological courses. It is typical of higher plants and is fundamentally the same as in the higher animals, although

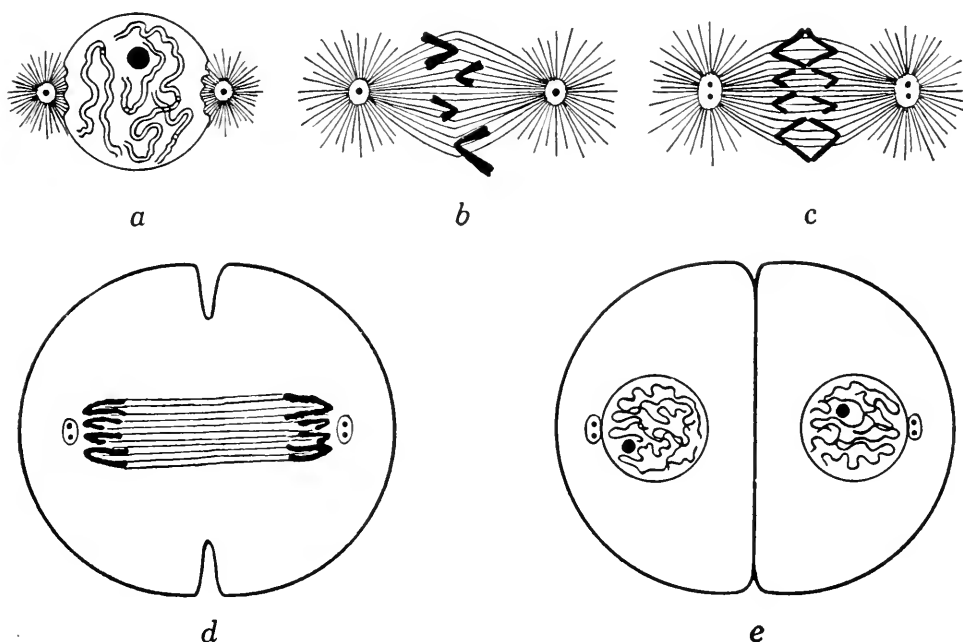

FIG. 4. Mitosis in an animal cell: (a) prophase; (b) metaphase; (c) early anaphase; (d) late anaphase; (e) late telophase. Diagrammatic.

there are some differences in animal cells that should be considered. The chief difference between the two groups of organisms lies in the formation of the spindle, which arises in animal cells from two centrosomes (Fig. 4).

Chromonemata

Only an indication so far has been given of the internal structure of the chromosome. When stained with hematoxylin,

no structure is generally visible inside the metaphase or anaphase chromosome. If, however, the cells are pretreated before fixation with weak ammonia, hot water, or several other agents, and stained with crystal violet, each chromatid is seen to consist of a thin, coiled thread, the *chromonema* (Fig. 5), or *gene string*, surrounded by a wide matrix.

Although some visual evidence seems to indicate that the chromonemata become double during late prophase or early meta-



FIG. 5. Coiled chromonemata in *Trillium*. (a) Anaphase. (b) Late diakinesis showing five pairs of chromosomes, each with its four chromatids. (c) Diakinesis, showing two unpaired chromosomes; two pairs of chromosomes are at the top and one pair is at the right side; at the bottom are the paired E chromosomes, each of whose arms is as long as most of the other pairs. (Photomicrographs courtesy of Dr. C. L. Huskins.)

phase one cell division before that at which the halves separate to opposite poles, the chromosomes, when subjected to bombardment by X-rays, usually behave as a single structure at metaphase, anaphase, and telophase and in the resting stage and do not behave as a double structure until early prophase or just before prophase. Apparently the reason for this is that at metaphase and anaphase, the chromosome as a whole is single even though the chromonema inside may be double, and it is the whole chromosome that reacts to the X-rays.

The process by which a new chromonema forms from an old one is not adequately known, but there is some evidence that each constituent part of a chromonema, the gene, regenerates another identical with and alongside itself. These new genes then become joined up, and a duplicate of the original chromonema is formed.

At metaphase and anaphase, the chromonemata are tightly coiled within a retaining matrix. When the matrix disappears at telophase, the chromonemata are free to stretch out through the cell, which they do; but apparently they never stretch out to their fullest extent and retain some of their coiled nature. Thus the loose coils in which the chromosomes at early prophase are arranged are the relics of the tight coils of the previous metaphase and anaphase. These prophase coils are called *relic coils*.

Chapter 2

CHROMOSOMES AND GENES

As usually observed, chromosomes appear as thick, homogeneous bodies during metaphase and anaphase, and as long, thin threads at prophase. The prophase threads do not visually show any differentiations except for the centromeres and numerous granules, or *chromomeres*, which are most noticeable during the prophase of the first of the two divisions that form spores in most plants and germ cells in animals. Although a chromosome shows little differentiation visually, it consists of a large number of submicroscopic structures, or *genes*, spaced along the thread in a linear order but not an equal distance apart from one another. The chromonema is a series of such genes separated by inert regions and has therefore been referred to as a *gene string*. These genes, or *factors* as they are sometimes called, are too small to be observed with the photomicroscope, but they are regions of great physiological activity. Exerting their effect during development and in conjunction with one another and with the environment, the genes determine the various physical and mental characteristics which make up the mature plant or animal. It is very difficult to obtain a reasonably accurate estimate of the size of a gene, but it has been suggested that it is about the size of some viruses and that its maximum dimensions are roughly about $100 \times 20 \times 20 \text{ m}\mu$.*

The number of genes in a plant or animal is apparently large. Not many organisms have been studied intensively but in *Drosophila melanogaster*, over 500 genes have been discovered, and in *Zea mays*, about 400. These are by no means the total numbers of genes in these organisms but only the numbers found and identified; they are probably only small fractions of the total numbers. Muller has estimated that at least 1150 genes are

* One μ , or micron, is one one-thousandth of a millimeter. A $\text{m}\mu$ is a millimicron and is one one-thousandth of a micron.

present in *Drosophila melanogaster*, and Waddington places the figure for this fruit fly and also for lilies at possibly about 10,000.

Alleles

It was pointed out in Chapter 1 that the chromosomes are always found in pairs in typical organisms. Since each chromosome always has an identical mate or homologue, the genes must

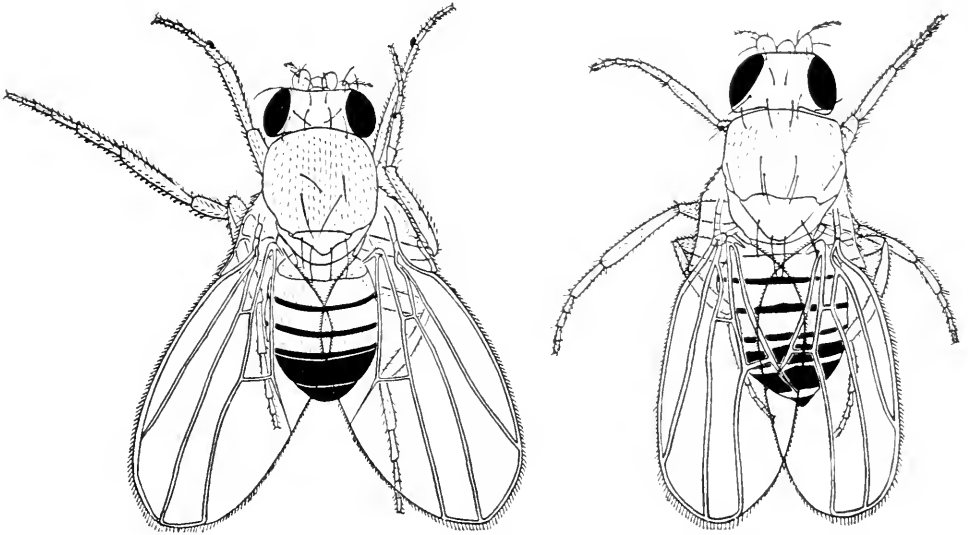

FIG. 6. Male (left) and female of wild type of *Drosophila melanogaster*. Note the sex combs on the legs of the male. $\times 19$. Camera lucida drawings.

also always be found in pairs. For example, in the long, V-shaped chromosome of *Drosophila melanogaster*, known as chromosome II, a gene about one-third of the distance from one end affects the shape and size of the fly's wing. Since every normal fly of that species has two of those chromosomes, every normal fly must have two of those genes that affect the wing. In other words, on *each* homologous chromosome there is a gene at a particular place or *locus* that always affects the wing. However, the genes at that locus on the two homologues do not always affect the wing in the *same manner* in all flies of that species. In most flies, the two genes will be alike, and each will act to produce a normal, or *wild-type*, wing in the adult (Fig. 6). Adult flies possessing those two genes will have normal wings. There are other flies, however, in which the two genes

at that same place in chromosome II will act differently on the developing wing of the fly and will produce in the adult not normal or wild-type wings, but very small, *vestigial* wings (Fig. 7). Flies with these tiny, undeveloped wings cannot fly but can only crawl about like ants. Obviously, such vestigial-winged flies would be at a great disadvantage in nature and would probably not survive in competition with their wild-type relatives. They have been found in laboratory stocks and have been pre-

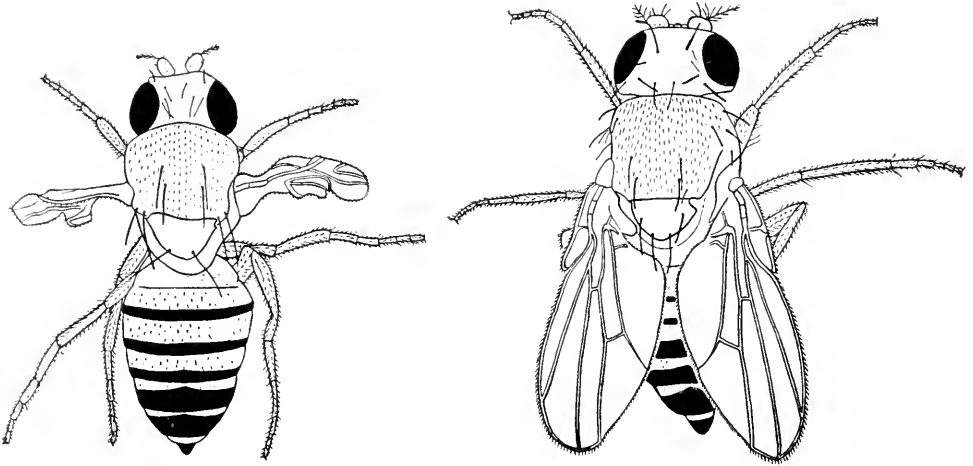

FIG. 7. Mutant wing types of *Drosophila melanogaster*. *Left*, vestigial wings. *Right*, miniature wings. Both are female. $\times 18$. Camera lucida drawings.

served for many generations in an environment free from competition and in which they do not have to travel great distances in search of food.

The important thing to note is that the genes at that particular locus of the second chromosome always affect the wing, even though the effect produced is not always the same. The gene that produces a normal wing and the gene for vestigial wing cannot, therefore, be so very different. They must be much more alike than either one would be like the gene that produces white eyes or the gene that produces yellow body color or the gene that produces forked bristles, hairless body, or purple-colored eyes. They are very similar, although not identical, not so much because they affect the same part of the body as because they are at the same *locus*. In a sense, then, they are merely variants of the same gene, and not two distinctly different genes. The

“vestigial gene” can be considered just a *different form* of the “normal-wing gene” which is present at that locus and vice versa. Two genes at the same locus but producing somewhat different effects on the developing individual are called allelomorphs or, more usually, *alleles*. Therefore, the vestigial gene is an allele of the gene for normal wings which is at the same locus.

Flies with two normal-wing genes have normal wings and those with two genes for vestigial wings will have vestigial wings. Every normal fly must have two members of chromosome II, but some may have one chromosome with a gene for normal wings and the other with a gene for vestigial wings. The question may well be asked whether the wings of such flies will be normal, vestigial, intermediate, or something else. In this particular case, such an adult fly would have normal wings because it happens that the effect produced by the wild-type gene during the development of the fly completely overcomes the effect produced by the vestigial gene. Whenever one allele alone is expressed to the exclusion of the other, the allele whose effect is expressed is said to be *dominant* over the one whose effect is not expressed, known as a *recessive* gene.

An organism in which the two genes at one locus are identical is *homozygous* for that gene. Thus the vestigial-winged fly and the fly with the two genes for normal wing are homozygous. The normal-winged fly that has one dominant gene and also the recessive allele for vestigial wings is *heterozygous*. An individual in which the two genes at any one locus are different is heterozygous *for that pair of alleles*.

The two members of all pairs of alleles do not show this dominant-recessive relationship for some heterozygous individuals are intermediate in nature. Although it is usually true that the wild-type or “normal” gene is dominant over its allele, sometimes the “normal” gene is recessive to the “abnormal.” Thus in *Drosophila* the gene for bar eyes that produces an eye in which most of the facets are undeveloped is partially dominant over the normal, and the gene for hairless body is dominant over its allele that produces the wild-type or normal hairy condition. Such traits as normal wings, vestigial wings, bar eyes, and hairless bodies are frequently referred to as *characters*.

Heterozygous plants and animals show that all individuals that *look alike* are not necessarily *genetically alike*. Both the homozygous wild-type fly and the heterozygote have perfectly normal wings and are absolutely indistinguishable in appearance. It can be shown that they are different genetically, however, when they are used to produce subsequent generations. The vestigial-winged fly, on the other hand, must have two genes for vestigial wings because if it had even one of the dominant genes for normal wings it would have normal wings. It is possible, therefore, to identify flies that are homozygous recessives by examining their external appearance, or *phenotype*, and thus to know their genetic constitution, or *genotype*. *All individuals that are homozygous for a recessive gene are alike both phenotypically and genotypically* (with respect to that locus). All individuals that have a dominant gene are alike phenotypically but may be different genotypically for they may be either homozygous for the dominant allele or heterozygous.

Gene Symbols

It is rather cumbersome to write "the gene for vestigial wings" and "the gene for normal wings." The geneticist, like the mathematician and the chemist, substitutes symbols for such expressions, and with a little practice such symbols are readily grasped. The gene for vestigial wings has the symbol vg , and its allele for normal wings has the symbol Vg . The small v indicates that the gene is recessive, the large V indicates a dominant gene. It happens that the allele for the vestigial gene is the one present in flies gathered in from nature; and that this gene is the one found in such wild-type flies is indicated by research workers on *Drosophila* by modifying the symbol to read vg^+ or $+^{vg}$ or frequently by using merely a plus sign. In this book, however, the symbol Vg is generally used as it is less confusing to beginning students.

In choosing symbols to represent genes, it is helpful although not essential for the symbol to indicate the name and chief effect of the gene. The symbol vg cannot be mistaken for any gene other than vestigial, and the symbol Vg indicates clearly that this gene is the dominant allele of vestigial. However, when plants and animals were first studied genetically, symbols were assigned to genes arbitrarily. In Mendel's original paper, for

example, the genes *A* and *a* stand, respectively, for peas with round and with wrinkled seeds; *B* and *b* symbolize genes for yellow and green cotyledons; and *C* and *c* represent genes for gray-brown and white seed coats. In organisms in which over twenty-six pairs of alleles have been discovered, the alphabet is insufficient to symbolize all the genes. It was soon recognized that various combinations of letters were necessary to provide symbols for such large numbers of genes. Thus in *Drosophila melanogaster*, *v* stands for the vermilion-eye gene, *vg* for the gene for vestigial, and *ve* for the gene for veinlet. When this system was introduced, the second letter was written as a subscript, as v_g , V_g , v_e , and V_e , but the present system was adopted because it was easier to set in type.

Pleitropy

Since the genes *Vg* and *vg* determine the shape of the wing if all other genes that affect the wing are wild-type genes, it might be inferred that they have no effect except on the shape of the wing. This is not true for actually *one gene may affect many parts of the body*. Some parts are affected in a more striking manner than others, however, and a gene is usually named from the most striking effect that it produces. In *Drosophila melanogaster*, the gene *Delta* produces a delta-like expansion where the longitudinal vein of the wing joins the marginal vein; but it also produces smaller, rougher eyes, modifications of the bristles, and still other changes of an even less striking nature. It receives its name and symbol, *Dl*, however, from one of its most striking effects. Similarly the genes at the locus for white eye affect not only the color of the eye but also the shape and color of the spermatheca. Another rather curious case of *pleiotropy*, or the multiple effects of genes, is shown by the white- and red-eye genes. Flies with yellow bodies may have either red or white eyes. In the white-eyed flies, the gene for eye color affects the yellow pigment also, and affects it in such a way that it is easily extracted with alcohol.

Often cited as examples of pleiotropy are instances of pigment formation in plants where a certain gene may produce a red pigment in several organs such as flowers, stems, and leaves. Considering these as separate organs, one may be inclined to think of the gene as simultaneously producing red flowers, red

stems, and red leaves, and therefore as having several different effects. It is probably more correct to think of the gene as having one general effect, the production of pigment, and not several effects, for, after all, the plant is a unit and it is only the botanist who subdivides it into organs.

A very interesting situation that might readily be classed as pleiotropy if it were not sufficiently analyzed is the effect produced by the frizzle gene in poultry. This gene is an incom-

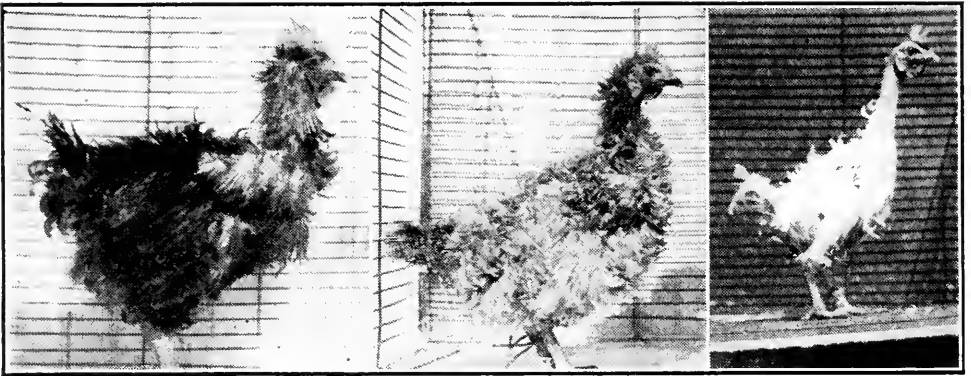

FIG. 8. Frizzle fowl. *Left*, a homozygous frizzle male. *Center*, homozygous frizzle female. *Right*, bare homozygous frizzle female. (Photographs courtesy of Dr. W. Landauer.)

pletely dominant gene. In fowl homozygous for frizzle (Fig. 8), the feathers are very abnormal, being narrow and curled and very fragile. They break off easily, so that after a while such birds are almost featherless. In heterozygotes the feathers are wavy rather than curly, and the whole frizzled effect is less pronounced.

The frizzled and fragile condition of the feathers is apparently the only direct effect of the frizzle gene, but fowl homozygous for this gene are very different from normal fowl in many other respects. When all or most of the feathers are broken off, their insulating effect is naturally lost, and such naked fowl lose their body heat much more rapidly than normal fowl. To compensate for this excess loss of heat, a number of adaptations take place in the bodies of the frizzle individuals. Their basal metabolism is strikingly accelerated, thus increasing the supply of hormones from the thyroid and adrenal glands. This increased hormone production severely taxes these glands and results in

changes in the glands themselves. The extent of these changes depends largely upon the temperature at which the birds are kept. If the temperature is as favorable as possible, the thyroid gland may increase in size but be otherwise normal; but if the conditions under which the fowl are kept are less favorable, the gland may be hypertrophied. If the birds are raised in a low temperature, the loss of heat is so great and there is such a drain upon the thyroid glands that they may become exhausted and atrophied.

As a consequence of heat loss, the oxygen consumption is increased by an increase in the rate of the heart beat, accompanied by hypertrophy of the heart and an increase in the volume of the circulating blood. The excess loss of body heat also calls for a greater amount of heat production by the fowl, partly accomplished by an increase in the amount of food they eat. The increased food intake produces an enlargement of the pancreas, crop, gizzard, and kidneys. Frizzle fowl, therefore, show changes not only in their feathers but also in the nature and size of a number of their organs. All these effects are brought about because of one gene, but the effect on the feathers is the only direct effect that that particular gene has. All the other effects are indirect, not caused by the gene, although they are the result of the presence of that gene; they therefore might easily be wrongly interpreted as an example of pleiotropy. Pleiotropy refers only to the production of more than one direct effect by a gene and does not include such cases of indirect effects.

Unit Characters and Gene Interaction

We have pointed out that flies with the gene Vg have normal wings whereas those that are homozygous for vg have vestigial wings. In the earlier days of the science of genetics many similar cases were observed in which one character appeared to be due to one gene only whereas a "contrasting character" was due only to the allele of that gene. The notion that a pair of contrasting characters was conditioned only by one pair of alleles led to the suggestion that an individual was made up of a large number of characters and that each one was the result of the action of one gene. Such monogenically conditioned characters were called *unit characters*, and an individual was thought to be a

mosaic of these unit characters. Such a position is a very extreme one and, for most characters, is undoubtedly unsound.

In chromosome I in *Drosophila melanogaster* there is another pair of allelic genes which affect the shape of the wing. Flies homozygous for the gene *m* have miniature wings (Fig. 7) much like the wild-type wing but considerably smaller. Wild-type flies have the gene *M* which is dominant over the gene for miniature wings. We had previously stated that wild-type flies had the *Vg* gene and now we say that they have the *M* gene. Is this inconsistent? Actually the statements that *Vg* produces a wild-type wing and that *M* produces a wild-type wing are erroneous although such statements are frequently made by people who understand the correct situation. The wild-type wing is not produced by *Vg* alone or by *M* alone but is the result of both genes acting together. In other words, the wild-type wing is not a unit character because it is not produced by only one gene. Similarly, the miniature wing is not the result of *m* alone but of *m* working in conjunction with *Vg*. Gene *Vg*, therefore, does not produce a normal wing; it merely produces a normal wing if *M* is present. Gene *vg*, likewise, produces a vestigial wing in the presence of *M* but produces a type known as vestigial-miniature if *m* is present. Practically, the last type is indistinguishable phenotypically from a vestigial.

The early notion of unit characters certainly cannot apply in this situation, but it is easy to see how it might have developed. If a geneticist has only wild-type and vestigial stocks of flies, he has flies which all have the *M* gene. Since his wild-type flies are *VgVgMM* genotypically and his vestigial flies are *vgvgMM*, the *M* gene is not important, and apparently wing shape is determined by *Vg* and *vg* alone. Unless he later obtained some miniature flies, the presence of gene *M* would never be detected and normal and vestigial wings would act simply as unit characters. If, now, another geneticist had only wild-type (*VgVgMM*) and miniature (*VgVgmm*) flies, the presence of *Vg* would never be revealed, and wing shape would appear to be conditioned only by the genes *M* and *m*. If these two geneticists then got together and traded their stocks, by making the appropriate crosses they would learn of the presence of both pairs of genes and would realize that wild-type, vestigial, and miniature

were not unit characters but were due to the interaction of two pairs of genes.

The situation is not even so simple as we have just pictured it. The wild-type wing is due not only to Vg and M but also to the alleles of the genes that produce cut wing, jammed wing, curved wing, plexus wing, curled wing, bent wing, and other wing variations. A partial formula for the wild-type wing, then, would be $CtCt MM jj VgVg CC PxPx CuCu BtBt$; a miniature fly would be $CtCt mm jj VgVg CC PxPx CuCu BtBt$; and a vestigial fly would be $CtCt MM jj vgvg CC PxPx CuCu BtBt$.

This example shows that the wild-type fly has a certain combination of genes. It shows further that the miniature fly differs from the wild-type in one certain pair whereas the vestigial differs from the wild-type with respect to a different pair. Ordinarily, in discussing miniature *versus* wild-type flies, we do not bother to write the full formula in either case but only the differential, which is M and m ; we merely understand and imply that the other genes are present and are alike in each case. When we say that a vestigial fly is $vgvg$ we recognize that these other genes are present but we omit them from the formula because they are the same in both the vestigial and wild-type flies. It is incorrect to say that Vg produces wild-type flies and vg produces vestigial, but it is permissible as a time and space saver provided we realize that a number of other genes which affect the wing are also present and that they are the same in each case.

This example of gene interaction is further interesting because it shows that the wild-type fly does not necessarily consist of all dominant genes. At the locus of jammed, the wild-type fly has the recessive gene, whereas the nonwild-type, jammed, is produced by the dominant allele. The wild-type fly has a certain combination of genes. Each other type has a somewhat different combination. Throughout the course of evolution, flies with the wild-type wing apparently were better adapted to their environment than the other types. Because of this evolutionary factor, a certain combination of genes is found much more frequently in nature than any other combination. We frequently think of this more frequent combination as the normal one because it is the one present in almost all the flies we gather in

from nature and because the shape of the wing it produces looks more efficient and more suitable than the wing of any other gene combination.

Gene interaction is by no means confined to wing shape in *Drosophila*. Eye color and other traits in this fly and many characters in many other plants and animals have proved to be the result of the interaction of many genes rather than of the action of one gene alone. In fact, so many examples of interaction have been discovered that one wonders whether there are any true cases of unit characters. Certainly, in the broad sense the unit character idea is philosophically untenable for the organism is a unit and not a mosaic of independent structures. Since all the parts of a body act together for the benefit of the body as a whole, it is difficult not to believe that all the genes must act together also. Although all genes probably affect all parts of the body at least slightly or in an indirect manner, some genes affect some parts more strongly than others. In a sense, probably all genes have multiple effects and probably all characters are influenced to some degree by a number of genes.

The Genome

It has been mentioned previously that *Drosophila melanogaster* has eight chromosomes, or two sets of four chromosomes in its somatic cells. In fact, this is a much more significant way of stating the chromosome number. Since each chromosome has a mate, each gene must have a mate (either a similar gene or an allele). Therefore, this fly also has two sets of genes. One set is located in one set of four chromosomes, and the other set of genes is located in the other four chromosomes. Since each set of four chromosomes with its set of genes is known as a *genome*, this particular species of fly has two genomes.

Similarly, in maize there is one set of ten chromosomes with its genes and another set of ten chromosomes which are morphologically identical with the first ten and have genes allelic to the genes of the first set. Like *Drosophila melanogaster*, this plant also has two genomes.

Many plants and most animals are similarly composed of two genomes, but in a number of plants and in some animals three, four, or more genomes have been found. Occasionally, also, an

organism has been produced which has only one genome, but such organisms are usually very weak and delicate. With a few exceptions, every locus must be represented at least once for the organism to survive. If a piece of a chromosome is missing, as may result from subjecting germ cells to X-rays, a deficiency results. If the deficiency is present in the same region of two homologous chromosomes, it is homozygous, and if the deficiency is in one chromosome but not in the homologue, it is heterozygous. Heterozygous deficiencies frequently have marked phenotypic effects which are sometimes mistaken for the results of gene action. Frequently organisms with heterozygous deficiencies are less viable than those with two complete genomes, and this is especially marked when the missing segment is a long one. When the deficiency is homozygous, the organism usually fails to survive past the egg stage. In a few cases, however, where the deficiency is very short, as in the yellow deficiency of *Drosophila*, the organism may occasionally reach the adult stage. From these deficiencies we can conclude that, with a very few exceptions, at least one member of every pair of genes must be present for an organism to develop normally and that in most organisms two complete genomes provide the best background for normal development. Plants with more than two genomes are discussed in later sections of this book.

Multiple Alleles

In normal diploid organisms, there are two genomes and *every locus is represented by two genes*. It has been shown, however, that the two genes at a given locus are not necessarily alike, for in heterozygotes one is an allele of the other; but in every heterozygote, there can be only two different alleles at any one locus.

Although any individual diploid plant or animal may have only two genes at any given locus, in many species three or more different alleles may be found at the same locus of a given chromosome distributed among the different individuals, with no individual having more than two. For example, in the common bean, some plants may be homozygous for G , a gene that determines yellow pods and green foliage, and others may be homozygous for the allele g , when they will have yellow pods and yellow foliage. Other plants may be Gg and will look like GG plants because G is completely dominant to g . However, in some

strains of beans, another gene, *Gr*, is found *at the same locus*. This gene produces plants with green pods and green foliage. At this locus, therefore, three alleles may be found, *but any one bean plant can have only two of the three*. More than two alleles at one locus are called *multiple alleles*, and series of multiple alleles are quite common among plants and animals. In beans, *Gr* is dominant over both *G* and *g*, and *G* is dominant over *g*. Any plant may be homozygous for any one of the three or heterozygous for any two. Thus these combinations will result:

	<i>GrGr</i>	<i>GrG</i>	<i>Grg</i>	<i>GG</i>	<i>Gg</i>	<i>gg</i>
Pods	green	green	green	yellow	yellow	yellow
Leaves	green	green	green	green	green	yellow

It is customary to differentiate most of the members of a series of multiple alleles by the addition of a superscript to the symbol of the recessive although this rule has not always been adhered to. Thus at the white locus in *Drosophila melanogaster*, in addition to the genes *w* (white) and *w⁺* or *W* (red or wild type), are found *w^w*, wine; *w^{co}*, coral; *w^{bb}*, blood; *w^c*, cherry; *w^a*, apricot; *w^e*, eosin; *wⁱ*, ivory; *w^b*, buff; *w^t*, tinged; and *w^{ec}*, ecru.

QUESTIONS AND PROBLEMS

1. In maize, the sugary gene *su* is recessive to its allele, the starchy gene *Su*. Would plants of these genotypes be sugary, starchy, neither, or both: *Susu*; *susu*; *SuSu*?

2. In four-o'clocks, gene *w* produces white flowers when homozygous and gene *W*, its allele, produces red flowers when homozygous. There is no dominance, and the heterozygote is pink. What would be the color of plants with these genotypes: *WW*, *ww*, *Ww*?

3. If you had a starchy corn plant, how could you tell whether it was homozygous or heterozygous? If the plant was a sugary plant could you tell?

4. Can you tell the genotypes of these plants by merely looking at the plant: white four-o'clock; sugary maize; red four-o'clock; starchy maize; pink four-o'clock?

5. Suggest workable symbols for these characters that Mendel studied:

	<i>Dominant</i>	<i>Recessive</i>
1. Seed form	smooth	wrinkled
2. Cotyledon color	yellow	green
3. Seed coat	opaque	transparent
4. Pod type	hard	soft
5. Pod color	green	yellow
6. Flowers	axial	terminal
7. Plant height	tall	dwarf

6. In *Drosophila melanogaster*, these recessive genes for eye color are found: *car* = carnation; *bw* = brown eye; *pr* = purple; *w* = white; *p* = pink. The dominant alleles of these genes interact to produce a wild-type (red) eye. Write the complete formula (as far as these pairs of alleles are concerned) for flies with these eye colors: pink, carnation, red, purple, white, brown.

Chapter 3

GENES AND CHARACTERS

Genes act at various stages during the development of the organism to produce definite characters but, although each gene acts always in cooperation with other genes and with the environment, the effect of the environment may not be the same upon all genes. Some genes behave so differently in different environments that the characters they produce are strikingly different; other genes appear to produce the same result under all known environmental conditions. It cannot be too strongly emphasized that heredity and environment are factors which are continually interacting. The developed character is the product of a certain hereditary constitution and a certain set of environmental conditions both of which are acting during development to produce the character in question.

Environmental Effects

As an illustration of characters which develop in the same way under different environmental conditions and of those which are different if the environment is different, some of the genes that affect the color of the fruits in maize may be cited. Certain strains always have white ears because they have genes that produce white fruits under apparently all conditions of the environment. Other strains have genes that produce red fruits even when the plant develops under a variety of conditions, and such strains always have red-fruited ears. In some strains, however, there is a gene that produces different results, depending upon whether the ear is kept dark or is exposed to the light as it develops (Fig. 9). If the ears of plants that have this "sun-red" gene are allowed to mature normally in their husks where they are completely protected from sunlight, the mature ears are white. On the other hand, if the husks are removed from the developing ear, the ear turns a bright red. If only portions of the ear are exposed, only those portions will become red; the

other parts will remain white. The sun-red gene, therefore, reacts to produce a white ear if the environment of the ear is complete darkness but produces a red ear if the ear is developed in the

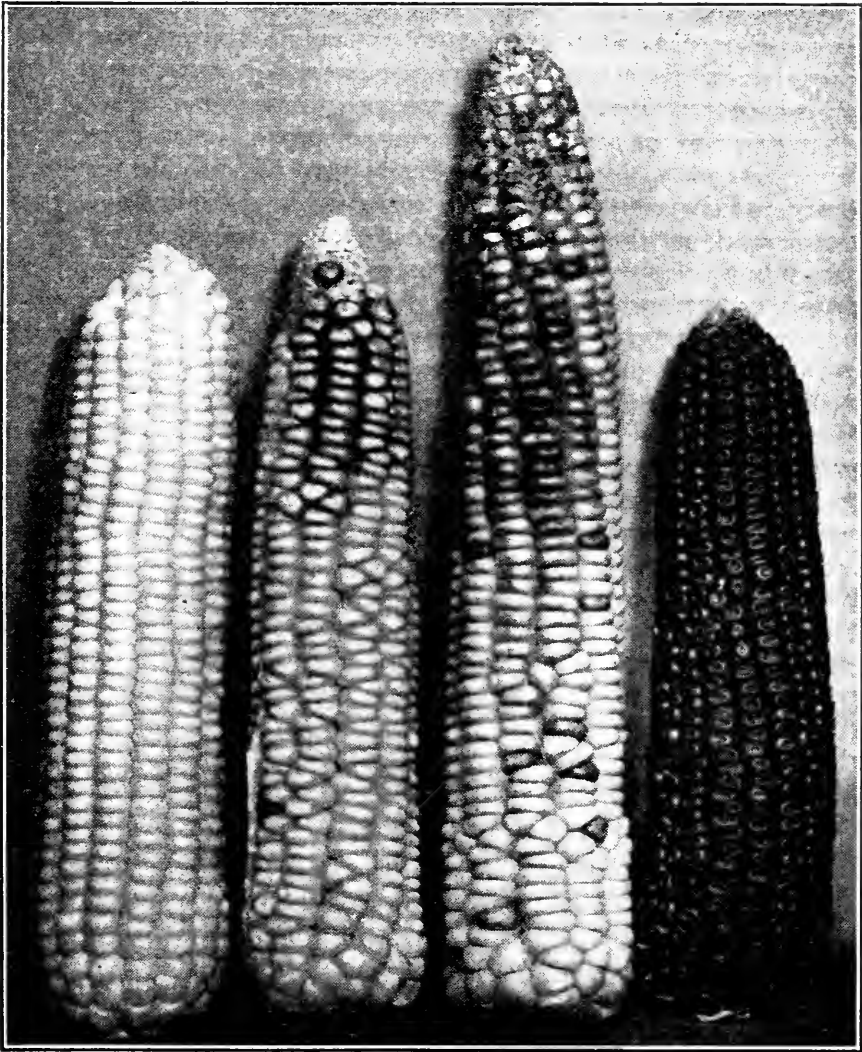

FIG. 9. Red and white ears in maize. The left ear is white and the right ear is a red pericarp type. The two center ears are of the sun-red type and are white where covered and red where exposed to the sun. The red pericarp type is red whether covered or exposed. The few colored grains in the white part of the sun-red ears are the result of stray pollen. (Photographs by Dr. W. Brooks Hamilton.)

light. This is a different gene from the normal red pericarp gene, which produces red ears no matter whether the developing ear is kept light or dark.

The effect of temperature on the gene *vg* in *Drosophila melano-*

gaster has been studied in considerable detail and is another good example of the principle that some genes produce different phenotypes if they act in different environments. Under the environment in which the flies normally develop, homozygous *vg* flies have very small and very poorly developed wings when compared to those with the wild-type allele. Such flies are normally raised around "room temperature," or about 20° to 25° C. If, however, homozygous *vg* flies are raised during the larval stage at various temperatures from 14° to 34° C, the wings of the adult will be very different in size and shape. The wings of flies raised at 14° are smaller and are more poorly developed than those of flies raised at 22°. At increasing larval temperatures, the adult wings become increasingly larger and more and more like the wing of a wild-type, *Vg*, fly.

Penetrance and Expressivity

The statement made in Chapter 2, that an individual that is homozygous for a given recessive gene is phenotypically recessive, is true for most of the genes that have been studied thoroughly, but some genes prove to be exceptions. All flies of *Drosophila melanogaster* that are homozygous for vestigial have vestigial wings; but only about 70 per cent of the human beings that are homozygous for the recessive gene for susceptibility to poliomyelitis acquire the disease when exposed. Such genes as *vg* are said to have complete *penetrance* whereas the gene for poliomyelitis has only 70 per cent penetrance. In other words, penetrance of a gene is the percentage of all the individuals possessing that gene and showing phenotypically the character that is determined by it. If all homozygous recessives show the recessive character, the penetrance of that gene is complete. If almost but not quite all the individuals show it, the gene has a high penetrance; but if only a small percentage of the individuals are phenotypically recessive, the gene has a low penetrance. Dominant genes as well as recessives may differ in their penetrance.

Genes are known with various intermediate degrees of penetrance. Because genes with high penetrance are the easiest to work with, such genes have been the ones most frequently studied, but in studying human genetics many genes are encountered

which have a low or intermediate penetrance. If we are to learn how inherited traits are transmitted in human beings, these genes cannot be ignored. The analysis of poliomyelitis in McDowell County in West Virginia by Addair and Snyder points to the conclusion that this gene for susceptibility has a reduced penetrance as only 29 individuals contracted infantile paralysis whereas the relationships of the families studied would suggest that 40 individuals were homozygous for the recessive gene for susceptibility. In a case in fowl, reported by Hutt and Child, a recessive gene for inherited tremor is present in which the affected individuals continually shake to a greater or lesser extent. This gene has an unusually low penetrance. Their breeding studies indicated that about 112 individuals were homozygous recessive for this gene, but actually only 39 chicks showed the character. Therefore, the penetrance of this gene is about 35 per cent. Genes are known with a lower penetrance than that, such as the gene for abnormal abdomen in *Drosophila funebris*, in which the penetrance is only 10 to 15 per cent.

It is not always clear why a given gene has a low or high penetrance. It is probably due to the nature of the gene itself. If a certain gene has low penetrance, apparently its action during development is weak and can easily be disturbed by the action of other genes and also by external factors. These genes with low penetrance are so easily affected that in most individuals their action is negatived completely and the individual develops the character of an allele. The action of genes with high or complete penetrance is so strong that in few or no cases can it be upset or blocked by any other combination of genes or by environmental conditions.

Hutt and Child interpret the low penetrance of the gene for tremor as the result of modifying genes. In some recessive individuals these modifying genes are powerful enough to prevent the recessive gene from being expressed in any degree; in other individuals some or all of these modifying genes are absent and the individuals are recessive phenotypically. In *Drosophila melanogaster*, the gene *giant* has a low penetrance, but environmental conditions are responsible. If the food is so scanty that there is extreme competition among the larvae, the action of the recessive gene for *giant* is inhibited in the homozygotes and the adults are normal in size.

Thirty-nine chicks in Hutt and Child's study showed the tremor character, but the extent to which it appeared varied greatly in different individuals. In some chicks this tremor was so pronounced that they could not even stand up, whereas others showed only a barely perceptible tremor. Various intermediate conditions were observed. This difference is known as the *expressivity* of the character. Penetrance and expressivity are not the same thing. In determining penetrance, every chick was counted that manifested the character in any degree irrespective of the extent of the expression of the character in that individual. In determining the penetrance of the gene for poliomyelitis, Adair and Snyder also took expressivity into account. Although cases with high expressivity were readily recognized, the possibility existed that there might have been susceptible individuals in which the expressivity was so low that the infection produced only a fever or other mild illness instead of the usual crippling paralysis. A careful check was made to learn whether any brothers or sisters of paralyzed children had mild cases during the period when the less fortunate members of their family were affected. Since no such cases were found, it seemed clear that the expressivity of the gene was high and that the penetrance was not complete.

Inherited Characters in Plants and Animals

Several examples of characters produced by one or more genes have been mentioned in this and the last chapters; many more are discussed later in this book. We might mention here, however, that all organs of plants and animals are under genic control. In plants, a list of inherited characters would include stem height, length of internodes, type of branching, leaf shape, chlorophyll deficiencies, flower color and color patterns (Fig. 10), shape of flower parts, shape of fruit, color of seed coats and endosperm, and even seedlessness. In animals we could list such traits as abnormalities of bone growth in the skull and other bones (Fig. 11), the presence of excess fluid between the brain and the skull, absence or reduction of the jaws, eye color, congenital cataract, color of the fur or feathers (Fig. 12), albinism, woolly hair, hairlessness, inherited bleeding, size and weight, glandular abnormalities, and many more far too numerous to mention. Dunn and his co-workers described in 1940 a very

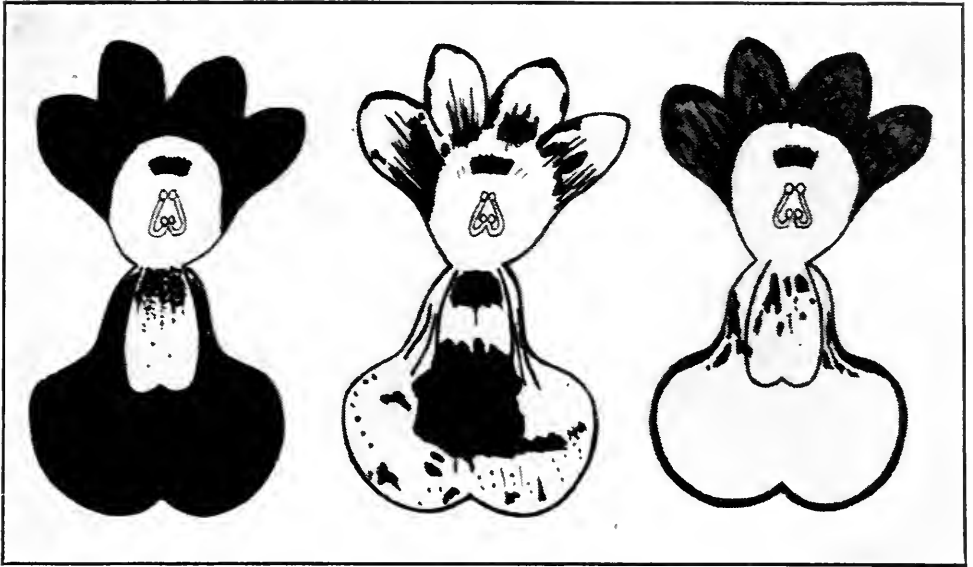

FIG. 10. Flower color patterns in *Nemesia strumosa*. For clarity, each flower is cut along both sides of the tube and is flattened out. *Left*, the red type with the genotype, *C Sp Gr Ro*. *Center*, the spotted modification of red; *C sp Gr Ro*. *Right*, the red outline modification; *C Sp Gr ro*. $\times 1.6$. (From Riley in the *Botanical Gazette*.)

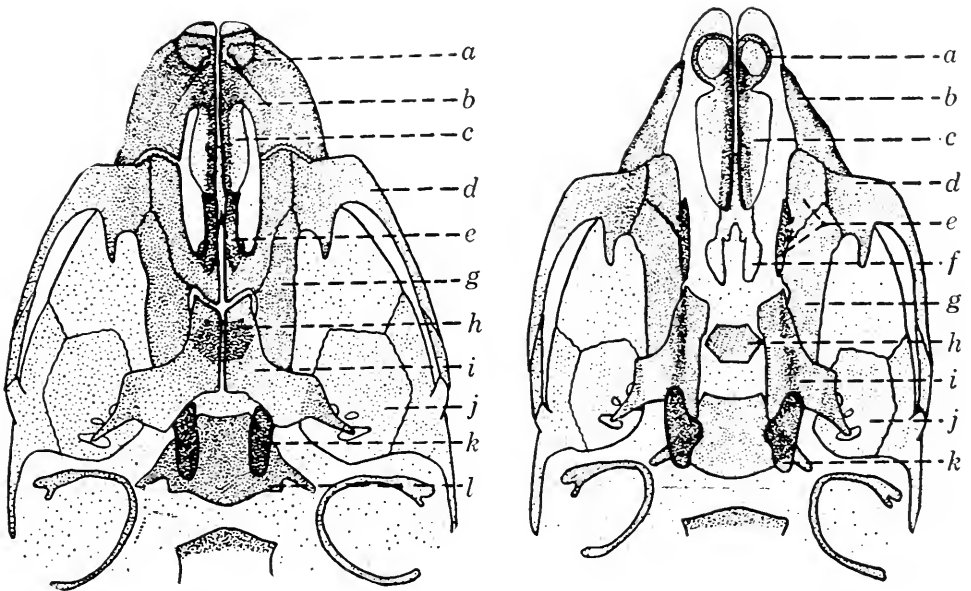

FIG. 11. Harelip in the mouse. Ventral view of the cranium of a newborn normal (*left*) and harelip (*right*) mouse. *a*, incisor alveolus; *b*, pre-maxilla; *c*, palatine process of maxilla; *f*, vomer; *g*, alveolar process of maxilla; *h*, presphenoid; *i*, palatine; *j*, alisphenoid; *k*, inner pterygoid process of the alisphenoid; *l*, basisphenoid. (Courtesy of Dr. S. C. Reed, in the *Anatomical Record*.)

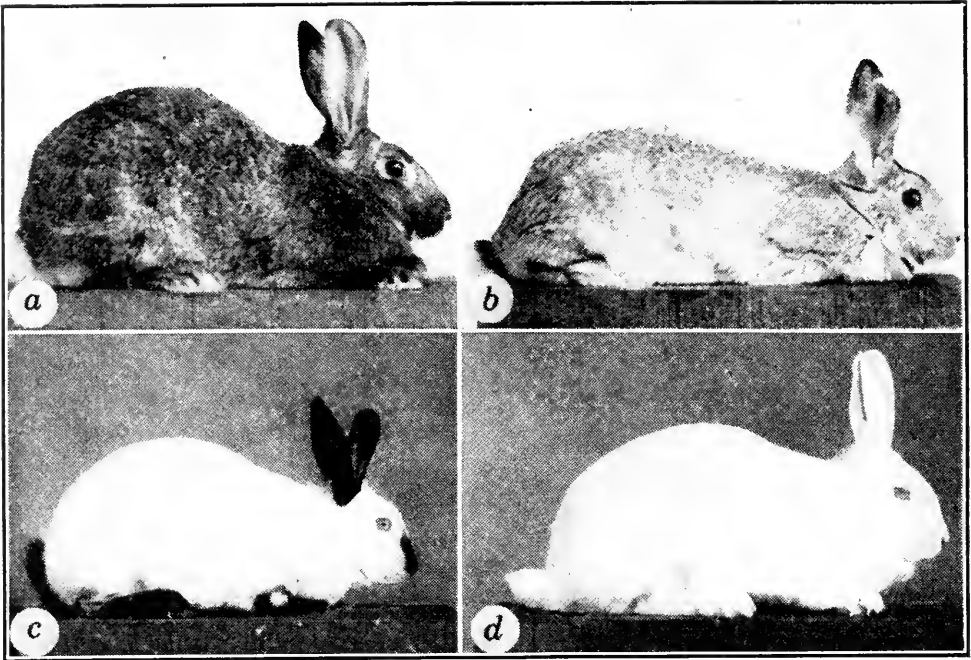

FIG. 12. Inherited coat colors in rabbits. (a) normal, CC ; (b) chinchilla, $c^{ch}c^{ch}$; (c) Himalayan, c^Hc^H ; (d) albino, cc . These genes form a series of multiple alleles. (From Keeler in the *Journal of Heredity*.)

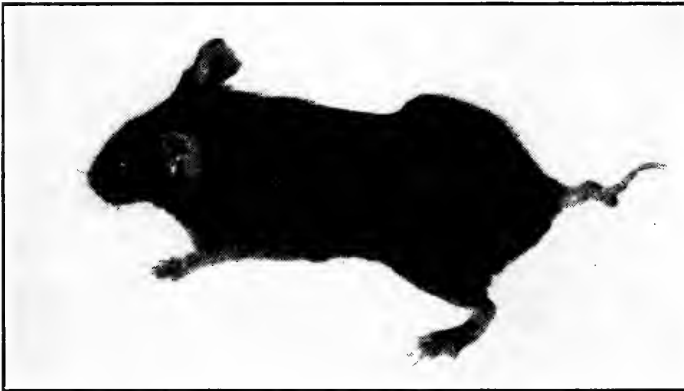

FIG. 13. An adult mouse showing a short-tail mutation. Vertebrae are present at the base of the tail, but not at the tip. (From Dunn, Gluecksohn-Schoenheimer, and Bryson in the *Journal of Heredity*.)

interesting gene that affects the body structure of mice. The dominant gene, *Sd*, when heterozygous, produces either short or no tails, often shortened or crooked spines, abnormalities of the kidneys, and a generally lowered vitality (Fig. 13). The homozygotes are completely tailless, have spines divided by a cleft into two parts, have no kidneys or external genitalia, and die shortly after birth. This whole complex of characters behaves as a unit.

Some Characters in Human Beings

For several reasons it is far more difficult to study the genetics of human beings than inheritance in plants or in other animals. The technique which is widely used in studying the way the genes of plants and other animals are distributed among individuals, long known as the *pedigree culture* method, cannot be applied to man because of the social nature of human beings. Also, it is far more difficult to control or at least to analyze the environmental conditions under which human beings develop than those of other organisms, and unless the environment can be eliminated as a variable, our genetic results are always open to criticism. Many of the characters studied in other forms are unit characters in which one gene alone is mainly responsible for the development of a character; in human beings many of the characters which have been studied appear to be caused by the interaction of a number of different genes and are therefore much more difficult to analyze. Another complicating factor is that in plants or other animals we can often deal with genes having high penetrance, whereas in human beings many genes seem to have reduced penetrance. Although several hundred characters in human beings have been observed and studied, our knowledge is satisfactory for only a small percentage.

Studies in the heredity of human traits are complicated also by the fact that in some instances two or more genes in different chromosomes may independently produce the same character, or characters that appear the same unless they are carefully studied. In human beings, some of our supposed traits, especially some of the psychological ones, are themselves poorly understood, and until the characters are recognized and distinguished, the genes that are active in their production cannot be identified. Insanity illustrates the last point. Some years ago,

geneticists were interested in the inheritance of insanity but could make little progress in determining what genes were involved in its production. More recently, the psychologist has informed us that what has usually been termed "insanity" may be any one of twenty or more different conditions. It is obviously impossible to treat twenty characters some of which may be due to dominant genes and some to recessives, some of which may have high penetrance while others have low, as one character and expect to get a satisfactory genetic analysis.

A number of inherited conditions in man are fairly well known, and it appears that every part of the body and many physiological and psychological processes can be affected by genes or combinations of genes. Sometimes dominant genes are involved and sometimes recessives seem to be responsible. Often the condition is so difficult to analyze or so few cases have been found that on the basis of present knowledge it is impossible to determine the exact nature and number of genes involved even though the available evidence points distinctly to an inherited condition. Some of the more striking or more important discoveries will be cited here, but no attempt will be made to give a complete list of inherited human traits.

Genes have been found which affect the color of the skin. Probably the most familiar is the recessive albino gene which is similar to the albino gene in other animals and completely prevents the formation of pigmentation in the skin, eyes, and hair. Other differences in skin color such as the skin of the black and yellow races in contrast to the white race are usually of interest to most people. In both these situations, multiple genes seem to be involved. Negroes seem to differ from whites by two pairs of genes. In both there is a lack of dominance, and all four genes interact cumulatively. Thus an individual with the genotype $AA BB$ would be very dark, whereas an $aa bb$ individual would be white. Mulattoes with $AA Bb$ or $Aa BB$ combinations would be dark, those with $Aa Bb$, $AA bb$, or $aa BB$ would be intermediate, and those with the genes $Aa bb$ or $aa Bb$ would be between an intermediate and a pure white. Other modifying genes might also operate to influence these main types. The gene differences between the white and yellow races also involve several pairs of alleles.

Negroes with an interesting piebald spotting have been reported by Keeler. Individuals with this dominant gene have normal dark pigmentation in the head, back, hands, and feet except for a white head blaze and a white patch under the chin. Their abdomen, sides, arms, and legs are generally white but are speckled with small patches of normally pigmented skin. The pattern of these individuals is essentially the same as that found in the Dalmatian coach dog, the English rabbit, and Hereford cattle.

Abnormal conditions of skin texture are known. One of the most striking is *ichthyosis vulgaris*, in which the skin is covered with small, horny flakes or scales. This condition, the result of a dominant gene, produces the "porcupine men" of the sideshow. Cockayne has listed an unusual abnormality, *ichthyosis hystri gravior*, which occurs only in males. Their entire bodies, except for the face, palms, and soles, are covered with dark brown horny growths which appear after they are two months old. A skin defect that can be quite serious is the inherited absence of sweat glands. Individuals lacking these glands cannot perspire. In warm weather they must go to a cooler region or must remain in water or keep their clothes wet to prevent too great a rise in body temperature. This condition may also affect the skin, nails, teeth, hair, mammary glands, and mucous membranes, and persons with this abnormality may be unable to shed tears. The condition is the result of a recessive gene.

Genes affecting the hair include a dominant gene that produces a white forelock in otherwise dark hair. It was traced for five successive generations in one family. A curious character, the result of a dominant gene, affects the hair in the front of the head in such a way that it falls out when it has grown to five or six inches. When this hair has fallen out new hair comes in, so that affected individuals always have short hair, or bangs, over their foreheads. Other unusual and inherited hair conditions are woolly hair and a condition in which the embryonic hair continues to grow after birth in such abundance that an individual with this dominant gene can appear in circus sideshows as a "dog-faced" man.

A number of genes affect the axial skeleton, producing abnormalities that may often have a very harmful effect. The gene for inherited hollow chest reported by Snyder and Curtis pro-

duces a curious condition that apparently is not harmful in the least. Individuals with this dominant gene have a depression in the chest that looks as if it had been produced by a ball that had been pressed in. A far more harmful gene is the dominant that produces cartilaginous growths on the bones. Another dominant gene affects the bones in such a way that they are easily broken; a person with this gene may have a couple of dozen bone fractures during the course of his life.

Several types of dwarfism, or nanism, are inherited. The ateliotic type or midget, in which the individual is correctly proportioned but much smaller in every way than a normal person, results apparently from the interaction of two dominant genes. The achondroplastic type appears also to be the result of two interacting dominant genes. When both dominants are present, the person has shortened limbs but a normal-sized trunk. Both types of dwarfs may be found in side-shows.

Abnormalities of the fingers and toes are fairly numerous. In polydactyly, a condition that has been reported a number of times, the individual has extra fingers or toes. A number of families of the white race have been studied in which this character appears to result from a dominant gene. Negroes with polydactyly apparently are homozygous for a different gene which is a recessive. Hefner has recorded an interesting case of a dominant gene for polydactyly which is very variable in its expressivity. In some individuals, the terminal joint of the thumb is long and slender and tends to taper to a point, but the thumb is otherwise normal. Other individuals have thumbs which are long and finger-like and usually bent at a very decided angle toward the index finger. In still others, there may be an extra thumb which is joined to the metacarpal of one or both of these finger-like thumbs while an extra toe is present between the big toe and the normal second toe. This condition appears to be the result of one dominant gene, but it has appeared rather irregularly in several families, indicating probably a gene with reduced penetrance. Other characters affecting the digits are syndactyly, or webbed fingers and toes, which appears to be due to a dominant gene in some families and a recessive in others, brachydactyly, in which a dominant gene results in the absence of the middle phalanx of each finger, causing it to be considerably

shorter than normal, and minor streblomicrodactyly (Fig. 14), in which the little fingers are bent. Symphalangism, or the fusion of the phalangeal joints of the digits, is a character caused by



FIG. 14. Crooked little fingers (minor streblomicrodactyly). The abnormality is especially noticeable in side view. (Courtesy of Dr. R. A. Hefner in the *Journal of Heredity*.)

a dominant gene. Strandkov has reported a case of the inherited absence of thumbnails. This character is probably the result of a dominant gene, although the number of cases is too few for certainty; it is generally accompanied also by a slight abnormality of the nails on some of the other fingers.

The color of the eyes is greatly affected by certain genes. In albinos, previously mentioned, the eye lacks color entirely (except for the pink color produced by blood in the blood vessels of the eye) because of a homozygous recessive gene. In the presence of the allele of this gene, the eye is colored, but the specific color depends upon the presence of other genes, the exact number of which is not always easy to determine. One pair of alleles seems to produce a basic brown or blue, but these, and especially the brown type, are considerably affected by other genes. The dominant of this pair, *B*, produces a purple-black color in the uvea and choroid behind the iris and a brown layer in front of the iris. Because of the latter pigment, the eyes appear brown. In the homozygous recessives, only the first of these two layers is present, and the eyes consequently are not brown and appear blue or gray, depending upon the angle of reflected light, age of the individual, and perhaps modifying genes. The brown type can vary from a very dark brown to a light yellow-brown according to the presence of various modifying genes.

Eye defects are of many kinds. Dominant genes are known which cause *ectopis lentis* or a congenital displacement of the lens, *aniridia*, the complete lack of an iris, and *glaucoma*, a defect in which the normal drainage of the lymph from the eye is blocked and the retina becomes atrophied. Congenital *cataract* is caused by a dominant gene with incomplete penetrance, for it occasionally fails to appear in individuals possessing the gene. Eye defects produced by recessive genes include a condition in which the optic nerve becomes inflamed and atrophied, and *microphthalmus*, in which the eyeball is very small and consequently vision is impaired or the affected individual is blind.

In some families a particular defect may be produced by a dominant gene and in others by a recessive. Apparently during the course of evolution, different genes appeared in different individuals and probably at different times, producing the same character or characters which are so nearly alike that they are not separated into different categories. Examples include extreme shortsightedness or *high myopia*, which is brought about by a recessive gene that produces a globe of unusual length or by a dominant that causes the cornea to be too greatly curved. Farsightedness or *hyperopia* is a condition in which the globe is so short that the rays are focused behind instead of on the retina.

In most families it appears to be the result of a dominant gene but in some instances is due to a recessive. In *nystagmus* the eyeball shows a continuously rolling movement. In some families this is the result of a recessive gene. In others it is caused by a dominant and the character, itself, is somewhat different for the rolling of the eyeball is accompanied by movements of the head. Nystagmus may be caused by environmental conditions as well as by genes. Some injuries to the brain and some brain tumors may cause the same condition as that brought about by the dominant gene. This should caution us against a too hasty judgment as to the inherited or noninherited nature of a certain character.

An interesting ear abnormality reported by Potter is the result of a dominant gene which causes the pinna to be small, deformed, and inverted. Several genes that affect hearing are on record. Deaf-mutes are born totally deaf. This character may be the result of either one of two recessive genes, *d* and *e*, or both. If both dominant alleles are present, the individual is normal, but if a person is homozygous for either *d*, or *e*, or both, he is a deaf-mute. Other inherited conditions of deafness are labyrinthine deafness, in which the auditory nerve begins to degenerate at about forty years of age, and *otosclerosis*, a progressive deafness which begins at about thirty.

A number of inherited tooth defects have been observed. Dominant genes have been identified which cause such abnormalities as absence of the upper incisors, absence of certain incisors and molars, lack of permanent upper canines, lack of two or more wisdom teeth, supernumerary teeth, and defective enamel, resulting in brown teeth. The two center incisors of both jaws are missing in some families as the result of a recessive gene.

In addition to various structural traits, we find that physiological processes and susceptibilities to various diseases may come under gene control. The ability to taste certain substances is an interesting character. Blakeslee and some of his co-workers showed that about seven people out of ten can taste crystals of phenylthiocarbamide. To them, it generally tastes very bitter, although the strength of the taste varies with different people, and to some it appears to be salty. To the other 30 per cent it is tasteless. An examination of a number of families has shown that the ability to taste is due to a certain

dominant gene and that the homozygous recessives detect no taste. Other genes are known that affect the sense of smell and determine whether an individual can detect certain odors.

Other characters that have been reported are hereditary *epistaxis* or bleeding of the nose. It is due to a dominant gene and may be associated with red spots on the skin and a general susceptibility to colds and nasal infections. An inherited tendency for susceptibility to certain diseases has been noted in many families. A recessive gene for susceptibility to poliomyelitis has been discussed. Recessive genes have also apparently been discovered that produce susceptibility to tuberculosis, scarlet fever, and diphtheria. Studies of inheritance of diseases of this nature are complicated by the fact that a causative infectious agent must be present for the disease to be contracted while other conditions such as general health, insufficient food, and certain conditions under which a person works may contribute to his susceptibility. Considering, however, that every person who is exposed to the disease does not contract it, and considering the pedigrees of a number of people who have contracted it, susceptibility or resistance to these diseases appears to depend in part upon the homozygous condition of a certain recessive gene.

Sugar diabetes or *diabetes mellitus* is reported to be inherited as a recessive. It may also, however, be caused by syphilis, other diseases, or certain emotional states. That a disease may sometimes be caused solely by environmental factors does not preclude the possibility that it may sometimes be inherited. Actually, this disease may be caused by anything that disturbs the functioning of the islands of Langerhans in the pancreas, resulting in a normal secretion of these structures in a lower amount than in healthy individuals. The cause of the disturbance may be a disease or an emotional condition or a gene.

Certain genes appear to disturb the activity of the thyroid gland, producing such conditions as goiter. Apparently a recessive gene produces *alkaptonuria*, a condition in which a certain acid, alkapton, is present in the urine, causing it to turn dark. A very rare condition is *steatorrhea*, a condition in which fat is not digested. It appears to result from one or more pairs of recessives. Another very rare condition, reported by Macklin, is *porphyrinuria*. Caused by a homozygous recessive, it results

in the deposition of large quantities of pigment in the tissues, bones, and teeth, and a red color in the urine. A dominant gene seems to be the cause of a general allergic tendency which is expressed in a great many forms. Some individuals possessing this gene have hay fever, some have eczema, some have hives, some have asthma, and others exhibit still other forms of hypersensitiveness.

The inheritance of psychological traits is, as a rule, more difficult to analyze than the inheritance of physical or of many physiological characters. The most difficult of all is general intelligence, a trait that is not easy to define or to measure. The differences in intelligence between various individuals are not clear-cut and there is a wide range of such differences, with very superior persons at one extreme and very inferior ones at the other and a continuous series of gradations between them. The genetic situation is complicated for apparently a large number of genes is involved in determining intelligence, and they may interact in a very complicated fashion. It is a rather generally accepted view among geneticists that the upper limits of a person's intelligence are determined by his genotype, but how nearly any individual ever reaches his upper limits depends upon a great many factors such as training and other environmental conditions.

Certain grades of insanity are more readily susceptible of genetic analysis partly because they are more readily recognized. *Dementia praecox* apparently results from the interaction of several recessive genes and is a condition in which a person gradually withdraws into himself and lives in a dream world. The manic-depressive type of insanity is also complex in its inheritance and results from the interaction of several genes, some of which appear to be dominants. A manic-depressive has alternate periods of great elation and extreme depression. These two types of insanity are hard to analyze genetically, but that they can be identified simplifies the problem considerably. Before they were recognized as distinct conditions and when all types were lumped together under the term "insanity," it was impossible to make a genetic analysis.

Certain other cases of low-grade mentality have been studied sufficiently for at least part of the hereditary cause of the condition to be known. *Huntington's chorea* is known to be due to a

dominant gene with almost complete penetrance. Affected individuals show an uncontrollable twitching of head, body, and limbs which develops in the adult and becomes progressively worse. In *spinal ataxia*, which is due to the interaction of one dominant gene and a homozygous condition at another locus, the afferent nerve tracts become degenerated and the individual loses his sense of equilibrium. Many other inherited conditions of mental disorders might be listed, but those that are mentioned here should probably be sufficient to give a general picture of the need for taking the genotype into account when studying the numerous types of low-grade mentality that are known.

QUESTIONS AND PROBLEMS

1. Breeding results indicate that 103 plants are homozygous for the dominant gene, *A*, but only 79 of them are *A* phenotypically. What is the penetrance of that gene?

2. An individual is born with six fingers on one hand, but, because this would make him a curiosity and handicap him socially, the extra finger is removed shortly after birth. Would this affect his genetic constitution? Would it prevent his offspring from having six fingers?

Chapter 4

REPRODUCTION AND MEIOSIS

It is frequently seen that the same character may be possessed by a number of individuals in different generations of a family, and it is reasonable to assume that these individuals must possess the same gene. One of the important problems of genetics is the way these related individuals came to possess the same gene. It happens that this problem of the distribution of genes is probably the best-understood problem in genetics.

Since the genes are located in the chromosomes, the problem of gene distribution becomes a problem of chromosome distribution, and since chromosomes are found only in cells the whole problem comes down to a study of how cells are transmitted from one generation to another. Long years of study have shown that at no time during the life of an individual does it receive any cells from its parents except at the moment of reproduction. It is therefore important to understand the various methods by which living organisms reproduce before delving into the manner in which genes are distributed.

The fundamental processes of reproduction are the same in plants and in animals although the details and accessory processes may vary considerably. In the simplest process an entire individual divides into two, but this method is necessarily restricted to the very lowest forms of life. In many organisms a piece of an individual consisting of several cells may develop into a new individual, as in the fragmentation of filamentous algae and of certain coelenterates and flatworms, in the formation of buds in *Hydra* and some sponges, in the gemmules of certain sponges and the gemmae of liverworts, and in various types of vegetative reproduction in the higher plants. None of these methods involves the *union* of any cells; they are examples of *asexual reproduction*.

In contrast to asexual reproduction is *sexual reproduction*, which involves typically the union of two cells known as *germ*

cells or *gametes*. Some lower forms reproduce sexually by the fusion of identical gametes, but a differentiation of the gametes into male and female is the rule in the higher groups.

Reproduction and Life Cycles in Higher Animals

Sexual reproduction in the higher animals is generally brought about by the union of two unlike gametes, each of which is contributed by a different individual. One gamete, the *egg*, is large and nonmotile, is produced by the female, is usually spherical, and contains a nucleus and cytoplasm. In the cytoplasm is found the food or yolk. The male gamete, which is much smaller than the egg, is known as the spermatozoon or simply the *sperm*. It usually consists of three parts: the head, middle piece, and tail. The head is essentially a nucleus surrounded by a very thin layer of cytoplasm and is generally spherical or elliptical in shape. The middle piece is much smaller than the head and, at least in some animals, contains a centrosome. The tail is very long, extremely delicate, and is a flagellum which propels the sperm from place to place. The union of an egg and a sperm is called *fertilization*. This process results in a cell, the *zygote*, which will develop into a new adult individual of the same species as the parents.

It was stated previously that every cell of the body, with the exception of the germ cells, contained the same number of chromosomes. In man, the number in the somatic cells is 48 chromosomes or 24 pairs. If the germ cells were produced by *typical* mitotic divisions and, therefore, if they had the same number of chromosomes as the body cells, the number of chromosomes of a species would double each generation. Thus it would not be long before the chromosome number of all organisms would be in the thousands and even millions. Actually, however, this does not happen for, with the development of sexual reproduction, a modification of the ordinary mitotic process has developed which, in animals, produces gametes with *half* the number of chromosomes as in the body cells of the parents. Thus in *each* generation of human beings the body cells have 48 chromosomes and the gametes have 24. In discussing animals in general, without reference to any particular species, it can be said that the body cells contain $2n$ chromosomes and the germ cells contain n , where n stands for a definite number. This num-

ber happens to be 24 in man. The $2n$ or somatic number is called the *diploid* (Greek, *diploos*, twofold, double; Latin, *duplex*) number whereas the n or gametic number is generally referred to as the *haploid* (Greek, *haploos*, single; Latin, *simplex*) and occasionally as the *monoploid* (Greek, *monos*, alone, only) number.

The haploid number in the gametes is also called the *reduced* number and is brought about by two successive mitoses which differ from ordinary mitotic divisions in several important details. These peculiar mitoses do not occur in all parts of the body but only in the ovary and testis. To differentiate them from somatic cell divisions, these two divisions are called the *reduction divisions*, *meiosis*, or, because they occur during the maturation or differentiation of the germ cells, the *maturation divisions*. There are always two meiotic divisions, and consequently each cell that divides by meiosis produces four cells.

In the male animal, a number of cells in the testis become set apart and generally become larger than the others. They are the *primary spermatocytes* and they undergo the first meiotic division, by which each forms two *secondary spermatocytes*. The second meiotic division immediately follows, with the result that four *spermatids* have been produced from *each* original primary spermatocyte. These spermatids do not divide further, but usually change their shape by elongating and by developing a tail. Each becomes a mature spermatozoon.

In the ovary, when the eggs are about to form, certain cells become very large. These *primary oöcytes* divide to form two cells but they are not alike. One is large and contains all the stored food; the other is no more than a nucleus with some cytoplasm around it. This small cell is the *first polar body* and remains attached to the large cell which is the *secondary oöcyte*. The secondary oöcyte and frequently the first polar body, also, then undergo the second meiotic division. The secondary oöcyte forms a large functional *egg* and a small, nonfunctional secondary polar body, whereas the first polar body, if it divides, forms two polar bodies. Thus each primary oöcyte forms either three or four cells, but only one of them is functional.

In the higher animals, all the somatic cells are diploid. The eggs and sperm of the animals possess the haploid number of chromosomes and unite to produce new individuals which like

the parents have the diploid number. A succession of events, starting with one stage of life and including all the steps that occur until a new individual at the same stage as the first is found, is called the *life cycle* of the organism. The life cycle of most animals, including the vertebrates, is very simple.

Reproduction and Life Cycles in Higher Plants

In plants above the Thallophytes and, indeed, in many algae and fungi, reproduction is complicated by a more involved life cycle than is generally found in the Animal Kingdom. Although we frequently think that we can recognize the body of a certain kind of plant, few of us except botanists recognize that in all these higher plants the complete life cycle includes *two different plant bodies*. In the fern plant, for example, we are all familiar with the often large, leafy structure that bears typical "fern leaves." These leaves bear minute spores in clusters on their under side. When these spores germinate, they do not produce typical fern plants but small, flat, green bodies, perhaps half an inch long or less, which lie close to the ground. These bodies are fern plants just as much as the more familiar types and they bear the gametes. When the gametes unite, a zygote is produced which develops into the familiar type of fern plant. Thus the complete life cycle of a fern includes two bodies: the large body on which these spores are found, the *sporophyte*, and the small body that bears the gametes, the *gametophyte*.

The meiotic divisions in the fern occur not in the formation of the gametes, as in animals, but in the development of the spores. The sporophyte plant has $2n$ chromosomes and produces haploid spores. They germinate and by a series of regular mitotic divisions produce the haploid gametophyte, which in turn produces haploid gametes. They unite to form a diploid zygote, which, in turn, develops into the diploid sporophyte body. This alternate production of sporophyte and gametophyte bodies is called *alternation of generations*.

The existence of two generations in the life cycle of the higher plants can best be grasped from such a plant as the fern, where each generation is throughout most of its life a separate and independent structure. In the seed plant the gametophyte is reduced in size and complexity to only a few cells.

In the angiosperms, the sporophyte, commonly regarded as the plant itself, bears two kinds of spores which in turn produce two kinds of gametophytes. The male spores or microspores are formed in the anthers of the flower. Cells towards the inside of the anthers enlarge and become *microspore mother cells* or *microsporocytes*. They undergo the usual two meiotic divisions, and each forms four microspores. A microspore is a round cell with one nucleus and, as it develops, it secretes about itself a thick wall which is usually yellow and highly sculptured in such a characteristic way that the species of plants can be identified from the ridges and furrows of the microspore walls. A microspore is a one-nucleate *pollen grain*; but soon after it is formed, the nucleus and sometimes also the cytoplasm divide into a *tube nucleus* or *tube cell* and a *generative nucleus* or *cell*. This two-nucleate or two-celled pollen grain is a microgametophyte.

The female spores form from *megaspore mother cells* or *megasporocytes*, located in the ovules. The female organ is the pistil of the flower. It is enlarged at the base into an ovary which contains one or more ovules, each of which can develop into a seed. Each ovule contains only one megasporocyte, and it divides by meiosis to form a row of four cells, each of which is a potential megaspore. Three of these cells degenerate and the fourth enlarges to form a large functional megaspore or young *embryo sac*. The nucleus divides by ordinary mitosis to form two, four, and finally eight nuclei within the one embryo sac. Three nuclei collect at each end and two in the center, and cell walls are formed about the three at each end. One of the cells at one end of the embryo sac is the female gamete or *egg*. The embryo sac at this stage is mature and is the *female gametophyte* or *megagametophyte*.

When the two-celled pollen grain is mature, it is liberated from the anther and blows or is carried by insects to the end of the pistil, where it adheres. The wall of the pollen grain bursts, and the protoplasm grows out as a *pollen tube* which grows down through the tissues of the pistil until it enters the ovary. The pollen tube is a later stage of the microgametophyte. The tube nucleus precedes and the generative nucleus follows farther behind in the tube (Fig. 15). As the tube approaches the ovule, the generative nucleus divides by mitosis to form two *sperm nuclei* or male gametes. The tube then passes through the micro-

pyle, a small hole in the ovule, and enters the embryo sac. The tube nucleus disintegrates, while one sperm nucleus fertilizes the egg to form the zygote and the other unites with the two nuclei at the center of the embryo sac, the *polar nuclei*, to form *endosperm*, a tissue in which food is stored for the developing embryo. The zygote is the first stage of the new sporophyte.



FIG. 15. Pollen tube showing two sperm nuclei. (Courtesy of Dr. George H. Conant.)

Higher plants have a much more complicated life cycle than animals because two generations are necessary to complete the entire cycle.

Meiosis

The basis of the difference between the two meiotic divisions and any two successive somatic mitoses is to be found at the beginning of the prophase of the first of the two meiotic divisions. It has been pointed out that the chromosome in the resting stage is either a single structure or is composed of two chromonemata which are in such an intimate relationship that they behave as a single structure. By the beginning of prophase in an ordinary somatic mitosis, either the single chromonema has doubled or the two chromonemata of each chromosome have become sufficiently separated that the chromosomes are definitely double structures. At the prophase of the first meiotic mitosis, however, the chromosome is still effectively single, just as it was in the resting stage. This is a fundamental difference between mitosis and the first meiotic division.

Another important difference is that shortly after the chromosomes appear, they begin to lie alongside one another in pairs. *Each chromosome* pairs with the chromosome which is identical with it in size and shape—in other words, with its *homologue*. In meiosis, it is not until *after* the chromosomes have paired that each chromosome becomes a double structure. After each chromosome has become double, a chromatid from one homo-

logue may break and the broken pieces join up with broken pieces of a chromatid of the homologous chromosome. All these processes occur in the first prophase, and consequently this stage is of longer duration than the prophase of ordinary mitotic divisions. Cytologists have found it convenient to subdivide the first meiotic prophase into five substages.

First Prophase. At the beginning of the first prophase, the chromosomes are present in the diploid number just as in a mitotic prophase, but they are single throughout and not double. This stage of the first meiotic prophase is known as *leptotene*. In leptotene the chromosomes are very long, thin threads probably corresponding to the chromonemata of the anaphase chromosomes of the preceding mitotic division. They have a more granular appearance than the chromosomes in prophase of a somatic mitosis, and they often appear as loosely strung strings of beads of unequal size (Fig. 16). They are coiled loosely in relic coils of the previous division. Other morphological differentiations are not usually noticeable except that the centromere is frequently stained more lightly and may at this stage appear thicker than the rest of the chromosome.

Shortly after the chromosomes have appeared, they begin to pair up, each with its homologue. This *pairing* or *synapsis*, which occurs during *zygotene* and continues until all the chromosomes are completely paired, is very precise, for each part of a chromosome will lie exactly alongside the corresponding part of its partner. This is true to such an extent that if pieces of one chromosome are broken away or inverted, that chromosome and its homologue will twist about so as to bring corresponding parts together (Fig. 17). In most higher plants and in some animals in which the chromosomes lie at random in the nucleus throughout leptotene and zygotene, the homologues may begin to pair at any place, but sometimes they do so at the centromere or at the ends. In many animals and in some higher plants the chromosomes may have the orientation of the preceding telophase so that one or sometimes both ends are pointed towards one region of the nucleus. In organisms with definitely oriented or *polarized* chromosomes, pairing usually begins at the ends nearest the nuclear membrane and continues along the chromosomes until they have completely paired. When the chromo-

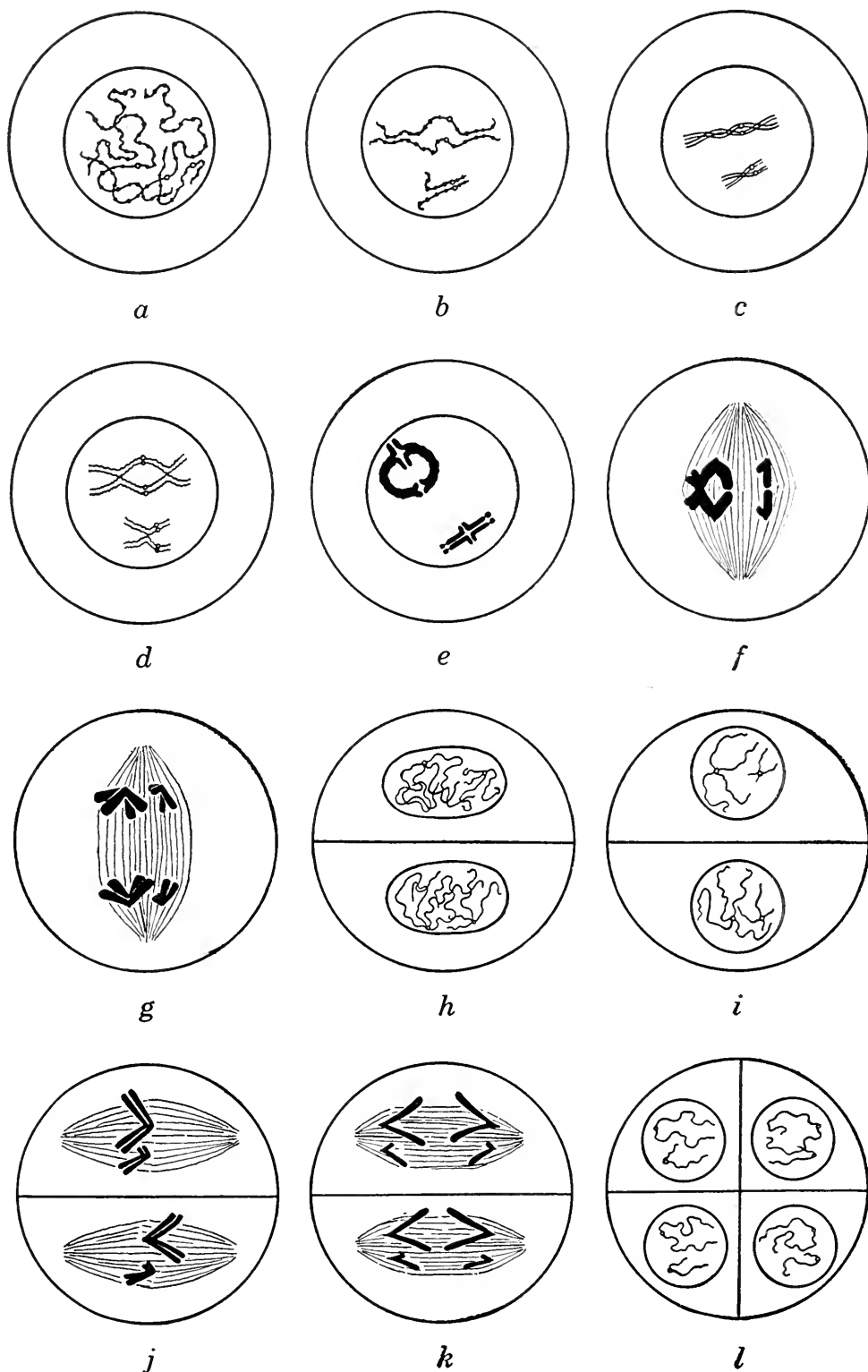

FIG. 16. Meiosis in plants: (a) leptotene; (b) zygotene; (c) pachytene; (d) diplotene; (e) diakinesis; (f) first metaphase; (g) first anaphase; (h) first telophase; (i) second prophase; (j) second metaphase; (k) second anaphase; (l) second telophase. Diagrammatic.

somes are polarized they are sometimes said to be in the *bouquet* stage.

Zygotene is followed by *pachytene*, a stage characterized by several important features. The two homologous chromosomes which had paired in *zygotene* now twist about one another in

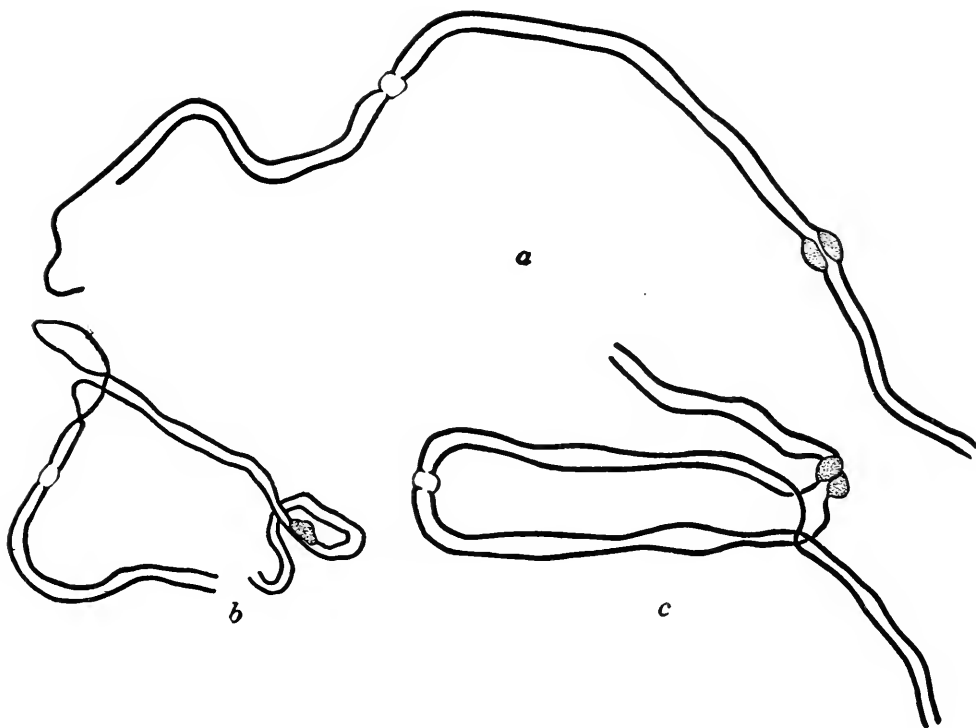

FIG. 17. Chromosome pairing in which one of the pairing homologues has a deleted or an inverted segment: (a) a terminal deletion; (b) an intercalary deletion; (c) an inversion. (Courtesy of Dr. B. McClintock in *Research Bulletin of the University of Missouri Agricultural Experiment Station.*)

what are called *relational coils* (Fig. 18), and each soon becomes a double structure. It is immaterial for our purpose whether this is because two chromatids in very close contact and constituting one chromosome become so separated now as to be visible as a double structure or whether one original thread was present which now forms another thread like it and alongside it. It is often stated that at this time "the chromosomes split longitudinally," but it is more likely either that two intimate chromonemata separate or that one thread regenerates another.

After this doubling occurs, the two chromatids of one chro-

mosome are still twisted about the two chromatids of the homologous chromosome in relational coiling, but this is further complicated by a coiling of the two chromatids of each chromosome around each other. Thus two threads (chromatids) which are coiled about each other are coiled relationally about two other

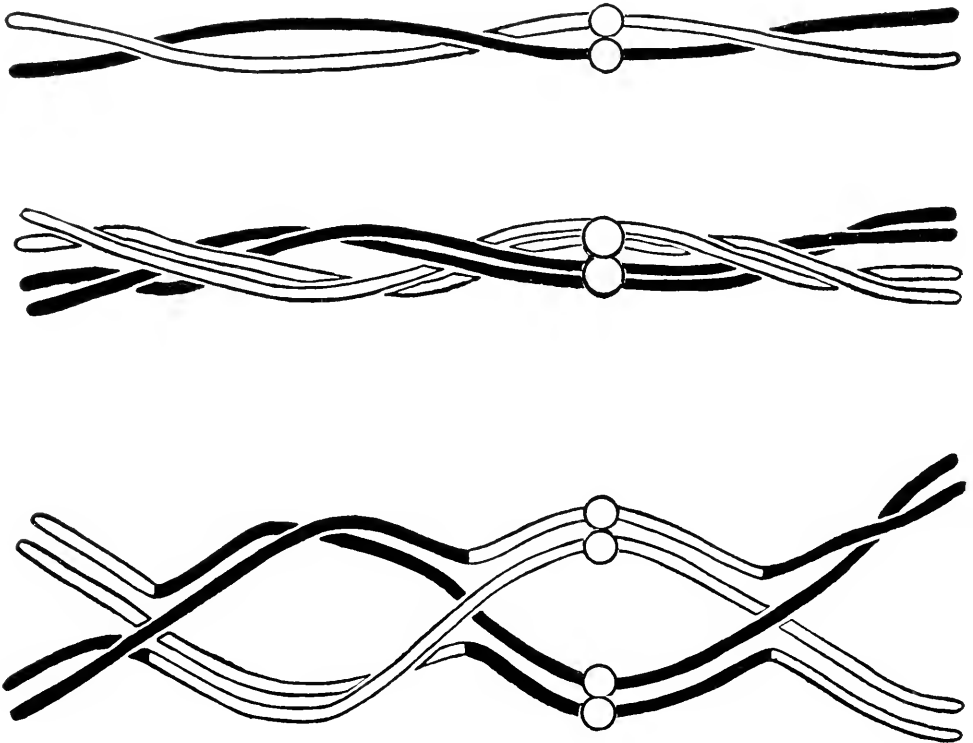

FIG. 18. One bivalent in stages of the first meiotic division. *Top*, zygotene or early pachytene before the chromosomes have become double. *Center*, pachytene with each chromosome consisting of two chromatids. *Bottom*, diplotene showing chiasmata.

threads (chromatids) which are coiled about each other. It can be seen from this that the chromosomes are under considerable strain. Before the chromosomes become double, there is an attraction of an unknown nature which causes them to remain paired. Once the chromosomes are doubled this attraction ceases and is translated into an attraction between the chromatids of each pair. When the attraction between chromosomes lapses, one pair of chromatids begins to repel the other pair, increasing the strain. The result will be that at one or more places one of the four threads will break, and it will not necessarily be the same thread that breaks at any two places.

When one chromatid breaks at a certain place, one of the two chromatids of the other chromosome also breaks at *exactly* the same place. The broken ends then uncoil. The broken end of one chromatid in some way seems to come into contact with the broken end of the other broken chromatid and they fuse. This fusion largely eliminates relational coiling. If one such break, followed by a fusion, occurs, one chromatid of each chromosome remains unchanged but the other two chromatids are new and are composed in part of one original chromatid and in part of the other. Since the break is at the same place in each of the two chromatids, the new chromatids are exactly the same as the old ones in size and appearance; but the new arrangement of segments of chromatids has a very important effect on the transmission of groups of genes, resulting in what is known genetically as *crossing over*. Since more than one break-and-fusion usually occurs in a pair of homologous chromosomes, and since they may involve any chromatid of either pair at any one place, the results in terms of the original nature of the four threads can be quite complicated.

The breaks and exchanges of partners produce cross-shaped figures in the paired chromosomes when viewed under the microscope. They are best observed in the next stage of the first meiotic prophase, *diplotene*. During diplotene, the repulsion between the pairs of chromatids is very strong, and the two pairs now tend to separate from one another. They cannot do so completely, however, because at various places one chromatid from one chromosome is attached to a piece of one chromatid from the other chromosome. The parts that are not joined separate as widely as they can. If one break had occurred in pachytene, the two homologous chromosomes would present a cross-shaped figure, and the length of the arms of the cross would depend upon the original position of the break. If more than one break had occurred, the chromosomes would open out into loops. The regions where they are tied together as the result of the previous breaks are known as chiasmata.

The two homologous chromosomes which have paired at zygotene are known as a *bivalent*. When four threads are present as the result of the doubling of each chromosome, the configuration is known as a *tetrad*. The tetrad nature of a bivalent is not

so easily observed at pachytene because the threads lie close together, but at diplotene as the result of the repulsion and consequent opening out of the threads, the four-strand nature is easily seen. The diplotene chromatids are long and thin but, as diplotene progresses, they contract greatly and become much thicker. This contraction is due to the coiling or spiralization of the long, thin threads that were present originally. At the same time, they rotate in such a way that in a bivalent with several chiasmata the successive loops lie at right angles to one another, whereas if only one chiasma is present, the arms rotate through 180° . As at mitosis, a matrix which stains very heavily begins to collect around the threads so that the internal structure of the chromosome is not easily visible late in this stage. The repulsion which starts with the beginning of diplotene continues and is often strong enough to cause the chromatids to slide along one another so that the chiasmata appear to move towards the ends. This *terminalization* begins towards the end of diplotene and may continue through the next stage and up to metaphase. Chiasmata may terminalize completely or only partially. Terminalization is, in general, greatest in small chromosomes and least in large ones, although the degree of terminalization also seems partly a characteristic of certain species.

The chromosomes pass gradually from diplotene to the last stage of the prophase, *diakinesis*. At this stage, the bivalents are very short and thick and are quite deeply stained, and the two chromatids of each chromosome are close to one another, with the result that the identity of the individual chromatids is usually lost except possibly at the ends when the chiasmata are not completely terminalized. During this stage, the spiralization of the chromatids may continue, causing them to become somewhat shorter than at the beginning of diakinesis, and terminalization may also continue if it had not been completed in diplotene. The bivalents tend to repel each other during diakinesis. They move to the periphery of the nucleus just inside the nuclear membrane and are frequently arranged so that each is as far away from every other one as it can get, although this last feature seems more noticeable in small than in large nuclei. The nucleolus disappears during diakinesis, and this stage is terminated by the disappearance of the nuclear membrane.

First Prometaphase. When the nuclear membrane disappears, a spindle forms and the bivalents move towards the equator. The chromosomes are even shorter and thicker than they were during prophase. The chromatids are not usually visible under ordinary methods of staining but can be made to appear by special techniques.

First Metaphase. When the bivalents reach the equator they arrange themselves on it. They are especially clear in plants with few chromosomes (Figs. 19 and 20). If the plant has both large and small chromosomes, the small ones are usually towards the center (Fig. 21). There are several outstanding differences between metaphase of the first meiotic division and a metaphase of a somatic mitosis. In a somatic division, the metaphase chromosomes are placed so that their centromeres lie on the equator. In the first meiotic metaphase, the centromeres could not lie on the equator unless the bivalent lay on its side. The bivalents are oriented so that the centromeres are towards the poles and the chiasmata in the equatorial plane.

The way any bivalent is oriented is purely a matter of chance. That is, the centromere of the chromosome which came from the male parent may point to either pole, and obviously the centromere from the original female parent will point in the direction of the opposite pole. Not only is any one pair of chromosomes oriented at random with respect to the poles but each bivalent is also arranged entirely independently of any other.

First Anaphase. When the bivalents have become arranged on the spindle, they begin to pull apart. This separation is apparently the result of a strong repulsion between the opposite centromeres, which drag the rest of the chromatids after them. When the chiasmata are terminalized, the chromosomes break apart easily as the centromeres move towards the pole; when nonterminalized, the chiasmata slip along towards the ends until the chromosomes have pulled apart. The two sister chromatids are still in contact at the centromere, but the double nature of each chromosome, often completely obscured at metaphase, is now very evident. The anaphase chromosomes are much shorter and thicker than the anaphase chromosomes in a somatic mitosis of the same plant and would hardly be recognized as belonging to the same organism.

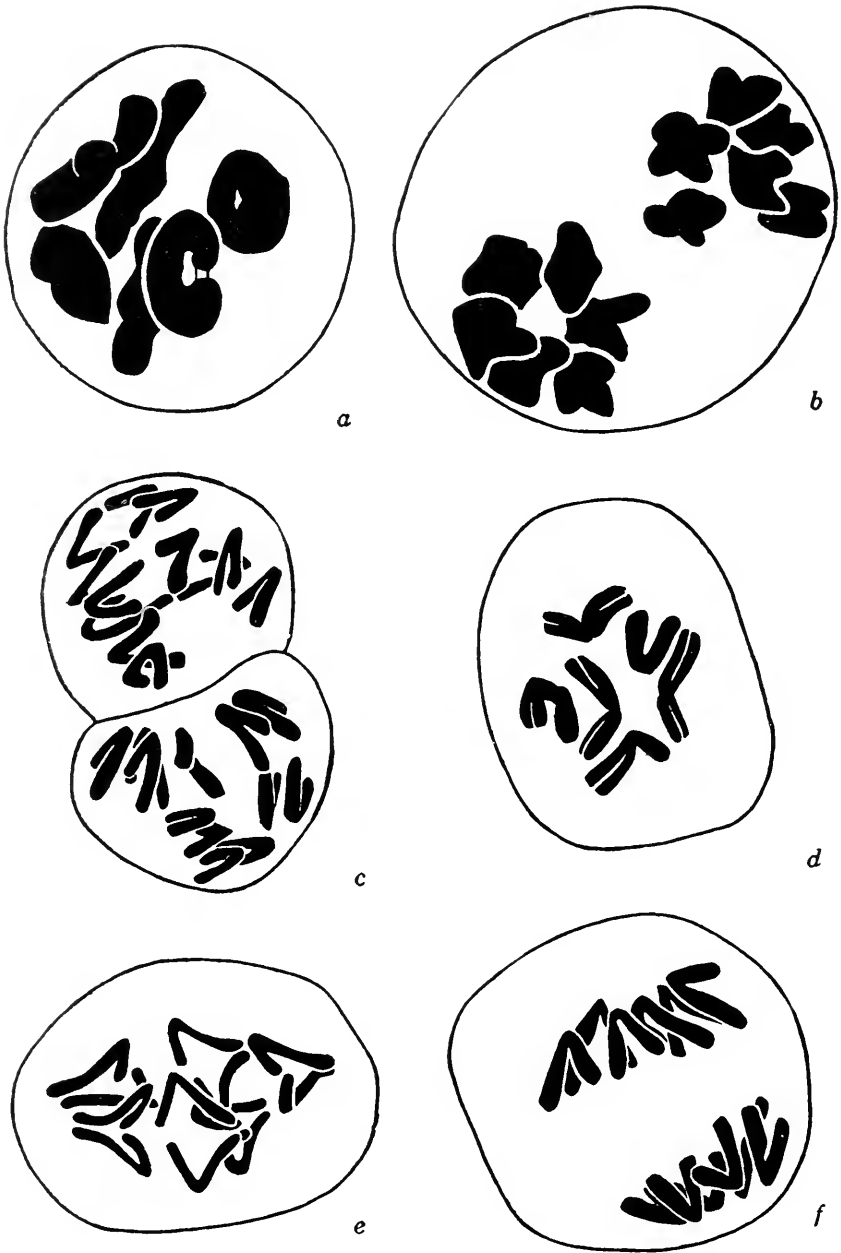

FIG. 19. Stages in the development of the pollen grains in *Tradescantia paludosa*: (a) first metaphase; (b) first anaphase; (c) second anaphase; (d) metaphase of the microspore or first postmeiotic division; (e) early anaphase, and (f) late anaphase of the microspore division. Camera lucida drawings.



FIG. 20. Two plants with excellent chromosomes for cytological study. Left, *Gasteria* sp.; right, *Tradescantia patulosa*. (Photographs by Dr. W. Brooks Hamilton.)

First Telophase. After the anaphase chromosomes have reached their respective poles, they frequently become very long and they may largely uncoil as in mitosis. A new nuclear membrane may form around each group of chromosomes, constituting

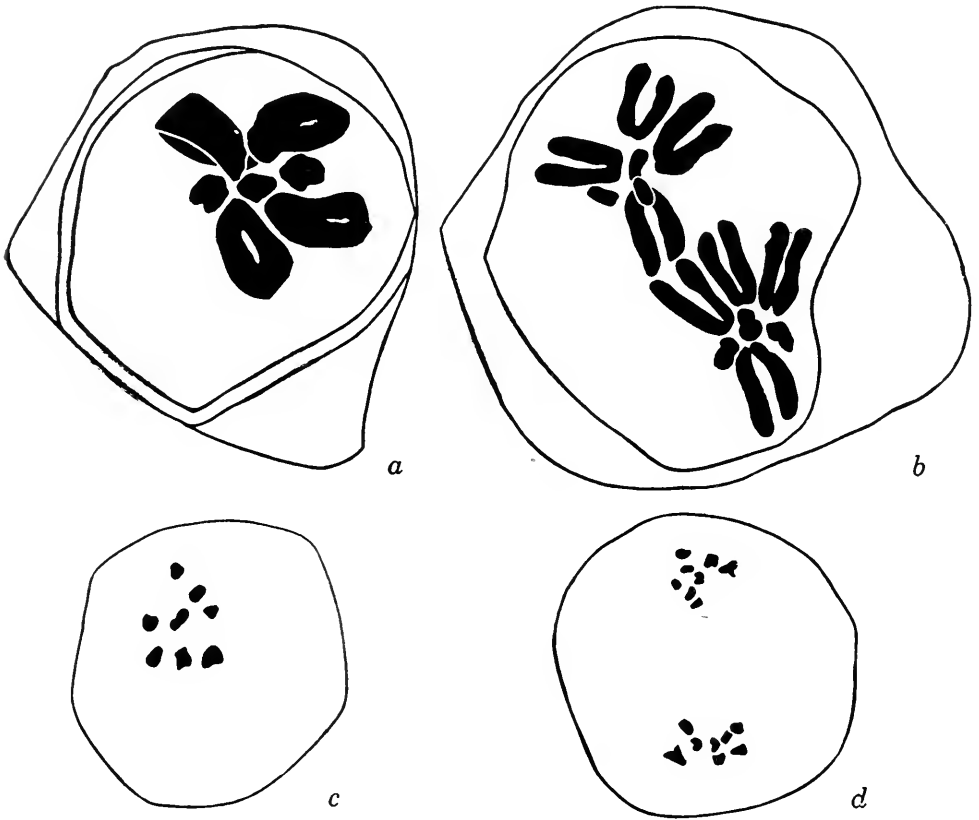

FIG. 21. Metaphase and anaphase of the first meiotic division in two plants with chromosomes of very different size: (a) metaphase of *Gasteria nigricans*; (b) anaphase of *Gasteria laetepunctata*; (c) metaphase of *Capsella (Bursa) rubella*; (d) anaphase of *Capsella grandiflora*. In *Gasteria* there are four pairs of very large and three pairs of much smaller chromosomes. In these species of *Capsella* there are eight pairs of very small chromosomes. (a) and (b) $\times 930$; (c) and (d) circa $\times 2000$. Camera lucida drawings.

two daughter nuclei, a nucleolus may appear in each nucleus, and a new cell wall may now form, dividing the original cell into two. However, sometimes the first telophase is apparently dispensed with, and the chromosomes may pass unchanged from the first anaphase into the second prometaphase.

Interkinesis. After the first telophase, the daughter nuclei sometimes go into a typical resting stage just as they do after

a somatic mitosis. This stage between the end of the first telophase and the beginning of the second prophase is known as *interkinesis*. It is usually short, and may be entirely absent. Sometimes the chromosomes seem to go into a partial but not complete resting stage between the first and the second prophase.

Second Prophase. If an interkinesis follows the first telophase it is in turn followed by the prophase of the second meiotic division. In the second prophase the chromosomes appear as double structures, the result of the "split" or separation of the chromatids *which took place at pachytene* or one whole cell division previous to their appearance here. The chromatids of each chromosome are held together by the centromere, but the arms repel one another instead of lying in close approximation as in a somatic mitosis. This arrangement gives the chromosomes a very different appearance from the prophase chromosomes of a somatic mitosis for in the second meiotic division they are X-shaped figures whereas in a somatic mitosis they are two parallel threads. In a somatic mitosis there are $2n$ prophase chromosomes, but in the second meiotic prophase the chromosomes are present in only the haploid number. During the second prophase, the nucleoli, if they appeared during the first telophase, disappear again, and finally the nuclear membranes disappear.

Second Prometaphase. When the two nuclear membranes break down, two new spindles are formed in the position of the former nuclei, and the chromosomes of each nucleus move on to the equators of their respective spindles. If a new cell wall formed at first telophase, each spindle is in a separate cell, but if the wall did not form, as is normal in many organisms, both spindles are in one cell. The two spindles may lie approximately parallel and alongside one another, as in spermatogenesis in animals or the formation of the microspore in plants. Then the four cells which form subsequently are arranged in the form of a tetrahedron. In megasporogenesis in plants, however, the spindles are oriented in the same direction and lie in the same plane; the resulting four cells are in a linear row.

Second Metaphase. As in somatic mitosis, the chromosomes are lined up with the centromeres on the equator. The repulsion of the arms found at second prophase is now completely or partially overcome, and the two chromatids of each chromosome

often lie close together as in a somatic mitosis, although they sometimes diverge. Where there is no interphase, the spindle of the first division seems to break up into two spindles just as the anaphase chromosomes of the first division have reached the poles, and the two groups of anaphase chromosomes move immediately on to the equatorial plates of the new spindles and become the second metaphase chromosomes. They usually elongate in the process.

Second Anaphase. Second anaphase begins when the daughter centromeres pull apart towards the opposite poles. The chromosomes of second anaphase are not the short, thick bodies of the first meiotic division but are much more like the anaphase chromosomes of a somatic mitosis.

Second Telophase. When the anaphase chromosomes reach the poles, new nuclei form in the usual manner. The chromosomes lengthen and almost completely uncoil, and nuclear membranes and nucleoli appear. Cell walls usually divide these two cells into four although occasionally no walls form, as in megasporogenesis of the lily. In organisms in which cell walls do form, if a wall did not form during the first telophase, the one cell with four nuclei now becomes divided into four cells.

Reduction

If an animal has 16 somatic chromosomes, at leptotene there would be 16 chromosomes and therefore 16 centromeres. After pairing and "splitting" of the chromosomes there would be 32 chromatids; but since the centromeres either do not divide or divide but remain with the daughter centromeres in very intimate contact during the first division, only 16 effective centromeres would still be present. At first anaphase, 8 effective centromeres and therefore 8 chromosomes would pass to each pole. The fact that each chromosome was composed of 2 chromatids would not make it more than one chromosome for, as long as the centromeres are intact or together, the chromosomes behave as a unit irrespective of the number of chromatids of which they are composed. Therefore, at first anaphase, 8 chromosomes go to each pole. In the second division, the daughter centromeres separate so that each chromosome now becomes two separate units. As a result of this separation of the centromeres, 8 chromosomes go to each pole at the second anaphase.

At the beginning of meiosis the primary spermatocytes and primary oöcytes of the above animal have 16 chromosomes. At the end of the first division, the secondary spermatocytes and the secondary oöcytes have only 8. Since the number is reduced half, this division is often referred to as the *reduction division*. The reduction division reduces the *number* of chromosomes and centromeres. In the second meiotic division, the chromatids of each chromosome separate from one another. Because of the "split" of the centromeres, there is no further reduction of the number of centromeres or of chromosomes in each daughter cell. It is not, therefore, a reductional division, but is often called the equation division because of the equal separation of sister chromatids to the daughter nuclei.

Usually the first division is reductional and the second equational for the *number of effective centromeres* and for the *number of chromosomes*. Because of breaks in the chromatids and the formation of new combinations of segments of chromatids at pachytene which result if chiasmata occur at diplotene, reduction is true only in a quantitative sense and is not true qualitatively for the whole of all the chromatids. If there were no exchanges of chromatids and no chiasmata (assuming that the chromosomes were still paired), the entire homologues would separate reductionally in a qualitative sense at first anaphase and equationally at second anaphase. Normally, however, one or more chiasmata are formed. In a chromosome having one long and one short arm, let us assume that one chiasma can form in the long arm but that the other arm is too short for a chiasma. The result is a chromosome passing to one pole at first anaphase which is composed of one normal chromatid plus a sister chromatid which is normal for the short arm and the part of the long arm nearest the centromere (the *proximal* part) but has a *distal* piece of a homologous chromatid. Similarly, the chromosome passing to the other pole is normal except for the corresponding distal segment. As a result, the first anaphase is reductional for the centromere, short arm, and proximal piece of the long arm, but is equational for the distal end of the long arm of one chromatid of each chromosome. Correspondingly, the second division is equational for the short arm and proximal part of the long arm but reductional for the distal portions. If more than one chiasma is present, the chromatids are more complex.

Plant morphologists have frequently called the first meiotic division the *heterotypic division*, or division different from a typical mitosis, and the second meiotic division the *homeotypic division*, or division like a typical mitosis. In number of chromosomes involved and in the position of the arms of the "split" chromosome in prophase, however, this second meiotic division differs from a somatic division.

Vegetative Reproduction

In higher plants various vegetative methods of reproduction may be found by which a new plant may arise from a piece of one of the vegetative organs of another. Such asexual methods of reproduction may be the only usual methods in some plants, and in many plants they may be of great importance from an agricultural viewpoint.

If plants reproduce by a vegetative method, whether from roots, stems, or leaves, all the new plants will be exactly like one another and like the parental plant. A group of plants produced vegetatively from *one* original plant is called a *clone*. All the plants of a given clone are alike.

Hermaphrodites

In many animals and some higher plants, each individual is either male or female; but in some animals and most higher plants, both sexes are represented in each individual. Organisms in which one individual contains both male and female sex organs are known as *hermaphrodites*. In some hermaphroditic animals, like Hydra, the sperm of one animal will fertilize the eggs of the same animal; but in the earthworm, the eggs must be fertilized by sperm from a different animal. When an hermaphroditic animal or plant produces a new individual by the union of egg and sperm from the same parent, such an organism is said to be *self-fertilized*; but when the gametes are from different individuals, such an organism is *cross-fertilized*. Many seed plants have elaborate mechanisms to ensure that they will be cross-fertilized, peas and others are regularly self-fertilized, and still others may produce seeds by either self- or cross-fertilization.

Parthenogenesis

Eggs normally require fertilization in order to develop into mature organisms, but the eggs of some plants and animals may develop without fertilization. The development of an unfertilized egg is known as parthenogenesis. Although this occurs normally in the production of certain insects such as male bees and the parasitic wasp *Habrobracon*, it can be induced in some eggs by treating them with certain chemicals or other abnormal environmental conditions.

QUESTIONS AND PROBLEMS

1. Consult books on general zoology and suggest some animals that have a more complicated life cycle than the vertebrates. What are the chromosome numbers of the various stages of some of these other life cycles?

2. Diagram the life cycle in *Ulothrix*, *Fucus*, *Nemalion*, *Polysiphonia*, black stem rust of wheat, and other lower plants. Consult textbooks on general botany or on the morphology of the Thallophytes.

3. Discuss the relative importance of the sporophyte and gametophyte in various divisions of the Plant Kingdom.

4. The number of chromosomes in the root tip cells of maize is 20. What is the number in the following cells or tissues: (a) microsporocyte; (b) tube nucleus; (c) nucellus; (d) antipodal cells; (e) cells of anther wall; (f) style; (g) embryo sac mother cell; (h) megaspore; (i) palisade cells of leaf; (j) endosperm?

5. Assume that a plant has two long and two short chromosomes. Diagram cells of that plant in (a) metaphase and anaphase of a somatic mitosis, (b) metaphase and anaphase of the first meiotic division, and (c) metaphase and anaphase of the second meiotic division.

6. Explain what is meant by relational coiling and relic coiling.

7. What is meant by Darlington's "Precocity Theory"?

8. If several chiasmata form in one arm of a chromosome and if they all terminalize, why do they all terminalize to the free end of that arm? Why do not some terminalize to the end of the other arm? Would they still all terminalize to the end of that arm if no chiasmata formed in the other arm?

9. Show by a diagram why a chiasma holds two chromosomes together at diplotene. Use colored crayons to differentiate the two homologues or, still better, use colored modeling clay.

Chapter 5

SPECIAL CHROMOSOMES AND SEX INHERITANCE

Sex and the Sex Chromosome

For most animals and a few plants, there is one outstanding and regular exception to the statement that all the chromosomes of a normal, diploid organism are in pairs and that each chromosome has a mate which is an exact duplicate of it in morphology and in the loci of which it is composed. In all individuals of *Drosophila melanogaster*, the second, third, and fourth chromosomes are present in pairs, and the first chromosome, rod-shaped and of medium length, is paired in the female. In the male,

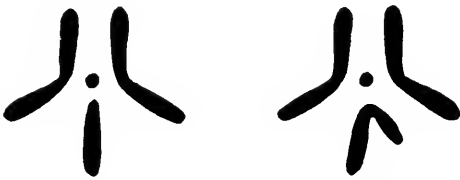

FIG. 22. Chromosomes in a female-determining (left) and a male-determining sperm of *Drosophila melanogaster*. Diagrammatic. (After Bridges in *Genetics*.)

however, only one of these medium-sized rod-shaped chromosomes is present, and another chromosome, which is longer, J-shaped, and absent in a normal female, is also present. It is customary to refer to the rod-shaped chromosome as the *X chromosome* and the J-shaped one as the *Y chromosome*. At meiosis in the male, the X and Y chromosomes separate so that all sperm carry one X

or one Y in addition to one chromosome from each of the three pairs (Fig. 22). Since females have two X chromosomes, all eggs have one X chromosome in addition to one member of each of the other pairs. The X and Y chromosomes are therefore differentials in the determination of sex. When an X-bearing sperm unites with an egg, the resulting individual has two X chromosomes and is a female. Similarly, a male is produced by the union of a Y-bearing sperm and an egg, since it has one X and one Y chromosome (Table 1).

The chromosome mechanism that explains sex in *Drosophila* is not universal as to details, and yet the fundamentals are the same in all organisms in which the sexes are separate. This type, in which the male has both an X and a Y chromosome while the female is XX, is the more general condition, although the Y chromosome is not J-shaped in all organisms, nor is it always larger than the X chromosome. In human beings, for example, the Y is a very short chromosome and is considerably smaller than the X. In human beings, 48 somatic chromosomes are present; half the sperm have one X chromosome and 23 others

TABLE 1

SETS OF AUTOSOMES (A) AND SEX CHROMOSOMES (X, Y, Z, AND W) IN FEMALES AND MALES, IN THEIR GAMETES, AND IN THEIR OFFSPRING IN DIPLOID ORGANISMS HAVING THE XY AND IN THOSE WITH THE ZW TYPE OF SEX CHROMOSOMES

	<i>XY Type</i>		<i>ZW Type</i>	
	Female	Male	Female	Male
Parents	AAXX	AAXY	AAZW	AAZZ
Gametes	AX	AX and AY	AZ and AW	AZ
Offspring	Female AAXX	Male AAXY	Female AAZW	Male AAZZ

and are female-determining, and half have a Y chromosome and 23 others and are therefore male-determining. Since the sex chromosomes are so important in determining sex, the sex of a child is determined at the time of fertilization. Because of the nature of the sex-determining mechanism, theoretically half of all children born should be boys and half girls. Actually, the ratio is about 105 boys to 100 girls, a slight deviation from theoretical expectations hard to account for. It has been supposed that the male-determining sperm move just slightly faster than the other type, but experimental proof is lacking.

In such organisms as grasshoppers and certain bugs, the female is XX and the male is XO. In other words, there is no Y chromosome, and the male thus has one chromosome less than the female. This situation, sometimes referred to as the *Protenor* type, was the first one discovered; the unpaired chromosome in the male was called the "accessory" chromosome before its function was realized. This type is similar to the *Drosophila* type except that

half the sperm have neither an X nor a Y chromosome and are male-determining.

Autosomes

In all organisms the eggs and sperm carry one member of each of the other pairs of chromosomes in addition to the X or Y chromosome. These other chromosomes are known as the *autosomes*. In *Drosophila melanogaster* there are 6 autosomes in the somatic cells of both the male and female and 3 in each gamete; in man, there are 46 autosomes in each body cell and 23 in each gamete.

Heterogametic Females

In moths, butterflies, birds, and some fishes, the situation as regards the sex chromosomes is the opposite from that in *Drosophila* and man. In these organisms, the female is the heterogametic sex. This type is generally referred to as the *Abraxas* or bird type, and the sex chromosomes in the female are usually designated Z and W whereas the male is ZZ. Inheritance of sex in these organisms is shown in Table 1.

The Y Chromosome

Apart from its frequent difference in shape, the Y chromosome differs in one marked respect from the X chromosome and from the autosomes. It generally contains at most just a few genes. Often no genes at all have been discovered in the Y chromosome, and even where genes have been found they are frequently not alleles of genes in the X chromosome. In the Y chromosome of *Drosophila melanogaster* genes that have been discovered are a gene for long bristles, which is an allele of the gene "bobbed" in the X chromosome, and two genes for male fertility which appear to have no corresponding allele in the X chromosome. The presence of the allele of *bobbed* indicates that there is one small segment of the X chromosome which is represented by a homologous segment in the Y chromosome. The remaining parts of the X chromosome have no counterpart in the Y chromosome, and almost all the Y chromosome is completely nonhomologous with the X chromosome. Apart from the few genes, the Y chromosome of *Drosophila* appears to be made up of inert material usually

called *heterochromatin* to distinguish it from the active or *euchromatic* regions. These two types of chromatin stain somewhat differently during mitosis. Although most of the Y chromosome is inert, heterochromatic material is not confined to the Y chromosome, for about one-third of the X chromosome nearest the centromere and small regions of the autosomes on either side of their centromeres appear to be heterochromatic.

As in *Drosophila*, there is an homologous segment in both the X and Y chromosomes of human beings, but this segment is small in comparison with the nonhomologous regions and only a few genes have been found in it. A number of loci are found in the X chromosome which are not represented in the Y chromosome, and several genes are known in the part of the Y chromosome not represented in the X chromosome. Some of the characters produced by genes on the X and Y chromosomes in man have been mentioned in Chapter 3.

Meiosis in the Sex Chromosomes

The meiotic behavior of the chromosomes in individuals with two X chromosomes, such as the females of many species, or with two Z chromosomes, as the males of birds and a few other animals, is exactly like the meiotic behavior of the autosomes. This is to be expected since the two X chromosomes are homologous throughout their length. Thus they pair at zygotene, exchange segments, and form chiasmata in exactly the same way as autosomes. In the heterogametic sex, however, the behavior depends upon the presence or absence of the Y chromosome and, if a Y chromosome is present, upon the extent of homology between it and the X chromosome. In organisms of the XO type naturally there is no chromosome with which the X chromosome can pair (Fig. 23). It will usually pass intact to one or the other pole at the first meiotic anaphase and divide equationally at the second. If it does so, it goes to the pole either before or after but never at the same time as the autosomes. Sometimes the univalent X chromosome divides equationally at the first division and reductionally at the second. In either case only two of the four resulting cells contains an X chromosome. In the XY type in most organisms, pairing may occur between the X and Y chromosomes provided they have a segment in common, but pairing is always between homologous

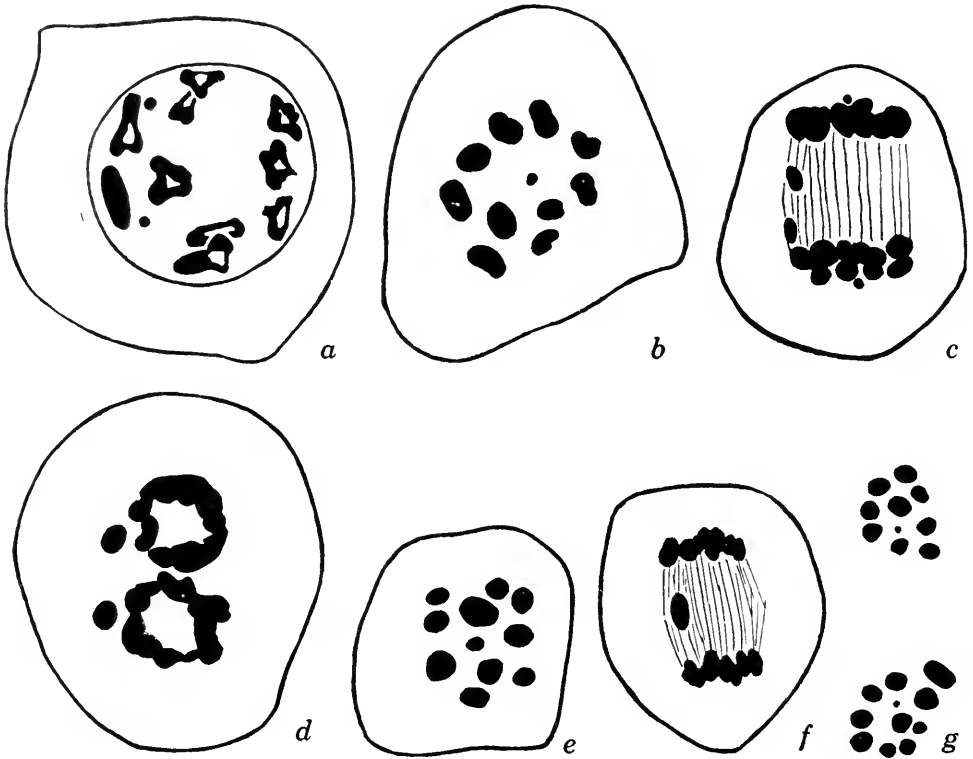

FIG. 23. Meiosis in a male squash bug, *Anasa tristis*. The sex chromosomes in the female sex are XX and in the male XO. (a) Late prophase of division of primary spermatocyte showing nine bivalents, one unpaired X chromosome, and two small univalents which have not paired but will pair as the spindle forms. (b) First meiotic metaphase in polar view; the paired small chromosomes are in the center and the large X chromosome is toward the outside of the principal ring. (c) First anaphase; the small chromosomes separate in advance of the others; the X chromosome divides equationally at the first division and is shown separating to the poles slightly later than the autosomes (which are dividing reductionally). (d) First telophase; the X chromosomes appear to be outside the principal ring formed by the others. (e) Second metaphase in polar view. (f) Second anaphase; the X chromosome passes undivided to one pole but later than the others; the equational splitting at the first division and the passing reductionally at the second spermatocyte division have been termed *postheterokinesis*. (g) Second telophase; one cell has nine large and one small autosomes, and the other has nine large and one small autosomes and one X chromosome. $\times 1425$. Camera lucida drawing.

parts only. If the homologous parts are not too short, chiasmata are formed, and genes are exchanged between the two chromosomes. Since nonhomologous parts do not pair, there is no exchange of segments between them and no chiasmata are formed, but the presence of large nonhomologous regions does not prevent pairing in homologous parts.

Sex Chromosomes in Plants

Most seed plants are monoecious—that is, both sexes are present on each plant. There is no sex chromosome mechanism, and sex is not a problem of heredity but one of differentiation during development. In some species of plants, however, each individual is either male or female. In some of these plants a sex mechanism has been discovered like that in animals. In *Lychnis dioica*, G. H. Shull showed from genetic grounds that the male was heterogametic. Definite X and Y chromosomes have been found in *Elodea canadensis*, *Melandrium album* (which is partially synonymous with *Lychnis dioica*



FIG. 24. Metaphase of first meiotic division in a diploid male plant of *Lychnis* (*Melandrium*). Eleven pairs of autosomes are present and one pair which consists of the X and Y chromosomes. Photomicrograph $\times 1400$. (Courtesy of Dr. H. E. Warmke in the *American Journal of Botany*.)

since it was included in Shull's *L. dioica*), hops, poplar, and other plants (Fig. 24); inheritance in these plants is of the *Drosophila* type. One seed plant, *Fragaria elatior*, is of the *Abraxas* type. In species of the dock, *Rumex*, the male is heterogametic for sex, but has two small Y chromosomes and one large X. The two Y chromosomes separate from the X at meiosis, and a male gamete with two Y's produces a male on fertilization whereas one with the one X produces a female.

Salivary Gland Chromosomes

After fertilization in *Drosophila*, the egg is laid in moist food and proceeds to hatch out into a small, crawling larva. Inside the larva, extending back from the mouth a distance of one-fourth to one-third the length of the entire body, are two large

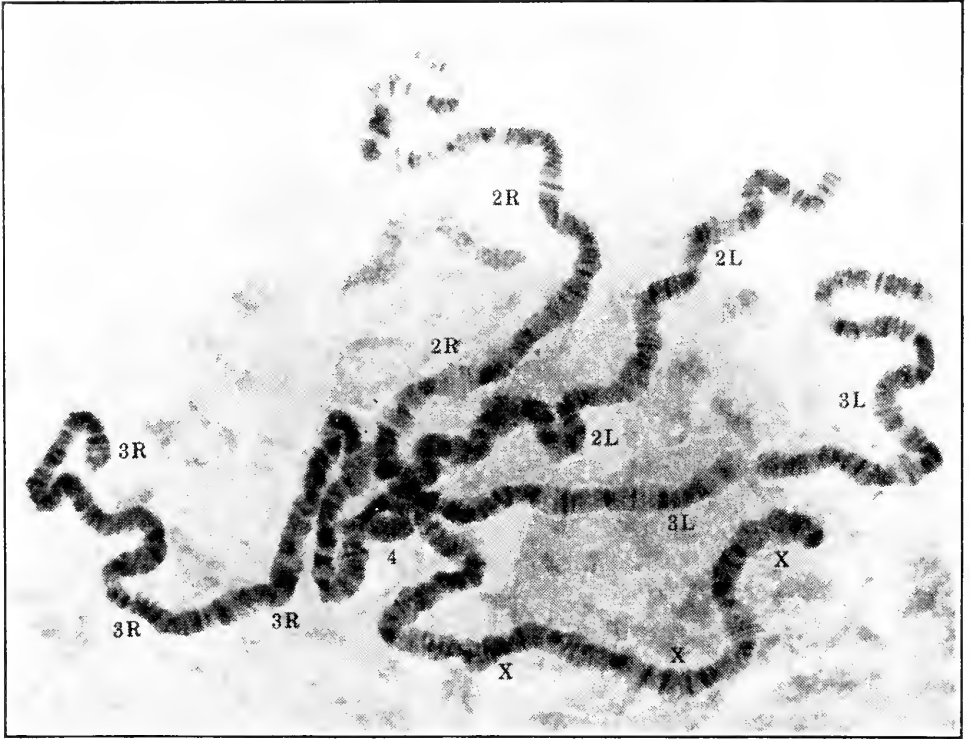

FIG. 25. Chromosomes in a cell of the salivary gland of *Drosophila melanogaster*. (Courtesy Dr. B. P. Kaufmann.)

salivary glands. These glands have cells so large that they can easily be seen with the low powers of a dissecting microscope. The nuclei of these cells are much larger than those of ordinary cells, being generally about $25\ \mu$ in diameter, and the chromosomes in the nuclei are so large that they are 50 to 200 times as large as the chromosomes in the reproductive cells or in the ordinary body cells of this organism (Fig. 25). Such large chromosomes are characteristic of the salivary glands, the rectal epithelium, and the Malpighian tubules of the entire group, the Diptera, to which *Drosophila* belongs. They were first observed in 1881 by Balbiani in the related organism, *Chironomus*. Their

possibilities as a tool for studying genetics were not realized for a long time, and during the end of the last century and the early part of the present century they were merely regarded as a puzzling curiosity of no known significance or importance. A little over fifty years after discovery these large chromosomes were correctly interpreted by Heitz and Bauer in *Biblio hortulanus* and by Painter in *Drosophila*, and since then they have been studied very intensively.

In addition to being much larger than ordinary chromosomes, the chromosomes in the salivary gland nuclei are atypical in several other respects. Although the nuclei in which these chromosomes are found are not dividing and will not divide again, the chromosomes are not in a typical resting stage but appear to be in a permanent prophase stage with the two homologues of each pair of chromosomes closely paired throughout their length. The pairing of homologous somatic chromosomes is certainly not general but is common in the Diptera, where it occurs in other somatic cells as well as in salivary gland cells. The salivary gland chromosomes are therefore mitotic prophase chromosomes which have uncoiled and lost the "relic coils" of the previous division and which show a marked somatic pairing.

Striations and Bands

Ordinary somatic chromosomes consist of one or two thin chromonemata or gene strings, but the number of chromonemata in these giant chromosomes is considerably greater. In typical somatic chromosomes, the division of the chromonemata is shortly followed by the division of the chromosome itself, so that the number of chromonemata in a chromosome is never large. In the salivary gland chromosomes of the Diptera, the chromonemata divide a number of times, but these divisions are not accompanied by division of the chromosome as a whole. The result is that a number of these fine threads will be embedded in a common matrix. The number varies with different members of the group. In *Drosophila* it appears to be about 64, but in other members of the Diptera the number is larger. In *Chironomus* it is about 400. These chromonemata are completely uncoiled and lie parallel and close to one another throughout the length of the chromosome. They are not uniformly thin,

but contain a large number of deeply staining chromomeres, some large, some small, arranged so that the threads appear like strings of loosely strung beads of different sizes. Since all the chromonemata within a common matrix arose from one original chromonema by successive divisions, they should be alike. Apparently they are, for the chromomeres on one chromonema are identical in size and position with the chromomeres on the sister chromonemata. All the chromonemata have a chromomere at exactly the same place on the thread. Since the chromonemata are very close to one another, the chromosomes are in contact laterally. An aggregation of identical chromomeres on the numerous chromonemata appears as a cross-band or disc at right angles to the long axis of the chromosome. One of the outstanding features of these giant chromosomes is the presence of these numerous cross-bands which differ in thickness and in staining capacity and are at various distances apart. Their properties depend upon the size and nature of the chromomeres of which they are composed.

One other feature of the bands is of great genetic significance. In size, position, and sequence the bands in one chromosome are *identical* with those in the homologous chromosome. Therefore, when the two homologues are paired, as they always are in the salivary glands, the bands of one must lie exactly alongside the corresponding bands of the other. This is strictly true. Pairing of two homologous salivary gland chromosomes is very precise, just as it is in zygotene of meiotic chromosomes. This is so universal a rule, that if a piece of one of the paired homologues involving several bands is deleted by X-rays, the bands of the other homologue corresponding to those deleted have no bands with which to pair and form a loop to one side. The missing bands in no way alter the pairing of the bands which are present in both homologues. One of the valuable features of these giant chromosomes is the evidence they give of the nature of chromosome pairing.

Bands and Genes

The bands appear to contain a large amount of nucleic acid, whereas the nonstaining or lightly staining regions between the

bands appear not to contain so much nucleic acid. The many chromonemata that make up the salivary gland chromosome are composed of bundles of fibers of complex organic chemical substances known as polypeptids. Part of these bundles of polypeptid fibers attract nucleic acid, and the remaining parts do not. The parts that contain the nucleic acid stain deeply and form the chromomeres. The fusion of such adjacent deeply staining regions produces a band. If all the chromomeres do not fuse laterally, the band appears as broken. The exact relation between the bands and genes cannot easily be determined. By means of X-rays, certain flies can be produced which have a marked notch in the wing. When the salivary glands of larvae from such flies are examined, one of the bands is usually seen to be missing from one of the chromosomes, although not from its homologue. The many examples of such notch-winged flies that have been found point to the conclusion that every locus corresponds to at least one band. The bands are therefore in some way correlated to genes although it cannot be said definitely that a band is a gene.

The Chromocenter

Salivary gland chromosomes exhibit one peculiarity not found in other chromosomes. It has been shown that the Y chromosome is made up largely of heterochromatin and that the X chromosomes and autosomes have heterochromatic material around their centromeres although they consist mostly of euchromatin. This condition has little effect upon their behavior in meiotic or in ordinary somatic cells, but in the cells of the salivary gland of *Drosophila* it has a striking effect. In these cells, all the heterochromatic material of *all* the chromosomes is fused into a mass from which the euchromatic material extends like tentacles. The entire chromatic material appears like an octopus, with a heterochromatic body and five long and one short euchromatic arms. The long arms are the right arm and left arm of both the V-shaped second and third chromosomes and the rod-shaped X chromosome, and the very small fourth chromosome makes up the sixth projection. In the female, all six arms are of uniform thickness for each consists of two paired homologues. In the male, the X chromosome, since it is an unpaired structure,

is noticeably thinner than the corresponding chromosome of the female and is thinner than the autosomes of both sexes. The Y chromosome of the male forms part of the chromocenter.

The chromocenter is not a characteristic of dipteran salivary gland nuclei, although it is a prominent and characteristic feature of *Drosophila*. In forms like *Chironomus* and *Sciara* there is no such union of heterochromatic material, and the chromosomes are independent units in the same number as in typical somatic cells.

“Lampbrush” Chromosomes

Another unusual type of chromosome has recently received considerable attention. In some animals, including amphibians and birds, during the maturation of the egg, the chromosomes of the first meiotic prophase may increase greatly in length. This increase occurs in those forms whose developing eggs remain in the prophase for a considerable time. The homologous chromatids pair normally, but their chromonemata then proceed to become extended by uncoiling. As this continues, outgrowths which are very fine threads appear from the sides of the chromonemata. They grow out approximately perpendicular to the chromonemata and then bend around into loops. These loops always appear in a certain order on the main thread, being of a characteristic number and a characteristic distance apart from one another. It has been suggested that they give forth substances into the cytoplasm which exert an action in directing the development of the egg, but they need more study for a completely satisfactory explanation of their behavior.

QUESTIONS AND PROBLEMS

1. Show by diagrams how the X chromosome and the Y chromosome would pair at meiosis if the X chromosome were rod-shaped and the Y chromosome were J-shaped if: (a) the long arm of the Y chromosome were completely homologous with the X chromosome; (b) the proximal part of the long arm of the Y chromosome were homologous with an interstitial segment of the X chromosome; (c) there were no homologous parts in the X and Y chromosomes.

2. Discuss the possibilities (a) that maleness is determined by the presence of a Y chromosome and (b) that sex is determined in a diploid animal by either one or two X chromosomes.

3. Does the presence of two X's or of an X and a Y have any effect on the somatic divisions of an organism? If so, what is the effect?
4. By a series of diagrams show how the formation of many new chromonemata within a common matrix could produce banded structures such as are found in salivary gland chromosomes.
5. What is the significance, if any, of the chromocenter? Is it an essential feature of salivary gland nuclei?

Chapter 6

THE GENETIC DISTRIBUTION OF A PAIR OF ALLELES LOCATED IN AUTOSOMES

It has been shown that plants and animals may be homozygous for a dominant or for a recessive gene or that they may be heterozygous. For example, an evening primrose plant may be homozygous for the recessive gene, *bullata*, and have short, crinkled leaves, or it may contain the dominant allele, in which case it will have noncrinkled, or normal, leaves. In the four-o'clock, plants which are homozygous for the gene for red will have the character, red flowers, and those homozygous for white, the allele of red, will have the character, white flowers. As these genes do not exhibit dominance, the character shown by the heterozygote is pink flowers. Obviously, it is the gene and not the character that is transmitted from generation to generation since germ cells do not have such structures as leaves and flowers. The method by which the genes are distributed is one of the most important and best-understood problems of the science of genetics.

Since the genes are located in the chromosomes, the problem of the distribution of genes is inseparable from the problem of the distribution of the chromosomes. The behavior of the chromosomes in the formation of spores, gametophytes, gametes, and zygotes has already been pointed out. The next step is to study the behavior of a pair of chromosomes which contain a certain known pair of alleles. In the second chromosome of *Drosophila melanogaster* the locus of *c*, the gene for curved wings, is found about three-fifths of the distance (genetically) from the end of one arm. The other five hundred odd genes in this species can be ignored for the present and observation can be limited to gene *c* and its allele, *C*. In cooperation with a large number of non-allelic wild-type genes, *C* produces normal wings. When only one pair of genes is under consideration, the situation is simple. Organisms which are heterozygous for only one pair of alleles or

organisms in which only one pair of alleles is being studied are called *monohybrids*. Some interesting characters in maize determined by single genes are shown in Fig. 26, and a striking structural character in Shepherd's-purse in Fig. 27.

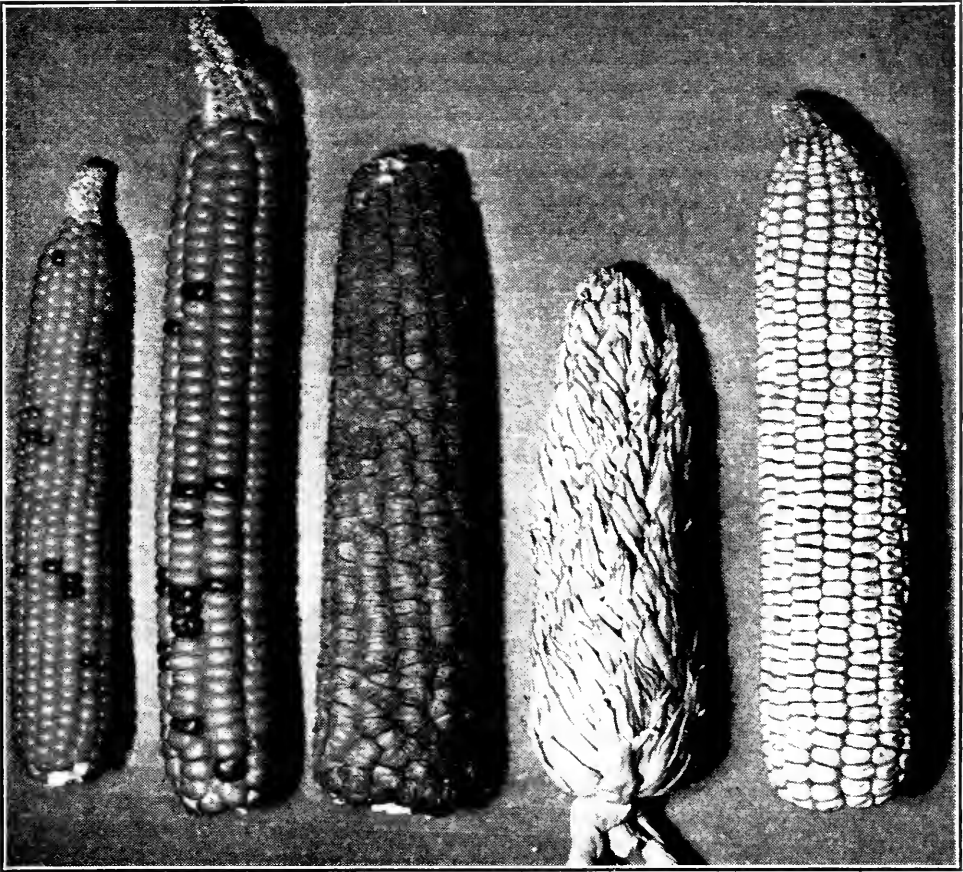

FIG. 26. Some interesting inherited types in *Zea mays*. Left to right, pop, flint, sweet, pod, and dent. The sweet and floury types appear to differ from flint by single recessive genes, and the pod type by a dominant, but popcorn and dent probably differ by a number of interacting genes. (Photograph by Dr. W. Brooks Hamilton.)

If a fly is homozygous for curved wings, it will have two *c* genes, one in each homologue. Since the two homologues separate at meiosis the two *c* genes must separate, or *segregate*, also. Since each gamete has only one member of chromosome II, it can have only one *c* gene; and since the fly is homozygous, all its gametes must be alike. Similarly, in flies homozygous for the dominant allele, all the gametes must have gene *C* and must have only one

such gene, for meiosis operates in the same manner in a dominant as in a recessive. In the heterozygote, one chromosome bears C and the homologous chromosome bears c . Since these chromosomes separate during meiosis and enter different gametes, every gamete must have C or c , but *never both*. Theoretically, exactly half the gametes of the heterozygote would have C and exactly half would have c . *The two genes at a given locus segregate from*

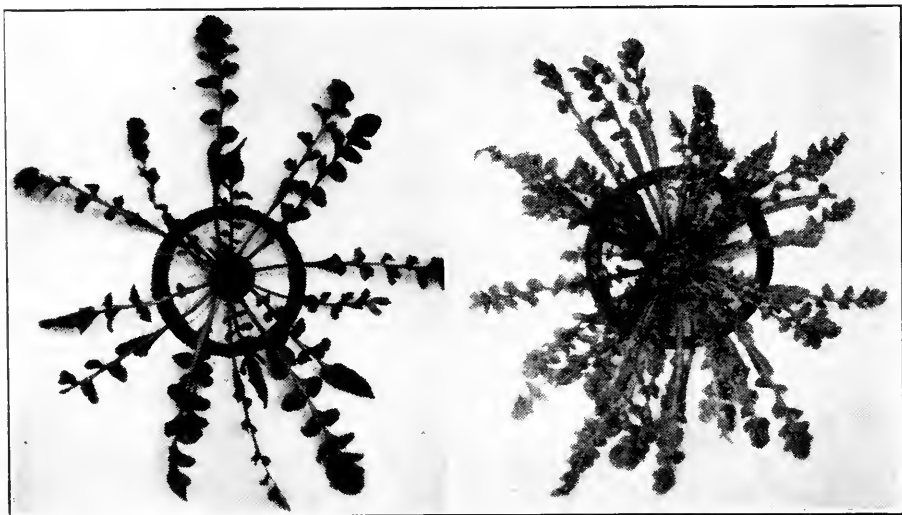

FIG. 27. A single gene difference in Shepherd's-purse: *left*, a rosette of *Capsella (Bursa) grandiflora* and, *right*, a rosette of *C. Viguieri* of the same age. The latter type possesses a dominant gene which produces a heavy fasciation of the stem.

one another at meiosis; as a result, only one member of the pair of alleles is present in each gamete. This separation of the two genes at any locus is the principle involved in *Mendel's first law*, often called the *law of segregation*. The behavior of the genes in the formation of gametes and plant spores is merely a function of the behavior of the chromosomes.

The genetic constitution of an organism is the result of the particular gametes which happen to unite when that individual is formed. For example, if an egg bearing C is fertilized by a sperm which has the C gene, a homozygous normal-winged fly is produced. If both the egg and sperm happen to contain the gene c , the resulting individual will have curved wings. If the egg is C and the sperm c , or if the egg is c and the sperm C , the new fly will be genotypically heterozygous and phenotypically wild type.

It can be seen, therefore, that all the offspring of a homozygous dominant will be phenotypically dominant *irrespective of the genetic constitution of the other parent*, since all the gametes of the homozygous dominant would contain the dominant gene.

If a homozygous wild type is crossed with a curved, all the offspring will be heterozygous and will look like the dominant parent. The generation of the parents is called the *parental*, or P_1 , *generation*; the generation of the offspring is known as the *first filial*, or F_1 , *generation* (pronounced "eff one"). Since all the F_1 flies are alike genotypically, all will produce the same kinds of gametes. Since all are heterozygous, one half the gametes of each fly will be C and the other half will be c . If two F_1 flies are mated together, the grandchildren of the original two parents will be produced. This generation is known as the *second filial*, or F_2 , *generation*. One half the eggs of the F_1 fly which is used as a female will contain C and one half will contain c . Similarly, the male F_1 fly will produce C and c sperm in equal numbers.

Whether a C -bearing sperm unites with a C or with a c egg is a matter of pure chance as the probabilities are theoretically even. The same is true for the sperm which bear c . The chance that a C egg will be fertilized by a C or by a c sperm is exactly even, and the same is true for a c egg. Therefore, four combinations are possible in the F_2 and will exist in equal numbers: CC , Cc , cC , and cc . Since Cc and cC flies are alike genotypically, the nature of the F_2 can be written as a ratio of $1CC : 2Cc : 1cc$. In terms of fractions, the F_2 population will be $\frac{1}{4}CC : \frac{1}{2}Cc : \frac{1}{4}cc$. These ratios, however, are genotypic. As both homozygous C and heterozygous flies are phenotypically alike, the phenotypic F_2 ratio is 3 normal-winged : 1 curved or $\frac{3}{4}$ normal and $\frac{1}{4}$ curved. This is shown diagrammatically in Fig. 28, in which the method of arriving at the F_2 is determined by the conventional "checkerboard." It must be understood that if only four flies are produced, three of them will not necessarily be normal and one curved. This ratio is theoretical, based on chance, and means that out of a large number of cases, approximately three-quarters will be normal and approximately one-quarter will be curved. The larger the number of F_2 flies, the more nearly the numbers obtained may be expected to approximate the theoretical ratio.

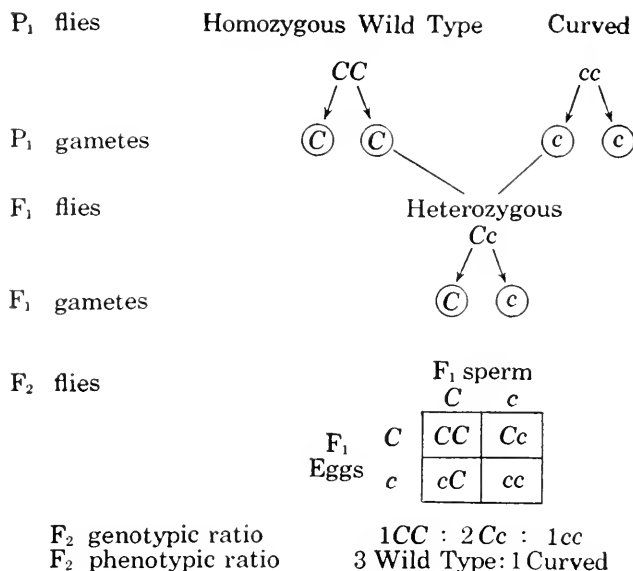

Backcross of F₁ to
Dominant Parent

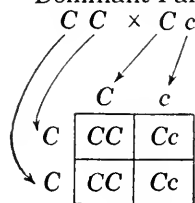

All Wild Type

Backcross of F₁ to
Recessive Parent

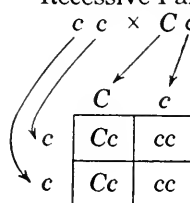

1 Wild Type: 1 Curved

FIG. 28. The checkerboard method of determining the F₂ and backcross generations. A cross between a wild-type female (CC) and curved winged male (cc) produces a heterozygous wild type (Cc). The eggs of the F₁ are C or c as are the sperm. Since either kind of sperm can unite with either kind of egg at random, four possible kinds of F₂ individuals will be produced in equal numbers; but since two kinds are alike, the F₂ genotypic ratio will be 1CC : 2Cc : 1cc. Since dominance is complete, the F₂ phenotypic ratio will be 3 wild type : 1 curved. The backcrosses of the F₁ to the dominant and to the recessive parents are indicated in the lower half of the figure.

Backcross

If an F₁ fly is mated with one of its own parents, the cross is called a backcross. If the F₁ is backcrossed to the dominant parent, all the offspring will be alike phenotypically although genotypically half will be CC and half Cc. If the backcross is made with the recessive parent, one half the offspring will be genotypically Cc and the other half will be homozygous for the

c gene. The phenotypic ratio when the F_1 is backcrossed to the recessive parent is 1 wild type : 1 curved. The 1 : 1 ratio will be obtained whenever any heterozygote is crossed with a homozygous recessive. "Backcross" is literally appropriate only when an F_1 animal or plant is crossed with one of its own parents. At other times "testcross" is more appropriate, although the terms are frequently used indiscriminately.

Testcross

The cross of a heterozygote with a recessive will give a 1 : 1 ratio whereas a cross between a homozygous dominant and a recessive will produce only dominants. Use can be made of these facts to test whether a dominant plant of unknown ancestry is homozygous or heterozygous. In certain varieties of lupines, red flowers are dominant over white. If a commercial seed house wishes to market seeds of a red variety of lupine, claiming that only red-flowered plants will be produced, and if they have a number of red-flowered plants from which to obtain their seeds, they must know the genotypes of the plants before they can market seeds from them with a guarantee that all will yield plants with red flowers. If the red-flowered plants used for seed are homozygous, all the seed from them will produce red-flowered plants; but if some are heterozygous, one-fourth of the seed from those plants will produce plants with white flowers. If the company guarantees the seeds to produce only red-flowered plants, it must know which of the plants are heterozygous and which will breed true for red flowers. One of the most widely used methods of testing them is to cross them with recessive, white-flowered plants. Those plants which produce only red-flowered offspring, when mated with recessives, are the homozygotes and are used to produce the red-flowered seed for the market. Those, on the other hand, that give approximately equal numbers of red- and white-flowered plants when crossed with the recessive are heterozygotes and worthless for this particular purpose. A cross of a dominant of unknown genotype with the recessive is a widely used method of determining the genotype of phenotypically dominant plants and animals.

Practical Considerations in Using the Testcross. It is obvious that the method of the testcross is not the only way of determining whether a plant is homozygous or heterozygous. Self-fertiliz-

ing a plant and raising the offspring would accomplish the same result. To be certain of including a sufficient number of recessives to establish the nature of the unknown within the realm of probability, however, the seedsman would have to grow a much larger number of plants from a selfing than from a testcross. The use of seed from a self-pollination would require more land than seed from a testcross, and that land might be used more profitably for another purpose; it also would require more labor to pot and set out the additional plants required by this method. Usually, therefore, the testcross method is more practical from an economic viewpoint. However, the best method to use is also determined in part by the nature of the plant under consideration. Each flower of wheat produces one seed. This plant is self-fertilized with no difficulty, but the labor involved in making over a hundred hand pollinations is a great item of expense. For wheat, the expense of making the crosses might outweigh that of the additional land and labor necessary for a test by self-fertilization and might make testcrossing impractical. The situation would be different for a plant like tobacco where one hand pollination would produce several hundred seeds; for it the testcross method would be more desirable.

Species of animals in which the individuals are of one sex only are tested by the testcross method as it is obviously impossible to self-fertilize them. It would be possible to test an unknown dominant animal by crossing with a known heterozygote, but such a method would be no simpler than to cross with a recessive and would require a greater number of offspring so as to be sure to include a reasonable number of recessives.

Incomplete Dominance

When a homozygous dominant is crossed with a homozygous recessive, the F_1 is phenotypically like the dominant parent and the F_2 splits into three dominants to one recessive if dominance is complete. When dominance is incomplete, however, the F_1 does not resemble either parent and the phenotypic ratio in the F_2 is identical with the genotypic ratio. In the four-o'clock, a red-flowered plant, WW , crossed with a white-flowered plant, ww , would give a pink-flowered F_1 , Ww ; this, when selfed, would show a segregation in the F_2 into 1 red (WW) : 2 pink (Ww) : 1 white (ww).

Another striking case of incomplete dominance is the often-cited blue Andalusian fowl. This variety is a heterozygote and can be produced only by crossing a black with a white. There is no dominance, and the F_1 from such a cross is neither black nor white but a peculiar intermediate shade called "blue" (Fig.



FIG. 29. A blue Andalusian female. This type is the heterozygote from a cross between certain black and white types. Therefore it never breeds true when crossed with a blue Andalusian male, but produces a ratio of 1 black : 2 blue : 1 white. In the female the neck feathers are dark blue. In the male the back and saddle feathers, in addition to the neck feathers, are almost a solid blue. (Courtesy of Dr. M. A. Jull.)

29). Since the blue fowls are always heterozygotes, they cannot possibly be made to breed true. When two blue fowls are mated, the offspring are in the ratio of 1 black : 2 blue : 1 white. When a blue is mated with a white the offspring are 1 blue : 1 white, and when a blue and a black are crossed the resulting ratio is 1 black : 1 blue.

An interesting dominance relationship is found in certain crosses between horned and hornless sheep. In Dorset Horn sheep, the males have very large horns and the horns of the

females are smaller. If Dorset sheep are crossed with a hornless breed such as the Suffolk, the F_1 females are hornless, but the males have horns, although these horns are considerably smaller than those in the pure Dorset Horn breed. Dominance of hornlessness is complete in the females and incomplete in the males.

Reversal of Dominance

If dominance is complete, the dominant character occasionally may develop more slowly in the heterozygote, in which there is only one dominant gene, than in the homozygote, in which two dominant genes are present. Shepherd's-purse, *Capsella bursa-pastoris*, is a good example of this. A gene, A , produces sharp leaf lobes, whereas its allele, a , produces rounded lobes. If a plant homozygous for A is crossed with a recessive, the F_1 plants resemble the recessives when young, but their leaf lobes gradually elongate and become pointed as they mature. In the mature condition the heterozygous F_1 plants are unmistakably like the homozygous dominants. In the F_2 when young plants are examined, the ratio appears to be 1 pointed lobe : 3 round lobes, but in the adult condition the ratio changes to 3 pointed : 1 round, as the dominant gene in the heterozygote comes into expression. The gene which produces the elongation of the lobes acts more slowly when present in only half quantity, but the mature heterozygotes are indistinguishable from the homozygous dominants.

Reciprocal Crosses

It is conventional in writing crosses (except in human genetics) to write the female first and the male second. The cross, wild type \times curved, means that a normal-winged female is mated with a curved-winged male, and curved \times wild type means that a female with curved wings is mated with a normal-winged or wild-type male. The cross curved \times wild type is known technically as the *reciprocal* of the cross wild type \times curved. For genes on autosomes the results are generally the same no matter in which direction the cross is made. The F_2 of the cross curved \times homozygous wild type segregates into 3 wild type and 1 curved just as did its reciprocal. In testercrosses, also, the results are the same no matter in which direction the cross is

made when dealing with genes in autosomes. Thus the offspring of the F_1 and the curved parent are 1 wild type : 1 curved no matter whether the F_1 or the curved fly is used as the female.

Distribution of Genes in Human Beings

In Chapter 3 a number of genes were mentioned which are known to produce certain inherited characters in human beings. These genes act on the developing organism in apparently the same manner as genes in other animals and in plants. They are also repeated in succeeding generations in exactly the same way as genes in other organisms. Since, however, human families are normally smaller than most other animal families, and since large numbers of offspring are never produced comparable to families of plants, it is not always so easy to determine the mode of inheritance of genes in human beings.

An interesting example of the transmission of a human trait is shown in Fig. 35a, page 102. A man who was born with crooked little fingers married a woman with normal fingers. From this marriage six children were produced. Since four had crooked fingers and two did not, it appears very probable that this trait was inherited. From this information we can infer either that crooked fingers are the result of a dominant gene and that the male parent is heterozygous or of a recessive and that the mother is heterozygous. Either way, a family in which four had crooked fingers and two had normal ones could be produced. One daughter with crooked little fingers married a normal man and produced two children with crooked little fingers. A son with the trait married a normal woman and produced two normal children. Another daughter with the character married a normal man and had one normal daughter and one with crooked little fingers, and the other affected child of the original mating had three daughters, all of whom had crooked little fingers.

If we assume that crooked little fingers are produced by a dominant gene, all the F_1 individuals with crooked little fingers would be heterozygous. Therefore, when four of them married normal recessive individuals, each family should have affected and normal people in equal numbers. Since, however, all families had only two or three children, it is quite within the limits of probability for all the children of any one family to be either affected or normal. None of the four families disagrees with

the theory that the gene producing minor streblomicrodactyly is a dominant gene.

If a recessive gene caused minor streblomicrodactyly, the normal individuals who produced some offspring with crooked little fingers were heterozygous for this recessive gene. Although this is possible, it is improbable that at least three out of four normal people apparently selected at random would have the gene for crooked little fingers in a heterozygous condition, for if this were true, we should expect to find many more people with crooked little fingers. If we add to these a fourth individual who also produced a child with minor streblomicrodactyly, the theory of a recessive gene as the causative agent becomes even more improbable. It is much more probable that a dominant gene is involved (although it is also explainable on an assumption of low penetrance). In dealing with such problems we must first rule out all explanations that are impossible. Then, of the possible explanations, we should select the most probable at least as a tentative hypothesis, realizing, of course, that high probability is not the equivalent of certainty.

Inheritance of Multiple Alleles in Autosomes

It was shown in Chapter 2 that more than one allele may be present at the same locus of several homologous chromosomes although, of course, there is only one in each chromosome and therefore there would be only two in any one diploid individual. In sheep, three such alleles have been found and are designated H , H' , and h . In the female, gene H is dominant to the other two, and gene H' is recessive to H and dominant to h . In the males, incomplete dominance is found and leads to more complicated results.

Such breeds as the Shropshire, Southdown, Cotswold, and Suffolk are hornless in both sexes, and, in the place of horns, small depressions are found in the skull (Fig. 30). These strains have been bred for a long time and are homozygous for H . Gene H' is found in the Dorset Horn breed from Dorsetshire. In this breed the male has very large horns and the female also has horns, although hers are smaller than the male's. Purebred strains of this type are homozygous for H' . The Merino group, including the Rambouillet, is the recessive; the males have smaller horns than the males of the Dorset Horn breed and the females are

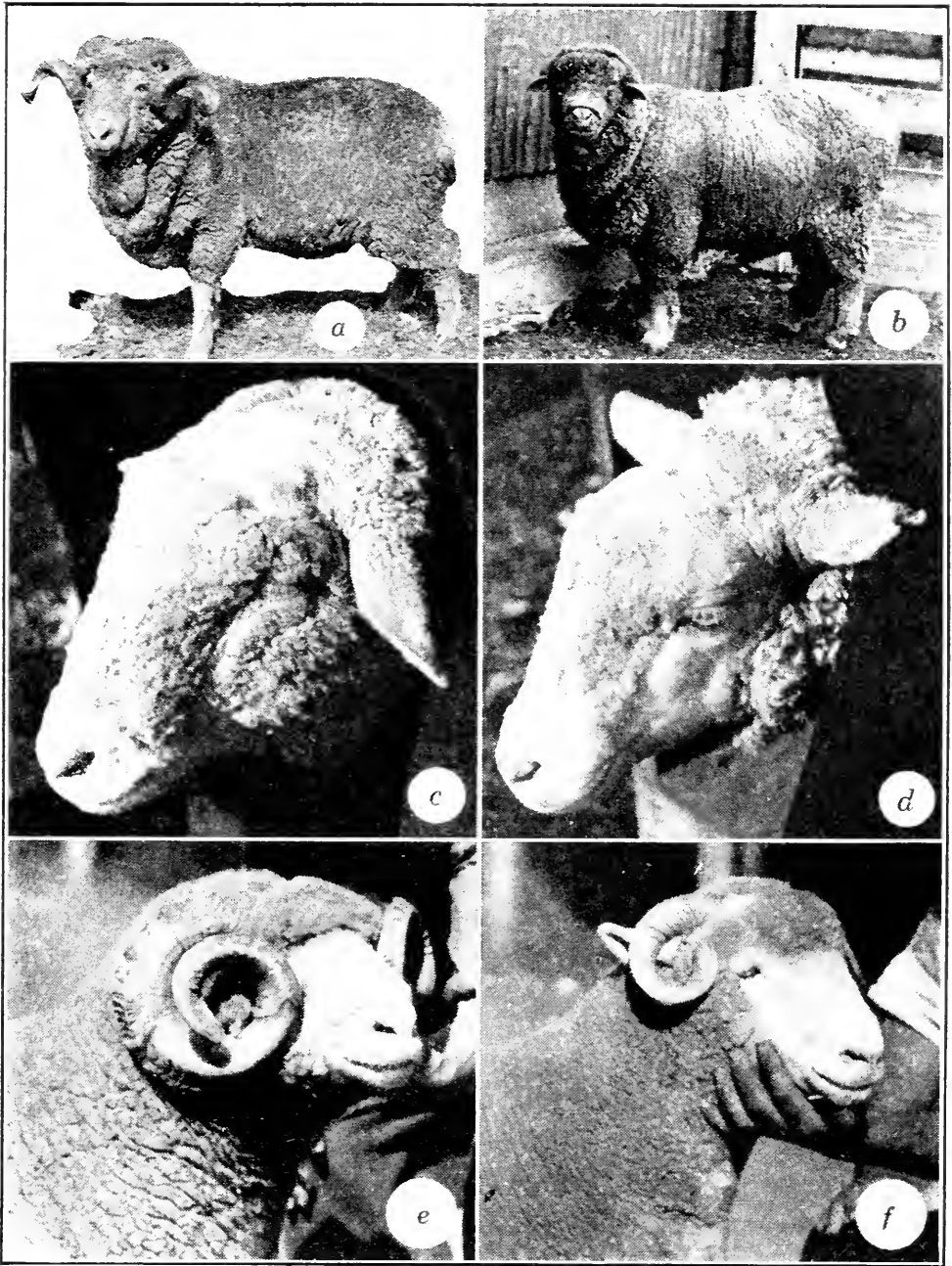

FIG. 30. Types of horns in sheep. (a) Merino rams showing typical horns of the Merino-Rambouillet type. (b) A Rambouillet ram homozygous for hornless. (c) A "horned" Rambouillet ewe with wool clipped to show the knobs which sometimes break through the skin to form scurs. (d) Hornless ewe with depressions instead of knobs or scurs. (e) A Dorset ram. (f) A Dorset ewe. Genotypes are: (a), hh ; (b), HH ; (c), hh ; (d), HH or Hh ; (e) and (f), $H'H'$. (Figures (a) through (d) courtesy of Dr. B. L. Warwick; (e) and (f) from J. F. Abernathy, Chicago. From Warwick and Dunkle in the *Journal of Heredity*.)

hornless. The hh females can be differentiated from the H females by the small growths, or scurs, and not depressions, which they have in place of horns. Hornless (HH) crossed with Dorset horns ($H'H'$) gives only hornless females (HH'), and hornless by Merino (hh) gives only hornless females (Hh). When Dorset is crossed with Merino, the females are horned like the Dorset parent and are heterozygous ($H'h$) (Fig. 31). Other examples of multiple alleles are found in later chapters.

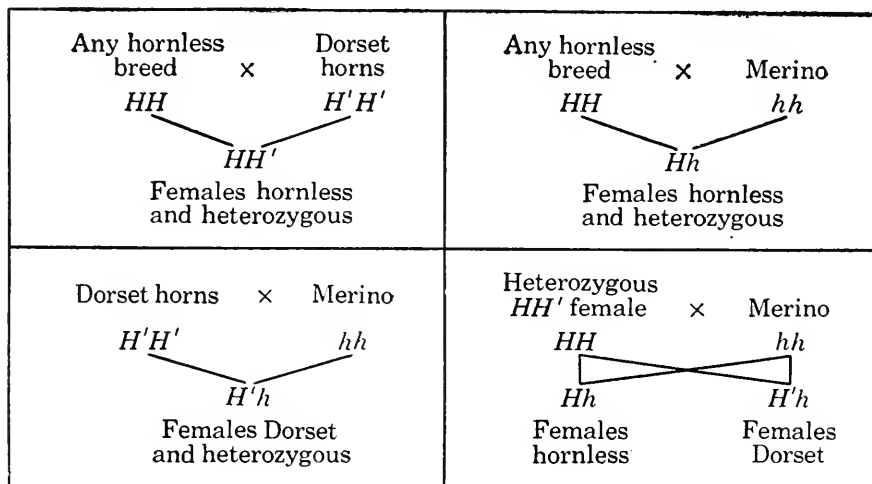

FIG. 31. Diagram of the inheritance of horns in sheep (females only). The hornless type results from the dominant gene H , Dorset horns from H' , and Merino horns from h . These three genes form a series of multiple alleles.

QUESTIONS AND PROBLEMS

1. In *Phlox Drummondii*, salver-shaped corolla is dominant over funnel-shaped. If a plant with funnel-shaped flowers is crossed with one homozygous for the genes for salver-shaped flowers, what are the genotypes and phenotypes of the F_1 and F_2 ? What are the phenotypes and genotypes of the offspring of a cross between the F_1 and the salver-shaped parent and of that between the F_1 and the funnel-shaped parent? What would be the nature of the offspring (F_3 generation) of each F_2 plant?

2. Looking over a field of F_2 plants it would occur to you that some of those with salver-shaped flowers were homozygous and some were heterozygous. How could you tell which was which (a) by inspection and (b) by breeding? Might it ever be important to know? Why?

3. In rabbits, long hair (l) is recessive to short (L). If a homozygous short-haired female is mated with a long-haired male, what are the phenotype and genotype of the F_1 and of the F_2 and of the backcross

of the F_1 with the male and with the female parents? These genes are in autosomes.

4. In human beings, albinos are homozygous for the recessive gene, c , the allele of normal. A normal man marries an albino woman. They have one child, who is an albino. From this one child, can we tell whether the father was homozygous or heterozygous? If the one child was normal, what would we know of the father?

5. In *Drosophila melanogaster*, vestigial wing is recessive to normal. A geneticist has three wild-type flies. He crossed fly A with fly B and got 112 wild-type offspring; fly A crossed with fly C gave 83 wild-type and 30 vestigial; fly B crossed with fly C produced 79 wild-type flies. What would be the expected phenotypic and genotypic ratios when each of these flies was crossed with a vestigial?

6. In phlox, the gene for entire petals is incompletely dominant to its allele which produces incised, or *cuspidata*, petals. The heterozygote is intermediate and is called *fimbriata*. What are the offspring from the following crosses: *fimbriata* \times entire; *fimbriata* \times *fimbriata*; entire \times *cuspidata*; *cuspidata* \times *fimbriata*; entire \times entire; *cuspidata* \times *cuspidata*?

7. If all the blue Andalusian fowls died out, could new ones be produced? How? If all black and white fowls were killed, but blue Andalusians were not, could new black and new white ones become established? How?

8. Congenital cataract in human beings is dominant over normal (absence of congenital cataract). It may sometimes be cured by an operation. A normal woman marries a man homozygous for the gene for cataract. They have two children, A and B. The man then has an operation and the cataracts are successfully removed. After that they have two more children, C and D. What would be the expected phenotypes of A, B, C, and D?

9. B. J. Chumlea has reported a pedigree of otosclerosis, a form of deafness due to abnormal bone growth, in human beings. From this pedigree, which includes four generations, would you consider the trait as due to a dominant or to a recessive gene?

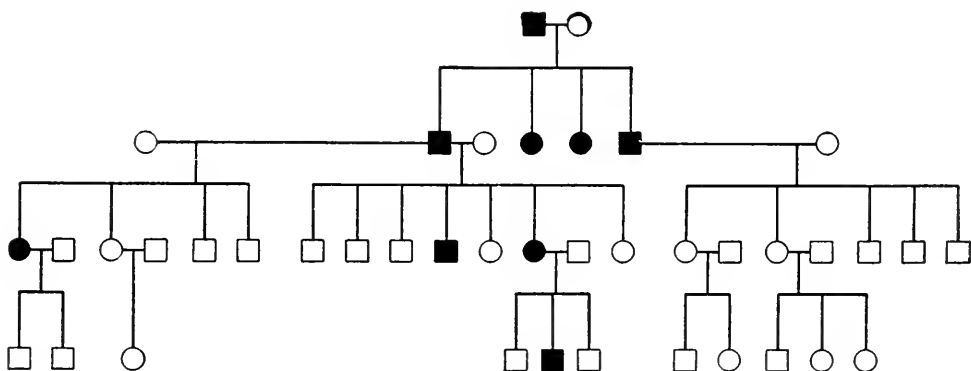

10. Edmonds and Keeler report the inheritance of “pierced ears” in a family from a small village in Italy. What does this family indicate as to the mode of inheritance of this trait and the degree of penetrance of the gene responsible?

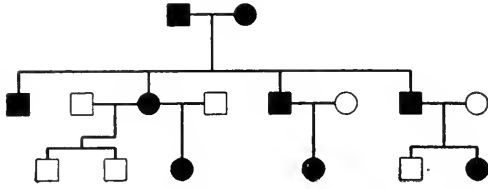

11. In the following family reported by S. E. Stoddard, the solid black symbols indicate individuals in whom the little fingers of both hands are flexed while the half-black symbols indicate persons with a flexed little finger on the right hand. What is indicated as to the dominance, penetrance, and expressivity of the gene?

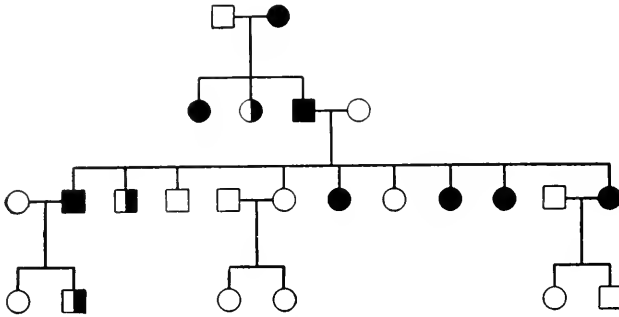

12. If you know of any persons with unusual traits that might be inherited, learn if you can, whether other members in the family (including those no longer living) show this trait. If the data are sufficient, determine the mode of inheritance.

Chapter 7

THE GENETIC DISTRIBUTION OF GENES IN THE X AND Y CHROMOSOMES

It was pointed out in Chapter 5 that there are genes on the X chromosome and rarely on the Y chromosome. Because only one of a pair is present in one sex and because the phenotypes can be correlated with sex, the inheritance of genes on the sex chromosomes can be considered a special problem.

The inheritance of genes on the sex chromosomes may be considered under three headings: (1) genes on a region of the X chromosome which has no counterpart in the Y chromosomes; (2) genes on a section of the Y chromosome which is not homologous with any section of the X chromosome; and (3) genes located in a chromosomal segment which is homologous in both the X and Y chromosomes. The first type has long been known as "sex linkage." A great many sex-linked genes have been found in animals and a few in plants. The second type may be called "Y chromosome inheritance." Only a few genes are known in the Y chromosomes of animals. The third type, "incomplete sex linkage," is not common.

Sex Linkage

XY and XO Type. As shown in Chapter 6, two alleles such as A and a which are located in a pair of autosomes segregate during gametogenesis or sporogenesis so that half the gametes contain A and the other gametes a . A pair of alleles in the X chromosome of an XX female behaves in exactly the same manner. If this female is heterozygous for A and a , half the eggs produced will have A and the other half will have a . In the male, however, there is only one X chromosome and therefore only one gene of the pair, for even in XY males there is no locus in the Y chromosome corresponding to the locus of a sex-linked gene. If the male has a dominant gene, A , half the gametes will have one X chromosome with the A gene and the other half of

the sperm will have neither an *A* nor an *a* gene. Similarly, recessive males will produce two kinds of gametes in equal numbers; one kind will have an X chromosome with the *a* gene and the other kind will have no X chromosome and neither an *A* nor an *a* gene.

In some individuals of *Drosophila melanogaster* a recessive gene that produces miniature wings may be found in the X chromosome. The dominant allele of this gene acts to produce wild-type wings. A homozygous wild-type female will have two X chromosomes, each of which will bear one wild-type allele of miniature. A miniature-winged male will have one X chromosome with the miniature gene and a Y chromosome which has neither allele. If these two flies are mated together, all the F₁ offspring will be wild type. The females will be heterozygous since they received an X chromosome with a wild-type gene from their female parent and an X chromosome with a miniature gene from the male parent. The F₁ males, however, will have only one X chromosome; since it came from the female parent, it will have the wild-type gene.

The F₁ females will produce two kinds of gametes. One half will have an X chromosome with the wild-type gene and the other half will have an X chromosome with the miniature gene. The F₁ males will also produce two kinds of gametes in equal numbers. One half will have an X chromosome with a wild-type gene and the other half will have a Y chromosome. If the two F₁ flies are mated together, four different genotypes will result in the F₂, and they will be found in equal numbers. One half the females will have two wild-type genes, one from the F₁ female and one from the F₁ male. The other half will have a wild-type gene from the F₁ male and a miniature gene from the F₁ female. All the males will naturally have an X chromosome from the F₁ female and a Y chromosome from the F₁ male. Since the female is heterozygous for miniature, half the males will have a wild-type gene and half will have a gene for miniature. Phenotypically, all the F₂ females will be wild type and of the males half will be wild type and half miniature (Fig. 32).

When genes are in autosomes reciprocal crosses normally give identical results, but when genes located in the X chromosome are dealt with, the results of reciprocal crosses are different.

When a miniature-winged female is mated with a wild-type male (in contrast to the reciprocal cross just described) all the females in the F_1 are wild type but all the males are miniature. The males receive an X chromosome from their mother but it

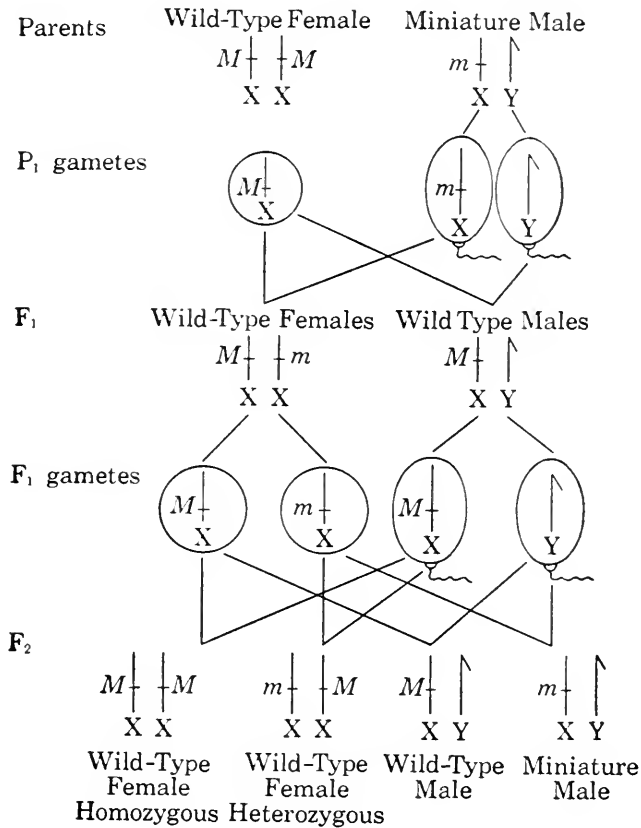

FIG. 32. Diagram of sex-linked inheritance in a cross between a homozygous wild-type female and a miniature-winged male of *Drosophila melanogaster*. The F_1 consists of wild-type females and males, and the F_2 falls into a ratio of 2 wild-type females : 1 wild-type male : 1 miniature-winged male.

has a gene for miniature, and they receive merely a Y chromosome from their father. As Fig. 33 shows, the F_2 consists of wild-type females, miniature females, wild-type males, and miniature males in equal proportions. Neither the F_1 nor the F_2 of this cross is the same as the corresponding generation from the reciprocal cross.

Because a recessive female crossed with a dominant male produces dominant females and recessive males this method of inheritance is often referred to as "crisscross inheritance." This

term is descriptive but it is unnecessary and in a sense might be considered misleading. The only fundamental difference between this and other crosses is that the Y chromosome lacks the locus under consideration, for genes which are present are

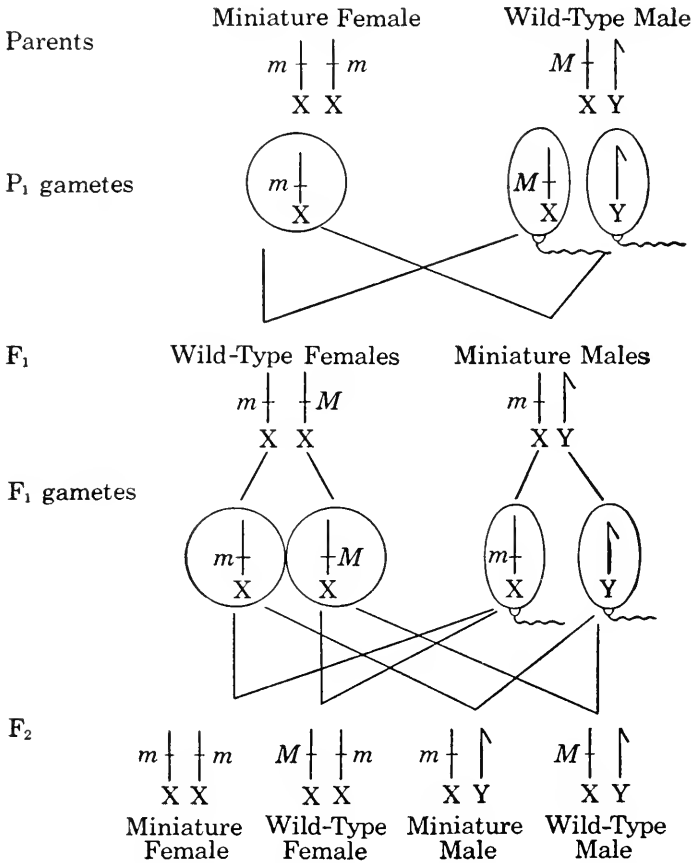

FIG. 33. Diagram of sex-linked inheritance in a cross between a miniature-winged female and a wild-type male of *Drosophila melanogaster*. This is the reciprocal of the cross in Fig. 32. The F₁ consists of wild-type females and miniature males and the F₂ of equal numbers of wild-type females, miniature females, wild-type males, and miniature males. The relationship of the P₁ and F₁ generations has resulted in the term "criss-cross" inheritance for this cross.

distributed and behave in exactly the same fashion as genes located in autosomes.

ZW and ZO Sex Linkage. In animals with the *Abraxas* and similar types of sex inheritance, the results obtained in the F₁ and F₂ will be the reverse of those in the XY and XO types. One of the best-known examples is the barred gene in Plymouth

Rocks and several other types of domestic chickens (Fig. 34). Barred feathers (B) are dominant over nonbarred (b), and these genes are on the Z chromosome. In the chicken, the male is ZZ , having eighteen pairs of chromosomes, and the female is ZO , having only one sex chromosome in addition to the seventeen pairs of autosomes.

Daltonism. Several striking sex-linked characters have been found in human beings. One of them is a type of color blindness

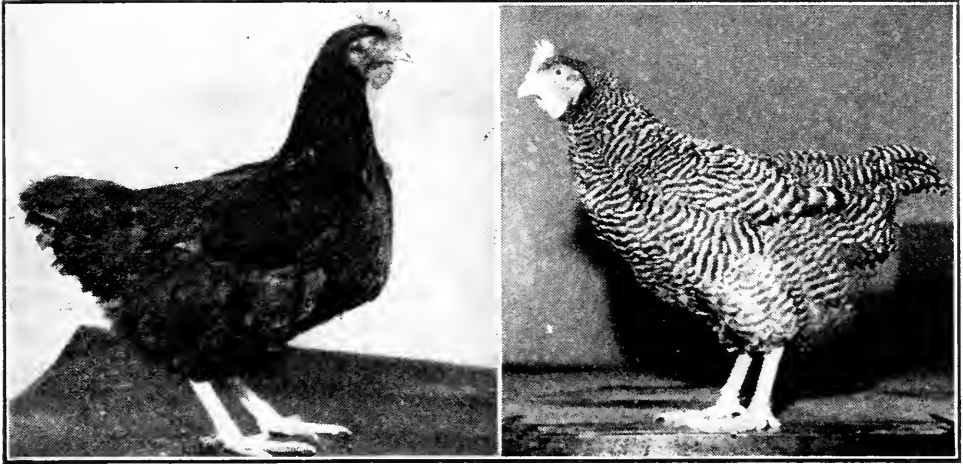

FIG. 34. A nonbarred Rhode Island Red (*left*) and a barred Plymouth Rock. Barred is the result of a dominant gene B and is located on the Z chromosome. (Courtesy of Dr. F. A. Hays.)

known as Daltonism which is caused by a recessive gene. Individuals not possessing the dominant allele cannot distinguish between red and green. As human beings follow the XY type of sex inheritance, a cross between a heterozygous woman and a normal man would produce normal daughters; half the sons would be normal but the other half would be color blind. Thus men inherit color blindness from their mother and not from their father. This red-green color blindness is very much rarer in women than in men. The frequency of men is 8 per cent and that of women 0.64 per cent, or the frequency of women equals the frequency of men squared.

It is interesting to consider why this is so. Since men have only one X chromosome and therefore only one gene at that locus, they will be color blind if this single gene is recessive. Women, however, will not be color blind unless they have two

recessive genes. If a color-blind man marries a normal homozygous woman, all his offspring will be normal, although his daughters will be heterozygous and will therefore be "carriers." It is only when a color-blind man marries a "carrier" that an individual with two recessives can be formed. Such an individual would be a color-blind woman. The number of carriers and the number of color-blind men are small when compared with normal people. Therefore, if mating is at random, as it usually is, the chance that a carrier would marry a color-blind man is very small. Since even then such a marriage does not necessarily produce a daughter, and since only half the daughters would be expected to be color blind, the chance that a color-blind woman would be produced is extremely small. If a small community became settled by several families one of which carried the color-blind gene, and if this community was so isolated by geographical, racial, religious, or other factors that there tended to be a great deal of intermarriage within the community, the chance that a color-blind woman would appear would be much greater than in the usual situation of purely random mating. However, even in such a community, more men than women would be color blind.

Hemophilia. Hemophilia is another sex-linked human character which is caused by a recessive gene. Individuals possessing this character show a deficiency in the power of their blood to clot, with the result that they may bleed to death from a cut which, in a normal person, would be regarded as trivial. Consequently, people with this character are "bleeders" and frequently fail to live to reach their twenties. Just as they are less likely to be color blind, and for the same reason, women are much less likely than men to have hemophilia. In fact, it has generally been questioned whether such women do or even could exist. Snyder examined 250 published pedigrees of hemophilia and found only one in which a known hemophilic male was married to a known carrier. In this family and one from his own records there were three normal daughters and two hemophilic sons. Since half the daughters from that type of mating would be expected to be normal, these two families are inconclusive. The question of whether women *can* have hemophilia is unsolved. The chances are extremely small and no known hemophilic woman has yet been discovered and called to the attention of

scientists. Some geneticists have considered that two genes for hemophilia have a lethal effect so that potentially hemophilic women would never develop much past the zygote stage of development. This hypothesis is wholly in accord with other known genetic phenomena, but it has not been proved.

Other Sex-Linked Genes in Human Beings. Although green-eyed color blindness and hemophilia are the two best-known sex-linked characters in human beings, others have also been found. Among them are recessive genes for Gower's muscular atrophy, absence of two center incisors, absence of sweat glands, optic atrophy, some cases of nystagmus, some cases of microphthalmus, some types of night blindness, and a dominant gene for defective enamel of the teeth.

In Fig. 35*b* ten families are listed which seem to indicate that a certain fingerprint pattern is the result of a sex-linked recessive gene. This gene produces a radial loop rather than an ulnar loop on the index finger of the right hand. In eleven matings between people who did not have a radial loop on that finger males were produced who had the radial loop although none of their sisters had it. In the only two instances in which females were produced with a radial loop the fathers had radial loops. Although all the families are small, the evidence suggests that radial loops result from a sex-linked recessive gene and that the female parents of these families were heterozygous.

Sex Linkage in Plants

In most plants both sexes are represented in the same individual, and sex is a matter of development. In some plants, however, the sexes are separate, and sex is controlled by a mechanism similar to that in many animals. Genes located in these sex chromosomes behave in the same way as genes in the sex chromosomes of animals. One of the earliest discoveries of sex-linked genes in plants was made in *Lychnis dioica* independently by G. H. Shull and Erwin Baur. In this species, broad leaves are dominant to narrow. From the way these genes behaved genetically, Baur and Shull concluded that they were located in a sex chromosome although cytological observation had not been made. If homozygous broad-leaved females are crossed with narrow-leaved males, the F_1 plants are all broad-leaved. In the

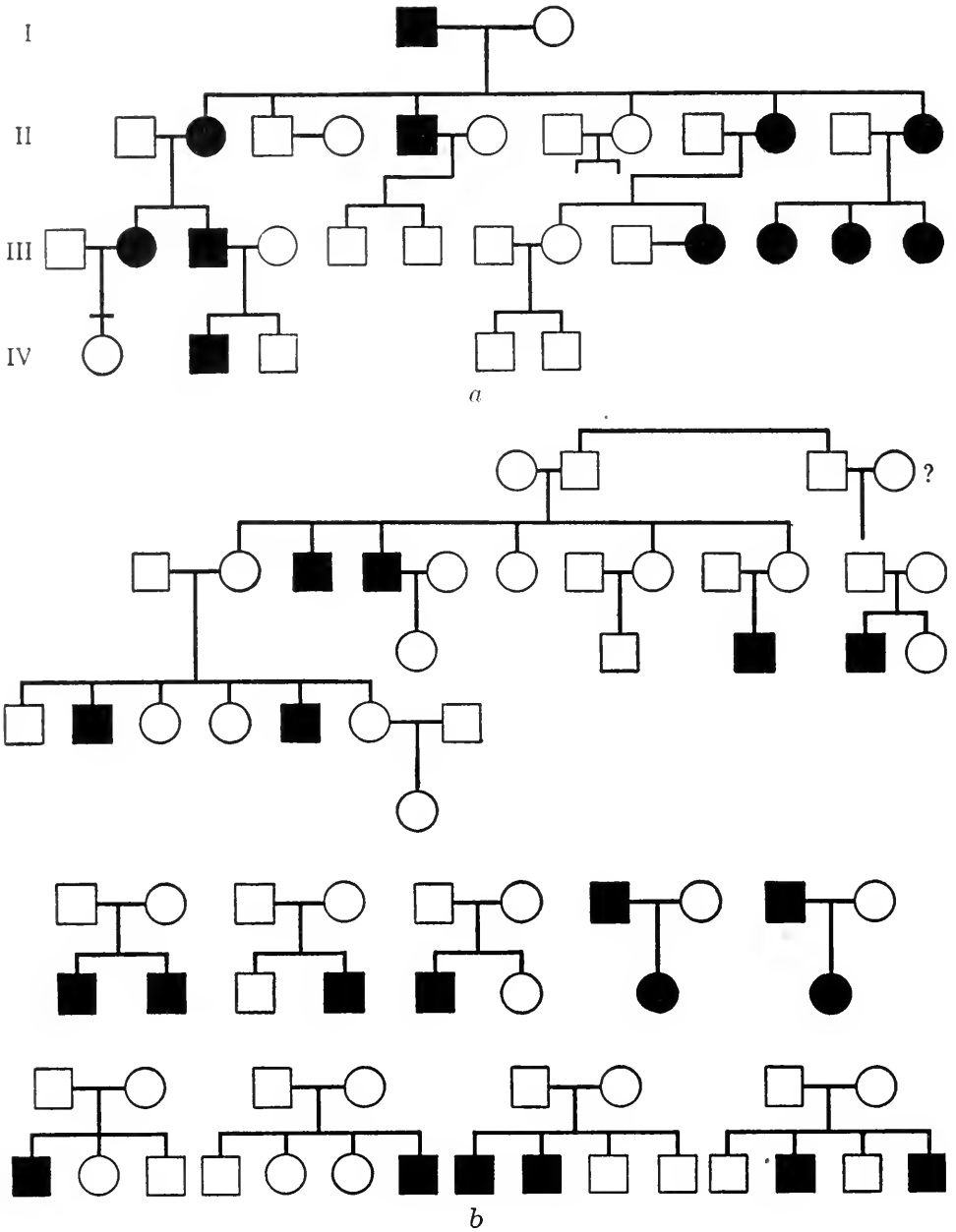

FIG. 35. Human pedigrees. (a) Inheritance of crooked little fingers, *minor streblomicrodactyly*, a simple dominant. (From Hefner in the *Journal of Heredity*.) (b) Inheritance of the radial loop fingerprint pattern on the right index finger, probably the result of a sex-linked recessive gene. (From Walker in the *Journal of Heredity*.) In both diagrams, males are indicated by squares and females by circles. Individuals that show the trait in question are identified by black or solid squares or circles in contrast to normals, who are represented by white or hollow symbols. In human genetics it has become customary to place the male first in a cross although in plant genetics the female is conventionally placed first.

F₂, the females and half the males have broad leaves, whereas half the males have narrow leaves. More recently, cytological observations in the species *Lychnis alba* which was included in Shull's *L. dioica* showed that an XY mechanism was present in the male.

Multiple Alleles in the X Chromosome

Multiple alleles are found in the X chromosome as well as in autosomes. In fact, one of the first series of multiple alleles to be discovered was in the sex chromosome of *Drosophila melanogaster*. At the locus for white, a number of alleles may be found including *W* (red) and *w^e* (eosin). *W* is dominant to *w^e* and to *w*, and *w^e* is dominant to *w*. The following types of flies can be found:

(<i>WX</i>) (<i>WX</i>)—red female	(<i>w^eX</i>) (<i>wX</i>)—eosin female
(<i>WX</i>) (<i>w^eX</i>)—red female	(<i>w^eX</i>) Y —eosin male
(<i>WX</i>) (<i>wX</i>) —red female	(<i>wX</i>) (<i>wX</i>)—white female
(<i>WX</i>) Y —red male	(<i>wX</i>) Y —white male
(<i>w^eX</i>) (<i>w^eX</i>)—eosin female	

Various combinations can be crossed. Thus homozygous red crossed with white gives red females and red males in the F₁ and red females, red males, and white males in the F₂ in a ratio of 2 : 1 : 1. The reciprocal cross, white female by red male, gives red females and white males in the F₁ and red females, white females, red males, and white males in equal proportions in the F₂.

A red-eyed female may be heterozygous as well as homozygous, and the other allele may be the gene for white or the gene for eosin. If a heterozygous red-eyed female which also has the gene for eosin is crossed with a white-eyed male, the results are rather complicated. As can be seen from Fig. 36, the F₁ consists of red females, eosin females, red males, and eosin males in equal numbers. If all the possible matings are made between the two F₁ females and the two F₁ males and if each cross produces a population of the same size, the F₂ would contain a ratio of five red females, three eosin females, two red males, two eosin males, and four white males. There would be no white-eyed females.

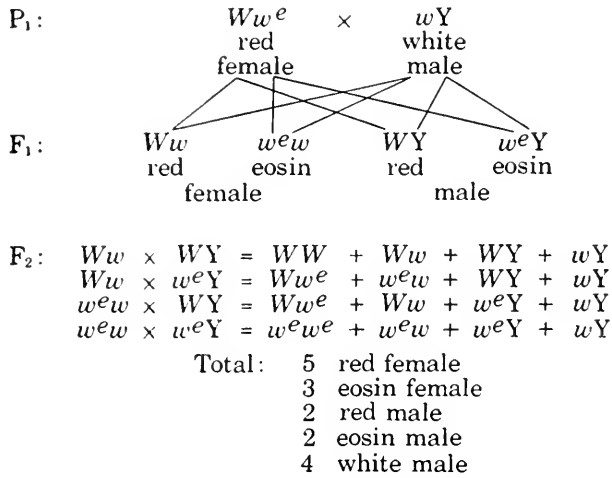

FIG. 36. Inheritance of red, eosin, and white eyes in *Drosophila melanogaster*. Red results from gene W (or $+$), eosin from w^e , and white from w . These three genes form a series of multiple alleles for they are all found at the same locus of the X chromosome. A cross between a Ww^e female and a white-eyed male produces red and eosin males and females. All four crosses between the two types of females and males result in red and eosin females but red, eosin, and white males.

Y Chromosome Inheritance

If a gene is located in a portion of the Y chromosome which is not homologous with any part of the X chromosome the character resulting from its action must be present in both father and son, and must never appear in a female. Y chromosome genes are apparently rare and in *Drosophila melanogaster* include two genes for male fertility. Four genes reported for the Y chromosome in man are genes for *ichthyosis hystrix gravior*, a skin ailment, for *keratoma dissipatum*, a skin ailment affecting the hands and feet, for *hypertrichosis of the ears*, and for webbed toes in certain families. (In other families apparently a similar but different gene is involved.)

The genetic distribution of a gene on the Y chromosome is indicated in Fig. 37. The male parent has the hypothetical character A which is determined by gene A located in the Y chromosome. Half the gametes of this male parent have an X chromosome with no A gene, and the other half have a Y chromosome in which an A gene is located. The female parent has two X chromosomes but no A gene, and all her gametes lack A . The daughters from this cross have two X chromosomes but they

have no *A* gene and therefore do not show phenotypically the character *A*. All the males, of course, have a *Y* chromosome. Since all the *Y* chromosomes of the male parent have gene *A*, all the sons have gene *A*, and therefore all the males are phenotypically *A*. It is impossible to say whether gene *A* is a domi-

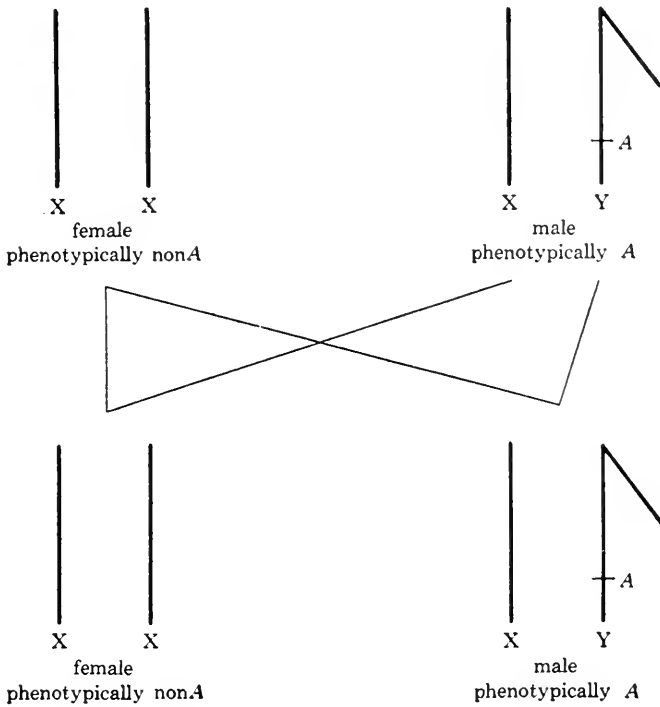

FIG. 37. Inheritance of a gene on the *Y* chromosome. Since gene *A* is on a segment which is not homologous with any segment of the *X* chromosome, there is no crossing over and gene *A* remains on the *Y* chromosome. It, therefore, produces its effect in all males.

inant or recessive. Since there is no corresponding allele in the *X* chromosome, we cannot say that gene *A* is either dominant or recessive to anything. In earlier days when the “presence and absence” hypothesis was in vogue, it was customary to refer to a dominant gene as present and to regard the recessive gene as merely the absence of the dominant. The discovery of multiple alleles showed that dominance and recessiveness were not merely the presence or absence of one thing, but were really the presence of two distinct things. There is no point to considering this *Y* chromosome gene as either dominant or recessive until we find an allele to which it is dominant or recessive.

Incomplete Sex Linkage

If a gene is located in a chromosomal segment which is found in both the X and Y chromosomes, it is incompletely sex-linked. The behavior of a dominant gene located in the homologous part of the X chromosome only is similar in many respects to sex linkage. If that dominant gene is located only in the Y chromosome the results are comparable in part to Y chromosome inheritance. However, the results are always complicated by the fact that the X and Y chromosomes in the male may exchange segments during meiosis. This exchange of segments is known as "crossing over," and is discussed in Chapter 10.

QUESTIONS AND PROBLEMS

1. A red-eyed female is mated with a white-eyed male. The offspring (F_1) were 32 red-eyed females, 29 white-eyed females, 31 red-eyed males, and 27 white-eyed males. What are the genotypes of the two parents?

2. A normal woman married to a normal man has two sons. One is normal and the other is a "bleeder." What do we know of the genotypes of the parents?

3. Mrs. A, who is normal, married Mr. B, who is also normal, and they have one daughter, C. Mrs. L, who is normal, has a normal son, P, by her hemophilic husband, Mr. M. C and P marry and have one son R, who is a bleeder. From which grandparent did R get his gene for hemophilia?

4. In poultry, barred feathers are dominant over nonbarred, and are sex linked. A nonbarred hen is mated with a barred cock and three offspring are produced which are respectively a barred female, a nonbarred female, and a barred male. What are the genotypes of the hen and cock?

5. A breeder has a nonbarred hen and a rooster heterozygous for barred. He wants to establish a true-breeding race of barred poultry. How would he do it, and how many generations would he have to raise before he was sure his poultry would breed true? Would it take him a longer or a shorter time to establish a true-breeding nonbarred stock?

6. Give the F_1 and F_2 of the following crosses of which the parental genotypes are given: the symbols refer to eye color in *Drosophila melanogaster*: $WW \times wY$; $Ww^e \times wY$; $Ww \times wY$; $w^e w^e \times wY$; $w^e w \times wY$; $WW \times w^e Y$; $Ww^e \times w^e Y$; $Ww \times w^e Y$; $w^e w \times w^e Y$; $ww \times w^e Y$; $Ww^e \times WY$; $Ww \times WY$; $w^e w^e \times WY$; $w^e w \times WY$; $ww \times WY$.

7. A red-eyed female *Drosophila* is crossed with an eosin-eyed male. The F_2 consisted of 5 red females; 2 eosin females; 1 white female; 2 red males; 4 eosin males; 2 white males. What are the genotypes of the parents and the phenotypes and genotypes of the F_1 ?

8. What is the method of inheritance of the human trait in the accompanying diagram? What is your reason?

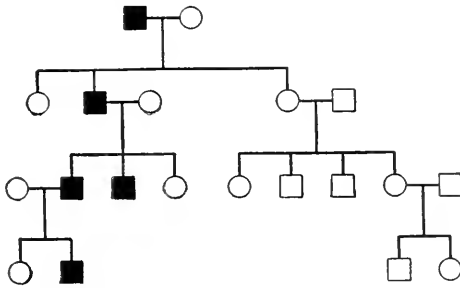

9. Suggest a method of inheritance for the trait in the accompanying diagram and explain.

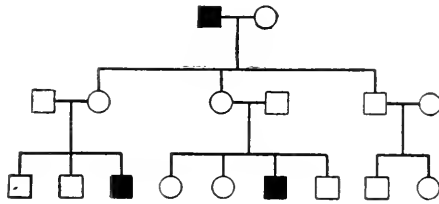

10. In cats, gene b produces black fur and the allele B produces yellow. The heterozygote has a peculiar fur called tortoise-shell. These genes are in the X chromosome. What are the F_1 and F_2 from crosses between a black female and a yellow male and a yellow female and a black male?

11. If all black male cats were killed at birth, would tortoise-shell cats be eliminated? Explain. Would black cats be eliminated? Explain.

12. In *Drosophila melanogaster*, sable body (s) is recessive to wild type (S). These genes are sex linked. What are the phenotypes and genotypes from a cross between a homozygous wild-type female and a sable male and from the reciprocal cross?

Chapter 8

PROBABILITY

Perhaps one of the most frequently asked questions is, "What is the chance that my child will be a boy?" People also wonder whether the chance that the fourth child will be a boy is greater when the first three children are girls than it is when they are boys. These and many other questions in genetics involve the theory of probability. A student of genetics should become acquainted with the elements of the theory of probability, as the interpretation of all genetic ratios is based on that theory. For example, in tobacco, gene F , which produces anthocyanin pigments in the flowers of *Nicotiana Sanderae*, is dominant over its allele, f , which produces no color. If a plant with colored flowers is crossed with a white-flowered plant, and if the offspring consist of 672 colored plants, one would say that it is highly probable that the colored parent was homozygous for F and one would assume that as a working basis.

The situation is different in cattle, which cannot produce such a large number of offspring. The polled or hornless condition is produced in cattle by gene H and is dominant over horned (h). If a polled cow is crossed with a horned bull, all the offspring should be polled if the cow is homozygous for H , but the offspring should segregate into a 1 : 1 ratio if the cow is heterozygous. However, let us assume that only one calf is produced from the mating. If the polled cow were of unknown ancestry, and a polled calf were produced, it would be impossible to tell the genotype of the cow. If the cow were homozygous, only polled calves would be *possible*. On the other hand, if she were heterozygous, it would be equally probable that the one calf would be either polled or horned. If the calf had been horned, there would be no doubt that the cow was heterozygous for it would be impossible for a homozygous polled cow to produce a horned calf. A distinction must be made between certainty and probability, and it must be realized, also, that the larger the

number of individuals, the greater the margin of safety when dealing with probabilities. One polled calf tells nothing.

What is the probability that in a family of four all will be boys? Is the chance that there will be three boys and one girl greater or less than the chance that all four will be boys? Both are possible, so the question becomes one of probability. The ratio of men to women is actually about 106 : 100, but for practical purposes it can be assumed that the chances are even, i.e., 1 : 1. or more popularly "fifty-fifty." Since, as we are assuming, it is equally probable that one child will be either male or female, the problem is identical with the problem of whether a toss of a coin will result in a head or a tail. That is a problem more familiar to most people, so let us consider it first. If a penny is tossed into the air, the chances are even that it will land head or tail. With one toss, the chance of a head is $\frac{1}{2}$ and of a tail, $\frac{1}{2}$. The word "chance" does not imply that it is not a question of cause and effect. The effect after tossing the coin is a head or a tail, but the causes which determine that effect are numerous.

One cause is the way the coin is held in the hand. Another cause is the exact motion of the fingers and arm as the penny is being tossed. The height of the toss is still another factor for if the height had been a trifle less, the other side, other things being equal, would have turned up. The amount of spin to the coin, air currents as the coin is ascending and descending, the precise way the coin hits the ground, whether it strikes a smooth place or a slight bump in the ground, whether it rolls or lands dead, how much it rolls—all these are *causes* that work together to produce the effect. However, these causes are too difficult to measure and too numerous to analyze. Furthermore, all are not working in the same direction. Some of these causes tend to make the penny turn up a head; other causes tend to make it a tail. By *chance* is meant that the effect is produced by a very large number of causes, some of which act in one direction and some in the other direction, some may be greater in effect and some lesser, and all or most defy analysis. In other words, when an effect is not produced by one or a few readily observed causes, it is said to be due to chance.

When a penny is tossed, the chance of a head is $\frac{1}{2}$. The same is true of a dime. If a penny and a dime are tossed

together, whether the penny turns up head has absolutely no bearing on whether the dime is head or tail. They are two independent events. If they are tossed together, the chance that the penny will be head is $\frac{1}{2}$ and the chance that the dime will be head is $\frac{1}{2}$; the chance that both will be head is $\frac{1}{2} \times \frac{1}{2}$ or $\frac{1}{4}$. Whenever there are two independent events, the chance that both will occur together is the chance that one will occur multiplied by the chance that the other will occur. For example, if the chance that team A beats team B in football is $\frac{1}{3}$, and the chance that team C beats team D in basketball is $\frac{1}{4}$, the chance that both A and C will win is $\frac{1}{3} \times \frac{1}{4}$ or $\frac{1}{12}$. Similarly, the chance that both the penny and the dime will be tail is $\frac{1}{4}$. In the same way, the chance that the penny will be head and the dime tail at the same time is $\frac{1}{2} \times \frac{1}{2}$ or $\frac{1}{4}$, and the chance of a simultaneous tail on the penny and head on the dime is $\frac{1}{4}$. If the denominations of the coins are disregarded, and the only point considered is the chance that *either* one will be a head while the other is a tail, the chance is $\frac{1}{4} + \frac{1}{4}$ or $\frac{1}{2}$. In sex, which we discussed earlier, the chance that a certain child will be a boy is $\frac{1}{2}$ and the chance is also $\frac{1}{2}$ that the same child will be a girl. If there are two children the chance that both will be boys is $\frac{1}{4}$, the chance that one will be a boy and the other a girl is $\frac{1}{2}$, and the chance that both will be girls is $\frac{1}{4}$.

If three coins are tossed at a time, the chance of three heads is $\frac{1}{2} \times \frac{1}{2} \times \frac{1}{2}$ or $\frac{1}{8}$, and the same is true of three tails. The chance of two heads and a tail is $\frac{3}{8}$ and the chance of one head and two tails is the same. The chance that three children will be boys is similarly $\frac{1}{8}$, and the chance that all will be girls is also $\frac{1}{8}$. In a family of three, the chance of getting two boys and a girl is $\frac{3}{8}$ and the chance of one boy and two girls is also $\frac{3}{8}$. The algebraic-minded student will begin to see that this fits in with the binomial theorem, which is generally expressed by $(a + b)^n$. In problems dealing with probability, this is usually written $(p + q)^n$, where p is the chance that a certain event will happen, q the chance that it will not happen, and n is the number of individuals concerned in the event. In sex, p could represent the chance that an individual would be a boy, and would be $\frac{1}{2}$, and q would represent the chance that the child would not be a boy (and, therefore, the chance of its being a girl) and would

also be $\frac{1}{2}$. Naturally, $p + q = 1$. When $(p + q)^n$ is expanded, the coefficients represent the number of cases, the exponent of p represents the number of successes of p , and the exponent of q the number of failures of p or number of successes of q . If three coins are tossed, n is 3, p , the chance of a head, equals $\frac{1}{2}$, and q , the chance of not being a head and therefore of being a tail, equals $\frac{1}{2}$. The expanded binomial is $p^3 + 3p^2q + 3pq^2 + q^3$. Adding the exponents, we have eight cases in all. One of the eight has all three heads and is represented by the term p^3 . One of the eight has no heads and is represented by q^3 . Three of the eight have two heads and one tail, and three have one head and two tails; these two situations are represented by the terms $3p^2q$ and $3pq^2$, respectively.

In a family of five children (or in five tosses of a coin), what will be the chance that all will be boys (or head, etc.)? Here the binomial becomes $(p + q)^5$, and when this is expanded the result is $p^5 + 5p^4q + 10p^3q^2 + 10p^2q^3 + 5pq^4 + q^5$. If the coefficients are added, there are thirty-two cases. They will be distributed as follows:

All boys (or heads) and no girls (or tails)— p^5 — $\frac{1}{32}$
 Four boys (or heads) and one girl (or tail)— p^4q — $\frac{5}{32}$
 Three boys (or heads) and two girls (or tails)— p^3q^2 — $\frac{10}{32}$
 Two boys (or heads) and three girls (or tails)— p^2q^3 — $\frac{10}{32}$
 One boy (or head) and four girls (or tails)— pq^4 — $\frac{5}{32}$
 No boys (or heads) and all girls (or tails)— q^5 — $\frac{1}{32}$

In other words, the chance of getting a family of four boys and one girl is 5 out of 32. This can also be arrived at as follows:

$$p^5 = p \cdot p \cdot p \cdot p \cdot p; \quad p = \frac{1}{2};$$

$$\therefore p^5 = \frac{1}{2} \cdot \frac{1}{2} \cdot \frac{1}{2} \cdot \frac{1}{2} \cdot \frac{1}{2} = \frac{1}{32}$$

$$5p^4q = 5(p \cdot p \cdot p \cdot p \cdot q); \quad p = \frac{1}{2} \quad \text{and} \quad q = \frac{1}{2};$$

$$\therefore 5p^4q = 5(\frac{1}{2} \cdot \frac{1}{2} \cdot \frac{1}{2} \cdot \frac{1}{2} \cdot \frac{1}{2}) = \frac{5}{32}$$

This same method can also be applied to cases in genetics other than sex. A testercross will illustrate exactly the same situation. If the polled F_1 calf is mated with a horned animal, the theoretical ratio is 1 polled : 1 horned. Therefore, in the binomial, p (polled)

$= \frac{1}{2}$ and q (horned or not polled) $= \frac{1}{2}$. With four offspring the various probabilities would be determined by $(p + q)^4$, which equals $p^4 + 4p^3q + 6p^2q^2 + 4pq^3 + q^4$. To determine the chance that two animals would be polled and two horned, the term $6p^2q^2$ is used. Substituting the values of p and q gives $6(p \cdot p)(q \cdot q)$ or $6(\frac{1}{2} \cdot \frac{1}{2})(\frac{1}{2} \cdot \frac{1}{2})$ or $\frac{6}{16}$. Thus, out of every sixteen such families of four, six should be expected which would include two polled and two horned offspring.

So far, we have considered only 1 : 1 ratios, but the same method can be applied to 3 : 1 and other ratios. If a homozygous colored tobacco plant is crossed with a white, a 3 : 1 ratio should be expected in the F_2 . That is, the chance that any one F_2 plant would have red flowers is $\frac{3}{4}$ and the chance that any plant of the F_2 generation should have white flowers is $\frac{1}{4}$. Therefore, p (the chance of red-flowered plants) $= \frac{3}{4}$ and q (the chance of the failure of a plant to be red-flowered) $= \frac{1}{4}$. In a family of five plants, the probabilities would be obtained by expanding $(p + q)^5$ and would be:

$$\begin{aligned}
 p^5 &= p \cdot p \cdot p \cdot p \cdot p = \frac{3}{4} \cdot \frac{3}{4} \cdot \frac{3}{4} \cdot \frac{3}{4} \cdot \frac{3}{4} = 243 \text{ families out of 1024 with 5 red-flowered plants} \\
 5p^4q &= 5(p \cdot p \cdot p \cdot p)q = 5(\frac{3}{4} \cdot \frac{3}{4} \cdot \frac{3}{4} \cdot \frac{3}{4})\frac{1}{4} = 405 \text{ families out of 1024 with 4 red-flowered and 1 white-flowered plant} \\
 10p^3q^2 &= 10(p \cdot p \cdot p)(q \cdot q) = 10(\frac{3}{4} \cdot \frac{3}{4} \cdot \frac{3}{4})(\frac{1}{4} \cdot \frac{1}{4}) = 270 \text{ families out of 1024 with 3 red-flowered and 2 white-flowered plants} \\
 10p^2q^3 &= 10(p \cdot p)(q \cdot q \cdot q) = 10(\frac{3}{4} \cdot \frac{3}{4})(\frac{1}{4} \cdot \frac{1}{4} \cdot \frac{1}{4}) = 90 \text{ families out of 1024 with 2 red-flowered and 3 white-flowered plants} \\
 5pq^4 &= 5(p)(q \cdot q \cdot q \cdot q) = 5 \cdot \frac{3}{4}(\frac{1}{4} \cdot \frac{1}{4} \cdot \frac{1}{4} \cdot \frac{1}{4}) = 15 \text{ families out of 1024 with 1 red-flowered and 4 white-flowered plants} \\
 q^5 &= q \cdot q \cdot q \cdot q \cdot q = \frac{1}{4} \cdot \frac{1}{4} \cdot \frac{1}{4} \cdot \frac{1}{4} \cdot \frac{1}{4} = 1 \text{ family out of 1024 with 5 white-flowered and no red-flowered plants}
 \end{aligned}$$

In other words, even if a ratio of three red to one white is expected, a family of five white-flowered plants is not impossible for it would be expected to happen in one case out of 1024. Other ratios than the 1 : 1 testcross ratio and the 3 : 1 mono-

hybrid ratio are frequently encountered in genetics. The method would be the same for them.

It will be noted that the sum of the probabilities of all possible events gives a total probability of 1. Thus, in the family of 5 children in which a ratio of 1 boy to 1 girl is involved, the sum of all the possible probabilities (i.e., the probability of 5 boys + the probability of 4 boys and 1 girl, etc.) is $3\frac{2}{32}$, or 1, whereas in a 3 : 1 ratio with 5 plants, the sum of the probabilities is $10\frac{2}{1024}$, or 1. The value of 1 is certainty, and unless an event is certain, its probability is expressed as a fraction or decimal. The expression $p + q = 1$ must be true, for $1 - p = q$, which means that the certainty of an event less the probability that it will happen equals the probability that it will not happen. If an event is certain, the probability that it will happen is 1 and the probability that it will not happen is 0, so $1 - 0 = 1$.

In *Nicotiana Sanderae* a testcross showed 672 colored and no white plants. If the colored parent were heterozygous, would it be possible for so many colored plants and no white plants to be produced? If it were possible, what then would be the probability? Since this is a testcross, the ratio would be 1 : 1; therefore $p = \frac{1}{2}$ and $q = \frac{1}{2}$. The binomial $(p + q)^{672}$ could be expanded, but this would not be necessary, since the first term would give all the information needed. The probability of getting a family of 672 colored plants from a testcross would be p^{672} or $(\frac{1}{2})^{672}$. It is very obvious that the probability of getting such a result from a cross between a heterozygote and a recessive is so small that one would be well justified in assuming that the colored plant tested was homozygous.

This last example shows that although the method of binomial expansion is theoretically correct it has some very practical limitations. In practice, it is not usual to apply this method to populations over 50, as it is far too cumbersome. In fact, even with numbers between 15 and 50, the binomial expansion becomes unwieldy. Warwick, however, has worked out the probabilities for numbers up to 50, and by using his tables, much labor is avoided. For example, in *Nemesia strumosa*, orange flower color is dominant over white. A cross of an orange by a white gave a ratio of 25 : 17, when the expected testcross ratio would have been 21 : 21. An examination of Warwick's table shows that the probability of getting a ratio of 25 dominants and 17 re-

cessives out of 42 plants is 0.0579. Geneticists are usually not so much concerned with the chance that all the members of a certain family will be of a certain phenotype or that a family will segregate into a given ratio as with the problem of how truly a certain observed ratio fits a theoretical (expected) one and whether the deviations found in the observed ratio are due to chance alone or whether they are so large in relation to the number of individuals in the population that the ratio cannot be considered a true example of the theoretical one.

Standard and Probable Error

Several methods are in use for determining whether a certain observed ratio is a true example of a certain theoretical one. Two methods are the standard error and the probable error. These methods are based on the deviation of the observed ratio from a theoretical ratio comprised of the same number of individuals. The standard error of the ratio is expressed by $\sigma = \sqrt{\frac{p \cdot q}{n}}$, where p is the probability of the first term of the ratio, q the probability of the second term, and n the number of individuals.

To show how this method is applied in practice, let us take a ratio published by Professor Sewall Wright for guinea pigs. Gene *A* produces what is called the agouti coat color and its allele produces a nonagouti coat. A heterozygote was crossed with a nonagouti and the offspring segregated into 48 agouti and 63 nonagouti. This is not an exact 1 : 1 ratio, and the problem is to find out why. There are a number of possible reasons. Other genes may be exerting an effect to suppress the action of the agouti gene, the environment may be affecting the expression of the agouti gene so that some agouties actually look like nonagouties, agouti animals may less frequently survive in birth, other genetic explanations may have to be sought, or the deviation from the exact ratio may be due to chance alone, in which case this ratio may be considered to be a 1 : 1 ratio even though it deviates to some extent. There are two ways of applying the formula. All the figures must be expressed as actual numbers or they must be converted into percentages, but the two methods

must not be mixed. Using the actual numbers in Wright's guinea pig experiment, we may apply the method as follows:

	A	a	
Observed numbers	48	63	$\sigma = \sqrt{\frac{p \cdot q}{n}} = \sqrt{\frac{55.5 \times 55.5}{111}} = 5.27$
Expected (1 : 1) numbers	55.5	55.5	$\frac{d}{\sigma} = \frac{7.5}{5.27} = 1.4$
Observed deviation	7.5	7.5	

The standard deviation or standard error is 5.27 and the observed deviation is 7.5. The actual deviation is only 1.4 times the standard error. If it were more than twice the standard error, we should consider that the observed ratio probably is not a true example of a 1 : 1 ratio and we should then proceed to search for an explanation. In the guinea pig experiment, the deviation is only 1.4 times the standard error so that we are safe in assuming that a ratio of 48 : 63 is a 1 : 1 ratio within the limits of probability and we do not need to try to explain the excess of recessives. The same method may be used by converting the numbers into percentage and finding the standard error in percentage; p and q are then also expressed in percentages.

	A	a
Observed numbers	48	63
Per cent of each class	43.2	56.8
Expected per cent	50	50
Deviation in per cent	6.8	6.8

$$\sigma = \sqrt{\frac{p \cdot q}{n}} = \sqrt{\frac{0.50 \times 0.50}{111}} = 4.8 \text{ per cent}$$

$$\frac{d}{\sigma} = \frac{6.8 \text{ per cent}}{4.8 \text{ per cent}} = 1.4$$

The deviation expressed in per cent is 6.8 and the standard error is 4.8 per cent. Again the deviation is 1.4 times the standard error. With either method the result is the same, but the student must remember that if the standard error is expressed in per cent, the deviation must also be expressed in per cent.

While the equation $\sigma = \sqrt{\frac{p \cdot q}{n}}$ is the equation for the standard error of any ratio, the student will frequently find that his calculations will be simplified for figuring the standard error of a 1 : 1

ratio if he uses the formula $\sigma = \frac{1}{2}\sqrt{n}$, which is algebraically the same since $p = \frac{1}{2}n$ and $q = \frac{1}{2}n$. By this method the calculation of the previous problem becomes:

$$\sigma = \frac{1}{2}\sqrt{n} = \frac{1}{2} \cdot 10.54 = 5.27$$

This formula can be used only for a 1 : 1 ratio.

Ratios other than 1 : 1 may also be tested by this method. Let us examine a possible 3 : 1 ratio. In *Nemesia strumosa* a common type of flower has white lips whereas a less common but very attractive type has a margin of blue around all the upper lips of the corolla. This blue-margin type is found in plants homozygous for *bm*, a recessive gene, whereas the white type that lacks the blue margin has the dominant allele, *Bm*. Two white-flowered plants were crossed and the progeny segregated into 86 white and 23 blue-margin. Is this ratio a true example of a 3 : 1 ratio? If so, it must be presumed that both white-flowered parents were heterozygous. Let us find it by the percentage method:

	White	Blue-Margin
Observed ratio	86	23
Per cent of each class	78.9	21.1
Expected per cent	75.0	25.0
Deviation	3.9	3.9

$$\sigma = \sqrt{\frac{p \cdot q}{n}} = \sqrt{\frac{0.75 \times 0.25}{109}} = 4.15 \text{ per cent}$$

$$\frac{d}{\sigma} = \frac{3.9 \text{ per cent}}{4.15 \text{ per cent}} = 0.94$$

With 109 plants, the standard error for a 3 : 1 ratio is 4.15 per cent whereas the deviation was only 3.90 per cent. It is safe, then, to assume that this ratio is a true example of a 3 : 1 ratio.

As for the 1 : 1 ratio, calculations of standard errors of 3 : 1 ratios may often be simplified by the use of a special formula derived from the general formula which can be applied only to a 3 : 1 ratio. This formula is $\sigma = \frac{\sqrt{3n}}{4}$. When we apply this to our case in *Nemesia*, we have:

$$\sigma = \frac{\sqrt{3n}}{4} = \frac{\sqrt{327}}{4} = \frac{18.08}{4} = 4.52$$

The deviation in this problem is 4.25 so that the deviation divided by the standard error is $4.25/4.52$ or 0.94, which agrees with the result obtained previously. The probability of occurrence for various ratios of the deviation to the standard error are listed in Table 2.

The methods of the probable and the standard errors are similar except that the probable error is 0.6745 times the standard error. If the deviation is greater than three times the probable error, the observed ratio is considered not a true example of the theoretical. The probable error has been used longer than the standard error. Because it requires a further multiplication, there is a tendency today to replace it with the standard error, although many geneticists still use the older method.

Chi Square

Still another method of determining whether an observed ratio is a true example of a theoretical ratio is the χ^2 (chi square) method. It is often used when the ratio includes more than two terms, as explained in Chapter 9, but is also useful when there are only two terms. Chi square is obtained by finding the actual deviations of the observed frequency from the expected frequency for each term of the ratio, squaring them, dividing each squared deviation by the expected frequency of that term, summing these values, and finding the probability from the appropriate place in a prepared table which lists the probabilities for various values of χ^2 .

If we return to our problem of orange and white flowers in *Nemesia strumosa*, we recall that a cross between an orange-flowered plant and a white-flowered plant yielded a ratio of 25 orange to 17 white. Is this a true example of a testcross ratio? On the basis of a 1 : 1 ratio, we should expect 21 orange- and 21 white-flowered plants. Let x_1 represent the observed number of orange plants and x_2 the observed number of whites. Then let m represent the expected number in each class, which happens to be the same since this is a 1 : 1 ratio. To determine χ^2 , we use the formula:

$$\chi^2 = \frac{(x_1 - m)^2}{m} + \frac{(x_2 - m)^2}{m}$$

TABLE 2

SHOWING THE PROBABILITY OF OCCURRENCE OF STATISTICAL DEVIATIONS OF DIFFERENT MAGNITUDES RELATIVE TO THE STANDARD ERROR

(From Pearl with the permission of the W. B. Saunders Company.)

Deviation S.E.	Probable Occurrence of a Deviation as Great as or Greater than Designated One in 100 Trials	Odds against the Occurrence of a Deviation as Great as or Greater than the Designated One
0.67449	50.00	1.00 to 1
0.7	48.39	1.07 to 1
0.8	42.37	1.36 to 1
0.9	36.81	1.72 to 1
1.0	31.73	2.15 to 1
1.1	27.13	2.69 to 1
1.2	23.01	3.35 to 1
1.3	19.36	4.17 to 1
1.4	16.15	5.19 to 1
1.5	13.36	6.48 to 1
1.6	10.96	8.12 to 1
1.7	8.91	10.22 to 1
1.8	7.19	12.92 to 1
1.9	5.74	16.41 to 1
2.0	4.55	20.98 to 1
2.1	3.57	26.99 to 1
2.2	2.78	34.96 to 1
2.3	2.14	45.62 to 1
2.4	1.64	60.00 to 1
2.5	1.24	79.52 to 1
2.6	0.932	106.3 to 1
2.7	0.693	143.2 to 1
2.8	0.511	194.7 to 1
2.9	0.373	267.0 to 1
3.0	0.270	369.4 to 1
3.1	0.194	515.7 to 1
3.2	0.137	726.7 to 1
3.3	0.0967	1,033 to 1
3.4	0.0674	1,483 to 1
3.5	0.0465	2,149 to 1
3.6	0.0318	3,142 to 1
3.7	0.0216	4,637 to 1
3.8	0.0145	6,915 to 1
3.9	0.00962	10,390 to 1
4.0	0.00634	15,770 to 1
5.0	0.0000573	1,744,000 to 1
6.0	0.00000020	500,000,000 to 1
7.0	0.0000000026	400,000,000,000 to 1

Substituting, we have

$$\begin{aligned}\chi^2 &= \frac{(25 - 21)^2}{21} + \frac{(17 - 21)^2}{21} = \frac{(4)^2}{21} + \frac{(-4)^2}{21} = \frac{16}{21} + \frac{16}{21} \\ &= 0.762 + 0.762\end{aligned}$$

The value of χ^2 for this particular problem is 1.524, but what does that mean? How do we know whether this ratio is a true example of a 1 : 1 ratio merely by knowing that $\chi^2 = 1.524$? Without going any more deeply into the mathematics behind all this, we may say that it is fairly generally agreed that whenever, in a problem such as the one above, χ^2 is 3.841 or larger, the observed ratio is probably not an illustration of the ratio for which it was tested. To restate that, if χ^2 is 3.841 or larger it is considered to be *significantly great* or merely *significant*. In a ratio involving only two terms, such as 1 : 1 or 3 : 1, when χ^2 is greater than 3.841 the chance of getting this ratio as the result of chance alone is one out of 20. In other words, if we cross a heterozygote with a recessive we should expect that our family would segregate into an observed ratio having a χ^2 greater than a 3.841 in only 5 per cent of the cases. In our problem, $\chi^2 = 1.524$. It has been calculated that a family with such a χ^2 value would occur in 20 to 30 per cent of the families tested. Since the probability of getting a 25 : 17 ratio when we expect 21 : 21 are between 20 and 30 per cent, it is highly probable that our ratio is a true example of a 1 : 1 ratio. If, on the other hand, our ratio had been 28 : 14, would it be considered a 1 : 1 ratio? Now the value of χ^2 is:

$$\begin{aligned}\chi^2 &= \frac{(28 - 21)^2}{21} + \frac{(14 - 21)^2}{21} = \frac{(7)^2}{21} + \frac{(-7)^2}{21} = \frac{49}{21} + \frac{49}{21} \\ &= 2.333 + 2.333 = 4.666\end{aligned}$$

Since this value of χ^2 lies beyond the 5 per cent point, we should say that it is significant and that a 28 : 14 ratio is probably not a true example of a 1 : 1 ratio.

The χ^2 method is equally applicable for testing a 3 : 1 ratio, in which, of course, the expected frequency is different for each term. Let us designate the observed frequency of any term by x and the expected frequency by m , and let us use as an illustra-

tion the cross between the two white-flowered *Nemesia* plants which produced 86 white and 23 blue-margin plants.

	x	m	$x - m$	$(x - m)^2$	$\frac{(x - m)^2}{m}$
White	86	81.75	+4.25	18.0625	0.221
Blue-margin	23	27.25	-4.25	18.0625	0.663

$$\chi^2 = 0.884$$

In this problem, χ^2 has a very low value and is certainly not significant. On the basis of the χ^2 test, this ratio can be considered a true example of a 3 : 1 ratio, and any deviation that it shows from a perfect 3 : 1 ratio can be ascribed purely to chance.

If the observed ratio happens to be exactly the same as the expected ratio there is no deviation and consequently $\chi^2 = 0$. The greater the deviation, the greater the value of χ^2 , and the smaller the probability that the observed ratio is a true example of the ratio that is being tested. If χ^2 is 0, the probability is 100 per cent that the observed ratio is a true example of the expected ratio; but if χ^2 is 0.016, the probability is only 90 per cent. That is, if you expect a certain ratio, chance alone will give you an observed ratio with a χ^2 value of 0.016 in nine times out of ten. If χ^2 is 0.455, however, the probability of occurrence is only 50 per cent and, if χ^2 is 1.642, the probability is only 20 per cent. Other values of χ^2 in terms of the probability of occurrence are given in a table in Chapter 9.

The term *probability of occurrence* as used in the χ^2 test must not be confused with the term *probability* as used in the binominal expansion. The χ^2 method states the percentage of cases in which a certain deviation and all greater deviations would occur by chance from a given theoretical ratio for a family consisting of a certain number of individuals. The binominal expansion tells us the probability that we should get a certain number of individuals of each class in a family of a given size if the numbers were segregating into a given ratio. The binominal expansion tells us what would be the chances of getting a family of four boys and two girls if the sexes appear in equal numbers. The χ^2 method tells us what would be the probability of occur-

rence in per cent due to chance alone of a deviation as great as (or greater than) one from an expected ratio of 3 : 3.

Samples

The student might well be inclined to ask why it is necessary to apply statistical methods in genetics and why they were invented in the first place. If we cross two *Nemesia* plants whose genotypes are *Bmbm*, we should get a ratio of three white to one blue-margin, and we should get exactly such a 3 : 1 ratio if we had an infinite number of offspring. Similarly, if we tossed a coin an infinite number of times, we should get heads and tails in exactly equal numbers. However, the student must be aware that an infinite number of plants does not exist and that there is no such thing in our finite world as an infinite number of tosses. If we raise 100 or 200 or even 1000 plants, we still do not have the entire theoretical population of offspring that might be produced from such a cross. What we have is a *sample*, and from this sample we must judge whether or not the entire population would be segregating into a 3 : 1 ratio. Samples are subject to the laws of chance, and statistical methods are applied to the sample to determine whether the variation shown by the sample from the theoretical ratio is merely the degree of variation that chance alone would produce in a given percentage of samples or whether the variation is so great that it is highly improbable that the observed ratio could be considered a sample of the theoretical ratio we are considering.

Statistical methods are also applied to finite populations which are so large that it is impractical to examine every individual of the population. If we have a carload of ears of corn to be sold, the purchaser must, of course, have an idea of the quality of the corn before he purchases it. Since it would be impractical to examine every ear, he examines merely a small sample, and on the basis of that sample he judges what he will pay for the entire carload. Obviously, such a sample will not be an exact picture of the whole population, but if it is obtained in a purely random manner, and if it is reasonably large, it will furnish a sufficiently accurate estimate of the whole carload.

QUESTIONS AND PROBLEMS

1. If a family contains six children, what is the probability that all will be boys; that all will be girls; that there will be four boys and two girls?

2. If a penny, dime, and nickel are tossed at the same time, what is the chance that there will be three heads; that there will be two heads and a tail; that the penny and dime will be heads and the nickel tail?

3. A man tosses a penny 200 times and gets 150 heads and 50 tails. Using χ^2 , figure the probability of this result. Can the deviation be attributed to chance? If not, how could you account for it?

4. In drawing blindly from a complete pack of cards which has been thoroughly shuffled, what is the chance of drawing a red ace; the ace of diamonds; a red card?

5. A man draws the ace of diamonds from a pack of cards. What is the chance that he will draw the ace of hearts on the next draw? Is the chance any different whether or not he replaces the ace of diamonds before he makes the second draw? Why?

6. What is the chance that one of the four hands in a bridge game will contain all spades?

7. Two men draw seven cards each from a complete pack, replacing each card and reshuffling after each draw. A draws one heart, three diamonds, two spades, and a club. B draws six hearts and a club. What is the chance that A will draw a heart on the eighth draw? What is the chance that B will draw a heart on the eighth draw?

8. Family A has four boys and family B four girls. Which family has a better chance of obtaining a boy for the fifth child? Explain.

9. In maize, green silks are dominant to salmon. Maize is regularly cross-pollinated. A farmer who had both varieties sows the seeds of a plant which was heterozygous ($Smsm$), but he has no idea of the male parentage of these seeds. He obtains 74 green-silked and 39 salmon-silked plants. Using χ^2 , figure the probability that this is a 1 : 1 and that it is a 3 : 1 ratio. From the probabilities obtained, what would you conclude as to the male parent or parents of these seeds?

10. A farmer has one green-silked maize plant growing in a field of salmon-silked plants. He detassels the green-silked plant. He uses the seed from this plant and obtains 167 green-silked and 173 salmon-silked plants in the next generation. What is the probability that this plant was a heterozygote? What is the possibility that it was a homozygote?

11. A heterozygote, when selfed, gives 632 dominants and 199 recessives. What is the probability that this is a 3 : 1 ratio? Figure this by both the standard error and χ^2 methods and compare the results. Are they identical? Are they fundamentally different or is the difference between the two methods insignificant?

12. A green-silked maize plant is crossed with a salmon-silked plant. The offspring segregated into 220 green and 180 salmon. Is the deviation significant?

13. If the offspring in problem 12 segregated into 420 green and 380 salmon, is the deviation significant? Here the deviation is the same but the sample is larger. Why should this make any difference?

14. Using the same number of plants in problem 12 (400 plants), what must be the deviation from expected to give the same value of χ^2 as was obtained in problem 13?

15. In the following six experiments (Wright in *Genetics*) the size of the family and the percentage of males obtained in each experiment are listed. Determine by the method of the standard error whether males and females are produced in equal proportions in the guinea pig.

<i>Experiment</i>	<i>Number of Individuals</i>	<i>Per Cent of Males</i>
(AB)B	486	47.9
(AD)D	359	45.7
(AF)F	417	48.9
(AE)E	230	55.7
(BD) ²	380	47.9
(CD) ²	285	46.7

16. In guinea pigs, gene p produces pink eye and P produces black. Wright crossed two animals which were supposedly heterozygous and obtained 197 black and 90 pink. Calculate how much greater is the deviation than the standard error. Can this be considered a true example of a 3 : 1 ratio? If not, how do you explain the ratio obtained? Could such a result possibly be explained as an extreme chance deviation? Consult Wright's paper for his explanation.

17. Determine the probability that the observed ratio in problem 16 is a true example of a 3 : 1 ratio by the χ^2 method.

Chapter 9

THE DISTRIBUTION OF TWO OR MORE PAIRS OF ALLELES IN TWO OR MORE CHROMOSOMES

Two Pairs of Genes in Two Pairs of Autosomes

In *Zea mays* there are ten pairs of chromosomes, and they can be distinguished from one another by their size and general morphology. Their morphological characteristics include the position of their centromeres, the presence and position of secondary constrictions, and the presence of knobs of various sizes on the ends of the chromosomes (Fig. 38). The ability to distinguish the various chromosomes enables us to say that when a maize plant undergoes meiosis, one member of each pair of chromosomes enters each gamete. Furthermore, there is a great amount of evidence to show that the segregation of any one pair is entirely unaffected by the segregation of any other pair, but most of this evidence is genetical rather than cytological.

In chromosome VI of maize, a gene is present for purple plant color, *Pl*, which is dominant to its allele for green, *pl*. A homozygous purple plant crossed with a green gives a purple F_1 and three purple to one green in the F_2 . In chromosome III, the gene for normal leaves, *Cr*, is dominant to crinkly leaves, *cr*; and when a homozygous normal is crossed with a crinkly, the F_1 is normal and the F_2 segregates into three normal and one crinkly. If a plant which is homozygous for both purple color and normal leaves is crossed with one that has green color and crinkly leaves, the F_1 is purple and normal and is heterozygous for each pair of genes. This F_1 plant receives the genes *Pl* and *Cr* from its female parent and the genes *pl* and *cr* from its male parent, and when it undergoes meiosis the chromosome which bears *Pl* separates from the one with *pl*. In like manner the chromosome bearing *Cr* separates from its homologue which bears *cr*. However, the segregation of the *Pl* and *pl* chromo-

somes is *entirely independent* of the segregation of the *Cr* and *cr* chromosomes, so that four types of gametes will be produced by the F_1 plant in equal numbers.

Once the maternal and the paternal chromosomes enter the F_1 their identity as maternal and paternal chromosomes is en-

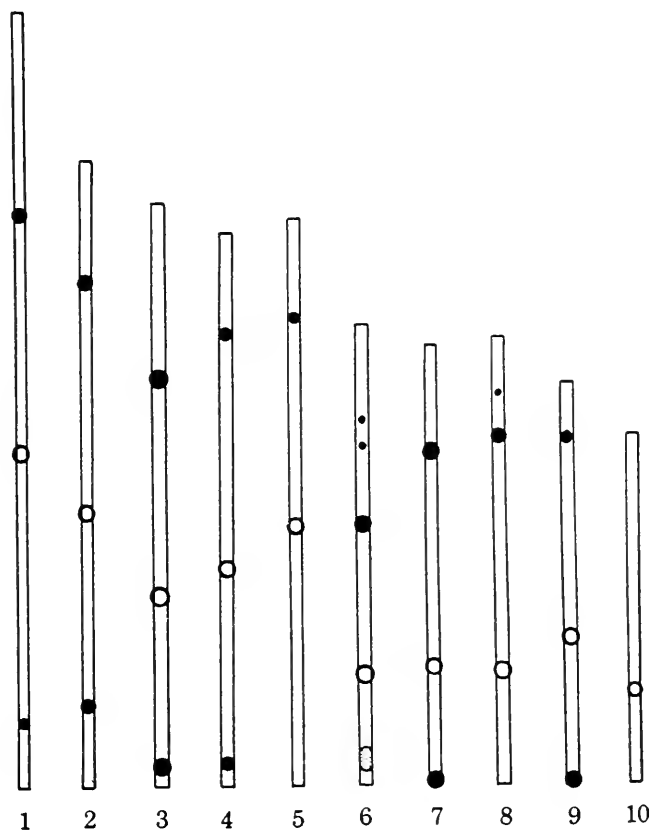

FIG. 38. Diagram of the ten chromosomes of *Zea mays* showing the relative mean length at midprophase I. The centromeres (kinetochores) are indicated by open circles, the known knob positions by black circles, and the nucleolus-organizing body by stippling. (Redrawn from Longley in the *Botanical Review*.)

tirely lost. The way the homologues of one pair separate is entirely unaffected by the way the homologues of any other pair separate. It is purely a matter of chance whether an F_1 gamete which has a “maternal” chromosome III will also have a “maternal” chromosome VI or whether it will have a “paternal” chromosome VI. Since it is entirely a matter of chance, the four types of gametes will be present with equal frequency, within

the limits of statistical error. This phenomenon, known as *independent assortment*, is the second law of Mendel. It applies to all ten pairs of chromosomes in maize and not merely to the two pairs just mentioned. In maize, each of the ten pairs of chromosomes segregates entirely independently of *any* other pair, so that gametes from F_1 plants will be found with all numbers of either maternal or paternal chromosomes from zero to ten. This

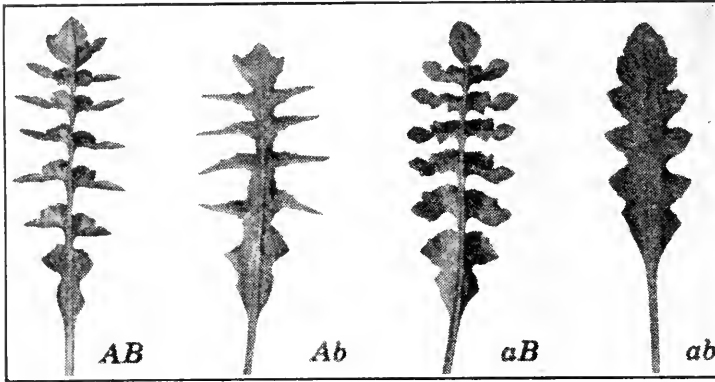

FIG. 39. Four inherited types of rosette leaves in *Capsella* (Bursa). These types result from the independent assortment of two pairs of genes. Gene *A* draws out the primary lobes of the leaves into relatively long sharp points whereas in *aa* plants the primary lobes are rounded. Gene *B* divides the leaf by deep sinuses, usually reaching nearly or quite to the midrib, but in *bb* plants the sinuses are not so deep. The four types from left to right with their genotypes are: *AB* or *heteris*; *Ab* or *tenuis*; *aB* or *rhomboidea*; and *ab* or *simplex*. (Photographs courtesy of Dr. G. H. Shull.)

law of independent assortment applies to all plants and animals as well as to maize (Fig. 39).

This independent separation of the homologous chromosomes of each pair was suspected on genetic grounds long before it was demonstrated cytologically. It is normally difficult to show cytologically because the two members of a pair of homologous chromosomes are identical in appearance except in a few rare instances. The independent segregation of two or more pairs of chromosomes can be detected cytologically only if the two homologues of each of the two or more pairs can be differentiated from one another morphologically. Normally that is impossible. Miss Carothers, however, found that in the orthopteran, *Trimerotropis suffusa*, there are three pairs of homologues, each consisting of one chromosome with a centromere at the end

(telomitic) and one in which the centromere is not at the end (atelomitic). That these can be arranged at metaphase in four different ways so as to give eight different gametes (Fig. 40) shows that the members of one pair segregate entirely independently of other pairs.



Fig. 40. Independent segregation of chromosomes. Three pairs of heteromorphic chromosomes are present and separate in all possible combinations. (Redrawn from Carothers in the *Journal of Morphology*.)

Recombination. In a monohybrid the gametes of the male unite in an entirely random fashion with the gametes of the female. It is also true when the F_1 is heterozygous for more than one pair of genes. Let us illustrate this point in a *dihybrid*, where the F_1 is heterozygous for two pairs of genes. In the cross between $PlPl CrCr$ and $plpl crcr$ the F_1 is $Plpl Crcr$. Four kinds of eggs and four kinds of male gametes are formed by the F_1 plant. They are genetically $Pl Cr$, $Pl cr$, $pl Cr$, and $pl cr$. Any male gamete can unite with any egg, and in fact does so with equal frequency. The result of this combination of four different eggs with four different male gametes would be sixteen plants, and those sixteen possibilities can be illustrated by a diagram known as a "checkerboard" (Fig. 41). When the various kinds of genotypes are tabulated the result is:

<i>Genotypes</i>	<i>Phenotypes</i>
1 $PlPl CrCr$	} 9 purple color, normal leaves
2 $PlPl Crcr$	
2 $Plpl CrCr$	
4 $Plpl Crcr$	
1 $PlPl crcr$	} 3 purple color, crinkly leaves
2 $Plpl crcr$	
1 $plpl CrCr$	} 3 green color, normal leaves
2 $plpl Crcr$	
1 $plpl crcr$	} 1 green color, crinkly leaves
16	16

Since dominance of both genes is complete, the phenotype ratio in the F_2 is 9 Dominant Dominant : 3 Dominant recessive : recessive Dominant : 1 recessive recessive.

The checkerboard is an easy means of showing the results of combining the four eggs with the four male gametes at random. It is somewhat cumbersome, however, and need not be used if the student approaches the F_2 as a problem of combined ratios. If for the moment only the Pl and pl genes are considered, the F_2 genotypic ratio is 1 $PlPl$: 2 $Plpl$: 1 $plpl$. If the genes Cr

		Male Gametes			
		$Pl Cr$	$Pl cr$	$pl Cr$	$pl cr$
Eggs	$Pl Cr$	$Pl Cr$ $Pl Cr$	$Pl Cr$ $Pl cr$	$Pl Cr$ $pl Cr$	$Pl Cr$ $pl cr$
	$Pl cr$	$Pl cr$ $Pl Cr$	$Pl cr$ $Pl cr$	$Pl cr$ $pl Cr$	$Pl cr$ $pl cr$
	$pl Cr$	$pl Cr$ $Pl Cr$	$pl Cr$ $Pl cr$	$pl Cr$ $pl Cr$	$pl Cr$ $pl cr$
	$pl cr$	$pl cr$ $Pl Cr$	$pl cr$ $Pl cr$	$pl cr$ $pl Cr$	$pl cr$ $pl cr$

FIG. 41. Checkerboard method of determining the F_2 from a cross between a homozygous purple, normal-leaved maize plant of the genotype $PlPl CrCr$ and a green, crinkly-leaved plant, $plpl crcr$.

and cr are considered, the F_2 genotypes are 1 $CrCr$: 2 $Cr cr$: 1 $cr cr$. Now when we combine two independent monohybrid ratios we see that one-fourth the $PlPl$ plants will also be $CrCr$, that one-half will be $Cr cr$, and that the remaining one-fourth will also be $cr cr$. The same is true of all the $Plpl$ and also of all the $plpl$ plants. The method of obtaining a dihybrid F_2 genotypic ratio by combining the two independent F_2 monohybrid genotypic ratios of which it is composed is shown in Fig. 42. It is easily seen that the results are the same as those obtained by the checkerboard method.

In a similar manner, the dihybrid phenotypic ratio can be determined by combining the two monohybrid phenotypic ratios (Fig. 42). Although the independent monohybrid ratios have been presented in the form of ratios of whole numbers (3 : 1), they could also be written in the form of ratios of probabilities ($\frac{3}{4}$: $\frac{1}{4}$). The probability of getting a purple plant is $\frac{3}{4}$ and the probability of getting a noncrinkly plant is $\frac{3}{4}$. Therefore, the probability of getting a plant that is both purple and noncrinkly is $\frac{3}{4} \times \frac{3}{4}$ or $\frac{9}{16}$. The probabilities of the other com-

binations can be worked out in the same way. It is customary to express the results by a ratio of whole numbers rather than of fractions, and the ratio of 9 : 3 : 3 : 1 is well known as the F_2 dihybrid ratio.

Similar instances of dihybrid ratios could be cited by the thousands in the many plants and animals that have been

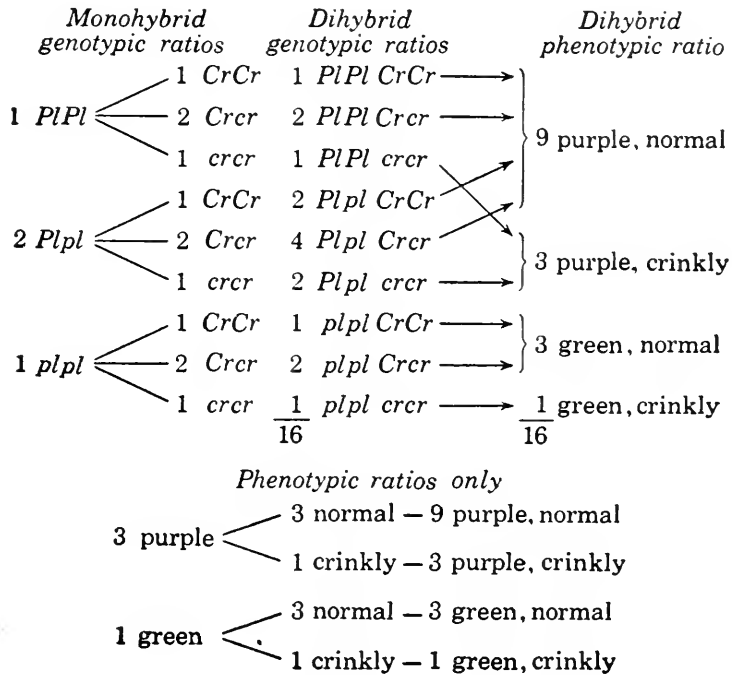

FIG. 42. The determination of the F_2 from the cross $PIPl CrCr \times plpl crCr$ by the method of combined ratios. The *Pl* and *pl* genes segregate into a genotypic ratio of 1 *PIPl* : 2 *Plpl* : 1 *plpl* and the *Cr* and *cr* genes into a ratio of 1 *CrCr* : 2 *Crcr* : 1 *crcr*. When the two independent ratios are combined, the F_2 genotypic ratio is obtained. Similarly, by combining the phenotypic ratios of 3 purple : 1 green and 3 normal : 1 crinkly, the dihybrid phenotypic ratio results.

investigated genetically. An example from *Drosophila* may be used to show that the same phenomenon is observed in the Animal Kingdom. Curved wing (*c*) is recessive to normal wing (*C*) and is located in the second chromosome; ebony body (*e*) is recessive to wild-type or gray (*E*) and is in the third chromosome. If a curved, ebony fly (*cc ee*) is crossed with one that is homozygous for normal wing and gray body (*CC EE*), the F_1 is phenotypically normal-winged, has a gray body, and is genotypically *Cc Ee*. The F_2 segregates into 9 normal-wing, gray : 3

normal-wing, ebony : 3 curved-wing, gray : 1 curved-wing, ebony. The F_1 and F_2 would be the same both genotypically and phenotypically if one parent was homozygous dominant for one gene and recessive for the second while the other parent was recessive for the first and homozygous dominant for the second. Thus a homozygous normal-winged, ebony fly ($CC ee$) mated with a homozygous curved, gray fly ($cc EE$) would give normal-winged, gray flies in the F_1 and would produce an F_2 ratio of 9 normal, gray : 3 normal, ebony : 3 curved, gray : 1 curved, ebony. As in monohybrids, the results of reciprocal crosses are the same.

A Dihybrid Human Pedigree. Dihybrid ratios are much less common in human beings because most of the characters that have been discovered and analyzed genetically have been the rarer abnormalities that appear in only a few isolated families. Therefore, the chance that two such traits should appear in one family is much more remote than the chance of getting a dihybrid in plants or other animals where the individual characters that have been discovered are of much wider distribution. An interesting dihybrid pedigree was reported by Beers and Clark.

In human beings short first toe is inherited as a simple autosomal dominant. Individuals with the gene for this character have a short first metatarsal bone, and the big toe appears about an eighth to a fourth of an inch shorter than the second toe. Another human character is hemangioma or blood tumors which are inherited in this pedigree as a simple autosomal dominant. They are harmless but produce red spots from one millimeter to several centimeters in size. A woman who had short first toes married a man with hemangioma. The woman apparently was heterozygous as three of their offspring had short first toes and two did not, but the man appears to have been homozygous for all the children had hemangioma. The three short-toed children married people with neither short first toes nor hemangioma. Four of their children had short first toes and hemangioma; one had short first toes only and one had neither short first toes nor hemangioma (Fig. 43).

Incomplete Dominance. With one pair of alleles, when dominance is incomplete, the F_1 is intermediate and the F_2 segregates

into a ratio of 1 dominant : 2 intermediate : 1 recessive. If a plant is segregating independently for two pairs of alleles and if dominance is incomplete in both, the F₂ phenotypic dihybrid ratio is the same as the genotypic. In cotton, when a plant with brown lint (*WW*) is crossed with a plant that has white lint

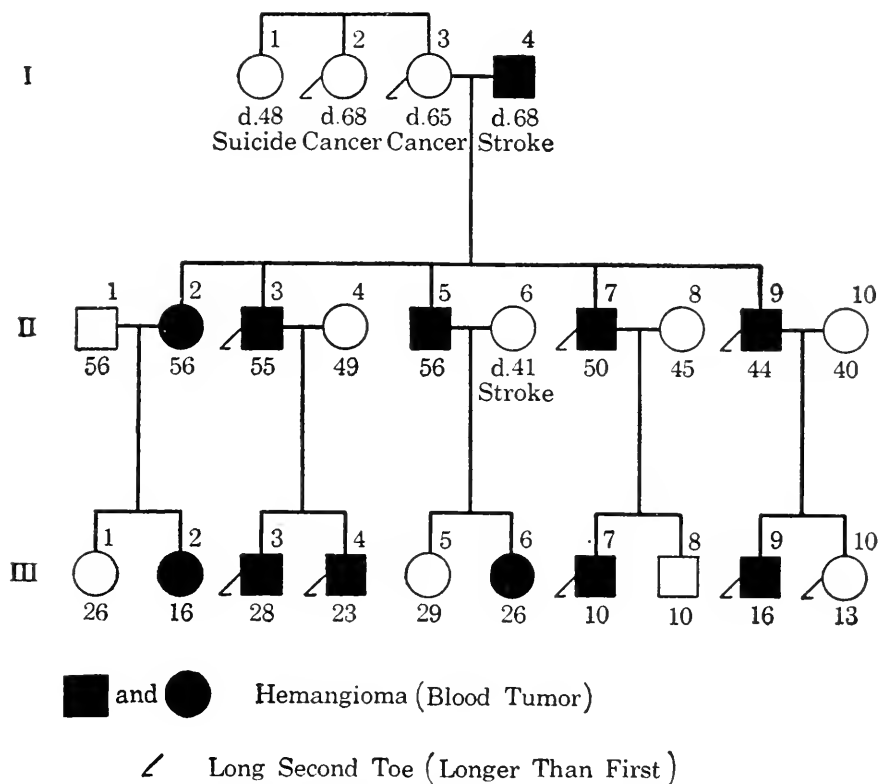

FIG. 43. A dihybrid pedigree in human beings. (From Beers and Clark in the *Journal of Heredity*.)

(*ww*), the F₁ is cream (*Ww*) and the F₂ segregates into a ratio of 1 brown : 2 cream : 1 white. When plants with red-spotted leaves (*SS*) are crossed with plants that have no spots on the leaves (*ss*), the F₁ (*Ss*) has spots but they are of weaker intensity than the spots on the red-spotted parent. The F₂ segregates into a ratio of 1 deep spots : 2 pale spots : 1 no spots. If plants which are spotted and have brown lint (*SS WW*) are crossed with plants that have no spots and white lint (*ss ww*), the F₁ has intermediate spotting and cream-colored lint, and the F₂ segregates into:

1 <i>SS WW</i> —deep spots, brown lint	2 <i>Ss ww</i> —pale spots, white lint
2 <i>SS Ww</i> —deep spots, cream lint	1 <i>ss WW</i> —no spots, brown lint
2 <i>Ss WW</i> —pale spots, brown lint	2 <i>ss Ww</i> —no spots, cream lint
4 <i>Ss Ww</i> —pale spots, cream lint	1 <i>ss ww</i> —no spots, white lint
1 <i>SS ww</i> —deep spots, white lint	16

If there is complete dominance in one pair of genes but incomplete dominance in another pair, the F_2 ratio is still different. Von Tschermak showed that in barley normal spike is completely dominant to branched and that tall culm is incompletely dominant to short. If a homozygous normal-spiked, tall plant ($BB SS$) is crossed with one homozygous for branched-spike and short culm ($bb ss$) the F_1 is normal-spiked with culms of intermediate height. The F_2 should then segregate into:

$\left. \begin{array}{l} 1 BB SS \\ 2 Bb SS \end{array} \right\} 3 \text{ normal, tall}$	$1 bb SS \text{ branched, tall}$
$\left. \begin{array}{l} 2 BB Ss \\ 4 Bb Ss \end{array} \right\} 6 \text{ normal, intermediate}$	$2 bb Ss \text{ branched, intermediate}$
$\left. \begin{array}{l} 1 BB ss \\ 2 Bb ss \end{array} \right\} 3 \text{ normal, short}$	$1 bb ss \text{ branched, short}$

Testcross. In maize the F_1 between a homozygous purple, normal-leaved plant and a green, crinkly-leaved plant is phenotypically purple and normal-leaved and produces four kinds of

“Checkerboard” Method		Testcross	
Gametes of Recessive <i>pl cr</i>		Testcross Ratio of <i>Plpl</i>	Method of Combined Ratios Testcross Ratio of <i>Cr cr</i> Combined Testcross Ratio
F ₁ Gametes	<i>Pl Cr</i> <i>Plpl Cr cr</i>	1 <i>Plpl</i>	1 <i>Cr cr</i> ----- 1 <i>Plpl Cr cr</i>
	<i>Pl cr</i> <i>Plpl cr cr</i>		1 <i>cr cr</i> ----- 1 <i>Plpl cr cr</i>
	<i>pl Cr</i> <i>plpl Cr cr</i>	1 <i>plpl</i>	1 <i>Cr cr</i> ----- 1 <i>plpl Cr cr</i>
	<i>pl cr</i> <i>plpl cr cr</i>		1 <i>cr cr</i> ----- 1 <i>plpl cr cr</i>

FIG. 44. The result of testcrossing or backcrossing an F_1 plant heterozygous for *Pl* and *Cr* with the double recessive. *Left*, the checkerboard method, and, *right*, the method of combined ratios.

gametes in equal numbers: *Pl Cr*, *Pl cr*, *pl Cr*, and *pl cr*. If this F_1 is backcrossed to a crinkly-leaved, green plant, the ratio of offspring will be 1 : 1 : 1 : 1, shown by a checkerboard (Fig. 44) or by combining the testcross ratios of the individual pairs of alleles. The testcross can be used for two independent genes in

the same way as for one. If a plant phenotypically dominant for both characters is suspected of being a double heterozygote, it can be tested with the double recessive. If the unknown dominant is heterozygous for both genes the ratio will be 1 : 1 : 1 : 1, but if it is homozygous for both, all the offspring will be dominant for both characters. If it is homozygous for one pair and heterozygous for the other, the testcross ratio will be 1 : 1. For example, if the "unknown" plant is genotypically *Plpl CrCr*, the offspring of the testcross will be 1 purple, normal-leaved : 1 green, normal-leaved.

F₃ Generation. When the various *F₂* plants are self-fertilized to produce the *F₃* generation, all the plants of the same phenotype do not produce the same results as they are not genotypically alike. For example, in the *F₂* of the cross between homozygous purple, normal-leaved and green, crinkly-leaved plants, three-sixteenths are purple and have crinkly leaves. When they are self-fertilized, one-third of them breed true and produce only purple, crinkly-leaved plants; but the other two-thirds produce both purple, crinkly-leaved plants and green, crinkly-leaved plants in the ratio of 3 : 1. When all the various kinds of *F₂* plants are selfed, the results are:

<i>F₂</i> Phenotypes	<i>F₂</i> Genotypes	<i>F₃</i> Phenotypes
$\frac{9}{16}$ purple, normal-leaved	$\frac{1}{9}(PlPl CrCr)$	gives all purple, normal
	$\frac{2}{9}(PlPl Crcr)$	gives 3 purple normal : 1 purple crinkly
	$\frac{2}{9}(Plpl CrCr)$	gives 3 purple normal : 1 green normal
$\frac{4}{9}$ purple, crinkly	$\frac{4}{9}(Plpl Crcr)$	gives 9 purple normal : 3 purple crinkly : 3 green normal : 1 green crinkly
	$\frac{1}{3}(PlPl crcr)$	gives all purple crinkly
$\frac{3}{16}$ purple, crinkly	$\frac{2}{3}(Plpl crcr)$	gives 3 purple, crinkly : 1 green, crinkly
	$\frac{1}{3}(plpl CrCr)$	gives all green, normal
$\frac{3}{16}$ green, normal	$\frac{2}{3}(plpl Crcr)$	gives 3 green, normal : 1 green, crinkly
	$\frac{1}{3}(plpl crcr)$	gives all green, crinkly
$\frac{1}{16}$ green, crinkly	: all (<i>plpl crcr</i>)	gives all green, crinkly

Autosomes and Sex Chromosomes

Independent segregation of chromosomes and their genes occurs between the sex chromosome and a pair of autosomes as

well as between two pairs of autosomes as Miss Carothers demonstrated cytologically in the invertebrate animals, *Brachystola magna*, *Arphia simplex*, and *Dissosteira carolina*. In each she found a pair of autosomes which was *heteromorphic*; that is, a pair in which one of the homologues was visibly different from its mate. In *Arphia* the male has one X chromosome and no Y chromosome, and the heteromorphic pair of autosomes consists of a large and a small chromosome. In a large number of

Wild-Type × Miniature, Purple		Miniature, Purple × Wild-Type	
P ₁	(XM)(XM) PrPr × (Xm) Y prpr	(Xm)(Xm) prpr × (XM) Y PrPr	
F ₁	(XM)(Xm) Prpr + (XM) Y Prpr	(XM)(Xm) Prpr + (Xm) Y Prpr	
F ₂			
6	$\left\{ \begin{array}{l} 1(XM)(XM) PrPr \text{ normal, red female} \\ 2(XM)(XM) Prpr \text{ " " "} \\ 1(XM)(Xm) PrPr \text{ " " "} \\ 2(XM)(Xm) Prpr \text{ " " "} \end{array} \right.$	$\left\{ \begin{array}{l} 3 \left\{ \begin{array}{l} 1(XM)(Xm) PrPr \text{ normal, red female} \\ 2(XM)(Xm) Prpr \text{ " " "} \end{array} \right. \\ 1 \left\{ \begin{array}{l} 1(XM)(Xm) prpr \text{ " purple "} \\ 1(Xm)(Xm) PrPr \text{ " " "} \end{array} \right. \\ 3 \left\{ \begin{array}{l} 1(Xm)(Xm) PrPr \text{ miniature, red "} \\ 2(Xm)(Xm) Prpr \text{ " " "} \end{array} \right. \\ 1 \left\{ \begin{array}{l} 1(Xm)(Xm) prpr \text{ " purple "} \\ 1(Xm)(Xm) prpr \text{ " purple "} \end{array} \right. \\ 3 \left\{ \begin{array}{l} 1(XM) Y PrPr \text{ normal, red male} \\ 2(XM) Y Prpr \text{ " " "} \end{array} \right. \\ 1 \left\{ \begin{array}{l} 1(XM) Y prpr \text{ " purple "} \\ 1(XM) Y prpr \text{ " purple "} \end{array} \right. \\ 3 \left\{ \begin{array}{l} 1(Xm) Y PrPr \text{ miniature, red male} \\ 2(Xm) Y Prpr \text{ " " "} \end{array} \right. \\ 1 \left\{ \begin{array}{l} 1(Xm) Y prpr \text{ " purple "} \\ 1(Xm) Y prpr \text{ " purple "} \end{array} \right. \end{array} \right.$	

FIG. 45. The F₁ and F₂ of reciprocal crosses between a gene (miniature wings) in the X chromosome and one (purple eye) in an autosome. *Left*, wild-type female × miniature, purple male. *Right*, miniature, purple female × wild-type male.

anaphases of the first meiotic division of males, the X chromosome went into the same cell as the large member of the heteromorphic pair of autosomes about 50 per cent of the time.

The genetic ratios in a dihybrid when one of the pairs of genes is in the X chromosome are naturally different from the ratios when both pairs of genes are in autosomes. In *Drosophila melanogaster* the gene for miniature wings (*m*) is in the X chromosome and the gene for purple eye (*pr*) is in the autosome, chromosome II. If a wild-type female, homozygous for both *M* and *Pr*, is crossed with a miniature, purple male, all the F₁ flies are wild type and the phenotypic ratio in the F₂ is 6 wild-type females : 2 purple-eyed females : 3 wild-type males : 1 purple-eyed male : 3 miniature-winged males : 1 miniature-winged, purple-eyed male. The reciprocal cross gives different results in both the F₁ and F₂ because of the presence of the sex-linked gene (Fig. 45).

Measuring "Goodness of Fit" in Dihybrids. In Chapter 8, it was pointed out that the test of whether an observed ratio fits a theoretical expectation, such as 3 : 1 or 1 : 1, could be made by comparing the deviation of the observed ratio with its standard error and that it could equally well be determined by the χ^2 method. In a ratio involving more than two terms, however, the usual method of the geneticist is to determine goodness of

TABLE 3
VALUES OF χ^2 *

Degrees of Freedom	Probability of Occurrence (= P)							
	0.99	0.95	0.50	0.30	0.20	0.10	0.05	0.01
1	.000157	.00393	.455	1.074	1.642	2.706	3.841	6.635
2	.0201	.103	1.386	2.408	3.219	4.605	5.991	9.210
3	.115	.352	2.366	3.665	4.642	6.251	7.815	11.345
4	.297	.711	3.357	4.878	5.989	7.779	9.488	13.277
5	.554	1.145	4.351	6.064	7.289	9.236	11.070	15.086

* Table 3 is abridged from Table III of Fisher: *Statistical Methods for Research Workers*, Oliver & Boyd Ltd., Edinburgh, by permission of the author and publishers.

fit by calculating χ^2 . By means of a table like R. A. Fisher's, the probability that a deviation as great or greater than the one in question will occur by chance can be determined from the value calculated for χ^2 . In a ratio of four terms, the method differs from the method used when the ratio contains only two terms, chiefly by the number of degrees of freedom involved. In a 3 : 1 or other ratio involving two terms only, the probability is obtained by using the first line in Table 3. The reason is that if there are a certain number of individuals in the population there may be any number of dominants or of recessives from zero to the number in the population, but when either the number of dominants or the number of recessives is determined, the number in the other term in the ratio is fixed because it must include all the rest. In a ratio of two terms, there is only one

degree of freedom; therefore line one of the table must be used. For a 9 : 3 : 3 : 1 ratio, or other ratio composed of four terms, there are three degrees of freedom, and the probability is determined from the χ^2 value in the third line of the table. In ordinary ratios encountered in genetics, the number of degrees of freedom is one less than the number of terms in the ratio.

A cross made by Demerec in maize can be used as an example. A gene, v_3 , causes very young seedlings to be yellowish white, and is recessive to the normal green seedlings. These virescent-3 seedlings become green very quickly, but the effect of the gene is striking during early stages of the plant's life. Liguleless leaf (lg) is recessive to normal (Lg). The F_2 segregated into 769 nonvirescent, liguled : 247 nonvirescent, liguleless : 279 virescent, liguled : 85 virescent, liguleless. The observed and expected frequencies with deviations and χ^2 are:

<i>Class</i>	(<i>x</i>)	(<i>m</i>)	(<i>X</i> - <i>m</i>)	(<i>X</i> - <i>m</i>) ²	$\frac{(X - m)^2}{m}$
$V_3 Lg$	769	776.25	- 7.25	52.5625	0.0677
$V_3 lg$	247	258.75	-11.75	138.9625	0.5336
$v_3 Lg$	279	258.75	+20.25	410.0625	1.5848
$v_3 lg$	85	86.25	- 1.25	1.5625	0.0181
	<hr/> 1380	<hr/> 1380.00	<hr/> 0.00	<hr/>	<hr/>
				$\chi^2 = 2.2042$	

The probability that this observed ratio is a true example of a 9 : 3 : 3 : 1 ratio can be determined from Table 3. It is found that with three degrees of freedom and a χ^2 of 2.2042, the probability is between 50 and 70 per cent. This means that if the experiment were repeated a large number of times, as great a deviation as this or a greater would be found in 50 to 70 per cent of the number of times the cross was repeated. The deviation found here was undoubtedly the result merely of chance. If χ^2 was of such value that this deviation would occur in less than 5 per cent of the reported trials, it would generally be considered that it did not fit and that something other than chance was causing the deviation.

Trihybrids

If two plants or animals differ with respect to three pairs of genes in three pairs of autosomes, the F_2 ratios are fairly com-

plicated. If two homozygotes are crossed, such as $AA BB CC \times aa bb cc$, the F_1 is $Aa Bb Cc$. It is heterozygous for all three pairs of genes and is known as a *trihybrid*. Since each pair of homologous chromosomes acts independently of every other pair at meiosis, there are eight different kinds of gametes formed by the F_1 and eight different kinds of phenotypes in both the F_2 and the backcross of the F_1 to the triple recessive.

In the F_2 of the cross $AA BB CC \times aa bb cc$, genes A and a give a phenotypic ratio of $3A : 1a$ and genes B and b a ratio of $3B : 1b$. Of the A plants, three-quarters will be B and one-quarter b , and the a plants will fall into the same ratio with respect to the B and b phenotypes. Thus, if these two pairs of genes are considered alone, the F_2 is $9AB : 3Ab : 3aB : 1ab$. But C and c must also be considered. A CC plant or animal crossed with one that is cc will produce an F_2 phenotypic ratio of $3C : 1c$. Since the segregation of these genes is independent of *both* the other pairs, three-quarters of the AB plants will also be C and one-quarter will be c ; similarly, three-quarters of each of the other phenotypes (Ab , aB , and ab) will be C and one-quarter of each of them will be c . The F_2 phenotypic ratio can be obtained very easily by the method of combined monohybrid ratios, as in Fig. 46. It is customary to write this ratio $27 : 9 : 9 : 9 : 3 : 3 : 3 : 1$. This F_2 phenotypic ratio is obtained whether the cross of the P_1 generation is $AA BB CC \times aa bb cc$ or $AA BB cc \times aa bb CC$ or $AA bb CC \times aa BB cc$ or $aa BB CC \times AA bb cc$ and irrespective of which genotype is the male and which is the female in each of these four crosses.

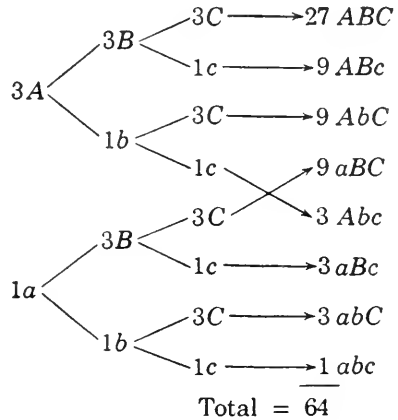

FIG. 46. The F_2 trihybrid ratio by the method of combined ratios. The three independent ratios are: $3A : 1a$; $3B : 1b$; $3C : 1c$. The F_2 ratio is found if the original crosses are $AA BB CC \times aa bb cc$, or $AA BB cc \times aa bb CC$, or $AA bb cc \times aa BB CC$, or $AA bb CC \times aa BB cc$, and irrespective in each cross of which is the male and which the female.

The checkerboard method of determining the F_2 is just as

correct for a trihybrid as for a dihybrid, but is necessarily more complicated and correspondingly less useful. In the hypothetical case just mentioned, the F_1 from any of the combinations of different genotypes will be $Aa Bb Cc$. Each gamete will contain three genes, *one from each pair of alleles* (plus, of course, one of each of all the thousands more or less of pairs of genes

P_1 : $AABBCC \times aabbcc$

F_1 : $AaBbCc$

F_2 :		<i>ABC</i>	<i>ABc</i>	<i>AbC</i>	<i>aBC</i>	<i>Abc</i>	<i>aBc</i>	<i>abC</i>	<i>abc</i>
	<i>ABC</i>	<i>ABC</i> <i>ABC</i>	<i>ABc</i> <i>ABC</i>	<i>AbC</i> <i>ABC</i>	<i>aBC</i> <i>ABC</i>	<i>Abc</i> <i>ABC</i>	<i>aBc</i> <i>ABC</i>	<i>abC</i> <i>ABC</i>	<i>abc</i> <i>ABC</i>
	<i>ABc</i>	<i>ABC</i> <i>ABc</i>	<i>ABc</i> <i>ABc</i>	<i>AbC</i> <i>ABc</i>	<i>aBC</i> <i>ABc</i>	<i>Abc</i> <i>ABc</i>	<i>aBc</i> <i>ABc</i>	<i>abC</i> <i>ABc</i>	<i>abc</i> <i>ABc</i>
	<i>AbC</i>	<i>ABC</i> <i>AbC</i>	<i>ABc</i> <i>AbC</i>	<i>AbC</i> <i>AbC</i>	<i>aBC</i> <i>AbC</i>	<i>Abc</i> <i>AbC</i>	<i>aBc</i> <i>AbC</i>	<i>abC</i> <i>AbC</i>	<i>abc</i> <i>AbC</i>
	<i>aBC</i>	<i>ABC</i> <i>aBC</i>	<i>ABc</i> <i>aBC</i>	<i>AbC</i> <i>aBC</i>	<i>aBC</i> <i>aBC</i>	<i>Abc</i> <i>aBC</i>	<i>aBc</i> <i>aBC</i>	<i>abC</i> <i>aBC</i>	<i>abc</i> <i>aBC</i>
	<i>Abc</i>	<i>ABC</i> <i>Abc</i>	<i>ABc</i> <i>Abc</i>	<i>AbC</i> <i>Abc</i>	<i>aBC</i> <i>Abc</i>	<i>Abc</i> <i>Abc</i>	<i>aBc</i> <i>Abc</i>	<i>abC</i> <i>Abc</i>	<i>abc</i> <i>Abc</i>
	<i>aBc</i>	<i>ABC</i> <i>aBc</i>	<i>ABc</i> <i>aBc</i>	<i>AbC</i> <i>aBc</i>	<i>aBC</i> <i>aBc</i>	<i>Abc</i> <i>aBc</i>	<i>aBc</i> <i>aBc</i>	<i>abC</i> <i>aBc</i>	<i>abc</i> <i>aBc</i>
	<i>abC</i>	<i>ABC</i> <i>abC</i>	<i>ABc</i> <i>abC</i>	<i>AbC</i> <i>abC</i>	<i>aBC</i> <i>abC</i>	<i>Abc</i> <i>abC</i>	<i>aBc</i> <i>abC</i>	<i>abC</i> <i>abC</i>	<i>abc</i> <i>abC</i>
	<i>abc</i>	<i>ABC</i> <i>abc</i>	<i>ABc</i> <i>abc</i>	<i>AbC</i> <i>abc</i>	<i>aBC</i> <i>abc</i>	<i>Abc</i> <i>abc</i>	<i>aBc</i> <i>abc</i>	<i>abC</i> <i>abc</i>	<i>abc</i> <i>abc</i>

Cross: $AaBbCc \times aabbcc$

Offspring:		<i>ABC</i>	<i>ABc</i>	<i>AbC</i>	<i>aBC</i>	<i>Abc</i>	<i>aBc</i>	<i>abC</i>	<i>abc</i>
	<i>abc</i>	<i>ABC</i> <i>abc</i>	<i>ABc</i> <i>abc</i>	<i>AbC</i> <i>abc</i>	<i>aBC</i> <i>abc</i>	<i>Abc</i> <i>abc</i>	<i>aBc</i> <i>abc</i>	<i>abC</i> <i>abc</i>	<i>abc</i> <i>abc</i>

FIG. 47. The F_2 and backcross of a trihybrid by the checkerboard method.

which make up the particular genotype but do not concern the immediate problem). This fact is emphasized because students frequently become confused in writing the gametes and place the two genes of one pair of alleles in the same gamete, failing to include a gene from one of the other pairs. The eight kinds of gametes from the F_1 are ABC , ABc , AbC , aBC , Abc , aBc , abC , and abc , and they are found with equal frequency. In forming a "checkerboard," these eight types, representing the male gametes, would be placed at the top of the diagram, and the same eight, representing the female gametes, would be in a column at the left. There would be sixty-four squares in the

“checkerboard,” as illustrated in Fig. 47. When the various types of the F_2 are tabulated, the phenotypic and genotypic ratios are:

Phenotypic:	27ABC	9ABc	9AbC	9aBC	3Abc	3aBc	3abC	1abc
Genotypic:	1 AA BB CC	1 AA BB cc	1 AA bb CC	1 aa BB CC	1 AA bb cc	1 aa BB cc	1 aa bb CC	1 aa bb cc
	2 AA BB Cc	2 AA Bb cc	2 AA bb Cc	2 aa BB Cc	2 Aa bb cc	2 aa Bb cc	2 aa bb Cc	
	2 AA Bb CC	2 Aa BB cc	2 Aa bb CC	2 aa Bb CC				
	2 Aa BB CC	4 Aa Bb cc	4 Aa bb Cc	4 aa Bb Cc				
	4 AA Bb Cc							
	4 Aa BB Cc							
	4 Aa Bb CC							
	8 Aa Bb Cc							

It is readily seen from the above that each kind of homozygote is represented once; each genotype which is heterozygous for one pair of genes, as $AA BB Cc$, $AA Bb cc$, $aa bb Cc$, is represented twice; each double heterozygote, as $AA Bb Cc$, $Aa Bb cc$, is represented four times; and 8 individuals out of the 64 are heterozygous for all three genes. This is easily understandable. A plant which would be genotypically $AA BB Cc$, getting the C gene from the mother and the c gene from the father, would be the same as one which received c on the female side and C on the male, for once the two alleles get together in one plant or animal any difference with respect to their parentage is lost. Therefore, the two types, $AA BB Cc$ and $AA BB cC$, would be classed together. A double heterozygote would have two such pairs, so there would be four individuals of each double heterozygote; the triple heterozygote would have three pairs, and there would be eight combinations of these which would be identical.

Testcross. When an F_1 plant or animal, heterozygous for three pairs of genes, is crossed with a triple recessive, eight types of offspring are produced in equal numbers, as shown in Fig. 47. The testcross from a trihybrid is, therefore, 1 : 1 : 1 : 1 : 1 : 1 : 1 : 1.

Polyhybrids

Plants and animals that have more than three pairs of chromosomes may naturally have more than three pairs of genes which show independent assortment. Since in *Drosophila melanogaster* there are four pairs of chromosomes, four pairs of genes could show independent assortment, although one pair would be located in the sex chromosome. In maize, ten pairs

of genes could segregate independently as maize has twenty somatic chromosomes. When two plants or animals differ by more than three pairs of genes, the F_2 phenotypic and genotypic ratios are correspondingly more complicated than for a trihybrid. Phenotypic ratios up to a tetrahybrid are:

Monohybrid																				3 : 1											
Dihybrid																					9 : 3 : 3 : 1										
Trihybrid																					27 : 9 : 9 : 9 : 3 : 3 : 3 : 1										
Tetrahybrid	81	:	27	:	27	:	27	:	27	:	9	:	9	:	9	:	9	:	9	:	9	:	3	:	3	:	3	:	3	:	1

When the F_1 is heterozygous for more than three pairs of genes, the F_2 ratios become very large. Fortunately, in solving practical genetic problems, it is rarely necessary to deal with such complicated ratios. Polyhybrids are interesting algebraically, since they show that phenotypic ratios involving a number of genes in different chromosomes can be obtained by applying the binomial theorem, expanding the binomial $(3a + b)^n$, where the exponent of a represents the *number* of dominant genes in a term, the exponent of b the *number* of recessives, and n the number of heterozygous genes in the parent. The F_2 can thus be determined for any number of heterozygous pairs of genes on separate chromosomes.

Heterozygous Populations in Man

From considering the complicated ratios involved in polyhybrids involving four and more pairs of genes, we learn the important fact of the great diversity resulting from self-fertilizing a plant that is heterozygous for a large number of genes. This great diversity is especially important in studying inheritance in human beings. People are frequently encountered who "do not believe in genetics" because children often differ greatly from either or both their parents. When the facts are considered, such divergence from the parents should be expected as well as considerable variation among brothers and sisters, for there are twenty-four pairs of chromosomes in man and a large number of genes in human beings are in a heterozygous condition. As most individuals are heterozygous for a great many genes considerable diversity should be exhibited in their children.

A plant or animal heterozygous for one pair of alleles, when self-fertilized, or two individuals heterozygous for the same

pair of genes, when crossed, should produce two types of offspring phenotypically. When the organism is a dihybrid, four kinds of offspring should result. For a polyhybrid heterozygous for n pairs of genes, the number of kinds of offspring should be 2^n . If two people heterozygous for the same pair of genes in each of man's 24 chromosome pairs should mate, they could produce 2^{24} or 16,777,216 different kinds of offspring. There is no wonder, therefore, that children do not look exactly like one parent. The possibilities for diversity among offspring are great in a population as heterozygous as that of human beings.

Heterozygous Populations in Plants

Many plants and animals also are highly heterozygous and produce a wealth of different types of offspring. For that reason, plant breeders often have to resort to vegetative propagation in order to maintain a certain type. Let us suppose that a hybridizer crosses two different varieties of apples and obtains among the offspring one plant that is a superior type of apple in every respect. He naturally wishes to propagate this new variety and to sell it commercially. Because the parents differed by many genes, however, this new variety would be highly heterozygous. Therefore, the offspring which it would produce from seed would show great variation; probably only a very few out of a very large number of plants would be sufficiently like the heterozygous parent to be worth raising. These plants, too, would undoubtedly fail to breed true for they would also be heterozygous for a number of genes. After many generations, the hybridizer, if he were still living, would perhaps succeed in establishing a true-breeding strain of this excellent variety, but at a tremendous cost in labor and acreage that could be devoted to other purposes.

Rather than try to establish such a true-breeding strain, he would reproduce this desirable apple vegetatively, by taking buds and grafting them on to stocks of inferior types. Since the branches which developed from the bud would be like the tree from which the buds were taken, they would produce the same kind of apples that were found on this superior plant. Those branches would be highly heterozygous and would not breed true any more than the original plant. They would produce superior fruit, however, and that is all that would be re-

quired of them. Vegetative propagation is used exclusively for commercial purposes whenever the plants are highly heterozygous and whenever they are the kinds of plants that can be reproduced vegetatively. Because they notoriously fail to breed true, vegetative reproduction is used to propagate many of our ornamental trees, all our important fruit crops, potatoes, some nut trees, and some forest trees.

The number of F_2 phenotypes, when dominance is complete, can be expressed by 2^n , where n represents the number of genes that are heterozygous in the F_1 and consequently the number of genes by which the two homozygous parents differ. Similarly, these F_1 plants would produce 2^n gametes, and the number of different genotypes and phenotypes from a testcross would also be 2^n . The number of genotypes in the F_2 , and the number of F_2 phenotypes if dominance were not complete for any of the genes involved would be 3^n . The number of combinations of F_1 gametes, although not all of them different, would be 4^n , and, similarly, the smallest possible number of F_2 individuals which would theoretically yield all the genotypes would be 4^n .

Goodness of Fit

Since trihybrid and polyhybrid ratios involve more than two terms, the best method of determining goodness of fit is the one used for dihybrids, except, of course, the number of degrees of freedom is different.

QUESTIONS AND PROBLEMS

1. As shown by Mendel, in the garden pea, round seeds (W) are dominant over wrinkled (w) and tall plant (D) is dominant over dwarf (d). What are the genotypes and phenotypes of the F_1 and F_2 from the cross $WW DD \times ww dd$?

2. What are the genotypes and phenotypes of the F_1 and F_2 from the cross $ww DD \times WW dd$?

3. What are the genotypes and phenotypes of the offspring of the two following crosses: $WW Dd \times ww dd$ and $Ww dd \times ww Dd$?

4. A man crossed a round-seeded, dwarf pea with a wrinkled-seeded, tall. In the F_2 he got 219 round, tall : 77 round, dwarf : 80 wrinkled, tall : 24 wrinkled, dwarf. Determine χ^2 and from it decide whether these two characters were showing independent assortment.

5. A cross between a round tall plant and a round dwarf gave 121 round, tall : 124 round, dwarf : 42 wrinkled, tall : 37 wrinkled, dwarf. What are the genotypes of the parents? Calculate goodness of fit by χ^2 .

6. In *Drosophila*, gray body (E) is dominant over ebony (e) and red eye (Ca) over claret (ca). A cross between a heterozygous gray red and an ebony claret gave 108 gray red : 47 gray claret : 41 ebony red : 104 ebony claret. Calculate χ^2 and determine goodness of fit to a 1 : 1 : 1 : 1 ratio.

7. If χ^2 in question 6 is too large, what does it signify? How can you explain the results obtained?

8. In *Capsella*, A produces elongated, pointed primary leaf lobes, whereas a produces blunt, shorter primary lobes; B divides the leaf by deep sinuses, usually reaching nearly or quite to the midrib, whereas b produces only shallow sinuses. An $AA BB$ plant is crossed with an $aa bb$ plant. What are the genotypes and phenotypes of the F_1 and F_2 and of the backcross of the F_1 to the double recessive?

9. In *Capsella*, AB plants are known as *heteris*, Ab as *tenuis*, aB as *rhomboidea*, and ab as *simplex*. What are the phenotypes of the F_1 and F_2 of the following crosses: *heteris*, homozygous for both genes \times *tenuis*, homozygous for A ; homozygous *heteris* \times homozygous *rhomboidea*; homozygous *tenuis* \times *simplex*; homozygous *rhomboidea* \times *simplex*?

10. What are the genotypes of the offspring of the following *Capsella* crosses: $AA bb \times AA Bb$; $aa Bb \times Aa bb$; $AA bb \times aa BB$; $AA Bb \times Aa Bb$?

11. In *Drosophila melanogaster*, black body (bl) is recessive to gray (Bl) and spineless (ss) is recessive to spined (Ss). If a homozygous black spineless is mated with a homozygous gray spined, what are the genotypes and phenotypes of the F_1 and F_2 ?

12. What are the genotypes and phenotypes of the backcross of the F_1 of question 11 to each parent and of the testcross of the F_1 to a black spineless fly?

13. In *Drosophila*, normal wing (Vg) is dominant to vestigial (vg) and red eye (P) is dominant to pink (p). What are the genotypes of flies which produce the following types of offspring when crossed: (a) 83 normal red : 30 normal pink : 28 vestigial red : 9 vestigial pink; (b) 167 normal red : 53 normal pink; (c) 156 normal red : 59 normal pink : 114 vestigial red : 109 vestigial pink; (d) 310 normal red : 318 normal pink : 105 vestigial red : 110 vestigial pink; (e) 68 normal red : 24 normal pink : 71 vestigial red : 27 vestigial pink? Calculate χ^2 in each part of this problem.

14. In *Drosophila*, white eye (w) is recessive to red (W) and is in the sex chromosome; vestigial wing (vg) is recessive to normal (Vg) and is in an autosome. What are the genotypes and phenotypes of the F_1 and F_2 from the following crosses: $WW VgVg \times wY vgv$; $WW vgv \times wY VgVg$; $ww VgVg \times WY vgv$; $ww vgv \times WY VgVg$?

15. In soybeans, broad leaf is incompletely dominant to narrow; the heterozygote is intermediate. Purple flower is dominant to white. What is the phenotypic F_2 ratio if a broad-leaved plant which is homozygous for purple flowers is crossed with a narrow-leaved, white-flowered plant? What would be the offspring of a cross between the F_1 and a narrow-leaved, white-flowered plant; of a cross between the F_1 and an intermediate-leaved, white-flowered plant; of a broad-leaved plant that was homozygous for red flowers?

16. In soybeans, how would a breeder obtain true-breeding races of broad-leaved, white-flowered plants; of intermediate-leaved, white-flowered plants; of narrow-leaved, white-flowered plants? Assume that he started with the two plants in question.

17. The statement is made that if dominance is incomplete for each of two pairs of genes that are in different chromosomes, the phenotypic ratio in the F_2 is the same as the genotypic. Why should this be true?

18. In *Capsella*, various F_2 seeds are sown to produce an F_3 generation. What would be the genotypes of the F_2 plants that produced F_3 families that segregated as follows: (a) 3 *heteris* : 1 *tenuis*; (b) all *tenuis*; (c) all *simplex*; (d) 3 *heteris* : 1 *rhomboidea*; (e) all *heteris*; (f) 3 *tenuis* : 1 *simplex*; (g) 9 *heteris* : 3 *tenuis* : 3 *rhomboidea* : 1 *simplex*; (h) 3 *rhomboidea* : 1 *simplex*?

19. A *Bibl Ssss* fly (as in question 12) is testcrossed with the double recessive. The offspring are selfed. What are the phenotypes from each of the selfed offspring?

20. In *Drosophila melanogaster*, the gene for purple eye (*pr*) is recessive to the gene for red and is in chromosome II; the gene for hairless (*H*) is in chromosome III, and the gene for bent wing (*bt*) is in chromosome IV. What are the genotypes and phenotypes of the F_1 and F_2 from the cross *PrPr HH BtBt* \times *prpr hh btbt*?

21. What are the genotypes and phenotypes from a backcross of the F_1 in question 20 to the triple recessive?

22. In the F_2 of the cross, *AA BB CC DD EE* \times *aa bb cc dd ee*, what proportion will be homozygous for all the dominant genes? What proportion will be phenotypically dominant for all the genes?

23. What are the gametes produced by each of the following?

Aa Bb CC dd Ee

Aa Bb CC Dd ee

aa Bb cc DD ee

aa bb cc DD EE

aa BB Cc Dd Ee

24. Assume that an organism is heterozygous for six pairs of genes. (a) How many different kinds of gametes does it produce? (b) How many different kinds of phenotypes are produced on selfing? (c) How many different kinds of individuals are found in the offspring of the test-cross of that organism to an organism recessive for all six genes? (d) How many different kinds of genotypes are produced if this organism is selfed? (e) What is the smallest theoretical number of individuals required to get an individual recessive for all six genes if this organism is selfed?

25. In *Capsella*, genes *A* and *B* determine leaf shapes (see problem 8); gene *v* produces fasciated stems and is recessive to *V*, the gene for non-fasciated stems. What are the phenotypes of the offspring from the following crosses?

$$AA Bb vv \times aa bb VV$$

$$Aa Bb VV \times aa bb vv$$

$$Aa bb vv \times aa Bb Vv$$

26. What are the phenotypes of the F_2 from the following crosses (assume all parents to be homozygous):

tenuis nonfasciated \times *rhomboidea* fasciated

heteris nonfasciated \times *simplex* fasciated

tenuis fasciated \times *rhomboidea* nonfasciated

tenuis fasciated \times *simplex* nonfasciated.

27. Plant *AA BB CC* was crossed with *aa bb cc*. The F_2 segregated into 557*ABC* : 189*ABc* : 169*AbC* : 184*aBC* : 58*Abc* : 66*aBc* : 62*abC* : 19*abc*. Calculate χ^2 and the probability that this is a true trihybrid ratio.

28. In *Nemesia strumosa*, colored (*C*) is dominant to colorless (*c*), orange (*O*) is dominant to white (*o*), and mark (*m*) on the lower lip is recessive to no mark (*M*). A family of plants of unknown parentage produced the following plants: 91 colored, orange, nonmarked : 88 colored, orange, marked : 29 colored, white, nonmarked : 30 colored, white, marked : 31 noncolored, orange, nonmarked : 28 noncolored, white, marked. What are the genotypes of the parents?

29. What are the offspring of the following crosses (see question 28)?

$$Cc Oo Mm \times CC Oo mm$$

$$Cc Oo Mm \times cc oo mm$$

$$Cc Oo Mm \times cc oo Mm$$

30. Write all the gametes from a plant whose genotype is $Aa Bb Cc Dd Ee Ff Gg$. If it were testcrossed to the recessive, what would be the relation of the number of kinds of offspring to the number of kinds of gametes you have listed?

31. Two plants are crossed that are heterozygous for fifteen genes. What percentage of the offspring would be expected to have nine dominant and six recessive characters?

Chapter 10

THE GENETIC DISTRIBUTION OF TWO PAIRS OF GENES ON ONE PAIR OF CHROMOSOMES

The extensive work of the late T. H. Morgan and his students and of others who have worked on *Drosophila melanogaster* has resulted in the discovery of over five hundred different genes in that small organism. Since there are only four pairs of chromosomes in this species, there must be many more than one gene on each chromosome. If a fly is heterozygous for two pairs of genes on two different chromosomes, the two alleles on one pair of chromosomes will segregate independently of those on the other pair, thus fulfilling Mendel's second law. If the genes are on the *same* chromosome, should they also show independent assortment? On chromosome II are found the genes *c*, curved, and *sp*, speck, causing a dark spot in the axil of the wing. A fly that is homozygous for *C* and *Sp* will have one *C* and one *Sp* gene on each of its second chromosomes, whereas a double recessive fly will have one *c* and one *sp* gene on each. The F_1 fly will have one chromosome with *C* and *Sp* and an homologous chromosome with *c* and *sp*.

When meiosis takes place in the F_1 flies, the two chromosomes will separate from one another. Some germ cells will have a chromosome with both *C* and *Sp* and others will have one with both *c* and *sp*. If these genes had been on separate chromosomes, four types of gametes, *C Sp*, *C sp*, *c Sp*, and *c sp*, would have been produced by the F_1 in equal numbers. Since they are on the same chromosome, however, the two genes, such as *C* and *Sp* or *c* and *sp*, that entered a fly from the same parent must always enter the same gamete, unless, of course, the chromosomes should break. Barring any breakage of chromosomes or chromatids, these two genes always remain together as they pass from one generation to another. This phenomenon is called *linkage*.

Gene Symbols and Linkage

In the symbolic method of denoting genes which geneticists have adopted to simplify their writing are ways of indicating linkage. Some geneticists indicate the two homologous chromosomes by two horizontal lines, with the genes on one chromosome above one line and those on the other chromosome below the other line. More recently, this symbol has been simplified by merging the lines into one. It is also written all on one line by using a slanting rather than horizontal line. The two pairs of genes in the heterozygote, by these methods, would be indicated as:

$$\frac{C Sp}{c sp} \quad \text{or simply} \quad \frac{C Sp}{c sp} \quad \text{or} \quad C Sp / c sp$$

The last two methods are widely used by *Drosophila* geneticists today and they are also used by students of other organisms. As the *Drosophila* geneticist usually indicates the wild-type gene by a + sign, the linkage symbols can be still further simplified to read $\frac{+ +}{c sp}$; but often even the + sign is omitted, the symbol being written, $\frac{\quad}{c sp}$. Many geneticists enclose the two genes of one chromosome in parentheses. By this method of notation the heterozygote in this case would be indicated as $(C Sp) (c sp)$. A still further method indicates linked genes as $\widehat{C Sp} \widehat{c sp}$.

Crossing Over

It was shown in Chapter 4 that when two homologous chromosomes have paired at pachytene each "splits" into two chromatids. The two chromatids of one chromosome are twisted about the two chromatids from the homologous chromosome, and at various places one chromatid from each homologue breaks. The broken ends of one chromatid join up with the broken ends of the other, forming new associations and producing the cross-shaped chiasmata which are seen at diplotene.

It has just been pointed out that *C* and *Sp* always remain together in the formation of the F_1 gametes in the above cross and that *c* and *sp* do likewise unless the chromosomes or chromatids should break. Such a break would enable the two linked

genes to become separated, and the realignment of segments from different chromatids would allow *C* and *sp* and *c* and *Sp* to be together in some gametes. This breakage and realignment of the chromatids would have no significance in regard to the behavior of two given linked genes unless they happened to occur in a region of the chromatids *between* them. Usually such a break may occur at any place in a chromatid, except possibly near the centromere, and therefore may occur between the two linked genes in a certain percentage of the cases. If we can assume, with reservations, that it can occur at random at any place on the chromosome, it must naturally occur more frequently between genes whose loci are far apart on a chromosome than between loci that are close together. If a break with subsequent chiasma occurs between two chromatids in the region between two known genes, of the four gametes resulting from the mother cell in which the break occurs, two will have unbroken chromatids and the other two will have new chromatids and will therefore show a new combination of genes. If an F_1 fly has the genes (*C Sp*) from one parent and (*c sp*) from the other, and if one break occurs between the *C* and *Sp* loci in one primary oöcyte, of the four eggs and polar bodies that result, two will be (*C Sp*) and (*c sp*), in other words *parental types*, and the other two will be (*C sp*) and (*c Sp*) and will be *non-parental types* or *recombinations* (Fig. 48). However, in 100 primary oöcytes, a break between those genes would not be expected in every case unless the genes were far apart. The genes *C* and *Sp* are actually not so far apart. Every oöcyte that did not have a break would produce one egg and three polar bodies, all of which would be of the parental types, whereas each oöcyte that had one break would produce two parental and two nonparental types of eggs and polar bodies. The polar bodies are not functional, of course, but if 100 oöcytes had no break between these loci, they would produce 50 eggs of the paternal type and 50 of the maternal. Of the 100 eggs from the 100 oöcytes in which a break occurred, 25 would be paternal and 25 maternal; the other 50 eggs would be nonparental types. Since there are some oöcytes in which a break did not occur between *C* and *Sp*, there would be more parental than nonparental types of gametes.

Testcross. If an F_1 female whose genetic constitution is $C Sp / c sp$ is testcrossed with a $c sp / c sp$ male, will all the offspring be like the parental generation, will they segregate into a 1 : 1 : 1 : 1 ratio as in independent assortment, or will they give some other result? Such a question can best be answered by carrying out an experiment. Fortunately, we do not have to do so as such experiments have been carried out a

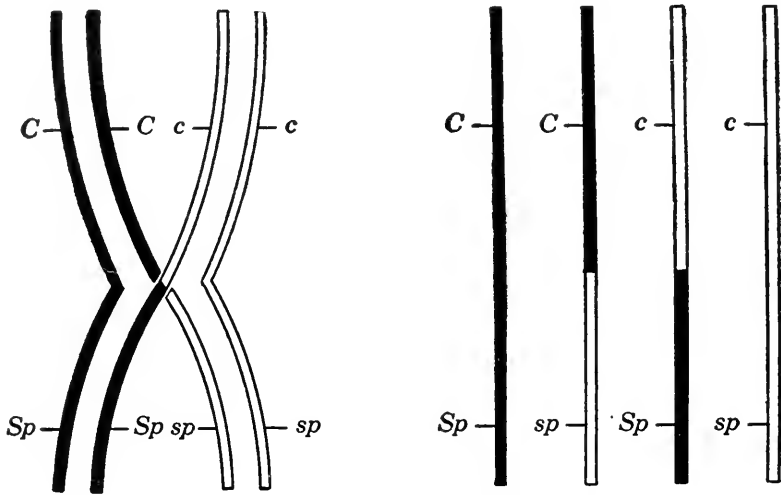

FIG. 48. The results of the formation of a chiasma between the loci of c and sp . One chromatid of each chromosome has broken and exchanged partners. Four kinds of chromatids have formed, two of which are unbroken, parental types ($C Sp$ and $c sp$) and two are recombinations or crossover types ($C sp$ and $c Sp$).

number of times. Data from such a cross involving genes c and sp have been summarized by Bridges and Morgan. They show that out of 10,042 flies, from the testcross, 3037 were curved and nonspeck or noncurved and speck. In other words, 69.8 per cent of the offspring were like the original parents whereas 30.2 per cent were nonparental types.

When two genes on the same chromosome separate from one another because of a break and recombination of chromatids in the region between the loci of those genes, they are said to *cross over* and the phenomenon is called *crossing over*. Similarly the nonparental gametes may be called *crossover gametes* and the parental gametes may be called *noncrossover gametes*. Since the ratio of the offspring from the testcross was approximately

0.7 $C Sp$: 0.3 $C sp$: 0.3 $c Sp$: 0.7 $c sp$, the gametes of the F_1 must have been in the same ratio (Fig. 49a). Obviously, then, a crossover did not occur between the loci of c and sp in every primary oöcyte. We may well ask the question, "In how many did it occur?"

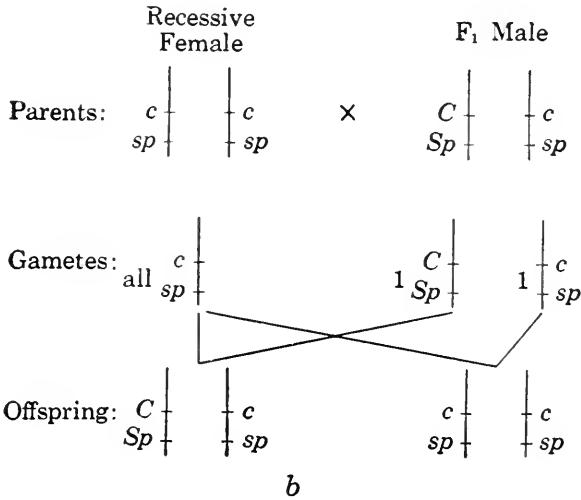
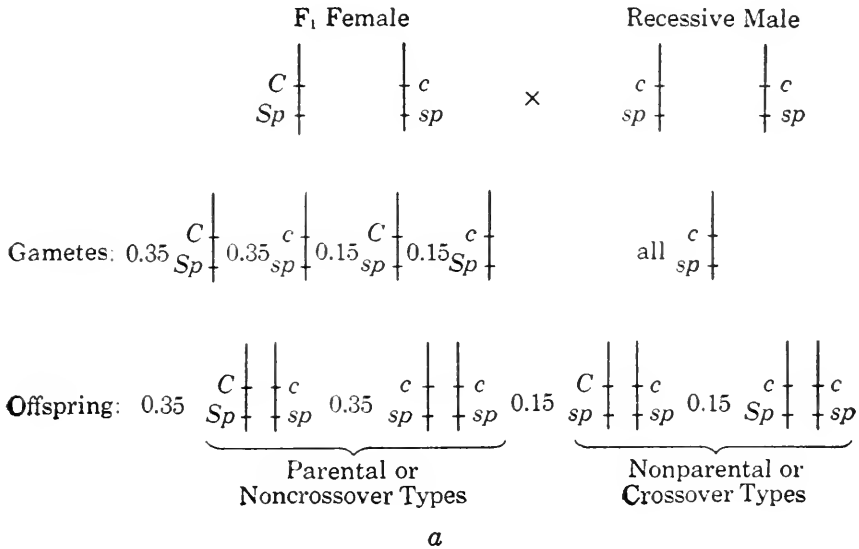

FIG. 49. Crosses involving linked genes in *Drosophila*. (a) A cross of a heterozygous female ($C Sp/c sp$) with a recessive male ($c sp/c sp$). Crossing over in the female produces four types of gametes in the ratio of 7 $C Sp$: 3 $C sp$: 3 $c Sp$: 7 $c sp$. Four types of offspring result: 0.35 $C Sp$: 0.15 $C sp$: 0.15 $c Sp$: 0.35 $c sp$. (b) A cross between a recessive female and a heterozygous male. Because no crossing over occurs in the male, only two kinds of gametes are produced and the offspring are in the ratio 0.5 $C Sp$: 0.5 $c sp$.

If crossing over took place between whole chromosomes, as was once thought, and not between chromatids, a break in the chromosomes between the two loci in 30 per cent of the primary oöcytes would produce 30 per cent of crossover gametes and 70 per cent of gametes of the parental types. As crossing over takes place only between two out of four chromatids, however, each nonparental type must have resulted from an oöcyte that produced two nonparental and also two parental gametes. Crossing over must therefore have taken place between chromatids in 60 per cent of the oöcytes.

Let us assume for purposes of illustration that there were originally 50 primary oöcytes and that crossing over occurred in 30 of them. Each oöcyte formed four eggs. To simplify the problem, it is assumed here that the four cells of each primary oöcyte are functional. The 20 oöcytes that did not have a crossover between the *c* and *sp* loci would form 80 parental-type gametes. The 30 oöcytes that had a crossover would produce 60 crossover and 60 noncrossover gametes, because only two chromatids from every such oöcyte crossed over. Out of the 200 gametes that were produced from the original 50 oöcytes, only 60 or 30 per cent would be crossover types. A break of two chromatids followed by a fusion of the broken ends produces a chiasma. The 20 oöcytes that had no break between *c* and *sp* would have no chiasmata in that region, but each of the other 30 oöcytes would have one chiasma between those two loci. Therefore, 60 per cent of the oöcytes would have one chiasma in that region but only 30 per cent of the gametes would be of the nonparental or crossover type (Fig. 50). For every 2 per cent of the oöcytes that have a chiasma between two given genes, only 1 per cent of the eggs would show genetic crossing over between these genes.

Crossing Over in Male Drosophila. When a cross between a *c sp / c sp* female and an F_1 male ($C Sp / c sp$) is made, a rather unique phenomenon is encountered. Half the offspring will be $C Sp$ and the other half will be *c sp*, and there will be *no crossover* types (Fig. 49*b*). This is the reciprocal of the previous cross. All the gametes of this F_1 male are parental types because no breaking and realignment of chromatids at pachytene and no chiasmata are formed in the male *Drosophila*. Unless such breaks and chiasmata occur, no crossover types of

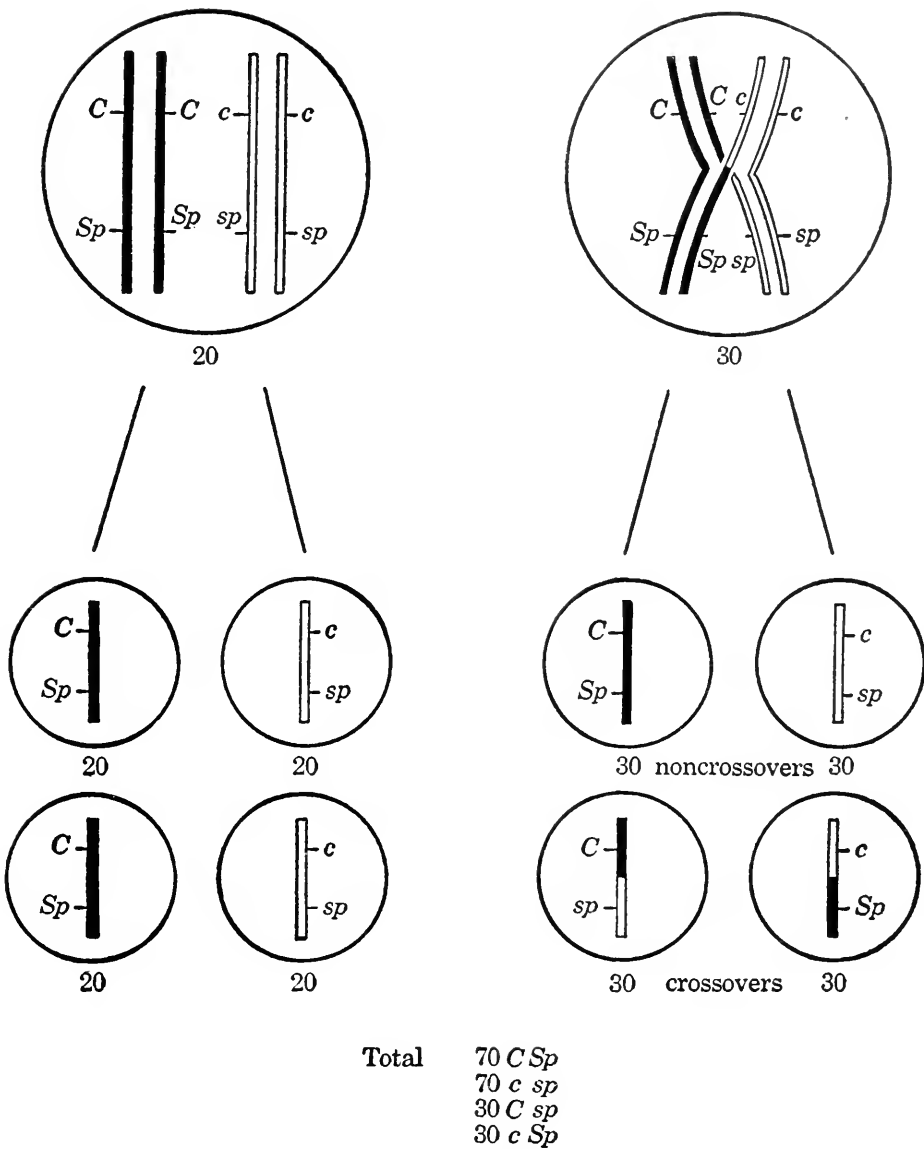

FIG. 50. Gametes resulting if a chiasma forms between *c* and *sp* in 60 per cent of the oocytes. Starting with 50 oocytes, 20 would have no chiasma between *c* and *sp* and would therefore produce 80 noncrossover gametes. Thirty oocytes would have a chiasma and would produce 60 crossover and 60 noncrossover gametes. Thus, 60 out of the 200 gametes would be of the crossover type, and we should say that there was 30 per cent crossing over. To simplify the problem, all products of meiosis are treated as functional, and polar body formation is disregarded.

gamete can be produced. *There is no crossing over in the Drosophila male.* (In the inert regions of the X and Y chromosomes, near the centromere, two chiasmata have been said to form.) In spite of this lack of chiasma formation in the male, pairing at metaphase appears more or less normal, and the chromosomes separate in a regular manner to the opposite poles. This separation, which is not the result of normal meiotic processes, is discussed further in Chapter 13. Such regular failure of chiasma formation in one sex is of very limited occurrence, but is usual in dipteran males and in females of the silkworm. In all such animals, this failure occurs in the heterogametic sex.

Crossing Over in Plants. Linkage and crossing over are of universal occurrence, but in most organisms crossing over is approximately the same in both sexes. In the third chromosome of maize, gene *a* (anthocyanin-1) produces green plants, colorless aleurone and brown pericarp, and its dominant allele, *A*, produces anthocyanin pigments in these regions. Gene *Rg* (ragged leaf), on the same chromosome, produces a plant with torn and split leaves; the homozygous *RgRg* plant is very weak, but the heterozygote is perfectly healthy.

A plant which was heterozygous for both pairs of genes and whose genetic constitution was *Rg A / rg a* was testcrossed to a *rg a / rg a* plant by Brink and Senn. The offspring were:

	<i>Noncrossovers</i>		<i>Crossovers</i>	
	<i>Rg A</i>	<i>rg a</i>	<i>Rg a</i>	<i>rg A</i>
Observed frequencies	160	142	103	115
Expected if 1 : 1 : 1 : 1	130	130	130	130

Obviously, the offspring did not fall into a typical testcross ratio as there were too many parental and too few nonparental types. The percentage of crossover types was 41.9. As crossing over in maize is the same in both sexes, it should not matter whether the F_1 plant was used as the male or as the female.

Coupling and Repulsion. In discussing independent assortment, it was pointed out that the F_2 and testcross ratios are the same whether the original cross is $AA BB \times aa bb$ or $AA bb \times aa BB$. Is this also true if the genes are on the same chromosome? Let us examine a cross involving the anthocyanin-1 and ragged leaf genes of maize made by Brink (reported by Emerson, Beadle, and Fraser) in which one parent was *rg A / rg A*

and the other was $Rg a / Rg a$, and let us compare it with the one by Brink and Senn just cited. The F_1 was obviously $Rg a / rg A$. It was phenotypically like the F_1 from Brink and Senn's cross and was genotypically the same to the extent that it had the same genes, but the arrangement of the genes on the two chromosomes was different. In Brink and Senn's cross, the genes of the F_1 were linked in a combination of $Rg A / rg a$ whereas in Brink's they were $Rg a / rg A$. Does this make any difference? When Brink's F_1 was backcrossed to the recessive, $rg a / rg a$, the offspring were:

	<i>Noncrossovers</i>		<i>Crossovers</i>	
	<i>Rg a</i>	<i>rg A</i>	<i>Rg A</i>	<i>rg a</i>
Observed frequencies	616	724	480	488
Expected if 1 : 1 : 1 : 1	577	577	577	577

Again, the percentage of crossover or recombination types was 41.9, but now the $Rg A$ and $rg a$ plants are the recombination types whereas in the other cross they were the parental types; and the $rg A$ and $Rg a$ plants now are the parental types whereas they previously were nonparental types. In other words, when two pairs of alleles are on separate chromosomes, the ratio obtained by backcrossing the F_1 to the double recessive is exactly the same whether the parents of the F_1 were homozygous for the two dominants and the two recessives, or whether each was homozygous for one dominant and one recessive; but when the two alleles are on the same chromosome, and therefore show linkage, the results are very different.

When genes A and B are linked, and when the original cross is between AB / AB and ab / ab , the AB and ab types are more numerous in the testcross than the Ab and aB types; but when the original cross is $Ab / Ab \times aB / aB$, the Ab and aB types are more numerous than the AB and ab types. However, it must be noted that *the percentage of recombinations is the same no matter which way the cross is made*. The only difference is that the parental types in the one cross are the crossover types in the other.

Through long usage, it is customary to speak of the cross $AB / AB \times ab / ab$ as being in the *coupling* phase, and the cross $Ab / Ab \times aB / aB$ as being in the *repulsion* phase.

These terms have no more significance today than to indicate the manner in which the genes were combined on the chromosomes of the F_1 generation, but they are terms of convenience and are frequently encountered in genetic literature. At one time they referred to concepts which have long been discarded. Genes of maize in the coupling and repulsion phases are shown in Fig. 51.

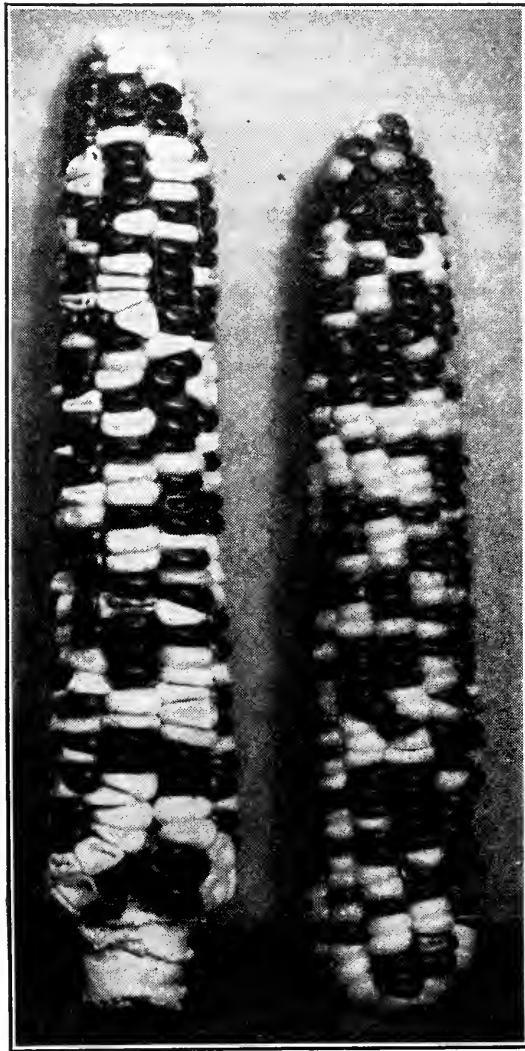

FIG. 51. Linkage between colored and shrunken in maize. *Left*, the coupling phase resulting from the cross $C Sh / c sh \times c sh / c sh$ and showing a preponderance of colored, nonshrunken and noncolored, shrunken types. *Right*, the repulsion phase resulting from the cross $C sh / c Sh \times c sh / c sh$ and showing a preponderance of the colored, shrunken and noncolored, nonshrunken types. (Photographs by Dr. W. Brooks Hamilton.)

Crossing Over and the F₂.

So far, in discussing linked genes, only the results of backcrossing the F_1 to the recessive have been discussed. This is usually the simplest method of determining the percentage of crossing over between two genes, because the testcross ratio is exactly the same as the ratio of crossover to noncrossover types among the gametes. It is this gametic ratio that indicates the percentage of crossing over and therefore the amount of chromatid breakage that occurred at meiosis in the F_1 . Sometimes, however, there are practical difficulties in making backcrosses or testcrosses, and it is simpler to raise an F_2 by selfing the F_1 plants.

What would be the genotypic and phenotypic ratios in the F_2 for the genes for ragged leaf and anthocyanin-1 in maize?

Obviously the phenotypic ratio could not be 9 : 3 : 3 : 1, for this ratio would be obtained only if the ratio of the gametes were 1 $Rg A$: 1 $Rg a$: 1 $rg A$: 1 $rg a$. The actual gametic ratio, when the crossover percentage is 42, would be 0.29 $Rg A$: 0.21 $Rg a$: 0.21 $rg A$: 0.29 $rg a$ if the original cross was $Rg A / Rg A \times rg a / rg a$, and 0.21 $Rg A$: 0.29 $Rg a$: 0.29 $rg A$: 0.21 $rg a$ if the original cross was in the repulsion phase. The F_2 could be determined from a checkerboard in which these gametes were represented in their correct ratio. For simplicity of the arithmetic let us assume that the crossover percentage is 40 instead of 42. The F_2 from crosses in both the coupling and the repulsion phases is tabulated in Fig. 52, and it is seen to be different in the two phases. In each phase the ratio is different from the 9 : 3 : 3 : 1 ratio, as expressed in terms of percentage; and in both the coupling and repulsion phases, the difference is in favor of the parental types. In the coupling phase, the percentage of $Rg A$ and $rg a$ types is respectively 59 and 9 instead of 56.25 and 6.25, whereas in the repulsion phase the percentage of $Rg a$ and $rg A$ is 21 for each type instead of 18.75.

The specific F_2 ratios for coupling and repulsion that were given in Fig. 52 will be obtained only if there is 40 per cent crossing over between the two genes in question. If the percentage is greater or less than 40 the F_2 ratios will be different from those listed, for the ratios will actually differ according to the percentage of crossing over. We often find it advantageous, therefore, to state the F_2 ratio in general terms.

If we let p represent the percentage of crossing over expressed

	$\frac{p}{2} AB$	$\frac{1-p}{2} Ab$	$\frac{1-p}{2} aB$	$\frac{p}{2} ab$
$\frac{p}{2} AB$	$\frac{p^2}{4} AB$	$\frac{p(1-p)}{4} Ab$	$\frac{p(1-p)}{4} aB$	$\frac{p^2}{4} ab$
$\frac{1-p}{2} Ab$	$\frac{p(1-p)}{4} AB$	$\frac{(1-p)^2}{4} Ab$	$\frac{(1-p)^2}{4} aB$	$\frac{p(1-p)}{4} ab$
$\frac{1-p}{2} aB$	$\frac{p(1-p)}{4} AB$	$\frac{(1-p)^2}{4} Ab$	$\frac{(1-p)^2}{4} aB$	$\frac{p(1-p)}{4} ab$
$\frac{p}{2} ab$	$\frac{p^2}{4} AB$	$\frac{p(1-p)}{4} Ab$	$\frac{p(1-p)}{4} aB$	$\frac{p^2}{4} ab$

Total: $\frac{2+p^2}{4} AB$
 $\frac{1-p^2}{4} Ab$
 $\frac{1-p^2}{4} aB$
 $\frac{p^2}{4} ab$
a

	0.5Ab	0.5ab
$\frac{p}{2} AB$	$\frac{p}{4} \frac{AB}{Ab}$	$\frac{p}{4} \frac{AB}{ab}$
$\frac{1-p}{2} Ab$	$\frac{1-p}{4} \frac{Ab}{Ab}$	$\frac{1-p}{4} \frac{Ab}{ab}$
$\frac{1-p}{2} aB$	$\frac{1-p}{4} \frac{Ab}{aB}$	$\frac{1-p}{4} \frac{aB}{ab}$
$\frac{p}{2} ab$	$\frac{p}{4} \frac{Ab}{ab}$	$\frac{p}{4} \frac{ab}{ab}$

Total: $\frac{1+p}{4} AB$
 $\frac{2-p}{4} Ab$
 $\frac{1-p}{4} aB$
 $\frac{p}{4} ab$
b

FIG. 53. General linkage ratios: (a) the F₂ ratio from the cross *Ab/Ab* × *aB/aB*; (b) the offspring from the cross *Ab/aB* × *Ab/aB*. In each cross, *p* is the per cent of crossing over. By substituting the proper value for *p*, this method can be used for any linked genes.

Complete Linkage and the F_2

When linkage is complete, the F_2 ratios are different from the 9 : 3 : 3 : 1, and are also different depending on whether the original cross was made in the coupling or in the repulsion phase. In testing to determine whether the gene *bullata*, *bu*, which causes the rosette leaves to be greatly crinkled in the evening primrose was linked with the gene for old-gold flowers,

	Coupling	Repulsion																		
$P_1:$	$\frac{V Bu}{V Bu} \times \frac{v bu}{v bu}$	$\frac{V bu}{V bu} \times \frac{v Bu}{v Bu}$																		
$F_1:$	$\frac{V Bu}{v bu} \times \text{self}$	$\frac{V bu}{v Bu} \times \text{self}$																		
$F_2:$	<table style="margin: auto; border-collapse: collapse;"> <tr> <td></td> <td style="text-align: center;"><i>V Bu</i></td> <td style="text-align: center;"><i>v bu</i></td> </tr> <tr> <td style="text-align: center;"><i>V Bu</i></td> <td style="border: 1px solid black; padding: 2px;"><i>V Bu</i></td> <td style="border: 1px solid black; padding: 2px;"><i>V Bu</i></td> </tr> <tr> <td style="text-align: center;"><i>v bu</i></td> <td style="border: 1px solid black; padding: 2px;"><i>v bu</i></td> <td style="border: 1px solid black; padding: 2px;"><i>v bu</i></td> </tr> </table>		<i>V Bu</i>	<i>v bu</i>	<i>V Bu</i>	<i>V Bu</i>	<i>V Bu</i>	<i>v bu</i>	<i>v bu</i>	<i>v bu</i>	<table style="margin: auto; border-collapse: collapse;"> <tr> <td></td> <td style="text-align: center;"><i>V bu</i></td> <td style="text-align: center;"><i>v Bu</i></td> </tr> <tr> <td style="text-align: center;"><i>V bu</i></td> <td style="border: 1px solid black; padding: 2px;"><i>V bu</i></td> <td style="border: 1px solid black; padding: 2px;"><i>V bu</i></td> </tr> <tr> <td style="text-align: center;"><i>v Bu</i></td> <td style="border: 1px solid black; padding: 2px;"><i>v Bu</i></td> <td style="border: 1px solid black; padding: 2px;"><i>v Bu</i></td> </tr> </table>		<i>V bu</i>	<i>v Bu</i>	<i>V bu</i>	<i>V bu</i>	<i>V bu</i>	<i>v Bu</i>	<i>v Bu</i>	<i>v Bu</i>
	<i>V Bu</i>	<i>v bu</i>																		
<i>V Bu</i>	<i>V Bu</i>	<i>V Bu</i>																		
<i>v bu</i>	<i>v bu</i>	<i>v bu</i>																		
	<i>V bu</i>	<i>v Bu</i>																		
<i>V bu</i>	<i>V bu</i>	<i>V bu</i>																		
<i>v Bu</i>	<i>v Bu</i>	<i>v Bu</i>																		
	<p>3 <i>V Bu</i> 0 <i>V bu</i> 0 <i>v Bu</i> 1 <i>v bu</i></p>	<p>2 <i>V Bu</i> 1 <i>V bu</i> 1 <i>v Bu</i> 0 <i>v bu</i></p>																		

FIG. 54. F_2 ratios obtained between two genes that appear to show complete linkage. Both the coupling and repulsion phases are indicated.

v, G. H. Shull crossed a yellow-flowered *bullata* plant with an old-gold flowered non*bullata*. Yellow flowers, *V*, are dominant to old-gold, *v*, or *vetaurea*, and the *bullata* gene is recessive to non*bullata*, so that this cross was made in the repulsion phase, $V bu / V bu \times v Bu / v Bu$. If there were no linkage between *bu* and *v*, the F_2 would segregate into 9 *V Bu* : 3 *V bu* : 3 *v Bu* : 1 *v bu*. The actual results was in the ratio of 2 *V Bu* : 1 *V bu* : 1 *v Bu* : 0 *v bu*. How could such a ratio be obtained?

If the genes *v* and *bu* were linked and if they were so close together on the chromosome that a break would be unlikely to occur between them, what would be the result in the F_2 if the original cross was made with the parents in the coupling phase and would it be the same if they were in the repulsion phase? As shown in Fig. 54, when these completely linked genes enter in the coupling phase, the F_2 ratio becomes 3 *V Bu* : 1 *v bu*; but

when they enter in the repulsion phase, the F_2 ratio becomes $2 V Bu : 1 V bu : 1 v Bu : 0 v bu$. The results which Shull obtained can be interpreted on the basis that these genes are linked and that they are so completely linked that no crossing over took place. Actually, as subsequent tests showed, linkage was not complete, but these genes were so close together that the chance of a break of chromatids in the region between them was very small. In a family of only 108 plants, no crossovers occurred. Had the family consisted of 10,800 plants, a small percentage of crossover gametes would probably have been produced.

It is a rule that *when linkage is complete and when the original cross is in the repulsion phase, the F_2 ratio will be $2 : 1 : 1 : 0$* . This is true when linkage is complete in only one sex as well as when it is complete in both, as has been shown many times in *Drosophila*. Let us again consider the *curved* and *speck* genes. The gametes of the female F_1 fly, if the cross was made in the repulsion phase, are $0.3 C Sp : 0.7 C sp : 0.7 c Sp : 0.3 c sp$, but since linkage is complete in the male, the sperm are in the ratio of $0.5 C sp : 0.5 c Sp$. When two $C sp / c Sp$ flies are mated, the offspring are $2 C Sp : 1 C sp : 1 c Sp : 0 c sp$. This principle has been widely used when a new gene in *Drosophila* has been discovered to determine with which of the many known genes this new gene is linked.

Complete Linkage and Multiple Alleles

Although a $2 : 1 : 1 : 0$ ratio may be obtained in the F_2 from a cross involving completely linked genes in the repulsion phase, the same ratio will also be found in certain crosses involving multiple alleles. Therefore, it is sometimes difficult to determine whether a particular ratio is the result of completely linked genes or multiple alleles. Sometimes further extensive studies have resulted in the appearance of a few crossovers, thus showing that linked genes are involved which are not completely linked but nearly so. Sometimes such extensive studies are not practical and it is impossible to decide from the data available the cause of the ratios. It is sometimes assumed as a tentative hypothesis that multiple alleles are the cause if the three types are merely differences in the same part of the organism but

that complete linkage is the cause if, as in the old gold-bullata cross, two widely different parts of the plant or animal are affected in the different phenotypes. Even this distinction is not always valid, however, for occasionally members of a series of multiple alleles affect principally different regions of the organisms.

Statistical Tests

In Chapter 9 it was shown that χ^2 may be used to determine whether an observed ratio could be considered an example of a 9 : 3 : 3 : 1 or other ratio involving more than two terms. If an observed ratio has a value of χ^2 low enough to be considered a 9 : 3 : 3 : 1 ratio, we assume that we have independent assortment and that the genes are on separate chromosomes; but if χ^2 is too large, we must find another explanation.

In their early work on the sweet pea, Bateson and Punnett found that purple flowers (*B*) were dominant over red (*b*) and that long pollen grains (*L*) were dominant to round (*l*). A homozygous purple-flowered, round pollen plant when crossed with one that was homozygous for red flowers and long pollen gave the results tabulated below (data from Punnett, 1913); χ^2 is calculated on the basis of independent assortment:

	<i>BL</i>	<i>Bl</i>	<i>bL</i>	<i>bl</i>
Observed frequencies	226	95	97	1
Expected frequencies	235.69	78.56	78.56	26.19
<i>d</i>	-9.69	16.44	18.44	-25.19
<i>d</i> ² /expected frequency	0.40	3.44	4.29	24.23

$$\chi^2 = 32.36; n = 3$$

On the basis of an expected dihybrid 9 : 3 : 3 : 1 ratio this particular observed ratio showed a χ^2 value of 32.36. As there are four terms in this ratio, three degrees of freedom should be used in calculating probability from Fisher's table (Table 3). From the table we learn that a χ^2 of 32.36 with three degrees of freedom would occur in less than one per cent of similar experiments as the result of chance alone. We must therefore conclude that this ratio is not a true example of a 9 : 3 : 3 : 1 ratio and that we are not dealing with a case of independent assortment. If these statistical methods tell us we do not have

a case of independent assortment, do they tell us what is the reason for the peculiar ratio? Unfortunately, the answer is no. All we can learn from applying χ^2 is that we probably do not have two genes on separate chromosomes.

We must then find another explanation for our unusual results. The student must be given a word of caution here. Just any explanation that seems to fit the data will not do except, of course, as a preliminary hypothesis which we are willing to abandon. The explanation must be consistent with known biological observations and should, preferably, be one that can be used to predict future results. Actually, Bateson and Punnett offered an explanation based on the reduplication of parental gametes in excess of nonparental. Although it agreed with the data it was not founded on sound biological facts, and ultimately it was abandoned in favor of the much more accurate explanation of linkage and crossing over.

Could the χ^2 method be used to show that Brink's testcross data did not indicate independent assortment? Let us retabulate these data and calculate χ^2 .

	<i>Rg A</i>	<i>Rg a</i>	<i>rg A</i>	<i>rg a</i>
Observed frequencies	160	103	115	142
Expected frequencies	130	130	130	130
<i>d</i>	30	-27	-15	12
$d^2/\text{expected frequencies}$	6.92	5.61	1.73	1.11

$$\chi^2 = 15.37; n = 3$$

Again we have three degrees of freedom, and again our value of χ^2 is so large that this ratio could be found as the result of chance alone in less than one per cent of our cases. Again, the hypothesis of independent assortment must be abandoned.

It was stated previously that there was 41.9 per cent crossing over between these two genes. Could the method of χ^2 be applied to determine whether this observed ratio was a true example of the ratio to be expected if there were 41.9 per cent crossing over? The method is applicable and is applied just as in the previous case except that the expected frequencies would be different. Since our total population included 520 plants, the expected frequency of each crossover class (20.45 per cent of 520) would be 108.94, whereas the expected frequency of each parental class (29.55 per cent of 520) would be 151.06.

	<i>Rg A</i>	<i>Rg a</i>	<i>rg A</i>	<i>rg a</i>
Observed frequencies	160	103	115	142
Expected frequencies	151.06	108.94	108.94	151.06
<i>d</i>	8.94	-5.94	6.06	9.06
<i>d</i> ² /expected frequencies	0.53	0.32	0.34	0.54

$$\chi^2 = 1.75; n = 3$$

When we compare our observed ratio with an expected ratio on the basis of 41.9 per cent crossing over, $\chi^2 = 1.73$. Since there are four terms in the ratio we still have three degrees of freedom, and on that basis χ^2 tells us that we could expect such a ratio on the basis of chance alone in over 50 per cent of similar families. Obviously, the hypothesis of linkage with 41.9 per cent crossing over is highly probable.

The standard error can also be used to determine whether a given ratio deviates less from one based on independent assortment or from one based on linkage. Let us illustrate this method with some data from Wright's work on the guinea pig. An animal homozygous for black and for rough fur (*BB RR*) was crossed with one with brown and smooth fur (*bb rr*). The F_1 was testcrossed to the recessive. If there is linkage, the *BR* and *br* phenotypes are the parental types and the *Br* and *bR* animals would represent crossovers. Let us combine the two parental types and also the two possible crossover types. If there is no linkage, the parental and nonparental types should be in the ratio of 1 : 1, but if there is linkage, the ratio would not be 1 : 1 and would vary with the strength of the linkage. Therefore, the observed combined ratio is tested against a 1 : 1 ratio. The results are:

	<i>BR br</i>	<i>Br bR</i>	$\sigma = \sqrt{\frac{184.191}{375}} = \sqrt{93.72} = 9.68$
	88 96	98 93	
Observed	184	191	$\frac{d}{\sigma} = \frac{3.5}{9.68} = 0.36$
Expected	187.5	187.5	
Deviation	-3.5	3.5	

The deviation of the observed ratio from a 1 : 1 ratio is only 0.36 times the standard error. Therefore, this ratio agrees very well with expectation based on independent assortment, and there is no evidence to support the idea of linkage.

What is the result of applying this method to Brink's data? Let us calculate the deviation and standard error.

	$Rg A$	$rg a$	$Rg a$	$rg A$	$\sigma = \sqrt{\frac{302 \cdot 218}{520}} = \sqrt{126.61} = 11.25$
	160	142	103	115	$\frac{d}{\sigma} = \frac{42}{11.25} = 3.73$
Observed	302		218		
Expected	260		260		
Deviation	42		42		

When we test this ratio with the hypothesis of independent assortment, we find that the deviation is 3.73 times the standard error. Since any deviation greater than twice the standard error makes it improbable that the observed ratio is an example of the expected, we are forced to conclude that there is no independent assortment here, which is in accord with our results from the χ^2 method. It would also be possible to use this method with F_2 data instead of testcross data, but the calculation of the standard error becomes more complicated. As the testcross is much more widely used, the method from F_2 data need not be given.

Different Crossover Values

It has been shown that the percentage of recombinations between two linked genes is the same whether the original cross was in the coupling or in the repulsion phase. From the crosses cited in *Drosophila*, maize, the evening primrose, and the sweet pea, we see that the percentage of crossovers is not the same for all pairs of linked genes. If we test several genes located on the third chromosome of maize, we find that the crossover percentage between the genes for anthocyanin-1 and ragged leaves is 42; that between anthocyanin-1 and crinkly leaf-1 is as high as 48; but the percentage of recombinations between anthocyanin-1 and nana-1 is only 28. Therefore, we find that the percentage of crossing over may be very different for different pairs of genes. However, for any two given linked genes, the crossover percentage is always constant, provided that the plants or animals are grown under the same conditions.

In maize, the crossover percentage between *a* and *cr* will always be 48 and, for *a* and *na*, it will always be 28 no matter how often the experiment is carried out, provided the conditions are the same in each experiment. The crossover per-

centage differs for different pairs of genes because the amount of crossing over depends on the frequency with which breaks in the chromatids occur between the two genes; this frequency is further dependent chiefly upon the distance these genes are apart on the chromatids. Assuming for the present that breaks can occur equally easily at all points on a chromatid, we may say that the farther two genes are apart, the more likely, as the result of chance, breaks will occur between them. As two genes are normally always the same distance apart on a chromosome, the chance that a break can occur between them is always the same, and, therefore, the percentage of recombinations is always the same. The percentage of crossovers between any two pairs of genes can never be stated until proper experiments have been carried out. Once the experiments have been made, the amount of crossing over between those genes can be predicted, but there is no way of telling what that percentage will be before it is tested experimentally.

Factors Influencing Crossing Over

The above discussion is based upon the consideration that the experiments are carried out under the same conditions, for the ease with which breaks can occur in the chromatids is influenced by the environment. Heat, X-radiation, and some chemicals may produce striking differences in the percentage of recombinations, usually having the effect of increasing the percentage. Plough demonstrated that when *Drosophila* females are raised at high temperatures, the percentage of crossovers is increased over that obtained when the flies are reared at ordinary room temperature. Strangely enough, however, low temperatures also produce an increased percentage of crossover types as compared with ordinary, medium temperatures.

Crossing over can be affected by internal as well as external factors. Differences in the percentage of recombinations in the different sexes have been mentioned in connection with the male *Drosophila* and the female silkworm, but they are frequently observed also in other organisms, although in them the sex differences are not so great. The age of the individual may also affect the frequency of crossing over, for Bridges has demonstrated that, in *Drosophila*, as the female gets older the percent-

age of recombinations tends to increase. Inversions of a part of one chromosome may inhibit crossing over, and anything that tends to affect normal meiosis will have an effect on crossing over.

QUESTIONS AND PROBLEMS

1. In the Emily Henderson sweet pea, Bateson and Punnett found that purple flowers (*Bl*) were dominant to red (*bl*) and elongated pollen (*L*) was dominant to round (*l*). When a homozygous purple long plant was crossed with a red, round F_2 ratios were 177 purple, long : 15 purple, round : 15 red, long : 49 red, round. Could this be due to independent assortment? If not, why not? If not, how could this F_2 ratio be accounted for?

2. By figuring the value of χ^2 in the previous problem, what is the probability that this is a 9 : 3 : 3 : 1 ratio?

3. If the genes *bl* and *l* are linked with 12.5 per cent crossing over, what would be the percentage of recombinations if the F_1 in problem 1 was backcrossed to a *bl l* / *bl l* plant?

4. If the genes in problem 1 are linked with 12.5 per cent crossing over, what would be the F_1 gametes and the progeny of a testcross if the P_1 plants were *Bll* / *Bll* and *bl L* / *bl L*? Show by a diagram. Is this the coupling or the repulsion phase?

5. What would be the ratio in the F_2 from selfing the F_1 plant of the previous question?

6. Is the reduplication hypothesis or the theory of linkage more in agreement with cytological phenomena? Which agrees more closely with our observations on gametogenesis and sporogenesis? Why?

7. Genes *A* and *B* are linked with 10 per cent crossing over. It has been calculated that an average of one chiasma forms between genes *B* and *C* in 20 per cent of the sporocytes. Do more chiasmata form between *B* and *C* or between *A* and *B*? Why?

8. In an F_1 plant whose genotype is *LV* / *lv* a chiasma forms between *L* and *V* in 40 per cent of the sporocytes. If this plant is testcrossed to the double recessive, what ratio would be obtained?

9. Do the ratios obtained as the result of genetic crossing over and the cytological observation of chiasmata seem to have any direct connection? How? If only one of these phenomena were known, could the other be inferred on theoretical grounds? Would such an inference prove its existence?

10. We have pointed out on many occasions that the genes are located on the chromosomes. This was not always known. Do you think that the discovery of linkage and of chiasmata might have helped to prove the connection between genes and chromosomes? Explain.

11. Assume you have found a new gene in *Drosophila melanogaster*. Describe in detail how you would demonstrate on which of the chromosomes that gene was located. Would this problem be easier in *Drosophila* than in most organisms?

12. In *Drosophila melanogaster*, sepia eyes (*se*) are recessive to red (*Se*), and dichaete hairs (*D*) are dominant to normal (*d*). They are on chromosome III. If the cross $Se D / Se D \times se d / se d$ is made and the F_1 is testcrossed with the double recessive, 15 per cent of the offspring are recombinations. Hairy body (*h*) is recessive to hairless. The cross $Se H / se h \times se h / se h$ shows 0.5 per cent of recombinations. Gene *h* is also on the third chromosome. Which genes do you think are farther apart on the chromosome, *Se* and *D*, or *Se* and *H*? Why?

13. If a fly whose genotype is $se D / Se d$ (see question 12) is crossed with another fly of the same genotype, what are the phenotypes of the offspring? What are the phenotypes of the offspring if two flies whose genetic constitution is $Se h / se H$ are mated?

14. In the domestic rabbit, yellow fat (*y*) is recessive to white (*Y*), and brown hair and skin pigmentation (*b*) is recessive to black (*B*). W. E. Castle showed that these genes are linked with about 27 per cent crossing over. If a $YY bb$ animal is crossed with a $yy BB$ and the F_1 is testcrossed to a double recessive, what is the ratio of the offspring?

15. If two F_1 animals from question 14 are mated, what is the ratio of the phenotypes in the F_2 ? Although the original cross is in the repulsion phase, why is the F_2 ratio not 2 : 1 : 1 : 0?

16. The gene for colored (*C*) in rabbits is dominant over colorless (*c*). Genes *C* and *Y* (see question 14) are linked with 14 per cent crossing over. Give the phenotypic ratios from the following crosses:

$$c y / c y \times C Y / c y$$

$$C Y / c y \times C Y / c y$$

$$C y / c Y \times c y / c y$$

$$C y / c y \times c Y / c y$$

17. In maize, shrunken endosperm (*sh*) is recessive to full (*Sh*) and waxy endosperm (*wx*) is recessive to nonwaxy (*Wx*). A $Sh Wx / sh wx$ plant was testcrossed with a $sh wx / sh wx$. The offspring were 142 full, nonwaxy : 63 full, waxy : 57 shrunken, nonwaxy : 138 shrunken, waxy. Are these genes on the same or on different chromosomes? If on the same, what is the percentage of crossing over? What would be the offspring from the cross $Sh wx / sh Wx \times sh wx / sh wx$?

18. In maize, colored aleurone (*C*) is dominant over colorless (*c*). In the cross $C sh / c Sh \times c sh / c sh$ (see question 17) the following offspring were obtained : 638 colored, full : 21,379 colored, shrunken :

21,906 colorless, full : 672 colorless, shrunken. If these genes are linked, what is the percentage of crossing over? What would be the results of the following crosses?

$$C Sh / c sh \times C Sh / c sh$$

$$C Sh / c sh \times c sh / c sh$$

$$C sh / c Sh \times C sh / c Sh$$

$$c sh / c sh \times C sh / c Sh$$

Chapter 11

LOCATING GENES ON CHROMOSOMES

Since there are many different genes on a chromosome, they must be arranged in some sort of order. In a number of plants and animals the exact or approximate places at which many of the genes are located have been determined. The work of locating genes is tedious but not difficult, once the principles of the technique are understood. The general method is genetical and is based upon crossover data. It gives the order in which the genes occur and their distances apart as well as can be determined from crossover data, but it does not necessarily give the exact points at which the genes are found on the chromosomes. This method can be followed by a cytological method which will locate them much more precisely on the chromosome.

The genetic method is based upon the assumptions that crossing over is due to breaks in the chromatids, that these breaks occur purely by chance, and that the possibility that a break can occur is the same for all parts of a chromosome. If these hypotheses are true, it follows that the farther apart two genes are, the greater the chance that a break will occur between them, and, when tested genetically, the higher the percentage of crossovers between them. In practice, the percentages of crossing over between various genes are obtained experimentally, and from that information the genes are mapped in their order on the chromosome. In mapping genes, a unit of distance must be used, just as in mapping cities or anything else. The unit used in genetics is one per cent of crossing over, called a *map unit* or a *unit of map distance*. As shown in the last chapter, the percentage of crossing over is influenced by both internal and external conditions. When the internal conditions are known they can be discounted, but when they are not known they may lead to erroneous conclusions. The external conditions can be controlled, and "normal" or "standard" conditions are used when obtaining crossover data for the purpose of mapping genes.

If two genes give 5 per cent of recombination types when the experiment is conducted under standard conditions, they are said to be five map units apart on the chromosome.

Location of Three Genes

A rule widely followed in plotting genes is that if genes *A* and *B* are known to be linked, and if gene *C* is found by experiment to be linked with *A*, it must also be linked with *B*. This principle follows from the fact that two linked genes are on the same chromosome. If *A* and *B* are on the same chromosome, and if *A* and *C* are found to be on the same chromosome, naturally *B* and *C* must be on the same chromosome also. This statement may seem too self-evident to be worth mentioning, but consider the following situation. If genes *A* and *B* are linked with 20 per cent crossing over, and if the heterozygote is backcrossed to the double recessive, 80 per cent of the offspring would be parental types and 20 per cent recombination types. Let us assume now that *A* is tested with *C* and that 30 per cent of the offspring of this testcross are found to be recombinations. Genes *A* and *B* would then be on the same chromosome 20 units apart and genes *A* and *C* would be on the same chromosome 30 units apart. If they were arranged in the order *C-A-B*, genes *B* and *C* should therefore be 50 units apart, as shown in this diagram:

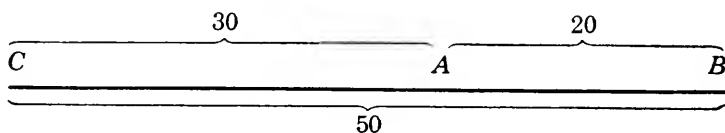

If a *CB/cb* organism is now crossed with one that is *cb/cb*, there should be 50 per cent of parental types and 50 per cent of recombinations among the offspring. It would, however, mean a ratio of $1CB : 1Cb : 1cB : 1cb$, exactly the ratio that would be obtained if the genes showed independent assortment. If only genes *B* and *C* were investigated, there would be no evidence that they were linked, but *B* must be linked with *C* since both are on the same chromosome as *A*.

In the diagram, the three genes were mapped although the crossover percentage between *B* and *C* was not known. How much information must be available to locate three genes in

their proper order and with the proper distances between them? The method is the same as that used in locating the order of cities. About a thousand miles west of New York is Chicago. Another two thousand miles west is Seattle. If the *order* in which these cities are located is known and the distance between any two pairs of them is also known, they can be mapped and the third distance can readily be determined. If the order in which they are located is not known, they could not be plotted on a map unless all three distances were known. If all that was known was that Seattle and New York were three thousand miles apart and that New York and Chicago were one thousand miles apart, they could not be mapped because Chicago might be east of New York, in which case it would be four thousand miles from Seattle. Similarly, to plot three genes on a chromosome map the distances between all three pairs must be known or the distances between any two pairs plus the order in which they occur.

In the second chromosome of *Drosophila melanogaster*, the genes black (*b*) and curved (*c*) show about 27 per cent of crossing over, and curved and vestigial (*vg*) show about 8.5 per cent. Historically, the black-curved linkage is interesting for it was the first case discovered of linkage in autosomes in *Drosophila*. It happened to be found first in the repulsion phase. These three genes cannot be plotted without further information as they might be arranged in either of two ways:

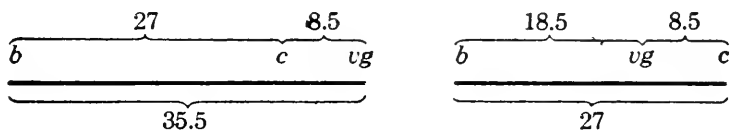

If they were arranged the first way, *b* and *vg* should show 35.5 per cent of recombinations; but if they were in the second order, only 18.5 per cent of crossovers should be found between these two genes. Since the latter figure more nearly accords with experimental data, the second arrangement is the actual one.

Double Crossing Over

So far, we have assumed that only one chromatid of each chromosome breaks between two genes. This statement is true for any one place in a chromosome and is also true between any

If two genes give 5 per cent of recombination types when the experiment is conducted under standard conditions, they are said to be five map units apart on the chromosome.

Location of Three Genes

A rule widely followed in plotting genes is that if genes *A* and *B* are known to be linked, and if gene *C* is found by experiment to be linked with *A*, it must also be linked with *B*. This principle follows from the fact that two linked genes are on the same chromosome. If *A* and *B* are on the same chromosome, and if *A* and *C* are found to be on the same chromosome, naturally *B* and *C* must be on the same chromosome also. This statement may seem too self-evident to be worth mentioning, but consider the following situation. If genes *A* and *B* are linked with 20 per cent crossing over, and if the heterozygote is backcrossed to the double recessive, 80 per cent of the offspring would be parental types and 20 per cent recombination types. Let us assume now that *A* is tested with *C* and that 30 per cent of the offspring of this testcross are found to be recombinations. Genes *A* and *B* would then be on the same chromosome 20 units apart and genes *A* and *C* would be on the same chromosome 30 units apart. If they were arranged in the order *C-A-B*, genes *B* and *C* should therefore be 50 units apart, as shown in this diagram:

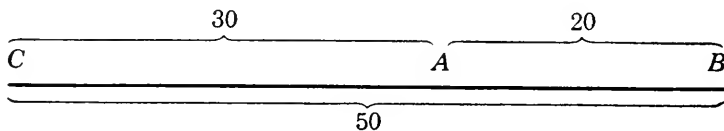

If a *CB/cb* organism is now crossed with one that is *cb/cb*, there should be 50 per cent of parental types and 50 per cent of recombinations among the offspring. It would, however, mean a ratio of $1CB : 1Cb : 1cB : 1cb$, exactly the ratio that would be obtained if the genes showed independent assortment. If only genes *B* and *C* were investigated, there would be no evidence that they were linked, but *B* must be linked with *C* since both are on the same chromosome as *A*.

In the diagram, the three genes were mapped although the crossover percentage between *B* and *C* was not known. How much information must be available to locate three genes in

their proper order and with the proper distances between them? The method is the same as that used in locating the order of cities. About a thousand miles west of New York is Chicago. Another two thousand miles west is Seattle. If the *order* in which these cities are located is known and the distance between any two pairs of them is also known, they can be mapped and the third distance can readily be determined. If the order in which they are located is not known, they could not be plotted on a map unless all three distances were known. If all that was known was that Seattle and New York were three thousand miles apart and that New York and Chicago were one thousand miles apart, they could not be mapped because Chicago might be east of New York, in which case it would be four thousand miles from Seattle. Similarly, to plot three genes on a chromosome map the distances between all three pairs must be known or the distances between any two pairs plus the order in which they occur.

In the second chromosome of *Drosophila melanogaster*, the genes black (*b*) and curved (*c*) show about 27 per cent of crossing over, and curved and vestigial (*vg*) show about 8.5 per cent. Historically, the black-curved linkage is interesting for it was the first case discovered of linkage in autosomes in *Drosophila*. It happened to be found first in the repulsion phase. These three genes cannot be plotted without further information as they might be arranged in either of two ways:

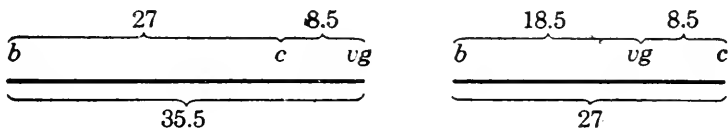

If they were arranged the first way, *b* and *vg* should show 35.5 per cent of recombinations; but if they were in the second order, only 18.5 per cent of crossovers should be found between these two genes. Since the latter figure more nearly accords with experimental data, the second arrangement is the actual one.

Double Crossing Over

So far, we have assumed that only one chromatid of each chromosome breaks between two genes. This statement is true for any one place in a chromosome and is also true between any

two genes that are very close together. When dealing with genes that are far apart, we find that sometimes two or even more breaks may occur between them. When one chiasma is formed between two genes, the break and fusion of the broken chromatids need not always occur at the same place, for as the result of chance it should occur at any place between the two genes with equal frequency. No matter where the break between two genes occurs, the results are exactly the same, provided that only one such break occurs. If, however, two breaks and exchanges occur at the same time, and two chiasmata are formed between the two genes, the results will be different.

There are several ways in which two chiasmata can be formed between two given loci of a chromosome, as are shown in Chapter 13, depending upon which chromatids are involved in forming each chiasma. If the same two chromatids are involved in each break so that two reciprocal chiasmata are formed between genes A and C , the four gametes resulting will be exactly the same as if no chiasma had occurred between these genes (Fig. 55a). It may fairly be asked how it is known when two chiasmata were formed between A and C and when none was formed since the genetic results are the same in each situation. The answer is that there is no way of knowing unless three heterozygous genes, such as A , B , and C , are present and one crossover occurs between A and B and the second between B and C . Then, as illustrated in Fig. 55b, the two noncrossover chromatids would be ABC and abc and the two crossover chromatids would be aBc and AbC . It is only when three such genes are present that the organisms produced by a gamete in which the two crossovers occurred can be distinguished from those in which none occurred.

When two crossovers are formed between two genes, the phenomenon is known as *double crossing over*, and the aBc and AbC gametes are *double crossover gametes*. Naturally, double crossing over does not occur between two given genes as frequently as single crossing over, but it does have the effect of appearing to reduce the amount of crossing over that occurs between them. For that reason, data involving three genes are more accurate than data which include the two extreme genes only; and this is more noticeable the farther apart the two

given genes are. It is well illustrated by data of Rhoades (summarized by Emerson, Beadle, and Fraser) for some genes in the fifth chromosome of maize. Three genes, *bm* (brown midrib), *pr* (red aleurone) and *v* (virescent or light yellow seedlings), were involved. The cross $Bm Pr V / Bm Pr V \times bm pr v / bm$

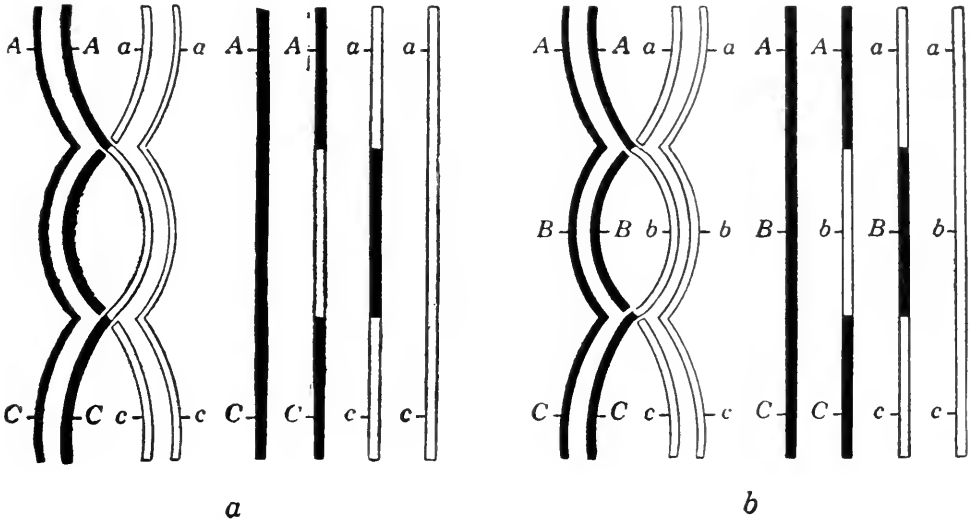

FIG. 55. Double crossing over. If two genes are far apart on a chromosome, as *a* and *c*, and only these genes are under observation, all the resulting chromatids may be of the parental type and the double crossover types may remain unnoticed. If, however, a gene located between them, as *b*, is also present, the double crossing over may be more readily detected. For discussion, see text.

pr v gave an F_1 plant with green midrib, purple aleurone, and green seedlings, and having the genetic constitution $Bm Pr V / bm pr v$ or $\frac{+ + +}{bm pr v}$. It was backcrossed to a $bm pr v / bm pr v$ plant, and these testcross data were obtained:

<p>+ + +—232 plants <i>bm pr v</i>—235 plants</p>	<p>Parental types = 467 or 42.11 per cent</p>
<p>+ <i>pr v</i>— 84 plants <i>bm</i> + +— 77 plants</p>	<p>Single crossover between <i>bm</i> and <i>pr</i> = 161 or 14.52 per cent</p>
<p>+ + <i>v</i>—201 plants <i>bm pr</i> +—194 plants</p>	<p>Single crossover between <i>pr</i> and <i>v</i> = 395 or 35.62 per cent</p>
<p>+ <i>pr</i> +— 40 plants <i>bm</i> + <i>v</i>— 46 plants</p>	<p>Double crossovers = 86 or 7.75 per cent</p>

When the testcross phenotypes are tabulated with respect to the genes *bm* and *pr* only, these results are obtained:

<i>Noncrossovers</i>	<i>Crossovers</i>
+ + (+)—232	+ <i>pr</i> (<i>v</i>)— 84
<i>bm pr</i> (<i>v</i>)—235	<i>bm</i> + (+)— 77
+ + (<i>v</i>)—201	+ <i>pr</i> (+)— 40
<i>bm pr</i> (+)—194	<i>bm</i> + (<i>v</i>)— 46
862	247
	= 22.27 per cent
	1109

There are 22.27 per cent of recombinations between these genes. When genes *pr* and *v* only were considered, these results were obtained:

<i>Noncrossovers</i>	<i>Crossovers</i>
(+) + +—232	(+) + <i>v</i> — 201
(<i>bm</i>) <i>pr v</i> —235	(<i>bm</i>) <i>pr</i> +— 194
(+) <i>pr v</i> — 84	(+) <i>pr</i> +— 40
(<i>bm</i>) + +— 77	(<i>bm</i>) + <i>v</i> — 46
628	481
	= 43.37 per cent
	1109

Thus there are 43.37 per cent of crossover phenotypes when this testcross is made. Now if only genes *bm* and *v* are considered and gene *pr* is omitted, and only the *Bm V*, *bm v*, *Bm v*, and *bm V* phenotypes are tabulated, the results are:

<i>Noncrossovers</i>	<i>Crossovers</i>
+ (+) +—232	+ (<i>pr</i>) <i>v</i> — 84
<i>bm</i> (<i>pr</i>) <i>v</i> —235	<i>bm</i> (+) +— 77
+ (<i>pr</i>) +— 40	+ (+) <i>v</i> — 201
<i>bm</i> (+) <i>v</i> — 46	<i>bm</i> (<i>pr</i>) +— 194
553	556
	= 50.14 per cent
	1109

According to this, there should be 49.86 per cent of parental combinations and 50.14 per cent of recombinations. If these three genes are plotted on a chromosome, using one per cent of crossovers as one map unit, the resulting map appears as:

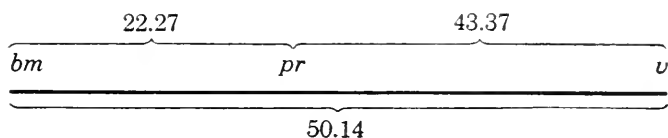

In other words, an independent test of the *bm* and *v* genes would show them 50.14 units apart, but *bm* and *pr* are 22.27 units apart and *pr* and *v* are 43.37 units apart. The laws of mathematics tell us that the whole equals the sum of its parts, but this case seems to defy the laws of mathematics. Actually, of course, the discrepancy is that the value of 50.14 units between *bm* and *v* is inaccurate. The distance between two genes, in map units, equals the percentage of crossing over between them, but the examination of the testcross phenotypes when just *bm* and *v* are studied does not show the true percentage of crossovers that occurred between these two genes. When *all three* genes are considered at a time, some of the phenotypes that were regarded as parental combinations are seen to be double crossovers. In determining the percentage of crossovers between *bm* and *v* these double crossovers must be taken into account for, instead of representing a parental type, each double crossover represents two crossovers. Bearing this fact in mind, we should revise the determination of the percentage of crossing over as follows:

<i>Noncrossovers</i>	<i>Crossovers</i>
+ + +—232	+ <i>pr v</i> — 84
<i>bm pr v</i> —235	<i>bm</i> + +— 77
<hr style="width: 100px; margin-left: 0;"/>	
467	+ + <i>v</i> — 201
	<i>bm pr</i> +— 194
	+ <i>pr</i> +— 80 (40 × 2)
	<i>bm</i> + <i>v</i> — 92 (46 × 2)
	<hr style="width: 100px; margin-left: 0;"/>
	$\frac{728}{1109} = 65.64$ per cent

Now when the distances between *bm* and *pr* (22.27 units) and between *pr* and *v* (43.37 map units) are added together, their sum (65.65 map units) equals the percentage of crossovers between *bm* and *v* when the double crossovers are taken into account. The same value could be obtained by adding to the

percentage of crossovers obtained when only bm and v were considered, twice the percentage of double crossovers in the cross involving all three genes. It will give the same value—65.64 per cent of crossing over or 65.64 map units.

This problem shows that when genes are not close together, and especially when the distance between them approaches 50 units, double crossing over reduces the single crossovers between the two genes to about 50 per cent. For this reason, the cross-over value never exceeds 50 per cent, even though two genes lie more than 50 units apart. (In this problem, the value was so slightly over 50 per cent that it can be considered as not exceeding the figure.) This problem also shows that, in order to obtain an accurate distance between two genes, (1) the three-point method, when an intermediate gene is involved, must be used and (2) genes that are close together should be used in determining map distances rather than genes widely separated on the chromosome.

In the discussion of two linked genes in the last chapter, it was pointed out that the original cross may be made in either the coupling or the repulsion phase, and that although the parental combinations and recombinations are different for the two types of crosses, the percentage of crossing over is the same. It is also true of a three-point cross. This cross in maize can be made in four possible ways and will produce these four possible F_1 plants:

$$\frac{+ + +}{bm\ pr\ v}, \quad \frac{+ + v}{bm\ pr +}, \quad \frac{+ pr +}{bm + v}, \quad \text{and} \quad \frac{bm + +}{+ pr v}$$

No matter in which way the genes entered the F_1 , the per cent of recombinations between bm and pr , between pr and v , and between bm and v will be the same.

It will be noted that the double crossovers are less frequent than either of the single crossover classes. It is naturally to be expected because the chance of one break of chromatids in a certain region is greater than the chance of two breaks in the same region. This fact can be utilized, however, in locating the genes on the chromosome. If the order of the genes in the previous cross was not known, the original parental combinations could be written tentatively as $BmBm\ PrPr\ VV \times bmbm\ prpr\ vv$. The order of the genes here has no significance. Then, looking

over the three crossover percentages, we should see that 7.75 per cent is the smallest. Therefore, the *Bm pr V* and *bm Pr v* combinations must represent the double crossovers. Since the *Bm* and *V* genes and the *bm* and *v* were the parental combinations, the *pr* and *Pr* genes must have been the middle of the three genes in the series. This simple fact is an aid in determining the order in which the genes were located.

Interference and Coincidence

It was shown earlier that one chromatid of each of two paired chromosomes may break at a given spot and that the two chromatids may then rejoin in a new arrangement, resulting in genetic crossing over. Although the cause is not well understood, it is an observed fact that when a break occurs at one particular spot, another break cannot occur for a certain distance from the first. The effect of this is to reduce the number of double crossovers that would be expected on the basis of chance alone. Thus, when one crossover occurs at a certain point, another is prevented from occurring within a certain distance from it. This prevention of or interference with the formation of a second crossover is known technically as *interference*. The cause may not be a purely mechanical matter, for the degree of interference is not the same in all chromosomes of the same species or even in all parts of the same chromosome.

The phenomenon of interference can be observed by considering the percentage of double crossovers in its relation to the theory of probability. In Chapter 8 we saw that when two independent events occur, the probability that they will occur at the same time is the probability that one will occur alone multiplied by the probability that the other will occur alone. In the problem in maize, the crossover value between *bm* and *pr* was 22.27 per cent, or the chance of getting *one* crossover between these genes was 22.27 out of 100. The chance of getting a crossover between *pr* and *v* was similarly 43.37 per cent. The chance of getting two crossovers in those two regions, and hence between *bm* and *v*, is 0.2227×0.4337 , or 9.66 per cent. In other words, if there were no interference 9.66 per cent of double crossovers should be obtained, whereas actually there were only 7.75 per cent. The difference is due to interference. This discrepancy can be expressed as the *coefficient of coincidence* (also called

merely *coincidence*), which is the ratio between the observed percentage of double crossovers and the number that would be expected on the basis of chance. The coefficient of coincidence in this problem would be $7.75/9.66$ or 0.802 .

When the coefficient of coincidence is 1.00, there is no interference, and when it is 0, interference is 100 per cent. All values between 0 and 1 may be obtained; and the higher the coincidence, the smaller the amount of interference.

Chromosome Maps Including More Than Three Loci

If several genes are discovered in an organism, how can their linkage relations and the order in which they would appear on a chromosome be determined? For example, how could the genes for black body (*b*), purple eyes (*pr*), vestigial wings (*vg*), curved wings (*c*), plexus veins (*px*), and speck (*sp*), be mapped? These genes are in the second chromosome of *Drosophila melanogaster*. The characters are readily identified, and stocks of these genes can be purchased for laboratory experiments. Without considering the actual sequence in which these genes were discovered and in which their linkage relations worked out, and without presenting the actual data, let us assume that in several experiments consisting of three-point crosses, enough information has been obtained to plot the genes. If a three-point cross involving *pr*, *vg*, and *px* showed that the percentage of recombinations between *pr* and *vg* was 12.5, between *vg* and *px* was 33.5, and between *pr* and *px* was 46, the genes could be mapped in either of the two orders:

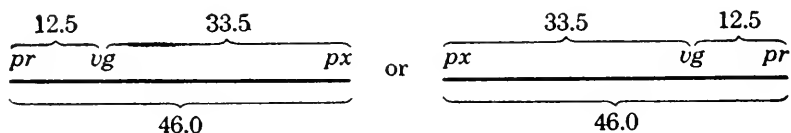

Although one arrangement is the reverse of the other, the sequence of the genes is the same in each case; and either arrangement can be adopted arbitrarily with equal justification. The first will be used. If the gene *sp* is now discovered, it could be tested in a three-point cross with two of these other three genes. If it were tested with *vg* and *px* and found to give 6.5 per cent of crossovers with *px* and 40.0 per cent with *vg*, the

only way it could be plotted would be to the other side of px from that on which vg lies, as:

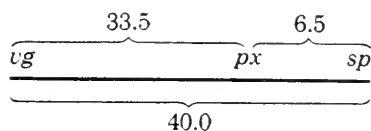

Four of the six genes are now plotted. If gene c , when tested with pr and sp in a three-point cross, showed 21.0 per cent of recombinations with pr and 31.5 with sp , and if now pr and sp appeared to be 52.5 map units apart, since pr is 46 units to one side of px and sp is 6.5 units to the other side, gene c would be placed in the following position:

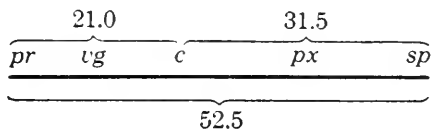

As the genes used for this three-point test were rather far apart, the position of c could be further tested in a three-point cross involving vg and px . If b were now tested, it could be placed in position. Not knowing where it might be located, we might try it first with vg and sp . If the recombinations were $b\ vg = 18.5$ per cent, $vg\ sp = 40.0$ per cent, and $b\ sp = 58.5$ per cent, after corrections were made, b could be placed only to the left of vg and 18.5 units away, so that the extended map would become:

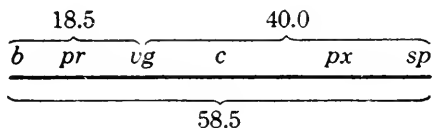

In mapping the genes, b would be placed at the extreme left end of the chromosome at locus 0; then, if the appropriate units to the right were counted off, each gene would be placed in position the correct number of units from its nearest genes. Actually, many more than these six genes have been found on the second chromosome of *Drosophila melanogaster*, and a number have been found even to the left of gene b . As new genes are discovered and located, the maps must be continually re-

vised. Any linkage map, therefore, must be considered only tentative. It has been found that aristaless (*al*) is 48.5 map units to the left of *b*. This discovery means that the tentative map just pictured must be revised and rewritten as:

<i>al</i>	<i>b</i>	<i>pr</i>	<i>v</i>	<i>c</i>	<i>px</i>	<i>sp</i>
0	48.5	54.5	67.0	75.0	100.5	107.0

In considering such linkage maps, we must remember that the actual distances are always subject to revision as more data are accumulated. *Drosophila* map distances are the result of much careful work involving numerous crosses and many thousands of flies. Map distances based on one experiment are untrustworthy and must never be considered final, but most map distances in *Drosophila* are the average of so many experiments that the degree of error has been reduced greatly.

QUESTIONS AND PROBLEMS

1. By means of a testcross, it was found that the percentage of recombinations between genes *l* and *m* was 13.5; that between *m* and *n* it was 20; that between *l* and *n* it was 6.5. Plot these genes on their chromosome. Could they be plotted if only two of these three values were obtained?

2. In rabbits, yellow fat (*y*) is recessive to white (*Y*), chinchilla fur (*c^{ch}*) to Himalayan (*c^H*), and brown hair (*b*) to black extremities (*B*). A heterozygote, *Yy c^Hc^{ch} Bb*, crossed to a triple recessive gave (data from Castle in *Proceedings of the National Academy of Sciences*, volume 19):

	<i>Fat</i>	<i>Coat</i>	<i>Extremities</i>
151 <i>Y c^H B</i> —white		Himalayan	black
67 <i>Y c^H b</i> —white		Himalayan	brown
33 <i>Y c^{ch} B</i> —white		sable	black
2 <i>y c^H B</i> —yellow		Himalayan	black
11 <i>Y c^{ch} b</i> —white		sable	brown
23 <i>y c^H b</i> —yellow		Himalayan	brown
48 <i>y c^{ch} B</i> —yellow		sable	black
142 <i>y c^{ch} b</i> —yellow		sable	brown

Determine whether there is linkage, and plot any linked genes on their chromosomes. If there was no linkage at all, what would be the expected ratio?

3. Could the double crossover classes in problem 2 be determined merely by inspecting the numbers of each class? What is the percentage of double crossovers, and what is the coincidence, if any?

4. In *Pisum*, salmon flowers (*b*) are recessive to purple (*B*), reduced

stipules (*s*) to normal, and green pod (*v*) to purple (*V*). In the backcross $\frac{B S V}{b s v} \times b s v$, the following phenotypes were obtained: 166 B S V : 14 B S v : 3 B s V : 70 b S V : 76 B s v : 2 b S v : 14 b s V : 146 b s v. Plot these genes on their chromosomes.

5. Determine the percentage of double crossing over and determine coincidence in problem 4.

6. Using the chromosome map you obtained in problem 4, calculate the expected ratio for families of 400 plants if the crosses were $B s v / b S V \times b s v / b s v$ or $B s V / b S v \times b s v / b s v$.

7. What would be the expected ratios of the offspring of the following crosses: $B S V / b s v \times b s v / b s v$; $B s v / b S v \times b s v / b s v$; $B s V / b s v \times b s v / b s v$; $b S v / b s V \times b s v / b s v$?

8. A three-point test in maize involving the genes *o*₂, *gl*, and *ij* give the following counts (data from Singleton in *Genetics*):

F ₁ genotype	non-		<i>o</i> ₂ — <i>gl</i> ,		<i>gl</i> — <i>ij</i> ,		double		total
	crossovers		single crossovers		single crossovers		crossovers		
<i>o</i> ₂ ++	467	513	115	150	94	123	28	23	1513
+ <i>gl ij</i>	980		265		217		51		

Plot these genes on their chromosomes and determine coincidence.

9. In *Drosophila melanogaster*, the genes *ct* (cut wing) and *v* (vermillion eye) are on the X chromosome and are 13 map units apart. If a ++ / *ct v* female were mated with a double recessive male, what would be the expected ratio in both sexes of the offspring? Would there be any double crossings over involving *ct*, *v*, and sex?

10. The gene *s* (sable body) in *Drosophila melanogaster* is on the X chromosome 10 map units from *v*. What would be the expected ratio in the offspring from the cross ++ *s* / *v* + × *v s*?

11. Using the information in problems 9 and 10, what would be the expected ratios of offspring from the cross +++ / *ct v s* × *ct v s*? The order of the genes is *ct-v-s*. What would be the expected percentage of double crossovers?

12. In *Drosophila melanogaster*, gene *b* (black body) is on the second chromosome and is approximately 27 units to the left of gene *c* (curved wing); gene *sp* (speck) is approximately 32 units to the right of *c*. What offspring should be expected from the cross +++ / *b c sp* × *b c sp* / *b c sp*?

13. Considering the same genes as in problem 12, what offspring should be expected from the cross *b c sp* / *b c sp* × +++ / *b c sp*?

14. In *Pisum*, thick pod wall (*n*) is recessive to thin (*N*), keeled wings (*k*) are recessive to normal (*K*), and normal seed (*q*) is recessive to aborted

cotyledon (*Q*). A cross $NN KK qq \times nn kk QQ$ gave the following phenotypes:

7.5 per cent	thin pod, normal wings, aborted cotyledon
17.5 per cent	thin pod, normal wings, normal seed
7.5 per cent	thin pod, keeled wings, aborted cotyledon
17.5 per cent	thick pod, normal wings, aborted cotyledon
17.5 per cent	thin pod, keeled wings, normal seed
7.5 per cent	thick pod, normal wings, normal seed
17.5 per cent	thick pod, keeled wings, aborted cotyledon
7.5 per cent	thick pod, keeled wings, normal seed

Plot these genes on their chromosomes or chromosome.

15. What would be the approximate ratio of the types in problem 14 if the cross was $NN KK QQ \times nn kk qq$?

16. What would be the approximate ratio of the types in problem 14 if the cross was $Nn Kk Qq \times Nn Kk Qq$?

17. In maize, *zb* produces zebra striping, *Tu* produces tunicate ear, and *gl* produces glossy seedling. The following results were obtained from individual selfings (data from Hayes and Chang in *Genetics*):

$Zb Tu / zb tu \times Zb Tu / zb tu$ gave 410 *Zb Tu* : 64 *Zb tu* : 64 *zb Tu* : 90 *zb tu*.

$Zb gl / zb Gl \times Zb gl / zb Gl$ gave 326 *Zb Gl* : 148 *Zb gl* : 135 *zb Gl* : 19 *zb gl*.

$Tu gl / tu Gl \times Tu gl / tu Gl$ gave 314 *Tu Gl* : 160 *Tu gl* : 147 *tu Gl* : 7 *tu gl*.

Is there any evidence of linkage? If so, determine the percentage and plot the genes on their chromosome.

18. Suppose you have the following three different strains of the same species of plant: *aa BB cc*, *aa bb CC*, and *Aa Bb Cc*. You desire to determine whether these genes are linked. Outline the complete procedure you would use to determine whether there was any linkage.

19. In using a three-point test, must all the linkages involved be in either the coupling or the repulsion phase?

20. In *Nemesia strumosa*, orange (*O*) is dominant to white (*o*); a strain of *oo* plants was found which had a recessive gene for blue-margin (*bm*). When a white, blue-margin plant was crossed with an orange, the offspring were 18 orange : 19 blue-margin. Is there any evidence of linkage? Is it conclusive?

21. If genes *a* and *b* are on the same chromosome but show 50 per cent crossing over, does this indicate that no chiasmata are formed between *a* and *b*?

22. Crossing over between the following genes was observed: *a* and *b*, 30 per cent; *a* and *c*, 50 per cent; *b* and *c*, 20 per cent; *c* and *d*, 20 per cent;

b and *d*, 40 per cent. What percentage of crossing over would be expected between *a* and *d*?

23. If a new gene, *e*, was found and if it showed 50 per cent crossing over with all four of the genes mentioned in question 22, could you state with certainty that it was not on the same chromosome with the other genes?

24. If linkage was complete in both sexes (as it is in the male *Drosophila*), could you plot the genes on the chromosomes?

Chapter 12

CHROMOSOME MAPS

Linkage Groups

In the last chapter it was shown that a number of linked genes could be mapped on the assumptions that the amount of crossing over is proportional to the distance between the genes on the chromosome and that a crossover may occur with equal freedom at any place on a chromosome except the region immediately adjacent to another crossover. On this basis genes have been mapped in a number of organisms.

A group of genes showing linkage relationships with one another genetically is a *linkage group*; and since all the genes in one linkage group are believed to be located on the same chromosome, the number of linkage groups should correspond with the number of chromosomes observed cytologically in the same species. It has been found to be true in several organisms in which the number of genes discovered and located is sufficiently large for the number of linkage groups to be determined with reasonable assurance. To be sure of the correspondence between the number of linkage groups and the number of chromosomes, a large number of genes must be used in most organisms for, if only a few are found, it is highly probable that some would be so far removed from the others on the same chromosome that they would give the same genetic ratios as they would if they were on a separate chromosome. To be certain of the number of linkage groups, then, ordinarily a large number of genes must be discovered. It would not, of course, be necessary for such an organism as *Drosophila melanogaster* in which there is no crossing over in one sex, for one gene far removed from the others could still be placed in its proper linkage group by means of the 2 : 1 : 1 : 0 ratio obtained from crosses in the repulsion phase when there is complete linkage in one sex. Linkage groups have been worked out carefully for

TABLE 4

A LIST OF SOME OF THE GENES OF THE FOUR LINKAGE GROUPS OF *Drosophila melanogaster*

<i>Chromosome I (X)</i>	<i>Chromosome II</i>	<i>Chromosome III</i>	<i>Chromosome IV</i>
0.0 yellow B—y	0.0 aristaless B—al	0.0 roughoid E—ru	<i>Centromere</i>
0. scute H—sc	0.1 expanded W—ex	0.2 veinlet E—ve	0.1 bent W—bt
0. hairy W—Hw	1.3 star E—S	19.2 javelin H—jv	0.1 shaven H—sv
1.5 white E *—w	11.0 echinoid E—ed	20.0 divergent W—dv	0.2 eyeless E—ey
3.0 facet E—fa	12.0 gull W—G	26.0 sepia E—se	
5.5 ecinus E—ec	13.0 dumpy B—dp	26.5 hairy H—h	
6.9 bifid W—bi	16.0 streak B—Sk	30.0 curvoid W—cur	
7.5 ruby E—rb	31.0 dachs B—d	37.0 rotated B—rt	
13.7 crossveinless W—cv	41.0 jammed W—J	41.0 dichæte H—D	
18.2 carmine E—cm	44.0 abrupt H—ab	41.4 glued E—Gl	
20.0 cut W—ct	48.5 black B *—b	43.2 thread H—th	
21.0 singed H—sn	48.7 jaunty W—j	44.0 scarlet E *—st	
27.5 tan B—t	54.5 purple E *—pr	<i>Centromere</i>	
27.7 lozenge E—lz	54.8 bristle H—Bl	47.5 deformed E—Dfd	
33.0 vermilion E—v	55.0 light E—lt	48.0 pink E *—p	
36.1 miniature W *—m	<i>Centromere</i>	50.0 curled W—cu	
38.7 furrowed E—fw	55.1 rolled W—rl	57.9 crossveinless—W—cv	
43.0 sable B—s	55.3 thick legs—B—tk	58.2 stubble H—Sb	
44.4 garnet E—g	55.4 apterous W—ap	58.5 spineless H *—ss	
50.5 scalloped W—sd	57.5 cinnebar E—cn	58.8 bithorax B—bx	
56.7 forked H—f	62.0 engrailed B—en	59.9 fluted W—fl	
57.0 bar E *—B	67.0 vestigial W *—vg	62.0 stripe B—sr	
59.5 fused V—fu	72.0 lobe E—L	63.1 glass E—gl	
62.5 carnation E—car	75.5 curved W *—c	66.2 delta V—Dl	
66.0 bobbed H—bb	82.0 fringed W—fj	69.5 hairless H—H	
<i>Centromere</i>	93.3 humpy B—hy	70.7 ebony B—e	
	99.2 arc W—a	75.7 cardinal E—cd	
	100.5 plexus W *—px	79.7 minute WH—Mw	
	104.5 brown E—bw	91.0 taxi W—tx	
	106.7 lanceolate W—ll	91.1 rough E—ro	
	107.0 speck B *—sp	100.7 claret E—ca	
		106.2 minute-g H—Mg	

Those marked with an asterisk are usually readily available for teaching purposes. Before the name of each gene is the locus at which it is found on its chromosome. After each name is the part of the body chiefly affected and then the symbol of the gene. The parts are: *B*, body; *E*, eye; *H*, hairs or bristles; *V*, veins of the wings; *W*, wings.

the following species, and in each it is seen that the number of linkage groups is the same as the haploid number of chromosomes:

<i>Species</i>	<i>Linkage Groups</i>	<i>Haploid Number of Chromosomes</i>
<i>Drosophila melanogaster</i>	4	4
<i>D. willistoni</i>	3	3
<i>D. obscura</i>	5	5
<i>D. pseudoobscura</i>	5	5
<i>D. virilis</i>	6	6
<i>Zea mays</i> (maize)	10	10
<i>Lathyrus odoratus</i> (sweet pea)	7	7

A number of genes in the four linkage groups of *Drosophila melanogaster* are listed in Table 4. With the name of the gene are presented the locus of the gene, the part of the body principally affected by the gene, and the symbol used to identify the gene. This list is not intended to be complete as only a small percentage of the genes actually discovered is included. Table 5 is a similar linkage map for the ten chromosomes of maize.

TABLE 5

SOME OF THE GENES LOCATED IN MAIZE WITH THE NAME OF EACH, ITS SYMBOL, AND ITS LOCUS

<p><i>Chromosome I</i></p> <p>0 pericarp color—<i>P</i> 25 asynapsis—<i>as</i> 52 brachytic plant—<i>br</i> 57 fine stripe-1—<i>fs₁</i> 74 anther ear-1—<i>an₁</i> 101 green-striped-1—<i>gs₁</i> 128 brown midrib-2—<i>bm₂</i></p>	<p><i>Chromosome II</i></p> <p>0 liguleless—<i>lg</i> 19 glossy seedling-2—<i>gl₂</i> 38 plant-color booster—<i>B</i> 45 silkless—<i>sk</i> 57 floury endosperm—<i>fl</i> 63 tassel seed-1—<i>ts₁</i> 71 virescent seedling-4—<i>v₄</i></p>	<p><i>Chromosome III</i></p> <p>0 aleurone color—<i>a₁</i> 28 nana-1—<i>na₁</i> 39 barren stalk-1—<i>ba₁</i> 56 tassel seed-4—<i>ts₄</i> 63 ragged leaf—<i>Rg</i> 85 dwarf-1—<i>d₁</i> 103 crinkly leaf-1—<i>cr₁</i></p>
<p><i>Chromosome IV</i></p> <p>0 defective endosperm-1—<i>de₁</i> 35 gametophyte—<i>Ga</i> 56 tassel seed-5—<i>Ts₅</i> 66 small pollen—<i>sp</i> 69 lethal ovule—<i>lo</i> 71 sugary—<i>su</i> 74 defective endosperm-16—<i>de₁₆</i> 100 tunicate—<i>Tu</i> 105 japonica-2—<i>j₂</i> 111 glossy seedling-3—<i>gl₃</i></p>	<p><i>Chromosome V</i></p> <p>0 aleurone color—<i>a₂</i> 6 brown midrib-1—<i>bm₁</i> 12 brevis height—<i>bv</i> 31 red aleurone-1—<i>pr₁</i> 40 yellow stripe-1—<i>ys₁</i> 72 virescent seedling-2—<i>v₂</i></p>	<p><i>Chromosome VI</i></p> <p>0 polymittotic—<i>po</i> 13 yellow endosperm-1—<i>Y₁</i> 41 purple plant color—<i>Pl</i> 51 salmon silk—<i>sm</i> 61 pigmy—<i>py</i></p>
<p><i>Chromosome VII</i></p> <p>0 virescent seedling-5—<i>vs₅</i> 14 ramosa ear-1—<i>ra₁</i> 18 glossy seedling-1—<i>gl₁</i> 28 teopod—<i>Tp</i> 34 Iojap striping—<i>ij</i> 52 brown aleurone-1—<i>Bn₁</i></p>	<p><i>Chromosome VIII</i></p> <p>0 male-sterile-8—<i>ms₈</i> 18 japonica-1—<i>j₁</i></p> <p><i>Chromosome X</i></p> <p>0 narrow leaf-1—<i>nl₁</i> 18 golden-1—<i>g₁</i> 32 colored aleurone and plant—<i>R</i></p>	<p><i>Chromosome IX</i></p> <p>0 knob 2 yellow green-2—<i>yg₂</i> 21 aleurone color—<i>C</i> 24 shrunken endosperm—<i>sh</i> 39 brown pericarp—<i>bp</i> 54 waxy endosperm—<i>wx</i> 66 virescent seedling-1—<i>v₁</i></p>

Other Genetical Methods of Determining Linkage Groups

The method for determining linkage groups described in the last chapter is the method in almost universal use. Others, however, have been suggested and have been used to a limited extent. One method, suggested by Muller and Painter, is based upon the frequency with which changes or mutations in genes occur. Another method is based upon crossing over in organisms which have three sets of haploid chromosomes instead of two.

As these methods are of interest to advanced rather than beginning students, they are not discussed here.

Cytological Methods

A linkage group shows the genes linked with one another, the order in which they are arranged and the distance they are apart from one another as determined by genetic means. Genetic methods alone, however, are not sufficient to show exactly which chromosome as observed through the microscope corresponds to a given linkage group, although sometimes it may be inferred from the size of the linkage groups and the size of the chromosomes. Combined genetic and cytological studies, utilizing either spontaneous chromosomal abnormalities or similar aberrations induced by radiation, have in some cases supplied this missing information.

In *Drosophila melanogaster* there are four linkage groups. Two are very long and almost the same size, one is extremely short and includes only a few genes, and the fourth is intermediate in length. A cytological examination of this species shows two pairs of very long chromosomes that are almost the same size, a pair of very short ones, and the intermediate-sized chromosome, which is paired in the female and single in the male, and is the X chromosome. In the male, a Y chromosome is also observed cytologically. It is reasonable to correlate the very small linkage group with the very short fourth chromosome. The fact that the genes of the intermediate-sized linkage group are sex-linked establishes definitely the connection between this linkage group and the intermediate-sized chromosome. It is impossible, however, to state which of the large linkage groups corresponds to each of the pairs of large chromosomes merely by looking at them. By observing a series of translocations, however, Dobzhansky was able to resolve this difficulty.

A translocation is a chromosomal aberration in which a piece of one chromosome becomes broken off in some manner and becomes attached to another chromosome, frequently at the end. If the translocated piece includes genes, these genes no longer show linkage relationships with the genes with which they were previously linked and now show linkage and crossing over with the genes of the chromosome to which they had become attached. In other words, translocation changes the structure of

the chromosomes and also the composition of the linkage groups. Several of Dobzhansky's translocations involved segments of the third chromosome, which became attached to the X chromosome or to the very short chromosome IV. Chromosome III is the longer of the two long chromosomes. By observing which genes had changed their linkage groups, Dobzhansky was able to determine which linkage group corresponded to the longest pair of chromosomes. Similar translocations of pieces of the second chromosome established the correspondence between the shorter of the pair of long chromosomes and the genes of the second linkage group.

Translocations have also been used to locate individual genes in definite regions of their chromosome. An interesting example is Stern's determination of the location of genes for male fertility in *Drosophila melanogaster*. Males with both an X chromosome and a Y chromosome that has lost its short arm are sterile. Other males which have lost the long arm of their Y chromosome are also sterile. When both arms of the Y chromosome are present, the male is fertile. It follows that the two arms of the Y chromosome contain genes for fertility and that genes of both arms must be present if the fly is to be fertile. These fragments of the Y chromosome arose spontaneously.

By the use of a large series of translocations the position of a number of genes on the chromosomes has been shown. Although crossover data give the sequence of the genes and the distance between them, these distances are calculated purely statistically and must necessarily be based on the assumption that crossing over occurs with equal ease in all parts of the chromosome. Whether these distances and the genetic maps based upon them correspond to the true spatial relationships of the genes on the chromosomes depends entirely upon the correctness of this assumption. If the frequency of crossing over per unit of chromosomal length is different in different parts of a chromosome, the linkage map will not give a picture of the exact distribution of the genes in space on that chromosome. If the genes cross over more frequently in one particular region of the chromosome, the linkage map for that region will be too long; and if in another part of the chromosome inert material is present in which crossing over does not occur so that crossovers occur with

a smaller frequency there, the linkage map for that region will appear too short.

The general method in use in attacking this problem is this. (1) By subjecting organisms to X-rays, pieces of the chromosomes are broken off and translocated to other chromosomes. (2) Genetic linkage studies are then undertaken to determine at what place on the genetic map each break occurred. (3) The chromosomes of each fly with a translocation are then examined cytologically and the place of the break determined by noting the nearness of the break to the end, to the centromere, and to various secondary constrictions that may be present. (4) The proportionate length of the broken piece is determined by measurement. (5) The proportionate size of each translocation is compared with the break in the linkage map of that fly. (6) By these comparisons the approximate position on the chromosome is determined for a number of genes.

When a large number of translocations are studied the actual spatial relationship of the genes of the linkage group can be determined reasonably accurately. These translocations have been studied for the metaphase chromosomes, and the cytological map constructed by this means is called a "metaphase chromosome map." The student must not get the impression that the cytologist can direct the X-rays so as to break a chromosome at any desired point. He frequently wishes he could, but, so far, it has been impossible. The breaks occur by chance and the cytologist must take them as they come. If a sufficient number of flies is treated, however, the chance is good of obtaining a number of breaks at different places in the same chromosome.

A comparison of a genetic linkage map and the corresponding metaphase chromosome map of the X chromosome, chromosome II, and chromosome III of *Drosophila melanogaster* (Fig. 56) shows that in each case the *order* of the genes is the same but that the genetic distances and cytological distances do not always agree. In the two large chromosomes, genes near the centromere are much farther apart on the metaphase chromosome than would be supposed from linkage studies alone. For example, Dobzhansky has pointed out that on the second chromosome the distances between the genes *lt* (light eye), *rl* (rolled wings), and *tk* (thick legs) amount to less than one one-hundredth of the

genetic map but actually cover one-fourth of the metaphase chromosome. Similarly for chromosome III, *st* (scarlet eye) and *cu* (curled wings) occupy about one-eighteenth of the genetic map but one-fifth of the metaphase chromosome. Other discrepancies appear also in other parts of these chromosomes. For these two chromosomes, genes near the centromere are relatively farther apart on the metaphase map than on the genetic map;

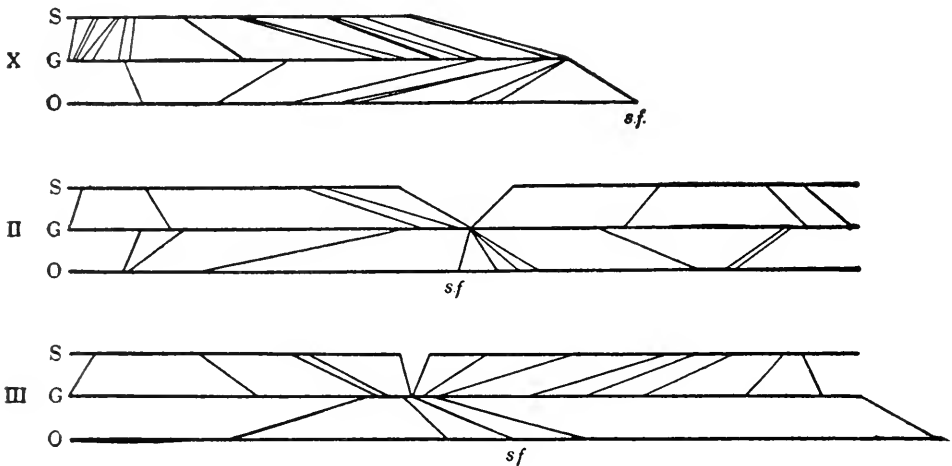

FIG. 56. A comparison of genetic and cytological maps of the X, second, and third chromosomes of *Drosophila melanogaster*. G, genetic map; S, salivary gland map; O, mitotic map. Centromere is marked *sf*. Corresponding loci on the three types of maps are connected by transverse lines. (Redrawn from Mather in *Biological Reviews*.)

the genes in the middle region of either arm of both chromosomes are relatively farther apart on the genetic map; those near the ends of the second chromosome are relatively farther apart on the metaphase map.

Discrepancies also appear when the X chromosome is studied and are even more marked, for only one gene, *bobbed*, is present in the third of the chromosome nearest the centromere. This part of the chromosome is the "inert" region and, although it appears to be a normal part of a chromosome when the metaphase chromosome is examined under the microscope, it forms part of the chromocenter of the salivary gland chromosomes and therefore must be different from the rest of the chromosome (see Chapter 5). The remaining two-thirds of the chromosome contains all the known genes except *bobbed*, but even in this part of the chromosome the distances between the genes are not the

same in genetic and cytological maps. For example, a large number of genes appear to occupy a small part of one end of the linkage map but to cover a relatively much greater part of the metaphase map. In general, it seems that the genes on the *Drosophila* chromosomes are much more evenly spaced on the metaphase map than on the map constructed from crossover data.

Essentially the same techniques which are used in the construction of metaphase chromosome maps are also used to compare the order and distance of genes on the linkage maps of *Drosophila melanogaster* with the order and position of the bands on the salivary gland chromosomes. It was pointed out in Chapter 5 that these giant chromosomes are characterized by the presence of a number of bands or discs of different size and staining capacity which are separated by regions of nonstaining material. Some bands are thick and very deeply stained with aceto-carmin; others are thin and very lightly stained. P. N. Bridges has counted 3795 such bands (counting as one certain bands that appear double when the chromosomes are greatly stretched).

The important problem is whether these bands indicate the regions in which the genes are located. The method of study involves considerable labor. The first problem was to study the morphological features of the normal salivary gland chromosomes and determine the position and order of each band and its relation to gross permanent features of the chromosomes, such as swollen portions and thinner regions. Once this was known, the next steps were to produce translocations, inversions, and deletions. In all cases, the material had to be known genetically, so that it could be determined from phenotypic studies where the breaks in the linkage groups occurred. Cytological observation was then made to determine which bands or groups of bands had changed position.

If a piece is broken from the interior region of one chromosome (an intercalary deletion), the remaining parts pair with the corresponding parts of the homologous chromosome band for band. The part of the normal chromosome which corresponds to the part that is missing from the deleted chromosome bulges out to one side and takes no part in pairing (Fig. 57). Cytological observations show which bands are missing

from the deleted chromosome, and genetic linkage studies indicate which genes are missing. The assumption naturally is made that the missing genes are located in the region of the missing bands. Patterson has shown that short deletions can be produced with considerable frequency by subjecting flies to radiation. Short deletions are naturally better for this type of work than long ones for they restrict the number of genes and

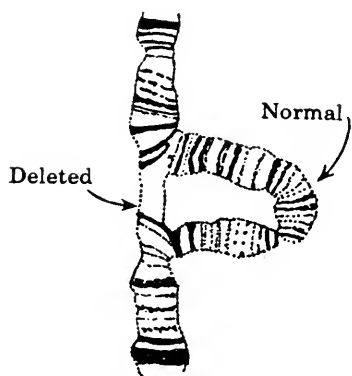

FIG. 57. Pairing in a small section of a salivary gland chromosome of *Drosophila melanogaster* in which one chromosome has a deleted segment. The corresponding segment of the homologous chromosome forms a loop. (Redrawn from Painter in the *Journal of Heredity*.)

bands involved. By using a large number of such deletions, Painter, Mackensen, and others have succeeded in locating the regions of a number of genes. In addition to series of overlapping deletions, translocations and inversions are also used and yield the same types of evidence. By these various related methods, salivary gland chromosome maps have been made for the X chromosome and for both arms of chromosome II and chromosome III. The most recent maps have been published by C. B. and P. N. Bridges (Fig. 58).

The translocation technique has recently given us some interesting information on the fourth chromosome of *Drosophila melanogaster*. This chromosome had generally been regarded as a very tiny dot-like chromosome with the centromere at one end, although the possibility of a strictly terminal centromere has recently been very strongly questioned. Griffen and Stone succeeded in breaking off a small piece of the X chromosome just to the right of the five sharp bands which mark the *white* locus; this piece then became translocated to the fourth chromosome. Metaphase studies of a fly heterozygous for this translocation showed one normal chromosome IV and one that was two-lobed, indicating that the translocated piece had apparently become attached to the centromere end (Fig. 59a). An examination of the salivary gland chromosomes of such flies showed the translocated piece up to and including the region of *white*, but also revealed a region between *white* and the centromere of chro-

mosome IV. This region contained several distinct bands and several finely dotted bands. When the broken end of the X chromosome was studied, it was found that none of the bands to the right of the region of *white* was missing. This region between the translocation and the centromere of chromosome IV must therefore represent a left arm of chromosome IV which had previously not been observed (Fig. 59b). It had apparently been overlooked in previous studies because the whole chromosome is very small and because it is almost always observed in the temporary aceto-carminic mounts with which salivary gland chromosomes are frequently studied. To show this arm, the smearing must be done with great care, and Bridges's permanent method should be used.

Linkage Groups in Human Beings

Extensive linkage maps have been prepared for *Drosophila melanogaster* and *Zea mays*, but almost nothing is known of linkage in man. In most organisms in which a number of genes have been discovered, these genes are frequent enough for appropriate crosses to be made to test the linkage relationships of a large number of them. In man, however, most of the genes that have been discovered are infrequent in natural populations; the chance that two such genes will be found in any one family is therefore small. In man, too, the number of chromosomes is considerably larger than in the plants and animals in which linkage has been studied intensively. For example, the chance that two random genes would be on the same chromosome is greater in *Drosophila melanogaster* than in man, where the

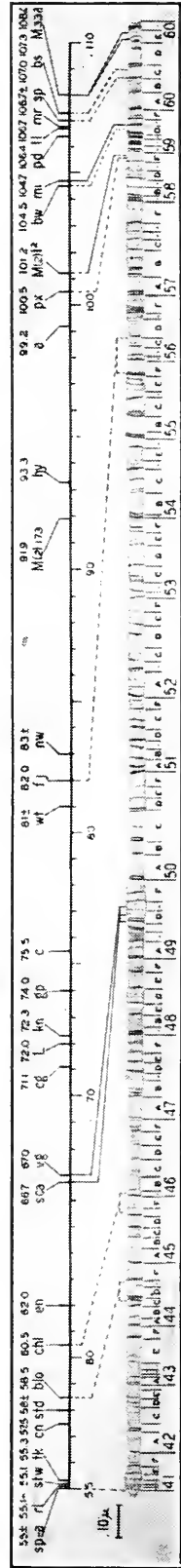

FIG. 58. Linkage and salivary gland map of the right arm of chromosome II of *Drosophila melanogaster*. (From Bridges and Bridges in the *Journal of Heredity*.)

haploid chromosome number is 24. It is impossible to set up mating experiments in human beings; therefore, the pedigree culture method cannot be used. A technique based on statistical studies of natural families has recently been worked out, but

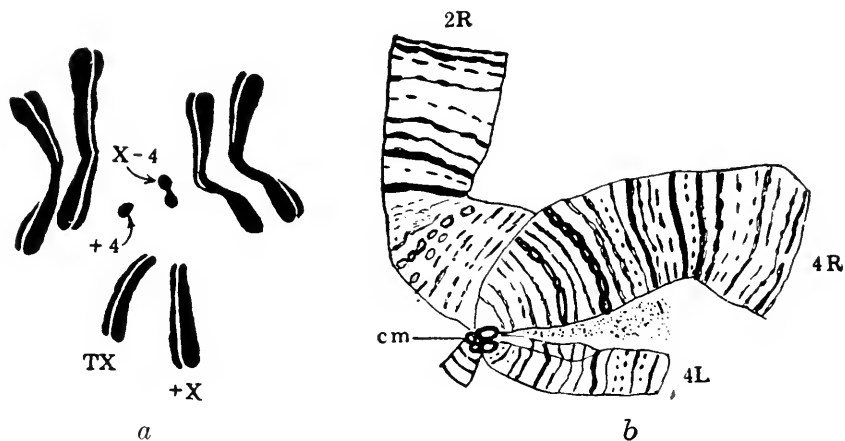

FIG. 59. A translocation of a piece of the X chromosome to chromosome IV in *Drosophila melanogaster*. (a) metaphase and (b) salivary gland chromosomes. For discussion, see text. (Redrawn from Griffen and Stone in *University of Texas Publication* 4032).

since it is very new in comparison with the methods used in studying linkage in other forms of life, much less progress has been made in our studies of human beings.

Incomplete Sex Linkage in Man

In Chapter 7 it was pointed out that if a gene is located in a part of the X chromosome which is not homologous with any part of the Y chromosome, that gene follows a pattern of transmission known as sex linkage. It was also shown that if a gene is in a part of the Y chromosome which is not homologous with any part of the X chromosome, the gene will always be transmitted directly from father to son. If the gene, however, is located in that chromosomal segment which is present in both the X and Y chromosomes it is said to be incompletely sex linked. So far, nine such genes are known in man.

If a certain dominant gene, *O*, is found in the X chromosome of a man while the homologous segment of the Y chromosome bears the allele, *o*, and if that man is mated with a homozygous recessive woman, four types of offspring will be produced. The

noncrossover types will be a heterozygous female who will be phenotypically *O* and a homozygous recessive man. These two types follow the crisscross pattern expected of ordinary sex-linked genes, but, in addition, two crossover types will be present which do not appear in sex linkage. They are a homozygous recessive woman and a heterozygous, phenotypically *O* man (Fig. 60*a*). These new types show that we are not dealing with X

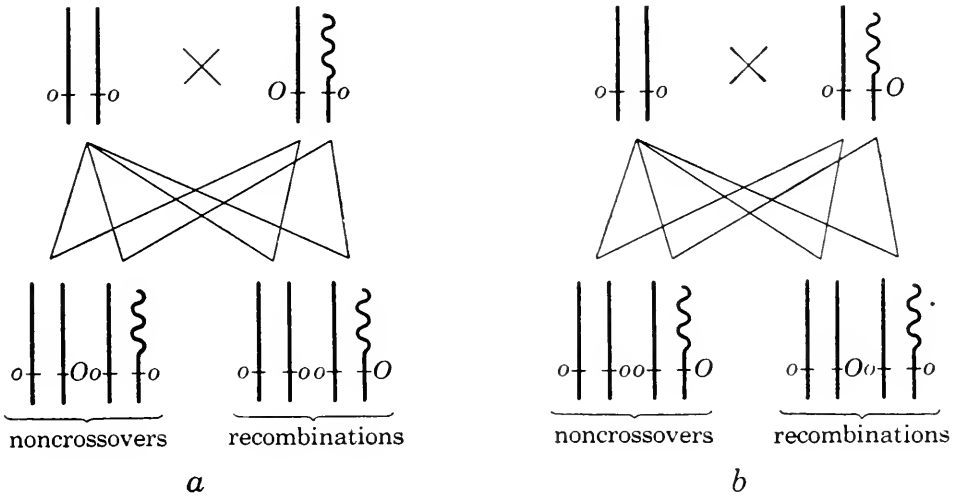

FIG. 60. Scheme of inheritance of an incompletely sex-linked gene in human beings. (a) A cross between a female homozygous for the recessive gene *o* and a male with *O* on the X chromosome and *o* on the homologous part of the Y chromosome. (b) A cross between the *oo* female and a male with *o* on the X and *O* on the Y chromosome.

chromosome inheritance alone. If sex is disregarded, the ratio of 1 *Oo* : 1 *oo* makes the cross appear to be an ordinary test-cross. When, however, the sex of the individuals is also taken into account, the greater abundance of *Oo* females and *oo* males shows that the gene is in the sex chromosome. The percentage of recessive women and dominant men will vary with the gene under investigation and will depend upon the distance the particular gene happens to be from the nonhomologous segments. By the use of these different percentages, Haldane has constructed a linkage map for this homologous segment.

If the male used in a test had the *O* gene on the Y chromosome and the *o* gene on the X chromosome, the noncrossover types would be recessive females and dominant males as in Y chromosome inheritance. The appearance of dominant females

and recessive males (Fig. 60b) could be accounted for only by crossing over between alleles in the X and Y chromosomes.

Nine genes have been plotted on the homologous segment of the X and Y chromosomes (Table 6). The gene for complete color blindness or day blindness prevents the afflicted person from distinguishing any color and must not be confused with Daltonism. *Xeroderma pigmentosum* is a condition in which a person's skin and eyes are abnormally sensitive to light. It leads generally to a fatal malignant disease of the skin. This gene is almost completely recessive, but the heterozygotes are often heavily freckled. Oguchi's disease is a form of night blindness found mainly in Japan, but also reported in Europe. This condition is characterized by a peculiar golden appearance of the light-adapted fundus which disappears on dark adaptation. *Spastic paraplegia*, resulting in a motor weakness of the lower limbs, may be caused by both dominant and recessive genes. The dominant gene is located in an autosome, but the recessive type appears to be partially sex linked and to result from three or more alleles determining different ages of onset. A group of diseases are characterized by the formation of bullae in the skin. In the dystrophic form of *epidermolysis bullosa* the bullae are formed in deep layers and give rise to scars. The dystrophic form results from both dominant and recessive non-allelic genes, but the recessive form is probably incompletely sex linked, is more severe than the dominant type, and is often fatal. *Retinitis pigmentosa* is a type of night blindness involving a contraction of the visual field, thickening of the retinal blood vessel, the production of ophthalmoscopically visible pigmentation of the retina, and often complete blindness. It may result from several dominant and recessive genes. In some pedigrees the dominant form appears to be incompletely sex linked with a crossover value of about 28 per cent. Two of the recessive forms result from autosomal genes, and one of these also produces deafness. A recessive type without deafness appears to result from a recessive allele of the incompletely sex-linked dominant gene for it shows the same percentage of crossing over. Hereditary *hemorrhagic diathesis* is another character that appears to be incompletely sex linked. The condition is generally characterized by purpura and by prolonged spon-

taneous bleeding from the nose, uterus, and mucous membranes. Another incompletely sex-linked gene is one for idiopathic convulsive disorder. Children first show the trait when about one

TABLE 6

A LIST OF NINE GENES THAT ARE PROBABLY INCOMPLETELY SEX-LINKED IN MAN

(Compiled from Haldane, Kaliss and Schweitzer, and Snyder and Palmer.)

Locus	Character	Effect	Significant References
0	Nonhomologous segment Beginning of homologous segment		
9	Achromatopsia	Complete color blindness, or day blindness	Bell (1926); Haldane (1936)
14	<i>Xeroderma pigmentosum</i>	Abnormal sensitivity to light	Siemens and Kohn (1925); Haldane (1936)
17	Oguchi's disease	Form of night blindness	Komai (1934); Haldane (1936)
18	Spastic paraplegia	Motor weakness of lower limbs	Haldane (1941)
20	Recessive <i>epidermolysis bullosa dystrophica</i>	Formation of bullae in skin	Cockayne (1933); Haldane (1936)
28	Some cases of dominant <i>retinitis pigmentosa</i>	Night blindness; pigmentation of retina	Bell (1922); Haldane (1936)
28	One type of recessive <i>retinitis pigmentosa</i>	Night blindness; pigmentation of retina	Bell (1922); Haldane (1936)
34	<i>Hemorrhagic diathesis</i>	Bleeding from nose and mucous membranes	Kaliss and Schweitzer (1943)
?	Idiopathic convulsive disorder	Spasms; early physical and mental degeneration	Snyder and Palmer (1943)

year old. A series of spasms appear which last for a few minutes and are followed by unconsciousness for a half hour to an hour. Spasms recur in cycles, and the children begin to degenerate physically and mentally. They usually die between

the ages of four and twelve. The gene involved is a recessive, incompletely sex-linked lethal.

QUESTIONS AND PROBLEMS

1. Why does it seem logical that the number of linkage groups should equal the haploid number of chromosomes?

2. What is the difference between a "genetic" and a "cytological" map?

3. What are the fundamental assumptions in plotting genes on a linkage map?

4. If the order of the genes on a genetic map corresponds with the order on a cytological map, why do the distances not always correspond?

5. Look up and discuss genetic methods used in constructing linkage groups other than the method based on the frequency of crossing over.

6. In *Primula*, short style (*S*) is dominant over long (*s*), blue flower (*B*) over nonblue (*b*), green stigma (*G*) over colored (*g*), and light red leaf (*L*) over dark (*l*). In the backcross of $SBGL/sbgl \times sbgl/sbgl$, the following phenotypes (male only) were obtained:

458 <i>SBGL</i>	1 <i>SbGl</i>	65 <i>Sbgl</i>
7 <i>SBgl</i>	2 <i>Sbgl</i>	29 <i>sBgl</i>
5 <i>SBgL</i>	0 <i>sBGL</i>	3 <i>s b Gl</i>
25 <i>SbGL</i>	0 <i>sBgl</i>	9 <i>s b g L</i>
82 <i>sBGL</i>	271 <i>s b GL</i>	467 <i>s b g l</i>
270 <i>SBgl</i>		

Determine all the linkages involved and plot the genes on their chromosome or chromosomes.

7. Calculate the linkage values in problem 6. Using these values, calculate the expected backcross ratio. Compare your expected ratio with the observed ratio.

8. Assume that you have conducted an experiment in *Drosophila melanogaster* involving the following genes: *cur* (curved wing); *d* (dachs body); *bt* (bent wing); *se* (sepia eye); *b* (black body); *ca* (claret eye); *st* (scarlet eye); *S* (star eye); *pr* (purple eye); *rt* (rotated abdomen). Assume that you obtained the following crossover values:

<i>cur—st</i>	14 per cent
<i>d—b</i>	18 per cent
<i>S—b</i>	47 per cent
<i>se—rt</i>	11 per cent
<i>se—cur</i>	4 per cent
<i>S—d</i>	30 per cent
<i>se—st</i>	18 per cent

<i>b—pr</i>	6 per cent
<i>cur—rt</i>	7 per cent
<i>d—pr</i>	24 per cent
<i>rt—st</i>	7 per cent

Assume that all other combinations showed 50 per cent crossing over. Plot these genes on their chromosome or chromosomes. (Data are approximate and not based on actual experiment.)

9. What is a translocation? Of what value are translocations in linkage experiments?

10. What are the difficulties involved in constructing linkage maps in human beings? Would such maps be of practical value to a physician?

Chapter 13

MISCELLANEOUS LINKAGE TOPICS

Cytogenetic Proof of Crossing Over

That genetic crossing over was caused by breaks and realignments between chromatids at pachytene was not always realized; and even after the analogy between crossing over and chiasmata was pointed out, it lacked experimental proof for a considerable time.

That the genes might be located in the chromosomes was suggested by Sutton in 1903 who, however, had no conception of crossing over. The possibility that genes in one chromosome could exchange with their alleles in the homologous chromosome was suggested at about the same time by de Vries and others, but the exact mechanism of meiosis was not understood at that time and the possible method of bringing about such exchanges was largely a matter of speculation. A few years later, evidence of the mechanism of such exchanges was furnished by Janssens, who demonstrated chiasmata. The possible explanation of all linkage phenomena on the basis of Janssens's chiasmata was suggested by Morgan in 1911, who pointed out that if the genes were arranged in a linear order on the chromosome, the genes in a chromosome which came from the maternal parent could lie during synapsis next to their alleles in the homologous chromosome derived from the paternal parent. As the result of this pairing of alleles, the exchange of groups or blocks of genes on one chromosome with similar groups on the homologous chromosome could occur and undoubtedly did occur at about the time of chiasma formation. This theory agreed with the then known observations, but, for twenty years thereafter, conclusive proof was lacking. There was no proof because the two homologous chromosomes are identical when viewed under the microscope, and although such chiasmata can be interpreted as due to an exchange of homologous segments, there is no way

of differentiating visually the maternal segments from the paternal.

In 1931, the demonstration that genetic crossing over is correlated cytologically with an exchange of pieces of homologous chromatids was made independently by Creighton and McClintock in maize and by Stern in *Drosophila*, and the methods of demonstrating it were the same in each organism.

Since two homologous chromosomes are normally indistinguishable cytologically, the object of the method was to find or create chromosomes in which the *two ends* of two homologues were *visibly* different, while the central part, in which there were known genes whose phenotypic effects could be observed, was the same. In maize, chromosome IX was studied. It bears the genes *C* and *c* for colored and colorless aleurone and *Wx* and *wx* for starchy and waxy endosperm. Some strains of maize have a chromosome IX in which a large "knob" of genetically inert heterochromatin is present at the end towards which gene *C* lies; other strains lack the knob. Otherwise identical, the two homologues can be distinguished in the heterozygote only at the end with the knob; the other end is alike in all strains so that a crossover between two such heteromorphic chromosomes cannot be demonstrated cytologically. Occasionally, however, abnormalities in meiosis occur by which a piece of one chromosome can become exchanged with a piece of a *nonhomologous* chromosome. This *segmental interchange*, or *reciprocal translocation*, occurs very rarely in maize under supposedly normal conditions and may be produced by X-rays or radium.

Creighton and McClintock found a strain of maize in which a piece of a chromosome IX from a knobbed strain had changed places with a larger segment of chromosome VIII at the end away from the knob. These new chromosomes are known as "interchange" chromosomes. As Fig. 61 shows, this exchange produced a knobbed chromosome IX which was longer than the normal, and as a result could be distinguished at both ends from a normal chromosome IX of the knobless strain. When a normal knobless strain was crossed with an interchanged knobbed strain, the offspring had one normal knobless chromosome IX and one interchanged and knobbed chromosome IX. Since only homologous parts of homologous chromosomes pair, the non-

homologous ends are not paired. The normal knobless chromosome had the genes *c* and *Wx*, whereas the interchange knobbed chromosomes had *C* and *wx* (Table 5). The original cross was

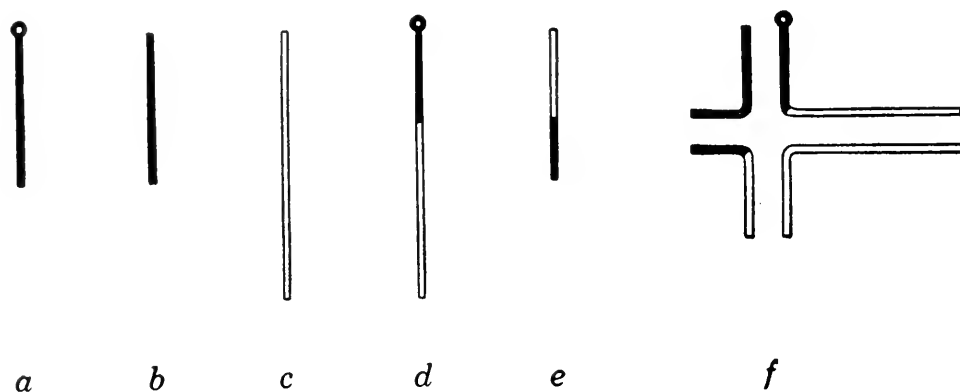

FIG. 61. Chromosomes involved in Creighton and McClintock's demonstration of crossing over: (a) a normal knobbed chromosome IX; (b) a normal knobless chromosome IX; (c) a normal chromosome VIII. By a reciprocal translocation, a piece of chromosome VIII exchanged with a piece of chromosome IX of the knobbed strain, producing an interchange chromosome IX (d) and an interchange VIII (e). In a plant with a normal knobless IX, a normal VIII, and the two interchange chromosomes, a quadrivalent figure would be found as at (f).

made, then, in the repulsion phase, and the F_1 was crossed with a plant that had two normal knobless chromosomes and the genes *c Wx / c wx*. If only the *c wx* chromosome is considered, this represents a testcross. If a crossover occurred between the *c* and *wx* loci of the F_1 , the parental types and nonparental types should be:

	<i>Phenotypes</i>	<i>Chromosomes</i>
Parental types:	colorless; starchy colored; waxy	knobless; normal knobbed; long
Recombinations:	colorless; waxy colored; starchy	knobless; long knobbed; normal

All four types were recovered. The phenotypes showed that genetic crossing over had occurred between the *c* and *wx* loci. Cytological observations of the heteromorphic bivalent showed that a break and realignment had occurred between the knobbed end and the interchanged end. The correlation between the cytological observations and the genetic results afforded proof of

the cytological basis of crossing over that had not been found previously.

Stern's work in *Drosophila* was very similar (Fig. 62). Here two X chromosomes were heteromorphous. In one strain, which

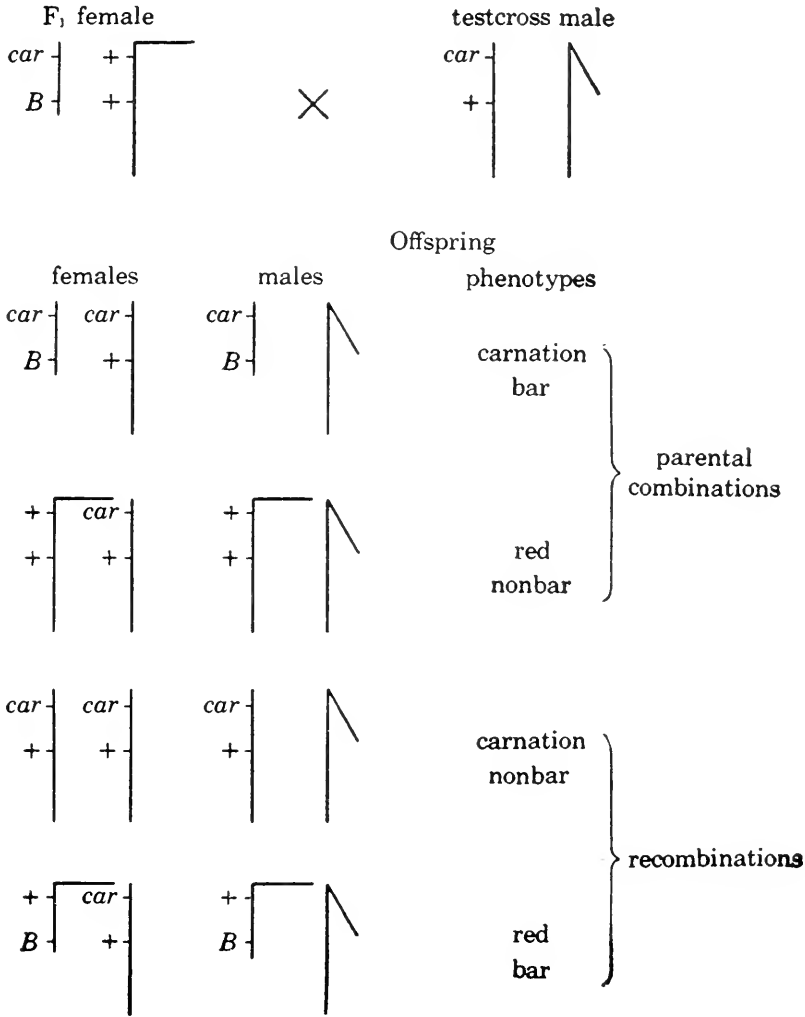

FIG. 62. Stern's method of demonstrating genetic crossing over cytologically by means of a translocation in the X chromosome of *Drosophila melanogaster*. For explanation, see text.

carried the genes *car* (carnation-colored eye) and *B* (bar-shaped eye), a piece of the X chromosome had broken off from the *B* end. This piece had become attached to one of the members of chromosome IV so that its genes were not lost. In the other strain, a piece of the Y chromosome had broken off and become attached to the *car* end of the X chromosome; it carried the

wild-type genes $+^{car}$ (red eye) and $+^B$ (normal-shaped eye). Thus the two ends could be distinguished by observation. When the two strains were crossed, the F_1 females were heterozygous for both pairs of genes and were heteromorphous for the X chromosome. The F_1 was testcrossed to a $car +^B$ male; it was the double recessive and had a normal X chromosome. This testcross produced flies that were phenotypically of the parental types and had parental-type chromosomes. It also yielded, however, a small percentage of flies which were phenotypically recombinations and had chromosomes showing that a break and realignment had occurred between the two morphologically different ends. As in maize, cytological crossing over was accompanied by genetical crossing over, and the theory of crossing over was further substantiated.

Four-Strand Crossing Over

It has been pointed out in previous chapters that crossing over occurs between only one chromatid of each homologous chromosome at any one place and that crossing over occurs between chromatids and not between whole chromosomes. Since it occurs when there are four chromatids, it is said to occur in the *four-strand stage* or *double-strand stage*. In Janssens's earlier work on chiasmata, however, two types of crossing over were described. One type, often called *total chiasmotypy*, occurs when the *two* chromatids of one homologue break and exchange with the *two* chromatids of the other homologue *at the same place*. This is the type that Janssens believed to be most common. As a result of this method, all four gametes (or spores) from one mother cell would be recombinations and there would be no gametes of the parental type (Fig. 63). He also recognized that *partial chiasmotypy* might exist by which only one chromatid of each chromosome could exchange and four types of gametes would be produced. Today it is believed that total chiasmotypy never occurs, and that crossing over occurs only in the four-strand stage between two chromatids, one from each chromosome.

It was pointed out in Chapter 10 that the percentage of chiasmata (chiasma frequency) observed in a given region of a chromosome in the prophase of the first meiotic division is twice as great as the percentage of recombinations between two genes

on either side of this region. This statement was based on the assumption that crossing over occurs between only two chromatids at any one point and would not be true if all four chromatids, or if whole chromosomes, crossed over at one point.

It has been stated that crossing over occurs between one chromatid of one chromosome and one chromatid of the *other* chromosome. It might seem possible that the two chromatids from the *same* chromosome might also cross over. The two chromatids derived from the same chromosome are spoken of

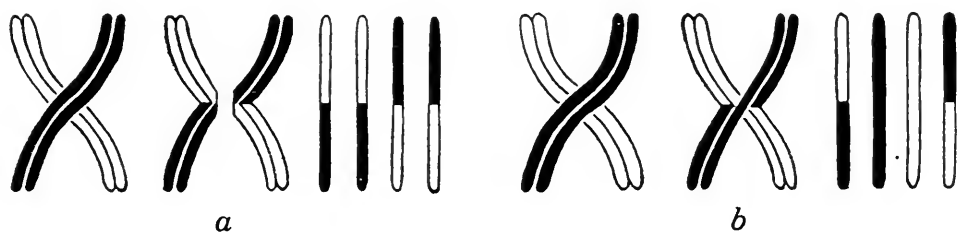

FIG. 63. Crossing over and the resulting chromosomes according to (a) the theory of total chiasmotypy and (b) the theory of partial chiasmotypy.

as *sister chromatids* whereas two chromatids from different homologues are called *nonsister chromatids*. The evidence indicates that crossing over occurs between nonsister chromatids only and not between sister chromatids.

Classical Theory of Chiasmata

When seen under the microscope, all four chromatids of a bivalent are normally indistinguishable. According to the partial chiasmatype theory, breaks occur at pachytene between two of the four. These two rejoin in a new arrangement, and chiasmata result which are observable when the threads open out into loops at diplotene. According to this theory, every chiasma represents a place where a break occurred at pachytene. As will be seen from Fig. 64*b*, sister threads are always paired and are always found together at each side of a chiasma. Another and older theory has also been suggested which is a basically different interpretation of the same observed phenomena. Neither theory can be proved on the basis of visual observation of normal bivalents alone, but the study of a heteromorphic bivalent and of complex interlocking of bivalents shows that the theory

of partial chiasmotypy more nearly represents the correct situation.

The older, or *classical theory*, assumes that crossing over does not produce chiasmata, but that it is caused by chiasmata. According to this theory, when the four twisted chromatids open out at diplotene they are still unbroken, and they open out in such a manner that sister and nonsister threads are together

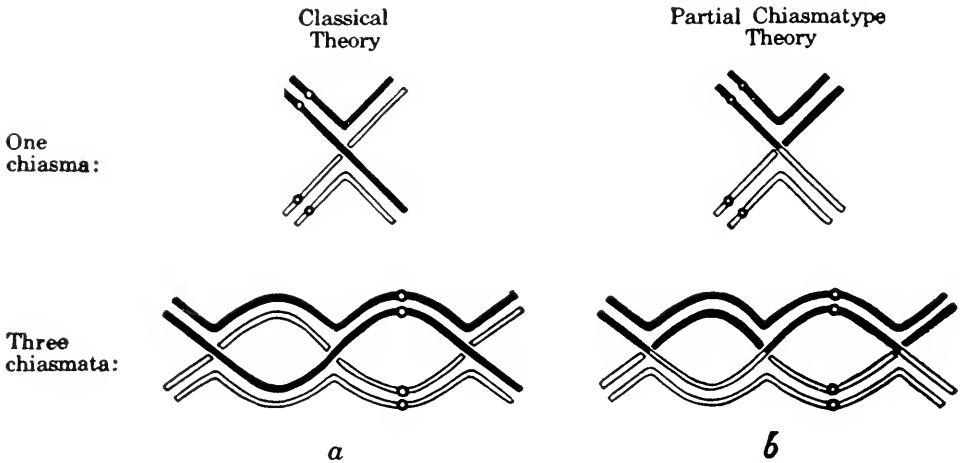

FIG. 64. The interpretation of chiasmata according to the classical theory (a) and the theory of partial chiasmotypy (b).

alternately in successive loops. Beginning at the centromere, sister threads are together; if there is a chiasma on each side of the centromere, nonsister threads would be together on the opposite sides of each chiasma (Fig. 64a). These chiasmata produce strains as the paired threads repel one another, and as a result of the strains, some or all of the chiasmata break, producing crossovers at the breaks. As the theory of partial chiasmotypy is more generally accepted today, a detailed discussion of the merits of the two theories and of the various arguments in support of each is unnecessary.

Exactness of Crossing Over

One of the most significant features of crossing over is the exactness with which it occurs in the two chromatids which cross over. This feature of crossing over cannot be emphasized too strongly because it is this fact that makes genetic crossing over so regular and permits the construction of linkage maps.

Occasionally, however, crossing over is not so precise; the chief exception to the rule is found at the locus of the so-called bar "gene" (Fig. 65) in *Drosophila melanogaster*. The bar "gene" is located between the loci of forked (*f*) and fused (*fu*). Occasionally, when crossing over occurs between bar and one of these genes, it is so inexact that the two bar "genes" are included in the same chromatid, whereas the other chromatid has no bar "gene" (Fig. 66a). Thus, if one chromatid has the genes *forked*, *bar*, and *fused*, and the other has *nonforked*, *bar*, and *nonfused*, one of the crossover chromatids might be *forked*, *bar*, *bar*, and *nonfused*, and the other *nonforked* and *fused*. Thus a new form, *double bar*, arises which has the normally narrow eye of bar even further reduced. At the same time recessive wild-type (*nonbar*) flies appear even when the original fly was homozygous for the dominant "gene" for bar.

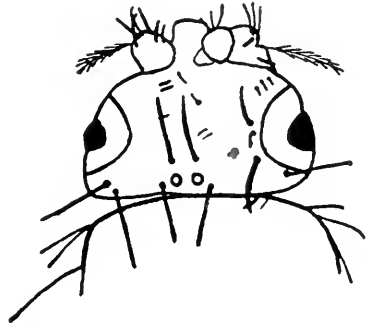

FIG. 65. The bar eye mutant of *Drosophila melanogaster*.

This situation for a long time was very puzzling, for it seemed contradictory to the general rule that crossing over is precise. With the discovery of the salivary gland chromosomes, the *bar* locus could be examined cytologically. It was then found that the bar "gene" was not a gene, as we usually understand the term, but was the result of reduplication of a small segment of one chromosome. The wild-type fly has this segment, but it is represented only once. In the *bar* fly, this segment is present twice, and these two duplicate segments follow one another immediately on the chromosome. Sometimes, in pairing, the lower of the two segments of one chromosome happens to pair with the upper segment of the homologous chromosome (Fig. 66b). A crossover will then produce a chromatid with three segments, or *double bar*, and one that has only one segment, and is *reverted bar*. Flies that are reverted bar are phenotypically like the wild type. What had once been an unexplainable situation can now be understood as caused by a chromosomal aberration. Not only does this duplicated segment illustrate why crossing over is

not exact at this locus, but it also explains another puzzling point—why homozygous, dominant bar-eyed flies can occasionally produce the recessive, nonbarred type.

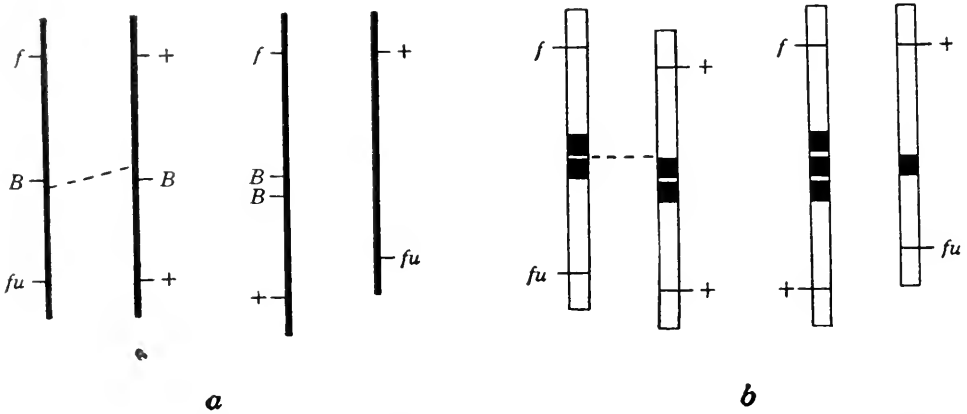

FIG. 66. Unequal crossing over at the bar locus of *Drosophila melanogaster*. Before the discovery of the giant salivary gland chromosomes the bar locus was believed to be a gene. As shown in (a), it appeared that unequal crossing over was often found so that chromatids were produced with two bar genes and with none. It has since been shown that the bar locus is a reduplicated segment of the X chromosome involving about six bands. Pairing as in (b) would thus produce chromatids with three segments or with only one. Flies with three reduplicated segments are *double bar* and those with one are *bar reverted*.

Double Chiasmata

In discussing double crossing over, it was shown that more than one chiasma frequently occurred in a bivalent. For our example we selected a case where the same two chromatids were involved in each chiasma (Fig. 55). However, any two nonsister chromatids may form a chiasma, and each chiasma is formed entirely independently of every other. It follows, therefore, that either the same or different chromatids may be concerned at successive chiasmata.

When the same two chromatids are involved in the second chiasma as are involved in the first, the chiasmata are said to be *reciprocal* (Fig. 67). The second chiasma restores the order which was changed by the first chiasma, and two noncrossover chromatids are produced. When both the chromatids concerned with the second chiasma are different from the two involved in the first chiasma, the chiasmata are said to be *complementary*. Two chiasmata of this type would produce all

single crossover gametes; there would be no noncrossover gametes and no double crossover gametes. Reciprocal and complementary types taken together are known as *compensating*.

When one of the four chromatids is involved in the formation of both chiasmata and one is involved in neither, the type is known as *noncompensating*, *diagonal*, or *disparate*. There are two such types. If the two chromatids from one chromosome are designated *a* and *b*, and the two chromatids of the other chromosome are *c* and *d*, and if chromatids *b* and *c* exchange segments at the first chiasma, one of the two diagonal types would arise if *a* and *c* formed the second chiasma; the other type would arise if the second chiasma were formed by an exchange between *b* and *d*. In each type of diagonal chiasmata, one noncrossover chromatid, two single crossovers, and one double crossover would be produced, but they would be different chromatids in the two types. As observed cytologically, these two types show no difference, but if one chromosome contained a number of dominant genes and the other chromosome their recessive alleles, the two types would produce very different results genetically.

An examination of these four types will show why crossing over cannot exceed 50 per cent. If we assume that 2 given nonsister chromatids form the first chiasma and that a second chiasma can be formed at random between any 2 nonsister chromatids entirely independently of the first chiasma, the four types will occur with equal frequency. When the 16 possible chromatids are tabulated, 4 are found to be noncrossovers, 4 are double crossovers, and 8 are single crossovers. Since the two chiasmata form *between* the two genes, the noncrossovers and the double crossovers will appear as parental types whereas all the single crossovers will be recombinations. Thus only 8 out of 16 chromatids will be crossover types, and crossing over will be 50 per cent (Fig. 67).

It might be interesting to consider the effect of three chiasmata on the percentage of crossing over. If each chiasma may be formed at random between any 2 nonsister chromatids, and if the first is formed between 2 given ones, there are sixteen possible arrangements of chiasmata and 64 possible chromatids. Of these, 8 will be noncrossovers, 24 will be double crossovers, 24

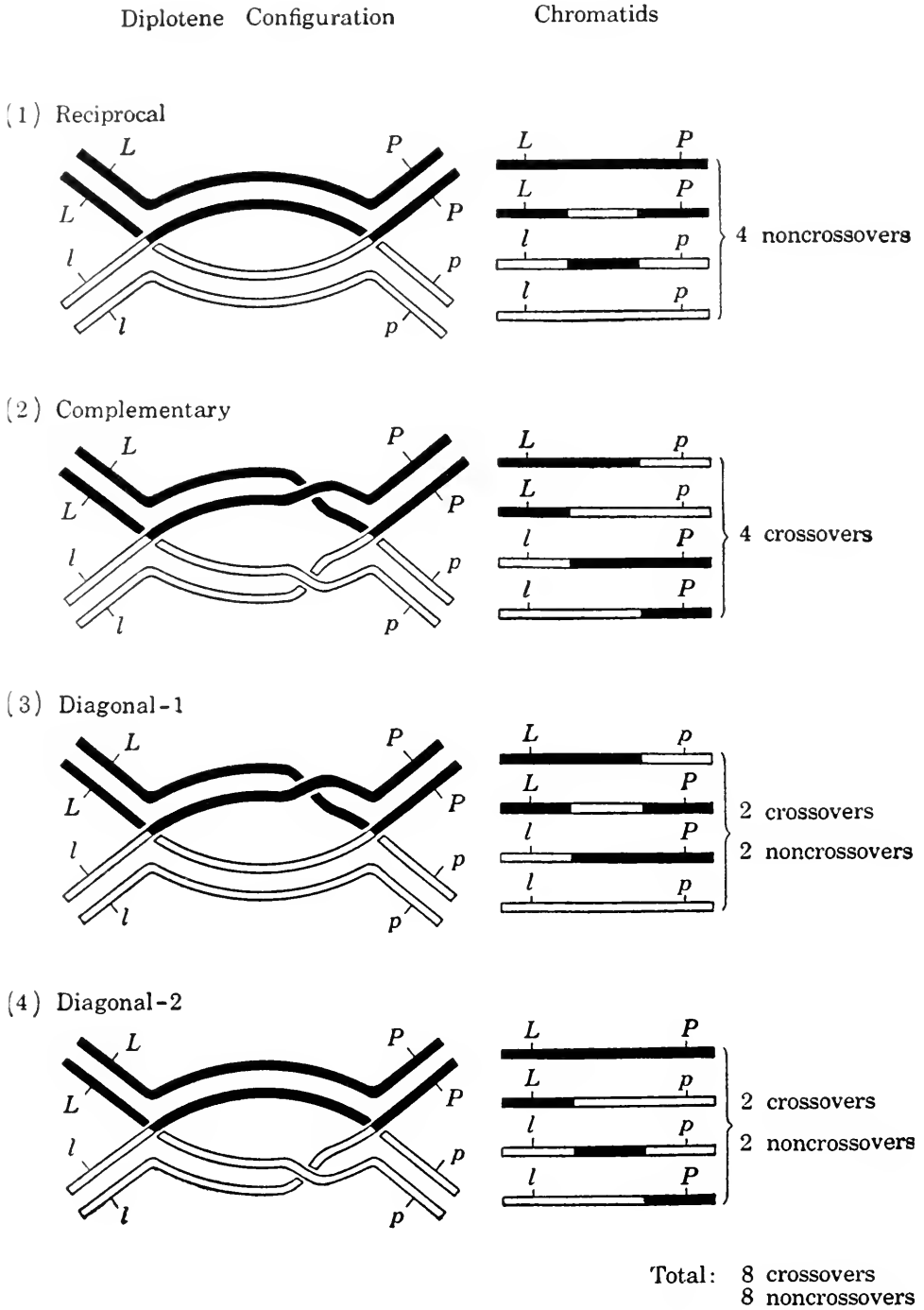

FIG. 67. Compound crossing over. The four possibilities of chiasma formation when two chiasmata are formed in one bivalent, and the chromatids produced from each type. For explanation, see text. (Based on Mather in the *Biological Reviews*.)

will be single crossovers, and 8 will be triple crossovers. As all the noncrossovers and double crossovers appear as parental types, whereas all the single and triple crossovers appear as recombinations, there will be 32 parental and 32 recombination chromatids, and crossing over will again be no greater than 50 per cent.

If the two genes are so close on a chromosome that one chiasma fails to form between them in every meiocyte, that is, every cell undergoing meiosis, the percentage of crossing over will be less than 50. If one forms in every meiocyte, the percentage will be 50. For all the cells with two, three, or more chiasmata, the percentage of crossover gametes that come from them will be 50. Thus, although the percentage of crossing over may vary between none and 50, it can never exceed 50 no matter how many chiasmata are formed. No matter how many chiasmata are present, the number of gametes with an odd number of crossovers will equal the number with no crossovers or with an even number. Those with an odd number will be recombination gametes; those with an even number or none will be parental gametes.

Pairing without Chiasmata

We mentioned in Chapter 10 that there is no crossing over in the males of the Diptera or in the females of silkworms. In spite of this, the chromosomes appear to be paired at metaphase in a more or less normal fashion and they separate at anaphase in a regular manner. This suggests two questions. If there is no crossing over, are chiasmata formed? If there are no chiasmata, what forces are responsible for chromosome pairing at the first meiotic metaphase? Answers have been given by several investigators but they are not all in agreement.

In most plants and animals, the chromosomes during somatic mitoses are distributed on the metaphase plate in a purely random manner with reference to one another so that a given chromosome does not tend to lie alongside its homologue any more frequently than it lies next to any other chromosome. However, in many of the Diptera, the two chromosomes of each homologue tend to lie near one another at metaphase. Corresponding parts of the two homologues lie opposite one another, but the chromosomes are not actually in contact at any point. Such an ar-

rangement of pairs of chromosomes has been termed *somatic pairing*. The exact cause of this somatic pairing has not been determined but has been explained as resulting from exaggerated forces of attraction.

In the male *Drosophila*, during the first meiotic division, there is no pairing at zygotene or chiasma formation at pachytene in the autosomes and the peculiar pairing at metaphase has been attributed by Darlington to the same type of forces responsible for somatic pairing. Darlington, however, considers that the autosomes are unique in this respect and that the sex chromosomes pair by chiasmata. However, chiasma pairing between the X and Y chromosomes cannot be considered entirely normal for this pairing apparently occurs only between their homologous inert regions and because two reciprocal chiasmata must always form. Since this reciprocal chiasma formation occurs only in the inert region, it cannot be detected by genetic means, for the interchanged segment bears no genes. There must always be two chiasmata in this inert region and they must always be reciprocal, as any other arrangement would produce new chromatids which could be detected genetically, and such new chromatids never form. Darlington's explanation for chromosome pairing in such organisms, then, assumes two different mechanisms, one for the autosomes and one for the sex chromosomes. It assumes, furthermore, that the sex chromosomes operate by the usual meiotic mechanism but by a very restricted form of it that has some strong elements of improbability.

A theory for chromosome pairing which does not involve chiasmata has been suggested by Cooper for the male of *Olfersia bisulcata*, a parasitic fly from Panama, and it has also been applied to *Drosophila* males. In the *Olfersia* male are three pairs of autosomes. One type is large and V-shaped, one is long and rod-shaped, and the third is small and dot-like. There are also a large submedian chromosome and a smaller median one which are believed to be the X and Y chromosomes. Since this relationship has not been proved conclusively, they are designated as X' and Y'. During the somatic mitoses that precede meiosis, the autosomes show decided somatic pairing at midprophase, although they do not pair through their entire lengths. The rod-shaped pair are associated only at their distal regions whereas the V-shaped homologues are together at three

places. The short arm of each homologue is associated at one interstitial region, and the longer arm at one interstitial region and again at the end. At other regions on these chromosomes, the two arms either fail to attract or actually repel one another. As prophase advances, the paired regions separate from one another, and during metaphase they are not paired but tend to lie next to each other on the equatorial plate. The sex chromosomes do not pair during midprophase but they do lie next to one another at metaphase.

During the first meiotic division in the males of *Olfersia*, at a stage comparable to late diakinesis, the autosomes are associated as bivalents at apparently the same regions where they were joined during the somatic divisions. The rod-shaped chromosomes are together at their distal region, whereas the V-shaped ones are associated in three places and open out into two loops, which gives this bivalent the appearance of one with three chiasmata. The two dot-like autosomes lie very close to each other, but the sex chromosomes are not paired and may frequently be widely separated in the nuclei. By late diakinesis, however, the sex chromosomes are found associated together in regions fairly close to the centromere.

At first metaphase, the two dot-like autosomes are usually separated from one another, but the other three pairs of chromosomes form bivalents. They are still paired, but not as in most organisms, for they are held together not by chiasmata but by small chromosomal segments, *conjunctive segments*, each of which appears to have the power of adhering to the similar segment of the homologous chromosome. Both the autosomes and sex chromosomes behave as though they possessed one or more of these relatively short conjunctive segments. They may initiate the approach of the homologues and they are responsible for their cohesion in bivalents. Without them, chromosomes in the male fly would not pair and therefore would not disjoin so regularly at meiosis. They may also be the regions from which emanate the hypothetical forces believed to be responsible for somatic pairing. It has been further suggested that similar conjunctive segments rather than reciprocal chiasmata are the basis of the association of the X and Y chromosomes of *Drosophila* and that the autosomes associate as the result of essentially the same forces, but that these forces are distributed

throughout the entire length of the autosomes of *Drosophila* instead of being restricted to certain small, highly localized segments. Cooper also suggests that these conjunctive segments are nongenic, chromosomal organelles comparable to the centromere, matrix, and nucleolus organizers. He has named them *collochores*.

Somatic Crossing Over

Is crossing over purely a phenomenon of meiosis or does it also occur in somatic cells? In most organisms, there is no evidence that somatic crossing over occurs, and it is hardly to be expected since the two chromosomes of a homologous pair do not attract one another at prophase and since they line up on the equatorial plate independently of one another. In *Drosophila melanogaster*, however, Stern has produced data that can hardly be explained except by assuming somatic crossing over. The opportunity for such an occurrence would be greater in *Drosophila* than in most organisms because in the Diptera the homologous chromosomes tend to lie alongside one another in ordinary somatic cells.

Somatic crossing over has been found between the genes *y* (yellow body) and *sn* (singled bristles). The locus of *y* is at the distal end of the X chromosome about sixty-six map units from the centromere, whereas *sn* is twenty-one map units from yellow, on the side nearer the centromere. Somatic crossing over is increased by the presence of certain dominant genes known as the *minutes*. If a fly is heterozygous for *y* and *sn*, having received one chromosome with *y* and *sn* from one parent and one chromosome with the two wild-type alleles from the other parent, crossing over may occur between one chromatid of one somatic chromosome and one chromatid of the homologue (Fig. 68). The two chromosomes may then line up on the metaphase plate in one of two ways. If they are so oriented that a ++ chromatid and a *y sn* chromatid go to one pole and the *y* + and + *sn* chromatids to the other pole, both cells will be wild-type with respect to each pair of alleles. On the other hand, if a ++ and a + *sn* chromatid go to one pole and a *y* + and a *y sn* chromatid to the other, the latter will form a cell which has no wild-type allele for *y*. Such a cell would divide a number of times to produce a group of such *y* cells. They would be observable phenotypically as a small area of yellow-colored body in the

normally gray body. Wherever such a somatic crossing over took place a small yellow spot would be visible on the body of the fly. Somatic crossing over, like pachytene crossing over, occurs in a four-strand stage between two nonsister chromatids. It does not, however, form chiasmata, or, if it does, the chiasmata disappear before metaphase and do not affect the orientation of the chromosomes on the spindle. It does not, of course,

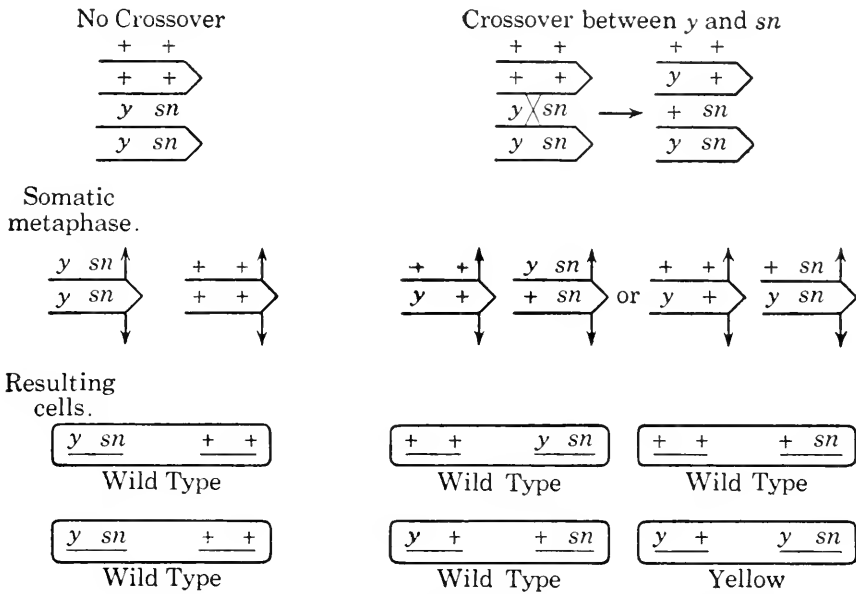

FIG. 68. Somatic crossing over between the loci of yellow and singed in *Drosophila melanogaster*. For explanation, see text.

have any effect on germinal tissue. Its results are immediate, for daughter cells of the one in which the crossover occurred will be phenotypically different from the normal cells, provided that, as in this case, the part of the body affected is a part under the control of the gene which crossed over.

QUESTIONS AND PROBLEMS

1. Show by diagrams how a heteromorphic bivalent might be used to give evidence in support of either the classical or the partial chiasma-type theories. Is the evidence positive or negative?

2. If bar eye appears to be due to a reduplication of a small segment of a chromosome, does this have any possible bearing on the nature or existence of genes?

3. Could somatic crossing over produce small areas with singed bristle? Show by a diagram.

4. By diagrams, show the sixty-four possible chromatids when three chiasmata form between two genes. Tabulate noncrossovers, single, double, and triple crossovers.

5. Show that, by applying the binomial theorem, the number of non-crossover, single crossover, etc., chromatids may be easily calculated no matter how many chiasmata form between two genes.

Chapter 14

THE NATURE OF AND CHANGES IN GENES

Some Properties of Genes

Since the early days in the study of genetics there has been much speculation upon the physical and chemical properties of genes. Various suggestions have been offered as to their nature, and approximations of their size and chemical constitution have been hypothesized from different lines of evidence. In previous chapters certain generally recognized facts have been brought out. Some additional facts in regard to the nature and behavior of genes are discussed in Chapters 15 through 22.

A prevalent view of the relation of genes to chromosomes has been well stated by Demerec. The fundamental part of the chromosome is the long fiber-like chromonema. This "thread," which extends the entire length of the chromosome, appears to be the same chemically and physically throughout its length. Furthermore, the chromonema of one chromosome is considered to be identical in nature with the chromonemata of the other chromosomes in the same cell. Since a chromonema appears to be homogeneous, it must be concluded that the genes do not form part of the chromonema. Although our knowledge of genes and chromosomes is still in a rather hazy state, the chromonema can be visualized as the backbone of the chromosome, but it can be pictured as having a large number of side "branches" protruding from it and approximately at right angles to it throughout its length. Chemical radicals appear to attach themselves to these "branches" of the chromonema, and these attached radicals may be different chemically from one another. This attached material, therefore, differentiates various sections of the chromosome into different units. These units, which are different from one another chemically and are attached to the chromonemata, appear to be the genes. It is interesting in this connection to note that when the chromosomes of *Drosophila* are bombarded with X-rays they may be broken at various

places and the breaks occur purely at random. This fact seems to indicate that the string-like chromonema, which is the structure affected by the X-rays, is the same for all parts of all the chromosomes. It is true for both euchromatic or heterochromatic regions, for the differentiation of the chromosome into these two regions is not due to a difference in the chromonema "backbone" but to the material which attaches itself to the chromonema.

Active and Inert Regions of the Chromosome

As mentioned in Chapter 5, the chemical nature of the active and of the apparently inert regions of a chromosome seems to be somewhat different. The active regions are generally said to be made up of euchromatin (that is, true chromatin) whereas the inactive regions are composed of heterochromatin. The relative proportions of these two substances differ, however, in such chromosomes as the giant salivary gland chromosomes of *Drosophila* and other somatic chromosomes of the same individual. The giant chromosomes have a relatively smaller amount of heterochromatin than the chromosomes of most body cells, and the heterochromatic material at the centromeres of all the salivary gland chromosomes of *Drosophila* is united into the chromocenter. Just why the heterochromatic region is proportionately larger than the euchromatic region in ordinary mitotic chromosomes is not clear, but Waddington suggests as a tentative hypothesis that there may be an abnormally large concentration of nucleic acid on the chromosome in somatic mitoses.

The property that chromosomes exhibit of staining deeply with "nuclear" stains is apparently the result of the presence on the chromosome of nucleic acid. In the salivary gland chromosomes of *Drosophila*, the euchromatin stains more deeply than the heterochromatin because it has more nucleic acid, but in the mitotic chromosomes of the same individuals, both the euchromatin and the heterochromatin seem to have a high nucleic acid content and to stain uniformly very deeply. Darlington and La Cour showed that although the euchromatin of the plants *Paris* and *Trillium* contains a large amount of nucleic acid during metaphase and anaphase of mitosis, it begins to lose some of this nucleic acid during anaphase so that at telophase the amount of nucleic acid is considerably less than it had been at metaphase.

During the resting stage which follows, the euchromatin has almost no nucleic acid. During the following cell division, the amount of nucleic acid in the euchromatic regions begins to increase at prophase and reaches the maximum again in the metaphase and anaphase of this division. Although the heterochromatin also contains its maximum amount of nucleic acid at metaphase and anaphase, it does not lose so much during telophase and has a fairly high content even during the resting stage. Consequently, with nuclear stains, the chromosomes at metaphase and anaphase are stained uniformly deeply, whereas, during the resting stage, the heterochromatin alone becomes stained. Studies on *Fritillaria pudica* show that, during the resting stage, the heterochromatic parts of the chromosomes not only obtain all the nucleic acid and therefore become very deeply stained, but they may also fuse to give branched structures. For that reason, the number of deeply staining bodies in the resting nucleus does not always correspond to the number of heterochromatic parts of the chromosomes.

Since both the euchromatin and heterochromatin contain large amounts of nucleic acid when the chromosomes are in metaphase and anaphase, these chromosomes are normally stained evenly and appear to have a smooth outline. Darlington and La Cour, however, have shown that the heterochromatic regions of *Fritillaria pudica*, Paris, and Trillium can be differentiated from the euchromatic regions by keeping the plants at a temperature below 3° centigrade and by allowing them to undergo mitosis at that temperature. The low temperature reduces the amount of nucleic acid in the nucleus. Normally, there is enough of this material for all the parts of the chromosomes, but in the cold-treated plants, the amount is reduced to such an extent that there is no longer a sufficiency. During mitosis of plants raised at these low temperatures, the reduced amount of available nucleic acid is taken up by the euchromatin and, therefore, the heterochromatin has less than it has normally. As a result, the euchromatic regions of the mitotic chromosomes during metaphase and anaphase become stained very deeply, whereas the heterochromatic regions are stained less deeply and seem thinner, appearing as slight constrictions (Fig. 69). Apparently there is considerable variability in the nucleic acid content of the hetero-

chromatin of cold-treated plants, for comparable results were not found in other species of *Fritillaria*.

The difference in the amount and position of the heterochromatin in the chromosomes of various species of *Drosophila* is very interesting. In the most familiar one, and the one that we have cited most frequently, *D. melanogaster*, about one-third

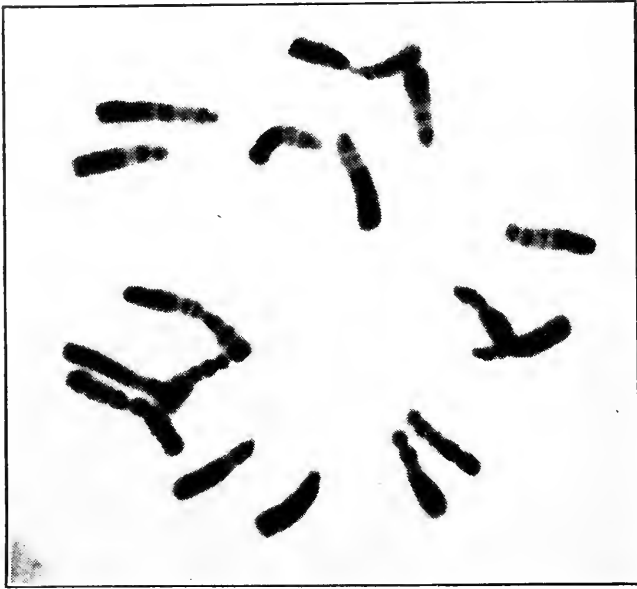

FIG. 69. Chromosomes in metaphase of mitosis in the pollen grains of a triploid *Fritillaria pudica*. The plant was subjected to cold for over three weeks. As a result, the production or distribution of nucleic acid is hindered and the available nucleic acid is seized by the euchromatin. The heterochromatin in such chromosomes stains much less heavily and is represented by the light areas in the figure. (From Darlington and La Cour in the *Journal of Heredity*. Courtesy of Dr. C. D. Darlington.)

of the X chromosomes and up to one-sixth of each arm of each autosome is heterochromatic. In the salivary glands, all the chromosomes are united to the chromocenter, which is made up almost equally of material from the X chromosome and the two large, V-shaped autosomes. The chromosomal picture of *D. simulans* is practically the same. In *D. virilis*, a little less than half the length of each chromosome is heterochromatic, and all chromosomes contribute almost equally to the chromocenter. Very different from these is *D. hydei*. In this species the X chromosome is V-shaped; one arm appears to be entirely hetero-

chromatic and the other has just a small heterochromatic region at the centromere. Apparently the autosomes have no heterochromatin or just a very small section near the centromere.

In *D. pseudoobscura*, the X chromosome also contains two arms which unite to form a V-shaped structure. One of these arms has a large amount of heterochromatin, but the other arm of the X chromosome and two autosomes have considerably less. The third autosome and the small autosome corresponding to chromosome IV of *D. melanogaster* are mostly euchromatic. A still different situation is found in *D. funebris*, which has a long rod-shaped X chromosome, about half of which is heterochromatic, and four pairs of rod-shaped autosomes which have very small regions of heterochromatin near the centromeres.

In *D. pallidipennis*, a recently discovered species from Brazil, Dobzhansky showed that all the heterochromatin is concentrated in the X and Y chromosomes except for a few interstitial sections in the autosomes. In this species, the X and Y chromosomes are enormous and consist chiefly of heterochromatin. The centromere ends of the autosome have little heterochromatin, if any, and all the autosomes are only occasionally connected with the chromocenter in the salivary gland nuclei. Frequently there is an association of two, three, or four of the autosomes by their bases, and one, two, three, or four autosomes may be in contact with the heterochromatin of the X chromosome by their bases. In the X chromosome there is no sharp boundary between the heterochromatin and the euchromatin, and many discs appear to be heterochromatic in some cells and of euchromatin in others.

Prochromosomes

In the resting nuclei of many organisms, a number of deeply staining bodies have been observed which frequently correspond to the number of chromosomes seen during mitosis. They appear to be segments of chromosomes that have remained condensed and must have a high nucleic acid content. Various terms have been applied to them, but those most commonly used are *prochromosomes* and *chromocentric* regions. They are probably heterochromatic regions of chromosomes. That they exist frequently in the same number as the chromosomes would indicate that each chromosome in many species has just one large hetero-

chromatic region, probably located around the centromere. Where the prochromosomes are more numerous than the metaphase chromosomes, the chromosomes undoubtedly have more than one large heterochromatic region. In the cold-treated plants of Paris and Trillium, a number of heterochromatic regions of various sizes are found in the metaphase chromosomes, and this number is in close agreement with the number of condensed chromocenters observed in the resting stage. When the number of chromocenters or prochromosomes is fewer than the number of chromosomes or of heterochromatic regions, it is undoubtedly because two or more of these regions have fused together in the resting cell.

Salivary Chromosome Bands

It is interesting to speculate on the possibility that each band in a salivary gland chromosome is a gene, but, unfortunately, the experimental evidence on this point is not yet so clear as is desirable. There are, however, several lines of evidence that point to the view that a band is a gene locus. For one thing, it has been shown that genes are found in greatest numbers in the deeply staining euchromatic regions of the salivary gland chromosomes, whereas very few are found in heterochromatic regions. Similarly, most of the bands are in these euchromatic regions and very few are located in regions predominantly heterochromatic. The frequent association of missing bands with changes in the phenotype of the affected fly also lends support to this view. A study of notch deficiencies caused by X-radiation indicates that there is a field or area of the chromosome which will produce a notch phenotype if a break is induced within it. The position in the chromosome of a number of such breaks within the area or field indicates that a certain band is approximately in the center of this field and provides additional evidence in support of the position that bands are associated with loci. If this association can be assumed as a working hypothesis, some notion of the maximum size of a gene can be obtained. Measurements show that these bands vary between $0.2\text{ m}\mu$ and $1\text{ m}\mu$ in thickness. If a band is a gene, or if it contains the gene, the gene must be no greater in width than the width of a band.

Mutations and Fluctuations

Strains that are apparently homozygous sometimes produce individuals different in appearance from the usual type. Often such individuals result from different environmental conditions. Differences, which are the direct result of changes in the environment, are called *fluctuations*. Environmental differences of this sort act only on the body, or soma, of the individual and do not affect the germ cells. They are therefore not inherited and are of no consequence in the study of genetics except to show that for comparable results all the individuals must have as nearly the same environment as possible.

Sometimes, however, the new types that appear may not be the result of any environmental influence and they may transmit their new characters to subsequent generations. Such nonenvironmental, heritable, suddenly appearing, new types

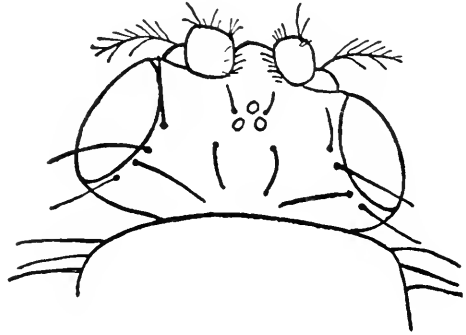

FIG. 70. The head of the white-eye type of *Drosophila melanogaster*. Contrast with Figs. 6, 7, and 65.

are *mutations* and are of great importance in the study of genetics. An example of such a new form is the white eye mutation of *Drosophila melanogaster*. In a stock of true-breeding red-eyed flies, a fly with white eyes (Fig. 70) suddenly appeared for no known reason. When this fly was mated to red-eyed flies, the white-eye character behaved as if it were determined by a recessive gene located in the X chromosome. This new type was *inherited* and was a *mutation*. Discovered by Morgan in 1910, it was the first sex-linked mutation that appeared in *Drosophila* cultures.

Types of Mutations

The possibility that new types may appear suddenly and without any traceable cause and that they may be inherited was suggested by de Vries in 1901 as the result of some observations on the evening primrose, *Oenothera Lamarckiana*. He showed that this plant occasionally but regularly produces new

mutations or "sports" (Fig. 71) and suggested that these new types are a greater factor in evolution than the small, gradual changes which Darwin had thought were so important. Since that time, mutations have been discovered in a great many plants and animals.

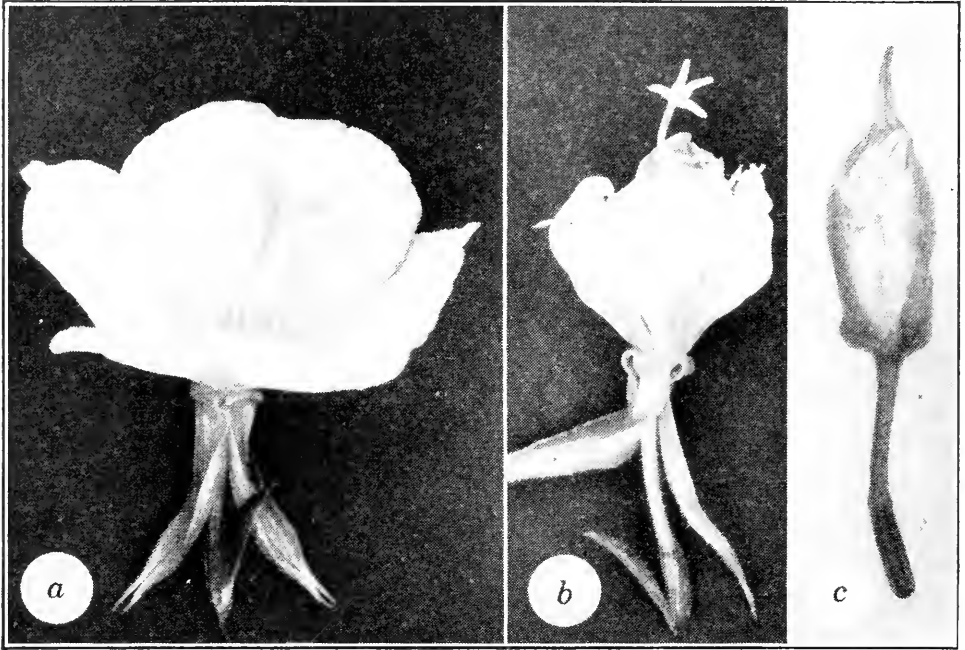

FIG. 71. Buds and flowers of the evening primrose. (a) Flower of *Oenothera Lamarckiana*. (b) Mutant *substella* of Shull; note the style and stigma above the small petals. (c) Mutant *confusa* of Shull; in this mutant the stigmas and stamens are massed together in such a way as to occupy completely the lumen of the bud cone at the stigmatic level forming a barrier to the elongation of the petals; the buds open broadly between two sepals, merely split between the others, and the petals never spread. These two mutants are new. (Courtesy of Dr. G. H. Shull.)

Many of the inherited new types that have appeared in various organisms were subsequently shown to be *recombinations* of previously known genes, such as the "outside-in" type of flower in the Evening Primrose which resulted from the combination of the recessive genes *supplena* (double flowers) (Fig. 72) and *brevistylis* (short style), never previously together in the same plant (Fig. 73). Other new inherited types have resulted from changes in the number of chromosomes or from rearrangements of, losses of, or duplications of chromosomal segments, and they have been classified as *anomozygous mutations*. Still other

newly appearing, inherited types are the result of actual changes in the genes themselves and are known as *gene mutations*.

Although these three types have all frequently been classed as mutations, since they all appear suddenly and are inherited, the word *mutation* has more recently been used largely in the



FIG. 72. A double-flowered *Oenothera*; mutant *supplena* of Shull, a homozygous recessive type. (Courtesy of Dr. G. H. Shull.)

restricted sense of *gene mutations*. Throughout this book, however, it is used for all inheritable changes unless preceded by a qualifying adjective.

Gene Mutations

A gene mutation is the result of a change in the structure of an individual gene. It is also known as a *point mutation*, since it involves a change at only one point or locus in the chromosomes of the organism.

Gene mutation is one of the most important if not the most important factor in the origin of new species. Other factors are also involved in speciation, but gene mutations provide the

new material on which these other factors can act. An accumulation of independent mutations has often resulted in an organism so distinct from its ancestors that it has been classed as a new species.

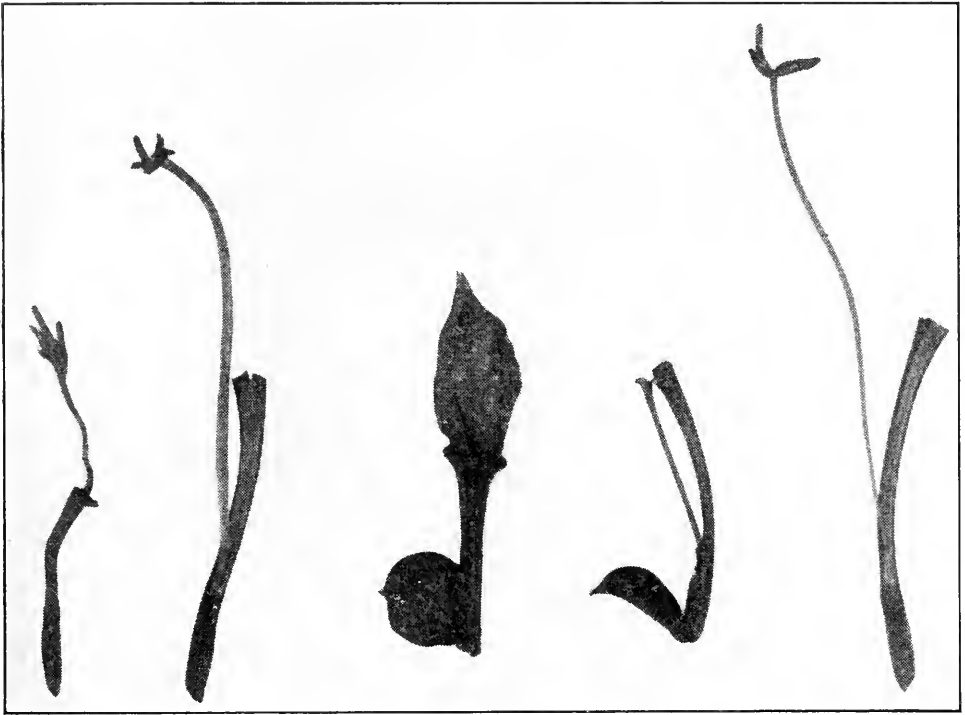

FIG. 73. Pistils of five types of *Oenothera*. *Right*, *Oe. Lamarckiana* of the genotype $SpSp BrBr$. *Next left*, *brevistylis*, homozygous recessive for the gene for short style, $SpSp brbr$. *Second from left*, *supplena*, homozygous recessive for the gene for double flowers, $spsp BrBr$. *Center*, "outside in," the double recessive $spsp brbr$. Genes sp and br are complementary for the outside-in type of flower, which type is not merely the summation of the effects produced by the two genes alone. In each of these illustrations the petals and sepals and the set of stamens have been removed, leaving only the gynoecium or its homologue. The big central bud in "outside in" is therefore the homologue of the functional style of *supplena* and *brevistylis*. *Left*, mutant *pollicata*, a homozygous recessive with a solid floral tube or hypanthium. (Courtesy of Dr. G. H. Shull.)

QUESTIONS AND PROBLEMS

1. Are there any chemical differences between euchromatin and heterochromatin? Can you suggest any methods to show whether genes are located exclusively in euchromatic or in heterochromatic regions?
2. Prepare to discuss viruses, bringing out what they are, what they do, and where they might be found. Discuss the possibility of obtain-

ing them in crystalline form and the philosophical implications of such a discovery. Has any possible relation between viruses and genes ever been suggested?

3. What effect did the theory of mutations have on the theory of evolution?

4. What would be the state of our knowledge of the transmission of genes if gene mutation had never occurred? Explain.

5. Does a newly appearing phenotype always indicate a point mutation? Explain.

Chapter 15

THE NATURE OF GENE MUTATIONS

It is difficult to state exactly how a gene mutation occurs until more is known of the structure and chemistry of the genes themselves. If genes can be pictured as molecules or as large chemical radicals that are attached to an undifferentiated thread, they are probably complex radicals with numerous side chains. One theory suggests that the mutation is the result of a rearrangement of some of the atoms of the molecule or radical which constitutes the gene. It is also possible, as has been suggested, that a part of a molecule might be lost. According to these views, the gene is a more or less distinct entity with its own complex structure and a mutation is merely a loss or rearrangement of intramolecular material. According to another theory the chromosome as a whole is to be regarded as the unit of heredity and the so-called gene mutations are merely rearrangements of segments of the chromosome. This rearrangement is discussed further in Chapter 17.

The kinds of changes that mutations may produce in the phenotype of an organism are countless. In both plants and animals, all parts of the organism may be affected, and each part may be affected in many different ways. Mutations are known which affect the shape, size, and color of almost every known organ of plants and animals, and some have been found which affect even such characteristics as the stability of another gene, the mutation rate of other genes, spindle formation at meiosis, viability of gametes, incompatibility of certain eggs and sperm, and other similar fundamental biological processes.

Finally, in many organisms, mutations have arisen which lead to the death of the individual by upsetting normal embryological development or by affecting certain fundamental organs or physiological processes.

Although some mutations produce rather large and striking effects, many mutations produce small effects, as was shown by

some extensive studies on *Drosophila* and on the snapdragon. It is probably true of most if not all organisms.

Harmful Nature of Mutations

Most gene mutations have been shown to be harmful to the organism to a greater or lesser extent when the mutant is compared with its wild type. Often it is true only because the mutant and the wild type are compared in an environment to which the wild type has become adjusted over the course of thousands of years. For example, flies with vestigial wings cannot compete successfully with their long-winged contemporaries in a normal environment because the "normal" environment frequently requires the fly to cover longer distances in search of food than the *vestigial* fly can negotiate. In situations where food is abundant, as in laboratory bottles, the ability to fly long distances is of no great advantage, and vestigials can compete on more equal terms. Often a mutation is "harmful" only because the wild type has evolved into such a balanced state of equilibrium with a particular environment that any deviation from this condition would tend to be in the direction of an unbalance.

In addition to mutations which put the organism at a disadvantage in competition, there are many that have a more or less harmful effect on the viability of the organism. Dobzhansky has pointed out, however, that although most mutations that have appeared in *Drosophila* cultures decrease the viability of the fly under the usual conditions in which the flies are raised, mutations in *Drosophila* and in other organisms show a range from lethals at the one extreme through less harmful and neutral mutations to mutations at the other extreme which actually are favorable to viability.

Whether a gene is actually harmful depends in part upon the other genes present in the organism and in part upon the environment. Morgan and Tice showed that if a fly was segregating into wild types and recessives, the recessive types would often appear in fewer numbers than expected when large numbers of flies were raised from mass cultures in the same bottle. However, if only one female parent was placed in a large culture bottle and the amount and quality of the food were adjusted to optimum conditions, the mutant type would usually appear in

the expected percentage. That the environment is a factor in the viability of a mutant was also shown by Timofeeff-Ressovsky, who found that certain mutants would be much less viable than the wild type at certain temperatures but would be as viable and sometimes more viable at other temperatures. He showed also that not only is the environment important but the other genes as well. For example, at 24 to 25° centigrade, *miniature* flies are only 69 per cent as viable as the wild type whereas the *bobbed* mutants are 85 per cent as viable; flies that are both *miniature* and *bobbed*, however, are 97 per cent as viable as the wild type or more viable than either mutant type alone.

Sterility

Some mutations tend to make one or both sexes sterile. In *Drosophila melanogaster*, the gene *rudimentary* produces a wing abnormality and also affects egg development so that the females are highly sterile, only occasionally producing any eggs at all in the ovary. Similarly the genes *fused* and *morula* produce sterility in the female in addition to affecting the wing veins and the facets of the eye.

Recessive Nature of Mutations

In Table 4 is a list of some of the genes that have been discovered in *Drosophila melanogaster*, arranged according to the four chromosomes on which they are located. Following each gene is its symbol. All these genes have arisen as mutations from the wild-type fly and almost all are believed to be gene mutations although a few, including bar eye and hairy wing, are the result of the reduplication of a very small segment of a chromosome. If the symbol of a mutant gene begins with a lower-case letter, the mutant is recessive to the wild type; but if it begins with a capital letter, the mutant is dominant. A glance over the list shows that most of the mutant genes are recessive to the wild type. A far greater number of recessive than dominant mutants have been discovered in *Drosophila melanogaster*, and they also have been observed in other species of fruit fly and in a number of other animals. In organisms in which there is no definite wild type, as in many plants, most of the mutants that have been discovered are recessive to the

type from which they arose. To sum up, then, most mutants are recessive to the original stock.

Mutation and the Life Cycle

A gene mutation may occur at any stage of the life cycle of a plant or an animal, and therefore in sporophytic or gametophytic and in somatic or germinal tissue. Unless and until the mutation is followed by a further mutation or by a reverse mutation of the same gene, all the cells derived from the cell in which the mutation occurred will contain the mutant gene.

If a gene mutation occurred in only one gamete, that gamete and the individual which resulted from it after fertilization would have the mutant gene. If the new gene affected somatic tissue and was a dominant mutation, the new character would be noted immediately in the individual produced by the mutated gamete. If the mutation was recessive, it would be hidden unless it was in the sex chromosome of the heterogametic sex.

If the nonlethal mutation occurred in one member of a pair of homologous chromosomes before meiosis or before the "chromosome split" took place, half the gametes or half the megaspores or microspores from the meiocytes in which the mutation occurred would bear the mutated gene. In plants it would be carried through the gametophyte and gametes to the new sporophyte. If it was a gene that exerted an effect on the gametophyte, it would be detected immediately whether it was a dominant or a recessive mutation since the gametophyte is haploid. If the character produced by the mutant was a character that was visible in the sporophyte only, it would not show up in the gametophyte and would appear in the sporophyte only if it was dominant. If the mutation was recessive, it would be hidden in the sporophyte, but would appear in the next sporophyte generation in about one-quarter of the offspring of that plant, provided the plant was self-fertilized. It is frequently difficult to say just when or in what particular individual a mutation occurred if it was recessive and affected only the diploid stage of the life cycle, and if the plant or animal was one that was normally cross-fertilized. Such mutations might remain hidden for several generations.

Mutations may occur in somatic tissue at any stage and in any part of the developing organism. If a mutation occurred in

the zygote, the whole animal or plant sporophyte would have the mutant gene and would show that mutant character if it was a dominant mutation. If, however, the mutation occurred in one of the two cells that result from the first division of the zygote, only half the organism would have the new gene. If the mutation occurred late in somatic development, only those cells derived by division from the mutant cell would have the mutant gene; one or more patches of mutant tissue would be found in the body of the individual, if it was a dominant mutation or if it was a mutation in the X chromosome or Z chromosome of the heterogametic sex. The number of patches would depend upon the number of cells of the immature organism in which the mutation occurred and the size of the patches would depend upon the stage of development of the individual in which the mutation arose.

Although mutations have been observed at various stages of development, they seem to occur with greater frequency at some times than at others. The time of greatest frequency is just before or during meiosis, apparently in both plants and animals. Evidence is based on the fact that dominant mutations and mutations that occur in the X or Z chromosomes (that is, mutations that can be detected in the immediate offspring) appear generally in only one individual. If the mutation had occurred early in germinal tissue, a much larger number of mutated gametes and therefore of mutant phenotypes would be expected.

Bud Mutations

One class of somatic mutations in plants is of considerable importance from an agricultural and horticultural point of view. This type, known as a *bud mutation* or *bud sport*, occurs in the meristematic tissue of a bud. If the mutation occurs in the earliest stages of bud development, all or practically all the cells of the bud will be mutant in nature; and when the bud develops into a shoot, all the cells of the shoot will be of the mutant type. If the mutation occurs later in development, only some of the cells will be mutant. The bud will therefore be part mutant and part nonmutant, and the shoot which arises from such a bud will likewise be made up of two kinds of tissue, mutant and nonmutant. A shoot which is thus a mixture of two or more genotypically different tissues is a *chimera*.

Somatic mutations, whether they are bud sports in which the whole bud is mutant tissue or are chimeras, are produced by the same causes that produce mutations in general. A small percentage may be the result of recombination resulting from somatic crossing over (fruit flies with small patches of yellow and singed tissue in an otherwise normal body are a form of chimera); a very large number may arise from chromosomal aberrations of various kinds; many are due to gene mutations.

Somatic mutations in animals are lost with the death of the individual in which they occur, but bud mutations in many plants may be preserved indefinitely by means of vegetative reproduction and sometimes by seeds produced by the mutated branch. An excellent example is the bud mutation of the peach which produces the smooth-skin type known as the nectarine. The nectarine behaves as a recessive when crossed with the peach; but peach trees occasionally produce nectarine bud sports, and occasional bud mutations on a nectarine tree result in branches which bear peaches.

In some plants, propagation is carried out chiefly by budding or grafting. In such plants, bud sports are propagated by inserting buds from the mutated branch into other trees which are used as a stock. Bud mutations from the Washington navel orange are perpetuated in this way. A variety that often arises as a bud mutation is the Thomson strain, but these trees frequently produce one or more fruits of the Washington strain, showing that bud mutations in these varieties are produced in both directions.

The occurrence of the same somatic mutation at various stages in the development of a bud or shoot is also illustrated by the navel orange. If the mutation occurs early in the development of the bud, the whole limb will be of a mutant nature and will bear the mutant type of fruit. If, however, the mutation occurs in the cells that produce merely a single fruit, just one fruit on the limb will be of the mutant type.

Frequency of Gene Mutations

The problem of the frequency of gene mutations is not an easy one to solve. With wild populations it is complicated by natural selection, for harmful mutations would tend to be eliminated in competition with the nonmutant, better-adapted genes.

In laboratory stocks, natural selection is not an important factor; but there are certain technical problems that present difficulties when we try to follow the mutation rate of any specific gene. The evidence from mutations in some organisms shows that perhaps the most frequent mutations are those that produce only slight effects. Such small mutations are extremely difficult to detect in wild populations, and even in controlled cultures they make a complete analysis almost impossible. As genes are ordinarily very stable, a determination of the mutation rate of most genes would begin to be accurate only when very large numbers of individuals were raised and examined. Although populations of necessary size would be possible in *Drosophila*, they would ordinarily be impractical, and they would be almost out of the question for plants and for most animals. In spite of the difficulties, a surprisingly large amount of data has been obtained both from wild populations of *Drosophila* in parts of Russia and for lethal mutations in the X chromosome of laboratory stocks of *Drosophila melanogaster*.

The data that have been collected show that most genes are very stable, but that gene mutation cannot be considered to be a rare event. The actual mutation rate of a gene depends (1) on the particular gene in question, (2) on the species, (3) on the environment in which the organism is living, and (4) on the entire genetic constitution of the organism.

Some genes are exceedingly stable; others mutate frequently. A genetic locus cannot be identified unless at least two alleles at that locus are observed. Since estimates of the number of loci in various organisms indicate that most loci have never been discovered, the inference is that most genes are so stable that they do not mutate at all or that they mutate so infrequently that the few mutants never chanced to be found. From this extreme case, various mutation rates can be found. Stadler showed that in maize this difference may range from the condition at the waxy locus where no mutations were observed in one and a half million tested gametes to the locus of the gene for colored aleurone and plant, *R*, which mutated at a rate of 492 per million tested gametes. Various intermediates were found. At the other extreme from the very stable genes are a number of genes which mutate so frequently that they are known as *mutable genes* or *unstable genes*.

Mutable Genes

In 1914, Emerson suggested that some genes might not be completely stable. He studied a variegated variety of maize that had a white pericarp with numerous red spots of varying size. Genetically, these plants were homozygous for the recessive gene for white. Emerson considered that this gene must be unstable, that it can mutate spontaneously into the dominant allele for red, and that each red spot on the kernel is made up of cells which came from one cell in which such a mutation arose. This was a very revolutionary idea at that time. More recently, Jones has found other spotted kernels in maize which he believes are caused by somatic gene mutations of a similar nature. In Jones's material, six colored spots that were found on otherwise colorless seeds were composed of six to forty-three colored aleurone cells. These cells were similar in size, shape, and color to the aleurone cells of a colored variety of the genotype *A C R Pr*, although the particular strain was homozygous for *c*. The suggestion was made that gene *c* has mutated to *C* upon these six occasions and that each colored spot represents one somatic mutation from the recessive to the dominant allele.

Since Emerson's discovery of mutable genes, several others have been found, the best known of which are the rose- and purple-variegated races of *Delphinium* and the miniature character of *Drosophila virilis*. The rose-variegated race is homozygous for the recessive gene, rose-a.* Flowers of this race are rose-colored but flecked with numerous dots and small spots of purple. The rose color is the expression of the homozygous rose-a gene, but each spot of purple is the result of a mutation of one of the rose-a genes to its dominant allele for purple. When a gene mutates to purple in a cell, that cell and all the others which come from it by cell division will be purple, for apparently the gene does not mutate back to rose-a. If a mutation occurs just at the last cell division, the purple spot will include only one cell. If it takes place at the division before the last, the spot

* Mutant alleles were originally designated by the name of the mutant followed by a Greek letter, as miniature-alpha, miniature-beta, and miniature-gamma. Because of the inconvenience in typewriting manuscripts and the added expense of printing that the use of the Greek alphabet entails, the Greek letters have recently been replaced by Roman letters, as miniature-a, miniature-b, and miniature-c.

will be formed from two cells. In other words, the earlier the mutation occurs in the development of a flower, the larger the purple patch. Therefore, the time at which the mutation occurred can be determined fairly accurately from the size of the mutated area.

All these mutations are somatic mutations in cells of the flower, but Demerec has found evidence that this same gene mutates in germ cells as well. When a rose-a plant was self-fertilized, most of the offspring had typical rose-a variegated flowers. Some, however, had solid purple flowers, and a small percentage had large purple sectors or chimeras in an otherwise normal rose-variegated flower. The purple-flowered plants are believed to have arisen as the result of gene mutations in the formation of germ cells. If one rose-a gene mutated to purple at that stage, one germ cell would have the dominant gene for purple and a plant which arose from it would have purple flowers. Plants with large purple chimeras in the flowers are believed to have resulted from somatic mutations very early in the development of the flower. In the sepals of normal rose-variegated plants, the rate of mutability of the rose-a gene was practically the same during the last twelve cell generations in the development of the flower. In gametogenesis, the rate was found to be 267 per million cells, a value close to that for the rate of mutability in the sepals. It is interesting to note that this rose-a strain originated from a plant which was heterozygous for rose-a and lilac. Since all the subsequent plants came from this one, all were the descendants of one rose-a gene.

Another gene that is unstable in *Delphinium ajacis* is the lavender-a (or lavender-alpha) gene. Lavender-variegated flowers have numerous small spots of purple on a lavender background. These spots are the result of many somatic mutations of the lavender-a gene to the dominant allele for purple in plants homozygous for that recessive gene. That all the dots are small and of approximately the same size indicates that this gene has a high rate of mutability towards the end of the development of the sepals and petals. Differing from rose-a, lavender-a flowers have no large or intermediate-sized spots or streaks. This absence of any purple spots other than small dots indicates that the gene is stable or that it mutates at only a very low rate during all but the last stages of development of the flower. Like

the rose-a gene, this gene can also mutate to the dominant allele during the formation of germ cells. Lavender-variegated plants have been found with very large purple sectors sometimes amounting, apparently, to half the plant. Such chimeras represent gene mutations during very early embryonic development of the plant. Mutations at those stages are frequent in the lavender line but are rare in the rose strains. The lavender gene changes with high frequency very early and very late in ontogeny and is constant or mutates with a very low frequency at other stages. The rose-a gene appears to mutate at a virtually uniform rate throughout the whole life cycle.

In *Drosophila virilis*, the recessive gene, miniature-3 produces miniature-winged flies. As this gene is unstable, however, flies with wild-type patches on an otherwise miniature wing have been observed, and each patch indicates a somatic mutation from the recessive to the dominant condition. Some flies from miniature-3 parents have completely wild-type wings. In such flies, the mutation from recessive to dominant occurred in the formation of germ cells instead of in somatic tissue.

Most of the mutations which occur in unstable genes are from the recessive to the dominant and almost always are from the mutant type to the wild type. Sometimes, however, the mutation is not to the dominant but to a third allele, which is also unstable. This condition is well illustrated by considering all the recessive alleles at the miniature locus in *Drosophila virilis*. There are five alleles at this locus other than the wild-type alleles, and each produces a miniature wing of a different size. Miniature-1, miniature-2, and miniature-4 are normal, stable genes, mutating very infrequently, whereas miniature-3 and miniature-5 are unstable. Furthermore, each of these two unstable genes exists in three forms. In each gene, the phenotypic expression is the same, but the degree of stability is different. The "alpha" or "a" form of each gene is unstable in both germinal and somatic tissue; the "gamma" or "c" form is unstable in somatic tissue; and the "beta" or "b" form does not revert to the wild type in either kind of tissue. In these forms, mutations occur not only to the wild-type allele but also to one of the other forms of the same allele. This series suggests, as Demerec has pointed out, that each allele at the miniature locus

differs from the others by a different structural component of the gene molecule and that the different forms of the same allele merely vary slightly within the same component.

That some genes mutate relatively frequently and are called "unstable" should not be interpreted to mean that frequent mutability is a hit-or-miss proposition and that genes may suddenly indulge in a wild orgy of mutation at any time. Such is far from the truth. We have pointed out that the "alpha," "beta," and "gamma" forms mutate at certain stages of the life cycle only. A great regularity in mutation rate is observed at certain stages when the rose-a and lavender-a genes are studied, and the reddish-a gene in *Drosophila virilis* is found to mutate only at meiosis in heterozygotes. Such regular behavior indicates that mutation in mutable genes is a well-ordered process. Mutable genes appear to become unstable only when a certain stage in the development of an organism is attained, and the precise stage appears to vary with different mutable genes.

Different Mutation Rates in Different Species

The rate of gene mutation in one species is not necessarily the same as in another. Baur has indicated that it is about 10 per cent in the snapdragon but that most of these mutations produce only very small changes. In *Drosophila*, Schultz found that the mutation rate of sex-linked lethals was 0.18 per cent, whereas Spencer found the rate of visible mutations to be about 0.005 per cent. In maize cultures, a large number of mutant genes has been discovered. The rate varies considerably for individual genes, and some mutations have turned up again and again. In the evening primrose, on the other hand, although the investigations have been extensive, only a few gene mutations have appeared and no gene mutation has appeared twice except the *funi-folia* mutant which arose once in Cobb and Bartlett's cultures of *Oenothera pratincola* and once in Shull's strains of *Oe. Lamarckiana*.

Mutation and Environment

The mutation rate of different genes may be greatly affected by environmental conditions. Muller, for example, found fewer lethal mutations at low temperatures than at high, and the

tremendously increased rate when plants and animals are subjected to radium, X-rays, ultraviolet light, and high temperatures has been demonstrated on many occasions. This subject is discussed more fully in the next chapter.

Effect of Other Genes on Mutability

Rhoades has reported an interesting case of a stable gene that becomes unstable in the presence of a nonallelic gene. In maize, plants which have the genes *B* and *Pl* are purple if *A* is present but are brown if homozygous for *a*. If the gene *Dt* is present in *aa* plants, the *a* gene undergoes frequent mutations to *A* in somatic cells throughout the plant, producing plants having husks and culms which are brown with longitudinal purple stripes. The stripes are small, indicating that the mutations occur late in somatic development. The gene *a* is an unstable gene in the presence of *Dt* but not in homozygous *dt dt* plants, for such plants never have the purple stripes. This frequent mutation occurs not only in vegetative parts of the plant but also in the aleurone layer of the fruit. Since this layer is part of the endosperm tissue, each gene is present in three doses instead of two. At the *a* locus is another allele *a^p* producing a pale color. Plants which are *a^pa^pa* and also have the gene *Dt* have only a third as many dots in the aleurone as *aaa* plants which have *Dt*. This shows that *Dt* affects only the *a* allele and that a greater number of *a* genes increases somatic mutations.

Demerec found a similar gene in *Drosophila melanogaster*. In studying the rate of spontaneous mutation of flies collected from fifteen different localities all over the world, he found that the frequency of spontaneous lethal mutations in the X chromosome was much higher in a strain from Florida than in the others. A genetic analysis showed that this higher rate resulted from the presence of a recessive gene in the second chromosome. This gene produces not only a high frequency of lethal mutations but also an increase in the rate of visible mutations in a number of other genes.

QUESTIONS AND PROBLEMS

1. In a plant, would a recessive gene mutation be detected more easily if it affected the gametophyte or if it affected the sporophyte? Is the same true of a dominant mutation?

2. If you had two fruit trees that were identical except that in one bud sports appeared rather frequently, which would you select as the better for propagating nursery stock? Why?

3. If it could be proved that somatic mutations were inherited, would we have to revise our concepts of heredity and evolution?

4. Two fruit trees are of the same variety, but one is grown in poor soil and the other is grown under very favorable conditions. The second produces a better yield, but when bud grafts are made from both trees, those of the first produce better yields. Explain.

Chapter 16

THE INDUCTION OF GENE MUTATIONS

In the last chapter it was pointed out that gene mutation may be greatly influenced by the environment in which an organism lives. It is natural, then, that geneticists should look for environmental conditions by means of which they can artificially induce the mutation of genes.

Attempts to induce mutations were begun rather early in the history of genetics. Frequently the results were negative, and the few times there was an indication of positive results, the results were not clear. When there was an indication of positive results mutations sometimes appeared in the controls as well as in the treated material, and sometimes repetitions of the experiment did not substantiate earlier claims. Environmental conditions which were tried included variations in the amount of food, unusual conditions of temperature, moisture, and light, and the subjection of organisms to radium rays and X-rays. In this early period, although most of the work was unsuccessful, Morgan succeeded in obtaining some wing mutations in *Drosophila* by treatment with radium.

The years 1927 and 1928 mark the beginning of the extensive work on the induction of gene mutations by radiation. During those years, Muller published the results of some X-ray studies in *Drosophila* for which he was awarded the Nobel prize in 1946. Stadler demonstrated the effect of X-rays in producing mutations in plants, and Gager and Blakeslee recorded two mutations induced in the plant, *Datura Stramonium*, by gamma rays from "radium emanation," in addition to a number of chromosomal aberrations. Since that time, extensive work on the induction of mutations by radiation has been carried on in a great many organisms. Muller's publication in 1927 can be regarded as ushering in the radiation program, for it preceded Stadler's by almost a year, and Gager and Blakeslee's studies were concerned more with chromosomal aberrations than with

gene mutations. Muller's studies surpassed the previous work by developing special techniques that eliminated the questionable elements of the earlier investigations.

X-rays and Radium

X-rays and radium are the most effective means of inducing gene mutations in animals and plants. Figure 74 illustrates a

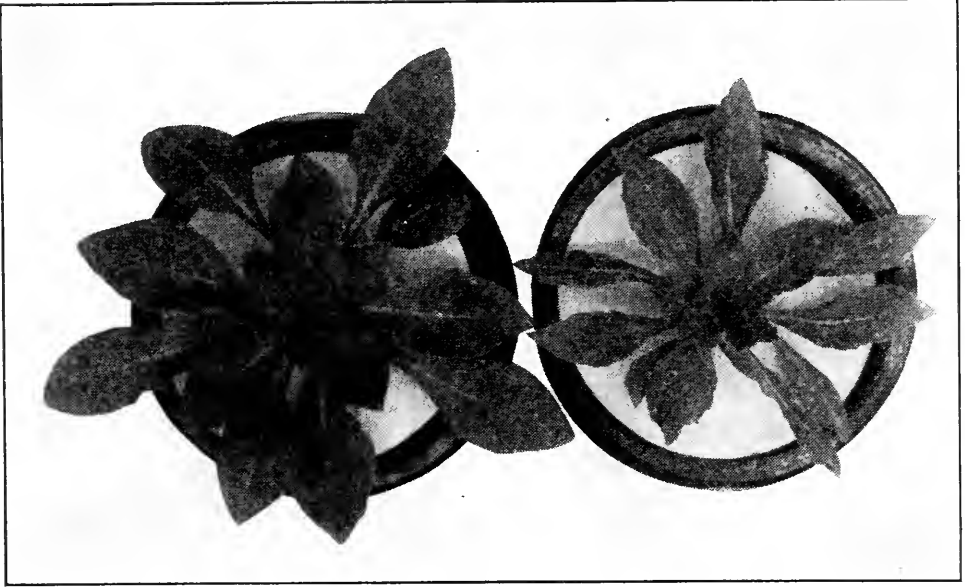

FIG. 74. A gene mutation in *Oenothera* induced by radon. A rosette (right) of mutant *pannosa* of Dr. W. H. Brittingham and one of *Oenothera Lamarckiana* (left) not exposed to radium emanation. (Courtesy of Dr. G. H. Shull.)

leaf mutation in *Oenothera* induced in Brittingham's cultures by radon. The organism is placed near the window of an X-ray tube, or small tubes containing "radium emanation" are placed alongside the tissue to be treated. The time of exposure has varied in the different experiments and, to be effective, differs with the organism to be studied.

The relation between X-ray dosage and the production of mutations is considered by many geneticists to be very simple. Studies of this nature have largely been carried out by noting the number of lethal mutations produced in *Drosophila melanogaster* after subjecting the flies to different amounts of X-rays or to the same amount over different periods of time. Other

organisms have also been used and nonlethal as well as lethal mutations have been studied, but the technique which employs the study of lethals in *Drosophila* is far simpler and the results generally appear to be more reliable. There is no reason to suppose, however, that the simple relationship which was found is unique for *Drosophila* or for lethal mutations.

It is customary to measure the intensity of radiation by a unit known as the Roentgen unit or r-unit. Without attempting to explain the nature of X-rays, we can say that an organism can be subjected to the same number of r-units by exposing it to an intense radiation for a short time or by exposing it for a longer period to a radiation of less intensity. In other words, the number of r-units may be varied by varying either the strength of the radiation, the time of exposure, or both. Studies using different amounts of r-units indicate that the relationship between dosage and percentage of induced lethal mutations is probably linear. That is, a certain increase in the amount of r-units will always produce a certain increase in the percentage of lethal mutations. Experimental data show that although this statement is apparently true for low dosages, there is a falling off in the number of mutations detected with higher dosages. This falling off is often interpreted as the result of a defect in the technique used for the detection of lethal mutations, and it is very likely that the linear relationship holds throughout the range of dosages. An interesting feature of these studies is that the extent of lethal mutation will be the same for a certain dosage whether that dosage is the result of a certain intensity of radiation applied continuously or intermittently.

Visible Mutations

In general, mutations produced by X-rays or radium are not different from those that occur spontaneously. Many of the mutant types that have appeared spontaneously have reappeared in radiated organisms, and both "visible" and lethal mutations have occurred in radiated and nonradiated material. Reverse mutations have occurred after treatment with X-rays or radium and are similar to reverse mutations that have occurred spontaneously. The chief difference is that under radiation, many more mutations will take place in a given unit of time than under normal conditions. For example, in the X chromosome of

Drosophila melanogaster an average of two lethal mutations occurs in every thousand chromosomes per generation, and a dosage of 4800 Roentgen units will increase this rate about seventy times.

Although it would be far beyond the scope of this book to catalogue all the visible mutations that have been induced by X-rays or radium, a few examples will give the student some conception of the kinds of phenotypes that result from irradiation. In *Drosophila melanogaster*, mutations have been produced at a number of loci. For example, X-rays have caused the gene w^+ to mutate to some of the other alleles at that locus, such as w (white), w^e (eosin), and w^a (apricot). Similarly, w^{co} (coral), w^b (buff), w^c (cherry), w^a (apricot), w^e (eosin), and w^t (tinge) have mutated to white and occasionally to some of the other members of the series. All such mutations cannot be interpreted as losses in the sense that the mutation is always to a lower member in the series, for *white* has been known to mutate to some of the higher members such as *eosin*, and *eosin* has mutated to the dominant of the series, the wild type. It should be noted that these mutations are similar to spontaneous ones at the same locus.

Whiting and his students have carried out extensive X-ray experiments on the parasitic wasp, *Habrobracon*, and have listed twenty-two mutant types which have resulted from irradiation and are visible as phenotypic characters. These mutations include such abnormalities as pale, opaque, greenish-yellow body and head color, flattened and curved hind feet, wings which fail to fold over the body, wrinkled wings, black body color, dark red compound eyes, drooping antennae, and small eyes (Fig. 75). The procedure in these experiments was to X-ray mated females and test the offspring by breeding experiments. Since the males develop from unfertilized eggs and therefore have only one set of chromosomes, any mutations that should occur in the unfertilized eggs would be detected immediately in the male offspring. If a mutation was produced in either the egg or sperm nucleus of the fertilized egg, the resulting daughter would be heterozygous for the mutant gene. If the mutation was dominant, it would immediately be detectable, but if recessive it could be discovered only by subsequent breeding tests.

Interesting visible mutations have also been produced in a large number of plants, only a few of which can be mentioned here. In Stadler's work on barley he observed a very large number of seedling mutations. Although these mutations affected many parts of the plant and influenced such fundamental properties as the manner in which the stem grows, many of them were chlorophyll characters, producing the same types of chlorophyll deficiencies that have occurred spontaneously. Similar



FIG. 75. Lemon lethal, an X-ray induced mutation in *Habrobracon*. (Courtesy of Dr. A. R. Whiting.)

studies have been carried out by Gustafsson, who identified about six hundred chlorophyll deficiencies, most of which he could group into one of five types. These types are not clear-cut but include albinos and plants which are yellow, greenish, or striped. In addition to these defects in the chlorophyll apparatus, Gustafsson has obtained a number of other changes affecting the morphology or physiology of the plant. They include such characters as the *erectoid* types, which have more compact, erect heads with shorter and stiffer straw, types which flower considerably later than normal plants, plants with larger kernels, and types with brownish or with yellow instead of yellow-green kernels. Gustafsson and Åberg found a very interesting X-ray mutation in Golden barley. In this cultivated variety the glumes are linear and have short awns. In the mutant type, the outer glumes are identical in size and shape with

the lemmas, and each has a long awn of the same length as those on the lemmas. This mutation is of interest from the morphological relationships and also because no cultivated species or variety of barley known in either Europe or America has outer glumes similar in appearance to the lemmas.

Detection of Visible Mutations

Several different methods have been used in applying X-rays or radium for the production of mutations. In plants, dormant seeds, sprouting seeds, flower buds, and pollen have been treated; experimenters on animals have irradiated sperm, unfertilized eggs, and fertilized eggs. Somatic tissues have sometimes been treated, but they, of course, would not produce inherited mutations in animals.

If a visible, nonlethal mutation is produced, it will usually be detected more readily if it is a mutation to a dominant form than if it is a recessive mutation. If seeds are irradiated, and a certain recessive gene mutates to its dominant allele, this mutation will be detected at once, provided that it is a gene that affects the sporophyte. On the other hand, a similar mutation of a dominant gene to the recessive allele will not be detected until the plant is self-fertilized and the next generation is raised; and if the plant is dioecious, or self-sterile, the recessive mutation may not be detected for several generations. In animals the problem is also a difficult one, since most of the animals that have been studied cannot be self-fertilized, and, as most of the mutations that have been produced are recessive, the detection of mutations may often be difficult.

Many mutant types are strikingly different from and are easy to distinguish from the nonmutant organism, but perhaps many differ only slightly. Although these "slight" mutations can sometimes be detected, especially in lethals, it is the opinion of some geneticists that a large number are never observed and recorded.

In one peculiar strain of *Drosophila melanogaster*, known as the "attached-X" strain, a very favorable situation is present for the detection of recessive visible mutations which may be produced in the X chromosome. In the attached-X stock, two X chromosomes are attached to one another at the ends nearest the centromeres. Because of this attachment, the two chromosomes must always go to the same pole during meiosis. At-

tached-X females have the two attached X chromosomes and a Y chromosome. They are females because of the two X's. When such a female is crossed with a normal male, four types of individuals are theoretically possible. If the two attached-X's unite with the Y chromosome from the male, an attached-X female is produced; and if the Y chromosome from the attached-X female parent unites with the X chromosome of the male parent, a normal male is produced. When, however, the two attached X chromosomes unite with the X chromosome from the male, an individual is produced which has three X chromosomes. It is known as a "superfemale," but it frequently dies at a very early stage of development and is never fertile. The fourth theoretical type results from the union of the Y chromosome of the attached-X female with the Y chromosome of the male. These individuals possess no X chromosomes and therefore do not have one complete genome; they die at an early stage. Therefore, a cross between an attached-X female and a normal male results in an attached-X female and a normal male plus sterile and inviable types. The interesting feature of this cross is that the normal male offspring receive their X chromosome from their *male* parent instead of from their female parent as is usual.

In this method, stocks are prepared in which known recessive genes are present. The recessives are different in the attached-X female stock from those in the normal male stock, and, in this way, the actual parentage of the individual X chromosomes is known. The normal males used as the male parents are irradiated and are then mated to females from the attached-X stock. If a visible mutation was produced in the X chromosome of the male parent, it would appear in the male offspring of a cross between that male parent and an attached-X female because the male offspring have all received their X chromosome from their father and their Y chromosome from their mother. If normal female stocks were used, a recessive mutation produced in the X chromosome of the male parent would become lost in the next generation because this X chromosome would be transmitted to the female offspring and the recessive mutation would be "covered up" by the dominant allele in the other X chromosome. The attached-X stock is therefore a very useful tool for detecting these recessive mutations that have a visible effect on the phenotype.

Lethal Mutations

That genes can result in the early death of an individual was mentioned in Chapter 3. Lethal mutations can be induced by irradiation, and they act in the same manner as do those that arise spontaneously. As a matter of fact, about 80 per cent of the mutations induced by irradiation are lethals. Probably a large percentage of the lethal mutations are really chromosomal deficiencies rather than true gene mutations, and some may be due to other chromosomal aberrations such as translocations and inversions.

If treatment with X-rays or radium induces a dominant lethal mutation, the effect is immediate. If such a mutation should be produced in one of the chromosomes of the egg or of the sperm, either that gamete would die or, if it were capable of functioning, the individual formed as the result of its union with a normal gamete would die in a very early stage of development. On the other hand, a recessive lethal mutation will have no lethal effect unless it is homozygous. If irradiation induces the production of a recessive lethal mutation in a sperm, and if that sperm then fertilizes an egg, the resulting individual will survive because there is no lethal at the same locus of the homologous chromosome which was received from the egg. The lethal from the sperm in a sense is "covered up" by the nonlethal allele in the homologous chromosome. If a heterozygous individual is self-fertilized, or if two heterozygotes bearing a lethal at the *same* locus are mated, a fourth of the offspring will be homozygous for this lethal and will fail to reach maturity. The effect of a recessive lethal, therefore, will not be so immediate in expression as the effect of a dominant. One exception may be made to this statement. A recessive lethal induced in one of the sex chromosomes of the female will be immediately apparent in the male offspring. Most of the induced lethal mutations that have survived and been detected have been recessives.

Often induced lethal mutations are not gene mutations but are losses of small chromosomal segments, known as deficiencies. Sometimes the deficiencies may be large enough to be detected by examining or measuring somatic chromosomes, but usually they are too small to be observed by such means. In *Drosophila*, many of these smaller deficiencies may be detected by the loss

of a band or of a few bands in the salivary gland chromosomes even though ordinary somatic chromosomes would not reveal such a small loss of chromatin material. Many lethals, however, cannot be detected cytologically even in such favorable material as the giant chromosomes of the salivary glands. The question then arises whether these lethals are true gene mutations or whether they are chromosomal deficiencies that are too small to be detected by present cytological methods.

Probably some lethals are true gene mutations. Gene mutations may be induced which produce a visible effect; by analogy, some of the lethals for which there is no known cytological cause may be actual gene mutations. An attempt to correlate the number of induced dominant lethals with the number of induced chromosome aberrations shows that a dosage of 1000 roentgens will produce a much larger percentage of lethals than of cytologically detectable changes in the chromosomes. That all lethal mutations are not structural changes is indicated by the temperature studies of Plough and others who found that the mutation rate of fruit flies could be increased by raising the larvae at temperatures higher than normal. Sometimes lethal mutations revert to the nonlethal condition, indicating that these lethals are gene mutations, for it is difficult to visualize how a deficient segment of a chromosome can reappear.

Detection of Induced Lethals

Much of our information on the frequency with which lethal mutations are induced by radiation comes from studies on *Drosophila melanogaster*. For detecting the presence of a new lethal in the X chromosome of that fruit fly, a very clever technique has been devised which is very simple to use and by which results may be obtained in large numbers. It is known as the *ClB* method (Fig. 76).

To estimate the frequency with which induced lethal mutations are produced in the X chromosome, male flies are exposed to radiation of known kind and intensity and are then mated with nonradiated females. If a lethal is induced in the X chromosome of the male it will not be detected in the female offspring because it will be "covered up" by the nonlethal in the X chromosome received from the female parent; but when these female offspring are subsequently mated to normal males, the

mutation will appear in the next generation and will be manifested as a deficiency in the male population. The treated X chromosome of the male passes into a female and subsequently again into males. These males have no X chromosome other than the one from the treated male; therefore, a lethal mutation in that X chromosome results in the early death of these males.

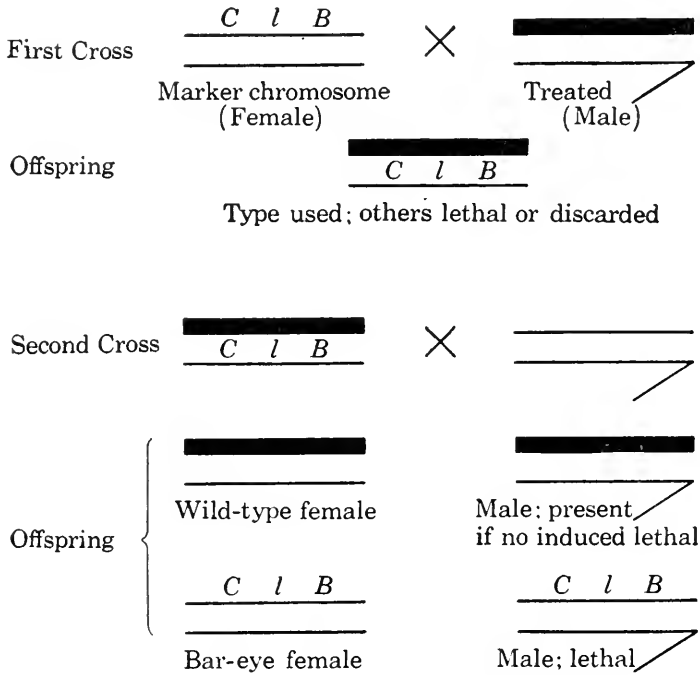

FIG. 76. The *Clb* method of detecting X-ray induced mutations in the X chromosome of *Drosophila melanogaster*. (Based upon the work of Dr. H. J. Muller.)

In actual practice, the female first mated to the irradiated male is of a special stock. It contains one X chromosome which has a lethal gene, *l*, the dominant gene, *B*, for bar eye, and an inversion of a segment of the chromosome which is usually designated by the symbol *C*. When these flies are mated, a fourth of the offspring will have one treated X chromosome and one *ClB* X chromosome and will be females. One fourth will be male but will have a *ClB* X chromosome and will die because of the lethal. The other half of the offspring will not contain the *ClB* chromosome and will not be used for further study. The *ClB* females with the treated X chromosome will then be mated with a normal male. In a normal female, crossing over takes

place between the two X chromosomes, and the induced lethal might be transferred from the treated chromosome to the non-treated X chromosome. The *ClB* chromosomes are used because the crossover suppressor (gene *C* or an inverted chromosomal segment) prevents such a substitution of a nonlethal for the new lethal mutation in the treated chromosome. The bar gene has no effect but it enables the observer to identify the flies that have the crossover suppressor. Since this is a dominant gene, all females with the treated chromosome and the chromosome with the crossover suppressor can readily be separated from those that have the treated chromosome but have an X chromosome that lacks the suppressor.

When the treated *ClB* females are mated to a normal male, the female offspring are discarded. Half the males fail to survive because they have the old lethal, *l*. If the radiation treatment had induced the appearance of a *new* lethal, the other half of the males would also die. Examining the offspring easily determines whether males are present. If no lethals were induced, the offspring should segregate into 2 females : 1 male: but if a new lethal had arisen as the result of the irradiation the offspring would consist of females only. Gene *l* is necessary to eliminate the males that lack the treated chromosome. Because of its presence, however, females heterozygous for the *ClB* chromosome must be used in the original mating because homozygous *ClB* flies do not exist.

It has been pointed out by Stancati and Whiting that the method of determining the production of dominant lethals by noting a decrease in the number of offspring produced frequently fails to distinguish between inactivated sperm and zygote lethals. For example, males are irradiated and mated to females, and a decrease in the normal number of offspring results. Is this decrease caused by inactivated sperm, thus preventing fertilization or by zygote lethals which have killed the offspring shortly after fertilization? This question is not easy to answer for organisms in which all the individuals must arise from a fertilized egg but can easily be answered in such organisms as *Habrobracon juglandis*, in which the males with a few exceptions develop from unfertilized eggs.

If some of the sperm of this wasp are inactivated, the number of fertilized eggs and therefore the number of female offspring

would be reduced. Since more eggs would remain unfertilized than normally, and since they would produce males, the decrease in females would be accompanied by an increase in the males among the offspring. If zygote lethals were produced, there would be a decrease in the females, but there would be no accompanying increase in the males, and the number of offspring would be fewer than in a normal progeny. In a series of experiments, females were crossed with X-rayed males, and in many of the experiments only males were produced. As the number of offspring is only about half the normal number, there is good evidence that dominant zygote lethals were induced. In some families, females were produced, but they were much fewer than in a normal population; and again the number of offspring was considerably below the normal numbers. Whether these dominant zygotic lethals are true gene mutations or chromosomal aberrations is not easy to determine, as the effect would be the same in either case.

Temperature

Numerous studies have been made on the effect of temperature on the production of mutations in *Drosophila melanogaster*. A number of geneticists have worked on this problem, but probably the most significant work has been done by Plough, Child, and Ives, and their students. When they raised larvae at various temperatures from 4° C to just below the killing temperature they found that a definite increase in the number of spontaneous lethal mutations was produced by temperatures above the normal. In studying lethal mutations at different temperatures, the *ClB* method previously described can be used for the X chromosome, but another and somewhat more laborious method must be used for chromosome II and chromosome III.

The various studies on lethal mutations have shown that mutation frequency at different temperatures depends in part upon the particular stock or strain of the fruit fly, even though all the stocks are phenotypically wild type. For example, Demerec found that between 22° and 25° C, the range of temperature at which flies are normally raised, the mutation rate in chromosome I of a stock from Florida was 1.09 per cent whereas the rate of a strain from Formosa was only 0.39 per cent and of a par-

ticular stock from Oregon, 0.07 per cent. Other investigators have observed differences in other strains. It is interesting to note that different investigators obtained the same mutation rate for chromosome I from Florida stocks and that if the mutation rate of chromosome I is high (or low) in a given stock, the rate of mutation in chromosome II is also high (or low) for the same stock. Different strains of *Drosophila* differ significantly in the rate at which mutations occur. This fact must be considered whenever studies are made on the effect of environmental differences on rates of mutation. Another factor that must be considered is the elimination of spontaneous lethal mutations by selection. If, over a period of several generations, those lines are repeatedly discarded which show lethals while the lines which show the most offspring are used for continuing the stock, the percentage of lethals will be considerably less in these lines than in unselected families of the same stock. Selection will definitely decrease the percentage of spontaneous lethals.

Detection of Autosomal Lethals

The method of detecting recessive lethal mutations which are induced in autosomes is somewhat more laborious than the method used to detect induced lethals in the X chromosome. This is because autosomal lethals must be made homozygous before they can be detected whereas sex-linked lethals can be detected in the male even though only one such gene is present since the Y chromosome does not bear the nonlethal allele. In the method first indicated by Muller but set up by Child (described by Plough, 1941), a wild-type stock is raised at the desired temperature and is then mated with a marker stock (Fig. 77). The marker chromosomes bear certain dominant genes for identification and crossover suppressors to prevent a transfer of an induced lethal from a treated to an untreated chromosome. A stock frequently used has one member of chromosome II with a gene for Curly wings (*Cy*) and a crossover suppressor (*C*) and a homologue with the gene for Star eye (*S*); one member of chromosome III has a crossover suppressor (*C*) plus the genes *Sb* (Stubble bristles) or *D* (Dichaete wings), whereas the other member has such genes as *H* (Hairless) or *Dfd* (Deformed). All the genes except the crossover suppressors are lethal when homozygous so that *CyCy SbSb* stocks cannot be used.

When the treated flies are crossed with the marker stock, sixteen possible types of offspring are found (combining four treated with four marker chromosomes). Twelve are discarded that have *S* or *H* or both and therefore have no crossover suppressor.

First Cross × $\frac{C \quad Cy}{S}$ $\frac{C \quad Sb(or D)}{H}$
 Treated chromosomes II III Marker chromosomes II III

Offspring $\frac{C \quad Cy}{C \quad Sb}$
 Type used; others discarded

Second Cross $\frac{C \quad Cy}{C \quad Sb}$ $\frac{C \quad Sb}{C \quad Sb}$ × $\frac{C \quad Cy}{S}$ $\frac{C \quad Sb}{H}$

Offspring $\frac{C \quad Cy}{C \quad Sb}$ $\frac{C \quad Sb}{C \quad Sb}$
 Type used: others lethal or discarded

Third Cross $\frac{C \quad Cy}{C \quad Sb}$ $\frac{C \quad Sb}{C \quad Sb}$ × $\frac{C \quad Cy}{C \quad Cy}$ $\frac{C \quad Sb}{C \quad Sb}$

Offspring $\left\{ \begin{array}{ll} \frac{C \quad Cy}{C \quad Sb} \quad \frac{C \quad Sb}{C \quad Sb} & \frac{C \quad Cy}{C \quad Cy} \quad \frac{C \quad Sb}{C \quad Sb} \\ \text{Always present} & \text{Present if no lethal in II} \\ \frac{C \quad Cy}{C \quad Cy} \quad \frac{C \quad Sb}{C \quad Sb} & \frac{C \quad Cy}{C \quad Cy} \quad \frac{C \quad Sb}{C \quad Sb} \\ \text{Present if no lethal in III} & \text{Present if no lethal in II and III} \end{array} \right.$

FIG. 77. A method for the detection of X-ray induced lethal mutations in the second and third chromosomes of *Drosophila melanogaster*. (Based upon the work of Child, Plough, and others.)

To discard undesirable types is very simple because dominant marker genes are used. The four remaining types are all *Cy Sb*, but differ in the treated chromosomes. If it is desired to test the number of lethal mutations in a certain member of chromosome II and one of chromosome III, one of the *Cy Sb* flies heterozygous for treated wild-type chromosomes is then mated with the original marker stock to produce a number of identical flies, all with the same two treated chromosomes. This is the second

cross of Fig. 77. Of the sixteen possibilities from this cross, three die because they are homozygous for *Cy*, three die because they are *SbSb*, and one is lethal because it is homozygous for both *Cy* and *Sb*. All the *S* and *H* types are discarded, and only the viable *Cy Sb* flies are retained. All have one treated chromosome from each pair, and the treated chromosomes are the same in all these flies.

For the final cross in the test, two *Cy Sb* flies heterozygous for the same two treated chromosomes are mated together. Sixteen theoretical types of offspring are possible but those homozygous for *Cy*, *Sb*, or both never appear because these genes are homozygous lethals. If no new lethal mutations had been produced in the original treated stock, one-ninth of the viable offspring would have two treated chromosomes of both pairs and would be phenotypically wild type; two-ninths would have two identical treated second chromosomes but one untreated member of chromosome III, and would be phenotypically + *Sb*; two-ninths would have a marker chromosome II but two treated third chromosomes and would be *Cy* + phenotypically; the remaining four-ninths would have one marker chromosome of each pair and would be *Cy Sb*. This last type is always present, but some of the other types are sometimes missing and their absence is the key to the test. If a lethal had been induced in chromosome II, all flies that had two treated members of this pair would fail to survive because they would be homozygous for that lethal. In such a case two-thirds of the surviving offspring of the third cross would be *Cy Sb* and one-third *Cy* +. Similarly, if a lethal had been induced in chromosome III, two-thirds of the surviving offspring would be *Cy Sb* and one-third would be + *Sb*. If, however, a lethal had been induced in both chromosomes, only the *Cy Sb* offspring of the third cross would be found. By testing a large number of treated chromosomes, an estimate of the minimum number of induced lethals can be obtained.

Mutation Frequency

When tests were carried out on the first three chromosomes of a Florida stock of *Drosophila melanogaster*, it was found that at 25° C, the temperature which is most suitable for raising *Drosophila melanogaster*, 1.09 per cent of lethals were produced

in chromosome I, 1.75 per cent in chromosome II, and 2.56 per cent in chromosome III. These figures show that the percentage of lethals is not the same in all chromosomes, but it should hardly be expected since some chromosomes are larger than others. It is very interesting to note that the frequency of mutations in chromosomes I and II stands in about the same ratio to one another as their respective number of genes. This relationship does not hold for chromosome III, however, as almost 50 per cent more lethals are found in III than in II, whereas chromosome III has only about 10 per cent more genes. These percentages show that when all conditions of the environment are the same, the frequency of mutations is not always proportional to the number of genes in a chromosome, indicating, probably, that some genes tend to mutate more frequently than others.

Studies were made on the number of lethal mutations in chromosomes I and II for different constant temperatures from 8° to 31° C. In both chromosomes the percentage of lethals increases with the temperature. At the optimum temperature (23° to 25° C), the percentage of mutations in chromosome II was 0.82, at 28° it was 0.95, and at 31° it was 2.77. Below 23°, no mutations were observed. These results on constantly applied temperatures are consistent with many other similar studies but are very different from the results produced by temperature shocks, that is, by sudden short exposures to higher or lower temperatures. With temperature shocks, the number of mutations is greatly increased by sudden exposure to either high or low temperatures. The data for constant temperatures indicate a Q_{10} of about 5, or for every 10° rise in temperature the number of mutations is multiplied fivefold. A Q_{10} (temperature coefficient) of this value tends to indicate that these mutations are probably the result of biochemical reactions.

An increase in temperature does not always produce an increase in the rate of spontaneous mutation and, at times, has actually produced a decrease. Fabergé and Beale found that the unstable gene for colored spots in *Portulaca grandiflora* mutated less frequently the higher the temperature. This gene produces well-defined spots or streaks of magenta in the epidermis of the petals, stems, and leaves. Each colored spot is the result of a single mutation in one cell. If this mutation

occurred early in the development of the organ, the resulting spot is large; but if it occurred late, the spot is small. Three plants having this frequently mutating gene were studied. Four cuttings were made and rooted for each plant, and one cutting from each plant was allowed to develop at 25° C, one at 30° C, one at 35° C, and one at 40° C. Counts were made of the number of spots on each plant, and the mutation rate was then calculated per unit of stem length, per cell and per unit of time.

TABLE 7

CALCULATED NUMBER OF MUTATIONS PER CENTIMETER OF A PORTULACA STEM 2 MM THICK, AND PER CELL AT FOUR DIFFERENT TEMPERATURES

(Rearranged from Fabergé and Beale in the *Journal of Genetics*.)

	25° C		30° C		35° C		40° C	
	per cm	per cell	per cm	per cell	per cm	per cell	per cm	per cell
Plant 1	2.89	1.70	2.05	1.98	1.07	1.25	0.54	0.96
Plant 2	2.92	2.42	2.39	2.14	1.09	1.28	0.60	0.71
Plant 3	2.75	3.45	2.22	2.59	0.86	0.90	not scored	

The results obtained per unit of length and per cell are listed in Table 7. For this gene, increase in temperature results in a decrease in the number of mutations per unit of length, per cell and per unit of time.

Another instance in which an unstable gene mutates less frequently at a higher temperature than at a lower has been reported by Rhoades. In the last chapter we mentioned that Rhoades had discovered a gene, *Dt*, in maize that causes the normally stable gene, *a*, to become unstable and to mutate frequently to the dominant allele, *A*, thus producing colored spots in an otherwise colorless aleurone and dominant stripes in the pericarp and in the stems and leaves. When such *a Dt* plants were raised at 15.5° C, an average of 41.8 mutations was observed per seed; but when other members of the same strain were raised at 27° C, the average was only 9.3.

Other Radiation

Other types of radiation such as ultraviolet light and neutrons have been used to determine their effect as causative agents of mutation. Whiting used the same technique in studying the effect of neutrons in the production of dominant lethal mutations that he had used in X-ray studies. Males were subjected to various dosages of neutrons and were then mated (Fig. 78).

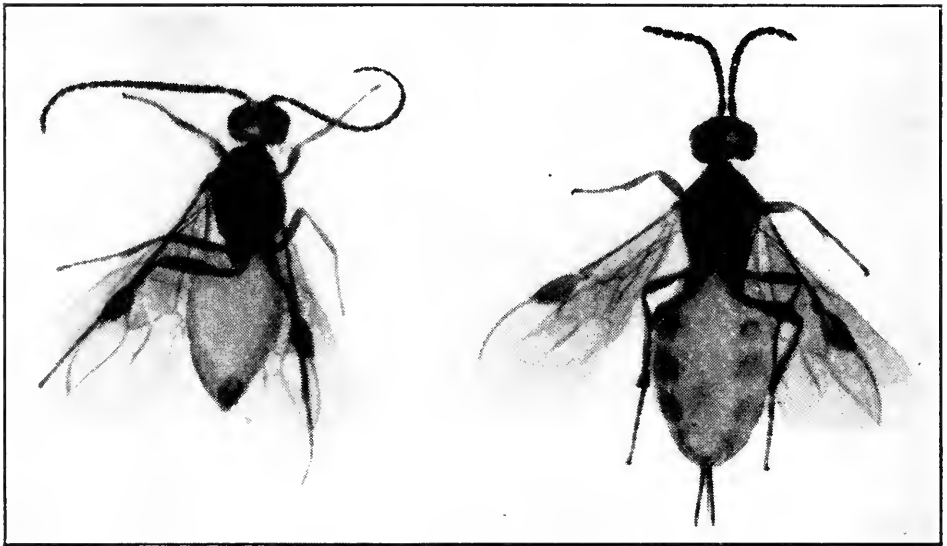

FIG. 78. Male (left) and female (right) of *Habrobracon juglandis*. (Courtesy of Dr. P. W. Whiting; female from the *Journal of Heredity*.)

If a dominant zygote lethal was produced, the number of biparented females would be less than in the controls and the number of males approximately the same. The results he obtained (Table 8) show definitely that neutrons produce dominant lethal mutations; actually, they are more effective than X-rays.

Ultraviolet light is far less satisfactory for studying induced mutations than X-rays, gamma rays, or neutrons because most of the radiation is absorbed by the tissues of the organism and consequently the penetration of the rays to the germ cells is low. Altenburg and Demerec, Hollaender, Houlahan, and Bishop have devised means of reducing the absorption and have shown that ultraviolet light will increase the frequency of mutations. Altenburg treated cells of the germ tract at the time they form a polar cap in the developing *Drosophila* egg. As they are

near the surface of the egg, there was not much intervening tissue to absorb the rays. He pointed out that if ten pole cells were present at the time of treatment and that if a mutation occurred in one, about one-tenth of the sperm cells of the adult should have the mutation. Studying the frequency of lethals in the X chromosome by the *ClB* method, he found eight cases

TABLE 8

DOMINANT LETHALS CAUSED BY NEUTRONS IN *HABROBRACON*(From P. W. Whiting, in *Science*.)

Treatment	Total Days during Which Progeny Was Being Produced	Progeny			
		Orange Males	Wild-Type Females	Males per Day	Females per Day
Control	70	42	139	0.60	2.00
530 R	20	14	35	0.70	1.75
900 R	75	43	50	0.57	0.66
1900 R	65	20	5	0.31	0.08

Fluctuations in number of male offspring are probably due to small numbers involved.

of these "reduplicated" lethals from 108 treated males. Demerec and his co-workers reduced the amount of absorption by compressing the abdomens of fruit flies between quartz plates during irradiation. Sex-linked lethals were determined by the *ClB* method. Although the results were complicated by a high degree of induced sterility due, apparently, to injury through radiation which penetrates the wall of the abdomen, the production of lethal mutations by ultraviolet light of different wave lengths was definitely demonstrated.

QUESTIONS AND PROBLEMS

1. Why is it easier to detect recessive visible mutations in the X chromosome by using the attached-X strain than by using a normal strain of *Drosophila melanogaster*?

2. Assume that in radiating a leaf primordium you caused a single dominant gene affecting leaf shape to mutate to a recessive allele. Could you detect the mutation? Would it be transmitted to later generations? Would your answers to these questions be different if (1) the mutation were from a recessive to a dominant; (2) somatic crossing over took place; (3) the plant could be propagated vegetatively by cuttings?

3. Why is the *CIB* method simpler than methods used for detecting lethals in autosomes?

4. Why is it necessary to use a crossover suppressor when studying induced lethals by the *CIB* method?

Chapter 17

RADIATION, EVOLUTION, AND THE POSITION EFFECT

Since it has been shown definitely that radiation can cause the production of gene mutations, several interesting questions are presented on the importance of natural radiation and the method by which radiation acts both in changing genes and in breaking chromosomes.

Radiation and Evolution

Since mutations can be produced by radiation, and since there is always some radiation in the air, it might well be asked whether mutations which arise spontaneously are caused by this natural radiation. This point is not easy to determine. A few experiments have been carried out by placing *Drosophila* in regions where the natural radiation is higher than normal, such as carnotite mines, which contain an ore possessing a small percentage of the radioactive metal, uranium. Such flies showed a higher mutation frequency than those raised in regions of "normal" radiation. Although these experiments indicate that regions of high natural radiation will increase mutation frequency, they still do not indicate whether the small amount of radiation found in areas of low natural radiation causes the few mutations found there nor do they show that all spontaneous mutations are caused by natural radiation. Other calculations have indicated that natural radiation in places where radiation is "normal" is not enough to bring about even the few spontaneous mutations that are found.

Plough has pointed out that the studies on the effect of temperature on mutation frequency in *Drosophila* indicate that temperature may be an important factor in evolution. He shows that high temperature during development tends to accentuate the degree in which a mutant character is expressed and that it tends to make a recessive gene partially dominant. If this was

a highly beneficial gene, natural selection would tend to preserve it; if it was harmful, selection would tend to eliminate it. It could be eliminated from a population much more readily if it was dominant or partially dominant than if it was recessive. Another factor to be considered is the demonstrated fact that high temperature and temperature shocks increase the mutation rate. An increase in the frequency of mutations increases genetic variability and provides more opportunity for the action of selection. In this connection it is very interesting to note that many more species of plants exist in tropical areas than in temperate ones and that about 80 per cent of the species of reptiles and 58 per cent of the species of mammals are found in tropical regions. Another factor is that both high and low temperatures tend to break up large populations into smaller units. In such small communities, various types of mutations accumulate to high levels, and if these small units mingled together in the summer, a more favorable situation for continuous evolutionary change would be brought about.

Position Effect

One of the interesting effects of radiation is to cause pieces of chromosomes to break off and to become attached to either the normal or to broken ends of other chromosomes. Such translocations and reciprocal translocations are discussed more fully in Chapter 24, but the effect of such translocations on certain genes is taken up here. As the result of a reciprocal translocation, a gene will be separated from the genes next to which it is normally located and will be placed next to a gene with which it had not previously been in contact. It is interesting to note whether after it is in its new position the gene will produce the same or a different effect from that which it produced when it was in its "normal" position on its old chromosome. It has been shown that the effect is sometimes different. Such a change in the behavior of a gene is known as the *position effect*. In a few instances this effect has been found in flies that were not subjected to radiation.

In Chapter 13 it was pointed out that the bar-eyed fly is the result of the reduplication of a very short piece of the X chromosome. If a fly has just one such segment per chromosome it is nonbar, or wild type, even though it has one segment in each

of the two homologues as in the normal female. If it has two segments in one chromosome, it has bar eyes. It may be homozygous or heterozygous. If homozygous, it will have four of the chromosomal segments, two in each homologue. The double bar type has three such segments in succession in one chromosome, whereas the homologous chromosome of the female may have only one. Such a fly has a total of four of these similar segments, just as the homozygous bar, but it has three in one chromosome and one in the other instead of two in each. The phenotypic effects of the two types of distribution of these segments are very different, for the eye of the double bar fly is much narrower than the bar's. In other words, the arrangement of such segments in an individual, not their number, is the important consideration. Three segments following one another on one chromosome have a very different effect from two segments. Similarly, a bar-eyed male has two segments on the X chromosome and none on the Y. Its eyes are much smaller than a wild-type female's, even though the female has just as many segments, for the two segments of the normal female are on separate chromosomes. This relation of the segments at the bar locus indicates that at least sometimes the effect of a gene may be determined in part by the place it occupies in relation to the other genes on the chromosome. In other words, its effect may be influenced by its position in relation to other genes.

Another example of the position effect is shown by the hairy wing mutant in *Drosophila melanogaster*. Like the bar eye situation, this mutant is also the result of the duplication of a small part of a chromosome; but whereas the bar eye duplication involves a segment of the X chromosome long enough to include six bands, hairy wing is a duplication of only one band lying very near the tip of the left end of the X chromosome. Flies that show the hairy wing character have extra bristles along the veins of the wings and on the head and thorax. Demerec and Hoover showed that normal, wild-type females (+ / +) have just one band at that region on each X chromosome and have no extra hairs, whereas males with one such band on their single X chromosome also have no extra hairs. Heterozygous hairy wing females which have two bands on one X chromosome and just

one on the other ($Hw / +$) have about seventeen extra hairs whereas hairy wing males (Hw / Y) have between thirteen and fourteen (Table 9). In other words, two bands next to one another on one X chromosome produce extra hairs whereas two

TABLE 9

AVERAGE NUMBER OF EXTRA HAIRS ON FLIES CARRYING VARIOUS COMBINATIONS OF BANDS INVOLVED IN THE HAIRY-WING LOCUS

(Adapted from Demerec and Hoover in *Genetics*.)

Genetic Constitution	Number of Bands	Average Number of Extra Hairs on Wing	Number of Occipitals
<i>Females</i>			
$+ / +$	1 / 1	0	0
$+ / + / D$	1 / 1 / 1	0	1-2
$Hw / +$	2 / 1	17.05	2
$Hw / + / D$	2 / 1 / 1	18.06	2
Hw / Hw	2 / 2	21.17	2
$Hw / Hw / D$	2 / 2 / 1	32.96	2
<i>Males</i>			
$+ / Y$	1 / 0	0	0
$+ / Y / D$	1 / 0 / 1	0 (plus a few)	1-2
Hw / Y	2 / 0	13.56	2
$Hw / Y / D$	2 / 0 / 1	17.37	2

$+$, a normal wild-type X chromosome with one band. Y , a normal Y chromosome with no bands. Hw , a mutant X chromosome with two bands. D , a small translocated piece of the X chromosome including one band attached to the centromere of Chromosome IV.

similar bands on separate X chromosomes produce no extra hairs. There is an interesting quantitative relationship here, also. A homozygous Hw / Hw female (which has two bands in each chromosome) has more extra hairs than the heterozygote $Hw / +$ (which has a total of three bands), and both have more extra hairs than a Hw male, which has only two bands. The quantitative effect can be further enhanced by the presence of an extra segment of the X chromosome. In one case, a piece of the left end of the X chromosome, which included only one of these

bands, was broken off and became attached to the centromere of the fourth chromosome. Female flies could be produced which therefore had two normal X chromosomes plus two members of chromosomes IV, one of which had the translocated piece. Such a female fly would therefore have three bands on three separate chromosomes, but such flies do not have extra hairs. The position effect is again illustrated, for such flies have no extra hairs in spite of the three bands, whereas flies with two bands next to one another on the same chromosome have many. However, if the *Hw* duplication is present in one or both X chromosomes, an additional band on the translocated segment will increase the numbers of extra hairs slightly.

Of great importance to the study of position effect are cases where euchromatic regions have been translocated into heterochromatic regions and vice versa. By means of radiation, Caspersson and Schultz obtained translocations of euchromatic regions of *Drosophila* chromosomes into heterochromatic or "inert" regions. They found that an increase in the nucleic acid content of the euchromatic regions was brought about which showed itself in the salivary gland chromosomes by a darkening of the bands nearest the heterochromatic regions. In fact, the closer a band was to the "inert" region, the more deeply it was stained. Schultz has also reported, however, that sometimes the bands placed next to the heterochromatic regions became invisible, whereas bands a little farther away were stained more deeply than normally. Prokofyeva-Belgovskaya seems to find that if euchromatic regions are transferred to the chromocenter, they become like the chromocenter, and if heterochromatic regions from the chromocenter are transferred into the euchromatic part of the chromosome, they become like the euchromatic regions.

Action of Radiation

Among the most important problems that arise from the study of radiation-induced gene mutations (as distinct from chromosomal aberrations) are the actual effect produced on the gene and the mechanism by which this effect is produced. Two major explanations of this mechanism have been suggested. One supposes that the action is direct and is the result of hits by electrons; the other considers that it is indirect and that it arises from chemical changes set up within the cell by the radiation.

The "direct hit" theory assumes that the electrons given off when a plant or animal is subjected to X-rays or radium hit the genes directly. It is assumed that whenever an electron hits a gene a chemical change is brought about in the gene, as the result of which the gene thereafter produces a phenotypic effect different from the effect produced by the gene before it was hit. If this theory is correct, the greater the number of electrons, the greater the number of hits, and, therefore, the greater the number of mutations. In other words, there should be a linear relationship between the X-ray dosage and the frequency of gene mutation. Such a linear relationship has been found by a number of investigators for the frequency of induced lethal mutations in the X chromosome of *Drosophila*. However, if direct electron hits are the only determining factor in induced gene mutation, all strains of *Drosophila melanogaster* would be expected to show the same mutation frequency when the same dosage was applied. Since different strains from different regions do not show the same frequency of induced lethal mutations under similar treatment, other factors, probably biochemical, must be taken into consideration, indicating that the direct hit concept is too simple. There is also another piece of evidence against the theory of direct hits. It has been shown that for lower wave lengths of X-rays, mutation frequency is independent of the wave length used. When continuously higher values of the wave length are used, a point should be reached at which the distance between adjacent molecules on the chromosome is about the same as the diameter of the genes. From that point on, mutation frequency should no longer be independent of wave length. Studies on *Drosophila*, however, have shown that even beyond this point mutation frequency is not dependent upon wave length.

The other theory maintains that mutations are not caused by direct hits of electrons on genes but by the transfer of energy from neighboring molecules in the gene environment and that these molecules are activated first by the radiation. Such sensitized reactions may be the result of the activation of molecules by the passage of a photoelectron. There is competition among various cell constituents, including the genes, for the energy of these activated molecules. Genes that win this energy become

mutant genes. Another possibility has also been suggested that other cell constituents may obtain the energy of these activated molecules and that they may therefore undergo chemical changes; these chemical changes in the medium in which the gene is found may then bring about the mutations. This "indirect" theory is compatible with the linear relationship between dosage and mutation frequency and also with the observation that mutation is independent of wave length. If we assume that the cellular environment of the genes is different in different strains of the same species, the different mutation frequencies in such strains can be readily explained by the "indirect" hypothesis.

Basing his conclusions on the behavior of his *Dt* and *a* genes in maize, Rhoades has suggested the possibility that an altered cellular environment may be responsible for gene mutation. He considers that the best explanation for the fact that the *Dt* gene causes the *a* gene to become highly mutable although it is very stable on a *dt dt* background is that the *Dt* gene alters the cellular environment of the *a* gene chemically. He points out that the *Dt* gene is specific in its nature since it acts on only one gene whereas the action of X-rays, radium, and temperature is general. Also, short-wave radiation and temperature cause numerous chromosome abnormalities whereas the *Dt* gene does not. However, the possibility still remains that various factors, both internal and external, that increase mutation rate may act by changing the chemical nature of the gene environment.

QUESTIONS AND PROBLEMS

1. Would you expect to have much success in improving a stock of plants by the induction of mutations by radiation? Explain.
2. Assuming that the average yearly temperature of two regions is the same, would you expect to find more mutations in a region of uniform temperature or in one in which the temperature fluctuates considerably with wide extremes? Why?
3. What are the phenotypes of the following flies:

$$\frac{f + fu}{f + fu}, \frac{f + fu}{+ B +}, \frac{f B fu}{+ B +}, \frac{f BB fu}{+ B fu}, \frac{f BB fu}{+ BB fu}$$

4. Could position effect have been of any importance in evolution? Explain.

5. In producing mutations, can the X-rays be directed to hit a certain gene or a certain chromosome? If not, how can a certain mutation be induced by radiation?

Chapter 18

MULTIPLE ALLELES

That more than two alleles can be present at the same locus has previously been discussed. In Chapter 2, two series of multiple alleles were mentioned, and the method of transmission of multiple alleles that lie on the X chromosome was discussed in Chapter 7. In Chapter 6 the transmission of multiple alleles on an autosome was described, with the horned series of alleles in sheep as an example. Multiple alleles are frequently found in plants and animals, but several series are of especial interest to human beings because they determine the various types of human blood groups. The series of alleles that determines self-sterility or self-incompatibility in many species of plants is a good example of an identical series of multiple alleles in a large number of organisms.

Self-Sterility

Self-sterility is a phenomenon found in a great many species of plants and in a few of the hermaphroditic lower animals. In a self-sterile plant, the eggs may be perfectly good and the pollen may be normal and functional, and yet, when pollen from such a plant is placed upon its own stigma, seeds will not be produced (Fig. 79). This situation is different from true sterility in which either the eggs or the male gametes or both will be absent or nonfunctional. Self-sterility is actually an incompatibility though the gametes are functional. It is referred to as "self-incompatibility" by some geneticists, but the term "self-sterility" is older and is still frequently used although it is less descriptive. A feature of the phenomenon of self-sterility is a peculiar cross-sterility of such a nature that the various individuals of a self-sterile species can be grouped into cross-sterility classes in which all the members of the same class will fail to set seed with each other but will usually set a normal seed complement with all the other individuals of all the other classes.

Self-sterile species have been known for a long time although the genetic basis for self-sterility in most plants has been known only since 1925. The botanist, Koelreuter, in 1764 probably published the first discussion of self-sterility in plants, and Castle in 1896 reported the first known case in animals. Darwin considered the problem at length in 1876 but failed to realize



FIG. 79. Sterile and fertile combinations in the self-sterile (self-incompatible) *Capsella grandiflora*. *Left*, a sterile combination in which none of the ovaries has developed. *Right*, a fertile cross in which all the ovaries of the flowers that were cross-pollinated have developed into mature capsules and contain a full complement of seeds. (From Riley in *Genetics*.)

the cross-sterility relationship among plants from other than the same clone. Darwin's philosophical view of the problem considered that self-sterility was a personal reaction of the individual plant brought about by a decrease in the differentiation of the sexual elements of the same plant. With this decrease in differentiation these sexual elements tend to become sufficiently alike so that they no longer will fertilize one another.

Several different hypotheses have been advanced to explain the mechanism which controls the inheritance of self-sterility in various organisms. Although it is possible that several different mechanisms are instrumental in different plants, one is undoubtedly operative in almost all plants known to be self-sterile. This mechanism, first described independently by Prell and by East and Mangelsdorf and during the following year by Lehmann and Filzer, is often referred to as the "oppositional factor hypothesis."

In Chapter 4, the method of reproduction in angiosperms was described in detail. If a pollen grain adheres to the stigma, a pollen tube emerges from it and grows down into the ovary. It grows toward an ovule, enters through the micropyle, and discharges its contents, including the male gametes or sperm nuclei, into the embryo sac. East and Park have shown that self- or cross-sterility or self- or cross-fertility are determined by the rate of growth of these pollen tubes. In a fertile combina-

tion, the pollen tubes grow at a continually accelerated rate. In a sterile mating, on the other hand, this acceleration does not occur. The pollen tubes in both types of mating grow at the same rate during the earlier stages of growth, and the subsequent failure of acceleration in an incompatible combination prevents the pollen tubes from reaching the ovules before the flowers wither and drop off.

The genetic basis for the different behavior of the pollen tubes was worked out by East and Mangelsdorf for the genus *Nicotiana* but is similar in most other plants. Let us suppose that a plant has two different alleles for self-sterility, which can be designated s^1 and s^2 . (The original notation of East and Mangelsdorf used subscripts, as S_1 and S_2 . Since multiple alleles are generally denoted by superscripts, this notation should be observed for the self-sterility alleles.) These oppositional genes behave in such a way that if the tissues of the style contain the s^1 gene, pollen tubes containing the s^1 gene will not be accelerated in their growth through the style. Similarly, s^2 pollen tubes will not be accelerated if an s^2 gene is present in the female plant. Therefore, if an s^1s^2 plant is self-fertilized, neither kind of pollen tube will be accelerated and no fertilization will occur. The same results will be obtained if two s^1s^2 plants are mated.

In some plants, a third allele, s^3 , may be found. If an s^1s^2 plant is crossed with one whose genetic constitution is s^1s^3 , the s^1 pollen will not be stimulated as before, but the s^3 pollen will grow at an accelerated rate since there is no s^3 gene in the female plant to "oppose" it. The cross $s^1s^2 \times s^1s^3$ will be fertile. In the reciprocal cross, $s^1s^3 \times s^1s^2$, the s^2 pollen will grow at an accelerated rate because no s^2 gene occurs in the female plant, and fertility again will be the result. In a similar manner, plants of the genotype s^2s^3 will be fertile reciprocally with both s^1s^2 and s^1s^3 plants. If a fourth allele is present, plants of the constitution s^1s^4 , s^2s^4 , and s^3s^4 might be found. They would all be fertile together reciprocally and would be fertile with all the three types previously mentioned. It will be noted that no normal diploid plant has more than two members of the series of alleles. Since an s^1 gene in the style prevents the s^1 gene in the pollen from fertilizing the eggs, homozygous plants, such as s^1s^1 , are not normally produced. In some plants, however, includ-

ing *Nicotiana*, homozygotes can be obtained by self-pollinating young buds instead of mature pistils.

The results of crossing two self-sterile but interfertile plants are very interesting. If the two parents have no allele in common, four intrasterile, interfertile classes will be produced. If a plant of the constitution s^1s^2 is pollinated by an s^3s^4 plant, the four classes will be s^1s^3 , s^1s^4 , s^2s^3 , and s^2s^4 . Thus, if 100 offspring were raised, we should expect theoretically 25 plants of each class. All the plants would be self-sterile but each plant would be fertile with only 75 out of the other 99 plants, for it would be cross-sterile with the other 24 plants of its own class.

If the two plants which are crossed have one self-sterility allele in common, only two classes are produced in the offspring, and they should appear with equal frequency. The two classes from such a cross, however, are not both the same as the two that are produced by the reciprocal cross. The following two crosses illustrate this point:

$$\begin{aligned} s^1s^2 \times s^1s^3 &= s^1s^3 + s^2s^3 \\ s^1s^3 \times s^1s^2 &= s^2s^3 + s^1s^2 \end{aligned}$$

It will be observed from this that if a common allele is present, the class of the *mother* is never represented in the offspring.

If an s^1s^2 plant is self-pollinated in the young bud, fertilization may result. Three classes will be produced in the offspring, and one of them will contain half the individuals. Since neither the s^1 nor the s^2 pollen may grow sufficiently slowly to prevent fertilization after a bud pollination, $s^1s^2 \times s^1s^2$ in the young bud will give $1s^1s^1 : 2s^1s^2 : s^2s^2$. If plants of these three classes are backcrossed to the parent, those of the second type will be sterile with the parent in both directions. When the parent is the female, each of the other two classes will fail to set seed with it if pollinated normally. If, however, the parent is the male, fertility will be the result with plants of each of these homozygous classes. The establishment of homozygous types is very useful in identifying classes. Figure 80 shows the results of crossing plants of various normal and homozygous classes.

If genes for various morphological characters are linked with the genes for self-sterility, the ratios will be greatly disturbed

because of the elimination of certain gametes. The first case of such linkage was discovered by Brieger and Mangelsdorf, who found that the basic color gene, *C*, in *Nicotiana* was incompletely linked with the self-sterility alleles. Other cases of such linkage are genes for pollen color and for length of the corolla

♀ \ ♂	s^1s^2	s^1s^4	s^2s^4	s^1s^1	s^2s^2	s^4s^4
s^1s^2	S	F	F	S	S	F
s^1s^4	F	S	F	S	F	S
s^2s^4	F	F	S	F	S	S
s^1s^1	F	F	F	S	F	F
s^2s^2	F	F	F	F	S	F
s^4s^4	F	F	F	F	F	S

Fig. 80. Results of all self- and cross-pollinations among self-sterile plants of six different genotypes. Three of the plants are homozygous for one of the alleles. S, sterile, and F, fertile combinations. Female gametes at left, male at top.

tube in *Nicotiana*, for basic white flowers and for pink flowers in the red clover, and for buff and bicolor flowers in *Nemesia strumosa*.

If a pair of alleles, *A* and *a*, are linked with self-sterility alleles, and if two *Aa* plants are mated, the offspring will segregate into a 3 : 1 ratio if there is no self-sterility allele common to the two parents. If, however, there is a common allele, the ratio of *A* to *a* will not be 3 : 1 but will vary according to the manner and degree of linkage. If the linkage is complete, and if the *A* gene is on the same male chromosome as the common self-sterility allele, there will be a ratio of 1*A* : 1*a*. Such a cross is $s^1A / s^2a \times s^1A / s^3a$. Because of the elimination of the s^1 male gametes, the two resulting types of offspring will be s^1A / s^3a and s^2a / s^3a . If linkage is not complete, the ratio will be less than 3 : 1 and greater than 1 : 1 and will depend upon the amount

of crossing over. If the recessive morphological gene is coupled with the common self-sterility allele in the male, all the offspring will be dominant if linkage is complete. Thus the cross $s^1A / s^2a \times s^1a / s^3A$ will give s^1A / s^3A and s^2a / s^3A offspring.

No common self-sterility allele					
♀ \ ♂	.327 $s^3 Bi$.173 $s^3 bi$.173 $s^4 Bi$.327 $s^4 bi$	Total
.5 $s^1 bi$.1635 $s^1 bi / s^3 Bi$.0865 $s^1 bi / s^3 bi$.0865 $s^1 bi / s^4 Bi$.1635 $s^1 bi / s^4 bi$.50 Bi
.5 $s^2 bi$.1635 $s^2 bi / s^3 Bi$.0865 $s^2 bi / s^3 bi$.0865 $s^2 bi / s^4 Bi$.1635 $s^2 bi / s^4 bi$.50 bi
Common self-sterility allele in male coupled with Bi					
♀ \ ♂	.327 $s^1 Bi$.173 $s^1 bi$.173 $s^3 Bi$.327 $s^3 bi$	Total
.5 $s^1 bi$	none	none	.0865 $s^1 bi / s^3 Bi$.1635 $s^1 bi / s^3 bi$.346 Bi
.5 $s^2 bi$	none	none	.0865 $s^2 bi / s^3 Bi$.1635 $s^2 bi / s^3 bi$.654 bi
Common self-sterility allele in male coupled with bi					
♀ \ ♂	.173 $s^1 Bi$.327 $s^1 bi$.327 $s^3 Bi$.173 $s^3 bi$	Total
.5 $s^1 bi$	none	none	.1635 $s^1 bi / s^3 Bi$.0865 $s^1 bi / s^3 bi$.654 Bi
.5 $s^2 bi$	none	none	.1635 $s^2 bi / s^3 Bi$.0865 $s^2 bi / s^3 bi$.346 bi

FIG. 81. The results obtained from testcrosses involving the gene bi (bicolored flowers) in *Nemesia strumosa* and the self-sterility alleles if there is no common self-sterility allele as in the cross $s^1 bi / s^2 bi \times s^3 Bi / s^4 bi$ and if a common self-sterility allele is coupled with Bi as in $s^1 bi / s^2 bi \times s^1 Bi / s^3 bi$ or with bi as in $s^1 bi / s^2 bi \times s^1 bi / s^2 Bi$. The expected ratio in the offspring is different in each of the three crosses. The reciprocal of each cross, however, would yield a 1 : 1 ratio.

If linkage is not complete, the ratio will be greater than 3 : 1. Figure 81 illustrates linkage between self-sterility alleles and the gene for bicolor in *Nemesia strumosa*.

If testcrosses are made between Aa and aa individuals, and if these genes are linked with the self-sterility alleles, the results of reciprocal crosses may be different. If the heterozygote is the male, and if linkage is complete, the offspring will all be Aa

in the cross $s^1a / s^2a \times s^1a / s^3A$, but all will be aa if the cross is $s^1a / s^2a \times s^1A / s^3a$. However, the reciprocal of each of these crosses will segregate into a ratio of $1Aa : 1aa$. As at least 176 species of plants representing 55 families of both monocotyledons and dicotyledons are known to be self-sterile, the geneticist must be prepared to encounter disturbed ratios as the result of linkage of morphological genes and self-sterility alleles, for undoubtedly many more such cases will be discovered than have already been found.

In addition to the self-sterility alleles, alleles at the same locus but producing self-fertility have been found. In *Nicotiana Sanderae* and *N. alata grandiflora*, East and Yarnell discovered sixteen alleles at the s locus. A number of these alleles are characterized by different ratios of pollen tube growth after selfing, but in only one was the rate of growth sufficiently great to produce self-fertility. Fifteen of these alleles (s^1-s^{15}) are alleles for self-sterility, but the sixteenth, s^f , is a gene for self-fertility. If an s^1s^f plant is selfed, the s^1 pollen tubes are not accelerated; but the s^f pollen tubes grow rapidly enough to set seed since the s^f gene in the style does *not* act as a barrier. Such a self-pollination, therefore, would be fertile and the offspring would be s^1s^f and s^fs^f . Plants which have the s^f gene are, therefore, self-fertile.

The large number of different alleles at this locus is interesting. It is presumed that all arose as point mutations at various times. Although 16 alleles were identified, East himself states that this number does not indicate the actual number that might be found from wild material. A study of the number of alleles in wild populations of *Oenothera organensis* was made by Emerson. In this species of evening primrose which inhabits the Organ Mountains in New Mexico, 37 self-sterility alleles were discovered in about 500 plants. All behaved as a series of multiple alleles and all apparently represent a different gene mutation at the same locus of the same chromosome. In red clover, Williams found 37 alleles in a series of 40 plants and 41 s -alleles in another series which consisted of 48 plants. In red clover, Atwood crossed 49 plants from each of two populations with a s^1s^1 plant. One plant was chosen from the offspring of each cross, and all these plants were crossed together to test the number of dif-

ferent alleles in them. In the first series there were 36 different alleles; in the second series, 39 were different.

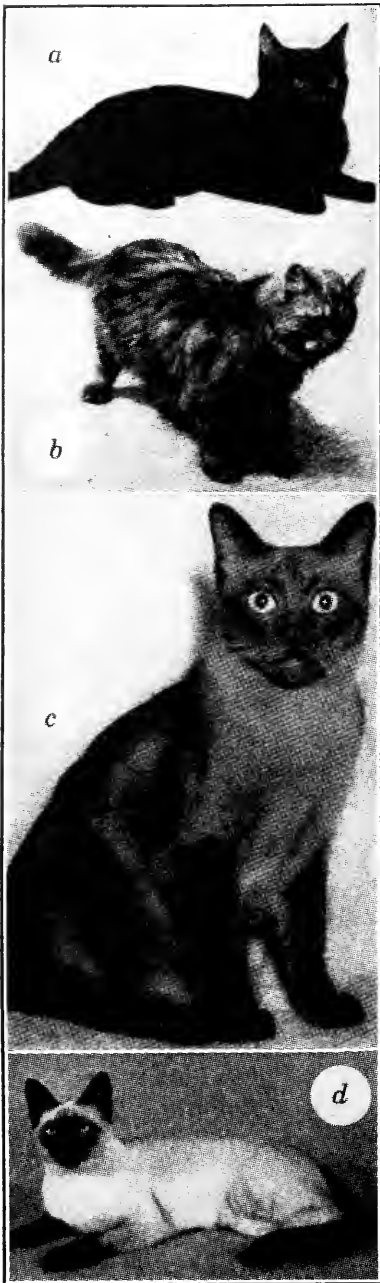

Chinchilla, Himalayan, and Albino Mammals

Another example of a similar series of multiple alleles in related species is the albino series in several animals. In each species, full color, C , is dominant to complete absence of pigment, c . This latter condition, known as albinism, results in white animals with pink eyes. Albinism in many other animals and in human beings is the result of a completely recessive gene. In rabbits, mice, and guinea pigs, there are two conditions intermediate between the full color and albino extremes. The full color, "gray," or wild type is a blend of yellow and black pigment. The intermediate type, known as chinchilla, is less intensely colored, having somewhat less of the black pigment and almost none of the yellow. The Himalayan type has a white body and pink eyes like the albino, but has black ears, feet, tail, and nose. These types result in each of these animals from a series of four alleles, C (self-color), c^{ch} (chinchilla), c^H (Himalayan), and c (albino). Each member of the series is dominant over the others in that order.

FIG. 82. Multiple alleles for coat color in cats. The normal type (with the tabby gene) is at a ; silver, corresponding to chinchilla in the rabbit is at b ; at c is the Burmese type resulting from an allele not found as yet in the rabbit; the Siamese cat, d , results from an allele apparently identical with the one that produces the Himalayan rabbit. The albino has not yet been found in cats. (Compare with Fig. 12. From Keeler in the *Journal of Heredity*.)

The allelic relationship can be proved by a series of crosses. A cross between a chinchilla ($c^{ch}c^{ch}$) and a Himalayan (c^Hc^H) gives chinchilla ($c^{ch}c^H$); but if these types were produced by nonallelic recessive genes on different chromosomes, a cross between them would produce only wild-type offspring.

Since each gene is completely dominant over those below it in the series, several of these types may be heterozygous. Thus, the wild-type animal may be CC , Cc^{ch} , Cc^H , or Cc ; the chinchilla may be $c^{ch}c^{ch}$, $c^{ch}c^H$, or $c^{ch}c$; the Himalayan may be c^Hc^H or c^Hc ; but the albino can be only cc . Keeler and Cobb have shown that a similar series of alleles is also present in cats except that the albino member either does not exist or has not yet been discovered. The chinchilla type is known as "silver" and the Himalayan as "Siamese" in cats, but apparently silver and Siamese stand in exactly the same allelic relationship as do chinchilla and Himalayan in these other mammals (Fig. 82).

Multiple Alleles at the *a* Locus of Maize

In the last two chapters we have mentioned the *a* locus of maize in connection with the effect of *Dt* in making the stable gene, *a*, unstable and in causing it to mutate frequently to *A*. Emerson and Anderson and Rhoades have discovered eight alleles at this locus which show a very interesting relationship. These alleles with their phenotypic effects are listed in Table 10. All these genes produce striking effects on three parts of the plant—the aleurone layer, the leaves and stems, and the pericarp. An interesting feature of this series is that one gene may be dominant over another with respect to one part of the plant but recessive to the other gene or may produce the same effect as produced by the other gene in another part of the plant. We find, for example, that a^p is dominant over *A* in pericarp color but is recessive to *A* in aleurone and general plant color. Also, A^b is dominant over *A* in pericarp color, but has the same effect as *A* on the color of the aleurone layer and of the stems and leaves.

TABLE 10

PHENOTYPIC EFFECTS OF ALLELES AT THE *a* LOCUS IN MAIZE(Modified from Rhoades in *Cold Spring Harbor Symposium.*)

Allele	Aleurone Color	Stem and Leaf Color	Pericarp Color	Effect with <i>Dt</i>
<i>A</i>	deep	purple	red	none
<i>A^b</i>	deep	purple	dominant brown	none
<i>A^{br}</i>	deep	purple	recessive brown	none
<i>A^{rb}</i>	deep	purple	recessive red-brown	none
<i>a^p</i>	pale	red-brown	dominant brown	none
<i>a^{br}</i>	pale	red-brown	recessive brown	none
<i>a</i>	colorless	recessive brown	recessive brown	mutates frequently to <i>A</i>
<i>a^s</i>	colorless	recessive brown	recessive brown	mutates less frequently

QUESTIONS AND PROBLEMS

1. If two *Nicotiana* plants of the constitution s^3s^4 and s^3s^7 are crossed reciprocally, into what classes would the offspring of each cross segregate?

2. If each class of the offspring of $s^3s^4 \times s^3s^7$ were crossed with each class of the offspring from the reciprocal cross, what percentage of the crosses would be sterile?

3. Diagram a pistil of an s^1s^2 plant. On the stigma place pollen from s^1s^2 , s^1s^3 , and s^3s^4 plants. Draw the pollen tubes as they would appear after several hours, showing which ones would have grown longer.

4. Suppose that genes *A* and *a* are completely linked with self-sterility alleles. What ratios would be obtained from the following crosses: $s^1A / s^2a \times s^3A / s^4a$; $s^1A / s^2a \times s^1a / s^3a$; $s^1a / s^2a \times s^1A / s^3a$; $s^1a / s^2a \times s^1a / s^3A$? What ratios would be obtained if the self-sterility alleles and the *Aa* genes were linked with 20 per cent crossing over?

5. In *Nemesia strumosa*, a self-sterile species, the following crosses were made and results obtained (*bu* = buff flowers; *Bu* = orange flowers):

Cross	Orange	Buff
<i>Bubu</i> × <i>Bubu</i>	21	23
<i>Bubu</i> × <i>Bubu</i>	10	10
<i>bubu</i> × <i>Bubu</i>	16	0
<i>bubu</i> × <i>Bubu</i>	36	3

Are these results to be expected from monohybrid inheritance? How might they be explained?

6. A chinchilla rabbit bearing the Himalayan gene is crossed with another chinchilla which has the albino gene. What are the phenotypes and genotypes of the offspring?

7. A cross between two rabbits resulted in four chinchillas, two Himalayans, and two albinos. What were the genotypes and phenotypes of the parents?

8. A rabbit breeder crossed a full-colored animal known to have the albino gene with a chinchilla. One of the offspring was a Himalayan. What were the genotypes of the parents?

9. If gene c^{ch} produces silver fur in cats, and gene c^H the Siamese coat, what offspring would be produced from the following crosses?

$$Cc^H \times c^{ch}c^H; Cc^{ch} \times c^{ch}c^H; c^{ch}c^H \times c^{ch}c^H; Cc^H \times Cc^H$$

Chapter 19

BLOOD GROUPS

It had long been known that blood transfusions could not be made freely among all people, for sometimes the individual that received the blood died almost instantly. The reason for this was not clear until 1900, when Landsteiner discovered that the addition of blood serum from one person sometimes caused the red blood corpuscles of another to clump together. Such clump-

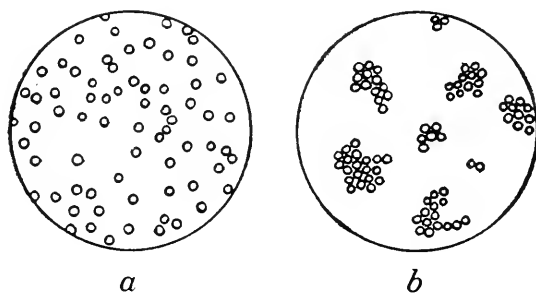

FIG. 83. Agglutination of cells: (a) no agglutination; (b) cells clumped together or agglutinated.

ing, known as “agglutination” (Fig. 83), is merely one phase of a general reaction known as the antigen-antibody reaction.

An antigen-antibody reaction occurs when a substance which does not normally occur in the body of a given individual is injected into his blood stream. The body of the individual into whom the injection is made reacts by producing substances which tend to oppose or neutralize the foreign body. It is apparently an attempt at protection against something which does not belong in and may therefore be harmful to the individual. The protective substance formed is called the *antibody*, and the foreign substance that calls forth this reaction is an *antigen*. The particular type of antibody produced depends upon the nature of the antigen, and the reaction depends upon the type of antibody.

Blood Groups in Rabbits

Agglutination is especially well illustrated by considering the effect of injecting blood from one rabbit into another. As shown by Castle and Keeler, rabbits in general may possess either one, both, or neither of the agglutinogens H_1 and H_2 . If blood is taken from a rabbit that is known to possess the agglutinogen H_1 , and if it is injected into a rabbit that does not possess this agglutinogen, the second rabbit after several such injections a few days apart will develop an agglutinin. If blood serum from the recipient rabbit is then added to blood of rabbits that possess the H_1 agglutinogen, the blood corpuscles of these other rabbits will then become agglutinated. The H_1 agglutinogen acts as an antigen in the body of the rabbit that does not possess it and calls forth the production of this agglutinin. If blood from a rabbit possessing the H_1 agglutinogen, however, is injected into a rabbit that already possesses this agglutinogen, it is not foreign, and no H_1 agglutinin is produced. Similarly, blood from a rabbit that has the H_2 agglutinogen will call forth the production of an H_2 agglutinin in rabbits that do not have the H_2 agglutinogen.

The possession of either of these agglutinogens depends upon the possession of certain genes which may be designated H^1 and H^2 and are allelic to each other. A third allele, h , is also present at the same locus, but this gene does not produce any agglutinogen. Rabbits, then, may be divided into four groups on the basis of these three alleles and the agglutinogens which are merely the phenotypic expression of these genes. The four groups with their genotypes are:

Group O	hh
Group H_1	H^1H^1 or H^1h
Group H_2	H^2H^2 or H^2h
Group H_1H_2	H^1H^2

Group O has no agglutinogens and therefore stimulates the formation of no agglutinins in any animals. Group H_1 causes the production of H_1 agglutinin in either group O or group H_2 individuals, but not in rabbits of either of the other groups. Group H_2 blood causes the production of H_2 agglutinin only in animals of groups O or H_1 . Blood from individuals with both

agglutinogens causes the formation of both types of agglutinins in group O individuals, of H_2 agglutinin in individuals of group H_1 , of H_1 agglutinins in rabbits of group H_2 , but does not cause any agglutinins in rabbits of the fourth group, H_1H_2 .

The A-B Blood Groups in Human Beings

Blood groups in human beings are also controlled by multiple alleles. Actually, there are several sets of blood groups in man. Those which are best known and chiefly determine whether or not transfusions can be made are the Landsteiner or A-B blood groups. Like rabbits, human beings can have two agglutinogens, designated A and B; and any person may have either, both, or neither. Persons with agglutinogen A only belong to group A; those with agglutinogen B only, to group B; a person with both agglutinogens is in group AB; a person with neither belongs in group O. If only the agglutinogens are considered, this situation is very much like the one just described for rabbits; but when the agglutinins are considered, the two cases are very different. Rabbits normally possess no agglutinins, but certain agglutinins may be developed in their bodies by the injection of certain agglutinogens. In human beings, however, the agglutinins corresponding to the A and B agglutinogens are already present in the serum (or plasma) of certain individuals and are not merely the result of a reaction caused by an injection. Some individuals have the agglutinin or antibody for A, some have the agglutinin for B, some have both agglutinins, and others have neither. Obviously, nobody has the agglutinin (antibody) for any agglutinogen (antigen) which he may carry, for if he did, his own blood would have been agglutinated in early development and he would not have survived. When a human adult lacks a certain antigen, he *always* has the corresponding antibody (Landsteiner's rule). Nobody, therefore, lacks both antigens and both antibodies. The agglutinin specific for agglutinogen A is usually designated as alpha or anti-A, that specific for agglutinogen B is beta or anti-B.

The method of inheritance of the blood groups indicates that a series of three multiple alleles is operative (Bernstein's theory). A recessive gene is assumed to produce no isoagglutinogen and individuals homozygous for this gene belong to group O. A dominant allele in the series results in the production of agglu-

tinogen A and a second dominant allele results in the production of agglutinin B. Neither of these two dominant genes is dominant over the other.

Several systems of symbols have been used by various scientists to designate these alleles. The early theory of Bernstein used *O* to represent the gene that resulted in no agglutinin, *A* for the gene producing agglutinin A, and *B* for the gene for agglutinin B. Thus, the three alleles are *O*, *A*, and *B*. This system is adequate, but is not in conformity with the usual system of genetic nomenclature, according to which all genes at a given locus have the same symbol except for the use of a capital or lower-case form to designate dominance or recessiveness, or for the plus sign which indicates the wild type, and except for the addition of different superscripts to indicate the various members of a series of multiple alleles. In an attempt to have the genes for the blood groups conform to this system, some authors use *a* for Bernstein's *O*, and *a^B* for his *B*. This system is an improvement but would tend to suggest that gene *A* was the top dominant in the series whereas it is not dominant over *a^B*. Another system assumes that group O is the wild type or standard and uses a plus sign to indicate Bernstein's gene *O*, retaining the symbols *A* and *B*. Another method, and one which is in harmony with genetic practice, was suggested by Strandskov. He suggests the symbol *i* for the gene for no isoagglutinin and *I^A* and *I^B* for the dominant genes producing agglutinogens A and B respectively. Without passing on the merits of the various systems, the early system of *O*, *A*, and *B* will be adopted for this book because it is so widely used by the active workers in the field. Because it is so formally correct, the symbols of Strandskov will also be indicated in many places.

Disregarding the subgroups which will be mentioned later, individuals of group O will be genotypically *OO* (or *ii*). Those of group A will be *AO* or *AA* (*I^Ai* or *I^AI^A*) and those of group B will have the genotypes *BB* (*I^BI^B*) or *BO* (*I^Bi*). Genes *A* and *B* (*I^A* and *I^B*) show no dominant and recessive relationship with respect to one another. If an individual is genotypically *AB* (*I^AI^B*), he possesses both agglutinogens and therefore belongs to group AB.

If blood from a group A person is injected into people of groups A or AB, no harmful consequences arise because such

people do not possess the alpha agglutinin or antibody. If, however, it is injected into group O or group B individuals, they may die because they possess the alpha agglutinin and their red corpuscles will be clumped together into small masses which block the circulation of the blood. In a similar way, blood from persons of group B can safely be introduced into people of groups B and AB but not into individuals of groups O or A. Blood from group O can be introduced with reasonable safety into people of types A, B, and AB because it does not contain the A or B agglutinogen (antigen) and therefore will not be agglutinated by A, B, or AB types of blood serum. Finally, blood from people of group AB can be introduced only into people of the same group. Such persons have both the A and B agglutinogens (antigens); therefore their blood will be agglutinated by any blood that has either or both of the agglutinins (antibodies). The four groups with their respective genotypes, agglutinogens, and agglutinins, and the various agglutination reactions are summarized in Table 11.

TABLE 11

THE LANDSTEINER BLOOD GROUPS AND SOME OF THEIR PROPERTIES

Blood Group	Genotypes		Agglutinogens Present	Agglutinins Present	Groups Whose Serum Will Agglutinate the Cells of the Group at the Left	Groups Whose Cells Will Be Agglutinated by Serum of the Group at the Left
	Bernstein's	Strand-skov's				
O	<i>OO</i>	<i>ii</i>	none	α and β	none	A, B, and AB
A	<i>AA</i> or <i>AO</i>	<i>I^AI^A</i> or <i>I^Ai</i>	A	β	O and B	B and AB
B	<i>BB</i> or <i>BO</i>	<i>I^BI^B</i> or <i>I^Bi</i>	B	α	O and A	A and AB
AB	<i>AB</i>	<i>I^AI^B</i>	A and B	none	O, A, and B	none

The question of blood groups is interesting genetically because it is another case of multiple alleles. Its practical nature is very important, however, for the blood-group reaction not only determines what transfusions can and cannot be made with safety but also has been used in several legal cases where the question of dubious parentage is involved. Sometimes it can be shown definitely that a child cannot be of a certain putative parentage because a cross between two individuals of certain blood groups cannot produce certain other blood groups. If a

group O and a group A person are mated, the cross must be either $OO \times AA$ or $OO \times AO$. The offspring could be only group A (AO) in the former case or group A (AO) or O (OO) in the latter. If the child is of group B or group AB, courts will admit the blood group relationships as evidence that such a child could not be the child of those parents. Blood groups will not establish parentage but will show *sometimes* that the supposed parentage *could not be* the correct one. Various combinations of genotypes with the possible offspring they could produce are shown in Table 12.

Some recent studies indicate that both group A and group AB are composed of two or more subgroups. Earlier results had indicated that when group A blood was mixed with group B serum, the serum was absorbed by the group A blood until it no longer could agglutinate group A blood. This reaction was to be expected since group A blood contained agglutinin A whereas group B serum contained group A agglutinin. In some tests, however, when the blood of some individuals of group A was used to absorb the group B serum, the serum lost the power of agglutinating the blood of these individuals but could agglutinate the blood of most other individuals of group A. This seemed to indicate that there were two varieties of group A blood, designated by Landsteiner and Levine A_1 and A_2 . The agglutinogens found in these subgroups are designated as agglutinogens A_1 and A_2 , and the genes which determine their presence may be designated A_1 and A_2 or I^{A1} and I^{A2} (theory of Thomsen *et al.*). Since two agglutinogens determine the two subgroups of group A, one could expect to find similar subgroups of group AB. Such subgroups have been found and are designated A_1B and A_2B .

It has been found, also, that the anti-A or α agglutinin also is composed of several subtypes. Anti-A or α agglutinin reacts with both the A_1 and A_2 agglutinogens, and the reaction is somewhat less intense with A_2 . Agglutinin anti- A_1 or α_1 , on the other hand, reacts strongly with agglutinin A_1 but only very feebly with agglutinin A_2 . Group B and group O usually contain both the α and the α_1 agglutinins, but this latter α_1 may also be present in rare cases as an irregular agglutinin in A_2 or A_2B blood. Very rarely, sera from A_1 or A_1B bloods

contain an agglutinin known variously as α_2 or as anti-O since it appears to react with type O blood and less strongly with certain bloods containing on A_2 agglutinogen. One theory has

TABLE 12

RESULTS OF CROSSES BETWEEN VARIOUS COMBINATIONS OF GENOTYPES FOR THE AB BLOOD GROUPS

Genotypes of Parents		Phenotypes of Parents	Phenotypes of Offspring; No Other Phenotypes Are Possible
Bernstein's	Strandskov's		
$OO \times OO$	$ii \times ii$	Groups O \times O	All group O
$OO \times AA$	$ii \times I^A I^A$	" O \times A	" " A
$OO \times AO$	$ii \times I^A i$	" O \times A	1O : 1A
$OO \times BB$	$ii \times I^B I^B$	" O \times B	All group B
$OO \times BO$	$ii \times I^B i$	" O \times B	1O : 1B
$OO \times AB$	$ii \times I^A I^B$	" O \times AB	1A : 1B
$AA \times AA$ or AO	$I^A I^A \times I^A I^A$ or $I^A i$	" A \times A	All group A
$AO \times AO$	$I^A i \times I^A i$	" A \times A	3A : 1O
$AA \times BB$	$I^A I^A \times I^B I^B$	" A \times B	All group AB
$AO \times BB$	$I^A i \times I^B I^B$	" A \times B	1B : 1AB
$AA \times BO$	$I^A I^A \times I^B i$	" A \times B	1A : 1AB
$AO \times BO$	$I^A i \times I^B i$	" A \times B	1O : 1A : 1B : 1AB
$AA \times AB$	$I^A I^A \times I^A I^B$	" A \times AB	1A : 1AB
$AO \times AB$	$I^A i \times I^A I^B$	" A \times AB	2A : 1B : 1AB
$BB \times BB$ or BO	$I^B I^B \times I^B I^B$ or $I^B i$	" B \times B	All group B
$BO \times BO$	$I^B i \times I^B i$	" B \times B	3B : 1O
$BB \times AB$	$I^B I^B \times I^A I^B$	" B \times AB	1B : 1AB
$BO \times AB$	$I^B i \times I^A I^B$	" B \times AB	2B : 1A : 1AB
$AB \times AB$	$I^A I^B \times I^A I^B$	" AB \times AB	1A : 1B : 2AB

Results of reciprocal crosses are the same.

been advanced that the anti-O agglutinin is really directed specifically against type O blood. According to this theory, this agglutinin agglutinates OO blood (group O). In bloods of group A_1 which are genotypically $A_1 O$ (or $I^{A1} i$), this anti-O serum causes no agglutination presumably because gene A_1 (I^{A1})

is completely dominant over $O(i)$. Anti-O serum appears to give weak reactions with group B blood in a small percentage of the cases and no reaction usually. This behavior has been explained on the basis of an incomplete dominance of gene B (I^B) over $O(i)$. The reaction of anti-O serum to blood of group A_2 is explained by supposing that the cases in which the reaction occurs are individuals whose genotype is A_2O (or $I^{A_2}i$) and that the reaction is with the product of the $O(i)$ and not that of the other gene. If this explanation is correct, the anti-O (α_2) serum should not react with homozygous individuals of subgroup A_2 , whose genotype is A_2A_2 (or $I^{A_2}I^{A_2}$). It is very difficult to identify such homozygotes with certainty unless both parents are of group A_2B , a very rare situation because of the infrequency of the A_2B subgroup.

On the other hand, Wiener and Karowe have suggested that the anti-O sera are related to the blood groups in the same manner that the anti-Hr sera are to the Rh blood types which will be discussed later. According to this view, anti-O sera react with the properties determined by genes O and A_2 but not with those determined by A_1 and B . If so, anti-O serum should give strong reactions with OO , A_2A_2 , and A_2O individuals, weak reactions with people whose genotypes are A_1A_2 , A_1O , BO , and A_2B , but negative reactions with A_1A_1 , BB , and A_1B people.

A third subgroup of group A has also been found. It has been called A_3 , and gives a very weak reaction with anti-A sera. It appears to be even rarer than subgroup A_2 . Another rare subgroup, designated A_4 , has also been reported. It is characterized by a very weak reaction with sera of group B. To account for subgroups A_1 , A_2 , and A_3 , and groups B and O, five multiple alleles have been suggested. They are designated A_1 , A_2 , A_3 , B , and O (or I^{A_1} , I^{A_2} , I^{A_3} , I^B , and i). Gene $O(i)$ is recessive to all the others. Gene $B(I^B)$ is dominant to O but shows no dominant-recessive relationship with any of the other three alleles, but A_1 is dominant over A_2 and both are dominant over A_3 . The relationship might be indicated as $A_1 > A_2 > A_3 > O < B$. The various groups and subgroups produced by the various combinations of genes (excluding the combination responsible for subgroup A_4) would be:

$A_1A_1 (I^{A1}I^{A1})$	}	Subgroup A ₁	$A_1B (I^{A1}I^B)$ —Subgroup A ₁ B
$A_1A_2 (I^{A1}I^{A2})$			$A_2B (I^{A2}I^B)$ —Subgroup A ₂ B
$A_1A_3 (I^{A1}I^{A3})$			$A_3B (I^{A3}I^B)$ —Subgroup A ₃ B
$A_1O (I^{A1}i)$			
$A_2A_2 (I^{A2}I^{A2})$	}	Subgroup A ₂	$BB (I^BI^B)$
$A_2A_3 (I^{A2}I^{A3})$			$BO (I^Bi)$
$A_2O (I^{A2}i)$			
$A_3A_3 (I^{A3}I^{A3})$	}	Subgroup A ₃	$OO (ii)$ —Group O
$A_3O (I^{A3}i)$			

There is no reason to believe that more subgroups of group A may not be found later. There is some evidence also that there may be subgroups of group B, but they have not yet been demonstrated.

The MN Series of Blood Types in Human Beings

In addition to the four AB blood groups and their various subgroups, two other agglutinogens have also been discovered, the M and N agglutinogens of Landsteiner and Levine. All human beings possess either or both of these agglutinogens so that, with respect to these blood types, all people may be classed as types M, N, or MN. These groups bear no relation to the AB groups, for all three of the MN types are distributed with the same frequency in each of the four AB blood groups. The MN blood groups resemble the H groups in rabbits in that human beings only extremely rarely carry the agglutinins for these antigens, but their heredity is different. By injecting blood from the M, N, or MN types into rabbits, however, the corresponding antibodies may be produced, and sera from such immunized rabbits may be used to test human blood for its particular agglutinin.

Two varieties of N agglutinin have been found. The agglutinin N₁ is the common N agglutinin, but another, designated as agglutinin N₂, has been found in a few very rare instances and differs from N₁ only in that it gives an extremely weak agglutination reaction.

The MN blood types appear to be inherited as if three multiple alleles were operating. Gene N¹ (or Aⁿ¹) produces the N₁ agglutinin, gene N² (or Aⁿ²) produces the very rare N₂ agglutinin, and the M agglutinin is the result of a third allele, M (or A^m). Omitting from consideration the N₂ agglutinin because of its rarity, the M type is homozygous for the M gene.

the N type is *NN*, and the MN type is *MN*. The various possible crosses among these types with the genotypes of the parents and ratios in the offspring are illustrated in Table 13. A study of this table shows that neither the M nor the N agglutinin can be present in the blood of a child unless it was also present in the blood of one or both parents. It shows also that an individual of type M cannot give rise to a child of type N, since type N would be homozygous for gene *N*, and that a type N

TABLE 13

RESULTS OF CROSSES BETWEEN VARIOUS GENOTYPES PRODUCING THE MN BLOOD TYPES

Genotypes of Parents		Phenotypes of Parents	Phenotypes of Offspring; No Other Phenotypes Are Possible
Older	Strandskov's		
<i>NN</i> × <i>NN</i>	<i>AⁿAⁿ</i> × <i>AⁿAⁿ</i>	N × N	all N
<i>MM</i> × <i>MM</i>	<i>A^mA^m</i> × <i>A^mA^m</i>	M × M	all M
<i>NN</i> × <i>MM</i>	<i>AⁿAⁿ</i> × <i>A^mA^m</i>	N × M	all MN
<i>NN</i> × <i>MN</i>	<i>AⁿAⁿ</i> × <i>A^mAⁿ</i>	N × MN	1MN + 1N
<i>MM</i> × <i>MN</i>	<i>A^mA^m</i> × <i>A^mAⁿ</i>	M × MN	1MN + 1M
<i>MN</i> × <i>MN</i>	<i>A^mAⁿ</i> × <i>A^mAⁿ</i>	MN × MN	2MN + 1M + 1N

The results of reciprocal crosses are the same. The subtypes of type N are not considered here.

person cannot produce a child whose blood belongs to type M, since type M would be homozygous for gene *M*. Such relationships are taken into account when these blood groups are used as tests of dubious parentage. These M, N, and MN types, however, do not usually interfere with blood transfusions because human serum does not normally contain the agglutinins which would cause the blood to be agglutinated.

The Rhesus Blood Groups

An extensive series of studies by Wiener, Levine, Race, Taylor, and others have shown that another series of antigens is also present in human beings. The presence of such antigens was revealed independently by Levine and Stetson and by Landsteiner and Wiener. The latter two investigators showed that

when blood of the rhesus monkey was injected into rabbits an immune serum was produced in the blood of the rabbit. When this antiserum was mixed with human blood, agglutination resulted in about 85 per cent of the cases which they tested, showing that the rhesus monkey and most human beings contain this particular agglutininogen in their blood. They designated this agglutininogen as Rh. Preliminary studies of the presence or absence of this agglutininogen in several families indicated that it behaved as if it were the result of a certain dominant gene, which can be designated *R*. It was further shown that in certain types of matings *Erythroblastosis foetalis*, a familial hemolytic disease of the newborn, resulted. If the mother was Rh-negative and the father was Rh-positive and homozygous, the offspring would be genotypically *Rr*, would possess the agglutininogen, and would therefore be Rh-positive.

Apparently this agglutininogen can often pass through the placenta from the fetus and can enter the mother's blood. There it will stimulate the production of the antibody or agglutinin, which can also diffuse through the placenta and enter the blood of the fetus. Since the blood of the fetus contains the agglutininogen, it will be agglutinated by the introduction of the agglutinin and the fetus may be stillborn. This reaction occurs entirely independently of the blood groups of the parents and fetus. It does not, however, occur in all cases in which the mother is Rh-negative and the child Rh-positive. For example, the first-born child is seldom affected, if at all, but apparently the first Rh-positive child sensitizes the mother so that subsequent Rh-positive children are much more likely to be affected. In a few cases the first-born child was affected, but in most of these the mother had previously received a transfusion of Rh-positive blood. Even the subsequent children, however, do not die in nearly so high a frequency as is expected, for only about one out of twelve pregnancies which could result in an erythroblastotic infant do so. Apparently more than one pregnancy is sometimes necessary before a sufficient degree of sensitization develops.

It is quite reasonable to suppose that in some of the pregnancies which do not result in death an effect may be produced which may be harmful although not fatal. Some observations

of feeble-mindedness have indicated that some of the Rh-positive children who survived may be feeble-minded. For preliminary studies have shown that in two groups of feeble-minded children, a considerably higher percentage were Rh-positive children whose mothers were Rh-negative than would be found in a population of normal individuals. A further study of a number of patients who had a hemolytic reaction to blood transfusions of a homologous blood group and of mothers of erythroblastotic babies showed that the Rh-positive individuals actually included a number of different types or subtypes. All of them were Rh-positive and were apparently determined by a series of five alleles, all of which were allelic to the recessive gene r . During the course of these studies the symbols for the various genes have been modified as increasing knowledge of the phenomena were obtained, but the symbols adopted by Wiener (1946) will be used here.

Gene r is recessive to all the other genes in this series of multiple alleles. It produces no agglutinin and reacts with no agglutinin. Gene r^0 produces agglutinin Rh_0 and reacts positively with anti- Rh_0 agglutinin. Gene R' produces agglutinin Rh' and reacts with anti- Rh' agglutinin. Gene R^1 produces both Rh_0 and Rh' agglutinogens and reacts with both anti- Rh_0 and anti- Rh' antibodies. Gene R'' produces Rh'' agglutinin and reacts with antisera containing the anti- Rh'' agglutinin, whereas gene R^2 results in the presence of both Rh_0 and Rh'' agglutinogens and reacts with both antibodies, anti- Rh_0 and anti- Rh'' . None of these genes is dominant to any other, but all are dominant to r .

Twenty-one theoretically possible genotypes can result from these six alleles and are listed in Table 14. They can produce eight different phenotypes or rhesus blood types. Three antibodies, anti- Rh_0 , anti- Rh' , and anti- Rh'' , have been found, and may form five types of sera. Rh-antiserum anti- Rh_0 has agglutinin Rh_0 , whereas anti- Rh' has agglutinin anti- Rh' , and anti- Rh'' antiserum contains agglutinin Rh'' . Combinations of anti- Rh_0 antiserum may also be found with either of the other two types, giving antiserum anti- Rh_0 , Rh' (also called anti- Rh_1) and anti- Rh_0 , Rh'' (also designated as anti- Rh_2). An interesting feature of the genes that determine the Rh-types is that the

TABLE 14

THE EIGHT RHESUS BLOOD TYPES, THEIR THEORETICAL GENOTYPES, AND THEIR REACTIONS WITH RH-ANTISERUM AND WITH HR-ANTISERUM

(Modified from Wiener [1943] and Wiener *et al.* [1946])

Rh Blood Type (Phenotype)	Theoretically Possible Genotypes	Reactions with Rh-antiserum					Reactions Expected with Hr Antiserum
		Anti-Rh ₀	Anti-Rh'	Anti-Rh ₁	Anti-Rh''	Anti-Rh ₂	
rh	<i>rr</i>	—	—	—	—	—	strong
rh ₀	<i>r⁰r⁰</i> <i>r⁰r</i>	+	—	+	—	+	strong
Rh'	<i>R'R'</i> <i>R'r</i>	—	+	+	—	—	none weak
Rh ₁ (also called Rh ^{0'})	<i>R¹R¹</i> <i>R¹r</i> <i>R¹r⁰</i> <i>R'R'</i> <i>R'r⁰</i>	+	+	+	—	+	none weak weak none weak
Rh''	<i>R''R''</i> <i>R''r</i>	—	—	—	+	+	strong
Rh ₂ (also called Rh ^{0''})	<i>R²R²</i> <i>R²r</i> <i>R²r⁰</i> <i>R²R''</i> <i>R''r⁰</i>	+	—	+	+	+	strong
Rh'Rh''	<i>R'R''</i>	—	+	+	+	+	weak
Rh ₁ Rh ₂ (also called Rh ^{0'} Rh ^{0''})	<i>R¹R²</i> <i>R¹R''</i> <i>R'R²</i>	+	+	+	+	+	weak

Gene *R¹* has also been designated *R^{0'}* and *R²* has been designated *R^{0''}*.

antigen which results from the action of a single gene may be indistinguishable serologically from that produced by the combined action of two alleles. For example, gene R^1 gives a positive reaction with antibodies Rh_0 and Rh' , as do also gene r^0 and R' together. Thus a person with gene R^1 will show the same reactions as an r^0R' individual. Similarly, gene R^2 acts like r^0 and R'' together.*

In Table 14 we have seen that eight Rh types are theoretically possible. When the reactions of these eight to anti-Rh' and anti-Rh'' sera are considered, it is clear that these types fall into four classes as in Table 15. These four classes are comparable to the four Landsteiner or A-B blood groups. When anti-Rh₀ antiserum is also taken into account, each class can be further subdivided into two subclasses—those that give a negative reaction with anti-Rh₀ antiserum and those that are Rh₀-positive. This classification makes the relationship of the eight types somewhat clearer.

The rhesus blood types have been studied rather intensively among the white population of New York City, and it has been found that the frequencies of the various types are very different. Some studies have shown that about 54 per cent have the Rh' agglutinin only, 14 per cent the Rh'' agglutinin only, and about 17 per cent both these agglutinins. Approximately 86 per cent possessed the Rh₀ agglutinin but only 2.5 per cent of these lacked both the other agglutinins. About 12 per cent of the cases studied were Rh-negative. Of the eight theoretical types of blood, all have been found, but the Rh'Rh'' type is exceedingly rare.

The Hr Factor

In 1941 Levine and Javert reported that when the blood of a woman who was Rh-positive, but who had produced an erythro-

* Originally, type rh^0 was designated as type Rh. Because the term *Rh types* is often used in a general sense, it was considered advisable to change the designation of this specific Rh type to Rh₀. The gene was correspondingly changed from *Rh* to *Rh*₀ (Wiener, 1944). As it is more conventional to use superscripts for multiple alleles, Rh^0 , R^0 or r^0 are preferable (Wiener *et al.*, 1946). Genes R^1 and R^2 were formerly designated Rh_1 (or Rh_0') and Rh_2 (or Rh_0''), respectively. Antisera anti-Rh₀, anti-Rh', and anti-Rh'' were formerly designated anti-Rh, anti-Rh₁, and anti-Rh₂.

blastotic child, was tested, the serum was found to contain an antibody which could agglutinate all Rh-negative bloods. This new property was designated Hr and the corresponding agglutinin anti-Hr. A similar agglutinin was reported in 1943 by Race and Taylor in England who designated it the St factor. Levine and Javert, however, had apparently used a weak anti-serum which gave only about 30 per cent positive reactions.

TABLE 15

THE EIGHT RHESUS BLOOD TYPES ARRANGED TO SHOW THAT THEY FALL INTO FOUR CLASSES WITH RESPECT TO THEIR REACTIONS TO ANTI-RH' AND ANTI-RH'' SERA

(Modified slightly from Wiener, Sonn, and Belkin in the *Journal of Experimental Medicine*.)

Classes	Antisera			Type	Frequencies,* per cent	Antisera			Type	Frequencies,* per cent
	Anti-Rh ₀	Anti-Rh'	Anti-Rh''			Anti-Rh ₀	Anti-Rh'	Anti-Rh''		
W	-	-	-	Rh negative	12.4	+	-	-	Rh ₀	2.5
U	-	+	-	Rh'	0.8	+	+	-	Rh ₁ (or Rh ₀ ')	53.6
V	-	-	+	Rh''	0.5	+	-	+	Rh ₂ (or Rh ₀ '')	13.4
UV	-	+	+	Rh'Rh''	0.0	+	+	+	Rh ₁ Rh ₂ (or Rh ₀ 'Rh ₀ '')	16.8

* Among whites in New York City.

Each class can be divided into two subclasses based on the reaction to anti-Rh₀ sera.

whereas Race and Taylor's serum was stronger and gave about 80 per cent positive reactions. That the same property was present in the two factors and that both should be called Hr was pointed out by Wiener, Davidsohn, and Potter who suggested that the weak antiserum of Levine failed to test blood which was heterozygous for the Hr factor.

The Hr factor in the blood is apparently not the result of a new gene but is a property of genes r , r^0 , R'' , and R^2 , for it is found in the agglutinogens determined by each of those genes. On the other hand, genes R' and R^1 do not appear to result in the production of the Hr factor for the agglutinogens determined by these two genes do not contain this Hr factor. If Wiener's assumption is correct that a stronger reaction with anti-Hr serum

is given by homozygous r , r^0 , R'' , and R^2 individuals than by those persons who have only one of these genes and also either R' or R^1 , the results expected from all the possible Rh genotypes are listed in Table 14. The Hr factor can be used as a presumptive test for the homozygosity or heterozygosity of type Rh₁ fathers in families with erythroblastic infants (Wiener, 1946).

Other Alleles

Two other alleles at the r locus have been discovered although they are rare. Race and Taylor and Murray, Race, and Taylor found genes which they designated Rh_y and Rh_z and which Wiener has designated R'' and R_{12} , both of which react positively with Rh' and Rh'' antisera but negatively with anti-Hr serum. Gene R'' gives negative results and R_{12} positive results with Rh₀ antiserum. Although these genes appear to be rare among whites, they are far more common among Mexican Indians.

Wiener has also found some bloods which give intermediate reactions. He suggests that there may be some "intermediate" genes such as are listed in Table 16.

Linked Genes

Multiple alleles at one locus have not been the only explanation offered for the inheritance of the Rh blood types. Fisher, Race, Levine, and others have suggested an alternate explanation. They assume that three loci are concerned, that these loci are very close together on one chromosome, and that at least two alleles are present at each locus. The pairs of genes are D and d , C and c , and E and e , and the antibodies with which they react are Δ or anti- D , δ or anti- d , Γ or anti- C , γ or anti- c , H or anti- E , and η or anti- e . Comparing this terminology of Levine and the British workers with that of Wiener previously discussed, we find that anti- C is the same as anti-Rh' and anti- c the same as anti-Hr'. Similarly, anti- D is anti-Rh₀ and anti- d is anti-Hr₀, and anti- E is anti-Rh'' and anti- e is anti-Hr''. The anti-Hr' serum was originally called St by Race and Taylor and simply anti-Hr by Levine.

The symbols D and d , C and c , and E and e are not intended

to imply any dominant-recessive relationship but indicate the genes that are found at the same locus. Evidence from gene frequencies makes it appear that the order of the genes on the chromosome is $D-C-E$.

Let us now compare the genotypes of the two theories. According to the theory of linked genes, genotype CDe reacts with C, D, and e serum. It corresponds with gene R^1 of the other

TABLE 16

FOUR ADDITIONAL ALLELES AT THE r LOCUS AND THEIR REACTIONS WITH THE STANDARD ANTISERA

(From Wiener in *Science* [1944])

Inter- mediate Types	Reactions with Antisera			Formerly Classed Together with Major Types
	Anti-Rh ₀	Anti-Rh'	Anti-Rh''	
Rh ₁ (^{''})	Positive	Positive	Weak	Rh ₁
Rh ₂ (['])	Positive	Weak	Positive	Rh ₂
Rh ₀ (^{''})	Positive	Negative	Weak	Rh ₀
Rh(₀)'	Weak	Positive	Negative	Rh'

theory, a gene which reacts with anti-Rh₀ and anti-Rh', but not with anti-Rh'' (Table 14). Genotype cDE is the same as R^2 and reacts with anti-D (anti-Rh₀), anti-E (anti-Rh''), and anti-c (anti-Hr'). Genotype cDe is r^0 and reacts with anti-D (anti-Rh₀), anti-c, and anti-e (anti-Hr''). Similarly Cde is R' , reacting with anti-C (anti-Rh') anti-d (anti-Hr₀), and anti-e, and cdE is R'' and reacts with E (anti-Rh''), anti-d, and anti-c. Genotype cde corresponds to r and reacts with anti-c, anti-d, and anti-e sera. A third allele has been found at the C locus; it is called C^w .

Both theories have their advocates and it is unnecessary now to decide between them. They raise again the interesting problem of multiple alleles versus closely linked genes, a problem which was mentioned in Chapter 10. As long as genes C , D , and E are completely linked, the question is largely an academic one. If

there is crossing over, it should be small in amount and difficult to prove.

QUESTIONS AND PROBLEMS

1. Blood from a group O rabbit is injected into a second rabbit. Blood from the second rabbit is then mixed with blood from all four groups. With which groups, if any, will a positive agglutinin reaction be obtained?

2. What agglutinins will develop in the blood of a group O rabbit if blood is injected into it from (a) group H_1 ; (b) group H_2 ; (c) group H_1H_2 rabbits?

3. A person of blood group B is injured and must be given a transfusion. You, the physician, are offered blood from people of all four groups. Which groups would you accept and which would you reject? Why?

4. What would be the blood groups of the offspring of the following crosses:

$$(a) OO \times AO$$

$$(b) OO \times BO$$

$$(c) AO \times AB$$

$$(d) AB \times BO$$

$$(e) BB \times BO$$

5. Mrs. W is of group A and Mr. W is of group B. Mrs. Y is of group AB and Mr. Y is of group B. There are four children, one of each group. Can you identify any child as the offspring of one couple but not of the other? Could any of the children be the offspring of either couple?

6. What may and what must be the blood groups of the children of the following crosses:

$$(a) \text{Group O and group B}$$

$$(b) \text{Group B and group AB}$$

$$(c) \text{Group A and group B}$$

$$(d) \text{Group O and group O}$$

$$(e) \text{Group AB and group O}$$

7. If the mother is of group O, to which blood groups can the father *not* belong if the children are of (a) group A; (b) group O; (c) group B?

8. What may be the blood types of the children of the following crosses:

- (a) Type M \times type N
- (b) Type MN \times type MN
- (c) Type N \times type MN
- (d) Type M \times type M

9. In the following cases, to which types may the father belong:

- (a) Mother is type M; child is type M
- (b) Mother is type M; child is type MN
- (c) Mother is type MN; child is type M

10. What are the offspring from the following crosses among rhesus blood types:

- (a) $R^0r \times r^0r$
- (b) $r^0r \times R'r$
- (c) $R^1r^0 \times R^1R'$
- (d) $R^1r^0 \times R'R''$
- (e) $R^1r^2 \times R'r$

11. From the point of view of the offspring, is it more or less desirable for an R-negative man to marry an R-positive woman than it is for an R-positive man to marry an R-negative woman? Explain.

12. Provided there is no agglutination because of the A-B or M-N blood groups, is there any objection if: blood from an R+ woman is injected into an R+ woman; blood from an R+ woman is injected into an R- woman; blood from an R- woman is injected into an R+ woman? Would it matter in any of these cases if the R- woman had had a child by an R+ man?

Chapter 20

GENE ACTION

It was pointed out in earlier chapters that inherited characters are the result of the interaction of certain alleles with all the other genes of the organism and with the environment. Thus we say that one plant has white flowers because it has genes for white flowers and another has red flowers because it has the allele for white flowers. These two alleles, superimposed on the same genetic background and in plants which develop under the same environmental conditions, will produce two strikingly different results. Why? Unfortunately, this question is not easily answered on the basis of our present information. We have a good understanding of the manner in which genes are transmitted from one generation to another and we know the phenotypic and genotypic ratios to be expected from certain types of crosses, but the reasons why certain genes produce certain phenotypes while their alleles produce others are still much of a puzzle. For a number of genes we have some evidence that may indicate a clue to this problem, but there is much still to be learned of the action of genes in general. This phase of genetics is closely allied to both embryology and biochemistry.

In considering gene action, we must realize that the individual is a unit and not merely an aggregation of a large number of smaller units. The individual usually starts out as a fertilized egg. This zygote divides and the two cells which result from that division divide. Many cell divisions follow until the mature plant or animal is produced. As the cells divide, differentiation takes place, for some cells assume different shapes and sizes. This differentiation in form is accompanied by a differentiation in function. Thus the individual becomes gradually differentiated until the final, mature form is attained. Some of the steps in this differentiating process occur early and affect

a large part of the individual; others occur later in development and produce only small, localized effects.

The development of an individual involves many complicated chemical and physical interactions. The unfertilized egg consists of a nucleus containing cytoplasm and one haploid set of maternal chromosomes. To this, on fertilization, are added a haploid set of paternal chromosomes and perhaps a trace of paternal cytoplasm. This fertilized egg is oriented in a certain position and is in a given environment which is normal for that species. This orientation may have a definite effect on development, subjecting part of the egg to certain stimuli that the rest of the egg does not receive. Whatever the cause, the early stages of development of an embryo are usually a characteristic of a species or a larger group.

Let us take *Crepidula*, the slipper limpet, as an example. The zygote divides into two large cells, which then divide to form a quartet of four *blastomeres*. These cells divide to form four cells much smaller in size, called *micromeres*. The large blastomeres are referred to as *macromeres*. Another quartet of micromeres is then formed from the macromeres. The first set of micromeres divides so that the sixteen-cell stage consists of twelve micromeres and four macromeres. The left posterior macromere then divides to form a cell known as the 4D cell (Fig. 84). Successive divisions of the various cells proceed to form the embryo. It is important to recognize that these successive divisions always occur in a regular manner and that the various groups of cells will develop into definite parts of the animals. The four macromeres, exclusive of the 4D cell, form the entire endoderm of the adult and the micromeres produce the ectoderm; from the 4D cell develops the entire mesoderm of the mature animal.

The earliest stages in the development of an animal seem to be directed by the cytoplasm of the egg, which is, of course, purely maternal in character.

The complete development from the unfertilized egg to the mature individual is an extremely complicated series of phenomena even in those forms that we generally regard as "lower" animals. There is considerable variation in the developmental pattern in the various forms, but one thing stands out. Within each species there is a certain pattern of development that is

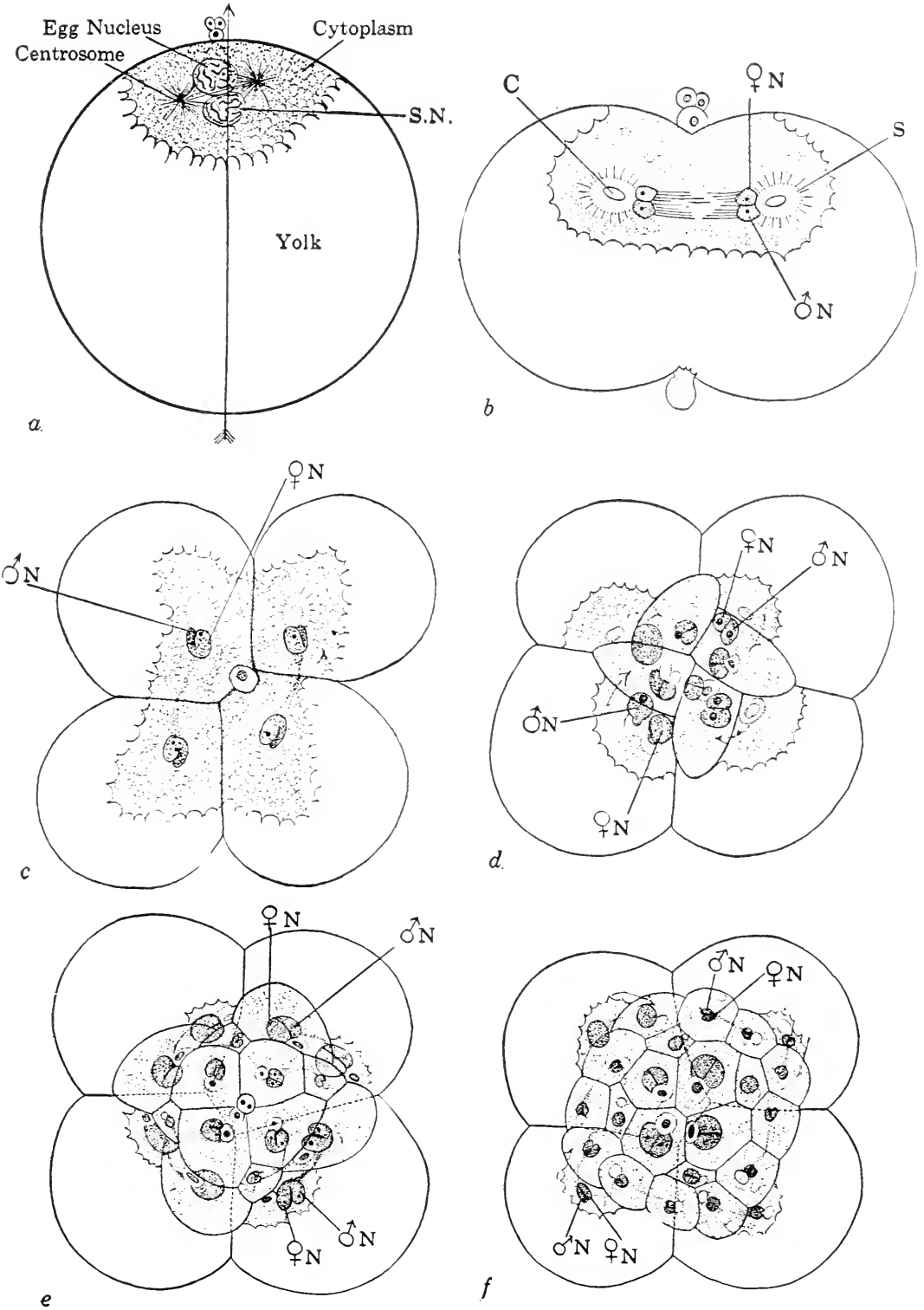

FIG. 84. Early stages in the development of the egg of the mollusk, *Crepidula plana*. The male and female halves of each nucleus are indicated. (Courtesy of Dr. E. G. Conklin. b-f from *Heredity and Environment* with permission of the Princeton University Press.)

normal. If any serious disturbance to this pattern occurs, developmental processes following such a disturbance are no longer normal, and growth and development thereafter fail to follow the normal pattern. Such a disturbance may be genetic or it may be environmental.

The processes of development are many and complicated. During the earliest stages, just after fertilization, various currents appear in the cytoplasm which initiate the whole developmental pattern and start development off in the manner of that species. Such plasma flowings are described in detail by Conklin for *Crepidula plana*. Modifications due to environmental influences may change the normal currents and thus alter normal development. Later development seems to be due to chemical reactions between the genes of the two species and the cytoplasm and may also be disturbed by unusual conditions of the environment. Unless these conditions are extreme, however, development proceeds normally according to the pattern of the species. Although all gene products are interacting at all times, it is probable that the differences between two organisms that are unlike by only one pair of alleles occur at the time the organs specifically affected by those genes are developing.

In the vestigial and wild-type fruit flies, the *vg* and *vg*⁺ genes in both organisms are interacting with the other genes and with the cytoplasm during the earliest stages of development, but up to the time of wing formation and growth, no differences between the two types of flies can be detected. When the wing is being formed, however, these two genes are still interacting with other genes and with the cytoplasm, but now the reaction is of such a nature that the two types can be differentiated. During wing formation, one gene affects the developing wing in such a way that it remains small and poorly developed, whereas in a related fly, even a sib, the other gene affects the developing wing so as to cause it to develop "normally." Thus, while all genes are probably producing gene products throughout development, the difference between two alleles will not be obvious until a certain organ has reached a certain state of development. The time at which the action of a gene becomes noticeable phenotypically differs with different genes. Some genes appear to act early because they affect an organ that develops early; other genes do not come into prominence until much later. Some genes that

have an early effect, such as genes for general growth, affect all subsequent development; other genes, such as the eye-color genes in *Drosophila*, have an early differential effect and then no longer exert any striking influence.

In a recent symposium, Wright has made some interesting suggestions regarding the physiology of genes. He has considered especially the method by which a gene produces more genes, the way it controls metabolism, and its behavior in connection with the growth of an organism.

We have previously pointed out that most geneticists believe that a gene is produced by the reproduction of a preexisting gene, which in some generally unexplained way produces another gene like itself. Wright has shown that genes are not completely autonomous but show a high degree of autonomy. He pointed out also that a gene is a highly specific giant nucleoprotein and that to consider that it might be built up in a step-by-step fashion from very simple substances is to assume a very complex process. He thought that it is more likely that within the living cell various simple molecules from the nutrients that are present are arranged on the surface of the gene in such a way that the gene itself is duplicated (Fig. 85).

Many cell processes occur as the result of the action of numerous enzymes. Available information seems to indicate that these enzymes are proteins, or proteins combined with a group known as a prosthetic group, and generally obtained by the organism from its food as a vitamin. It is generally believed, also, that these enzymes are produced by gene action. A way they might be produced has been suggested by Wright and is pictured in the second section of Fig. 85. There is an obvious relationship between the synthesis of enzymes and of new genes.

Wright has also pointed out that certain phases of growth involve the multiplication of proteins specific to the species and to the individual. In this respect, growth is closely connected with these other aspects of gene physiology that we have just mentioned. If these proteins are produced in much the same manner as the genes and enzymes just described, the problem arises that the gene must have to produce millions of protein molecules to account for a doubling of a cell, whereas each gene produces only one daughter gene between these cell divisions. This tremendous production of proteins must be accounted for.

As shown in the third section of Fig. 85, Wright has suggested that special genes in the nucleus may produce model nucleoproteins which migrate into the cytoplasm, where they retain their genic property, although this property is subject to decay, at least along the germ line. These model nucleoproteins then duplicate themselves many times in the cytoplasm and thus

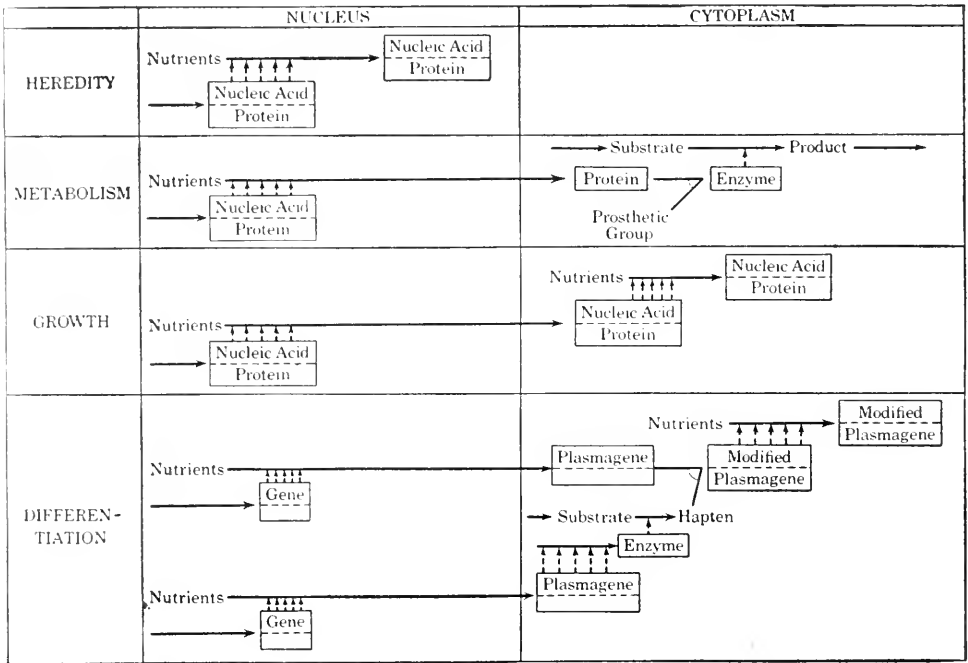

FIG. 85. Wright's scheme of gene action. For explanation, see text. (After Wright in the *American Naturalist*.)

build up the large numbers of proteins necessary to produce a new cell by cell division.

A suggestion concerning the way various cells become differentiated is given in the lowest section of Fig. 85. This scheme seeks to throw light on the problem of how a simple, undifferentiated cell in one particular region becomes a tracheid while another one near it becomes a parenchyma cell, a fiber, or a cell of the phloem. Our knowledge is by no means complete, but there is considerable reason to believe that this differentiation has a cytoplasmic basis. Wright's suggestion is that the cytoplasmic differences which cause cells to differentiate into cells of different shapes, sizes, and functions result from a controlled mutation of plasmagenes. As Fig. 85 shows, plasmagenes are

produced by the ordinary genes found in the nucleus. Different chemical groups which become available under special conditions then combine with these plasmagenes to modify them. The hapten which modifies a plasmagene may be of the nature of a hormone but may be produced as the result of gene action.

Whether this picture of Wright's is the correct explanation of gene physiology we cannot say at present. All these processes, however, whether gene formation, cellular metabolism, cell growth, or cell differentiation, are based on the belief that genes can synthesize substances like themselves.

Eye-Color Hormones in *Drosophila*

Gene products have been mentioned frequently. The curious reader will surely ask what gene products are and how they act. This question is not easy to answer because, being of an intracellular nature, they do not lend themselves readily to experimentation. It is generally believed that gene products are of the nature of catalysts or hormones, but experimental evidence to support this view is not extensive. Occasionally, however, the presence or absence of certain hormones in individuals of a certain genotype has been demonstrated.

Beadle, Ephrussi, Tatum, and others have given us considerable knowledge of the hormones necessary for the development of the wild-type eye color in *Drosophila melanogaster*. They found that two water-soluble hormones, v^+ and cn^+ , must be present for the development of the particular shade of red found in the eye of the wild-type fly. In the wild type, two pigments must be present. One pigment is soluble in water. Its color depends upon the acidity of the solution in which it is found, for it is red in a base and yellow in an acid. Since it is normally red in the wild-type fly, it can be considered a red pigment. The other pigment is insoluble in water and is brown, but if it is oxidized it is yellow and if reduced is red. In the wild-type fly both reduced and oxidized forms are present in equilibrium, and the color is brown.

The exact shade of the eye will depend upon the relative amounts of these two pigments. In the white-eyed fly, neither pigment is present, and the eye is colorless or "white." If the red pigment alone is absent, the eye is brown. Such an eye color is found in flies homozygous for the recessive gene, bw , but

possessing all the other wild-type alleles. If the brown pigment is absent or reduced in amount, the eye is redder than in the wild type. In the cardinal (*cdcd*) fly, there is less brown pigment than in the wild type and consequently the eye color is closer to the red color. In the vermilion (*vv*) and cinnabar (*cncn*) types, there is no brown pigment and the eye is bright red. Definite hormones have been discovered which are necessary for the formation of the brown pigment. In the vermilion flies, the v^+ hormone is absent, and therefore the brown pigment is not formed. In the wild type, this hormone is present. The v^- hormone is formed in the Malpighian tubules, in fat bodies, and in the eye tissue. In the cinnabar fly, the v^+ hormone is present, but another hormone, the cn^+ , is absent. This hormone is also necessary for the formation of brown pigment, and is formed in the wild-type fly in the Malpighian tubules and in the eye but not in the fat bodies. The cn^+ hormone is formed from the v^+ hormone.

Chemical studies have carried even further our knowledge of pigment formation. The ultimate basis of the brown pigment is tryptophane. In the wild-type fly, the v^+ gene produces an enzyme which oxidizes tryptophane to another substance, kynurenin, which seems to be the v^+ hormone. The chemical relationship of these two substances is:

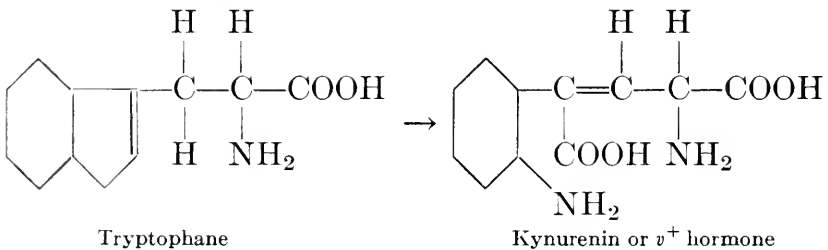

Of course, if the v^+ gene is not present, v^+ hormone is not formed and none of the subsequent steps in the formation of the brown pigment can occur. Actually, even in the vermilion fly, a small amount of kynurenin is formed. Most of it is converted into the inactive kynurenic acid, but a very small amount is converted into brown pigment.

In the wild-type fly, some of this kynurenin is probably transformed into the inactive kynurenic acid, but much of it is transformed into cn^+ hormone by an enzyme secreted by the cn^+

gene. This is probably also an oxidation. In the wild-type fly, further chemical changes occur which convert this cn^+ hormone first into a tan pigment and then into the brown pigment. This chain of reactions is not well understood and may be modified by other mutant genes. In the scarlet (*stst*) and cardinal (*cdcd*) types, the cn^+ hormone is affected in such a way that the full amount of brown pigment is not produced.

Much of the early knowledge of these hormones resulted from transplantation studies. If pieces of tissue (*anlage*) which will develop into an eye are injected into the body cavity of another larva, they will develop into normal eyes within the body cavity. They can later be dissected out and studied to observe whether the tissues of the host have produced any changes in them. When wild-type eye tissue is transplanted into vermilion or cinnabar hosts, the transplanted eyes develop into wild-type eyes because they secrete their own v^+ and cn^+ hormones. If, however, pieces of eye tissue from vermilion or cinnabar are transplanted into wild-type larvae, they develop into wild-type eyes. In their own bodies they would be vermilion or cinnabar because of the absence of v^+ or cn^+ hormone. In the wild-type flies, however, large amounts of these hormones are produced and they are diffusible. They then diffuse into the developing transplanted eye tissue and supply the hormones necessary for the development of these transplanted eyes into the wild type.

An interesting feature of these hormones is that they are apparently not specific to *Drosophila*. In the moth, *Ephestia*, a hormone is produced which seems identical in every way with v^+ hormone. This hormone can also be synthesized by a certain species of bacterium. This species of bacterium will produce a large amount of a substance that is apparently identical with v^+ hormone if it is grown under aerobic conditions on a medium which contains tryptophane. In fact it was this situation which led to the discovery of the relation of tryptophane and kynurenin to the v^+ hormone.

Growth Hormones in "Lazy" Maize

Another example of a known hormonal situation correlated with gene action is the behavior of "lazy" maize. This type is homozygous for gene *la* in the fourth chromosome. If normal maize plants are tilted at an angle or are placed on their side

during development, the growing tip of the stem curves upward and the new growth is upright. Such growth is said to be negatively geotropic because it is against the direction of gravity. Lazy plants, however, when placed at the same angles fail to bend upward and continue to grow in the direction in which they are placed. Numerous studies during the 1930's have shown

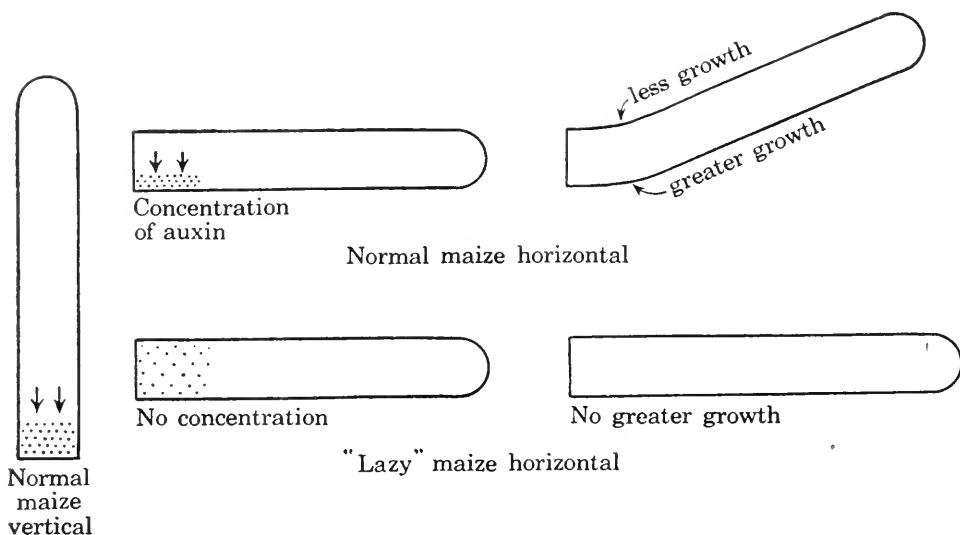

FIG. 86. Diagram to indicate the action of auxin in maize stems. When a normal branch is placed on its side, the hormone becomes concentrated on the lower side, causing this side to grow more rapidly than the upper and thus causing the stem to grow upwards. In the homozygous recessive "lazy" type, there is no movement of the hormone to the lower side; there is no greater growth there, and the stem does not curve upwards. (Based on the work of van Overbeek.)

that growth in plants can be stimulated by a hormone known as "auxin." When a normal maize plant is placed on its side, this auxin diffuses because of gravity to the lower part of the stem. Growth is then stimulated on the lower side, and the lower side grows more rapidly than the upper. This greater growth of the lower side makes that side longer than the upper and the stem bends upward (Fig. 86). In lazy maize, there is no such redistribution of the auxin, the lower side does not grow more rapidly than the upper, and the stem continues to grow straight and does not bend upward. The *la* gene apparently interferes with the distribution of auxin which occurs in *La* plants. This is another example of a phenotypic effect produced by a gene by the action of hormones.

Van Overbeek has also demonstrated another auxin relationship in maize. A recessive gene, *na*, when homozygous, produces dwarf plants. Studies of the auxin content of the stems show that these dwarfs form auxin but apparently have an enzyme which causes it to be oxidized. The oxidized auxin has little or no growth-stimulating effect, and the unoxidized auxin content of *nana* plants is lower than in normal plants. This reduced amount of active auxin prevents the cells of the internodes from elongating to the same extent as cells in a normal plant, and the net result is a plant with shorter internodes and therefore smaller height.

Enzymes

It has long been known that the speed of certain chemical reactions will be greatly accelerated or retarded if certain other substances are present even in small amounts. Substances which thus affect the rate of a chemical reaction are called *catalysts*. Similar substances may be found in living organisms, and many of them are very important in the metabolism of the plant or animal. These organic catalysts, found in living organisms, are known as *enzymes*. Hormones are very similar but act on the organism in a different region from the one where they are produced.

That genes may act as enzymes or that they might produce enzymes as intermediate products in the development of a character has long been postulated, but the actual cases in which an enzyme has been identified are not yet numerous. One definite enzyme has recently been demonstrated in white clover. Certain chemical substances of the type known as *glucosides* can be converted into hydrocyanic acid if an appropriate enzyme is present. Chemical tests have shown that white clover plants possessing a certain dominant gene have a cyanogenetic glucoside in their tissues and those homozygous for the recessive allele lack this glucoside. Another dominant gene will produce the enzyme whereas homozygous recessives will lack the enzyme. By appropriate crosses, plants can be obtained which (1) possess both glucoside and enzyme, (2) possess the glucoside but not the enzyme, (3) possess the enzyme only, or (4) possess neither the enzyme nor the glucoside. These plants are good illustrations of the direct production of a specific enzyme by a certain gene.

Chlorophyll

Normal, green plants possess the green pigment, chlorophyll, so necessary for their life. Because of the presence of certain genes, however, many plants have a smaller amount of chlorophyll pigment than is normal for individuals of that species. There are several types of chlorophyll-deficient plants which differ chiefly in the amount of chlorophyll present. Some normally green plants have no chlorophyll and live only a short time.

Other Plant Colors

Colors other than chlorophyll have been studied in a number of plants both genetically and chemically, and it has been shown in some instances that a certain gene acts by producing a specific chemical reaction. Such information is largely due to the work of Wheldale (Mrs. Onslow), Scott-Moncrieff (Mrs. Meares), and Lawrence. These studies show that genes can control the production of the yellow plastid pigments, of the soluble yellow flavones, and of the anthocyanins, which produce the blue and red colors so frequently found in plants. Other genes are known which bring about the oxidation of pigments or cause differences in the acidity of the cells where the pigments are found. As the anthocyanins are indicator pigments, being red in the presence of acids and blue in the presence of bases, the pH of the cell sap in which these pigments are dissolved is of importance in determining their color.

Lawrence, Scott-Moncrieff, and Sturgess have shown that in hybrids between *Streptocarpus Rexii* (blue) and *S. Dunnii* (red), seven types of flower color may be produced by the interaction of four pairs of alleles. Chemical analyses of the flowers demonstrate what particular anthocyanin pigments are present in each flower type. Flowers homozygous for *a* have no anthocyanin and are ivory white. Anthocyanin pigment is produced by the allele *A*. This anthocyanin is derived from the chemical substance, pelargonidin, in the absence of genes *R* and *O*. If *R* is present, the anthocyanins are derived from cyanidin, whereas if *O* is present, they are derived from delphinidin. The pink and salmon types are *rr oo*. Gene *R* adds one hydroxyl or methoxyl group to the anthocyanin molecule and changes the color

to magenta or rose, whereas gene *O* adds two such groups, changing the color to blue or mauve. Thus it is seen that the more the hydroxyl or methoxyl groups, the bluer the color. It is also seen that genes can act by bringing about chemical substitutions in a complex organic molecule. Another gene, *D*, brings about a further change, causing hexose molecules to be substituted at positions 3 and 5 on the pigment molecule, and in *dd* plants a hexose and pentose molecule is at position 3 and no substitution at 5. Structural formulae for three of these types are shown in Fig. 87.

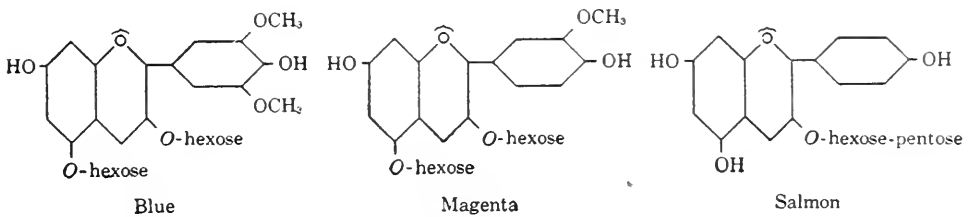

FIG. 87. Structural formulae for three anthocyanin types in *Streptocarpus*. (Redrawn from Lawrence, Scott-Moncrieff, and Sturgess in the *Journal of Genetics*.)

Color in Animals

As in plants, enzymes appear to play an important role in the determination of color in animals. The black pigments of animals belong to a group known as the melanin pigments, which result from the reaction of a chromogen, such as tyrosin with an enzyme. If either the chromogen or the enzyme is missing, the pigment does not develop. One of the earlier studies shows that in rabbits the presence or absence of color depends upon the enzyme, for the chromogen is present even in albinos. Onslow found that in dark-colored animals enzymes of the type known as peroxidases were present which react with tyrosin to produce the melanin pigment; in albinos this enzyme was absent and the pigment could not be formed. Wright has postulated two enzymes to explain pigment in animals in general. Both these enzymes can oxidize chromogen, but they act in different ways. He assumes that the chromogen is present in all individuals. If one of the enzymes is present (enzyme I), the chromogen is oxidized and a yellow pigment is formed. If the second enzyme is also present (enzyme II), it interacts with enzyme I and the two together react with the chromogen to

produce a darker color such as brown or black. Both enzymes are oxidizing enzymes, but enzyme II has no effect unless enzyme I is also present. The exact color produced will depend not only upon the presence of these two enzymes but also upon their relative amounts and potencies. As these factors may vary with different genes, a wide variety of colors may be produced. Thus a number of different possibilities exists even with a system involving only two enzymes. The important thing is that all these chemical differences are the result of gene action.

Vitamins in Neurospora

Beadle and Tatum have shown that certain gene mutations can be induced which will prevent the synthesis of certain vitamins by the ascomycete *Neurospora*. They grew strains of this fungus and then subjected them to X-rays just before meiosis with the purpose possibly of inducing gene mutations. Single-spore cultures from the X-rayed material were then grown on a medium containing as many as practicable of the chemical substances which this fungus normally synthesizes. When established, they were transferred to culture media containing none of these substances. The theory was that if a strain grew on the "complete" medium but not on the other, a gene mutation had occurred which prevented the mutated strain from synthesizing something, since the untreated fungus will grow well on media which do not contain any of these substances. By then growing the mutated strain on a series of media lacking different ones of these constituents, it could be determined which particular substance the fungus could not synthesize. About 2000 such strains were grown, and three were found that could not grow on the "incomplete or minimal" medium. Subsequent tests showed that one strain could not synthesize vitamin B₆ (pyridoxine), the second could not synthesize vitamin B₁ (thiamine), or more exactly the thiazole half of the B₁ molecule, and the third strain could not synthesize para-aminobenzoic acid. All three mutations were proved to be single-gene mutations. Since all these substances are essential for growth, and since they are normally synthesized by this fungus, this is an example of genes which normally act by the synthesis of certain chemical growth substances.

Genes Affecting Form

Genes have been found which affect the ratio of growth of organs or parts of organs and in that way determine the final size and shape that an organ will have. For example, Sinnott showed that if two squash plants were crossed, one of which bore essentially round fruit known as "sphere" and the other a flattened type known as "disc," all the F_1 plants had disc-shaped fruit, whereas the F_2 segregated into a ratio of three discs to one sphere. Studies indicated that one locus was involved and that the gene for disc was completely dominant over its allele for sphere. Such a statement, however, considers only the end product and does not begin to show what is the true relationship of these alleles as functional units and *why* the effect in one case is a disc-shaped and in the other case a sphere-shaped fruit. Other types of squashes and gourds are of still a different shape. Although the difference is sometimes due to more than one gene, the important facts in all these questions of the development of form are that, irrespective of the number of genes involved, the development of the fruit is under genic control and it may be possible to determine at least some of the steps by which two different genotypes produce two different phenotypes.

The difference in shape between the disc and sphere cucurbit fruits is caused by a difference in shape which is present as soon as the ovary primordia are. In other words, these two genes act very early in the life of the ovary, producing differences in the two ovaries as soon as the ovaries can be identified. Only very small changes occur during all subsequent development of the ovary and fruit, so that final differences in shape are due to initial differences in shape. Such a discovery advances our knowledge slightly, but merely pushes the problem back a little. Instead of asking now why the gene difference produces a difference in fruit shape, we ask why the gene difference produces a difference in the shape of the ovary primordia.

Initial shape differences do not explain all the differences in the shape of the various races of gourds, for some gourds which differ greatly in shape when mature have ovary primordia that are practically indistinguishable. If two races have identical ovary primordia, they will have fruit of the same size and shape

if they grow at the same rate for all dimensions. If, however, one developing ovary grows more rapidly in length, whereas length and width grow at the same rate in a second type or the second race grows more rapidly in width, the two fruits will have a very different shape when mature (Fig. 88).

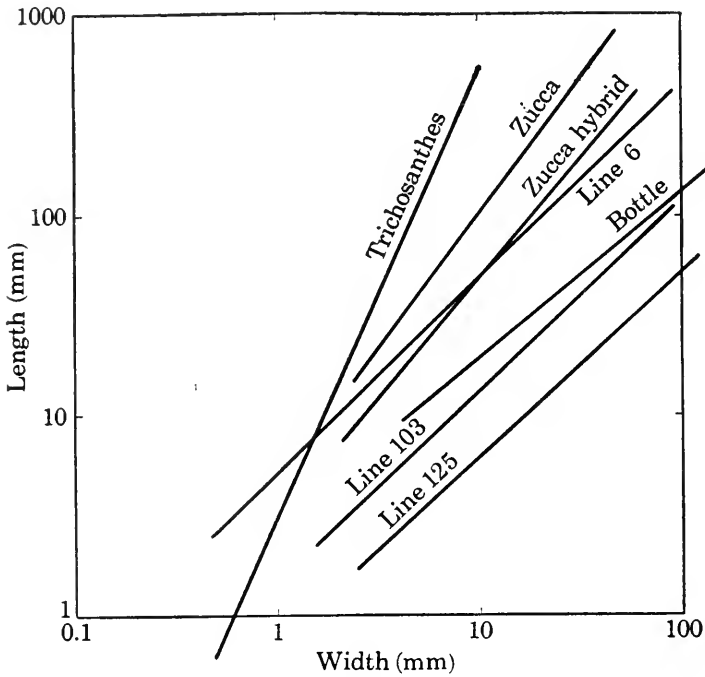

FIG. 88. Developmental lines showing differences in relative growth of length and width in various cucurbit fruits. Lines 6, 103 and 125 are *Cucurbita Pepo*. "Zucca" and "bottle" are varieties of *Lagenaria vulgaris*. *Trichosanthes* is the "snake gourd." (From Sinnott in the *American Naturalist*.)

In *Cucurbita Pepo* the relative growth rates of the length and width of the fruit are almost equal and large fruits have almost the same shape as small ones. In the "bottle" gourds growth is considerably faster in width, and the fruits become *increasingly* wider the longer they grow; but the "Hercules club" or "zucca" fruits grow more rapidly in length. In contrast to the disc and sphere fruits, the genes that produce differences in the shape of the bottle and zucca types act after the ovary is formed and throughout subsequent development.

In *Cucurbita Pepo*, where length and width increase at almost the same rate, the spindles of the dividing cells are oriented in all directions approximately equally. In *Lagenaria*,

the ovary grows considerably faster in length than in width, and in this plant more mitotic spindles run lengthwise or nearly so than in any other direction; and in *Trichosanthes*, the "snake" gourd in which the ovary grows much more rapidly in width than in length, an even higher percentage of the spindles are oriented parallel to the long axis of the developing fruit. When there is a tendency for the spindles to be oriented, those in metaphase and anaphase are even less oriented than those at telophase. Apparently the ultimate position of the spindle is determined by the polarity of the cytoplasmic body of the cell, but the spindle shifts its position somewhat until it settles down at telophase to the final position. This cytoplasmic polarity of the cells of the ovary is a determining factor in the ultimate shape of the ovary. It is, of course, itself under genic control. How the "shape" genes affect this polarity of the cytoplasm is not easily determined.

Some interesting studies of a similar nature were made by W. G. and C. Y. Whaley on leaves of the common nasturtium of the garden, belonging to the genus *Tropaeolum*. Mature leaves of several shapes and sizes were found. In the juvenile condition, all types have leaves with prominent lobes and sinuses. In one type whose genetic constitution is *lluu*, the lobes enlarge at about the same rate as the sinuses, and the mature leaf is deeply lobed and looks like merely an enlarged version of the juvenile leaf. When the dominant allele *U* is present, as in *llU-* plants, the sinuses grow somewhat more rapidly than the lobes, and the mature leaf is roundly lobed in outline. In the presence of gene *L*, as in *L-U-* and *L-uu* plants, the growth of the sinuses is very much more rapid than of the lobes and the mature leaves are orbicular (Fig. 89). The presence of *L* and *U* in the same plant also appears to produce a greater absolute growth. Studies of cell size in these three types indicates that in the youngest juvenile leaves there are more cell divisions in the sinus regions of the roundly lobed and orbicular types than in the acutely lobed type, and, therefore, there are more cells. Later, during the period of cell expansion, all the cells of a given tissue tend to expand to approximately the same size. Consequently, the leaves which have more cells per unit of area in the sinuses have shallower sinuses when mature and sometimes become rounded. The direct action of the gene seems to be

the control of cell division in the very young leaves so that some forms have more and smaller cells whereas others have fewer but larger cells. The results of the different number of cells are leaves of different shape. Whereas superficial studies would

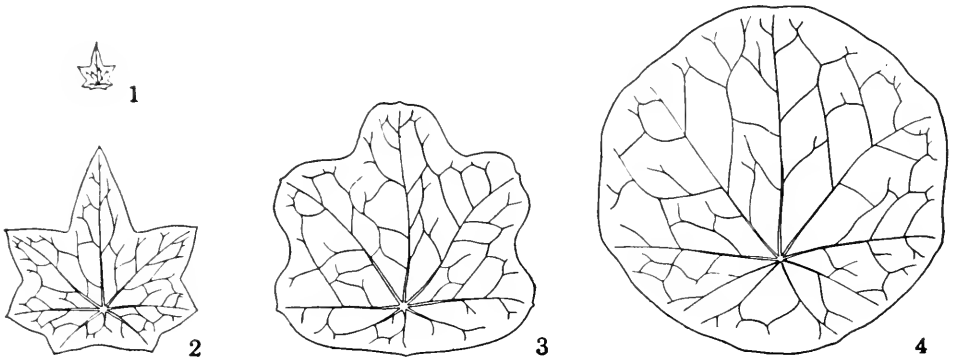

FIG. 89. Leaf types in the common nasturtium and their development: (1) a juvenile leaf; (2) an acutely lobed leaf of the genotype uu ; (3) a roundly lobed type, uU -; (4) the orbicular type, $L-uu$. (Courtesy Dr. W. G. Whaley in the *American Journal of Botany*.)

tend to have us speak of a gene "for round leaves," a more accurate statement would be a gene "for more cells per unit of area in the sinuses of juvenile leaves."

Genes and Cytoplasm

Although the exact role of the cytoplasm in heredity is not known, there is much evidence that the genes interact with the cytoplasm in such a way that the cytoplasm may be changed as the result of the action of genes. The individual begins his or her development under the influence of a certain cytoplasmic pattern found in the egg, but his or her own genes may so influence the cytoplasm that it would have a different pattern in the eggs of subsequent generations.

The coiling of snails illustrates the role of the maternal cytoplasm in certain cases. In the gasteropod mollusks, the mature shell is twisted into either a right- or left-handed spiral. It has long been known that the type is determined by the position of the mitotic spindle at the second or perhaps even at the first division of the egg. Thus, at a very early stage of ontogeny, the type of spiral is determined. The inheritance of this character is interesting for, although it appears to be dependent

upon a single pair of alleles, the expression seems to be delayed one generation. Apparently left-handed (sinistral) coiling is recessive to right-handed (dextral). Let us use l to designate the gene for left-handed coiling and L the gene for the right-handed type.

In the cross $Ll \times ll$ (dextral female \times sinistral male), half the offspring are Ll and half are ll . They are *all* coiled dextrally, however, because their type of coiling was initiated under the influence of the cytoplasm of the egg from which they were produced, and this egg, in turn, had developed under the influence of the genotype of their mother. Similarly, if a sinistral-type female is crossed with a homozygous dextral-type male, the offspring are all Ll ; but they all coil to the left because they started to coil in that direction very early in ontogeny under the influence of the cytoplasm of the egg produced in a snail which was homozygous for gene l . Thus in the cross $ll \times LL$, the F_1 are sinistral but Ll , all the F_2 are dextral, and the F_3 segregate into a 3 : 1 ratio. The particular type of coiling does not indicate the genotype of the individual but does show the genotype of its mother.

Chapter 21

INTERACTION OF GENES

In Chapter 9 dihybrid ratios were described in which one pair of genes affected one part of the plant and the other pair affected an entirely different part. In the maize cross, $PlPl CrCr \times plpl crcr$, the genes Pl and pl affect the color of the plant, and Cr and cr determine whether the leaves will be smooth or crinkly. Examples of dihybrid ratios where two different regions of the organisms are involved could be cited by the thousands. Less numerous but by no means rare are cases where the two pairs of genes affect the same part of a plant or animal.

In the simplest situation of gene interaction in a dihybrid both pairs of genes affect the same part of the same organ. Four different phenotypes are produced, for the AB , Ab , aB , and ab classes are all phenotypically different from one another. In the evening primrose, *Oenothera Lamarckiana*, the nonallelic genes S and V together produce a yellow flower; S and v produce a flower that is old-gold in color; s and V together produce a sulfur-colored flower; and s and v interact to produce a flower called "gold-center." Thus a cross between a homozygous sulfur-colored plant (mutant *sulfurea*) and a homozygous old-gold (mutant *vet aurea*) would produce a yellow-flowered F_1 . The F_2 would segregate into $9SV$ (yellow) : $3Sv$ (old-gold) : $3sV$ (sulfur) : $1sv$ (gold-center). This is a normal dihybrid ratio, but all four genes are exerting an effect on the same part of the organism. If one pair of genes is homozygous and the other heterozygous, the offspring will show typical monohybrid F_2 ratios, as:

$$SSVv \text{ (yellow)} \times \text{self} = 3SV \text{ (yellow)} : 1Sv \text{ (old-gold)}$$

$$ssVv \text{ (sulfur)} \times \text{self} = 3sV \text{ (sulfur)} : 1sv \text{ (gold-center)}$$

$$SsVV \text{ (yellow)} \times \text{self} = 3SV \text{ (yellow)} : 1sV \text{ (sulfur)}$$

$$Ssvv \text{ (old-gold)} \times \text{self} = 3Sv \text{ (old-gold)} : 1sv \text{ (gold-center)}$$

Both pairs of genes alone will segregate 3 : 1 ratios in the F_2 , but the actual color produced by the S and s genes will depend

on whether V or v is present; and the phenotypes produced by V or v will depend upon whether the plant also has S or s . The inheritance of the "rose," "pea," and "walnut" combs in fowl is of a similar nature, depending upon the interaction of two pairs of nonallelic genes.

Epistasis of a Dominant Gene

Two nonallelic genes do not always cooperate equally in the production of a different character, for sometimes one of them has so strong a reaction that it prevails over the other. Let us assume that gene A is dominant over a and that B is dominant over b . It is conceivable that the product of gene A could be so potent that it would prevail over the products of both B and b and make the AB and Ab phenotypes identical. Such reactions do occur and are probably of the same nature as the simple dominance of one allele over the other. The term "dominance," however, is best reserved for the relation between two *alleles*. When one gene exerts a dominating influence over another gene which is *not* an allele, the first gene is said to be *epistatic* and the gene which is suppressed is hypostatic. The phenomenon is called *epistasis*.

An excellent example of the epistasis of a dominant gene is found in the summer squash. Sinnott and Durham showed that two pairs of genes for fruit color were interacting in an epistatic-hypostatic relationship. Gene W is dominant to w and is epistatic to the Y and y genes. A plant with one or two W genes has white fruit. The other genes, Y and y , exert their effect only in ww plants. Plants which are ww and have one or two Y genes have yellow fruit, whereas $wwyy$ plants have green fruit. If a white-fruited plant homozygous for W and for the hypostatic dominant gene Y is crossed with a green plant, the F_1 is $WwYy$ and has white fruit. The F_2 segregates as follows:

$$\begin{array}{l}
 3W \left\{ \begin{array}{l} 3Y \rightarrow 9WY \\ 1y \rightarrow 3Wy \end{array} \right\} = 12 \text{ white} \\
 \\
 1w \left\{ \begin{array}{l} 3Y \rightarrow 3wY = 3 \text{ yellow} \\ 1y \rightarrow 1wy = 1 \text{ green} \end{array} \right.
 \end{array}$$

In these plants, genes w and Y interact to give yellow and w and y interact to produce green, but W interacts with both Y and y to produce the same character, white. A testcross of the heterozygote to a green plant would result in a ratio of 2 white ($1WY + 1Wy$) : 1 yellow (wY) : 1 green (wy).

TABLE 17

F₁ AND F₂ FROM VARIOUS COMBINATIONS OF CROSSES AMONG ROUGH-, SMOOTH-, NEAR-SMOOTH, AND INTERMEDIATE-AWNED TYPES OF DURUM WHEAT

(From work of Knowles in the *Canadian Journal of Research*.)

Phenotypes of Parents	Genotypes of Parents	F ₁	F ₂
rough × smooth	$RRss \times rrss$	rough ($Rrss$)	3 rough : 1 smooth
rough × intermediate	$RRss \times rrSS$	rough ($RrSs$)	12 rough : 1 intermediate : 2 near-smooth : 1 smooth
rough × smooth	$RRSS \times rrss$	rough ($RrSs$)	12 rough : 1 intermediate : 2 near-smooth : 1 smooth
intermediate × smooth	$rrSS \times rrss$	near-smooth ($rrSs$)	1 intermediate : 2 near-smooth : 1 smooth
near-smooth × smooth	$rrSs \times rrss$	1 near-smooth ($rrSs$) : 1 smooth ($rrss$)	1 near-smooth : 1 smooth or all smooth

Knowles has reported a study in wheat in which the hypostatic genes showed incomplete dominance. In *durum* wheat, gene R produces rough awns, whereas its recessive produces awns that are not rough. Another pair of genes, S and s , also affects the awns. If a plant is $rrSS$, it has awns intermediate between smooth and rough; if it is $rrSs$, the awns are nearly smooth; in $rrss$ plants the awns are smooth. Various crosses produce the results listed in Table 17.

Epistasis of a Recessive Gene

In summer squash, one dominant gene is epistatic, producing the same result when interacting with either the dominant or the recessive of the other pair. Similarly, a recessive gene may be epistatic and, if so, the F_2 dihybrid ratio becomes 9 : 3 : 4. An example of the epistasis of a recessive gene is found in the common bean, *Phaseolus vulgaris*. Gene P is dominant to p and gene B to b . Genes P and B interact to produce a purple color on the seed coat, and P and b interact to produce a yellow or brown color. The recessive gene p , however, is epistatic to the other genes and produces a white seed coat with either of them. This relationship could be illustrated by a "checkerboard," as in Fig. 90.

Many examples of the epistasis of a recessive gene, resulting in a 9 : 3 : 4 ratio, have been found. Baur showed that in the snapdragon, a white-flowered and an ivory-flowered plant, when crossed, produce a magenta-flowered F_1 , while the F_2 segregates into a ratio of 9 magenta : 3 ivory : 4 white. In flax, *Linum usitatissimum*, Miss Tammes showed that a lilac-flowered plant crossed with a certain type of white-flowered plant produces a blue-flowered F_1 , whereas the F_2 ratio is 9 blue : 3 lilac : 4 white. The relationship is not confined to plants. In such rodents as the mouse and the guinea pig, the normal wild type has a peculiar gray color, called *agouti*. This color is the result of two interacting genes, C and A . If two rodents which are heterozygous for both genes are crossed, the offspring fall into the ratio of 9 agouti (CA) : 3 black (Ca) : 4 white ($cA + 1ca$).

Most epistatic recessive genes are genes affecting color. A possible chemical explanation for them was suggested a number of years ago and throws some light on the general question of gene interaction. It can be assumed that (in the general situation) gene A produces a colored substance and that a produces a colorless substance. These substances would be chemical compounds. It can be further assumed that B produces a chemical that can react with the colored substance produced by A to change its color. In the specific example of Shull's beans, P produces a yellow pigment. This substance reacts chemically with the enzyme secreted by B so that it is converted from a yellow

substance to a purple one. Thus PB plants are purple. Since Pb plants have no color-changing enzyme, they are yellow. Plants with the genes pB and pb have no colored substance to begin with and are white. They are alike because B , the enzyme, has no colored substance with which to react and does not affect the gene product of p any more than b .



		♂			
		PB	Pb	pB	pb
F_2	♀ PB	 $PPBB$	 $PPBb$	 $PpBB$	 $PpBb$
	Pb	 $PPBb$	 $PPbb$	 $PpBb$	 $Ppbb$
	pB	 $PpBB$	 $PpBb$	 $ppBB$	 $ppBb$
	pb	 $PpBb$	 $Ppbb$	 $ppBb$	 $ppbb$

Total: $9PB =$ purple
 $3Pb =$ yellow
 $3pB$
 $1pb$ } = white

FIG. 90. Checkerboard showing the 9 : 3 : 4 ratio in beans. A cross of a homozygous purple, $PPBB$, and a white, $ppbb$, produces a purple F_1 ($PpBb$). The F_2 segregates into 9 purple (PB) : 3 yellow (Pb) : 4 white ($3pB$ and $1pb$). This can possibly be explained by assuming that P produces a colored and p a colorless chemical compound and that the colored compound is yellow in the presence of gene b but can be changed to purple by the enzyme B . (Based on the work of Dr. G. H. Shull.)

Inhibiting Genes

Since the dominant gene W in squash is epistatic over Y , W and w produce two different phenotypes in the presence of either Y - or yy genotypes, but the Y and y genes produce two different phenotypes only when the other recessive, w , is homozygous. The recessive gene a in rodents is epistatic to C and c so that the latter genes produce two different phenotypes in the presence of either A or a , whereas genes A and a produce two phenotypes only in the presence of the other dominant, C . In some organisms two genes, A and a , produce two different phenotypes in the presence of B but produce only one when b is homozygous, whereas genes B and b produce two phenotypes only in the presence of homozygous a and only one when A is present. Such cases are classically called *inhibiting factors*, but this situation has been appropriately called *dominant and recessive epistasis* by Snyder.

The classical example of this type of gene interaction is found in poultry. If white Leghorns are crossed with white Plymouth Rocks, the F_1 is white, but the F_2 segregates into 13 white : 3 colored. Two pairs of genes interact to produce color. Gene C is dominant over c , and I is dominant over i . Genes C and i together produce a colored fowl, but the combinations CI , cI , and ci are white. Gene C is thought to be a dominant gene which would produce color, but I is regarded as a gene that inhibits the action of the gene product of C . White Leghorns are homozygous for C and would be colored except for the fact that they are also homozygous for I , which inhibits C from producing color. White Plymouth Rocks are $cc ii$ and are white because they lack any gene that can produce color. A cross of these two breeds produces the following results:

White Plymouth Rock × White Leghorn
 cc ii *CC II*

F_1 : $Cc Ii$ = white because of inhibiting gene

$3C$ $\begin{cases} 3I & - & 9CI = \text{white because of inhibiting gene} \\ 1i & - & 3Ci = \text{colored because of no inhibition} \end{cases}$

F_2 :

$1c$ $\begin{cases} 3I & - & 3cI = \text{white because of no color-producing gene} \\ & & \text{and a color inhibitor} \\ 1i & - & 1ci = \text{white because of no color-producing gene} \end{cases}$

A 13 : 3 ratio is obviously a case of a 9 : 3 : 3 : 1 ratio in which three of the terms appear alike. Independently, the *I* and *i* genes give a 3 : 1 ratio in the presence of *C* but not in *cc* individuals. Thus $CC\ II \times CC\ ii$ gives a white F_1 ($CC\ Ii$) and an F_2 ratio of 3 white (CI) : 1 colored (Ci); but $cc\ II \times cc\ ii$ gives a white F_1 ($cc\ Ii$) and all white in the F_2 ($3cI + 1ci$). Similarly, the *C* and *c* genes give a 3 : 1 ratio in *ii* fowl but not when gene *I* is present. An inhibiting gene is generally regarded as a gene that has no effect of its own but can act only to inhibit a nonallelic gene. In this sense, *I* and *i* produce no phenotypic effect unless *C* is present and therefore produce two different phenotypes only in fowl that also have the gene *C*. Similar inhibiting genes have been identified in maize (Fig. 91) and other organisms.

Complementary Genes

The term "complementary factors" has been applied to any two nonallelic genes that act together to produce a phenotype different from that produced by either alone. The term as originally proposed, however, was restricted to a case in which two nonallelic dominants produced one phenotype, whereas the two recessives or either dominant with the other recessive produced a second phenotype. Bateson in 1905 discovered that if he crossed two white-flowered strains of the Emily Henderson sweet pea, purple-flowered plants were produced in the F_1 . The two strains were phenotypically identical in every respect but they must have been different genotypically as, otherwise, the F_1 would have been white-flowered. When the F_2 generation was raised, nine-sixteenths were purple-flowered and the other seven-sixteenths were white. This peculiar result can be explained if it is assumed that each strain had two pairs of genes for flower color, that these pairs are in different chromosomes, and that the gene products of the two dominants interact to produce purple flowers, whereas all other gene combinations give white flowers. If one gene pair is *C* and *c* and the other is *P* and *p*, the original parents would have been $ccPP$ and $CCpp$. Both parents were homozygous as these strains had been raised separately and inbred for a number of generations. When these plants were crossed, the F_1 was $CcPp$, and had purple flowers. The F_2 segregated as in Fig. 92. The F_2 ratio is a regular di-

hybrid ratio genotypically. As to external appearance, however, it so happens that the interactions of C and p , of c and P , and of



FIG. 91. Segregation of colored grains in ears of maize. *Left*, an ear segregating 3 colored ($1CC + 2Cc$) : 1 noncolored (cc). *Right*, an ear segregating for the color-inhibiting gene, I , as well as for C , thus producing the ratio: 13 noncolored ($9CI + 3cI + 1ci$) : 3 colored (Ci). These ears are also segregating for other genes, as sugary. (Photograph by Dr. W. Brooks Hamilton.)

c and p all produce flowers that are indistinguishable in appearance so that the normal 9 : 3 : 3 : 1 ratio becomes modified to 9 : 7. On a chemical analogy, C might produce a colorless

(white) pigment which could be converted into purple by the colorless enzyme, *P*. Thus *Cp* plants would be white because there was no enzyme present to convert the white pigment into purple, whereas the *cP* and *cp* plants would be white because there was no pigment present.

These complementary genes can be considered as an example of epistasis in which two independent recessive genes are epistatic to both alleles of the other pair. Thus in the presence of *cc*, neither the *P* nor the *p* genes show a different expression, whereas in the presence of *pp*, both *C* and *c* produce the same

	<i>CP</i>	<i>Cp</i>	<i>cP</i>	<i>cp</i>
<i>CP</i>	<i>CCPP</i> purple	<i>CCPp</i> purple	<i>CcPP</i> purple	<i>CcPp</i> purple
<i>Cp</i>	<i>CCPp</i> purple	<i>CCpp</i> white	<i>CcPp</i> purple	<i>Ccpp</i> white
<i>cP</i>	<i>CcPP</i> purple	<i>CcPp</i> purple	<i>ccPP</i> white	<i>ccPp</i> white
<i>cp</i>	<i>CcPp</i> purple	<i>Ccpp</i> white	<i>ccPp</i> white	<i>ccpp</i> white

FIG. 92. Checkerboard showing the 9 : 7 ratio in sweet peas. A cross between two white strains genotypically *CCpp* and *ccPP* produces a purple F_1 , *CcPp*, because these genes are complementary, and an F_2 segregating into 9 purple (*CP*) : 7 white ($3Cp + 3cP + 1cp$). (Based on the work of Bateson.)

phenotypes. Gene *c* is therefore epistatic to *P* and *p*, and *p* is epistatic to *C* and *c* when *c* and *p* are homozygous. In the heterozygote *CcPp* the recessive epistasis of *c* and *p* is lost because neither is homozygous. Examples of this and other ratios in maize are found in Fig. 93.

Blakeslee's study of complementary genes in the yellow daisy, *Rudbeckia hirta*, showed that the *Cp* and *cP* classes could be distinguished in this plant by chemical tests. He had two yellow-coned strains which were alike phenotypically but different genotypically. When they were crossed, the F_1 plants had purple cones and the F_2 segregated into $\frac{9}{16}$ purple-coned and $\frac{7}{16}$ yellow-coned plants. This ratio is clearly one of complementary genes, in which the *AB* type is purple-coned. Can it be explained by the pigment-enzyme theory? If *A* produced a yellow substance which turned purple in the presence of the gene product of *B*, and if *a* produced a yellow substance like the other in color but different chemically because it did not react with *B*,

and if B and b produced only colorless substances, the conditions would be fulfilled. By this theory, the substances produced by A and a would be different chemically although they were both



FIG. 93. Segregation in ears of maize. *Left*, ratio of 12 white : 3 purple : 1 red from the cross $AA CC RR PrPr \ddot{u} \times AA CC RR prpr II$. *Center*, a ratio of 9 purple : 7 white from a cross $AA cc rr PrPr \times AA CC RR PrPr$. *Right*, a ratio of 9 starchy ($Su Sh$) : 3 shrunken ($Su sh$) : 4 sweet ($su Sh + su sh$) from the cross $SuSu shsh \times susu ShSh$. All these ratios are F_2 ratios, and the genotypes given are those of the P_1 generations. In the ear at the left it is difficult to distinguish between the purple and red kernels in a black-and-white illustration. (Photographs by Dr. W. Brooks Hamilton.)

yellow, so that the Ab plants would contain a different chemical substance from that found in the aB and ab plants. That this is not pure speculation was shown when Blakeslee dipped the flowers of all his yellow-flowered plants in dilute potassium

hydroxide. This alkali turned the flowers of three-sevenths of the yellow type a reddish color, and the flowers of the other four-sevenths turned a very deep purple. Very probably the plants whose flowers turned reddish were genotypically the Ab type and the others were aB and ab . By this chemical test, the 9 : 7 ratio is resolved into a 9 : 3 : 4 ratio. The difference between them is that in the 9 : 3 : 4 ratio A produces a substance different in appearance as well as in chemical nature from that produced by a .

Duplicate Genes

In some plants and animals, two identical pairs of genes are present in different chromosomes, so that A is dominant over a , and B , which is the same as A , is dominant over b , which is the same as a . These are called *duplicate* genes, and it is sometimes believed that the presence of such genes indicates more or less remote polyploidy. It is conventional today to designate two such pairs of genes by the same letter followed by different numerical subscripts, as A_1a_1 and A_2a_2 . Because A_1 produces the same phenotype as A_2 , the A_1a_2 and a_1A_2 classes are the same and are different from the a_1a_2 class. In some cases A_1 and A_2 together produce the same phenotype as A_1a_2 or a_1A_2 ; in other cases the two dominants interact to produce something different. For example, in the common shepherd's-purse, *Capsella bursa-pastoris*, which is often found in waste places in America, the seed pod, or capsule, is triangular, but in one of the less well-known species *Capsella Heegeri*, from Germany, the capsules are spindle-shaped and appear round in cross-section. The triangular-shaped capsule is dominant over the round type, but in typical plants two pairs of genes for capsule shape are present. These pairs of genes have been designated Cc and Dd . (These symbols were chosen before the present-day system was adopted of designating duplicate genes by the same symbol followed by a different subscript. These gene pairs would now be designated T_1t_1 and T_2t_2 .) *Capsella bursa-pastoris* is homozygous for the two dominant genes whereas *C. Heegeri* has the genetic constitution $ccdd$. The F_1 has triangular capsules and is genotypically $CcDd$ whereas the phenotypic F_2 ratio is 15 triangular : 1 round. The plants with triangular-shaped cap-

sules are the CD , Cd , or cD types; the round-capsuled plants are $ccdd$. The segregation of these types in the F_2 is:

$$\left. \begin{array}{l} 3C \begin{cases} \nearrow 3D \rightarrow 9CD \text{—} \\ \searrow 1d \rightarrow 3Cd \text{—} \end{cases} \\ 1c \begin{cases} \nearrow 3D \rightarrow 3cD \text{—} \\ \searrow 1d \rightarrow 1cd \text{—} \end{cases} \end{array} \right\} = 15$$

$$\left. \begin{array}{l} \\ \\ \\ \\ \\ \\ \\ \\ \\ \\ \end{array} \right\} = 1$$

Duplicate genes are common among plants but less so in animals. They probably indicate that the plant that contains them has more than two sets of chromosomes, a situation discussed in Chapters 26 and 27. They can be considered as duplicate dominant epistatic genes since C and c produce the same phenotype in the presence of D , whereas D and d give plants indistinguishable phenotypically in the presence of C .

Cumulative Duplicate Genes

If two duplicate dominant genes interact to produce a result different from that produced by either one plus the recessive allele of the other, the 15 : 1 ratio becomes 9 : 6 : 1. A ratio of this sort was reported by Miyake and Imai for grain color in barley. Some plants have purple grains and others have white grains, and the former type is dominant over the latter. When a dark purple-grained and a white-grained plant were crossed, the F_2 ratio was 15 purple : 1 white; but the purple was not of the same intensity in all the purple-grained plants. This ratio was caused by two pairs of duplicate genes, P_1 and P_2 , which interacted so that the plants with the two dominant genes P_1 and P_2 were of a deeper purple than those with P_1 and p_2 or with p_1 and P_2 genes. These two nonallelic dominants have a cumulative or additive effect such as was not found for capsule shape in *Capsella*.

Nilsson-Ehle showed that the situation in wheat is even more complex, for not only are duplicate genes present but there is incomplete dominance as well. Grain color is either red or white, and the intensity of the red color depends upon the number of color-producing genes present. The genes can be designated R_1 , r_1 , R_2 , and r_2 . If a deep red-grained plant, $R_1R_1R_2R_2$ is

crossed with a white, $r_1r_1 r_2r_2$, the F_1 is red but is of a lighter shade than its red parent. The F_2 plants are:

1	$R_1R_1 R_2R_2$	—very deep red	—4 genes for red
2	$R_1R_1 R_2r_2$	—deep red	—3 genes for red
2	$R_1r_1 R_2R_2$	—deep red	—3 genes for red
4	$R_1r_1 R_2r_2$	—intermediate red	—2 genes for red
1	$R_1R_1 r_2r_2$	—intermediate red	—2 genes for red
2	$R_1r_1 r_2r_2$	—pale red	—1 gene for red
1	$r_1r_1 R_2R_2$	—intermediate red	—2 genes for red
2	$r_1r_1 R_2r_2$	—pale red	—1 gene for red
1	$r_1r_1 r_2r_2$	—white	—0 genes for red

If like phenotypes are classed together, the F_2 would segregate into $\frac{1}{16}$ very deep red : $\frac{1}{4}$ deep red : $\frac{6}{16}$ intermediate red : $\frac{1}{4}$ pale red : $\frac{1}{16}$ white. When there are more than two duplicate genes with a cumulative action, and dominance is incomplete, the F_2 ratio of phenotypes becomes even more complex.

Interaction in Polyhybrids

The simplest examples of gene interaction involve two pairs of genes, but in many instances three or more pairs interact in various ways.

Gene Interaction in Primula. An excellent example of interaction in polyhybrids is found in the Chinese primrose, *Primula sinensis*. The form of the leaf is due to the interaction of at least seven pairs of genes, and the normal type is produced by *all the dominants together*. The normal leaf form is called “palm” (Fig. 94). In this type the clefts or incisions are sharp and are arranged so that the leaf is reminiscent of the fan-shaped type of palm leaves. Other types are the “tongue” and “oak.” In the “tongue” the leaf is elongated and the clefts are slight. In the “oak” the lobes are fewer than in the “palm” and the clefts between the lobes are so deep as to extend almost to the midrib. If an “oak” is crossed with a “tongue,” the F_1 is “palm” and the F_2 consists of 9 “palm” : 3 “tongue” : 3 “oak” : 1 “tongue-oak.” The last type is easily distinguishable from the others and resembles a combination of a “tongue” and an “oak” type. The “tongue” plants are homozygous for the recessive gene t and also have the gene O in homozygous or heterozygous condition. The “oak” plants are oo and have one

or two *T* genes. The F_1 and F_2 “palm” plants are $T-O-$; the “oak-tongue” type is $tt oo$. Other genes may also interact with these to give still different types. The type known as “fern”

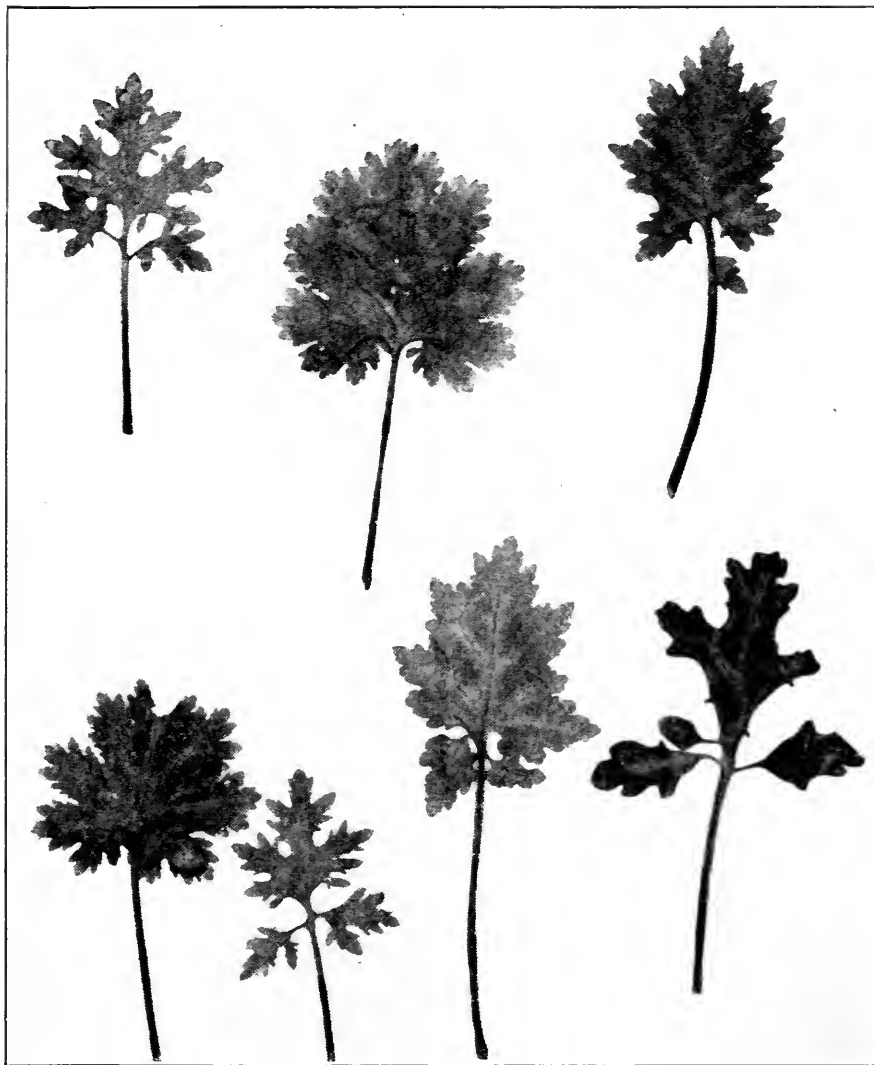

FIG. 94. Gene interaction in *Primula*. An oak-leaved plant, $oo TT$ (upper left), was crossed with a tongue, $OO tt$ (upper right), to form a palm type, $Oo Tt$ (upper center). The F_2 segregated into the four types in the bottom row from left to right: 9 palm (OT) : 3 oak (oT) : 3 tongue (Ot) : 1 oak-tongue (ot). (Photograph by Dr. W. Brooks Hamilton from herbarium material furnished by Dr. Edgar Anderson.)

(Fig. 95) has narrower leaves than the “palm”; the clefts are arranged as in a typical fern leaf. Such plants are produced by the genes yy in cooperation with the dominant genes T and O .

A "palm" is produced by Y , O , and T acting together, and a "fern-oak" ($yy oo TT$) crossed with a "tongue" ($YY OO tt$)

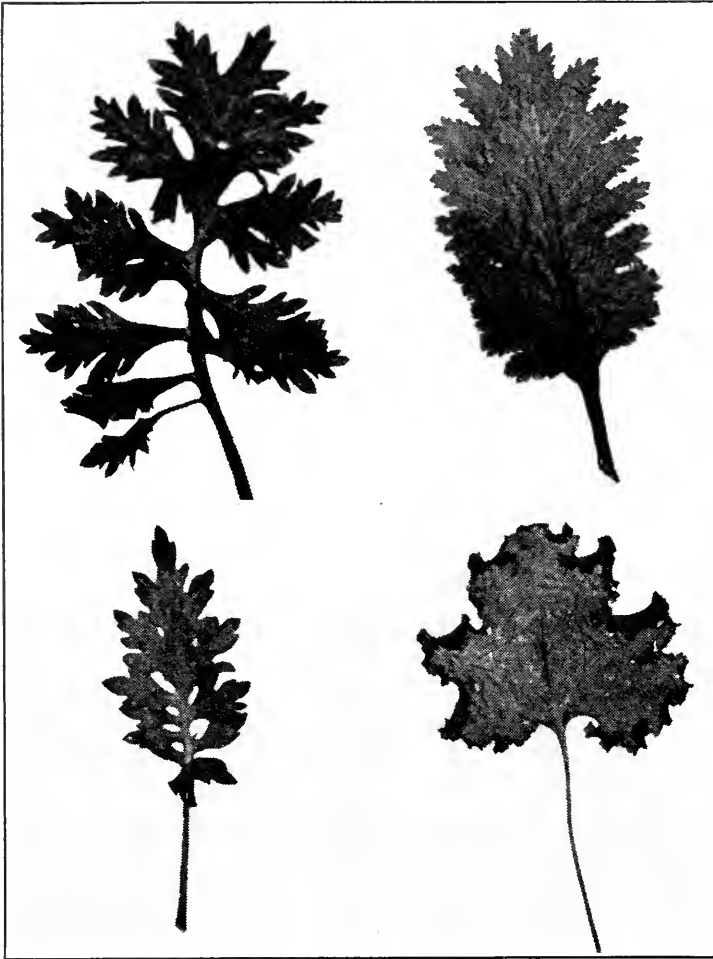

FIG. 95. Leaf types in *Primula* resulting from gene interaction. *Upper left*, fern-oak, $y o T$; *upper right*, fern, $y O T$; *lower left*, fern-oak-tongue, $y o t$; *lower right*, a crimp type. (Photograph by Dr. W. Brooks Hamilton from herbarium material furnished by Dr. Edgar Anderson.)

would give a "palm" ($Yy Oo Tt$). The F_2 phenotypic ratio would be:

27 "palm" — $Y O T$	3 "fern-oak" — $y o T$
9 "fern" — $y O T$	3 "fern-tongue" — $y O t$
9 "oak" — $Y o T$	3 "oak-tongue" — $Y o t$
9 "tongue"— $Y O t$	1 "fern-oak-tongue"— $y o t$

Even this, however, does not explain the complete situation in *Primula sinensis*. Other types are "maple," claw," and two types with crimped leaves. Each crimped type is the result of

different recessive genes. All seven pairs of genes interact to produce a large number of phenotypes.

The Wild-Type Drosophila. Other examples could be given of the interaction of a number of genes. In *Drosophila melanogaster*, the various eye colors are due to nonallelic, recessive genes such as white (*w*), ruby (*rb*), vermilion (*v*), garnet (*g*), carnation (*car*), purple (*pr*), sepia (*se*), scarlet (*st*), and pink (*p*). The normal, or wild-type, fly is red-eyed and results from the interaction of the dominant alleles of all the above genes. Its formula would therefore be *W Rb V G Car Pr Se St P*. It is not literally correct to say that red eye is dominant to white. The formula for white eye is *w Rb V G Car Pr Se St P*, and a more correct statement is that the wild-type eye is produced by a certain combination of genes, whereas the white eye is produced by exactly the same genes with the substitution of the recessive *w* for the dominant *w*⁺ or *W*. Similarly, ruby-eyed flies have the formula *W rb V G Car Pr Se St P*, purple-eyed flies are *W Rb V G Car pr Se St P*, and flies with pink eyes are *W Rb V G Car Pr Se St p*. Since a wild-type and a white-eyed fly differ only by the presence of *W* or *w*, it is customary to *assume* that *all* the other dominants are present and to omit them from the formula. In like manner, it is much simpler to state that a purple-eyed fly has purple eyes because it is homozygous for *pr* and to omit the additional requirement that all the other dominant genes must be present. It must always be understood, however, that eye color is due not to one gene alone but to the interaction of many genes.

Complementary Genes in Polyhybrids. When three or more pairs of genes interact, dominant and recessive epistatic, inhibiting genes and complementary and duplicate genes may be involved. If three complementary genes are interacting, so that all three dominants produce one character, such as color, and all other combinations of genes produce a different character, such as white, the F_2 ratio would be 27 colored : 37 white. Four such genes would give 81 colored : 175 white.

Duplicate Genes in Polyhybrids. If three duplicate noncumulative, dominant genes are interacting, the F_2 ratio will be 63 dominants to one recessive, whereas four such genes will result in a ratio of 255 : 1. If three pairs of duplicate, cumulative genes that show dominance are present, the F_2 will be in the

ratio of 27 triple dominant : 27 double dominant : 9 single dominant : 1 recessive. If such duplicate, cumulative genes show incomplete dominance, the situation is the one that Nilsson-Ehle found in wheat. In some strains red color in the grain results from the action of two pairs of genes, but in other strains, three such pairs are found, R_1R_1 , R_2R_2 , and R_3R_3 . In these strains the shade of red depends upon the number of large-lettered genes. When a very deep red plant ($R_1R_1 R_2R_2 R_3R_3$) is crossed with a white ($r_1r_1 r_2r_2 r_3r_3$), the F_1 is intermediate ($R_1r_1 R_2r_2 R_3r_3$) and the F_2 ratio is:

1—deepest red	—(6 genes for red)
6—very deep red	—(5 genes for red)
15—deep red	—(4 genes for red)
20—intermediate	—(3 genes for red)
15—pale red	—(2 genes for red)
6—very pale red	—(1 gene for red)
1—white	—(0 genes for red)

Duplicate, cumulative, incompletely dominant genes and their relation to quantitative characters are discussed further in the next chapter.

Modifying Genes

In the above examples of gene interaction, the genes acted apparently with relatively equal weight. In a number of instances, however, a certain character is determined by one gene, but is modified slightly by others. All the interacting genes in this case do not appear to have equal strength, but there seems to be one “main” gene whose effect can be varied slightly by other, often numerous, “minor” genes. Such minor genes are known as *modifying genes* because they produce no effect other than a slight modification of a character which is determined fundamentally by another gene. A good example of modifying genes is the genes which modify gene W in mice, a gene that results in a coat with white spots. The extent of the spotting is determined by these other genes. If only a few are present, the area covered by the white spots is small; but in animals with more such genes, the white area is increased so that some animals are almost entirely white. That these are modifying genes is shown by the fact that they have no effect unless the “major” gene, W , is present. In ww mice, there are no white

spots on the coat, no matter how many modifying genes are present.

Another excellent example is the modifiers of eosin eye in *Drosophila melanogaster*. Eosin is one of the series of multiple alleles at the white locus, and eosin-eyed flies are $w^e w^e$ (plus all the dominants mentioned previously). The shade of the eosin color may vary from light to dark, depending upon the presence of several modifying genes. If a nonallelic gene called *dark* is present, the eosin color is darker than in the absence of the dark gene. There are seven genes that have a lightening effect on the eosin, and some lighten the color much more than others. Pinkish lightens the color slightly, and the gene known as whitening lightens it so much that it is almost white. Intermediate shades are produced by five genes known as cream *c*, cream *b*, cream *a*, cream *III*, and cream *II*. They are all modifying genes, because their only effect is to vary slightly the expression of a character determined fundamentally by another gene.

An interesting and rather unusual group of modifying genes affects the frequency with which another gene mutates. In *Drosophila virilis*, a species closely related to the more familiar *melanogaster*, is a gene known as "miniature-gamma" ($mt-\gamma$), which produces a miniature wing instead of one of normal size. This gene, however, has a peculiar property of suddenly mutating back to the wild-type or normal condition. In the developing wing of a miniature-gamma fly, all the cells naturally are homozygous for $mt-\gamma$, but here and there the gene in one of the cells of the wing will mutate. All the cells that develop from these cells will be normal. Thus the wing will be a mosaic of miniature and normal tissue. This is the effect of the "main" gene, and the modifying genes stimulate the rate of this reverse mutation greatly. Two of these modifying genes are dominants, *S-1* and *S-3*; the other, *s-2*, is a recessive. A miniature fly homozygous for *S-2* was crossed with an $s-2 s-2$ miniature. All the F_2 flies were miniature, but one-quarter were homozygous for $s-2$. Out of 796 F_2 flies, Demerec found that 584 showed little or no change of $mt-\gamma$ to the dominant allele and therefore little or no mosaicism in the wing, while the other 212 flies had mosaic wings showing that mosaic formation is greatly stimulated by genes $s-2$. Genes *S-1*, $s-2$, and *S-3* are definitely modifying genes and produce no effect except in $mt-\gamma mt-\gamma$ flies.

QUESTIONS AND PROBLEMS

1. Give the phenotypes of the following crosses made between plants of *Oenothera Lamarckiana*:

- | | |
|--------------------------|--------------------------|
| (a) $Ss Vv \times ss vv$ | (d) $Ss Vv \times ss VV$ |
| (b) $Ss Vv \times Ss VV$ | (e) $Ss Vv \times SS vv$ |
| (c) $Ss Vv \times SS Vv$ | (f) $Ss Vv \times Ss Vv$ |

2. In poultry, what are the results obtained from crossing a walnut-combed F_1 fowl with (a) a pure-bred pea, (b) a pure-bred rose, and (c) a single? What are the offspring from crossing a single with (a) a heterozygous rose and (b) a heterozygous pea?

3. In rats, gene C produces a pigmented coat, whereas c produces an unpigmented or albino coat. Genes A and R interact to produce gray fur; A with homozygous r results in yellow; aa with R produces black; $aa rr$ animals are cream. These four coat colors, however, are found only if C is also present. What are the results of the following crosses?

- | | |
|--------------------------------|--------------------------------|
| (a) $CC Aa Rr \times CC Aa Rr$ | (c) $CC Aa Rr \times CC Aa rr$ |
| (b) $CC Aa Rr \times CC aa Rr$ | (d) $CC Aa Rr \times CC aa rr$ |

4. Give the phenotypes of the offspring of the following rat crosses (see problem 3):

- | | |
|--------------------------------|--------------------------------|
| (a) $CC aa Rr \times cc aa Rr$ | (f) $CC Aa rr \times cc Aa rr$ |
| (b) $Cc aa Rr \times Cc aa Rr$ | (g) $Cc Aa rr \times Cc Aa rr$ |
| (c) $Cc aa Rr \times cc aa Rr$ | (h) $Cc Aa rr \times cc Aa rr$ |
| (d) $Cc aa rr \times Cc aa Rr$ | (i) $Cc aa rr \times Cc Aa rr$ |
| (e) $cc Aa Rr \times cc Aa Rr$ | |

5. In flax, two blue-flowered plants were crossed, and the offspring segregated into 65 blue, 20 lilac, and 27 white. What were the genotypes of the parents?

6. In the summer squash, gene W produces white and gene w colored fruit. Gene Y if combined with w colors the fruit yellow, whereas $ww yy$ plants have green fruit. What are the phenotypes and genotypes of the offspring of the following crosses?

- | | |
|--------------------------|--------------------------|
| (a) $ww YY \times Ww yy$ | (d) $Ww yy \times ww Yy$ |
| (b) $Ww Yy \times Ww Yy$ | (e) $WW yy \times ww YY$ |
| (c) $Ww Yy \times ww yy$ | |

7. In squash (see question 6), a yellow-fruited plant crossed with a white-fruited one produced the following offspring: 46 white : 35 yellow : 13 green. What are the genotypes of the parents?

8. In squash (see question 6), a $WW yy$ and a $ww YY$ plant were crossed. By selfing the F_2 plants, what would be the chance of producing a pure-breeding white-fruited strain?

9. A pure-bred White Leghorn fowl is crossed with a pure-bred Plymouth Rock. Two F_1 birds were mated. What are the phenotypes and genotypes of the F_2 ?

10. What phenotypes are produced by crossing the F_1 obtained in question 9 with (1) a pure-bred White Leghorn and (2) a pure-bred Plymouth Rock?

11. Two purple-flowered Emily Henderson sweet peas, when crossed, produced 94 purple- and 75 white-flowered plants. Statistically, could this be considered a 1 : 1 ratio? If not, how would you interpret it, and what would be the genotypes of the parents?

12. What offspring are produced from the following crosses in the Emily Henderson sweet pea?

(a) $CC pp \times cc Pp$

(d) $Cc Pp \times Cc Pp$

(b) $Cc Pp \times cc pp$

(e) $Cc pp \times cc PP$

(c) $Cc pp \times cc Pp$

(f) $CC Pp \times cc pp$

13. In poultry, Black Langshans have feathered shanks and Buff Rocks have shanks without feathers. When crossed, these breeds produced a feathered F_1 . Two F_1 's were crossed, and the F_2 segregated into 15 feathered : 1 unfeathered. Explain.

14. In poultry, feathered shanks are dominant over unfeathered and are the result of the duplicate genes F_1 and F_2 . What are the offspring of the following crosses:

(a) $F_1f_1 F_2f_2 \times f_1f_1 f_2f_2$

(b) $F_1f_1 f_2f_2 \times F_1f_1 f_2f_2$

(c) $f_1f_1 F_2f_2 \times F_1f_1 f_2f_2$

15. In shepherd's-purse, triangular capsule is dominant over round and is due to the duplicate genes, C and D . What are the genotypes of the parents that would produce the following results?

(a) 15 triangular : 1 round

(b) 3 triangular : 1 round

(c) all triangular

(d) 7 triangular : 1 round

16. In barley, purple is dominant over white. Two pairs of cumulative, duplicate genes, P_1p_1 and P_2p_2 , are involved. Two light purple plants, $P_1P_1 p_2p_2$ and $p_1p_1 P_2P_2$, were crossed. Explain the F_2 segregation into a 9 : 6 : 1 ratio.

17. Assume that there are three pairs of noncumulative duplicate genes, Aa , Bb , and Cc . The cross $AA BB CC \times aa bb cc$ was made and the F_1 selfed. What ratio would be obtained in the F_2 ?

18. In Nilsson-Ehle's wheat, what would be the phenotypes of the following crosses?

$$(a) R_1R_1 r_2r_2 \times r_1r_1 R_2R_2$$

$$(b) R_1R_1 r_2r_2 \times R_1R_1 r_2r_2$$

$$(c) R_1R_1 r_2r_2 \times R_1r_1 R_2r_2$$

$$(d) R_1r_1 R_2r_2 \times r_1r_1 r_2r_2$$

$$(e) R_1r_1 R_2R_2 \times R_1r_1 r_2r_2$$

19. When Nilsson-Ehle crossed an $R_1R_1 R_2R_2$ with an $r_1r_1 r_2r_2$ and raised the F_2 generation, he obtained a ratio of 1 : 4 : 6 : 4 : 1. Compare this ratio with the coefficients of the terms obtained by expanding the binomial $(a + b)^4$. Is there any possible connection here?

20. In *Primula*, what phenotypes would be obtained from the following crosses?

$$(a) \text{fern} \times \text{oak} \qquad (d) \text{fern-oak} \times \text{tongue}$$

$$(b) \text{fern} \times \text{tongue} \qquad (e) \text{fern-tongue} \times \text{oak}$$

$$(c) \text{oak} \times \text{tongue} \qquad (f) \text{oak-tongue} \times \text{fern}$$

21. In *Primula*, what phenotypes are obtained from the following crosses?

$$(a) yy OO TT MpMp \times YY oo TT mpmp$$

$$(b) Yy Oo Tt \times Yy Oo Tt$$

$$(c) Yy Oo tt \times yy oo Tt$$

22. In some strains of wheat, three pairs of duplicate, cumulative, incompletely dominant genes are present. The cross $R_1R_1 R_2R_2 R_3R_3 \times r_1r_1 r_2r_2 r_3r_3$ gave a ratio of 1 : 6 : 15 : 20 : 15 : 6 : 1. If a stands for one degree of redness and b one degree of whiteness, so that the formula a^4b^2 would mean a redder type than a^2b^4 , show that this same ratio can be obtained by expanding the binomial $(a + b)^6$.

23. In *Nemesia*, orange, O , is dominant over white, o , nonbuff, Bu , is dominant over buff, bu , and nonpale-upper, P , over pale-upper, p . Gene

o is epistatic to both the *Bubu* and *Pp* pairs of alleles. What are the results of the following crosses?

(a) $Oo\ Bubu \times oo\ bubu$

(d) $oo\ bubu \times oo\ BuBu$

(b) $oo\ Pp \times Oo\ pp$

(e) $OO\ bubu \times oo\ Bubu$

(c) $Oo\ Pp \times Oo\ Pp$

(f) $Oo\ Pp \times oo\ PP$

Chapter 22

QUANTITATIVE CHARACTERS

It was shown in the last chapter that when two duplicate, cumulative genes which lack dominance are interacting to produce a colored grain in wheat, the ordinary dihybrid ratio takes on a different appearance. If, for example, a plant with very deep red grains due to four genes for red is crossed with a white-grained type, the F_1 will be intermediate because it contains only two genes for red, and the F_2 will segregate into a ratio of 1 : 4 : 6 : 4 : 1, with the intermediate type most numerous and the extremes resembling the two parents, and considerably less frequent. The depth of color in each class depends upon the presence of a certain number of positively acting genes, the symbols of which can be designated by capital letters. Since one allele is not dominant over the other, the terms "dominant" and "recessive" cannot accurately be used to describe these duplicate, cumulative, nondominant genes. According to this theory, one gene adds something to the strength of the expression of the character, whereas its allele neither adds nor subtracts from that strength. Therefore, we can designate the former type as a *contributing gene* and the latter as a *neutral gene*, and we can use capital letters for the contributing genes and lower-case letters for their neutral alleles. In Nilsson-Ehle's wheat, R_1 and R_2 would be contributing genes, and r_1 and r_2 would be their neutral alleles. The color depends entirely upon the *number* of contributing genes possessed by a given plant. If one of these wheat plants has two such genes, it is intermediate in color, and it matters not whether its genotype is $R_1R_1r_2r_2$, $r_1r_1R_2R_2$, or $R_1r_1R_2r_2$; no other combination of genes would produce an intermediate color.

If three pairs of duplicate, cumulative, nondominant genes are interacting, the F_1 will again be intermediate; but the ratio in the F_2 will become 1 : 6 : 15 : 20 : 15 : 6 : 1. Out of 64 plants, one will be as dark as the dark parent, one will be colorless,

resembling the light parent, and 20 will be intermediate. Six of the 64 will be somewhat lighter than the darkest, 15 will be still lighter but not so light as the intermediate type, 15 will be somewhat paler than the intermediates, and 6 will be still paler but not colorless. When both three and two pairs of genes are interacting the F_1 is intermediate, but with three pairs there are more classes in the F_2 and the percentage of parental types to be expected is smaller. In each case, however, some parental types are expected, but no plants deeper than the dark parent nor paler than the light parent would be recovered in the F_2 .

The Theory of Polymery

Duplicate, cumulative, nondominant genes might be found which determine other characters than color. In fact, differences in gross size, in weight, in yield per acre, and in many other measurable characteristics in a number of plants and animals have been explained by assuming the presence of a certain number of such genes. Let us set up some hypothetical cases and see how they might be explained on the basis of this scheme.

Let us assume that two plants differ in height by 24 cm. The smaller is 30 cm tall and the larger 54. Let us assume, also, that the difference in height is produced by four interacting, cumulative, duplicate, nondominant genes, and that each contributing gene adds 6 cm to the height of the plant. The genotype of the smallest parent would be $t_1t_1 t_2t_2 XX$, where XX represents 30 cm common to both parents, whereas the larger parent would be $T_1T_1 T_2T_2 XX$. This parent would have the 30 cm contributed by XX and 6 cm for each of the four contributing genes, and would be 54 cm tall. The F_1 would be $T_1t_1 T_2t_2 XX$, would have only two contributing genes in addition to the residual heredity indicated by XX , and would be 42 cm tall, exactly intermediate between the two parents. The F_2 would segregate as in Fig. 96a. More F_2 plants would be intermediate than would be found in any other class, the parental types would be the least common, and no plants would be found more extreme than either parent. Since all the F_1 plants are genotypically identical, different F_2 families from selfing different F_1 plants should theoretically all be alike. If there is any difference among them it should be due to the inability to grow all the plants of a family that are theoretically possible

or to different environmental conditions under which the families are grown, or both. In all such families fluctuating differences that appear should be small. F_3 families from different F_2 plants, however, might be very different.

The F_2 from the above cross will segregate into $1 T_1T_1 T_2T_2 : 2 T_1T_1 T_2t_2 : 2 T_1t_1 T_2T_2 : 4 T_1t_1 T_2t_2 : 1 T_1T_1 t_2t_2 : 2 T_1t_1 t_2t_2 : 1 t_1t_1 T_2T_2 : 2 t_1t_1 T_2t_2 : 1 t_1t_1 t_2t_2$. If various F_2 plants are

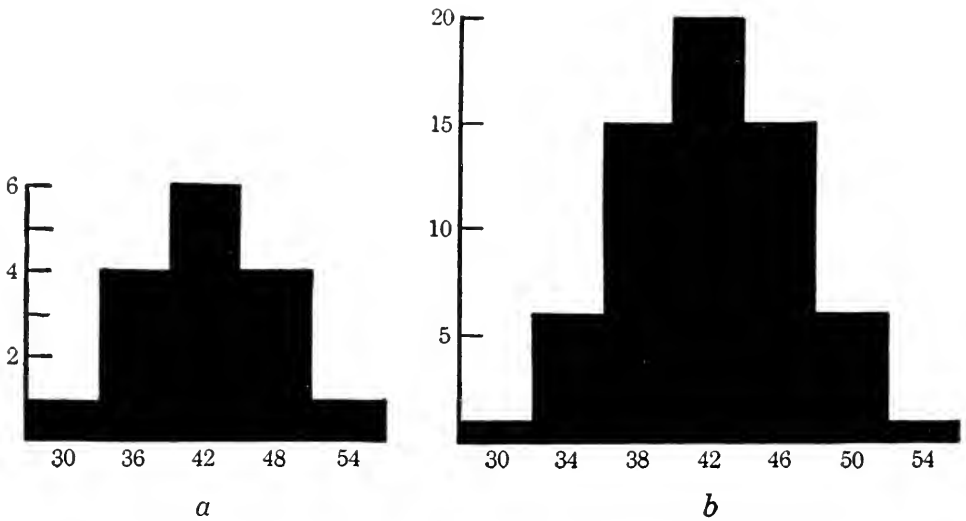

FIG. 96. Histograms showing the distribution in the F_2 of plants of different heights from crosses involving four (a) and six (b) polygenes. The F_1 's would be respectively $T_1t_1 T_2t_2 XX$ and $T_1t_1 T_2t_2 T_2t_2 XX$, as explained in the text.

selfed, the F_3 families may be quite different because of these differences in the genotypes. For example, the 54-cm F_2 plant should breed true because it is homozygous for both loci for tallness. The 42-cm plants, however, may be $T_1T_1 t_2t_2$, $t_1t_1 T_2T_2$, or $T_1t_1 T_2t_2$. The first two plants, when selfed, will produce F_3 families, all the plants of which are 42 cm tall, because these plants are both homozygous, but the $T_1t_1 T_2t_2$ F_2 plant, although it is of the same height, will produce an F_3 family consisting of plants varying from 54 to 30 cm and segregating into exactly the same ratio as is found in the F_2 . Different F_3 families from different F_2 plants may differ considerably in the amount of variability that they display, and two F_3 families may be quite different even though they come from F_2 plants that are phenotypically alike.

If six genes of this type were interacting to determine height, the F_2 would fall into more classes, but the same principles would hold true. Let us suppose that the smaller plant is again 30 cm tall and the taller is 54 cm, but let us suppose that the difference is caused by six interacting genes each of which contributes 4 cm to the height of the plant. The two parents would be $T_1T_1T_2T_2T_3T_3XX$ (54 cm) and $t_1t_1t_2t_2t_3t_3XX$ (30 cm), and the F_1 would be $T_1t_1T_2t_2T_3t_3XX$ (42 cm). The contributions of the various F_1 genes could be indicated as $4 + 0 + 4 + 0 + 4 + 0 + 30$, which equals 42 cm. The F_2 from any F_1 plant would fall into various classes, as in Fig. 96b. As in the example involving four contributing genes, the intermediates are more frequent in the F_2 than the members of any other class, parental types are recoverable, and no plants are to be expected more extreme than either parent. Since F_2 plants which are phenotypically alike do not necessarily have the same genotypes, the F_3 families may differ from one another both in average size and in variability, even though they have come from F_2 plants which are indistinguishable.

In both these examples, the number of interacting genes is relatively small. Conceivably, any number might be interacting in various situations. If we admit this possibility, we can determine easily the number of expected classes in the F_2 and the frequency of each class for any given number of pairs of duplicate, cumulative, nondominant genes merely by applying the binomial theorem. If n equals the number of interacting genes (and $n/2$ will therefore equal the number of loci), the F_2 ratio can be determined from the expansion of $(a + b)^n$. The coefficient of a given term of the expansion indicates the frequency of the corresponding class of the F_2 , and the exponent of a indicates the number of contributing genes and therefore the strength of the expression of the character of that class. The F_1 is always intermediate. The number of classes in the F_2 is one greater than the number of contributing genes, and the greater the number of contributing genes, the smaller the relative frequency of the class of intermediate size. The greater the number of contributing genes, the smaller the relative frequency of either parental type and, as they are in all cases the classes of least frequency, the smaller the chance of recovering either parental type. If two parents are of the same size in two or more crosses

and if one is homozygous for contributing genes only, whereas the other is homozygous for neutral genes, the more numerous the contributing genes, the less each one contributes, the more numerous the classes between the two extremes, and the smaller the difference between any two successive classes. If the contributing genes are very numerous, the difference between successive classes may be smaller than the amount of variation which is normally the result of environmental differences, and individuals of one class may overlap those of another. Where these class differences are so small, the variation in the F_2 population seems to be *continuous*. Where only four or six cumulative genes are interacting, it may be possible to classify the F_2 individuals into a few classes which are sufficiently distinct to admit of ready separation, but when more such genes are involved, the classes usually run together. Where there are a few distinct classes, the variation is said to be *discontinuous*.

We have cited many examples of discontinuous variation throughout this book. A few such characters are *bullata* and normal leaves in the evening primrose; curved and normal wings in *Drosophila*; red, white, and pink flowers in the four-o'clock; crooked and normal fingers in human beings; and many other characters that have been discussed in the chapters dealing with the transmission of genes. In all those examples, the individuals can easily be classified as possessing one or the other character, and such classification can be made by simple inspection, without resorting to any scale of measurements. When the variation is continuous, however, an individual can be classified only after a measurement is made, and he cannot be scored by simple observation. Where the variation is discontinuous and measurements are not necessary for classification, the character is frequently said to be a *qualitative character*, whereas those characters that can be scored only by measurement because they vary continuously are *quantitative*. If the quantitative characters are the result of numerous, duplicate, cumulative, nondominant genes, such genes are frequently known as *polymeric genes* or *multiple factors*.

According to the theory of duplicate genes, a small number of cumulative genes is interacting to produce a few discontinuous classes. The expansion of this theory into the theory of polymeric genes, in which many such duplicate genes are interacting

to produce a trait that shows continuous variation, is a fascinating speculation. The important question, however, is whether this theory can actually be used at least as a working hypothesis to explain actual cases of continuous variation. It has been applied by a number of investigators in the field of genetics to many different characters in plants, human beings, and other animals and, at least for some quantitative characters, seems to be a reasonable working assumption even though, as some others claim, it may not actually represent the facts. Let us construct

TABLE 18

F₂ FAMILY FROM A CROSS BETWEEN A 54-CM PLANT AND A 30-CM PLANT WHICH DIFFER BY TWELVE POLYMERIC GENES

(Each contributing gene adds 2 cm to the height of the plant.)

Number of Contributing Genes	12	11	10	9	8	7	6	5	4	3	2	1	0
Size of Plants in Centimeters	54	52	50	48	46	44	42	40	38	36	34	32	30
Frequency	1	12	66	220	495	792	924	792	495	220	66	12	1

a more complicated situation and see how it would work out.

Let us assume that two plants differ by six loci or a total of twelve polymeric genes. Let us assume that they share a residual heredity of 30 cm and that each contributing gene adds 2 cm to height. A plant 54 cm tall of the genotype $T_1T_1 T_2T_2 T_3T_3 T_4T_4 T_5T_5 T_6T_6 XX$ is crossed with one only 30 cm in height and of the genotype $t_1t_1 t_2t_2 t_3t_3 t_4t_4 t_5t_5 t_6t_6 XX$. The F₁ has one contributing gene from each locus and is therefore 42 cm tall. All the F₁ plants would be alike genotypically so that any phenotypic differences between them would be purely environmental. The F₁ as a whole would show little variability, and the same would be true of the two homozygous lines from which the parental plants were taken. When any F₁ plant was selfed it would produce an F₂ family which would theoretically segregate as is shown in Table 18. Theoretically each parental extreme would be recovered; but 4096 would be the theoretically minimum number of plants that would have to be raised to obtain one plant of each parental type. The average height of an F₂

family would be 42 cm, which is exactly intermediate between the two parents and is exactly the same as the average height of the F_1 plants. However, although the average height of the F_1 and F_2 is the same, the variability would be very different in the two generations. All the variation to be found in the F_1 would theoretically be due to the environment and is usually

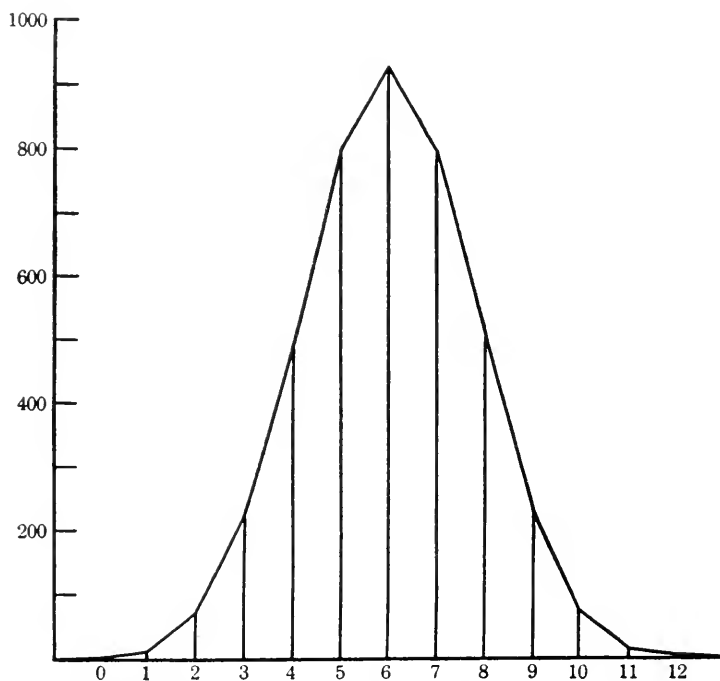

FIG. 97. Frequency curve showing the distribution of the plants of the F_2 from a cross in which the parents differed by twelve polygenes for height.

not so great as that found in the F_2 . The F_2 would vary from the extreme of one parent to the extreme of the other, and this variation would be due largely to differences in genotype. The F_2 generation can, perhaps, be understood better from a frequency curve, as in Fig. 97. In all three examples discussed in this chapter, the two parents were the same height, but the parents of each family differed from the parents of the other families in the number of polymeric genes that were present. In each case, however, the size and variability of the F_1 plants were the same. In each example, the average height of all the F_2 plants was the same, but Figs. 96 and 97 show the great differences in frequencies of plants of different size.

Now that we have considered several theoretical cases of different degrees of complexity, let us study an actual example. In 1916, Dr. E. M. East published some results of crosses between two plants of the genus *Nicotiana*. Among other characters that he studied was length of the corolla tube. This character is good for genetic studies because it is little affected by environmental differences. The flowers of *N. Langsdorffii* averaged about 21 mm in length whereas those of *N. alata* averaged about 82 mm. As can be seen from Table 19, *Langsdorffii* shows very little variability, undoubtedly because of the almost universal self-fertilization of that species. The other species is somewhat more variable (Fig. 98). Theoretically, the F_1 should average about 51.5 mm, but actually the average corolla length of the F_1 plants was only 41 mm. This discrepancy between theory and observation has not been explained. As is to be expected from the theory of polymeric genes, however, the variability in the F_1 is low. The average length in the F_2 is somewhat in excess of 38 mm. Again, this average is considerably less than expected, but the average of the F_2 is practically the same as of the F_1 , an observation well in accord with the expectation according to hypothesis. The F_2 shows far greater variability than the F_1 and in this respect agrees with the theory. Two of the F_2 plants are about as small as some of the *Langsdorffii* strain, but no plants were as tall as the shortest plants of *N. alata*. If a large number of genes were contributing to height, the 581 F_2 plants would probably not constitute a population large enough to ensure the recovery of parental types.

A study of various F_3 families from this cross offers interesting support for the explanation of corolla size based upon polymeric genes. Various F_2 plants, when selfed, should produce F_3 populations which differ markedly in their average length of corolla. That this is true can readily be seen from Table 19. For example, family 7 averages only 21 mm whereas 3 averages 39 mm and 4 averages 54 mm. This splitting up of the F_3 into different lines with different average corolla lengths is one of the features demanded by the theory of polymeric genes. Another requirement of the hypothesis is that various F_3 families should show different amounts of variability, whether or not they average the same in size. We showed previously that this is to be expected because some plants are heterozygous for a number

TABLE 19

FREQUENCY DISTRIBUTION OF THE COROLLA LENGTHS IN THE P₁, F₁, F₂, AND F₃ GENERATIONS OF THE CROSS *Nicotiana Langsdorffii* × *N. alata* AND THE STATISTICAL CONSTANTS FOR THE FREQUENCY DISTRIBUTION
(Data and statistical constants from East, 1916 in *Genetics*.)

Genera- tion	Size in Parent	Class Centers in Millimeters																Mean	S.D.	C.V.	No.															
		19	22	25	28	31	34	37	40	43	46	49	52	55	58	61	64					67	70	73	76	79	82	85	88	91	94					
P ₁ (1)		13	56																	21.43 ± .10	1.17 ± .07	5.46 ± .31	69													
P ₁ (2)																				81.76 ± .49	5.08 ± .35	6.21 ± .42	49													
F ₁				1	4	24	16	1																	40.78 ± .22	2.20 ± .15	5.39 ± .38	46								
F ₂		2	3	13	65	110	132	107	82	33	15	6	7	0	4	2																	38.30 ± .17	5.99 ± .12	15.64 ± .32	581
F ₃ (1)	23	40	10																	22.65 ± .12	1.24 ± .08	5.47 ± .37	51													
F ₃ (2)	37																	35.44 ± .15	1.62 ± .11	4.57 ± .31	50															
F ₃ (3)	40	4	11	26	6	1																	39.31 ± .25	2.54 ± .17	6.46 ± .44	48										
F ₃ (4)	63																	54.04 ± .44	5.52 ± .31	10.61 ± .61	71															
F ₃ (5)	60	1	1	5	12	17	9	11	7	2	1	0	0	0	1																	51.02 ± .51	6.16 ± .36	12.07 ± .71	67	
F ₃ (6)	60	2	2	9	27	29	29	17	28	15	3	3	1	3																	52.79 ± .35	6.79 ± .25	12.86 ± .48	168		
F ₃ (7)	21	11	39																	21.34 ± .12	1.24 ± .08	5.81 ± .39	50													

of loci and others are almost, if not entirely, homozygous, although they might be of the same size because they contain the same number of contributing genes. In this study of corolla length, families 1, 2, and 7 of the F_3 generation show little variability, family 3 shows a little more, and 4, 5, and 6 are much more highly variable.

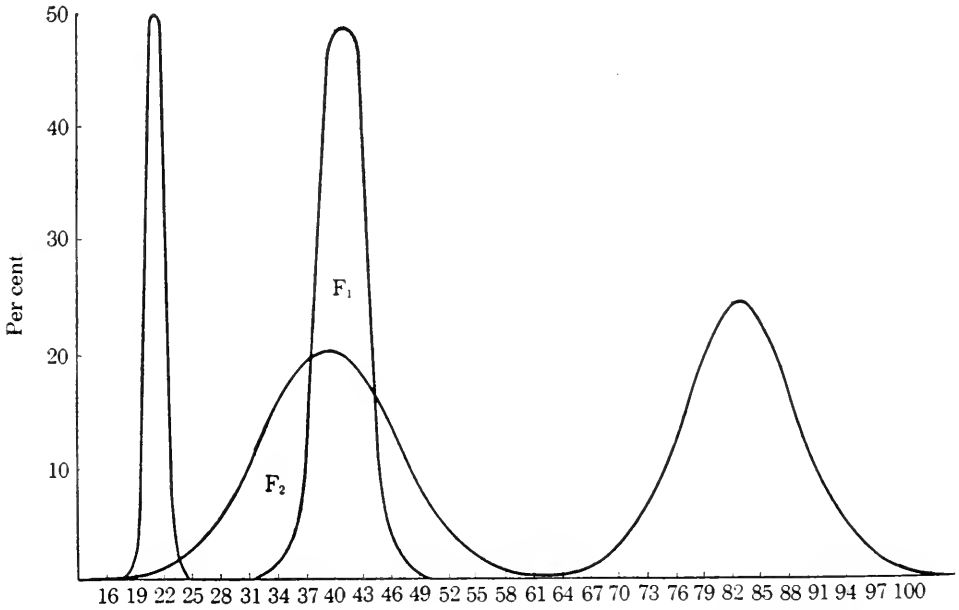

FIG. 98. Frequency curves for length of corolla tube in *Nicotiana*. *Left*, *N. Langsdorffii*; *right*, *N. alata*; *center*, the F_1 and F_2 from a cross between these two species. Note that the means of the F_1 and F_2 are about the same but that the F_2 shows much greater variability. (Redrawn from East in *Genetics*.)

According to the theory of polymery, all the F_1 plants should be genetically alike and, therefore, all the F_2 families should be of the same average size and should show the same amount of variability. In other words, smaller F_1 individuals should not produce an F_2 population with any lower average size than larger F_1 individuals. To test this out, East raised five F_2 families, each of which came from an F_1 plant of different size. He found that the average size of all the F_2 families was very similar, and there was no correlation between the size of the F_1 plant and the average of the F_2 family from it. All in all, this cross between two plants of different length of corolla agrees rather well with the theory of polymeric genes.

In a further study of corolla length, H. H. Smith introduced some modifications of East's methods. He crossed *Nicotiana Langsdorffii* with *N. Sanderae* (Fig. 99) but used the geometric mean between the length of the corolla tube and the length of

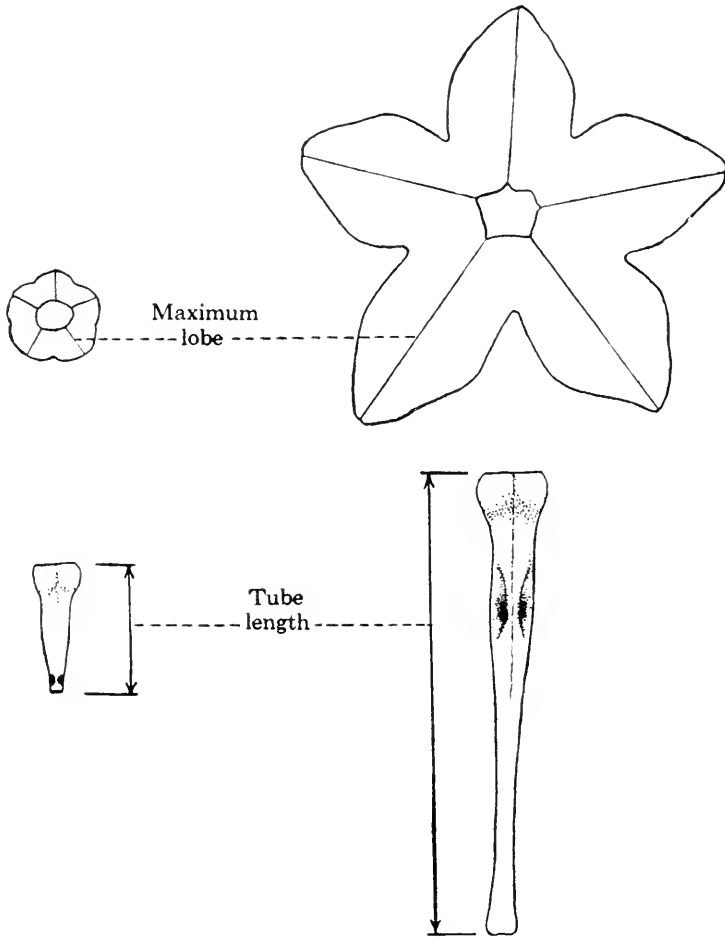

FIG. 99. Measurements of corollas in *Nicotiana Langsdorffii* (left) and *N. Sanderae* used by Smith in studies of corolla size. (Courtesy of Dr. H. H. Smith in *Genetics*.)

the maximum lobe for his measurements rather than just tube length. Furthermore, he found, as did East, that the variation of the original species was not comparable, for *Sanderae*, the species with the larger flowers, showed much greater variability than the other species. He adjusted this initial difference in variability by plotting the various values not on an ordinary arithmetical scale but on a logarithmic scale to the base 10. By this technique, the picture of variability of the two species was

probably much truer. Smith expanded his study further to include possible linkage relations between the various genes that determine flower size and a number of genes that determine flower color. Like East, Smith found that apparently a large number of genes for flower size was involved and that they acted as duplicate, cumulative genes of comparable magnitude. Some, if not all, of these polymeric genes were nondominant. Each of the color genes was linked with some of the size genes, and some of the size genes were linked with the self-sterility alleles. This case appears to be explainable on the basis of the multiple factor hypothesis, for all these cumulative genes seemed to have about equal value in determining size, and there was no gene that had any pronounced major effect.

Other Explanations

Although the multiple factor hypothesis (or theory of polymericity) seems to be a very handy explanation for the inheritance of quantitative characters, it has frequently been questioned by geneticists on the grounds, largely, of its improbability. Duplicate genes in which two or three loci are operating are recognized beyond any dispute, but most quantitative characters demand the simultaneous interaction of genes at considerably larger numbers of loci, all of which genes are duplicates of each other. The probability of the existence of so many duplicate genes in one organism has been questioned. If they do exist, they must have arisen in some way. If they arose independently as gene mutations, we must assume that the same mutation arose a number of times at different places on different chromosomes. If they did not arise independently, their presence must be accounted for by assuming that a certain chromosomal segment became incorporated a number of times into various chromosomes by polyploidy and numerous translocations. For Shull's duplicate genes for triangular capsule in *Capsella*, it has been established that the species concerned are tetraploids and have four instead of two genomes. It is possible, therefore, that each gene for capsule shape is present four times instead of two. It has been shown, also, that polyploidy exists in wheat and that it might easily account for Nilsson-Ehle's cases of duplicate genes in that genus. For most quantitative characters, however, so many genes must be present that too high a polyploid

number would have to be assumed, or the one particular segment of a chromosome would have to have been incorporated by numerous translocations into almost every chromosome in the organism. Both situations are highly unlikely.

In Chapter 21 we mentioned that some genes exert a prominent effect but their exact expression may be influenced in a number of ways by modifying genes which would probably be undetected if the gene whose character they modify were not present. That such modifying genes might have an influence on size cannot be doubted. It is possible, then, to explain at least some quantitative characters by assuming not many polymeric genes of equal value but a number of genes no two of which might produce the same effect. Three or four genes might be present each of which would add considerably to size, but no two would increase the size by the same amount. In addition, a number of modifying genes might be present, some of which would vary to a greater or lesser extent the size increment produced by different ones of the main size genes. Furthermore, some genes might also be present which would not increase size but would actually decrease it. The situation might be further complicated by an interaction of the various genes such that two together would produce a different result from that expected merely by adding together the effects produced by both individually. Although the theory of polymeric genes usually assumes that none of the genes is dominant over its allele, it is quite probable that some of the "major" genes and some of the modifying genes might show dominance, some might not, and some might be incompletely dominant over their alleles. Such a complicated interaction of dominant and nondominant genes of different values is much less easy to analyze than the simpler assumption of multiple factors.

An objection to the theory of many cumulative, polymeric genes as the causative agents in size inheritance was raised many years ago by Shull and Hagedoorn. Shull classified the genes that determine quantitative characters into *duplicate* and *plural determiners*. The duplicate genes are those which, when separated from each other, produce characters so similar that they cannot be distinguished from one another. They would correspond to the polymeric genes or multiple factors often used to account for quantitative characters. The plural determiners,

or genes, independently produce a given character or modify it in some way so as not to destroy its identity. Plural genes include duplicate genes.

One of the real difficulties with the theory of polymeric genes is that it treats a quantitative character as a unit when often it is a very complex phenomenon. Can plant height, for example, be treated as one thing, when the height of a plant depends upon both the length of the internodes and their number? If ten genes acted in such a way that each added one centimeter to the length of each of five internodes, such genes would be duplicate genes; and if their action was cumulative, and no gene was dominant over its allele, we would have a typical case of polymeric genes. The height of a plant, after the amount due to residual heredity was subtracted, would then be proportional to the number of genes present. Although such a situation is abstractly possible and may be found in some plants, it seems unlikely to occur very often. It seems more likely that one gene might add five centimeters to the lowest internode, a second increase each internode by one centimeter, and a third increase the number of internodes from five to six. In addition, genes that increase or decrease the amount added by the first two genes might also be present, as might a gene for dwarfing that reduces the number of internodes from five to three. Different degrees of dominance might be shown by different genes. In other words, the second scheme, although more complicated, may coincide more closely with other situations we have in genetics.

Some interesting plural genes for body size in mice have been described by Castle, who found that a majority of the common mutant genes in mice influence the size of the body, either increasing or decreasing it. The gene for brown coat color (*b*) is one of the genes that increases weight, body length, and tail length (Table 20). Interestingly, the gene for brown in rats and rabbits also increases body size. As Castle says, "It seems probable, therefore, that in mammals generally production of brown instead of black pigment in the integument permits greater growth in other body structures." In mice, the genes for dilution (*d*) and yellow (*A^y*), which also affect pigmentation, bring about an increase in body size, but yellow can act only in a heterozygous condition for it is lethal when homozy-

gous. Color genes, however, do not always increase size, for the agouti and albino (*c*) genes apparently have no effect at all, whereas the genes for pink-eye (*p*) and leaden (*ln*) retard

TABLE 20

PERCENTAGE CHANGE IN BODY SIZE EFFECTED BY CERTAIN GENES AND COMBINATIONS OF GENES IN MICE

(From Castle, 1941.)

Genes	Weight	Body Length	Tail Length
<i>bb</i>	+ 4.27	+1.51	+1.30
<i>dd</i>	+ 2.10	+0.90	+2.64
<i>bb dd</i>	+ 5.81	+2.70	+3.89
<i>Bb lnl</i>	- 3.64	-0.61	-2.94
<i>bb lnl</i>	- 5.47	-1.00	-3.42
<i>bb Lnl</i>	+ 1.07	+0.71	+0.55
<i>A^ya</i> ♂♂	+33.00	+2.60	+1.50
<i>A^ya</i> ♀♀	+62.00	+4.90	+0.20
<i>aa</i>	0	0	0
<i>cc</i>	0	0	0
<i>pp</i>	- 1.01	-0.14	-0.72
<i>sese</i>	- 4.42	-0.72	-0.78
<i>dwdw</i>	-75.00		

growth. The gene for short ear, *se*, also retards growth, as does, of course, the gene for dwarf, *dw*, whose main effect is on size.

Further studies on these genes in mice show that they do not always act cumulatively as one would expect with polymeric genes. Animals homozygous for both brown and dilution are heavier than those homozygous for either of these genes alone. When brown and nonleaden are homozygous (*bb LnLn*) body size is greatly increased over homozygous nonbrown nonleaden (*BB LnLn*) and also over the brown heterozygous nonleaden type (*bb Lnl*). Homozygous leaden (*BB lnl* and *Bb lnl*) decreases body size considerably and brown leaden (*bb lnl*) even more so.

Some light has been thrown recently on the problem of genes for general body size as contrasted with genes for the size of

special body parts. Is a large rabbit larger because he is larger throughout his body or because certain parts only of his body are larger? Castle and Gregory, as the result of an embryological study, showed that generally rabbits of a large race grow more rapidly throughout development, are larger at birth, and continue to grow more rapidly and for a longer time after birth. In such rabbits, therefore, greater growth is a general phenomenon throughout the body. On the other hand, there are also special genes which increase the growth of special body parts, such as length of hair, ear, and tail. Summing up, Wright concludes that the inheritance of body size is chiefly a general phenomenon throughout the body but that groups of organs (as legs of mammals or legs and wings of birds) and even individual organs themselves may vary in size independently of general body size.

Castle's genes for body size are very different from the duplicate, cumulative, nondominant genes that have been described for corolla length in tobacco and for other quantitative characters. They are not duplicates, they do not act cumulatively, and they are not nondominant. Some act in a positive direction and some in a negative direction, and they all differ in the amount they increase or decrease the various elements of body size. Some quantitative characters such as body size in mice are clearly not the result of polymeric genes. Some quantitative characters such as Nilsson-Ehle's wheat appear to result from polymeric genes. Most quantitative characters, however, are not conclusively proved to result either from polymeric genes or from some other type of plural determiners. For those characters, the theory of multiple factors is very valuable, provided that it is recognized as a working hypothesis only and that without further evidence it is not understood to be a true representation of facts. The problem of quantitative characters is a very important one, for many physical traits show continuous variation and almost all psychological traits are of that nature.

Mather has concluded that quantitative characters are the basis of differences between species. He divides characters into oligogenic and polygenic. *Oligogenic* characters are controlled by only a few genes each of which has a large effect when compared with nonheritable fluctuation. Almost all the characters

we have discussed in chapters previous to this one resulted from oligogenes, and they include characters determined by single genes or by the interaction of only a small number of genes with large effects. Oligogenes determine characters that show discontinuous variation. *Polygenic* characters are controlled by the joint action of a large number of genes each of which has but a small effect when compared with the total nonheritable fluctuation of the character, and hence show continuous variation. Polygenes, therefore, include duplicate, cumulative, nondominant genes when the number of such genes is large enough so that each has a small effect compared with fluctuation. They have individual effects which are similar to one another and are small, but they may often show dominance and do not always act strictly cumulatively. If there is dominance, some dominant genes may increase while others decrease the expression of the character, and a symmetrical frequency distribution will result from the presence of an equal number of both types of dominant polygenes. The interaction of polygenes is not always purely additive. Some polygenes interact so as to give a perfectly symmetrical frequency distribution if a certain type of scale is used to plot the measurements, but a skewed curve if the type of scale is changed. Apparently, however, polygenes may also show various types of epistasis with respect to one another.

Some Statistical Constants

In Table 19, the distribution of the plants in the P_1 , F_1 , F_2 , and some F_3 families is tabulated, and this is followed by three columns headed " \bar{x} ," " σ ," and " v ." Since nothing has been said as yet about the meaning of these terms the student will, perhaps, wonder whether their presence has any significance. Most assuredly it has! These expressions, known as *statistical constants*, are of great value in giving us a clear concept of the family to which they refer and they enable us to compare at a glance two or more families. Another important characteristic of these families is the number of plants that they contain. The size of each family is listed in the last column in these two tables.

Although these statistical constants have been used in this specific problem to describe families of plants, they are of very wide application and are used in many fields of biology, psy-

chology, education, economics, and other branches of knowledge. In one specific problem, each group of measurements represents a group of plants. In general, such a group would be known as a *population*. Thus each family would comprise a different population. If we consider a population such as the F_1 generation from a cross between a plant of *Nicotiana Langsdorffii* and one of *N. alata*, how many plants would be included in such a population? Theoretically, the number is *infinite*, and the F_1 population which we have studied represents a small *sample* of this theoretically infinite population.

The problem that interests us is how near to the true, abstract, theoretical statistical constants of the infinite population are the constants of the sample. An indication of this is obtained by calculating either the *standard error* or the *probable error*, either of which values gives us a measure of the reliability that can be placed in the constants of the sample as indications of the true values of the corresponding constants of the infinite population. The probable error, the older of these two constants, states that the corresponding constant from another sample will be expected to fall within certain limits in half the cases. The standard error states similarly that the corresponding constant of another sample will fall within certain limits in about two cases out of three. The probable error is perhaps slightly more useful because it gives values for an *even* chance, but it involves a multiplication by 0.6745 and for that reason is less used today than it was twenty years ago. In Table 19, the values following the \pm sign are the probable errors of the various constants, as the standard error was little used at the time East carried out this work.

Mean

The arithmetical average, known in statistics as the *mean* or *arithmetic mean*, is frequently characterized by the symbol \bar{x} , read *x*-bar or bar-*x*. It is determined by adding together all the individuals in a population and dividing the sum by the *number* of individuals, usually designated by the symbol *n*. Let us use the F_1 from Table 19 for an example. This F_1 population consists of 46 individuals, but we find that many of them have the same value. Four plants have corollas 37 mm long, and it is simpler to multiply the 37 by 4 than it is to add 37 four times;

the results are exactly the same in either case. Similarly, the value 40 is multiplied by 24, and 43 is multiplied by 16. The student may wonder why no plants are listed with corollas 35, 36, 38, 39, 41, 42, 44, or 45 mm long. Certainly, corolla length is not always found in units of 3 mm. For purposes of handling data, however, it is customary to group our individual values into *classes*. Any fallacies that this might introduce are small and are more than justified by the simplicity of this computation method. When breaking up our array of figures into classes, arbitrary class ranges must be chosen which must be the same for all classes. East, for example, chose 3 mm as his class range. For this F_1 family, the classes were 33–35, 36–38, 39–41, 42–44, and 45–47. The values listed in Table 19 are the *class centers*, and these are the values that are used in determining the statistical constants. Obviously, the class center is just half-way between the two extreme values of the class. To determine the mean, each class value (V) is multiplied by the frequency of that class (f). The sum, Σ , of these products is divided by the number of individuals. The formula for this is

$$\bar{x} = \frac{\Sigma fV}{n}$$

and the actual calculation is worked out in Table 21. The student is further reminded that formulae should be understood and not merely committed to memory.

Standard Deviation

The second column of constants in Table 19 represents the standard deviation, which is usually designated by a lower-case Greek sigma, σ . The mean gives us a considerable amount of information about a population and helps us to compare two populations. A glance at the means of the two P_1 and the F_1 generations in Table 19 shows us that all three populations are considerably different from one another. The plants of P_1 (1) have corollas only about 21 mm long, those of P_1 (2) have corollas about four times as long, and the corollas of the F_1 family have an average length nearly intermediate between the other two. Such information is very helpful.

When we examine the means of the F_1 and F_2 populations, we are led to believe that (so far as the average length of the

corolla is concerned) these two populations are almost identical, for the difference in the means of the two populations is slight. However, when we look at the distribution of the corolla lengths

TABLE 21

THE DETERMINATION OF SOME STATISTICAL CONSTANTS OF THE COROLLA LENGTH OF A FAMILY OF F_1 PLANTS FROM THE CROSS *Nicotiana Langsdorffii* \times *N. alata*

(Based on data from East in *Genetics*.)

Class Range	Class Value (V)	Frequency (f)	fV	Deviation of Class from the Mean (d)	d^2	fd^2
33-35	34	1	34	-6.78	45.97	45.97
36-38	37	4	148	-3.78	14.29	57.16
39-41	40	24	960	-0.78	0.61	14.64
42-44	43	16	688	-2.22	4.93	78.88
45-47	47	1	46	-5.22	27.25	27.25
		$n = 46$	$\Sigma fV = 1876$			$\Sigma fd^2 = 223.90$

$$\bar{x} = \frac{\Sigma fV}{n} = \frac{1876}{46} = 40.78$$

$$\sigma = \sqrt{\frac{\Sigma fd^2}{n}} = \sqrt{\frac{223.90}{46}} = 2.20$$

$$\text{S.E.}_{\bar{x}} = \pm \frac{\sigma}{\sqrt{n}} = \frac{2.20}{6.78} = \pm 0.32$$

$$\text{S.E.}_{\sigma} = \pm \frac{\sigma}{\sqrt{2n}} = \frac{2.20}{9.59} = \pm 0.23$$

$$\text{P.E.}_{\bar{x}} = \pm \frac{.6745\sigma}{\sqrt{n}} = \pm 0.22$$

$$\text{P.E.}_{\sigma} = \pm \frac{.6745\sigma}{\sqrt{2n}} = \pm 0.15$$

$$v = \frac{100\sigma}{\bar{x}} = \frac{100 \times 2.20}{40.78} = 5.39$$

$$\text{S.E.}_v = \pm \frac{v}{\sqrt{2n}} \sqrt{1 + 2 \left(\frac{v}{100} \right)^2} = \pm 0.56$$

$$\text{P.E.}_v = \pm \frac{.6745v}{\sqrt{2n}} \sqrt{1 + 2 \left(\frac{v}{100} \right)^2} = \pm 0.38$$

of these same populations in Table 19, or their frequency curves as drawn in Fig. 98, we see that so far as the range of values is concerned these two populations are very different, for the small-

est corolla length in the F_1 is 34 mm and the largest is 46, whereas the F_2 plants range from 22 mm at one extreme to 64 at the other. The *variation* of a population cannot be determined from the mean alone, and the best method of determining this characteristic of a population is the *standard deviation*.

The method of calculating σ is slightly longer than that for the mean. Unless one class coincides with the mean, each class deviates from it to a greater or lesser extent. The deviation is determined for each class. If it is adjusted for differences in frequencies by multiplying each deviation by its frequency and if the values for all classes are summated and if the sum is divided by the number of individuals, a measure of variation known as the *average deviation* is arrived at. The standard deviation is somewhat similar but is mathematically better. It consists of squaring the deviation of each class, of adjusting each squared deviation for the frequency of the class, averaging these values, and then extracting the square root of the average. The formula is

$$\sigma = \sqrt{\frac{\Sigma fd^2}{n}}$$

and the value for corolla lengths of the F_1 is computed in Table 21.

When we observe both the mean and the standard deviation of our F_1 and F_2 populations, we have a much clearer understanding of their relationship than we possibly could from the mean alone. The standard deviation of the F_2 is considerably larger than the standard deviation of the F_1 . When we observed the actual distribution of the two populations in Table 19, we saw that the range of the F_2 was much greater than the range of the F_1 , and we concluded that the F_2 shows greater variability. The standard deviation gives us the same information, is much more reliable than the range, and is much more convenient than a graphic representation of the distribution. Furthermore, it is an important constant in the derivation of some other constants. In general, we can say that other things being equal, the larger the standard deviation, the greater the variability.

Coefficient of Variability

At times it is desirable to compare the variability of two things measured in different units. For example, we may wish

to know whether the length of the corolla is more variable than the area of the corolla or than the weight of the flower. Since the units of measurement are different, the standard deviation alone cannot be used. The same is also true even if the units of measurement are the same, provided that the two means are significantly different. Plants P_1 (2) and the F_2 plants have standard deviations that are not far apart, but their means are considerably different. Even in this case, the standard deviation alone cannot be used to compare the two populations. A constant that can be used is the *coefficient of variability*, which is nothing more than the ratio of the standard deviation to the mean of the same population multiplied by 100 so as to convert the value of the coefficient of variability to the familiar basis of percentage. The symbol for this constant is v , and its formula is

$$v = \frac{100\sigma}{\bar{x}}$$

The coefficient of variability of the F_2 is much greater than that of the plants of *N. alata* (Table 19).

Standard and Probable Errors

The standard and probable errors of a constant are important indications of the reliability of that constant. They were discussed for ratios in Chapter 8 and now can be applied to data showing continuous variation.

In the F_1 from the *Nicotiana* cross, 46 plants were measured; they averaged 40.78 mm in length of corolla. These 46 plants were drawn by chance from a population of infinite size. We could, therefore, choose a great many other samples of 46 plants from this same population of infinite size, and we could also choose numerous samples containing more or fewer plants than 46. If we did this, could we expect that the mean corolla length would always be 40.78 mm? The answer is a decided no. If we measured a number of F_1 populations, we would obtain a number of different means. If these *means* were then plotted in the same manner that the original measurements were plotted, we should see that the means would themselves form a frequency curve which, like the other, had most of the means in the central part of the curve and fewest at the ends.

After plotting these means, we could calculate the mean and the standard deviation of the means. If we did, the standard deviation of the means would give us the *standard error* of the original population. If we then added the standard deviation of the means to the mean of the original sample, and if we also subtracted this standard error from the original mean, we should have a range of values in which the mean of another sample of similar size would fall in about two-thirds of the cases. Except as an exercise to check the method, there would be no necessity for studying large numbers of samples, and, indeed, sometimes this would be impossible. The standard error of the mean of a sample can be calculated from the formula

$$\text{S.E. } \bar{x} = \frac{\sigma}{\sqrt{n}}$$

which merely says that the standard error of the mean equals the standard deviation divided by the square root of the number of individuals in the population. The probable error is the same value multiplied by the constant 0.6745. Let us refer again to the F_1 of the Nicotiana cross. When the mean is written, $\bar{x} = 40.78 \pm 0.32$, it means that if we took a large number of other samples from this same F_1 , the mean of these samples would fall within the values 40.46 and 41.10 about two-thirds of the time and would be less than 40.46 and greater than 41.10 in about one-third. If the probable error is used, the mean is written $\bar{x} = 40.78 \pm 0.22$, and the means of other samples would fall within the values 40.56 and 41.00 in half the cases. Obviously, the greater is either the standard error or the probable error of a given constant, the less reliable is that constant. It matters not whether the standard error or the probable error is used, provided that the one used is *clearly indicated*.

Formulae for both the standard error and the probable error of the standard deviation and for the standard error and the probable error of the coefficient of variability and the calculations for these errors in the F_1 population are given in Table 21.

QUESTIONS AND PROBLEMS

1. What character was used by Lang to illustrate his theory of polymeric genes? How many loci did he consider were involved? Does Davenport's theory of the same character differ as to the number of loci? Explain.

2. Plant A is 20 cm tall and plant B is 70 cm tall. When these two are crossed, the F_1 is 45 cm tall. If the F_1 plants are selfed and a very large F_2 population is raised, what would be the expected size of the smallest plant, of the largest plant, and of the plants of greatest frequency?

3. Let us suppose that the 50 cm difference in the last problem is the result of ten polymeric genes at five loci. What are the genotypes of the two parents and of the F_1 ? What are the phenotypes and genotypes of the F_2 ?

4. Select various F_2 plants. Show how the mean and variability of the F_3 families from them compare. What proportion of the F_2 plants would breed true?

5. If a seedsman had the plants mentioned in question 2, how could he establish races that were 20, 40, 45, 55, and 70 cm tall?

6. The following data were obtained by Emerson and East for lengths of ears in maize. Explain. Calculate all constants and their probable errors. See *Research Bulletin 2* of the Nebraska Agricultural Experiment Station.

Parent Class	Class Centers in Centimeters																				
	5	6	7	8	9	10	11	12	13	14	15	16	17	18	19	20	21				
P_1 (1)	4	21	24	8																	
P_1 (2)									3	11	12	15	26	15	10	7	2				
F_1					1	12	12	14	17	9	4										
F_2 (total)				1	10	19	26	47	73	68	68	39	25	15	9	1					
F_3 (1AS)	11		4	3	13	13	18	23	9	5	4	3	3	1							
F_3 (7ES)	18				6	9	10	8	18	14	26	24	28	12	10	4					
F_3 (1BO)	8				1	8	5	13	10	18	18	11	2	2							
F_3 (1ES)	10		1	0	14	15	24	10	2	2	1										

7. Egg production in fowls is a quantitative character. Hays has found that it differs in stocks that possess or lack certain other characters as follows (data from Hays in *Poultry Science*):

No. of Birds	Classes	Annual Production	Differences
309	All five characters	251.6	Control
19	Lack early maturity	244.7	6.9
162	Lack intensity	220.2	31.4
195	Lack nonpause	227.4	24.2
20	Lack nonbroodiness	234.8	16.8
23	Lack persistency	196.4	55.2

Could this situation be explained on the basis purely of polymeric genes? Explain.

8. Davenport has suggested that duplicate, cumulative, nondominant genes might determine skin pigmentation in human beings and that two loci are probably involved. If the contributing genes are C_1 and C_2 , what is the ratio of offspring from a cross between two mulattoes whose genotype is $C_1c_1 C_2c_2$? If Davenport's theory of skin color is correct, could two dark-skinned people produce a white-skinned child, and could two whites produce a child of darker skin?

9. A small plant is 20 cm tall and a large one is 32 cm tall. They differ by twelve genes at six loci. These genes are polymeric and each adds one centimeter to height. The two plants are crossed. What is the appearance of the F_1 and F_2 ? Draw each in the form of a frequency polygon. Calculate the mean and standard deviation.

10. A small plant is 20 cm tall and a large one is 32. The tall plant has three dominant genes A , B , and C , each of which contributes 2 cm to height. The small plant has three dominant genes D , E , and F , each of which subtracts 2 cm from height. The large plant is $AA BB CC dd ee ff$ and the small plant is $aa bb cc DD EE FF$. What is the appearance of the F_1 and F_2 ? Draw each in the form of a frequency polygon. Calculate the mean and the standard deviation. Compare both generations with those in problem 9.

11. A small plant is 20 cm tall and a large one is 32. The large one is $AA BB CC dd$ and has three dominant genes each of which adds 2 cm to the basic height. The small one is $aa bb cc DD$ and has one gene, D , which subtracts 6 cm from basic height. Plot the F_1 and F_2 and calculate the mean and standard deviation of each. Compare with problems 9 and 10.

12. Would the results in problems 10 and 11 be different if none of the genes showed any dominance?

Chapter 23

INBREEDING, SELECTION, AND HETEROSIS

Inbreeding

When offspring are produced from closely related parents, we say that they are produced by *inbreeding*. The degree of inbreeding may vary considerably in different organisms and will depend in part upon the method of reproduction in the species in question. Many plants and some animals reproduce entirely or largely by self-fertilization. It results in the most extreme degree of inbreeding. In normally cross-fertilized organisms, reproduction may be carried out by father-daughter and mother-son crosses, by sib crosses, by crosses between uncle and niece, or aunt and nephew, or first cousins, or by crosses between more distant cousins. All such matings are considered as inbreeding, but the closer the relationship between the two parents, the greater is the degree of inbreeding. When two unrelated persons are mated, the degree of inbreeding is zero; the offspring arise by *outbreeding* and the cross is an *outcross*.

The results of inbreeding have been under discussion for many years as the effect upon the organism often seems to be very deleterious. One of the best examples of this is maize, a plant that is normally cross-fertilized. When a vigorous, highly productive strain is repeatedly inbred by self-fertilization, there is a decline in quality, vigor, and yield for several generations; after about half a dozen generations the resulting strains are so inferior that no farmer would consider planting them (Fig. 100). Similar harmful effects noted in other organisms have led to the rather popular belief that rapid deterioration is inevitable if a strain is closely inbred. Because of this belief and because close breeding among human beings has sometimes produced very unfortunate results, it is generally considered undesirable for first cousins to marry.

Why is inbreeding often harmful, and is it always harmful? First, we must understand that there is nothing mysterious about

inbreeding and that a harmful result, when it occurs, is not caused by some mysterious force that produces weaknesses in some undefined way. Second, there are organisms in which inbreeding is not harmful and also organisms in which it appears to

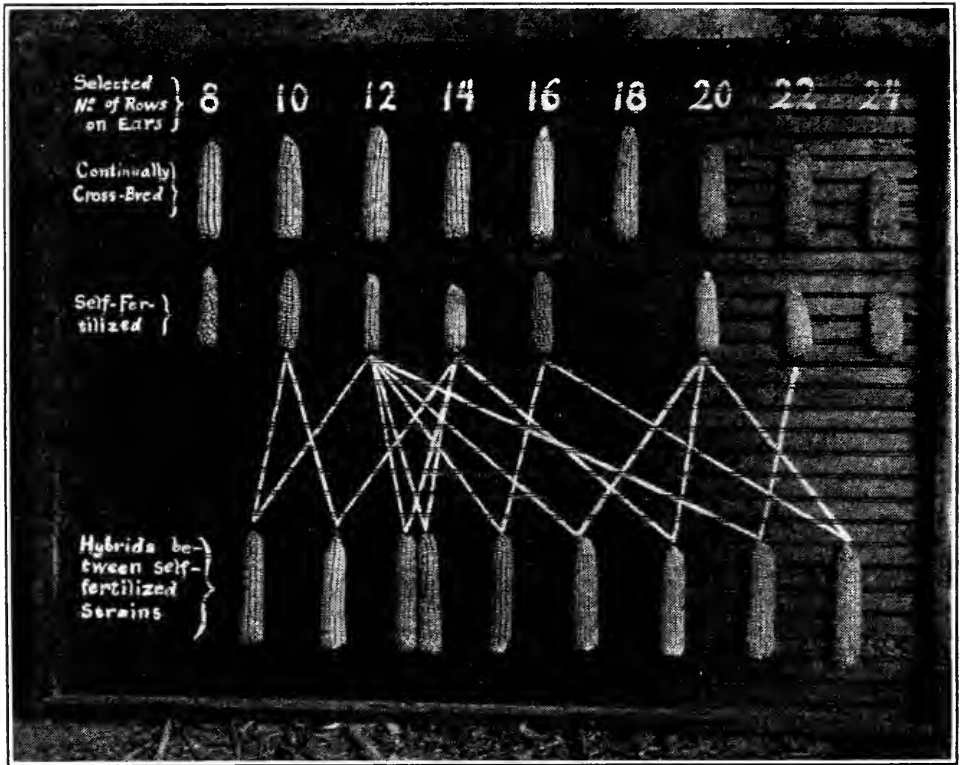

FIG. 100. Shull's first demonstration of heterosis in maize. The top line of ears consists of cross-bred types differing in the number of rows. Continual self-fertilization of these strains produced the vastly inferior types shown in the middle row. The fine, large ears of the bottom row resulted from certain crosses between self-fertilized lines and show heterosis. From an exhibit at Omaha, Nebraska, before the annual meeting of the American Breeders Association. (Photograph made Dec. 7, 1909. Courtesy of Dr. G. H. Shull.)

be beneficial. Some plants, such as peas, beans, wheat, and oats, regularly produce seed by self-fertilization and do not seem to benefit if they are cross-fertilized. An experiment in brother and sister matings in Poland China swine, which is as close inbreeding as can be carried out in such animals, was made at the Minnesota Agricultural Experiment Station. After eight successive generations on the whole no loss of vigor resulted. As for human beings, the Ptolemies of Egypt formed a succession

of wise and able rulers, but regularly adhered to a custom of brother-and-sister marriages. The marriage of Charles Darwin to his first cousin, Emma Wedgwood, produced offspring that were well above the average. If inbreeding is not always harmful, what is its effect?

The effects of inbreeding were effectively demonstrated and stated by the Danish geneticist, Johannsen, in 1903. He chose a commercial variety of the common garden bean, known as the Princess Bean, for studies of the effect of selection on weight of the seed. Taking a sample from a mixed lot of beans of different sizes, he showed that the progenies of the heavier beans in general weigh more than those of the lighter beans, and that not all the seeds of the same size produce offspring of the same average weight. He also compared the average weight and the variability of offspring of individual mother plants and found that the progeny of each particular plant showed much less variability than the whole group with which he started. He then self-fertilized these strains for several generations, being especially careful to prevent one line from becoming crossed with another.

The results of several successive generations of inbreeding from different original mother plants (of which he happened to use nineteen) showed that each of these different inbred lines had a certain average weight and that this value was essentially the same for each generation of any given line. For example, the line with the smallest seed weight had an average of about 35 cg, a value essentially the same for all generations that were produced by self-fertilization within that line. Another line had a seed-weight average of about 64 cg, and this weight was maintained for all generations that were produced by self-fertilization of any seed in the line. When we point out that the average weight of the seeds of any generation in one of the lines has a certain value, we do not mean that there was no variation in that group of plants for, of course, there was. The interesting feature of this variation, however, is that it is not inherited. For example, the average seed weight of line 2 of the original nineteen lines was 55.8 cg, and yet beans were found which weighed as little as 40 cg or as much as 70. To test the efficacy of selection within this particular inbred line, progeny were obtained from the self-fertilization of plants of that line which weighed

40, 50, 60, and 70 cg respectively. The seed-weight average of the offspring from these four plants was, respectively, 57.2, 54.9, 56.6, and 55.5 cg, a series of values which show clearly that selection of the larger or smaller seeds of this inbred line has absolutely no effect on the average weight of the progeny. The average weight varies little in all the progenies, and what little variation there is in the average bears no relation to the weight of the mother, for the heaviest average of these four progenies came from the lightest seed.

Within inbred lines, the variation that is present is not inherited; it must be the result of environment. Johanssen tested this out further by continuous breeding for half a dozen years from both the largest and smallest types within an inbred line. Six years of selection in both directions failed to produce any significant difference in seed weight.

The largest seeds of the original lot produced progenies with a much higher seed-weight average than progenies of the smallest seeds but both the large and small seeds produced progenies of the same average weight when they were from the same inbred line. The reason is clear, for the original lot of seeds was a heterogeneous mixture which had undoubtedly come from a number of different parents with very different genotypes and which showed variation that was both genic and environmental. Within any given inbred line, however, all the plants had the same genotypes, and therefore any inbred progeny showed only environmental variation. The bean normally reproduces by self-fertilization and most plants are homozygous. A homozygote will produce a progeny that consists of only homozygous plants (barring infrequent mutations) which are genetically all alike and are like their parent.

If two homozygous plants which differ by a number of genes are crossed, the F_1 plants will be heterozygous for many genes and will show only environmental variation. Various F_1 plants upon self-fertilization will produce F_2 families which will be much more variable than the F_1 , but will have about the same mean as the F_1 . If various F_2 plants are self-fertilized, and if subsequent generations are also produced by self-fertilization, different strains will separate out which may differ from one another in their means, will show much less variability than the F_2 , will after a few generations establish a fixed value for each

strain that may differ for the various strains, and after a few generations will show only as much variation as might be expected as the result of fluctuations. These strains are homozygous and, since they are homozygous, they reach a fixed value, or as we generally say, they *breed true*. Because they are homozygous they show no genetic variation.

A true-breeding homozygous strain is called a *pure line*, which may be defined as the progeny produced solely by self-fertilizations from an original homozygous individual. Because each pure line consists of only homozygous plants, the offspring from large, intermediate, or small variants will all show the same average size and the same amount of variation. Johannsen's study of pure lines in beans showed that *within the pure line* selection has no effect in producing any change in the character, for the only variation found within a pure line except for occasional mutations is environmental. When a mutation occurs in a "pure line," the *line* does not become less pure, since no out-cross has taken place. The individuals of such a pure line are no longer homogeneous genotypically, however, as they now consist of both the mutated and unmutated *biotypes*. It might be mentioned here that in Johannsen's terminology "pure lines" and "biotypes" are not synonymous terms. A biotype may be heterozygous, such as the pink-flowered type of four-o'clock and the blue Andalusian type of the domestic fowl.

In a hypothetical problem in the last chapter, we assumed the presence of three pairs of duplicate, cumulative, nondominant genes (although exactly the same actual results could be attained with dominant genes, some of which act in a plus direction and others in a minus direction). Self-fertilization for several generations resulted in the segregation of homozygous lines which were both larger and smaller than the F_1 . The larger lines resulted from the homozygous condition of some of the contributing genes; the smaller lines had many of the neutral alleles in homozygous condition. If the F_1 were therefore heterozygous for a number of dominant genes, the subsequent generations would differ from it phenotypically only to the extent that they were homozygous for some of the recessive alleles. Homozygous dominant lines would segregate out, to be sure, but because of dominance, a line homozygous for all the dominants would be phenotypically the same as one that was heterozygous. The two

lines would differ only in the type of progeny they produce. If there is dominance, then, the important effect of inbreeding is to segregate out homozygous recessives.

The number of homozygous lines which will segregate out from inbreeding depends upon the number of genes for which

TABLE 22

HOMOZYGOUS LINES THAT SEPARATE OUT FROM INBREEDING FROM AN ORGANISM HETEROZYGOUS FOR DIFFERENT NUMBERS OF PAIRS OF GENES

Number of Loci	Genotypes of Homozygous Lines					Number of Homozygous Phenotypes	
						If non-duplicate	If poly-genes
1	<i>AA</i>	<i>aa</i>				2	2
2	<i>AA BB</i>	<i>AA bb</i> <i>aa BB</i>	<i>aa bb</i>			4	3
3	<i>AA BB CC</i>	<i>AA BB cc</i> <i>AA bb CC</i> <i>aa BB CC</i>	<i>AA bb cc</i> <i>aa BB cc</i> <i>aa bb CC</i>	<i>aa bb cc</i>		8	4
4	<i>AA BB CC DD</i>	<i>AA BB CC dd</i> <i>AA BB cc DD</i> <i>AA bb CC DD</i> <i>aa BB CC DD</i>	<i>AA BB cc dd</i> <i>AA bb CC dd</i> <i>AA bb cc DD</i> <i>aa BB CC dd</i> <i>aa BB cc DD</i> <i>aa bb CC DD</i>	<i>AA bb cc dd</i> <i>aa BB cc dd</i> <i>aa bb CC dd</i> <i>aa bb cc DD</i>	<i>aa bb cc dd</i>	16	5
<i>n</i>						2^n	$n + 1$

the original organism is heterozygous. If the heterozygote is a monohybrid, two homozygous lines, *AA* and *aa*, can be produced. If it is a dihybrid, four homozygous lines (*AA BB*, *AA bb*, *aa BB*, and *aa bb*) will separate out (Table 22). If the genes are not duplicate or cumulative, 2^n different homozygous lines are to be expected when the original organism is heterozygous for n pairs of genes; but if the genes are duplicate and cumulative and show no dominance, the number of different homozygous lines is $n + 1$. Thus, in our hypothetical problem where duplicate, cumulative, nondominant genes are involved at three loci, four different true-breeding phenotypes are produced.

Apparently the effect of inbreeding in human beings is the same as in other organisms. If in a human family there are several recessive genes for serious defects and if they are normally not expressed because of dominant genes, brother-and-sister or even first-cousin marriages will tend to produce children that are homozygous for some of these serious recessive defects. In those families, inbreeding will be highly undesirable if not tragic. If, however, the recessives in a certain family produce a more desirable result than their dominant alleles, inbreeding will not only not be harmful but will also produce a more beneficial result than outcrossing. Unfortunately, most families probably possess some very harmful rather than only desirable recessive genes so that in general inbreeding should not be encouraged.

One of the most extensive studies of the effect of inbreeding in animals was carried on over twenty years ago by Wright. About 34,000 animals were studied over a period of 15 years. They include 25,000 animals in 23 separate lines, each of which was descended from an original pair of guinea pigs by brother-and-sister matings. They also include about 4000 animals in a control stock in which inbreeding was very carefully avoided and about 5000 animals in crosses among the various inbred lines. The results of this inbreeding showed no obvious degeneration but did indicate an average decline in vigor in all characteristics. This decline was most marked in the frequency and size of litter. The decline, also, was greater in the gains made after birth than in the weight at birth and was also greater in the percentage of animals raised than in the percentage born alive. There was a decline in fertility and in resistance to tuberculosis, but there was no effect on the sex ratio. Dr. Wright concluded that loss in vigor, especially in fertility, is a more or less direct consequence of close inbreeding.

Other interesting results also came to light in this study. The segregation of new color types and patterns appeared, and different families and subfamilies became true-breeding for different colors and patterns. Some subfamilies bred true for a tendency toward a reappearance of an ancestral fourth toe on the hind feet, but relatively few monstrosities appeared. In some families, eyeless individuals or those with rudimentary legs were found, but there was no connection between the tendency

of a family to produce a given type of monstrosity and a decline in vigor. The isolation of biotypes showed that apparently there was no inheritance of general vigor, for in many families there was extreme vigor in certain respects and extreme weakness in others, and there were those in which all kinds of vigor and all kinds of weakness were combined. This study illustrates clearly that one of the most important results of inbreeding is the bringing to light and fixing of characters in a family. Very similar results have been reported for various herbage grasses by Nilsson, who emphasizes that all the effects of inbreeding may be explained by the segregation of genes. Inbreeding does not *create* anything new but merely (and very effectively) sorts out what was already present and fixes it.

In Chapter 4 we pointed out that some of the higher plants are capable of reproduction from vegetative organs. If vegetative reproduction occurs in this manner for a number of generations from one original plant, all the various plants will be direct asexual descendants of the original plants or, more strictly speaking, will be *pieces* of that original plant. All these individuals form a *clone*. Since all the individuals of a clone are really pieces of one plant, they will be genotypically alike except for somatic mutations. Being alike genetically and being the lineal descendants of one original plant, they resemble the pure lines that segregate out by successive self-fertilizations among the descendants of one original homozygous plant. They differ from such pure lines, however, in two fundamental ways. First, the various plants of a sexually produced pure line are genotypically identical except for mutations and are homozygous. The members of a clone are also genotypically identical except for mutations, but they may or may not be homozygous and, unless the original individual of this clone was homozygous, are not homozygous. Second, repeated self-fertilizations from a heterozygous plant result in the establishment of a number of different pure lines, but only one clone is produced by repeated vegetative reproduction from one original heterozygous plant, apart from somatic mutations.

Selection

Let us carry our hypothetical problem in plant heights a little further. Let us suppose that we had two strains whose geno-

types were $T_1T_1T_2T_2t_3t_3$ and $t_1t_1t_2t_2T_3T_3$. The plants of the first strain averaged 46 cm in height; those of the second were 38 cm tall on the average. Both strains were homozygous and therefore showed little variation. Let us simplify our problem further, however, by assuming that there is no variation due to the environment. If plants of these two strains are crossed, the F_1 would all be 42 cm tall and would all have the genotype $T_1t_1T_2t_2T_3t_3$. When various F_1 plants are selfed, F_2 generations would be produced which in theory should average 42 cm and should range from 54 cm at the one extreme to 30 at the other. Let us assume, however, that because of lack of space or other limitation our F_2 was not sufficiently large to include plants as tall or as short as is theoretically possible. We did, however, have some 50-cm and some 34-cm plants, both of which types were more extreme than either parent. Having obtained this F_2 , we are not satisfied, but would like to build up as tall a race and also as dwarf a race as we can.

In order to obtain a tall strain, we self-fertilize some of the 50-cm plants. They are all $T_1t_1T_2T_2T_3T_3$, $T_1T_1T_2t_2T_3T_3$, or $T_1T_1T_2T_2T_3t_3$. All three types will segregate into $\frac{1}{4}$ 54 cm tall : $\frac{1}{2}$ 50 cm tall : $\frac{1}{4}$ 46 cm tall. So far, we have built up our strain from 46 to 54 cm in three generations. Pleased with our success, we then select the 54-cm plants and self-fertilize those. To our dismay, however, their offspring are all only 54 cm tall. We then self-fertilize these, but again our offspring are no taller than 54 cm. After several more attempts we are forced to conclude that we cannot increase our height beyond 54 cm.

We then turn to our smaller plants to attempt to create a dwarf strain. Our smallest F_2 plant is 24 cm tall and has one of the following genotypes: $t_1t_1t_2t_2T_3t_3$, $t_1t_1T_2t_2t_3t_3$, or $T_1t_1t_2t_2t_3t_3$. When one of these is selfed, we get F_3 plants that are 38 cm tall (homozygous for one of the contributing genes), those that are 34 cm tall (heterozygous for one locus), and some that are 30 cm tall ($t_1t_1t_2t_2t_3t_3$). The last plants are shorter than anything we encountered in any previous generation. When we self-fertilize them, however, we find that they have apparently reached their minimum size, for they produce nothing smaller in any subsequent generation.

In attempting to create a giant strain and a dwarf strain, we systematically chose the tallest plants in each generation as the

parents of the next generation in the one case, and the smallest plants in each generation in the other. Such a regular choice, year after year, of a plant of a certain type as the parent of the next generation is known as *selection*. It is probably the oldest method of plant and animal breeding and is certainly a very important one. In some of our generations above, selection was an important factor in increasing or decreasing the height of our plant, but in other generations it was not. Why is there this difference? When we study the genotypes of these two groups of plants, we find that the plants that *were not* effective in selection were *homozygotes*, whereas those that *were* effective were *heterozygous* for at least one locus. It is a well-established rule, specifically established by Johanssen in 1903, that when we are dealing with homozygotes we can *not* vary our strain by selection.

In discussing the previous case, we simplified our problem by the implied assumption that all the variation was hereditary. Obviously, it would not be so in an actual experiment, although the extent to which variation is the result of environmental factors will differ with the organism, the particular part of the organism, and the nature of the environment. Even though we attempt to eliminate the effect of environment by raising all the plants or animals of a given experiment under essentially the same conditions, we can never control external conditions so rigidly that their effects cannot be noticed at least to a small extent.

Environment may sometimes have such a large effect that organisms of one genotype may appear phenotypically like those of a class larger or of a class smaller. Thus the action of environment on quantitative characters may result in the overlapping of phenotypes. In our hypothetical problem, some $T_1t_1 T_2T_2 T_3T_3$ plants which should be theoretically 50 cm tall might grow in such rich, moist soil that they would attain a height of 53 or 54 cm. On the other hand, some $T_1T_1 T_2T_2 T_3T_3$ plants might grow in such an unfavorable location that they would be only 51 or 52 cm. Because of environmental differences, these two groups of plants would be confused with plants of different genotypes. In trying to establish a giant strain, we should probably choose the 53- or 54-cm plant as the parent of the next generation because of its large size, but we would find that its

offspring would on the average be smaller than the offspring from the 51- or 52-cm plant. Offspring of a 54-cm plant which was homozygous for all six contributing genes would be identical with those produced by the 51-cm plant but not with those from the 54-cm plant, which was merely an extreme variant of the next lower class.

To be successful, selection must be based on the genotype. If two plants have the same genotype but differ because of environmental conditions, it makes no difference whether the larger or the smaller plant is used for seed, for the offspring of each will have the same mean and standard deviation (within the limits of error). A small variant from a plant with more contributing genes will, however, be a better choice for a parent than a large variant from one with fewer contributing genes. Selection acts only on genotypical differences and not on fluctuations. *Environmental variants are of no value in breeding.*

In our hypothetical problem, we repeatedly selected for reproduction the seeds of single plants, and we always kept the offspring from one plant separated from those of other plants. This method is known as *line selection*. Another method often used is mass selection. Either method may be based upon the nature of the father, the mother, or both parents. In our problem, also, we chose the plants to be used for further reproduction according to the nature of their phenotypes. Other methods are selection according to the nature of the ancestors of the plants used for breeding and selection upon the basis of the phenotypes of their offspring, a method known as *progeny selection* or the *progeny test*.

Mass selection is probably the oldest method of selecting parents. By this method, a farmer will go through his field and pick a number of his best plants for seed. His selection may be based upon phenotype, pedigree, or performance but probably in the earlier selections was based entirely on phenotype. If the plant is normally self-pollinated, selection will take both parents into account; but if it is normally cross-pollinated, the male parent will frequently be disregarded and only the quality of the female considered. The seeds of the various plants chosen for reproduction are then sown together, and no attempt is made to keep separate the seeds from individual plants.

This method has been used in a number of plants and has produced some very valuable results. For years it was the only method of improving maize by breeding and was probably practiced by corn growers from the earliest times until just a few years ago, when it was largely replaced by the method of hybrid corn. One of the most active periods of selection in maize was about one hundred years ago, and some of the corn breeders of that era were masters at mass selection, which is probably more of an art than a science. It has been suggested that when mass selection is based both upon the phenotypic quality of the plants used for seed and upon the performance of the offspring, it is perhaps the best method of maintaining the yield of varieties adapted to a given region in a cross-pollinated plant such as maize. Mass selection has been known as the "German method" or the "German method of broad breeding" because it was widely used at one time in Germany for improving sugar beets and small grains such as rye and wheat.

Line selection in a plant that normally is self-pollinated results in the isolation of pure lines or homozygous biotypes more rapidly than any other method. In an animal or in a plant that is normally cross-pollinated the result is slower, but it can be produced by a suitable selection of male and female parents. In many selection experiments, however, the female parent only was considered and no attention was paid to the male. This method, known as *maternal-line selection*, has produced some very striking results in some experiments.

One of the first maternal-line selection experiments was instituted by C. G. Hopkins a number of years ago at the Illinois Agricultural Experiment Station. Selection was for high and low oil content and for high and low protein content in the kernels of maize. East points out that this work illustrates the "rapidity with which progress can be made by selecting only from the maternal side, even in the face of constant intercrossing." The work was started in 1896 from a very old type, Burr's White. The method of selecting seed was known as the ear-to-row method.

Some of the kernels from an ear are planted in one row, and the yield is later determined for the plants of that row. A number of rows are grown, each of which has come from part of a different ear. Either seed is selected for the next year's

crop from the most productive rows, or the remaining kernels of the ears that produced the most desirable rows are sown the following year. This procedure is repeated over a period of years. In these experiments, the desirable types were determined by chemical analyses of some of the fruits of certain ears, and the remaining fruits of the extreme ears were planted. Curves of oil and protein content show that great progress is made during the first year, that after a few years progress becomes slower, and that finally a horizontal line results showing that after a while no further progress is made. After ten generations the average crop of the high protein line had 14.26 per cent protein and of the low line 8.64 per cent. The original line was slightly under 11 per cent, which shows that considerable progress was made in selecting in each direction. After the first ten years, however, practically no further gain was made even when selection was continued as before.

Results were slightly different when selecting for oil. Starting with a strain that showed about 4.6 per cent oil, the low oil strain reached 2.66 per cent after ten generations, declined to about 2 per cent after seventeen generations, and thereafter remained essentially at that level. The high oil strain reached 7.37 per cent after ten generations, was close to 8 at the seventeenth generation, and continued to increase slightly after that.

East's explanation for the results obtained in this selection experiment assumes the original stock was a mixed race containing a number of different biotypes which were rapidly isolated by selection. After this isolation was complete, which came about when the strains became essentially homozygous, selection accomplished nothing. The ear-to-row method of breeding appeared to be a very excellent method when it was introduced, but it has very decided limitations. M. T. Jenkins in the 1936 *Yearbook of Agriculture*, for example, points out that it has been effective over a period of a few years in increasing the yield of plants that are relatively unselected to begin with but that there was no evidence that this method had any cumulative effect.

An interesting development of the maternal-line method was reported for alfalfa by Fryer in 1939 at the University of Alberta in Canada. This method involves the use of four-year cycles. During the first year about 80 progenies containing ap-

proximately 50 plants in each are grown in rows, one progeny to a row. The plants are so spaced that each has equal and ample growing space. During the second year the plants are allowed to set seed and about the middle of August are scored for seed-setting capacity. The method of scoring is by means of an arbitrary scale from 0 to 5, based on the density of the pods. A plant with no pods is 0 and those in which the pods are densely crowded are 5, whereas the various intermediate conditions are 1, 2, 3, and 4. In this second year any decidedly poor plants or progenies are removed from the field.

During the third year of the cycle, all the plants that were not discarded during the second year are again scored for density of pods. The scores of the second and third years are then combined, and all the plants are removed from the field except about 100 of the best plants. In the fourth year all plants except about 80 of the best may be removed. These 80 plants are allowed to set seed in the field. Since such seed is produced under conditions of open pollination, it comes from intercrossing among the highly selected plants which are, of course, isolated from all other stands of alfalfa. The seed is harvested at the end of the summer and used to establish 80 new progenies, one from each plant, in a new four-year cycle the following year.

The results of this method have been highly successful. In a three-year test at Edmonton, a stock which had been selected by this method for ten years was compared with three ordinary, unimproved varieties and one selfed line. As Table 23 shows, the strain that was improved by maternal-line selection was decidedly better than any of the other four varieties in seed production. This high seed production was not procured at the expense of hay-yielding ability, for the average annual yields for all five types were nearly the same.

A good example of the use of the phenotype as a criterion for selecting individuals for reproduction is afforded by the poultry industry. When breeding for egg production, the number of eggs a hen produces is the phenotype of that hen. It seems to be common among poultrymen to consider that the breeding value of a hen can be determined by the number of eggs she lays during her first laying year and to assume that a hen will be a good breeder if she lays 200 or more eggs during that first year. When actual experiments were carried out by testing the egg

production of daughters from hens that had a good first-year record, it was frequently observed that the daughters were less productive, although in some tests the higher the first-year record of a hen, the better the egg production of her daughters.

The use of pedigrees has been practiced as the basis for selection in some animals. It is a very ancient method; perhaps the oldest pedigree records are the ancient records kept by the Arabs

TABLE 23

DISTRIBUTION OF ALFALFA PLANTS FOR POD SETTING, IN PER CENT

(Modified from Fryer.)

Variety or Strain	Total	Percentage of Plants Scoring							
		0	1	2	3	4	5	3 and Over	4 and Over
Grimm	505	1.0	49.9	27.7	15.6	3.6	2.2	21.4	5.8
Ladak	649	1.8	59.1	22.2	10.5	5.5	0.9	16.9	6.4
Cossack	654	5.8	65.0	15.3	9.0	4.0	0.9	13.9	4.9
Selfed line	635	3.3	50.2	27.3	10.6	5.8	2.8	19.2	8.6
Selected line	643	0.5	28.8	25.0	22.6	14.9	8.2	45.7	23.1

for horses. A pedigree is nothing more than a list of the parents, grandparents, and other ancestors of a plant or animal so far as is known. Pedigree breeding is merely breeding by mating together two individuals whose pedigrees are known. Pedigrees have been used as a criterion for selection in the breeding of poultry. This method has produced some good results but has certain limitations. Jull considers that the pedigree method can be combined advantageously with the method of performance, suggesting that if two hens have the same first-year record for egg production, the one with the better pedigree is to be preferred. However, he warns that there is no guarantee that a hen of good ancestry will always produce good progeny. Jull suggests further that variation in environmental conditions over a period of years detracts greatly from the reliance that can be placed upon pedigrees and that normally very little significance

can be attached to individual records of egg production of ancestors beyond the third generation. This latter point is also maintained by Steele, who suggests that for race horses and saddle horses individuals beyond the third generation may be ignored for all practical purposes. Even though pedigree records for horses are among the oldest and most elaborate, Steele considers that there is insufficient genetic significance for the current use of lengthy pedigrees.

Probably the best criterion yet devised for determining the breeding value of a plant or animal is the progeny test. By this method the individuals selected for breeding are not those that necessarily appear the best or have the best ancestors, but those that produce the most desirable offspring. For example, when breeding for high egg production the hens selected for carrying on the line are not those which produce the most eggs or those whose ancestors produce the most eggs, but those whose daughters have the best records. When selecting in plants, seeds are obtained from a number of individuals. A portion of each lot of seeds is sown, and the offspring are raised and classified. If the offspring from one or more test portions of seeds is superior to those from others, the remaining seeds from the plants that produced this superior test portion are then sown to produce the next generation. The progeny test has been widely used in a number of organisms, and in poultry some very valuable results have been obtained by Hays at the Massachusetts Agricultural Experiment Station.

Although the individual that is used to start a breeding program based on selection and inbreeding is frequently a heterozygous representative of a certain species or variety, he very often is a hybrid produced by crossing together two species or varieties that differ in a number of traits. Being a hybrid, he would ordinarily be heterozygous for a large number of genes. For example, crosses have been made between the usual breeds of cattle raised in this country and strains that are used in very hot climates, such as the Brahman cattle of India and the Africander cattle of South Africa. The purpose is to select strains which segregate out that possess the good beef quality of the more usual strains and the ability to thrive in the warmer regions of the United States.

Yarnell and Hawthorn obtained some interesting results from

selection following a cross between two varieties of tomatoes. The ordinary commercial varieties do not produce well with the advance of the summer season of Texas, but a local variety (Cherry) maintains both its size and its productivity during the

TABLE 24

FRUIT WEIGHT AND YIELD PER PLANT IN SELECTIONS FROM A CROSS BETWEEN THE LARGE-FRUITED TOMATO, BONNY BEST, AND THE SMALL-FRUITED, HEAT-RESISTANT TOMATO, CHERRY, AT WINTER HAVEN, TEXAS

(From Yarnell and Hawthorn in *Proceedings of the American Society for Horticultural Science.*)

Variety or Strain	Average Weight of Fruit (Grams)		Ripe Fruit per Plant (August 28)
	June 17	August 28	
Red Cherry	5.9	2.3	16.0
Large Red Cherry	33.1	5.9	8.5
	<i>Third Generation Lots</i>		
3-4	81.2	17.2	5.3
3-7	77.6	21.8	5.2
	<i>Fourth Generation Lots</i>		
B-1	72.1	17.2	4.7
B-2	50.8	15.4	2.6
D-1	45.4	16.3	3.6
D-6	22.7	2.4
D-7	80.7	19.1	2.4

summer season. Unfortunately, however, although it is very prolific, its fruit is so small as to be of little commercial value. A good commercial variety, Bonny Best, was crossed with Cherry. A selection from this cross, Large Cherry, produced an abundance of fruit during the summer, and it was then backcrossed to Bonny Best. Selection was carried out from this backcross for several generations. Some of the selected strains combined the summer productivity of the Cherry tomato with fruit that was considerably larger (Table 24). That they had commercial value was well indicated by the fact that they had

a ready sale on the local markets during a period in which normal-sized tomatoes had to be imported.

Heterosis

The sorting out of genotypically different homozygous lines as the result of inbreeding opens up an interesting question. What will be the result if these homozygous lines are crossed together? We have had the answer to that since G. H. Shull's report in 1908 showing that what may appear to be a uniform variety of maize is really a series of very complex hybrids involving a number of distinct biotypes. He pointed out, as we have discussed under inbreeding, that these biotypes can be isolated by continued self-fertilization and that if they are crossed together after isolation the hybrids have much greater vigor and strength than the inbred lines. He showed also that one or two of them even exceeded the original hybrid combinations that comprised the maize field, thus indicating that the way to maximum yields with respect to *any desired characteristic* was to find the right pair of inbreds and repeat the cross. The vigor of certain hybrids had been recognized for at least two hundred years before that, but it was the work of Shull that clarified the phenomenon. To this vigor of the hybrids the terms *hybrid vigor* and *heterosis* have been applied. The vigor manifests itself differently in the numerous plants and animals in which it has been recorded, but it frequently is revealed in some form as greater plant height, greater size and weight of the fruit, greater yield per acre, greater length of ear, number of rows, and number of kernels per row in maize, more internodes per plant, and greater gross weight. The difference between inbred lines and the hybrids can be readily appreciated from Fig. 100. This vigor, however, is not maintained at the same high level unless provision is made to repeat the same effective heterozygous genotype, and this repetition can be achieved only by maintaining the purebreds and repeating the cross between them each year or by some vegetative method of reproduction.

The cause of the greater vigor in the hybrids has puzzled geneticists for a number of years. Several theories have been suggested and various modifications and extensions of some of these theories have been offered, but no explanation yet proposed is entirely satisfactory. It is, of course, possible that sev-

eral mechanisms operate in different species or even in the same organism, each of them producing a greater vigor in hybrids between inbred lines than in the inbreds, themselves, or in the original stock from which the inbred lines were produced.

One of the widely advocated theories maintains that the vigor of hybrids is the result of their state of heterozygosity. Continued inbreeding develops strains which are highly homozygous, but the different inbred lines may be homozygous for different genes. When they are crossed, the hybrid is much more heterozygous than either line. Thus the cross $AA\ bb\ cc\ DD\ ee \times aa\ BB\ CC\ dd\ EE$ would produce a hybrid $Aa\ Bb\ Cc\ Dd\ Ee$, which was heterozygous for a number of genes. This theory, then, suggests that there is something inherent in the heterozygous condition of a number of genes that brings about a greater vigor in an organism and that heterogeneity in the general protoplasmic constitution is a favorable condition that stimulates physiological reactions in general. Another theory assumes that increased size is the result of the interaction of a number of dominant genes for size. Thus, in the above cross, if each dominant gene added 5 cm to the height of a 30-cm plant, and if the genes were duplicate, cumulative, and dominant, the two parents would be respectively 40 cm and 45 cm tall, but the hybrid between them would be 55 cm tall. This theory of the interaction of favorable, dominant genes also has had considerable support. It is far beyond the scope of this book to present a critique of the various theories, but it might be well to mention one or two of the important modifications of them.

Jones has proposed a modification of the dominance theory by assuming that there might be a number of dominant genes but that various groups of them might be linked together in the several chromosomes. Objections to the theory of the accumulation of dominant size-producing genes were that in generations subsequent to the F_2 races would segregate out which are homozygous for all the positive genes for growth or for their negative alleles and that the distribution in the F_2 would be unsymmetrical for the characters which showed heterosis in the F_1 . If several size genes are on the same chromosome, and if there are several such chromosomes, and if the positive size genes of each chromosome are different from those of its homologue, the F_1 will show heterosis, the F_2 will be symmetrically distributed, and

homozygous lines containing all the positive or all the negative size genes will segregate out, only extremely slowly. Even with linked genes, we could finally arrive at homozygous strains of maximum qualities as a result of crossovers. The process would be merely slowed by linkage.

This theory has been accepted by a number of geneticists but has not yet been proved to the exclusion of other possibilities, and there are some definite objections especially by some that approach the problem from the physiological side. Jones's hypothesis does not necessarily demand that the dominant allele of each pair be dominant within the usual meaning of the term. It is adequate merely to assume that the "dominant" gene in a heterozygote has more than half the effect that it would have in a homozygote. East has modified this theory further by assuming that at most loci there are at least three alleles. One is deleterious and the other two are contributing, but not to the same extent. One parent might be a^1a^1 and the other a^2a^2 . There is no dominance of either of these alleles over the other, and both act in the hybrid, which is a^1a^2 . The hybrid has the size increase of each and therefore is larger than either parent. The really deleterious recessives, however, East considers of no importance in heterosis.

Some interesting ideas on heterosis have come out of the recent studies by Dobzhansky and others on natural populations. They have pointed out that most mutations are harmful, varying from lethals at the one extreme to only mildly deleterious genes at the other. Harmful dominant mutations are readily eliminated by natural selection, but recessives accumulate in a population as they usually exist in a heterozygous condition. If the species regularly reproduces by self-fertilization, as species of wheat, the recessives quickly become homozygous and are eliminated unless they are only slightly harmful. The same would be true if the effective population size is very low—that is, if the population is so small that a union of gametes with the same harmful genes occurs frequently. If a species has an intermediate or moderately large effective population size and normally is cross-fertilized, as *Drosophila pseudoobscura*, probably most domesticated animals, and possibly man, deleterious recessives accumulate in natural populations. If inbred strains

are crossed there will be more or less pronounced heterosis, but inbreeding with selection may sometimes produce inbred lines that are equal in vigor to crossbred ones. If the effective population size of a species is large, harmful recessives accumulate to the fullest extent possible, depending upon the mutation rates of these genes. Homozygotes occur only very rarely, so potentially harmful mutations are rarely eliminated. Large numbers of such deleterious genes then accumulate in the population. Inbreeding will make them homozygous and, if they are not lethal, the various inbred lines that contain them will survive, although considerably lacking in vigor. Maize probably is to be found in this group, and it is here that heterosis will be most striking in its effect.

A word might be said of the practical value of heterosis in breeding maize. G. H. Shull outlined a method of breeding as early as 1909 by which hybrid vigor would be utilized. It was opposed as impractical by East, who advocated using commercial strains, as had Morrow and Gardner about fifteen years previously. Support for a pureline method did not come until Jones's proposal of the double cross about 1917, but in spite of these early discoveries, hybrid corn was still very much of a novelty as late as about 1930. Ten years later, however, more than 75 per cent of the commercially produced sweet corn was hybrid corn, and by 1945 there were large areas of sweet corn regions where no other type was grown. The best of the sweet corn hybrids are produced from single crosses between two inbred lines, as Shull had originally proposed; but certain practical considerations in field corn breeding make a modification of this method necessary. The inbred lines, themselves, are not very productive and have smaller kernels than hybrids. Much of the field corn is planted by machines that were constructed for larger seeds. Jones's use of double crosses avoids this difficulty. Four inbred lines are used, as in Fig. 101. Line B is pollinated with pollen of line A, and line C with pollen of line D, producing two hybrid lines, both of which show heterosis. The first hybrid is then crossed by the second, and the double hybrid is used to produce the maize crop. Because the hybrid used as a female shows heterosis, it has large, productive ears and the large kernels suitable for a corn-planting machine.

Heterosis is by no means confined to maize or even to plants. One of the best examples of heterosis is the mule, and many other examples have been described in both plants and animals. Buchholz has recently shown that hybrid vigor is exhibited in crosses between some species of pines. In seedling stages, the growth of the hybrids is much greater than in seedlings from the wind-pollinated parents. Comparisons of hybrids with the parents during stages in the development of the seeds show that in their general dimensions and in their shape indices the embryos of the hybrids are, stage for stage, intermediate be-

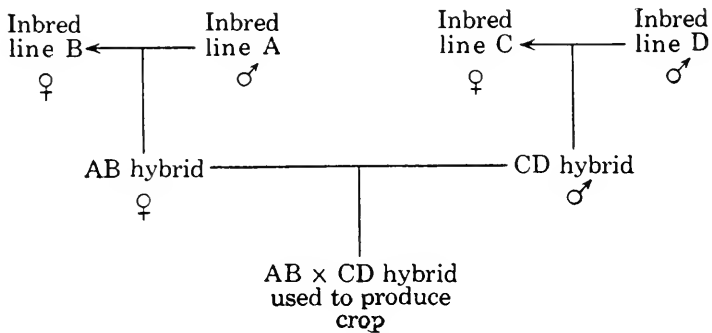

FIG. 101. An outline of Jones's double cross method of producing hybrid corn commercially. For explanation, see text.

tween those of their parents during comparable stages of growth. However, the embryos grow more rapidly in the hybrids so that comparable stages are reached more quickly. The embryos of the hybrids are not larger in the mature seeds because the seeds have a fixed size determined before fertilization which restricts the size of the embryo. The difference in growth rate manifested during the early stages of the development of the seed is again apparent in the young seedlings after they are planted. Buchholz concludes that in pines hybrid vigor is definitely a physiological vigor of growth and that its explanation is to be sought in physiological and possibly biochemical investigations.

Another explanation that has been advanced to explain heterosis is the hypothesis of A. F. Shull that heterosis is the result of an *initial* stimulation resulting from the entrance of a sperm into a new cytoplasmic environment in a specifically different egg. It has received some support but, like other questions of the role of the cytoplasm, is difficult of experimental proof.

QUESTIONS AND PROBLEMS

1. In an experiment on maize, Jones started with a variety of Leaming dent corn yielding 88.0 bushels per acre. After ten generations of selfing, one line had a yield of 32.8 bushels and another of 31.8. A third line reached 59.3 bushels after two generations. Two plants were selfed from this point on; after eight more generations, one yielded 32.7 bushels per acre and the other 19.2. Explain.

2. If maize is inbred until a number of homozygous lines have become established, would all single crosses between the various lines show the same degree of heterosis? Explain.

3. In cotton, selection had developed excellent late-maturing types. When the boll weevil arrived, these late-maturing varieties could not be grown in spite of their superiority in other ways. Some years later the cotton wilt arrived and spread over large areas. How would such events affect a cotton-breeding program?

4. Would selection be easier in a self-fertilized crop such as wheat or a cross-fertilized one such as maize? Explain.

5. Assume that six genes, *A*, *B*, *C*, *D*, *E*, and *F*, add 4 cm each to the height of a 50-cm plant, while their alleles add nothing. These genes are dominant. A cross is made between two plants whose genotypes are *AA bb CC dd ee* and *aa BB cc DD EE*. What is the height of each of these plants? Does the F_1 show heterosis. Explain.

6. Assume that a plant has twelve dominant genes each of which adds 2 cm to the height of a plant 50 cm tall. These genes are on two chromosomes. The following cross is made:

$$\frac{A b C d E f G h I j K l}{A b C d E f G h I j K l} \times \frac{a B c D e F g H i J k L}{a B c D e F g H i J k L}$$

What would be the height of the F_1 ?

7. Assume the cross in problem 6. How many plants would be necessary in the F_2 to be sure to get a homozygote as large as the F_1 plants if there was no crossing over. Would the result be different if there was crossing over?

8. Assume the cross in problem 5. Starting with the F_1 , you wish to obtain two pure-breeding types, one of which is 74 cm tall and the other 50 cm. How would you go about establishing such lines? Would either line be easier to establish than the other? Explain.

9. In establishing the lines in question 8, would it speed up the process if the selections for the tall line were grown in good, rich soil, whereas those for the short line were grown in poor, barren soil? Explain.

Chapter 24

INTRACHROMOSOMAL ABERRATIONS

We have regarded each chromosome as a rather stable unit of definite size and shape and we have assumed that the chromosome number of each plant and animal is $2n$ in the somatic cells of the animal body and plant sporophyte and n in gametes, spores, and gametophytes, but we have also mentioned upon several occasions that there are exceptions to these principles. We have pointed out that the somatic chromosome number is not always $2n$, and we have cited a number of examples that show definitely that a chromosome is neither unchanging nor indestructible. In the next few chapters we discuss such situations more thoroughly and indicate some of the effects they have had on evolution. That the chromosomes are fixed in their structure and that they always occur either in the diploid or haploid condition, except for the endosperm of angiosperms, where they are triploid, are among the earlier concepts of genetics. Therefore, these other situations are regarded as *chromosomal aberrations*. Chromosomal aberrations are of three types, involving pieces of chromosomes, whole chromosomes, and whole genomes. In this chapter, we consider the first type.

Deficiency

A *deficiency* is a chromosomal aberration in which a segment of a chromosome is missing. A chromosome with a deficiency, therefore, is not a complete chromosome so that a deficiency in one or more chromosomes of a set results in a deficient genome. We have discussed some important points in regard to deficiencies in Chapters 2, 4, 5, 12, and 16. It might be well to summarize those points here and to add some information.

If the missing portion is at the end of a chromosome, the aberration is known as a *terminal deficiency*, but if it occurs at any other place, it is an *intercalary deficiency* or a *deletion*. Terminal deficiencies are considerably less common than dele-

tions but they have been found in some organisms, and several have been reported in maize. There has been some dispute as to the presence of true terminal deficiencies in *Drosophila*. The ends of chromosomes have sometimes been thought to have peculiar properties because they do not usually become attached to one another or to broken chromosomal segments, and the name telomere has been given to them. It has been suggested also that true terminal deficiencies do not occur but that apparent terminal deficiencies are actually intercalary deletions near one end of the chromosome in such a position that only the telomere fails to be eliminated. Sutton, however, has found several deficiencies in *Drosophila* which appear to be truly terminal deficiencies. She considers that the broken ends heal and thereafter become functionally normal and that no previously existing telomere is present at the end of the chromosome after the break has occurred.

As we have pointed out in Chapter 2, deficiencies may be heterozygous or homozygous. If an animal has a homozygous deficiency, it usually fails to survive to an adult stage, because it does not have one complete set of genes. If a deficiency occurs in the X chromosome, the effect is usually the same as if there were a homozygous deficiency in an autosome, for the missing piece is usually not "covered up" by a corresponding piece of a homologous chromosome. Such a deficiency is usually lethal, although there are a few deficiencies in the X chromosome of *Drosophila*, such as that involving the yellow locus, which are not lethal. Such nonlethal deficiencies are always very small and include only one or two loci. The Y chromosome is different, for large pieces of this chromosome may be deficient without producing any lethal effect on the fly. It is really not so strange, however, when it is remembered that much of the Y chromosome does not contain any genes and that large pieces could be removed without the loss of a single gene. Heterozygous deficiencies are much more viable than homozygous deficiencies or deficiencies in the X chromosome, but in some animals even these result in death unless they are relatively short.

In plants a deficiency frequently fails to survive in the gametophyte generation. Since the gametophyte is haploid, as we pointed out in Chapter 4, any deficiency will result in the failure of this generation to have a complete set of genes. There is fre-

quently a difference in viability, however, between the megagametophyte and the microgametophyte, for deficient chromosomes are sometimes carried along in the female gametophyte even though in the same plant they cause the male gametophyte to die. If it were not for this viability on the female side, heterozygous deficiencies would ordinarily be found in plants only if they arose in sporophyte tissue. Because microgametophytes with a deficiency rarely survive, homozygous deficiencies are very uncommon.

Stadler has reported an interesting example of deficiency in maize. One X-ray-induced deficiency involved one-sixth of the length of chromosome 10. In the male, microgametophytes bearing the deficiency were apparently normal until after the division of the microspore nucleus to form the tube and generative nuclei. After this division, two types of pollen grains were found, large and small. The larger ones divided earlier than the others and were in metaphase when most of the smaller ones were still in early prophase. The generative nucleus of the smaller pollen grains was apparently normal, however, even though its division was delayed; but when the pollen was shed, the smaller ones had accumulated much less starch even in proportion to their size. Normal maize pollen shrivels shortly after it is shed, but the deficient grains shrivel much more rapidly. After $3\frac{1}{2}$ minutes almost all the small grains, but none of the normal ones, had shriveled. If deficient pollen grains are placed on the silks before they have begun to shrivel, protoplasmic movement and digestion of food reserves occur as in normal grains, but pollen tubes rarely, if ever, emerge from the grains.

In the female gametophyte the deficiency was injurious but not lethal. Almost half the ovules of the heterozygous deficient plant contained small and subnormal embryo sacs at the time of pollination, and only a small proportion was well enough developed to function normally in fertilization and seed development. The proportion of seeds lacking an embryo was higher among deficient megagametophytes than among the nondeficient ones on the same ears, and seeds heterozygous for the deficiency were slightly reduced in size. The maize plants heterozygous for the deficiency had somewhat reduced vitality, as shown by a slightly smaller size and a slightly delayed time of flowering, a

condition often found in an organism that is heterozygous for a deficiency.

Although homozygous deficiencies are rare in both plants and animals and deficiencies almost never survive in the microgametophyte, McClintock has reported several deficiency mutants in maize that not only are viable in the sporophyte but are also transmitted through the pollen. All these are minute deficiencies that have arisen from changes in ring-shaped chromosomes.

Pairing at zygotene in an organism with a deficiency is very easy to understand if one keeps in mind the rule that, to the fullest extent possible, pairing between a chromosome and its homologue is between identical parts only so that every gene lies alongside the same gene or one of its alleles. The configurations to be found between a deficient chromosome and its normal homologue are seen in Figs. 17 and 57.

It is not known how deficiencies arise spontaneously. It is possible that terminal deficiencies arise by a simple breaking of a chromosome; but although such breaking is readily understandable as the result of X-ray treatment, it is not so easily understood if no external agent is applied. Intercalary deficiencies after X-raying may result from two breaks in a chromosome with a dropping out of the broken piece or by one break at two places in a twisted chromosome, followed by a fusion of the broken ends. It has been suggested that these deletions may occur spontaneously following illegitimate crossing over, a crossing over between noncorresponding parts of homologous chromosomes or between nonhomologous chromosomes. Small deficiencies may be produced by an X-ray hit that breaks two adjacent gyres of the chromonema when it is coiled in early prophase (Fig. 102), as Sax has pointed out, and may even arise spontaneously from a similar break and fusion, as Husted has found. Studying a series of X-ray-induced deletions in *Tradescantia*, Rick suggests that the large rod-shaped ones result from single hits and large ring-shaped ones from two interstitial hits, whereas the small deletions appear to have been caused by two breaks in adjacent gyres of the relic coils following one or two hits.

If a piece breaks out of a chromosome, its future depends upon whether or not it includes the centromere. If the deleted piece lacks this important chromosomal structure, it usually fails to

go to one of the poles during mitosis and therefore usually fails to become included in the new nucleus. It generally remains in the cytoplasm, often rounding up in certain types of cells into a very small replica of a nucleus, often termed a "micronucleus,"

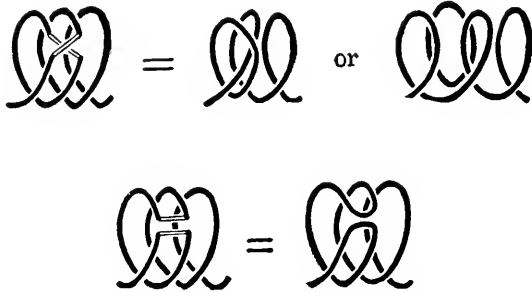

FIG. 102. Sax's explanation for the production of small deficiencies and inversions by an X-ray hit that breaks two adjacent gyres of a chromonema coiled in early prophase. If the breaks are followed by a criss-cross reunion, a ring deletion will result; if by a reunion of adjacent ends, a small inversion will be produced. (Redrawn from Sax in *Genetics*.)

but it soon becomes digested and lost to view. Such a broken piece of chromosome is an *acentric fragment*. If the deleted piece includes the centromere, it is a *centric fragment* and behaves like a normal chromosome; the remainder of the original chromosome, which is now acentric, usually becomes lost very soon.

Duplication

When, in a normal diploid organism, one or more loci, but not so many as to constitute a whole chromosome, are present three times or more instead of twice, the reduplicated segment is known as a *duplication*. The reduplicated segment may be a centric fragment or it may be a chromosomal segment attached to or inserted in either one of the chromosomes with which it is homologous or in one of those with which it is not homologous. If it happens to be inserted in a homologous chromosome *next to* the segment which is identical with it, the situation is one that we have described in Chapters 13 and 17 when we discussed the Bar and the Hairy wing duplications in *Drosophila melanogaster*.

Because the genes located in the duplicated segment are present three times instead of twice, duplications can give disturbed

genetic ratios. If the duplicated segment lies next to the identical segment as at the Bar locus (that is, if the duplication is a *repeat*), the position effect will sometimes result.

McClintock has reported an interesting situation in which one allele for brown midrib, *Bm*, when present as a duplication, produced nonbrown midrib tissue in an otherwise homozygous *bm bm* (brown midrib) plant. By X-rays two deficiencies were produced in chromosome V in maize. Each deficiency was a small, intercalary one that became a small ring, and each carried the *Bm* gene. Strangely, in each deletion, the original centromere had broken in half so that both the small ring deletion and the rod-shaped remainder of the chromosome had half a centromere, and each half centromere was functional. When a plant possessed two normal chromosomes V, each of which had the *bm* gene, and one of the rings with the *Bm* gene, it was nonbrown midrib because one *Bm* gene was dominant over two *bm* genes. The small ring-shaped chromosomes, however, behaved abnormally in somatic mitoses. They were lost from the nuclei or they changed in size. In these *Bm* duplications the plants were green because of the *Bm* gene but had streaks of brown midrib tissue. Cytological examination showed that most of these streaks of brown midrib tissue had cells in which the ring chromosome bearing the *Bm* gene became lost at some previous somatic division. The ring chromosome was lost during any stage of development. If it was lost very early, the entire plant was brown midrib; if it was lost later, there were wide sectors of brown midrib tissue; and if lost very late in ontogeny, there were merely small patches of *bm* cells. Thus by the peculiar behavior of these chromosomes during somatic development, many types of variegated brown midrib plants were produced.

The way these ring chromosomes change in size is very interesting. Let us assume a ring whose segments are numbered 1 to 8 (Fig. 103). After it has divided, in some mitotic prophase the two sister halves form one continuous ring with two centromeres instead of two freely separating rings with one centromere each. Whether this occurs by a somatic crossing over or in some other way has not been determined. At metaphase, this small dicentric ring opens out on the equator with each centromere orientated towards one pole. Especially if the original ring is very small, the new dicentric ring usually remains at the equator

and fails to be included in the daughter nuclei. Sometimes, however, the ring breaks and the centromeres can move to the poles. Each daughter nucleus will then have a segment of this original ring. The two broken ends of each ring unite, and thus new rings are formed. Since the place where the dicentric ring may break is not necessarily the place where the two original sister halves

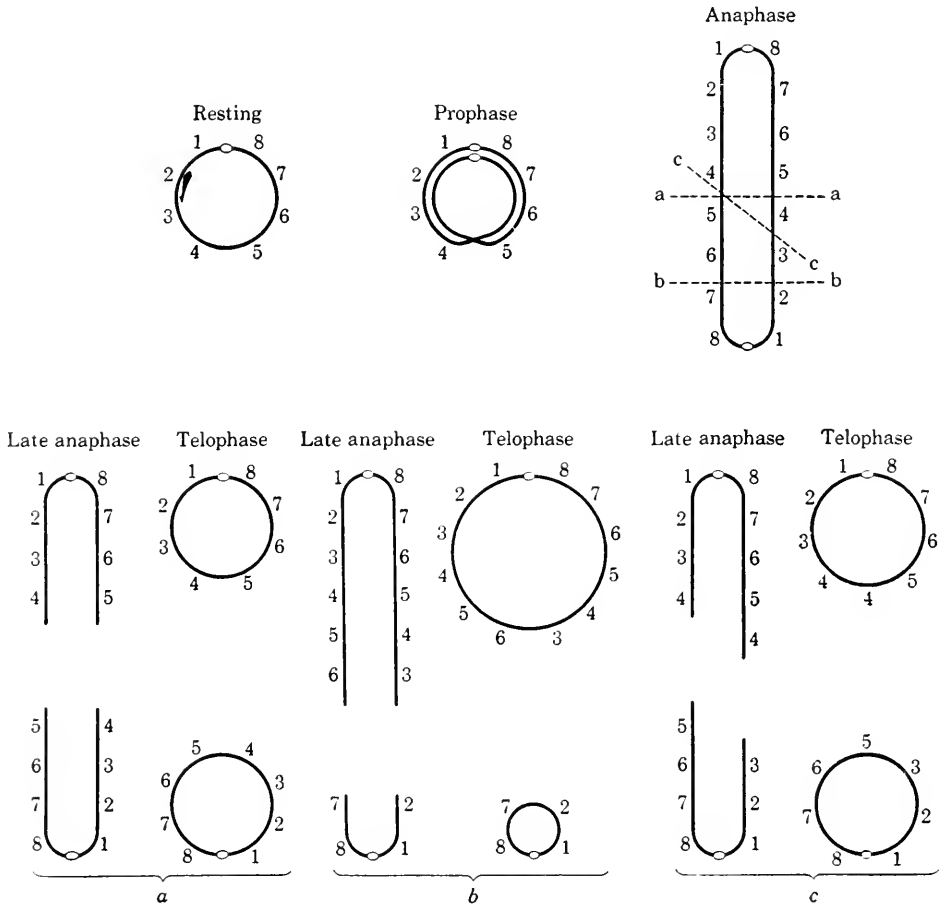

FIG. 103. McClintock's explanation of ring chromosomes in maize. A ring chromosome is shown in the resting stage at *upper left*; the small oval is the centromere and the numbers represent segments of the chromosome. At *upper middle* is a prophase showing a "crossover" between the two sister chromatids of the divided ring chromosome. When this is oriented on the spindle a dicentric is seen as at *upper right*. The chromatin strands break at various places. If a break occurs at a-a, new ring chromosomes will form as at *lower left*; if the break is at b-b, the new ring chromosomes will be of unequal size as at *lower middle*; a break at c-c will produce the rings at *lower right*. (Courtesy of Dr. B. McClintock in *Genetics*.)

become joined and since it may be different in different cells, the subsequent rings may be either larger or smaller than the original and may differ from cell to cell.

Inversion

An inversion is an aberration in which one segment of a chromosome has become inverted in position so that a chromosome which was previously *abcd efgh ij* now has a changed structure such as *abcd gfed hij*. The *efg* segment in the original chromosome has become completely inverted in its position. How both terminal and intercalary inversions are produced is not entirely clear but, like deficiencies, they arise spontaneously and can also be produced by various types of irradiation. The intercalary type is far more common.

We pointed out in Chapter 4 that the rule of strict part-by-part pairing at zygotene holds even for a pair of homologous chromosomes one of which has an inversion. The effect of this rule is to throw the chromosomes into a loop which includes the inverted segment and the noninverted corresponding segment of the homologue (Fig. 17). This loop effect is also found in the salivary gland chromosomes as the result of the pairing of identical bands (Fig. 104).

One of the most interesting features of inversions is the result produced when one or more crossovers occur between chromatids within the inverted segment, perhaps best understood from Fig. 105. Since the chromosomal segments in the inverted region are perfectly normal, they "split" into two chromatids, just as any other regions of a chromosome; and crossing over can take place between any two of the four chromatids just as it can in any noninverted region. Because of the inversion, however, the subsequent results are different, and they are most striking at anaphase of the two meiotic divisions.

If the inversion does not include the centromere and if one crossover occurs within the inversion, two of the four chromatids will be unchanged; the other two chromatids, however, will become joined together in such a way that a long chromosome with two centromeres and a much shorter fragment with no centromere will be produced. At anaphase of the first meiotic division, the long chromosome will be so oriented that the two centromeres

will be at opposite poles whereas the segment between them will extend from pole to pole as a chromatid bridge (Figs. 105, 106, and 107). At each pole will be one unchanged chromatid, and the fragment will lie on the equator and move toward neither pole. This dicentric bridge chromosome soon will break, and

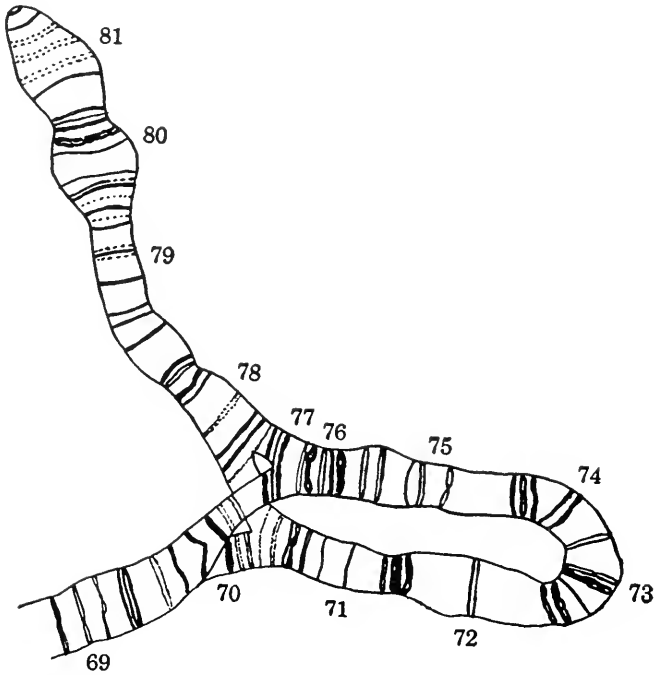

FIG. 104. Pairing in salivary gland chromosomes of *Drosophila melanogaster* heterozygous for an inversion. (Redrawn from Dobzhansky and Epling in *Publication 554* of the Carnegie Institution of Washington [1944].)

the fragment will be included in one of the two daughter cells. The result will be two cells with one normal and one broken chromatid that will appear more or less normal; one cell will also have a fragment. The anaphase of the second division will appear more or less normal, although one cell will contain a fragment that will probably not enter into division. The four chromatids can be identified by tracing the chromatids in the prophase drawing at the top of Fig. 105 and allowing for a crossing over at either 1 or 2.

If there are two crossovers within the inversion involving all four strands, as at 1 and 2 in Fig. 105, first anaphase will consist of a double chromatid bridge and two unpaired fragments. Since each bridge will break during first anaphase, the second anaphase

will appear more or less normal except for the fragments. One fragment may be found in each cell or there may be two in one and none in the other. Other anaphase configurations may be

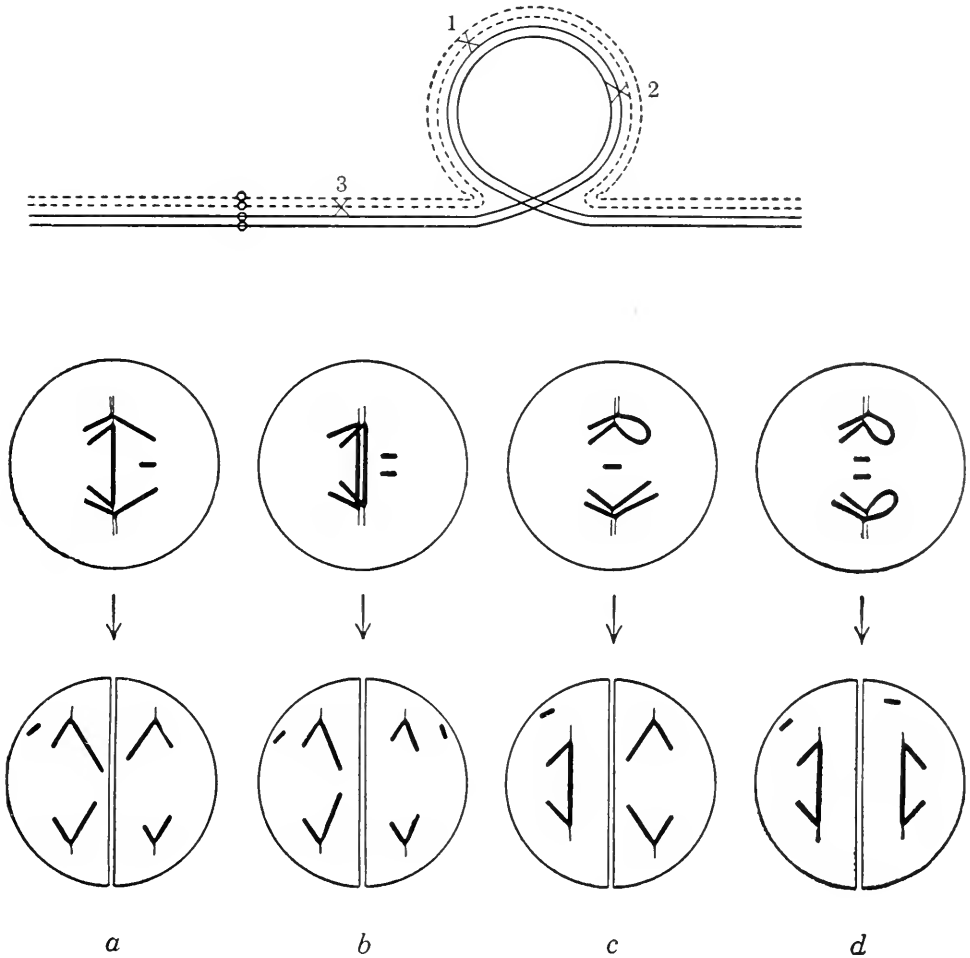

FIG. 105. Configurations at Anaphase I (first row) and Anaphase II (second row) following crossing over within the inversion diagrammed above. (a) Configurations following a crossover at 1 or 2 in the inversion. (b) Those following crossovers at both 1 and 2, both within the inverted segment. (c) Configurations following crossovers at 2 and 3. (d) Those following crossovers at 1, 2, and 3. (Courtesy of Dr. B. McClintock in *Research Bulletin* 290 of the University of Missouri Agricultural Experiment Station.)

found if there is a crossover between the inversion loop and the centromere as well as within the inversion. Dicentric chromosomes and chromatid bridges arise spontaneously and have been induced by X-rays (Fig. 107).

If the inversion includes the centromere and there is one cross-over within it, dicentric chromosomes and fragments are not to be found, but only two of the resulting four chromatids are normal. One of the chromatids will be duplicated for one of the segments not included in the inversion and will be deficient for

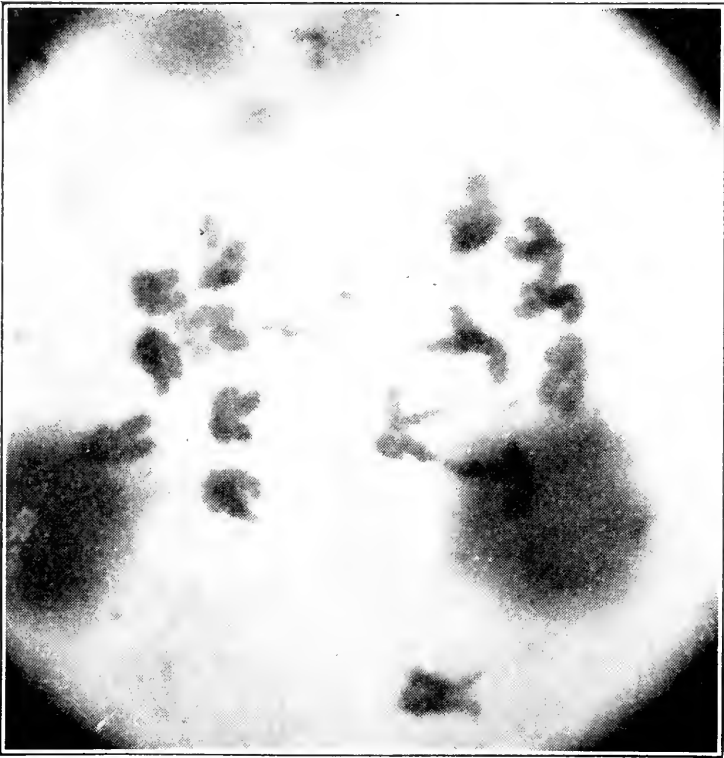

FIG. 106. Chromatid bridges and a fragment in a triploid natural hybrid between *Tradescantia paludosa* and *T. canaliculata*. Three of the 18 chromosomes are not shown in the photomicrograph. One long bridge with a fragment is approximately in the center of the figure, and the other, a much shorter bridge, is to one side.

the other; the fourth chromatid will be deficient for the first segment and duplicated for the other. Because of the presence of loops at zygotene or in salivary gland chromosomes and of chromatid bridges and fragments at anaphase in natural populations, the possibilities to be realized in inversion heterozygotes should be understood.

Plants or animals homozygous for an inversion do not present the same problems that we find in those that have only one chromosome with an inverted segment. No loops are observed

at first prophase and no dicentric bridge chromatids or fragments are present at either the first or second anaphase. Only two differences may be observed between an inversion homozygote and the original stock. In the first place, the linear order of the genes in the chromosome bearing the inversion is not the

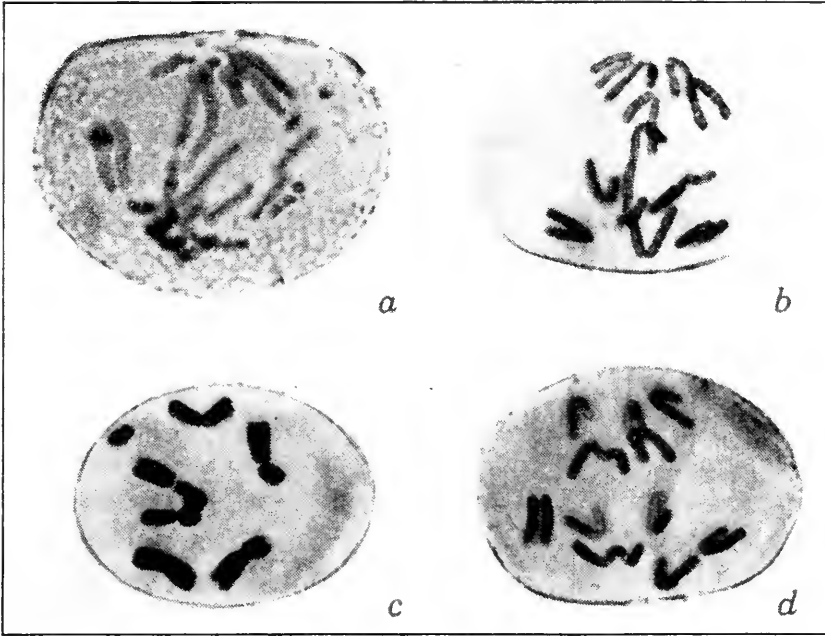

FIG. 107. Dicentric chromatids in microspores of *Tradescantia* following treatment with X-rays. (a) *T. gigantea*; two bridges with balanced fragments at anaphase following radiation during the resting stage preceding the microspore division. (b) *T. sp.*; anaphase showing aberration produced by one hit at prophase; one chromatid bridge and a partly straightened U-shaped fragment are present. (c) Metaphase showing a dicentric chromosome and an accompanying fragment; this is a two-hit chromosome aberration. (d) Anaphase showing the behavior of dicentric chromosomes. (b, c, and d courtesy of Dr. Sax in *Genetics*; a, original.)

same throughout as in the original chromosome, for the genes in the inverted segment are in reverse order with respect to the remainder of the chromosome. Consequently, the linkage map of the chromosome with the inversion is different from the map in the original. In the second place, because of the inversion, genes lie next to a different region of the chromosome from the original one. This change in position may cause one or more of those genes to produce a new phenotype. The meiotic behavior of the plant or animal with the homozygous inversion is

perfectly normal. If, however, the strain with the homozygous inversion is crossed with the original strain, the offspring will be heterozygous for the inversion and all will have loops at zygotene. Especially if the inversion is large, crossing over within the inversion will produce a fairly high degree of sterility among the heterozygotes. This inversion may act as a barrier to hybridization in nature and in that way may have some effect on evolution within the species.

One other property of inversions might be mentioned here. In inversion heterozygotes, the inversion may act as a complete or partial crossover suppressor in the pair of chromosomes in which it is found. Because of this property, they are used as a tool in the methods for detecting lethal mutations, as we have mentioned in Chapter 16.

Plants and animals may be heterozygous for two or more inversions at the same time. If an organism has two inversions, they may be in two different pairs of chromosomes or both may be in the same chromosome. If both are in the same chromosome, they may be independent, included, or overlapping as Dobzhansky and Sturtevant have described. If the original chromosome is $abcdefghij$, one that differs from it by two independent inversions would be $abedcfgihj$. A chromosome differing from the original by two included inversions would be $abhgfedc ij$, and one that had two overlapping inversions might be $abfhehgcdij$. This last type could originate if the first inversion resulted in the chromosome $abfedcghij$. If the second inversion included the segments from d through h , inclusive, the overlapping chromosome would be obtained. Such overlapping inversions have occurred spontaneously a number of times in *Drosophila pseudoobscura*. An appreciation of them is necessary for an understanding of the historical development of the various strains of this species and for a comparison of different races and species.

Translocations

A *translocation* is a chromosomal aberration by which a portion of one chromosome is transferred to another position on the same chromosome or to another chromosome by some process that is not normal crossing over. If nothing else occurs except the transfer of one chromosomal segment to another, the aberra-

tion is a *simple translocation*. They are probably rare, and some geneticists have questioned their existence. Far more common is a *reciprocal translocation*, by which a piece of one chromosome becomes exchanged for a segment of a nonhomologous chromosome. The exchanged segments need not be of equal length. If not, they are often detected cytologically by the differences in chromosome size in the original and interchanged strains (Fig. 108).

Like inversions, translocations may be both homozygous and heterozygous. Also like inversions, translocation homozygotes are little different cytologically from the normal type. Since the two members of each pair of chromosomes are alike, a translocation homozygote will show nothing but normally paired chromosomes. The only difference observable cytologically between this and the original type which gave rise to the reciprocal translocation may appear if the two translocated pieces are of different size. If a long segment was translocated from one chromosome to another and a short segment from the second to the first, the chromosomes would be of different lengths from those observed in the original type. As is also true of inversions, the presence of a homozygous translocation may not be detectable by cytological examination. It will, however, bring about a change in the linkage groups and therefore can be detected by a genetic study.

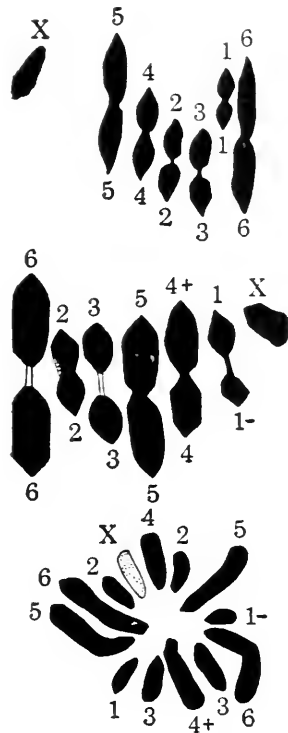

FIG. 108. Translocation induced by X-rays in the grouse locust, *Apotettix eurycephalus* Hancock. *Top*, primary spermatocyte of a normal individual showing six pairs of chromosomes and an unpaired X chromosome. *Middle*, primary spermatocyte of X-rayed individual showing that a piece of one of the homologues of chromosome 1 had broken off and become translocated to one homologue of chromosome 4. *Bottom*, spermatogonium of the X-rayed individual. Note that in the two lower figures one chromosome 1 is shorter and one chromosome 4 is longer than normal. (Redrawn from Nabours and Robertson in *Proceedings of the National Academy of Sciences*.)

In *Drosophila*, translocation homozygotes are largely lethal.

How simple translocations and reciprocal translocations occur is not definitely known. As the simple type is very rare, perhaps does not exist, there is no need to speculate upon how it may arise. Reciprocal translocations are well known both in wild populations, where they have sometimes been of considerable evolutionary significance, and in plants that have been subjected to X-rays. One of the more likely explanations is that a break and a realignment follow illegitimate crossing over between nonhomologous chromosomes.

Meiotic configurations are very interesting in plants or animals that are heterozygous for a reciprocal translocation. They are easy to figure out if we remember our rule that like parts of a chromosome pair only with like parts. If an organism is heterozygous for one reciprocal translocation, it has a set of four chromosomes, no two members of which are alike. Let us suppose that the original stock had one pair of chromosomes designated $a b c d$ and another slightly shorter pair $k l m$ (Fig. 109).

If one reciprocal translocation had occurred, two new chromosomes would be present as would one of each of the original pairs. The new chromosomes would be variously constituted, depending upon where the translocated pieces had broken off, but they might well be $a b m$ and $k l c d$. Since the a pairs with the a , and each other segment pairs at zygotene with the corresponding segment, a cross-shaped configuration would be produced. It would not necessarily be a regular cross; that would depend upon the relative lengths of the original chromosomes and of the translocated pieces. Unless one of the translocations was very short, however, one or more chiasmata would form in each arm, and they would be especially obvious at diplotene.

The metaphase configuration would depend upon the number and position of the chiasmata in each arm and also upon the degree of terminalization of the chiasmata. If terminalization was complete, and if at least one chiasma had formed in each arm, the metaphase configuration would be a ring of four chromosomes. Such rings have been found in a number of plants that have a reciprocal translocation. If terminalization is not complete, the interstitial chiasmata will be numerous and the

configuration may more nearly approach a cross than a ring. In organisms in which terminalization is complete or nearly so, the chromosomes tend to become oriented on the metaphase plate in such a way that alternate chromosomes go to the same pole; in other forms, the chromosomes line up in a purely random manner. The ring may consist of more than four chromosomes

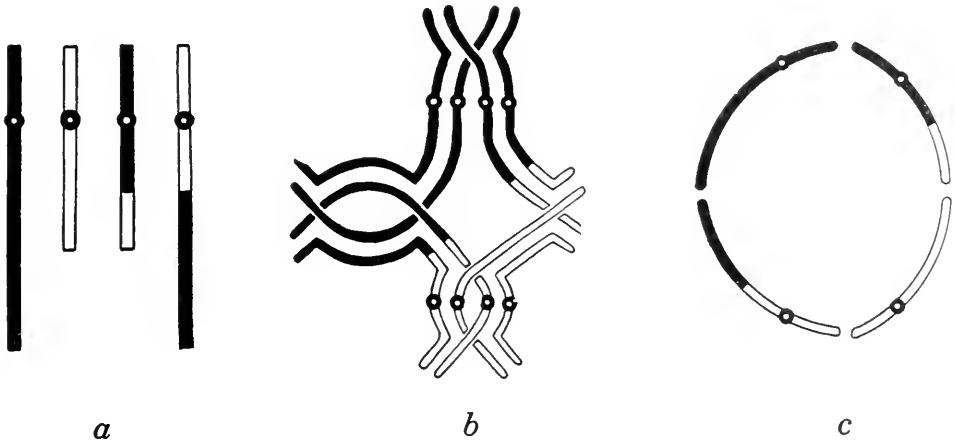

FIG. 109. Pairing of chromosomes in an individual heterozygous for a reciprocal translocation. (a) The two original chromosomes (*left*) and the two interchange chromosomes. (b) Diplotene showing eight chromatids and one or two chiasmata in each arm. (c) The following metaphase (not showing chromatids) assuming complete terminalization of chiasmata. The chromosome at the left in (a) would be chromosome *abcd* of the text and the one immediately to the right chromosome *klm*. Next in order would be the *abm* and *klcd* chromosomes mentioned in the text.

as in numerous wild strains of *Oenothera* and in *Rhoeo* (Fig. 110), and such large rings may also be produced by X-rays.

In plants like *Datura* and *Oenothera*, where there is a considerable number of reciprocal translocations in various strains but in which terminalization is complete, the rings are usually oriented as in Fig. 111*a*, with alternate chromosomes going to each pole and therefore with alternate chromosomes included in each type of gamete. In plants in which there is no terminalization, however, all three possible orientations (Fig 111*a*, *b*, and *c*) are usually found with approximately equal frequency. If, in a given plant or animal, the passing of alternate chromosomes to the same pole is a regular feature of meiosis, all the spores or gametes of that organism will be viable and functional and that

organism will be highly fertile. On the other hand, if the passing of alternate or adjacent chromosomes to the same pole is a purely random matter, only about one-third of the spores or gametes will have a complete genome (Fig. 111, bottom) and, especially in plants, the organism will be only partly fertile. Theoretically, two-thirds of the gametes of such plants will be sterile. In sev-

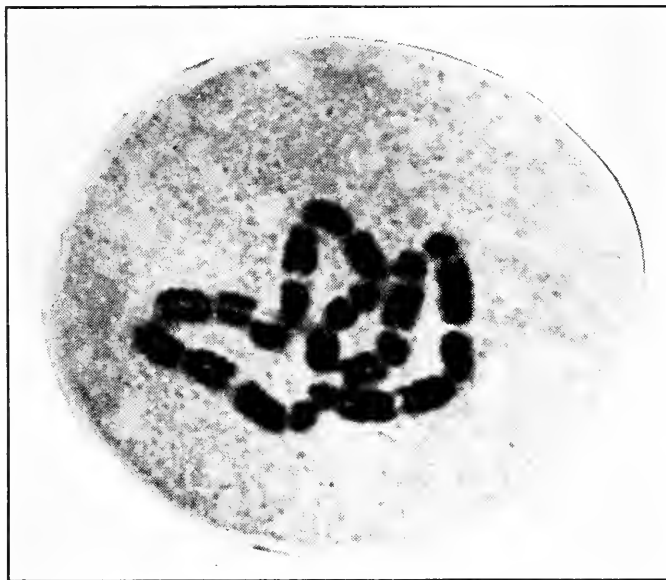

FIG. 110. Chromosomes of *Rhoeo discolor* at the first meiotic metaphase. All the chromosomes are arranged in a complete ring because of numerous reciprocal translocations. (Courtesy of Dr. K. Sax in the *Journal of the Arnold Arboretum*.)

eral actual cases, however, only about half the gametes were found to be sterile. Brink, Burnham, Sutton, and others have reported the occurrence of "semi-sterile" or "half-sterile" plants in maize, peas, and other plants (Fig. 112).

If a translocation heterozygote is self-fertilized, three types of offspring will be produced in a 1 : 2 : 1 ratio. One-fourth of the offspring will be homozygous and will be like the original type without the translocation, whereas one-fourth will be homozygous but will be of the interchange or translocation type. Both types will exhibit perfectly normal chromosomal pairing and will be highly fertile. The other half of the offspring will be translocation heterozygotes and will therefore show cross-shaped configurations in zygotene. If alternate or adjacent chromosomes in this translocation heterozygote can pass to the same

pole with equal frequency, these plants will be semi-sterile. The original homozygous, noninterchange line is sometimes referred to as the "standard" type, following the practice in *Datura*.

Apparently reciprocal translocations have occurred in a number of species and races of *Datura*. Blakeslee and his co-workers

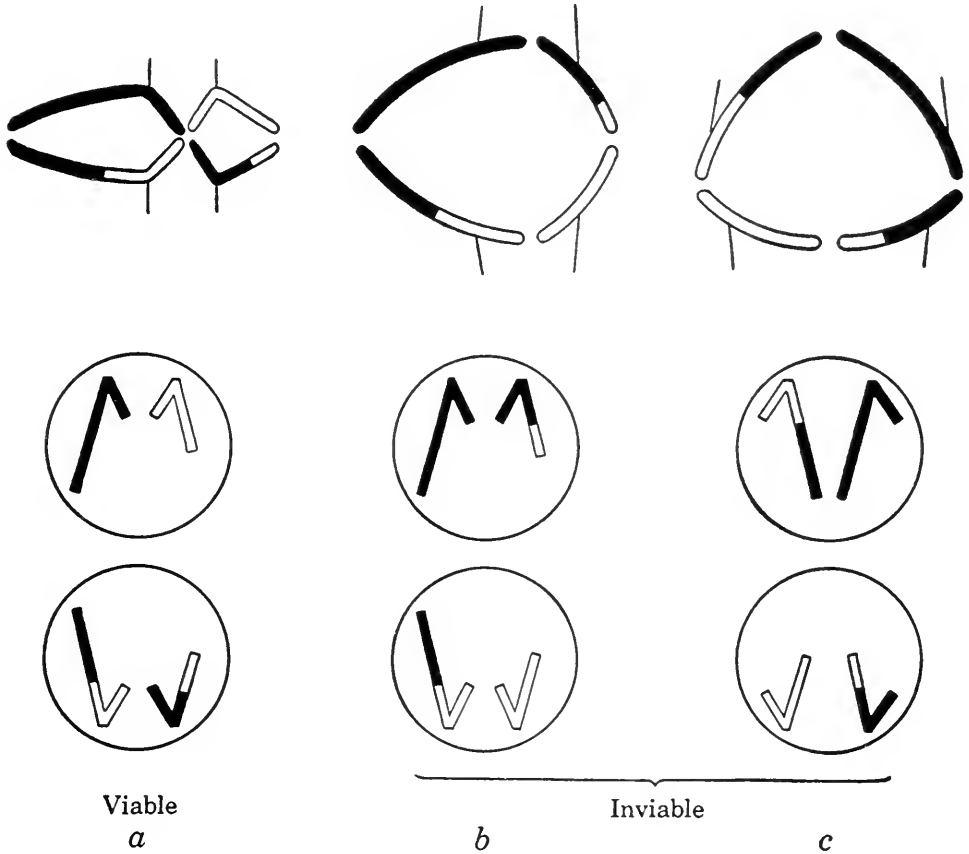

FIG. 111. The three possible orientations in rings of four chromosomes resulting from a reciprocal translocation. In (a) two viable types result; one has the two interchange chromosomes and the other the two noninterchange chromosomes. In (b) and (c) all the gametes are inviable for all carry a deficiency and also a duplication.

have found that many different types of interchanged chromosomes exists in six species. They were originally called "races," but they are now referred to as "prime types." The methods of analysis of these types and of identification of an unknown are interesting. The ordinary species of *Datura* have twelve pairs of chromosomes, each pair designated by two numbers, each of which represents the end of a chromosome. Thus in prime type 1 (formerly line 1) of *D. stramonium*, the twelve pairs of homo-

gous chromosomes may be identified as 1·2, 3·4, 5·6, 7·8, 9·10, 11·12, 13·14, 15·16, 17·18, 19·20, 21·22, and 23·24. As this is a pure-breeding type, each chromosome is represented twice. When a second prime type (PT2; formerly, line B) is crossed

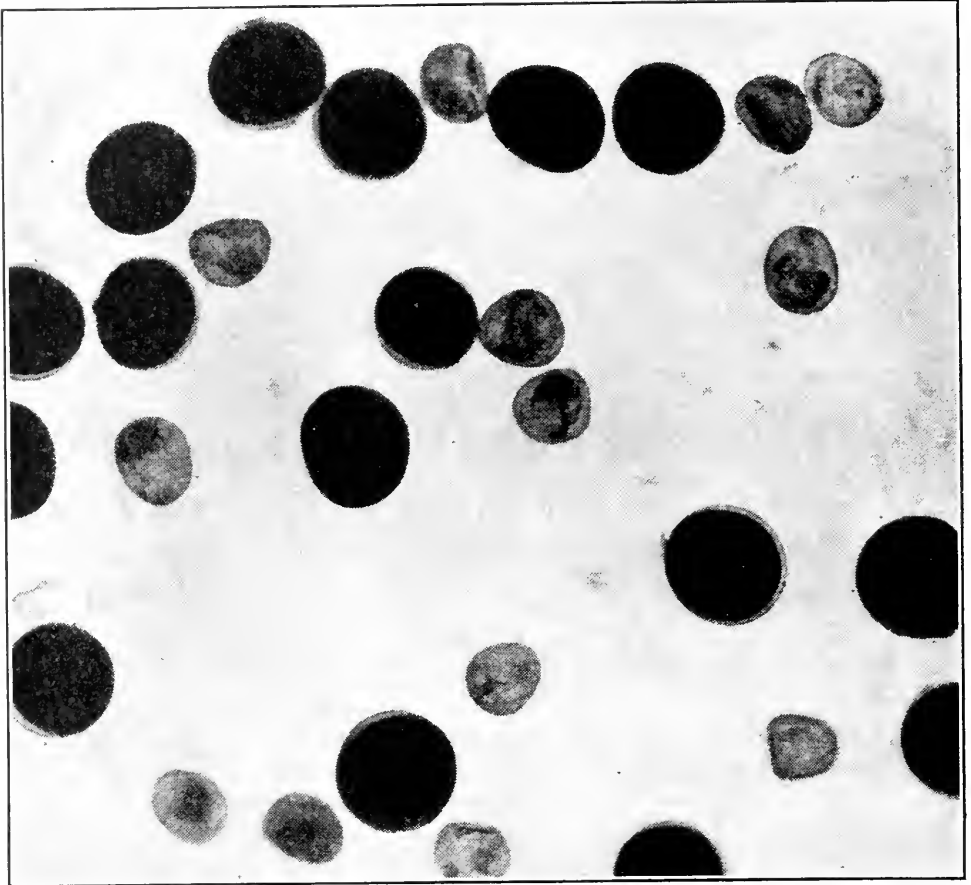
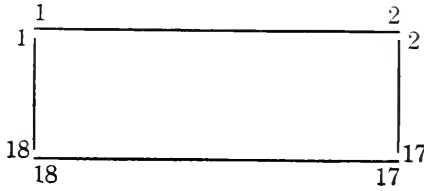

FIG. 112. Pollen grains in semi-sterile maize. The large, round, full, deeply staining grains are viable, but the small, shriveled, nonstaining ones are inviolate, being nothing but empty pollen grain walls. (Courtesy of Dr. R. A. Brink in the *Journal of Heredity*.)

with a plant of PT1, ten pairs and a circle of four chromosomes are found in the first meiotic prophase of the hybrid. The ten pairs signify that PT1 and PT2 have ten chromosomes which are identical, whereas the circle of four indicates that one interchange between segments of two chromosomes of PT1 has differentiated PT2. The interchange had occurred between chromosomes 1·2 and 17·18 so that PT2 is homozygous for the new chromosomes 1·18 and 2·17. In other words, the ends numbered

2 and 18 had exchanged places. Because PT2 is homozygous for both these translocation chromosomes, it shows nothing but twelve pairs of chromosomes. By an observation of the chromosomes or of the meiotic divisions of these two types by themselves, there is no indication that they differ by a reciprocal translocation. It is only the hybrid that reveals this information, for the hybrids are heterozygous for the translocation and form the circle:



Another prime type is PT3. This type also has nothing but paired chromosomes and therefore is homozygous for any inversions that it might include. When it is crossed with PT1, it also forms one circle of four in the hybrid, showing that it, also, differs from PT1 by one interchange. The interchange that differentiates PT3 from PT1 may or may not be the same interchange that differentiates PT2 from PT1. The only way to determine this is to cross plants of PT2 and PT3. When it is done, the hybrid shows two circles of four chromosomes. If both PT2 and PT3 differed from PT1 by the same interchange, their chromosomal segments would have a similar arrangement and the hybrid between PT2 and PT3 would show nothing but paired chromosomes. The fact that two circles are formed shows that they differ by two interchanges involving four chromosomes. Thus PT2 differs from PT1 by having 1·18 and 2·17 instead of 1·2 and 17·18 chromosomes, whereas PT3 differs from it by having two chromosomes that are 11·21 and 12·22 instead of 11·12 and 21·22. When PT2 and PT3 are crossed, the chromosomes in the hybrid pair as:

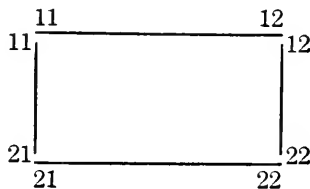

Another interesting prime type is PT94. When this is crossed with PT1, the offspring show a circle of six chromosomes and nine pairs. How could a circle of six be produced? If one interchange between 1·2 and 17·18 produced an interchange as 1·18 and 17·2, a second interchange between the new 1·18 chromosome and another one such as 13·14 would result in three new chromosomes, 1·14, 13·18, and 17·2, no one of which would be found in PT1. If this new type was then crossed with PT1, the offspring would form a circle of six, as:

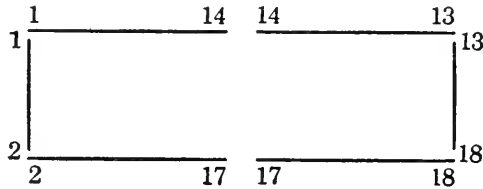

If this hypothesis were true, PT94 would differ from PT2 by only one interchange and should therefore produce offspring with it that had only a circle of four. Actual crosses between these two prime types result in hybrids that have only four chromosomes in a circle. On the other hand, PT94 should then differ from PT3 by two translocations in three chromosomes and another in a separate pair of chromosomes. Cytological observations of hybrids between these two types show one circle of six and a separate circle of four. The chromosome ring configurations in these hybrids are:

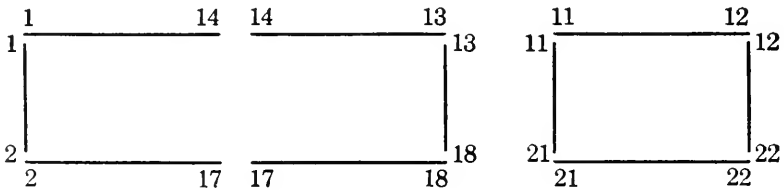

It is by crossing together all these prime types that the various translocations that have arisen in them can be identified. It happens that in *Datura* terminalization is practically complete so that alternate chromosomes go to the same pole. Therefore, these translocation heterozygotes are usually highly fertile, although some combinations give about 25 per cent sterility and the environment has a considerable effect on the fertility of some of the hybrids.

Chromosomal translocations have been worked out by Blakeslee and by Bergner for six species, including 681 races of *D. stramonium*.

B-Type Chromosomes

In discussing fragments, we have pointed out that segments of a chromosome that have a centromere behave as a normal chromosome in both mitosis and meiosis except for difficulties of chiasma formation resulting from their small size. A number of such very small chromosomes are found in some strains of maize. These chromosomes, which consist of a centromere and heterochromatin with a much smaller amount of euchromatin, are called *B-type chromosomes*. No genes have been identified in them. Many strains do not have these small chromosomes, but when they are present, they can be accumulated by breeding. Randolph has by selection produced plants with as many as thirty-four B-type chromosomes in addition to the twenty normal chromosomes. These chromosomes are not essential to normal growth and reproduction and do not appear to have any beneficial effects. Large numbers of B-type chromosomes, however, appear to bring about reduced fertility, decrease in vigor, increase in the size of the pollen and of other reproductive structures, defective seeds, scarred endosperm, and an increase in cell size. Although the origin of these chromosomes has not been satisfactorily explained, it has been suggested that the effects of these large numbers may be the result of genes located in the euchromatic regions. By breakage of the B-type chromosomes, smaller ones have been produced and are generally classified according to their size. They range from the C-type, which is shorter than the B's but still is elongated, to the F-type, which is only slightly above the lower limit of visibility of the photomicroscope.

QUESTIONS AND PROBLEMS

1. Two of the chromosomes in a certain plant are *abcdefghij* and *abghij*. Show how they would pair at meiosis. If such a plant were selfed, what would be the viable offspring? Would such heterozygotes be more likely to be found among the offspring in plants or in animals? Explain.

2. Position effect has been observed in certain duplications. Is it theoretically possible that it might be found as well in other chromosomal aberrations? Explain.

3. If X-rays produce a small ring deficiency, show how the behavior will differ if the ring has the centromere, if the centromere remains with the rod-shaped segment of the chromosome, and if the centromere splits in half so that the ring has half and the rod has half.

4. A man has two strains of a particular plant. One is homozygous for the chromosome *abcdefghijklmn* and the other is homozygous for the chromosome *abcdefghijklkmn*. Show the configurations in each of these plants and in the hybrid between them.

5. What would be the gametes of the hybrid in problem 4 if there was (a) a single crossover within the inversion, (b) one crossover between the inversion and the centromere; (c) two crossovers within the inversion involving all four strands; (d) one crossover in the inversion and one between the inversion and the centromere; and (e) two crossovers in the inversion and one between the inversion and the centromere.

6. Diagram the configurations in each part of problem 5 in the first anaphase and second anaphase of meiosis.

7. Diagram the configurations formed by each of the following pairs of chromosomes:

- (a) *abcdefghijklj* and *abedcfghij*
- (b) *abhgefcdij* and *abcdefghijklj*
- (c) *abcdefghijklj* and *abfehgcddij*

8. A geneticist has a strain of plants two of whose chromosomes are *abcdefghijklj* and *klmnopqrst*. He subjects them to X-rays and produces a reciprocal translocation between these two chromosomes. The two new chromosomes are *abcdefghpqrst* and *klmnoij*. Diagram the zygotene configurations in the translocation heterozygote.

9. What would be the offspring of the translocation heterozygote in question 8? How would the chromosomes pair in each of the types of offspring?

10. In *Datura quercifolia*, three interchange types have been found and have the following chromosomes: type 1 = 1·18, 3·4, 5·6, 7·20, 9·10, 11·21, 13·14, 15·16; 17·2, 19·8, 12·22, and 23·24; type 2 = 1·18, 3·4, 5·6, 7·20, 9·2, 11·21, 13·14, 15·16, 17·10; 19·8; 12·22, and 23·24; type 3 = 1·18, 3·4, 5·6, 7·8, 9·10, 11·21, 13·14, 15·16, 17·2; 19·20; 12·22, and 23·24. What would be the chromosomal arrangement at meiotic first prophase in the hybrids between type 1 and type 2, between type 1 and type 3, and between type 2 and type 3?

11. What would be the chromosomal arrangement in hybrids between these three types and PT1 of *D. stramonium* (see text)?

12. A plant has the following chromosomes: 1·2, 3·4, 5·6, 7·8, 9·10, 11·12, 13·14, 15·16. It is X-rayed and an interchange occurs between chromosomes 7·8 and 11·12, so that the new chromosomes are 7·12 and 11·8. The homozygous interchange type is later X-rayed and new interchange types are produced. (a) One produces a circle of four with the interchange type and only pairs with the original type; (b) another produces a circle of four with the interchange type and two circles of four with the original type; (c) a third produces a circle of four with the original type and a circle of six with the interchange type. What might be the interchanges that formed these three new types?

Chapter 25

ANEUPLOIDS AND NONDISJUNCTION

We discussed in the last chapter such chromosomal aberrations as deficiencies, duplications, inversions, and translocations. All these aberrations involved segments of chromosomes but not whole chromosomes. We shall consider in this chapter abnormal situations in which one or more whole chromosomes will be deficient from a genome or will be present as extra chromosomes. Some of these whole-chromosome aberrations are similar to some of the intrachromosomal abnormalities except that they involve a complete chromosome instead of a piece. For example, a chromosome may be missing, just as a chromosomal segment may be deficient. An extra chromosome may be present in the same manner that a segment may be duplicated. Of course a chromosome could not be inverted because a chromosome has no fixed position in the sense that an inverted segment is fixed in its inverted position by its attachment to the remainder of the chromosome. Finally, attached-X strains are examples of the translocation of one whole chromosome to another. Whether an aberration involves a whole chromosome or only a segment, the behavior at zygotene is determined by the rule that the parts of a chromosome pair only with homologous chromosomal segments. Chromosomal aberrations which include whole chromosomes but not chromosomal sets are termed *aneuploids*.

Monosomics

A *monosomic* type is an individual which is deficient for one whole chromosome. Since, in a diploid animal, the chromosome number in the somatic cells is $2n$, that in a monosomic form of the same species would be $2n - 1$. The characteristics of a monosomic are essentially the same as those of a deficiency. If the lost chromosome in an animal is small, the animal may survive but the genes in the missing chromosome will be absent; if the lost chromosome is large, the animal will not survive; $n - 1$

gametophytes usually do not survive; animals homozygous for a deficient whole chromosome do not survive.

Probably the best-known monosomic is the haplo-IV type of *Drosophila melanogaster*. This type is deficient one of the members of the very small pair of chromosomes known as chromosome IV. Since this chromosome is exceedingly small, and since it is no longer than some of the missing segments in flies deficient for parts of the three other chromosomes, haplo-IV types survive. Since these diploid organisms do not have two complete genomes, they are not so robust or so healthy as their normal brothers and sisters and they are a little slower to develop. They also have bristles which are shorter and eyes which are more roughened than those of normal, wild-type flies.

We pointed out in the last chapter that homozygous deficiencies produced a lethal effect except rarely where the missing segment was very small. Since the fourth chromosome, small as it is, greatly exceeds such a segment in length, no flies have been found which have no fourth chromosome. Similarly, large deletions may be lethal even if heterozygous. Probably for that reason no flies have been found which are haplo-II or haplo-III.

In diploid plants large deletions usually do not survive the gametophyte stage. Similarly, in normal, diploid plants, a missing chromosome is lethal in the gametophyte generation. In polyploids, however, where every chromosome is represented more than twice in the sporophyte and where every chromosomal segment may be present more than once in the gametophyte generation, the loss of one chromosome need not result in the absence of a complete genome. In such plants, monosomic types may exist but, strictly speaking, they are not $2n - 1$ but $4n - 1$. In fact, Lammerts has pointed out that the discovery of monosomics in a diploid species would be evidence of its polyploid nature.

Chromosome pairing in a monosomic is just what would be expected from the rule of strict part-by-part pairing at zygotene. If one whole chromosome is missing, the homologue has nothing with which to pair, and therefore behaves as a univalent chromosome. Although all the other chromosomes may line up in pairs at first metaphase, the univalent may be found on the equator by itself. At anaphase, then, it may pass apparently at random to either pole, giving theoretically gametes with n and those with $n - 1$ chromosomes in equal numbers. Such univa-

lents frequently behave abnormally at meiosis, often lagging behind the other chromosomes and failing to be included in the daughter nuclei. Because of such lagging, a higher percentage of $n - 1$ gametes may be found than would be expected. McClintock has found a $2n - 1$ chromosomal chimera in a maize

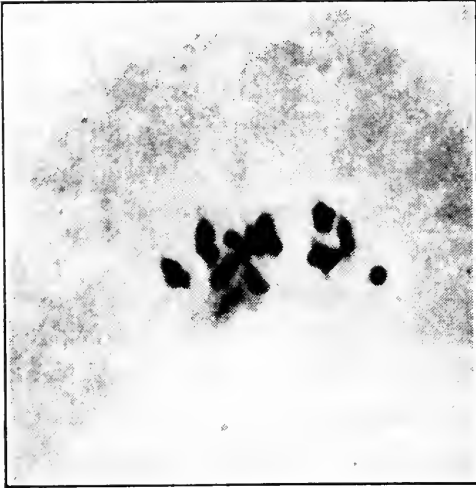

FIG. 113. Metaphase of the first meiotic division in the developing microspores of a $2n - 1$ maize plant. Nine bivalents and one univalent are present. (Courtesy of Dr. B. McClintock in the *Journal of Heredity*.)

plant which clearly showed nine bivalents and one univalent at the metaphase of the first meiotic division instead of the expected ten bivalents (Fig. 113). This univalent usually lagged at the equator after the bivalents had separated or it split into two halves which were frequently not included in the daughter nuclei. Root-tip studies from the same plant showed twenty chromosomes. Apparently, early in ontogeny a mitosis had been irregular, and the upper part of the plant became monosomic. Since maize is presumably a

diploid, a monosomic would not be likely to occur unless it was produced in this manner by an abnormal somatic mitosis.

Trisomics

If an organism has an extra chromosome, it is known as a *trisomic*. Normally, this name implies that one complete chromosome is present three times rather than twice, as it would be in a normal diploid; but in a few cases the extra chromosome is not a normal complete chromosome but an interchange chromosome.

One of the well-known trisomics is the triplo-IV *Drosophila*. Unlike the haplo-IV, in which one of the fourth chromosomes is missing, this type contains one extra member of chromosome IV so that it has in all nine chromosomes instead of eight. Also unlike the haplo-IV type, triplo-IV flies cannot be identified

with any degree of reliability by their general phenotypic appearance. In fact, in general, an extra chromosome does not produce so striking an effect as a missing one. In plants trisomics are much more frequent than monosomics, and the extra chromosome does not have the same lethal effect, at least in the female gametophyte, that is observed in monosomic types.

Chromosome pairing in a trisomic is very interesting, and, to understand it, we must understand three principles. (1) With a very few minor exceptions, chromosome pairing at zygotene is between homologous chromosomal segments only. (2) *At any one place*, chromosome pairing is between two chromosomes only. (3) Except for mechanical difficulties that might influence two regions near to one another on a chromosome, the two threads that pair at one place on the chromosomes have no determining influence on the threads that pair at any other place. Unless the chromosomes are very short, all three chromosomes will be involved in the pairing at various places so that the three chromosomes will together form a *trivalent* configuration. If two of the three homologues are paired throughout their length while the third is not paired at any point, the three chromosomes will not form one configuration but will be paired as a bivalent and a univalent. This bivalent will arrange itself on the equator in the same manner as any other bivalent, but the univalent will appear on the equator by itself and behave much as does the univalent in a monosomic. Usually, pairing occurs in such a manner that a trivalent is formed (Fig. 114).

After pairing has occurred, the chromatids form chiasmata, and the characteristic diplotene appearance of nodes and internodes is observed as in any normal bivalent. Perhaps the process is most easily understood if the figure is not regarded as a trivalent but as a combination of several bivalent segments. Each bivalent segment then acts like the segments of a bivalent configuration, forming chiasmata in the same way. These chiasmata may or may not terminalize. If they do, the chromosomes will be joined together at the ends, and the particular figure will depend upon the position of the paired segments. At diakinesis and at the following metaphase, the trivalent may have the form of a chain of three chromosomes, or of a ring of two with the third chromosome attached to the ring at one end (a ring-and-rod),

or of the letter "Y," or finally of a ring bivalent with the third chromosome attached to the ring at each end.

When the chromosomes orient themselves on the spindle of the first meiotic division, the trivalent takes a position on the

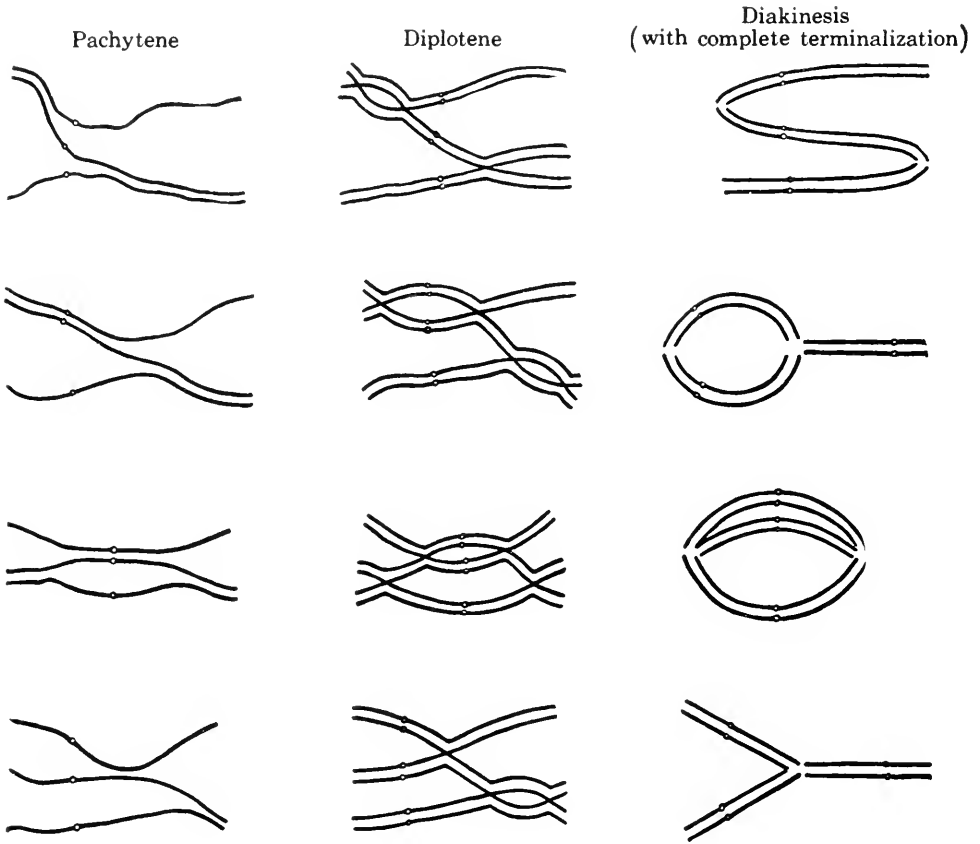

FIG. 114. Trivalent configurations. A chain of three, a ring and rod, three chromosomes joined together at each end, and a Y-shaped trivalent are illustrated at diakinesis. The possible pairing arrangements at pachytene and the formation of chiasmata in the paired segments at diplotene are indicated. It is assumed that terminalization is complete.

equator with the bivalents and adjusts itself so that the centromeres point towards the poles as well as they can. At first anaphase, regardless of which of the four types the trivalent has assumed, two of the three homologous chromosomes go to one pole and the third goes to the other; it is purely a matter of chance to which pole the extra chromosome is transmitted. After meiosis, two of the gametes or spores will be normal haploid structures whereas the others will have $n + 1$ chromosomes and, if they are viable, will be able to transmit the trisomic condition.

The question of the viability of the gametophytes that bear the extra chromosome is very interesting, for decidedly the presence of an extra chromosome upsets the balance of the genes. It is true that in a trisomic there is no incomplete genome as there is in a monosomic type, but it is conceivable that the genic balance will be so disturbed that the gametophyte generation will not be normal. One of the most complete studies of the effect of the extra chromosome has been in the genus *Datura*. The Jimson weed, *D. stramonium*, has normally twelve pairs of chromosomes. It is conceivable, therefore, that twelve different trisomic types might be found, each one of which is trisomic for a different one of the twelve pairs. In the normal diploid each chromosome is represented twice; therefore each gene in the plant is represented twice. Supposedly, the plant has existed in that condition for a long time, and any variation from it is in the direction of an unbalance. Thus if a certain chromosome is trivalent while all the others are bivalent, its genes will each be represented three times, and the characters controlled by those genes will be exaggerated. Since each of the twelve pairs of chromosomes bears different genes, it might well be possible to identify from their phenotypes twelve morphological types which differ from the normal and also from each other, each of which is trisomic for one of the twelve pairs of chromosomes. Blakeslee and his co-workers have identified twelve such morphological types and have determined cytologically that they are trisomic forms. Figure 115 shows the capsules of each of these twelve types and below them the chromosome with respect to which the types are trisomic.

Such an unbalance, however, may affect not only the phenotype of the plants but also the viability of the gametophyte generation. It is more reasonable to expect an unbalance in the gametophyte generation than in the sporophyte. The chromosome number of trisomic sporophytes is $2n + 1$, which means that the genes in the trisomic chromosome stand in the relationship of 3 : 2 to those in the other chromosomes. However, gametophytes which bear the extra chromosome have $n + 1$ chromosomes. In those gametophytes the genes in the trisomic chromosome are twice as numerous as those in the other chromosomes, and, therefore, there is a greater unbalance in the gametophyte than in the sporophyte. Specifically, however, only

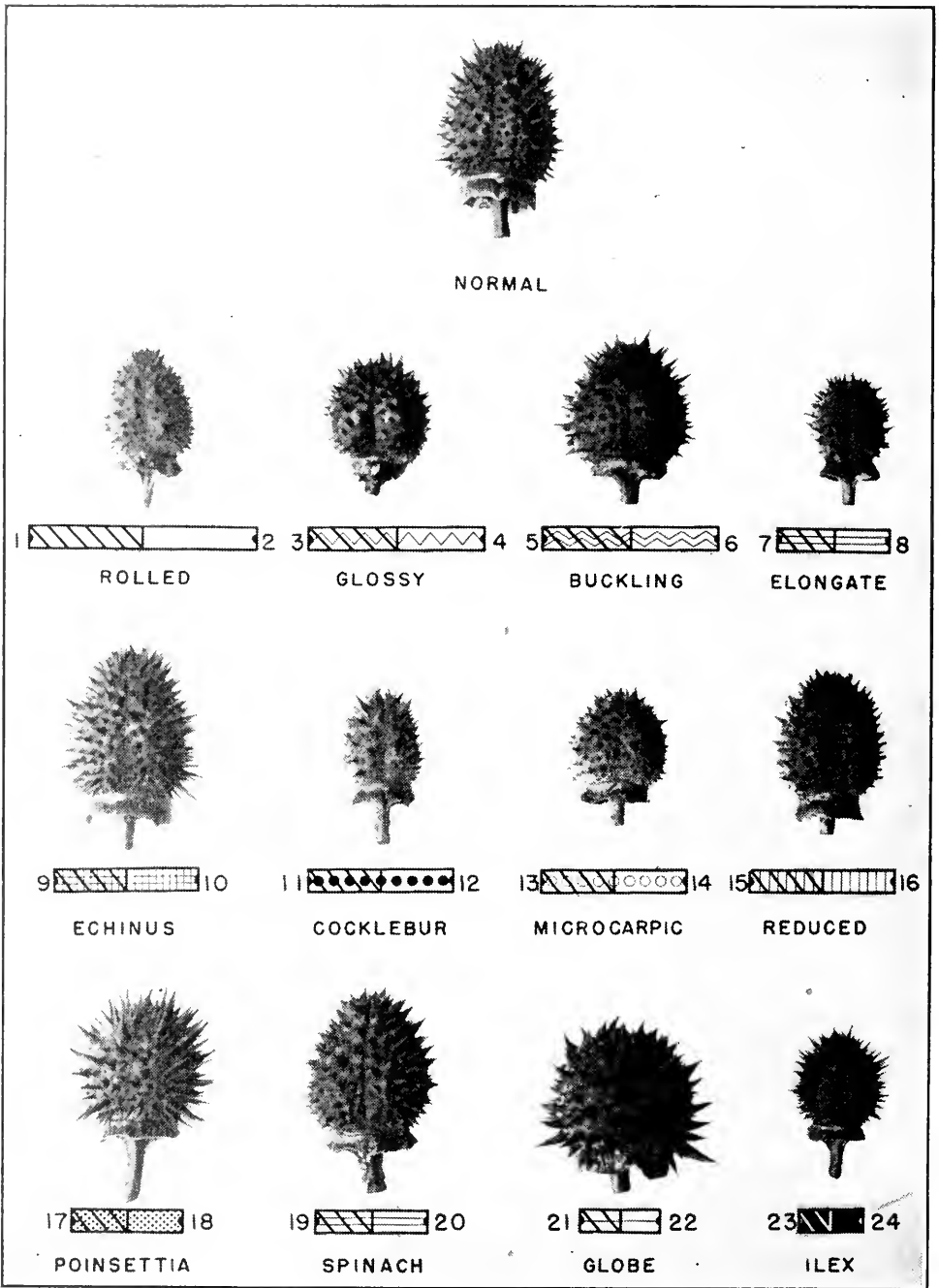

FIG. 115. Seed capsules of Blakeslee's twelve primary trisomic types of *Datura stramonium*. Beneath each of these trisomic capsules is a diagram of the extra chromosome found in that type with the numbers used to designate its two ends. (Courtesy of Dr. A. F. Blakeslee.)

genes that affect the gametophyte would show this unbalance, for the specific effect of a gene that controls the shape of a sporophytic structure such as a capsule would be the same in the gametophyte whether it was present twice as frequently as other genes or merely as frequently. Since very few gametophyte genes have been identified, therefore, we must look merely for a general effect rather than for a specific one in the gametophyte. This general effect is often expressed, at least in part, in viability, for $n + 1$ gametophytes on the whole do not survive as well as normal n gametophytes. This lowered viability, furthermore, is usually more apparent on the male than on the female side. The reason for this is not too clear, but the loss of $n + 1$ microgametophytes is at least in part the failure of such pollen tubes in competition with normal pollen tubes. This low viability on the male side is extreme in *Datura*, where probably no $n + 1$ microgametophytes function.

If specific, known genes are present on the chromosome that is in the trisomic condition, the ratios that they will yield will differ from the normal (Fig. 116). One of the best-known examples is the inheritance of the recessive gene *eyeless* in *Drosophila melanogaster*. If a triplo-IV fly with three dominant alleles of the gene *eyeless* is crossed with a normal fly homozygous for *eyeless ey*, the F_1 will be normal, wild-type *Ey ey* and triplo-IV, wild-type *Ey Ey ey*. If a normal F_1 fly is testcrossed to a normal *eyeless*, the offspring will be half wild type and half *eyeless*. When a triplo-IV F_1 fly is crossed with a normal *eyeless*, however, the offspring will segregate into five wild type to one *eyeless*. The *eyeless* will be normal as will two of the five wild type, but the remaining three wild-type flies will be trisomic. A 5 : 1 ratio is typical of a testcross of a trisomic with two dominant genes and one recessive gene to a normal, homozygous recessive. Of course, if the trisomic bears only one dominant allele, the ratio in the offspring will be 1 : 1, and it will not be possible to detect the trisomic condition from the breeding ratios.

The actual ratio which will be obtained in plants, however, may differ from this because of the elimination of some of the trisomic types in the gametophyte. It will also be disturbed if crossing over occurs between the locus tested and the centromere, a possibility which does not occur in the study of the *eyeless*

gene. If a normal, recessive female plant is crossed with a male which is trisomic and has two dominant and one recessive alleles, the elimination of $n + 1$ male gametes will change the ratio to 2 wild type : 1 recessive. If the female is the trisomic type

Orientation of trivalent	Gametes	Offspring of Backcross	Phenotype of Offspring
			Trisomic dominant
			Normal dominant
			Normal dominant
			Trisomic dominant
			Trisomic dominant
			Normal recessive

FIG. 116. Inheritance in a trisomic with the genetic constitution AAa . The three possible orientations of this trivalent at metaphase (first column) and the six possible gametes that result (second column). The third column shows the genotypes and the fourth column the phenotypes formed when an organism with this trivalent is backcrossed to the recessive. A ratio of 5 dominant : 1 recessive would be found.

and the male the normal recessive, the elimination of some of the $n + 1$ female gametophytes and gametes will reduce the percentage of trisomic types in comparison with the percentage found for eyeless where there is no elimination. The actual ratio will depend upon the percentage of gametophytes eliminated and will vary between 2 : 1, where all $n + 1$ gametes are eliminated, to 5 : 1, where there is no elimination.

Although we have assumed so far that the extra chromosome is identical with one of the normal chromosomes in a genome, this

need not necessarily be so. In fact, Blakeslee has found three types of trisomics in *Datura*. The type we have just described has one normal chromosome in excess so that one pair of homologues is represented by three members. This type is frequently called a *primary trisomic*. In *Datura*, the primary trisomic Rolled has the 1·2 chromosome present three times instead of twice. If two of these homologous chromosomes were to undergo reciprocal translocation at about the centromere, two new chromosomes would be formed which would be 1·1 and 2·2. If now a trisomic was formed which had two normal 1·2 chromosomes plus this new 1·1 chromosome, this trisomic would be different in its pairing and in the resulting phenotype from the normal primary trisomic. These new trisomic types are known as *secondary trisomics*. In *Datura*, the primary trisomic Rolled (1·2) has two corresponding secondaries, Polycarpic (1·1) and Sugarloaf (2·2). If we remember our rule of part-by-part pairing, metaphase configurations of a secondary trisomic with complete terminalization of chiasmata will include some circles of three chromosomes.

In *tertiary trisomics* the extra chromosome arose by a reciprocal translocation between two nonhomologous chromosomes.

Nondisjunction

Now that we have discussed both monosomic and trisomic types, it may well be asked how they originate. They appear to arise from an irregularity at a cell division such that the two homologous chromosomes become included in the same daughter nucleus instead of being distributed one to each daughter nucleus. This distribution usually occurs at meiosis but may, as we have pointed out, occur at a somatic mitosis, producing chromosomal chimeras.

Should the chromosomes fail to pair at the first meiotic division, should they not form chiasmata, or should the chiasmata slip completely off the ends, the two chromosomes will not move on to the equator as a bivalent, but as two separate univalents. As univalents, each homologue is independent of the other, and can go to either pole, and it is purely a matter of chance whether one goes to one pole and the other to the opposite pole or whether both go to one pole, leaving the other pole without any member of that homologous pair. Thus two of the spores or gametes will

be $n + 1$ and two will be $n - 1$. This abnormal behavior, as the result of which the members of a homologous pair fail to separate normally so that both members become incorporated into one of the daughter nuclei while the other daughter nucleus has neither, is known as *nondisjunction*. It actually results, of course, from *nonconjugation*.

Since there are four pairs of chromosomes in *Drosophila melanogaster*, each gamete should have four chromosomes if meiosis is normal and regular. Since one of the pairs in the female consists of two X chromosomes, each egg should have one and only one X chromosome. Any other result indicates some irregularity in the meiotic system. Such irregularities do occur, although not with any great frequency, and, when they do, nondisjunction results.

When nondisjunction of the X chromosome occurs, either the two X chromosomes remain in the egg or they both pass into the polar body, leaving the egg with no sex chromosome. If both remain in the egg, such eggs will have three autosomes and two X chromosomes. They can be fertilized by either an X chromosome-bearing sperm or by a sperm that has a Y chromosome. If a sperm with an X chromosome unites with such an egg, the resulting individual will have three pairs of autosomes, as in the normal diploid fly, but will have three X chromosomes instead of two. A fly with such a chromosomal complement is a *triplo-X* fly and is trisomic for the X chromosome. The chromosomal unbalance in this case is so great, however, that triplo-X flies normally die before reaching the adult stage. If an egg with two X chromosomes is fertilized by a sperm that bears a Y chromosome, the resulting individual will have four pairs of chromosomes like any normal female, but will have a Y chromosome in addition. It will behave as a normal female.

If the two X chromosomes go into the polar body leaving none in the egg, the egg will carry only the three autosomes. If this egg is fertilized by a sperm with an X chromosome, the individual which results will have three pairs of autosomes and one X chromosome. Such a fly will be a male, but it will be sterile. If the egg deficient in an X chromosome is fertilized by a Y chromosome-bearing sperm, the resulting zygote will have three pairs of autosomes and a Y chromosome, but it will have no X chromosome. The lack of an X chromosome proves fatal to this

type, and such flies die when only a few cell divisions past the zygote stage.

If known genes in the X chromosome are traced in nondisjunction, the genetic ratios will be different from those expected if meiosis is normal. In fact, it was the unexpected appearance of certain phenotypes that led to the discovery of nondisjunction in *Drosophila* by Bridges in 1916. As demonstrated frequently, a white-eyed female when mated with a red-eyed male normally produces only red-eyed females and white-eyed males. If, however, two X chromosomes each bearing a *w* gene remain in the egg, and if this egg is fertilized by a Y-bearing sperm from a red-eyed male, the offspring will be a female, but will be white-eyed because both its X chromosomes were derived from its female parent (Fig. 117). If a nondisjunctional egg which is deficient for an X chromosome is fertilized by a sperm containing an X chromosome on which is located a *w*⁺ gene, the offspring will be male and will have red eyes because its X chromosome was introduced from its red-eyed father. These white-eyed females and red-eyed males are abnormal types and suggest that something unusual has occurred. Normally, in *Drosophila*, a male receives his only X chromosome from his mother. Males that result from nondisjunctional eggs, however, receive their X chromosome from their father and hence are known as *patroclinous males*. Similarly, females normally receive one X chromosome from each parent. The white-eyed females that result from a nondisjunctional egg are called *matroclinous females* because they receive both their X chromosomes from their mother.

Nondisjunction is also found in both the sex chromosomes and the autosomes of other animals and in many plants. In fact, probably all monosomies and trisomies have arisen from nondisjunction. Failure of pairing at zygotene or failure of chiasmata probably are responsible for nondisjunction in most plants and animals; but in those in which the chromosomes are heterozygous for reciprocal translocations, nondisjunction may arise from other causes.

A good example of nondisjunction not resulting from failure of pairing or of chiasmata is found in *Oenothera Lamarckiana*. In *Oenothera* certain species are permanently heterozygous for one or more translocations so that at meiosis their chromosomes

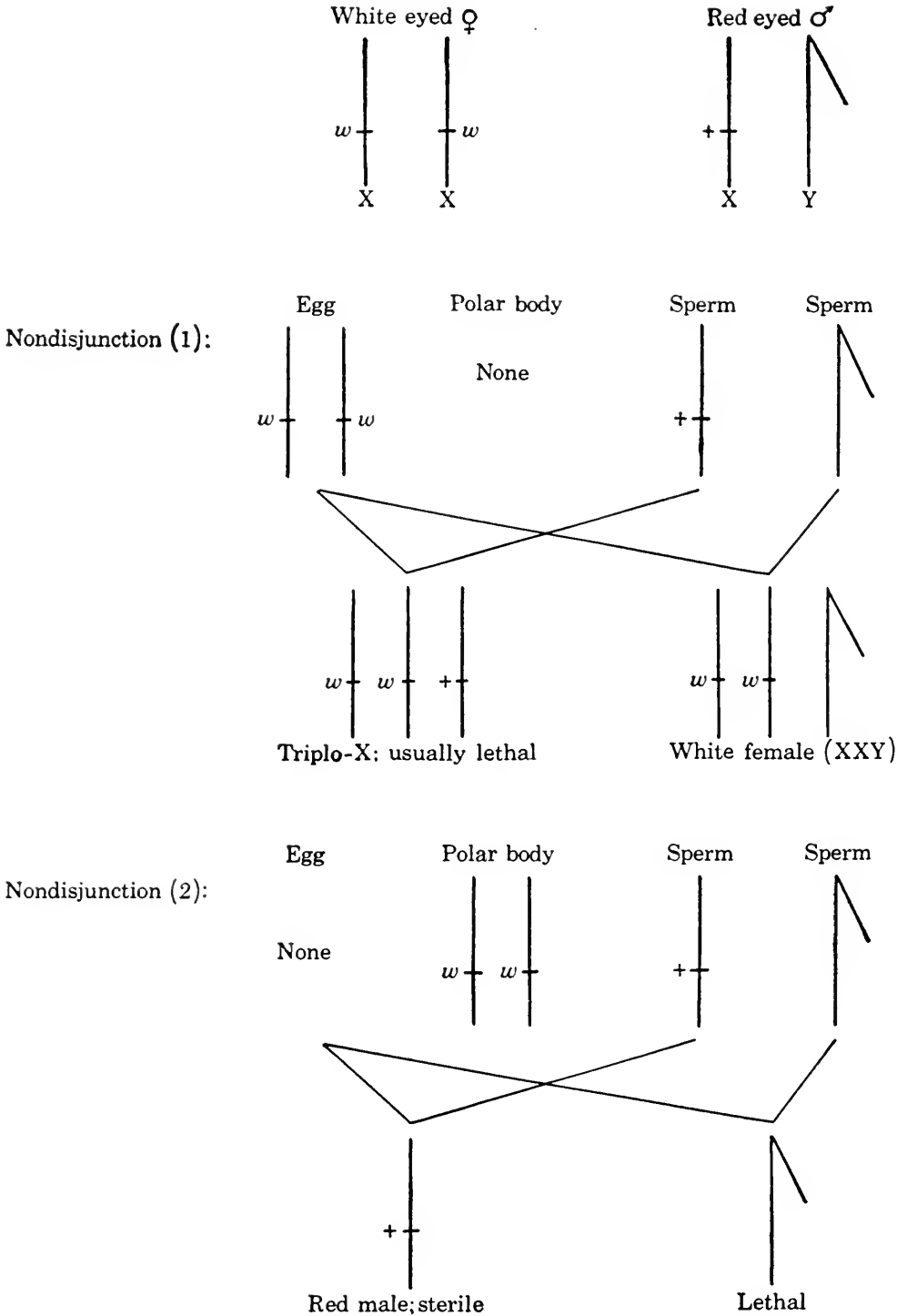

FIG. 117. Diagram showing the result of nondisjunction of the X chromosome of *Drosophila melanogaster* in the female of a cross between a white-eyed female and a red-eyed male. The normal result of such a cross is red-eyed females and white-eyed males, but as a result of nondisjunction white-eyed females and red-eyed males are produced.

regularly form rings or circles, the size and number of which depend upon the number and position of the translocations for which they are heterozygous. For example, in *Oe. Lamarckiana*, the chromosomes are arranged at meiosis in the form of one pair and a circle of twelve. The pair represents a chromosome that bears no translocation. The circle is composed of one set of chromosomes whose ends are designated as 3·4, 5·8, 7·6, 9·10, 11·12, and 13·14 and one set whose ends are 3·14, 5·6, 7·4, 12·10, 11·8, and 13·9. Terminalization is complete in *Oenothera*,

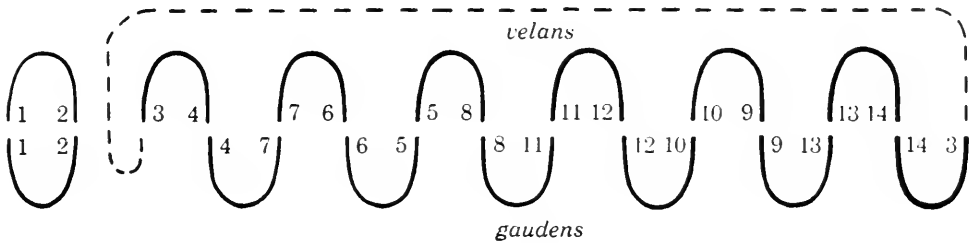

Fig. 118. Arrangement of the chromosomes at the first meiotic metaphase of *Oenothera Lamarckiana* showing one pair and a circle of twelve chromosomes. Six of the chromosomes belong to the *velans* complex and normally always go to one pole; the other six belong to the *gaudens* complex and go to the opposite pole. These two complexes have arisen as the result of a number of reciprocal translocations.

and normally the chromosomes are arranged so that alternate ones go to the same pole, and therefore always remain together. Such a group of chromosomes is called a *complex*; and to facilitate discussion about the various interchange types, the different complexes are given names. Thus the first group of chromosomes above, along with one of the 1·2 chromosomes, is called the *velans* complex; the second group with one of the 1·2 chromosomes is the *gaudens* complex. Because of the position and number of the interchanges between these two complexes, they form one pair and a circle of twelve when they are together in the same plant.

The chromosomes are so oriented that the ones of the *velans* complex go to one pole while the *gaudens* chromosomes go to the other (Fig. 118). Apparently both the *velans* and *gaudens* complexes carry lethal genes or small deficiencies which are different in the chromosomes of the two complexes. Therefore, both *velans* · *velans* and *gaudens* · *gaudens* forms are homozy-

Other causes for the origin of trisomies are also possible. Rhoades, for example, found a strain of maize in which an extra chromosome was present consisting of the short arm of chromosome V, broken in such a fashion that the centromere was at the end of this centric fragment chromosome. A terminal centromere is unstable and produces a number of abnormalities. Oc-

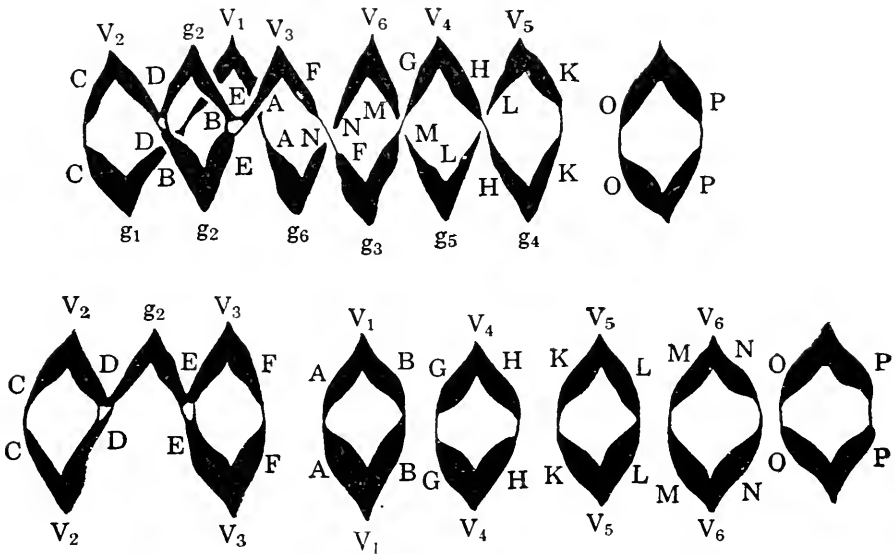

FIG. 119. Two of the trisomies of *Oenothera Lamarckiana*. The designation of chromosomal ends by letters rather than numbers was a temporary expedient of the British geneticists before their material and the American material could be compared and similar numbers adopted for both. *Above*, pairing in plant resulting from union of a gamete with seven *velans* and one *gaudens* chromosomes with a normal *gaudens* gamete. *Below*, pairing in a plant from the same eight-chromosome gamete and a *velans* gamete. (Redrawn from Catcheside in the *Journal of Genetics*.)

asionally, it divides transversely instead of longitudinally, and in this way it can produce a secondary trisomic with two identical arms.

Somatic Nondisjunction

If a red-flowered plant is heterozygous for the gene *C*, nondisjunction of the chromosome that carries the *C* gene during somatic divisions of the cells of the epidermis of the developing petals may produce cells with the constitution *CCc* and others with only the *c* gene. All cells that develop from the first cell that lacks the *C* gene will be white instead of red; white patches

will then appear on the otherwise red petals and will be wedge-shaped. The size of these white patches will depend upon the stage in the formation of the flower at which the nondisjunction occurred. If the flower was young, the white sectorial chimera will be large, but if it was nearly developed at the time the nondisjunction took place, the white area will be small. Lawrence has reported several such chimeras in *Dahlia variabilis*.



FIG. 120. A purple flower of *Nemesia strumosa* showing two relatively large and one small sectorial chimeras resulting probably from somatic nondisjunction. The small chimera resulted probably from a nondisjunction which occurred at a later stage in the ontogeny of the flower than the aberrations that produced the other chimeras. Compare with Fig. 10.

Wedge-shaped sectorial chimeras have been observed in *Nemesia strumosa* (Fig. 120) and probably result from somatic nondisjunction. In *Nemesia*, some purple flowers have white sectors as do some orange-colored flowers, showing that apparently both the *C* and the *O* gene are on chromosomes that can undergo somatic nondisjunction. In a very few white flowers of plants heterozygous for *bm*, the gene for blue-margin, a blue chimera was found on the upper lips of the flower.

Organisms with More Than One Extra Chromosome

Since a plant or animal might have one extra chromosome, we might wonder whether it could have more than one. Theoretically, if a plant could be trisomic for one pair of chromosomes, every chromosome pair might be in the trisomic condition. In *Datura* plants have been found which are trisomic for two pairs of chromosomes. Such double trisomies have the formula $2n + 1 + 1$, and they are generally less viable than simple trisomies. Plants trisomic for three chromosomes are $2n + 1 + 1 + 1$, but are practically nonexistent.

Plants with $2n + 2$ chromosomes are tetrasomic for one of the chromosomes. They show a greater exaggeration of the characters determined by their genes and a greater unbalance than the corresponding trisomic, and they are generally weaker and less viable. In *Datura* four primary chromosomes can be trans-

mitted as $n + 1$ types through the pollen, and three have resulted in tetrasomics when a trisomic was selfed. When a tetrasomic was selfed, it produced normal $2n$ plants, tetrasomics like itself, the corresponding primary trisomics, and also secondary trisomics. When crossed as both a male and a female with normal diploid plants, it produced diploids and trisomics but no tetrasomics. Apparently $n + 2$ gametophytes are inviable either as males or females.

QUESTIONS AND PROBLEMS

1. Assume that A is dominant over a and that a plant is trisomic for the chromosome bearing the a locus. Assume that $n + 1$ pollen is not viable. What would be the ratio of A to a in the $2n$ and $2n + 1$ offspring from a self-fertilization of plants whose genotypes are: (1) AAA ; (2) AAa ; (3) Aaa ; (4) aaa ?

2. What would be the offspring in question 1 if all the pollen and eggs were viable?

3. What would be the offspring in question 1 if only 30 per cent of the $n + 1$ eggs and none of the $n + 1$ pollen were viable?

4. In *Datura*, the genes for purple (P) and white (p) are in the "18" end of the 17·18 (*Poinsettia*) chromosome. This chromosome is rarely transmitted through the pollen and to only 27.7 per cent of the eggs in primary trisomics. What would be the ratio of purple to white from self-pollinations of PPp and Ppp plants, and what would be the results of backcrosses in both directions to pp plants? (Neglect the fact that in *Datura*, $n + 1$ gametes are transmitted through the female in greater proportion when the male is another plant than when the trisomic is self-pollinated.)

5. In plants of Prime Type 1 of *Datura*, the following extra chromosomes are present producing trisomics: (a) 1·2; (b) 7·7; (c) 19·20; (d) 1·18; (e) 17·17. Which types (primary, secondary, or tertiary) would they produce, and what configurations would they produce in a Prime Type 1 plant?

6. If the extra chromosomes in question 5 were present in Prime Type 2 plants, which types do they produce (primary, secondary, or tertiary), and what configurations would they produce?

7. How, by means of trisomics, could a newly discovered gene be placed in its particular chromosome?

8. Arrange the following in order from the greatest to least genic unbalance which they produce, assuming that the same chromosome is involved in each case: (a) primary trisomic; (b) secondary trisomic; (c) tetrasomic; (d) monosomic. Explain.

9. Could attached-X flies produce trisomics? Explain. Could other translocations produce nondisjunctions and aneuploids? Explain.

10. If a white-eyed female produced as the result of primary nondisjunction were crossed with a wild-type male, what offspring would be possible? Explain.

11. Show by diagrams how nondisjunction of the fourth chromosome of *Drosophila melanogaster* might occur, and how triplo-IV and haplo-IV types might result.

12. What are nullosomic types? How could they be produced? Would you expect to find nullosomic plants or animals? Explain.

Chapter 26

HAPLOIDS AND AUTOPOLYPLOIDS

Chromosome aberrations involving segments of a chromosome or individual whole chromosomes are by no means the only aberrations, for many plants and some animals differ from the regular diploid type by possessing only one genome or chromosomal set, or by consisting of three or more. Those forms with only one chromosome set are *haploids* (or *monoploids*) whereas those that have three or more complete genomes are *euploids* or, more frequently, *polyploids*. Organisms with three complete sets of chromosomes are *triploids*; those with four, five, six, and eight are known, respectively, as *tetraploids*, *pentaploids*, *hexaploids*, and *octoploids*. If an organism consists of more than two genomes, its genomes may be alike or dissimilar. If they are all alike, the polyploid is an *autopolyploid*, but if two or more different genomes are present, the organism is an *allopolyploid*. Thus we have the terms autotriploid, autotetraploid, allotetraploid, and similar designations. When dealing with many other biological phenomena, we often find it easier to designate categories than to place plants and animals into them as simply as we should prefer to do. The situation is the same for polyploids, for some organisms are not easily classified as either autopolyploids or allopolyploids, and some may actually be autopolyploid for some chromosomes and allopolyploids for others. In general, however, the designations are useful and widely used.

Haploids

Haploid organisms contain only one genome or set of chromosomes. In some organisms certain phases of the life cycle are regularly haploid. These phases are adjusted to the haploid condition, and there is nothing abnormal about their behavior, for the normal condition is to behave the way they do. It is only when tissue that is normally diploid develops with only

one genome that there is anything abnormal about the haploid state.

In Chapter 4, we pointed out that the gametophyte generation of plants is normally haploid. In some animals, such as the bees and related insects, the females are always diploid whereas the males are haploid. Since this is a normal condition, and since the males produce normal, viable sperm, the meiotic divisions which occur in the production of germ cells in animals must be modified in such a way that the haploid number already present is not further reduced. In the adjustment which this organism makes the first meiotic division is an abortive affair, resulting in a normal haploid secondary spermatocyte and a small mass of cytoplasm without a nucleus. The second meiotic division is of the equational type and produces cells which mature into haploid spermatozoa.

In organisms in which a generation that is normally diploid is produced with the haploid number of chromosomes, there is no such adjustment to the haploid condition, and no modification of the meiotic mechanism has been developed of such nature that large numbers of haploid products of meiosis will result. A haploid plant or animal can merely be regarded, so far as its meiotic behavior is concerned, as an organism which is *monosomic for all its chromosome pairs*. Each chromosome behaves like a monosomic and is normally independent of all the others. There is no zygotene pairing, as no chromosome has a partner, so that each chromosome moves on to the equator as a univalent and passes to either pole at random and completely independently of the others. Theoretically, the chance that any given chromosome will pass to a certain pole is $\frac{1}{2}$ and that all the chromosomes will pass to the same pole is $\frac{1}{2} \times \frac{1}{2} \times \frac{1}{2} \dots$ to n terms, where n represents the number of univalent chromosomes. In other words, the frequency of spores or gametes with n chromosomes will be $1/2^n$. Quite obviously, the greater the number of chromosomes, the smaller the chance of including all in one cell. Since gametes or gametophytes that have fewer than n chromosomes are frequently inviable, such haploids are highly sterile.

Although theoretically all the chromosomes at the first meiotic division of haploids should be univalents, they are not always

so. Sorghum plants have been found with only ten chromosomes instead of the usual number, twenty, and with ten univalents in most cells. At anaphase all possible types of separation were found from five to each pole to ten to one and none to the other, with the four to six and three to seven distributions very common. In these plants, however, occasionally one, two, or three bivalents were observed in a nucleus, and about 10 per cent of the nuclei had bivalents. In pepper haploids twelve univalents were often observed (Fig. 121), but in other nuclei there were one to six bivalent associations. It has even been reported that in three plants of *Triticum monococcum* there is no chromosome pairing in prophase but that at diakinesis, the chromosomes may be in chains of varying lengths up to the whole seven chromosomes. These configurations are lost by metaphase and in only about 2 per cent of the microsporocytes are there any bivalents.

Where the haploid condition has become established as a regular feature of one phase of the life cycle there is not necessarily any advantage or disadvantage in the haploid condition. In fact, in such organisms there may be no resemblance in any way between the haploid and diploid generations, that is, one is not merely a small or a large version of the other. In some of the lower plants the haploid and diploid generations are identical; in others they are very different. In some lines of evolution the haploid generation developed more prominently than the diploid, but in other lines the diploid stage became more prominent and the haploid generation became extremely small and inconspicuous. Here, however, the haploid is not merely a feeble version of the diploid, but it has become established as something that is different in kind from the diploid generation. However, when a haploid develops as an aberrant form of a stage that is normally diploid it is usually somewhat less robust, less vigorous, and smaller than the corresponding diploid, and frequently very much inferior. Müntzing, for example, has found haploids of *Triticum vulgare*, *Hordeum vulgare*, *Phleum pratense*, *Dactylis glomerata*, and *Poa pratensis*, and he says that they are all "rather conspicuous by their small dimensions." In pepper hybrids, on the other hand, Christensen and Bamford report that it was very difficult to distinguish the haploid plants

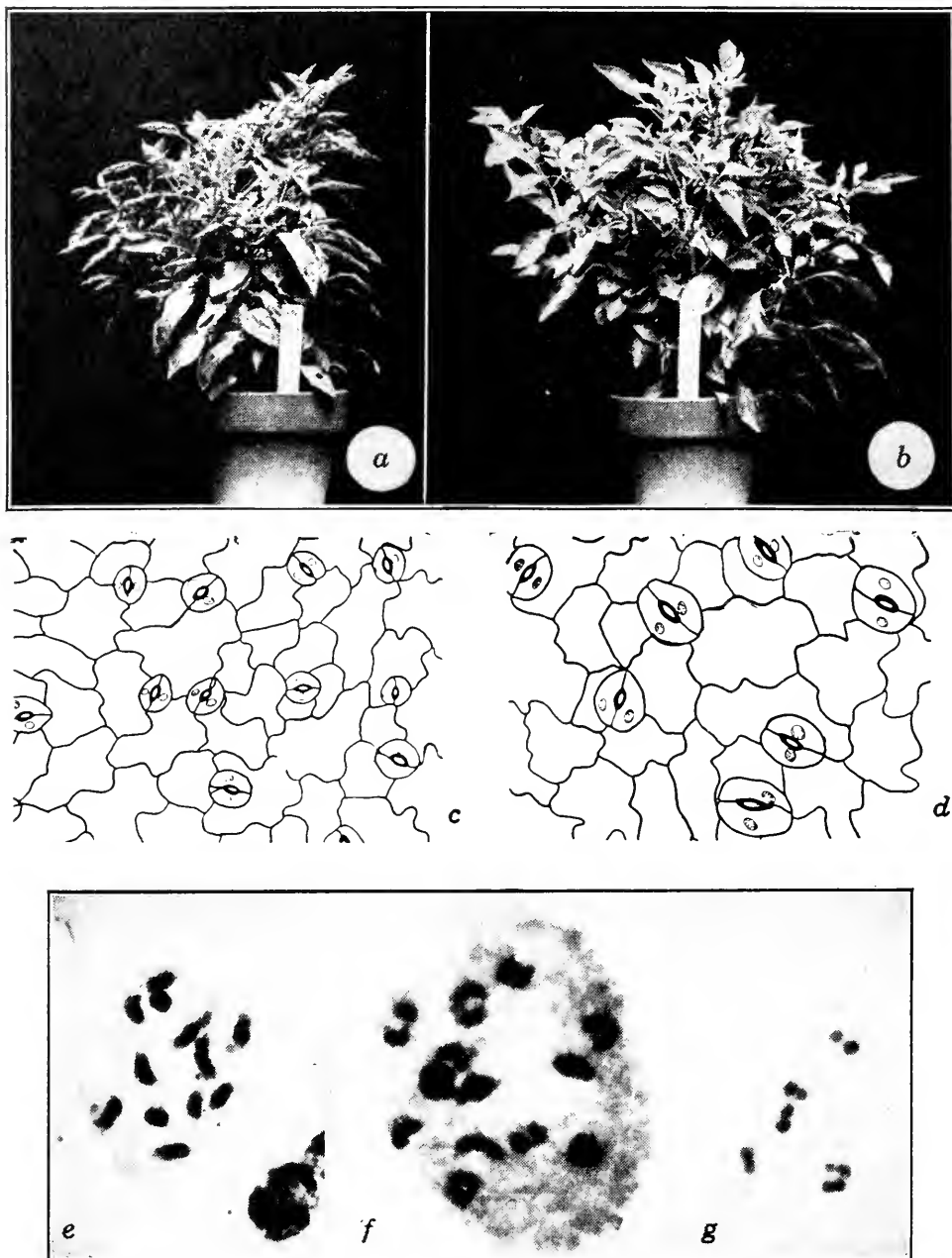

FIG. 121. Diploid and haploid peppers: (a) and (b), haploid and diploid plants; (c) and (d), stomata from haploid and diploid plants; (e), diakinesis in a haploid showing twelve univalents; (f), diakinesis in a diploid, showing twelve bivalents; (g), late diakinesis in the haploid with chromosomes associating in pairs. Note that the haploid is generally smaller and has smaller stomata and guard cells than the diploid. (Courtesy of Dr. R. Bamford from Christensen and Bamford in the *Journal of Heredity*.)

by their size, flowers, or leaves. The haploid, though, had smaller stomata, very poor pollen, and smaller fruits, and rarely produced seeds. Haploid sporophytes have been found in tobacco, tomatoes, maize, rye, *Datura*, wheat, sorghum, and other plants. Haploid animals that are normally diploid have occasionally been produced by drastic changes in their environment.

Although haploids are highly sterile, they are theoretically not completely so, for no matter how many chromosomes they have, a certain percentage of their eggs and sperm should contain a haploid set of chromosomes. In a plant that is normally a true diploid, no gametophyte with less than a haploid set of chromosomes will survive. If an egg with one complete haploid set should be fertilized by a sperm which also has n chromosomes, a normal diploid organism would be produced, just as it would if two normal, haploid gametes from a diploid organism should unite. However, this diploid organism that comes from a haploid, except for possible gene mutations, will be *homozygous for all its genes*. Thus, if haploids could be produced at will, homozygous diploid organisms could be produced with relative ease and much more readily than by a program of inbreeding.

If the "diploid" that gave rise to the haploid was not a true diploid, but an amphidiploid such as we describe in the next chapter, the offspring would be different. From a haploid of *Triticum vulgare* pollinated by a diploid wheat, Sears obtained thirteen plants which had 40 to 42 chromosomes. Only two of the 42-chromosome plants had all bivalents; the other eleven had one or two univalents. Four of the eleven plants had one or two trivalents, and one of the plants with a trivalent and one other had a ring of four chromosomes. One of the 41- and one of the 42-chromosome plants, when selfed, produced nullosomics among the offspring. Such $2n - 2$ plants could not be found in a normal diploid.

Numerous attempts have been made to produce haploid animals, and various methods to induce an egg to begin development when it has only one nucleus have been successful. Usually, however, the haploid individuals which resulted are abnormal and survive only a few weeks. One individual of the European newt, *Triton taeniatus*, survived to the one hundredth day of its

life when unfortunately it was drowned. This animal, produced by Baltzer and Fankhauser from an egg fragment, was dwarfed and slightly anemic. Its reactions were very slow, it had difficulty feeding, and its metamorphosis began much later than in normal diploid animals.

Fankhauser also raised a haploid individual of the Japanese newt, *Triturus pyrrhogaster*, to the fifty-ninth day. This haploid was produced by tying a loop of fine hair around the egg shortly after the entrance of the sperm and tightening the loop until the egg was cut into two parts. Usually one of the fragments survives and consists of a nucleus with about half the cytoplasm, thus preserving the nucleocytoplasmic ratio more faithfully than by methods that merely inactivate one nucleus of a fertilized egg and leave the full amount of cytoplasm. The particular fragment that developed into this individual contained the paternal set of chromosomes. It developed more slowly than the normal diploid from the very beginning, and by the ninth day just showed signs of the tail fin and of pigment cells, although in the diploid a narrow fin surrounded the tail and melanophores were scattered over the dorsal side and the flank of the body. This retardation in growth became more and more pronounced, and after a while the head and anterior part of the trunk became distended with fluid in the tissues and body cavity (edema). The head also became bent to the left and ventral sides. The blood was anemic, and the animal became weaker and slower to respond to stimuli. On the fifty-ninth day, when it was obviously near death, the haploid and its diploid controls were preserved. There is no doubt that this animal was a haploid, for a piece of the tail tip was removed on the nineteenth day and examined cytologically. Diploid and haploid larvae are shown in Fig. 122. The dividing cells of haploids show twelve chromosomes, the haploid number (Fig. 123).

We have pointed out that the cells of the gametophyte generation of plants are haploid. Since the starch food (endosperm) in the seeds of gymnosperms consists of a mass of gametophyte cells, such tissue should be haploid. K. and H. J. Sax used this tissue to study the number and morphology of the chromosomes in a cytotaxonomic survey of the conifers. They find that the root tips of conifers are not suitable material for a study of chromosomes because the chromosomes are long with the arms

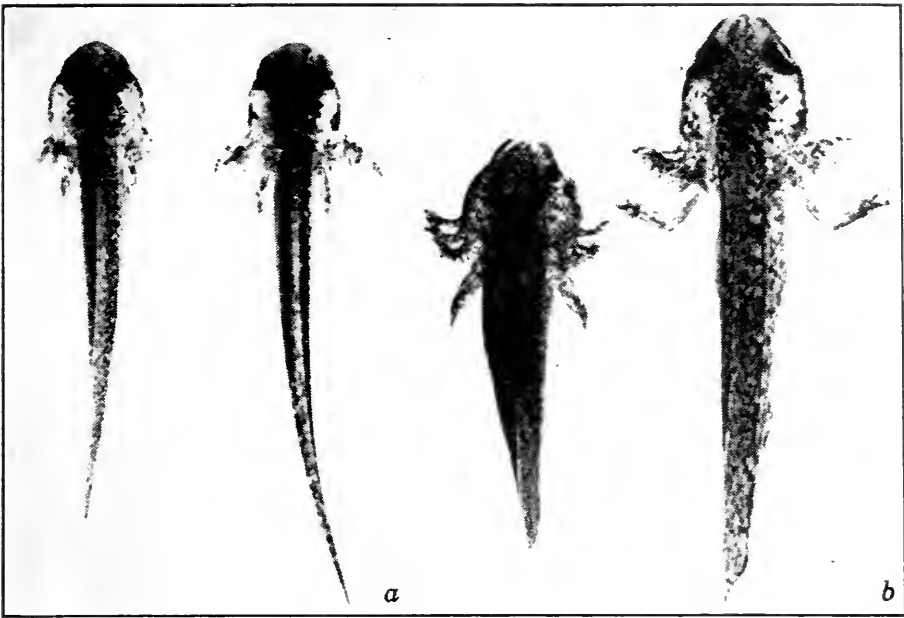

FIG. 122. Haploids in the newt, *Triturus pyrrhogaster*. (a) Haploid (left) and diploid larvae; the haploid was developed from a cold-treated egg; larvae 18 days old before amputation of the tail tips. (b) Another cold-induced haploid larva (left) and its control, 31 days old. The haploid shows dwarfing, edema, and microcephaly. Photographs $\times 8$. (Courtesy of Dr. G. Fankhauser in the *Quarterly Review of Biology*.)

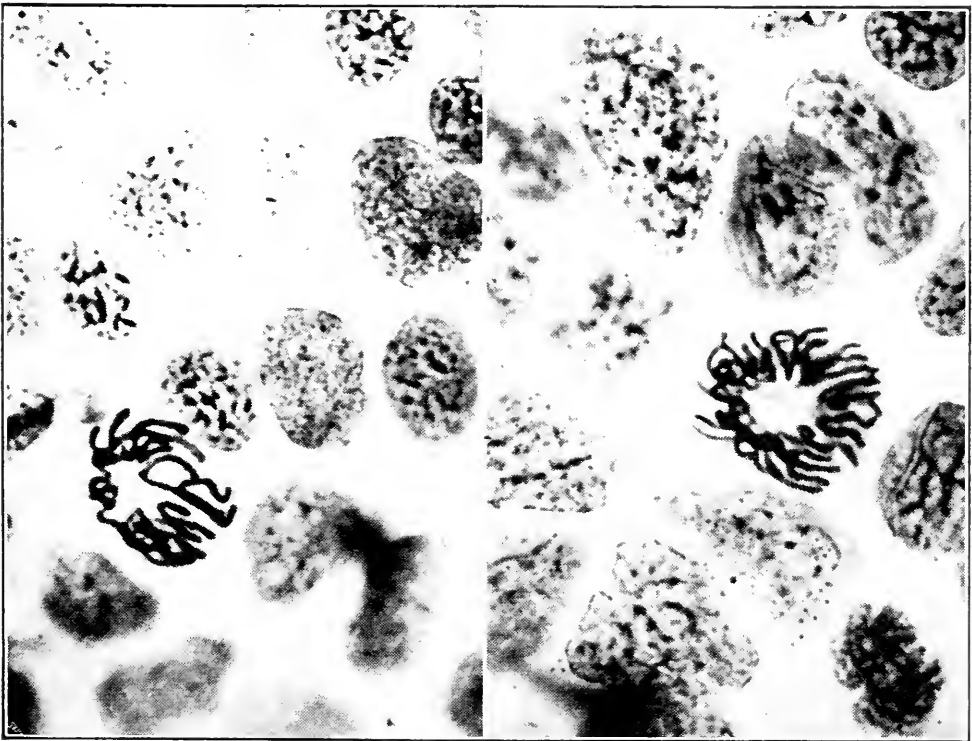

FIG. 123. Somatic chromosomes at metaphase from the epidermal cells of the tailfins of haploid (left) and diploid larvae. $\times 760$. (Courtesy of Dr. G. Fankhauser.)

usually more or less at right angles to the metaphase plate, making polar views practically useless, whereas side views are of



FIG. 124. Chromosomes from the endosperm of *Pinus Thunbergiana* (left) and *Thuja orientalis*. The first has twelve and the second eleven chromosomes. (Redrawn from Sax and Sax in the *Journal of the Arnold Arboretum*.)

little value because the $2n$ number of chromosomes is so large that the individual chromosomes become obscured. In the endosperm, on the other hand, only n chromosomes are present, cell divisions are numerous, and the chromosomes are readily observed in either side or polar views by the smear technique (Fig. 124). The

method is also very useful for the Cycadales when female cones are available.

Autotriploids

Autotriploids are organisms that have three identical genomes or, to put it somewhat differently, are primary trisomics for *all* their chromosomes. Therefore, when they undergo the meiotic divisions we should expect the same configurations for all their chromosomes that we find for one of the chromosomes in a primary trisomic.

Autotriploids are rare in animals but have been found in a great many plants. *Drosophila* triploid females with three sets of autosomes and three X chromosomes are not very different in general appearance from diploid females with only two sets of autosomes and two X chromosomes. In general, however, they are somewhat more robust and have larger cells in the wings. Triploids of the male sex are not true males. They are discussed in Chapter 29.

This generally greater robustness is a rather constant attribute of triploids and is often revealed in plants by a somewhat larger size, more vigorous growth, and greater ability to become adapted to a wider environment. Navashin's study of triploids in *Crepis* affords an interesting example. He found that triploids of three species had increased dimensions of both cells and cell organs. The fruits were enlarged and the entire

plant was somewhat larger than normal; fertility was low and the pollen was largely bad. Triploids are usually highly sterile, as a matter of fact, and are not self-perpetuating sexually in spite of their greater vigor. However, if they can reproduce asexually, as by rhizomes, they may establish permanent clones that have a decided advantage in competition with their diploid relatives.



FIG. 125. Photomicrographs of first metaphase in a triploid *Tradescantia* showing trivalent configurations. At left, five Y-shaped trivalents and a ring-and-rod (towards bottom of picture). At right, two chains of three chromosomes are clearly visible. In the upper left corner of the picture at the left are two small centric fragments.

If an autotriploid can be regarded as merely an organism that is trisomic for all its chromosomes, it should form the same kinds of meiotic configurations for all its chromosomes that the primary trisomic does for its single triplicated chromosome. Sometimes it should have only trivalents, at other times it should have some bivalents and univalents in place of some trivalents. Perhaps, very rarely, it should have only bivalents and univalents, although this would hardly be likely to occur in an autotriploid unless some special circumstances were present. The trivalents should exhibit the same rods, Y's, and other configurations found in Fig. 114, although the type in which all three chromosomes are joined at one end is rare. Plants with such configurations have often been found (Fig. 125). A good example is an autotriploid of *Tradescantia bracteata*, which was

studied by King in 1933. He found that about 90 per cent of the figures were trivalents with only about 10 per cent bivalents and univalents.

Because of the presence of an extra set of chromosomes, it is easy to understand why triploids are so highly sterile. As we pointed out for trisomies, whether the configuration is a trivalent or a bivalent and a univalent, two of the daughter cells at the first meiotic division receive two of the homologues whereas the other cell receives one. Obviously, if each trivalent (or univalent) segregates independently of every other, all types of gametes from n to $2n$ should result and should be distributed in the form of a frequency curve, with the n and $2n$ types least frequent and the intermediate unbalanced types most frequent. As in the haploid, the frequency of the types should be expressed by the expansion of the binomial $(\frac{1}{2} + \frac{1}{2})^n$, where n is the number of chromosomes in a genome. Triploids are known in which lagging of chromosomes, dicentric chromatids and chromatid bridges, fragments, and other chromosome aberrations are common.

Triploidy in higher animals is not common, although triploids are known among vertebrates in frogs and salamanders. Fankhauser studied 100 larvae of the newt, *Triturus viridescens*. Chromosome counts from the epidermis of the tail fin showed that 96 were diploids with 22 chromosomes, whereas 4 had 33 chromosomes and were undoubtedly triploids. A similar examination of 134 larvae of the salamander, *Eurycea bislineata*, showed that 119 were diploid, 13 were triploid, and 2 were tetraploid.

Endosperm

In discussing the life cycle of plants we pointed out that the gametophyte generation is haploid and the sporophyte diploid. There is one tissue, however, that is regularly and normally triploid. This tissue is a new one in the evolution of plants, for it is found only in the highest and most recently developed group of plants, the angiosperms. This tissue is the endosperm of the seed, which is not the megagametophyte as it is in gymnosperms but a structure that arises during double fertilization by a fusion of one sperm nucleus with the two polar nuclei in the center of the embryo sac. This tissue is an important one for

the angiosperm seed and is interesting genetically from several angles.

In maize, several genes are present which affect the endosperm. One gene, *Y*, produces a yellow color in the endosperm whereas its allele, *y*, produces no color. If a *yy* female is crossed with a *YY* male, the embryo in the seed is genotypically *Yy*. The endosperm is *Yyy* having received a *Y* gene in a sperm nucleus and two *y* genes in the two polar nuclei. Since the *Y* gene affects the endosperm, the color of the endosperm will be yellow. This is actually only an example of a gene that exerts its influence on the endosperm instead of on part of the mature plant. It happens that the *Y* gene is dominant over two *y* genes, but this is not true of all genes affecting the endosperm. This situation is interesting historically because it was formerly considered to be an example of the direct influence of the male. As such, this phenomenon was termed *xenia*.

The same result is found for the sugary gene (*su*) in maize and its allele (*Su*) for starchy. If a row of sweet corn (*su su*) is planted next to one of field corn (*Su Su*), pollen from the field corn may blow on to the silks of the sweet corn. Because *Su* is dominant over two doses of *su*, and because these genes affect the endosperm, seeds which are fertilized by this pollen will have starchy rather than sugary endosperm. In this example, *xenia* is again observed because of the dominance relations, for if one dominant gene were dominant over one recessive and not two, the endosperm would show the character of the female parent instead of the male.

The importance of the endosperm has also been shown in certain hybrids where the abnormal development of the endosperm will cause the hybrid seed to fail to develop. Brink and Cooper showed that seeds of the hybrid *Nicotiana rustica* × *N. glutinosa* abort early in development whereas those of *N. rustica* × *N. tabacum* usually abort at a later stage of development, although a few develop to the stage where they can germinate. A comparison of these two hybrids with seeds of *N. rustica* shows that the embryo is probably viable in all three but complete or partial failure of the endosperm in the hybrids usually interferes with the nourishment of the developing embryo. After double fertilization the endosperm normally begins to develop and apparently also secretes some growth-promoting substances

that diffuse into the surrounding tissues and regulate the way they develop. One of these developmental changes is the formation of a channel of conducting tissues in the integument and megasporangium (nucellus), through which nutrients pass into the growing embryo sac. In the hybrids, endosperm development is slower, and this secretion is probably reduced in amount although it may also differ qualitatively. Whatever may be the cause, these conducting elements fail to develop in the hybrids.

At the same time, the megasporangium begins to grow. This structure always remains one-celled in *N. rustica*, but in the hybrids it becomes several cells thick. The slow development of the endosperm, accompanied by a hyperplasia of the megasporangium, results in a markedly lower endosperm/megasporangium ratio in the hybrids. In some hybrids the growth of the megasporangium is so pronounced that this tissue completely surrounds the endosperm; in others a gap remains in the megasporangium leaving an opening from the endosperm to the integument as in *N. rustica*. When the embryos were in the eight- to sixteen-cell stage, all seeds of *N. rustica* had this gap, as did 75 per cent of the seeds of *N. rustica* \times *N. tabacum* and only 26 per cent in *N. rustica* \times *N. glutinosa*. Apparently the nutrients are cut off from the endosperm in practically all the *glutinosa* hybrids, with the result that practically all the developing ovules collapse early. In some of the *tabacum* hybrids, however, enough nutrient material seems to reach the endosperm so that these ovules attain a more advanced stage of development and even develop occasionally into shrunken but germinable seeds. This study reveals that the endosperm is an important structure and sometimes may act as a barrier to hybridization between species. The endosperm in this hybrid appears to divide normally, but its whole development is slow.

Sterility in hybrids between barley and rye also results from the failure of the endosperm to develop in normal fashion. Thompson and Johnston found that such a cross was incompatible because of abnormal development of the endosperm in the hybrid seed and particularly of the endosperm nuclei. Cooper and Brink made a similar cross in which the seeds aborted completely from the fourth to the thirteenth day. In this intergeneric hybrid, the primary endosperm nucleus often divides somewhat later than normally, and subsequent behavior of the

endosperm nuclei is abnormal. The distribution of the chromosomes becomes very irregular, and the nuclei that result may exhibit a considerable range of sizes and shapes. Cell walls fail to form around the nuclei of the endosperm as they do about forty-eight hours after fertilization in plants of barley. The whole endosperm tissue sooner or later disintegrates, and the seeds thereupon collapse. The embryo itself is normal, although retarded, but eventually dies of starvation. The peculiar behavior of the endosperm in the hybrids is a secondary effect, resulting from abnormal development of the antipodal cells. In plants of the grass family, the antipodals enlarge greatly and form a prominent tissue in the embryo sac that resembles secretory tissue. They appear to secrete something necessary for the normal development of the endosperm for about twenty-eight hours after fertilization. In the hybrid, they fail to enlarge, become dormant or almost so, and apparently fail to supply the endosperm with substances necessary for its normal behavior. The endosperm is abnormal and fails to supply the embryo with its normal supply of food.

Autotetraploids

Autotetraploids are tetrasomic for all the chromosomes. Although probably most tetraploids are allotetraploids, autotetraploids have been found in nature and have been produced in the experimental field. In general, they are slightly larger and more robust than the corresponding diploids and are more adaptable to different environmental conditions. They are not nearly so sterile as autotriploids, but frequently they are somewhat more sterile than the diploids from which they were derived.

Since autotetraploids have their chromosomes in a tetrasomic condition, it is to be expected that at least some of their configurations at metaphase would be quadrivalents. Since, in zygotene pairing, like parts normally pair and only two threads are associated at any one place, a number of possibilities exist. If all four threads of a tetrasomic group are tied in together at zygotene, as in Fig. 126*a*, and if chiasmata form and terminalize, the chromosomes will open out into a ring of four which resembles in every way the ring of four produced by reciprocal translocation. Such a ring is often found at first metaphase. If chiasmata fail to form in one of the arms (Fig. 127*g*), the con-

figuration will open out into a chain of four instead of a ring of four. Pairing sometimes is so arranged that a ring bivalent is produced with one chromosome tied in at each side, as in Fig. 126*b*. If one of the rod chromosomes fails to be tied in by a chiasma, the figure will be a ring and rod trivalent plus a univalent. If only two chiasmata form among the arms of the four

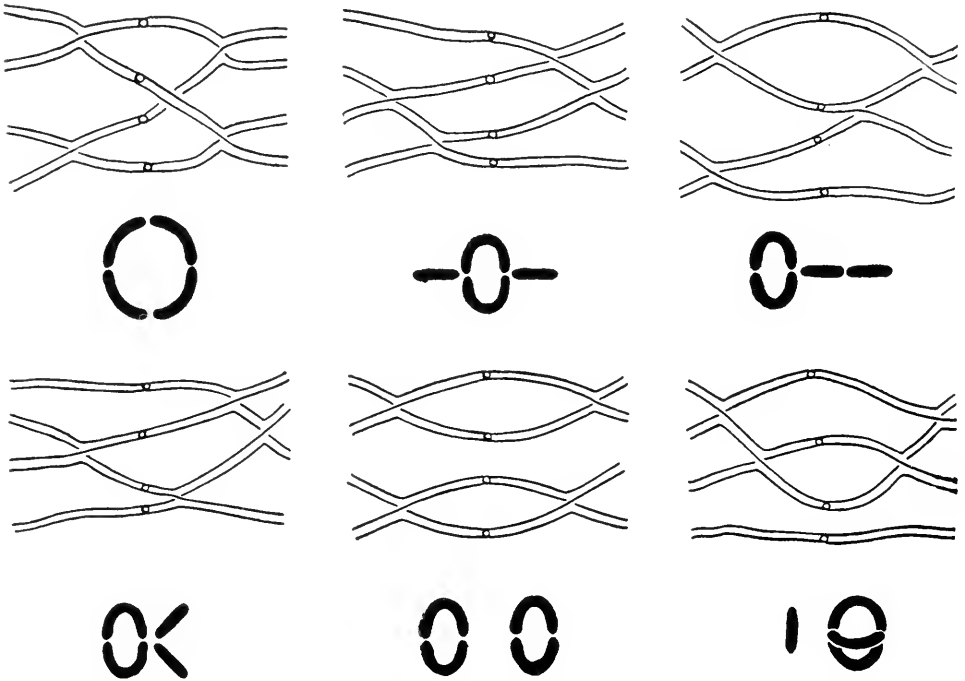

FIG. 126. Some of the configurations formed in a tetraploid when there are four chiasmata. Complete terminalization is assumed. The chromosomes are shown at diplotene and (*below*) at the subsequent metaphase. Top line from left to right (*a*), (*b*), and (*c*); bottom line, (*e*), (*f*), (*g*).

homologous chromosomes, they may form a chain of three and a univalent (Fig. 127*c*), two rod bivalents (Fig. 127*b*), or a ring bivalent with two univalents (Fig. 127*a*). Other configurations are also possible with two, three, or four chiasmata. If no chiasmata form, which is highly unlikely, four univalents result; and if only one chiasma forms, the only possible configuration is a rod bivalent and two univalents.

In many autotetraploids pairing relationships result in several types of configurations in one cell (Fig. 128). Thus there may be two or more types of quadrivalents along with bivalents, univalents, and perhaps a trivalent. Trivalents are rare in pure

autotetraploids if they are found. *Tradescantia* affords some good examples of quadrivalent formation in autotetraploids. Anderson and Sax have said that more than half the chromosomes are in quadrivalents in autotetraploids in this genus and that

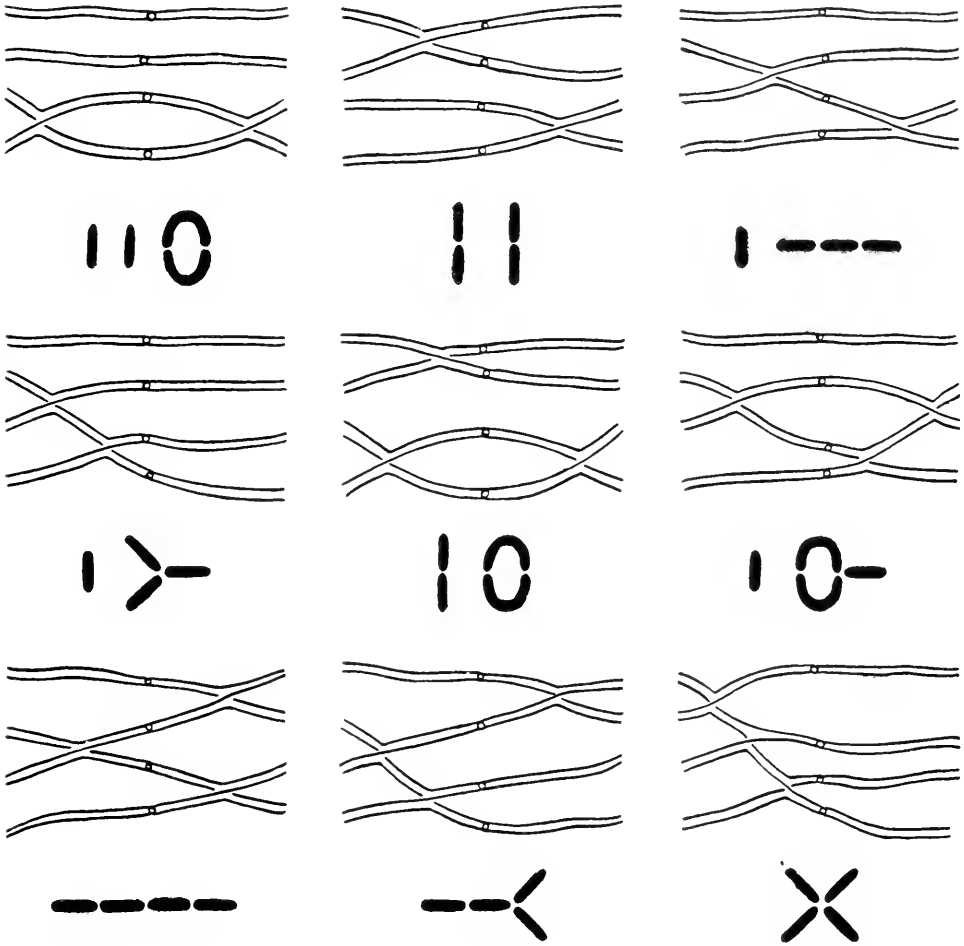

FIG. 127. Some of the configurations formed in a tetraploid when there are fewer than four chiasmata. Below each diplotene configuration is the metaphase to be derived from it. Top line, (a), (b), (c); middle line, (d), (e), (f); bottom line, (g), (h), (i).

they are usually in the form of chains or rings. The chiasma frequency per chromosome is lower in the tetraploids than in the diploids, and almost all the chiasmata are terminal in the tetraploids. In *T. virginiana* some quadrivalents are twisted around so as to resemble the number "8," and usually the adjacent chromosomes in the quadrivalent pass to opposite poles. In

the tetraploid form of *Setcreasia brevifolia*, another member of the Tradescantiae, meiotic behavior was very similar to that of *Tradescantia virginiana*. The average number of quadrivalents per nucleus and the size and form of the metaphase configurations were very similar in the two species. On the other hand, in autotetraploid tomatoes there were a number of quad-

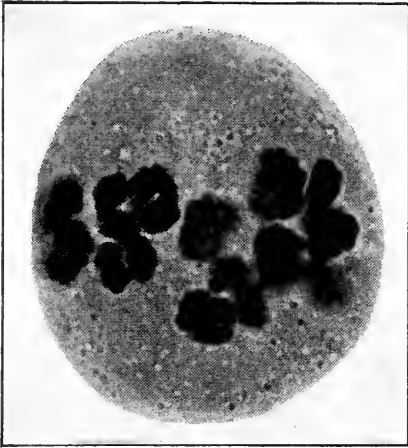

FIG. 128. Chromosomes at first metaphase in a tetraploid *Tradescantia*. Two quadrivalents and eight bivalents are present. *Left*, two bivalents; *next left* a figure-of-8 quadrivalent with a bivalent below; the other quadrivalent is at the *extreme right*.

rivalent configurations in prophase of the first meiotic division, but they broke up into bivalents by late diakinesis or metaphase so that at metaphase twenty-four bivalents lined up on the equator. Thus the absence of quadrivalents is not a sure sign that a plant is not an autotetraploid.

The segregation of genes in autotetraploids is interesting. If we assume that any one of the arms can pair with the homologous arm of any of the other three chromosomes, random pairing among the four chromosomes is attained. Random pairing should result in random disjunction such that if one particular chromosome goes to a given daughter nucleus, it will be accompan-

ied by any one of the other three with equal frequency. Therefore, if the genes on the four chromosomes are $AAaa$, there are equal chances that the gametes will contain the two A 's, the two a 's, the first A and first a , the second A and second a , the first A and second a , and the second A and first a . The gametic ratio from such a tetraploid will be $1AA : 4Aa : 1aa$. Similarly, a plant whose genotype is $Aaaa$ would have the gametes $1Aa : 1aa$, whereas one that is $AAAA$ would produce gametes in the ratio of $1AA : 1Aa$. If an autotetraploid has one dominant gene, we say that it is *simplex* for that gene, whereas if it has two or three, we refer to it as *duplex* or *triplex*, respectively. A plant with no dominant genes is *nulliplex*; one with four dominants is *quadruplex*.

When a duplex plant is crossed with a nulliplex the ratio of offspring is $5A : 1a$. If a duplex plant is self-fertilized, the ratio is $35A : 1a$. Such ratios are not expected among diploids nor are they to be expected among pure allotetraploids, which, as we see in the next chapter, behave at meiosis essentially as diploids. Since pure allotetraploids produce only bivalents and autotetraploids produce some quadrivalents, quadrivalent formation has been suggested as a criterion for autotetraploidy as opposed to allotetraploidy. Unfortunately, it has limitations, for some undoubted autotetraploids do not form quadrivalents, and some plants that are in part auto- but also in part allotetraploids do form quadrivalents. Dawson, therefore, has suggested that tetrasomic inheritance in the progeny of a tetraploid and the extent to which it occurs are better criteria. One note of caution needs to be interjected. Even in a pure autotetraploid, true tetrasomic inheritance occurs only for genes that are so near the centromere that practically no crossing over occurs between them and the centromere. Although we cannot consider chromatid crossing over in polyploids in this book, we should say that such cross-overs disturb these tetrasomic ratios and even produce $aaaa$ plants from the cross $AAAA \times aaaa$ or when a tetraploid with gene A in the triplex condition is self-fertilized.

Size Relationships

In many respects autopolyploids are larger than the diploids from which they are derived, whereas the corresponding haploids are smaller. These size differences may be manifested in general body structure, or in specific organs and structures, or in functions, or in more than one quantitative feature. For example, in *Nicotiana Langsdorffii*, H. H. Smith found that in a series consisting of haploids, diploids, triploids, tetraploids, and octoploids there was an increase with each additional set of chromosomes in the width of the tube of the corolla, in the ratio of the width to the length of the leaves, in the thickness of the parts of the plant, in lateness of maturity, and in the size of the cells throughout the plant, including pollen, microsporocytes, guard cells, and cells in the root tips and in the leaves when viewed in cross-section. From the haploid to the tetraploid there was a general increase in the size and sturdiness of the plants and their organs, but the octoploid was very abnormal. It was somewhat dwarfed,

it bloomed later than the others, it was sterile, and it had small, thick, wrinkled leaves (Fig. 129).

A similar diploid-tetraploid relationship was observed by Bamford and Winkler when a tetraploid snapdragon that arose spontaneously was found to have larger stems, inflorescences, leaves, and flowers and larger pollen grains and stomata than the related diploid strains. H. J. Sax pointed out that although the frequency of stomata could not be used as an absolute index of polyploidy, there is enough correlation between stomatal frequency and chromosome number to make a study of stomatal frequency helpful in a preliminary search for polyploidy in studies of herbarium material. Blakeslee and Warmke use several criteria in making a preliminary separation of tetraploids and diploids. They suggest that although the final decision in regard to any given plant must be determined by counting its chromosomes, a preliminary, tentative classification may be made from the fact that the tetraploid usually has larger pollen grains, larger seeds, larger stomata, wider, thicker leaves, leaves deeper green in color, larger floral parts, and shorter, stouter fruit. Regarding the size of stomata, Birdsall and Neatby found that an increase in the number of chromosomes was correlated with an increase in the size of the stomata and a decrease in their number in species of *Triticum*. None of these criteria is infallible, however, for in some plants the size relationship in the polyploid series does not exist.

Fankhauser has pointed out that differences in size between polyploids and diploids are found in some animals but not in others. For example, triploid forms of *Trichoniscus elisabethae* and of *Drosophila* as well as tetraploids of *Artemia salina* and *Solenobia* have been found that are larger than diploids, but other investigators have reported no increase in size in triploid *Drosophila*, triploid *Habrobracon*, and triploid and tetraploid *Bombyx*. Fankhauser found four triploid specimens of the newt, *Triturus viridescens*, and only one was strikingly larger than the diploids. The three animals of approximately normal size had body organs which were normal in size but were composed of cells that were larger than cells of the diploids. This discrepancy is explained by the smaller number of cells in these organs. The cells of the triploid are larger than the cells of the diploids, but during development an adjustment is made to this condition so

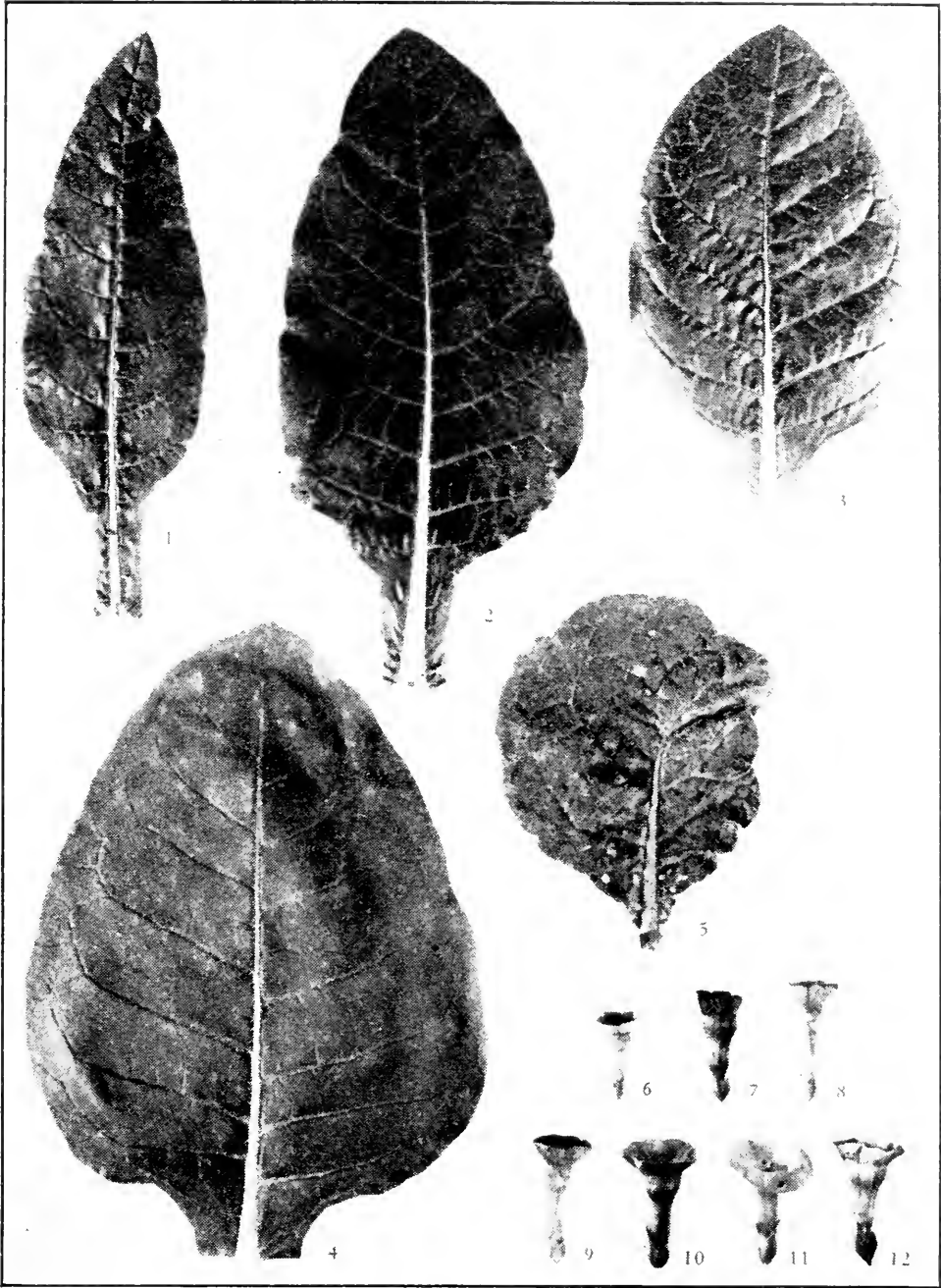

FIG. 129. Leaves and flowers in polyploids and aneuploids of *Nicotiana Langsdorffii*. The leaves are from haploid (1), diploid (2), triploid (3), tetraploid (4), and octoploid (5) plants. The flowers numbered 6 through 12 are from plants which have respectively 9, 17, 18, 32, 34, 36, and 72 chromosomes. (Photographs courtesy of Dr. H. H. Smith in the *American Journal of Botany*.)

that fewer cells develop and the size of the organs and of the body is the same as in diploids. The cause of this regulation is not understood, but in general amphibian embryos appear to have considerable regulatory power, as the result of which normal or nearly normal embryos are produced in spite of serious disturbances.

Higher Autopolyploids

Autopolyploids with more than four complete sets of chromosomes are known but are far less common than autotetraploids. Meiosis is generally more irregular in these forms, and there are

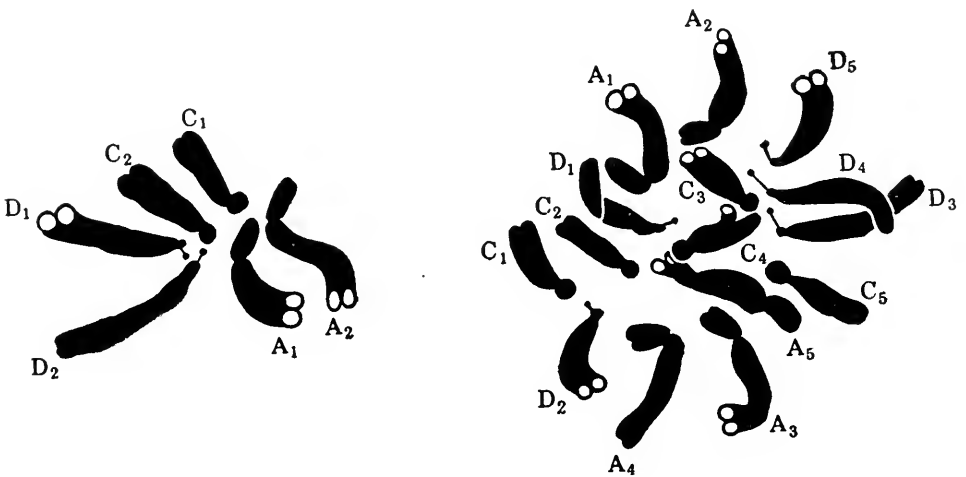

FIG. 130. Chromosomes in the metaphase of the root tips of diploid (*left*) and pentaploid plants of *Crepis*. Homologous chromosomes are indicated by the same letter. The chromosomes in these forms can be identified by their morphology. (Redrawn from Navashin in *Genetics*.)

often configurations of more than five chromosomes. One apparently clear case of pentaploidy was reported by Navashin in a species of *Crepis*. A genome of this species consists of three chromosomes. Chromosome A is long, with a very long and a relatively short arm. Chromosome C has a long and a very short arm. Chromosome D is readily identified by a satellite. These chromosomes are readily identified in somatic cells of the pentaploid, where it is observed that there are five of each (Fig. 130). Müntzing has described meiotic behavior in pentaploids of the orchard grass, and they seem to be typical. Meiosis is characterized by a variable number of configurations

ranging from one to five (Fig. 131). In fifteen different metaphase figures of the first meiotic division there were fourteen different combinations. The average numbers per cell were: univalents, 1.73; bivalents, 3.60; trivalents, 2.60; quadrivalents, 1.40; and quinquevalents, 2.67. As is to be expected according



FIG. 131. Meiotic configurations of a pentaploid *Dactylis*. Present in the cell are 1 hexavalent, 4 quinquevalents, 1 quadrivalent, 2 bivalents, and 2 univalents. (Redrawn from Müntzing in *Hereditas*.)

to the behavior of chiasmata, there were fewer quinquevalents in the pentaploid than there were quadrivalents in related tetraploids, and in turn there were fewer quadrivalents in these tetraploids than there were trivalents in related triploids.

Autopolyploids and Evolution

Because of the generally greater size and vigor of autopolyploids, the possibility that they might have played an important role in evolution must be considered. Because of their sterility, triploids are of little importance unless they reproduce vegetatively. As a matter of fact, however, neither triploids nor tetraploids represent anything strikingly new in most genera, for they usually differ from the diploid stock merely in vigor and other attributes of growth. This difference has been studied carefully in *Tradescantia*.

Both *T. occidentalis* and *T. canaliculata* contain diploids and tetraploids, and in both species the two types resemble one another so completely that not only are they not classified as separate subspecies or varieties but they cannot even be classed as diploids or tetraploids on the basis of their external appearance. When they have been classified by cytological examinations, it is easy to see that the tetraploids are definitely larger and have longer blooming seasons. Because of their greater vigor, they have greater ability to colonize. Each species apparently arose

as a diploid in a small region of the United States from central Texas to northwestern Arkansas. Subsequently, apparently autotetraploid strains arose and spread out over more than a million square miles. *T. occidentalis* occupied a western area reaching Arizona, Wyoming, and North Dakota, whereas *T. canaliculata* spread through the Middle West and east of the Mississippi into Wisconsin, Ohio, and Virginia.

Although autotetraploidy does not usually create new species, it has produced types which can flourish under such a wider variety of situations and can spread over such a wider region than the diploids that it has been an important factor in the dissemination of certain species and in the establishing of certain species as important members of certain areas. Autopolyploidy often seems to result in strains that can cover newly exposed areas. For example, in *Biscutella laevigata* Manton showed that the diploids are restricted to small preglacial or interglacial areas in central Europe but the autotetraploids are much more successful colonizers and cover a much wider area. They appear to be postglacial immigrants in many of the areas they now occupy and they may still be spreading.

QUESTIONS AND PROBLEMS

1. What percentage of fertile gametes would be expected from haploid plants that had respectively 6, 7, 8, and 9 chromosomes?

2. What percentage of fertile gametes would be expected from triploid plants that had respectively 18, 21, 24, and 27 chromosomes? Compare results with problem 1.

3. If you had a haploid plant and made very many self-pollinations, would it be possible to obtain offspring? If so, what would be their chromosome number in terms of n ? What would be the result if the plant was a triploid?

4. In a given plant, red flowers (W) are dominant over white (w) and long leaves (S) over short (s). If a triploid of the genotype $WWwSSs$ is crossed with one which is $wwwsss$ and enough pollinations are made to ensure an adequate number of offspring, what would be the ratio of the WS , Ws , wS , and ws types in the offspring? (Assume no crossing over between genes and centromeres.)

5. In maize, wx (waxy) is recessive to Wx (nonwaxy). This gene affects the endosperm. A $wxwx$ female is crossed with a $Wxwx$ male. What is the nature of the ears that result, and what are the genotypes

of the offspring? Is the result different from the reciprocal cross? Explain.

6. It is interesting to note that kernels with waxy endosperm stain red with iodine and those with the *Wx* gene (starchy) stain blue. The *wx* gene also affects the pollen. Pollen grains with the *wx* gene stain red while those with the *Wx* gene stain blue. What would be the color of the pollen grains after staining in the plants in question 5?

7. If the plant in question 4 were a tetraploid, what offspring would be expected from the following crosses: $Wwww Ssss \times www ssss$; $WWww ssss \times www SSss$; $WWWw ssss \times www ssss$?

8. By diagramming the chromatids, show how *aaaa* plants could be produced by the cross $AAaA \times aaaa$ if crossing over occurs between the locus of *a* and the centromere.

Chapter 27

ALLOPOLYPLOIDS

Let us assume that a certain diploid plant has six chromosomes which we can designate AA BB CC. Since this plant has two identical sets of chromosomes, the chromosomes of each set would be A B C. We pointed out in the last chapter that autopolyploids have more than two genomes and that all the genomes of an autopolyploid are alike. In an autotriploid form of this plant, the chromosome constitution would be AAA BBB CCC, whereas in an autotetraploid which was derived from this diploid it would be AAAA BBBB CCCC. We will use "genome" here as synonymous with the more cumbersome "set of chromosomes," disregarding any differences that might be due simply to different alleles.

Let us assume now that we have two diploid plants whose chromosomal constitutions are respectively AA BB CC and LL MM PP and that they are able to cross together and produce a hybrid. This hybrid would have a genome from each of the two plants and would therefore consist of two *different* genomes. Since its constitution would be A B C L M P, no chromosome would have a mate, there would be no chromosome pairing, the plant would behave like a haploid plant with six univalent chromosomes, and the plant would be highly sterile. If, however, the chromosomes of this sterile hybrid became doubled in some way, a plant would be formed whose chromosomes would be AA BB CC LL MM PP. This plant could be regarded as a tetraploid because it had four genomes, but since two of the genomes were alike and different from the other two which were identical, each chromosome would be represented only twice as in a diploid instead of four times as in an autotetraploid, and the plant would behave as a diploid. Such a tetraploid would be an *allotetraploid*. Because it behaves like a diploid but nevertheless is composed of two kinds of genomes, it is often called an *amphidiploid*.

In the allotetraploid we have mentioned, the chromosome number is twelve. It is four times the haploid number, and because of this $4n$ condition, the plant is considered to be a tetraploid. However, amphidiploids may be produced from two plants which differ with respect to chromosome number. If a plant with six and a plant with eight chromosomes were crossed and produced an amphidiploid hybrid, the chromosome number would be fourteen, which is not a multiple of the haploid number of either of the diploid parents. We could still regard this plant as an allopolyploid because it has four sets of chromosomes so that in dealing with allopolyploids it is better to consider their polyploid nature in the light of the number of genomes rather than of the number of chromosomes. Of course, the problem does not arise when dealing with autopolyploids.

In our allotetraploid, the genomes of the two parents differed completely from one another. Although it makes the situation clearer to assume two completely different genomes, it might well be questioned whether plants which differed so completely could cross at all. In most allotetraploids the two sets of chromosomes are different but not so completely different. Instead of designating the two genomes as A B C and L M P, it would probably be more accurate, in most cases, at least, to designate them $A_1 B_1 C_1$ and $A_2 B_2 C_2$, so that the chromosome constitution of the allotetraploid would be $A_1A_1 A_2A_2 B_1B_1 B_2B_2 C_1C_1 C_2C_2$.

Amphidiploids

Some known amphidiploids are the result of hybridization between two species of the same genus; others arose from crosses between species belonging to two different genera. Some amphidiploids have arisen spontaneously throughout the course of evolution; others have been created by experimentation. Several amphidiploids that have arisen spontaneously have been duplicated or nearly duplicated by appropriate crosses between species that are believed to have been the original parents of the spontaneous form.

An interesting amphidiploid is the species *Spartina Townsendii*, which is believed to have arisen spontaneously as an amphidiploid sometime before 1871, which is the first time that it was collected. Morphologically this species resembles both *S. alterniflora* and *S. stricta*. Huskins's study of the number of chromo-

somes in these species shows that *S. Townsendii* has 126, and the other two species have respectively 70 and 56. To reconstruct the probable sequence of events, a 35-chromosome gamete of *S. alterniflora* united with a 28-chromosome gamete of *S. stricta* to form a hybrid which had 63 chromosomes and was probably highly sterile. In some way that we cannot explain, the number of chromosomes of the hybrid became doubled to produce a plant with 126 chromosomes, which was practically fully fertile. This plant was *S. Townsendii*. This species has four genomes, but the two genomes of *S. alterniflora* are so different from those of *S. stricta* that chromosomes from the two species never pair with one another and, as a result, only bivalents are formed. Each bivalent consists of either two *alterniflora* chromosomes or two homologues of *stricta*.

Numerous similar amphidiploids that arose from crosses between two species of the same genus might be cited. To mention a very few, there are *Primula kewensis*, which arose from a cross between *P. floribunda* and *P. verticillata*; *Digitalis mertonensis*, which arose from crossing among themselves hybrids between *D. purpurea* and *D. ambigua*; and *Galeopsis Tetrahit*, which arose in nature from a cross between *G. pubescens* and *G. speciosa* and was also synthesized artificially by Müntzing, who crossed these species together. Apparently a large number of cultivated plants have originated as allopolyploids. Some species of cotton have 13 pairs of chromosomes; others have 26 pairs. The former group includes wild species from Asia, Africa, Australia, Central America, and the Galapagos Islands and the cultivated Asiatic cottons, whereas the 26-chromosome group includes wild plants from Mexico, South America, the Galapagos Islands, and the Hawaiian Islands and the American types of cultivated cotton. Skovsted has suggested that the 26-chromosome American varieties are amphidiploids which arose from a cross between 13-chromosome types from America and Asia. This suggestion has been strongly supported by Beasley's experimental evidence, based on a resynthesis of a similar 26-chromosome type from a cross between an American 13-chromosome cotton and a type from Asia which also had 13 chromosomes. Apparently our cultivated tobacco arose as a 48-chromosome amphidiploid between two 24-chromosome species. Al-

though the exact species involved have not been proved conclusively, Clausen and his co-workers believe that the original parents of *Nicotiana tabacum* were closely related to *N. sylvestris* and *N. tomentosiformis*. Numerous other amphidiploids among cultivated plants have been reported, and many of them have been listed and discussed by Schiemann.

Intergeneric amphidiploids have been produced between closely related genera. Probably the best known is Raphanobrassica, Karpechenko's synthesized hybrid between a radish (*Raphanus*) and a cabbage (*Brassica*). Each of the parental species has nine pairs of chromosomes and the amphidiploid had eighteen pairs. The latter was perfectly fertile, as might be expected from the nature of its meiotic behavior. All the gametes have nine radish and nine cabbage chromosomes.

A series of amphidiploid hybrids between wheat (*Triticum*) and rye (*Secale*) has also been studied. These amphidiploids constitute a new genus, *Triticale*. Müntzing examined six such strains which differed in the particular wheat and rye biotypes that formed the parents. In pollen fertility they varied from 61.8 to 92.5 per cent fertile, although they varied within the strain from year to year. Two of the strains showed bivalents and univalents at the first meiotic division (Fig. 132), with the frequency of univalents higher in one strain than in the other. Higher configurations were extremely rare. The various strains differ in height, in vigor, in winter hardiness, and in their quality in baking. Apparently the properties of a particular strain of *Triticale* depend less upon their polyploid nature as such than upon the particular biotypes of the wheat and rye plants that were their parents.

Other amphidiploids have been made among the *Triticenae* by Sears. Eighteen amphidiploids from ten species in which the haploid number of chromosomes was seven were synthesized, and seven of them were from intergeneric crosses involving the genera *Triticum*, *Haynaldia*, and *Aegilops* (Fig. 133). They were generally intermediate between their parents in their morphological characters and varied in fertility from very highly sterile to very highly fertile. At meiosis most of the configurations were bivalents. However, there were some univalents, trivalents, and quadrivalents in almost all, and a few of the amphidiploids

diploids had some configurations with more than four chromosomes.

Genetic ratios in allopolyploids are usually different from those in autopolyploids. In our theoretical "pure" allotetraploid, in which the genome from the one parental species is entirely different from that of the other species, no locus should be common

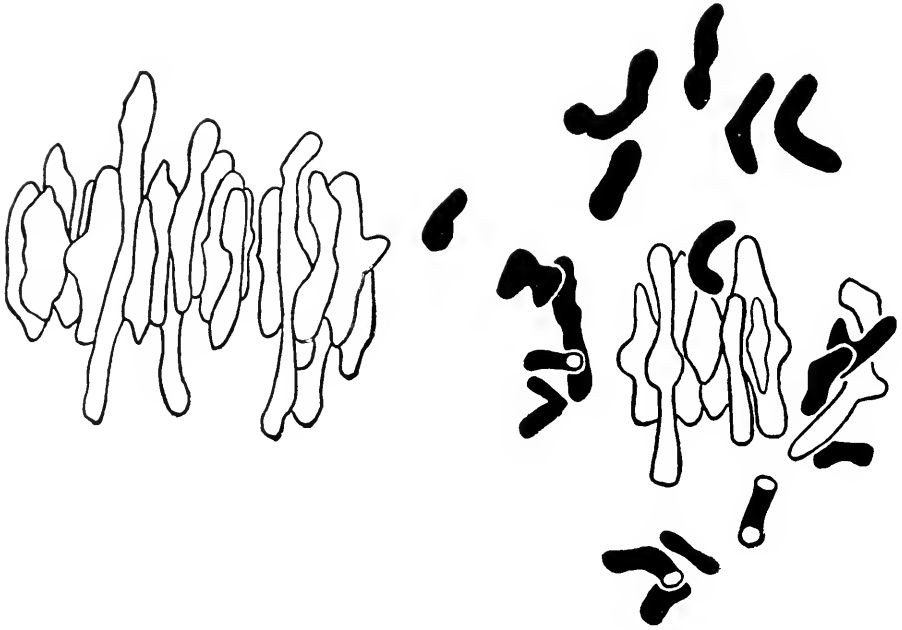

FIG. 132. First metaphase in the intergeneric wheat-rye hybrid, Triticale. *Left*, no univalents and only bivalents present; *right*, another cell from the same plant with eighteen univalents. These two cells indicate the great irregularity in this hybrid. (Redrawn from Müntzing in *Hereditas*.)

to the two genomes, so that all inheritance should be monogenic, giving simple mendelian ratios. However, since most allotetraploids are not so "pure," the one genome frequently has a number of small segments identical with segments of the other genome. It is conceivable that some loci should therefore be common to the two genomes, and such results have been found. If two segments carrying identical loci are so small that they rarely, if ever, pair, each locus will behave in transmission independently of the other; and if each is heterozygous, a 15 : 1 ratio will be obtained upon selfing. For example, if the identical segment of the amphidiploid just discussed contains the locus of gene *a*, and if each parent is *Aa*, the amphidiploid hybrid might well be *Aa Aa*. Using the conventional method of designating

duplicate genes, we should write these $A_1a_1A_2a_2$. Supposedly, this chromosomal segment might be so small that it practically never pairs. If such a plant was selfed, the ratio of offspring would be $15A$ ($9A_1A_2 + 3A_1a_2 + 3a_1A_2$) : $1a$ (a_1a_2), as we pointed out in Chapter 21. Thus amphidiploids often give ratios attributed to duplicate genes, and more or less remote amphidiploidy might be the cause of duplicate genes in a number of plants.

If the chromosomes of an allotetraploid are $AA\ BB\ CC\ LL\ MM\ PP$, and if one A chromosome will pair only with the other A while the others pair $BB\ CC\ LL\ MM$ and PP , we have an extreme allotetraploid. This type of pairing is between chromosomes from the same parent only and is usually called *autosyndesis*. On the other hand, if the chromosomes of the two species are sufficiently homologous so that we can designate them $A_1A_1B_1B_1C_1C_1A_2A_2B_2B_2C_2C_2$, A_1 may often pair with A_2 , B_1 with B_2 , and C_1 with C_2 , and frequently quadrivalents will be present. Pairing in an allopolyploid of chromosomes from both parents is *allosyndesis*. Much of the earlier confusion in studies of hybrids resulted from the fact that many are allopolyploid for some chromosomes and autopolyploid for others and some even incorporate similar and dissimilar segments in individual chromosomes.

We showed in the last chapter that if an autotetraploid is duplex for a dominant gene ($AAaa$), its gametes will be in the

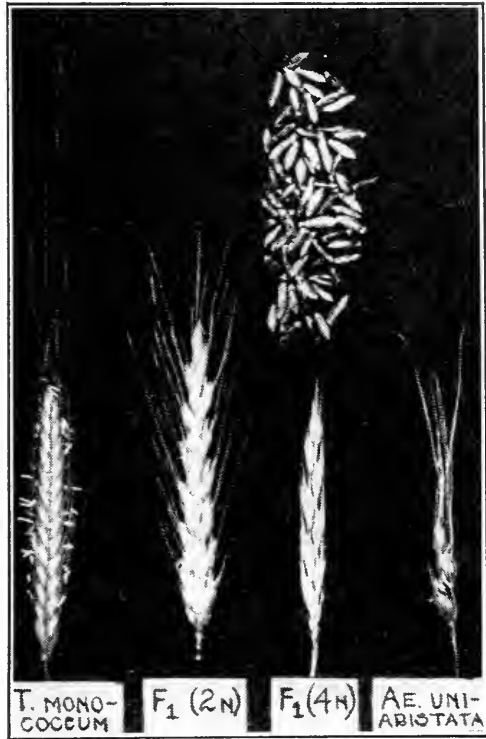

FIG. 133. A fertile amphidiploid intergeneric hybrid between *Triticum monococcum* and *Aegilops uniaristata*. The diploid ($2n$) F_1 is sterile but the amphidiploid ($4n$) is fertile. The $2n$ and parent spikes are in flower, but the $4n$ spike is mature. The seeds above the $4n$ spike are some of those harvested from the amphidiploid. (Photograph courtesy of Dr. E. R. Sears in the *Journal of Heredity*.)

ratio of $1AA : 4Aa : 1aa$. If such a plant is selfed, the offspring will be $1AAAA : 8AAAAa : 18AAAAaa : 8Aaaaa : 1aaaa$, or $35A : 1a$ phenotypically. This will be true not only if the configuration of the chromosomes bearing this gene is a quadrivalent, as in an autotetraploid and some allotetraploids that are not "pure," but also if there are only bivalents, provided that either autosyndesis or allosyndesis occurs at random. Yarnell has given us a good example of a $35 : 1$ ratio in an amphidiploid. A cross between *Fragaria bracteata* ($n = 7$) and *F. vesca rosea* ($n = 7$) resulted in some tetraploid plants. At meiosis, quadrivalents were occasionally found at diakinesis, but there were usually fourteen bivalents at first metaphase. The genetic ratios of a gene for pink flower color indicate that, so far as the chromosome which bears this gene is concerned, apparently chromosome pairing may be by allosyndesis or autosyndesis with equal frequency. Pink (P) is dominant over white (p). The *bracteata* parent was white-flowered (pp) whereas the *vesca rosea* parent had pink flowers and was apparently PP , so that the tetraploid hybrid was duplex for the P gene. When seven F_2 plants were tested for their genotypic constitution by crossing with recessive diploids, it was apparent that one was triplex or quadriplex for P , two were duplex, and four were simplex. The population is small but it indicates that the chromosomes bearing the P and p genes paired allosyndetically or autosyndetically at random.

Allotriploids

Allotriploids, like autotriploids, naturally represent an unbalanced condition. An allotriploid involving two species has two genomes from one parent and one from the other. In a "pure" allotriploid in which the odd genome is sufficiently distinct from the two which were introduced by the other parent, the two identical genomes form bivalents, whereas the other genome normally behaves as a set of univalent chromosomes. Hollingshead found some triploid hybrids between *Crepis capillaris* ($n = 3$) and *C. tectorum* ($n = 4$) that behaved in that manner. The triploids contained two *C. capillaris* genomes, which paired to form three bivalents, and one genome of *C. tectorum*, which consisted of four univalents (Fig. 134). A different result has been reported by Yarnell in triploids produced by crossing a *Fragaria*

bracteata \times *F. vesca rosea* tetraploid hybrid with such a diploid species as *F. collina*. At first metaphase in these triploids usually ten bivalents and a univalent are found, which would undoubtedly indicate pairing between chromosomes that are not strictly homologous. There are several possibilities in an allotriploid

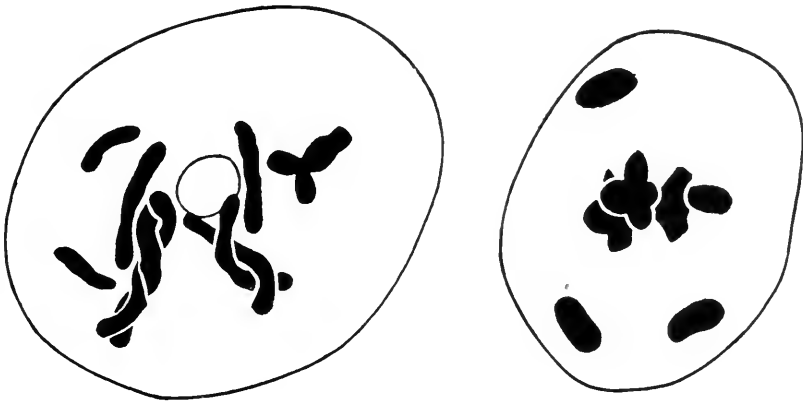

FIG. 134. Chromosomes in a triploid hybrid between *Crepis capillaris* and *C. tectorum*. *Left*, diakinesis showing three bivalents and four univalents. *Right*, first metaphase showing the same configurations. (Redrawn from Hollingshead in *University of California Publications in the Agricultural Sciences*.)

whose three genomes are A A B. Although frequently the two A sets pair and the B set forms univalents, sometimes the univalent chromosomes of the B set pair with one another so that only pairs or pairs plus one univalent are found. It is possible that the B set would be sufficiently like the A's that an A and a B set would pair, but in such a plant, trivalents would more likely be formed and the plant would behave like an autotriploid.

Higher Allopolyploids

In some genera of plants allopolyploids with more than four genomes are frequent. Often examination of the chromosome behavior at meiosis would indicate that the plants were diploids, for they form only bivalents, and it is only from further evidence that we could detect that the plant is perhaps a hexaploid or octoploid or some other type of higher polyploid. If the number of chromosomes in such a plant is large, we might suspect an allopolyploid situation, but even this is only suggestive. The pres-

ence of duplicate genes is also fairly strong evidence of a remote polyploid origin. In some genera, a series of species may be found with chromosome numbers in multiples, and this also indicates that the higher forms are probably allopolyploids.

It is interesting to note that two of the classic examples of duplicate genes, Nilsson-Ehle's genes for seed color in wheat and Shull's triangular capsules in *Capsella*, are found in genera where there is more than one diploid chromosome number. For example, *Capsella rubella*, *C. Viguieri*, *C. grandiflora*, and *C. tuscaloosae* are all diploids in which the haploid chromosome number is eight. Other species, however, such as *C. bursa-pastoris*, *C. Heegeri*, *C. occidentalis*, *C. orientalis*, *C. djurdjurae*, and *C. penarthae*, have sixteen as the haploid number and are very probably allotetraploids. It is highly interesting to note that the duplicate genes which have been found in this genus are only in the second group of species. In the known amphidiploid, *Galeopsis Tetrahit*, Müntzing has recorded several characters controlled by duplicate genes, and the possible connection between allopolyploidy and duplicate genes has been suggested by a number of investigators.

A complicated and interesting situation is found in wheat. Species of the genus *Triticum* can be divided up into three chromosome groups. The Einkorn group includes *T. monococcum* and is diploid, with $n = 7$. This species is of little importance economically but is generally more resistant to disease than the other species. The Emmer group includes *T. dicoccum*, *T. polonicum*, *T. persicum*, *T. dicoccoides*, *T. durum*, and *T. turgidum*. They are tetraploids ($n = 14$) and are of little value except for the last two, but they are more resistant to disease than the next group. The Vulgare group includes *T. vulgare*, *T. compactum*, and *T. spelta*. They are hexaploids ($n = 21$) and, with the exception of the last species, are of greatest economic importance and widest distribution. They are the bread wheats but unfortunately they are considerably more susceptible to disease than the other groups.

In all these species, meiosis is very regular, and all the chromosomal configurations are bivalents. The series of chromosome numbers in multiples of seven indicates that the species with higher numbers developed by polyploidy, and this view is strengthened by the presence of duplicate and triplicate genes

in the hexaploid species. In crosses between *T. monococcum* and *T. turgidum*, the hybrids have twenty-one chromosomes but form seven bivalents and seven univalents. Apparently one genome of *T. turgidum* is sufficiently like the genome of the other species that it pairs with the Einkorn genome, leaving the other *turgidum* genome unpaired. These seven chromosomes behave as univalents and usually pass to one pole or the other without dividing, but sometimes they divide equationally at the first division. The results are similar in hybrids between the Emmer and Vulgare species. The fourteen Emmer chromosomes pair with fourteen of the Vulgare chromosomes whereas the other seven Vulgare chromosomes behave as univalents. From the point of view of wheat improvement, it appears to be unfortunately true that most of the genes that make for the most desirable bread characteristics are located in the seven Vulgare chromosomes that do not pair and are generally eliminated from future generations in Emmer \times Vulgare crosses because they are unpaired.

Crosses between the Emmer and Vulgare wheats and species of the genus *Aegilops*, a grass native to the Mediterranean region, throw considerable light on the nature of the chromosomes in these two groups of wheats. When *Aegilops cylindrica* ($n = 14$) is crossed with the Vulgare wheats, seven *Aegilops* and seven *Triticum* chromosomes pair, leaving the other chromosomes of the two genera unpaired. This would indicate that each genus has one seven-chromosome genome in common.

Sax has proposed the following scheme for evolution in these genera. The Einkorn wheats are the most primitive wheats and have one genome; they are AA. The Emmer group evolved from it in part by a modification of this genome into B and are AA BB. In some way *Aegilops cylindrica* evolved with the genomic constitution CC DD. The C and D genomes are completely different from the ones in the Emmer wheats. A cross between *Aegilops cylindrica* and a wheat of the Emmer group, followed by a doubling of the chromosomes, produced the Vulgare wheats whose chromosome sets are AA BB CC. The relationship of these plants and the method of pairing to be expected in the various hybrids between them is indicated in Fig. 135. These studies show conclusively that although the Vulgare wheats behave as diploids they are actually allohexaploids.

Phleum pratense is another hexaploid species that has frequently been treated as a diploid because of regular pairing. It was regarded as an allohexaploid with three genomes, which Müntzing designated N, A, and B. A few "triploids" arose along with "diploids" in twin progenies and such "triploids" (really

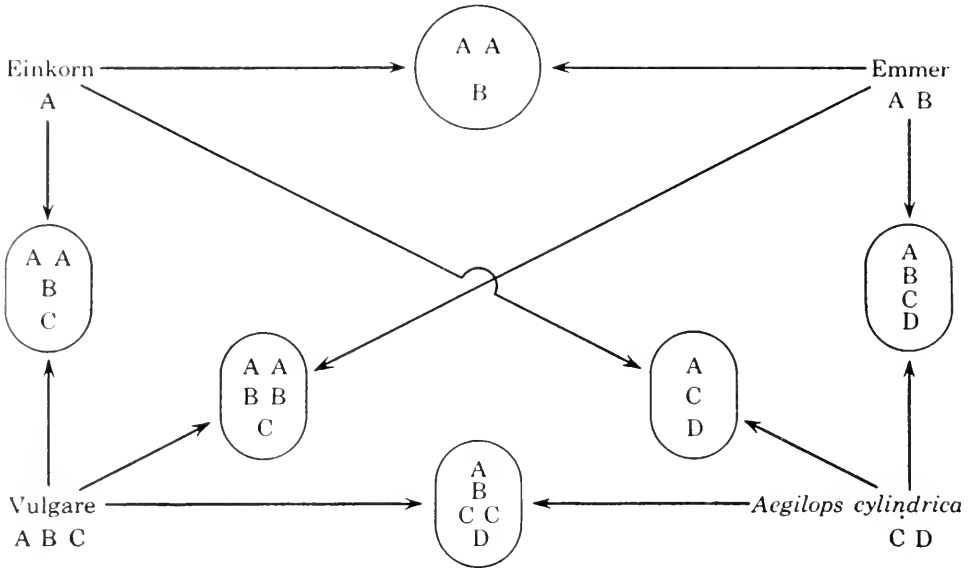

FIG. 135. Diagram showing the relationship between the *einkorn*, *emmer*, and *vulgare* wheats with one another and with *Aegilops cylindrica*. Illustrated also are the hybrids which would be produced between them. In their haploid stages, the *einkorn* wheats have genome A, the *emmer* group A and B, and the *vulgare* wheats A, B, and C. *Aegilops cylindrica* has genome C in common with the *vulgare* wheats and also a fourth genome, D.

enneaploids) are "autotriploids." Since each chromosome is represented three times, a high percentage of trivalents would be expected among the sixty-three chromosomes. Actually, however, most of the configurations are bivalents, there are some univalents, and only rarely does a trivalent appear. Müntzing believes that the high frequency of bivalents indicates that there is considerable allopolyploidy between the A and B genomes. He does not consider multivalents a good criterion for the type of polyploidy and suggests that many intraspecific polyploids that have been thought to be allopolyploids are really autopolyploids that do not regularly form multivalents.

Another hexaploid that occurs in nature is *Pentstemon azureus* subsp. *angustissimus* (Gray) Keck. This has a $2n$ chromosome

number of 48. The related species *P. laetus* has $2n = 16$, which would indicate that the species with the higher number is a hexaploid. Apparently these two species hybridize in one particular region of California to form *P. neotericus* Keek, which has 32 as the haploid number and would therefore be an octoploid hybrid. Because of the high chromosome number the loss of a chromosome or two does not greatly disturb the balance, and forms of *P. azureus* subsp. *angustissimus* and of *P. neotericus* are known which are respectively hypohexaploid or hypoöctoploid. The hybrid origin of *P. neotericus* is inferred from a number of different lines of evidence. It resembles both *laetus* and *azureus* and has often been classified as one or the other; the chromosome number represents the sum of the numbers of the two other species; the chromosomes in both *P. azureus* and *P. neotericus* behave as if they were high polyploids; *P. laetus* and *P. azureus* overlap in their geographic distribution, and *P. neotericus* occupies an area between the regions of the other two near a place where they overlap. When several different kinds of evidence point to the same conclusion, the argument is very convincing.

Interesting higher polyploids have been reported by Stebbins and his co-workers in the genus *Bromus*. *B. carinatus* has 56 chromosomes and always shows 28 bivalents. Since the basic chromosome number is believed to be 7, these plants are octoploids. A related species from Arizona, formerly classified as *B. carinatus* var. *arizonicus* but better regarded as *B. arizonicus*, has 84 chromosomes in sporophyte tissue and is a duodecaploid; it always forms 42 bivalents. A "diploid" hybrid between these species has $2n = 70$, receiving 42 medium-sized chromosomes from *B. arizonicus* and 21 medium and 7 large ones from *B. carinatus*. In the hybrid the 7 large chromosomes behave as univalents, and at least two sets of 7 medium chromosomes from *B. arizonicus* appear as univalents. Two sets of 7 medium chromosomes appear to be common to both species, for 14 bivalents are present. Up to 7 trivalents are present, resulting from the pairing of two sets of *B. arizonicus* and one set of *B. carinatus*. The hybrid is completely sterile. A large number of inversion bridges in the two meiotic divisions indicates that many of the homologous chromosomes are not identical with one another but differ at least by inverted segments. The manner of pairing in the

hybrid indicates that the genomes of the two parental species could be designated AA BB C₁C₁ L₁L₁ for *B. carinatus* and AA BB C₁C₁ C₂C₂ DD EE for *B. arizonicus*. The L₁ sets from the first species and the D and E sets of the second form the univalents. The 14 bivalents result from pairing between the two A sets and the two B sets, whereas pairing among the two C₁ sets and the one C₂ set is the cause of the 7 trivalents.

One of the classical examples of higher allopolyploidy is the genus *Rosa*. Hurst, Blackburn, and others have shown that a whole series of such polyploids exists. The basic chromosome number in this genus is 7, and there are five diploid species each of which may be considered a basic type from which all other species and varieties have been derived. Some of the other types are autotetraploids, hexaploids, and octoploids. There are, however, many varieties in which only some of the chromosomes pair and the others are univalents.

Secondary Association

Normal chromosome pairing is the result of homologous segments in chromosomes that are partially or wholly homologous. The chiasmata that arise in such paired segments hold the paired



FIG. 136. Polar views of the first metaphase of *Dahlia variabilis* ($2n = 64$) showing primary (multivalent) and secondary association of the chromosomes. (Redrawn from Lawrence in the *Journal of Genetics*.)

chromosomes together from zygotene to first anaphase, and if two chromosomes do not pair and form chiasmata during early prophase, they will not be joined in the same configuration at metaphase. This normal chromosome pairing is sometimes referred to as primary association to distinguish it from another type of chromosomal association which arises at prometaphase and is called *secondary association*. If secondary association occurs, two

or more bivalents may lie close together on the metaphase plate (Fig. 136). This type of association is believed to indicate a remote homology between the bivalents. This homology is not sufficiently close to bring about normal chromosome pairing, but it is close enough to cause the slightly homologous chromosomes to be side by side. Secondary association has

no effect on the segregation of chromosomes for the associated bivalents are not joined together in any way. However, it is believed to indicate some homology and has been used as a criterion of remote polyploidy in some plants. Apparently secondary association can occur only in plants with small chromosomes. In some diploid hybrids, such as the diploid *Raphanus-Brassica* hybrid from which the amphidiploid arose, there is no chromosome pairing because the chromosomes of the two sets are too dissimilar. Yet there may be enough resemblance to cause the univalents to tend to lie together in pairs on the metaphase plate, although since they are not united by chiasmata these univalents pass to the poles independently of one another. Secondary association occurs in allopolyploids with small chromosomes and even in plants that have been believed to be diploids.

QUESTIONS AND PROBLEMS

1. In a certain genus there are six chromosomes in a genome. Species L has the genomes A_1 , B, and C; species M has the genomes A_2 , B; species N has genomes A_1 , C. All combinations of these species are made. What would be the chromosome behavior at meiosis (*a*) in these three combinations and (*b*) in allopolyploids derived from each of the three combinations?

2. One dominant gene mutates to a recessive allele in a plant which reproduces readily by self-fertilization. Would the recessive character appear most easily if the plant were (*a*) a diploid, (*b*) an autotetraploid, (*c*) an allotetraploid? Explain.

3. Some of the more desirable apples are triploids. If you had an especially valuable mutation in one of these triploid trees, how would you establish an orchard of that variety?

4. In apples, the basic chromosome number is 17 and diploid varieties usually have seven bivalents. They are often grouped as the result of secondary association into seven groups of bivalents. What light, if any, does this throw on the original basic number of chromosomes in apples? Triploids have occasionally multivalent configurations, sometimes involving as many as nine chromosomes. Does this support or reject your other position? Explain.

Chapter 28

THE ORIGIN OF POLYPLOIDS

We pointed out in previous chapters that many species of plants and some animals are either autopolyploids or allopolyploids. If we start with the assumption, and it seems reasonable enough to do so, that the diploid condition is primitive and that polyploids are derived from diploids, the important questions are how did the polyploids arise and what mechanisms bring about the polyploid state?

Apparently only two factors can initiate polyploidy—doubling of the chromosome number in somatic tissue, which results in a polyploid branch, and doubling of the chromosome number in the formation of germ cells, which results in germ cells with a multiple of the n number of chromosomes. If the polyploid branch is one that later gives rise to germinal tissue, the gametes which form on it will have more than n chromosomes. These two conditions can arise spontaneously in nature but can also be brought about artificially by certain changes in the environment of the organism. If these conditions occur and polyploids are produced, polyploids of still other types can be brought about by a repetition of these fundamental changes or secondarily by self-pollination of the polyploids or by certain crosses of which polyploids are one or both of the members. These secondary methods of producing polyploids may occur spontaneously or may be carried out artificially.

If a disturbance of cell division occurs during the formation of megaspores or microspores (that is, at meiosis), individual male or female gametes develop which are $2n$. If two such unite, a tetraploid is produced whereas a triploid will result from the union of such a gamete with a normal haploid gamete. If the disturbance arises at mitosis in a bud primordium, a $4n$ branch will result. If a flowering branch, it will produce $2n$ gametes.

Once a polyploid has arisen, others may be produced from it. If doubling of the chromosome number in somatic tissue occurs

in a triploid or a tetraploid, a hexaploid or an octoploid results. If a tetraploid plant becomes established among a group of diploids it will probably produce further tetraploids by selfing but it may produce some triploids by crosses between it and the diploids. An apparent situation of that sort has been found in a colony of *Tradescantias* in southeastern Louisiana. A railroad track ran alongside a woods. In the woods grew the native *T. paludosa*, a diploid species, but on the railroad embankment running along the track were a number of tetraploid hybrids between *T. hirsutiflora* and *T. canaliculata*, seeds of which had apparently been introduced from more northern regions by the railroad. Intermingled with them were a few plants of *T. paludosa*. Three triploids were found near the region where the two species met. They were undoubtedly hybrids between the native diploid *T. paludosa* and the introduced tetraploids for they showed characters of all three species.

Division of the nucleus unaccompanied by the cell division which almost invariably follows it can be brought about artificially by certain rather drastic changes in the environment of the cell. Among the agents used have been sudden changes in temperature, wounding with the formation of callus tissue, narcotics, various other chemicals, bacteria, insects and similar infective agents, changes in osmotic pressure, and radiation. Sax, for example, subjected plants of *Tradescantia paludosa* to temperature changes by keeping them at 8° C for two weeks and then transferring them to a chamber kept at 38° C. Many chromosomal aberrations were produced by this change resembling those produced where the plants are exposed to X-rays. A number of different kinds of aberrations are produced, and among them are found diploid pollen grains. A day after the removal of the plants to the hot chamber many first anaphase figures were found in which the spindle apparatus had been so disturbed that the chromosomes fail to pass to the poles and all apparently became included in one nucleus. After the plants had been subjected to the high temperatures for four or five days, complete asynapsis or failure of pairing was found in the microsporocytes, there was no evidence of a spindle, and usually all twelve univalent chromosomes passed into the resting stage in a single nucleus. These meiotic abnormalities produce diploid pollen grains, some of which apparently function and therefore

lay the foundation for polyploidy. In both this plant and *Rhoeo* extreme variations in temperature were more effective than constant heat or constant cold. Similar results have been reported in other plants by other writers, and some polyploids have been

TABLE 25

RESULTS OF EXPERIMENTS ON EGGS OF SALAMANDERS SUBJECTED TO REFRIGERATION

(From Fankhauser in the *Quarterly Review of Biology*.)

Temperature: 0° to 4.35° C.

Duration of treatment: Usually 5 to 24 hours.

Species	Number of Eggs Treated	Number of Larvae Obtained	Chromosome Number			
			Triploid	Diploid	Haploid	Others
<i>Triturus viridescens</i> (results of all experiments performed from 1938 to 1944)	509	264	202 (78%)	50	4	7 haploid / diploid mosaics 1 haploid / triploid
<i>Triturus pyrrhogaster</i> (Fankhauser, Crotta, and Perrot, 1942)	117	29	13 (44.8%)	11	4	1 hyperdiploid ($2N + 3$ or 4)
<i>Triturus similans</i> (Costello, 1942)	?	100	13	81	4	2 haploid / diploid mosaics
<i>Triton taeniatus</i> (Böök, 1941, 1944)	129	57	5	50	2 *
Axolotl (Fankhauser and Humphrey, 1942, and current exp.)	?	1017	347 (34%)	633	26	1 tetraploid 3 pentaploid 3 hypodiploids ($2N - 3$ or 4) 2 haploid / diploid mosaics 1 triploid / pentaploid 1 diploid / pentaploid

* Three additional haploids were found among the nonviable embryos.

produced by the temperature treatment of plants during an early division of the embryo.

Temperature changes have been used to induce polyploidy in animals, but among the vertebrates only the amphibians have been studied. Low temperatures have been particularly successful in producing triploids of the newt *Triturus viridescens* and also of the Japanese newt, *T. pyrrhogaster*, and act, apparently, by suppressing the second maturation (meiotic) division. The egg of this amphibian is in metaphase of the second maturation

division at the time the sperm enters the egg. After fertilization, meiosis of the egg nucleus proceeds and the second anaphase is reached about 30 minutes after fertilization. If the eggs are refrigerated at 0° to 3° C just after fertilization, this second meiotic division fails to proceed normally, and a diploid egg nucleus is produced which fuses with the sperm nucleus to form the nucleus of the triploid animal. In the second species about 45 per cent of the treated individuals were triploids (Table 25), but in the first species one experiment was practically 100 per cent successful. When the first species was treated at temperatures of 34.2° to 37.2° C for 5 to over 50 minutes, about 80 per cent of the treated eggs developed into triploid larvae.

Colchicine

In addition to other environmental agents, various chemicals have been tested in order, if possible, to get an agent that is more uniformly effective than these other agents. In 1937, Blakeslee and Nebel, independently and approximately simultaneously, reported that extremely valuable results could be obtained by treating plants with the drug colchicine. Since then, so many investigators have used it on such a wide variety of plants that it would be impossible in this book to approach a complete discussion of the results obtained. In general, we can say that it has been highly successful in a wide variety of genera in producing both auto- and allopolyploids and that it has even succeeded in woody plants that had not previously yielded artificial polyploids from any treatment.

Other chemicals have been used since the discovery of colchicine, and a number have been found which produce more or less the same end result. They include benzene, benzene vapor, acenaphthene, veratrine, sulfanilamide, chloral hydrate, lack of oxygen, sanguinarine hydrochloride, and various growth substances such as heteroauxin. It is very interesting to note that although acenaphthene acts more slowly on *Allium* than colchicine, it can be used to produce tetraploids on *Colchicum*, although the latter, as might be expected, is not affected by colchicine.

One of the chief effects of colchicine on plant tissue is on the chromosomes of cells in the earlier stages of division. Apparently cells in the resting stage or in anaphase or telophase are not

affected, but in cells in metaphase marked alterations are observed in the behavior of the chromosomes. Perhaps these alterations have been shown most clearly in O'Mara's work in *Allium Cepa*. When onion root tips are treated with colchicine in the proper concentrations, metaphase figures appear to lack the spindle mechanism normally found in dividing cells. This disturbance to the spindle has also been observed by Eigsti and

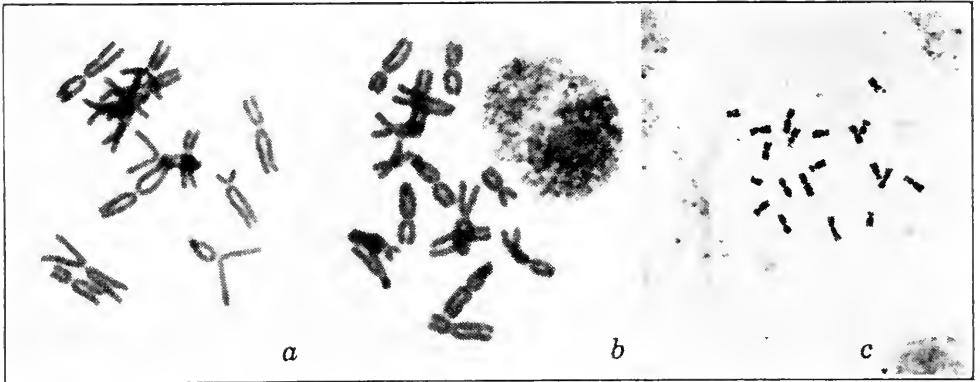

FIG. 137. The immediate effects of some chemicals on chromosomes. (a) and (b) Cells from onion root tips. (a) Typical effect of colchicine on chromosomes; isolated chromosomes show lack of coiling and differences in sizes. (b) Cell in which the contraction has shortened the chromosomes far below their normal lengths. (c) Cells of maize treated with para-dichlorobenzene which produces an effect very similar to that of colchicine. (Courtesy of Dr. J. G. O'Mara; a and b in the *Journal of Heredity*; c in *Stain Technology*.)

others in different genera. With the disappearance of the spindle naturally further division is inhibited, and the cell remains in this metaphase condition for a considerable time. In the meantime, cells in anaphase or telophase at the time of treatment continue to divide until they pass into the resting stage, whereas cells that had just begun to divide continue to do so until they reach this irregular metaphase condition. In this way metaphase figures gradually accumulate.

Cells in metaphase undergo some changes that give them an abnormal appearance. The chromosomes contract and thicken gradually and lose entirely their relational coils. The two chromatids lie side by side but are quite independent of one another except at the centromere, where they remain attached (Fig. 137). Sometimes they separate more or less and sometimes extend out

at right angles to one another to produce X-shaped figures. If the treatment continues for a sufficiently long time the two chromatids separate at the centromere, and each lies in the cell as a single chromosome. Thus the number of chromosomes is increased from the diploid to the tetraploid. In some chromosomes a distinctly double appearance is noticed soon after the two chromatids have completely separated. It is the result of a "split" in anticipation of the division to follow the one in which they are, and has probably occurred just before the separation of the chromatids into individual chromosomes. This separation of chromatids creates a cell with the tetraploid number of chromosomes.

From this colchicine-metaphase the chromosomes may then go apparently directly into a resting stage or may go through the same abnormal performance one or more times to form octoploid cells or cells with even higher multiples of chromosomes. Levan, in fact, has even reported finding onion root-tip cells with 500 to 1000 chromosomes as the result of treatment with colchicine. It might be added here that it has become conventional to refer to a metaphase resulting from colchicine treatment as a *c-metaphase* and to use such terms as *c-mitoses* and *c-treatment* wherein the "c" obviously stands for "colchicine."

Various methods of applying the drug have been used. The treated parts are usually seeds or growing buds, and the colchicine is often applied in solutions varying from 0.1 to 0.8 per cent. Treatment may be by soaking seeds, immersing a twig (Fig. 138), applying one or more drops to a bud, spraying with an atomizer, and wrapping a bud in a string, one end of which is in the solution. Sometimes the colchicine has been applied in an emulsion

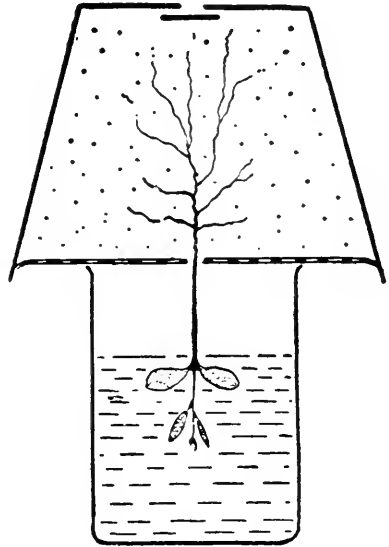

FIG. 138. One of the methods used to apply colchicine to a plant. The colchicine solution is placed in a beaker and the seedling is inverted over it so that all the growing points are in the solution. (From Nebel and Ruttle in *New York State Agricultural Experiment Station Circular* 183.)

of stearic acid, morpholine, or lanolin. Other methods have also been used.

Animals

Polyploidy is far less common in animals than in plants, but some attempts have been made to induce polyploidy by the use of colchicine. As in plants, the formation of the spindle appears to be inhibited and dividing cells remain in metaphase. In most animals, the treated cells do not proceed from c-metaphase into the following resting stage with a doubling of the number of chromosomes, but degenerate, thus ending any possibility of polyploidy. In a few experiments, cells with the double number of chromosomes have been produced as the result of colchicine treatment, but they have not lived long or produced polyploid organisms. When colchicine was applied to eggs of *Arbacia punctata* ten minutes after insemination, the cell remained in metaphase when the concentration of the colchicine was above 10^{-4} molar, but somewhat lower concentrations allowed the nucleus to divide abnormally although cleavage was impeded. At concentrations as low as 10^{-6} molar the rhythm of division during the early cleavage stages is not affected, but the subsequent development of the larvae is markedly stunted. Nebel summarizes the effects of colchicine in increasing concentrations as follows: normal cleavage is affected; astral rays fail to form; the spindle is reduced in size; the spindle fails to form; the chromosomes become pycnotic and fail to divide normally.

In higher animals several interesting experiments have been carried out. Pincus and Waddington subjected the fertilized rabbit egg developing in culture to dilute solutions of alcohol, ether, or colchicine in different strengths and for different lengths of time, or to brief exposure to temperatures above the normal. Good mitotic figures were observed for 40 eggs, and 15 of these were tetraploids. Of these, 13 were from eggs treated with colchicine and 2 from eggs treated with ether or alcohol. Colchicine prevents spindle formation and appears to inhibit cleavage by inhibiting almost all cytoplasmic movements and slowing down nuclear activities. The tetraploid ova ordinarily failed to cleave during 24 hours, but a few did undergo cleavage at a subnormal rate. Treatment with colchicine solutions of 24-hour chick embryos have been reported in a preliminary note by Higbee. She

obtained two males and two females from 20 injected eggs and observed that the combs and wattles of all were approximately twice the normal size and that two tail feathers of the roosters were greatly elongated. A hen, kept in a cage with one rooster, laid one nonhatching egg every two or three days.

Callus Formation

Polyploidy can be induced in certain genera merely by wounding a plant. Lindstrom and Koos by chance obtained a haploid tomato plant which had arisen spontaneously and had twelve univalent chromosomes. They decapitated this plant and removed all the axillary buds that appeared. Petrolatum was placed over the cut end to keep the tissue fresh, and a healthy callus formed over the cut surface. Within two weeks adventitious buds arose from the callus tissue, and many of them were removed, rooted, and raised to maturity. In the callus tissue a number of binucleate cells were observed, and in some of them the two nuclei were observed to fuse. Probably as a result of these binucleate cells, about 30 per cent of the adventitious buds that were tested were found to be diploids. These diploid plants obtained from the haploid by rooting the shoots that arose from the adventitious buds showed twelve pairs of chromosomes and were homozygous for all the genes investigated. Similar studies were made by decapitating the diploids. From this wound tissue about 30 per cent of the adventitious buds gave rise to tetraploid plants. They showed low fertility and had forty-eight chromosomes, most of which formed quadrivalents. These polyploids can be secured from the callus tissue in tomatoes that follows an injury.

In *Nicotiana*, another genus of the same family, callus tissue does not form naturally as in the tomato. Greenleaf found that by decapitating *N. sylvestris* \times *tomentosa* or *N. sylvestris* \times *tomentosiformis* hybrids, and by covering the surface of the wound with the growth hormone, indole-3-acetic acid in anhydrous lanolin (1 per cent), a callus tissue would be formed in which adventitious buds would arise. They developed into shoots which were rooted and examined for polyploidy. Of 1973 plants examined, 270 or 13.7 per cent were tetraploid. About 1 per cent of the shoots were octoploids, and some shoots with unbalanced chromosome complements also arose. Interestingly, whereas in

tomato adventitious shoots arise spontaneously from wounds covered with lanolin, they are not formed when the lanolin contains indole-3-acetic acid.

Chromosomal Chimeras

Some adventitious buds that arise from callus tissue appear to have arisen from a region on the surface of the wound that has contained both diploid and tetraploid cells, for some shoots appear to be of mixed nature. Jorgensen found a nightshade plant with a diploid core covered with a tetraploid skin and a tomato shoot that was also composed of both $2n$ and $4n$ tissue. A plant that consists of genotypically diverse tissue is a chimera, and if the different kinds of tissue differ with respect to chromosome number, the plant is a chromosomal chimera.

Chromosomal chimeras have been produced in *Datura* by Blakeslee and his co-workers by treating seeds of diploids with colchicine. After the treatment, the germinating seeds were found to be mixtures of $2n$ and $4n$ tissue. In some, periclinal chromosome chimeras were produced in which the cells of the inner part of the branches was $2n$ and those of the outer parts were $4n$. The valuable feature of this work is that in the developing shoot the $2n$ and $4n$ cells can be distinguished readily by their size. Other chimeras contained $8n$ tissue, which was also distinguishable from the diploid and tetraploid cells. By studying various periclinal chimeras which differed with respect to the chromosomal constitution of the outer and inner regions, it was possible to identify the three independent germ layers of the shoot and floral apices and to determine the contribution of each germ layer to the formation of each organ. This ability to distinguish the products of various germ layers has been of great value in ontogenetic studies. Chromosomal chimeras, both periclinal and sectorial, have been reported by Dermen in cranberry. In this plant also they are valuable for studies of histogenesis of primary tissues and the ontogeny of various plant organs.

QUESTIONS AND PROBLEMS

1. In a certain area plants of *Tradescantia paludosa* ($n = 6$) and hybrids ($n = 12$) between *T. canaliculata* and *T. hirsutiflora* were growing near one another. Tetraploid hybrids were found with characters

of all three species. Show how such trispecific tetraploids might have arisen.

2. Which should be easier: (a) to obtain triploids if you have only tetraploids and diploids or (b) to obtain tetraploids if you have only triploids and diploids?

3. Which should be easier: (a) to obtain triploids if you have only tetraploids or (b) to obtain tetraploids if you have only triploids?

4. If a chemical could be found that is as successful in producing haploids as colchicine is in producing polyploids, how could homozygous true-breeding strains be developed rapidly?

Chapter 29

THE DETERMINATION OF SEX

One of the important problems to geneticists is reproduction and especially that type of reproduction designated as "sexual reproduction." It is so not only because all genes present in succeeding generations become present in each individual at the time of reproduction but also because the segregation of alleles and the reassortment of genic combinations that make up so much of the body of genetics occur only as a product of sexual reproduction. In addition, of course, the genetic ratios obtained from certain characters indicate that they are intimately connected with sex. While geneticists have been studying the problem of sex ever since the science of genetics was founded, a definition of sex or of sexual reproduction is not easily constructed. Sexual reproduction certainly involves certain cells called gametes. They arise in animals directly by meiosis and in plants from the gametophyte generation which came directly from spores produced by meiosis. In either form, the gametes have half or approximately half the number of chromosomes found at some other stage in the life cycle. These gametes usually unite by a process called fertilization, but sometimes they produce a new individual without any such union. In some of the lower forms of life the gametes that unite are alike morphologically and in some organisms probably physiologically as well, but in the higher animals and plants the gametes are distinctly different. Often the individuals in which one type of gamete is produced differ in many morphological and physiological respects from those in which the other type is found, but in many plants even this distinction is largely obscured because the two types of gamete-bearing plants are located in one sporophyte. All these various illustrations can be classified as sexual reproduction, which might be defined for our purposes as reproduction involving gametes.

ANIMALS

Sex Chromosomes

The relation of chromosomes to sex determination was pointed out in Chapter 5. In *Drosophila*, human beings, and other mammals, the female has two X chromosomes and the male is XY, but in some animals the male has one X chromosome but no Y. In moths, butterflies, birds and some fish the female is the heterogametic sex. There is some question how the sex chromosomes in animals of this type should be designated. Originally, the sex chromosomes of the female were designated Z and W, and the male was said to be ZZ. Reasoning that it is unnecessary to use the additional symbols Z and W when X and Y can be used for the sex chromosomes in all organisms irrespective of whether the male or the female is heterogametic, some geneticists use the symbols X and Y for the sex chromosomes in the female of animals in which the female is heterogametic and XX for the males of such forms. Thus the symbols are the same as those of the *Drosophila* except that the sexes are reversed with respect to the chromosome constitution of the sex chromosomes. Castle, however, has suggested that X be used to indicate a sex chromosome with a female tendency and Y one with a male tendency. If this scheme is carried out, Castle points out that in the *Abraxas* or bird type the female should be XY and the male YY. Although the choice of symbols is largely a matter of preference, the use of both XX and YY by different geneticists for the male with the accompanying reversal in meaning of the "X" and "Y" in the female of moths and birds is a little confusing. For that reason, largely, the older system of ZW and ZZ has been adopted in this book.

Balance Theory of Sex

With a mechanism such as the sex chromosome mechanism in *Drosophila melanogaster*, it is possible that maleness might be determined by the presence of a Y chromosome or that femaleness might be determined by two X chromosomes. So far as the evidence from diploid organisms is concerned, either possibility is philosophically sound. Further evidence from organisms which are polyploids or aneuploids, however, indicate that the second

possibility is the correct one. According to this evidence, the X chromosome contains one or probably a number of female-determining genes, whereas numerous male-determining genes are located in the autosomes (or at least the balance of the sex-determining genes in the autosomes is male-determining); the ratio of the sex chromosomes to the autosomes is the important consideration.

In a normal female, there are two X chromosomes and two sets of autosomes so that the ratio is 1 : 1, but in the normal male only one X chromosome is present and the ratio is 1 : 2. Apparently the male-tendency genes in the autosomes are not so effective as the female-tendency gene or genes which are in the X chromosome for a 1 : 1 ratio produces a typical female, and the normal male appears only when there are twice as many sets of autosomes as X chromosomes. Intermediate between these normal individuals are the *intersexes* which Bridges has described. These forms can be considered as modified triploids and have three sets of autosomes but only two X chromosomes. Consequently the ratio of X chromosomes to sets of autosomes is 1 : 1.5. With respect to their ratios these flies are intermediate between females and males, and in their external appearance they are complex mixtures of both female and male characters. They are not all alike and vary from some that have mostly male characters to others that are largely female-like. Very few lack the sex comb, a structure normally found on the forelegs of males. Intersexes are mixtures of phenotypically female-like and male-like parts although they are not composed of genetically male and female parts, for all the cells of an intersex have the same genetic constitution. Apparently during development each structure can develop only as in a female or as in a male and cannot be intermediate. Apparently each fly starts to develop as a male and subsequently switches over and develops as a female. The earlier this switch occurs, the more female-like will be the fly. If they develop late in ontogeny, male characters are less and female characters more likely to be normal. Intersexes are sterile.

If an individual possessing three sets of autosomes has only one X chromosome, its ratio is 1 : 3. Such flies are *supermales*. Their viability is poor and they are highly sterile. At the other end of the list are the *superfemales* with three X chromosomes

but only two sets of autosomes. These aneuploids have a ratio of 1.5 : 1 and are females but have poor viability and are highly sterile. Thus, the higher the ratio of X chromosomes to autosomes, the greater the tendency towards femaleness.

That the Y chromosome does not determine maleness in *Drosophila* is also shown in flies in which this chromosome had become lost as the result of a meiotic abnormality. Such flies have one X chromosome and two sets of autosomes but are typical males. They are sterile, however, but this is another matter. Although the Y chromosome does not have an effect on sex determination it does contain genes for male fertility which are necessary for the production of a fertile male. That the Y chromosome is not the determining factor in sex is further supported by aberrant diploid individuals such as the attached-X type in which two sets of autosomes, two X chromosomes, and one Y chromosome are present. These individuals are females in spite of the presence of the Y chromosome. Thus the absence of a Y chromosome does not prevent a fly from being a male whereas the presence of a Y does not cause a fly to be a male.

Although the ratio of X chromosomes to autosomes is operative in determining sex in *Drosophila melanogaster*, it is not a universal mechanism. Kosswig has shown that in *Platyphidium*, a fish, the determining factor is the ratio of the autosomes to the Y chromosomes, and later in this chapter we discuss at length the plant *Lychnis (Melandrium) dioica*, in which the female-tendency genes are in the X chromosome and the male-tendency genes in the Y chromosome.

Intersexes in *Lymantria*

A number of intersexes of different grades have been found in crosses between different geographical races of the Gypsy moth, *Lymantria dispar*. They range from normal males through various stages of low intersexuality and high intersexuality to females which are genetically males but have undergone a sex reversal, or from normal females through all grades of intersexes to males which are genetically females. These intersexes have formed the basis of Goldschmidt's quantitative theory of sex determination. In *Lymantria* the females are the heterogametic individuals so that, according to the notation we have adopted in this book, the females would be ZW and the males ZZ. In

crosses between individuals of the same race or strain, all ZW individuals are females and all ZZ moths are males. The problem of intersexes and sex reversal arises only when races or strains from different localities are crossed and even then not in every such cross. To explain such results, Goldschmidt has assumed the presence of a female-determining substance located in the cytoplasm and a male-determining substance found in the Z chromosome. The relative strengths of these substances within any one race are such that two doses of male-determining substance as found in the two Z chromosomes in a male overcome the action of the female-determining substance produced by its cytoplasm. This female-determining substance, however, is sufficiently potent to overcome the action of the single dose of male-determining substance in the female. If we assign the symbol "F" to the female-determining substance in the cytoplasm and "M" to the male-tendency genes in one Z chromosome, the formula of a female is F / M and of a male is F / MM, where $MM > F$ and $F > M$.

Both the F and M sex determiners differ in potency or *valency* in different races, although their relative strengths are approximately the same in every race. Thus there are *strong* and *weak* F's and *strong* and *weak* M's. If a strong F and a weak M are combined in a race, which is crossed with races that have M's of different strength, individuals that are ZZ and therefore genetically males will result which might not be phenotypically males. If the M-determiner introduced is strong (of highest valency), it may be sufficiently powerful to overcome the strong F-determiners in the cytoplasm, and the offspring will be males. If the M-determiner is intermediate, the offspring may be an intersex; but if the M-determiner is very weak, the strong female-determining substance may be sufficiently powerful to overcome the male-determining substances of both the weak M's even when their action is combined. Such individuals will be genetically males but will be phenotypically females and will therefore be sex reversals. In one such test a strong F from a Tokyo race was combined with a very weak M from a race from Hokkaido, Japan. They were crossed with races from various parts of Europe and Asia which varied with respect to the valency of M. These crosses produced a very interesting series of intersexes. It

is probable that the M-determiners are actually genes at one locus and that the different strengths are produced by at least eight genes that form a series of multiple alleles.

Other Intersexes

In *Drosophila virilis* Lebedeff has found intersexes in diploid flies as the result of a single autosomal gene, ix^m . The wild-type allele of this gene, Ix^m is a gene for maleness and is located in the third chromosome. It produces a male tendency which reacts with a female tendency produced by gene F , located in the X chromosome. The Ix^m gene and the F gene are assumed to be equally potent, and the sex of the fly is determined by the balance between these genes. This balance is maintained by a set of suppressors which inhibit the activity of the Ix^m gene when it is opposed by an equal dose of F genes. These suppressors are believed to be neutral so far as sex determination is concerned and to act merely as the suppressors of sex genes. Two suppressors have been found, both dominant genes. They are gene S_3 , located in the third chromosome, and gene S , whose location has not been determined.

In individuals which are genotypically FIx^mIx^m the male tendency of the two Ix^m genes is so much more potent than the female tendency produced by the F gene that such individuals are male even if the Ix^m suppressors are present. $FFIx^mIx^m$ flies, however, are females because suppressors S_3S_3SS are normally also present and suppress the male tendency to such an extent that the two F genes overcome the two Ix^m genes and the individual is a female. The ix^m allele is also a male-determining gene but is much stronger in its action than Ix^m . Because of the suppressors, the Ix^m and F genes are in a balanced condition in the 2X : 2A individuals so that whether an individual is male or female is determined by the number of F genes and, since one F gene is in one X chromosome, therefore, by the number of X chromosomes in the diploid individual. When the recessive ix^m is homozygous, the balance attained in the 2X : 2A system if Ix^m is present is overcome in part, and individuals with two F genes are not females but sterile males. If only one F gene is present, the individual is male. If a fly is $FFix^mix^m$ and has the suppressors of the ix^m gene, it is female. However, if the suppressors

are not present, such individuals are converted into males which are sterile because the two ix^m genes are more potent than the two F genes. A number of other modifying genes which delay the transformation of $FF ix^m ix^m$ females into males is also present. This delay causes the individuals to be intersexes possessing both ovaries and testes instead of males.

Drosophila virilis is not the only species of that genus in which diploid intersexes have been found that have resulted from the action of a single gene. As in *D. virilis*, a recessive gene is the causative agent for certain intersexes in *D. simulans*, but in *D. pseudoobscura* intersexes have been produced by a dominant gene. In the last species, Dobzhansky and Spassky have found that most of the diploid intersexes have two sets of genital ducts and external genitalia, one of which is almost always more female-like whereas the other is usually more male-like. Because of these two sets of reproductive organs, these intersexes could also be termed hermaphrodites. There is, however, only one pair of gonads so that these aberrant flies have generally been regarded as intersexes rather than hermaphrodites. The intersexes were genetically females, as was revealed by a cytological examination which showed that they possessed two X chromosomes and two sets of autosomes, and they arose as a result of a dominant gene whose normal allele is believed not to be involved in any way in the mechanism of sex determination.

Heteropycnosis

One physical feature of the X chromosome in many animals is of considerable interest. In the heterogametic sex of a number of animals the sex chromosomes are much more condensed during certain stages of division than the autosomes. Such chromosomes, therefore, are much more compact and stain more deeply than the other chromosomes. They are said to be *heteropycnotic* and the phenomenon is *heteropycnosis* (Fig. 139). The condensed condition is often noticeable during the period of growth of the spermatocytes. Because of the compact, deeply staining nature of the X chromosome during this stage, it has the appearance of a karyosome or chromosome-nucleolus. Because of the difference in appearance between these heteropycnotic sex chromosomes and the autosomes, the sex chromosomes were once

called heterochromosomes to differentiate them from the autosomes, which were then called euchromosomes.

The particular stage of the life cycle at which the sex chromosomes show heteropycnosis appears to vary in different animals, and in some it does not appear to occur at all. It sometimes is found after the first spermatogonial division in animals in which the male is the heterogametic sex, and less frequently is found in the spermatogonia. In some organisms the heteropycnotic



FIG. 139. Heteropycnotic chromosome A of *Phrynotettix*: (a) diplotene; (b) late prophase. (Courtesy of Dr. D. H. Wenrich in *Bulletin of the Museum of Comparative Anatomy of Harvard University*.)

condition is observed in the prophase stages of the first meiotic division, or division of the primary spermatocyte, and it is frequently seen in the interkinetic stage between the two spermatocyte divisions. It is also found in the spermatids for a considerable time after the second meiotic division.

Heteropycnosis has recently been used by S. G. Smith to differentiate the two sexes during early stages of development in the spruce budworm, *Archips fumiferana*. It was desired to determine the sex ratio before high mortality occurs during larval development to learn whether this mortality affects the two sexes differently. Fortunately, the sex chromosome remains heteropycnotic in the resting cells of the female of this animal in many different kinds of somatic tissue, and especially in the large cells of the silk glands. Since the female is heterogametic in this organism, the heteropycnotic chromosome is found in that sex (Fig. 140). By examining the silk glands for cells with heteropycnotic chromosomes the sex can be determined during an early stage of development.

Chromosome Elimination

Several peculiar features have been observed in the behavior of chromosomes of the fly *Sciara* by Metz and his co-workers. In some species, in addition to the usual autosomes and sex chromo-

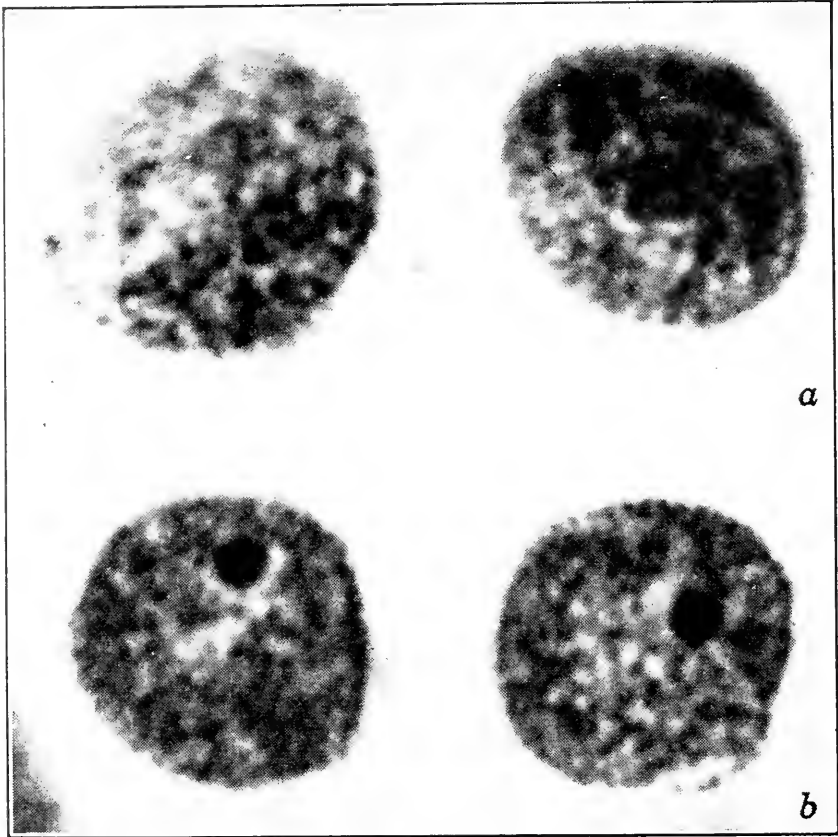

FIG. 140. Heteropycnosis of the sex chromosome in the spruce budworm, *Archips fumiferana*: (a) cells of silk glands of male showing no heteropycnosis; (b) similar cells of female showing heteropycnotic chromosome appearing as a large, dark lump. (Courtesy of Dr. S. G. Smith in the *Journal of Heredity*.)

somes, which together have been designated in this organism the "ordinary" chromosomes, there is also another type of chromosome which is larger and often of greater diameter than the ordinary chromosomes. These peculiar chromosomes are the "limited" chromosomes and appear to contain few, if any, genes. In some species each fly must have one complete limited chromosome if it is to develop normally, although this chromosome must be necessary only for the proper development of the gonads and

early cleavage stages since it is eliminated from the somatic cells during an early stage of somatic development. One or two additional limited chromosomes may apparently also be present without any resulting serious effect, but three is the largest number ever observed in one individual. These chromosomes appear to break up readily into fragments without any harmful effect. They also remain heteropycnotic in the primary spermatocyte, which would suggest that they may represent a true sex chromosome that had lost its function since, as we have just seen, sex chromosomes in other organisms may remain heteropycnotic.

One of the peculiar features of the chromosomes in *Sciara* is chromosome elimination. In *S. coprophila* (Fig. 141) the zygote may receive two rod-shaped and one V-shaped autosome from the egg and similar chromosomes from the sperm. The egg may also contribute one limited chromosome and one X chromosome whereas the sperm adds two limited chromosomes and two X chromosomes. The germ line and soma become set apart from one another during the first few cleavage divisions of the egg. At the fifth or sixth cleavage division the mitoses of the somatic line show certain peculiarities not found in the usual mitoses. During either of these divisions all the chromosomes behave normally except the limited chromosomes. The daughter halves of these chromosomes separate normally but do not pass along the spindle to the opposite poles. They lag on or near the equator and do not become included in the daughter nuclei, but they remain by themselves in the cytoplasm where they go through the usual mitotic changes for one or two divisions. Eventually they degenerate. At the seventh or eighth cleavage division a somewhat similar elimination of the X chromosomes occurs. One X chromosome becomes eliminated from eggs destined to produce females, and there is reason to believe that this is one of the two X chromosomes that entered from the sperm. However, two X chromosomes are eliminated from eggs destined to produce males, and it appears that both are X chromosomes that were contributed by the male parent.

In addition to this unusual elimination of chromosomes from somatic cells, there is also apparently an elimination from the germ cells, a process which, until recently, has not been so well understood. This elimination appears to occur at a later stage than elimination from the somatic line and in all eggs apparently

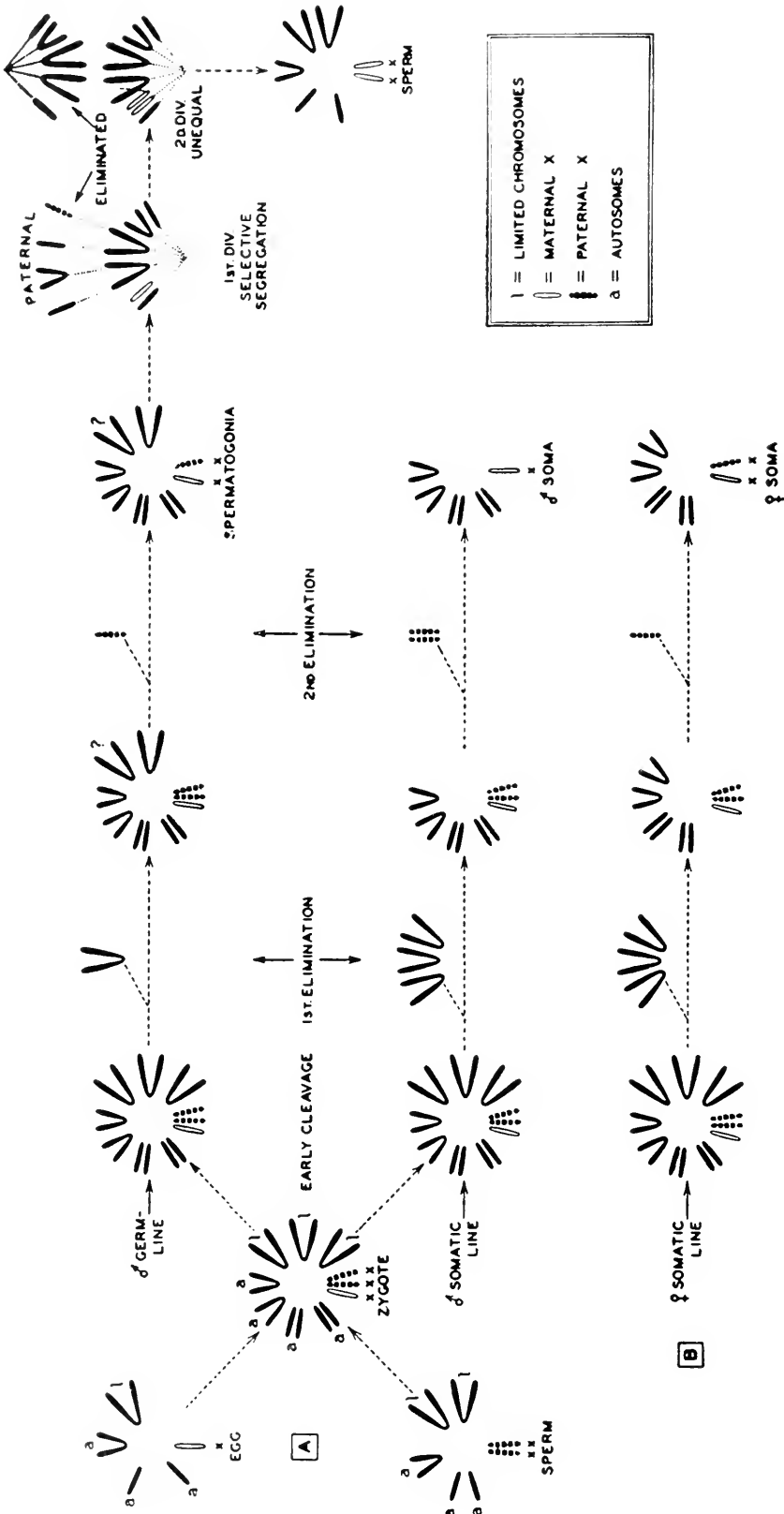

Fig. 141. Behavior of the chromosomes in *Sciara coprophila*. For explanation, see text. (Courtesy of Dr. C. W. Metz in the *American Naturalist*.)

involves one of the two X chromosomes that have been derived from the male parent, thus leaving in the germ line of all eggs one X chromosome which came from the mother and one which came from the father. One or more of the limited chromosomes must also be eliminated from the germ line as otherwise their number would increase with each generation.

Further behavior of the cells in the germ line after the elimination of the X chromosome is also of interest. Oögenesis is similar to that found in most organisms. The chromosomes pair normally at zygotene and show no peculiarities. There are three pairs of autosomes and two paired X chromosomes, and one member of each pair is subsequently found in the egg. In species with two limited chromosomes, these also pair and separate in the same manner as the autosomes. The regular behavior at oögenesis and at spermatogenesis, however, is quite in contrast. In the primary spermatocyte there is no zygotene pairing, and later only one pole is present instead of the more usual two. When the chromosomes pass to the pole, only the autosomes and X chromosome of maternal origin pass to the single pole; but all the limited chromosomes that may be present also pass to this pole. The paternal X chromosome and the three autosomes which had been contributed by the male parent move away from the pole and become pinched off from the egg, and in that way they are eliminated from further activity. In the division of the secondary spermatocyte, the achromatic figure is bipolar, but one pole develops before the other. All the chromosomes "split" normally except one, which evidence indicates is the X chromosome. This X chromosome moves towards the first pole formed before the daughter halves of the remaining chromosomes separate; it therefore has been termed the "precocious" chromosome. When the second pole forms, the daughter halves of all but the precocious chromosome separate in the usual manner; and the halves of the X chromosome separate from one another but remain at the same pole. The group of chromosomes which lacks the X chromosome then degenerates, and the other group with the halves of the X chromosome remains functional. All the sperms, therefore, are identical, and each contains only maternal chromosomes.

Berry has studied the elimination of an X chromosome during the development of the germ cells and has found that in both

sexes an X chromosome is eliminated from the germ cells during a resting stage. He studied *Sciara ocellaris*, but there is no reason to suppose that the behavior of this species and of *S. coprophila* is different. That some elimination must occur appeared from the fact that the zygote contains nine chromosomes whereas the gonads of the early larval stages have only eight. When oögenesis and spermatogenesis occur, only six autosomes and two X chromosomes are present. This species has no limited

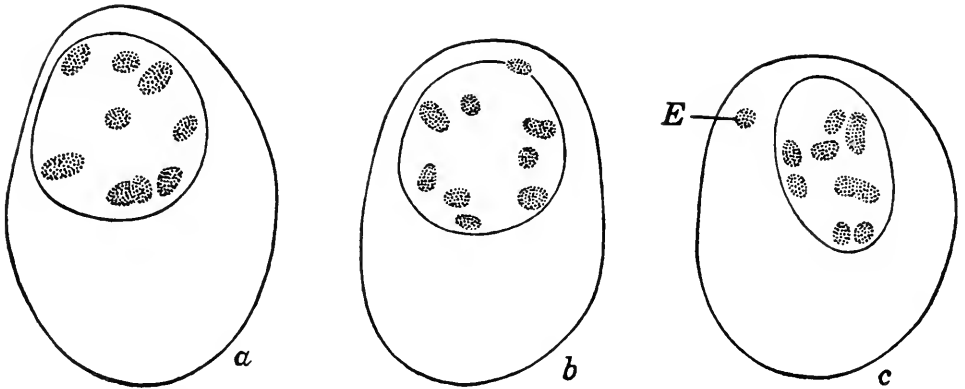

FIG. 142. Method of chromosome elimination in *Sciara ocellaris*. The chromosome to be eliminated comes into contact with the nuclear membrane and migrates through it apparently autonomously into the cytoplasm. (Courtesy of Dr. R. O. Berry in the *Proceedings of the National Academy of Sciences*.)

chromosomes. Genetic evidence indicates that the missing chromosome is one of the two X chromosomes of paternal origin. Berry has reported that the chromosomes are not eliminated from the germ cells during their cleavage stages, as is true of the somatic cells, but that a chromosome is eliminated after the germ cells have moved into their position in the gonads. During this migration and for a considerable period thereafter, the germ cells are in the resting stage; but the chromosomes appear as definite but diffuse bodies or prochromosomes (Fig. 142). During this resting stage, one chromosome moves towards the nuclear membrane and then apparently passes through it into the cytoplasm. This peculiar action occurs approximately simultaneously in all the germ cells of a given individual and at the same stage of development in all individuals. After it has passed into the cytoplasm, this eliminated chromosome remains there for several days and then degenerates.

Potentialities

The sex chromosomes are undoubtedly factors in the determination of sex, but they alone are not adequate to explain some intersexes and sex reversals. One suggestion that has received considerable support, although in several varying forms, is that all cells have the potentialities for both maleness and femaleness. In some cells the male potentiality predominates, but in others the female potentiality becomes expressed. All the genes for both sexes are present in each cell, although the XY- or ZW-mechanisms result in a difference in the quantitative relationships of these genes in different individuals. Thus XX individuals would have more female-tendency genes than XY individuals and, other things being equal, would be female rather than male. In some organisms this strictly quantitative relationship is itself not the only important factor. In *Lymantria* genes for both maleness and femaleness are present, but each type exists in several forms which differ in strength. Strong male genes, combined with weak female genes in an organism that would be female according to its chromosomes, would develop in a male direction and end up a female intersex, whereas weak male genes, combined with strong female genes, might convert an expected male into a female. Goldschmidt has suggested that, in the first example, the organism starts out as a female, but the strong male genes exert such an influence that a "Drehpunkt" or "turning point" is reached, after which the individual develops as a male. The organs or tissues that develop during the earliest stage of ontogeny and right up to the Drehpunkt become female; those that develop after this turning point are male. The intersex, then, is not an individual in which every organ and every tissue are intermediate between the two sexes but one in which some organs are wholly female, others wholly male, and some are mixtures of both male and female tissues. In the male type of intersex, the first-formed organs and tissues are male whereas those that develop during later developmental periods are female. A similar explanation has been offered for the triploid intersexes in *Drosophila*.

Although all cells may have both male and female potentialities so that organs and tissues may develop in either way according to the ratio of male-determining and female-determining

genes and also according to the relative strengths of these two kinds of genes, environmental conditions may also influence the way these potentialities are realized. It is especially true for certain species of animal.

Hormonal Control

The suggestion that all cells and therefore all animals are potentially both male and female is supported by a consideration of sex reversals in some of the higher animals. One of the classical cases is the famous Crew's hen. This animal started out as a normal hen that produced normal eggs. Apparently a tuberculosis of the ovary developed which completely destroyed that organ. The disappearance of the ovary stopped the secretion of ovarian hormones, and thereupon the fowl ceased to be a hen. Female birds contain in addition to normal ovaries a small, rudimentary testis that normally remains dormant but springs into activity as soon as the ovary ceases to function. When this ovary was destroyed, this testis developed, secreted male hormones, and converted this hen into a rooster which developed male external characters and a male sexual behavior. As a hen it had produced fertile eggs, and as a rooster it became the father of two chickens. This example shows that external conditions may influence development and completely reverse a certain sex pattern. It also shows that internal secretions from the sex glands themselves may operate throughout the life of an individual to maintain its sex. These secretions are merely examples of a large class of such internal secretions known as *hormones*. These hormones are secreted by various organs in the body, diffuse to other regions, and exert certain specific effects on these other regions.

The "freemartin" in cattle is another excellent example of the effect of certain hormones upon sex. In cattle twins are sometimes present of such a chromosomal constitution that one would be a male and the other a female. During their early embryonic development blood may pass freely from the one to the other and, if so, may carry hormones from one to the other. Apparently the male hormone in the one twin develops first and establishes that twin as a male. The female hormone develops later in the other twin and establishes it fundamentally as a female; but before the production of this female hormone, male hormone

from the male twin had entered into the female and had started some of its structures to develop in a male direction. The result of the two types of hormones in the developing female is a sterile female with some decidedly male characters. Even though the later-developing female hormone diffuses into the male, the male animal has developed so far at the time that the female hormone has no apparent effect. The situation responsible for the circulation of blood from one twin into the other is peculiar to cattle. Lillie showed that in cattle the twins develop a *common* circulation so that the female twin is actually supplied with blood that contains the male hormone. In other animals twinning is not accompanied by such anastomosis of the fetal circulatory systems, and no freemartin is produced.

Environmental Control

In Crew's hen, the removal of the ovary by disease controlled the sex of the individual. Similar results may be brought about experimentally during early development by the artificial removal of sex organs and the grafting of organs of the opposite sex and by artificially injecting into an animal the sex hormones of the opposite sex. Such methods show that the environment plays a considerable part in determining the sex of an individual that is potentially both a male and a female. A classical example of the effect of environment is illustrated by the marine worm *Bonellia*. The young individuals are potentially both male and female. When they are in the young larval stage, they swim about freely. If one comes into contact with an adult female and becomes attached to it, that larva develops into a male; but if a larva fails to locate on a female and merely undergoes its later development on the bottom of the ocean, it becomes a female. Sex develops comparatively late in these animals and according to the environment of the animal during its later larval development.

Hermaphrodites

Hermaphrodites, as we pointed out in Chapter 4, are individuals that produce both male and female gametes. Thus such an individual is both male and female at the same time. This situation is found as a normal feature of the life cycle of some of the lower animals, such as the common earthworm. It may

appear in some of the higher forms as an abnormal condition, but it is doubtful whether true hermaphrodites are ever found among mammals. Certain intersexes such as the diploid intersexes of *Drosophila pseudoobscura* might be regarded as hermaphrodites because they possess two sets of reproductive organs, one male-like and the other female-like. Dobzhansky and Spassky, however, prefer to regard them merely as intersexes because the reproductive organs that are present consist of genital ducts and external genitalia, but not gonads. It is probably preferable to restrict the term *hermaphrodite* to those animals in which actual, functional gonads of both sexes are present. These intersexes, however, approach the true hermaphroditic condition much more closely than the triploid intersexes of *Drosophila* or the diploid intersexes of *Lymantria*.

Gynandromorphs

In a few species individuals have been found, although rarely, which are composed of both genetically male and genetically female tissues. The two types of tissue may differ in extent, and theoretically such an individual may vary from a condition in which exactly half the body is of one sex and the other half is of the other sex to a state in which only one cell is male and the remainder of the body is composed of female tissue. Many sexual mosaics are bilaterally symmetrical; that is, one half the body is male and the other half female, and the boundary is the midventral line that runs lengthwise through the center of the body. This condition appears to arise during very early embryology in those animals in which the first cleavage division divides the fertilized egg into two cells, each of which will ultimately develop into one side of the body. If at about this first cleavage in an XX female one of the X chromosomes is lost or otherwise inactivated in one of the two cells, the side of the body which develops from it will be male whereas the side that develops from the cell which has retained two functional X chromosomes will be female.

A mitotic or other abnormality occurring at the first cleavage division cannot so readily explain gynanders in insects, for insects do not undergo cleavage divisions in the same manner as most animals, and the first cleavage does not divide the right from the left side. In insects, the egg is centrolecithal. The nucleus lies

in the yolk in the center of a large egg and is surrounded by some cytoplasm. It divides into two nuclei, each of which lies in the yolk mass and is also surrounded by some cytoplasm. These then divide into a number of nuclei with cytoplasm, all lying within the yolk towards the center of the egg. Thus early embryology in insects is very different from that of other animals, but even if the early development were the same in all animals it is possible that in insects the effect of abnormalities during cleavage might be lost subsequently at metamorphosis. A sharp median separation often appears in insects, but it is the result of synchronous growth of the imaginal discs rather than of cleavage. In *Habrobracon*, on the other hand, very few gynanders and other mosaics are divided into male and female halves with the boundary the midventral line; most are more or less scrambled, several very much so.

Individuals with both genetically male and female tissues are called *gynandromorphs* or *gynanders*. Gynandromorphs differ from intersexes. Intersexes are genetically alike throughout their bodies; on the contrary, however, gynandromorphs consist of two genetically different kinds of tissue. Some cells are genetically male and other cells are genetically female.

Gynandromorphs have been found in *Drosophila melanogaster*, in which one side of the body is male and the other female, and the interpretation that has been given assumes that the male side has lost one of the X chromosomes. If the fly is heterozygous for a number of genes on the X chromosome, the female side of the gynander will be phenotypically the expression of all the dominant genes on both chromosomes. The male side, however, will be the expression of either the dominants and recessives on one or the other X chromosome, depending upon which is lost. In so far as the genes on the autosomes are concerned, the fly will be identical on both sides of its body.

This gynandromorphic condition may theoretically result from a complete loss of one X chromosome from a somatic cell, with the result that all the cells that arise from this cell or from its descendants will lack one X chromosome and will be XO, whereas the remainder of the body will be XX. Such a loss could result from an abnormal mitosis in which probably one of the X chromosomes failed to be included in a daughter nucleus and became embedded in the cytoplasm, where it degenerated. On

the other hand, this condition could also result from a nondisjunction of an X chromosome resulting in some XO cells and other cells which would be XXX. In such a gynander part of the body would be male and the remainder would be superfemale. The actual chromosomal situation has not been confirmed by visual observations of the chromosomes, and, as superfemale tissue is not easy to differentiate from normal female tissue, it may well be that at least some of the gynanders are XO in one part of their body and XXX in the other. It is possible also that gynanders may result not from the loss of a complete X chromosome but merely from a deletion (or inactivation) of the female-determining genes in one of the X chromosomes. In such gynanders, however, the male region would not show the loss of any sex-linked genes unless they happened to be in the deleted region.

In gynanders, the extent of the male tissue will depend upon the particular cell division at which the X chromosome was eliminated and, of course, upon cell lineage, which may be variable. If chromosome elimination occurred during the division of the zygote, half the body would be male and half female; but if it occurred during some subsequent division the amount of male tissue would be less. In all gynanders, however, it is probable that the individual started out as a female. These flies often cannot function as either sex because of the abnormal condition of their sex organs but some gynanders are fertile, having sex organs of one type only.

Habrobracon

Gynandromorphs have thrown some light on the determination of sex in the parasitic wasp, *Habrobracon juglandis*. The females in this species are diploid and the males are haploid, but inbreeding always produces diploid males which are highly sterile unless selection against them is very rigid. Sex appears to be determined largely by the presence of different alleles of the sex factor which is present as a series of multiple alleles, x_a , x_b , x_c , etc. The rules for the formulation of genetic symbols indicate that superscripts should be used for multiple alleles, in which case the symbols here should be x^a , x^b , x^c , etc. However, the other symbols have been used for a number of years by the workers with *Habrobracon* and will be used here.

Females are always heterozygous for two of the series of multiple alleles and may therefore be xa / xb , xa / xc or some other combination of two of the series. Males are normally haploid and therefore have only one of the alleles, but some males are diploid and are homozygous for any one of the series. Normal males might be either xa or xb . If an xa male mated with the xa / xb female, the offspring would be xa / xb females, xa males, xb males, and xa / xa diploid males. If the male used in the cross was an xb individual, the offspring from the same female would be xa / xb females, xa males, xb males, and xb / xb diploid males. The xa and xb haploid males are indistinguishable phenotypically. Since femaleness is determined only when xa and xb sex alleles (or some other combination) interact, this appears to be a case of complementary genes. Although the stock that was just described contained only the xa and xb genes, another stock might contain only xc and xd . In this stock, females would be xc / xd and haploid males xc or xd , but diploid males would be produced by crosses within the stock and would be xc / xc or xd / xd . If the two stocks are crossed together, no diploid males are produced. For example, an xa / xb female mated with an xc male would produce xa / xc and xb / xc females and xa and xb males, but no males with two sex genes or with the gene xc . In *Habrobracon* all heterozygotes are female whereas all homozygotes and all haploids are males.

A sex-linked gene, *fused*, has been studied extensively and appears to be linked with the x genes with 10 per cent crossing over (Fig. 143). If an orange-eyed, *oo*, female heterozygous for *fused*, $Fufu$, is mated to a black-eyed, *O*, *fused* haploid male, the diploid males and females will be black-eyed and the haploid males will be orange. In this way, the two chromosomal types of males can be distinguished. If the cross is between members of the same stock, as $xb Fu / xa fu \times xa fu$, the diploid offspring will segregate into

9 nonfused females	$xb Fu / xa fu$	} crossovers
1 fused female	$xb fu / xa fu$	
1 nonfused male	$xa Fu / xa fu$	
9 fused males	$xa fu / xa fu$	

and the haploid males will be in the ratio of 1 nonfused (9 $xb Fu$ and 1 $xa Fu$) to 1 fused (9 $xa fu$ and 1 $xb fu$). If the original cross is $xb Fu / xa fu \times xb fu$, or $xa Fu / xb fu \times xa fu$ or xa

$Fu / xb fu \times xb fu$, a 9 : 1 : 1 : 9 ratio will also be found among the diploid wasps. These sex-linked ratios lend great support to the explanation based on complementary genes.

If the cross is an outcross (that is, if the male carries an allele not present in the female), the fu gene will still be linked with



FIG. 143. A fused female of *Habrobracon juglandis*. The short antennae, tarsi and palpi with segments fused together, and the indentation near the tip of the costal margin of the primary wing are characteristic of the fused mutant and segregate together as a single hereditary unit. (Courtesy, Dr. P. W. Whiting in the *Journal of Heredity*.)

the x alleles, but such linkage will be masked. In the cross $xa Fu / xb fu \times xc fu$, all the diploid offspring will be female and will segregate into

9 nonfused females	$xa Fu / xc fu$	
1 fused female	$xa fu / xc fu$	} crossovers
1 nonfused female	$xb Fu / xc fu$	
9 fused females	$xb fu / xc fu$	

Half the females will be wild type and half will be fused; therefore, there will be no evidence to indicate that the fused gene is sex linked. The same result would be obtained from the cross $xb Fu / xa fu \times xc fu$.

The first clue to the presence of complementary genes as sex determiners was afforded by the study of certain haploid males.

True gynanders appear occasionally in *Habrobracon* and consist of part diploid female and part haploid male tissue. In some eggs of this wasp, two haploid nuclei are present. If the female is homozygous for any recessive gene, each nucleus will have one of these genes. When such a binucleate egg is fertilized, the male nucleus unites with one of the two egg nuclei. If the male bears the dominant allele of these recessive genes, the diploid tissue which develops from the fertilized egg nucleus and will form the female part of the gynander will show the dominant character whereas the tissue which develops from the unfertilized egg nucleus will be phenotypically recessive. Such gynanders may have a head of one sex and an abdomen of the other, one side of one sex and the other side of the opposite sex, islands of male or female tissue in otherwise female or male regions, or other combinations of male and female regions. When the genitalia contain tissues of both types, there may be a full set of male structures and a half set of female structures.

Another type of gynander found in *Habrobracon*, although infrequently, has haploid male parts which have developed androgenetically. *Androgenesis* means haploid development from a sperm nucleus. Among fertilized eggs of this insect, about 1 per cent are fertilized by two sperm. If one of the sperm nuclei can develop without uniting with an egg nucleus, the tissue which arises from it will be haploid and therefore male, but will be androgenetic. Thus gynanders can be formed with some androgenetic tissue.

Resembling gynanders in some respects are certain haploid males called *gynandroid*. They develop from eggs which contain two functional haploid nuclei, but are not fertilized. They are mosaics of two types of tissue containing different sex alleles. They are entirely male in appearance except that certain small feminized structures are added to the male genitalia, usually on one side. The theory of complementary genes explains such situations admirably. If the female was xa / xb , one part of the body would be xa and the other xb , and both would be male. Where the two sections join, secretions from the xa region might diffuse into the xb region for a short distance, and in these regions of diffusion the complementary action of the two gene products would produce some female structures.

Parthenogenesis

In Chapter 4 we pointed out that upon some occasions eggs may develop into new individuals without ever having been fertilized. We stated there that this is a regular occurrence in such organisms as bees and wasps, but that it may be induced in many other animals and even in some vertebrates by some sudden change in environmental conditions. It is beyond our scope to describe examples of induced parthenogenesis, but the reader is referred to Morgan's *Experimental Embryology* and to other works in the fields of ontogeny and embryology.

Parthenogenesis may be either haploid or diploid. In haploid parthenogenesis meiosis occurs normally, and haploid eggs are produced which then proceed to develop without being fertilized. In diploid parthenogenesis the meiotic divisions are abnormal in some features, and the eggs which are formed and later develop without the assistance of any male cell have two genomes. Haploid parthenogenesis is a constant feature in the life cycle of the group known as the Hymenoptera, which includes the bees and wasps, and always results in male offspring. Diploid parthenogenesis is a regular feature of the life cycle of some animals. In some of the lower animals reproduction is almost solely by this method, with the result that males occur very rarely if at all; in other animals two or more generations of females are produced by this method, after which sexual forms are produced.

PLANTS

Sexual reproduction in the higher plants is complicated by the presence in the life cycle of two separate and distinct generations, as we mentioned in Chapter 4. Male and female gametes are present and arise respectively from male and female gametophyte plants. These in turn develop from the male and female spores, better known as the microspores and megaspores, and these spores form on the sporophyte plant on micro- and megasporophylls, which, in the angiosperms, are found in an organ known as the flower. The microsporophylls are the stamens and the megasporophylls are the carpels, and one or more carpels always forms an enclosed pistil. In most species of the flowering plants both stamens and pistils are present in the same flower. Such flowers are *perfect*, *bisexual*, or *hermaphrodite*. Flowers,

however, may lack either stamens or pistils, when they are *unisexual* or *imperfect*. If they bear only male structures, they are *staminate*; and if only female structures, they are *carpellate* or *pistillate*. Plants which bear both staminate and pistillate flowers are *monoecious*. In some of the flowering plants the sexes are in separate individuals as they are in animals. In these *dioecious* plants, some individuals will be male, bearing only staminate flowers, whereas other individuals will have only pistillate flowers and will be female. Intermediate conditions exist in which some of the flowers on a given plant will be perfect and others staminate or pistillate only. Such plants are *polygamous*. Like animals, plants in which both sexes are present may be considered hermaphroditic whether the flowers are perfect or whether the plant is monoecious. In this respect monoecious plants resemble hermaphroditic animals such as the earthworm in which sperms and eggs are produced within the same animal but in different organs.

The relationship between the various stages of the life cycles of animals and plants is interesting to consider and has been well stated by G. H. Shull. If we start with the zygote in animals, we find that it develops by numerous mitoses into the diploid animal body or soma. In the higher plants or Embryophyta, the zygote also develops into a diploid body, the sporophyte. In animals, meiosis takes place from certain cells in the animal body, resulting in spermatids in the male and oötidis in the female, whereas the similar products of meiosis in the sporophyte of the higher plants are called, respectively, microspores and megaspores. In some of the lowest plants, such as the Chlorophyceae or green algae, the zygote fails to develop into a mass of sporophyte tissue but remains in a resting condition for a while and then divides directly by meiosis to produce spores. In the embryophytes, the microspores and megaspores divide and their products undergo a number of mitotic divisions to produce masses of tissue called, respectively, the microgametophytes and megagametophytes; similar divisions of the spores in the Chlorophyceae produce multicellular gametophytes which are not differentiated with respect to sex. The microgametophytes and megagametophytes then produce, respectively, the sperm and the eggs, and the gametophytes of the green algae produce both male and female gametes. In animals, however, the gameto-

phyte stage does not appear, for the spermatids usually develop directly into the spermatozoa and the oötid become the eggs. Fertilization then reconstitutes the zygote in each organism. These relationships are shown diagrammatically in Fig. 144.

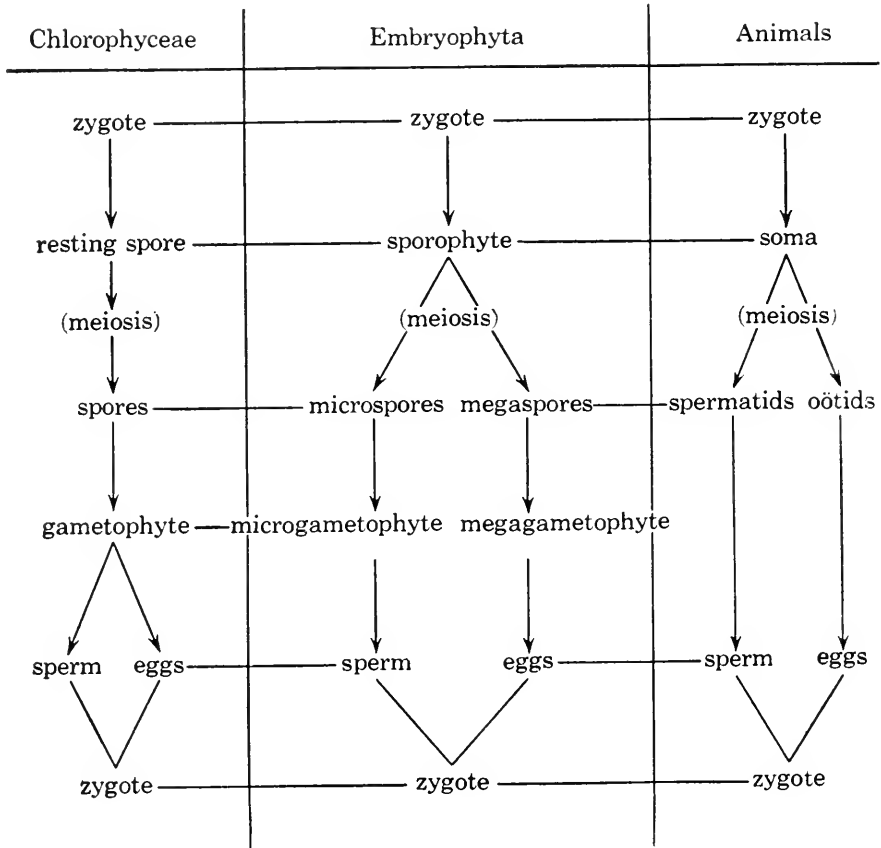

FIG. 144. Diagrams of life cycles of the Chlorophyceae, Embryophyta, and animals. In the Embryophyta the zygote develops into a multicellular structure, the sporophyte; in animals, this multicellular structure is the soma or body; in the green algae (Chlorophyceae) such a multicellular structure does not develop but the zygote becomes merely a resting spore. The products of meiosis in the Chlorophyceae and Embryophyta develop into a multicellular structure, the gametophyte, part of which subsequently produces the gametes by mitosis. In animals, the immediate products of meiosis (spermatids and oötid) do not divide into a multicellular structure but merely differentiate into the sperm and eggs.

Sex Chromosomes

Plants which might be thought most likely to resemble animals in their sexual behavior are the dioecious type since in these plants each diploid individual is either a male or a female and

does not contain the organs of both sexes. Because of the separation of the sexes in this type, it might be thought that it would be in this type that plants might be found which have sex chromosomes that operate like the XY or the ZW mechanism in the Animal Kingdom. A study of the chromosomes in many dioecious species has shown that sex chromosomes certainly are to be found in many of these forms but that dioecism is not necessarily determined by sex chromosomes that are distinguishable in their morphology. In a very extensive review of sex expression in the flowering plants, Allen has listed fifty-five species and two varieties of angiosperms in which the female is definitely XX and the male XY. This simple "Drosophila type" of mechanism is not the only sex chromosome mechanism that is operating in the dioecious angiosperms. In *Dioscorea sinuata* we find another familiar type in which the female is XX and the male XO, whereas in *Fragaria elatior* the female is the heterozygous sex and is ZW and the male is ZZ.

In some species we find sex chromosomal types that we do not encounter in animals. In *Humulus japonicus* and in eight species and two varieties of the dock *Rumex*, the female is XX and the male has one X chromosome but two Y's, designated Y_1 and Y_2 . The mechanism in *Humulus Lupulus* and in a variety of these species is much more complicated for, in addition to the two sets of autosomes, the female has two pairs of X chromosomes, designated X_1 and X_2 , and the male has one member of each of these pairs plus two nonhomologous Y chromosomes, designated Y_1 and Y_2 . Thus the complete formula for the female would be $2A + 2X_1 + 2X_2$ and for the male, $2A + X_1 + X_2 + Y_1 + Y_2$. Almost the same formula could be assigned to *Atriplex hymenelytra*, which differs only in the presence of but one Y chromosome in the male. The most unusual sex chromosome mechanism is found in *Phoradendron flavescens* var. *macrophyllum* and in *Ph. villosum*. In these plants the female has two sets of autosomes but no sex chromosomes and the male has the two sets of autosomes and a Y chromosome. At the first meiotic division this chromosome is unpaired and passes as a univalent to one pole. The female has twenty chromosomes and the male twenty-one.

In his tabulation of dioecious species, Allen has listed forty-six reported as having no chromosomes which can be identified as

sex chromosomes. In other words, there is no visibly heteromorphic pair of chromosomes in either sex. It does not necessarily mean that there are no chromosomes in these plants that have an important effect on sex determination but merely that any difference that does occur between the chromosomes of the two sexes is not evident from the morphology of the chromosomes. There may be sex chromosomes that are different from one another physiologically even though not morphologically.

In plants that have the XY mechanism one might easily suppose that the X chromosome might contain female-tendency genes and the autosomes male-tendency genes as in *Drosophila melanogaster*. As in the fruit fly, evidence on this point might easily be tested if heteroploid types could be produced similar to Bridges's series of intersexes and supersexes. In fact, the greater readiness with which heteroploid types are found in plants would indicate that such studies would be even more promising in them than in *Drosophila*. Studies of this nature were carried out in *Rumex acetosa* by Ono and by Yamamoto, who found that as in *Drosophila* female-tendency genes are in the X chromosome and male-tendency genes in the autosomes. A slight difference from *Drosophila* was pointed out by Yamamoto, who obtained good evidence that two of the autosomes tended to produce femaleness even though the tendency of the autosomes as a whole was to maleness.

Very interesting results have been obtained in species of *Lychnis* (*Melandrium*) by Warmke and Blakeslee and independently by Westergaard. In dioecious species of this genus the male is heterogametic. Since the ratio of X chromosomes to autosomes is of the greatest importance in *Drosophila melanogaster*, naturally it was examined in the diploids and the synthesized polyploids of *Lychnis*. Plants with a ratio of one X chromosome to one set of autosomes result from the genotypes $2A + XX$, $3A + XXX$, and $4A + XXXX$ and are female as in *Drosophila*. Two types with ratios of 1.25 ($4A + XXXX$) and 1.5 ($2A + XXX$) are also female. The 1.5 type is a superfemale in *Drosophila*. One type with a ratio of 0.75 ($4A + XXX$) and one with a ratio of 0.67 ($3A + XX$) are females although they are intersexes in *Drosophila*. Finally, plants with four sets of autosomes and two X chromosomes and, therefore, a ratio of 0.5 are female, although flies with a similar ratio are males. Since all these

types are females, apparently the ratio of X chromosomes to autosomes is not definitive.

Since all plants lacking a Y chromosome are female, the possibility must be considered that simply the presence or absence of the Y chromosome determines whether a plant is male or female. A number of $2n$, $3n$, and $4n$ plants were examined which

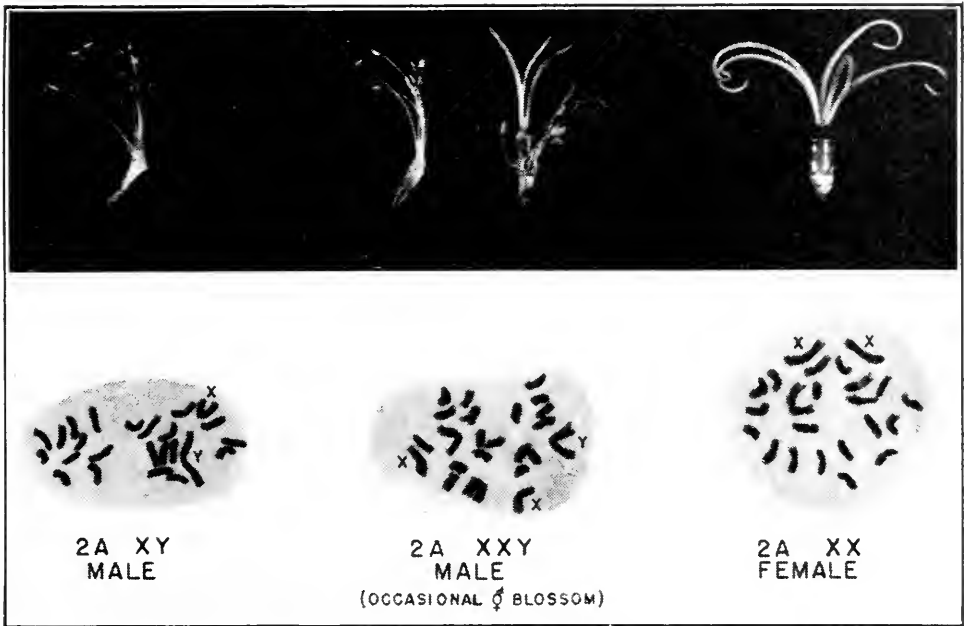

FIG. 145. Dissected flowers of *Lychnis (Melandrium) dioica*. Male, $2A XY$ (left), female, $2A XX$ (right), and male hermaphrodite, $2A XXY$ (center); beneath the flowers are photomicrographs of root-tip chromosomes of each type. (Courtesy of Dr. H. E. Warmke in the *American Journal of Botany*.)

had one to four X chromosomes and one or two Y chromosomes. Some were male, some were male with occasionally hermaphrodite flowers, and some were hermaphrodites with occasional male flowers (Fig. 145). That flowers can be produced with functional female organs in plants with one or two Y chromosomes shows that the presence of a Y chromosome is not the deciding factor.

The ratio of the X chromosome to the Y chromosome appears to be a much more satisfactory explanation (Table 26). Plants without an X chromosome are apparently not viable, for no $2A + YY$ individuals were found when male-hermaphrodites

were selfed even though a certain percentage would be expected among the male offspring. Plants in which the ratio is 0.5, 1.0, and 1.5 are male, but when the ratio is 2.0 or 3.0 the plants are males but have a few hermaphrodite flowers. When the ratio is 4.0, the plants are hermaphrodites with occasional male flowers.

TABLE 26

RATIO OF X CHROMOSOMES TO Y CHROMOSOMES IN DIPLOIDS AND POLYPLOIDS OF *LYCHNIS* (*MELANDRIUM*) AND ITS BEARING ON SEX

(Modified from Warmke in the *American Journal of Botany*.)

X/Y ratio	Sets of Autosomes	Sex Chromosomes	Sex
0.5	2A	XYY	male
1.0	{ 2A	XY	
	{ 3A	XY	
	{ 4A	XY	
1.5	{ 4A	XXYY	
	{ 4A	XXXYY	
2.0	{ 2A	XXY	male with occasional hermaphrodite flowers
	{ 3A	XXY	
	{ 4A	XXY	
	{ 4A	XXXXYY	
3.0	{ 3A	XXXYY	
	{ 4A	XXXYY	
4.0	4A	XXXXYY	hermaphrodite with occasional male flowers

When only X chromosomes are present, the plants are females.

The results of these different ratios indicate that the Y chromosome produces a male tendency and the X chromosome a female tendency. Since plants with a ratio of 1.0 and 1.5 are male, the male tendency in the Y chromosome must be stronger than the female tendency in the X chromosome. When there are two or three times as many X chromosomes as Y chromosomes, femaleness can be expressed when the internal and external environmental conditions are favorable. In such plants, less than 10 per cent of the flowers have female parts, and in less than 1

per cent the female parts possess ovules capable of developing into seeds. When there are four times as many X chromosomes, nearly all the flowers have well-developed pistils, setting abundant seeds. Warmke has pointed out that the X/Y balance is in the nature of a threshold reaction. Even though there is an increase in the relative number of X chromosomes in the ratios from 0.5 to 1.5, there is no increase in the degree of femaleness. Ratios of 2.0 and 3.0 are sufficiently high for femaleness to be expressed provided conditions are suitable, but when the ratio is 4.0 almost every flower contains functional female organs. The change from 3.0 to 4.0 apparently crosses the threshold so that one additional X chromosome results in an almost complete change from maleness to hermaphroditism. Increases beyond 4.0 in the ratio in plants containing at least one Y chromosome have not yet been obtained.

Although plants with the formula XXY are frequently male with a few hermaphrodite flowers, a type exists in which the XXY plants have stronger female tendencies. When this was selfed, XX and XY types were recovered which produced a ratio of 1 female : 1 male-hermaphrodite when crossed. The male-tendency genes in the Y chromosome are at least three, as can be shown by including in $2A + XX$ plants fragments of the Y chromosome whose lengths vary in different individuals. If the Y is completely absent, the plant is a female; but if parts of the Y are present, male structures will be found which usually do not attain complete development. Of the three genes, one appears to be near the centromere, and is necessary if male structures are to be initiated, one carries male development to completion, and one suppresses femaleness.

Monoecious and Hermaphroditic Plants

In a number of species some flowers are male and others female on the same plant, and in some species each type of flower is produced at only one particular part of the plant. In many of the higher plants, however, the stamens and the pistils are produced near each other in different regions of the same bisexual flower.

Monoecious and hermaphroditic plants do not appear to have any morphologically recognizable sex chromosomes, but they undoubtedly possess both male and female tendencies even

though the expression of one or the other tendency seems to prevail in certain cells and regions. Here sex is largely a developmental problem. As a perfect flower develops, certain cells become anthers and contain microspores whereas others become carpels and contain megaspores. Which type of spore is produced in a given region is apparently determined chiefly by the position of that region relative to the remainder of the flower. This pattern of development of the various parts of the flower is under the control of genes which are not to be considered as male- or female-determining. In monoecious plants with imperfect flowers such as maize the position of the region relative to the rest of the plant is apparently the chief determining factor, and it, too, is a matter of the ontogeny of the plant. Thus, as the terminal inflorescence is initiated, microspores become developed in it, whereas the lateral inflorescences generally contain only megaspores. In other words, in hermaphroditic plants the presence of a particular type of sex organ in a certain region of the plant is largely a problem of development in an organism in which both potentialities are present and in which sex is largely determined by the ontogenetic pattern. Even as a particular region develops, occasional deviations in the usual ontogenetic pattern may result in the development of organs of the opposite sex from that which normally is produced at a given point. Ears of maize are frequently terminated by a male spike, and female flowers and occasionally small ears may be found in tassels. Figure 146 illustrates a perfect small ear which has been produced in a tassel that also contains a number of male flowers. This ear illustrates the possibilities of the development of organs of the opposite sex in a definite region of a monoecious plant. Seeds are often produced in a maize tassel when the plants are grown during a shortened day.

Some interesting changes in the sexual condition of certain plants have been brought about experimentally by changes in the environment or by the manipulation of the genotype. Hemp is a dioecious plant whose sex expression has been studied rather intensively. In a long series of experiments Schaffner showed that length of day and other environmental factors could modify the sexual expression to the extent of producing some flowers of one sex on plants of the opposite sex. Similar modifications of sex expression in hemp by changes in length of day were obtained

by McPhee. As he has pointed out, such changes, of course, do not change the genotype. They merely indicate that a given genotype may have a somewhat different expressivity under different sets of environmental conditions in the same way that other genes may produce different phenotypes in different environments.

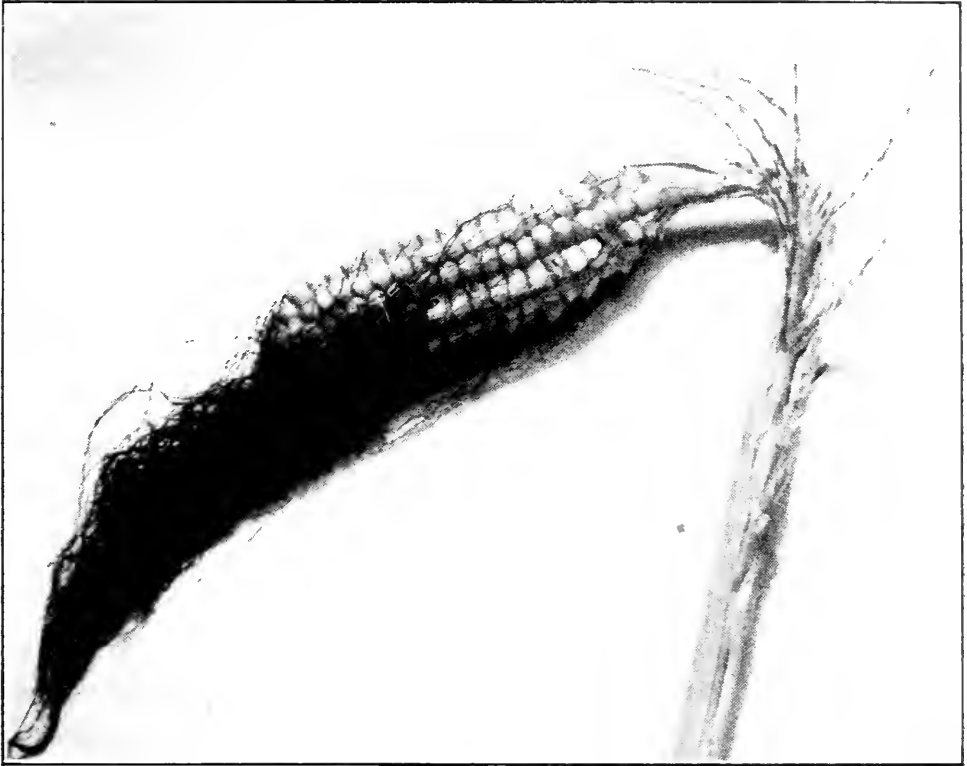

FIG. 146. Tassel of maize with a small, well-formed ear. Most of the male flowers in the tassel are sterile but a few are well developed. (Photograph by Dr. W. Brooks Hamilton.)

Any gene that affects the sexual processes, the sex organs, or the gametes themselves may be regarded as a sex gene. A number of such genes have been identified in maize. Some of them produce complete or partial male or female sterility or both. It may be accomplished by upsetting meiosis or otherwise directly affecting the spores or gametophytes, but it may also be brought about by affecting the organs in which the sporocytes are produced. Thus a gene that prevented the development of anthers might not be thought of as a "sex gene" but would be merely another gene that causes some abnormality in growth in the

somatic tissue of the plant. Since, however, male gametophytes and gametes arise only in anthers, this abnormality would eliminate the male reproductive phase of that monoecious plant and would convert it into a female. In fact, by combining such genes in a certain way, Jones has established a dioecious strain of maize.

There is a recessive gene on the second chromosome in maize known as silkless, *sk*, which, when homozygous, causes an abortion of the ovaries. The lateral inflorescences are otherwise normal, but the spike is entirely barren. The elimination of functioning female flowers makes *sksk* plants effectively male. Furthermore, there are several recessive genes which affect the tassel in such a way that in homozygotes the staminate flowers are replaced with pistillate ones. They are the *tassel seed*, *ts*, genes, and plants homozygous for any of them are effectively female plants. It so happens that tassel seed-2, one of these genes, is epistatic to silkless. Plants which possess both *Sk* and *Ts₂* are normal; those that are *sksk Ts₂Ts₂* or *sksk Ts₂ts₂* are male plants, since they are silkless; and plants that have one or two *Sk* genes and are also *ts₂ts₂* are female, since they have the stamens absent from the tassel. However, *sksk ts₂ts₂* plants are not completely sterile but are functional females because the homozygous silkless condition is not expressed when the plant is homozygous for *ts₂*.

If an *SkSk Ts₂ts₂* plant was selfed, the offspring would segregate into a ratio of 9 normal monoecious (*Sk Ts₂*) : 3 silkless male (*sk Ts₂*) : 4 tassel seed female (3 *Sk ts₂* + 1 *sk ts₂*). This epistatic relationship makes it possible to maintain a dioecious strain in which half the plants are female and half are male, provided the original female is *sksk ts₂ts₂* and the male is *sksk Ts₂ts₂*. If no outcrosses are made, this strain can be maintained perpetually in the dioecious condition, and it has been kept so for a number of generations by Jones, who created it. Since all plants in the strain are *sksk*, the sex is "determined" by *Ts₂* or *ts₂*. The *ts₂* locus is the differential that throws the balance towards the male or the female side. In a sense, then, the chromosome that carries this gene has become a sex chromosome, and the male is the heterogametic sex. By a proper selection of other genes that suppress or stimulate the male or female structures, other dioecious strains could be developed.

With certain gene combinations other chromosomes might become the sex differential and therefore the "sex chromosome," and in some particular gene combinations the female might become the heterogametic sex. Emerson has developed two dioecious strains; in one the male and in the other the female is the heterogametic sex. Although there is no assurance that dioecious species arose in this manner throughout the course of evolution, it is quite conceivable that they may have. It would also indicate why certain organisms happen to be of the XY type whereas others are of the ZW type. Jones has found¹ that all his families of the dioecious strain produce some individuals with intersexual tendencies; tassel seed plants may possess an occasional functional anther and silkless individuals may have a rare functional female flower. The various families differ with respect to the number and character of these intergrades and respond to selection. It is very probable that these factors which are known to be hereditary are of the nature of modifying genes.

Apomixis

As we pointed out in Chapter 4, all reproduction is not by seeds, nor does it involve sexual reproduction. Asexual reproduction that does not involve nuclear or cellular fusion and has arisen as a substitute for sexual reproduction has been called *apomixis*. The two main types may be classified, following Fagerlind and Stebbins, as vegetative apomixis and agamospermy, or apomixis through seed production. The first type does not include all vegetative reproduction but only those types that arise as substitutes for sexual reproduction. Various structures such as vegetative buds, bulblets, or proliferations would be included if they arose in place of flowers or flower clusters. Agamospermy is of three types. In one form, meiosis is normal, and a haploid egg is produced from which develops a haploid sporophyte. It most nearly resembles the situation we have mentioned in animals. In another type the nucellus or inner integument of the ovary proliferates and forms a new sporophyte. Since the nucellus and integument are part of the parental sporophyte, this type is a direct formation of a new sporophyte from the somatic tissues of the old. This type differs from vegetative apomixis in that it involves a structure connected with the seed and sometimes is dependent upon, although not utilizing directly, fertiliza-

tion, endosperm formation, or both, and in that it produces a new individual with the characteristics of a seedling whereas the individual arising by vegetative apomixis has the characteristics of an adult. In the third type a diploid gametophyte gives rise to a diploid sporophyte. In this type there is a regular alternation of generations, but, although the two generations differ morphologically, they do not differ with respect to their chromosome number. There are several methods by which this development of the two generations occurs which naturally does not involve either a normal meiosis or fertilization. Plants that arise by apomixis are usually very similar phenotypically, but occasionally show genetic variation.

QUESTIONS AND PROBLEMS

1. In some dioecious plants, occasional bisexual flowers are formed. If a bisexual flower on a normally female plant whose sex chromosomes are XX is self-fertilized, what would be the sex of the offspring?

2. In what fundamental ways do the balance theories of Bridges, Goldschmidt, and Correns agree and in what ways do they differ?

3. If no polyploid types of *Drosophila melanogaster* had ever arisen, what evidence would there be that sex was determined by the X chromosomes rather than by the Y chromosome?

4. In *Lychnis* (*Melandrium*) gene *B* determines broad leaves and *b* narrow leaves. These genes are on the X chromosome. All pollen with the *b* gene is lethal. What offspring would be expected from the following crosses?

$$XB / XB \times Xb / Y$$

$$XB / Xb \times Xb / Y$$

$$XB / Xb \times XB / Y$$

5. In *Silene otites*, the male appears to be heterogametic. In a colchicine-induced tetraploid, the female is XXXX and the male XXYY. If these are crossed, what should be the ratio of males to females if any tetraploid with a Y chromosome is a male?

6. If the female in problem 5 were the heterogametic sex, what would be the ratio in the offspring if two Y chromosomes are necessary to make a female? If a cross between two tetraploids produced a ratio of 5 males : 1 female, which theory would be correct, that the male is heterogametic as in problem 5 or that the female is the heterogametic sex? Explain.

7. If the tetraploid female in problem 5 is $XXXX$ and is crossed with a normal XY diploid male, what should be the ratio of the sexes of the triploid offspring? If the tetraploid female is $ZZWW$ as in problem 6, and it is crossed with a normal ZZ diploid male, what should be the sex ratio in the triploids. Would such tetraploid \times diploid crosses throw any light upon the question of the heterogametic sex?

8. Is heteropycnosis confined to sex chromosomes or to the higher plants?

9. What would be the offspring of the following crosses in Jones's maize:

$$Sksk \ Ts_2ts_2 \times sksk \ ts_2ts_2$$

$$Sksk \ ts_2ts_2 \times Sksk \ ts_2ts_2$$

$$Sksk \ Ts_2ts_2 \times sksk \ Ts_2ts_2$$

Chapter 30

CYTOGENETICS AND EVOLUTION

Species

The concept of a species has undergone numerous changes from the time it was believed that each species was a specially created entity until the present, when the frequent discoveries of numerous hybrids and intergrading forms keep reminding us that species change and that throughout the course of evolution various species have appeared and disappeared. To define a species according to our present factual information is by no means a simple problem, and many different definitions have been offered by various biologists from time to time.

One of the more satisfactory definitions is A. E. Emerson's. He defines a species as "a genetically distinctive, reproductively isolated, natural population." He elaborates this by saying, "The genetic distinction may be morphological, physiological, or behavioristic. The isolation, whatever the mechanism, effectively prevents interbreeding with other populations. The population concept emphasizes the interplay of biological factors between the individuals."

Unfortunately, however, most of the species that we know were established on the basis of one or several preserved specimens in a museum and have not been studied or recognized with any relationship to barriers, either biological or geographical.

Although we may regard a species as a biological unit consisting of a large number of plants or animals, we must understand that the individuals comprising it are not homozygous or even genetically identical. Since various members may be heterozygous for several genes and since the self-fertilization or crossing of various individuals may produce types that are phenotypically different from the parents, species show variation which differs in extent from species to species. Often certain genotypes may become more prevalent in certain geographic localities of the habitat of the species whereas other genotypes may become more

abundant in other localities. Thus different strains or subspecies may segregate out which can be identified from their external appearance but are not so different from one another as to warrant their being classed as separate species. The individuals that comprise a subspecies may differ somewhat from one another but may resemble one another more than they resemble those that make up another subspecies. The various subspecies also differ from one another, but the individuals of any subspecies resemble those of another subspecies of the same species more closely than they resemble individuals of another species. Individuals of one subspecies may frequently cross with those of another if the opportunity presents itself, and in a number of genera we have found that members of one species can cross with those of another. One of the important phases of the species problem is the mechanisms which normally prevent two subspecies or two species from crossing but occasionally can break down so as to permit the production of intraspecific or of interspecific hybrids.

Hybrids

A cross between two plants or animals of different types is known as a hybrid, but as the term has been used in several different senses, we might well ask whether any inherited difference is sufficient for the application of the term or whether the differences between the two parents must be of a certain order of magnitude.

Originally a hybrid was considered to be the offspring of two different species, genera, or at least races, forms, or subspecies, but with the publication of Mendel's classic paper on genetics a new significance was given the term. Mendel crossed peas which differed by only one, two, or a few genes and yet he applied the term "hybrid" to the offspring of such crosses. This use of the term for crosses between individuals of the same subspecies, form, or race was new. Today such heterozygous individuals are often referred to as *mendelian hybrids* or *gene hybrids*. Applying this same principle not to differences in individual genes but to differences in genomes, Darlington and others have used the term hybrid for any zygote which arises as the result of a union of two gametes dissimilar in any respect whatsoever or for a zygote or product of a zygote which produces gametes dissimilar

in some respect. Hybrids according to this usage might be mendelian or chromosomal, depending upon whether the gametes differed merely in gene loci or in some unit larger than a gene locus. Chromosomal hybrids would be of several different kinds.

The classification of plants that are not strictly true-breeding into the categories of "hybrids" which we have just mentioned ignores completely the taxonomic position of the parents. It also has the drawback sometimes of classifying one plant as a hybrid and another that is identical as not a hybrid. For example, if one gene is completely dominant over its allele, the heterozygote or hybrid will be indistinguishable phenotypically from the homozygous dominant which is not a hybrid. Also some structural hybrids might exhibit evidences that they are heterozygous for inversions or translocations but might be indistinguishable phenotypically from the types that were homozygous for the inverted segment and homozygous for the noninverted chromosome. If these two cytological types did not differ as to any alleles, and if the inversion was not accompanied by a position effect, the fact that the two gametes that formed the "hybrid" zygote were different could not be detected except by cytological examination. It is perhaps unfortunate that the term hybrid has been used in several different senses, but the fact is that it has.

Isolating Mechanisms

If two species can cross if given the opportunity and if F_1 offspring can be produced which are fertile, these offspring should be able to produce further offspring either by self-fertilization, by crossing with one another, or by backcrossing to the parents. Furthermore, these F_2 and backcross offspring would also probably be fertile, in which case they could also produce a new generation by the same methods. If the two original species were separated by geographical barriers which had become broken down so that the two species could come close enough to cross, such an array of F_1 , backcross, and subsequent generations would be produced in a small area after several breeding generations. If the organism was one whose life span exceeded several reproductive periods, individuals (or clones) of all these generations would be present at once. Such a heterogeneous mixture of types would be a *hybrid swarm*.

Barriers or *isolating mechanisms* that tend to keep species and to a lesser extent subspecies from intercrossing and producing hybrids and perhaps also hybrid swarms, occasionally break down and permit one species to cross with another. Let us examine some of the barriers that appear to separate the various species of a genus into natural populations relatively isolated from one another.

Geographical Isolation. One of the more obvious isolation mechanisms is *geographic isolation*. This type of barrier serves to prevent two species from interbreeding by keeping them apart in space. If two animals cannot come close together they cannot mate, and if two plants are not near enough for the pollen to be transferred from one to the other by wind or by insects they cannot produce offspring. If the two animals or plants represent different species, any factor that will prevent them from coming sufficiently close to one another during periods of reproduction to be within what might be called the *effective crossbreeding distance* will prevent the origin of hybrids. Such geographical barriers might be linear distance but might also be some other factor, such as mountains or rivers; and a factor that might constitute a barrier for the species of one genus might not operate as such between the species of another genus. Geographical isolation alone would not bring about the origin of new species, but it can set the stage for other necessary conditions such as the accumulation of different mutations in different localities.

If geographical barriers are the only isolating mechanism, the two isolated and differentiated species will cross and produce fertile hybrids and hybrid swarms once that barrier is removed.

Ecological Isolation. Of all the isolating mechanisms, the geographical one alone is a purely environmental mechanism. All the other types reflect at least some internal condition in the organisms. One of these barriers that depend upon something intrinsic in the organism is ecological isolation.

Ecological isolation operates in the same manner as geographical isolation. The two species are isolated in space and, as a result, are not crossed. The differences are that ecological isolation operates effectively over a much smaller area and the fundamental causes of the separation are different. For example, *Tradescantia canaliculata* grows in full sunlight at the tops of cliffs, and *T. subaspera* var. *typica* in the shade at the bottom.

Where erosion has broken the face of the cliff the two species can come together and produce hybrids (Fig. 147).

The Louisiana irises also illustrate ecological isolation and hybrid swarms. About twenty years ago a great assortment of different types was discovered, and the question was raised concerning their possible hybrid origin. In an ecological study Viosca showed that *Iris fulva*, a species with a coppery red-colored

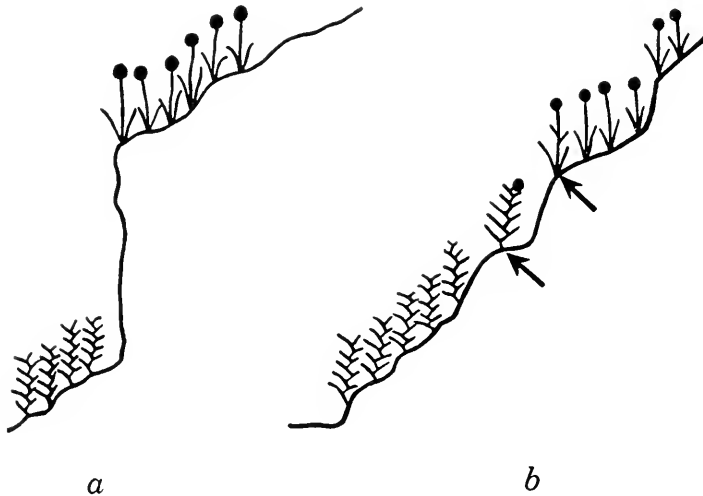

FIG. 147. An ecological barrier in *Tradescantia*. (a) A cliff with *T. canaliculata* growing above and *T. subaspera* var. *typica* below. (b) Hybrids (indicated by arrows) between these two species growing in a ravine where the surface of the cliff is worn away sufficiently that the species can come into close contact and hybridize. (Redrawn from Anderson and Hubricht in the *American Journal of Botany*.)

flower and a flower stalk 25 to 45 inches tall, was found in the clayey soils on the banks of deltaic streams and on the flat lands on the far sides of these deltaic ridges. It follows deltaic formations almost to sea level and therefore is often found in woods. *I. hexagona* var. *giganticaerulea* has columbine blue flowers with sepals 50 per cent larger than those of the other species. The flower stalks are normally 40 to 60 inches tall, but are sometimes even longer. This species is found only in low lands in rich, mucky clay with a high water content bordering a marsh. In many places the two species are not far apart, and the actual difference in elevation may be only 2 or 3 feet. However, the regions are ecologically so different that the two species can come together only if an intermediate habitat is present. Such a habi-

tat can be found if a swamp drainage bayou (which is never of deltaic origin) cuts across one of the long-established deltaic ridges. It is in an intermediate situation thus formed that almost all the large mass of hybrid types is found (Fig. 148).

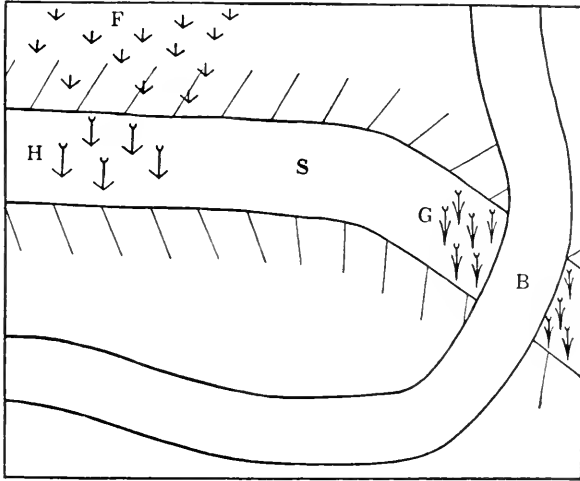

FIG. 148. A map of *Iris* colonies illustrating an ecological barrier. At *F* is a group of clones of *Iris fulva* growing on the bank of the alluvial ridge of a former deltaic stream, *S*, now filled in. A new bayou, *B*, has cut across the old stream bed and at their intersection a marsh has formed in which are growing clones of *I. hexagona* var. *giganticaerulea*, *G*. Normally, the two species do not come close enough together to hybridize. However, in a region such as this one, if man disturbs the land of the old deltaic stream as at *H*, hybrids may be found. The pasturing of cattle appears to aid in eliminating the barrier by fertilizing the soil, thinning out the competitors of *Iris*, and keeping the soil well cultivated. Plants or seeds of *giganticaerulea* washed up the old stream bed from *G* might successfully become established at *H*, where they would meet plants of *I. fulva* and form a hybrid swarm. (Redrawn from Riley in the *American Journal of Botany*.)

Seasonal Isolation. An intrinsic isolating mechanism that produces the same result as ecological isolation but operates through a time factor rather than through a space factor is seasonal isolation. If two species inhabit the same geographical and ecological regions but if each one is reproductively active at a time when the reproductive processes of the other are dormant, they might as well be thousands of miles apart for they cannot come together to produce hybrids. A number of species are separated by this type of barrier.

Mechanical and Psychological Isolation. Ecological and seasonal isolations are mechanisms that prevent two species from producing hybrids by keeping them apart either in space or in time as the result of forces partly within the species. There are two types of isolation mechanisms that keep two species from mating, even though they are close enough to one another to mate and even though they are both capable of reproduction at the same time. One of these is *mechanical* isolation.

It has been found that in some families of animals considerable differences are present in the external genital organs in different species. These differences are so marked in some forms that they have been used by taxonomists in distinguishing different species in some insects, in spiders, in mollusks, and in some fish and mammals. Because of these differences, the theory has been advanced upon a number of occasions that in forms with such complicated genital organs only the male and female of the same species are able to mate. There is only a slight amount of evidence to support this theory, and there are numerous observations of successful mating between species that are not closely related. More factual data are needed to clarify this point, but it appears to be the view of Dobzhansky, Kinsey, and other zoologists that the importance of this type of isolating mechanism has been greatly exaggerated.

Another mechanism that prevents mating even though the species are not separated in either time or space has been called *psychological isolation* or *sexual isolation*. In this type of isolation there are no morphological differences in the sex organs, but there are differences in the patterns of behavior that precede mating.

Some interesting examples have been pointed out by Dice for mice of the genus *Peromyscus*. In Glacier National Park, Montana, *Peromyscus maniculatus artemisiae*, a subspecies that inhabits the forests and *P. m. osgoodi*, a grassland subspecies, are found together but do not interbreed. Ecological isolation accounts for some of the failure of interbreeding, but will not account for all of it. In a number of places where the two habitats meet, both subspecies live together but do not interbreed. This failure of mating appears to result from psychological differences between the two subspecies. A similar failure to interbreed has been found in regions of the Dismal Swamp of Virginia, in north-

ern Alabama, and in the lower Mississippi Valley, where *Peromyscus leucopus* and *P. gossypinus* are found in the same region and in the same habitats and where there is no evidence of their mating except for two presumed hybrids found in Alabama. Dice has assumed that these two species were once separated geographically and that while they were separated they diverged psychologically to such an extent that they do not mate even when they are found in the same region.

Numerous other examples of isolation of species because of mating preferences upon the part of the individuals of the two species may be cited from fish, moths, spiders, snails, birds, and *Drosophila*, but the result is always the same—a failure of mating between individuals that may otherwise be fertile together.

Gamete Incompatibility Isolation. Two species may occupy the same region and habitat, may be sexually active at the same time, and may be separated by no mechanical or psychological barrier, but yet may not produce a new generation of sexually reproducing offspring. Even though they may mate, some other barrier may be present that prevents the establishment of hybrid swarms. One is the failure of fertilization after mating because the sperm never reaches the egg.

Gene-Cytoplasm Isolation. In the last class of isolation mechanisms, the sperm never reached the egg. In some inter-family crosses, however, as between echinoderms and annelids or mollusks, the sperm penetrates the egg only to be later thrown out or dissolved. The cause is an antagonism between the sperm nucleus and the cytoplasm of the egg and acts as an isolating mechanism by preventing the formation of species hybrids.

Hybrid Lethality Isolation. In this class of isolating mechanisms, the sperm enters the egg, the sperm and egg nuclei unite, and the embryo proceeds to develop. The embryo, however, does not usually develop very far, although in some organisms it may develop into an adult which dies before it reaches sexual maturity. Among animals this type of isolation has been reported in fish, beetles, and moths. The cause apparently is a general disharmony between the genes of the two parents, producing an animal that is structurally so abnormal that it cannot function properly and dies.

In some species crosses in plants the same phenomena are observed. The hybrid forms and dies at a very early stage. It may

result from a disharmony within the embryo itself such that the embryo is incapable of developing sufficiently normally to live. On the other hand, it may sometimes result from a disharmony between the developing embryo and some other structure in the seed, such as the seed coat or the endosperm. If the disharmony is within the embryo, apparently nothing can be done about it. Otherwise, the embryo may be removed from the seed, cultured *in vitro*, and thus raised to maturity. Although it cannot occur in nature, it is an interesting method of producing hybrids artificially in a few plants.

Hybrid Sterility Isolation. Another type of isolating mechanism results in the formation of sexually mature hybrids between the two parental species, but hybrids which are sterile. Such sterility is often the result of failure of the chromosomes to pair and to segregate normally at meiosis. It does not prevent the formation of hybrids but of hybrid swarms.

Combined Isolation. Although we have listed a number of mechanisms that isolate species, it so happens that many species are isolated simultaneously by a number of mechanisms. For example, Dobzhansky has shown that although the hybrids between *Drosophila miranda* and *D. pseudoobscura* are completely sterile, these species are also separated by a strong sexual (psychological) isolation and by a decrease in the viability of the F_1 hybrids. Probably more species are isolated by the simultaneous operation of two or more mechanisms than by merely one mechanism.

Embryo Culture

The culture in artificial media of young embryos of *Datura* hybrids has been spectacularly successful during the last few years as the result of a technique developed by van Overbeek and Conklin. The hybrid embryos are dissected out of the seed and are placed in media containing certain salts, vitamins, and an "embryo factor" found in coconut milk. Blakeslee and his co-workers have obtained hybrid embryos from eleven species combinations that had never before been successful and from other combinations that had previously yielded only one seed from many hundred pollinations. One of the most interesting hybrids thus obtained was between *Datura innoxia* and a tree *Datura*. Blakeslee has varied the coconut milk technique by

using powdered malt extract sterilized by filtration in place of the coconut milk as a source of the "embryo factor." This method has also been applied successfully to hybrids between *Iris pseud-acorus* and *I. versicolor* and between different species of *Lilium*.

In Chapter 26 we called attention to the work of Brink and Cooper on somatoplastic sterility. They have shown that the dominant tissue in a juvenile angiosperm seed is the endosperm. They have further maintained that the collapse of a seed produced from a cross between two species that are wide apart is the result of disharmony in the endosperm rather than in the embryo. A cross which they made between the squirrel-tail grass, *Hordeum jubatum*, and rye, *Secale cereale*, illustrates this. Hybrids are readily obtained and the hybrid seed develops 6 to 13 days and then collapses. Brink, Cooper, and Ausherman dissected the embryos from 9- to 12-day seeds and grew them upon artificial media. Of 81 treated embryos, 34 were free of fungal or bacterial contamination and made considerable growth in the nutrient media. One embryo differentiated normally and was potted up and raised to sexual maturity. A study of meiotic behavior indicated that there was little homology between the parental genomes. By embryo culture somatoplastic isolation may be overcome and hybrids produced between species that would never produce viable hybrids in the wild.

Index Frequency Method

A method which attempts to picture quantitatively the qualitative variation exhibited by hybrid swarms has been developed by Anderson largely for *Tradescantia* hybrids, and has been used by others in studying other genera. This method, criticized by some investigators, is highly subjective in the selection of characters and the way in which it weights them, but it has certain advantages that, provided its limitations are understood, make it a very useful technique for comparing populations.

Two species are compared with respect to a number of characters, each markedly different in the two types. The value 0 is assigned to each character of one species and another value as 2, 3, 4, or some other relatively low number to each corresponding character in the other species. If the two values are 0 and 2 for a certain trait, an intermediate type would be given the value 1. If the values are 0 and 4, the intermediate would be 2 and

other intermediate types more or less resembling one or the other species might be scored 1 or 3. In this manner, each of the characters of a certain plant is given a value. All the values are added together and the sum is the index value of the plant. The index value is a rough estimate of the position of the given plant with respect to the theoretical concepts of the two species for all the characters scored. If a natural population is under observation, the index values of all the plants are plotted in a histogram. The histograms for the two species do not overlap and are found at opposite extremes of a curve, but the histograms of various hybrid populations may fall between the others, depending upon the structure of the various populations.

Anderson made an interesting study between *Tradescantia virginiana* and *T. canaliculata*, the two most common Tradescantias of eastern North America. The former usually grows in shade or semi-shade; the latter is usually found in full sun, often on or near rocks or in dry sands. They are thus separated by an ecological barrier. Hybridization was studied in Jefferson County, Missouri, in a region little disturbed by man in which hybridization, therefore, was taking place under natural conditions. Populations of each species were studied as well as six populations of hybrids. Index values were assigned and plotted, as in Fig. 149. The distributions of these values show definitely that these were hybrid populations.

Introgressive Hybridization. If there is free intercrossing among the plants of the two species, among the hybrids, and between any hybrid plant and any member of either species, and if the two species are in equal numbers at the start of the hybridization, theoretically the hybrid swarm should be distributed, when scored by the index frequency method, according to a normal frequency curve. However, if one species is far more abundant than the other, the F_1 and subsequent hybrids will have far more opportunity to backcross to that species than to the less abundant species, and the hybrid swarm will present a curve which is strongly skewed in the direction away from the more abundant species. After a few such repeated backcrosses, most of the individuals of the hybrid swarm will appear rather as extreme variants of the pure species than as hybrids. This "absorbing" of one species by the other or, to look at it from the other angle, this "infection" of the second species by the first

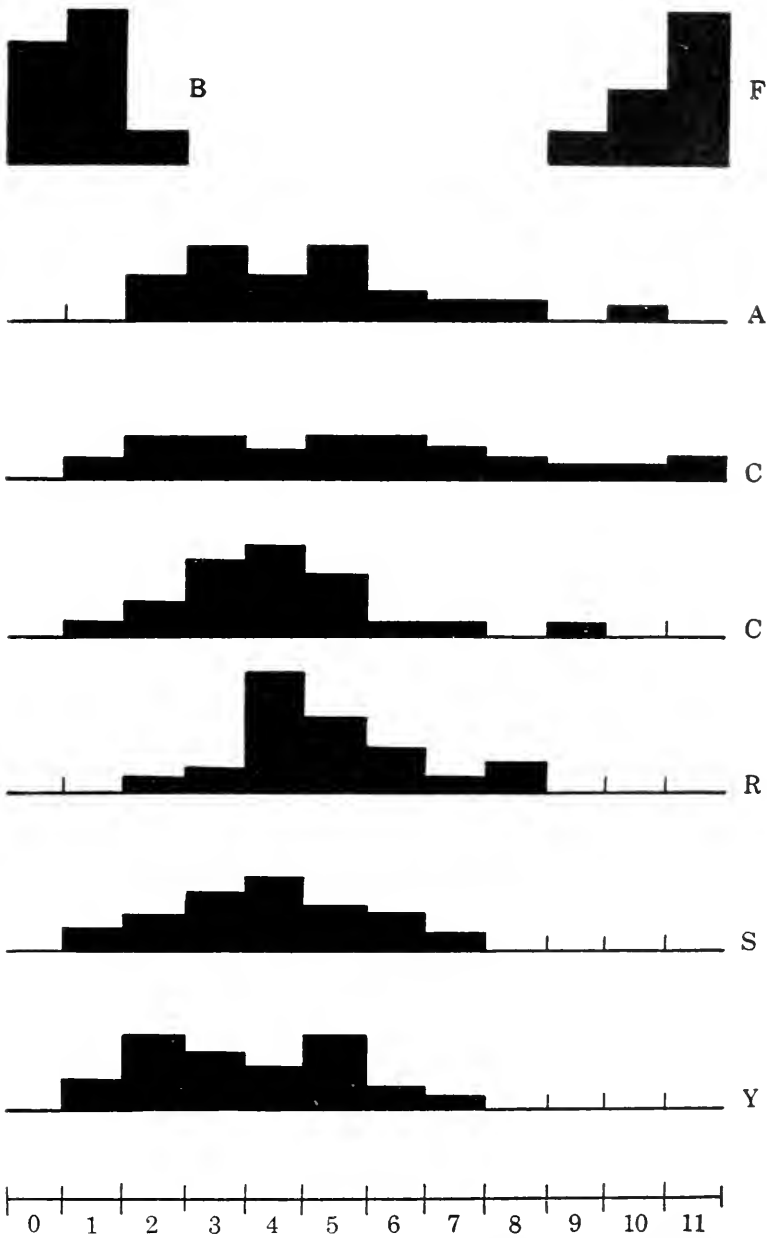

FIG. 149. Histograms of *Tradescantia* populations of thirty plants each. B, a population of *T. canaliculata* and F, one of *T. virginiana*. A, C, R, S, and Y represent six populations of hybrid swarms. All the populations are plotted by the same index-frequency method and their positions roughly show their relation to one another. (From Anderson in *Annals of the Missouri Botanical Garden*.)

has been termed *introgressive hybridization* by Anderson and Hubricht, who have illustrated it by a diagram reproduced as Fig. 150. In this figure, the solid black indicates species A, species B, or the F_1 hybrids, according to position. The stippled area illustrates the hybrid swarm exclusive of the F_1 's. The arrows indicate the approximate limits of the terms "species" and "hybrids" and show that many of the extreme variants included under species A are actually of more or less remote hybrid origin.

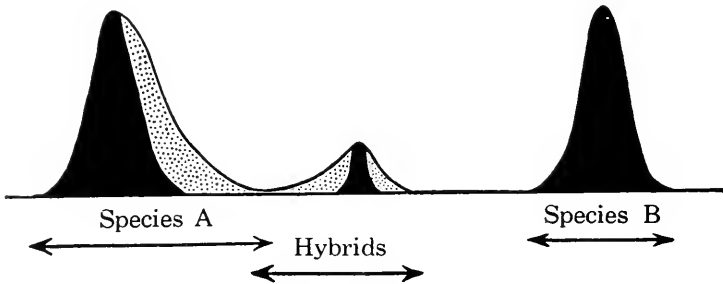

FIG. 150. Diagram showing the relation of two species, A and B (solid black), the first generation hybrids (also solid black), and later hybrid generations and backcrosses to species A (dotted). The arrows at the base of the figure delimit the "species" and "hybrids" in the populations in which introgressive hybridization is taking place. (Redrawn from Anderson and Hubricht in the *American Journal of Botany*.)

Studies of populations of *Tradescantia*, as examined and evaluated from herbarium material, show that there has been a strong introgression of *T. canaliculata* into *T. occidentalis* and also into *T. bracteata*. However, there is no evidence to show any introgression of *T. subaspera* into *T. canaliculata*, even though these species can be crossed to produce fertile offspring.

Other Indices. The method we have described of arbitrarily assigning index values to each of a number of characters of two species and their intermediate forms in order to assign a single value to individual plants as a means of comparing putative hybrids with both species is not the only method that has been used for that purpose. Hubbs and Whitlock introduced the *character index* for studying fish, and Anderson and Whitaker introduced a similar expression under the term *general index* in a study of *Uvularia*.

Hubbs has devised a valuable *hybrid index* method which has been applied successfully to groups of fish. The hybrid index is

obtained separately for each character of each hybrid individual. These individual hybrid indices may then be tabulated for all the hybrids to show how one character in all the hybrids compares with the mean value of that character in each parental type, or all the indices of any hybrid individual may be averaged together to give a composite picture of all the characters of that individual for comparison with the ensemble of each parental form. In computing the hybrid index for a given character, the average of one parental type is assigned the value 0, whereas the average of that character in the other parental type is valued at 100. The value, V_H , of that character in the particular hybrid is calculated, and the position, P , of the hybrid is calculated by the formula

$$P = \frac{V_H - M_1}{M_2 - M_1}$$

wherein M_1 and M_2 represent the mean values of the two parents. The hybrid index, I , is 100 times P . M_1 is usually applied to the parental species which seems to be the more primitive, if that is possible. For hybrid populations, the mean value of all the hybrids, M_H , is used in place of V_H in the above formula. In many hybrid populations the standard error of the hybrid index may also be computed.

The hybrid index is valuable as a test for hybridity and for mode of inheritance. If the putative hybrids are not hybrids but merely selected specimens of the two species, or if each character studied is determined merely by one pair of alleles, a curve obtained by plotting the individual indices would be a bimodal curve with one hump at either end of the scale. If, however, the putative hybrids are actually hybrids, a unimodal curve would result with the hump in the neighborhood of 50 on the scale. This curve would indicate characters determined by polygenes or, which is highly improbable, characters determined by genes that showed incomplete dominance. Hubbs considers that if unimodal curves were obtained for two or more unrelated traits in a given set of individuals, those individuals could be assumed to be hybrids. Hubbs has applied this method to interspecific and intergeneric crosses among suckers. A comparison of the hybrids and parents in five scale counts in several sucker popu-

lations is illustrated in Fig. 151. In these suckers, Hubbs has found that the hybrids show little more variability than the parental species, which indicates, among other things, that there

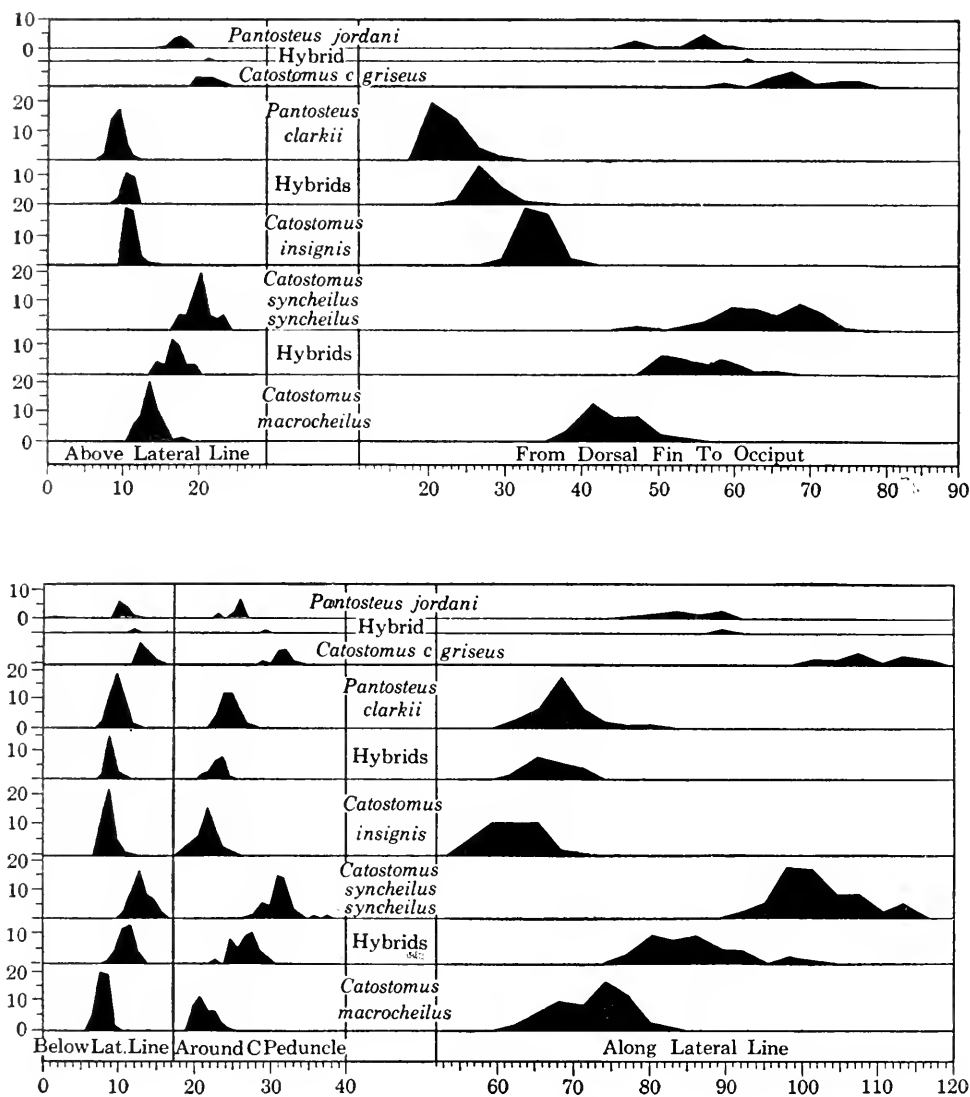

FIG. 151. The use of the hybrid index method of Hubbs to compare parent and hybrid populations of suckers with respect to five scale counts. (From Hubbs, Hubbs, and Johnson in *Contribution 22* from the Laboratory of Vertebrate Biology of the University of Michigan.)

is little backcrossing to the parental types. Hybrids were not common, and no real hybrid populations were built up, indicating that interspecific hybridization has not been important in the origin of species in the Catostomidae.

These index methods have received considerable attention of late among geneticists who are interested in a study of evolution, speciation, and hybridization. They are useful also to taxonomists and others who may be interested in natural populations.

Speciation

We might now consider some of the factors that bring about the formation of new species. Such species formation in nature is called *speciation* and can well be illustrated by *Crepis* and *Oenothera*.

Crepis. A genus that has been studied intensively for a number of years from the points of view of taxonomy, genetics, cytogenetics, and plant geography is the composite genus *Crepis*, which belongs to the tribe Cichorieae and is closely related to *Lactuca* and *Hieracium*. We shall point out briefly a few of the important genetic processes which have been operative in speciation and have been discovered largely through the extensive and intensive studies of Babcock and his many co-workers. Babcock recognizes 196 species of *Crepis*, of which he has grown and studied 113.

The genetic processes which have operated in speciation can be divided into the primary genetic processes and the secondary genetic processes. The first group includes gene mutations and changes in the structure of the chromosomes, whereas the secondary processes are interspecific hybridization, polyploidy, and apomixis.

One of the most important factors in speciation in the genus is gene mutation, a process that appears to occur frequently. Gene mutations have brought about numerous morphological and physiological variations within certain species and have apparently also been important in the differentiation of species after reproductive isolation has occurred. In a few species gene mutation has also apparently brought about sterility in certain interspecific hybrids that appear to have resulted from a cross between two parents that do not differ as to any large duplications, translocations, or other structural aberrations. This F_1 hybrid sterility is an example of a reproductive isolating mechanism that functions solely as the result of gene action. Finally, and this is apparently not too well established, gene action ap-

pears to have resulted in both a shortening of the length of the chromosomes and a general reduction in the size of the plant in some species.

Changes in the shape, number, and size of the chromosomes have been an important factor in evolution in *Crepis*. One of the effects of these changes is to cause sterility in interspecific hybrids and thus to erect a barrier to hybridization that can allow the accumulation of mutations in the two isolated strains

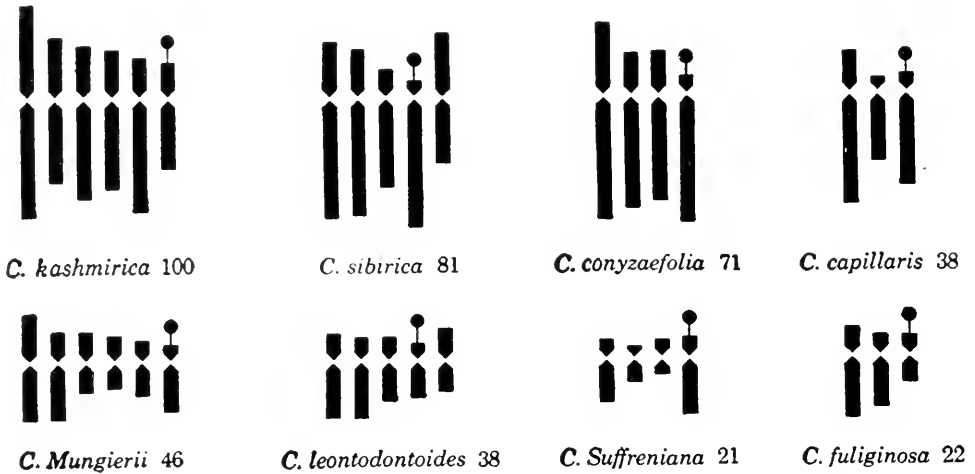

FIG. 152. Idiograms showing the evolution of karyotypes in *Crepis*. For discussion, see text. (Redrawn from Babcock, Stebbins, and Jenkins in the *American Naturalist*.)

to differentiate them sufficiently so that they are considered new species. Changes in chromosome structure, however, have also led to changes in the number and morphology of the chromosomes in some species.

Ninety-six species have been examined for chromosome number. Three species have seven haploid chromosomes, 14 have six, 19 have five, 57 have four, whereas in 3 species, $n = 3$. Morphological studies indicate that the six-chromosome and five-chromosome types are primitive and suggest that the others are derived from them. Babcock believes furthermore that coincident with or following a reduction in the number of the chromosomes there has been a reduction in the size of the plants and a specialization of the plants. Figure 152 shows the relative lengths and the shapes of the chromosomes in the extreme species whose haploid chromosome number equals 3, 4, 5, or 6. The

reduction in chromosome number has apparently resulted from changes in chromosome structure, especially reciprocal translocation.

Some work of Tobgy has illustrated how reduction in chromosome number could occur. He compared the chromosomes of *Crepis neglecta*, which can be designated A, B, C, and D, with the chromosomes of *C. fuliginosa*. This latter species has an A and a D chromosome that are similar

structurally to the A and D chromosomes of *neglecta*, except for one reciprocal translocation. Most of the B chromosomes of the two species are homologous, but the B of *fuliginosa* contains also the essential part of chromosome C of *neglecta*. The other arm of this C chromosome and its centromere are missing from *C. fuliginosa* (Fig. 153). Apparently a reciprocal

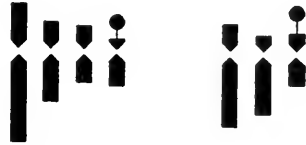

C. neglecta 31 *C. fuliginosa* 22

FIG. 153. Karyotypes of two species of *Crepis*. For discussion, see text. (Redrawn from Babcock, Stebbins, and Jenkins in the *American Naturalist*.)

translocation occurred between chromosomes B and C of either *neglecta* or a four-chromosome ancestor which placed the large part of a C chromosome on the B. The remainder of the original C was then lost. In considering the effect of changes in the chromosome complement (or *karyotype*), Babcock, Stebbins, and Jenkins consider that the change in the chromosomes is not a direct cause of speciation, but creates an interspecific sterility that acts as a reproductive isolating mechanism, since the *neglecta-fuliginosa* F_1 hybrids were highly sterile.

Interspecific hybridization has not been nearly so important a factor in speciation in *Crepis* as in some other genera. A few species apparently have arisen by amphidiploidy, but allopolyploidy has not approached gene mutation or structural changes in importance. The same can be said also of polyploidy and apomixis, which have played a definite but not an extensive part in the evolution of this genus.

Oenothera. Evolutionary phenomena in *Oenothera* have interested geneticists for many years as they present some problems that were very puzzling for a long time.

Among the intrachromosomal aberrations that we discussed in Chapter 24 were reciprocal translocations. Their effect on

circle formation in *Datura* was pointed out, and we showed that numerous interchanges had also occurred in *Oenothera*. In this latter genus numerous complexes are found. Each complex consists of a haploid set of chromosomes whose ends are arranged in a definite way and which possesses a certain group of alleles by which it can often be identified from purely genetic evidence. Thus we pointed out that *Oenothera Lamarckiana* consists of two complexes, *velans* and *gaudens*. Because of balanced lethals, all *velans·velans* and all *gaudens·gaudens* plants die at a very early stage. Some complexes have lost their lethal or never had any lethals and can therefore exist in a homozygous condition; this is true of the complex ^h*Hookeri* (haplo-Hookeri). By crossing it with various complex heterozygotes, and by crossing them together as well, the interchanges that have given rise to the various complexes can be determined and identified.

Figure 154, originally published by Cleland, shows the relationship between a number of the complexes. In this figure, each circle is a complex. The complexes that are related genetically are placed close together or overlap, whereas those that differ in all or most of their known genes are placed far apart. Complexes connected by a solid line are normally associated together in one of the types that occur in nature; those that are joined by a broken line have been found in plants that have been produced in the experimental field. The number and size of the circles formed by two complexes are indicated on the line that joins them. The somatic chromosome number of each type is 28. When the number of chromosomes in all the circles together in one plant is subtracted from 28, the remaining chromosomes are found in pairs.

Because of reciprocal translocations and balanced lethals, the *Oenotheras* present some taxonomic problems not found in most other genera. The genus is a far-ranging one in the Western Hemisphere. Fifteen subgenera are in existence and all are found in North America, but almost all the cytological studies have been upon the subgenus *Euoenothera*. The taxonomic situation has been worked out largely by Cleland and Munz. In California, Northern Mexico, and adjacent territory reciprocal translocation has not occurred, except very rarely. Almost all plants from this vast area show only paired chromosomes at meiosis

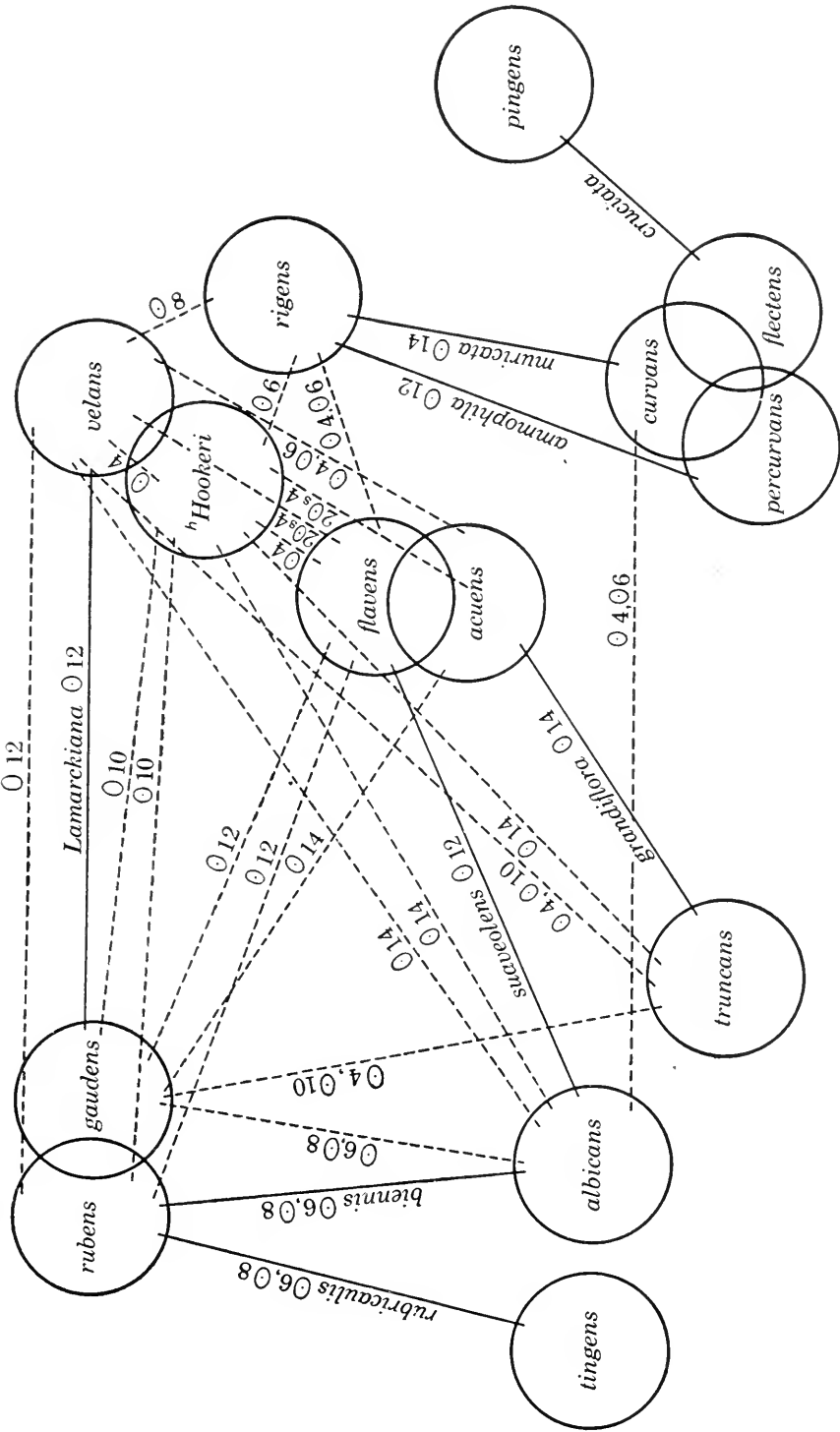

FIG. 154. A diagram showing the relationships between certain complexes of *Oenothera*. The chromosomal configurations of the various combinations of these complexes are shown. Complexes connected by solid lines normally form spontaneous races. The broken lines indicate combinations produced artificially and whose configurations have been determined. (Courtesy of Dr. R. F. Cleland in the *American Journal of Botany*.)

and lack any lethals. There are no true-breeding complex heterozygotes, and the situation with respect to species and speciation is comparable to that in most genera. In Arizona, New Mexico, and Utah, however, some or all the plants of a population will have circles of intermediate size. Lethals, both balanced and other kinds, are also present in a few plants. Spreading out into Colorado on the east and Washington on the north, most of the plants have a circle of fourteen and balanced lethals, so that all plants breed true. It is in these areas in which circles are found that the taxonomic problems arise, for a great many genetic types exist that are very difficult to classify.

According to Cleland, the Eastern *Oenotheras* are characterized by the presence of a large number of races, each of which is a complex heterozygote. These races breed true, although they are often highly heterozygous, because of balanced lethals. Several races frequently are found together in the same area, but they are usually reproductively isolated because of a strong tendency to self-pollination. These barriers must be broken down from time to time, as otherwise heterozygous types would not have arisen. On the whole, however, they are very effective in preventing widespread crossing and the formation of hybrid swarms. A taxonomic study is rendered even more difficult by the fact that in many races one of the complexes masks the other phenotypically so that the presence of the hidden complex cannot be detected without breeding studies. Further complicating factors are the great number of such races, the inability to distinguish certain races phenotypically, and the fact that complexes with the same arrangement of their translocated chromosomal segments may be present in more than one race. Larger groupings exist than the true-breeding races or biotypes, and they have more or less distinctive cytogenetic behavior. Unfortunately, however, these groups cannot always be distinguished from one another by their phenotypes, and for that reason there has been considerable hesitancy in referring them to the category of species.

Summarizing the problem of evolution in the *Oenotheras*, Cleland points out that as a group they have arisen relatively recently but that they have nevertheless developed a rather unusual combination of characters that results in a very effective isolating mechanism. This isolation has permitted the accumu-

lation of large numbers of recessive lethal and other mutations and has prevented the recombinations of numerous genes with the concomitant origin of many genetic types upon which natural selection can act. Interracial hybrids do not occur frequently and, when they do, those with a circle of fourteen are perpetuated indefinitely as true-breeding types. In the *Oenotheras*, a large number of forms has arisen, but they do not behave in the way that they would in a freely interbreeding population.

Apparently the balanced lethal mechanism which renders some complex heterozygotes permanently true-breeding also ensures them of the advantages of heterosis. In all the "half mutants," where the loss of one lethal allows homozygotes to be formed, these homozygotes are quite markedly inferior to the corresponding complex heterozygotes.

Gene Frequencies

We showed in Chapter 6 that if a heterozygote, Aa , is self-fertilized, it will produce an offspring whose genotypic ratio is $1AA : 2Aa : 1aa$. This was predicated upon several assumptions. It assumed that any egg could be fertilized by any sperm, that each type of egg was equally frequent, that each type of sperm was equally frequent, and that all possible types of offspring could be formed and would be viable. We demonstrated this graphically in Fig. 28 by the checkerboard method. That none of the eggs or sperm was preceded by any number that would denote their frequency indicated that the A and a eggs were present in a ratio of 1 : 1 or that each had a frequency of 0.5, and that this was also true of the sperm. In other words, if each type of egg and each type of sperm were present in equal frequency, the offspring would be present in a ratio of 1 homozygous dominant : 2 heterozygous : 1 recessive.

The genotypic ratio that is obtained in the F_1 by selfing a heterozygote is the same as the ratio found in the offspring of a population of organisms that reproduce sexually, provided that in both sexes the gametes bearing the dominant allele and those bearing the recessive allele are equally frequent, and provided furthermore that theoretically any egg can be fertilized by any sperm. The additional assumptions must also be made that the homozygous dominant, heterozygous, and recessive types all

can form and develop, that they are all equally fertile, and that the population is large. Selection of mates and mutations of the genes must also be excluded. This condition would be met if *equal* numbers of AA and aa organisms were suddenly placed together in the same area so that each would have an equal opportunity of mating with one like itself or with one of the other type. All the offspring from all these organisms would then be found in a ratio of $1AA : 2Aa : 1aa$, and repeated successive generations, provided that the original conditions were unchanged, would also show the same ratio of the three types. This constant ratio is always found because the ratio of A to a gametes is always $1 : 1$ for all generations. A checkerboard for any one generation would be the same as for the heterozygote, because the two types of gametes would be present in the same frequency both in a heterozygous organism and in a population of many organisms in which there were originally equal numbers of both the AA and aa types. This principle, discovered in 1904 by Pearson, is a special case of a general rule formulated independently in 1908 by Hardy and Weinberg.

In most natural populations, however, it is highly improbable that the original number of AA and aa organisms would be equal. Let us suppose that some cataclysm opened for invasion a new territory and that AA and aa plants were near enough to invade. If four times as many AA as aa plants became established in the new territory, the frequency of the A gene would be four times as great as of the a gene. The ratio of the offspring of these plants could be determined by the checkerboard method by merely indicating that the gene frequency of A was 0.8 and of a 0.2. The percentage of the offspring of each of the three types would then be $64AA : 32Aa : 4aa$.

	0.8A	0.2a
0.8A	0.64AA	0.16Aa
0.2a	0.16Aa	0.04aa

Provided that the offspring formed a sufficiently large population, the ratio of A and a gametes would again be $4 : 1$, and the

offspring from this population would again be in the ratio of $1/25 AA : 8/25 Aa : 1/25 aa$.

Obviously, the frequencies of the two original types might be any value. The general case, the Hardy-Weinberg law, can be stated by assuming that the original frequency of AA organisms is q and of aa organisms $(1 - q)$. If these values are substituted in the checkerboard, the offspring will fall into the ratio of $q^2 AA : 2q(1 - q) Aa : (1 - q)^2 aa$. If the gametes are obtained from all the organisms of this generation, they will be found with the following frequencies:

$$A = q^2 + \frac{1}{2} \cdot 2q(1 - q) = q$$

$$a = \frac{1}{2} \cdot 2q(1 - q) + (1 - q)^2 = (1 - q)$$

Thus the frequencies of A and a are exactly the same as they had been for the preceding generation so that the offspring of this generation will be in the same proportion as this generation itself. This proportion is repeated indefinitely so that the gene frequencies of both the dominant and the recessive genes will be the same generation after generation unless conditions change. To state this generally, the two types of gametes in any generation will be proportional to the gene frequencies. Such a population is said to be in equilibrium for it will continue to have the same structure unless some change occurs in the given conditions. Some of the factors that change the gene frequencies and thus upset the equilibrium are mutation, selection, nonrandom mating, and inbreeding. If, suddenly, one of these factors, such as mutation of one allele to the other, would arise, the previous equilibrium would be upset and, provided there were random mating, a new equilibrium would be established after one generation. This new equilibrium would then be maintained unless another change upset it and a still different equilibrium became established. Equilibrium will be reached when the proportion of heterozygotes is twice the square root of the product of the two homozygous classes. When there is equilibrium, there is no evolution; but a change in gene frequencies will lead to evolution.

The use of gene frequencies has become an important method in an analysis of human traits. This method is especially use-

ful there since the pedigree culture method cannot be applied to human beings.

Nonchromosomal Inheritance

Up to this point we have studied the behavior and importance of genes and chromosomes in heredity and evolution. However, there seems to be considerable evidence that certain bodies in the cytoplasm such as plastids and mitochondria are autonomous bodies, reproducing by division and arising apparently only from the division of preexisting plastids and mitochondria. We might well inquire, therefore, whether they are of any importance in evolution and heredity.

There is definite evidence that the inheritance of chloroplasts sometimes is merely a matter of the division of the plastids themselves. The discovery of this type of inheritance dates back to the early days of genetics to the work of Correns on the four-o'clock, *Mirabilis jalapa*. The normal chloroplasts in the leaves of this plant are dark green in color, but in one particular strain large areas of the leaves have plastids which have considerably less than the normal amount of chlorophyll. Areas with these chlorophyll-deficient chloroplasts are consequently very pale green, pale yellowish, or white. In regions where the normal green and the white areas are contiguous, both cells with normal chloroplasts and with defective chloroplasts are to be found. Plants with green and white areas in the leaves are variegated, and frequently this condition may apply to branches as well as to leaves. In *Mirabilis*, for example, occasionally entire branches may be white on an otherwise green or on a mottled green and white plant, and some branches also may contain patches of both green and white cells.

Apparently independently of the genotype of a variegated plant, all the seeds developed on wholly green branches produce only plants which are entirely green whereas those seeds that develop on a white branch of the same plant produce only plants entirely deficient in normal chlorophyll. When seeds that develop on the branches which are a mosaic of green and white tissue are planted, some of the resulting plants are completely green, some are variegated, and others are wholly white. Normally, chloroplasts are developed in the seed but not in the pollen grain or pollen tube so that all the chloroplasts a plant

has can be traced back through plastid division to the plastids that were present in the embryo sacs. Therefore, the factor that determines the plastid condition of a plant is the situation in the embryo sac, which in turn is a matter of the plastid situation in the particular part of the plant that gave rise to that embryo sac. Thus, in *Mirabilis*, the inheritance of chlorophyll is purely a maternal matter.

An interesting plastid behavior has been reported in *Oenothera*, by Renner, who also first suggested the presence of complexes in that genus. If *Oe. Lamarckiana* is crossed with the California species, *Oe. Hookeri*, two types of hybrids are produced, *Hookeri-laeta*, which has the complexes ^h*hookeri* and *gaudens*, and *Hookeri-velutina*, with the complexes ^h*hookeri* and *velans*. If *Hookeri* enters the cross as the female parent, both types of hybrid offspring are normally green. When, however, *Lamarckiana* is the female parent, the *velutina* hybrids are pale yellow and usually die at a very early stage, although the *laeta* hybrids are normal in color. It has been assumed by way of explanation that the two species have different kinds of plastids, a not impossible supposition when one considers the long period of complete isolation under which they developed. The further assumption is made that *Lamarckiana* plastids are not able to survive when the genetic constitution of the plant is made up of the *velans* and ^h*hookeri* complexes. A peculiar feature of *Oenothera* is that a few chloroplasts enter the zygote through the pollen tube, although far more are normally introduced through the embryo sac. When *Oe. Hookeri* is the female, some *Lamarckiana* plastids enter the zygote from the pollen tube but a great many more *Hookeri* plastids are introduced through the female side. In the *velutina* hybrids, probably the *Lamarckiana* plastids disintegrate, for these hybrids usually had a few yellowish spots although as a whole the plant was green. Supposedly these yellowish spots have chloroplasts which came from the male parent and degenerated. In like manner, in the *velutina* hybrids from the reciprocal cross, some of the plants had green spots although most of the plant was yellowish. The green spots are believed to be from *Hookeri* chloroplasts that entered the zygote through the pollen tube and survived, whereas the *Lamarckiana* plastids that came from the embryo sac, and, therefore, were far more numerous, degenerated.

These examples of plastid inheritance could be increased by the addition of many more, and yet most chlorophyll deficiencies are the result of the direct contact of definite genes, probably all of which are recessives. Many genes for albinism or for virescent seedlings have been identified in maize and other plants.

Another well-known example of the importance of the cytoplasm is the study of the moss, *Funaria*, by Wettstein. Hybrids between *F. mediterranea* and *F. hygrometrica* resemble the mother in most of their characters. Thus when *mediterranea* is the female parent, the offspring have small sporocarps with tall, acute opercula, leaf midribs that do not extend out to the apex, leaf apices which are filamentous, and paraphyses which are spiral. In all those characters, these hybrids resemble *mediterranea*. On the other hand, when *hygrometrica* is the female parent, the sporocarps are larger and have broad, flat opercula, the leaf midribs extend out to the apex, the leaf apices are not filamentous, and the paraphyses are not spiral. In these characters, the F_1 hybrids resemble *hygrometrica*. Wettstein backcrossed the hybrids a number of times so as to be certain to have the nucleus of one species in the cytoplasm of the other. No modification of the cytoplasm under the influence of the nucleus of the other species appeared to result even after a number of backcross generations. The conclusion from this work seems without doubt to indicate that the cytoplasm possesses some hereditary potentiality.

QUESTIONS AND PROBLEMS

1. Winge has shown that in *Taraxacum* a great many individuals have arisen that were morphologically distinct. Each individual has multiplied vegetatively and has formed a large clone. These clones are easily recognizable. Should each be considered a separate species? Explain. If not, how should they be considered? Explain.

• 2. How can you explain the great difficulty that arises in identifying the species of some genera (such as *Crataegus*)? Does that indicate anything concerning the age of the genus?

3. A population of snails showing some variation is bisected by a small stream which has changed its course. Discuss all the factors that might arise after this geographical isolation had occurred which could result in the origin of new species of snails within the area. Could more than one new species arise on one side of the stream?

4. What is meant by the age-and-area concept?

5. Two populations of the same species are 2000 miles apart. Over a long period of time, numerous small mutations accumulate, many of which affect the same characters. After a considerable period, they differ with respect to plant height, corolla size, seed weight, and the lengths of the leaves. These differences are noticeable but not great, but all are the result of multiple genes. Should the two new populations be classed as new species? Would your answer be the same if, in addition to these differences, they also produced hybrids that were partially or completely sterile? Explain.

6. Would your answer to question 5 be different if, instead of differing in those quantitative characters, the two populations differed with respect to opposite or alternate leaves, bicarpellate or tricarpellate ovaries, and pubescent or glabrous leaves, assuming that each of these three character differences is determined by a single pair of alleles? Assume both sterility and nonsterility of the hybrids.

7. *Oenothera biennis* is composed of two complexes, *albicans* and *rubens*, but breeds true. When it is crossed with *Oe. Hookeri*, it forms two types of plants (twin hybrids), *albicans* · ^h*Hookeri* and *rubens* · ^h*Hookeri*. Explain. If selfed, both these twin hybrids produce two types of progeny in their offspring. What would they be, and in what ratios?

8. *Oe. Lamarckiana* has the complexes *gaudens* and *velans*, and *Oe. chicaginensis* has *punctulans* and *excellens*. The cross *Lamarckiana* × *chicaginensis* gives two types of plants, *gaudens* · *punctulans* and *velans* · *punctulans*, and the reciprocal cross gives *excellens* · *gaudens* and *excellens* · *velans*. However, when *Lamarckiana* is crossed with *Oe. grandiflora*, which has *acuens* and *truncans*, four types are found, *gaudens* · *acuens*, *velans* · *acuens*, *gaudens* · *truncans*, and *velans* · *truncans*. Explain.

9. The segmental arrangement in the complex ^h*Hookeri* is 1 · 2, 3 · 4, 5 · 6, 7 · 8, 9 · 10, 11 · 12, 13 · 14. Complex *flavens* differs from it only in having 1 · 4, 3 · 2 instead of 1 · 2, 3 · 4. Complex *velans* differs from ^h*Hookeri* in having 5 · 8, 7 · 6; *acuens* differs from it by 1 · 4, 3 · 2, 7 · 10, 9 · 8; and ^h*Johansen* is different by 7 · 10, 9 · 8. All other chromosomes in these complexes are the same as in ^h*Hookeri*. How many circles and pairs would be found in all the possible combinations of two of those five complexes?

10. Red flower color (*W*) is dominant to white (*w*). Ten *WW* and one *ww* plant became established on an isolated island. If complete freedom of crossing and complete viability of offspring were assumed, what would be the composition of the plants on the island after three generations?

GENERAL REFERENCES

- ALTENBURG, E. 1945. *Genetics*. xii + 452 pp. New York: Henry Holt and Co.
- BABCOCK, E. B., and R. E. CLAUSEN. 1927. *Genetics in relation to agriculture*. 2nd ed. xiv + 673 pp. New York: McGraw-Hill Book Co.
- BALLS, W. L. 1912. *The cotton plant in Egypt, studies in physiology and genetics*. xvi + 202 pp. London: Macmillan and Co.
- BAUR, E. 1930. *Einführung in die Vererbungslehre*. 11th ed. Berlin: Borntraeger.
- BAUR, E., E. FISCHER, and F. LENZ. 1931. *Human heredity*. New York: The Macmillan Co.
- CAIN, S. A. 1944. *Foundations of plant geography*. xiv + 556 pp. New York: Harper & Bros.
- COCKAYNE, E. A. 1933. *Inherited abnormalities of the skin and its appendages*. x + 394 pp. London: Oxford University Press.
- CORRENS, C. 1912. *Die neuen Vererbungsgesetze*. viii + 75 pp. Berlin: Borntraeger.
- CREW, F. A. E. 1927. *The genetics of sexuality in animals*. 188 pp. Cambridge: University Press.
- DARLINGTON, C. D. 1937. *Recent advances in cytology*. 2nd ed. xiv + 671 pp. Philadelphia: P. Blakiston's Son and Company.
- DARLINGTON, C. D., and E. K. JANAKI AMMAL. 1946. *Chromosome atlas of cultivated plants*. 397 pp. London: Allen and Unwin.
- DARWIN, CHARLES. 1868. *The variation of animals and plants under domestication*. Vol. 1. viii + 411 pp. London: John Murray.
- DARWIN, CHARLES. 1877. *Effects of cross- and self-fertilization in the vegetable kingdom*. viii + 482 pp. New York: D. Appleton Co.
- DAVENPORT, C. B., and M. P. EKAS. 1936. *Statistical methods in biology, medicine and psychology*. 4th ed. xii + 216 pp. New York: John Wiley & Sons.
- DEMEREK, M., Editor. 1947. *Advances in genetics*. Vol. 1. xvi + 458 pp. New York: Academic Press.
- DE VRIES, H. 1909. *The mutation theory*. 2 vols. Chicago: Open Court Publishing Co.
- DOBZHANSKY, TH. 1937. *Genetics and the origin of species*. xvi + 364 pp. New York: Columbia University Press.
- DOBZHANSKY, TH. 1941. *Genetics and the origin of species*. 2nd ed. xviii + 446 pp. New York: Columbia University Press.
- FISHER, R. A. 1938. *Statistical methods for research workers*. 7th ed. Edinburgh: Oliver and Boyd.
- GATES, R. R. 1946. *Human genetics*. Vols. I and II. New York: The Macmillan Company.

- GOLDSCHMIDT, R. 1938. *Physiological genetics*. ix + 375 pp. New York: McGraw-Hill Book Co.
- GOLDSCHMIDT, R. 1940. *The material basis of evolution*. New Haven: Yale University Press.
- HEGNER, R. H. 1937. *College zoology*. 3rd ed. xvi + 742 pp. New York: The Macmillan Co.
- HUXLEY, J., Editor. 1940. *The new systematics*. viii + 583 pp. Oxford University Press.
- JOHANNSEN, W. 1903. *Über Erblichkeit in Populationen und in reinen Linien*. 68 pp. Jena: G. Fischer.
- JONES, W. N. 1934. *Plant chimaeras and graft hybrids*. viii + 136 pp. London: Methuen and Co.
- LANG, A. 1905. *Ueber die Mendelschen Gesetze, Art- und Varietätenbildung, Mutation und Variation, insbesondere bei unseren Hain- und Gartenschnecken*. Vortrag. Schweiz. Naturf. Gesellsch. Luzern.
- MATHER, K. 1938. *The measurement of linkage in heredity*. ix + 132 pp. New York: Chemical Publishing Co.
- MATSUURA, H. 1933. *A bibliographical monograph on plant genetics, 1925-1929*. Sapporo: Hokkaido University.
- MORGAN, T. H. 1927. *Experimental embryology*. xi + 766 pp. New York: Columbia University Press.
- MORGAN, T. H. 1928. *The theory of the gene*. xviii + 358 pp. New Haven: Yale University Press.
- MOULTON, F. R., Editor. 1940. *The genetics of pathogenic organisms*. 90 pp. Lancaster, Pa.: The Science Press.
- MULLER, H. J. 1939. *Bibliography on the genetics of Drosophila*. 132 pp. Edinburgh: Oliver and Boyd.
- MULLER, H. J., C. C. LITTLE, and L. H. SNYDER. 1947. *Genetics, medicine, and man*. 171 pp. Ithaca: Cornell University Press.
- ONSLOW, M. WHELDALE. 1925. *The anthocyanin pigments of plants*. viii + 314 pp. Cambridge: University Press.
- PEARL, R. 1940. *Introduction to medical biometry and statistics*. 3rd ed., revised and enlarged. xv + 537 pp. Philadelphia: W. B. Saunders Co.
- PEARSON, K. 1930. *Tables for statisticians and biometricians*. Part I. 3rd ed. Cambridge: University Press.
- PFEIFFER, H. H. 1940. *Experimentelle Cytologie*. xii + 243 pp. Leiden: Chronica Botanica Co.
- SANSOME, F. W., and J. PHILP. 1939. *Recent advances in plant genetics*. 2nd ed. xii + 412 pp. Philadelphia: P. Blakiston's Son and Company.
- SCHIEGMANN, E. 1932. Entstehung der Kulturpflanzen. *Handbuch d. Vererbungs-wissenschaft* 3:1-377. Translated into English by E. Midgard as Work Projects Administration No. 3888 O. P. 165-1-93-11.
- SCHRADER, F. 1944. *Mitosis*. 110 pp. New York: Columbia University Press.
- SHARP, L. W. 1934. *Introduction to cytology*. 3rd ed. xiv + 567 pp. New York: McGraw-Hill Book Co.
- SHARP, L. W. 1943. *Fundamentals of cytology*. x + 270 pp. New York: McGraw-Hill Book Co.

- SHULL, A. F. 1938. *Heredity*. xvii + 442 pp. New York: McGraw-Hill Book Co.
- SINNOTT, E. W., and L. C. DUNN. 1939. *Principles of genetics*. 3rd ed. xiv + 408 pp. New York: McGraw-Hill Book Co.
- SNEDECOR, C. W. 1940. *Statistical methods applied to experiments in agriculture and biology*. xii + 422 pp. Ames, Iowa: The Iowa State College Press.
- SNYDER, L. H. 1929. *Blood grouping in relation to clinical and legal medicine*. Baltimore: Williams and Wilkins Co.
- SNYDER, L. H. 1940. *The principles of heredity*. 2nd ed. x + 452 pp. New York: D. C. Heath and Co.
- SNYDER, L. H. 1941. *Medical genetics*. vii + 130 pp. Durham: Duke University Press.
- STURTEVANT, A. H., and G. W. BEADLE. 1939. *An introduction to genetics*. 391 pp. Philadelphia: W. B. Saunders Co.
- WADDINGTON, C. H. 1939. *An introduction to modern genetics*. 441 pp. New York: The Macmillan Co.
- WARNER, M. F., M. A. SHERMAN, and E. M. COLVIN. 1934. *A bibliography of plant genetics*. U.S.D.A. Miscellaneous Publications 164:1-552.
- WHITE, M. J. D. 1937. *The chromosomes*. viii + 125 pp. New York: Chemical Publishing Co.
- WIENER, A. S. 1943. *Blood groups and transfusion*. 3rd ed. xix + 438 pp. Springfield, Ill.: Charles C Thomas.
- WILSON, E. B. 1928. *The cell in development and heredity*. 3rd ed. xxxvii + 1232 pp. New York: The Macmillan Co.
- YULE, G. U., and M. G. KENDALL. 1937. *An introduction to the theory of statistics*. 12th ed. London: J. B. Lippincott Company.

SPECIFIC REFERENCES

CHAPTER 1

- E. VAN BENEDEN. 1883. Recherches sur la maturation de l'œuf, la fécondation et la division cellulaire. *Archiv. de Biol.* 4:265-641. — R. CHAMBERS. 1925. Études de microdissection. IV. Les structures mitochondriales et nucléaires dans les cellules germinales males de la sauterelle. *La Cellule* 35:105-124. — W. FLEMMING. 1879. Über das Verhalten des Kernes bei der Zelltheilung und über die Bedeutung mehrkerniger Zellen. *Virchow's Arch.* 77:1-29. — F. HEUSER. 1884. Beobachtungen über Zellkernteilung. *Biol. Centralbl.* 17: 27-157. — L. HUSTED. 1926. An analysis of chromosome structure and behavior with the aid of X-ray induced rearrangements. *Genetics* 21:537-553. — B. P. KAUFMANN. 1926. Chromosome structure and its relation to the chromosome cycle. I. Somatic mitosis in *Tradescantia pilosa* Lehm. *Amer. J. Bot.* 13:59-80. —

K. MATHER and L. H. A. STONE. 1933. The effect of X-radiation on somatic chromosomes. *J. Genet.* 28:1-24 ——— B. R. NEBEL. 1929. Chromosome structure. On coiling of chromosomes. *Amer. Natur.* 73:289-299. ——— H. P. RILEY. 1936. The effect of X-rays on the chromosomes of *Tradescantia gigantea*. *Cytologia* 7:131-142. ——— H. J. SAX and K. SAX. 1936. An analysis of chromosome structure and behavior with the aid of X-ray induced rearrangements. *Genetics* 31:537-553. ——— E. W. SINNOTT and R. BLOCH. 1941. Division in vacuolated plant cells. *Amer. J. Bot.* 20:225-232.

CHAPTER 2

C. B. BRIDGES and T. H. MORGAN. 1919. Contributions to the genetics of *Drosophila melanogaster*. II. The second chromosome group of mutant characters. *Carnegie Inst. Wash. Publ.* 278:123-304. ——— W. LANDAUER and E. UPHAM. 1936. Weight and size of organs in frizzle fowl. *Storrs Agric. Exp. Sta. Bull.* 210:3-42. ——— T. H. MORGAN. 1911. The origin of nine wing mutations in *Drosophila*. *Science* 33:496-499. ——— T. H. MORGAN, C. B. BRIDGES, and A. H. STURTEVANT. 1925. The genetics of *Drosophila*. *Bibliogr. Genet.* 2:1-262. ——— H. J. MULLER. 1926. The gene as the basis of life. *Proc. Internat. Cong. Plant Sci.* (Ithaca) 1:897-921. ——— K. TJEJBBES. 1931. Two linkage groups in the garden bean. *Hereditas* 15:185-193. ——— C. H. WADDINGTON. 1940. The physicochemical nature of the chromosome and the gene. *Biol. Symposia* 1:200-214.

CHAPTER 3

J. ADDAIR and L. H. SNYDER. 1942. Evidence for an autosomal recessive gene for susceptibility to paralytic poliomyelitis. Studies in human inheritance XXI. *J. Hered.* 33:307-309. ——— C. E. ALLEN. 1936. The genetics of Bryophytes. *Bot. Rev.* 1:269-291. ——— E. G. ANDERSON and R. A. EMERSON. 1923. Pericarp studies in maize. I. The inheritance of pericarp colors. *Genetics* 8:466-476. ——— I. ANDERSON-KOTTO. 1931. Genetics of ferns. *Bibliogr. Genet.* 8:269-294. ——— R. J. A. BERRY. 1941. An investigation into the mental states of the parents and sibs of 1050 mentally defective persons. *Proc. VII Internat. Genet. Cong.:* 64. ——— A. F. BLAKESLEE. 1932. Genetics of sensory thresholds: taste for phenylthiocarbamide. *Proc. Nat. Acad. Sci.* 18:120-130. ——— A. F. BLAKESLEE. 1935. Demonstration of differences between people in the sense of smell. *Sci. Monthly* 41:72-84. ——— C. BRUGGER. 1941. The genetic uniformity of mental deficiency without marked physical signs. *Proc. VII Internat. Genet. Cong.:* 82. ——— C. S. BUCHER and C. E. KEELER. 1934. The inheritance of allergy. *J. Allergy* 5:611-614. ——— J. M. CAPINPIN. 1937. Inheritance of nanism in man. *J. Hered.* 28:361-362. ——— C. B. DAVENPORT and J. W. BLANKINSHIP. 1923. Body build and its inheritance. *Carnegie Inst. Wash. Publ.* 329:1-176. ——— L. C. DUNN, S. GLUECKSOHN-SCHOENHEIMER, and V. BRYSON. 1940. A new mutation in the mouse. *J. Hered.* 31:343-348. ——— H. K. FINK. 1940. Hereditary epistaxis in man. *J. Hered.* 31:319-322. ——— L. C. GLASS and D. H. YOST. 1939. Inherited inability to sweat. *J.*

Hered. 30:477-478. — R. A. HEFNER. 1940. Inherited polydactyly associated with extra phalanges in the thumbs. *J. Hered.* 31:25-27. — R. A. HEFNER. 1941. Crooked little fingers. Minor streblomicrodactyly. *J. Hered.* 32:37-38. — F. B. HUTT and G. P. CHILD. 1934. Congenital tremor in young chicks. *J. Hered.* 25:341-350. — C. E. KEELER. 1934. The heredity of a congenital white spotting in negroes. *J. Amer. Med. Assoc.* 103:179-180. — M. T. MACKLIN. 1934. Inherited anomalies of metabolism II. *J. Hered.* 25:123-126. — R. PEARL. 1928. Experiments on longevity. *Quart. Rev. Biol.* 3:391-407. — E. POTTER. 1937. A hereditary ear malformation. *J. Hered.* 28:255-258. — L. H. SNYDER. 1934. Modern analysis of human behavior. *Eugenical News* 19:61-69. — L. H. SNYDER and G. M. CURTIS. 1934. An inherited "hollow chest." Koilosternia, a new character dependent upon a dominant autosomal gene. *J. Hered.* 25:445-446. — S. E. STODDARD. 1939. The inheritance of "natural bangs." Catatrichy, a new character dependent upon a dominant autosomal gene. *J. Hered.* 30:543-546. — H. H. STRANDSKOV. 1939. Inheritance of absence of thumbnails. *J. Hered.* 30:53-54.

CHAPTER 4

C. A. BERGER. 1938. Prophase chromosome behavior in the division of cells with multiple chromosome complexes. *J. Hered.* 29:351-357. — D. C. COOPER. 1935. Macrosporogenesis and development of the embryo sac of *Lilium Henryi*. *Bot. Gaz.* 97:346-355. — B. P. KAUFMANN. 1936. Chromosome structure in relation to the chromosome cycle. *Bot. Rev.* 2:529-553. — B. R. NEBEL. 1939. Chromosome structure. *Bot. Rev.* 5:563-566. — K. SAX and L. M. HUMPHREY. 1934. Structure of meiotic chromosomes in microsporogenesis of *Tradescantia*. *Bot. Gaz.* 96:353-362.

CHAPTER 5

E. G. BALBIANI. 1881. Sur la structure de noyau des cellules salivaires chez les larves de *Chironomus*. *Zool. Anzeiger* 4:637-641; 662-666. — W. R. DURYEE. 1938. A microdissection study of amphibian chromosomes. *Biol. Bull.* 75:345. — E. HEITZ. 1935. Chromosomenstruktur und Gene. *Zeits. f. indukt. Abstamm.- u. Vererb.-lehre* 70:402-447. — E. HEITZ and H. BAUER. 1933. Beweis für die Chromosomennatur der Kernschleifen in den Knäuelkernen von *Bibio hortulanus* L. *Zeits. Zellf. u. mikr. Anat.* 17:67-82. — C. E. McCLUNG. 1902. The accessory chromosome-sex determinant? *Biol. Bull.* 3:43-84. — T. S. PAINTER. 1933. A new method for the study of chromosome rearrangements and the plotting of chromosome maps. *Science* 78:585-586. — T. S. PAINTER. 1934. Salivary chromosomes and the attack on the gene. *J. Hered.* 25:464-476. — J. T. PATTERSON *et al.* 1940. Studies in the genetics of *Drosophila*. *Univ. Texas Publ.* 4032:11-256. — G. H. SHULL. 1910. Inheritance of sex in *Lychnis*. *Bot. Gaz.* 49:110-125. — G. H. SHULL. 1911. Reversible sex-mutants in *Lychnis dioica*. *Bot. Gaz.* 52:329-368. — G. H. SHULL. 1914. Sex-limited inheritance in *Lychnis dioica* L. *Zeits. f. indukt. Abstamm.- u.*

Vererb-lehre 12:265-302. — H. E. WARMKE. 1946. Sex determination and sex balance in *Melandrium*. *Amer. J. Bot.* 33:648-660. — E. B. WILSON. 1905. The chromosomes in relation to the determination of sex in insects. *Science* 22:500-502. — E. B. WILSON. 1911. The sex chromosomes. *Arch. f. mikro. Anat.* 77:249-271.

CHAPTER 6

C. HALLQUIST. 1921. The inheritance of the flower colour and the seed colour in *Lupinus angustifolius*. *Hereditas* 2:299-363. — R. A. HEFNER. 1941. Crooked little fingers (minor streblomicrodactyly). *J. Hered.* 32:37-38. — G. H. SHULL. 1929. Species hybridizations among old and new species of shepherd's purse. *Proc. Internat. Cong. Plant Sci.* (Ithaca) 1:837-888. — B. L. WARWICK and P. B. DUNKLE. 1939. Inheritance of horns in sheep. *J. Hered.* 30:325-329.

CHAPTER 7

E. BAUR. 1912. Ein Fall von geschlechtesbegrenzter Vererbung bei *Melandrium album*. *Zeits. f. indukt. Abstamm.- u. Vererb-lehre.* 8:335-336. — L. DONCASTER. 1908. On sex-inheritance in the moth *Abraxas grossulariata* and its variety *lacticolor*. *Reports to the Evol. Com. Roy. Soc.* (London) IV:53-57. — T. H. MORGAN. 1910. Sex-limited inheritance in *Drosophila*. *Science* 32:120-122. — T. H. MORGAN. 1912. Eight factors that show sex-limited inheritance in *Drosophila*. *Science* 35:472-473. — T. H. MORGAN. 1914. Sex-limited and sex-linked inheritance. *Amer. Natur.* 48:577-583. — T. H. MORGAN and E. CATTELL. 1912. Data for the study of sex-linked inheritance in *Drosophila*. *J. Exp. Zool.* 13:79-101. — L. H. SNYDER. 1932. Studies in human inheritance. VII. Hemophilia. *Ohio J. Sci.* 32:152-157. — C. STERN. 1929. Untersuchungen über Aberrationen des Y-Chromosoms von *Drosophila melanogaster*. *Zeits. f. indukt. Abstamm.- u. Vererb-lehre* 51:253-353.

CHAPTER 8

S. WRIGHT. 1941. Tests for linkage in the guinea pig. *Genetics* 26:650-669.

CHAPTER 9

C. V. BEERS and L. A. CLARK. 1942. Tumors and short-toe—a dihybrid pedigree. *J. Hered.* 33:366-368. — E. E. CAROTHERS. 1913. The Mendelian ratio in relation to certain Orthopteran chromosomes. *J. Morph.* 24:487-511. — E. E. CAROTHERS. 1917. The segregation and recombination of homologous chromosomes as found in two genera of Acrididae (Orthoptera). *J. Morph.* 28:445-520. — M. DEMEREC. 1924. Genetic relations of five factor pairs of virescent seedlings in maize. *Cornell Univ. Agric.*

Exp. Sta. Memoir 84:3-38. — R. A. EMERSON. 1921. The genetic relations of plant colors in maize. *Cornell Univ. Agr. Exp. Sta. Memoir* 39:1-156. — R. A. EMERSON. 1921. Heritable characters in maize. IX. Crinkly leaf. *J. Hered.* 12:267-270. — A. E. LONGLEY. 1941. Chromosome morphology in maize and its relatives. *Bot. Rev.* 7:263-289. — J. R. MAGNESS. 1937. *U.S.D.A. Yearbook of Agriculture*. 1937:1450-1456. — E. VON TSCHERMAK, 1923, in C. FRUWIRTH. *Handbuch der landwirtschaftlichen Pflanzenzüchtung*. Bd. IV. *Die Züchtung der vier Hauptgetreidearten und der Zückerribe*. Berlin.

CHAPTER 10

C. B. BRIDGES. 1929. Variation in crossing over in relation to age of the female in *Drosophila melanogaster*. *Carnegie Inst. Wash. Publ.* 399:63-89. — R. A. BRINK and P. H. SENN. 1931. Heritable characters in maize, XL. Ragged, a dominant character, linked with *A*, *Tsx*, and *D*₁. *J. Hered.* 22:155-161. — W. E. CASTLE. 1933. The linkage relations of yellow fat in rabbits. *Proc. Nat. Acad. Sci.* 19:947-950. — C. D. DARLINGTON. 1934. Anomalous chromosome pairing in the male *Drosophila pseudoobscura*. *Genetics* 19:95-118. — C. D. DARLINGTON. 1934. Crossing-over of sex chromosomes in *Drosophila*. *Amer. Natur.* 68:1-3. — R. A. EMERSON. 1918. A fifth pair of factors, *Aa*, for aleurone color in maize, and its relation to the *Cc* and *Rr* pairs. *Cornell Univ. Agric. Exp. Sta. Memoir* 16:225-289. — R. A. EMERSON, G. W. BEADLE, and A. C. FRASER. 1935. A summary of linkage studies in maize. *Cornell Univ. Agric. Exp. Sta. Memoir* 180:3-83. — H. FRIESEN. 1933. Artificially induced crossing-over in males of *Drosophila melanogaster*. *Science* 78:513-514. — H. FRIESEN. 1934. Künstliche Auslösung von Crossing-Over bei *Drosophila*-Männchen. *Biol. Zentralbl.* 54:65-75. — F. R. IMMER. 1930. Formulae and tables for calculating linkage intensities. *Genetics* 15:81-98. — H. PLOUGH. 1917. The effect of temperature on crossing over in *Drosophila*. *J. Exp. Zool.* 24:147-209. — H. PLOUGH. 1921. Further studies on the effect of temperature on crossing over. *J. Exp. Zool.* 32:182-202. — R. C. PUNNETT. 1913. Reduplication series in sweet peas. *J. Genet.* 3:77-103. — G. H. SHULL. 1928. A new gene mutation (*Mut. bullata*) in *Oenothera Lamarckiana* and its linkage relations. *Zeits. f. indukt. Abstamm.- u. Vererb-lehre*. Supplebd. II:1322-1342.

CHAPTER 11

H. K. HAYES and M. S. CHANG. 1939. Recent linkage studies in maize. I. Virescent seedling-16 (*v*₁₆). *Genetics* 24:59-60. — W. R. SINGLETON. 1939. Recent linkage studies in maize. V. Opaque endosperm-2 (*o*₂). *Genetics* 24:61. — D. DE WINTON. 1928. Further linkage work in *Pisum sativum* and *Primula sinensis*. *Zeits. f. indukt. Abstamm.- u. Vererb-lehre*. Supplebd. II:1594-1600.

CHAPTER 12

- E. G. ANDERSON and L. F. RANDOLPH. 1945. Location of the centromeres on the linkage maps of maize. *Genetics* 30:518-526. — J. BELL. 1922. Retinitis pigmentosa and allied diseases. Congenital stationary night-blindness. Glioma retinae. *Univ. London Galton Eugenics Lab. Memoir* 21: 1-123. — J. BELL. 1926. Colour-blindness. *Univ. London Galton Eugenics Lab. Memoir* 23:125-267. — C. B. BRIDGES. 1935. Salivary chromosome maps. *J. Hered.* 26:60-64. — C. B. BRIDGES. 1938. A revised map of the salivary gland X-chromosome. *J. Hered.* 29:11-13. — C. B. BRIDGES and P. N. BRIDGES. 1939. A revised map of the right limb of the second chromosome of *Drosophila melanogaster*. *J. Hered.* 30:475-476. — P. N. BRIDGES. 1941. A revised map of the left limb of the third chromosome of *Drosophila melanogaster*. *J. Hered.* 32:64-65. — P. N. BRIDGES. 1941. A revision of the salivary gland 3 R-chromosome map of *Drosophila melanogaster*. *J. Hered.* 32:299-300. — P. N. BRIDGES. 1942. A new map of the salivary gland 2 L-chromosome of *Drosophila melanogaster*. *J. Hered.* 33:403-408. — TH. DOBZHANSKY. 1929. Genetical and cytological proof of translocations involving the third or the fourth chromosomes of *Drosophila melanogaster*. *Biol. Zentralbl.* 49:408-419. — TH. DOBZHANSKY. 1930. Cytological map of the second chromosome of *Drosophila melanogaster*. *Biol. Zentralbl.* 50:671-685. — TH. DOBZHANSKY. 1936. Induced chromosomal aberrations in animals. Chapter XXXVIII, in *Biological Effects of Radiation* (ed. by B. M. DUGGAR). New York: McGraw-Hill Book Co. — A. B. GRIFFEN and W. S. STONE. 1940. Studies in the genetics of *Drosophila* IX. The second arm of chromosome 4 in *Drosophila melanogaster*. *Univ. Texas Publ.* 4032: 201-207. — J. B. S. HALDANE. 1936. A search for incomplete sex linkage in man. *Ann. Eug.* 7:28-57. — J. B. S. HALDANE. 1941. The partial sex-linkage of *recessive spastic paraplegia*. *J. Genet.* 41:141-147. — N. KALISS and M. D. SCHWEITZER. 1943. *Hereditary hemorrhagic diathesis*—a case of partial sex-linkage in man? *Genetics* 28:78. — T. KOMAI. 1934. *Pedigrees of hereditary diseases and abnormalities found in the Japanese Race.* Kyoto. — D. E. LANCEFIELD. 1922. Linkage relationships of the sex-linked characters in *Drosophila obscura*. *Genetics* 7:335-384. — O. MACKENSEN. 1935. Locating genes on salivary chromosomes. *J. Hered.* 26:163-174. — K. MATHER. 1938. Crossing-over. *Biol. Rev.* 13:252-292. — T. H. MORGAN. 1911. An attempt to analyze the constitution of the chromosome on the basis of sex-linked inheritance in *Drosophila*. *J. Exp. Zool.* 11:365-413. — H. J. MULLER and T. S. PAINTER. 1929. The cytological expression of changes in gene alignment produced by X-rays in *Drosophila*. *Amer. Natur.* 63:193-200. — T. S. PAINTER. 1934. Salivary chromosomes and the attack on the gene. *J. Hered.* 25:465-476. — J. T. PATTERSON. 1932. Lethal mutations and deficiencies produced in the X-chromosome of *Drosophila melanogaster* by X-radiation. *Amer. Natur.* 64:193-206. — H. W. SIEMENS and E. KOHN. 1925. Studien über Vererbung von Hautkrankheiten, IX. Xeroderma pigmentosum.

Zeits. f. indukt. Abstamm.- u. Vererb-lehre 38:1-61. — L. H. SNYDER and D. M. PALMER. 1943. An idiopathic convulsive disorder with deterioration. *J. Hered.* 34:207-212. — Ö. WINGE. 1936. Linkage in *Pisum*. *Comp. rend. Lab. Carlsberg ser. physiol.* 21:271-393.

CHAPTER 13

W. BATESON and R. C. PUNNETT. 1911. On gametic series involving re-duplication of certain terms. *J. Genet.* 1:293-302. — W. BATESON and R. C. PUNNETT. 1911. On the interrelation of genetic factors. *Proc. Roy. Soc.* B 84:3-8. — K. W. COOPER. 1944. Analysis of meiotic pairing in *Olfersia* and consideration of the reciprocal chiasmata hypothesis of sex chromosome conjunction in male *Drosophila*. *Genetics* 29:537-568. — H. B. CREIGHTON and B. McCLINTOCK. 1931. A correlation of cytological and genetical crossing over in *Zea mays*. *Proc. Nat. Acad. Sci.* 17:492-497. — H. B. CREIGHTON and B. McCLINTOCK. 1932. Cytological evidence for 4-strand crossing over in *Zea mays*. *Proc. VI Internat. Cong. Genet.* 2:392. — E. M. HEARNE and C. L. HUSKINS. 1935. Chromosome pairing in *Melanoplus femur-rubrum*. *Cytologia.* 6:123-127. — F. A. JANSSENS. 1909. Spermatogénèse dans les batraciens V. La théorie de la chiasmotypie. *La Cellule* 25:387-411. — C. C. LINDEGREN and G. LINDEGREN. 1937. Non-random crossing over in *Neurospora*. *J. Hered.* 28:105-113. — K. MATHER. 1933. The relation between chiasma and crossing over in diploid and triploid *Drosophila melanogaster*. *J. Genet.* 27:243-259. — T. H. MORGAN. 1911. Random segregation versus coupling in Mendelian inheritance. *Science* 34:384. — K. SAX. 1932. The cytological mechanism of crossing over. *J. Arnold Arbor.* 13:180-213. — C. STERN. 1931. Zytologische-genetische Untersuchungen als Beweise für die Morgansche Theorie des Faktorenaustauschs. *Biol. Zentralbl.* 51:547-587. — C. STERN. 1936. Somatic crossing over and segregation in *Drosophila melanogaster*. *Genetics* 21:625-730. — A. H. STURTEVANT. 1925. The effects of unequal crossing over in the Bar locus in *Drosophila*. *Genetics* 10:117-147. — W. S. SUTTON. 1903. On the morphology of the chromosome group in *Brachystola magna*. *Biol. Bull.* 4:24-39.

CHAPTER 14

W. T. ASTBURY and F. O. BELL. 1938. X-ray study of thymonucleic acid. *Nature* 141:747. — C. D. DARLINGTON and L. LA COUR. 1940. Nucleic acid starvation of chromosomes in *Trillium*. *J. Genet.* 40:185-212. — C. D. DARLINGTON and L. LA COUR. 1941. The detection of inert genes. *J. Hered.* 32:115-121. — M. DEMEREC. 1939. Chromosome structure as viewed by a geneticist. *Amer. Natur.* 73:331-338. — TH. DOBZHANSKY. 1944. Distribution of heterochromatin in the chromosomes of *Drosophila pallidipennis*. *Amer. Natur.* 78:193-213. — J. DOUTRELIGNE. 1933. Chromosomes et nucléoles dans les noyaux du type euchromocentrique. *La Cellule* 42:31-100. — A. PROKOFYEVA-BELGOVSKAYA. 1937. Observations on the structure of chromosomes in the salivary glands of

Drosophila melanogaster. *Bull. Acad. Sci. (U.S.S.R.)* 393-426. — J. SCHULTZ. 1936. Variegation in *Drosophila* and the inert chromosome regions. *Proc. Nat. Acad. Sci.* 22:27-33. — G. H. SHULL. 1928. The "outside-in" *Oenothera* flower, a new morphological type produced by the interaction of two recessive Mendelian factors. *Proc. Nat. Acad. Sci.* 14:142-146. — E. SUTTON. 1940. The structure of salivary gland chromosomes of *Drosophila melanogaster* in exchanges between euchromatin and heterochromatin. *Genetics* 25:534-540.

CHAPTER 15

H. H. BARTLETT. 1915. Mass mutation in *Oenothera pratincola*. *Bot. Gaz.* 60:425-456. — C. B. BRIDGES. 1919. The developmental stages at which mutations occur in the germ tract. *Proc. Soc. Exp. Biol. and Med.* 17:1-2. — M. DEMEREC. 1931. Behaviour of two mutable genes of *Delphinium ajacis*. *J. Genet.* 24:179-193. — M. DEMEREC. 1936. Unstable genes. *Bot. Rev.* 1:233-248. — M. DEMEREC. 1937. Frequency of spontaneous mutations in certain stocks of *Drosophila melanogaster*. *Genetics* 22:469-478. — M. DEMEREC. 1938. Eighteen years of research on the gene. *Carnegie Inst. Wash. Publ.* 501:295-314. — M. DEMEREC. 1941. Unstable genes in *Drosophila*. *Cold Spring Harbor Symposia on Quant. Biol.* 9:145-149. — R. A. EMERSON. 1914. The inheritance of a recurring somatic variation in variegated ears of maize. *Amer. Natur.* 48:87-115. — D. F. JONES. 1936. Mutation rate in somatic cells of maize. *Proc. Nat. Acad. Sci.* 22:645-648. — B. P. KAUFMANN and M. DEMEREC. 1937. Frequency of induced breaks in chromosomes of *Drosophila melanogaster*. *Proc. Nat. Acad. Sci.* 23:484-488. — I. MANTON. 1935. Some new evidence on the physical nature of plant nuclei from intra-specific polyploids. *Proc. Roy. Soc. B* 118:522-547. — T. H. MORGAN and S. C. TICE. 1914. The influence of the environment on the size of expected classes. *Biol. Bull.* 26:213-220. — M. M. RHOADES. 1938. Effect of the *Dt* gene on the mutability of the a_1 allele in maize. *Genetics* 23:377-395. — A. D. SHAMEL, L. B. SCOTT, and S. C. POMEROY. 1918. A study of bud variation in the navel orange. *U.S.D.A. Bull.* 623:1-146. — G. H. SHULL. 1921. Three new mutations in *Oenothera Lamareckiana*. *J. Hered.* 12:354-363. — W. P. SPENCER. 1935. Visible mutations in *Drosophila*. *Amer. Natur.* 69:223-238. — N. W. TIMOFÉEFF-RESSOVSKY. 1934. Über die Vitalität einiger Genmutationen und ihrer Kombinationen bei *Drosophila funebris* und ihre Abhängigkeit von "genotypischen" und von äusseren Milieu. *Zeits. f. indukt. Abstamm.- u. Vererb.-lehre* 66:319-344. — H. P. TRAUB and T. R. ROBINSON. 1937. Improvement of subtropical fruit crops: citrus. *U.S.D.A. Yearbook Agric.* 1937:749-826.

CHAPTER 16

E. ALTENBURG. 1933. The production of mutations by ultra-violet light. *Science* 78:587. — W. H. BRITTINGHAM. 1931. Variations in the evening

primrose induced by radium. *Science* 74:463-464. — M. DEMEREC. 1938. Hereditary effects of X-ray radiation. *Radiology* 30:212-220. — M. DEMEREC, A. HOLLAENDER, M. B. HOULAHAN, and M. BISHOP. 1942. Effect of monochromatic ultra-violet radiation on *Drosophila melanogaster*. *Genetics* 27:139-140. — A. C. FABERGÉ and G. H. BEALE. 1942. An unstable gene in *Portulaca*: mutation rate at different temperatures. *J. Genet.* 43:173-187. — U. FANO and M. DEMEREC. 1941. Measurements of the frequency of dominant lethals induced in sperm of *Drosophila melanogaster* by X-rays. *Genetics* 26:151. — C. G. GAGER and A. F. BLAKESLEE. 1927. Chromosomes and gene mutations in *Datura* following exposure to radium rays. *Proc. Nat. Acad. Sci.* 13:75-79. — Å. GUSTAFSSON. 1938. Studies on the genetic basis of chlorophyll formation and the mechanism of induced mutating. *Hereditas* 24:33-93. — Å. GUSTAFSSON. 1941. Mutation experiments in barley. *Hereditas* 27:225-242. — Å. GUSTAFSSON and E. ÅBERG. 1940. Two extreme X-ray mutations of morphological interest. *Hereditas* 26:257-261. — H. J. MULLER. 1927. Artificial transmutation of the gene. *Science* 66:84-87. — H. J. MULLER. 1927. Quantitative methods in genetic research. *Amer. Natur.* 61:407-419. — H. J. MULLER. 1930. Radiation and genetics. *Amer. Natur.* 64:220-251. — J. T. PATTERSON. 1931. Continuous versus interrupted irradiation and the rate of mutation in *Drosophila*. *Biol. Bull.* 51:133-138. — H. H. PLOUGH. 1939. Temperature in evolution as shown by studies on *Drosophila*. *The Collecting Net* 14:1-6. — J. SCHULTZ. 1936. Radiation and the study of mutation in animals. Chapter XXXIX in *Biological effects of radiation*, Vol. II. New York: McGraw-Hill Book Co. — L. J. STADLER. 1928. Mutations in barley induced by X-rays and radium. *Science* 68:186-187. — L. J. STADLER. 1936. Induced mutations in plants. Chapter XV in *Biological effects of radiation*, Vol. II. New York: McGraw-Hill Book Co. — M. F. STANCATI. 1932. Production of dominant lethal genetic effects by X-radiation of sperm in *Habrobracon*. *Science* 76:197-198. — N. W. TIMOFÉEFF-RESSOVSKY. 1934. The experimental production of mutation. *Biol. Rev.* 9:411-457. — A. R. WHITING. 1945. Effects of X-rays on hatchability and on chromosomes of *Habrobracon* eggs treated in first meiotic prophase and metaphase. *Amer. Natur.* 79:193-227. — A. R. WHITING. 1946. Motherless males from irradiated eggs. *Science* 103:219-220. — P. W. WHITING. 1935. Recent X-ray mutations in *Habrobracon*. *Proc. Pa. Acad. Sci.* 9:60-63. — P. W. WHITING. 1938. The induction of dominant and recessive lethals by radiation in *Habrobracon*. *Genetics* 23:562-572.

CHAPTER 17

E. B. BABCOCK and J. L. COLLINS. 1929. Does natural ionizing radiation control rate of mutation? *Proc. Nat. Acad. Sci.* 15:623-628. — C. B. BRIDGES. 1936. The Bar "gene" a duplication. *Science* 83:210-211. — T. CASPERSSON and J. SCHULTZ. 1938. Nucleic acid metabolism of the chromosomes in relation to gene reproduction. *Nature* 142:294-295. — G. P. CHILD. 1942. Temperature and the differentiation of characters in

Drosophila. *Biol. Symposia* 6:37-49. — M. DEMEREC and M. E. HOOVER. 1939. Hairy wing—a duplication in *Drosophila melanogaster*. *Genetics* 24:271-277. — TH. DOBZHANSKY. 1936. Position effects on genes. *Biol. Rev.* 11:364-384. — N. P. DUBININ. 1936. A new type of position effect. *Biol. Zhurnal* 5:851-874. — N. P. DUBININ and B. N. SIDEROV. 1934. Relation between the effect of a gene and its position in the system. *Amer. Natur.* 67:377-381. — R. GOLDSCHMIDT. 1937. Spontaneous chromatin rearrangements and the theory of the gene. *Proc. Nat. Acad. Sci.* 23:621-623. — F. B. HANSON and F. HEYS. 1930. A possible relation between natural (earth) radiations and gene mutations. *Science* 71:43-44. — H. J. MULLER. 1928. The measurement of the gene mutation rate in *Drosophila*, etc. *Genetics* 13:279-357. — H. J. MULLER and L. M. MOTT-SMITH. 1930. Evidence that natural radioactivity is inadequate to explain the frequency of natural mutations. *Proc. Nat. Acad. Sci.* 16:277-285. — H. H. PLOUGH. 1941. Spontaneous mutability in *Drosophila*. *Cold Spring Harbor Symposium on Quant. Biol.* 9:127-136. — H. H. PLOUGH. 1942. Temperature and evolution. Temperature and spontaneous mutation. *Biol. Symposium* 6:3-20. — H. H. PLOUGH and P. T. IVES. 1935. Induction of mutation by high temperature in *Drosophila*. *Genetics* 20:42-69. — M. M. RHOADES. 1941. The genetic control of mutability in maize. *Cold Spring Harbor Symposium on Quant. Biol.* 9:138-144.

CHAPTER 18

S. S. ATWOOD. 1944. Oppositional alleles in natural populations of *Trifolium repens*. *Genetics* 29:428-435. — F. BRIEGER and A. J. MANGELSDORF. 1927. Linkage between morphological characters and factors for self-sterility. *Hort. Soc. New York Memoir* 3:369-371. — W. E. CASTLE. 1896. The early embryology of *Ciona intestinalis* Flemming (L.). *Bull. Museum Comp. Zool. Harvard Univ.* 27:201-280. — E. M. EAST. 1929. Self-sterility. *Bibliogr. Genet.* 5:331-370. — E. M. EAST. 1940. The distribution of self-sterility in the flowering plants. *Proc. Amer. Philos. Soc.* 82:449-518. — E. M. EAST and A. J. MANGELSDORF. 1925. A new interpretation of the hereditary behavior of self-sterile plants. *Proc. Nat. Acad. Sci.* 11:166-171. — E. M. EAST and J. B. PARK. 1918. Studies on self-sterility II. Pollen-tube growth. *Genetics* 3:353-366. — E. M. EAST and S. H. YARNELL. 1929. Studies on self-sterility VIII. Self-sterility allelomorphs. *Genetics* 14:455-487. — S. EMERSON. 1939. A preliminary survey of the *Oenothera organensis* population. *Genetics* 24:524-537. — H. DE HAAN. 1932. The symbolizing of hereditary factors. *Genetica* 15:1-21. — C. E. KEELER and V. COBB. 1933. Allelomorphism of silver and Siamese coat variations in the domestic cat. *J. Hered.* 24:181-184. — J. G. KOELREUTER. 1761-1766. *Vorläufige Nachricht von einigen des Geschlecht der Pflanzen betreffenden Versuchen und Beobachtung, nebst Fortsetzungen*. Ostwald's Klassiker, Nr. 41. Leipzig: Engelmann. — D. LEWIS. 1943. The physiology of incompatibility in plants. II. *Linum grandiflorum*. *Ann. Bot.* 7:115-122. — H. PRELL. 1921. Das Problem der Unbefruchtbarkeit. *Naturw. Wschr.* 20:440-446. — H. P. RILEY.

1932. Self-sterility in shepherd's purse. *Genetics* 17:231-295.—— A. B. STOUT. 1938. The genetics of incompatibilities in homomorphic flowering plants. *Bot. Rev.* 4:275-369.—— A. B. STOUT. 1945. Classes and types of intraspecific incompatibilities. *Amer. Natur.* 79:481-508.—— R. D. WILLIAMS. 1941. Incompatibility alleles in *Trifolium pratense* L.; their frequency and linkage relationships. *Proc. VII Internat. Cong. Genetics*: 316.

CHAPTER 19

W. C. BOYD *et al.* 1946. Blood grouping. *Ann. New York Acad. Sci.* 46: 883-992.—— W. E. CASTLE and C. E. KEELER. 1933. Blood group inheritance in the rabbit. *Proc. Nat. Acad. Sci.* 19:92-100.—— R. A. FISHER. 1947. The rhesus factor. *Amer. Scientist* 35:95.—— W. GAMMELGAARD and P. V. MARCUSSEN. 1940. Nachweis eines vierten allelomorphen A-Gene (A_4). *Z. Immunitätsforsch.* 98:411-419.—— K. LANDSTEINER and A. S. WIENER. 1940. An agglutinable factor in human blood recognized by immune sera for rhesus blood. *Proc. Soc. Exp. Biol. Med.* 43:223.—— K. LANDSTEINER and A. S. WIENER. 1941. Studies on an agglutinin (Rh) in human blood reacting with anti-rhesus sera and with human isoantibodies. *J. Exp. Med.* 74:309-320.—— P. LEVINE, L. BURNHAM, E. M. KATZIN, and P. VOGEL. 1941. The role of isoimmunization in the pathogenesis of erythroblastosis fetalis. *Amer. J. Obstet. and Gynec.* 42:925.—— P. LEVINE, E. M. KATZIN, and L. BURNHAM. 1941. Isoimmunization in pregnancy. *J. Amer. Med. Assoc.* 116:825-827.—— P. LEVINE and R. E. STETSON. 1939. An unusual case of intragroup agglutination. *J. Amer. Med. Assoc.* 113:126-127.—— R. R. RACE and G. L. TAYLOR. 1943. A serum that discloses the genotype of some Rh-positive people. *Nature* 152: 300.—— R. R. RACE, G. L. TAYLOR, E. W. IKIN, and A. M. PRIOR. 1944. The inheritance of allelomorphs of the Rh gene in fifty-six families. *Ann. Eug.* 12:206-210.—— L. H. SNYDER, M. D. SCHONFELD, and E. M. OFFERMAN. 1945. The Rh factor and feeble-mindedness. Studies in human inheritance, XXVI. *J. Hered.* 36:9-10.—— C. STERN and D. R. CHARLES. 1945. The rhesus gene and the effect of consanguinity. *Science* 101:305-307.—— H. H. STRANDSKOV. 1941. The distribution of human genes. *Sci. Monthly* 52:203-215.—— O. THOMSEN. 1932. Über die A_1 - und A_2 -Receptoren in der sogenannten A-Gruppe. *Acta. Soc. med. fenn. duodecim.* A15:1-17.—— A. S. WIENER. 1943. Genetic theory of the Rh blood types. *Proc. Soc. Exp. Biol. Med.* 54:316-319.—— A. S. WIENER. 1944. The Rh series of allelic genes. *Science* 100:595-597.—— A. S. WIENER. 1946. Recent advances in knowledge of the Rh blood factors, with special reference to clinical applications. *The Lab. Digest*, June, 1946:1-12.—— A. S. WIENER, I. DAVIDSOHN, and E. L. POTTER. 1945. Heredity of the Rh blood types II. *J. Exp. Med.* 81:63-72.—— A. S. WIENER and H. E. KAROWE. 1944. Diagrammatic representations of the human blood-group reactions. *J. Immunol.* 49:5-61.—— A. S. WIENER, E. B. SONN, and R. B. BELKIN. 1944. Heredity of the Rh blood types. *J. Exp. Med.* 79:235-253.—— A. S. WIENER, E. B. SONN, and H. R. POLIVKA. 1946. Heredity of the Rh blood types, V. *Proc. Soc. Exp. Biol. Med.* 61:382-390.

CHAPTER 20

- S. S. ATWOOD and J. T. SULLIVAN. 1943. Inheritance of a cyanogenetic glucoside and its hydrolyzing enzyme in *Trifolium repens*. *J. Hered.* 34: 311-320. — G. W. BEADLE. 1945. Biochemical genetics. *Chem. Rev.* 37:15-96. — G. W. BEADLE and B. EPHRUSSI. 1936. The differentiation of eye pigments in *Drosophila* as studied by transplantation. *Genetics* 21: 225-247. — G. W. BEADLE and E. L. TATUM. 1941. Genetic control of developmental reactions. *Amer. Natur.* 75:107-116. — C. W. CLANCY. 1942. The development of eye color in *Drosophila melanogaster*. Further studies on the mutant claret. *Genetics* 27:417-440. — E. G. CONKLIN. 1897. The embryology of *Crepidula*. *J. Morph.* 13:1-226. — E. G. CONKLIN. 1938. Disorientations of development in *Crepidula plana* produced by low temperatures. *Proc. Amer. Philos. Soc.* 79:179-211. — M. DEMEREC. 1935. Behavior of chlorophyll in inheritance. *Cold Spring Harbor Symposium on Quant. Biol.* 3:80-86. — C. DIVER, A. E. BOYCOTT, and S. GARSTANG. 1925. The inheritance of inverse symmetry in *Limnaea peregra*. *J. Genet.* 15:113-200. — B. O. DODGE. 1942. A study of the inheritance of the factors for heterocaryotic vigor in *Neurospora tetrasperma*. *Amer. Philos. Soc. Year Book*, 1942:148-150. — A. FREY-WYSSLING and F. BLANK. 1943. Untersuchungen über die Physiologie des Anthocyanins in Keimlingen von *Brassica oleracea* L. var. *capitata* L. f. *rubra* (L.). *Ber. Schweiz. Bot. Gesell.* 53A:550-578. — A. J. KAVANAGH and O. W. RICHARDS. 1942. Mathematical analysis of the relative growth of organisms. *Proc. Rochester (N. Y.) Acad. Sci.* 8:150-174. — W. J. C. LAWRENCE and J. R. PRICE. 1940. The genetics and chemistry of flower colour variation. *Biol. Rev.* 15:35-58. — W. J. C. LAWRENCE and R. SCOTT-MONCRIEFF. 1935. The genetics and chemistry of flower color in dahlia; a new theory of specific pigmentation. *J. Genet.* 30:155-226. — W. J. C. LAWRENCE, R. SCOTT-MONCRIEFF, and V. C. STURGESS. 1939. Studies on *Streptocarpus* I. *J. Genetics* 38:299-306. — H. ONSLOW. 1915. A contribution to our knowledge of the chemistry of coat-colour in animals and of dominant and recessive whiteness. *Proc. Roy. Soc.* B 89:36-58. — J. VAN OVERBEEK. 1935. The growth hormone and the dwarf type of growth in corn. *Proc. Nat. Acad. Sci.* 21:292-299. — J. VAN OVERBEEK. 1938. "Laziness" in maize due to abnormal distribution of growth hormone. *J. Hered.* 29:339-341. — E. W. SINNOTT. 1936. A developmental analysis of inherited shape differences in cucurbit fruits. *Amer. Natur.* 70:245-254. — E. W. SINNOTT. 1937. The genetic control of developmental relationships. *Amer. Natur.* 71:113-119. — E. W. SINNOTT. 1944. Cell polarity and the development of form in cucurbit fruit. *Amer. J. Bot.* 31:388-391. — A. H. STURTEVANT. 1923. Inheritance of direction of coiling in *Limnaea*. *Science* 58:269-270. — E. L. TATUM. 1939. Development of eye-colors in *Drosophila*: bacterial synthesis of *v+* hormone. *Proc. Nat. Acad. Sci.* 25:486-490. — E. L. TATUM and G. W. BEADLE. 1942. The relation of genetics to growth-factors and hormones. *Fourth Growth Symposium*: 27-35. — E. L. TATUM and D. M. BONNER. 1943. Synthesis of tryptophane from in-

dole and serine by *Neurospora*. *J. Biol. Chem.* 151:349. — W. G. WHALEY and C. Y. WHALEY. 1942. A developmental analysis of inherited leaf patterns in *Tropaeolum*. *Amer. J. Bot.* 29:195-200. — R. D. WILLIAMS. 1939. Genetics of chlorophyll deficiencies in red clover. II. *J. Genet.* 37:459-482. — S. WRIGHT. 1916. An intensive study of the inheritance of color and of other coat characters in guinea-pigs. *Carnegie Inst. Wash. Publ.* 241:57-160. — S. WRIGHT. 1945. Genes as physiological agents. *Amer. Natur.* 79:289-303. — S. WRIGHT. 1945. Physiological aspects of genetics. *Amer. Rev. Physiol.* 7:75-106.

CHAPTER 21

W. BATESON and R. C. PUNNETT. 1906. Comb characters. *Rep. to Evol. Com. Roy. Soc.* II:11-16. — W. BATESON, E. R. SAUNDERS, and R. C. PUNNETT. 1905. Sweet pea (*Lathyrus odoratus*). *Rep. to Evol. Com. Roy. Soc.* II:80-99. — E. BAUR. 1910. Vererbungs- und Bastardierungsversuche mit *Antirrhinum*. *Zeits. f. indukt. Abstamm.- u. Vererb-lehre* 3:34-98. — A. F. BLAKESLEE. 1921. A chemical method of distinguishing genetic types of yellow cones in *Rudbeckia*. *Zeits. f. indukt. Abstamm.- u. Vererb-lehre* 25:211-221. — M. DEMEREC. 1929. Genetic factors stimulating mutability of miniature-gamma wing character of *Drosophila virilis*. *Proc. Nat. Acad. Sci.* 15:834-838. — E. M. EAST. 1927. The inheritance of heterostyly in *Lythrum salicaria*. *Genetics* 12:393-414. — R. A. FISHER and K. MATHER. 1940. Non-lethality of the mid factor in *Lythrum salicaria*. *Nature* 146:421. — R. P. GREGORY, D. DEWINTON, and W. BATESON. 1923. Genetics of *Primula sinensis*. *J. Genet.* 13:219-253. — P. R. HADLEY. 1913. Studies of inheritance in poultry. I. The constitution of the White Leghorn breed. *Rhode Island Agric. Exp. Sta. Bull.* 155:151-216. — P. F. KNOWLES. 1943. A second factor for awn barbing in durum wheat. *Can. J. Res., Ser. C* 21:198-204. — K. MIYAKE and Y. IMAI. 1922. Genetic studies in barley I. *Bot. Mag. (Tokyo)* 36:25-38. (Japanese with English summary.) — H. NILSSON-EHLE. 1908. Einige Ergebnisse von Kreuzungen bei Hafer und Weizen. *Botaniska Notiser.* 1908:257-294. — G. H. SHULL. 1908. A new Mendelian ratio and several types of latency. *Amer. Natur.* 42:432-451. — G. H. SHULL. 1914. Duplicate genes for capsule form in *Bursa bursa-pastoris*. *Zeits. f. indukt. Abstamm.- u. Vererb-lehre* 12:97-149. — G. H. SHULL. 1926. "Old-gold" flower color, the second case of independent inheritance in *Oenothera*. *Genetics* 11:201-234. — E. W. SINNOTT and G. H. DURHAM. 1922. Inheritance in the summer squash. *J. Hered.* 13:177-186.

CHAPTER 22

W. E. CASTLE. 1919. Piebald rats and the theory of genes. *Proc. Nat. Acad. Sci.* 5:126-130. — W. E. CASTLE. 1941. Size inheritance. *Amer. Natur.* 75:488-498. — W. E. CASTLE. 1942. Size genes in mice. *Proc. Nat. Acad. Sci.* 28:69-72. — W. E. CASTLE and P. W. GREGORY. 1929. The embryological basis of size inheritance in the rabbit. *J. Morph. and*

Physiol. 48:81-102. — D. R. CHARLES and H. H. SMITH. 1939. Distinguishing between two types of gene action in quantitative inheritance. *Genetics* 24:34-48. — E. M. EAST. 1910. A Mendelian interpretation of variation that is apparently continuous. *Amer. Natur.* 44:65-82. — E. M. EAST. 1916. Inheritance in crosses between *Nicotiana Langsdorffii* and *Nicotiana glauca*. *Genetics* 1:311-333. — E. M. EAST and H. K. HAYES. 1911. Inheritance in maize. *Conn. Agric. Exp. Sta. Bull.* 167:1-142. — A. L. HAGEDOORN and A. C. HAGEDOORN. 1914. Studies on variation and selection. *Zeits. f. indukt. Abstamm.- u. Vererb-lehre* 11:145-183. — F. A. HAYS. 1944. The significance of inherited characters affecting egg production. *Poultry Sci.* 23:310-313. — A. LANG. 1911. Fortgesetzte Vererbungsstudien. II. Die Hautfarbe der Mulatten und die Hypothese der Polymerie. *Zeits. f. indukt. Abstamm.- u. Vererb-lehre* 5:111-127. — K. MATHER. 1943. Polygenic inheritance and natural selection. *Biol. Rev.* 18:32-64. — K. SAX. 1923. The association of size differences with seed coat pattern and pigmentation in *Phaseolus vulgaris*. *Genetics* 8:552-560. — G. H. SHULL. 1921. Estimating the number of genetic factors concerned in blending inheritance. *Amer. Natur.* 55:556-564. — H. H. SMITH. 1937. The relation between genes affecting size and color in certain species of *Nicotiana*. *Genetics* 22:361-375. — S. WRIGHT. 1932. General, group and special size factors. *Genetics* 17:603-619.

CHAPTER 23

E. ASHBY. 1937. Studies in the inheritance of physiological characters. III. *Ann. Bot.* 1:11-41. — W. H. BLACK. 1936. Beef and dual-purpose cattle breeding. *U.S.D.A. 1936 Yearbook Agric.*: 863-886. — J. T. BUCHHOLZ. 1945. Embryological aspects of hybrid vigor in pines. *Science* 102:135-142. — C. B. DAVENPORT, H. R. HUNT, and G. H. SHULL. 1929. Should cousins marry? *Eugenics* 2:2-3. — TH. DOBZHANSKY. 1943. Heterosis. *Revista de Agricultura* 18:397-398. — E. M. EAST. 1909. The transmission of variations in the potato in asexual reproduction. *Conn. Exper. Sta. Rep.* 1909-1910:119-160. — E. M. EAST. 1910. The role of selection in plant breeding. *Pop. Sci. Monthly*, August, 1910:190-203. — E. M. EAST. 1936. Heterosis. *Genetics* 21:375-397. — E. M. EAST and H. K. HAYES. 1912. Heterozygosis in evolution and in plant breeding. *U.S.D.A. Bull.* 243:1-58. — R. A. EMERSON and E. M. EAST. 1913. The inheritance of quantitative characters in maize. *Neb. Agric. Exp. Sta. Res. Bull.* 2:1-120. — J. R. FRYER. 1939. The maternal-line selection method of breeding for increased seed-setting in alfalfa. *Sci. Agric.* 20:131-139. — Å. GUSTAFSSON. 1946. The effect of heterozygosity on variability and vigour. *Hereditas* 32:263-286. — F. A. HAYS and R. SANBORN. 1939. Breeding for egg production. *Mass. Agric. Exp. Sta. Bull.* 307 (revised): 1-36. — C. G. HOPKINS, L. H. SMITH, and E. M. EAST. 1905. Directions for the breeding of corn, including methods for the prevention of inbreeding. *Ill. Agric. Exp. Sta. Bull.* 100:600-626. — D. F. JONES. 1917. Dominance of linked factors as a means of accounting for heterosis. *Genetics* 2:466-479. — D. F. JONES. 1918. The effects of inbreeding

and crossbreeding upon development. *Conn. Agric. Exp. Sta. Bull.* 207:1-100. — D. F. JONES. 1939. Continued inbreeding in maize. *Genetics* 24:462-473. — M. A. JULL. 1936. Superior breeding stock in poultry. *U.S.D.A. 1936 Yearbook Agric.*: 947-995. — G. MORRISON. 1940. The fundamentals of seed breeding. *Nat. Seedsman*, February, 1940. — G. E. MORROW and F. D. GARDNER. 1894. Experiments with corn. *Ill. Agric. Exp. Sta. Bull.* 31:333-360. — F. NILSSON. 1934. Studies in fertility and inbreeding in some herbage grasses. *Hereditas* 19:1-162. — G. H. SHULL. 1908. The composition of a field of maize. *Rept. Amer. Breeders' Assoc.* 4:296-301. — G. H. SHULL. 1909. A pure line method of corn breeding. *Rept. Amer. Breeders' Assoc.* 5:51-59. — G. H. SHULL. 1910. Hybridization methods in corn breeding. *Amer. Breeders' Mag.* 1:98-107. — G. H. SHULL. 1922. Ueber die Heterozygotie mit Rücksicht auf den praktischen Züchtungserfolg. *Beiträge zur Pflanzenzucht* 5:1-24. — W. R. SINGLETON. 1941. Hybrid vigor and its utilization in sweet corn breeding. *Amer. Natur.* 75:48-60. — D. G. STEELE. 1944. A genetic analysis of recent thoroughbreds, standardbreds, and American saddle horses. *Ky. Agric. Exp. Sta. Bull.* 462:1-27. — A. B. STOUT. 1929. The clone in plant life. *J. N. Y. Bot. Gard.* 30:25-37. — W. G. WHALEY. 1944. Heterosis. *Bot. Rev.* 10:461-498. — S. WRIGHT. 1922. The effects of inbreeding and crossbreeding on guinea pigs. I. and II. *U.S.D.A. Bull.* 1090:1-63. — S. H. YARNELL and L. R. HAWTHORN. 1938. Breeding tomatoes to extend the fruiting season. *Proc. Amer. Soc. Hort. Sci.* 1938:585-589.

CHAPTER 24

A. D. BERGNER. 1943. Chromosomal interchange among six species of *Datura* in nature. *Amer. J. Bot.* 30:431-440. — A. F. BLAKESLEE. 1941. Chromosomal interchanges, pp. 37-46 in *Cytology, Genetics, and Evolution*. Philadelphia: University of Pennsylvania Press. — A. F. BLAKESLEE. 1941. Annual Report of Director of the Department of Genetics. *Carnegie Inst. Wash. Year Book* 40:211-225. — A. F. BLAKESLEE and R. E. CLELAND. 1930. Circle formation in *Datura* and *Oenothera*. *Proc. Nat. Acad. Sci.* 16:177-183. — R. A. BRINK. 1927. The occurrence of semi-sterility in maize. *J. Hered.* 18:266-269. — C. R. BURNHAM. 1930. Genetical and cytological studies of semisterility and related phenomena in maize. *Proc. Nat. Acad. Sci.* 16:269-277. — H. B. CREIGHTON. 1934. Three cases of deficiency in chromosome 9 of *Zea mays*. *Proc. Nat. Acad. Sci.* 20:111-115. — TH. DOBZHANSKY and A. H. STURTEVANT. 1938. Inversions in the chromosomes of *Drosophila pseudoobscura*. *Genetics* 23:28-64. — A. C. FABERGÉ. 1940. An experiment on chromosome fragmentations in *Tradescantia* by X-rays. *J. Genet.* 39:229-248. — A. E. GAIRDNER and C. D. DARLINGTON. 1930. Structural variation in the chromosomes of *Campanula persicifolia*. *Nature*, January 18, 1930:1-4. — N. GILES. 1940. Spontaneous chromosome aberrations in *Tradescantia*. *Genetics* 25:69-87. — L. HUSTED. 1937. Chromosome breakage and knot formation in *Paris* and *Pancreatium*. *J. Genet.* 34:329-338. — B. McCLINTOCK. 1931. Cytological observations of deficiencies involving known genes, trans-

locations, and an inversion in *Zea mays*. *Univ. Mo. Res. Bull.* 163:3-30. — B. McCLINTOCK. 1938. The production of homozygous deficient tissue with mutant characteristics by means of the aberrant mitotic behavior of ring-shaped chromosomes. *Genetics* 23:315-376. — B. McCLINTOCK. 1938. The fusion of broken ends of sister half-chromatids following chromatid breakage at meiotic anaphases. *Univ. Mo. Res. Bull.* 290:1-48. — B. McCLINTOCK. 1941. The association of mutants with homozygous deficiencies in *Zea mays*. *Genetics* 26:542-571. — K. MATHER. 1934. The behaviour of meiotic chromosomes after X-irradiation. *Hereditas* 19:303-322. — A. MÜNTZING. 1934. Chromosome fragmentation in a *Crepis* hybrid. *Hereditas* 19:284-302. — L. F. RANDOLPH. 1941. Genetic characteristics of the B chromosomes in maize. *Genetics* 26:608-631. — C. M. RICK. 1940. On the nature of X-ray induced deletions in *Tradescantia* chromosomes. *Genetics* 25:466-482. — K. SAX. 1931. Chromosome ring formation in *Rhoeo discolor*. *Cytologia* 3:36-53. — K. SAX. 1938. Chromosome aberrations induced by X-rays. *Genetics* 23:494-516. — L. J. STADLER. 1933. On the genetic nature of induced mutations in plants II. A haplo-viable deficiency in maize. *Univ. Mo. Res. Bull.* 204:3-29. — E. SUTTON. 1935. Half-deficiencies in an association of four chromosomes in *Pisum sativum*. *Ann. Bot.* 49:689-698. — E. SUTTON. 1940. Terminal deficiencies in the X chromosome of *Drosophila melanogaster*. *Genetics* 25:628-635. — C. R. SWANSON. 1940. The distribution of inversions in *Tradescantia*. *Genetics* 25:438-465. — T. W. WHITAKER. 1936. Fragmentation in *Tradescantia*. *Amer. J. Bot.* 23:517-519. — M. J. D. WHITE. 1937. The effect of X-rays on the first meiotic division in three species of Orthoptera. *Proc. Roy. Soc. (London)*, Ser. B 124:183-196.

CHAPTER 25

J. BELLING and A. F. BLAKESLEE. 1924. The configurations and sizes of the chromosomes in the trivalents of 25-chromosome *Daturas*. *Proc. Nat. Acad. Sci.* 10:116-120. — A. F. BLAKESLEE. 1921. The Globe, a simple trisomic mutant in *Datura*. *Proc. Nat. Acad. Sci.* 7:148-152. — A. F. BLAKESLEE. 1924. Distinction between primary and secondary chromosomal mutants in *Datura*. *Proc. Nat. Acad. Sci.* 10:109-116. — A. F. BLAKESLEE. 1928. Genetics of *Datura*. *Verh. V. Internat. Kong. Vererb.* 1:117-130. — A. F. BLAKESLEE and A. G. AVERY. 1938. Fifteen-year breeding records of $2n + 1$ types in *Datura stramonium*. Cooperation in Research, *Carnegie Inst. Wash. Publ.* 501:315-351. — A. F. BLAKESLEE and M. E. FARNHAM. 1923. Trisomic inheritance in the Poinsettia mutant of *Datura*. *Amer. Natur.* 57:481-495. — C. B. BRIDGES. 1916. Non-disjunction as proof of the chromosome theory of heredity. *Genetics* 1:1-52; 107-163. — C. B. BRIDGES. 1921. Genetical and cytological proof of non-disjunction of the fourth chromosome of *Drosophila melanogaster*. *Proc. Nat. Acad. Sci.* 7:182-192. — D. G. CATCHESIDE. 1936. Origin, nature and breeding behavior of *Oenothera Lamarckiana* trisomies. *J. Genet.* 33:1-23. — D. G. CATCHESIDE. 1937. The extra chromosome of

Oenothera Lamarckiana lata. *Genetics* 22:564-576. — R. E. CLAUSEN. 1941. Monosomic analysis in *Nicotiana Tabacum*. *Genetics* 26:145. — A. D. CONGER. 1940. Chromosome deficiencies in microspores of *Tradescantia*. *J. Hered.* 31:339-341. — C. E. FORD. 1936. Non-disjunction in *Oenothera* and the genesis of trisomics. *J. Genet.* 33:275-303. — W. E. LAMMERTS. 1932. Inheritance of monosomics in *Nicotiana rustica*. *Genetics* 17:689-696. — W. J. C. LAWRENCE. 1931. The genetics and cytology of *Dahlia variabilis*. *J. Genet.* 24:257-306. — B. McCLINTOCK. 1929. A $2n - 1$ chromosomal chimera in maize. *J. Hered.* 20:218. — H. P. OLMO. 1936. Cytological studies of monosomics and derivative types of *Nicotiana tabacum*. *Cytologia* 7:143-159. — M. M. RHOADES. 1940. Studies of a telocentric chromosome in maize with reference to the stability of its centromere. *Genetics* 25:483-520.

CHAPTER 26

E. ANDERSON. 1937. Cytology in its relation to taxonomy. *Bot. Rev.* 3:335-350. — E. ANDERSON and K. SAX. 1936. A cytological monograph of the American species of *Tradescantia*. *Bot. Gaz.* 97:433-476. — F. BALTZER. 1922. Über die Herstellung und Aufzucht eines haploiden *Triton taeniatus*. *Verh. Schweiz. Natf. Ges.* (Bern): 248-249. — R. BAMFORD and F. B. WINKLER. 1941. A spontaneous tetraploid snapdragon. *J. Hered.* 32:217-218. — J. M. BELLOWES, JR., and R. BAMFORD. 1941. Megagametophyte development in a triploid tulip. *Bot. Gaz.* 102:699-711. — A. D. BERGNER. 1944. Chromosome associations in tetraploid hybrids between Prime Type 1 and Prime Type 2 in *Datura stramonium*. *Proc. Nat. Acad. Sci.* 30:302-308. — J. E. BIRDSALL and K. W. NEATBY. 1944. Researches on drought resistance in spring wheat. III. *Canad. J. Res.* 22:38-51. — A. F. BLAKESLEE, J. BELLING, M. E. FARNHAM, and A. D. BERGNER. 1922. A haploid mutant in the Jimson weed, *Datura stramonium*. *Science* 55:646-647. — A. F. BLAKESLEE and H. E. WARMKE. 1938. Size of seed and other criteria of polyploids. *Science* 88:440. — R. A. BRINK and D. C. COOPER. 1944. The antipodals in relation to abnormal endosperm behavior in *Hordeum jubatum* \times *Secale cereale* hybrid seeds. *Genetics* 29:391-406. — M. S. BROWN. 1943. Haploid plants in sorghum. *J. Hered.* 34:162-166. — H. M. CHRISTENSEN and R. BAMFORD. 1943. Haploids in twin seedlings of pepper. *J. Hered.* 34:98-104. — D. C. COOPER and R. A. BRINK. 1944. Collapse of the seed following the mating of *Hordeum jubatum* \times *Secale cereale*. *Genetics* 29:370-390. — C. D. DARLINGTON. 1929. Chromosome behavior and structural hybridity in the *Tradescantia*e. *J. Genet.* 21:207-286. — C. D. R. DAWSON. 1941. Tetrasomic inheritance in *Lotus corniculatus* L. *J. Genet.* 42:49-73. — G. FANKHAUSER. 1938. The microscopical anatomy of metamorphosis in a haploid salamander, *Triton taeniatus* Laur. *J. Morph.* 62:393-413. — G. FANKHAUSER. 1941. Cell size, organ and body size in triploid newts (*Triturus viridescens*). *J. Morph.* 68:161-177. — H. KIHARA and Y. KATAYAMA. 1933. Reifungsteilungen bei dem haploiden *Triticum monococcum*. *Agric. and Hort.* (Japan) 8:1-17. German summary. — E. KING. 1933. Chromosome

behavior in a triploid *Tradescantia*. *J. Hered.* 24:252-256. — W. E. LAMMERTS. 1934. On the nature of chromosome association in *N. tabacum* haploids. *Cytologia* 6:38-50. — A. LEVAN. 1941. Syncyte formation in the pollen mother-cells of haploid *Phleum pratense*. *Hereditas* 27:243-252. — E. W. LINDSTROM and L. M. HUMPHREY. 1933. Comparative cyto-genetic studies of tetraploid tomatoes from different origins. *Genetics* 18:193-209. — I. MANTON. 1934. The problem of *Biscutella laevigata* L. *Zeits. f. indukt. Abstamm.- u. Vererb-lchre* 67:41-57. — A. MÜNTZING. 1936. The chromosomes of a giant *Populus tremula*. *Hereditas* 21:383-393. — A. MÜNTZING. 1937. The effects of chromosomal variation in *Dactylis*. *Hereditas* 23:113-235. — A. MÜNTZING. 1938. Note on heteroploid twin plants from eleven genera. *Hereditas* 24:487-491. — W. M. MYERS. 1944. The randomness of chromosome distribution at anaphase I in autotriploid *Lolium perenne* L. *Bull. Torr. Bot. Club* 71:144-151. — M. NAVASHIN. 1925. Polyploid mutations in *Crepis*. *Genetics* 10:583-592. — M. M. RICHARDSON. 1935. *Setcreasia brevifolia*, a further example of polyploidy and structural hybridity in the *Tradescantiae*. *Bot. Gaz.* 97:399-407. — S. SATINA, A. F. BLAKESLEE, and A. G. AVERY. 1937-1938. Chromosome behavior in triploid *Datura*. I, II, and III. *Amer. J. Bot.* 24:518-527; 621-627 and 25:595-602. — H. J. SAX. 1938. The relation between stomata counts and chromosome number. *J. Arnold Arboretum* 19:437-441. — K. SAX. 1937. Chromosome behavior and nuclear development in *Tradescantia*. *Genetics* 22:523-533. — K. SAX and J. M. BEAL. 1934. Chromosomes of the Cycadales. *J. Arnold Arboretum* 15:255-258. — K. SAX and H. J. SAX. 1933. Chromosome number and morphology in the conifers. *J. Arnold Arboretum* 14:356-375. — E. R. SEARS. 1939. Cytogenetic studies with polyploid species of wheat. I. *Genetics* 24:509-523. — H. H. SMITH. 1943. Studies on induced heteroploids of *Nicotiana*. *Amer. J. Bot.* 30:121-130. — W. P. THOMPSON and D. JOHNSTON. 1945. The cause of incompatibility between barley and rye. *Canad. J. Res., Sec. C* 23:1-15. — J. J. WESTFALL. 1940. Cytological studies of *Lilium tigrinum*. *Bot. Gaz.* 101:550-581. — M. W. WOODS. 1937. Meiotic studies in triploid *Tulipa* with special reference to bridging and fragmentation. *Bot. Gaz.* 99:103-115.

CHAPTER 27

J. O. BEASLEY. 1940. The origin of American tetraploid *Gossypium* species. *Amer. Natur.* 74:285-286. — J. O. BEASLEY. 1942. Meiotic chromosome behavior in species, species hybrids, haploids, and induced polyploids of *Gossypium*. *Genetics* 27:25-54. — K. B. BLACKBURN. 1925. Chromosomes and classification in the genus *Rosa*. *Amer. Natur.* 59:200-205. — B. H. BUXTON and C. D. DARLINGTON. 1931. Behaviour of a new species, *Digitalis mertonensis*. *Nature* 127:94. — D. G. CATCHESIDE. 1937. Secondary pairing in *Brassica oleracea*. *Cytologia*. Fujii Jubilee Vol.: 366-378. — J. CLAUSEN. 1933. Cytological evidence for the hybrid origin of *Penstemon neotericus* Keck. *Hereditas* 18:65-76. R. E. CLAUSEN. 1941. Polyploidy in *Nicotiana*. *Amer. Natur.* 75:291-306.

——— W. H. GREENLEAF. 1941. Sterile and fertile amphidiploids. *Genetics* 26:301-324. ——— L. HOLLINGSHEAD. 1930. Cytological investigations of hybrids and hybrid derivatives of *Crepis capillaris* and *Crepis tectorum*. *Univ. Calif. Pub. in Agric.* 6:55-94. ——— C. C. HURST. 1928. Differential polyploidy in the genus *Rosa* L. *V. Internat. Kong. Vererbungswiss.* 2:866-906. ——— C. L. HUSKINS. 1930. The origin of *Spartina Townsendii*. *Genetica* 12:531-538. ——— G. D. KARPECHENKO. 1928. Polyploid hybrids of *Raphanus sativus* L. \times *Brassica oleracea* L. *Zeits. f. indukt. Abstamm.-u. Vererb-lehre* 48:1-85. ——— W. J. C. LAWRENCE. 1931. The secondary association of chromosomes. *Cytologia* 2:352-384. ——— A. MÜNTZING. 1938. Sterility and chromosome pairing in intraspecific *Galeopsis* hybrids. *Hereditas* 24:117-188. ——— A. MÜNTZING. 1939. Studies on the properties and the ways of production of rye-wheat amphidiploids. *Hereditas* 25:387-430. ——— A. MÜNTZING and R. PRAKKEN. 1940. The mode of chromosome pairing in *Phleum* twins with 63 chromosomes and its cytogenetic consequences. *Hereditas* 26:463-501. ——— W. C. F. NEWTON and C. PELLEW. 1929. *Primula kewensis* and its derivatives. *J. Genet.* 20:405-467. ——— K. SAX. 1935. The cytological analysis of species hybrids. *Bot. Rev.* 1:100-117. ——— E. R. SEARS. 1941. Chromosome pairing and fertility in hybrids and amphidiploids in the *Triticinae*. *Mo. Agric. Exp. Sta. Res. Bull.* 337:3-20. ——— A. SKOVSTED. 1937. Cytological studies in cotton. IV. Chromosome configurations in interspecific hybrids. *J. Genet.* 34:97-134. ——— G. L. STEBBINS, H. A. TOBGY, and J. R. HARLAN. 1944. The cytogenetics of hybrids in *Bromus*. II. *Proc. Calif. Acad. Sci.*, 4th Ser. 25:307-322. ——— S. H. YARNELL. 1931. A study of certain polyploid and aneuploid forms in *Fragaria*. *Genetics* 16:455-489.

CHAPTER 28

C. A. BERGER. 1944. Experimental studies on the cytology of *Allium*. *Torreyia* 44:41. ——— A. F. BLAKESLEE and A. G. AVERY. 1937. Methods of inducing doubling of chromosomes in plants. *J. Hered.* 28:392-411. ——— A. F. BLAKESLEE, A. D. BERGNER, S. SATINA, and E. W. SINNOTT. 1939. Induction of periclinal chimaeras in *Datura stramonium* by colchicine treatment. *Science* 89:402. ——— H. DERMEN. 1940. Colchicine polyploidy and technique. *Bot. Rev.* 6:599-635. ——— H. DERMEN. 1945. The mechanism of colchicine-induced cytohistological changes in cranberry. *Amer. J. Bot.* 32:397-394. ——— O. J. EIGSTI. 1938. A cytological study of colchicine effects in the induction of polyploidy in plants. *Proc. Nat. Acad. Sci.* 24:56-63. ——— G. FANKHAUSER and R. C. WATSON. 1942. Heat-induced triploidy in the newt, *Triturus viridescens*. *Proc. Nat. Acad. Sci.* 28:436-440. ——— W. H. GREENLEAF. 1938. Induction of polyploidy in *Nicotiana*. *J. Hered.* 29:450-464. ——— R. B. GRIFFITHS. 1941. Triploidy (and haploidy) in the newt, *Triturus viridescens*, induced by refrigeration of fertilized eggs. *Genetics* 26:69-88. ——— E. HIGBEE. 1940. Some results of colchicine injections. *Science* 92:80. ——— C. A. JORGENSEN. 1928. The experimental formation of heteroploid plants in the genus *Solanum*. *J. Genet.* 19:133-211. ——— A. LEVAN. 1940. The effect of acenaphthene and

colchicine on mitosis of *Allium* and *Colchicum*. *Hereditas* 26:262-276. — M. LEVINE. 1946. The effect of colchicine and acenaphthene in combination with X-rays on plant tissue. II. *Bull. Torrey Bot. Club* 73:34-59. — E. W. LINDSTROM and K. KOOS. 1931. Cyto-genetic investigations of a haploid tomato and its diploid and tetraploid progeny. *Amer. J. Bot.* 18:398-410. — T. M. LITTLE. 1942. Tetraploidy in *Antirrhinum majus* induced by sanguinarine hydrochloride. *Science* 96:188-189. — B. R. NEBEL. 1937. Cytological observations of colchicine. *Biol. Bull.* 73:351-352. — B. R. NEBEL and M. L. RUTTLE. 1938. Colchicine and its place in fruit breeding. *N. Y. State Agric. Exp. Sta. Circ.* 183. — J. G. O'MARA. 1939. Observations on the immediate effects of colchicine. *J. Hered.* 30:35-37. — G. PINCUS and C. H. WADDINGTON. 1939. The effects of mitosis-inhibiting treatment on normally fertilized pre-cleavage rabbit eggs. *J. Hered.* 30:515-518. — H. P. RILEY. 1939. Introgressive hybridization in a natural population of *Tradescantia*. *Genetics* 24:753-769. — S. SATINA and A. F. BLAKESLEE. 1943, 1944, 1945. Periclinal chimeras in *Datura*. *Amer. J. Bot.* 30:453-462; 31:493-502; 32:72-81. — K. SAX. 1936. The experimental production of polyploidy. *J. Arnold Arboretum* 17:153-159. — K. SAX. 1937. Effect of variations in temperature on nuclear and cell division in *Tradescantia*. *Amer. J. Bot.* 24:218-225. — H. H. SMITH. 1939. The induction of polyploidy in *Nicotiana* species and species hybrids. *J. Hered.* 30:290-306. — H. E. WARMKE and A. F. BLAKESLEE. 1939. Induction of simple and multiple polyploidy in *Nicotiana* by colchicine treatment. *J. Hered.* 30:418-432. — S. J. WELLENSIEK. 1939. The newest fad, colchicine, and its origin. *Chron. Bot.* 5:15-17.

CHAPTER 29

C. E. ALLEN. 1940. The genotype basis of sex-expression in Angiosperms. *Bot. Rev.* 6:227-300. — S. A. ASDELL. 1944. The genetic sex of intersexual goats and a probable linkage with the gene for hornlessness. *Science* 99:124. — F. BALTZER. 1914. Die Bestimmung des Geschlechts nebst einer Analyse des Geschlechtsdimorphismus bei *Bonellia*. *Mitteilung aus der Zool. Station zu Neapel* 22:1-44. — R. O. BERRY. 1939. Observations on chromosome elimination in the germ cells of *Sciara ocellaris*. *Proc. Nat. Acad. Sci.* 25:125-127. — F. H. BILLINGS. 1933. Development of the embryo-sac in *Phoradendron*. *Ann. Bot.* 47:261-278. — C. B. BRIDGES. 1925. Sex in relation to chromosomes and genes. *Amer. Natur.* 59:127-137. — W. E. CASTLE. 1930. The quantitative theory of sex and the genetic character of haploid males. *Proc. Nat. Acad. Sci.* 16:783-791. — F. A. E. CREW. 1926. Abnormal sexuality in animals. I. Genotypical. *Quart. Rev. Biol.* 1:315-359. — TH. DOBZHANSKY and B. SPASSKY. 1941. Intersexes in *Drosophila pseudoobscura*. *Proc. Nat. Acad. Sci.* 27:556-562. — R. A. EMERSON. 1932. The present status of maize genetics. *Proc. VI Internat. Cong. Genetics* 1:141-152. — F. FAGERLIND. 1940. Die Terminologie der Apomixis-Prozesse. *Hereditas* 26:1-22. — G. FANKHAUSER. 1938. Sex differentiation in a haploid salamander, *Triton taeniatus* Laur. *J. Exp. Zool.* 79:35-49. — G. FANK-

- HAUSER. 1942. Induction of polyploidy in animals by extremes of temperature. *Biol. Symposia* 6:21-35. — R. GOLDSCHMIDT. 1934. Lymantria. *Bibliogr. Genet.* 11:1-186. — Å. GUSTAFSSON. 1946. Apomixis in higher plants. *Kungl. Fysiografiska Sällskapetets Handl. N. F.* 57:1-66. — H. HENKING. 1891. Untersuchungen ueber die ersten Entwicklungsvorgaenge in den Eiern der Insekten. II. *Zeits. Wissenschaftliche Zoologie* 51:685-736. — D. F. JONES. 1934. Unisexual maize plants and their bearing on sex differentiation in other plants and in animals. *Genetics* 19:552-567. — D. F. JONES. 1939. Sex intergrades in dioecious maize. *Amer. J. Bot.* 26:412-415. — C. KOSWIG. 1936. Nicht homologe Heterochromosomen bei nächtsverwandten Arten (Kreuzung von *Platypoecilus maculatus* und *Pl. xiphidium*). *Biol. Zentralbl.* 56:199-207. — G. A. LEBEDEFF. 1938. Intersexuality in *Drosophila virilis* and its bearing on sex determination. *Proc. Nat. Acad. Sci.* 24:165-172. — F. R. LILLIE. 1916. The theory of the free-martin. *Science* 43:611-613. — H. C. MCPHEE. 1924. The influence of environment on sex in hemp, *Cannabis sativa* L. *J. Agric. Res.* 28:1067-1080. — C. W. METZ. 1938. Chromosome behavior, inheritance, and sex determination in *Sciara*. *Amer. Natur.* 72:485-520. — T. H. MONTGOMERY. 1906. Chromosomes in the spermatogenesis of the Hemiptera-heteroptera. *Trans. Amer. Philos. Soc.* 21:97-124. — T. ONO. 1935. Chromosomen und Sexualität von *Rumex acetosa*. *Sci. Rept. Tókoku Imp. Univ.* 10:41-210. — R. C. ROLLINS. 1945. Evidence for genetic variation among apomictically produced plants. *Amer. J. Bot.* 32:554-560. — J. H. SCHAFFNER. 1929. Heredity and sex. *Ohio J. Sci.* 29:1-26. — A. F. SHULL. 1929. Determination of types of individuals in aphids, rotifers, and cladocera. *Biol. Rev.* 4:218-248. — G. H. SHULL. 1943. Genetics, the unifying science in biology. *Torreyia* 43:126-131. — STANLEY G. SMITH. 1945. Heteropycnosis as a means of diagnosing sex. *J. Hered.* 36:194-196. — G. L. STEBBINS, JR. 1941. Apomixis in the Angiosperms. *Bot. Rev.* 7:507-542. — H. E. WARMKE. 1942. Polyploidy investigations. *Carnegie Inst. Year Book* 41:186-189. — H. E. WARMKE. 1946. Sex determination and sex balance in *Melandrium*. *Amer. J. Bot.* 33:648-660. — H. E. WARMKE and A. F. BLAKESLEE. 1940. The establishment of a $4n$ dioecious race in *Melandrium*. *Amer. J. Bot.* 27:751-762. — D. H. WENRICH. 1916. The spermatogenesis of *Phrynotetix magnus*. *Museum. Comp. Zool. Harvard Bull.* 60:55-136. — M. WESTERGAARD. 1938. Induced tetraploidy in *Melandrium album*. *Nature* 142:917. — P. W. WHITING. 1940. Multiple alleles in sex determination of *Habrobracon*. *J. Morph.* 66:323-355. — P. W. WHITING. 1943. Multiple alleles in complementary sex determination of *Habrobracon*. *Genetics* 28:365-382. — P. W. WHITING. 1943. Androgenesis in the parasitic wasp *Habrobracon*. *J. Hered.* 34:355-366. — P. W. WHITING. 1945. The evolution of male haploidy. *Quart. Rev. Biol.* 20:231-260. — P. W. WHITING, R. J. GREB, and B. R. SPEICHER. 1934. A new type of sex-intergrade. *Biol. Bull.* 66:152-165. — H. WINKLER. 1908. Über Parthenogenesis und Apogamie in Pflanzenreich. *Prog. Rei. Bot.* 2:293-454. — Y. YAMAMOTO. 1938. Karyogenetische Untersuchungen bei der Gattung *Rumex* VI. *Mem. Coll. Agric. Kyoto Imp. Univ.* 43:1-59.

CHAPTER 30

- E. ANDERSON. 1936. Hybridization in American Tradescantias. I. and II. *Ann. Mo. Bot. Gard.* 23:511-525. — E. ANDERSON and L. HUBRICHT. 1938. Hybridization in Tradescantia. III. The evidence for introgressive hybridization. *Amer. J. Bot.* 25:396-402. — E. ANDERSON and T. W. WHITAKER. 1934. Speciation in *Uvularia*. *J. Arnold Arboretum* 15:28-42. — E. B. BABCOCK. 1942. Systematics, cytogenetics and evolution in *Crepis*. *Bot. Rev.* 8:139-190. — E. B. BABCOCK and G. L. STEBBINS, JR. 1938. The American species of *Crepis*. *Carnegie Inst. Wash. Publ.* 504:1-194. — E. B. BABCOCK, G. L. STEBBINS, JR., and J. A. JENKINS. 1942. Genetic evolutionary processes in *Crepis*. *Amer. Natur.* 76:337-363. — A. F. BLAKESLEE and S. SATINA. 1944. New hybrids from incompatible crosses in *Datura* through culture of excised embryos on malt media. *Science* 99:331-334. — R. A. BRINK. 1935. Cytogenetic evolutionary processes in plants. *Amer. Natur.* 69:97-124. — R. A. BRINK, D. C. COOPER, and L. E. AUSERMAN. 1944. A hybrid between *Hordeum jubatum* and *Secale cereale*. *J. Hered.* 35:67-75. — J. CLAUSEN, D. D. KECK, and W. H. HIESEY. 1941. Regional differentiation in plant species. *Amer. Natur.* 75:231-250. — R. E. CLELAND. 1931. Cytological evidence of genetical relationships in *Oenothera*. *Amer. J. Bot.* 18:629-640. — R. E. CLELAND. 1944. The problem of species in *Oenothera*. *Amer. Natur.* 78:5-28. — C. CORRENS. 1902. Ueber Bastardierungsversuche mit *Mirabilis*-Sippen. *Ber. deutsch. Bot. Ges.* 20:549-608. — L. R. DICE. 1940. Speciation in *Peromyscus*. *Amer. Natur.* 74:289-298. — TH. DOBZHANSKY. 1937. Genetic nature of species differences. *Amer. Natur.* 71:404-420. — TH. DOBZHANSKY. 1937. What is a species? *Scientia*, May, 1937:280-286. — TH. DOBZHANSKY. 1943. Genetics and human affairs. *Teaching Biologist* 12:97-106. — TH. DOBZHANSKY. 1944. Genetic structure of natural populations. *Carnegie Inst. Wash. Year Book* 43:120-127. — A. E. EMERSON. 1938. The origin of species: a review of Dobzhansky, *Genetics and the origin of species*. *Ecology* 19:152-154. — A. E. EMERSON. 1945. Taxonomic categories and population genetics. *Entomol. News* 56:14-19. — R. H. GOODWIN. 1937. The cytogenetics of two species of *Solidago* and its bearing on their polymorphy in nature. *Amer. J. Bot.* 24:425-432. — G. H. HARDY. 1908. Mendelian proportions in a mixed population. *Science* 28:49-50. — C. L. HUBBS, L. C. HUBBS, and R. E. JOHNSON. 1943. Hybridization in nature between species of Catostomid fishes. *Univ. Mich. Lab. Vert. Biol. Contrib.* 22:1-76. — C. L. HUBBS and S. C. WHITLOCK. 1929. Diverse types of form development in a single species of fish, the gizzard shad. *Papers Mich. Acad. Sci., Arts, and Letters* 10:461-482. — C. L. HUSKINS. 1941. Polyploidy and mutations. *Amer. Natur.* 75:329-344. — D. S. JORDAN. 1905. The origin of species through isolation. *Science* 22:545-562. — A. C. KINSEY. 1936. The origin of higher categories in Cynips. *Indiana Univ. Publ., Sci. Ser.* 4:1-334. — D. LEWIS. 1941. Male sterility in natural populations of hermaphrodite plants. *New Phytol.* 40:56-63. — W. J. MOENKHAUS.

1910. Cross fertilization among fishes. *Proc. Indiana Acad. Sci.* 1910:353-393. — H. J. MULLER. 1932. Some genetic aspects of sex. *Amer. Natur.* 66:118-138. — P. A. MUNZ. 1935. Studies in Onagraceae. IX. *Amer. J. Bot.* 22:645-663. — J. VAN OVERBEEK, M. E. CONKLIN, and A. F. BLAKESLEE. 1942. Cultivation in vitro of small *Datura* embryos. *Amer. J. Bot.* 29:472-477. — J. T. PATTERSON. 1942. Isolating mechanisms in the genus *Drosophila*. *Biol. Symposia* 6:271-287. — K. PEARSON. 1904. On a generalised theory of alternative inheritance, with special reference to Mendel's laws. *Philos. Trans. Roy. Soc.* A203:53-86. — O. RENNER. 1934. Die pflanzenlichen Plastiden als selbstaendige Elemente der genetischen Konstitution. *Ber. Math. Phys. Sächsischen Scad. Wiss.* 86:241-266. — G. E. DU RIETZ. 1930. The fundamental units of botanical taxonomy. *Svensk. Bot. Tidskrift* 24:333-428. — H. P. RILEY. 1938. A character analysis of colonies of *Iris fulva*, *Iris hexagona* var. *giganticaerulea* and natural hybrids. *Amer. J. Bot.* 25:727-738. — G. H. SHULL. 1923. The species concept from the point of view of a geneticist. *Amer. J. Bot.* 10:221-228. — G. H. SHULL. 1929. Significance of taxonomic units and their natural basis. Point of view of genetics. *Proc. Internat. Cong. Plant Sci.* 2:1578-1585. — M. J. SIRKS. 1938. Plasmatic inheritance. *Bot. Rev.* 4:113-131. — G. W. SKIRM. 1942. Embryo culturing as an aid to plant breeding. *J. Hered.* 33:211-215. — G. L. STEBBINS, JR. 1940. The significance of polyploidy in plant evolution. *Amer. Natur.* 74:54-66. — G. L. STEBBINS, JR. 1942. The role of isolation in the differentiation of plant species. *Biol. Symposia* 6:217-233. — C. STERN. 1943. The Hardy-Weinberg law. *Science* 97:137-138. — H. A. TOBGY. 1943. A cytological study of *Crepis fuliginosa*, *C. neglecta*, and their F₁ hybrid, etc. *J. Genet.* 45:67-111. — G. TURESSON. 1932. Die Genezentrumtheorie and des Entwicklungszentrum der Pflanzenart. *Kunigl. Fysiogr. Sallsk. i Lund Forhdl.* 2:76-86. — G. TURESSON. 1936. Rassenökologie und Pflanzengeographie. Einige kritische Bemerkungen. *Botaniska Notiser* 1936:420-437. — W. WEINBERG. 1908. Über den Nachweis der Vererbung beim Menschen. *Verein f. vaterländische Naturkunde in Württemberg Jahreshefte* 64:368-382. — F. VON WETTSTEIN. 1937. Die genetische und entwicklungsphysiologische Bedeutung der Cytoplasmas. *Zeits. f. indukt. Abstamm.- u. Vererb-lehre* 73:349-366. — Ö. WINGE. 1938. The genetic aspect of the species problem. *Proc. Linn. Soc. London*, Session 150:231-238. — S. WRIGHT. 1931. Evolution in mendelian populations. *Genetics* 16:97-159. — S. WRIGHT. 1946. The differential equation of the distribution of gene frequencies. *Proc. Nat. Acad. Sci.* 31:382-389. — S. WRIGHT. 1946. Isolation by distance under diverse systems of mating. *Genetics* 31:39-59.

AUTHOR INDEX

- Åberg, E., 247, 555
 Addair, J., 33, 34, 548
 Allen, C. E., 505, 548, 566
 Altenburg, E., 260, 545, 554
 Anderson, E., 333, 334, 520, 525, 526, 527, 528, 563, 568
 Anderson, E. G., 279, 548, 552
 Anderson-Kötto, I., 548
 Asdell, S. A., 566
 Ashby, E., 560
 Astbury, W. T., 553
 Atwood, S. S., 277, 556, 558
 Ausherman, L. E., 525, 568
 Avery, A. G., 562, 564, 565

 Babcock, E. B., 531, 532, 533, 545, 555, 568
 Balbiani, E. G., 74, 549
 Balls, W. L., 545
 Baltzer, F., 438, 563, 566
 Bamford, R., 435, 436, 450, 563
 Bartlett, H. H., 240, 554
 Bateson, W., 163, 164, 326, 328, 553, 559
 Bauer, H., 75, 549
 Baur, E., 101, 240, 323, 545, 550, 559
 Beadle, G. W., 154, 175, 307, 314, 547, 551, 558
 Beal, J. M., 564
 Beale, G. H., 258, 259, 555
 Beasley, J. O., 458, 564
 Beers, C. V., 130, 131, 550
 Belkin, R. B., 296, 557
 Bell, F. O., 553
 Bell, J., 199, 552
 Belling, J., 562, 563
 Bellows, J. M., Jr., 563
 Beneden, E. van, 547
 Berger, C. A., 549, 565
 Bergner, A. D., 411, 561, 563, 565

 Bernstein, F., 284, 285, 286, 288
 Berry, R. J. A., 548
 Berry, R. O., 491, 492, 566
 Billings, F. H., 566
 Birdsall, J. E., 450, 556
 Bishop, M., 260, 555
 Black, W. H., 560
 Blackburn, K. B., 468, 564
 Blakeslee, A. F., 43, 243, 328, 407, 411, 419, 420, 423, 450, 473, 478, 506, 524, 548, 555, 559, 561, 562, 563, 564, 565, 566, 567, 568, 569
 Blank, F., 558
 Blankinship, J. W., 548
 Bloch, R., 548
 Bonner, D. M., 558
 Böök, J. A., 472
 Boycott, A. E., 558
 Boyd, W. C., 557
 Bridges, C. B., 68, 150, 167, 194, 195, 425, 482, 506, 548, 551, 552, 554, 555, 562, 566
 Bridges, P. N., 193, 194, 195, 552
 Brieger, F., 275, 556
 Brink, R. A., 154, 164, 166, 406, 408, 443, 444, 525, 551, 561, 563, 568
 Brittingham, W. H., 244, 554
 Brown, M. S., 563
 Brugger, C., 548
 Bryson, V., 36, 548
 Bucher, C. S., 548
 Buchholz, J. T., 388, 560
 Burnham, C. R., 406, 561
 Burnham, L., 557
 Buxton, B. H., 563

 Cain, S. A., 545
 Capinpin, J. M., 548

- Carolina Biological Supply Co., 8
 Carothers, E. E., 126, 127, 134, 550
 Caspersson, T., 267, 555
 Castle, W. E., 182, 272, 283, 355,
 356, 357, 481, 551, 556, 557, 559,
 566
 Catcheside, D. G., 428, 429, 562,
 564
 Cattell, E., 550
 Chambers, R., 9, 547
 Chang, M. S., 184, 551
 Charles, D. R., 557, 560
 Child, G. P., 33, 34, 254, 255, 256,
 549, 555
 Christensen, H. M., 435, 436, 563
 Chumlea, B. J., 93
 Clancy, C. W., 558
 Clark, L. A., 130, 131, 550
 Clausen, J., 564, 568
 Clausen, R. E., 459, 545, 563, 564
 Cleland, R. E., 534, 535, 536, 561,
 568
 Cobb, V., 279, 556
 Cockayne, E. A., 39, 199, 545
 Collins, J. L., 555
 Colvin, E. M., 547
 Conant, George H., 52
 Conger, A. D., 563
 Conklin, E. G., 303, 304, 558
 Conklin, M. E., 524, 569
 Cooper, D. C., 443, 444, 525, 549,
 563, 568
 Cooper, K. W., 214, 216, 553
 Correns, C., 540, 545, 568
 Costello, D. P., 472
 Creighton, H. B., 203, 204, 553, 561
 Crew, F. A. E., 494, 495, 545, 566
 Crotta, R., 472
 Curtis, G. M., 39, 549

 Darlington, C. D., 214, 220, 221,
 222, 517, 545, 551, 553, 561, 563,
 564
 Darwin, C., 226, 272, 369, 545
 Davenport, C. B., 545, 548, 560
 Davidsohn, I., 296, 557
 Dawson, C. D. R., 449, 563
 Demerec, M., 219, 238, 239, 241,
 254, 260, 265, 266, 337, 545, 550,
 553, 554, 555, 556, 558, 559
 Dermen, H., 478, 565
 De Vries, H., 202, 225, 545
 Dice, L. R., 522, 523, 568
 Diver, C., 558
 Dobzhansky, Th., 189, 190, 191, 223,
 231, 386, 398, 402, 486, 496, 522,
 524, 545, 552, 553, 556, 560, 561,
 566, 568
 Dodge, B. O., 558
 Doncaster, L., 550
 Doutreligne, J., 553
 Dubinin, N. P., 556
 Duggar, B. M., 552
 Dunkle, P. B., 91, 550
 Dunn, L. C., 34, 36, 547, 548
 Durham, G. H., 321, 559
 Duryee, W. R., 549

 East, E. M., 272, 273, 277, 349, 350,
 351, 352, 353, 359, 360, 361, 365,
 378, 379, 386, 387, 556, 559, 560
 Edmonds, H., 94
 Eigsti, O. J., 474, 565
 Ekas, M. P., 545
 Emerson, A. E., 516, 568
 Emerson, R. A., 154, 175, 237, 279,
 365, 513, 548, 551, 554, 560, 566
 Emerson, S., 277, 556
 Ephrussi, B., 307, 558
 Epling, C., 398

 Fabergé, A. C., 258, 259, 555, 561
 Fagerlind, F., 513, 566
 Fankhauser, G., 438, 439, 442, 450,
 472, 563, 565, 566
 Fano, U., 555
 Farnham, M. E., 562, 563
 Filzer, P., 272
 Fink, H. K., 548
 Fischer, E., 545
 Fisher, R. A., 135, 163, 297, 545,
 557, 559
 Flemming, W., 547
 Ford, C. E., 428, 563
 Fraser, A. C., 154, 175, 551

- Frey-Wyssling, A., 558
 Friesen, H., 551
 Fruwirth, C., 551
 Fryer, J. R., 379, 381, 560
- Gager, S., 243, 555
 Gairdner, A. E., 561
 Gammelgaard, W., 557
 Gardner, F. D., 387, 561
 Garstang, S., 558
 Gates, R. R., 545
 Giles, N., 561
 Glass, L. C., 548
 Gluecksohn-Schoenheimer, S., 36, 548
 Goldschmidt, R., 483, 484, 493, 546, 556, 567
 Goodwin, R. H., 568
 Greb, R. J., 567
 Greenleaf, W. H., 477, 565
 Gregory, P. W., 357, 559
 Gregory, R. P., 559
 Griffen, A. B., 194, 196, 552
 Griffiths, R. B., 565
 Gustafsson, Å., 247, 555, 560, 567
- Haan, H. de, 556
 Hadley, P. R., 559
 Hagedoorn, A. C., 560
 Hagedoorn, A. L., 354, 560
 Haldane, J. B. S., 197, 199, 552
 Hallquist, C., 550
 Hanson, F. B., 556
 Hardy, G. H., 538, 539, 568
 Harlan, J. R., 565
 Hawthorn, L. R., 382, 383, 561
 Hayes, H. K., 184, 551, 560
 Hays, F. A., 99, 382, 560
 Hearne, E. M., 553
 Hefner, R. A., 40, 41, 102, 549, 550
 Hegner, R. H., 546
 Heitz, E., 75, 549
 Henking, H., 567
 Heuser, F., 547
 Heys, F., 556
 Hiesey, W. H., 568
 Higbee, E., 476, 565
 Hollaender, A., 260, 555
 Hollingshead, L., 462, 463, 565
 Hoover, M. E., 265, 266, 556
 Hopkins, C. G., 378, 560
 Houlahan, M. B., 260, 555
 Hubbs, C. L., 528, 529, 530, 568
 Hubbs, L. C., 530, 568
 Hubricht, L., 520, 528, 568
 Humphrey, L. M., 549, 564
 Humphrey, R. R., 472
 Hunt, H. R., 560
 Hurst, C. C., 468, 565
 Huskins, C. L., 14, 457, 553, 565, 568
 Husted, L., 393, 547, 561
 Hutt, F. B., 33, 34, 549
 Huxley, J., 546
- Ikin, E. W., 557
 Imai, Y., 331, 559
 Immer, F. R., 159, 551
 Ives, P. T., 254, 556
- Janaki Ammal, E. K., 545
 Janssens, F. A., 202, 206, 553
 Javert, C., 295, 296
 Jenkins, J. A., 532, 533, 568
 Jenkins, M. T., 379
 Johannsen, W., 369, 370, 371, 376, 546
 Johnson, R. E., 530, 568
 Johnston, D., 444, 564
 Jones, D. F., 237, 385, 386, 387, 388, 512, 513, 554, 560, 567
 Jones, W. N., 546
 Jordan, D. S., 568
 Jorgensen, C. A., 478, 565
 Jull, M. A., 87, 381, 561
- Kaliss, N., 199, 552
 Karowe, H. E., 289, 557
 Karpechenko, G. D., 459, 565
 Katayama, Y., 563
 Katzin, E. M., 557
 Kaufmann, B. P., 74, 547, 549, 554
 Kavanagh, A. J., 558
 Keck, D. D., 568
 Keeler, C. E., 39, 94, 278, 279, 283, 548, 549, 556, 557

- Kendall, M. G., 547
 Kihara, H., 563
 King, E., 442, 563
 Kinsey, A. C., 522, 568
 Knowles, P. F., 322, 559
 Koelreuter, J. G., 272, 556
 Kohn, E., 199, 552
 Komai, T., 199, 552
 Koos, K., 477, 566
 Kosswig, C., 483, 567

 La Cour, L., 220, 221, 222, 553
 Lammerts, W. E., 415, 563, 564
 Lancefield, D. E., 552
 Landauer, W., 22, 548
 Landsteiner, K., 282, 284, 286, 287,
 290, 291, 557
 Lang, A., 546, 560
 Lawrence, W. J. C., 312, 313, 430,
 468, 558, 563, 565
 Lebedeff, G. A., 485, 567
 Lehmann, E., 272
 Lenz, F., 545
 Levan, A., 475, 564, 565
 Levine, M., 566
 Levine, P., 287, 290, 291, 295, 296,
 297, 557
 Lewis, D., 556, 568
 Lillie, F. R., 495, 567
 Lindgren, C. C., 553
 Lindgren, G., 553
 Lindstrom, E. W., 477, 564, 566
 Little, C. C., 546
 Little, T. M., 566
 Longley, A. E., 125, 551

 McClintock, B., 55, 203, 204, 393,
 395, 396, 399, 416, 553, 561, 562,
 563
 McClung, C. E., 549
 McPhee, H. C., 511, 567
 Mackensen, O., 194, 552
 Macklin, M. T., 44, 549
 Magness, J. R., 551
 Mangelsdorf, A. J., 272, 273, 275, 556
 Manton, I., 454, 554, 564
 Marcussen, P. V., 557

 Mather, K., 192, 212, 357, 546, 548,
 552, 553, 559, 560, 562
 Matsuura, H., 546
 Meares, R. S., 312
 Mendel, G., 20, 82, 126, 147
 Metz, C. W., 488, 490, 567
 Miyaki, K., 331, 559
 Moenkhaus, W. J., 568
 Montgomery, T. H., 567
 Morgan, T. H., 147, 150, 202, 225,
 231, 243, 502, 546, 548, 550, 552,
 553, 554
 Morrison, G., 561
 Morrow, G. E., 387, 561
 Mott-Smith, L. M., 556
 Moulton, F. R., 546
 Muller, H. J., 16, 188, 240, 243, 244,
 252, 255, 546, 548, 552, 555, 556,
 568
 Müntzing, A., 435, 453, 458, 459, 460,
 464, 466, 562, 564, 565
 Munz, P. A., 534, 568
 Murray, J., 297
 Myers, W. M., 564

 Nabours, R. K., 403
 Navashin, M., 440, 452, 564
 Neatby, K. W., 450, 563
 Nebel, B. R., 473, 475, 476, 548, 549,
 566
 Newton, W. C. F., 565
 Nilsson, F., 374, 561
 Nilsson-Ehle, H., 331, 336, 342, 353,
 357, 464, 559

 Offerman, E. M., 557
 Olmo, H. P., 563
 O'Mara, J. G., 474, 566
 Ono, T., 506, 567
 Onslow, H., 313, 558
 Onslow, M. W., 312, 546
 van Overbeek, J., 310, 311, 524, 558,
 569

 Painter, T. S., 188, 194, 549, 552
 Palmer, D. M., 199, 553
 Park, J. B., 272, 556

- Patterson, J. T., 194, 549, 552, 555, 569
 Pearl, R., 118, 546, 549
 Pearson, K., 538, 546, 569
 Pellew, C., 565
 Perrot, M., 472
 Pfeiffer, H. H., 546
 Philp, J., 546
 Pincus, G., 476, 566
 Plough, H. H., 167, 251, 254, 255, 256, 263, 551, 555, 556
 Polivka, H. R., 557
 Pomeroy, S. C., 554
 Potter, E. L., 43, 296, 549, 557
 Prakken, R., 565
 Prell, H., 272, 556
 Price, J. R., 558
 Prior, A. M., 557
 Prokofyeva-Belgovskaya, A., 267, 553
 Punnett, R. C., 163, 164, 551, 553, 559

 Race, R. R., 291, 296, 297, 557
 Randolph, L. F., 411, 552, 562
 Reed, S. C., 35
 Renner, O., 541, 569
 Rhoades, M. M., 175, 241, 259, 269, 279, 429, 554, 556, 563
 Richards, O. W., 558
 Richardson, M. M., 564
 Rick, C. M., 393, 562
 Du Rietz, G. E., 569
 Riley, H. P., 35, 272, 521, 548, 556, 566, 569
 Robertson, W. R. B., 403
 Robinson, T. R., 554
 Rollins, R., 567
 Ruttle, M. L., 475, 566

 Sanborn, R., 560
 Sansome, F. W., 546
 Satina, S., 564, 565, 566, 568
 Saunders, E. R., 559
 Sax, H. J., 438, 440, 450, 548, 564
 Sax, K., 393, 394, 401, 406, 438, 440, 465, 471, 548, 549, 553, 560, 562, 563, 564, 565, 566
 Schaffner, J. H., 510, 567
 Schiemann, E., 459, 546
 Schonfeld, M. D., 557
 Schrader, F., 546
 Schultz, J., 240, 267, 554, 555
 Schweitzer, M. D., 199, 552
 Scott, L. B., 554
 Scott-Moncrieff, R., 312, 313, 558
 Sears, E. R., 437, 459, 461, 564, 565
 Senn, P. H., 154, 551
 Shamel, A. D., 554
 Sharp, L. W., 546
 Sherman, M. A., 547
 Shull, A. F., 388, 547, 567
 Shull, G. H., 73, 101, 103, 126, 161, 162, 226, 227, 228, 240, 244, 323, 324, 353, 354, 368, 384, 387, 464, 503, 549, 550, 551, 554, 559, 560, 561, 567, 569
 Siderov, B. N., 556
 Siemens, H. W., 199, 552
 Singleton, W. R., 183, 551, 561
 Sinnott, E. W., 315, 316, 321, 547, 548, 558, 559, 565
 Sirks, M. J., 569
 Skirm, G. W., 569
 Skovsted, A., 458, 565
 Smith, H. H., 352, 353, 449, 451, 560, 564, 566
 Smith, L. H., 560
 Smith, S. G., 487, 488, 567
 Snedecor, C. W., 547
 Snyder, L. H., 33, 34, 39, 199, 325, 546, 547, 548, 549, 550, 553, 557
 Sonn, E. B., 296, 557
 Spassky, B., 486, 496, 566
 Speicher, B. R., 567
 Spencer, W. P., 240, 554
 Stadler, L. J., 236, 243, 247, 392, 555, 562
 Stancati, M. F., 253, 555
 Stebbins, G. L., Jr., 467, 513, 532, 533, 565, 567, 568, 569
 Steele, D. G., 382, 561
 Stern, C., 190, 203, 205, 216, 550, 553, 557, 569
 Stetson, R. E., 291, 557
 Stoddard, S. E., 94, 549

- Stone, L. H. A., 548
 Stone, W. S., 194, *196*, 552
 Stout, A. B., 557, 561
 Strandskov, H. H., 41, 285, *286*, 288, *291*, 549, 557
 Sturgess, V. C., 312, *313*, 558
 Sturtevant, A. H., 402, 547, 548, 553, 558, 561
 Sullivan, J. T., 558
 Sutton, E., 391, 406, 554, 562
 Sutton, W. S., 202, 553
 Swanson, C. R., 562

 Tammes, T., 323
 Tatum, E. L., 307, 314, 558
 Taylor, G. L., 291, 296, 297, 557
 Thomsen, O., 557
 Thompson, W. P., 444, 564
 Tice, S. C., 231, 554
 Timoféeff-Ressovsky, N. W., 232, 554, 555
 Tjebbes, K., 548
 Tobgy, H. A., 533, 565, 569
 Traub, P., 554
 von Tschermak, E., 132, 551
 Turesson, G., 569

 Upham, E., 548

 Viosca, P., Jr., 520
 Vogel, P., 557

 Waddington, C. H., 17, 220, 476, 547, 548, 566
 Walker, J. F., *102*
 Warmke, H. E., 73, 450, 506, *507*, *508*, 509, 550, 563, 566, 567

 Warner, M. F., 547
 Warwick, B. L., *91*, 113, 550
 Watson, R. C., 565
 Weinberg, W., 538, 539, 569
 Wellensiek, S. J., 566
 Wenrich, D. H., *487*, 567
 Westergaard, M., 506, 567
 Westfall, J. J., 564
 Wettstein, F. von, 452, 569
 Whaley, C. Y., 317, 559
 Whaley, W. G., 317, *318*, 559, 561
 Wheldale, M., 312
 Whitaker, T. W., 528, 562, 568
 White, M. J. D., 547, 562
 Whiting, A. R., *247*, 555
 Whiting, P. W., 246, 253, *260*, *261*, *500*, 555, 567
 Whitlock, S. C., 528, 568
 Wiener, A. S., 289, 291, 293, *294*, 295, *296*, 297, *298*, 547, 557
 Williams, R. D., 277, 557, 559
 Wilson, E. B., 547, 550
 Winge, Ö., 553, 569
 Winkler, F. B., 450, 563
 Winkler, H., 567
 Winton, D. de, 551, 559
 Woods, M. W., 564
 Wright, S., 114, 115, 123, 165, 305, *306*, 307, 313, 357, 373, 550, 559, 560, 561, 569

 Yamamoto, Y., 506, 567
 Yarnell, S. H., 277, 382, 383, 462, 556, 561, 565
 Yost, D. H., 548
 Yule, G. U., 547

Note. In this index and the subject index which follows the references in italics are to figures and tables.

SUBJECT INDEX

- Abraxis type of sex inheritance. 481
 Accessory chromosome. 69
 Acentric fragment. 394, 397, 398.
 399, 400
Aegilops cylindrica, 465, 466
 Agamospermy, 513
 Agglutination, 282
 Agglutinins, 283 ff.
 Agglutinogens, 283 ff.
 Albinism. 34, 278, 313, 350, 542
 Alfalfa, 379, 380, 381
 Allele, 17 ff., 82, 138
 multiple, 27, 28, 90, 92, 103, 104,
 105, 162, 271 ff., 278, 283 ff.,
 498-501
 Allelomorph. 19
 Allium, induction of polyploids in,
 473, 474
 number of chromosomes in, 6, 11,
 12
 Allohexaploids, 465, 466
 Allopolyploid, 433, 456 ff., 470, 473,
 533
 Allozyndesis, 461, 462
 Allotetraploid, 433, 445, 449, 456,
 457, 464
 genetic ratios in, 460, 461
 Allotriploid, 462, 463
 Alternation of generations, 50, 514
 Amphidiploid, 437, 456 ff., 460, 461,
 533
 Anaphase, 7 ff., 8, 13, 53 ff., 54, 60,
 62, 71, 72
Anasa tristis, 72
 Androgenesis, 501
 Aneuploid, 414 ff., 451
 Animal breeding, 367 ff.
 Annelids, 523
 Anomozygous mutations, 226
 Antibody, 282, 284, 286, 290, 292
 Antigen, 282, 283, 284, 286, 290, 291
 Apomixis, 513, 514, 531, 533
Apotettix curycephalus, 403
Arbacia punctata, 476
Archips fumiferana, 487, 488
Arphia simplex, 134
Artemia salina, 450
Ascaris megalocephala, 10
 Aster, 5
 Asynapsis, 471
Atriplex hymenelytra, 505
 Attached-X chromosomes, 248, 414,
 483
 Autopolyploids, 433, 440-454, 456,
 470, 473
 size of, 449, 450, 451, 453
 Autosomes, 70, 71, 72, 77, 89, 96, 133,
 173, 505, 506, 508
 heterochromatin in, 222, 223
 ratio to sex chromosomes, 482,
 483, 506, 507
 Autosyndesis, 461, 462
 Autotetraploid, 433, 445-449, 453,
 454, 456
 size in, 445, 449, 450, 451, 453
 Autotriploid, 433, 440-445, 453, 456,
 462, 463
 Auxin, 310, 311
 Average deviation, 362
 Axolotl, 472
 Backcross, 84, 85, 138, 155, 157, 518,
 526, 528, 542
 Bacteria, 309
 Balanced lethals, 534, 536, 537
 Bands, salivary gland, 75-77, 193,
 194, 251, 267
 and genes, 224
 number of, 193
 Barley, 132, 247, 331

- Barley-rye hybrids, 444, 445
 Barriers, 402, 518, 519, 532, 536
 ecological, 520, 521
 removal of, 520, 521, 536
 Bean, 27, 369, 370
 Bee, 67, 502
 Beetles, 523
Bibio hortulanus, 75
 Binomial theorem, 110, 111, 112, 113,
 120, 140, 345
 Biotype, 371, 374, 378, 379, 384, 459,
 536
 Birds, 70, 71, 281, 523
Biscutella laevigata, 454
 Bisexual flowers, 502
 Bivalent chromosomes, 57 ff., 210,
 416, 417, 441, 442, 446, 447,
 448, 457 ff., 460, 463
 Blood groups, 282 ff.
 in human beings, A-B, 284, 286,
 287, 288, 289, 290
 Blood types, in human beings, M-N,
 290, 291
 in human beings, Rh, 289, 291,
 292, 293, 294, 295, 296, 297,
 298
 Bombyx, 450
 Bonellia, 495
 Bouquet stage, 55
Brachystola, magna, 134
 Breeding true, 371
Bromus arizonicus, 467
Bromus carinatus, 467
 Brother-and-sister matings, 367, 368,
 369, 373
 B-type chromosomes, 411
 Bud mutation, 234, 235
 Butterflies, 70, 481

 Cabbage, 11, 459
 Cabbage-radish hybrid, 459
 Callus formation and polyploids,
 477, 478
Capsella (Bursa), 126
 bursa-pastoris, 88, 330, 331, 464
 djurdjurae, 464
 grandiflora, 62, 82, 272, 464
 Heegeri, 330, 331, 464
 Capsella (Bursa) (continued)
 occidentalis, 464
 orientalis, 464
 penarthae, 464
 rubella, 62, 464
 tuscaloosae, 464
 Viguieri, 82, 464
 Carpellate flowers, 503
 Cat, 278, 279
 Catalyst, 307, 311
 Catostomidae, 530
 Cattle, Africander, 382
 Brahman, 382
 horns in, 108, 111, 112
 sex reversal in, 494, 495
 Cell, 1, 2
 dividing, 6 ff., 8, 10, 13
 embryonic, 3, 4
 metabolic, 2
 parenchyma, 4
 resting, 2 ff.
 somatic, 13
 Cell polarity, 317
 Cell wall, 3, 4
 Centric fragment, 394, 411, 429, 441
 Centriole, 5
 Centromere, 7 ff., 16, 53 ff., 77, 124,
 125, 149, 191, 216, 224, 393, 418
 breaking of, 395, 429
 distance of genes near, 191, 194
 of chromosome IV of *Drosophila*
 melanogaster, 194, 196
 Centrosome, 3, 13
 Centrosphere, 5
 Chance, 109, 114, 136, 434
 importance of in locating genes
 on chromosomes, 171, 174
 Character, 19
 Character index, 528
 "Checkerboard," 83, 127, 128, 137,
 138, 139, 158, 323, 324, 538
 Chemical nature, of chromosome,
 220
 of genes, 230
 Chemicals, effect on crossing over,
 167

- Chemicals (*continued*)
 induction of polyploids by, 471, 473-476, 474
 test for genotypes by, 328, 329, 330
- Chi square, 117, 119, 135, 136, 163, 164, 166
- Chiasma frequency, 206, 447
- Chiasmata, 56, 57, 58, 59, 65, 73, 148, 150, 174, 202
 between X and Y chromosomes, 154, 214
 classical theory of, 207, 208
 compensating, 211
 complementary, 210, 212
 diagonal, 211, 212
 disparate, 211
 in trivalents, 417, 418
 independent formation of, 210
 noncompensating, 211
 nondisjunction and, 425
 partial chiasmotypy and, 207, 208
 reciprocal, 174, 210, 212, 214
 relation of to crossing over, 152, 153, 202
- Chiasmotypy, 206, 207, 208
- Chimera, 234, 235
 chromosomal, 416, 423, 478
 flower-color, 238, 239, 430
- Chironomus, 74, 75, 78
- Chlorophyceae, 503, 504
- Chlorophyll, 136, 175 ff., 188, 312, 540 ff.
- Chloroplast, 4, 540, 541
- Chondriosomes, 3
- Chromatid, 7, 10 ff., 52 ff., 56, 63 ff., 474, 475
 breaking of, 57, 65, 147, 148, 150, 152, 157, 167, 171, 173, 174, 178, 179, 202
 fusion of broken end of, 57, 148, 174, 202
- Chromatid bridge, 398, 399, 400, 401, 442, 467
- Chromatin reticulum, 4, 6, 7
- Chromocenter, 77, 78, 192, 222, 223, 267
- Chromomere, 16, 76
- Chromonema, 6, 7, 13 ff., 14, 52 ff., 75 ff., 219, 393, 394
- Chromosome, 1, 6, 16, 52, 53, 58, 59, 64
 daughter, 12
 effect of calchicine on, 474, 475
 location of genes on, 171 ff., 186, 202
 salivary gland, 74
 secondary constriction on, 10, 124
- Chromosome aberrations, 2, 55, 189, 235, 243, 254, 390 ff., 414 ff., 433 ff., 471, 531, 533
- Chromosome anastomoses, 7
- Chromosome arms, 7, 10, 11, 63, 65, 66
- Chromosome circles at meiosis, 406, 407, 408, 409, 427, 428, 429
- Chromosome knobs, 10, 124, 125, 203, 204
- Chromosome map, 171 ff.
- Chromosome pairing, 52, 53, 64, 414 ff., 491
 between the X and Y chromosomes, 214, 215
 without chiasmata, 213, 214, 215
- Chromosome reduction, 65
- Chromosome "split," 55, 63, 64, 65, 148, 397, 475, 491
- Chromosome structure at, meiosis, 52 ff., 54, 55, 56, 60, 62
 mitosis, 7 ff., 8
- Chromosome unbalance, 419, 421, 430
- Class centers, 360
- Class frequency, 345, 360, 361, 362
- CIB method, 251, 252, 253, 254, 261
- Clone, 66, 374, 441, 518
- Clover, flower color in, 275
 glucosides and enzymes in, 311
 self-sterility in, 277
- Coconut milk, 524, 525
- Coefficient of variability, 350, 361, 362, 363
- Coiling of chromosomes, 14, 15, 58, 64
- Coincidence, 179, 180
- Colchicine, 473 ff., 474, 475

- Colchicum, 473
 Collochores, 216
 Color, animals, 313, 314
 barley, 247, 331
 bean, 323, 324
 cat, 278, 279
 cotton, 131, 132
 daisy, 328, 329, 330
 Delphinium, 237, 238, 239
Drosophila melanogaster, body of,
 18, 21, 27, 173
 eyes of, 21, 28, 103, 104, 134,
 191, 192, 205, 206, 307, 308,
 309, 335, 337, 425
 flax, 323
 fowl, 325, 326
 Fragaria, 462
 guinea pigs, 114, 115, 165, 278,
 323
 maize, anthocyanin, 154, 155, 157,
 158, 164, 166
 fruit, 156, 175, 203, 236, 237,
 327, 329, 443
 purple, 124, 127, 128, 129, 132,
 133, 241, 280, 320
 seedlings, 136, 175
 mouse, 278, 323, 336, 355
Nemesia strumosa, 35, 113, 116,
 117, 120, 121, 275, 276
 Nicotiana, 108, 112, 113, 275, 353
 Oenothera, 161, 320
 plants, 312, 313
 Portulaca, 258, 259
 rabbit, 278, 313, 355
 red clover, 275
 snapdragon, 323
 squash, 321, 325
 Streptocarpus, 312, 313
 sweet pea, 163, 326, 327, 328
 wheat, 331, 336, 342, 464
 Combined ratios, method of, 128,
 129, 137
 Complementary genes, 228, 326, 327,
 328, 329, 335, 499, 500, 501
 Complexes, 427, 534, 536, 537
 Compound crossing over, 212
 Conifers, 438
 Conjunctive segments, 215
 Continuous variation, 346, 347, 358
 Contributing genes, 342, 346, 347,
 351, 371
 Cotton, allopolyploids in, 458
 spotted leaves, 131, 132
 white vs. brown lint, 131, 132
 Coupling, 154, 155, 156, 157, 161,
 166, 178
 Cousins, marriage of, 367, 369, 373
 Cranberry, 478
Crepidula plana, 302, 303, 304
 Crepis, chromosomes in, 452, 532,
 533
 karyotypes in, 532, 533
 reciprocal translocations in, 533
 reduction in chromosome number
 in, 532, 533
 speciation in, 531, 532, 533
 triploids in, 440, 462, 463
Crepis capillaris, 462, 463, 532
Crepis conyzaefolia, 532
Crepis fuliginosa, 532, 533
Crepis kashmirica, 532
Crepis leontodontoides, 532
Crepis Mungierii, 532
Crepis neglecta, 533
Crepis sibirica, 532
Crepis Suffreniana, 532
Crepis tectorum, 462, 463
 Crisscross inheritance, 97
 Crossing over, 57, 148, 150, 151, 152,
 421
 between chromatids, 206
 between sister chromatids, 207
 between the X and Y chromo-
 somes, 197, 198, 214
 compound, 212
 determination of per cent of from
 F₂ data, 159
 double, 173, 174, 175, 177, 178, 179,
 180, 210
 effect of age on, 167
 effect of environment on, 167
 effect of on F₂ ratios, 157, 158,
 160, 161, 162
 exactness of, 208, 209, 210
 genetical and cytological, 189, 202,
 203, 204

- Crossing over (*continued*)
 in an inversion, 397, 398, 399, 400, 402
 in four-strand stage, 206
 in male *Drosophila*, 152, 154, 162
 in plants, 154, 157
 in ring chromosomes, 396
 not more than 50 per cent, 178, 211
 percentage of, 150, 152, 153, 154, 155, 157, 158, 159, 160, 166, 171, 176, 177, 178, 211
 relation of to chiasmata, 152, 153, 202
 somatic, 216, 217
 use of in locating genes on chromosomes, 171
- Crossover suppressor, 252, 255, 256, 402
- Cross-sterility classes, 271, 273, 274, 275, 276, 277
- Cucurbits, 315, 316
- Cumulative genes, 331, 332, 343, 345, 353, 354, 357, 358, 371, 372, 385
- Cycadales, 440
- Cytogenetics, 2
- Cytological map, 191, 193
- Cytology, 1
- Cytoplasm, 3, 4, 5, 6, 9, 10, 12, 78, 540, 542
- Cytotaxonomy, 2, 438
- Dactylis glomerata*, 435, 453
- Dahlia variabilis*, 430
- Datura*, chromosomal chimeras in, 478
 embryo culture in, 524
 haploids in, 437
 reciprocal translocations in, 405, 407, 408, 409, 534
- Datura innoxia*, 524
- Datura Stramonium*, induced mutations in, 243
 trisomics in, 419, 420, 421, 423, 430
- Deficiency, 27, 250, 390, 391, 392, 393, 394, 414, 427, 428
 behavior of at meiosis, 394
- Deficiency (*continued*)
 origin of, 393
 X-ray induced, 392, 393, 394, 395
- Deletion, 55, 193, 194, 390, 393, 395
- Delphinium, 237, 238, 239, 240
- Development of the individual, 301, 302, 303
- Diakinesis, 14, 54, 58, 417, 448
- Dicentric chromosome, 396, 397, 398, 399, 400, 401, 442
- Digitalis, 458
- Dihybrids, 127, 142, 320
 modified ratios in, 321 ff.
- Dioecious plants, 503 ff.
- Dioscorea sinuata*, 505
- Diploid number of chromosomes, 49, 53
- Diploids, production of from haploids, 477
 size in, 449, 450, 451
- Diplovene, 54, 56, 57, 58, 65, 418, 446, 447
- Discontinuous variation, 346, 358
- Dissosteira carolina*, 134
- Dominance, reversal of, 88
- Dominant genes, 19, 20, 105
- Double cross method of breeding
 hybrid corn, 387, 388
- Double crossing over, 173, 174, 175, 177, 178, 179, 180, 210, 211, 212, 213
- Double nature of chromosomes, 52, 53, 55, 56, 59, 63
- Drosophila*, crossing over in, 167
 isolating mechanisms in, 523
 lethal effect of homozygous translocations, 404
 terminal deficiencies in, 391
 triploids in, 440, 450
- Drosophila funebris*, abnormal abdomen, 33
 heterochromatin in, 223
- Drosophila hydei*, heterochromatin, in, 222
- Drosophila melanogaster*, attached-X, 248
 autosomes in, 70, 506

- Drosophila melanogaster* (continued)
- chromosome I, 24, 68, 187, 255, 258
 - chromosome II, 17, 19, 68, 77, 80, 81, 129, 147, 187, 190, 191, 194, 254, 255, 256, 257, 258
 - chromosome III, 68, 77, 187, 190, 191, 192, 194, 254, 255, 256, 257, 258
 - chromosome IV, 68, 77, 187, 190, 194, 196
 - left arm of, 195, 196
 - crossover suppressor, 252, 255, 256
 - double bar, 209, 210, 265
 - effect of temperature on, 30, 31
 - eye-color hormones, 307, 308
 - first sex-linked mutation in, 225
 - genes, apricot, 28, 246
 - aristaless, 182, 187
 - bar, 19, 187, 205, 206, 209, 210, 232, 252, 264, 265, 394, 395
 - bent, 25, 187
 - black, 173, 180, 181, 182, 187
 - blood, 28
 - bobbed, 70, 187, 192, 232
 - brown, 187, 307, 308, 309
 - buff, 28, 246
 - cardinal, 187, 308, 309
 - carnation, 187, 205, 206, 335
 - cherry, 28, 246
 - cinnabar, 187, 308, 309
 - coral, 28, 246
 - cream, 337
 - curled, 25, 187, 192
 - curly, 255, 256
 - curved, 25, 80, 84, 129, 130, 147, 148, 150, 151, 152, 153, 162, 173, 180, 181, 182, 187, 346
 - cut, 25, 187
 - dark, 337
 - deformed, 255
 - Delta, 21, 187
 - dichaete, 187, 255
 - ebony, 129, 130, 187
 - ecru, 28
 - eosin, 28, 103, 104, 246, 337
 - eyeless, 187, 421, 422
- Drosophila melanogaster*, genes (continued)
- forked, 18, 187, 209, 210
 - fused, 187, 209, 210, 232
 - garnet, 187, 335
 - giant, 33
 - hairless, 18, 19, 187, 255
 - hairy wing, 187, 232, 265, 266, 267, 394
 - ivory, 28
 - jammed, 25, 187
 - light eye, 187, 191
 - male fertility, 70, 104, 190
 - miniature, 18, 24, 25, 96, 97, 134, 187, 232
 - minute, 187, 216, 217
 - morula, 232
 - notch, 77, 224
 - pink, 187, 335
 - pinkish, 337
 - plexus, 25, 180, 181, 182, 187
 - purple, 18, 134, 180, 181, 182, 187, 335
 - rolled, 187, 191
 - ruby, 187, 335
 - rudimentary, 232
 - scarlet, 187, 192, 309, 335
 - sepia, 187, 335
 - singed, 187, 216, 217, 235
 - speck, 147, 148, 150, 151, 152, 153, 162, 180, 181, 182, 187
 - star, 187, 255
 - stubble, 187, 255, 256
 - thick, 187, 191
 - tinged, 28, 246
 - veinlet, 21, 187
 - vermilion, 21, 187, 308, 309, 335
 - vestigial, 18, 19, 20, 24, 25, 31, 32, 173, 180, 181, 182, 187, 304
 - white, 18, 21, 28, 103, 104, 187, 194, 195, 225, 246, 307, 335, 337, 425, 426
 - wine, 28
 - yellow, 18, 21, 27, 187, 216, 217, 235, 391
- genetic and cytological crossing over in, 205, 206
- gynandromorphs in, 497

- Drosophila melanogaster* (continued)
 haplo-IV, 415, 416
 heterochromatin in, 222, 223
 inheritance of sex in, 68, 69
 lethal mutations in, 236, 244, 245
 no crossing over in male, 152, 154, 162, 167, 186, 213
 nondisjunction in, 425, 426
 number of chromosomes in, 6, 26, 139, 147, 187, 424
 number of genes in, 16, 17, 147
 number of linkage groups in, 187, 189
 partial linkage map of, 187
 salivary gland chromosomes, 74, 75, 77, 398
 spacing of genes on chromosomes, 193
 spontaneous mutation in, 241
 superfemale, 249
 transplantation of tissues, 309
 triplo-IV, 416, 421
 triplo-X, 424
 triploid intersexes in, 482, 493, 496
 wild type, 17, 24 ff., 148, 231, 307 ff., 335
 X chromosome, 68 ff., 96, 187, 189 ff., 196, 245 ff., 481, 506
 Y chromosome, 68 ff., 189, 481
- Drosophila miranda*, 524
- Drosophila obscura*, number of chromosomes in, 187
 number of linkage groups in, 187
- Drosophila pallidipennis*, 223
- Drosophila pseudoobscura*, heterochromatin in, 223
 heterosis in, 386, 387
 hybridization with *D. miranda*, 524
 intersexes in, 486, 496
 inversions in, 402
 number of chromosomes in, 187
 number of linkage groups in, 187
- Drosophila simulans*, heterochromatin in, 222
 intersexes in, 486
- Drosophila virilis*, heterochromatin in, 222
 intersexes in, 485
 miniature, 237, 239, 240, 337
 mutable genes in, 237, 239
 number of chromosomes in, 187
 number of linkage groups in, 187
- Drosophila willistoni*, number of chromosomes in, 187
 number of linkage groups in, 187
- Duodecaploid, 467
- Duplex, 448, 461, 462
- Duplicate genes, 330 ff., 342 ff., 353 ff., 371, 372, 385, 461, 464
- Duplicate determiners, 354
- Duplication, 209, 210, 264 ff., 394 ff., 414
- Ear-to-row method of selection, 378, 379
- Echinoderms, 523
- Ectoderm, 302
- Egg, 48, 49, 51, 66, 67, 68, 70, 78, 149, 503, 504, 513
- Elimination of chromosomes in *Sciara*, 489, 490, 491, 492
- Elodea canadensis*, 73
- Embryo, culture of, 524, 525
- Embryo sac, 51, 52, 392, 442, 541
- Embryophyta, 503, 504
- Endoderm, 302
- Endosperm, 52, 390, 438, 440, 442-445, 514
 abnormal in hybrids, 443, 444, 445, 524, 525
 as barrier to hybridization, 444, 524, 525
- Environment, crossing over and, 167
 effect of on development, 304
 effect on gene mutation, 240, 241, 243
 effect on quantitative characters, 376
 effect on sex potentialities, 494, 495, 510, 511
 importance of, 30-32, 231, 301
 isolating mechanisms and, 519

- Environment (*continued*)
 plant and animal breeding and,
 377, 381
- Environmental differences, 225
- Enzyme, 305 ff., 306, 323, 324, 328
- Ephestia, 309
- Epistasis, of a dominant gene, 321,
 322
 of a recessive gene, 323
 of dominant and recessive genes,
 325, 326, 328
 of polygenes, 358
- Equation division, 65, 72
- Equator, 9, 10, 59, 63
- Equatorial plate, 9, 10, 11, 64
- Erythroblastosis foetalis*, 292, 293,
 295
- Euchromatin, 71, 77, 220, 221, 222,
 267, 411
- Euchromosomes, 487
- Euploid, 433 ff.
- Eurycca bislineata*, triploids in, 442
- Evening primrose, *see* *Oenothera*
- Evolution, 25, 516, 531
 amphidiploids and, 457
 autopolyploidy and, 453
 chromosome aberrations and, 390,
 402, 404
 effect of temperature on, 263, 264
 gene frequencies and, 539
- Evolution in wheat, 465, 466
- Expressivity, 32 ff., 511
- F₁ generation, 83
- F₂ generation, 83
- Factors, 16
- Feeble-mindedness, 293
- Fertilization, 48, 66, 67, 480
- Fish, character index in, 528
 inheritance of sex in, 70, 481, 483
 isolating mechanisms in, 522, 523
- Fluctuations, 225, 357
- Four o'clock, 80, 86, 346, 540
- Fowl, barred Plymouth Rock, 98,
 99
 blue Andalusian, 87
 breeding for egg production in,
 380, 381, 382
- Fowl (*continued*)
 comb shape in, 321
 effect of colchicine on, 476, 477
 frizzle, 22, 23
 incomplete dominance in, 87
 inherited tremor in, 33, 34
 inhibiting genes in, 325, 326
 number of chromosomes in, 99
 Plymouth Rock, 325
 Rhode Island Red, 99
 sex reversal in, 494
 White Leghorn, 325
- Fragaria, flower color in, 462
 hybrid in, 462, 463
- Fragaria bracteata*, 462, 463
- Fragaria collina*, 463
- Fragaria elatior*, 73, 505
- Fragaria vesca rosea*, 462, 463
- Fragments, chromosomal, 190, 394,
 442, 509
- Frequency curve, 348, 351
- Fritillaria pudica*, 221, 222
- Frogs, 442
- Funaria hygrometrica*, 542
- Funaria mediterranea*, 542
- Galeopsis pubescens*, 458
- Galeopsis speciosa*, 458
- Galeopsis Tetrahit*, 458, 464
- Gamete, 47, 50, 51, 66, 82, 83, 127,
 138, 480, 502, 503, 504, 517, 518
- Gametic elimination, 275
- Gametophyte, 50, 434, 438, 480, 502,
 503, 504, 514
 chromosomal deficiencies and, 391,
 392, 415
 effect of mutation on, 233
 extra chromosomes and, 419, 421,
 422
- Gamma rays, 260
- Gasteria, 61, 62
- Gene, 5, 6, 14, 16, 17, 77
 complementary, 228, 326, 327, 328,
 329, 335, 499, 500, 501
 contributing, 342, 346, 347, 351,
 371
 cumulative, 331, 332, 343, 345, 353,
 354, 357, 358, 371, 372, 385

- Gene (*continued*)
 duplicate, 330 ff., 342 ff., 371, 372, 385
 effect of environment on, 304
 epistatic, 321 ff.
 female-tendency, 482, 485, 493, 498, 506
 for sex, 511, 512
 in *Habrobracon*, 498 ff.
 for size, 342 ff., 367 ff.
 inhibiting, 325, 326, 327
 location of on chromosomes, 171, 202
 male-tendency, 482, 484, 485, 493, 506, 509
 modifying, 33, 336, 337, 354
 mutable, 236, 237, 238, 239, 240, 241, 259, 269
 nature of, 219, 220, 230, 305
 neutral, 342, 346, 371
 plural, 354, 355
 polymeric, 346, 347, 348, 349, 351, 353, 354, 357
 reaction of with cytoplasm, 304, 306, 318
 salivary gland bands and, 77
 size of, 16, 224
 suppressor of sex genes, 485
 Gene action, 30-34, 301 ff., 306
 Gene frequencies, 537-540
 Gene interaction, 23-26, 304, 320 ff., 342 ff.
 Gene mutations, 227, 230, 235, 531, 533, 538, 539
 effect of environment on, 240, 241, 243, 263
 frequency of, 235, 236
 induction of, 243, 244, 245, 246, 247, 248, 249, 250, 251, 252, 253, 260, 267, 268
 Gene string, 14, 75
 Gene symbols, 20, 21, 148
 General index, 528
 Generative nucleus or cell, 51
 Genetics, 1
 Genic balance, 419, 421
 Genome, 26, 27, 353, 414, 415, 419, 433, 440, 456, 457, 458, 460, 462, 463, 465, 502
 deficient, 390, 414
 Genotype, 20, 511
 Genotypic ratio, 83, 127, 128, 129, 137, 139, 140, 157
 Germ cells, 47, 225, 489
 Germ layers, identified in chromosomal chimeras, 478
 Germ line, 489, 491
 German method of breeding, 378
 Golgi apparatus, 5
 Goodness of fit, 135, 142
 Grafting, 141, 235
 Grass, inbreeding in, 374
 polyploids in, 452, 453
 Grasshoppers, 69
 Grouse locust, 403
 Growth, 311, 314, 315, 316, 357
 Guinea pigs, 114, 115, 165, 323, 373
 Gynander, 496, 497, 498, 501
 Gynandroid males, 501
 Gynandromorphs, 496, 497, 498
Habrobracon, 67, 246, 260
 fused, 499, 500
 gynanders in, 497, 501
 gynandroid males, 501
 lemon lethal, 247
 lethals in, 253
 sex determination in, 498, 499
 sex linkage in, 499, 500
 triploid of, 450
 Half mutants, 537
 Haplo-IV, 415, 416
 Haploid number of chromosomes, 49, 63
 Haploid, size in, 449, 451
 Haploids, 433 ff.
 in animals, 437, 438, 439
 in insects, 434
 weakness of, 435
 Hapten, 307
 Hardy-Weinberg law, 539
 Heat, effect on crossing over, 167
 Height, inheritance of in plants, 343, 344, 345, 374, 375, 384

- Hemp, 510
- Hermaphrodites, 66, 486, 495, 496,
502, 507, 508, 509
- Heterochromatin, 71, 77, 203, 220,
267, 411
cold treatment and, 221, 222, 224
in *Drosophila* spp., 222, 223
- Heterochromosomes, 487
- Heterogametic sex, 154, 233, 483,
486, 487, 506, 513
- Heteromorphic chromosomes, 134,
203, 205, 506
- Heteropycnosis, 486, 487, 488, 489
- Heterosis, 384 ff., 537
in maize, 368, 384, 387
- Heterotypic division, 66
- Heterozygosity and hybrid vigor,
385
- Heterozygote, 19, 20, 82, 83, 85, 87,
88, 139, 140-142, 517
true-breeding, 428, 537
- Hexaploid, 433, 463, 464, 466, 467,
471
- Hexavalent configuration, 453
- Histogram, 344, 526, 527
- Homeotypic division, 66
- Homologue, 11, 17, 81, 125, 126
pairing of, 52, 53, 76, 148
- Homozygote, 19, 20, 82, 83, 85, 86,
88, 139
- Homozygous lines, establishment of,
371, 372, 384, 387
- Hordeum jubatum*, 525
- Hordeum vulgare*, 435
- Hormones, 22, 307, 308, 309, 310, 311,
494, 495
- Horses, 382
- Human beings, A-B blood groups
in, 284, 286, 287, 288, 289, 290
bleeding from the nose in, 44, 198,
199
characters in, 37-46, 198
color blindness in, 99, 100, 198, 199
Daltonism, 99, 100, 198
deafness, 43, 198
Dihybrids in, 130, 131
diseases in, 44, 45
distribution of genes in, 89, 90
- Human beings (*continued*)
dwarfism, 40
ear, abnormalities of, 43, 104
epidermolysis bullosa, 198, 199
eye, abnormalities of, 42, 43, 101
eye color, 42, 43
fingerprint pattern, 101, 102
fingers and toes, abnormalities of,
40, 41, 89, 90, 102, 104, 130,
131, 346
hair, 39
hemangioma, 130, 131
hemophilia, 100, 101
hemorrhagic diathesis, 198, 199
high degree of heterozygosity in,
140
incomplete sex linkage in, 196,
197, 198
insanity, 37, 38
linkage groups in, 195, 196
microphthalmus, 101
M-N blood types, 290, 291
muscular atrophy, 101
night blindness, 198, 199
number of chromosomes in, 6, 48,
69, 140, 196
psychological characters, 45, 199
retinitis pigmentosa, 198, 199
Rh blood types, 289, 291, 292, 293,
294, 295, 296, 297, 298
sex inheritance in, 69, 109, 481
sex-linked genes in, 99-101
skeleton, abnormalities of, 39, 40
skin, abnormalities of, 39, 44, 101,
104, 198
skin color, 38, 39
smell, 44
spasms, 199
spastic paraplegia, 198, 199
streblocmicrodactyly, 41, 102
susceptibility to poliomyelitis, 32,
44
taste, 43
teeth, abnormalities of, 43, 101
xeroderma pigmentosum, 198, 199
Y chromosome inheritance in, 104
- Humulus japonicus*, 505
- Humulus Lupulus*, 505

- Hybrid corn, 378, 387
 Hybrid embryos, culture of, 524, 525
 Hybrid index, 528, 529, 530
 Hybrid swarm, 518, 519, 521, 523, 524, 526, 527, 536
 Hybrid vigor, 384, 385, 388
 Hybrids, abnormal development of
 endosperm in, 443, 444, 445
 chromosomal, 518
 gene, 517
 in cattle, 382
 in maize, 384
 intergeneric, 459, 460, 461
 interspecific, 517, 530, 531, 532, 533
 in *Tradescantia*, 400, 519, 520, 525, 526, 527, 528
 intraspecific, 517
 mendelian, 517, 518
 sterility of, 456, 459, 467, 531, 532
 Hybridization, introgressive, 526, 528
 Hypostatic genes, 321
 Imperfect flowers, 503, 510
 Inbreeding, 367 ff., 539
 beneficial effects of, 368, 369
 harmful effects of, 367, 373
 in animals, 373
 in maize, 367, 384, 387
 Incomplete dominance, 22, 86, 87, 88, 130, 131, 332, 336, 343, 344, 345, 353, 357, 358, 371, 372
 Incomplete sex linkage, 95, 106
 in man, 196, 197
 Independent assortment, law of, 126, 137, 139, 147, 166
 Independent events, probability of occurrence of, 110, 179
 Index frequencies for comparing populations, 525, 526, 527, 528, 529, 530, 531
 Indole-3-acetic acid, 478
 Inert regions, 190, 192, 220, 267
 Inhibiting genes, 325, 326, 327
 Insanity, heredity of, 37, 38
 Insects, 522
 embryology of, 496, 497
 Interaction of genes, 23-26, 304, 320 ff., 342 ff.
 Interference, 179
 Interkinesis, 62, 63
 Intersexes, 482 ff., 493, 497, 513
 Introgressive hybridization, 526, 528
 Inversion, as crossover suppressor, 168, 252, 255
 crossing over within, 397, 398, 399, 400, 402
 independent, included, and overlapping, 402
 pairing in at meiosis, 55, 193, 194, 397 ff., 398, 399, 414
 X-rays and, 394, 399
 Iris, 10, 520, 521, 525
 Isolating mechanisms, 516, 518, 519
 Isolation, ecological, 519, 522
 gamete-incompatibility, 523
 gene-cytoplasm, 523
 geographic, 519
 hybrid lethality, 523
 hybrid sterility, 524, 531, 533
 mechanical, 522
 psychological, 522, 524
 seasonal, 521, 522
 sexual, 522
 Karyokinesis, 6
 Karyolymph, 6
 Karyosome, 486
 Karyotype, 532, 533
 Kinetochore, 7, 125
 Kynurenic acid, 308
 Kynurenin, 308, 309
 Lagging at meiosis, 416, 442
 Lampbrush chromosomes, 78
Lathyrus odoratus, round vs. long pollen, 163
 number of chromosomes in, 187
 number of linkage groups in, 187
 purple flowers, 163, 326, 327, 328
 Leptotene, 53, 54, 64
 Lethals, 101, 200, 231, 245, 250-257, 386, 427, 428
 balanced, 534, 536, 537

- Lethals (*continued*)
 deficiencies and, 391, 392, 393, 427, 428
 extra chromosomes and, 417
 missing chromosomes and, 415, 424
 mutation rate of, 236, 240, 241, 244, 245, 246
 translocations and, 404
 Lethal mutations, 231, 250-257, 258, 259, 260, 261
 Life cycle, 50
 Lily, 17, 525
 Line selection, 377, 378
 Linkage, 147, 148, 155, 156, 171
 between genes for size and color of flowers, 353
 complete, 152, 154, 161, 162
 Rh blood types and, 297
 first case of in autosomes of *Drosophila*, 173
 of size-genes and heterosis, 385
 Linkage groups, 186, 187, 188
 Linkage map, 171, 172, 173, 176, 177, 178, 180, 181, 182, 187
 chromosome aberrations and, 189, 401, 403
 genetical and cytological compared, 189
 incompletely sex-linked genes in man and, 197
 metaphase chromosome map and, 191, 192, 193
 salivary gland map and, 192
 Linkage with self-sterility alleles, 274, 275, 276, 277
Linum usitatissimum, 323
 Locus, 17, 18, 19, 27, 28, 68, 71, 77, 82, 174, 227, 236
 Lychnis, 73, 101, 103, 483, 507
Lymantria dispar, 483, 484, 485, 493, 496
 Maize, *see Zea mays*
 Mammals, 522
 Mapping genes on chromosomes, 171 ff., 186, 190
 by combined genetical and cytological methods, 191
 Mapping genes (*continued*)
 effect of inert material on, 190, 191
 Mass selection, 377, 378
 Maternal-line selection, 378, 379, 380, 381
 Matrix, 6, 7, 12, 14, 15, 58, 75, 76, 216
 Matroclinous males, 425
 Maturation divisions, 49
 Mean, 350, 359 ff., 361
 Megagametophyte, 51, 503, 504
 Megaspore, 51, 502, 503, 504, 510
 Megaspore mother cell, 51
 Megasporocyte, 51
 Meiocyte, 213
 Meiosis, 49 ff., 54, 60, 62, 68, 71, 72, 154, 480
 in aneuploids, 415, 416, 417, 418, 423
 in generations normally haploid, 434
Melandrium album, 73
 Melanin pigments, 313
 Mesoderm, 302
 Metaphase, 7 ff., 8, 13, 16, 54, 58 ff., 60, 62, 72, 127, 154, 422, 446, 447, 448, 460
 Metaphase chromosome map, 191, 192, 193
 Microgametophyte, 51, 503, 504
 Micronucleus, 394
 Microspore, 51, 63, 502, 503, 504, 510
 Microspore division, 60
 Microspore mother cell, 51
 Microsporocyte, 51
Mirabilis jalapa, 540, 541
 Mitochondria, 3, 4, 540
 Mitosis, 6 ff., 8, 48, 52, 58 ff., 71
 Modified ratios, 321 ff.
 Modifying genes, 336, 337, 354, 513
 Mollusks, 522, 523
 Monoecious plants, 503, 509, 510, 512
 Monohybrids, 81, 127, 130
 Monoploid, 49, 433
 Monosomic, 414 ff., 425, 434
 Moss, 542

- Moths, inheritance of sex in, 70,
481, 483, 484, 485
isolating mechanisms, 523
- Mouse, body size in, 355, 356
coat color of, 278, 323, 336, 355
color genes and body size, 356
harelip, 35
isolating mechanisms in, 522
pink eye, 356
short ear, 356
short tail, 36, 37
- Mule, 388
- Multiple alleles, 27, 28, 90, 92, 103,
104, 105, 162, 271 ff., 278,
283 ff., 498-501
- Multiple factors, 346, 353, 357
- Multivalents and autopolyploidy,
466
- Mutable genes, 236, 237, 238, 239,
240, 241
effect of other genes on, 241, 269
- Mutations, 225 ff.
accumulation of in populations,
519, 532, 536
bud, 234, 235
detection of, 249, 250, 251, 252-
257
effect of time of origin, 234
effect on viability, 231, 232
gene, 227, 230, 235
effect of environment on, 240,
241, 243, 258, 260, 263
induction of, 243, 244, 245, 246,
247, 248, 249-257
harmful nature of, 231, 235, 386
induced in *Drosophila*, 243, 244,
245, 246, 251, 252, 253, 254,
255, 256, 257
induced in *Habrobracon*, 246, 247,
253
induced in plants, 243, 244, 247,
248
lethal, 231, 250-257, 258, 259, 260,
261
nature of effects of, 230, 231
recessive nature of, 232, 233
reverse, 239, 245
somatic, 233, 235, 374
- Mutations (*continued*)
sterility, 232
time of occurrence, 234, 238
- Mutation rate, 236 ff., 240
- Natural polyploids, 471
- Natural selection, 235, 236, 264, 386
- Nectarine, 235
- Nemesia strumosa*, 35, 113, 116, 117,
120, 121, 275, 276, 430
- Neurospora, 314
- Neutral gene, 342, 346, 371
- Neutrons, 260, 261
- Newt, *see* Triton and Triturus
- Nicotiana, corolla length in, 275,
349, 350, 351
endosperm in hybrids of, 443, 444
flower color in, 275, 353
haploids, 437
pollen color in, 275
self-fertility in, 277
self-sterility in, 273, 274, 275
- Nicotiana alata*, 349, 350, 351, 359
- Nicotiana Langsdorffii*, 349, 350, 351,
352, 359, 449, 450, 451
- Nicotiana Sanderae*, 108, 112, 113,
352
- Nicotiana sylvestris*, 459
- Nicotiana sylvestris* × *N. tomentosa*,
477
- Nicotiana sylvestris* × *N. tomento-*
siformis, 477
- Nicotiana tabacum*, 459
- Nicotiana tomentosiformis*, 459
- Nightshade chimeras, 478
- Nonchromosomal inheritance, 540-
542
- Nonconjugation, 424
- Nondisjunction, 423 ff., 498
somatic, 429, 430
- Nucleus, 3, 4
- Nuclear membrane, 3 ff., 4, 58 ff.
- Nuclear sap, 6, 9
- Nuclear stains, 220, 221
- Nucleic acid, 76, 77, 220, 221, 222,
267, 306
- Nucleolus, 4, 6, 7, 12, 58, 62, 63, 125
- Nucleolus-organizing region, 216

- Nucleoprotein, 305, 306
 Nulliplex, 448
 Nullosonic, 437
- Octoploids, 433, 449, 450, 451, 463, 467, 471, 475, 477
- Oenothera*, chromosome circles in, 536
 complexes in, 427, 428, 429, 534, 535, 536, 537, 541
 double flowered, 226
 evolution in, 533-537
 gold-center flower color, 320
 induced gene mutation in, 244
 lethals in, 427, 428, 534, 536
 mut. *brevistylis*, 226, 228
 mut. *bullata*, 80, 161, 163, 346
 mut. *confusa*, 226
 mut. *funifolia*, 240
 mut. *pamosa*, 244
 mut. *pollicata*, 228
 mut. *substella*, 226
 mut. *sulfurea*, 320
 mut. *supplena*, 226, 227, 228
 mut. *vetaurea*, 161, 163, 320
 mutation rate in, 240
 number of chromosomes in, 534
 old-gold flower color, 161, 163, 320
 "outside-in" flower, 226, 228
 reciprocal translocations in, 405, 534
 short-styled, 226
 sulfur flower color, 320
- Oenothera Hookeri*, 541
- Oenothera Lamarckiana*, flower of, 226, 320
 mutations in, 225
 nondisjunction in, 425, 428, 429
 pistil of, 228
 plastids in, 541
 rosette of, 244
 trisomics, 428, 429
- Oenothera organensis*, self-sterility alleles in, 277
- Olfersia bisulcata*, chromosome pairing in, 214, 215
- Oligogenic characters, 357, 358
- Onion, *see* Allium
- Oöcytes, 49, 65, 149, 152
- Oötids, 503, 504
- Oppositional factor hypothesis, 272
- Orange, 235
- Outbreeding, 367
- Outercross, 367, 512
- Overlapping phenotypes, 376
- P₁ generation, 83
- Pachytene, 54, 55 ff., 56, 148, 152, 418
- Pairing of chromosomes, at meiosis, 52, 53, 64, 414 ff., 491
 exactness of, 53, 397
 failure of, 471, 524
 heterozygous for a deletion, 55, 193, 194, 393
 heterozygous for an inversion, 55, 193, 194, 397 ff., 398, 399, 414
 heterozygous for a reciprocal translocation, 404, 405, 406, 407
 in a haploid, 434, 435
 in a monosomic, 415
 in a trisomic, 417, 423
 in an allotetraploid, 458, 460, 461
 in an autotetraploid, 445, 446, 447
 in an autotriploid, 441, 442, 463
 nondisjunction and, 425
 without chiasmata, 213, 214, 215
- Paradichlorobenzene, induction of polyploids by, 474
- Paris, 220, 221, 224
- Parthenogenesis, 67, 502
- Patroclinous males, 425
- Pattern of development, 302, 304, 318
- Pea, 6, 20
- Peach, 235
- Pedigree, 381
- Pedigree culture method, 37, 196, 540
- Penetrance, 32-34
- Pentaploid, 433, 452, 453
- Pentstemon, 466, 467
- Pepper, haploids in, 435, 436
- Perfect flowers, 502
- Peromyscus, 522, 523

- Phaseolus vulgaris*, 323, 324
 Phenotype, 20
 Phenotypic ratio, 83, 128, 129, 137, 139, 140, 157
Phleum pratense, 435, 466
Phoradendron flavescens var. *macrophyllum*, 505
Phoradendron villosum, 505
 Phrynotettix, 487
 Pine, hybrid vigor in, 388
Pinus Thunbergiana, 440
 Pistillate flowers, 503
 Plant breeding, 85, 86, 141, 142, 235, 367 ff., 437
 Plasmagene, 306
 Plasma membrane, 3, 5, 12
 Plastids, 3, 540, 541, 542
Platypoecilus xiphidium, 483
 Pleiotropy, 21-23
 Plural determiners, 354, 355, 357
Poa pratensis, 435
 Point mutation, 227
 Polar body, 49, 149, 424, 425, 426
 Polar nuclei, 52, 442, 443
 Polarized chromosomes, 53
 Pollen grain, 51, 60, 392, 540
 Pollen tube, 51, 52, 392, 421, 540, 541
 differential growth rate of, 272, 277
 Polygamous plants, 503
 Polygenes, 344, 348, 372
 Polygenic characters, 357, 358
 Polyhybrids, 139, 140, 141, 142
 Polymeric genes, 346, 347, 348, 349, 351, 353, 354, 357
 Polymery, 343 ff.
 Polypeptid fibers, 77
 Polyploids, 330, 353, 354, 433 ff.
 evolution and, 453, 531, 533
 methods of inducing, 471
 monosomics in, 415
 origin of, 470 ff.
 Populations, 264, 351, 359 ff., 386, 387
 comparison of by index frequencies, 525, 526, 527, 528, 529, 530, 531
 Populations (*continued*)
 gene frequencies in, 537-540
 heterozygous, 140, 141, 142
 in equilibrium, 539
Portulaca grandiflora, 258, 259
 Position effect, 264, 265, 266, 267, 395, 401, 518
 Postheterokinesis, 72
 Poultry, *see* Fowl
 Presence and absence hypothesis, 105
 Prime types in *Datura*, 407, 408, 409
 Primula, 332, 333, 334, 335, 458
 Probability, 86, 108 ff., 179
 of occurrence, 120, 135
 Probable error, 117, 359, 361, 363, 364
 Prochromosomes, 223, 224, 492
 Progeny test, 377, 382
 Prometaphase, 7, 9, 58
 Prophase, 7 ff., 8, 13, 16, 52 ff., 72, 75, 221
 Proteins, 6, 305, 306
 Protenor type of sex inheritance, 69
 Protoplasm, 2
 Pure line, 371, 374, 378, 387
 Pycnotic chromosomes, 476
 Quadrivalent configuration, 204, 445, 446, 447, 448, 449, 453, 459, 462
 Quadruplex, 448, 462
 Qualitative characters, 346
 Quantitative characters, 342 ff.
 Quantitative effect at hairy wing locus, 266, 267
 Quinquevalent configurations, 453
 Rabbits, blood groups in, 283, 290
 body size in, 355
 coat color of, 278, 313, 355
 effect of colchicine on, 476
 Radiation, action of on genes, 267 ff.
 deletions and, 194
 gene mutations and, 241, 243, 251, 252, 253, 254, 255, 263, 267, 268, 269
 translocations and, 191
 Radish, 459

- Radish-cabbage hybrid, 459
- Radium, mutations and, 241, 243, 244, 245, 248, 268
- reciprocal translocations and, 203
- Range, 362
- Raphanobrassica, 459
- Ratios, 1 : 1, 84, 85, 135, 165, 421
- 1 : 1 : 1 : 1, 132, 133, 172
- 1 : 2 : 1, 83, 84, 86, 87, 128, 406, 537
- 1 : 4 : 1, 448, 462
- 1 : 4 : 6 : 4 : 1, 332, 342
- 1 : 6 : 15 : 20 : 15 : 6 : 1, 342
- 1 : 8 : 18 : 8 : 1, 462
- 2 : 1, 422
- 2 : 1 : 1, 161, 162, 186, 322
- 3 : 1, 83, 84, 128, 135, 161, 319, 320
- 3 : 3 : 1 : 1, 158
- 5 : 1, 421, 422, 449
- 9 : 3 : 3 : 1, 127, 128, 129, 130, 136, 157, 163, 320
- 9 : 3 : 4, 323, 324, 329
- 9 : 6 : 1, 331
- 9 : 7, 326, 327, 328, 329
- 12 : 3 : 1, 321, 329
- 13 : 3, 326, 327
- 15 : 1, 330 ff., 460, 461
- 27 : 9 : 9 : 9 : 3 : 3 : 3 : 1, 137
- 27 : 31, 335
- 35 : 1, 449, 462
- 63 : 1, 335
- 81 : 175, 335
- 255 : 1, 335
- Ratios, genetic, and nondisjunction, 425, 426
- in allopolyploids, 460
- in autotetraploids, 448, 462
- in trisomics, 421, 422
- Recessive genes, 19, 20, 105
- Reciprocal cross, 88, 89, 96, 130, 134, 152, 273, 276, 277
- Reciprocal translocation, 203, 204, 205, 264, 403, 423, 425, 532, 533
- and chromosome circles, 406, 407, 408, 409, 427, 428, 429, 534
- and nondisjunction, 425, 427, 428, 429
- and X-rays, 404
- Reciprocal translocation (*continued*)
- configurations at first meiotic metaphase, 406, 407, 408, 409
- pairing at meiosis in, 404, 405, 406, 407
- Recombinations of genes, 149 ff., 150, 171 ff., 206, 226
- Reduction division, 49, 65, 72
- Relational coils, 55, 56
- Relative growth, 315, 316
- Relic coils, 15, 53, 75, 393
- Repeat, 395
- Reproduction, asexual, 47, 66, 513, 514
- sexual, 47-52, 68 ff., 480 ff., 513
- vegetative, 66, 141, 142, 235, 374, 441, 453, 513
- Repulsion, 154, 155, 156, 157, 158, 161, 162, 166, 178
- Rhesus blood types, 289, 291 ff., 294, 295, 296, 297, 298
- Rhoeo discolor*, 405, 406, 472
- Ring chromosomes, 393, 394, 395, 396
- Rosa, 468
- Rudbeckia hirta*, 328, 329, 330
- Rumex, 73, 505, 506
- Rye, haploids in, 437
- number of chromosomes in, 11
- Rye-barley hybrids, sterility of, 444, 445
- Rye-wheat hybrids, 459, 460
- Salamanders, 442, 472
- Salivary gland chromosome map, compared with genetic and metaphase maps, 192
- construction of, 193, 194
- Salivary gland chromosomes, 74-78, 192, 193, 194, 251, 397
- and bar locus, 209, 210
- euchromatin and heterochromatin in, 220, 224
- pairing in if heterozygous for an inversion, 398
- Sample, 121, 359, 363
- Satellite, 10
- Sciara, 78, 488, 489, 490, 491, 492

- Secale cereale*, 525
- Secondary association, 468, 469
- Segmental interchange, 203
- Segregation, law of, 82
of genes in autotetraploids, 448
- Selection, 367 ff., 538, 539
and plant and animal breeding,
376, 377, 378, 379, 380, 381,
382, 383
elimination of spontaneous le-
thals by, 255
isolation of biotypes by, 379
within pure lines, 371
- Self-fertility, 277
- Self-fertilization, 66, 85, 86, 368, 369,
371
- Self-incompatibility, 271, 272
- Self-sterility, 271, 272, 273, 274, 275,
276, 277
- Self-sterility alleles, linkage of with
other genes, 274, 275, 276, 277,
353
- Semi-sterile plants, 406, 407, 408
- Setcreasia brevifolia*, 448
- Sex chromosomes, 68 ff., 513
heteropycnosis of, 486, 487, 488
ratio of to autosomes, 482, 483,
506, 507
- Sex inheritance, 68 ff., 480 ff.
attached-X stocks, 249, 483
balance theory of, 481-485, 486,
493
female-determining substance, 484,
493
hormones and, 494, 495
importance of environment on,
495
in plants, 73, 502-514
male-determining substance, 484,
493
potentialities for either sex, 493
probability of a male, 109, 110,
111
sex-gene suppressors, 485
strong and weak races, 484
XO type, 69, 70, 134, 481, 505
XY type, 68, 69, 481, 505, 506
ZW type, 69, 70, 481, 505
- Sex linkage, incomplete, 95, 106,
196, 197
in plants, 101-103
XY and XO types, 95, 97, 98
ZW and ZO types, 98, 99
- Sex-linked lethals, mutation rate of,
240, 261
- Sex reversal, 483, 484, 494
- Sheep, Cotswold, 90
Dorset, 87, 88, 90, 91, 92
horns in, 87, 90, 91, 92
Merino, 90, 91, 92
multiple alleles in, 90, 91, 92
Rambouillet, 90, 91
Shropshire, 90
Southdown, 90
Suffolk, 88, 90
- Silkworm, failure of chiasma for-
mation in females, 154, 167,
213
- Simplex, 448, 462
- Single nature of chromosomes, 52,
53
- Size, in polyploids, 449, 450, 451
- Size genes, 342 ff., 367 ff.
- Snail, 318, 319, 523
- Snapdragon, 323, 450
- Solenobia, tetraploids of, 450
- Soma, 225, 489, 503, 504
- Somatic crossing over, 216, 217, 235
- Somatic mutation, 233, 235, 238,
258, 259, 374
- Somatic nondisjunction, 429, 430
- Somatic pairing in Diptera, 214,
216
- Somatoplastic sterility, 525
- Sorghum, haploids, 435, 437
- Spartina, 457, 458
- Speciation, 227, 530, 531, 533
- Species concept, 516, 517, 526, 528
- Sperm, inactivated, 253
- Sperm nucleus, 51, 52, 442, 443
- Spermatids, 49, 503, 504
- Spermatocytes, 49, 65, 72, 434, 486,
491
- Spermatozoon, 48, 49, 66, 68, 69, 70,
434, 503, 504
- Spiders, 522, 523

- Spindle, 9, 12, 13, 59, 63, 64, 317, 318, 471, 474, 476
- Spindle fiber attachment point, 7
- Spindle fibers, 9
- Spore, 50, 480, 502, 503, 504
- Sporophyte, 50, 52, 480, 502, 503, 504, 513, 514
- effect of mutation on, 233
- Sports, 226, 235
- Spruce budworm, 487, 488
- Squash, 315, 321, 325
- Staminate flowers, 503
- Standard deviation, 115, 350, 361, 362, 364
- Standard error, 114-117, 118, 135, 165, 166, 359, 361, 363, 364, 529
- Statistical constants, 358 ff.
- Sterility, of haploids, 434, 437
- of hybrids, 456, 459, 467, 524, 531, 532
- of tetraploids, 445
- of triploids, 441, 453
- Stomata, size of in polyploids, 450
- Streptocarpus, 312, 313
- Subspecies, 517
- Suckers, 529, 530
- Superfemale, 249, 482, 498, 506
- Supermale, 482
- Sweet pea, *see* *Lathyrus odoratus*
- Swine, 368
- Synapsis, 53, 202
- Telomere, 391
- Telophase, 7, 8, 12, 13, 14, 15, 53, 54, 62, 63, 64, 72, 220, 221
- Temperature, and induction of polyploids, 471
- and mutation rate, 240, 241, 243, 251, 254, 255, 258, 259, 263, 264
- Terminalization of chiasmata, 58, 59, 417, 423, 445, 446, 447
- Testcross, 85, 86, 132, 133, 139, 150, 154, 157, 176
- Tetrad, 57
- Tetrahybrids, 140
- Tetraploid, 353, 433, 442, 445-451, 470, 471, 475
- sterility of, 445
- Tetrasomic, 430, 445, 449
- Three-point cross, 178, 180
- Thuja orientalis*, 440
- Tobacco, *see* *Nicotiana*
- Tomatoes, autotetraploid, 448
- climieras in, 478
- haploids in, 437, 477
- selection in, 383
- Trabant, 10
- Tradescantia, deficiencies in, 393
- effect of X-rays on, 401
- hybridization in, 519, 520, 525, 526, 527, 528
- tetraploids in, 448, 471
- triploids in, 441, 471
- Tradescantia bracteata*, 441, 442, 528
- Tradescantia canaliculata*, 400, 453, 471, 519, 520, 526, 527, 528
- Tradescantia gigantea*, 401
- Tradescantia hirsutiflora*, 471
- Tradescantia occidentalis*, 453, 454, 528
- Tradescantia paludosa*, 60, 61, 400, 471
- Tradescantia subaspera* var. *typica*, 519, 520
- Tradescantia virginiana*, 447, 448, 526, 527
- Translocations, 189, 190, 191, 193, 194, 195, 196, 264, 267, 353, 354, 402, 403, 414
- Transplantation, 309
- Trichoniscus elisabethae*, 450
- Trihybrids, 136 ff., 142
- Trillium, 14, 220, 221, 224
- Trimerotropis suffusa*, 126
- Triplex, 448, 462
- Triploid, 390, 400, 433, 440-442, 470, 471, 472, 473
- and sex, 482
- in *Fritillaria pudica*, 222
- size in, 449, 450, 451
- sterility of, 441, 442
- vigor of, 440
- Triplo-IV, 416, 421

- Triplo-X, 424
 Trisomic ratios, 421, 422
 Trisomics, 416, 417, 418, 419, 420, 421, 422, 423, 424, 425, 426, 428, 429, 430, 442
 primary, 423, 440
 secondary, 423, 429
 tertiary, 423
 Triticale, 459, 460
 Triticum, awn types of, 322
 color of fruit of, 331, 336, 342, 464
 interspecific crosses in, 465
 number of chromosomes in, 11
 stomatal size in polyploids of, 450
 Triticum \times Aegilops hybrid, 461, 465
Triticum compactum, 464
Triticum dicoccoides, 464
Triticum dicoccum, 464
Triticum durum, 464
Triticum monococcum, 435, 464, 465
Triticum persicum, 464
Triticum polonicum, 464
Triticum spelta, 464
Triticum turgidum, 464, 465
Triticum vulgare, 435, 437, 464
Triton taeniatus, 437, 472
Triturus similans, 472
Triturus pyrrhogaster, 438, 439, 472
Triturus viridescens, 442, 450, 472
 Trivalent configuration, 417, 418, 419, 422, 437, 441, 446, 447, 453, 459, 463, 467, 468
 Tropaeolum, 317, 318
 Tryptophane, 308, 309
 Tube nucleus or cell, 51, 52

 Ultraviolet light and mutation rate, 241, 260, 261
 Unisexual flowers, 503
 Unit characters, 23-26
 Univalent chromosome, 415, 416, 417, 423, 434, 436, 437, 441, 442, 453, 456, 459, 460, 462, 463, 465, 471, 477
 Unstable genes, 236, 239, 240, 241, 259

 Unstable genes (*continued*)
 effect of other genes on, 241, 259
 Uvularia, 528

 Vacuole, 3, 4
 Variation, 362, 516
 within inbred lines, 369, 370
 Vegetative propagation, 66, 141, 142, 235
 Vitamin, 305, 314

 W chromosome, 69, 70, 481, 483, 484
 Wasp, 67, 502
 Wheat, *see* Triticum
 Wheat-rye hybrids, 459, 460

 X chromosome, 68, 69, 70, 71, 72, 73, 77, 134, 154, 481, 482, 483, 496, 497, 505, 506, 507, 508, 509
 behavior of at meiosis, 71, 72
 deficiencies in, 391
 elimination of in *Sciara*, 489, 490, 491, 492
 genes on, 70, 95, 96
 heterochromatin in, 222, 223
 heteropogenesis of, 486, 487, 488
 induced lethal mutations in, 251-254
 nondisjunction of, 424, 426, 498
 ratio of to Y chromosome, 507, 508
 Xenia, 443
 X-rays, 14, 27, 77, 191, 471
 and deficiencies, 392, 393, 394, 395
 and inversions, 394, 399
 and mutations, 241, 243, 244, 245, 248, 260, 268, 314
 and reciprocal translocations, 203, 404
 and translocations, 403
 breaking chromosomes by, 219
 effect of on crossing over, 167
 relation of dosage to mutations, 244, 245, 268

 Y chromosome, 68, 69, 70, 71, 73, 77, 154, 481, 483, 505, 506, 507, 508, 509

- Y chromosome (*continued*)
 behavior of at meiosis, 71
 deficiencies in, 391
 genes on, 70, 95, 196
 heterochromatin in, 223
 ratio of to X chromosome, 507,
 508
- Y chromosome genes, dominance of,
 105
- Y chromosome inheritance, 95, 104,
 105
- Z chromosome, 69, 70, 481, 483, 484
- Zea mays*, B-type chromosomes in,
 411
 chromosomal chimeras in, 416
 chromosomes in, 124, 125
 deficiencies in, 392, 393
 dent, 81
 dioecious, 512
 flint, 81
 genes, anthocyanin, 154, 155, 157,
 158, 164, 166, 188, 280, 320
 brown midrib, 175, 176, 177, 178,
 179, 188, 395
 colored aleurone, 156, 175 ff.,
 188, 203, 204, 236, 237, 259,
 279, 280, 327, 329
 crinkly leaves, 124, 127, 128, 129,
 132, 133, 166, 188, 320
 lazy, 309, 310
 liguleless, 136, 188
 nana, 166, 188, 311
 pericarp color, 30, 31, 188, 279,
 280
 purple plant color, 124 ff., 188,
 241, 320
 ragged leaf, 154, 155, 157, 158,
 164, 166, 188
 shrunken, 156, 188, 329
- Zea mays*, genes (*continued*)
 silkless, 188, 512
 tassel seed, 188, 511
 virescent, 136, 175, 176, 177, 178,
 179, 188, 542
 waxy, 188, 203, 204, 236
 yellow endosperm, 188, 443
 genes for sex in, 511, 512
 genetic and cytological crossing
 over in, 203, 204
 haploids, 437
 heterosis in, 368, 384, 387
 hybrid vigor in, 384, 385, 386, 387,
 388
 inbreeding in, 367, 384
 induction of polyploids in, 474
 number of chromosomes in, 6, 11,
 26, 140, 187
 number of genes in, 16
 number of linkage groups in, 187
 partial linkage map of, 188
 pod, 81
 pop, 81
 reciprocal translocation in, 203
 selection in, 378, 379
 semi-sterile, 406, 408
 sex determination in, 510, 511, 512
 sex reversal in, 510, 511
 sugary (sweet), 81, 329, 443
 sun-red, 30, 31
 trisomic, 429
 univalent in, 416
 unstable genes in, 241
 variegated pericarp, 237
 xenia in, 443
- Zygote, 48, 50, 52, 502, 503, 504, 517,
 518
- Zygote lethals, 253, 254, 260
- Zygotene, 53, 54, 55, 56, 57, 71, 76,
 434

