





45

1 by Morgan

April 1936.





THE MACMILLAN COMPANY  
NEW YORK · BOSTON · CHICAGO · DALLAS  
ATLANTA · SAN FRANCISCO

*H. Morgan*  
R  
THE INVERTEBRATA

*A Manual for the Use of Students*

by

L. A. BORRADAILE

*Fellow of Selwyn College, Cambridge*

and

F. A. POTTS

*Fellow of Trinity Hall, Cambridge*

with Chapters by

L. E. S. EASTHAM

*Professor of Zoology in the University of Sheffield*

and

J. T. SAUNDERS

*Fellow of Christ's College, Cambridge*

SECOND EDITION.

NEW YORK: THE MACMILLAN COMPANY  
CAMBRIDGE, ENGLAND: AT THE UNIVERSITY PRESS

1935

*Copyright, 1935, by*  
THE MACMILLAN COMPANY

All rights reserved—no part of this book may be reproduced in any form without permission in writing from the publisher, except by a reviewer who wishes to quote brief passages in connection with a review written for inclusion in magazine or newspaper.

PRINTED IN THE UNITED STATES OF AMERICA



## PREFACE TO THE FIRST EDITION

This book is intended for the use of students who have completed a year's study of the principles of zoology and of the anatomy and physiology of a series of invertebrate types such as is provided by any of several elementary textbooks in use in this country. The types commonly included in these books—various Protozoa, *Hydra*, *Ascaris*, and the Liver Fluke, Earthworm, Leech, Crayfish, Cockroach, Pond Mussel, and Starfish—are not here described in detail. We have endeavoured to provide the student with a classification of the Invertebrata which proceeds as far as is usual in an honours course, with a concise statement of the characteristic features of each of the groups mentioned, and with a more detailed statement and discussion of matters of importance or interest concerning them. The choice of examples has been difficult, and we have not always been able to include all those we should have wished, but a fairly full account of certain representative genera has been given.

The writing of the book has been shared among us as follows: Chapters I–IV, X, XI (except Onychophora), XII, XVIII and XIX have been written by L. A. Borradaile, Chapters V (except Ctenophora), VII–IX, XIII, XV–XVII, and the Onychophora in Chapter XI by F. A. Potts, Chapter VI and the Ctenophora in Chapter V by J. T. Saunders, and Chapter XIV jointly by F. A. Potts and L. E. S. Eastham, but each of us has read and criticized the work of the others.

We desire to express our grateful thanks for valuable advice and criticism to Dr S. J. Hickson, Professor D. Keilin and Dr S. M. Manton; for much care bestowed upon the illustrations to Messrs A. P. Hayle, J. F. Henderson, and C. F. Pond; and for valuable assistance in the preparation of the index and in other matters to Mr B. Newman.

For permission to reproduce illustrations acknowledgment is due to Professor G. H. F. Nuttall; Messrs Geo. Allen & Unwin, Ltd. (*Textbook of Zoology*, Sedgwick); Messrs A. & C. Black, Ltd. (*Treatise on Zoology*, Lankester); the Council of the Cambridge Philosophical Society (*Biological Reviews*); Cambridge University Press (*The Determination of Sex*, Doncaster, *Plant Biology*, Godwin, *Ciliary Movement*, Gray, *Zoology*, Shipley and MacBride, *Primitive Animals*, Smith, *Paleontology*, Wood); Herrn Gustav Fischer, Jena (*Ergebnisse u. Fortschritte der Zoologie, Lehrbuch der Protozoenkunde*); Herren Walter de Gruyter & Co. (*Handbuch der Zoologie*); the Council of the Linnean Society of London (*Zoological Journal*); Messrs Macmillan & Co., Ltd. (*Cambridge Natural History*, Harmer and Shipley, *Human*

*Protozoology*, Hegner and Taliaferro, *Textbook of Comparative Anatomy*, Lang, *Textbook of Zoology*, Parker and Haswell); Messrs Methuen & Co., Ltd. (*Textbook of Entomology*, Imms); Oxford University Press (*The Animal and its Environment* and *Manual of Zoology*, Borradaile). Acknowledgment to the authors of the works from which these illustrations are taken is made in the legends.

THE AUTHORS

CAMBRIDGE  
February, 1932

### NOTE TO THE SECOND EDITION

The book is now eighty pages longer. The additional matter is chiefly in Chapters IV and XIV. In other chapters a number of smaller additions and corrections have been made to the text and to figures.

Each chapter has been revised by its writer, but the revision has been submitted to the other authors of the book.

Our grateful thanks for various assistance are due to Drs A. M. Bidder, O. M. B. Bulman, S. M. Manton, and C. F. A. Pantin, and to Messrs L. E. R. Picken, J. D. Robertson, and P. Ulllyott. Dr A. M. Bidder very kindly communicated to us certain facts, as yet unpublished, which are stated in the second half of p. 595.

THE AUTHORS

CAMBRIDGE  
February, 1935

# TABLE OF CONTENTS<sup>1</sup>

## CHAPTER I

Introduction: The Invertebrata	<i>page</i> 1
--------------------------------	---------------

## CHAPTER II

Subkingdom Protozoa	7
[Phylum Protozoa]	
Class Mastigophora (Flagellata)	45
Subclass Phytomastigina	46
Order Chrysomonadina	50
Order Cryptomonadina	50
Order Euglenoidina	52
Order Chloromonadina	54
Order Dinoflagellata	54
Order Volvocina	56
Subclass Zoomastigina	58
Order Rhizomastigina	60
Order Holomastigina	60
Order Protomonadina	63
Order Polymastigina	65
[Suborder Polymastigina <i>s.str.</i> ]	
[Suborder Diplomonadina]	
[Suborder Hypermastigina]	
Class Sarcodina (Rhizopoda)	68
Order Amoebina	68
Order Foraminifera	72
Suborder Monothalamia	72
Suborder Polythalamia	74
Order Radiolaria	76
[Suborder Periphyllaea (Spumellaria)]	
[Suborder Actiphyllaea (Acantharia)]	
[Suborder Monophyllaea (Nassellaria)]	
[Suborder Triphyllaea (Phaeodaria)]	
Order Heliozoa	83
Order Mycetozoa	86
Class Sporozoa	87
Subclass Telosporidia	88
Order Coccidiomorpha	88
Suborder Coccidia	89
Suborder Haemosporidia	91

<sup>1</sup> The names of groups which are mentioned in the text but not under a separate heading are here placed in square brackets.

60797

Order Gregarinidea	<i>page</i> 93
Suborder Schizogregarinaria	93
Suborder Eugregarinaria	95
Appendix: Piroplasmidea	98
Subclass Neosporidia	100
Order Cnidosporidia	100
[Suborder Myxosporidia]	
[Suborder Microsporidia]	
[Suborder Actinomyxidea]	
Order Haplosporidia	102
Order Sarcosporidia	102
Class Ciliophora	102
Subclass Ciliata	102
Order Holotricha ( <i>Aspirigera</i> )	106
Suborder Prociliata	106
Suborder Astomata	107
Suborder Gymnostomata	107
Suborder Vestibulata ( <i>Hymenostomata</i> )	109
Order Heterotricha	109
Suborder Polytricha	109
Suborder Oligotricha	110
[Tribe Tintinnina]	
[Tribe Entodiniomorpha]	
Order Hypotricha	111
Order Peritricha	111
Order Chonotricha	114
Subclass Suctoria	114

## CHAPTER III

Subkingdom Parazoa	117
[Phylum Porifera]	
Class Calcarea	126
Class Hexactinellida	126
Class Demospongiae	126
[Order Tetractinellida]	
[Order Monaxonida]	
[Order Keratosa]	
[Order Myxospongiae]	

## CHAPTER IV

Subkingdom Metazoa	128
--------------------	-----



## CHAPTER V

Phylum Coelenterata	<i>page</i> 146
Subphylum Cnidaria	152
Class Hydrozoa	153
Order Calyptoblastea	154
Order Gymnoblastea	154
Order Hydrida	154
Order Trachylina	164
Suborder Trachomedusae	164
Suborder Narcomedusae	164
Order Hydrocorallinae	165
Order Siphonophora	166
Order Graptolithina	169
Class Scyphomedusae (Scyphozoa)	172
[Order Stauromedusae]	
[Order Discomedusae]	
Class Actinozoa (Anthozoa)	180
Order Alcyonaria	180
Order Zoantharia	186
Subphylum Ctenophora	193
[Class Ctenophora]	
[Order Tentaculata]	
[Order Nuda]	

## CHAPTER VI

Acoelomate Triploblastica	197
Phylum Platyhelminthes	198
Class Turbellaria	213
Order Acoela	213
Order Rhabdocoelida	214
Order Tricladida	214
[Suborder Paludicola]	
[Suborder Maricola]	
[Suborder Terricola]	
Order Polycladida	215
Class Trematoda	216
[Order Temnocephalea]	
Order Heterocotylea	218
Order Malacocotylea	220
Class Cestoda	223
Order Monozoa	225

Order Merozoa	<i>page</i> 225
[Suborder Tetrphyllidea]	
[Suborder Diphyllidea]	
[Suborder Tetrarhynchidea]	
[Suborder Pseudophyllidea]	
[Suborder Cyclophyllidea]	
CHAPTER VII	
Phylum Nemertea	233
Phylum Rotifera	237
Phylum Gastrotricha	243
CHAPTER VIII	
Phylum Nematoda	244
Phylum Nematomorpha	257
Phylum Acanthocephala	258
CHAPTER IX	
[Coelomata]	
Phylum Annelida	260
Class Chaetopoda	261
Order Polychaeta	264
Order Oligochaeta	286
Class Archiannelida	294
Class Hirudinea	296
Class Echiuroidea	301
Class Sipunculoidea	304
CHAPTER X	
Phylum Arthropoda	305
CHAPTER XI	
Subphylum Onychophora	317
Subphylum Trilobita	323
CHAPTER XII	
Subphylum Crustacea	326
Class Branchiopoda	353
Order Anostraca	356
[Order Lipostraca]	

Order Notostraca	<i>page</i> 360
Order Diplostraca	362
Suborder Conchostraca	362
Suborder Cladocera	362
[Tribe Ctenopoda]	
[Tribe Anomopoda]	
[Tribe Onychopoda]	
[Tribe Haplopoda]	
Class Ostracoda	368
Class Copepoda	370
Class Branchiura	376
Class Cirripedia	376
Order Thoracica	377
Order Acrothoracica	382
Order Apoda	382
Order Rhizocephala	382
Order Ascothoracica	385
Class Malacostraca	386
Subclass Leptostraca	390
Subclass Hoplocarida (Stomatopoda)	391
Subclass Syncarida	392
Subclass Peracarida	393
Order Mysidacea	393
Order Cumacea	393
Order Tanaidacea	395
Order Isopoda	395
Order Amphipoda	400
Subclass Eucarida	403
Order Euphausiacea	403
Order Decapoda	404
[Suborder Penaeidea]	
[Suborder Caridea]	
[Suborder Palinura]	
[Suborder Astacura]	
[Suborder Anomura]	
[Suborder Brachyura]	

## CHAPTER XIII

Subphylum Myriapoda	418
Class Chilopoda	418
Class Diplopoda	422
[Class Pauropoda]	
[Class Symphyla]	

## CHAPTER XIV

Subphylum Insecta (Hexapoda)	<i>page</i> 425
Class Apterygota	463
Order Thysanura	463
Order Collembola	463
Order Protura	465
Class Pterygota	466
Subclass Exopterygota	466
Order Orthoptera	466
[Suborder Cursoria]	
[Suborder Saltatoria]	
Order Dermaptera	468
Order Isoptera	469
Order Plecoptera	471
Order Embioptera	471
Order Psocoptera	471
Order Odonata	472
[Suborder Zygoptera]	
[Suborder Anisoptera]	
Order Hemiptera or Rhynchota	474
[Suborder Heteroptera]	
[Tribe Cryptocerata]	
[Tribe Gymnocerata]	
[Suborder Homoptera]	
[Tribe Auchenorrhyncha]	
[Tribe Sternorrhyncha]	
Order Ephemeroptera	481
Order Mallophaga	483
Order Anoplura	483
Order Thysanoptera	485
Subclass Endopterygota (Holometabola)	485
Order Neuroptera	485
Order Mecoptera	486
Order Trichoptera	486
Order Lepidoptera	487
[Suborder Homoneura]	
[Suborder Heteroneura]	
Order Coleoptera	492
[Suborder Adephaga]	
[Suborder Polyphaga]	
Order Hymenoptera	495
[Suborder Symphyta]	
[Suborder Apocrita]	



Order Diptera	<i>page</i> 504
[Suborder Orthorrhapha]	
[Suborder Cyclorrhapha]	
Order Aphaniptera	512
Order Strepsiptera	514

## CHAPTER XV

Subphylum Arachnida	515
Class Scorpionidea	520
Class Eurypterida	524
Class Xiphosura	526
Class Araneida	530
Class Acarina	533
[Order Notostigmata]	
[Order Cryptostigmata]	
[Order Prostigmata]	
[Order Stomatostigmata]	
[Order Heterostigmata]	
[Order Parastigmata]	
[Order Mesostigmata]	
[Order Metastigmata]	
Class Phalangida	537
[Class Palpigradi]	
[Class Pedipalpi]	
[Class Pseudoscorpionidea]	
[Class Solifugae]	
Class Pantopoda (Pycnogonida)	538
<i>Incertae sedis:</i>	
Class Tardigrada	539
Class Pentastomida	541

## CHAPTER XVI

Phylum Mollusca	543
Class Amphineura	547
Order Polyplacophora	547
Order Aplacophora	548
Class Gasteropoda	550
Order Streptoneura (Prosobranchiata)	563
Suborder Diotocardia (Aspidobranchiata)	563 (564) <sup>1</sup>
Tribe Rhipidoglossa	563
Tribe Docoglossa	563

<sup>1</sup> References in brackets are to the pages on which examples are described.

## CHAPTER XIV

Subphylum Insecta (Hexapoda)	<i>page</i> 425
Class Apterygota	463
Order Thysanura	463
Order Collembola	463
Order Protura	465
Class Pterygota	466
Subclass Exopterygota	466
Order Orthoptera	466
[Suborder Cursoria]	
[Suborder Saltatoria]	
Order Dermaptera	468
Order Isoptera	469
Order Plecoptera	471
Order Embioptera	471
Order Psocoptera	471
Order Odonata	472
[Suborder Zygoptera]	
[Suborder Anisoptera]	
Order Hemiptera or Rhynchota	474
[Suborder Heteroptera]	
[Tribe Cryptocerata]	
[Tribe Gymnocerata]	
[Suborder Homoptera]	
[Tribe Auchenorrhyncha]	
[Tribe Sternorrhyncha]	
Order Ephemeroptera	481
Order Mallophaga	483
Order Anoplura	483
Order Thysanoptera	485
Subclass Endopterygota (Holometabola)	485
Order Neuroptera	485
Order Mecoptera	486
Order Trichoptera	486
Order Lepidoptera	487
[Suborder Homoneura]	
[Suborder Heteroneura]	
Order Coleoptera	492
[Suborder Adephaga]	
[Suborder Polyphaga]	
Order Hymenoptera	495
[Suborder Symphyta]	
[Suborder Apocrita]	

Order Diptera	page 504
[Suborder Orthorrhapha]	
[Suborder Cyclorrhapha]	
Order Aphaniptera	512
Order Strepsiptera	514

## CHAPTER XV

Subphylum Arachnida	515
Class Scorpionidea	520
Class Eurypterida	524
Class Xiphosura	526
Class Araneida	530
Class Acarina	533
[Order Notostigmata]	
[Order Cryptostigmata]	
[Order Prostigmata]	
[Order Stomatostigmata]	
[Order Heterostigmata]	
[Order Parastigmata]	
[Order Mesostigmata]	
[Order Metastigmata]	
Class Phalangida	537
[Class Palpigradi]	
[Class Pedipalpi]	
[Class Pseudoscorpionidea]	
[Class Solifugae]	
Class Pantopoda (Pycnogonida)	538
<i>Incertae sedis:</i>	
Class Tardigrada	539
Class Pentastomida	541

## CHAPTER XVI

Phylum Mollusca	543
Class Amphineura	547
Order Polyplacophora	547
Order Aplacophora	548
Class Gasteropoda	550
Order Streptoneura (Prosobranchiata)	563
Suborder Diotocardia (Aspidobranchiata)	563 (564) <sup>1</sup>
Tribe Rhipidoglossa	563
Tribe Docoglossa	563

<sup>1</sup> References in brackets are to the pages on which examples are described.

Suborder Monotocardia (Pectinibranchiata)	<i>page</i> 563 (565)
Tribe Rachiglossa	563
Tribe Taenioglossa	563
[Subtribe Platypoda]	
[Subtribe Heteropoda]	
Tribe Toxiglossa	563
Order Opisthobranchiata	567
Suborder Tectibranchiata	567
Suborder Nudibranchiata	567
Order Pulmonata	569
Suborder Basommatophora	570
Suborder Stylommatophora	570
Class Scaphopoda	572
Class Lamellibranchiata	573
Order Protobranchiata	579 (582)
Order Filibranchiata	579 (583)
Order Eulamellibranchiata	579 (585)
Order Septibranchiata	579
Class Cephalopoda (Siphonopoda)	587
Order Dibranchiata	588
Suborder Decapoda	588
Tribe Belemnnoidea	588
Tribe Sepioidea	588
Tribe Oegopsida	588
Tribe Myopsida	589
Suborder Octopoda	589
Order Tetrabranchiata	602
Suborder Nautiloidea	602
Suborder Ammonoidea	602

## CHAPTER XVII

Phylum Polyzoa	606
Class Endoprocta	612
Class Ectoprocta	613
Order Phylactolaemata	613
Order Gymnolaemata	613
Suborder Cyclostomata	613
Suborder Cheilostomata	613
Suborder Ctenostomata	613
Phylum Brachiopoda	613
Class Ecardines	618
Class Testicardines	618
Phylum Chaetognatha	618
Phylum Phoronidea	622



## CHAPTER XVIII

Phylum Echinodermata	page 623
[Subphylum Eleutherozoa]	
Class Asteroidea	634
Class Ophiuroidea	638
Class Echinoidea	640
Order Endocyclica	647
Order Clypeastroida	647
Order Spatangoida	647
Class Holothuroidea	648
Order Aspidochirotae	652
Order Pelagothurida	652
Order Elasipoda	652
Order Dendrochirotae	652
Order Molpadida	652
Order Synaptida (Paractinopoda)	652
[Subphylum Pelmatozoa]	
Class Crinoidea	654
Class Amphoridea	658
Class Carpoidea	658
Class Thecoidea (Edrioasteroidea)	658
Class Cystoidea	658
[Order Diploporida]	
[Order Rhombifera]	
Class Blastoidea	659

## CHAPTER XIX

Phylum Chordata	660
Subphylum Hemichorda ( <i>Enteropneusta s.lat.</i> )	662
[Class Enteropneusta ( <i>Balanoglossida</i> )]	
[Class Pterobranchia]	
Subphylum Tunicata (Urochorda)	669
Class Larvacea	679
Class Ascidiacea	680
Class Thaliacea	681
Order Pyrosomatida ( <i>Luciae</i> )	685
Order Salpida ( <i>Hemimyaria</i> )	685
Order Doliolida ( <i>Cyclomyaria</i> )	686
[Subphylum Cephalochorda]	
[Subphylum Vertebrata]	



## CHAPTER I

# INTRODUCTION

The Invertebrata have long since ceased to constitute one of the primary divisions in the scientific classification of the Animal Kingdom. Their name is now no more than a convenience for designating a group of phyla with which it is often necessary to deal as a whole. The primary lines of real cleavage in the Animal Kingdom divide it, not into Vertebrata and Invertebrata, but into three unequal sections, the Protozoa, Parazoa and Metazoa, which are ranked in the following chapters as subkingdoms.

Between the Protozoa, which are without cellular differentiation and contain a large group of photosynthetic members, and the Metazoa, in which such differentiation is always strongly marked and photosynthesis is absent, there is a gulf which is in fact far deeper than that which sunders the Protozoa from the lower plants. The view, indeed, has been put forward that these two components of the Animal Kingdom are not, as is usually held, directly related to one another, but arose, with the Plants, as entirely distinct branches of an ancestral stock of living beings. The Parazoa or sponges—unique among many-celled organisms in possessing collared flagellate cells—are probably derived from the Protozoa by an origin distinct from that by which the latter group gave rise (if they did so indeed) to the Metazoa.

Within the Metazoa, the most significant difference is that which exists between the Coelenterata or Diploblastica and the triploblastic phyla which constitute the rest of the subkingdom. The Coelenterata, which typically start life as a simple, two-layered, ciliate larva, the *planula*, either retain throughout life the two-layered condition, or depart from it only by the immigration, late in development, of cells from the two primary layers (ectoderm and endoderm, p. 128) into the space (blastocoele) between those layers. The triploblastic animals always possess a true third layer (mesoderm) which is early developed and forms important organs. They are the great majority of animals, and compose a number of phyla.

The brigading of these phyla is a difficult task—one, indeed, which it is at present impossible to effect completely. Two main stocks, however, stand out fairly clearly. The Annelida, Arthropoda and Mollusca—by the plan of their central nervous system, the mode and position of origin of their mesoderm, the types of cleavage of the ovum (p. 281) and of larva (the *trochosphere*) which the Annelida and Mollusca

share, and the presence of a cuticle and segmentation which the Annelida and Arthropoda have in common—constitute one of these stocks. The other comprises the Echinodermata and Chordata. Its members have a central nervous system which is not on the annelid plan and is peculiar in retaining its epithelium (p. 136); they exhibit a common mode of origin of the mesoderm, primitively as hollow pouches, from the gut wall; they possess, or give indications of, three primary mesodermal segments; the cleavage of their ova is entirely different from that which is characteristic of the Annelida and Mollusca, and between the larvae of the lowest chordates (the Enteropneusta) and those of certain echinoderms there is a remarkable and detailed resemblance.

The remaining phyla, smaller and less important, are hard to relate either to the foregoing groups or to one another. By the type of cleavage of their ova and the possession of flame cells (p. 202), the Platyhelminthes and Nemertea seem to be akin to the annelid stock. Their lack of coelom is a difficulty in this respect. The structure of the adults of the Rotifera and of the larva of the Polyzoa, which has the character of a trochosphere, might link these groups to the same stock. Some other small phyla (Brachiopoda, Chaetognatha) have possibly distant relationship to the echinoderm-chordate grouping. Others, notably the Nematoda, are more difficult to place.

In the great assemblage of triploblastic phyla, the backboned animals, or Vertebrata properly so-called, stand as a branch of one phylum, the Chordata. Yet their considerable numbers, the size, high organization, and intelligent activity of their members, and the fact that Man is one of them, give them an importance so great that they have always been the subject of a distinct department of zoological study, and were at one time regarded as a primary branch of the Animal Kingdom. That standing they have lost; but it is still necessary for many purposes to treat them apart.

The term "Invertebrata" is retained to cover all the non-chordate phyla and the chordates other than the Vertebrata. In that sense it is used in this book. Only the Cephalochorda (*Amphioxus*), which, though they are not vertebrates, have much in common with those animals, are left aside as best studied with them.

The limits of the several phyla are, with one or two exceptions, agreed among zoologists. As much cannot be said for the lower grades of the classification. Different views upon phylogeny, and considerations of convenience, lead to many divergences as to the extent and rank of the various divisions in the systems preferred by different authorities; and even when there is agreement as to the limits of a group different names may be applied to it. In no two works will quite the same arrangement be found. This fact should

be borne in mind by the student in using the table of classification which will be found as the Table of Contents at the beginning of this book.

In surveying the diverse organisms which constitute the Invertebrata, the student should bear in mind the following principles.

The most fundamental of the characteristics of living organisms is the way in which, in the face of an environment which presents as many dangers as opportunities, they hold their own by making adjustments within themselves. This statement applies equally to the struggle for existence of the individual and to the slow racial adjustments which we know as evolution.

The term *environment*<sup>1</sup> is a collective name for all the external things which affect any living being. Four principal factors constitute the environment—the ground or “substratum” (if any) upon which the organism stands, the “medium” (water or air) which bathes it, the heat and light which it receives from the sun’s rays or can lose to its surroundings, and the other organisms in its neighbourhood. Of these factors the *substratum* has in most cases relatively little importance, and we may dismiss it now.

The *medium*, on the other hand, is of enormous importance. Meeting all parts of the surface of objects that it contains, it exerts everywhere a pressure upon them, supports them, may transport them, affects the movements they execute, and controls all exchange, whether of matter or of energy, between them and the world about them; and from it animals obtain their supplies of free oxygen, often of water, and sometimes of food. If it be liquid, according as the concentration of substances dissolved in it be greater or less than that within the organism water and solutes will tend to pass to or from the body of any animal which is not covered by an impermeable cuticle. This exchange is of the utmost importance, both as a danger by upsetting equilibria within the body and as an advantage by facilitating the excretion of substances which are harmful in the organism. It is controlled by the surface layer of protoplasm, which either is, or owing to surface tension behaves as, a delicate membrane that has the power of actively regulating, to some extent, the passage of substances through itself, and by the activity of the organs of excretion. If the medium be gaseous, according to the amount of water vapour it contains water will tend to evaporate to it from the surface of the body. This is important owing to the necessity for the intake of water by the

<sup>1</sup> The student may occasionally be puzzled by the phrase “internal environment”. This bizarre contradiction in terms is sometimes applied to what we shall presently call the “internal medium” (p. 132).

mouth to compensate for it, and also because the latent heat of the evaporation lowers the temperature of the body. Whether the medium be liquid or gaseous, it offers, according to the free gases it contains, varying possibilities of interchange of oxygen and carbon dioxide with organisms. This has naturally extremely important effects upon respiration.

The loss or gain of *heat* tends, of course, to affect the temperature within organisms, and with this the chemical processes of the latter vary, being, as is usual in such processes, slowed as the protoplasm becomes colder and quickened when it is warmed, and being brought finally to a stop when its minute organization is destroyed either by the coagulation of certain of its proteins by heat or by the freezing of its water. Every organism is tuned to work within a range of temperature peculiar to it. "Warm-blooded" animals keep their temperature within proper limits by active chemical and physical means; "cold-blooded" animals (to which all invertebrata belong) are in this respect at the mercy of their surroundings except in so far as they can circumvent them by their habits. *Light*, while it is essential for photosynthetic organisms, has chemical effects of importance in many others, and in all which possess sense organs capable of appreciating it is a source of stimuli from the external world.

Relations between an animal and *other organisms* in its surroundings are almost always based in the long run on nutrition. Either such organisms serve the animal for food, or they attack it to make it their food, or they are competitors for a common food-supply, or in rarer cases they assist it, or obtain its assistance, in the quest for food or in defence against enemies which would use it or them for food. Only between members of opposite sexes of the same species are there relations of another kind, namely those which are concerned with reproduction. The coming of organisms into relation with one another usually involves the receipt of stimuli and more or less complicated behaviour, with the use of organs of locomotion and prehension.

The action of the environment upon the organism will be seen to be threefold: (1) it affects it mechanically, as by transporting it from place to place, by the impact of adjacent objects, or by the attacks of enemies; (2) it affects the working of the living machine by the compulsory introduction or abstraction of materials (water, salts, etc.) or of energy; (3) it directly stimulates it to activity, which may be an inevitable response, such as the movement of certain organisms towards light (phototaxis) or be dependent upon conditions existing at the moment in the organism; or it may inhibit such activity. Besides such action the environment may affect the organism negatively, by failure in respect of food, oxygen, or some other necessity which the organism is dependent upon obtaining from its surroundings. Where such

failures occur from time to time the organisms have usually means of enduring them (reserve stores, resting stages, etc.).

In proportion as the organism is unable to resist these influences of the environment it is liable upon occasion to be harmed by them. The process of evolution has been the development of organisms in such a way as to set them free from such influences in respect of their proper environments. Its results may be classed under three heads. (1) Some, such as the acquirement of a cuticle or of a habit of burrowing or of hibernation, merely fend off or avoid the action of the environment: these involve the least increase in the complexity of the organism. (2) Others, such as the formation of organs for the excretion of the excess of water, provide for remedial action: in these, as a rule, more complicated machinery is formed. (3) Others, such as the development of a nervous system or of organs of locomotion or weapons of offence, bring it about that the action which results from the receipt of stimuli is turned to the best advantage by the organism: these cause a considerable, often a very great, complication of the living machine.

Thus a general outcome of evolution is the forming of more complex, that is of "higher", organisms. But a relatively simple organism may, in its proper environment, enjoy as much autonomy as in other circumstances is possessed by one that is more highly organized. This is notably true of many parasites.

Some of the results of evolution, as for instance the formation of a nervous system or of a cuticle, are such as to increase the independence of the organism in *all* circumstances. Others, however, such as the substitution of pulmonary for branchial respiration, or of absorption for ingestion of food, are of value only in particular environments or modes of life, and even unfit the organism for other ways of living. Thus two distinct phenomena underlie the diversity of the Animal Kingdom—an increase in the autonomy of the individual, and the specialization of animals for particular modes of life.

Every species, however good a fight it maintains, is threatened with extinction owing to the continual loss of individuals, always by the action of its environment and usually also by that "natural death" which appears to await all organized protoplasm that is not periodically reorganized.<sup>1</sup> In *reproduction*, however, the individual provides by fission for the maintenance of its race. In the lower organisms the protoplasm of the body retains a certain plasticity, and in these there is very often an *asexual* process of reproduction in which the new construction that is necessary to organize at least one of the products

<sup>1</sup> See p. 27. It is possible that in some of the least highly organized metazoa natural death either is no more inevitable than in protozoa or is long delayed.

of fission, and often goes on in both, is carried out with cells (or, in protozoa, with organized protoplasm) which existed as such in the parent. In more highly organized animals the only protoplasm which retains the required plasticity is that of the germ cells, and consequently such animals have only the *sexual* reproduction which these cells perform. The germ cells (gametes), before they reconstitute the adult body, normally undergo the process known as *conjugation* or *syngamy*, which is not an essential part of the reproductive process but a provision for heritable variation whereby the race becomes adaptable to its surroundings. Conjugation can only be performed by uninucleate individuals and therefore, while in protozoa it sometimes takes place between adults (hologamy, p. 31), in metazoa it always requires the production of uninucleate young (the ova and spermatozoa). The lower metazoa reproduce both by means of these gametes and also asexually. In the higher animals, as we have seen, reproduction is solely by gametes, though conjugation may be suspended for one or more generations by the development of unfertilized ova (parthenogenesis).



## CHAPTER II

### THE SUBKINGDOM PROTOZOA

The Protozoa are sundered from the rest of the Animal Kingdom by a perfectly sharp distinction. The distinction consists in this: that in the body of a protozoon, whether there be one nucleus, or a few, or many, no nucleus ever has charge solely of a specialized part of the cytoplasm; whereas in other animals there are always many nuclei, each in charge of a portion of cytoplasm which is specialized for a particular function, such as contraction, or conduction, or secretion.

Stated thus, the definition of the Protozoa is quite unambiguous. Unfortunately, ambiguity is usually imparted to this subject by the introduction of a concept, that of the "cell", which has a different extension for different authorities. If that concept, primarily of use in other connections, is to be introduced here, we must frame our definition in one of two ways, according to the meaning which we attach to the word "cell". If we apply this term to every nucleus together with its cytoplasm, we must define the Protozoa as "animals which consist of one cell or of several cells which are all alike, save sometimes the reproductive cells". If, on the other hand, we give the term "cell" its earlier extension, applying it only to the specialized units of nucleus and cytoplasm which together compose the bodies of the higher animals and plants, we shall define the Metazoa as "cellular animals" and the Protozoa as "non-cellular". It will then be convenient to employ the term "energid" for application to any nucleus with its cytoplasm, whether they together constitute the body of a protozoon or a cell of a metazoon.

In any case the facts remain the same, and they provide one of the main sources of the interest which the study of the Protozoa offers, namely the carrying out of the processes of life, and often of a complex life, by an organization which, though it may visibly be of corresponding complexity, is purely cytoplasmic. Considered in this light the structure of, for instance, the more complicated ciliates and flagellates is exceedingly instructive. In three other respects the Protozoa are peculiarly interesting. In their bodies dead "formed" material, however plentiful it be as a covering or scaffold for the body, never assumes the importance which it has as ground substance or skeleton in the Metazoa, where the size of the body is such that the protoplasm cannot maintain its organization without support against forces that tend to deform it. Consequently, in observing the physiology and behaviour of a protozoon, we are seeing in the actual protoplasm of an

intact organism processes which in an intact metazoon we observe as the activities of a complex in which protoplasm is masked and conditioned by other components of the body: in short, in the Protozoa we observe the normal activities of protoplasm more directly than in the Metazoa. Again, a life cycle comprising more than one generation, which is comparatively rare among metazoa, is universal among protozoa, and its varieties are extraordinarily interesting. Finally, while every metazoon is thoroughly an animal, the Protozoa present an unbroken series from wholly plant-like organisms, through various intermediates, to members whose nutrition and behaviour are those of animals—or rather, as we shall see, there are several such series.

The Protozoa are all of small *size*. Most of them are minute, ranging from a few thousandths of a millimetre to a little over one millimetre in length: a few reach dimensions of several, or even of many centimetres, but these for the most part consist of a relatively thin layer of protoplasm (certain mycetozoa). With the small size of protozoa is probably to be connected, not only, as we have seen, the relative unimportance to them of dead skeletons, but also their characteristic type of organization. In larger organisms, the regions differentiated for special purposes must usually be correspondingly larger, and therefore require the services of nuclei of their own, the absence of which is the hall-mark of a protozoon. The actual size varies very much in each group. It is, on the average, least in the Mastigophora. The order of magnitude of certain representative species may be gathered from the approximate magnifications stated for figures below.

The bodies of the Protozoa vary greatly in *shape*. Whereas in each of the metazoan phyla there is a fundamental type of body form to which the members of the phylum conform in essentials, however aberrant from it they be, the Protozoa have no such type. When the surface of the protoplasm is virtually fluid and is not retained by a shell, it takes, while it is at rest, a spherical form. When there is a firm surface layer, the individual tends, if it be a flagellate, to have an egg or spindle shape, if it be a ciliate to be bilateral with a spiral twist at one end, in the Suctoria to be cup-shaped. Concerning the body form of the Sporozoa, which are parasitic, no generalization can be made. Bodies of any of these shapes may be anchored, and have then usually a stalk, which may be of dead material as, for instance, in *Acineta* and *Codosiga* (Figs. 1, 49), or a part of the living protoplasm. In the latter case it has generally a cuticular covering, as in *Vorticella* (Fig. 2), but may be naked (various flagellates).

Stalked forms, and occasionally others, may be *colonial*; that is to say, a number of *zooids*, each having a nucleus and the shape and complete organization of an individual of related solitary species, are united by protoplasmic connections to form a single living being. The

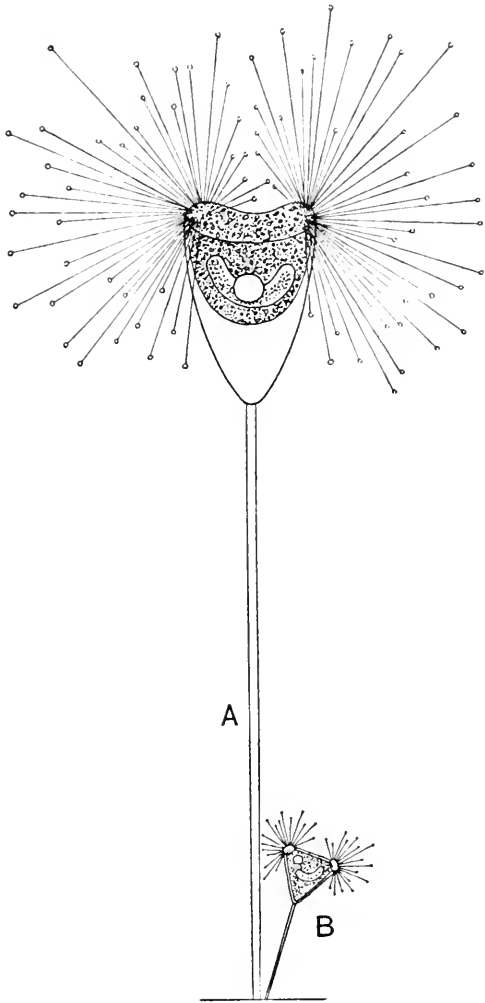

Fig. 1.

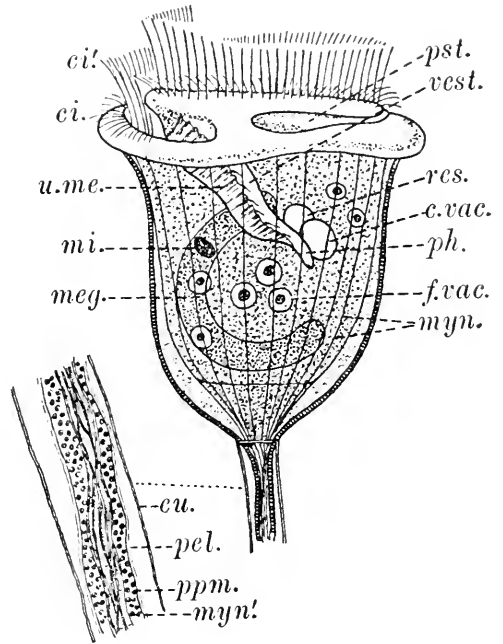

Fig. 2.

Fig. 1. Two species of *Acineta*,  $\times 100$ . After Saville-Kent. A, *A. grandis*. B, *A. lemmarum*.

Fig. 2. *Vorticella*: a generalized figure of an individual, magnified, with a portion of the stalk further enlarged. *c.vac.* contractile vacuole; *ci.* outer ciliary wreath; *ci.'* inner wreath, of the peristome; *cu.* cuticle; *f.vac.* food vacuole; *meg.* meganucleus; *mi.* micronucleus; *myn.* myonemes of bell; *myn.'* myoneme of stalk (containing elastic fibrils); *pel.* pellicle; *ph.* "pharynx" (terminal portion of vestibule); *ppm.* protoplasm of stalk; *pst.* peristome; *res.* reservoir; *u.me.* undulating membrane; *vest.* vestibule.

zooids of a colony are usually all alike, but differentiation may exist between them, in that certain of them are specialized for the production of new colonies, which is not performed by the other zooids (various volvocina, Figs. 3, 46; etc.). Colonies arise by the division of a single primary zooid, whose fission is not carried to completion, so that its products do not entirely separate. Their origin is therefore usually said to be a form of asexual reproduction. It may, however, also be looked upon from another point of view, as the repetition, within a continuous mass of protoplasm, of the nucleus and the other organs coincidentally. In this aspect, the colony is seen to have features in common with other multinucleate conditions of protozoa, such as (1) that of *Hexamitus* (Fig. 4), etc., in which a unitary body has

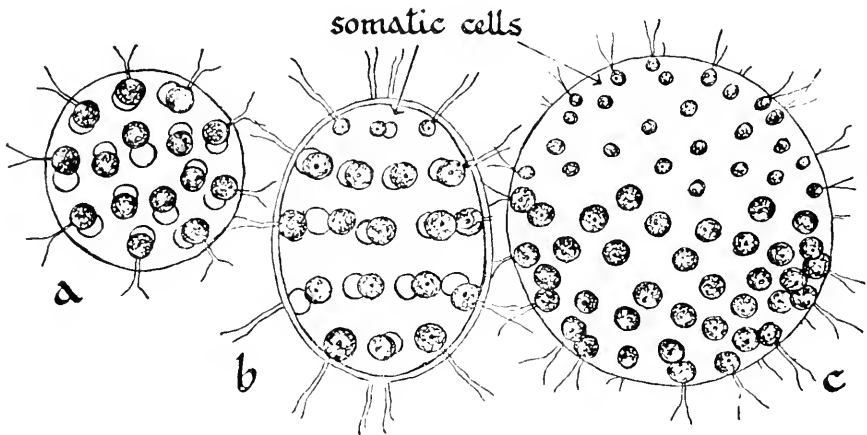

Fig. 3. Colonial volvocina. *a*, *Eudorina*, a spherical motile colony of thirty-two similar zooids all capable of division. *b*, *Pleodorina illinoiensis*, a spherical motile colony consisting of thirty-two zooids, of which four at one end of the colony constitute a "soma", which dies when the other twenty-eight zooids divide. *c*, *Pleodorina californica*. The "somatic cells" constitute about half the colony. After West and Fritsch.

two similar sets of organs, one on each side of the body, or several sets, with a nucleus assigned to each, (2) that of *Polykrikos* (Fig. 40 B), etc., in which there are several nuclei, and several sets of the other organs of the body, but the repetition (merism) of the nuclei and that of the other organs do not correspond, and (3) that of *Opalina* (Fig. 5), *Actinosphaerium* (Fig. 33), etc., in which there are numerous nuclei, but only one set of the other organs of the body. Multinucleate masses of protoplasm are known as *syncytia*. Syncytia which, like those cited above, arise by the division of an original nucleus in the mass of protoplasm are known as *symplasts*. An entirely different kind of syncytium arises by the union of uninucleate individuals, whose nuclei remain distinct in the resulting body. Such syncytia are known

as *plasmodia*. They are found in the Mycetozoa (Fig. 73) and occasionally elsewhere.

*Pseudocolonies*, consisting of distinct individuals united only by stalks, tubes, etc., of dead material, are formed by various mastigophora (Fig. 38) and vorticellids.

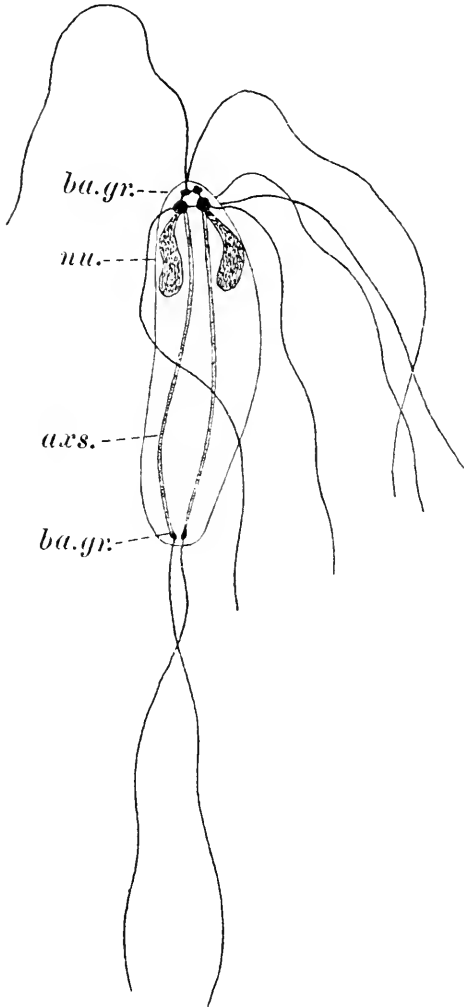

Fig. 4.

Fig. 4. *Hexamitus intestinalis*,  $\times 3800$ . After Dobell. *axs.* axostyle; *ba.gr.* basal granules of flagella; *nu.* nucleus.

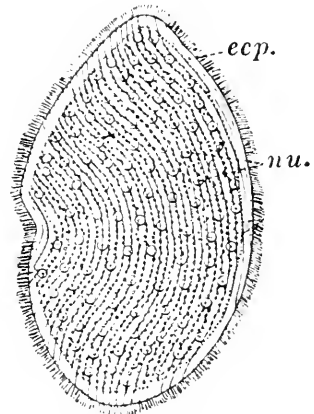

Fig. 5.

Fig. 5. *Opalina ranarum*,  $\times 150$ . From Bronn. *ecp.* ectoplasm; *nu.* nuclei.

The *protoplasm* of living protozoa is often apparently homogeneous, apart from inclusions such as granules of reserves and other manufactured substances, chromosomes, skeletal structures, and so forth. Sometimes, however, there is visible in it an apparent meshwork of

a more viscid substance, with a more fluid constituent in its meshes. Actually, the structure is then that of a foam, and the meshwork is an optical section of the walls of bubbles or *alveoli* which contain the liquid constituent. In the nucleus the more viscid constituent is the *linin* meshwork, the liquid the *karyolymph*; in the cytoplasm the meshwork is the *spongioplasm*, and its contents the *enchylema*.<sup>1</sup> The gelation to which this structure is due is produced by fixing reagents in many cases in which it does not exist in life. There is, perhaps, no fundamental distinction between the alveoli and the smaller of the spaces known as *vacuoles* of which so much use is made in the physiology of the Protozoa—for storage, as the site of chemical processes such as digestion, for drainage, for hydrostatic functions, etc. The largest vacuoles have often a definite wall of their own.

The *surface* of the protoplasm is protected in various ways. (a) Sometimes, as in some amoebae, it is apparently quite fluid. Then, however, there exists upon it an extremely thin membrane, known as the *plasmalemma*, which has the power of regulating the exchange of materials between the organism and the watery medium in which it lives. Without this power the protoplasm would soon be poisoned or dissolved. (b) In other cases, the surface layer is semi-solidified (gelated) as a visible, firm, but living *pellicle*. This is often “sculptured” in a pattern, as in *Paramecium* (Fig. 85 B, C). (c) Intermediate conditions connect the pellicle with the *cuticle*, a close-fitting dead membrane which may be nitrogenous, as in *Monocystis*, or of carbohydrate, as in many plant-like flagellates. In typical dinoflagellates (Fig. 40A) it is composed of stout plates of cellulose. (d) Again, there may be a *shell* from which protoplasm can issue through an opening. Such a shell may be nitrogenous, as in *Arcella* (Fig. 59), etc., of a nitrogenous basis with foreign bodies built into it, as in *Diffugia* and *Rhabdammina* (Figs. 60, 6A), of siliceous plates as in *Euglypha* (Fig. 7), calcareous, as in most foraminifera (Fig. 6 B, C), or of cellulose, as in the spores and sclerotium of the Mycetozoa. It is said that mineral shells always contain a groundwork of organic material. They are often composed of several chambers, and may be perforated by numerous small pores. *Houses* are loose-fitting, wide-mouthed shells (Fig. 38C). *Cysts* are temporary shells without opening. (e) Finally, there may be an external lattice, which is pseudochitinous in *Clathrulina* (Fig. 8) and siliceous in the Silicoflagellata (Fig. 38F), or a case of calcareous pieces (Coccolithophoridae, Fig. 38E). The siliceous lattice of many radiolarians is part of an internal skeleton.

The term *ectoplasm* is applied to any conspicuously differentiated outer layer of the protoplasm, and denotes very different conditions

<sup>1</sup> The term *hyaloplasm* has been used in this, but also in other, senses.

in different organisms—in *Amoeba*, a stratum which, save at its surface, is only unlike that below it in not containing granules; in various planktonic protozoa (Figs. 32, 33) a highly vacuolated layer

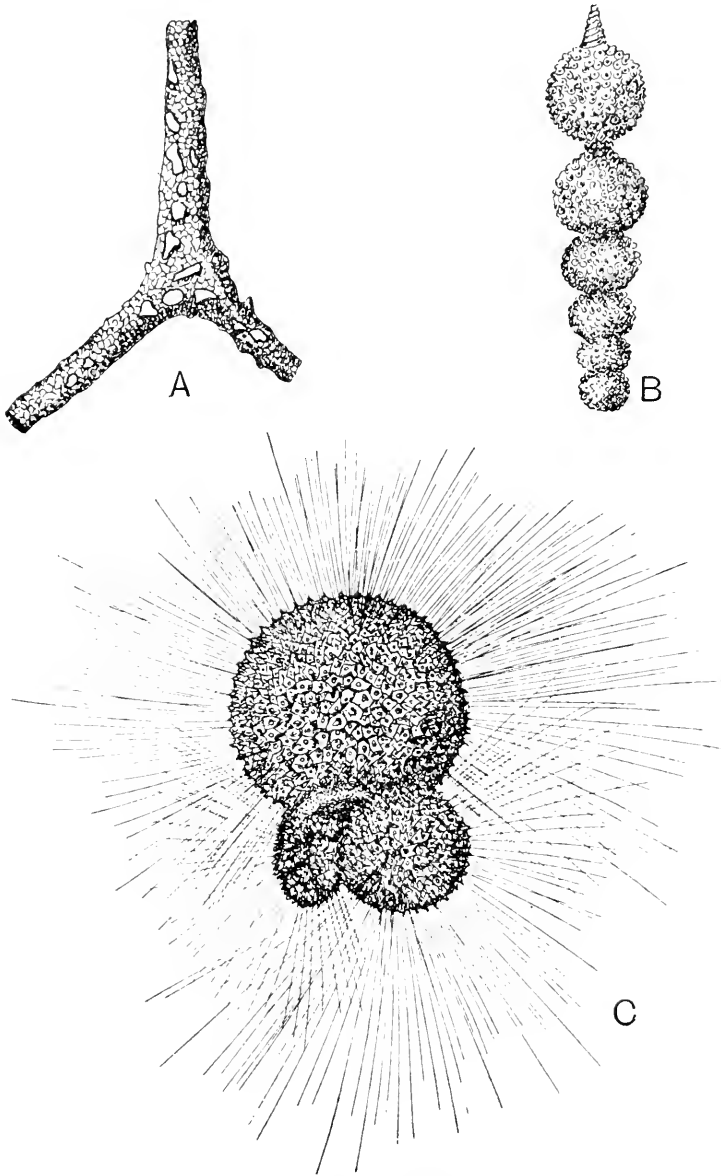

Fig. 6. Shells of foraminifera. A, *Rhabdammina abyssorum*,  $\times 4.5$ . B, *Nodosaria hispida*,  $\times 18$ . C, *Globigerina bulloides*,  $\times 55$ . After various authors.

whose low specific gravity confers buoyancy; in the Ciliophora and many flagellates and sporozoa a stout pellicle with an underlying layer, the *cortex*, which is said to be stiffer than the internal protoplasm (*endoplasm*) and may exhibit differentiations of various kinds.

Occasionally the protoplasm contains structures (trichocysts of ciliates and mastigophora, Fig. 9, so-called "nematocysts" in certain dinoflagellates, Fig. 40, pole capsules of neosporidia, Fig. 82), from which threads can be shot out upon the surface of the body. The function of these threads is often doubtful, but it has been shown that the trichocysts of *Paramecium* are fixing organs, others which lie around the mouth of their possessor (*Cyathomonas*, Fig. 39 C; etc.) seize prey, and the pole capsules serve to anchor spores to the lining of the host's gut. The threads of "nematocysts" and pole capsules

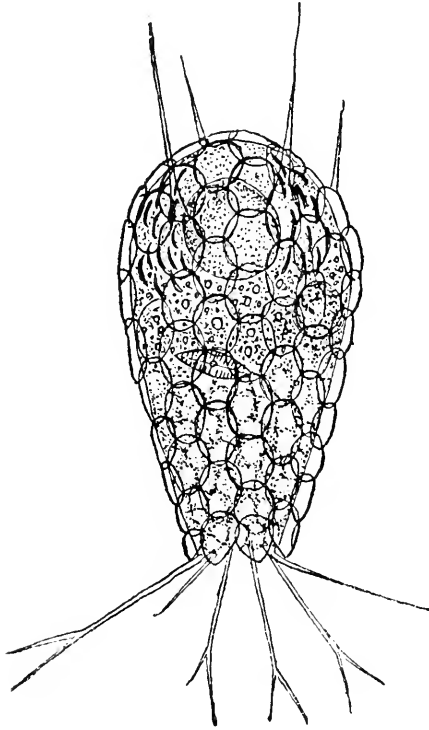

Fig. 7. *Euglypha alveolata*,  $\times 60$ . From Hegner and Taliaferro, after Calkins.

are coiled up in vesicles before they are shot out; those of trichocysts are formed by the stiffening of an extruded secretion.

The *motile organs* of the Protozoa are of several kinds, each of which is mainly found in one of the classes of the phylum. *Pseudopodia* are temporary protrusions of protoplasm. They are of various types—blunt *lobopodia* (Figs. 54, 59), fine *filopodia* (Fig. 7), branching and anastomosing *rhizopodia* (Figs. 61, 65), and *axopodia* (Fig. 71) with an internal supporting filament. They are used in various ways and for various purposes. Their mode of formation is not fully understood, but it is clear that, at least in many cases, they do not arise, as has been



alleged, by alterations in the surface tension of the protoplasm, and it is probable that the movement (*amoeboid movement*) in the course of which they are formed is not fundamentally different from the movements of muscles, or cilia, or flagella. Granules may often be seen to stream up and down the axopodia and rhizopodia. *Flagella* are lashes, long and usually few in number, which by a rowing (Fig. 10) or by an undulating motion (Fig. 11) draw or propel the body or attract particles to it. In the rowing stroke the flagellum is

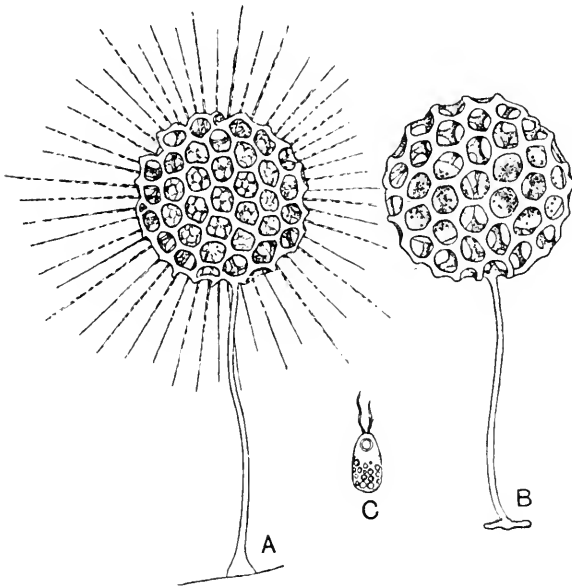

Fig. 8.

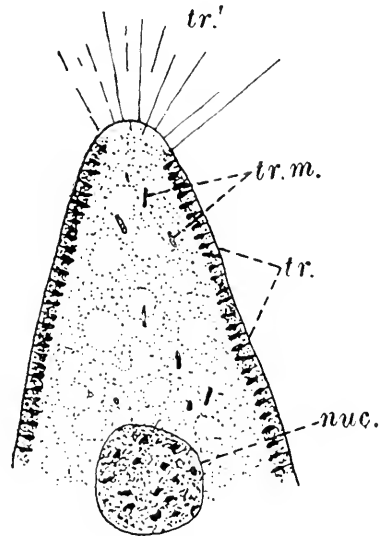

Fig. 9.

Fig. 8. *Clathrulina*. A, Ordinary individual,  $\times 200$ . B, Binary fission within the lattice. C, Escaped flagellate individual. After Leidy.

Fig. 9. Part of a longitudinal section through a *Paramecium* showing the trichocysts at the end of the body discharged, and in the endoplasm material for the replacement of trichocysts. From Saunders, after Mitrophanov. *nuc.* meganucleus; *tr.* undischarged trichocysts; *tr.'* discharged trichocysts; *tr.m.* material for replacing trichocysts.

held rigid and slightly concave in the direction of the stroke; in recovering its position it bends as it is drawn back, so that less resistance is offered to the medium. When, as is usually the case, the flagellum beats obliquely, or the undulations pass around as well as along it, the body rotates as it advances, or if it be fixed a whirlpool is set up. Down each flagellum runs an internal thread, the *axial filament*, which, on entering the body or at some distance within it, joins a *basal granule*.<sup>1</sup> The latter is in most cases connected to the

<sup>1</sup> This structure is sometimes called the *blepharoplast*, but as that name has also been applied to parabasal bodies its use is best avoided.

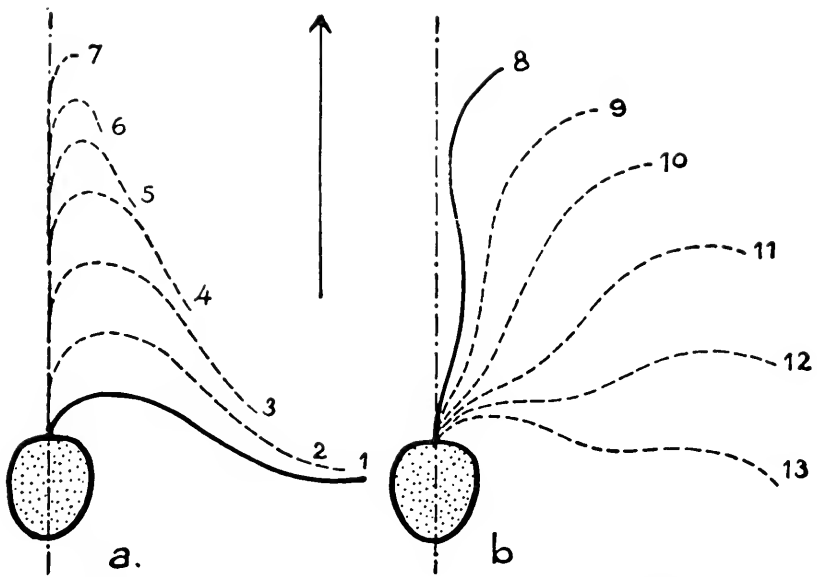

Fig. 10. Simplest type of movement of flagellum of *Monas* during rapid forward movement. *a*, 1-7. Successive stages in preparatory stroke. Note the flexure begins at the base and spreads to the tip. *b*, 8-13. Successive stages in the effective stroke. Note the rigidity of the flagellum. The arrow indicates the direction of movement of the organism. After Krijgsman.

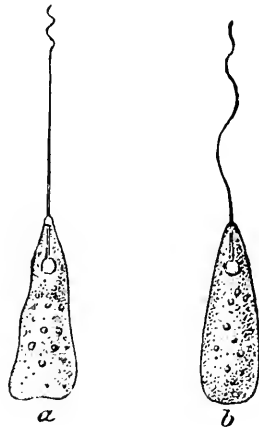

Fig. 11.



Fig. 12.

Fig. 11. *Peranema*. *a*, Slow forward movement with undulations restricted to the tip of the flagellum. *b*, Rapid forward movement with undulations along the whole length of the flagellum. After Verworn.

Fig. 12. *a*, Flagellum of *Trachelomonas* (Euglenoidina) showing axial filament and sheath. *b*, Transverse section of the flagellum. After Doflein.

nucleus by a thread or threads known as *rhizoplasts* (Fig. 47A). Sometimes it lies against the nucleus. Rhizoplasts may connect it to other structures, notably in many parasitic flagellates to a body of unknown function called the *parabasal body*. The "kintonucleus" of *Trypanosoma* (Fig. 47E) is a body of this class, which possibly includes structures of more than one kind. Sometimes, as in *Trypanosoma*, a flagellum runs for some distance parallel with the surface of the body and is connected to it by a film of protoplasm known as an *undulating membrane*, which must be distinguished from the structures of the same name which are formed by the fusion of cilia. When there are two flagella, it often happens that one is trailed behind the body and the other directed forwards (Figs. 47D, 53C, 70B). Flagella are often used for anchoring, and sometimes appear to have a sensory function. *Cilia* are smaller and more numerous lashes which by a rowing action repeated by one after another of them in "metachronal rhythm" (Fig. 13) cause movements of the animal or of the water near it. Like flagella they have each an internal filament, a basal granule, and a rhizoplast, which, however, does not connect with the nucleus. Often cilia are united into compound organs, which may be conical *cirri*, paddle-like *membranellae* (Fig. 14), or *undulating membranes* (Fig. 90). Many protozoa which possess a definite body form are able temporarily to alter it by contractions of the protoplasm stretching the pellicle (*metaboly*), and in various cases this contractility is localized in fibrils, known as *myonemes*, situated in the ectoplasm.

Systems of fibres which ramify from a central mass known as the "motorium" and have been thought to be of the nature of a *nervous system* have been described in various ciliates; in some of these cutting the fibres is said to destroy the co-ordination between different sets of ciliary organs. It is possible also that the rhizoplast system of flagellates may have a conducting function. *Sense organs* are possessed by various protozoa in the form of specialized flagella and cilia in which the tactile sense is highly developed, and by many of the plant-like flagellates as pigment spots (eye-spots), which may be provided with a lens. A chemical sense seems to be indicated by the fact that food is often recognized at a distance, and also probably in some of the cases of discrimination in ingestion (p. 19).

Internal *skeletal structures* are found in many members of the phylum. They may be part of the living protoplasm, as the axial fibres of axopodia and the *axostyles* which lie in the midst of the body of various mastigophora (*Trichomonas*, Fig. 50; etc.) and probably the central capsules of the Radiolaria, or of dead inorganic matter, as the skeletons of the Radiolaria (Fig. 69).

The Protozoa present every type of *nutrition* exhibited by organisms, except that of the "prototrophic" bacteria, which perform

chemosynthesis by the use of energy obtained from reactions between inorganic substances. *Holophytic* nutrition,<sup>1</sup> however, is found, among protozoa, only in certain of the Mastigophora (see below). Of the *holozoic* members of the phylum, some feed by amoeboid action.



Fig. 13.

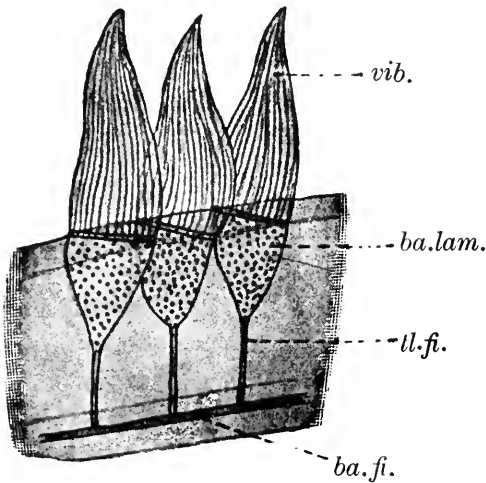

Fig. 14.

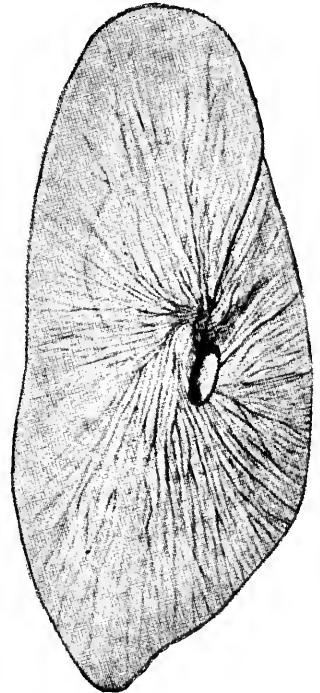

Fig. 15.

Fig. 13. Diagram illustrating the optical appearance given by a profile view of cilia beating in metachronal rhythm. After Verworn.

Fig. 14. Three membranellae from the adoral wreath of *Stentor*. After Doflein. *ba.fi.* basal fibre of the rhizoplast system; *ba.lam.* basal lamellae; *ul.fi.* terminal fibres; *vib.* vibratile elements; the band beneath each of these represents the fused basal granules of the constituent cilia.

Fig. 15. *Paramecium*, showing the motorium lying near the vestibule, and the fibrils which radiate outwards. After Rees.

<sup>1</sup> The nutrition of an organism is said to be *holophytic* when it is effected, as in typical plants, by the building up of complex organic substances from simple inorganic ones by use of the energy of certain of the sun's rays (photosynthesis). The radiant energy is obtained by means of the green, yellow, or brown structures known as "chromatophores" or "chromoplasts" (e.g. the

Usually this can be done at any point of the surface, as in the familiar case of *Amoeba*, but most of those flagellates which perform amoeboid ingestion do so in a particular region only. Other protozoa swallow through a permanent *mouth*. The true mouth is the spot at which the food passes below the ectoplasm. It may be (a) a bare patch of endoplasm, (b) the opening of an excavation (*oesophagus*) in the endoplasm, (c) the bottom of a depression (*vestibule*) in the ectoplasm, (d) the junction of a vestibule and an oesophagus. Any passage, whether oesophagus, or vestibule, or compounded of both, through which food enters is called a *gullet*, though not all cavities to which this name is applied are actually used in feeding. The opening of a gullet is the *cytostome*, which when there is a vestibule is not the true mouth. Gullets are found in many of the Mastigophora and most of the Ciliata. In ciliates either of the kinds may be present (p. 104). In the Mastigophora the gullet is at least sometimes ectoplasmic, but its morphology needs further investigation. A gullet may be supported by skeletal rods (Figs. 39E, 89A), and is then often dilatable: a vestibule may have ciliary apparatus, trichocysts, etc. for taking food (Figs. 39C, 90). The Suctoria (Fig. 1) draw the protoplasm of their prey into their bodies through tentacles. The details of ingestion into the protoplasm differ considerably in different organisms. In some amoeboid forms the cytoplasm comes into contact with the food at once, either by flowing over it or by its adhering to the surface and being drawn in; others enclose the particles to be swallowed without touching them, either by arching over them, as *Amoeba proteus* does, or by excavating a vacuole for their reception. In some at least of the organisms whose food is driven into a gullet, a vacuole forms for it, apparently by the pressure of the water forced in, and on reaching a certain size nips off. Often, but by no means always, discrimination is exercised between particles which appear equally capable of being swallowed. It is doubtful whether this discrimination is concerned solely with such properties as the size and shape of the particles or also with their chemical qualities. Solid food is digested in food vacuoles, which usually contain visible fluid and in which the reaction is often first acid and then alkaline. Live food dies during the acid phase, and protein is digested during the alkaline phase. Protozoa have

chloroplasts of green plants). In this mode of nutrition the simple materials of the food are absorbed through the surface of the body. In *holozoic* nutrition complex organic substances are swallowed through temporary or permanent openings as in the majority of animals. In *saprophytic* (or *saprozoic*) nutrition, practised by certain organisms, including among others various parasites, which are in contact with solutions of organic matter, relatively complex carbon compounds are taken, but these are absorbed through the body surface. The modes of nutrition classed under this head vary greatly in the complexity of the substances they require.

not been shown to digest fat, but can usually dissolve starch, and sometimes cellulose. The latter faculty becomes of great importance when they are symbionts in the alimentary canal of animals whose food consists of plant tissues (pp. 68, 111). In a few cases (*Balantidium*, some *Amoebae*) contractions of the protoplasm divide large morsels into fragments. Often, but not, for instance, in foraminifera, the food vacuoles circulate in the cytoplasm; sometimes they do this along a regular track. Their circulation is often due to streaming of the endoplasm, but sometimes (ciliates, etc.) it is brought about by peristalsis of the cytoplasm. Defaecation of the indigestible remains of food takes place at any part of the surface when there is no pellicle, but in pelliculate forms at a fixed spot. Sometimes there is a permanent rectal passage lined by ectoplasm (Fig. 88 B, *an*). *Saprophytic* forms range from some which can subsist on mixtures of substances as simple as aminoacids and acetates (or even, as *Polytoma* can, upon ammonium acetate alone), to parasites whose food probably differs chemically but little from that of holozoic forms.

*Reserve materials*, for use at times when nutriment is not being taken or when some process, such as rapid multiplication, is making heavy demands upon the resources of the organism, are stored by most protozoa, and are often conspicuous, as granules, vacuoles, crystals, etc., in the cytoplasm. The carbohydrates starch, paramylum (in the Euglenoidina), and leucosin (in the Chrysomonadina) are formed by holophytic organisms and by some colourless forms related to these (as by *Polytoma*, Fig. 24, *Peranema*, etc.). Glycogen is stored by parasitic and other anaerobic forms, in which it is perhaps split with evolution of energy, as in various anaerobic metazoa. Protein reserves are common in holozoic species. Nucleic acid ("volutin") is widespread, probably as a reserve for the nucleus. Oil reserves also occur in practically all groups—a rather remarkable fact, in view of the apparent inability of the Protozoa to digest fats. In *phosphorescent* forms (dinoflagellates, radiolarians) the oxidation of fats is the source of the emission of light.

The nitrogenous *excreta* of the Protozoa appear to be most often ammonia compounds, less often urea, and occasionally urates. Excretion doubtless frequently takes place from the general surface of the body. Sometimes there are recognizable in the cytoplasm granules or crystals of urates or phosphates, which may be expelled with the faeces but appear in other cases to be redissolved. Their material is then perhaps passed into the *contractile vacuoles*. The latter are spaces filled with water which periodically undergo collapse with expulsion of their contents to the exterior. In the simplest cases, as in the familiar laboratory types *Amoeba*, *Chlamydomonas* and *Actinosphaerium* (Figs. 23, 33 *c.vac.*), the contractile vacuoles are solitary,

spherical cavities, one or more in number according to the organism; over these in pelliculate genera there is a soft patch in the pellicle through which discharge takes place. Sometimes, as in *Euglena* and

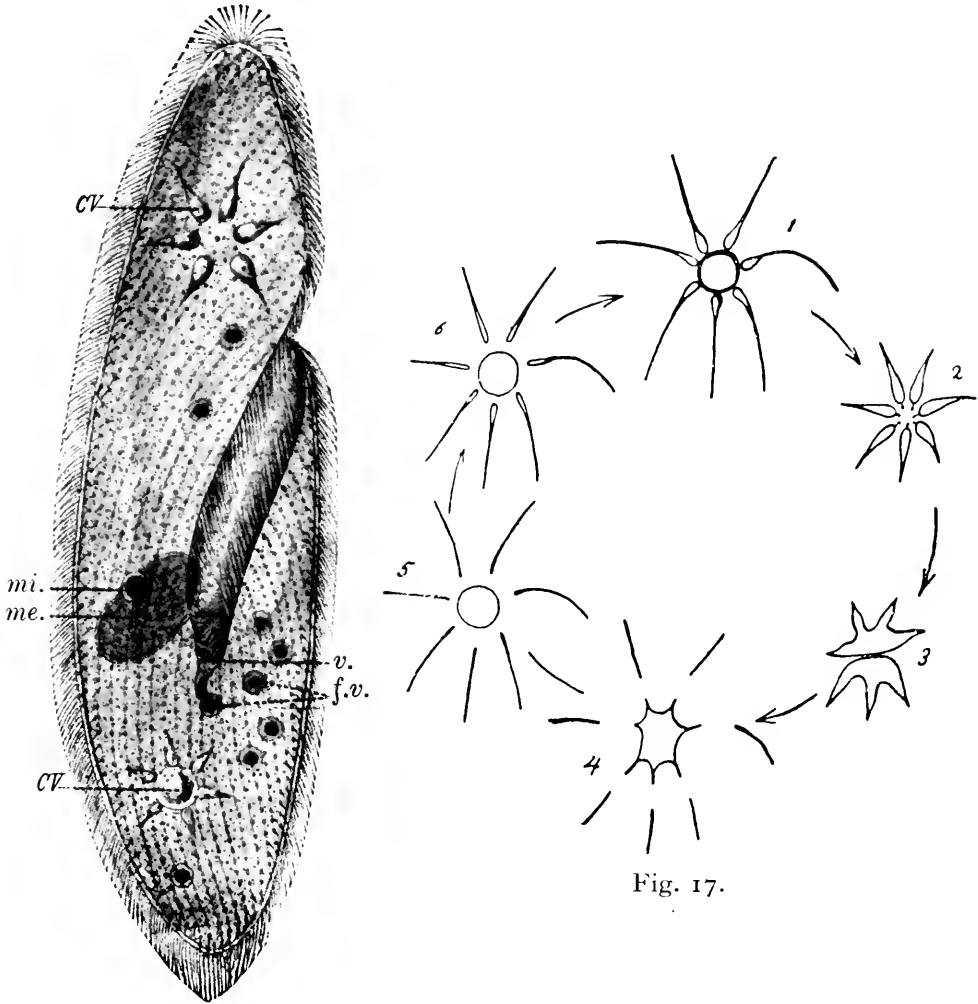

Fig. 16.

Fig. 16. *Paramecium caudatum* from the ventral side,  $\times 375$ . After Doflein. *CV*, contractile vacuoles: in the anterior one the main vacuole has just disappeared by discharging, and is about to be reconstituted from the accessory vacuoles, which are at their maximum size; in the posterior one the accessory vacuoles having re-formed the main vacuole are themselves re-forming; *f.v.* food vacuoles; *me.* meganucleus; *mi.* micronucleus; *v.* vestibule.

Fig. 17. The cycle of action of the contractile vacuole and its canals in *Paramecium*. From Lloyd, after Pütter.

*Paramecium*, they are accompanied by accessory vacuoles by whose contents they are reconstituted (Figs. 39D, 16, 17) and which in some ciliates (Fig. 89B, C) extend as long canals through the cytoplasm.

Another complication sometimes exists in the presence of a "reservoir" through which the vacuole communicates with the exterior, either directly, as in *Peranema* (Fig. 39E), or by way of the gullet, as in *Euglena* and *Vorticella* (Figs. 39D, 2). At least some contractile vacuoles appear to have a lining membrane, and it is probable that they are not entirely abolished at systole. The fact that these organs are commoner in freshwater protozoa than in marine or parasitic species suggests that their primary function may be the discharge of water, which must enter the body when the surrounding medium has a lower osmotic pressure than the protoplasm. Possibly, however, they serve also as organs of excretion.

*Respiration* no doubt takes place upon the whole surface of the body. It has been supposed that the contractile vacuoles subserve this function, but, while they no doubt remove carbon dioxide in solution, it is difficult to see how their activity could cause the entry of oxygen.

Many protozoa either regularly or occasionally pass a period of their lives in a *cyst*. The cysts may be coats of jelly or stronger coverings, usually organic, but sometimes, as in the Chrysomonadina, chiefly composed of inorganic material. The function of the cyst is nearly always to shield the organism, either from unfavourable circumstances or from stimuli which would interfere with some process, such as reproduction or digestion, but in a few cases it facilitates syngamy by keeping gametes together. Encystment is less common among species which live in the relatively equable conditions of the sea, than in freshwater and parasitic forms. Cysts which do not subserve reproduction may be *resistance cysts*, against drought, alterations of concentration, or the appearance of poisonous substances in the surrounding medium, either in the habitat in which encystment takes place or in those encountered in the course of distribution. They may on the other hand be *resting cysts*, which enable the organism to proceed undisturbed with digestion or photosynthesis or by quiescence to conserve its energy during starvation. Cysts which subserve reproduction may be *gamocysts*, in which union of gametes takes place (gregarines, Figs. 76-78), *oocysts*, containing a zygote, or *sporocysts* containing several small individuals produced by fission. The oocyst frequently becomes a sporocyst by fission of the zygote. Reproductive cysts are often also resistance cysts.

The *nuclei* of the Protozoa (Fig. 18) vary greatly in structure. They usually contain masses of some size composed of various materials. Such masses, when they consist only of the substance known as *plastin* (which takes acid stains), are known as *nucleoli*; if they also contain chromatin (basic-staining) they are *amphi-nucleoli*. A single central mass is an *endosome*: it may be a temporary



aggregation, as, for instance, in *Actinosphaerium*, but more often is permanent except, sometimes, at division. Such a permanent endosome is usually a nucleolus or an amphinucleolus, but is said sometimes to consist solely of chromatin or of achromatic matter. A permanent endosome consisting of plastin or chromatin, or both, is

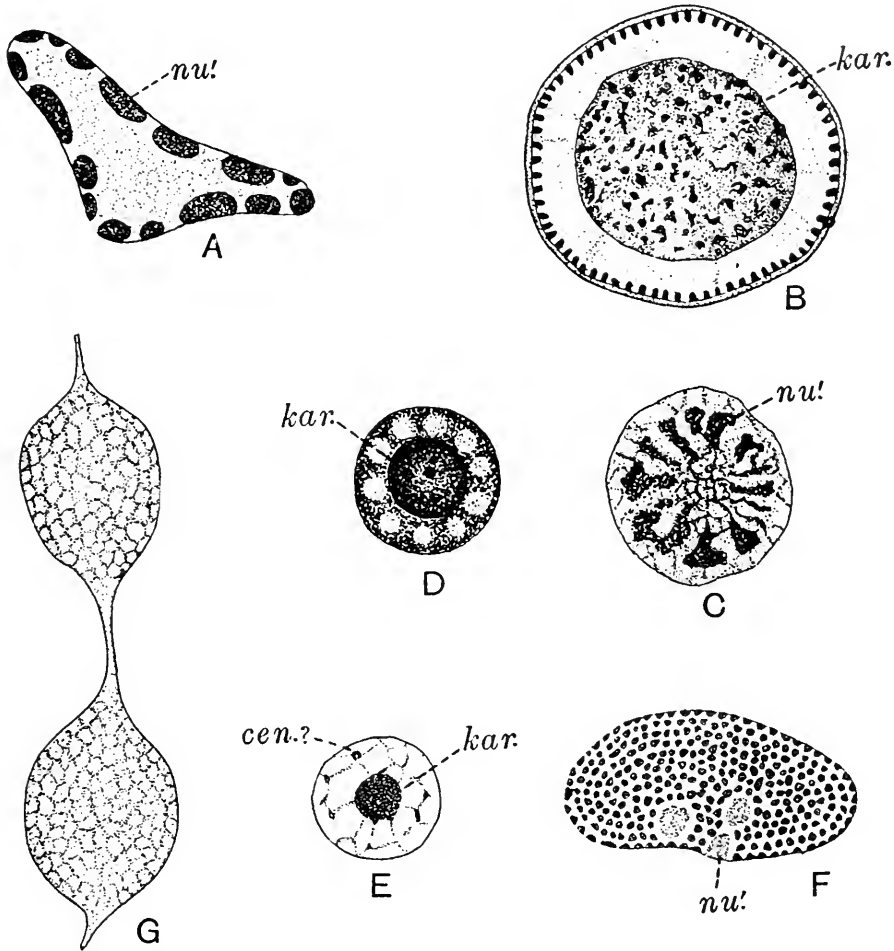

Fig. 18. Nuclei of Protozoa. A, *Polystomella crisper*. B, *Amoeba proteus*. C, *Actinosphaerium eichhorni*. D, *Naegleria bistadialis*. E, *Polytoma uvella*. F, *Ceratium fusus*. G, *Stentor coeruleus*. All highly magnified, to various degrees. After various authors. cen.? possible centriole; kar. karyosome, containing a centriole in D; nu.' nucleoli or amphinucleoli.

known as a *karyosome*. Two principal types of protozoan nuclei—the *dense* and the *vesicular*—may be distinguished; there are, however, intermediates between them, and they do not characterize each a distinct branch of the phylum, but the dense appears to have arisen more than once from the vesicular. In nuclei of the dense type the achromatic part has a relatively firm consistency, and often exhibits,

at least in fixed specimens, a fine meshwork. The plastin is in masses scattered through the nucleus, or occasionally in a single excentric mass. The shape is often not spherical (Figs. 87-90). The meganuclei of ciliophora and dinoflagellate nuclei belong to this type, which otherwise is rare. In vesicular nuclei the achromatic part is more fluid and its meshwork, if any, is coarse. The plastin may be in several masses under the nuclear membrane, but usually is in a karyosome.

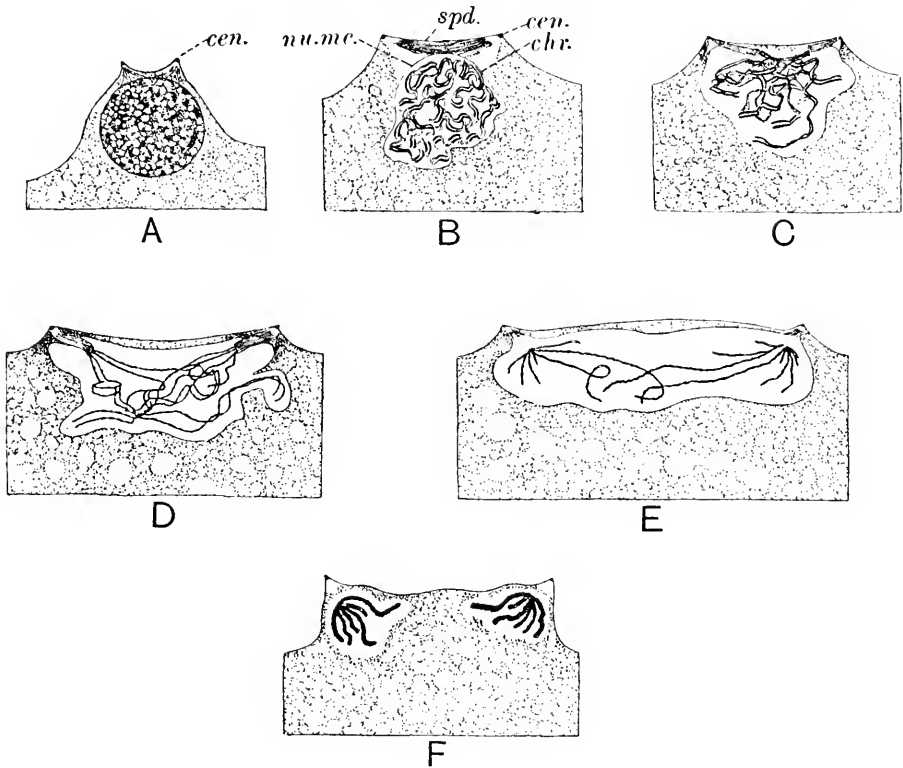

Fig. 19. Mitosis (paramitosis) of the sporogony of *Aggregata eberthi*. After Belar. A, Interphase between divisions. B, Early metaphase. C, Anaphase beginning. D, Later anaphase. E, Early telophase. F, Later telophase. *cen.* centriole; *chr.* chromosomes; *nu.me.* nuclear membrane; *spd.* spindle.

The *modes of division of protozoan nuclei* are also very various. Many were formerly classed as *amitoses* but are now regarded as unusual types of mitosis. True amitoses are rare, and perhaps occur only in the meganuclei of the Ciliophora. The *mitoses* are sometimes (Fig. 58) practically identical with those of the Metazoa, but are usually more or less aberrant. The "division centre" by which mitosis is initiated may be a centrosome consisting of centrosphere and centriole, or may be either of the latter two entities alone. The centrosphere often forms a plate or cap at each pole of the nucleus. Most often the nuclear membrane remains intact throughout the

process. The division centre may be intranuclear or extranuclear; when it is an extranuclear centriole, it is often identical or associated with the basal granule of a flagellum. Cases in which the chromosomes are distinct and on the whole behave like those of metazoa are known as *eumitoses*. Another set of mitoses, known as *paramitoses* (Fig. 19), differ from those of the Metazoa in that the chromosomes do not shorten in the metaphase, and are not symmetrically arranged on the equator of the spindle (if such be visible); and their longitudinal

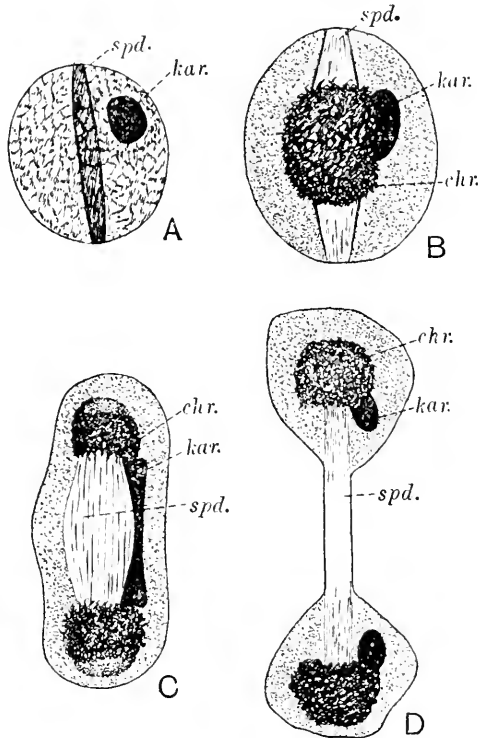

Fig. 20. Stages in the mitosis (cryptomitosis) of *Haplosporidium limnodrili*. After Granata. A, Resting nucleus: the spindle here persists. B, Metaphase. C, Anaphase. D, Telophase. *chr.* chromatin; *kar.* karyosome; *spd.* spindle.

halves, when they separate, hang together to the last at one end so that they appear, though deceptively, to divide transversely. In a third set, known as *cryptomitoses* (Fig. 20), there are no distinct chromosomes but the chromatin merely concentrates as a mass upon the equator of a spindle, whose fibres may not be visible, and divides into two halves which travel to opposite poles. Intermediate cases connect cryptomitoses with eumitoses. Paramitoses occur in coccidians, dinoflagellates, and the spore formation of radiolarians, cryptomitoses for the most part in parasitic and coprozoic forms, as in *Haplosporidium* and *Naegleria*.

In certain cases mitoses repeated several times without dissolution of the nuclear membrane give rise to *polyenergid nuclei* which possess numerous sets of chromosomes, the sets being finally liberated to form each a daughter nucleus. The polyenergid condition is probably always a provision for spore formation, and may (as in the coccidian *Aggregata*) occur only as a transient phase before sporulation, but in other cases (radiolarians) it persists for a long time, the nucleus dividing meanwhile as a whole by "giant mitoses" in which all the chromosomes take part. A remarkable process in *Amoeba proteus* is possibly to be interpreted as the multiplication of units in a polyenergid nucleus by cryptomitoses.

In the Ciliophora (other than the Opalinidae and the Chonotricha) the nucleoplasm, which in other protozoa is contained in one nucleus or in several which are all alike, is divided into two portions, a large amitotic *meganucleus* which breaks up periodically in "endomixis" (see p. 35) and also at conjugation, and one or more small *micronuclei*, by division of one of which the pronuclei of conjugation are provided and the meganucleus replaced when the latter disintegrates. Individuals without micronuclei have been observed and kept through several asexual generations. Thus the meganucleus is capable of conducting by itself the normal vegetative existence of the individual, though the absence of this nucleus at syngamy shows that it does not establish the characters of the race. That function must be performed by the micronucleus, but, since the latter does not exist without the meganucleus, save for a brief period during conjugation, it presumably does not regulate the life of the individual. The chromatin of the meganucleus is known as *trophochromatin*, that of the micronucleus as *idiochromatin*.

A similar distinction between trophochromatin and idiochromatin is discernible in various other protozoa. In the Opalinidae (Fig. 21 C) and Chonotricha there are two sets of chromosomes, an outer and an inner, which divide successively at mitosis. The members of the outer set (*megachromosomes*), larger and less regular than those of the inner, are held to represent the meganucleus of other ciliophora: the material of which they are composed is known to be cast out of the nuclei of the Opalinidae before gamete formation. The members of the inner set (*microchromosomes*) represent the micronucleus. In various cases of gamete and spore formation by members of other classes, especially of the Sporozoa, there is a destruction (Fig. 21 A, see legend), or a casting out from the body (Fig. 21 B), of a portion of nuclear substance which is probably trophochromatin. It has been suggested also that the obscurity of cryptomitoses is due to a veil of trophochromatin dividing amitotically around the idiochromosomes. It may be that all protozoa contain chromatin in both these conditions; and

it is perhaps in this respect, as well as in restriction of function, that the cells of metazoa differ from protozoa.

From the fact that, in many cases at least, the trophochromatin is periodically destroyed and replaced, and from further facts which we shall cite in discussing the significance of conjugation, it would appear that trophochromatin, or some part of the protoplasm associated with it, in the course of its regulative activity eventually becomes effete and is replaced from the idiochromatin, which is not liable to that fate. Perhaps the possession by protozoa of the facility for this re-

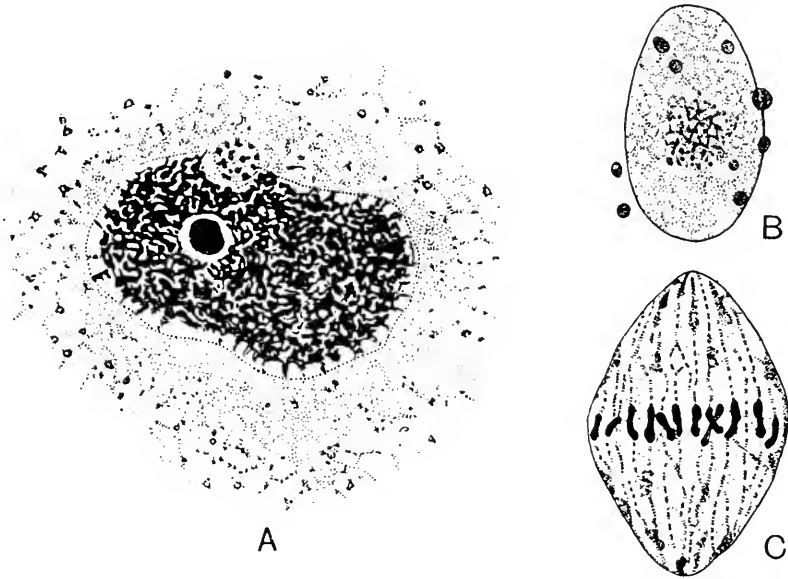

Fig. 21. Nuclear phenomena in protozoa. A, Extrusion of the germ nucleus from the somatic nucleus in *Gregarina cuneata* before gamogony. The somatic nucleus will break up and disappear. B, Extrusion of the substance of the endosome from the gamont of *Eimeria schubergi*, the germinal part of the nucleus remaining in the centre of the body. C, Mitosis in *Opalina ranarum*, megachromosomes in anaphase in outer part of nucleus, microchromosomes in metaphase internal to them. A, after Milojevic; B, after Schaudinn; C, after Tönniges.

placement, and the lack of such facility in the body cells of metazoa, is the explanation of the fact that protozoa are not subject to the "natural death" which eventually overtakes the body of a metazoan.

The loss of trophochromatin during the formation of gametes is not to be confused with the *reduction division* of maturation. Reduction divisions, however, have been seen in members of all classes of the Protozoa, and it may be suspected that a process of this kind occurs in all species in which there is syngamy. Such divisions are sometimes (*Actinophrys*, etc.) strikingly similar to those of the Metazoa, but in other cases (*Paramecium*, etc.) are peculiar. The reduction division

usually closely precedes syngamy, as in the Metazoa, but in the Telosporidia and Volvocina it takes place in the first division of the zygote, so that for the whole of the rest of its life history the organism is haploid.

In many protozoa there are present in the cytoplasm, scattered or massed into a group, numerous granules which, like chromatin, take basic stains and are known collectively as the *chromidium* (Fig. 22 A). They appear to arise from the nucleus, and have been said, but probably incorrectly, in some cases to give rise to nuclei by condensation. They may appear upon occasion or be present through the greater part of the life cycle. Their function is uncertain and probably not always the same.

The *fission* of the Protozoa takes place in several ways. Whether in

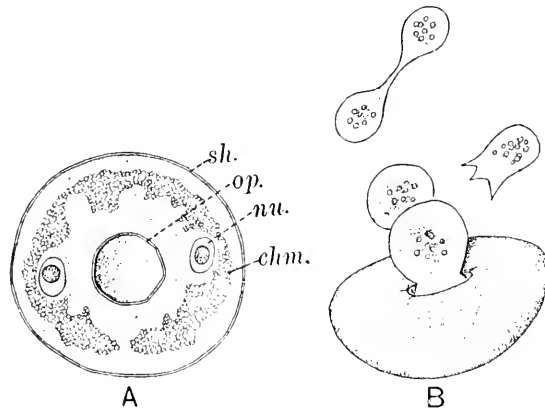

Fig. 22. *Arcella*. After Swarczewsky. A, Vegetative individual. B, Individual in process of budding. *chm.* chromidium; *nu.* nucleus; *op.* opening of shell; *sh.* shell.

asexual reproduction or in the formation of gametes, it may be: (a) equal *binary fission*, the familiar mode of division of *Amoeba*, *Paramecium*, and a vast number of other cases; (b) *budding*, in which one or more small products separate from a parent body, as in *Arcella* (Fig. 22 B), the Suctoria (Fig. 96), etc.; (c) *repeated fission*, in which equal divisions give rise to four or more young which do not separate till the process is completed, as in *Chlamydomonas* (Fig. 23), the microgamete formation of *Volvox* (Fig. 44), etc.; or (d) *multiple fission*, in which the nucleus divides several times without division of the cytoplasm, which finally falls into as many parts as there are nuclei, usually leaving behind some residual protoplasm, which may contain nuclear matter. Multiple fission is seen in the spore formation of numerous protozoa, as *Amoeba*, sporozoa (Fig. 74 C, D; G<sub>2</sub>, G<sub>3</sub>; K, L), etc. The fission of multinucleate protozoa, such as *Actinosphaerium*, *Opalina* (Fig. 86), etc., to form multinucleate offspring by

division of the cytoplasm without relation to that of the nuclei, is known as *plasmotomy*. It is usually binary, but occasionally takes place by budding or is multiple. The plane of simple binary or of repeated fission is often transverse to the principal axis—if there be one—of the body, but in most flagellates it is longitudinal. Repeated longitudinal fission in which the daughter individuals remain in position is called *radial*; such fission is common in the green flagellates of the order Volvocina (e.g. some species of *Chlamydomonas*, Fig. 23

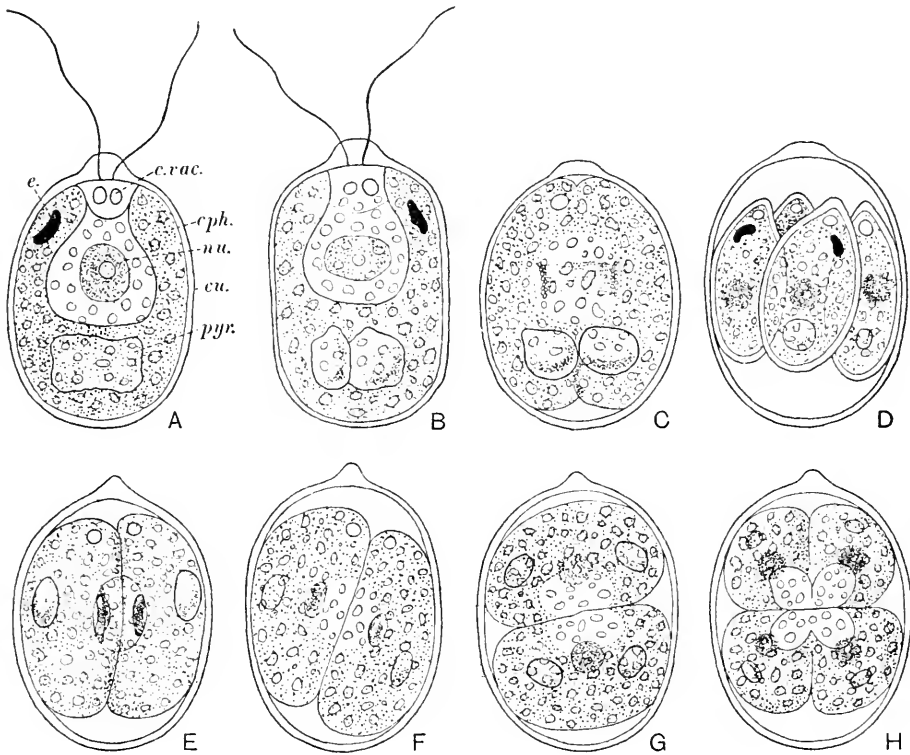
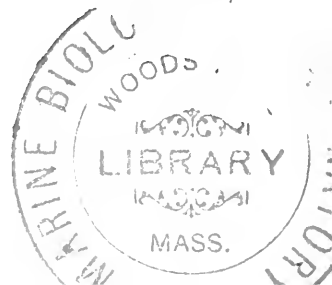

Fig. 23. *Chlamydomonas*. A, *C. angulosa*,  $\times 1000$ . B–D, the same, in fission (radial). E–H, *C. longistigma* in fission (pseudotransverse). Highly magnified. After Dill, with modifications. *c.vac.* contractile vacuole; *cph.* chromatophore; *cu.* cuticle; *e.* eye-spot; *nu.* nucleus; *pyr.* pyrenoid.

A–D). Sometimes an individual in longitudinal fission shifts in its cuticle during the process, till the plane of division becomes transverse. Fission of this kind is said to be *pseudotransverse*: it is seen, for instance, in some *Chlamydomonas* (Fig. 23 E–H). In *Polytoma* (Fig. 24) the only vestige of longitudinal fission consists in a slight obliquity of the first division of the nucleus.

Each type of fission takes place in some cases in a cyst and in others without encystment.



The fate of flagella at fission varies. Sometimes, as in *Chlamydomonas* and *Polytoma*, they are lost, early or late in the process. In other cases they are retained. When this happens in an organism with a single flagellum, that organ has been said sometimes to be split longitudinally, but usually, if not always, a second flagellum grows out from the basal granule, which divides. When several flagella are present and persist, they are distributed between the offspring, each of which grows new flagella to complete its equipment. Probably, a new flagellum always grows from a basal granule. Chromatophores divide, and if numerous may do so independently of the fission of the

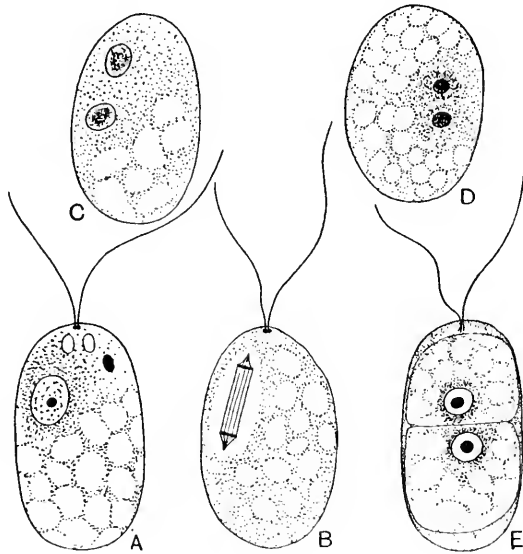

Fig. 24. *Polytoma uvella*,  $\times$  about 1300. A, Ordinary individual, showing nucleus, eye-spot, contractile vacuoles, flagella with basal granules, and starch grains, the latter confined to the hinder part of the body. B-E, stages of the first fission. In C and D the flagella are omitted. After Dangeard.

body. Contractile vacuoles and other organs rarely (*Euglena*) divide, but are usually shared as the flagella. Complex organs, however, are often destroyed (dedifferentiated) and remade by the individual that receives them.

*Conjugation*<sup>1</sup> or *syngamy*,<sup>2</sup> the union of two nuclei, accompanied by the fusion of such cytoplasm as each may possess, is, so far as our

<sup>1</sup> The name *conjugation* is by some authorities restricted to the peculiar process by which syngamy is accomplished in most ciliophora (p. 33).

<sup>2</sup> The union of nuclei is *karyogamy*: in most cases of syngamy it is accompanied by *plasmogamy* or the fusion of cytoplasm, but in typical ciliophora one of each pair of fusing nuclei has perhaps no cytoplasm; and autogamy (p. 33) is said sometimes to occur between nuclei whose cytoplasm has never been divided. *Plastogamy* (p. 36) is plasmogamy without karyogamy.



knowledge goes at present, by no means universal in the Protozoa. Especially among the Mastigophora, but also in other groups as in the Amoebina, there are many cases in which it appears not to occur. Probably, however, in the majority of species it either is known or may reasonably be inferred to take place. The energids by which it is performed, known here, as in all organisms, as *gametes*, may be either *merogametes*, formed by special acts of fission and smaller than the ordinary energids of the species, or *hologametes*, not formed by special fissions, and as large as, or larger than, the ordinary energids. Syngamy between like gametes is known as *isogamy*, that between unlike gametes as *anisogamy*. The simplest cases of the process are those instances of isogamy in which two full-sized ordinary individuals unite. Such unions are known as *hologamy* and are rare, though they occur in *Copromonas* (Fig. 39 F') and a few other species. The fact that nearly all protozoa in which it is certainly known to occur are coprozoic (p. 43) suggests that it is an adaptation to special conditions—perhaps to brief duration of the active stage—and is not, as might be assumed, the primitive form of syngamy. In all other cases the gametes are special individuals, and one at least is a merogamete. They may be isogamous or anisogamous, and in the latter case one—the *female gamete*—is less active than the other, which is the *male gamete*. Nearly always the female gamete (*macrogamete*) is larger than the male (*microgamete*), and often it is a hologamete. In the latter case the process is known as *oogamy*. As examples of isogamy of merogametes we may cite the syngamy of *Polystomella* (Fig. 66 C–E) and of some *Chlamydomonas* (e.g. *C. steini*).

Anisogamy occurs independently in many genera, and has more than once become oogamy. An interesting series of grades in this respect is provided by the Volvocina. *Chlamydomonas euchlora* exhibits the transition from isogamy to anisogamy. By undergoing different numbers (2–6) of divisions, its individuals form merogametes of several different sizes, but these pair indifferently, some unions being isogamous, some anisogamous. *C. brauni* and other species (Fig. 25) form merogametes of two sizes and are definitely anisogamous. *Volvox* (Fig. 46) and related forms have an anisogamy in which the female gamete is a hologamete (oogamy). A similar series is shown by the Sporozoa. The syngamy of some species of *Monocystis*, for instance, is isogamy of merogametes, that of others is anisogamy of merogametes with various degrees of unlikeness between the gametes, and that of the malaria parasite (Fig. 75) and its relations is anisogamy between a hologamete and a merogamete.

Syngamy, whether isogamous or anisogamous, nearly always is *exogamous*, that is, takes place between the offspring of different parents.

Since the male and female gametes are usually formed by distinct

parents, *sex* may be said to exist among protozoa, but it is rarely that (as in the sporozoon *Cyclospora*, etc.) the sexes may be distinguished

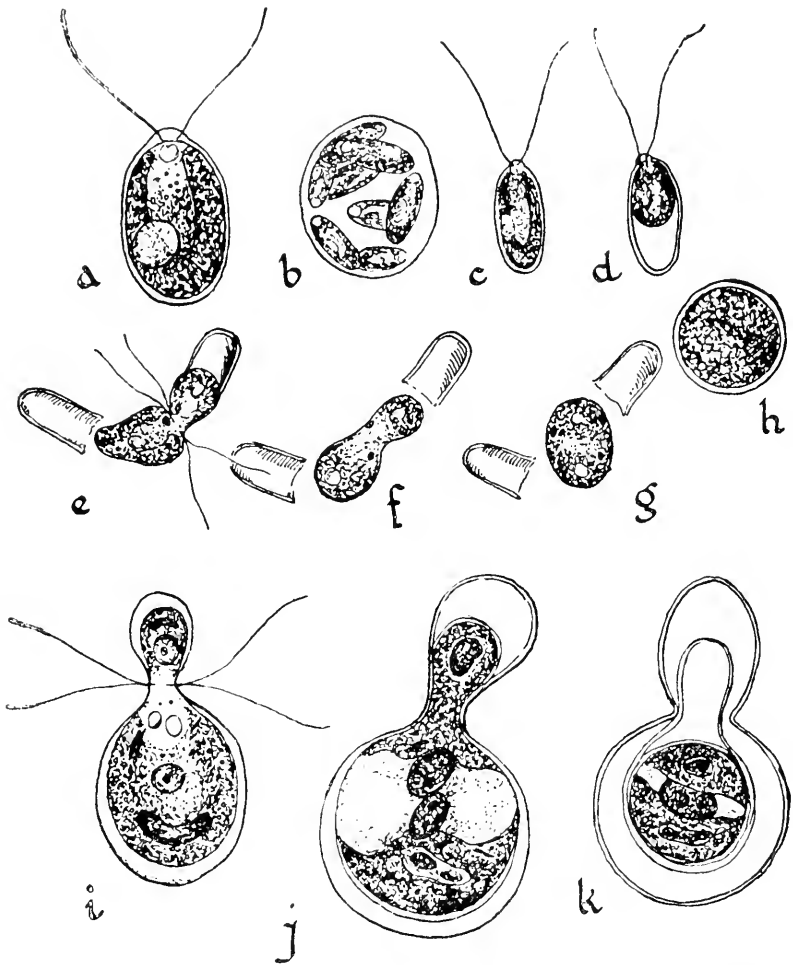

Fig. 25. Anisogamous syngamy of *Chlamydomonas*. *a-h*, *C. media*, after Klebs. *a*, Vegetative individual. *b*, Eight gametes produced inside the cuticle of the parent. *c*, Single gamete. *d*, Gamete before syngamy showing protoplasm at one end of the cuticle. *e, f, g*, Syngamy between two gametes of unequal size: the individuals slip out of the cellulose wall at the time of fusion, the cilia withdraw and there is a complete fusion of the individuals. *h*, The resultant thick-walled zygote. *i, j, k*, *C. brauni*, after Goroschankin: in this species the gametes fuse whilst yet within their cellulose walls and there is marked anisogamy, the small gamete slipping into the cuticle of the larger gamete. *j*, Shows the nuclei, chloroplasts and pyrenoids of the two gametes still separate. *k*, Shows the fused nuclei.

by other features. In many of the Telosporidia (e.g. *Monocystis*, Fig. 78) *sexual congress* may be held to occur, in that individuals, male and female in cases of anisogamy, apply themselves together at

the time of gamete formation, and their gametes unite each with one from the other parent. *Hermaphroditism* appears in the Ciliophora<sup>1</sup> (except the Opalinidae and Chonotricha). Here congress (Fig. 26) takes place between two individuals (*conjugants*) in each of which the meganucleus (see above) disintegrates, and the micronuclei divide to form a number of nuclei—perhaps a reminiscence of the formation of numerous merogametes. All but one of these nuclei disappear, and the survivor divides to form a male pronucleus, which passes over into the partner, and a female pronucleus which, in possession of the cytoplasm of the parent, awaits the arrival of the male pronucleus of the partner. Fusion now takes place between the male and female pronuclei in each of the pair of conjugants, the latter separate, and by the division of their zygote nuclei mega- and micronuclei arise. Two hermaphrodites have formed each a male and a female gamete and cross-fertilization has taken place.<sup>2</sup> In the Vorticellidae (Fig. 26 B) the individuals which enter into congress differ, one being of the ordinary size and fixed, the other small and free-swimming. The smaller arises from an ordinary individual, as a bud or by repeated fission. After reciprocal fertilization of the type just described, the smaller partner perishes, its endoplasm being sucked into the larger. This curious simulation of sexual dimorphism by hermaphrodites occurs in a less marked form in other ciliates.

A remarkable process known as *autogamy*, in which a nucleus divides into two which after maturation immediately reunite, occurs in *Actinophrys* and *Actinosphaerium* (see pp. 83–86), and possibly in some other cases.

*Parthenogenesis* is known to occur in members of at least three of the four classes of the phylum. The clearest case is presented by *Actinophrys*, when gametes which have failed in attempt at cross-fertilization develop parthenogenetically (p. 86): it is interesting that one of these gametes is a functional male. Individuals of *Polytoma* which are potential gametes will grow and divide, and the same is true of the gametes of some species of *Chlamydomonas* and *Haematococcus* when syngamy has been missed. The endomixis of ciliates (p. 35) is a phenomenon of this kind.

Since it is comparatively easy to observe the conditions which precede and the results which follow syngamy in the Protozoa, many experiments and observations have been made upon those creatures, with a view to discovering the significance which the process has for

<sup>1</sup> *Actinophrys* (p. 83) may be said to be hermaphrodite, and so perhaps are many of the Radiolaria. But it is not certain that the "gametes" of this group are not parasitic dinoflagellates. (See p. 80.)

<sup>2</sup> Occasionally (*Collinia*, *Dendrocometes*) the conjugants also exchange halves of their meganuclei. The latter, however, always disintegrate.

organisms in general. Most of these researches have been carried out upon ciliata. They have led to two theories: (1) that syngamy effects a periodical rejuvenescence of the organism; (2) that it produces new

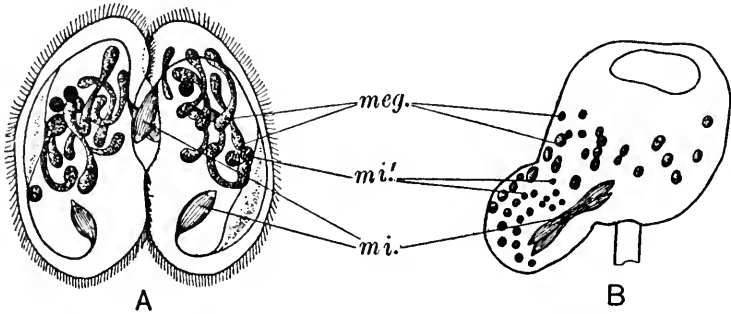

Fig. 26. Conjugation of ciliates. A, *Paramecium*. B, *Vorticella*. Both at the moment of the exchange of male pronuclei. *meg.* fragments of disintegrating meganuclei; *mi.* micronuclei: in each the male and female pronuclei produced by the division of a single nucleus still hang together by their spindle, but are parting, the male to pass into the other conjugant, the female to remain behind; *mi.'* abortive division products of the original micronucleus.

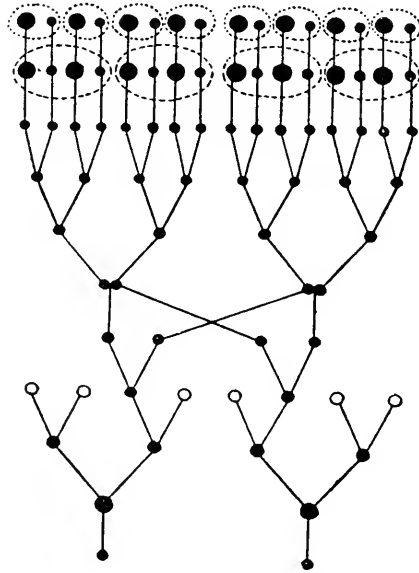

Fig. 27. A diagram of the behaviour of the micronuclei during the conjugation of *Paramecium caudatum*. From Borradaile. The white circles represent the portions which degenerate.

types of individual and therefore gives the species more chances of survival in the struggle for existence.

(1) Cultures of protozoa in which conjugation is prevented are liable after a time to fall into an unhealthy condition known as *de-*

*pression*, in which the nucleus<sup>1</sup> is overgrown, the body stunted, division retarded, and the various organs and functions increasingly degenerate, until finally digestion ceases and the organisms die. From this condition conjugation will recover a culture which is not too far gone. It was held that depression was the senility of the organism—ultimately of the same nature as that which in the Metazoa destroys the parent body, while the gametes, after syngamy, continue the existence of the species—and the conclusion was drawn that in both cases the effect of the union of nuclei was rejuvenation. Now, however, it is known that depression is a disease, which by more natural methods of culture can be avoided without conjugation. It is true that in cultures of ciliates there has been observed a periodical waxing

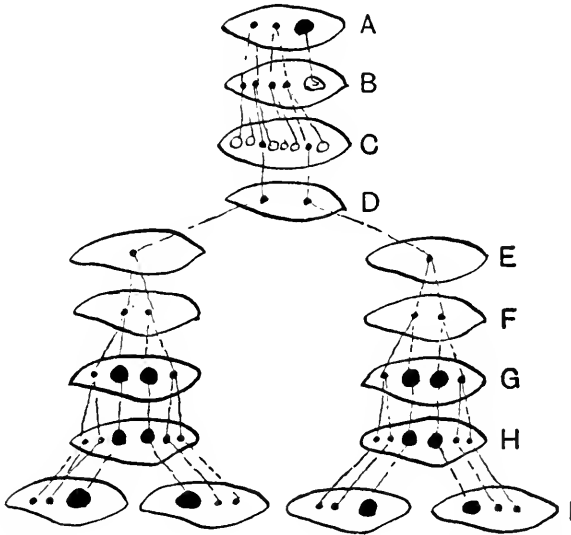

Fig. 28. A diagram of the nuclear changes in *Paramecium aurelia* during endomixis. From Robertson, after Jennings. The white circles represent degenerating nuclei. Fissions take place between D and E, and between H and I.

and waning of vitality of which the low points in some cases coincide with conjugation; but in other cases there occurs at these points not conjugation but a process known as *endomixis*, which closely resembles the procedure in conjugation, but takes place in solitary individuals and does not involve syngamy. In this process (Fig. 28) the meganucleus is destroyed and replaced by one of the products of the division of the surviving micronucleus, as in conjugation. It would appear from these facts that the invigorating effects of conjugation are due not to the true syngamy (union of nuclei) but to the accompanying replacement of the meganucleus, which probably has become effete (see p. 27). If, as has been suggested (p. 26), those protozoa

<sup>1</sup> In ciliophora the meganucleus.

which have no meganucleus have in their nuclei trophochromatin which is destroyed at syngamy, this conclusion may be extended to them also.

(2) Variety in a protozoan species is of three kinds: (a) that which results from the production of different *combinations* of genes at syngamy, and is permanent, forming races (*pure lines*) like those which exist in higher organisms in the absence of cross-fertilization; such pure lines have, for instance, been found in respect of body-length in cultures of *Paramecium*, each line in the culture breeding true so long as asexual reproduction continues; (b) that which results from the spontaneous appearance of *mutations*; this also is permanent; it has been studied in *Ceratium* and other genera; (c) that which results from modification of the individual by the direct action of the environment; this, like mutation, produces differences between individuals of a pure line, but it is not permanent, though it may be inherited for several generations before it disappears. It would seem that, apart from the occasional appearance of mutations, the permanent varieties in a species are produced only by syngamy.

Here may be mentioned the union of individuals by fusion of their cytoplasm, the nuclei remaining distinct, which is practised by the Mycetozoa (Fig. 73 F) and in some other cases. This process, which is not syngamy, is known as *plastogamy*, and its product as a *plasmodium*.

The life of a protozoon passes in the course of generations through a cycle in which individuals of different kinds succeed one another. The *life cycles* of various protozoa differ greatly, being related to the vicissitudes of the environment of the species and to the need for distribution as well as to the recurrence at intervals of conjugation, but it is possible to formulate a type of which all of them may be regarded as variants. After a period of "vegetative" existence and increase by asexual reproduction, during which the individuals are known as *agamonts*, there appears a generation known as *gamonts* because they produce *gametes*, the latter unite in pairs, and the *zygote* or *sporont* gives rise to a generation of *sporozoites* which, becoming agamonts, repeat the asexual part of the cycle. The table on p. 37 shows this typical life history.

In comparing this table with the actual course of the cycle in any species, the student should remember:

(1) that in each part of the cycle fission may take place in any of the modes described above, and that the agamogony of a species may proceed in more than one of these ways (as, e.g., that of *Amoeba proteus* by binary or multiple fission);

(2) that in the cycle of most protozoa there is a point at which adjustment must be made to unfavourable conditions, either recurring

in the local habitat or met with in the course of the distribution of the species (e.g. freshwater forms and parasites); and that at this time (a) the ordinary agamogony is suspended, (b) the syngamy, if any, usually takes place, (c) there is often a phase of protective encystment, (d) there is often very rapid multiplication by multiple or repeated fission, which may be the sporogony, the gamogony (eugregarines), or an agamogony;

(3) that any part of the cycle may be omitted; in such cases it is most often the sporogony which is dropped, but many species appear to omit gamogony, and in a few (e.g. *Monocystis* and the other eugregarines) there is no agamogony;

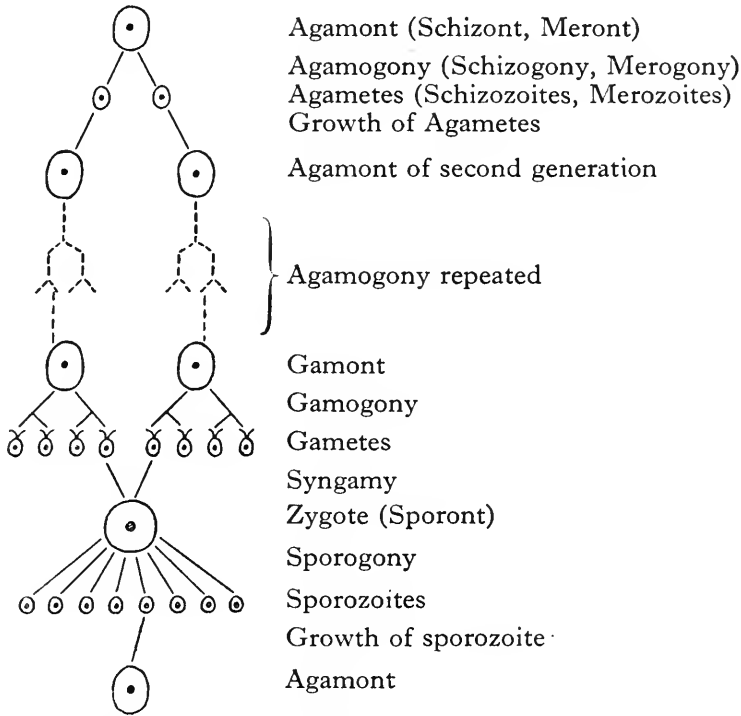

Fig. 29. A table of the life history of a protozoan.

(4) that a reduction division may occur at either of two points in the cycle—shortly before syngamy (most cases), or directly after the formation of the zygote (the Telosporidia and Volvocina)—and that correspondingly either the diploid or the haploid phase may extend over the greater part of the life history.

The term *spore* is applied to various phases of the life history in a way which is liable to cause confusion. (a) Strictly speaking, perhaps, it should be applied only to the products of repeated or multiple fission of a zygote (sporont). (b) Most often, however, it is used to denote the products of any repeated or multiple fission. (c) In a few

cases (e.g. the "ciliospores" of the Suctoria) it is applied also to products of budding. A cyst in which several spores are enclosed is a *sporocyst*. Individual spores may be enclosed in *spore cases*, when they are *chlamydospores* (as those of the Mycetozoa, Fig. 73 A), or naked, when they are *gymnospores*. The latter may be amoeboid (*amoebulae* or *pseudopodiospores*, e.g. *Amoeba*, *Polystomella*, Fig. 66 C), flagellate (*flagellulae* or *flagellisporae*, e.g. *Polystomella*, Fig. 66 B, *Chlamydomonas*), or ciliate (*ciliospores*, e.g. the Suctoria, Fig. 87 H). Spores may be gametes (e.g. the Mycetozoa, *Chlamydomonas*), or serve for the distribution of the species, when, if they are motile, they are known as "swarm spores". The *sporoblasts* of many telosporidia (e.g. *Plasmodium*, Fig. 75, 16-18) are spore-like bodies which are not set free, but give rise under cover to another generation of spores. The so-called spores of such sporozoa as *Monocystis* (Fig. 78 G, H) are really minute sporocysts, enclosing several spores ("falciform young").

The *life history of the individual protozoon* usually exhibits little change save increase in size. Sporozoites and other spores, however, may differ considerably from the adults into which they grow. This difference reaches its height in the ciliospores of the Suctoria.

The *behaviour* of a living being is that part of its life which consists in action upon the outer world. Like the rest of life it comprises activity of various kinds—mechanical, chemical, etc.—which in some cases, as in the direction of locomotion to or from the light or the shooting out of trichocysts, is immediately due to external circumstances (*stimuli*), while in others, as in the beating of cilia which continues even when the organism is encysted, it is not. Both these sorts of activity are so ordered that in normal circumstances they conduce to the welfare of the organism. The reactions of the Protozoa to stimuli are at least superficially analogous to the reflexes of the Metazoa. Study of them has chiefly been directed to those which result in locomotion. Such reflexes are of two kinds, *topotaxis* and *phobotaxis*. In *topotaxis* the organism orientates itself in relation to the stimulus, and moves either towards or away from it. This is the less common mode of reaction in protozoa, but it appears to be performed by some in the neighbourhood of food, by gametes in their union, and by certain green flagellates (*Volvox*, sometimes *Euglena*, etc.) in approaching the light.

In *phobotaxis*, which has been studied in many protozoa of various groups, the only circumstances which act as stimuli are those which are "unfavourable", that is from which the organism withdraws; and in doing this it is not repelled in a straight line, but turns away at an angle which has no necessary relation to the direction of the stimulus, and may again bring the individual into the unfavourable



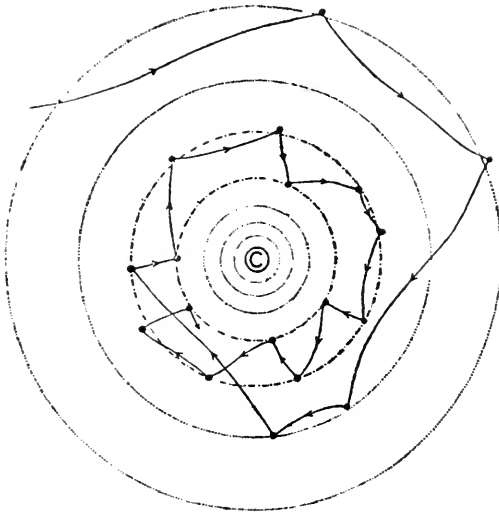

Fig. 30. A diagram of the path by which a protozoon is directed by phobotaxis into the zone of optimum concentration of a substance diffusing from a particle. From Fraenkel, after Kühn. C, Centre of diffusion. The arrows show the direction of movement of the protozoon, the circles define zones of equal concentration, the circles of dots and dashes enclose the optimal zone.

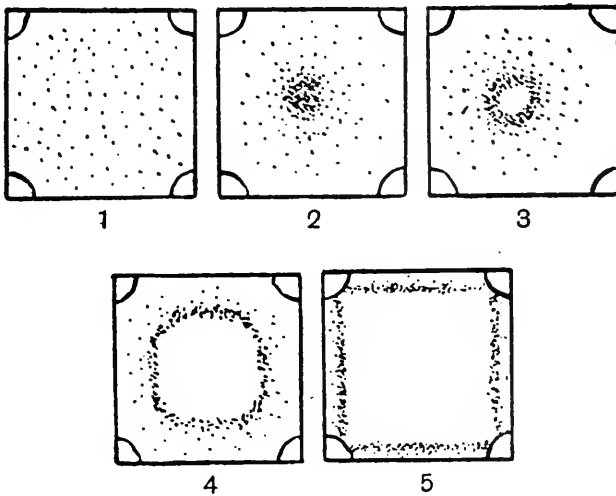

Fig. 31. Chemophobotaxis of *Bodo sulcatus*. From Fraenkel, after Fox. 1-5, Positions successively taken up by the members of a culture placed under a coverslip. The position in which the individuals gather in each case is that of the optimum concentration of oxygen, which alters as the supply of the element is lessened by the action of the flagellates.

circumstances. The reaction is then repeated. Thus the organism is shepherded by its reactions in the direction of the optimum conditions. Fig. 30 shows the path of an individual in the neighbourhood of a particle whence is diffusing some substance of which a certain concentration is optimal for the species to which the individual belongs. Any departure from this concentration turns the moving individual, so that it is led to and kept in a zone in which the optimum exists. Fig. 31 shows how members of a culture of the flagellate *Bodo sulcatus*, when placed under a coverslip, find by this reaction the optimum concentration of oxygen, which is at first in the middle of the field and recedes as the organisms use up the supply of the element.

The number of ways in which a protozoon can respond to stimuli is at most small, but the response to a stimulus by an individual in many cases depends not only upon the nature of the stimulus but also upon the condition of the individual at the moment (hunger, fatigue, etc.).

The *relation of protozoa to their environment* is governed primarily by the fact that, owing to their small size, any cuticle which is thick enough to protect their protoplasm from loss of water or poisoning by substances in the medium has the effect of immobilizing the organism. Hence in the active phase they are only found in water or in damp places on land, and are peculiarly susceptible to variations in the composition of the medium. Purely holophytic protozoa are also dependent upon the presence of sunlight. Save for these restrictions, members of the phylum are found in every environment in which any other species of organism can exist. *In the sea* they are plentiful alike in the plankton and in the benthos, and occur at all depths. Their planktonic members are liable to possess the same peculiarities which appear in members of other phyla in the same conditions—spininess (Figs. 6C, 67, 69), phosphorescence, buoyancy, etc. In attaining a low specific gravity they often show an expedient of their own, namely the presence in their protoplasm of vacuoles of water of lower saline content than the medium in which they are suspended (radiolarians, *Globigerina*, heliozoa; Figs. 32, 33, 69, 71). *In fresh waters* their species have the same cosmopolitan distribution as other small freshwater organisms. Most of them, however, are severely restricted, in all the localities in which they are found, by the necessity for conditions which only occur in some one type of environment, and often even there only during certain seasons or (as in the case of the dung fauna) for yet shorter periods. In this matter protozoa are particularly subject to the pH of the medium, its dissolved organic contents, and its saline contents. Thus *Polytoma* flourishes in an acid medium, *Spirostomum* requires a slightly alkaline one, and *Acanthocystis* pronounced alkalinity. *Euglena viridis* and *Polytoma* live in highly nitrogenous infusions, *Acti-*

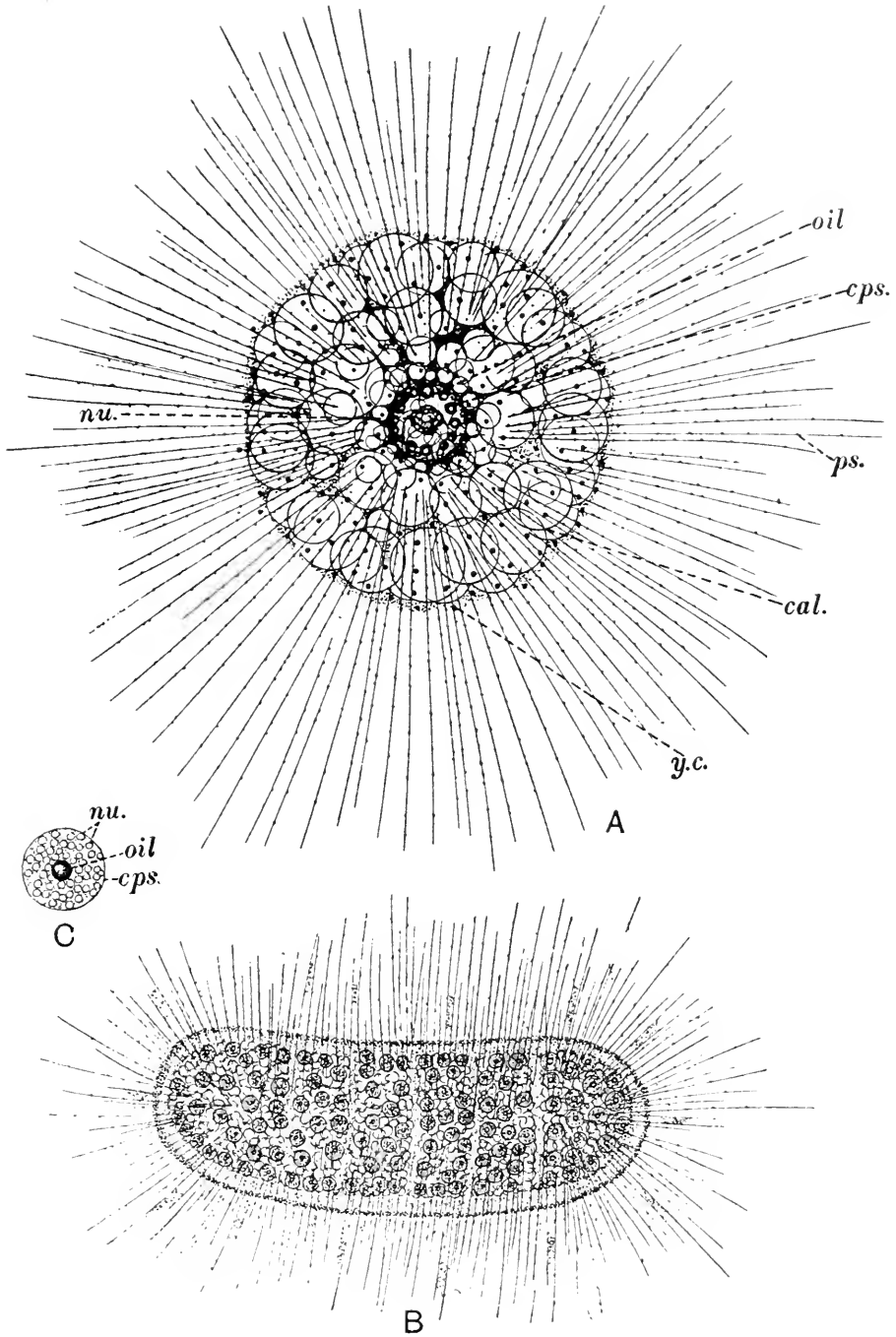

Fig. 32. Radiolaria without skeleton. A, *Thalassicolla pelagica*,  $\times 20$ . After Haeckel. B, *Collozoum inerme*. C, A central capsule of the same, more highly magnified. After Doflein. *cal.* calymma; *cps.* central capsule; *nu.* nucleus; *oil*, oil globule; *ps.* pseudopodium; *y.c.* "yellow cells" (*Zooxanthellae*).

*nosphaerium* and *Paramecium caudatum* in less highly organic infusions, *Volvox* and *Amoeba proteus* in much purer waters, *Haematococcus* in rain water. As a rule the marine and freshwater faunas are restricted by conditions of salinity, but *Polystomella* ranges from the sea into brackish waters. For many holophytic protozoa the amount of sunlight is important. Others, as *Euglena gracilis*, bleach in the absence of light, but can still flourish if the presence of organic matter in solution makes

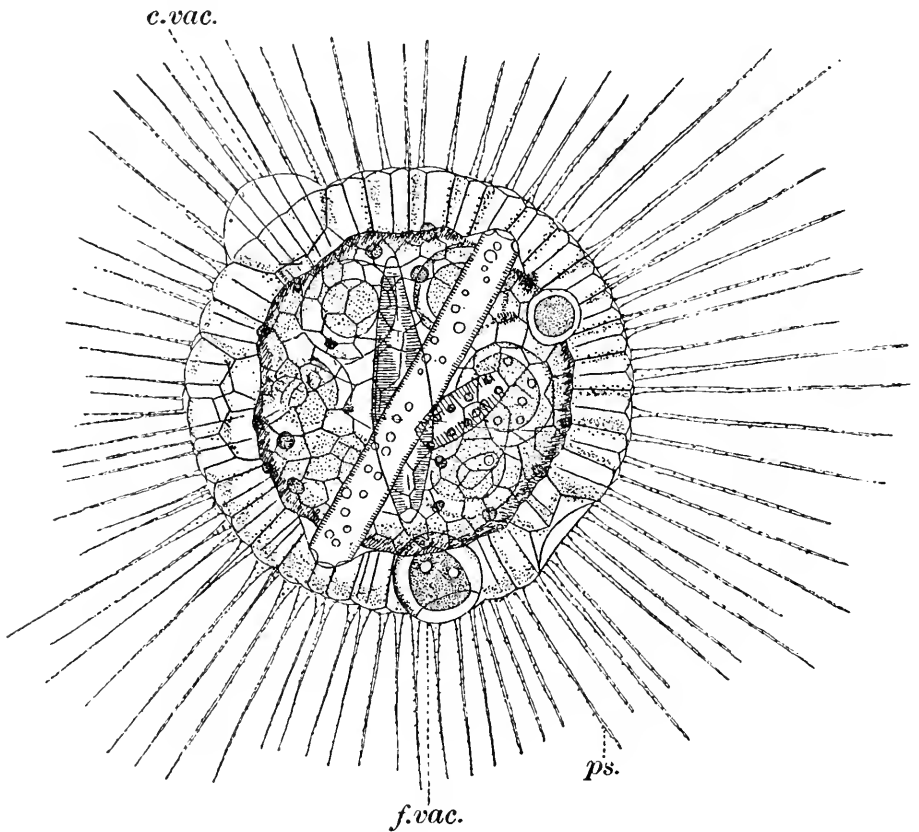

Fig. 33. *Actinosphaerium eichhorni*,  $\times 180$ . From Leidy. The endoplasm is crowded with food vacuoles containing diatoms, and nuclei are represented in the figure by the dark areas. *c.vac.* contractile vacuole; *f.vac.* food vacuole which has just swallowed a rotifer; *ps.* pseudopodia.

saprophytic nutrition possible. Holozoic species must of course have their proper food; in infusions they appear as this becomes plentiful, first, after the bacteria, those whose diet is purely bacterial, such as *Monas* and *Colpoda*, then those, such as *Stylonichia*, that feed upon the first comers, and so on; though some bacterial feeders, as *Paramecium*, are rather late to appear. Temperature has also an influence upon protozoan faunas. The powers, possessed by freshwater protozoa, of distribution across inhospitable regions and of surviving unfavourable

conditions at home are no doubt due to the facility with which they form resistance cysts (p. 22). In various cases all the unsuitable conditions of the environment indicated above have been found to induce encystment, and encysted protozoa have been discovered in dust from the most remote desert regions.

The protozoa which live in dung (*coprozoic* species) and in decaying bodies, and those of very foul waters, are branches of the aquatic fauna: they include many flagellates, *limax* amoebae (p. 69), and ciliates, and the conditions in which they are in the active state may exist only for a very short period. These faunas merge on the one hand into that of intestinal parasites, and on the other into that of damp earth. In the latter there is a large population, some of whose members (*Euglena*, *Arcella*, *Paramecium*, etc.) are of common occurrence elsewhere. It has important effects upon the fertility of the soil, by devouring valuable bacteria. Perhaps the only truly subaerial members of the phylum are certain mycetozoa.

*Parasitic* members are included in nearly all the principal divisions of the phylum, but not in the Radiolaria or Volvocina. The Sporozoa are exclusively parasitic. The relations of parasitic protozoa to their hosts are of all degrees of intimacy: they may be merely epizoid (as *Spirochona*, p. 114), ectoparasitic (as *Oodinium*, p. 55), inhabitants of internal cavities (as *Opalina*, p. 106), tissue parasites (as *Myxobolus*, p. 100), or intracellular (as *Plasmodium*, p. 91). They show, according to their degree of parasitism, the same peculiarities as other parasites—reduction of organs of locomotion, simplicity of form, means of fixation, the liberation of numerous young (in the Sporozoa), etc. Some, as *Entamoeba histolytica*, are harmful by destroying for their own nutriment the tissues of the host: more by secreting poisonous substances, as the malaria parasites do. Many are specific to a particular host or hosts. Not infrequently there are two successive hosts belonging to different phyla: both of these may be invertebrates, as with *Aggregata*, which passes from the crab to the octopus, but more often one is a vertebrate and the other an invertebrate. In such cases it is often possible to decide which was the original host, and this proves sometimes to be the vertebrate and sometimes the inverte-

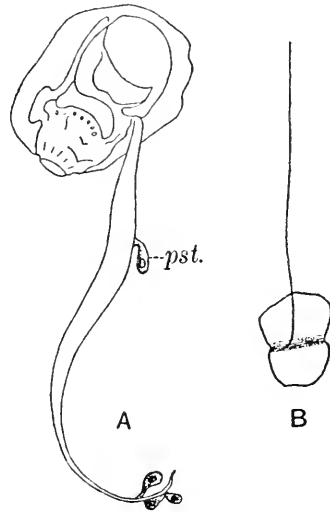

Fig. 34. *Oodinium poucheti*, parasitic on *Oikopleura*. A, An *Oikopleura* bearing the parasites. B, A free spore of the parasite. *pst.* parasite, on the tail of the host. The trunk of the *Oikopleura* is enclosed in the newly-secreted and not yet expanded "house".

brate. It is interesting that the two most dangerous protozoan parasites of Man, the sleeping-sickness and malaria parasites, differ in this way (pp. 63, 91).

*Symbiosis*<sup>1</sup> of various kinds is practised by both holophytic and holozoic protozoa. Instances of this are described below, on pp. 47, 68, 111, 193.

The *division of the phylum* into the four classes, Sarcodina, Mastigophora, Ciliophora, and Sporozoa, characterized by the presence or absence in the predominant phase of the life history of the several types of motile organs, will be familiar to the student. Two attempts have been made to brigade these classes into subphyla. One contrasts the Sarcodina under the name of *Gymnomyxa* with the other classes, or *Corticata*, on the ground that the latter possess a firm ectoplasm. The other contrasts the *Ciliophora* with the rest of the classes (*Plasmodroma*), which lack cilia and a meganucleus. Neither of these systems is satisfactory, for each is probably grounded, not upon a fundamental cleavage of the phylum, but upon the specialization of one branch of it.

The *ancestral group* of the Protozoa is probably the Mastigophora. This is fairly evident as concerns the Sporozoa—a class highly adapted to parasitism, and often possessing a flagellated phase—and the Ciliophora, also a greatly specialized group, which possesses in the cilia organs easy to derive from flagella. The Sarcodina, on the other hand, were formerly held to be ancestral to all protozoa, on account of the supposedly primitive condition of their protoplasm. But neither the structure nor the behaviour of amoeboid organisms is really simple; their holozoic nutrition is a less easy process and is much less likely to be primitive than photosynthesis, which is common in the Mastigophora; the sporadic occurrence of amoeboid forms in various groups of the Mastigophora probably indicates that the latter have more than once given rise to organisms resembling the Sarcodina; and, finally, the Sarcodina very commonly have flagellate young, but the Mastigophora do not have amoeboid young. The Mastigophora, indeed, are probably not only the basal group of the Protozoa but also not far removed from the ancestors of all organisms, for they alone present (and often can alternate) the modes of nutrition both of plants and of animals; and their characteristic organ, the flagellum, occurs in the zoospores of plants, in bacteria, and in the spermatozoa of metazoa.

<sup>1</sup> The term *symbiosis* has been used in various senses. It is here applied to all cases of partnership between two organisms of which one lives within the body of the other and both derive benefit from the association. It is sometimes restricted to cases, such as those described on p. 47, in which the infesting partner is photosynthetic.

The *connection between the Protozoa and the Metazoa* in the family tree of the Animal Kingdom is an interesting but a very obscure problem. Concerning it three theories are held. The first, supported by the morphological resemblance of the uninucleate protozoon to a cell in the body of a metazoon, and of *Volvox* to the blastosphere stage in the development of such a body, holds that the metazoon is a colony of protozoa, each differentiated as a whole for some function in the body which they compose. The second, based on the fact that the protozoon, which performs equally all the processes of life, is thus physiologically equivalent not to one cell but to the whole body of a metazoon, holds that the Metazoa arose from multinucleate protozoa by the nuclei taking in charge each a local, differentiated portion of the cytoplasm. The third, based on the fact that, save for their mode of nutrition, the Metazoa have—in their cellular structure, nuclear division, maturation of gametes, etc.—more in common with multicellular plants than with the Protozoa, holds that the earliest organism we can as yet envisage was multinuclear and photosynthetic, and gave rise independently to the Metazoa and, by reduction of the body, to flagellates, and so to the Protozoa, which on this view are not truly members of the Animal Kingdom.

### Class MASTIGOPHORA (FLAGELLATA)

Protozoa which in the principal phase possess one or more flagella; may be amoeboid, but are usually pelliculate or cuticulate; are often parasitic but rarely intracellular; have no meganucleus; and do not form very large numbers of spores after syngamy.

The *reproduction* of the Mastigophora is in most cases by equal longitudinal fission. The way in which in many of the solitary Volvocina this becomes transverse has been described above (p. 29). In the Dinoflagellata fission is oblique or transverse. The fission may be simply binary or repeated. The number of fissions often varies in the same species, and is usually greater in the formation of gametes than in asexual reproduction. Binary fission in forms which have not a stout cuticle usually occurs in the free-swimming stage, but may take place in a cyst or jelly case, as, for instance, occasionally in *Euglena viridis*. In forms with a stout cuticle, as in the Volvocina, the protoplasm shrinks from the cuticle, which serves as a cyst. Repeated fission usually occurs in a cyst. The fate of the flagella at fission has been dealt with on p. 30. The mitoses (see p. 25) in this group range from beautiful eumitoses to the extremest cryptomitoses, the latter generally in parasitic forms. Paramitosis occurs in the Dinoflagellata.

In many genera *syngamy* is not known to occur. Among those in which it does, all degrees of difference between gametes are found,

and in particular among the Volvocina there are interesting cases intermediate between hologamy and merogamy, and between isogamy and anisogamy. Thus in *Polytoma* the age at which the products of fission unite varies in a species, so that some are merogametes while others, delaying, become hologametes; in *Pandorina* (p. 58) isogamy and anisogamy are facultative; and various species of *Chlamydomonas* (see p. 31) make up a series in which there is a transition from complete isogamy to a pronounced anisogamy which rises to oogamy in *Volvox* and other colonial forms.

The zygote is very commonly encysted.

The Mastigophora fall into a number of fairly well-defined orders. It is convenient to group these by their nutrition into two subclasses—the *Phytomastigina*, containing orders most of whose members are holophytic (see p. 18), and the *Zoomastigina*, which have no holophytic members—but all the orders of the Phytomastigina contain some colourless members, whose nutrition is purely saprophytic, and all except the Volvocina include colourless holozoic forms. Owing to this fact it is impossible to frame a definition which will enable every member of each subclass to be recognized as such without comparison with other species. Certain characteristics, however, distinguish most members of the Zoomastigina from most of the colourless Phytomastigina. These characteristics are stated below, in the section which deals with the Zoomastigina.

#### Subclass *PHYTOMASTIGINA*

Mastigophora which possess chromatophores, and species without chromatophores which closely resemble such forms.

There can be no doubt, for reasons which have been given above, that this subclass contains the most primitive members of the phylum. Its *nutrition* is extraordinarily interesting from that point of view. Some of its species, notably among the Volvocina, are purely holophytic. Others are normally also saprophytic, and some of these, like *Euglena*, can upon occasion practise this mode of nutrition alone. Yet others, like *Polytoma*, have become colourless, and are purely saprophytic. Others again are both holophytic and, by amoeboid ingestion, holozoic. These lead insensibly to similar forms, members of the Zoomastigina (*Monas*, etc.), which, being without chromatophores, have not the faculty of photosynthesis, but are purely animal in their nutrition. Some of the coloured forms which possess a pit that is called a gullet are said to take food with it, and thus to combine holophytic and holozoic nutrition. In any case certain of their relatives which have lost the chromatophores (*Cyathomonas*, *Peranema*, etc.) take solid food through a similar gullet. Most of the holozoic forms



are probably also saprophytic. Certain species (*Ochromonas*, etc.) are known to make use of all three modes of nutrition. Thus all ways of obtaining nutriment meet in this group.

The species which practise photosynthesis do so, like plants, by means of *chromatophores*, of which they may possess one, two, or many. The chromatophores are plate- or cup-shaped masses of protoplasm of a green, yellow, or brownish colour, owing to the presence in various proportions of the pigments chlorophyll, xanthophyll, carotin, etc. The chlorophyll absorbs the rays of sunlight whose energy is used in photosynthesis. The green chromatophores are known as *chloroplasts*, the yellow as *xanthoplasts*. Often there are to be seen in or on the chloroplasts the protein bodies known as *pyrenoids*, which act as centres of starch formation. A red pigment, *haematochrome*, is frequently present, diffused through the cytoplasm. In bright light it spreads over the surface and is believed to shield the chloroplasts from excess of certain rays. A small red spot of carotin, sometimes darkened by another pigment, is generally present in photosynthetic species, and probably acts as a rudimentary eye, making the organism sensitive to light, which is of such importance in its nutrition.

The holophytic forms are usually capable of passing into a *resting phase*, in which the flagella are withdrawn, the body rounded off, a cyst or jelly case secreted, and the organism closely resembles a plant cell. Division may take place in that condition, establishing a pseudo-colonial stage known as the *palmella*, and from this there may be built up a branched body (Fig. 38D, D<sub>1</sub>) which simulates those of the lower algae. Plant-like forms of this kind occur in every order of the group. It is indeed impossible to define the Phytomastigina from the Algae, and the members of this subclass are regarded both by botanists and by zoologists as coming within the scope of their sciences.

Many of the coloured species are liable to produce colourless individuals. This happens in two ways: the chromatophores may become bleached owing to the animal living in darkness; or the rate of division of the chromatophores may lag behind that of the body, so that eventually there are produced offspring in which there are no chromatophores ("apoplastid" individuals). These facts show how the colourless species may have arisen.

Members of various orders of the Phytomastigina (cryptomonads, a chryomonad, a chlamydomonad, and perhaps dinoflagellates) are known to live in the resting stage as symbionts in holozoic organisms (other protozoa, sponges, coelenterates, worms, etc.). Nearly all are yellow or brown (*Zooxanthellae*); most green symbionts (*Zoochlorellae*) are algae belonging to the Protococcaceae. An exception to this is the

chlamydomonad of the genus *Carteria* which lives as a zoochlorella in the tissues of the turbellarian worm *Convoluta roscoffensis* (Figs. 35, 36). The photosynthetic partner in these symbioses benefits by a supply of carbon dioxide and the nitrogenous excreta of its host; the latter has waste matters removed, is supplied with oxygen, and sometimes draws on the supply of carbohydrates manufactured by the guest, though it is rarely, as *Convoluta*, unable to dispense with this nutriment, and often, as the reef corals (p. 193), makes no use of it. If kept in the dark it is apt to devour the guest. A photosynthetic organism is specific to a particular host species. In some cases the two partners are capable of living apart; in others, they are mutually dependent.

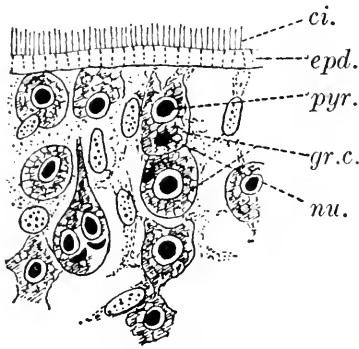

Fig. 35.

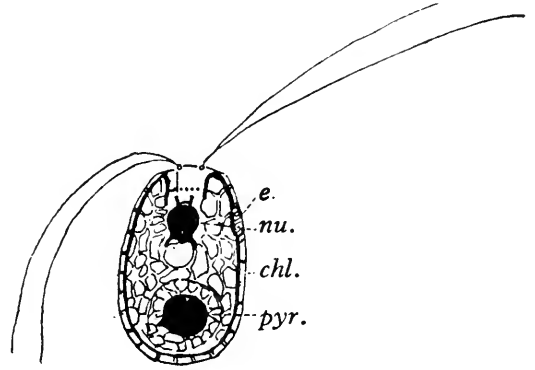

Fig. 36.

Fig. 35. A section through a portion of the superficial tissues of *Convoluta roscoffensis*, showing symbionts belonging to a species of *Carteria* (Chlamydomonadidae, Volvocina). From Keeble. *ci.* cilia of epidermis; *epd.* epidermis; *gr.c.* "green cells" (symbionts); *nu.* nucleus of symbiont; *pyr.* pyrenoid.

Fig. 36. A free individual of the species of *Carteria* which is symbiotic in the resting stage with *Convoluta roscoffensis*. From Keeble. *chl.* chloroplast; *e.* eye-spot; *nu.* nucleus; *pyr.* pyrenoid.

The plant organism usually enters the host by being ingested but not digested. It may be passed on from one generation to the next in asexual reproduction or even, as with the green *Hydra*, in the ovum, but is often lost in the gametes of its host, so that the zygote must be reinfected. Protozoan hosts in symbiosis are usually members of the Radiolaria (Figs. 32A, 37, 69A) or Foraminifera, but various ciliates, *Noctiluca*, etc., also harbour holophytic symbionts. Zooxanthellae are commonest in marine hosts, zoochloellae in fresh water.

The amoeboid faculty possessed by some members of the group may be limited to ingestion, but is often exhibited also in locomotion. Certain forms with such locomotion lose their flagella for shorter or longer periods: some may have done so altogether. When species with

amoeboid movement become colourless they are only to be separated from the Sarcodina by certain features (of their nuclei, cysts, swarm spores, etc.) which prove them to be related to various mastigophora.

Of the orders of the *Phytomastigina*, that which contains the most highly organized members is the large and protean group *Dinoflagellata*, characterized by the possession of two flagella, one longitudinally directed and the other transverse, usually in a groove around the body but in a few cases twisted about the base of the longitudinal flagellum. Three of the remaining orders differ from the rest in the possession, in the anterior part of the body, of a pit ("gullet") or groove, from which the flagella usually arise. One of these, the *Cryptomonadina*, has simple contractile vacuoles and its carbohydrate reserves are of starch: it is held by

some authorities to be related to the ancestors of the dinoflagellates. The second, the *Euglenoidina*, has a more complex contractile vacuole system, and its reserves are of paramylum. The third is the little group *Chloromonadina*, which differs from the *Euglenoidina* in having oil reserves only and in the delicacy of its pellicle. The orders without groove or gullet are the *Volvocina*, the most plant-like of the Mastigophora, with green chromatophores (except in a few colourless genera) and starch reserves; and the *Chrysomonadina*, by some regarded as the most primitive members of the class, which have yellow or brown chromatophores and no starch reserves and are often capable of becoming amoeboid.

Each of these groups exhibits most or all of the varieties of nutrition and motility which have been mentioned above. Each of them possesses (a) coloured, flagellate, solitary forms which constitute most of its membership, (b) coloured species, whose individuals pass most of their time in a non-flagellate condition, as a palmella, which is sometimes of branched, plant-like form, (c) colourless saprophytic forms, and (d), except in the *Volvocina*, colourless holozoic forms. More than one order has purely amoeboid members, non-flagellate throughout the greater part or all of their existence. The support which this versatility gives to the view that the Mastigophora, and in particular the *Phytomonadina*, are near the base of the genealogical tree of organisms has already been mentioned.

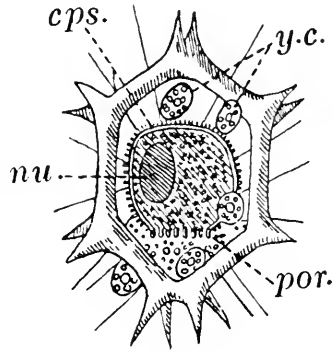

Fig. 37. *Lithocircus annularis*. After Lankester. *cps.* central capsule; *nu.* nucleus; *por.* pore plate; *y.c.* "yellow cells".

## Order CHRYSOMONADINA

Yellow, brown, or colourless phytomastigina; without starch reserves, but usually with leucosin and oil; without gullet or transverse groove; often amoeboid.

The genera briefly mentioned under this and the following orders illustrate the range of variety within the group.

*Chrysamoeba* (Fig. 38A, A<sub>1</sub>). One flagellum; two yellow chromatophores; no skeleton. Egg-shaped when swimming, but on the substratum becomes amoeboid and may lose flagellum. Ingests food by pseudopodia. In fresh waters.

*Ochromonas* (Fig. 38B). As *Chrysamoeba*, but with two unequal flagella; and usually one chromatophore.

*Dinobryon* (Fig. 38C). Two unequal flagella; two yellow chromatophores. Secretes a flask-shaped house, which in some species adheres to those of other individuals to form a pseudocolony. In fresh waters.

*Hydrurus* (Fig. 38D–D<sub>2</sub>). One flagellum; one chromatophore. Passes most of its life in the resting stage, which by division forms a plant-like growth (see p. 47). In fresh waters.

*Rhizochrysis*. Flagella normally lacking; one chromatophore; body naked and permanently amoeboid.

*Leucochrysis*. As *Rhizochrysis*, but colourless.

*Silicoflagellata* (or *Silicoflagellidae*). One flagellum; numerous yellow chromatophores; a lattice-work case of hollow, siliceous bars. Marine, planktonic, e.g. *Distephanus* (Fig. 38F).

*Coccolithophoridae*. One or two equal flagella; two chromatophores (sometimes green); a case composed of calcareous plates (*coccoliths*) or rods (*rhabdoliths*) enclosing the body. Marine, planktonic, e.g. *Syracosphaera* (Fig. 38E).

## Order CRYPTOMONADINA

Green, yellow, brown, or colourless phytomastigina; with starch (and occasionally also oil) reserves; with gullet or with longitudinal groove, without transverse groove; very rarely amoeboid.

Many of the yellow members of this group live in the resting stage as symbionts in other organisms.<sup>1</sup>

*Cryptomonas* (Fig. 39A). Two flagella; two chromatophores, usually green; a gullet. Marine and in fresh waters.

<sup>1</sup> Owing to certain features of their nucleus and its mode of division these symbionts have been held to be related to the Dinoflagellata. Their other features, however, are those of the Cryptomonadina.

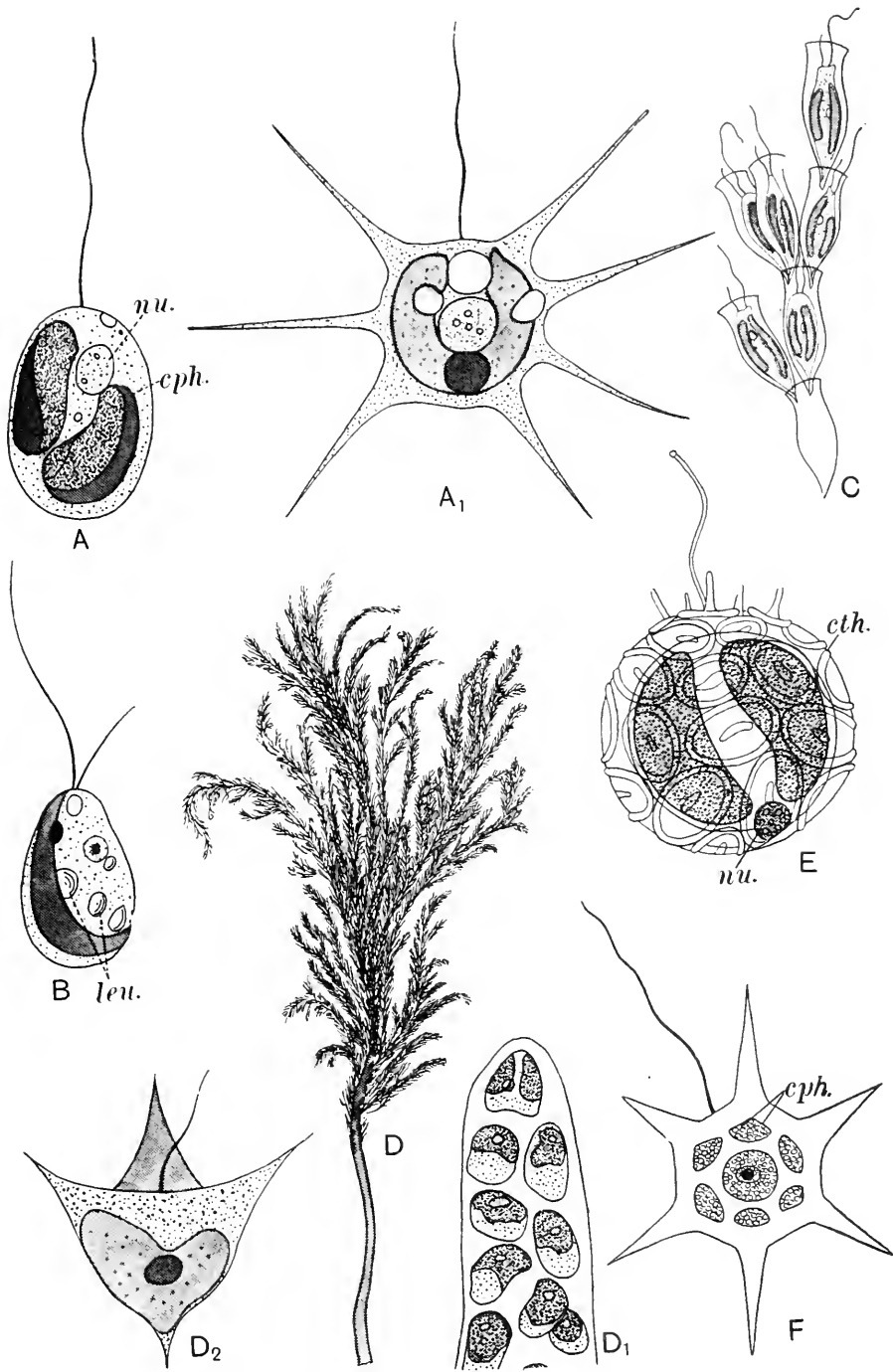

Fig. 38. Chryomonadina. A, *Chryamoeba radians* in the flagellate phase,  $\times 1250$ . A<sub>1</sub>, The same in the amoeboid phase. B, *Ochromonas* sp.,  $\times 1100$ . C, *Dinobryon sertularia*,  $\times 750$ . D, "Plant" of *Hydrurus*. D<sub>1</sub>, Tip of a branch of the same. D<sub>2</sub>, Flagellate stage ("swarmer") of *Hydrurus*. E, *Syracosphaera pulchra*,  $\times 2000$ . F, *Distephanus speculum*,  $\times 800$ . After various authors, with modifications. *cph.* chromatophore; *cth.* coccolith; *leu.* leucosin; *nu.* nucleus.

*Chrysidella* (Fig. 39B). Two flagella; two yellow chromatophores; a groove anteriorly. Symbiotic in foraminifera, radiolarians, etc.

*Cyathomonas* (Fig. 39C). Two flagella; chromatophores absent. Holozoic, seizing food by trichocysts in the gullet. In fresh waters.

*Chilomonas*. Two flagella; chromatophores absent; gullet very deep and narrow. Saprophytic. In foul fresh waters.

*Phaeococcus*. Normally in the palmella phase. Marine and in fresh waters.

#### Order EUGLENOIDINA

Phytomastigina which have numerous green chromatophores or are colourless; with reserves of paramylum and sometimes also oil; with gullet; with contractile vacuole opening by a "reservoir", usually into the gullet; without transverse groove; with stout pellicle, usually with metaboly ("euglenoid movement").

*Euglena* (Fig. 39D, D'). A typical member of the group, with chromatophores; one flagellum, arising from the bottom of the gullet, double at base, and connected by two rhizoplasts to a basal granule behind the nucleus; pyrenoids present only in a few species; paramylum reserves; and contractile vacuole fed by accessory vacuoles. The nutrition is interesting. Most species, at least, can live and multiply, with purely holophytic nutrition. All, however, flourish better if traces of aminoacids be present. If the medium be rich in organic substances, the use which is made of these varies with the species. Most, including *E. viridis*, can take in organic combination nitrogen, but not carbon; a minority, including *E. gracilis*, can also obtain carbon in that way. In the dark, if suitable compounds, especially peptones, be present, the latter set of species bleach and live as saprophytes. It has not been established that *Euglena* uses its gullet to take solid food. Fresh waters, and infusions.

*Peranema* (Figs. 11, 39E). Without chromatophores; gullet supported by rods and can open or close. Saprophytic and holozoic. Paramylum reserves formed. In infusions.

*Copromonas* (= *Scytomonas*, Fig. 39F, F'). Without chromatophores; body pear-shaped; no metaboly; gullet long and narrow. Nutrition holozoic, chiefly by bacteria. Coprozoic in dung of frogs. After some days of binary fission syngamy takes place between ordinary individuals (hologamy), the nuclei first throwing out two "polar bodies". Some zygotes encyst; others continue to divide. Finally all encyst. The cysts are washed away and swallowed by a frog or toad with its food. They pass uninjured through the gut and hatch in the moist faeces, where alone the active stage exists.

*Colacium*. Normally in the palmella phase, forming branched, plant-like growths.

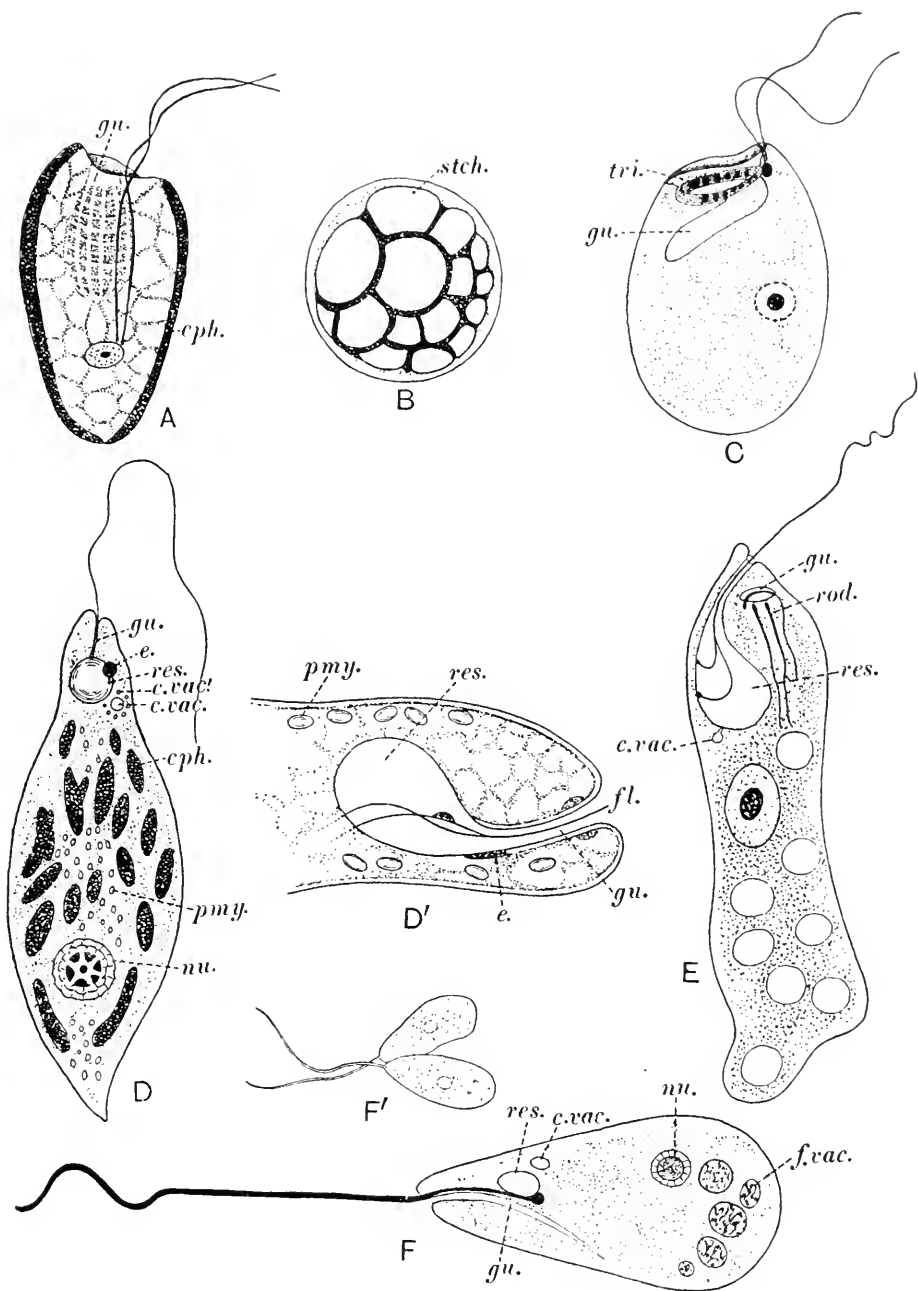

Fig. 39. Cryptomonadina and Euglenoidina. A, *Cryptomonas ovata*,  $\times 900$ . B, *Chrysidella schaudinni*, in the resting stage. C, *Cyathomonas truncata*,  $\times 1000$ . D, *Euglena viridis*,  $\times 400$ . D', A longitudinal section of the anterior end of the same, more highly magnified. E, *Peranema trichophorum*,  $\times 850$ . F, *Copromonas subtilis*,  $\times$  about 1700. F', A pair of the same, beginning to conjugate, less highly magnified. After various authors, with modifications. *c.vac.* contractile vacuole; *c.vac.'* accessory contractile vacuole; *cph.* chromatophore; *e.* eye-spot; *f.vac.* food vacuole; *fl.* flagellum; *gu.* gullet; *nu.* nucleus; *pmy.* paramylum grains; *res.* reservoir; *rod.* stiffening rods of gullet; *stch.* starch grains; *tri.* trichocysts.

## Order CHLOROMONADINA

Phytomastigina which have numerous green chromatophores or are colourless; with reserves of oil; gullet; and complex contractile vacuole; without transverse groove; possessing a delicate pellicle, or amoeboid.

*Vacuolaria*. Typical, bright green members of the group, which pass much of the life history in the palmella stage. In fresh waters.

## Order DINOFLAGELLATA

Phytomastigina which have numerous yellow, brown, or green chromatophores or are colourless; with reserves of starch or oil or both; with complex vacuole system; with two flagella, one directed backwards and usually in a longitudinal groove (*sulcus*) and the other transverse, usually in a more or less spiral groove (*annulus*); usually with an armour of cellulose plates, but sometimes amoeboid.

The complex *vacuoles* of dinoflagellates are not, as was held, contractile, but contain water driven into them through their external pores by the action of the flagella. Their function is unknown. Possibly they are hydrostatic, or alimentary, or both.

The plane of *fission* is oblique, but resembles the longitudinal fission of other Mastigophora in passing between the two flagella. Fission may be within or without a cyst: in either case it may be simply binary or repeated; within a cyst it is sometimes multiple. The products of repeated binary fission of pelagic forms sometimes hang together for a considerable time as a chain. The occurrence of *syngamy* is suspected but has not yet been proved beyond doubt.

The typical members of this order are free-living and highly organized, but it includes forms which are greatly degenerate and only recognizable as belonging to it while they are spores. The members may be holophytic, saprophytic, or holozoic, feeding in the latter case by pseudopodia either from a spot on the sulcus or at any point. They are usually pelagic, sometimes parasitic, and for the most part marine.

*Ceratium* (Fig. 40A). Typical, armoured, holophytic species; with three long spines. In freshwater forms the chromatophores are green; in marine species they are yellow or brown.

*Dinophysinae*. Pelagic genera, often of bizarre form, with the annulus at one end of the body, and the shell in two lateral plates.

*Polykrikos* (Fig. 40B). Soft-bodied species; colourless and holozoic; with the flagella and other external features repeated several times along the axis of the body, and the nucleus also repeated, but not in correspondence with the other features (see p. 10). The protoplasm contains peculiar nematocyst-like organs. Holozoic.



*Oodinium* (Fig. 34). Thin-cuticled; pear-shaped; colourless; living as an ectoparasite on marine pelagic animals, and possessing the typical dinoflagellate organization only in the spore stage.

*Dinamoebidium*. Colourless and holozoic; completely *Amoeba*-like in the ordinary phase, but forming dinoflagellate swarm spores in a fusiform cyst.

*Noctiluca* (Fig. 41). (Formerly placed in an independent order—*Cystoflagellata*.) Large, peach-shaped forms; colourless and holozoic; with highly vacuolated protoplasm; a stout pellicle; and, in

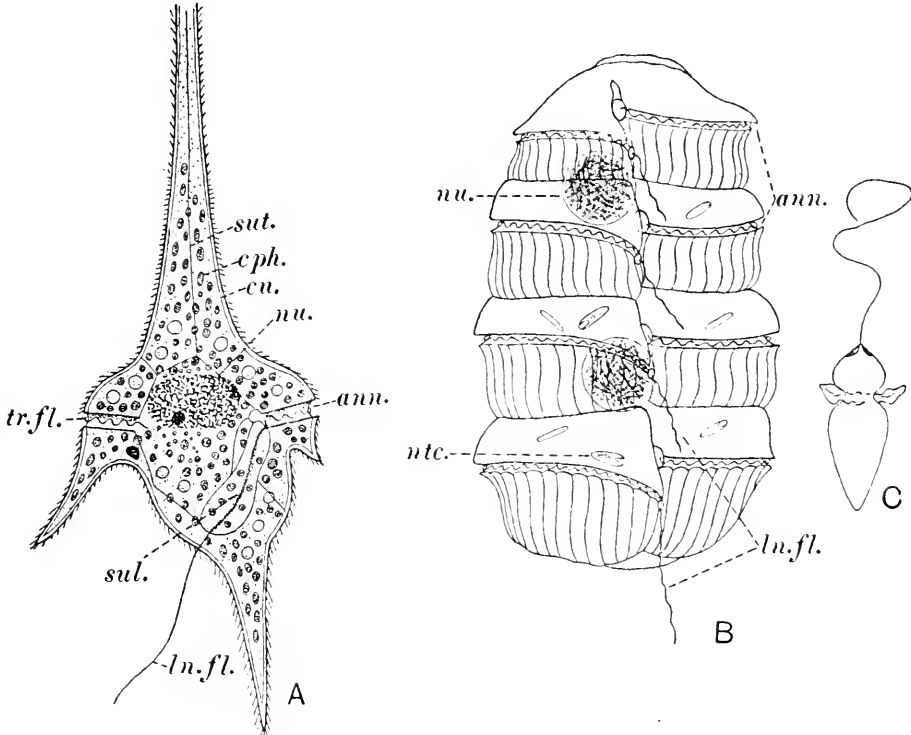

Fig. 40. Dinoflagellata. A, *Ceratium macroceras*,  $\times$  about 300. B, *Polykrikos schwarzi*,  $\times$  250. C, A discharged "nematocyst" of *Polykrikos*. After various authors, with modifications. *ann.* annuli; *cph.* chromatophore; *cu.* cuticle; *ln.fl.* longitudinal flagellum; *ntc.* "nematocyst"; *nu.* nucleus; *sul.* sulcus; *sut.* suture between plates of cuticle; *tr.fl.* transverse flagellum.

the groove of the peach, an elongate mouth, a small flagellum, a structure known as the tooth which is said to represent the transverse flagellum, and a strong tentacle, homologous with a similar structure in certain more normal dinoflagellates. *Noctiluca* is phosphorescent. Like other dinoflagellates it reproduces by binary fission and by spore formation after multiple fission. The spores are more dinoflagellate-like than the adult. Marine, pelagic.

*Dinothrix*. Normally in the palmella phase, forming thread-like growths. Marine.

## Order VOLVOCINA

Phytomastigina which have usually a flask-shaped, green chromatophore, with one or more pyrenoids, but are sometimes colourless, though never holozoic; form starch reserves, even when colourless; have no gullet or transverse groove; possess usually a cellulose cuticle and often haematochrome; and regularly undergo syngamy.

Of all the Mastigophora, the members of this order most closely resemble the typical plants.

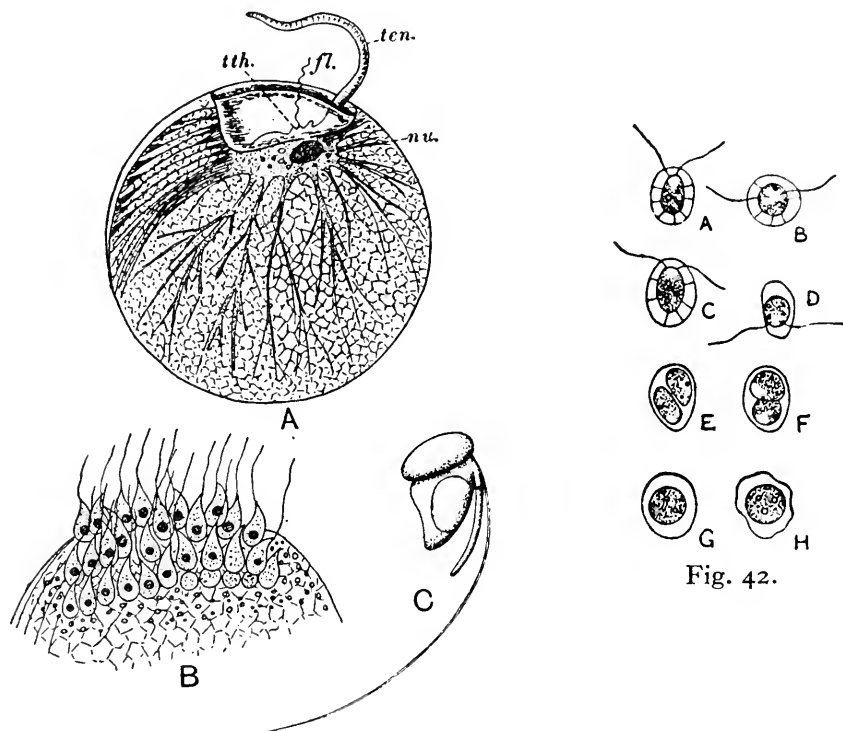

Fig. 41.

Fig. 41. *Noctiluca*,  $\times 65$ . A, Ordinary individual. B, Spore formation. C, A spore. After various authors, with modifications. *fl.* flagellum; *nu.* nucleus; *ten.* tentacle; *tth.* tooth.

Fig. 42. *Haematococcus lacustris*,  $\times 475$ . After West. A-C, Individuals in ordinary phase, showing strands of protoplasm from body to cuticle. D-F, Successive stages in fission. G, H, Individuals in resting phase.

*Chlamydomonas* (Figs. 23, 25). Typical solitary members of the order, with two flagella; an eye-spot; a close-fitting cellulose cuticle; and one pyrenoid. The various species exhibit isogamy, anisogamy, and intermediate conditions (see p. 31). In fresh waters.

*Polytoma* (Fig. 24). A colourless *Chlamydomonas*; retaining the eye-spot (usually) and the habit of starch formation; but with the

cuticle composed of some substance which does not give the cellulose reaction. Nutrition saprophytic by means of simple substances (fatty acids, aminoacids, etc.). Syngamy is facultatively hologamy or merogamy, isogamous or anisogamous, according to the age of the gametes. In infusions of decaying animal substances.

*Carteria* (Figs. 35, 36). Differs from *Chlamydomonas* in having four flagella. It is probably a species of this genus that is symbiotic in the turbellarian *Convoluta roscoffensis*.

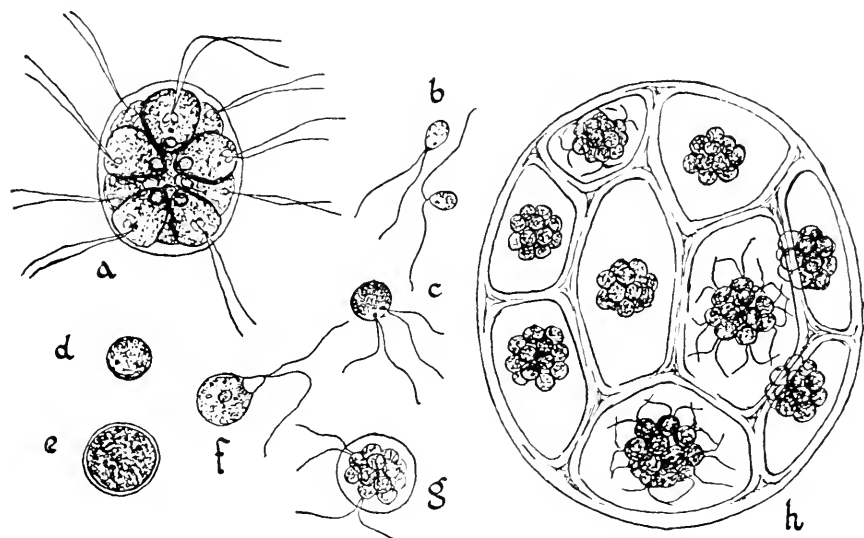

Fig. 43. *Pandorina*. From Godwin. *a*, The adult colony of sixteen similar flagellated zooids,  $\times 200$ . *h*, A colony undergoing asexual reproduction,  $\times 450$ —each zooid has divided to form a daughter colony which still remains within the parent body. Some of the colonies have already produced flagella, and will shortly break out of the wall which enclosed the parent. *b-g*, Stages in sexual reproduction—*b*, Motile gametes. *c*, Stage immediately after fusion of two gametes. *d*, Later stage showing flagella withdrawn. *e*, Later stage showing resting zygote with thickened wall. *f*, Motile individual produced by the zygote on germination. *g*, New colony produced by vegetative division of the motile individual.

*Haematococcus* (= *Sphaerella*, Fig. 42). Differs from *Chlamydomonas* in that there is a wide space, traversed by protoplasmic threads, between body and cuticle; several pyrenoids. Much haematochrome is often present. Isogamous. Common in collections of rainwater.

*Pandorina* (Fig. 43). Spherical, free-swimming colonies of 16 or 32 green pear-shaped zooids, each with the organization of the solitary members of the order, closely pressed together with the narrow end inwards and the flagella outwards. An additional cellulose envelope containing mucilage encloses the whole colony. The colonies are reproduced in two ways: (1) asexually, by the repeated fission of each

zooid to form a group of 16 like the parent colony, the dissolution of the colonial and zooid envelopes, and the setting free of 16 young colonies; (2) sexually, by the division of each zooid and the setting free of its products as gametes which, except in size, resemble ordinary zooids. Since the number of fissions in the formation of gametes differs in different colonies, the gametes differ in size. They unite indifferently, so that some of the unions are isogamous, though most are anisogamous. The zygote, after a period of encystment, becomes a free flagellate and divides to form a colony. In fresh waters.

*Eudorina* (Fig. 3 *a*). Colonies which differ from those of *Pandorina* in that: (*a*) the zooids are spaced on the inside of the common envelope, though connected by strands of protoplasm; (*b*) the sexual reproduction is strongly anisogamous, since in some colonies the zooids do not divide but, becoming somewhat larger, act as macrogametes, while in others each zooid divides into a bundle of 16–64 slender individuals (microgametes), which are set free and fertilize the individuals of a macrogamete (female) colony.

*Pleodorina* (Fig. 3 *b, c*). Rather larger colonies which differ from those of *Eudorina* in that some of the zooids do not perform reproduction. These zooids, which are smaller than the rest, are termed "somatic".

*Volvox* (Figs. 44–46). Large, subspherical colonies resembling in general features those of *Pleodorina* but with smaller and more numerous zooids, of which a much smaller proportion is reproductive. Those zooids which perform asexual reproduction are known as *parthenogonidia*: the plates of young zooids which arise by their radial fission, curving into spheres to form the new colonies, bulge into the hollow of the parent colony, where they remain for a time before they are set free. The clusters (*antheridia*) of microgametes arise in the same way. In some species the microgametes are considerably modified, being pale, very slender, and bearing their flagella in the middle of their length. Male, female, and asexual reproductive zooids may be found in any combination in a colony. Details of the structure of the colonies are shown in Figs. 45, 46.

### Subclass ZOOMASTIGINA

Mastigophora which do not possess chromatophores and are not otherwise practically identical with coloured forms.

By one or more of the following peculiarities of the Zoomastigina most members of the group are distinguished from most colourless members of the Phytomastigina.

1. The Zoomastigina never have starch or other amyloid reserves.

2. They often have more than two flagella. This is very rare in the Phytomastigina.

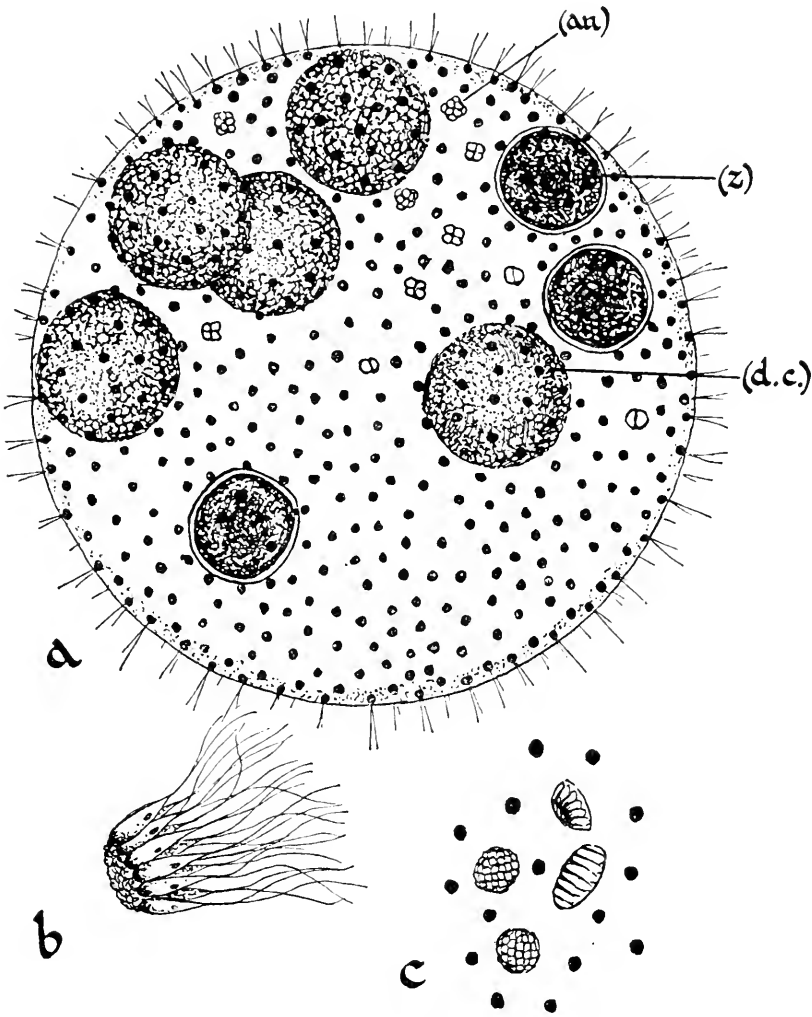

Fig. 44. *Volvox aureus*. After Klein. *a* ( $\times 180$ ), A medium-sized colony showing as round black dots the numerous "somatic cells" of which it is made up; the protoplasmic connections between them, and the cell-walls, can only be made visible by staining. The colony contains three types of reproductive units: daughter colonies (*d.c.*) produced asexually by division of a single zooid; ripe macrogametes or young zygotes (*z*); and young "antheridia" (*an*) whose contents are dividing up and will eventually form microgametes. *b*, A colony of microgametes which has just escaped from the antheridium. *c*, Mature antheridia as seen in surface view of a colony; in two the microgametes are seen sideways, and in two endways.

3. With a single exception,<sup>1</sup> it has not yet been established that syngamy occurs in any of them.

4. Many of their parasitic members possess parabasal bodies.

<sup>1</sup> *Helkesimastix*, a coprozoic member of the Protomonadina, performs hologamy.

## Order RHIZOMASTIGINA

Zoomastigina with one or two flagella, and the whole surface of the body permanently amoeboid.

*Mastigamoeba* (Fig. 47A). One flagellum; numerous, finger-like pseudopodia. In fresh waters.

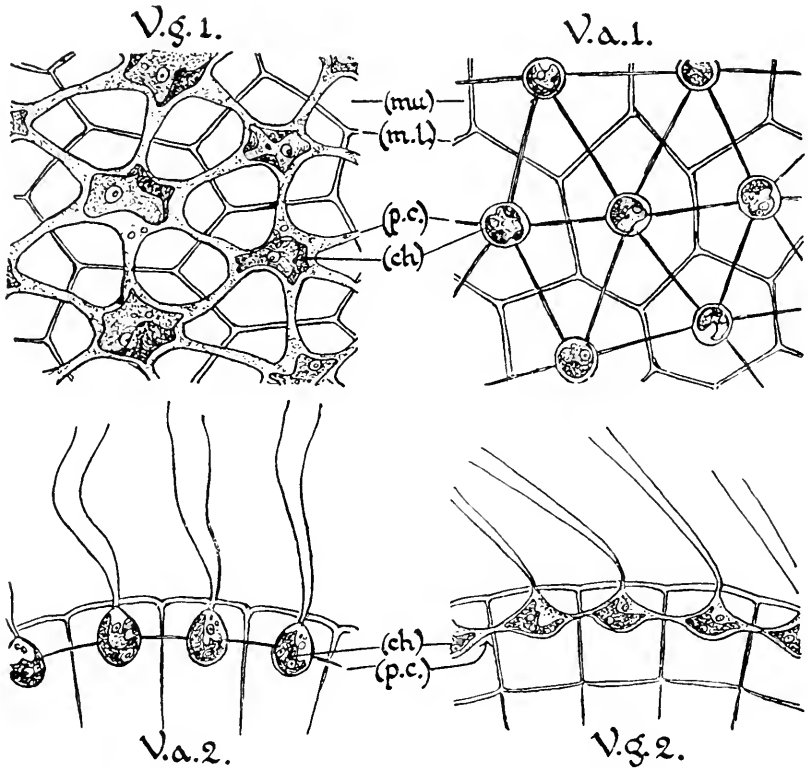

Fig. 45. Diagrams to show the structure of the colony of two species of *Volvox*. After Janet. *V.a.1.* Surface view of a small part of the colony of *V. aureus*. *V.a.2.* Section through a similar region. *V.g.1.* and *V.g.2.* show *V. globator* in the same way. The zooids are very different in shape in the two species, but in both they have been separated by the formation of mucilage (*mu*) by the cell-walls; the unaltered middle layer of the walls (*m.l.*) is still visible. Protoplasmic strands (*p.c.*), fine in the one species and thick in the other, connect the zooids. Each zooid, with its curved chloroplast (*ch*) often containing more than one pyrenoid, its eye-spot, and two flagella, has the structure of a *Haematococcus*.

## Order HOLOMASTIGINA

Zoomastigina with numerous flagella, and the whole surface of the body capable of amoeboid action.

*Multicilia*. Spherical, with 40 or 50 flagella scattered evenly over the whole surface, at any point on which food can be ingested by amoeboid action. A marine species with one nucleus; freshwater species multinucleate.

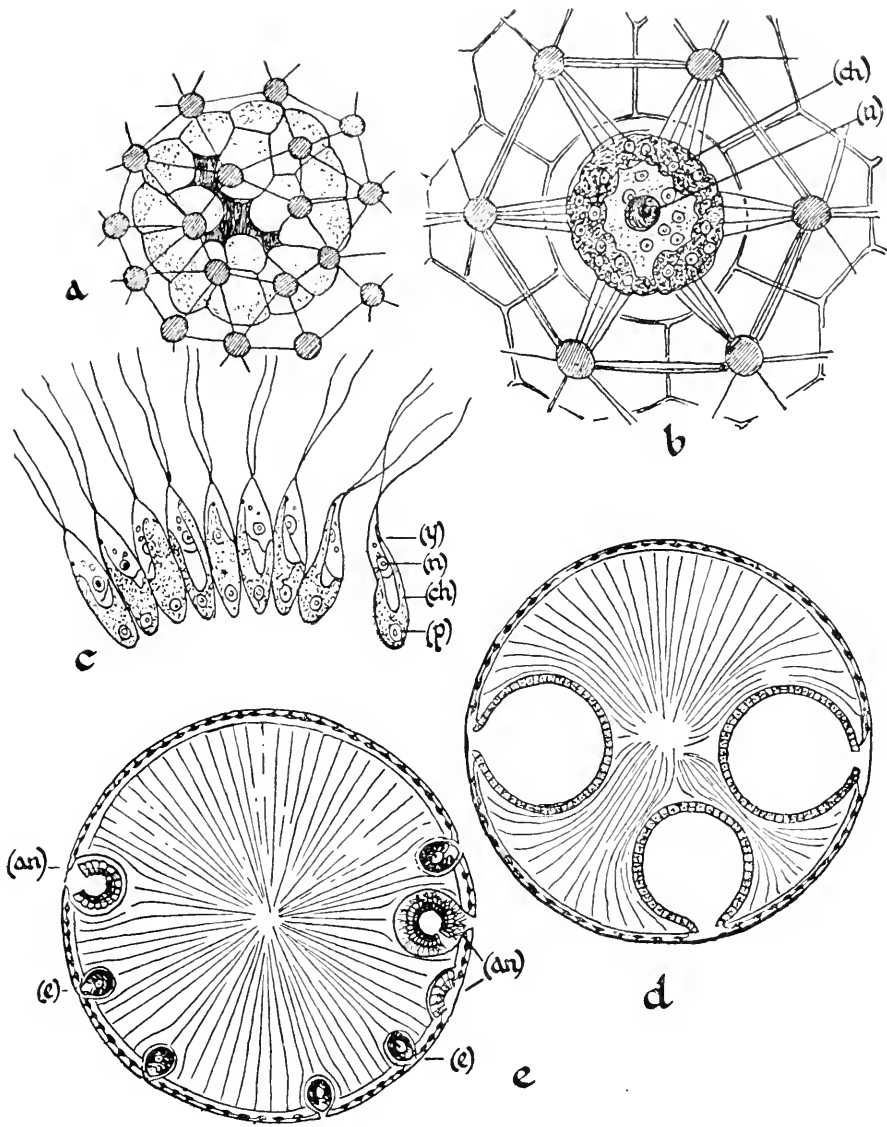

Fig. 46. *Volvox*. After Janet and Klein. *a*, *V. aureus*, a daughter colony of small size seen through the layer of zooids of the parent colony; the opening left in the young colony at its formation is shaded. *b*, *V. aureus*, a single macrogamete among the ordinary somatic zooids; abundant protoplasmic filaments connect it with surrounding zooids and it contains large nucleus (*a*) and chloroplast (*ch*). *c*, *V. aureus*, a plate of mature microgametes just liberated from an antheridium and now beginning to separate. Each contains nucleus (*n*), eye-spot (*y*), flagella, a chloroplast (*ch*), and pyrenoid (*p*). *d*, *V. globator*, diagrammatic section through the middle of an old colony showing three large daughter colonies projecting into the interior of the parent colony which is full of thin mucilage with a radiating structure. *e*, *V. globator*, similar section to *d*, showing three antheridia (*an*) in different stages of maturity and three large macrogametes (*e*). Both types of organ have been formed from a single zooid of the parent sphere into the interior of which they now project. In *d* and *e*, the flagella of the somatic zooids have been omitted.

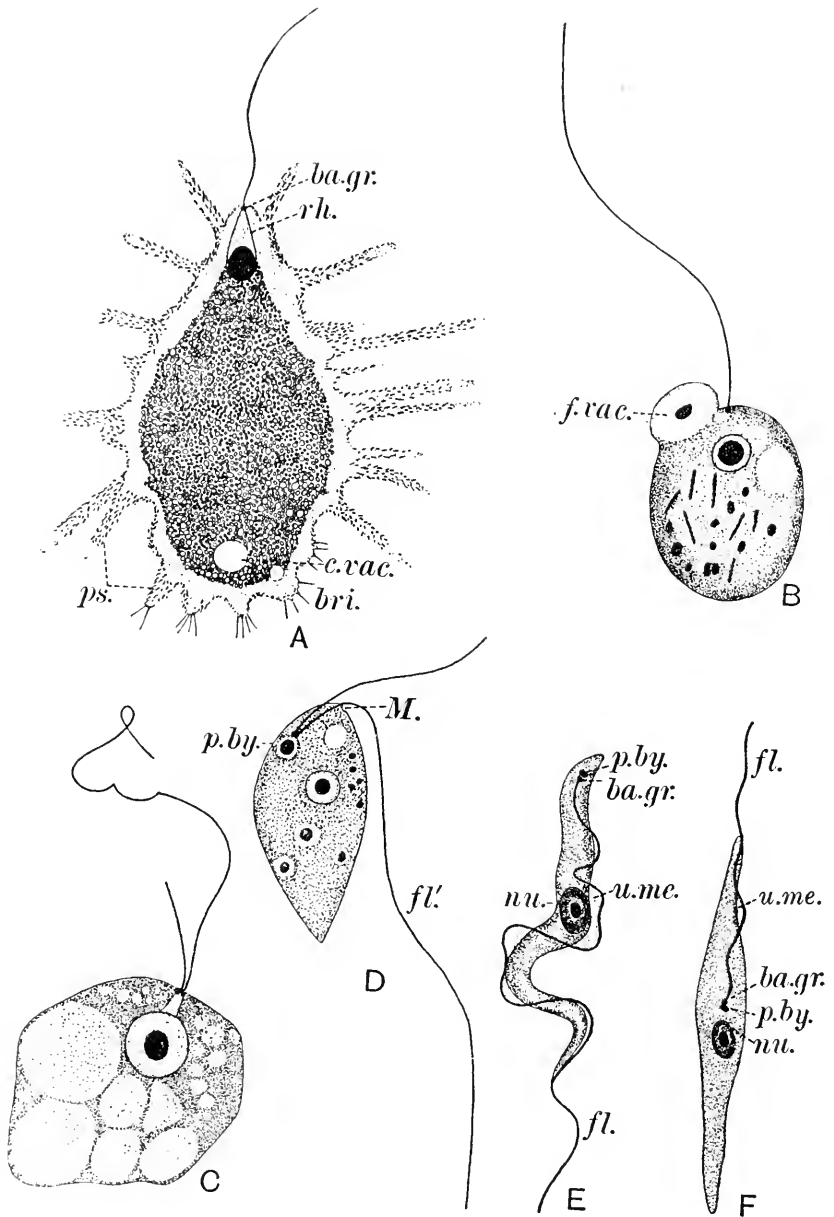

Fig. 47. Zoomastigina. A, *Mastigamoeba aspera*,  $\times$  about 300. B, *Oikomonas termo*,  $\times$  2000. C, *Monas vulgaris*,  $\times$  2000. D, *Bodo saltans*,  $\times$  2000. E, *Trypanosoma brucei*,  $\times$  2800. F, *Crithidia* sp.,  $\times$  2300. After various authors, with modifications. *ba.gr.* basal granules of flagella; *bri.* bristle-like processes borne by the surface of the protoplasm; *c.vac.* contractile vacuole; *f.vac.* food vacuole; *fl.* flagellum; *fl.'* trailing flagellum; *M.* position of mouth-spot; *nu.* nucleus; *p.by.* parabasal body; *ps.* pseudopodium; *rh.* rhizoplast; *u.me.* undulating membrane.



## Order PROTOMONADINA

Zoomastigina with one or two flagella; amoeboid movement, if present, not active over the whole surface of the body; and no extra-nuclear division centre.

*Monas* (Fig. 47C). Two unequal flagella. Ingestion at base of flagella. Except for absence of chromatophores much resembles *Ochromonas* among the Phytomastigina and is probably related to that genus. In fresh waters and infusions.

*Bodo* (Fig. 47D). Two rather unequal flagella, of which one trails freely behind and is used for temporary anchoring. Ingestion at a spot near the base of the flagella. In infusions and coprozoic.

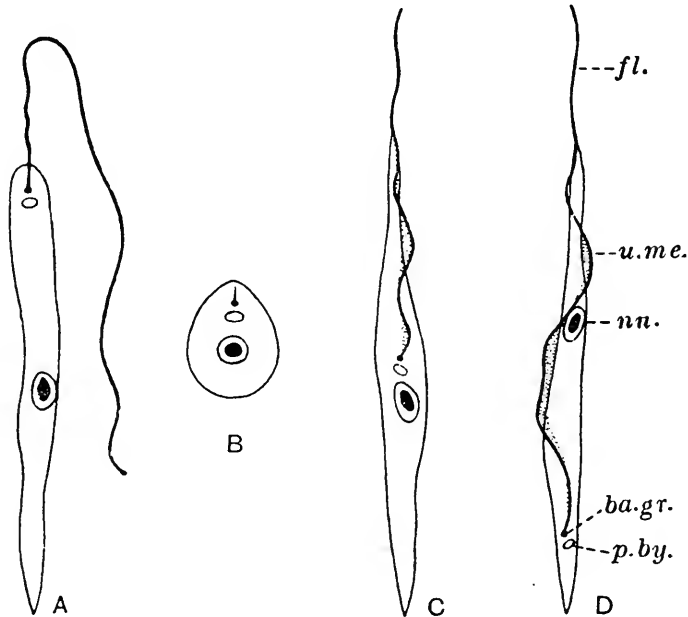

Fig. 48. A diagrammatic comparison of various Trypanosomidae. A, *Herpetomonas*. B, *Leishmania*. C, *Crithidia*. D, *Trypanosoma*. *ba.gr.* basal granule; *fl.* flagellum; *nu.* nucleus; *p.by.* parabasal body; *u.me.* undulating membrane.

*Oikomonas* (Fig. 47B). One flagellum. Ingestion of food as in *Monas*. This genus bears the same relation to certain uniflagellate Chrysomonadina that *Monas* bears to *Ochromonas*. In fresh waters and soil.

*Trypanosomidae* (Fig. 48). Parasites, with one flagellum; a slender, usually pointed shape; a strong pellicle without ingestion spot; a parabasal body; and no contractile vacuole. This family, which contains many dangerous parasites of man and domestic animals, appears to have originally infested invertebrates and to have obtained access

to vertebrates owing to the latter being subject to attack by the original hosts. The original mode of infection was by faeces. The species of each genus assume, in certain circumstances, the forms characteristic of other genera. The following are the principal genera.

*Herpetomonas* (= *Leptomonas*). Basal granule and parabasal body at one end, near the origin of the flagellum. Parasitic in the gut, principally of insects, but also of other invertebrates and of reptiles.

*Leishmania*. Oval bodies containing a nucleus, parabasal body, basal granule and rhizoplast, but with no flagellum, infesting the tissues of vertebrates, and transferred by flies of the genus *Phlebotomus*, in whose gut they assume the form of *Herpetomonas*. In Man they cause kala-azar and Oriental sore.

*Crithidia* (Fig. 47F). Flagellum starts from a basal granule near the middle of the long, slender body, to which the flagellum is united by an undulating membrane; parabasal body placed between the basal granule and the nucleus. Parasitic in the gut of insects.

*Trypanosoma* (Fig. 47E). As *Crithidia*, but the basal granule of the undulating membrane and the parabasal body are beyond the nucleus, towards the non-flagellate end. Many species, all parasitic in the blood and other fluids of vertebrates, and nearly all (not *T. equiperdum*) distributed by a second, invertebrate, host, which is usually an insect for terrestrial species and a leech for aquatic species. In the invertebrate the trypanosome passes for a time into a condition in which it resembles *Crithidia*, and during which it is incapable of reinfesting the vertebrate. Reinfection is in some species (e.g. *T. lewisi* in the rat, transmitted by a flea) by the invertebrate or its faeces being swallowed by the vertebrate; this is probably the original mode of obtaining entry to the vertebrate host. Other species (e.g. *T. gambiense*, transmitted by a tsetse fly) are reintroduced to the vertebrate by the bite of the invertebrate. *T. equiperdum*, parasitic in horses, in which it is the cause of "dourine", is transmitted by coitus and has dispensed with the invertebrate host.

Most, if not all, of the pathogenic species have a wild host with which they are in equilibrium and in which they are non-pathogenic. *T. lewisi*, non-pathogenic in the blood of the rat, has a period of intracellular multiple fission in the stomach of the flea and then passes into the rectum of the latter, where it changes from the crithidial to the trypanosome form and becomes capable of reinfesting the vertebrate, which it accomplishes in the manner mentioned above. *T. cruzi*, the cause of Chagas' disease in Man in South America, is non-pathogenic in the armadillo. It is transmitted by the bug *Triatoma*, in which it probably has an intracellular stage, and becomes infective in the faeces. In the vertebrate host, it passes most of its time, and reproduces, as a *Leishmania* form, in the tissues. *T. gambiense* and *T. rhodesiense*,

causes of sleeping sickness in man when they have passed into the cerebrospinal fluid, and *T. brucei*, the cause of African cattle sickness, are non-pathogenic in antelopes. Their crithidial stage is passed in the salivary glands of the tsetse (*Glossina*), reproduces by binary fission, and is not intracellular. They are transmitted to the vertebrate host by the bite of the fly.

*Choanoflagellata* (or *Choanoflagellidae*). Uniflagellate, generally fixed, forms; with a protoplasmic collar around the base of the flagellum. Ingestion by attraction of particles by the flagellum to the outside of the collar, adherence to this, and transference by streaming of protoplasm to the base of the collar, where they are received by a vacuole which is formed between the cuticle, if present, and the proto-

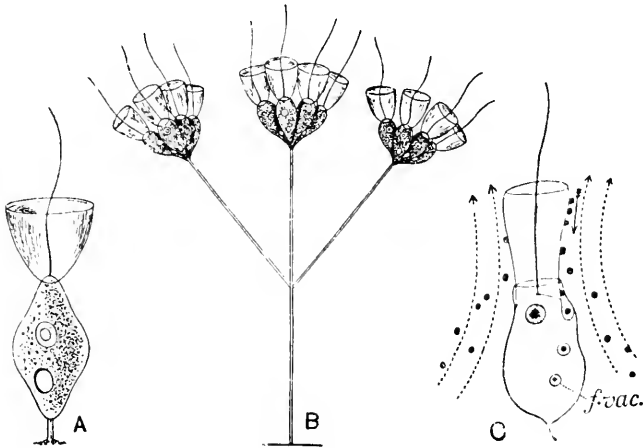

Fig. 49. Choanoflagellata. A, *Monosiga brevipes*,  $\times 1200$ . B, *Codosiga umbellata*,  $\times 310$ . Both after Saville-Kent. C, Ingestion in *Codosiga*. f.vac. food vacuole. The dotted lines show the currents set up by the flagellum, the small arrow the transport of the food particles on the collar.

plasm (Fig. 49C): defaecation within the collar. There is usually a stalk, generally not of living matter. This may branch, and thus unite numerous zooids. Examples are *Monosiga* (Fig. 49A), solitary, with protoplasmic stalk; *Codosiga* (Fig. 49B), branched, with cuticular stalk.

#### Order POLYMASTIGINA

Zoomastigina with two to many, generally with more than three, flagella, and an extranuclear division centre.

The genera here placed in one order are usually separated as Polymastigina, Hypermastigina, and Diplomonadina. They are the most highly organized members of the Mastigophora.

*Trichomonas* (Fig. 50). (One of the Polymastigina *sensu stricto*.) Body roughly egg-shaped; with four flagella, of which one is directed

backward and united to the body by an undulating membrane; a cytostome near the broad anterior end; and an axostyle which projects from the posterior end. The united basal granules act as a division centre, possibly in virtue of a centriole concealed among them. The cytostome is used for ingestion. A staining body which follows the base of the undulating membrane has been regarded as the parabasal body, but a deeper-lying structure is now asserted to represent that

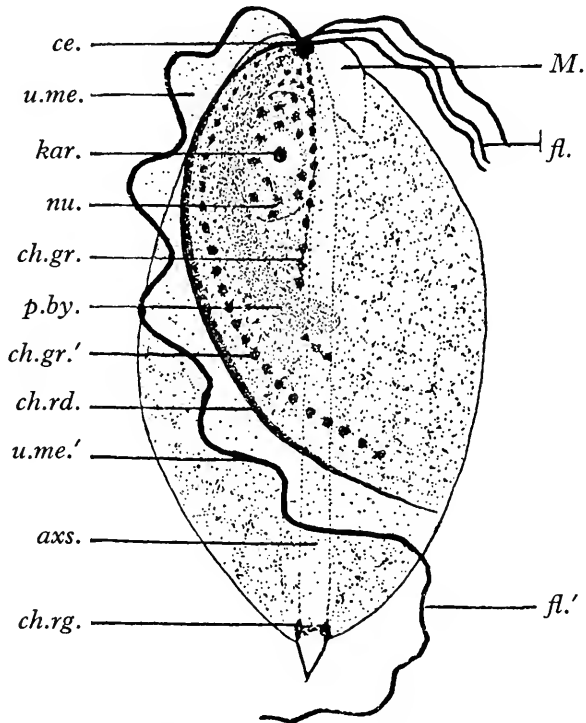

Fig. 50. *Trichomonas muris*, semidiagrammatic. From Hegner and Taliaferro, after Wenrich. *axs.* axostyle; *ce.* compound basal granule which acts as a centriole; *ch.gr.* inner row of chromatic granules; *ch.gr.'* outer row of chromatic granules; *ch.rd.* chromatic basal rod of undulating membrane; *ch.rg.* chromatic ring at the emergence of the axostyle; *fl.* anterior flagella; *fl.'* posterior flagellum; *kar.* karyosome; *M.* mouth (cytostome); *nu.* nucleus; *p.by.* parabasal body; *u.me.* undulating membrane; *u.me.'* posterior flagellum lying along the edge of the undulating membrane.

organ. In the cytoplasm, a number of "chromatic granules" are also present. Several species, parasitic in various cavities of vertebrates, including the mouth, intestine, and vagina of man.

*Hexamitus* (= *Octomitus*, Fig. 4). (Diplomonadina.) Body elongate; without gullet; presenting strong bilateral symmetry; and bearing on each side four flagella, three anterior and one posterior, the basal granules of the foremost being united; and an axostyle. Two nuclei are present, one on each side of the body, near the anterior

group of basal granules, with which they are connected. Intestinal parasites of vertebrates.

*Giardia* (= *Lamblia*, Fig. 51). (Diplomonadina.) Shaped like a half-

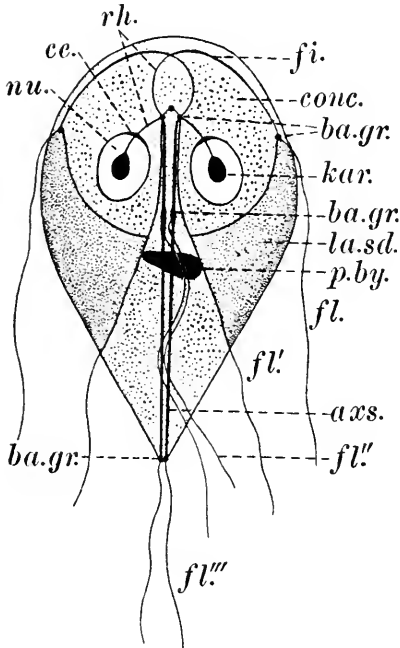

Fig. 51.

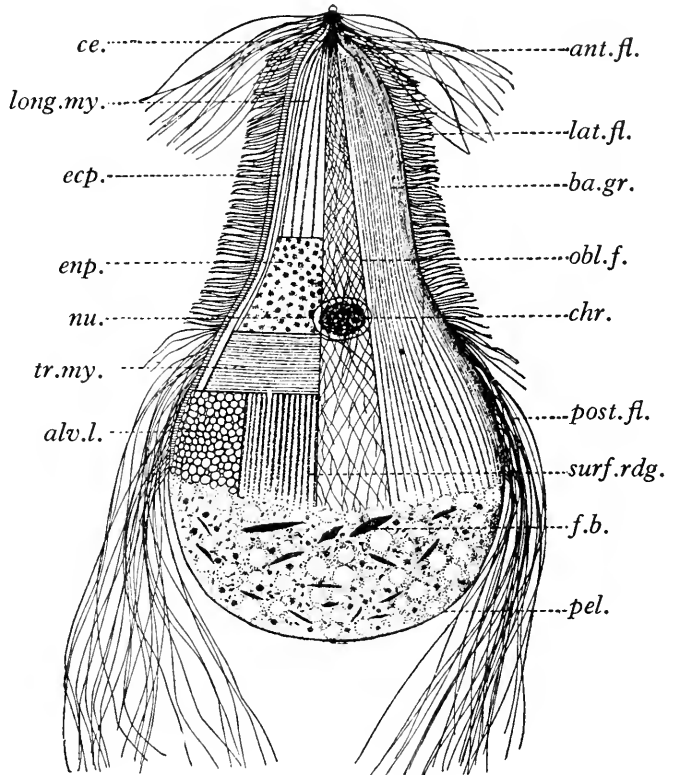

Fig. 52.

Fig. 51. *Giardia intestinalis*, from the intestine of man. Semidiagrammatic. *axs.* axostyle (axoneme); *ba.gr.* basal granules; *ce.* centriole; *conc.* ventral concavity ("sucker"); *fi.* fibre around concavity; *fl.*, *fl'*, *fl''*, *fl'''* anterolateral, posterolateral, ventral, and caudal flagella; *kar.* karyosome; *la.sd.* lateral shield, the thickest part of the body; *nu.* nucleus; *p.by.* parabasal body; *rh.* rhizoplasts.

Fig. 52. A diagram of the structure of *Trichonympha campanula*, showing a portion of each layer. From Hegner and Taliaferro, after Kofoid and Swezy. *alv.l.* alveolar layer; *ant.fl.* anterior flagella; *ba.gr.* rows of basal granules; *ce.* point at which the spindle arises in division; *chr.* chromatin granules in nucleus; *ecp.* ectoplasm; *enp.* endoplasm; *f.b.* food bodies; *lat.fl.* lateral flagella; *long.my.* longitudinal myonemes; *nu.* nucleus; *obl.f.* oblique fibres (rhizoplasts); *pel.* pellicle; *post.fl.* posterior flagella; *surf.rdg.* surface ridges of pellicle; *tr.my.* transverse myonemes.

pear, broad end forwards, with, on flat side, a concavity for adhesion. Organization as *Hexamitus* but all flagella in middle or hinder region. Parasitic in intestine of man and other mammals.

*Trichonympha* (Fig. 52). (Hypermastigina.) Body narrower in

front than behind; provided with very numerous flagella arranged in three distinct sets; without gullet. At the front end is a papilla. The ectoplasm, thin behind, is strong and complex in the fore part of the body, where it is composed of the following layers: (1) a pellicle, sculptured into longitudinal ridges, (2) a layer containing longitudinal rows of the basal granules of the flagella, (3) a layer containing a network of rhizoplasts ("oblique fibres"), (4) an alveolar layer, (5) a layer of transverse myonemes, (6) a layer of longitudinal myonemes. In the conical front region on which the first set of flagella stand, the rhizoplasts and basal granules are merged to form converging strands with which the flagella are connected. At division this conical apparatus acts as a division centre, dividing first and forming the spindle between its halves as they separate. Possibly it does so in virtue of a concealed centriole. *Trichonympha* is symbiotic with termites, in whose gut it lives (p. 435). The termite devours wood but is unable itself to digest it. The digestion is performed by the protozoon, which obtains in return food and lodging. Wood particles are contained in the endoplasm of the hinder part of the body of *Trichonympha*, into which they are ingested by the cupping-in of this region under the action of the myonemes of the forepart.

### Class SARCODINA (RHIZOPODA)

Protozoa which in the principal phase are amoeboid, without flagella; are usually not parasitic; have no meganucleus; and, though they may have a phase of sporulation, do not form large numbers of spores after syngamy.

With the exception of the Amoebina and Foraminifera, which are undoubtedly closely related, the orders of this class have much less affinity with one another than have those of the Mastigophora. In all of them flagellate young and gametes are common.

### Order AMOEBINA

Sarcodina which have no shell, skeleton, or central capsule; whose pseudopodia never form a reticulum and are usually lobose; and whose ectoplasm is never vacuolated.

Thus defined, the group excludes forms such as *Arcella* which differ from its members practically only in the possession of a shell. These forms, however, are also connected with the typical Foraminifera by intermediates (as *Lieberkühnia* and *Allogromia*). There is, indeed, a continuous series from naked amoebae to such foraminifera as *Polystomella*, and the drawing of a boundary line between the groups of which they are typical is a matter of convenience.

*Naegleria* (Fig. 53). Small amoebae which live in various foul infusions; possess a contractile vacuole; and in certain conditions pass into a biflagellate phase. *Naegleria* is placed here rather than among the Rhizomastigina because it is most often in the non-flagellate condition, its flagellate phase, though fully grown, is not known to perform reproduction, and the general features of the amoeboid phase are those of the amoebina of the *limax* group, most of whose members appear to have no flagellate phase. These organisms form one or two

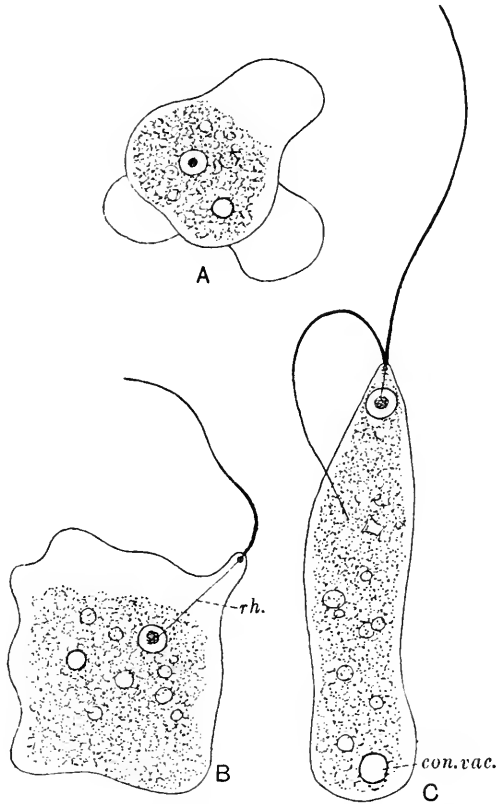

Fig. 53. *Naegleria bistadialis*,  $\times 800$ . Partly after Kühn, in Doflein. A, Amoeboid condition. B, Transition to flagellate condition. C, Flagellate condition. *con.vac.* contractile vacuole; *rh.* rhizoplast.

broad pseudopodia, are given to assuming a slug-like shape with one pseudopodium at the foremost end, and have a very simple nucleus with a large karyosome.

*Vahlkampfia*, also found in foul infusions, is a typical member of the *limax* group.

*Amoeba* (Fig. 54). Typical amoebae, with numerous pseudopodia; contractile vacuole; and no flagellate phase. Various species, of which the commonest three are shown in the figure. The true *A. proteus* is the largest of the common *Amoebae*, has a lens-shaped nucleus and

longitudinal ridges on the ectoplasm, forms spores endogenously in the unencysted condition, and does not normally feed on diatoms, which form a great part of the food of *A. dubia*.

*Entamoeba* (Figs. 55, 56). Parasitic amoebae; without contractile vacuole. Reproduction during most of the life history is by binary fission. Finally encystment takes place and in the cyst the nucleus divides several times. The cysts pass out of the host and infect a new

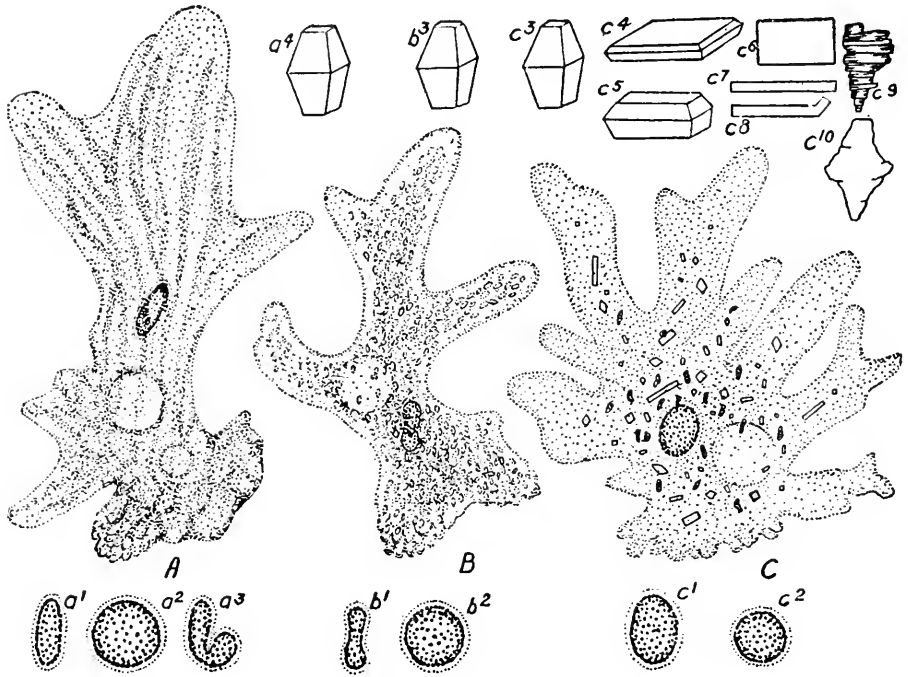

Fig. 54. *Amoebae*. From Hegner and Taliaferro, after Schaeffer. A, *A. proteus*.  $a^1$ , Equatorial view of nucleus.  $a^2$ , Polar view of nucleus.  $a^3$ , Equatorial view of nucleus in the folded condition often seen in this species.  $a^4$ , Crystal of the kind found distributed in the endoplasm of the species. B, *A. discoides*.  $b^1$ ,  $b^2$ , Equatorial and polar views of nucleus.  $b^3$ , Crystal. C, *A. dubia*.  $c^1$ ,  $c^2$ , Equatorial and polar views of the nucleus.  $c^3$ - $c^{10}$ , Crystals and concretions. Dimensions in microns: A, 600 in length. B, 450 in length. C, 400 in length.  $a^1$ ,  $46 \times 12$ .  $b^1$ ,  $40 \times 18$ .  $c^1$ ,  $40 \times 32$ .  $a^4$ , maximum 4.5.  $b^3$ , maximum 2.5.  $c^3$ - $c^{10}$ , maxima 10 to 30.

individual, in which they are dissolved and set free their contents, which divide into uninucleate young. The cysts must remain in a fluid medium if they are to cause reinfection. Several species exist, occurring in various vertebrates and invertebrates. *E. coli* is a harmless commensal in the colon of man, feeding on bacteria, etc. *E. histolytica* (= *E. dysenteriae*), a parasite which often causes dysentery and occasionally abscesses of the liver and other organs, differs from *E. coli* in having a distinct ectoplasm, in the central position of the karyo-



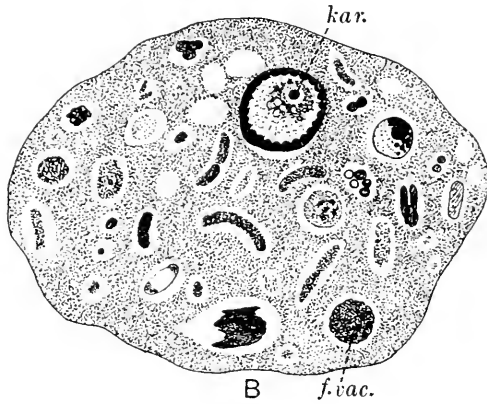
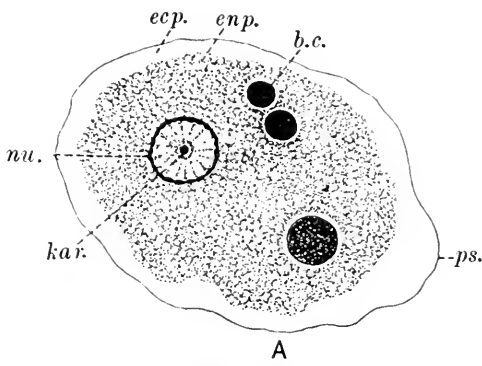

Fig. 55. *Entamoeba*,  $\times$  about 2000. After Dobell and O'Connor. A, *E. histolytica*. B, *E. coli*. b.c. ingested red blood corpuscles; ecp. ectoplasm; enp. endoplasm; f.vac. food vacuole; kar. karyosome, eccentric in *E. coli*; nu. nucleus; ps. pseudopodium.

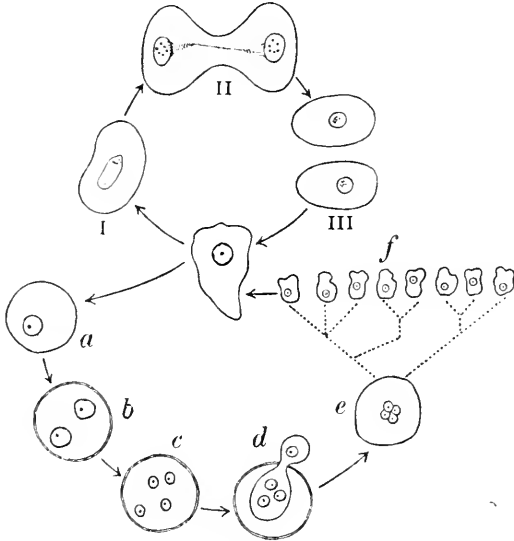

Fig. 56.

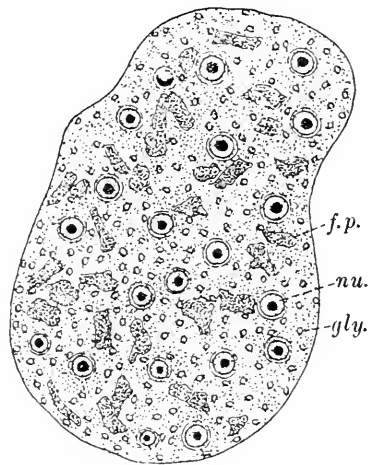

Fig. 57.

Fig. 56. A diagram of the life cycle of *Entamoeba histolytica*. a-f, Encystment and formation of amoebulae. I-III, Binary fission (in gut of host).

Fig. 57. *Pelomyxa palustris*. Partly after Doflein. f.p. undigested particles swallowed with food; gly. glycogen granules; nu. nuclei (stained).

some and in certain other features of the nucleus (Fig. 55), and in forming only four, instead of eight, nuclei in the cyst. This species breaks up by digestion cells of the intestinal epithelium and other tissues, absorbs the soluble products, and ingests portions of the destroyed cells and also red corpuscles.

*Pelomyxa* (Fig. 57). Large, multinucleate species, living in, and feeding by ingesting, the mud of stagnant fresh waters rich in vegetable debris. The cytoplasm contains glycogen granules (see p. 20).

### Order FORAMINIFERA

Sarcodina which have either a shell or reticulate pseudopodia or, usually, both these features; and in pelagic species a vacuolated outer layer of protoplasm.

The *shell* may be of one or of several chambers, and is composed in different cases of different materials, nitrogenous, calcareous, siliceous, or of foreign particles.

The *pseudopodia* may be lobose, filose, reticulate without streaming of particles along them, or reticulate with streaming. The latter type alone is found in the Polythalamia.

The *reproduction* of the single-chambered forms (Monothalamia) is both by binary and by multiple fission. In binary fission, *Lieberkühnia* and *Trichosphaerium* divide the shell. In the rest, a portion of the protoplasm emerges from the old shell and secretes a new one (Fig. 58), the nucleus or nuclei divide, one of the products of each passing into the protruded protoplasm while the other remains in the old shell, and the two portions of protoplasm break apart. Multiple fission usually produces amoebulae, sometimes flagellulae. The latter are known or suspected to be gametes. In these forms there does not usually appear to be a regular alternation of sexual and asexual reproduction. In the Polythalamia binary fission does not occur, and in some of them, perhaps in all, there is a more or less regularly alternate production of asexual amoebulae and flagellate gametes.

### Suborder MONOTHALAMIA

Foraminifera, usually of freshwater habitat; with non-calcareous, single-chambered shells; whose pseudopodia are rarely reticulate; and whose protoplasm does not extend as a layer over the shells.

*Arcella* (Figs. 22, 59). Shell pseudochitinous, shaped like a tam-o'-shanter cap, finely sculptured; pseudopodia lobose; two or several nuclei and a chromidium present. Gas vacuoles in the protoplasm are said to contain oxygen and to have a hydrostatic function. Reproduction by binary fission, or by budding to form amoebulae with fine pseudopodia (*Nucleariae*). In fresh waters.

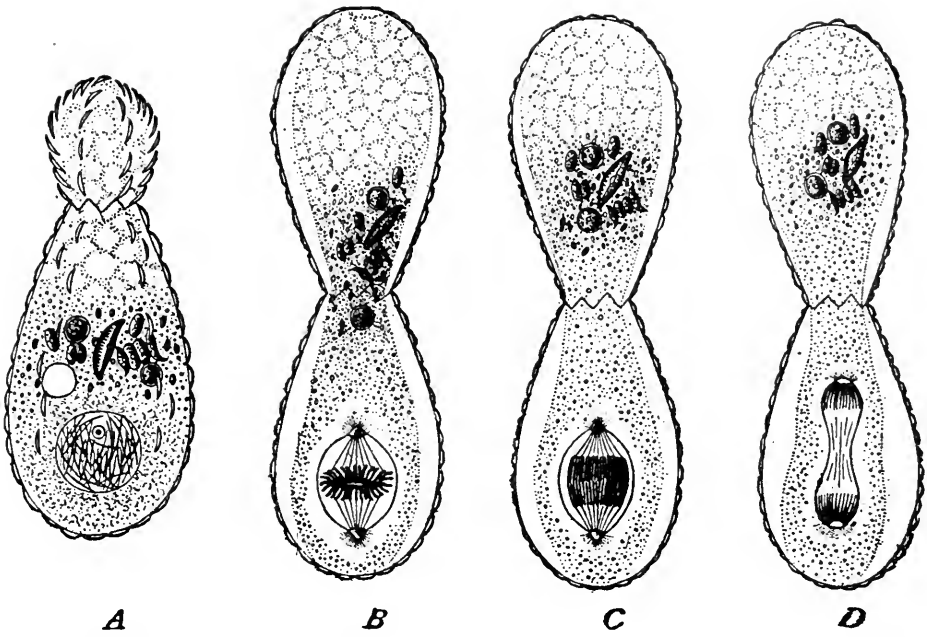

Fig. 58. Binary fission of *Euglypha alveolata*,  $\times$  about 450. From Hegner and Taliaferro, after Schewiakoff. A, B, C, D, Successive stages in the mitosis, with formation and occupation of a new shell.

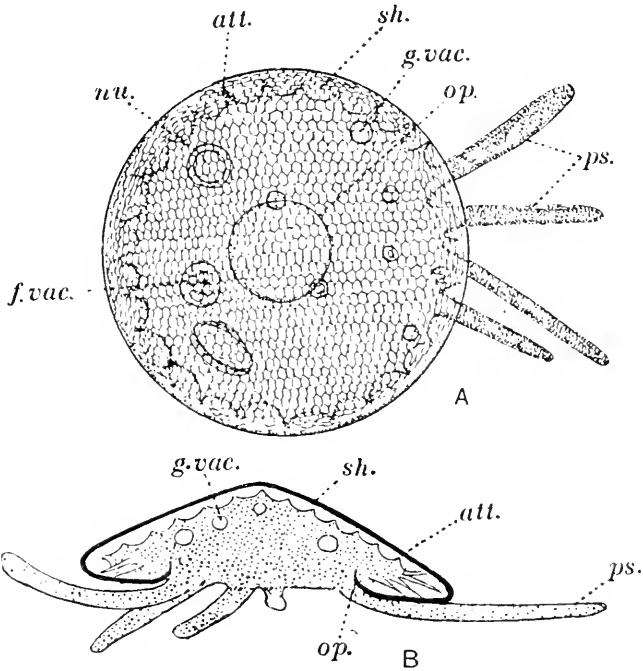

Fig. 59. *Arcella discoides*,  $\times$  500. From Leidy. A, Seen from above. B, Seen from the side, optical section. *att.* thread attaching animal to inner surface of shell; *f.vac.* food vacuole; *g.vac.* gas vacuole; *nu.* nucleus; *op.* edge of opening into shell; *ps.* pseudopodia; *sh.* shell.

*Diffugia* (Fig. 60). Shell of sand grains, etc., united by organic secretion, pear- or vase-shaped; pseudopodia lobose; one or two nuclei and a chromidium present. Gas vacuoles sometimes formed. In fresh waters.

*Euglypha* (Figs. 7, 58). Shell resembling that of *Diffugia* but formed of siliceous plates secreted by the animal; pseudopodia filose. In fresh waters.

*Trichosphaerium*. Flat, encrusting forms, with a jelly coat; finger-like pseudopodia protruding through separate openings in the coat; and numerous nuclei. Reproduction alternately by escape of amoebulae and of biflagellate isogametes; but both generations can perform plasmotomy. Marine.

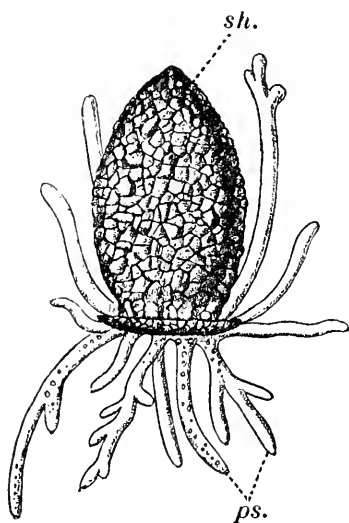

Fig. 60.

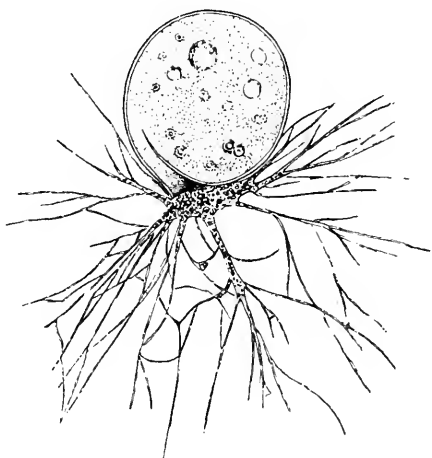

Fig. 61.

Fig. 60. *Diffugia urceolata*,  $\times 100$ . After Leidy. *sh.* shell composed of particles of sand containing body of the animal; *ps.* pseudopodia.

Fig. 61. *Lieberkühnia wagneri*. After Verworn.

*Lieberkühnia* (Fig. 61). Shell thin, flexible, egg-shaped, with mouth directed to one side; pseudopodia reticulate. Shell divided at binary fission. Marine and in fresh waters.

#### Suborder POLYTHALAMIA

Foraminifera, nearly always of marine habitat; usually with a shell of several chambers, which is most often calcareous, but sometimes with one chamber or no shell; whose pseudopodia are reticulate; and whose protoplasm extends as a layer over the shell.

The external layer of protoplasm can be withdrawn into the shell.

The *shells* of this group are typically many-chambered and calcareous, but a fair number are one-chambered, and most of these and some of the many-chambered shells are composed of foreign particles (*arenaceous*). Either kind may be *imperforate* or *perforate* by numerous small pores, but most of the non-calcareous shells are imperforate. The one-chambered shells are of various shapes. They usually grow

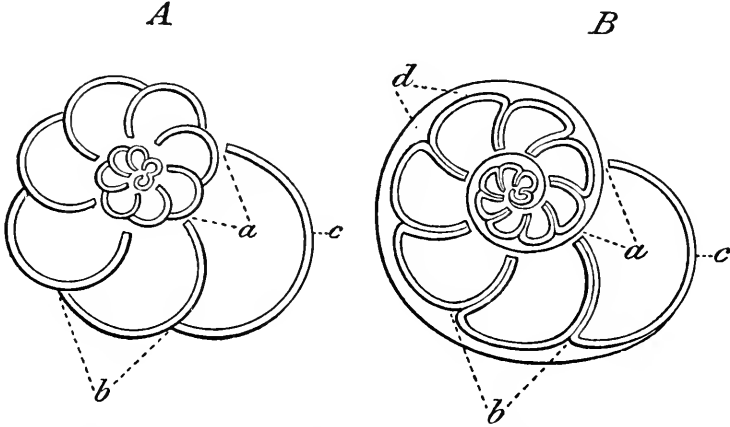

Fig. 62. A, Section of a foraminifer in which each septum is formed of a single lamella. B, One in which the septum is formed of two lamellae and a supplemental layer is present. After Carpenter. *a*, passages between the chambers; *b*, septum; *c*, anterior wall of last chamber; *d*, supplemental skeleton.

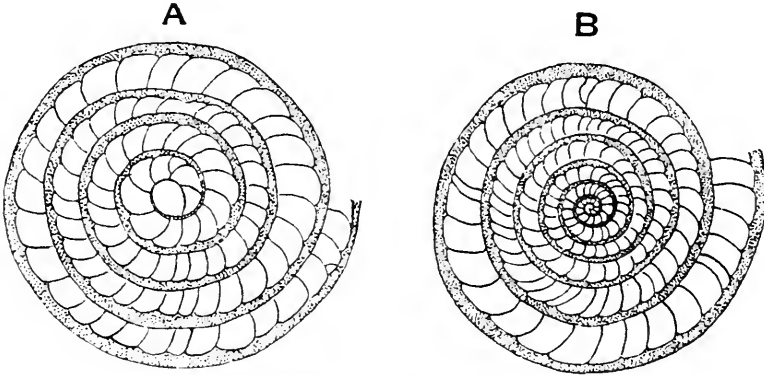

Fig. 63. Dimorphism of *Nummulites laevigatus*, Bracklesham Beds (Eocene), Selsea. From Woods. A, Section of the entire shell of the megalospheric form,  $\times 9$ . B, Section of the *central* part of the microspheric form,  $\times 9$ .

by extension at their openings. Shells with more than one chamber grow by the addition of chambers. The protoplasm bulges from the mouth of the shell and there secretes around itself a new chamber into which opens the previous mouth. The chambers may be arranged in a straight line, as in *Nodosaria* (Fig. 6B), or in a spiral, as in *Poly-stomella*, etc. (Figs. 62, 63, 65), or occasionally irregularly; and the shell may be strengthened by the deposition, upon their original

walls, of a supplemental layer (Fig. 62B). The nuclei, where there is more than one, bear no constant relation to the chambers.

In many species the shells are *dimorphic*, the two forms (Figs. 63, 66) being distinguished by the size and arrangement of the first formed chamber, which is small in one (the *microspheric* form) and larger in the other (*megalospheric*). These forms correspond to the alternation of generations in the life cycle (Fig. 66), the microspheric form, which usually becomes multinucleate at an early stage, reproducing asexually by multiple fission, while the megalospheric form, which remains uninucleate till it is about to reproduce, produces gametes.

Most foraminifera are creeping organisms, but the Globigerinidae are planktonic and have, correspondingly, vacuolated ectoplasm and long slender spines on the shell. The shells of such forms, falling to the bottom, form an important constituent of many deep-sea oozes.

*Allogromia* (Fig. 64). Shell one-chambered, egg-shaped, pseudo-chitinous. Marine and in fresh waters.

*Rhabdammina* (Fig. 6A). Shell one-chambered, straight or forked, tubular, composed of foreign particles. Marine.

*Nodosaria* (Fig. 6B). Shell perforate, calcareous, consisting of several chambers arranged in a longitudinal row, the mouth of each chamber opening into the next younger and larger. Marine.

*Polystomella* (Figs. 65, 66). Shell perforate, calcareous, consisting of numerous chambers, arranged in a flat spiral, and complicated as follows in the details of their architecture: each whorl is *equitant*, i.e. overlaps the previous whorl at the sides and thus hides it; the mouth is replaced by a row of large pores; backward pockets (*retrol processes*) stand along the hinder edge of each chamber; the supplemental layer contains a system of canals filled with protoplasm. Marine. The life cycle of this genus, which shows the alternation of generations described above, has been followed in detail (Fig. 66).

*Nummulites* (Fig. 63). As *Polystomella* but with more chambers. Marine. Includes, besides recent forms, large fossil species in Eocene limestones.

*Globigerina* (Fig. 6C). Shell perforate, calcareous, chambers fewer and less compact than in *Polystomella*, arranged in a rising (helicoid) spiral, and bearing long spines. External layer of protoplasm frothy, with large vacuoles by which the specific gravity is reduced. Marine, pelagic. Its shells are common in oceanic oozes and in chalk.

#### Order RADIOLARIA

Marine, planktonic Sarcodina, which have no shell but possess a central capsule and usually a skeleton of spicules; whose pseudopodia are fine and radial and usually without conspicuous axial filament; and the outer layer of whose protoplasm is highly vacuolated.

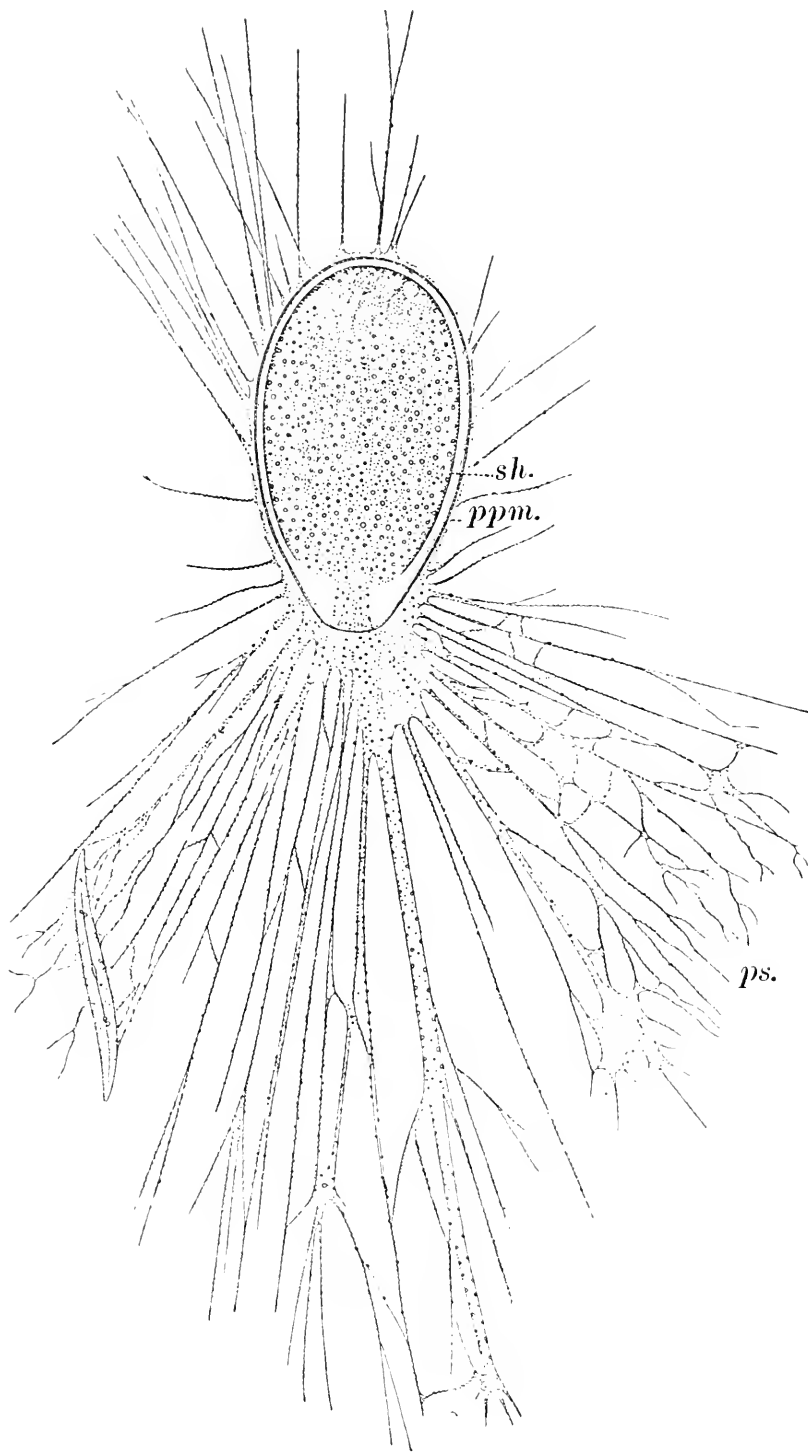

Fig. 64. *Allogromia oviformis*,  $\times 230$ , but the pseudopodia less than one-third their relative natural length. From M. S. Schultze. *sh.* shell; *ppm.* protoplasm surrounding shell; *ps.* pseudopodia, fusing together in places and surrounding food particles such as diatoms, which have adhered to the pseudopodia owing to the stickiness of the latter, and are digested *in situ*, without the formation of visible food vacuoles around them.

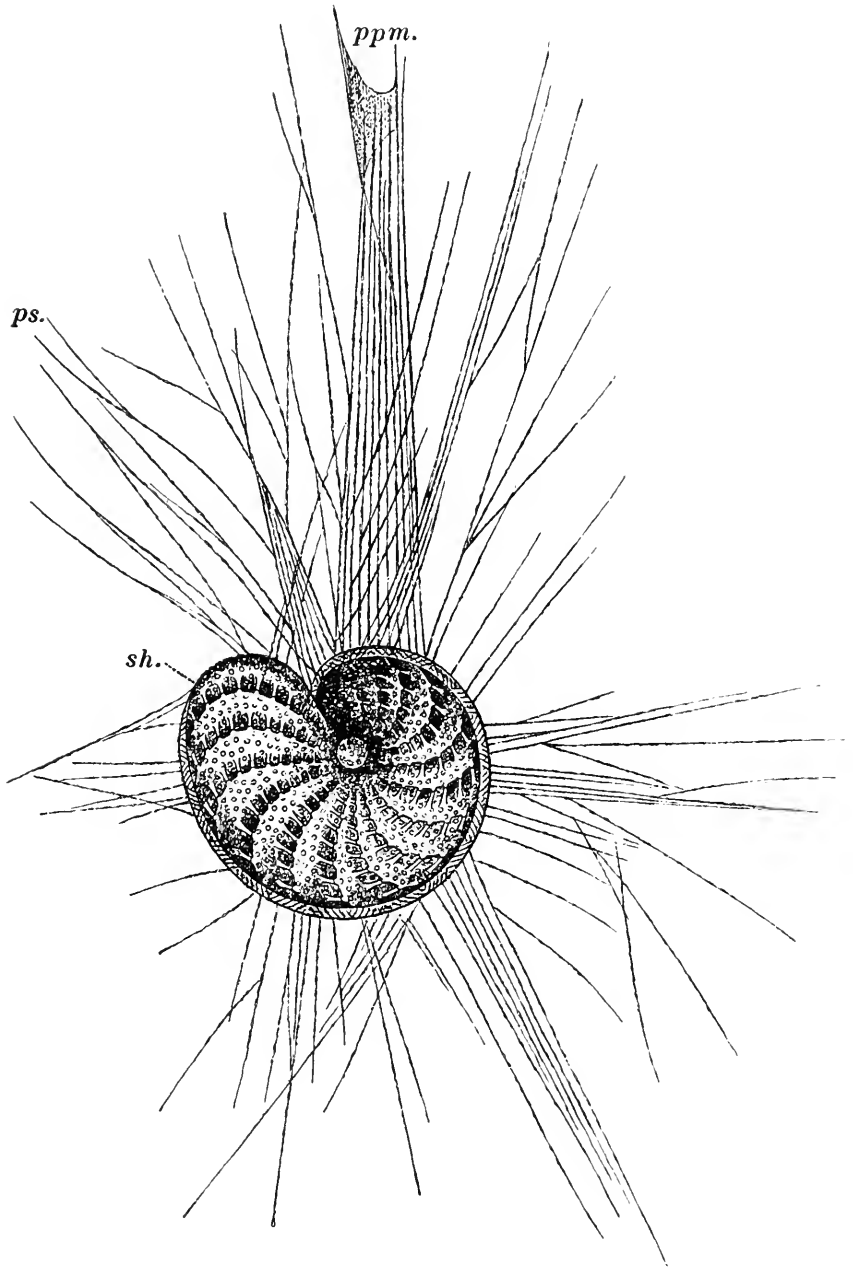

Fig. 65. *Polystomella crista*,  $\times 45$ . After M. S. Schultze. *sh.* shell; *ppm.* a mass of protoplasm formed by the fusion of pseudopodia; *ps.* pseudopodia. The retral processes are darkly shaded: the external protoplasm is not visible.



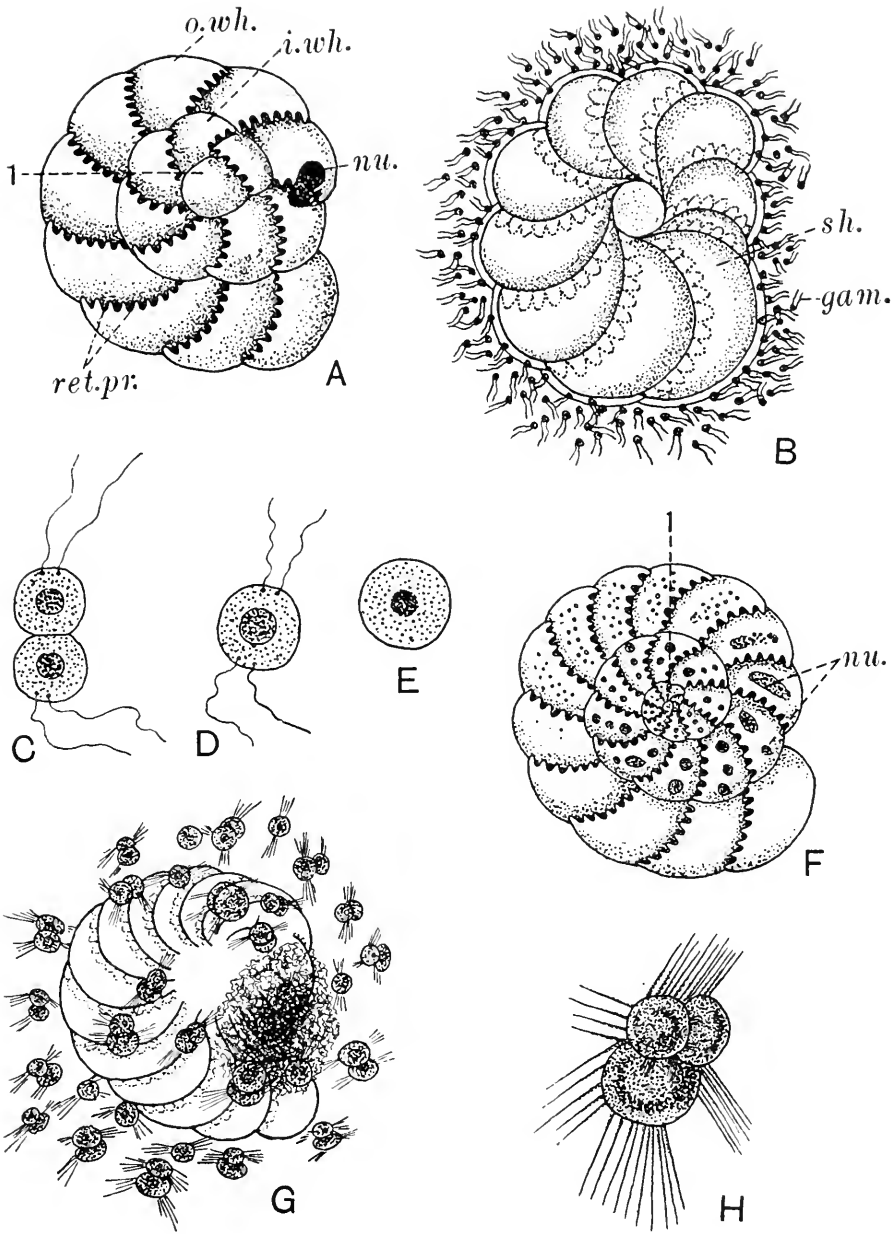

Fig. 66. Stages in the life cycle of *Polystomella*. Semidiagrammatic. A, Megalospheric form, decalcified and stained. B, Shell of the same surrounded by escaping gametes. C, D, Conjugation. E, Zygote. F, Microspheric form, decalcified and stained. G, Shell of the same surrounded by escaping amoebulae. H, Young megalospheric individual with three chambers. *gam.* gametes; *i.wh.* inner whorl of spiral; *o.wh.* outer whorl; *nu.* nucleus, *ret.pr.* retrol processes; 1, first chamber.

The *pseudopodia* branch, and to some extent join: they are said to contain an axial filament and they show streaming of granules. The *central capsule* is a pseudochitinous structure, of varying shape according to the species, which encloses the nucleus and some cytoplasm containing oil globules. It is perforated by pores, which by their arrangement characterize the suborders, being evenly distributed in the *Peripylaea* (*Spumellaria*), gathered into groups in the *Actipylaea* (*Acantharia*), concentrated into one "pore plate" in the *Monopylaea* (*Nassellaria*), and represented by three openings or "oscula" in the *Tripylaea* (*Phaeodaria*). The *spicules* are usually siliceous, but in one group (*Acantharia*) they are said to be of strontium sulphate. They are rarely absent, occasionally loose, but usually united into a lattice-work

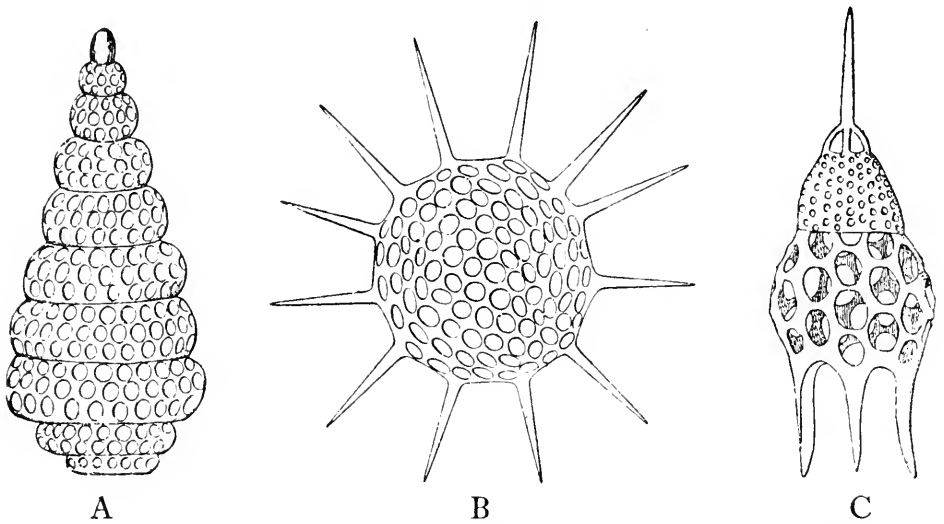

Fig. 67. Fossil Radiolaria. From Woods. A, *Lithocampe tschernyschevi*, Devonian. B, *Trochodiscus longispinus*, Carboniferous. C, *Podocyrthis schomburgki*, Barbados Earth (Tertiary). A and C, Nassellaria; B, Spumellaria.

(Figs. 67, 68), which is often very complicated, with projecting spines. The latter may be radial but do not meet at a central point except in the *Acantharia*. The *outer layer* of the body differs from that of the pelagic Foraminifera in that the vacuoles are contained in a layer of jelly (*calymma*) traversed by strands of protoplasm, which secrete it and the vacuoles, and in that it cannot be withdrawn.

There is no contractile vacuole.

The Radiolaria *reproduce* by binary fission and by spore formation. The spores found in them are sometimes alike (*isospores*) and sometimes of two kinds (*anisospores*). The latter are held to be gametes, and it is said that union between them has been observed. On account of their resemblance to the Dinoflagellata it has been suggested that they belong to parasitic members of that group. It is possible, on the other

hand, that the Radiolaria have an alternation of generations like that of the Foraminifera.

Peculiarities of the *mitoses* in this group have been mentioned above (pp. 25, 26).

Symbiotic flagellates, known as "yellow cells" (*Zooxanthellae*, see pp. 47, 50), are present in large numbers in the cytoplasm of many of the Radiolaria.

*Thalassicolla* (Fig. 32 A). (Suborder Spumellaria.) Skeleton absent or represented by some loose siliceous spicules; one nucleus; yellow cells in extracapsular protoplasm.

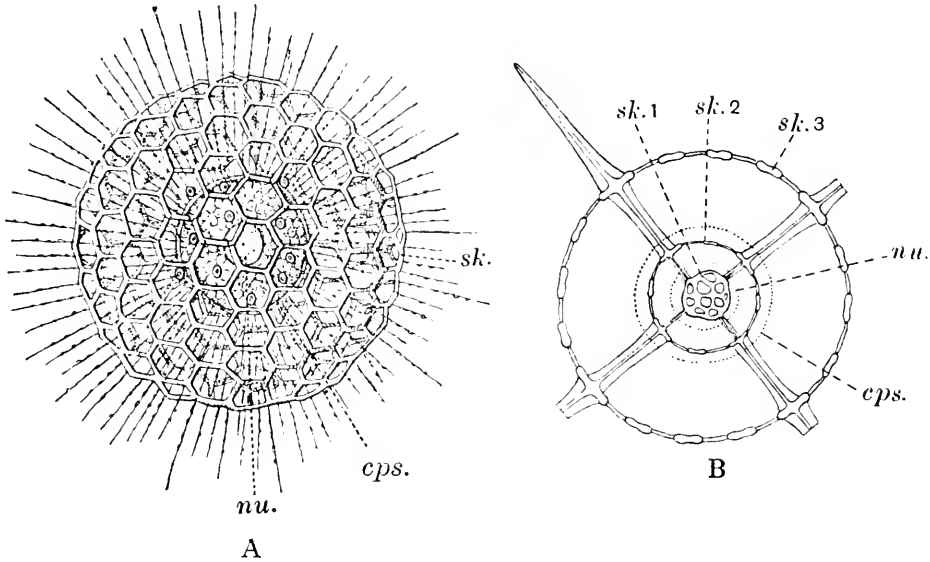

Fig. 68. A, *Heliosphaera inermis*,  $\times 350$ . After Hertwig. B, The skeleton of *Actinomma*. After Bütschli. *sk.* skeleton; *cps.* central capsule; *nu.* nucleus. The yellow cells are shown, but not labelled, in A.

*Collosoum* (Fig. 32 B). As *Thalassicolla*, but with central capsules united by their extracapsular protoplasm into a colony; and each capsule contains several nuclei.

*Heliosphaera* (Fig. 68 A). As *Thalassicolla*, but the skeleton has the form of a lattice-work on the surface of the body.

*Actinomma* (Fig. 68 B). As *Heliosphaera*, but the skeleton consists of several lattice spheres, formed successively at the surface as the animal grows, with radial struts joining them. Ultimately the innermost sphere may lie in the nucleus.

*Acanthometra* (Fig. 69 A). (Suborder Acantharia.) A skeleton of radial spicules of strontium sulphate meeting centrally in the central capsule; nuclei numerous; yellow cells intracapsular. Remarkable structures known as "myophrisks", surrounding the spines of this

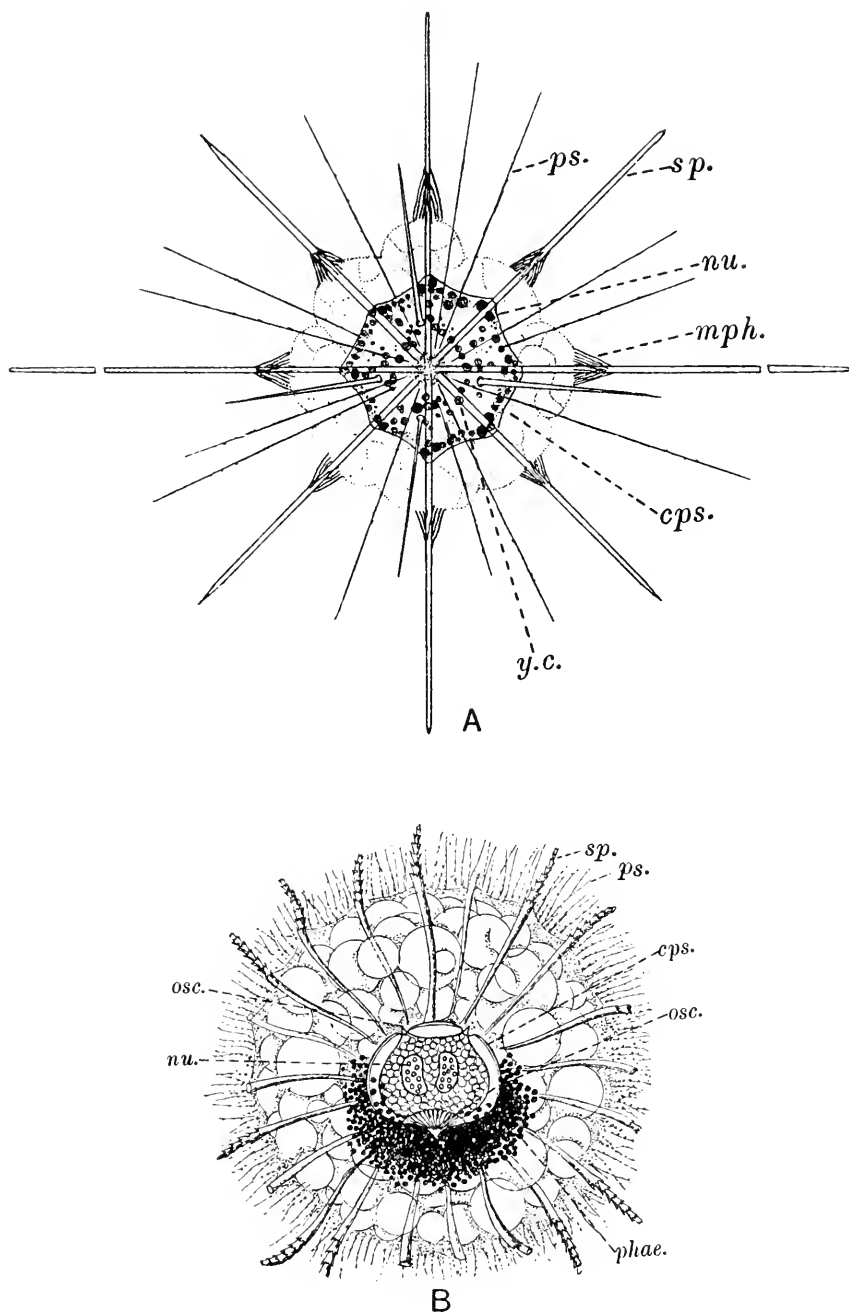

Fig. 69. Radiolaria. A, *Acanthometra elastica*, after Hertwig. B, *Aulac tinium actinastrum*, after Haeckel. cps. central capsule; mph. myophrisk; nu. nucleus; osc. oscula of central capsule; phae. phaeodium; ps. pseudo-podium; sp. spine; y.c. yellow cells.

genus at their junction with the calymma, are contractile and are used in the regulation of the diameter of the body.

*Lithocircus* (Fig. 37). (Suborder Nassellaria.) A siliceous skeleton in the form of a ring, bearing spines. Yellow cells extracapsular.

*Aulactinium* (Fig. 69B). (Suborder Phaeodaria.) A skeleton of hollow, radial, compound, siliceous spicules, not meeting in the centre; nuclei two; central capsule with three oscula, one of which is surrounded by a mass of coloured granules (the *phaeodium*, from which the suborder is named). Like the rest of the Phaeodaria this is a deep-sea form and does not possess yellow cells.

### Order HELIOZOA

Sarcodina, generally of floating habit and freshwater habitat; without shell or central capsule; sometimes with siliceous skeleton; with spherical bodies; typical axopodia; and usually a highly vacuolated outer layer of protoplasm.

The *locomotion* of members of this group, in the ordinary phase, is effected as rolling, due to contraction of successive pseudopodia in contact with the ground so that the body is pulled over. The pseudopodia usually show streaming of granules. When they bend, which they do to enclose prey which has adhered to one of them, their axial filaments are temporarily absorbed at the bend. Protoplasm from the pseudopodia then surrounds the prey and streams with it inward to the endoplasm, where a food vacuole is secreted around it.

*Contractile vacuoles* are present.

Asexual *reproduction* is usually by binary fission (or plasmotomy in multinucleate forms), sometimes by budding. Sexual processes have only been thoroughly investigated in *Actinophrys* and *Actinosphaerium*, where they take the form of autogamy (see below).

*Dimorpha* (Fig. 70), one of the Helioflagellata, a small group of organisms which is usually appended to the Heliozoa, bears somewhat the same relation to that order that *Naegleria* bears to the Amoebina. It has a biflagellate and a heliozoan phase, and can pass from one to the other. In the latter it retains the flagella, whose filaments share a common basal granule with those of the axopodia, and has no vacuolated layer or protecting case. In fresh waters.

*Actinophrys* (Figs. 71, 72). Unprotected; with one nucleus, against which the central filaments of the axopodia end; no skeleton. *Autogamy* (or more correctly *paedogamy*<sup>1</sup>) takes place as follows: the pseudopodia are withdrawn and a jelly cyst formed. Binary fission now takes place, so that two individuals lie side by side in the cyst.

<sup>1</sup> Paedogamy is a kind of autogamy in which not only the nucleus but also its cytoplasm divides and reunites.

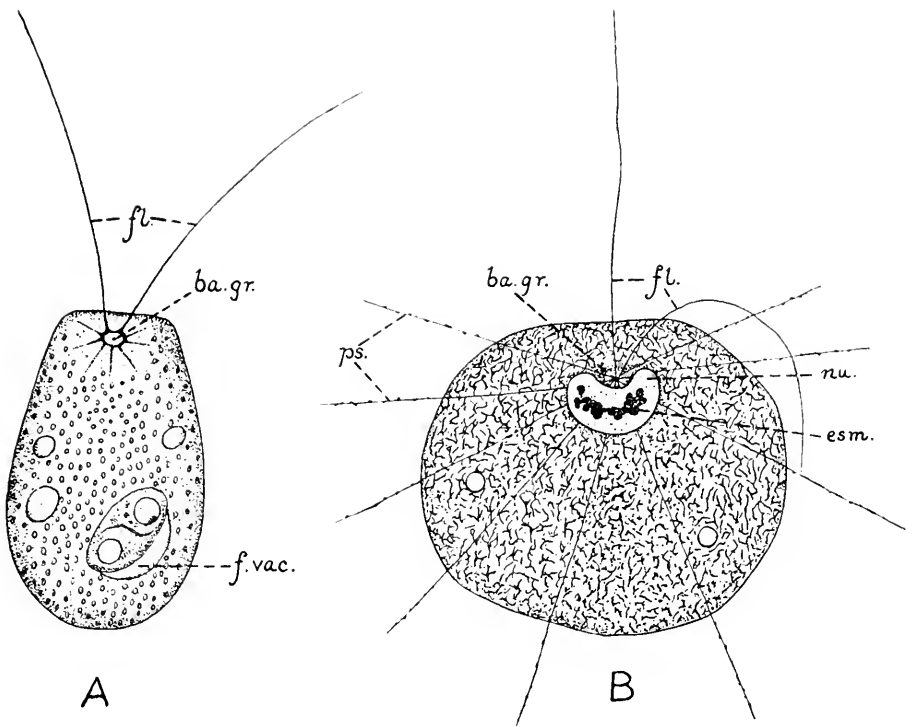

Fig. 70. *Dimorpha mutans*. Partly after Blochmann. A, In the flagellate phase, alive. B, In the heliozoan phase, stained, with pseudopodia as if alive. *ba.gr.* basal granule; *esm.* chromatic matter which will condense to form the endosome; *f.vac.* food vacuole; *fl.* flagella; *nu.* nucleus; *ps.* pseudopodia.

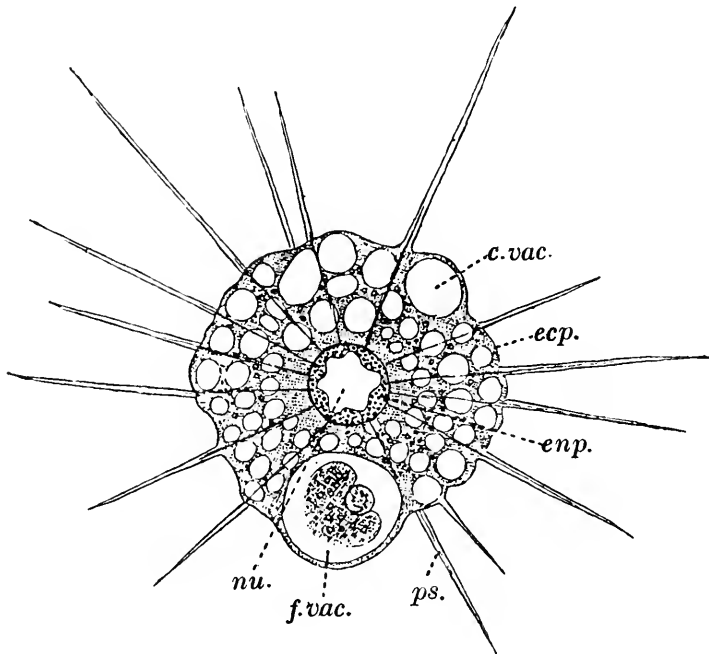

Fig. 71. *Actinophrys sol*,  $\times$  about 800. From Bronn. *ecp.* ectoplasm; *enp.* endoplasm; *c.vac.* contractile vacuole; *f.vac.* food vacuole; *nu.* nucleus; *ps.* pseudopodium.

Each divides mitotically twice, throwing out as a polar body one product of each division. The first of these two divisions is a reduction division. The two individuals now fuse, one behaving as a male by

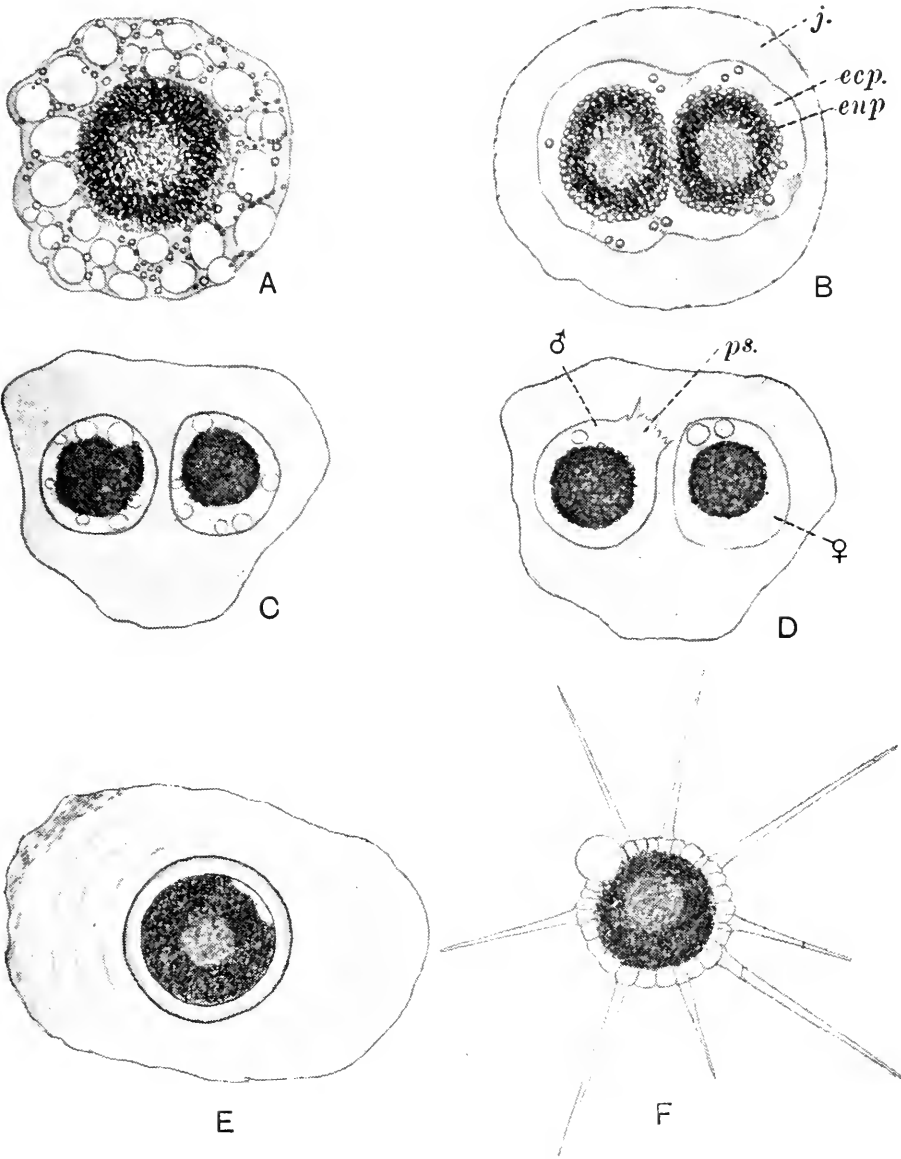

Fig. 72. A-F, Successive stages in the autogamy of *Actinophrys sol*. After Belar. *ecp.* ectoplasm; *enp.* endoplasm; *j.* jelly coat; *ps.* pseudopodium put out by ♂, the male gamete, towards ♀, the female gamete.

sending out a pseudopodium towards the other, and a strong inner cyst forms around the zygote. After a while the latter undergoes binary fission and the two products escape from the cyst. Occasionally two individuals enter a jelly cyst together and then either the two

gametes of each undergo cross-conjugation with those of the other, or there is one cross-conjugation and the remaining gamete of each of the two original individuals performs parthenogenesis. In fresh and marine waters.

*Actinosphaerium* (Fig. 33). Unprotected; with many nuclei, against which the central filaments of the axopodia do not end. In preparation for autogamy the nuclei are reduced in number and the cytoplasm divides into as many corpuscles as there are nuclei. Each of these then undergoes a process similar to that which occurs in *Actinophrys*, forming a zygote which hatches as an independent individual. In fresh waters.

*Clathrulina* (Fig. 8). Animal enclosed in a stalked, pseudochitinous lattice sphere; one nucleus. At binary fission, one product becomes a biflagellula and swims away. In fresh waters.

### Order MYCETOZOA

Plasmodial Sarcodina, living usually in damp places on land; which have in the active phase no shell, skeleton, or central capsule, but in the quiescent phase a cyst of cellulose; possess numerous, blunt pseudopodia; and are usually distributed by air-borne, cellulose-coated spores.

The life history of a typical mycetozoon is as follows. The adult plasmodium is a sheet of protoplasm containing many thousands of nuclei and numerous contractile vacuoles. In it there are to be seen veins along which streaming takes place, alternately towards and from the periphery. It feeds in a holozoic manner, usually upon decaying vegetable matter, sometimes (*Badhamia*) on a living plant. In drought it breaks up into numerous multinucleate cellulose cysts which constitute the *sclerotium*. It prepares for reproduction by condensing at certain points, at each of which it forms a cellulose *sporangium*, often stalked. In the sporangium is a *capillitium* of cellulose threads and entangled in the capillitium are uninucleate, cellulose-coated spores, whose formation is preceded by a reduction division. When the sporangium is ripe it bursts and the spores are disseminated by wind, etc. In damp surroundings they open and liberate each an amoebula which becomes a flagellula. The flagellulae perform syngamy and the zygote again becomes an amoebula. The amoebulae tend to fuse and form small plasmodia. By multiplication of their nuclei the adults arise.

*Chondrioderma* (Fig. 73). On bean stalks.

*Badhamia*. On fungi, especially *Stereum*.

*Plasmodiophora*. In turnips, causing "finger-and-toe" disease. No sporangia. Distribution by flagellulae in soil.



## Class SPOROZOA

Protozoa which in the principal phase have no external organs of locomotion or are amoeboid; are parasitic, and nearly always at some stage intracellular; have no meganucleus; and form after syngamy large numbers of spores, which may be sporozoites or undivided zygotes.

The two subclasses, Telosporidia and Neosporidia, of this class have little in common, and their association in classification is a matter of convenience.

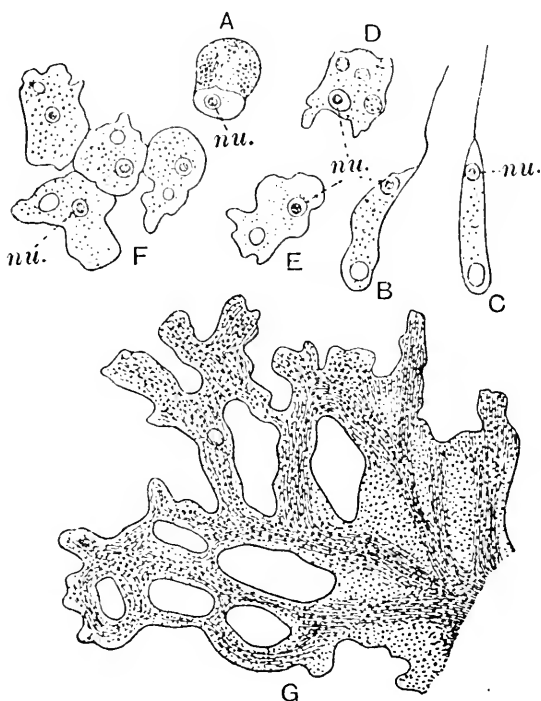

Fig. 73. Various stages of *Chondrioderma difforme*. From Strasburger. A, A spore hatching. B and C, Flagellulae. D, Young and E, Older amoebulae. F, Amoebulae fusing to form plasmodium. All  $\times 540$ . G, Portion of plasmodium,  $\times 90$ . nu. nucleus.

Though upon analysis the type of *life history* characteristic of the Telosporidia is found to differ profoundly from those of the Neosporidia, all sporozoan life histories are complicated. Usually they comprise all the phases indicated in the scheme on p. 37, though in the Eugregarinaria (and perhaps in the Actinomyxidea) agamogony is omitted. Each phase, moreover, is liable to be elaborated. The term *sporoblast* is applied to certain stages in various life histories, but unfortunately the stages so named are not all comparable with one another. In the Telosporidia it denotes either the zygote or the

products of the first of two successive multiple fissions whereby the sporozoites and other spore-like stages often arise. In the Neosporidia it denotes the syncytia (of different origins in different groups) from which by differentiation of cells complex spores are formed.

### Subclass *TELOSPORIDIA*

Sporozoa in which the adult of the vegetative stage has only one nucleus; and comes to an end with spore formation; and the spore cases, if present, are simple structures, which nearly always contain several sporozoites.

The vegetative stage (*trophozoite*) has usually a definite shape, but in some haemosporidia is amoeboid. Its fission (agamogony), if such occur, is multiple, and is usually known as *schizogony*, the term *schizozoites* or *merozoites* being applied to the offspring. Its single nucleus only divides to form those of the young into which this stage breaks up, but owing to such division the body may be for a while multinucleate. The trophozoite of one of the two orders (the Coccidiomorpha) remains intracellular: in the other order (the Gregarinidea) it after a time outgrows its cell host. Save in one suborder (Eugregarinaria), it passes through the usual phase of agamogony before giving rise to gamonts, but in the Eugregarinaria agamogony is omitted, and the members of the single vegetative generation become gamonts, which provide for the increase of the species by the formation of many gametes in both sexes. The gamonts may be free or intracellular. Free individuals are often able to adhere by a sticky secretion, forming what is known as a *syzygy*. When gamonts so adhere (Figs. 76, 6; 77 B) they do so in pairs<sup>1</sup> whose members are to be the parents of gametes that will unite reciprocally. Syngamy is isogamous in a few of the Gregarinidea, but is usually anisogamous, and in the Coccidiomorpha becomes an oogamy (p. 31). In some cases, perhaps in all, the first division of the zygote is a reduction division, so that nearly the whole of the cycle is haploid.

The little group Piroplasmidea, whose members in some respects resemble the Telosporidia, are best placed as an appendix to this subclass.

### Order COCCIDIOMORPHA

Telosporidia in which the adult trophozoite remains intracellular; and the female gamete is a hologamete.

Typically the members of this order are parasites of the gut, but more than once they have come to infest the blood. One such invasion gave rise to the suborder Haemosporidia. The rest of the group constitute the Coccidia.

<sup>1</sup> The term *syzygy* should perhaps be restricted to such pairs.

## Suborder COCCIDIA

Coccidiomorpha, for the most part gut parasites; of which the zygote is non-locomotory; the sporozoites are nearly always encased; and the gamonts often form a syzygy.

*Eimeria* (Fig. 74) is parasitic in the intestinal epithelium of various vertebrates and invertebrates. *E. schubergi*, from the intestine of the centipede *Lithobius*, may be described as a type of the suborder. The spherical trophozoite (agamont) undergoes schizogony (agamogony) by multiple fission within the epithelial cell which it inhabits. The spindle-shaped schizozoites (agametes) being set free into the cavity of the organ, each infects another cell in which it grows like its parent. After some days of this there occur fissions in which the young on invading a host cell grow into adults unlike their parents and of two kinds—male and female gamonts. Each female gamont extrudes stainable matter from its nucleus and thus becomes a female hologamete. In the male gamont the nucleus divides several times, and the daughter nuclei are set free with portions of the cytoplasm as biflagellate male gametes, which are thus merogametes. The gametes leave the host cell and unite while free in the gut cavity. The zygote nucleus undergoes what is probably a reduction division and encysts. Within its cyst (the oocyst) it divides by multiple fission into four sporoblasts each of which forms a cyst of its own (a secondary sporocyst) in which it divides into two sporozoites. Thus sporogony takes place in two stages. In each of these there is some residual protoplasm. Meanwhile the oocyst has passed out of the host in the faeces. Infection of a new host takes place by contamination of food by the encysted spores, which hatch in the intestine.

*Aggregata* is remarkable among coccidians for having two hosts. Its agamogony takes place in crabs and involves a generation of sporoblasts, but is not repeated. A cuttlefish, devouring a crab, ingests the agametes, which in the new host proceed to become gamonts. After gamogony with flagellate male gametes, fertilization, and sporogony, the spores, containing four or more sporozoites, are passed with the faeces of the mollusc and swallowed by a crab.

*Adelea* is parasitic in the epithelium of the gut of *Lithobius*. Its life history resembles that of *Eimeria*, but the gamonts, which differ considerably in size, the male being the smaller, become free and form a syzygy in the gut, though without encystment. The male gametes are consequently not under the necessity of reaching the female by swimming, and are not flagellated.

*Haemogregarina* has become completely a blood parasite, and has a life history closely resembling that of the Haemosporidia, with the sexual process in an invertebrate host (see below). Since, however, it

undergoes syzygy, the organism would appear to belong to the *Adelea* stock, whereas the Haemosporidia are probably related to *Eimeria*.

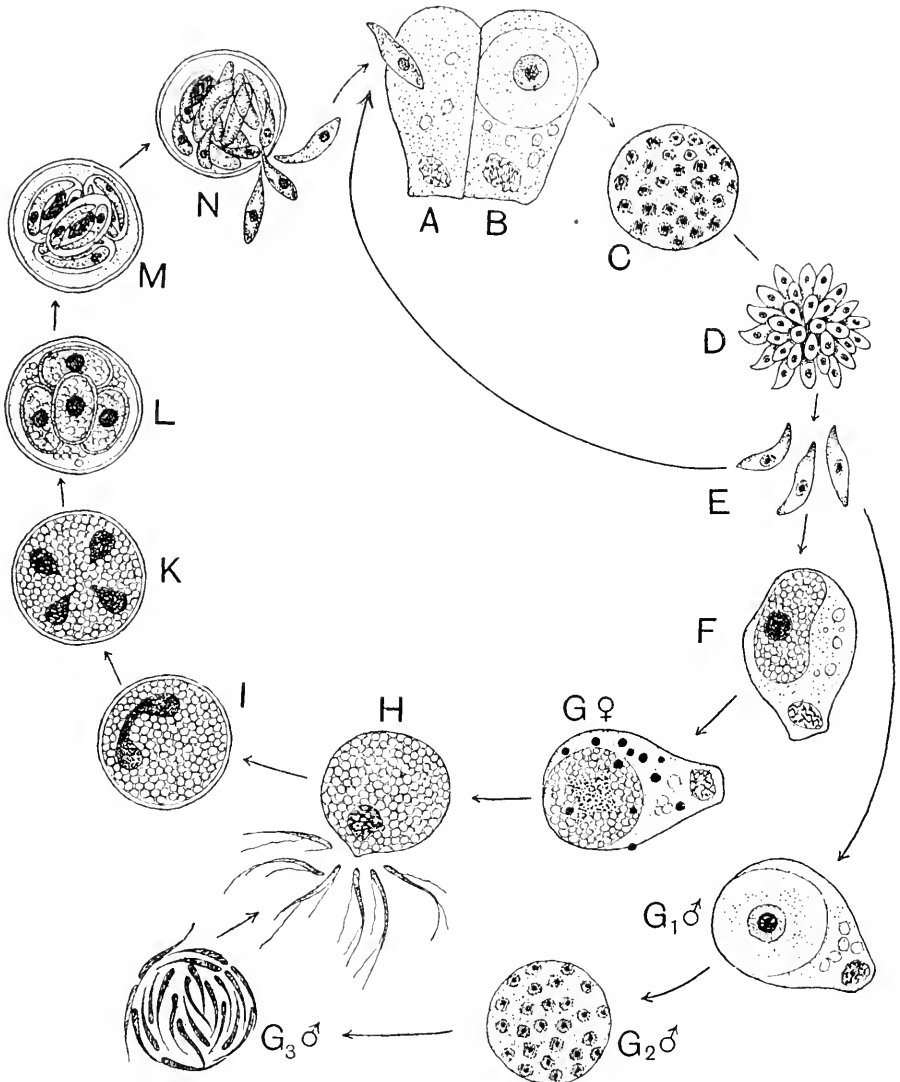

Fig. 74. A diagram of the life cycle of *Eimeria schubergi*. A, Infection of a cell of the intestinal epithelium of the host. B, Growth of the agamont. C-E, Agamogony (schizogony). F, G, Gamogony. H, Conjugation (syngamy). I-L, Division of the encysted zygote into sporoblasts. M, Division of each sporoblast within its cyst into two sporozoites. The oocyst containing the sporocysts is passed out of the host and swallowed by another. N, Escape of the sporozoites in the intestine of the new host.

*Schellackia* and *Lankesterella*, which have no syzygy, are transitional to the Haemosporidia, under which (on p. 91) their life histories are described.

Suborder *HAEMOSPORIDIA*

Coccidiomorpha, always true blood parasites; which have naked sporozoites; a locomotory zygote (*ookinete*); and no syzygy.

The members of this suborder are intracellular blood parasites of vertebrates and contain granules of pigment (melanin) derived from the haemoglobin of the host—a feature which is lacking in the blood parasites that belong to the Coccidia. They are transmitted from one vertebrate host to the next by a blood-sucking invertebrate. Their agamogony and the formation of their gamonts take place in blood cells of the vertebrate host, but their gametes are formed, and fertilization takes place, in the invertebrate. A series of intermediate cases shows how this condition may have arisen.

(1) *Schellackia* (suborder Coccidia), parasitic in the gut of a lizard, leaves the gut epithelium after schizogony and completes its cycle in the subepithelial tissues. In order to reach a new host it has therefore to rely on transference by a carrier instead of passing out with the faeces. To accomplish this, the sporozoites enter blood vessels, get into red corpuscles, and are sucked up by a mite. The blood-sucker, however, does not inject the parasite into the new vertebrate host, but is swallowed, so that the parasite infects the host through the gut epithelium, in which its schizogony is still performed.

(2) *Lankesterella* (suborder Coccidia), parasitic in frogs, passes its whole cycle in the epithelioid lining of blood vessels, the sporozoites being transferred, as in *Schellackia*, in red corpuscles, which are sucked up by a leech. Infection is still through the gut of the vertebrate, whose wall the sporozoites pierce on their way to the blood vessels.

(3) *Haemoproteus* (Haemosporidia), parasitic in birds, has its schizogony alone in the blood vessel walls, the sexual part of the cycle being remitted to the invertebrate host. The parasite enters the red corpuscles not as a sporozoite but earlier, as the young stage of the gamont, which grows up in the corpuscle. At the same time a change in the mode of infection has taken place, the blood-sucker injecting the sporozoites into the blood vessels of the vertebrate host. Thus the parasite has completely abandoned the gut wall and become a true blood parasite.

(4) *Plasmodium* (Haemosporidia), the cause of malaria and ague in man, is parasitic in the red blood-corpuscles of mammals and transmitted by the mosquito *Anopheles*. Its schizonts (trophozoites), as well as its gamonts, inhabit red corpuscles.

The trophozoites of *Plasmodium* (Fig. 75) are amoeboid. In the young stage they are rounded and each contains a large vacuole which gives it the appearance of a ring. They undergo schizogony in the

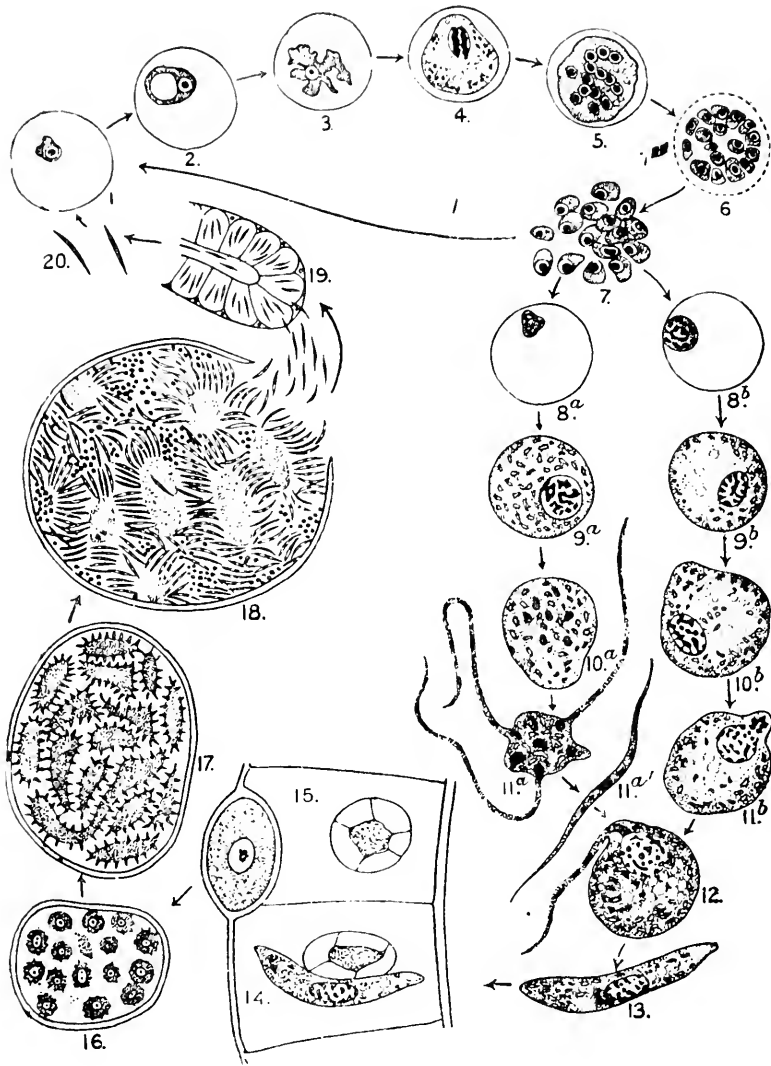

Fig. 75. A diagram of the life cycle of *Plasmodium vivax*. After Borradaile. 1-7, Schizogony (Merogony), asexual reproduction which takes place in man. 8-13, Gamogony and syngamy, which take place in the stomach of a mosquito. 14-20, Sporogony by the zygote (sporont), which takes place in the body cavity of the mosquito. 1, Infection of a red corpuscle. 2, Signet-ring stage. 3, Amoeboid stage. 4, Full-grown schizont preparing to divide. 5, Multinucleate stage. 6, Rosette stage, corpuscle breaking up. 7, Free schizonts. 8, Infection of red corpuscles by young gamonts. 9, Full-grown gamonts free in the mosquito's stomach. 10, 11, Formation of gametes. 12, Conjugation. 13, Zygote in the ookinete condition. 14, Invasion by zygote of endoderm cell of mosquito. 15, Encystment. 16, Sporoblasts formed by division of zygote (sporont). 17, 18, Formation of sporozoites. 19, Invasion by latter of salivary gland. 20, Sporozoites injected into blood of a man.

red corpuscles, which then break up, setting free the schizozoites (merozoites) and also products of the metabolism of the parasite which cause fever. After some generations, gamonts similar to those of *Eimeria* appear, but remain quiescent unless sucked up by a mosquito, in whose gut the female gamont becomes a spherical macrogamete, the male gamont throws off whip-like microgametes, and syngamy takes place. The zygote becomes elongate and active (an ookinete), and bores its way through the wall of the mosquito's stomach, on the outside of which it becomes encysted (oocyst). Here its nucleus divides and it breaks up into sporoblasts which in turn produce spindle-shaped sporozoites. The oocyst now bursts, setting the sporozoites free in the blood of the insect. They make their way into the salivary glands and are injected with the saliva into a mammalian host, where they give rise to trophozoites which infest the red corpuscles.

Three species of *Plasmodium* infest man—*P. vivax* which sets free a generation of schizozoites in forty-eight hours, *P. malariae* which does so in seventy-two hours, and *P. falciparum* whose schizogony occurs at more irregular intervals. Since the attacks of fever take place when the corpuscles break up and set free the toxins formed by the parasites, the fever caused by *P. vivax* returns every third day and is known as "tertian ague", and that caused by *P. malariae* ("quartan ague") recurs every fourth day, while *P. falciparum* causes irregular (quotidian) fevers which are more or less continuous. These latter are the "pernicious malaria" of the tropics. The morphological differences between the species are small, but *P. vivax* is distinguished by the active movement of its pigment granules and the large number (15-24) of its schizozoites, *P. malariae* by the sluggishness and often quadrilateral form of its amoeboid stage, *P. falciparum* by the paucity of its pigment and by its curved, sausage-shaped gamonts.

#### Order GREGARINIDEA

Telosporidia in which the adult trophozoite becomes extracellular; and the female (as well as the male) gametes are merogametes.

Intestinal and coelomic parasites of invertebrates, especially of arthropods and annelids.

#### Suborder SCHIZOGREGARINARIA

Gregarinidea which undergo schizogony.

*Schizocystis* (Fig. 76). Parasitic in the intestine of the larvae of dipterous flies. The young trophozoite attaches by one end to the gut epithelium of the host. Its nuclei multiply. When ripe it undergoes multiple fission. The products (schizozoites) either repeat asexual

reproduction or become gamonts. These undergo syzygy, coencystment, and gamogony. The gametes unite, and the zygotes form small oocysts ("spore cases") within the gamocyst. In its case each zygote divides into a bundle of sporozoites. The spores are set free and swallowed by new members of the host species, in whose intestine the spore cases are digested and the process repeated.

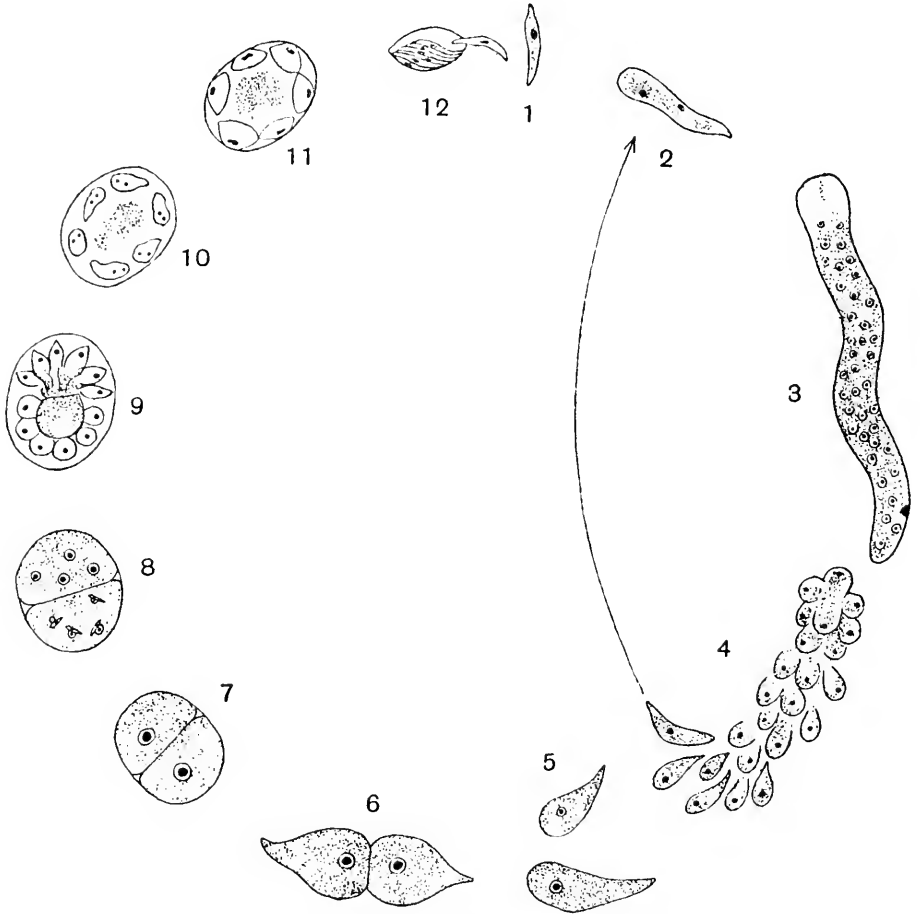

Fig. 76. A diagram of the life cycle of *Schizocystis*. 1-4, Schizogony. 5, Gamonts. 6, Syzygy. 7-9, Gamogony in a cyst (gamocyst). 10, 11, Syngamy. 12, Freed spore case containing sporozoites resulting from sporogony.

*Ophryocystis* (Fig. 77). Parasitic in the Malpighian tubules of beetles. The cushion-shaped trophozoites are attached to the host's cells by branched processes. After several generations of schizogony, they become free gamonts, enter into syzygies, encyst, and within the gamocyst undergo two divisions, whereby each forms one definitive gamete and a binucleate enveloping cell which perhaps represents abortive gametes. Syngamy then takes place, and the zygote divides



to form within the enveloping cells a parcel of eight sporozoites in a case. Thus each syzygy produces only one pair of gametes and results in only a single spore.

### Suborder *EUGREGARINARIA*

Gregarinidea which have no schizogony.

The adult trophozoite has a stout cuticle and the ectoplasm contains myonemes, longitudinal or transverse, or both. Partitions of the ectoplasm without myonemes may (Fig. 80F) divide the body into

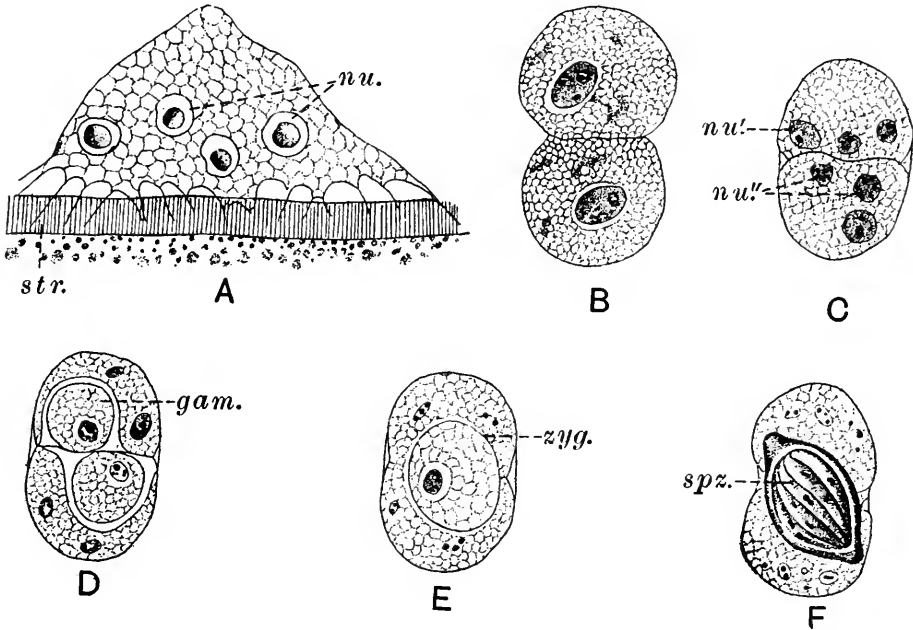

Fig. 77. Stages in the life history of *Ophryocystis mesnili*. A, Agamont, on the epithelium of a Malpighian tubule of the host. B, Syzygy. C, Formation of a cyst (gamocyst) and multiplication of nuclei. D, Formation of gametes. E, Zygote. F, Spore case with sporozoites, still enclosed in residual protoplasm of gamonts. *gam.* gamete; *nu.* nuclei of agamont; *nu.'* gamete nucleus; *nu. ''* nuclei of enveloping (residual) protoplasm; *spz.* sporozoites; *str.* striated border of epithelium of Malpighian tubule; *zyg.* zygote.

three segments—the *epimerite* or fixing organ, *protomerite*, and *deutomerite*, which latter contains the nucleus. When ripe the trophozoites become gamonts, joining in syzygies of two which together form a gamocyst and give rise to gametes (iso- or anisogametes according to species) by multiple fission in which residual protoplasm remains. Syngamy takes place within the cyst between the gametes of one parent and those of the other. The zygotes secrete small oocysts (*pseudonavicellae*) of their own, and within these divide into several sporozoites (“falciform young”). Passing out of the host these are

swallowed by another of the same species, within which their cysts are digested and a new infection begins by the sporozoites invading cells of the host. These they eventually outgrow, and lie in a cavity of the host, either entirely free or attached by an epimerite.

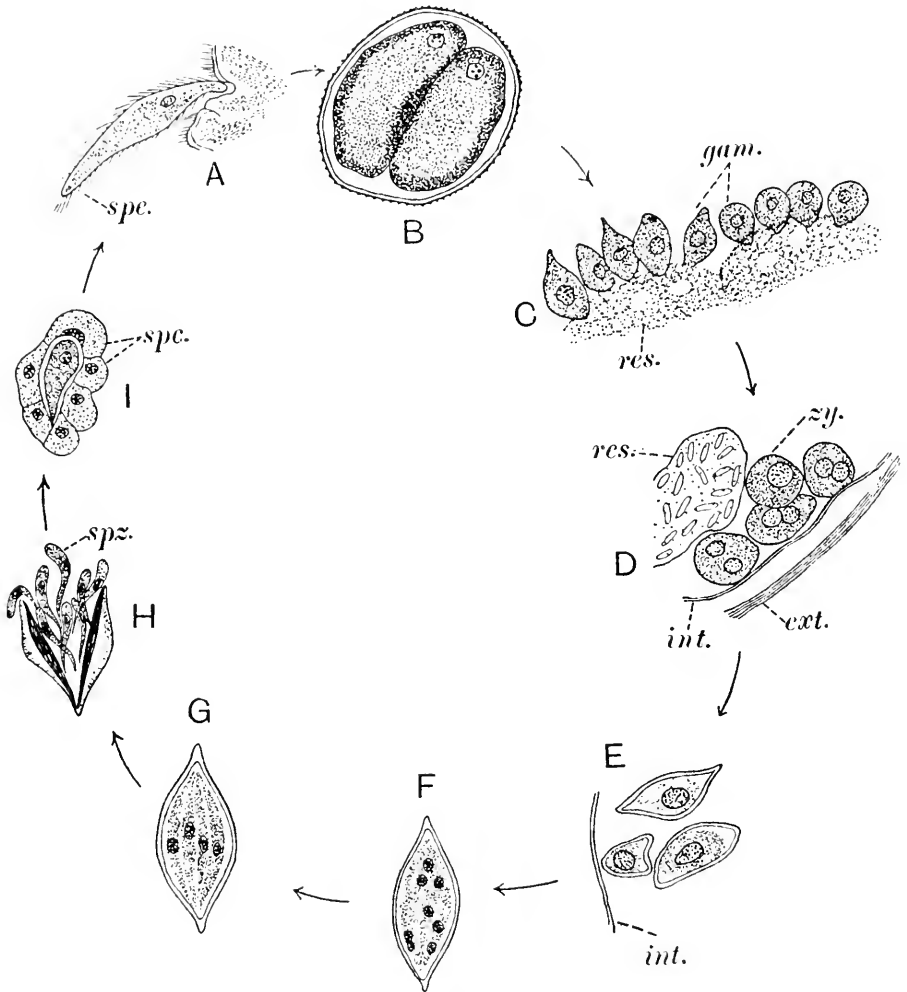

Fig. 78. A diagram of the life cycle of *Monocystis*. A, Trophozoite adhering to the seminal funnel of the host. B, Encysted syzygy. C, Formation of gametes. D, Conjugation. E, Encystment of zygotes. F, Multiplication of nuclei of the same. G, Formation of sporozoites (only four of the eight are shown). H, Release of sporozoites in intestines of new host. I, Infestation of sperm morula. *ext.* external coat of gamocyst; *gam.* gametes; *int.* internal coat of gamocyst; *res.* residual protoplasm; *spc.* cells of sperm morula; *spe.* tails of withered spermatozoa adhering to parasite; *spz.* sporozoites; *zy* zygote.

In comparing this life cycle with that of *Eimeria*, given above, it should be noted that in the gregarines, whose female gametes are merogametes and numerous, the "spores" (small sporocysts each

containing several sporozoites) are each the whole product of a zygote (i.e. are oocysts), whereas in the coccidians, where the female gamete

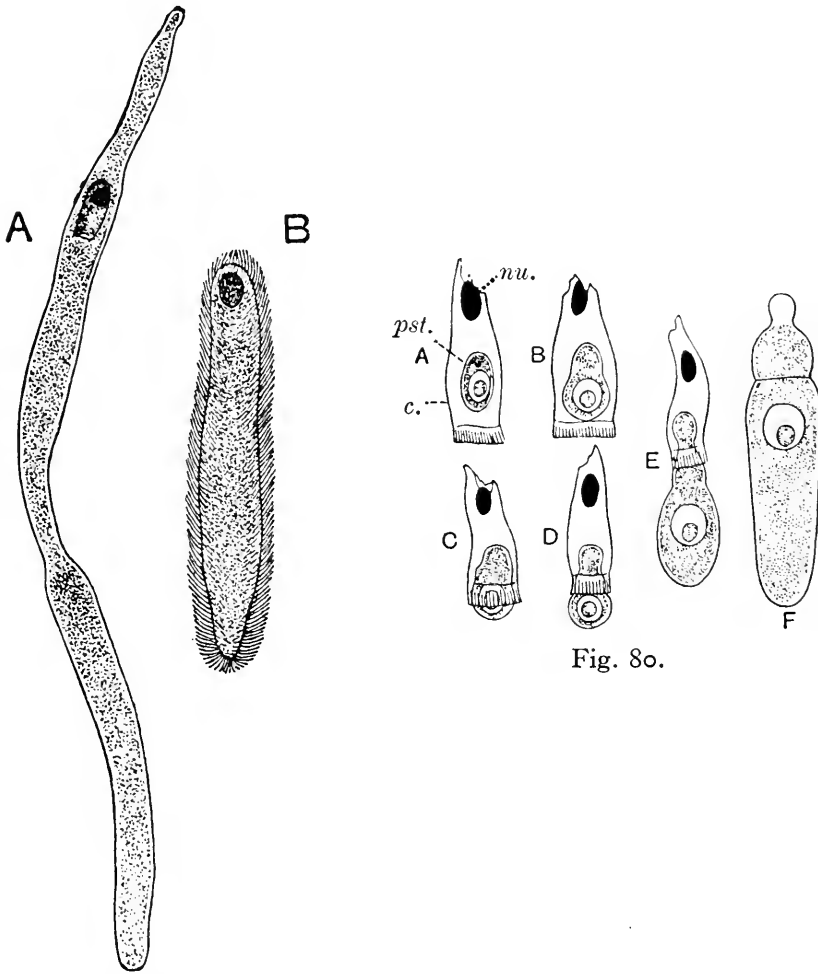

Fig. 79.

Fig. 79. *Monocystis*. From Borradaile. A, *M. magna*,  $\times 25$ . B, *M. lumbrici*,  $\times 85$ . The latter is covered with the tails of spermatozoa, the offspring of the sperm mother-cell in which it was embedded.

Fig. 80. *Gregarina longa*, from larva of *Tipula*, the Daddy-long-legs. Highly magnified. After Léger. A, B, C, D, E, Stages of the development of *G. longa* at first within and then pushing its way out of one of the cells of the intestine of the *Tipula* larva. F, Mature form. *c.* cell of intestine of host; *nu.* its nucleus; *pst.* parasite.

is a hologamete, the zygote forms, by means of a generation of sporoblasts, several such spores in its oocyst.

*Monocystis* (Fig. 79). Without divisions of the body. Parasitic in

seminal vesicles of earthworms. Several species, some isogamous, others anisogamous. The spores escape either down the vasa deferentia of the host or by the latter being eaten by a bird, whose faeces contain them intact. Swallowed by another worm, their cases are digested and the sporozoites traverse the intestinal wall to reach the vesiculae seminales, where they enter sperm mother-cells, in which they pass their earlier stages.

*Gregarina* (Fig. 80). All three divisions of the body present. Parasitic in the alimentary canals of cockroaches and other insects. The gamocyst develops into a complicated structure with ducts for the discharge of the pseudonavicellae.

## Appendix to the Telosporidia

### Order PIROPLASMIDEA

Protozoa, parasitic in red blood-corpuscles and transmitted by ticks; which have no external organs of locomotion; perform agamogony by binary fission; conjugate as hologametes; and after syngamy become motile zygotes which divide in a cyst into numerous, naked sporozoites.

The members of this group are of doubtful affinity. In the general course of the life-cycle they resemble the Telosporidia, but in the possession by the trophozoite of part of a flagellar apparatus, and in that the gametes are both hologametes, they differ from the other members of that subclass. An interesting feature of their life history is that they are transmitted in the ovum from one generation of the invertebrate host to the next. They are at present only known from mammals and ticks.

*Piroplasma* (= *Babesia*). Infests various mammals (cattle, dogs, monkeys) and causes the red-water fever of cattle and other diseases. The trophozoites, in red corpuscles, are pear-shaped and unpigmented, and have a rhizoplast and basal granule as if for a flagellum. When taken into the alimentary canal of a tick they become gametes and form zygotes, which are ookinetes (p. 91), bore through the gut wall of the host, and reach its ovary. There they enter ova in which they are transmitted to the next generation of the tick. They encyst in the ova and divide into amoeboid sporoblasts (sporokinetes) which are distributed as the cells of the host divide and by their own active migration. Thus some reach the salivary glands. There they become multinucleate and break up into sporozoites, which are injected with the saliva into a new mammalian host.

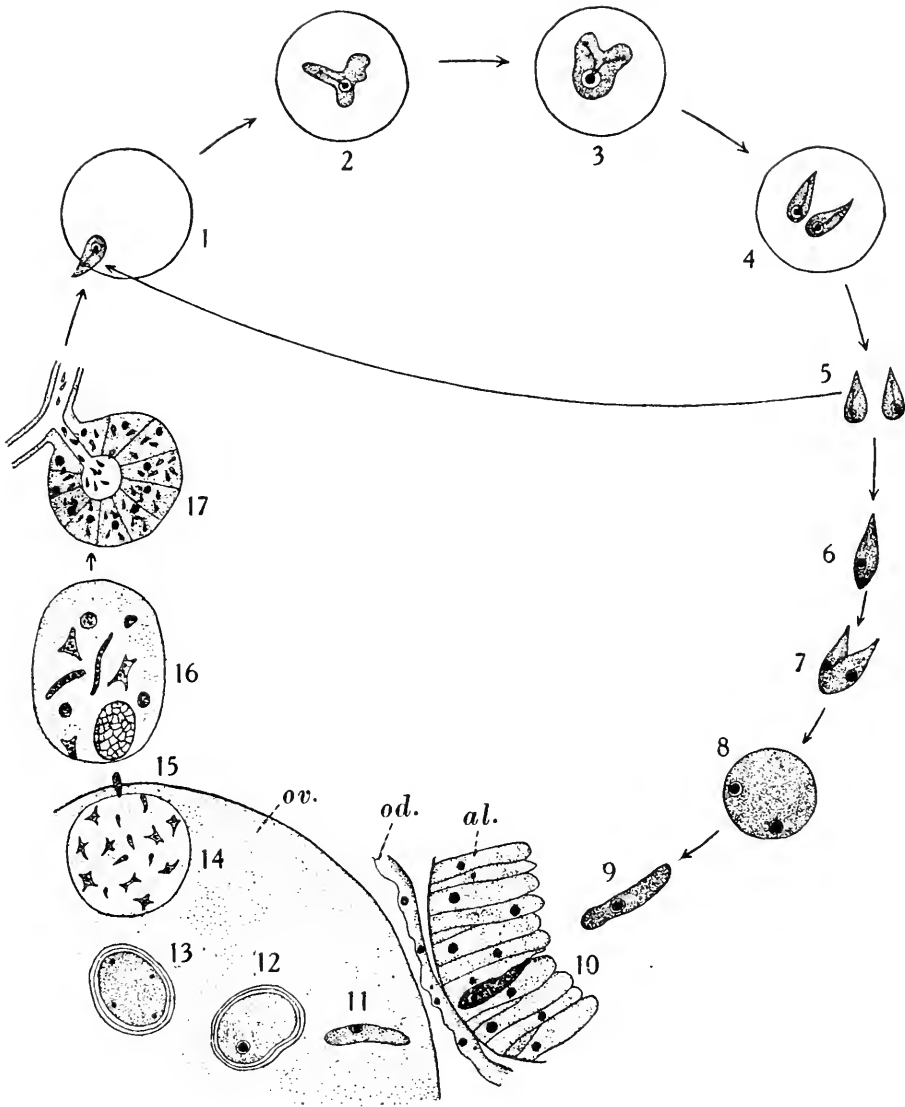

Fig. 81. A diagram of the life cycle of *Piroplasma*. After Dennis, with modifications. 1-5, agamogony in red corpuscles; 6, gamete; 7, 8, conjugation in gut of ticks; 9-12, passage of zygote through walls of gut and oviduct into ovum and encystment there; 13, 14, formation of sporoblasts; 15, migration of sporoblast; 16, sporoblasts, now multinuclear, in cell of rudiment of salivary gland of tick of second generation; 17 (less magnified), acinus of salivary gland containing sporozoites formed by break-up of sporoblasts. *al.* wall of gut; *od.* wall of oviduct; *ov.* ovum.

Subclass *NEOSPORIDIA*

Sporozoa in which the adult of the vegetative stage is a syncytium; which usually forms spores continuously within itself; and the spore cases are usually complex structures, which, except in the Actinomyxidea, contain only one germ.

## Order CNIDOSPORIDIA

Neosporidia whose spores possess pole capsules.

The formation of the spores in this group is a complex process of which the details and the relation to the typical life cycle of the Protozoa have not yet been completely elucidated. The following scheme provisionally co-ordinates the facts that have been established concerning it. In the syncytium (Fig. 82), which is the agamont and which often multiplies by plasmotomy, there arise, perhaps by the coming together of nuclei, bodies known as *pansporoblasts*, each composed of a couple of *envelope cells* with one or more cells known as *sporoblasts*. The nucleus of each sporoblast divides and the sporoblast gives rise to a complex, multicellular spore, composed of a *case* of two or three pieces, each with an underlying nucleus, one to five nematocyst-like *pole capsules*, each with a nucleus, and one or more *germs*. In most cases the germ is single and at first has two nuclei, which later fuse. Here we may regard the sporoblast as a gamont and the products of its division as homologues of gametes, of which some become the accessory cells of the spore and two (those which the germ at first possesses) the definitive gametes. In one group, however (the Actinomyxidea), there are several germs (often as a syncytium), and syngamy takes place not between nuclei in a germ but at an earlier stage, between pairs of cells in the pansporoblast, each zygote becoming a sporoblast. Here the sporoblast is a true sporont, and the products of its division are homologues of sporozoites, of which some become the accessory cells of the spore and the others (the germs) are the definitive sporozoites. It is a remarkable, but apparently an established, fact, that syngamy thus takes place at different stages in the formation of essentially similar spores.

Infection of new hosts is by the mouth, and the function of the pole capsules is, by discharging their threads, to anchor the spore to the gut wall. A schizogony may precede pansporoblast formation.

Of the three suborders of the Cnidosporidia, the *Myxosporidia* have two or four pole capsules in the spore, the *Microsporidia* one, and the *Actinomyxidea* three. The latter group also differ from the other two in respect of the germs, as mentioned above.

*Myxobolus* (Myxosporidia, Fig. 82). Large syncytia in the tissues of various freshwater fishes. Some species are harmless, others dangerous pests.

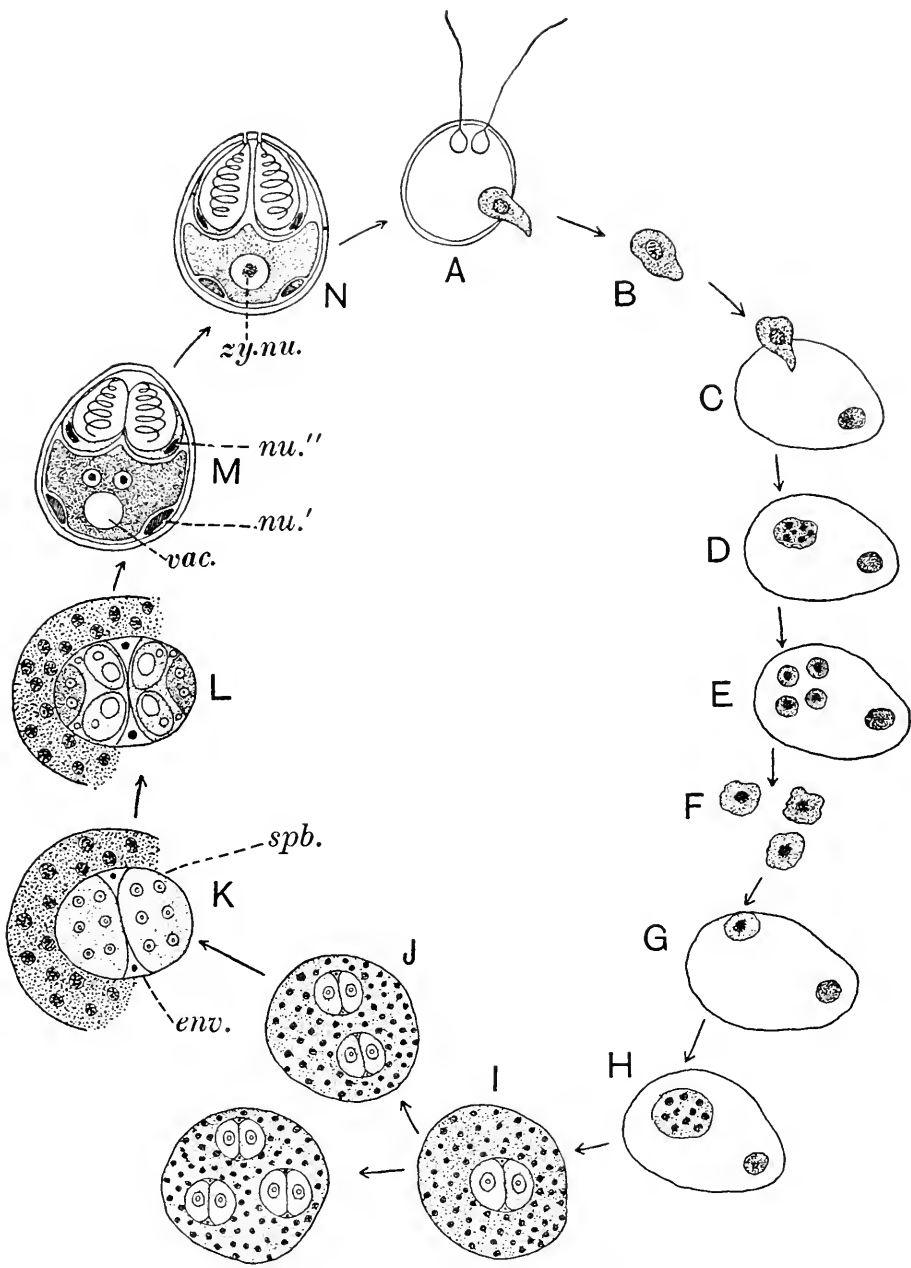

Fig. 82. A diagram of the life cycle of a typical member of the Myxosporidia. The schizogony shown here (D-F) probably often does not occur. A, Escape of germ. B, Migration within host. C, Infection of a cell of the latter. D-G, Schizogony and reinfection. H, Multiplication of nuclei. I, Appearance of first pansporoblast. J, Appearance of more pansporoblasts and multiplication of syncytium by plasmotomy. K, L, Development of spores in a pansporoblast. M, Fully formed spore, before conjugation. N, Ripe spore after conjugation. *env.* envelope cell; *nu.'* nucleus of spore case; *nu.''* nucleus of pole capsule; *spb.* undifferentiated sporoblast with nuclei which will become those of the germ, spore case, and pole capsules; *vac.* vacuole containing glycogen sometimes found; *zy.nu.* zygote nucleus.

*Nosema* (Microsporidia). The syncytium early breaks up, first into binucleate forms and finally into single sporoblasts. In the intestinal epithelium of insects. A serious pest of the silkworm, causing the disease known as pébrine, and of the bee.

*Sphaeractinomyxon* (Actinomyxidea). The whole body is reduced to a single pansporoblast, as in all members of the suborder. The spores are without the spines found in related genera. In annelids.

#### Order HAPLOSPORIDIA

Neosporidia whose spores possess cases with a lid, but have no pole capsules.

This order contains certain parasites which infest aquatic invertebrates. They are perhaps derived from the Cnidosporidia by loss of the pole capsules.

*Haplosporidium*, parasitic chiefly in annelids, is the typical genus.

#### Order SARCOSPORIDIA

Neosporidia whose spores do not possess cases or pole capsules.

These organisms are tubular syncytia with a radially striped ectoplasm, parasitic in the muscle fibres of mammals, and reproducing by simple, sickle-shaped spores.

*Sarcocystis* (Fig. 83). In various mammals, occasionally in man.

#### Class CILIOPHORA

Protozoa which, at least as young, possess cilia; are never amoeboid; if parasitic are very rarely intracellular; nearly always possess a meganucleus; and do not, after syngamy, form large numbers of spores.

This class, though some of its parasitic members are of comparatively simple structure, contains the most highly organized Protozoa. Facts concerning sundry of the organs and processes in its members (the ciliary apparatus, p. 17; the contractile vacuole system, pp. 21, 22; the nucleus, p. 26; conjugation, p. 33; etc.) have been stated above. The life history, except for the remarkable process of conjugation undergone by most of the class, is relatively uncomplicated. In particular, though the nuclear peculiarities of the typical members of the group render inevitable certain special features in the metagamic divisions, there is no true sporogony.

#### Subclass CILIATA

Ciliophora which as adults possess cilia; and which do not possess suctorial tentacles.

The *morphology* of this group is much affected by the disposition of the apparatus used in obtaining nutriment. The food may be ab-



sorbed through the surface: the shape of the body is then simple (Figs. 5, 87 A). Nearly always, however, there is a mouth. In some of the lower genera this is anterior and terminal, or nearly so (Fig. 89 A), but usually it is removed to one side of the body (Fig. 87 E). This side is then said to be "ventral", and that opposite to it is "dorsal".

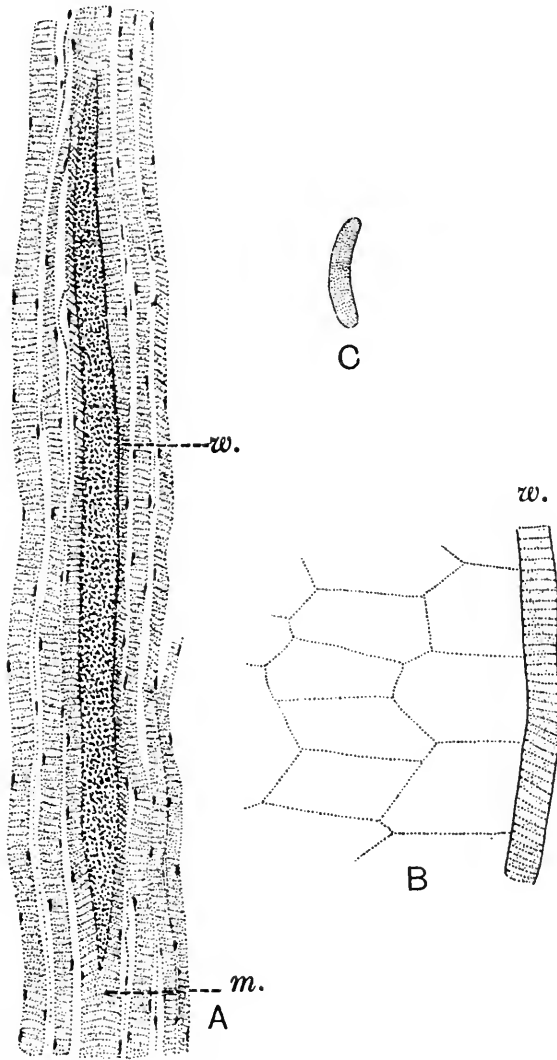

Fig. 83. *Sarcocystis lindemanni*, from the vocal cords of man. After Baraban and Saint-Rémy. A, Longitudinal section of muscle fibres, showing the parasite *in situ* in a fibre,  $\times 300$ . B, Enlarged portion of outer region of parasite, showing the striated wall, and some of the compartments which contain the spores. C, A single spore,  $\times 1600$ . *m.* muscle fibre; *w.* wall of parasite.

The *mouth*, either is merely a soft patch of exposed endoplasm or possesses a *gullet* (p. 19). In a relatively few cases (including all those in which the mouth is terminal and a few of those in which it is

ventral) the mouth is at the surface of the body: in such cases the gullet, if there be one, is an *oesophagus*, excavated in the endoplasm and capable of being opened and closed to seize the prey which is of some size. Most often, however, there is a *vestibule*. This, to which also the name "gullet" is often applied, is a depression leading to the mouth, incapable of being closed, lined by inturned ectoplasm, and containing a ciliary apparatus, which usually includes one or more *undulating membranes*. By this apparatus the minute objects which constitute the food of all ciliates that have a vestibule are drawn in, being meanwhile, in some cases at least, entangled by a mucous secretion. At the bottom of the vestibule lies the true mouth; sometimes an oesophagus is present (*Stentor*) or is represented by a cleft in the endoplasm (*Paramecium*). The inner part of the vestibule may be free from cilia, and so simulate an oesophagus (*Paramecium*, *Vorticella*).<sup>1</sup> The vestibule is usually approached by a *peristome*. This is a groove, of varying dimensions, which leads from the front end along the ventral side to the opening (cytostome) of the gullet. It is not straight, but runs in a longer or shorter spiral round the body, so that the anterior end of the latter is spirally deformed (Figs. 16, 84 A). The higher forms have along what is primarily the outer edge of the peristome a food-gathering row of cirri or membranellae, the *adoral wreath* (Fig. 90, *ad.mae.*). Typically, the spiral is open, as in *Paramecium*, but in some cases, as in *Stentor* (Figs. 84 B, 89 C), it has contracted, so that it lies coiled as a crown at the anterior end. In such cases the animal is usually fixed temporarily or permanently by the opposite end.

The members of one order (Hypotricha) are depressed dorso-ventrally, and have a flat ventral side, along which the peristome runs and which is usually provided with a complex apparatus of cirri (Figs. 90, 91). The animal applies this side to the substratum, in locomotion upon which certain of the cirri are used. The dorsal side is naked save for a few "sensory" cilia. It is probably from such forms that the familiar bell-animalcules and their relations (Peritricha) are derived. In these, the shape of the body and the position of the peristome at first suggest that the morphological peculiarities of the group are due to an evolution similar to that by which such forms as *Stentor* came into being—but the fact that the peristome, which in all other ciliates that possess it curves clockwise, is in the Peritricha twisted in the opposite direction, makes this view impossible. The origin of the Peritricha may be explained as follows (Fig. 84). In

<sup>1</sup> It is possible that this is a true oesophagus. Other regions are sometimes to be distinguished in the vestibule: in *Paramecium*, for instance, its outer section has trichocysts and cilia but no membranes, its middle section membranes only.

hypotrichous forms which had taken to fixing themselves to the substratum by that (ventral) side which they applied to it, the mouth, being no longer of use in its ventral situation, moved to the left side. The peristome accordingly came to run along the edge of the body, around which it became continued on the dorsal surface. In dorsal aspect its direction is of course reversed; and the adoral wreath has come to be internal. The body, in correspondence with the changed habit of life, has shortened, till its outline, seen from above, is circular, and has deepened. Thus the oral-aboral axis of the Peritricha is not anteroposterior as in *Stentor*, but dorsoventral.

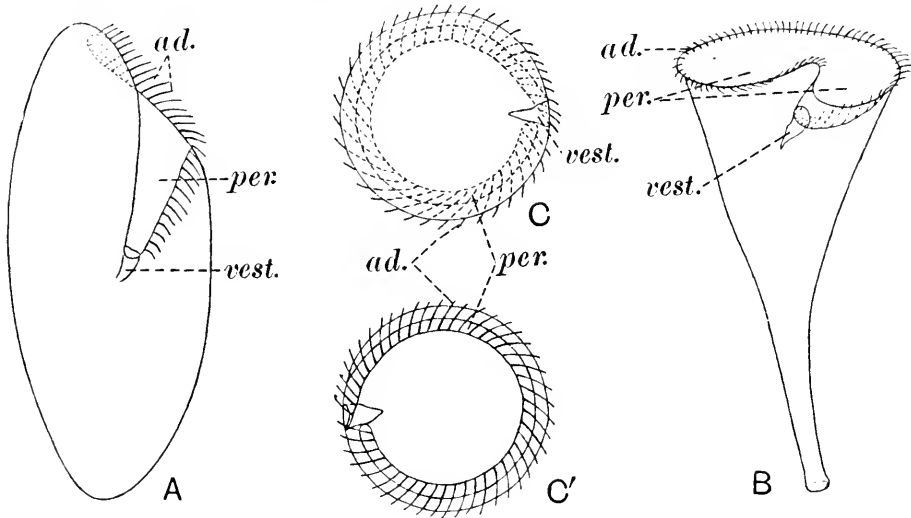

Fig. 84. A diagram of the disposition of the peristome in various ciliata. A, Ventral view of a typical heterotrichous form. B, Similar view of *Stentor*. C, Ventral (aboral) view of a peritrichous form without stalk, such as *Trichodina* (Fig. 86 D). C', Dorsal (oral) view of the same. *ad.* adoral wreath of membranellae; *vest.* vestibule; *per.* peristome.

The general surface of the body is in the lower and in some of the higher genera uniformly covered with cilia, but most of the more highly organized forms are naked save where there stand certain special pieces of ciliary apparatus. The ectoplasm (Fig. 85) has a definite and often complicated structure. There is always a tough pellicle, which is frequently sculptured. Under it is often an *alveolar layer* of minute, regular vacuoles. When there are myonemes, these lie on the inner walls of larger canal vacuoles of this layer. Under it again is usually a layer, the *cortex*, whose firm consistency prevents the granules, vacuoles, etc., of the endoplasm from entering it, though it may possess small granules of its own. The basal granules of the cilia lie immediately below the alveolar layer; trichocysts are imbedded in the cortex. Either the cortex or both it and the alveolar

layer may be absent. In *Paramecium* the cortex is covered by a thick pellicle which possibly contains a minute alveolar layer.

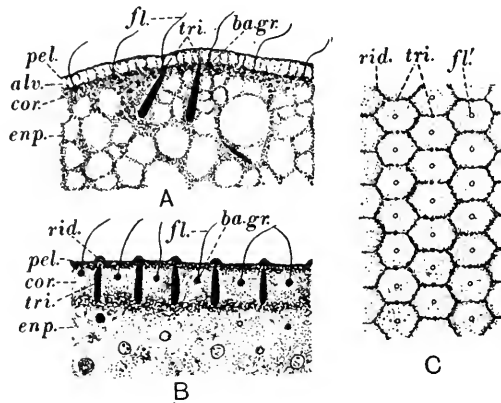

Fig. 85. Details of the ectoplasm of ciliates. After Wetzell. A, *Frontonia leucas* (Vestibulata). B, *Paramecium*. C, The same, surface view. *alv.* alveolar layer; *ba.gr.* basal granules; *cor.* cortex; *enp.* endoplasm; *fl.* flagellum; *fl.'* insertion of flagellum; *pel.* pellicle; *rid.* ridges of pellicle; *tri.* trichocyst.

### Order HOLOTRICHA (ASPIRIGERA)

Ciliata which do not possess an adoral wreath; and which nearly all have uniform ciliation of the whole surface of the body.

This order is a collection of relatively simply organized ciliates, some of which are primitive while others are degenerate through parasitism.

#### Suborder PROCILIATA

Holotricha without mouth; and without differentiation of meganuclei from micronuclei.

*Opalina* (Figs. 5, 21 C, 86). With several, usually many, nuclei, which are all alike. In each nucleus, however, there can be dis-

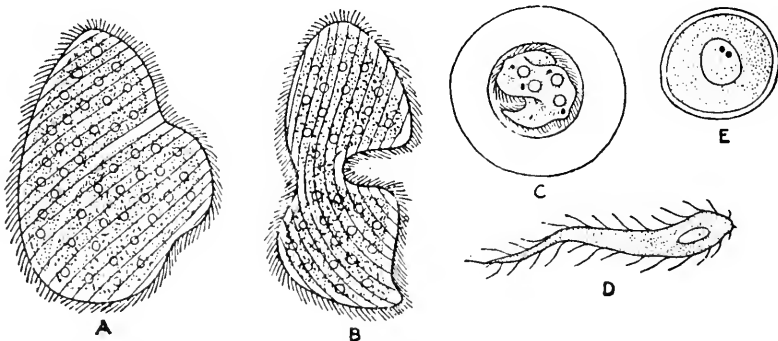

Fig. 86. *Opalina ranarum*. From Borradaile. A, Ordinary individual in longitudinal fission. B, The same in transverse fission. C, Small encysted individual (distributive phase). D, Gamete. E, Encysted zygote.

tinguished two kinds of chromosomes, which are held to represent the chromatin of the mega- and micronuclei of other ciliates. The life history differs from that of other members of the class in that syngamy is of the normal type. The agamont, parasitic in the rectum of a frog or toad, reproduces by binary plasmotomy. In the spring the plasmotomy outruns the nuclear divisions so that there arise small individuals with few nuclei. These encyst and pass out of the host. Swallowed by a tadpole, they hatch, and give rise to uninucleate gametes, of two sizes (anisogamous). After fusion of the gametes the zygote encysts for a while, issues, and by nuclear division becomes the adult agamont.

#### Suborder *ASTOMATA*

Holotricha without mouth; but with mega- and micronuclei.

Unlike *Opalina*, the members of this group are probably not primitive but degenerate through parasitism.

*Collinia*. Parasitic in the blood-spaces of the gills of *Gammarus* and other crustaceans.

*Anoplophrya* (Fig. 87A). Reproduction by repeated budding at one end of the elongate body, forming a chain. Parasitic in various annelids.

#### Suborder *GYMNOSTOMATA*

Holotricha with a mouth, whose gullet, if any, is without ciliary apparatus (i.e. an oesophagus); and with mega- and micronuclei.

*Ichthyophthirius*. Subspherical, with a mouth at one pole and short gullet; numerous contractile vacuoles near the surface of the body; and a meganucleus, but no micronuclei visible in the adult. Parasitic in various freshwater fishes, where it lies in blisters in the skin. When it is full-grown, it falls out of the host, encysts, and forms by repeated fission a number of small ciliospores, each of which has a mega- and a micronucleus, the latter having appeared during the process, perhaps from within the meganucleus. The spores infect new hosts. A sexual process of the nature of autogamy has been described, but is very doubtful.

*Prorodon* (Fig. 89A). Ovoidal, with mouth at one pole, a deep gullet which is supported by skeletal rods and is capable of opening and closing; one mega- and one micronucleus. In fresh waters.

*Loxodes*. Compressed, with mouth as a mere slit in the pellicle on the ventral edge of the body, overhung by the beak-like anterior end; numerous mega- and micronuclei; a row of vacuoles containing excreta along the dorsal border, and a contractile vacuole at the hinder end. In fresh waters.

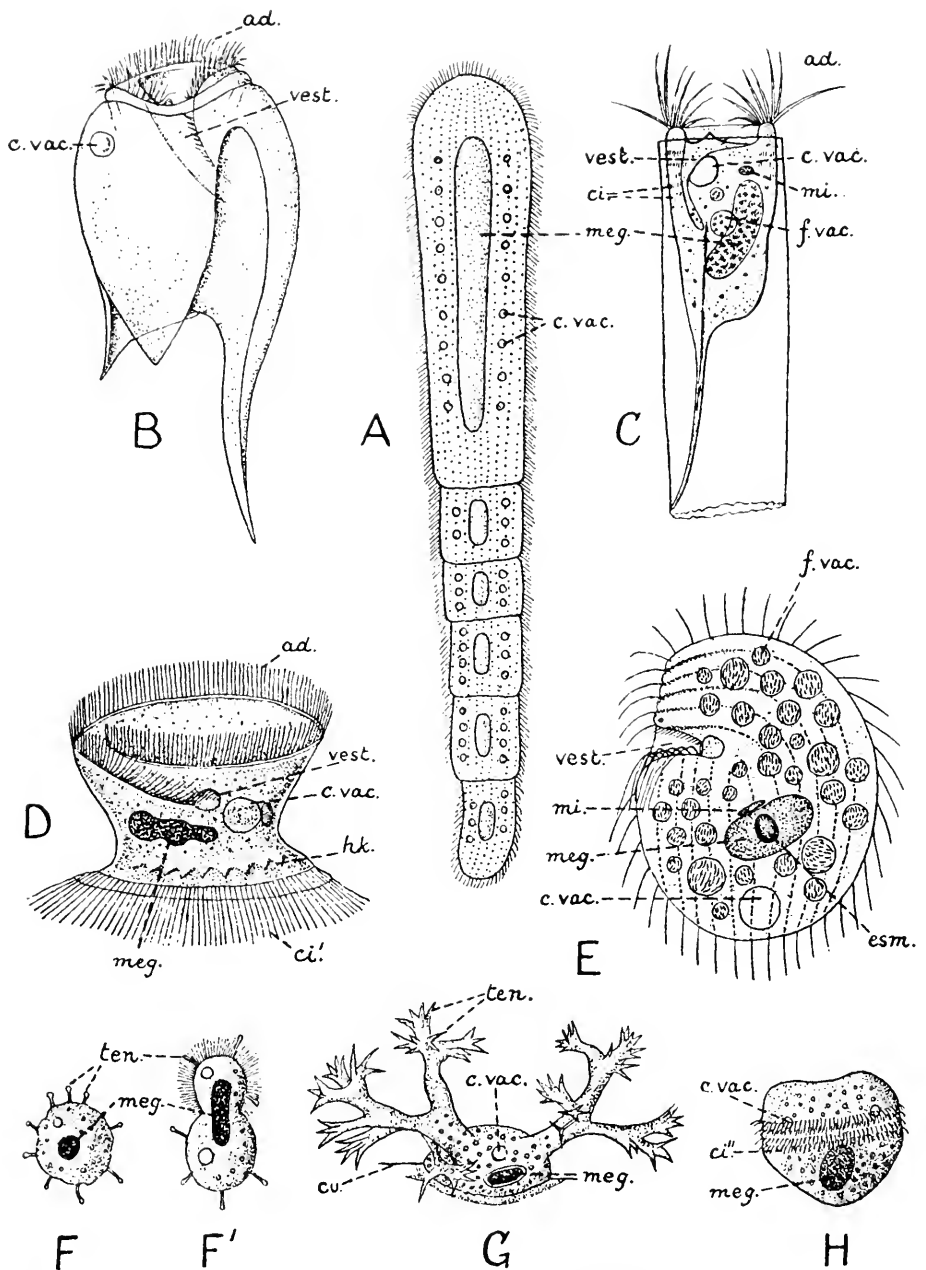

Fig. 87. Various Ciliophora. A, *Anoplophrya prolifera*,  $\times 200$ , after Saville-Kent. B, *Entodinium caudatum*, after Schuberg. C, *Tintinnidium inquilinum*, after Fauré-Fremiet. D, *Trichodina pediculus*,  $\times 450$ , after Bütschli. E, *Colpoda steini*,  $\times 1300$ , after Wenyon. F, *Sphaerophrya sol*, in the free stage,  $\times 170$ , after Bütschli. F', The same, dividing subequally to form a ciliated bud. G, *Dendrocometes paradoxus*,  $\times 250$ , after Bütschli. H, Free bud of *Tocophrya quadripartita*, after Bütschli. *ad.* adoral wreath; *c.vac.* contractile vacuole; *ci.* rows of body cilia; *ci.'* aboral ring of cilia; *ci.ii'* girdle of cilia; *cu.* cuticle of host; *esm.* endosome of meganucleus (an unusual feature); *f.vac.* food vacuole; *hk.* hooks; *meg.* meganucleus; *mi.* micronucleus; *ten.* tentacles; *vest.* vestibule.

Suborder *VESTIBULATA (HYMENOSTOMATA)*

Holotricha with a mouth and a gullet (vestibule) which is permanently open and usually possesses an undulating membrane; and with mega- and micronuclei.

*Colpoda* (Fig. 87 E). Kidney-shaped; with large vestibule on concave side; but no undulating membrane; and no peristome. Fission, binary or repeated, takes place in a cyst. Common in infusions, freshwater and marine.

*Colpidium*. As *Colpoda*; but with undulating membrane. Common in infusions, freshwater and marine.

*Paramecium* (Figs. 9, 15, 16, 17, 26, 85). Slipper- or pear-shaped according to species; with undulating membranes<sup>1</sup>; and peristome. Common in infusions, freshwater and marine.

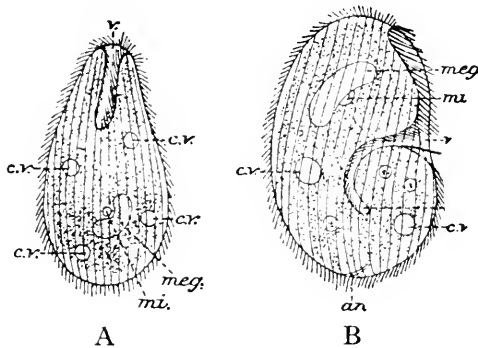

Fig. 88. Ciliata from the rectum of the frog. From Borradaile. A, *Balantidium entozoon*,  $\times 65$ . B, *Nyctotherus cordiformis*,  $\times 130$ . *an.* anus; *c.v.* contractile vacuole; *meg.* meganucleus; *mi.* micronucleus; *v.* vestibule.

## Order HETEROTRICHA

Ciliata which possess a gullet, permanently open and provided with undulating membrane; an adoral wreath, curving clockwise; and most often on the rest of the body a uniform covering of cilia; and whose body is not depressed.

Suborder *POLYTRICHA*

Heterotricha which retain the uniform ciliation of the general surface of the body.

*Balantidium* (Fig. 88 A). Egg-shaped; the peristome a deep groove at the anterior end. Parasitic in the rectum of frogs, the intestine of man (where it is occasionally harmful), etc.

*Nyctotherus* (Fig. 88 B). Kidney-shaped; with permanent anus. Parasitic in the rectum of frogs, the intestine of man, etc.

<sup>1</sup> There are three of these, each composed of four rows of cilia. See p. 104.

*Spirostomum* (Fig. 89 B). Rod-shaped; with the peristome as a long groove; meganucleus beaded; several micronuclei. In fresh waters and marine.

*Stentor* (Fig. 89 C). Long and funnel-shaped; attached by the base, but often frees itself to swim; meganucleus beaded; several micronuclei. The animal is very highly contractile. In fresh waters.

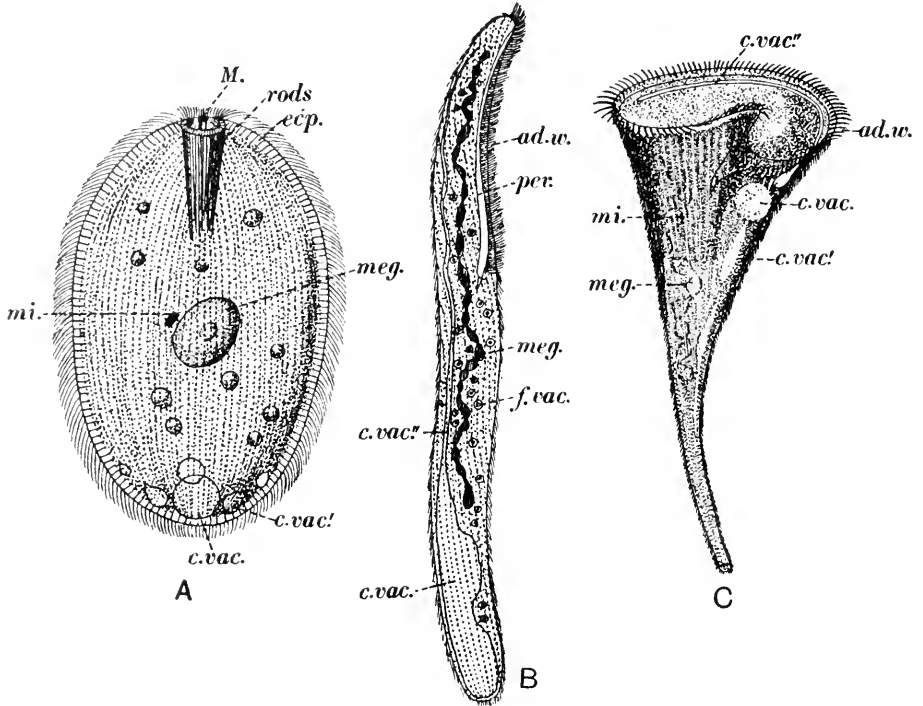

Fig. 89. Ciliata. After various authors. A, *Prorodon teres*,  $\times 500$ . B, *Spirostomum ambiguum*,  $\times 150$ . C, *Stentor coeruleus*,  $\times 50$ . *ad.w.* adoral wreath; *c.vac.* contractile vacuole; *c.vac.'* accessory vacuole; *c.vac. ''* accessory canal; *f.vac.* food vacuole; *ecp.* ectoplasm; *M.* mouth; *meg.* meganucleus; *mi.* micronucleus; *per.* peristome; *rods* in protoplasm around gullet.

### Suborder OLIGOTRICHA

Heterotricha of shortened form; with the body cilia reduced to a few rows or absent.

This suborder contains two tribes of very different habits, the pelagic Tintinnina, and the Entodiniomorpha, forms of bizarre shape parasitic in the alimentary canal of mammals, chiefly in the stomach of ruminants. Both suborders have an anterior peristome with very strong membranellae, and are naked on the rest of the body, save sometimes for a few cilia or patches of cirri.

*Tintinnidium* (Fig. 87 C). (Tintinnina.) Cup-shaped; anchored by an aboral process into a chitinous case. In fresh waters and marine.



*Entodinium* (Fig. 87 B). (Entodiniomorpha.) With three posterior processes, of which the largest is said to serve as a rudder. In the rumen and reticulum of sheep and oxen. Like others of the tribe, these organisms are present in such numbers that they are believed to be symbionts which play a part in the nutrition of the host, rendering the vegetable food more easily assimilable by feeding on it and being in turn digested further on in the alimentary canal. Infection of the host is probably by cysts on grass.

#### Order HYPOTRICHA

Ciliata with depressed body; a gullet, permanently open and provided with undulating membranes; an adoral wreath, curving clockwise; the dorsal cilia represented only by a few stiff hairs; and on the ventral side usually an elaborate system of cirri and other ciliary organs.

The animals can swim but spend much of their time crawling over solid objects by means of the cirri.

*Stylonichia* (Figs. 90, 91). A typical example. Common in infusions.

*Kerona*. With a less highly developed ciliary system than *Stylonichia*. Ectoparasitic on *Hydra*.

#### Order PERITRICHA

Ciliata, for the most part permanently fixed by the aboral surface; with a gullet, permanently open and provided with undulating membrane; an adoral wreath, curving counter-clockwise; and on the rest of the body no cilia, save those of an aboral ring in the free-swimming species and stages.

The conjugation of members of this group has been discussed on p. 33, their morphology on pp. 104, 105. The anus and contractile vacuole open into the deep vestibule, perhaps owing to an extension of the depression of the ectoplasm which forms the latter. The meganucleus is horseshoe-shaped.

*Trichodina* (Fig. 87 D). Dice-box shaped; with aboral ring of cilia for swimming, enclosing a ring of hooks for temporary attachment. Ectoparasitic on *Hydra* and other animals.

*Vorticella* (Figs. 2, 92). Shaped like a solid, inverted bell, with, in place of the handle, a stalk which consists of a prolongation of the body, and is clad in a cuticle and contractile by means of a myoneme. Solitary. In fresh waters and marine.

*Carchesium* (Fig. 93). As *Vorticella*, but colonial. In fresh waters.

*Epistylis*. As *Carchesium*, but the stalk is purely cuticular and non-contractile. In fresh waters and marine.

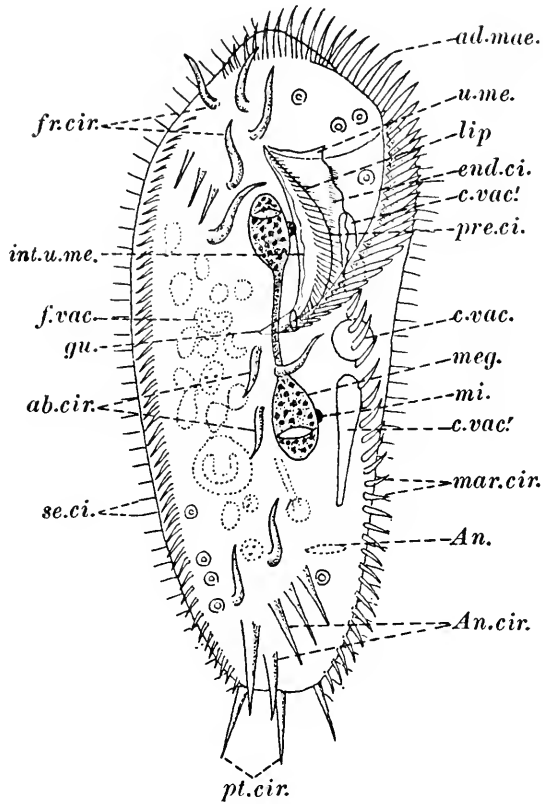

Fig. 90. *Stylonichia mytilus*, in ventral view,  $\times 200$ . After various authors. *ab.cir.* abdominal cirri; *ad.mae.* adoral membranellae; *An.* position of anus (on dorsal side); *An.cir.* anal cirri; *c.vac.* contractile vacuole; *c.vac.'* accessory canal of the same; *end.ci.* endoral cilia; *f.vac.* food vacuole; *fr.cir.* frontal cirri; *gu.* gullet; *int.u.me.* internal undulating membrane; *lip.* projecting lower lip of peristome; *mar.cir.* marginal cirri; *meg.* meganucleus; *mi.* micronucleus; *pre.ci.* preoral cilia; *pt.cir.* posterior cirri; *se.ci.* "sensory" cilia of dorsal surface; *u.me.* preoral undulating membrane (another undulating membrane is present but is omitted, to simplify the figure).

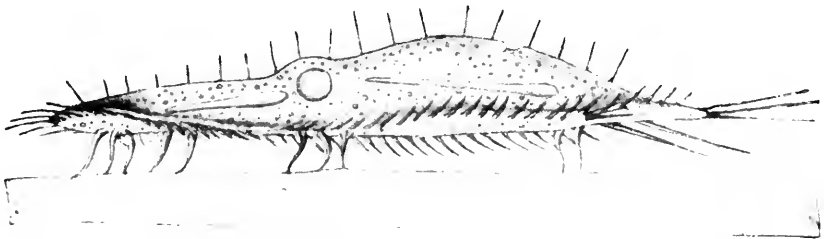

Fig. 91. *Stylonichia mytilus*, from the left side. After Bütschli.

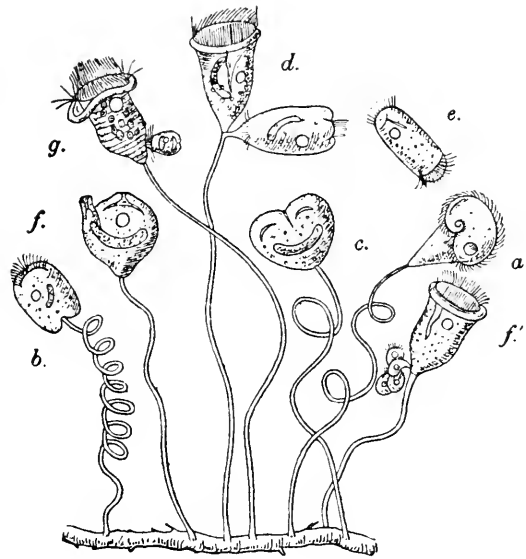

Fig. 92.

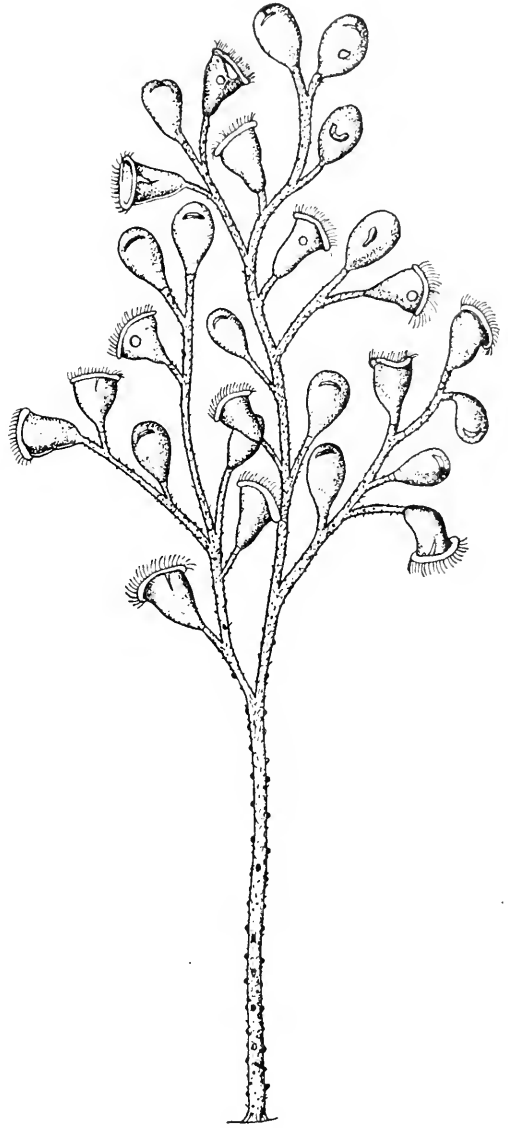

Fig. 93.

Fig. 92. A group of individuals of *Vorticella* in various phases of the life history. From Borradaile. *a*, Ordinary individual. *b*, The same contracted. *c*, Ordinary fission. *d*, A later stage of the same. *e*, Free-swimming individual produced by ordinary fission. *f*, *f'*, Two modes of fission to form microconjugants (*f*, budding; *f'*, repeated fission of one product of a binary fission). *g*, Conjugation.

Fig. 93. *Carchesium epistylidis*,  $\times 100$ . After Saville-Kent.

## Order CHONOTRICHA

Ciliata, permanently sessile by the posterior end upon the bodies of crustacea; with the peristome represented by a spiral funnel at the anterior end, coiled clockwise, ciliated inside, and leading to the mouth; and the rest of the body naked.

A small but very interesting group which shares with the Prociliata two characteristics not found elsewhere in the class, namely (1) that their nuclei are of one kind only and at mitosis form two sets of chromosomes (see p. 26), (2) that they form numerous gametes,

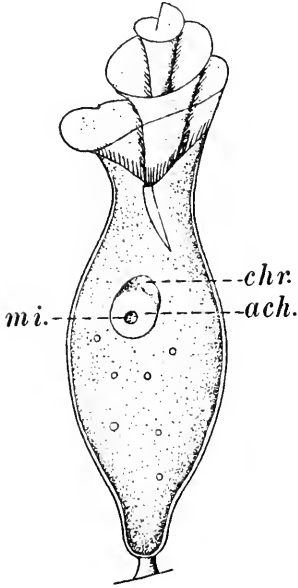

Fig. 94.

Fig. 94. *Spirochona gemmipara*,  $\times 520$ . *ach.* achromatic part of nucleus (centrosphere); *chr.* chromatin; *mi.* micronucleus (which divides within meganucleus, where it appears when division is impending).

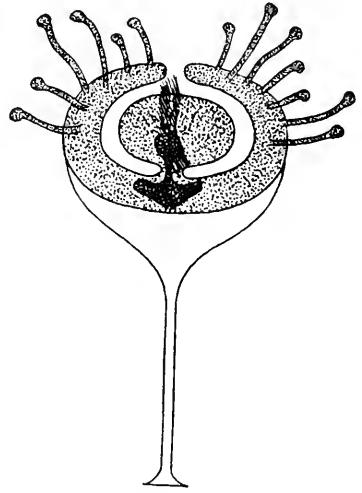

Fig. 95.

Fig. 95. A diagram of the formation of an internal bud by one of the Suctorium.

which unite in the same way as those of members of the other classes of the phylum. In the Chonotricha the reproduction, both sexual and asexual, is carried out by buds. The nucleus contains a large achromatic mass which acts as a division centre.

*Spirochona* (Fig. 94). Shaped like a slender vase. On the gills of *Gammarus*, etc., in fresh and marine waters.

## Subclass SUCTORIA

Ciliophora of which all but a few primitive forms lose their cilia in the adult; and which possess one or more suctorial tentacles.

A few members of the group are free; a few are endoparasitic; most

are attached, and these have usually a cuticular *stalk*, which is often expanded at the end to form a shallow cup in which the animal sits or a deep one which encloses it.

The suctorial *tentacles* contain a tube, lined by ectoplasm, which opens at the end, where there is often a knob. In some species there are also solid, sticky tentacles, used to capture prey.

*Reproduction* by simple binary fission does not occur. In a few cases fission is equal or almost so (*Podophrya*, *Sphaerophrya*, Fig. 87 F'), but here one of the products differs from the parent in losing its tentacles and acquiring cilia and thus resembles the buds of other species. This happens whether the parent be a stalked or a floating form. Most species multiply by typical budding. The buds may be external (Fig. 96 B) or formed in brood pouches (Fig. 95) from which they

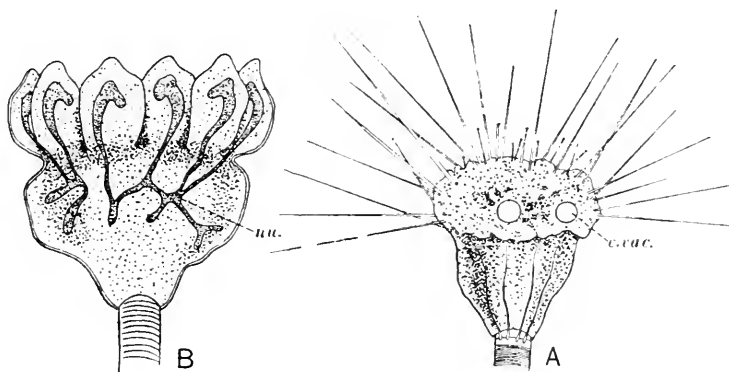

Fig. 96. *Ephelota gemmipara*. After Hertwig. A, Ordinary individual,  $\times 150$ . B, Budding individual. *c.vac.* contractile vacuoles; *nu.* meganucleus (stained); processes of this form the meganuclei of the buds, as in all the budding of the Suctoria (cf. Figs. 87 F', 95).

escape when they are ripe. External budding is the more primitive, internal the commoner process. In either, one bud or more than one may be formed at a time. The buds (Fig. 87 H), whether external or internal, are usually ciliated and at first without tentacles; the cilia form a girdle round the body, with sometimes the vestige of an adoral wreath. Certain species form also unciliated and often tentaculate offspring by external budding. Some species will, in unfavourable circumstances, resolve practically the whole body into one internal bud which swims away, leaving the pellicle and stalk behind.

*Conjugation* is of the same nature as in the Ciliata. Two individuals become united by pseudopodia-like processes of protoplasm, their meganuclei break up, and their micronuclei form pronuclei which unite reciprocally. Often, however, the conjugants do not break apart, but one detaches itself from its stalk to unite permanently with

the other. It is not known what happens to the two zygote nuclei in these cases.

The arrangement of the larval cilia in rings, the prevalence of a sessile habit, the frequent inequality of conjugants, and sometimes the absorption of one of these by its partner, suggest the derivation of this subclass from a form which resembled the Peritricha.

*Sphaerophrya* (Fig. 87 F, F'). Spherical species; which are at first free and provided with knobbed tentacles on all sides; afterwards become endoparasites in ciliates; and are then without tentacles. Fission equal or somewhat unequal; in the parasitic stage it is repeated before the young escape. Parasitic in *Paramecium*, etc.

*Ephelota* (Fig. 96). Stalked; not seated in a cup; bearing tentacles distally. Reproduction by external, usually multiple, budding. Marine.

*Acineta* (Fig. 1). Stalked; the stalk expanding to form a shallow cup. Reproduction by internal budding. In fresh waters and marine.

*Dendrocometes* (Fig. 87 G). Body lens-shaped; without stalk; with branched arms which end in several pointed tentacles. Reproduction by formation of one internal bud. Sessile upon the gills of *Gammarus*.

## CHAPTER III

### THE SUBKINGDOM PARAZOA (PORIFERA)

Multicellular organisms; invariably sessile and aquatic; with a single cavity in the body, lined in part or almost wholly by collared flagellate cells; with numerous pores in the body wall through which water passes in, and one or more larger openings through which it passes out; and generally with a skeleton, calcareous, siliceous, or horny.

The members of this phylum are the sponges.

The simplest sponge is a little creature, known as the *Olynthus* (Fig. 97), which is found only as a fleeting stage in the development of a few of those members of the group which possess calcareous skeletons; but the bodies of all sponges may be regarded as derived from it, even though it may not appear as a stage in their life history. It is a hollow vase, perforated by many pores, and having at the summit a single large opening, the *osculum*. Through the pores water constantly enters it, to pass out through the osculum. Herein it and its kind differ from all the Metazoa, using the principal opening not for intaking—as a mouth—but for casting out. The wall (Fig. 98) of the vase consists of two layers, (a) a *gastral layer*, composed of collared flagellate cells resembling the Choanoflagellata (p. 65) and known as *choanocytes*, standing side by side but not touching, which lines the internal cavity or *paragaster* except for a short distance within the rim; and (b) a *dermal layer*, which makes up the greater part of the thickness of the wall and is turned in a little way at the rim. This layer again consists of two parts, (i) a *covering layer* of flattened cells, known as *pinacocytes*, rather like those of a pavement epithelium, but with the power of changing their shape; and (ii) the *skeletogenous layer*, between the covering layer and the gastral layer. The skeletogenous layer consists

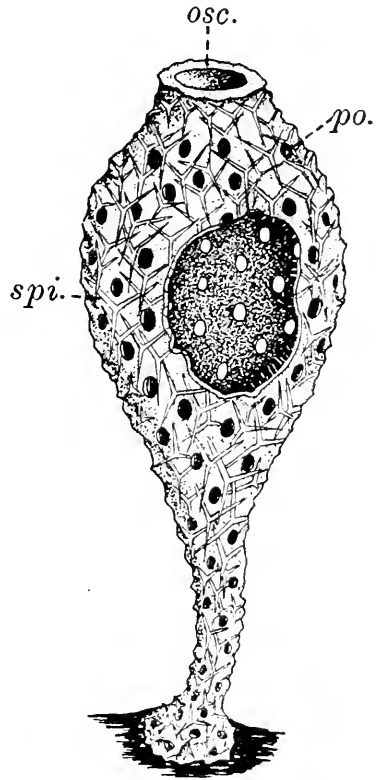

Fig. 97. The *Olynthus* of a simple calcareous sponge, with part of the wall cut away to expose the paragaster. *osc.* osculum; *po.* pore; *spi.* spicule.

of two parts, (i) a *covering layer* of flattened cells, known as *pinacocytes*, rather like those of a pavement epithelium, but with the power of changing their shape; and (ii) the *skeletogenous layer*, between the covering layer and the gastral layer. The skeletogenous layer consists

of scattered cells, with a jelly in which they are imbedded. The most numerous of these cells are engaged in secreting spicules of calcium carbonate by which the wall is supported. They wander from the covering layer into the jelly, and then each divides into two, and the resulting pair secrete in their protoplasm, which is continuous, a needle-like spicule which presently outgrows them. Most often the original spicule cells come together in threes before this process, so that the three spicules which they secrete become the rays of a three-rayed compound spicule. This lies in the wall with two rays towards the osculum and one away from it. Sometimes a fourth cell joins the others later, and forms a fourth ray which projects inwards towards the paragaster. Often there are simple spicules which project from the surface of the sponge. Other cells, known as *porocytes*, of a conical shape, extend through the jelly, having their base in the covering layer

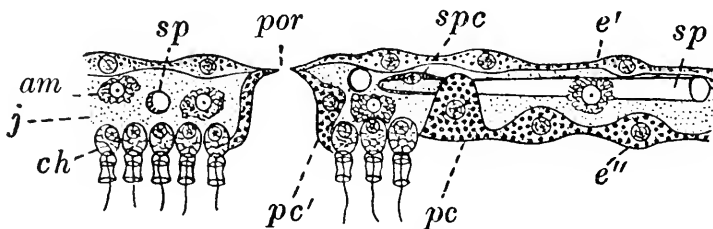

Fig. 98. Part of a longitudinal section of the wall of an *Olythus*, including a portion of the rim of the osculum. From Borradaile. *a.m.* amoeboid cell; *ch.* choanocyte; *e.*' flat covering cells (pinacocytes) of dermal layer; *e.*'' similar cells lining the rim of the osculum; *j.* jelly; *por.* pore; *pc.* young porocyte; *pc.*' fully developed porocyte; *sp.* spicule; *sp.c.* spicule cell.

while their apex reaches the paragaster between the choanocytes. Each is pierced from base to apex by a tube, which is one of the pores. Besides these cells of the dermal layer, there are in the jelly wandering amoeboid cells which appear, in some cases at least, to belong neither to the gastral nor to the dermal layer, but to be descended independently from blastomeres of the embryo. Some of them become ova; others, it is believed, give rise to male gametes; the rest are occupied in transporting nutriment and excreta about the sponge. There are no nerve or sense cells in this or any other sponge.

The current which flows through the body is set up by the working of the flagella of the choanocytes. It carries with it various minute organisms which serve the sponge for food, being swallowed, in some way which is still in dispute, by the collar cells. These digest the food, rejecting the indigestible parts into the space within the collar; and passing on the digested food to amoebocytes, which visit them to obtain it.



No sponge remains at this simple stage throughout its life. At the least the body branches and thus complicates its shape, and then often new oscula appear at the ends of the branches (Fig. 99). A higher grade is reached when, as in the calcareous sponge *Sycon* (Fig. 100), the greater part of the vase is covered with blind, thimble-shaped outgrowths, regularly arranged, and touching in places, but leaving

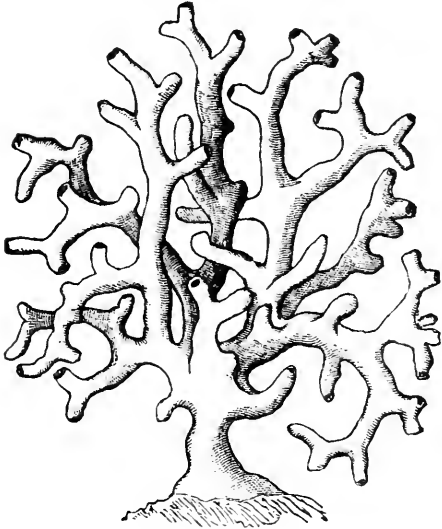

Fig. 99.

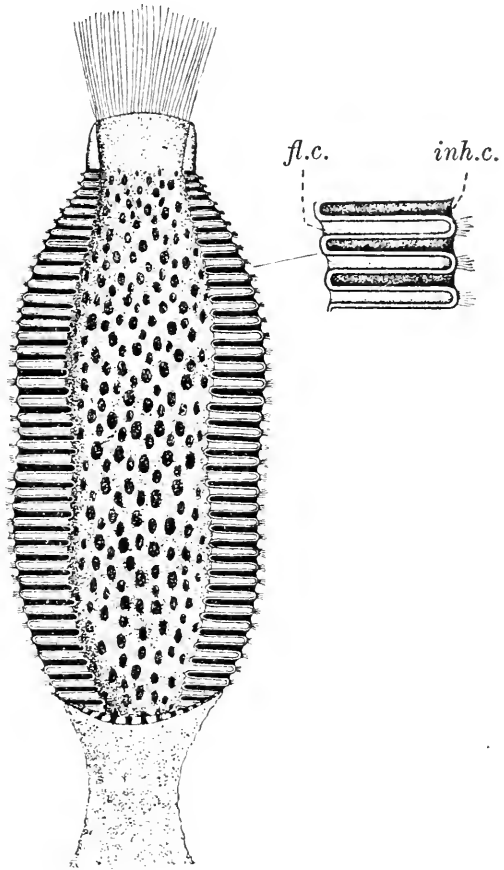

Fig. 100.

Fig. 99. A branched calcareous sponge of the first (*Ascon*) type. From Sedgwick, after Haeckel.

Fig. 100. A semidiagrammatic view of a simple *Sycon*, opened longitudinally, with a portion of the wall enlarged. *inh.c.* inhalant canal; *fl.c.* flagellated chamber.

between them channels, known as *inhalant* (or *afferent*) *canals*, whose openings on the surface of the sponge are often narrowed and are known as *ostia*. The thimble-shaped chambers are known as *flagellated chambers*, and are lined by choanocytes, but these are now lacking from the paragastrer, where they are replaced by pinacocytes. Water enters by the ostia, passes along the inhalant canals and through the

pores, now known as *prosopyles*, into the excurrent canals, leaves these through the openings, known as *apopyles*, by which they communicate with the paragaster, and flows outwards through the osculum. A third grade is found in sponges such as the calcareous sponge *Leucandra* (Fig. 101), where the wall of the paragaster is folded a second time, so that the flagellated chambers, instead of opening direct into the paragaster, communicate with it by *exhalant* (or *efferent*) *canals* lined with pinacocytes.

The three grades of sponge structure (Fig. 102), in which successively the choanocytes line the whole paragaster, are restricted to flagellated chambers, or are still further removed by the presence of exhalant canals, are known as the "Ascon", "Sycon", and "Leucon"

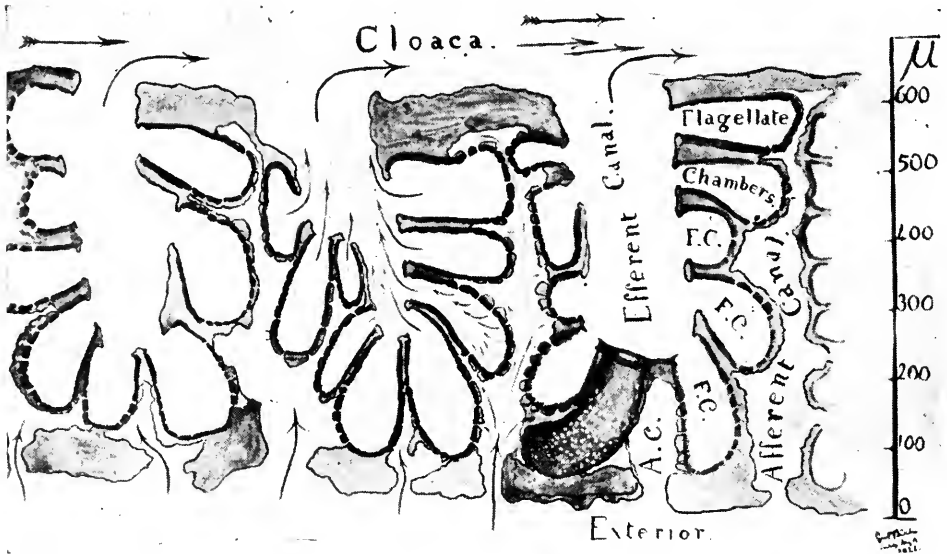

Fig. 101. Diagram of a section of the wall of the sponge *Leucandra aspersa*, showing the direction of the currents. After Bidder.

grades. In many of the sponges whose canal systems are of the third grade, the flagellated chambers are no longer thimble-shaped, but small and round. As the canal system has grown more intricate, complication has taken place also in the skeletogenous layer. It has grown thicker, forming outside the flagellated chambers a layer known as the *cortex*, in which the inhalant canals ramify; and there appear in it branched connective tissue cells which can change their shape.

The sponges which we have so far considered have skeletons composed solely of calcareous spicules, and their choanocytes are relatively large. They constitute a comparatively small group, the class *Calcarea*. The majority of the phylum are without calcareous spicules and have relatively small choanocytes. They have usually siliceous

spicules, of which there exist many different types (Fig. 103), characteristic of various groups of sponges, while minor differences distinguish those of the species, which are often only separable by this means. A horny substance, *spongin*, may occur as a cement uniting spicules, as fibres in which spicules are imbedded, or as a fibrous skeleton from which spicules are absent. The sponges in which the skeleton is in the latter condition constitute the horny

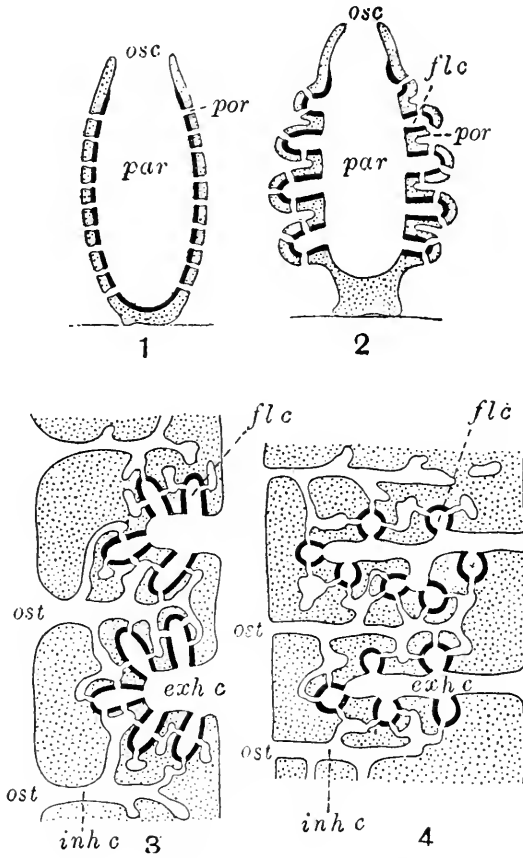

Fig. 102. Diagrams of the canal systems of sponges. Partly after Minchin. 1, Ascon grade. 2, Sycon grade. 3, Leucon grade. 4, Leucon with small, round flagellated chambers. *exh.c.* exhalant canal; *inh.c.* inhalant canal; *fl.c.* flagellated chamber; *osc.* osculum; *ost.* ostium; *par.* paragaster; *por.* pore.

sponges (Keratosa), of which the bath sponge (*Euspongia*, Fig. 104) is an example. Foreign bodies (sand grains, etc.) are often imbedded in the spongin fibres. In a few cases (Myxospongiae) there is no skeleton. The choanocytes of non-calcareous sponges are always restricted to flagellated chambers. Almost without exception these are arranged as in calcareous sponges of the Leucon type, and in most cases the system is made still more intricate by ramifications of the paragaster, the irregular appearance of numerous oscula, which

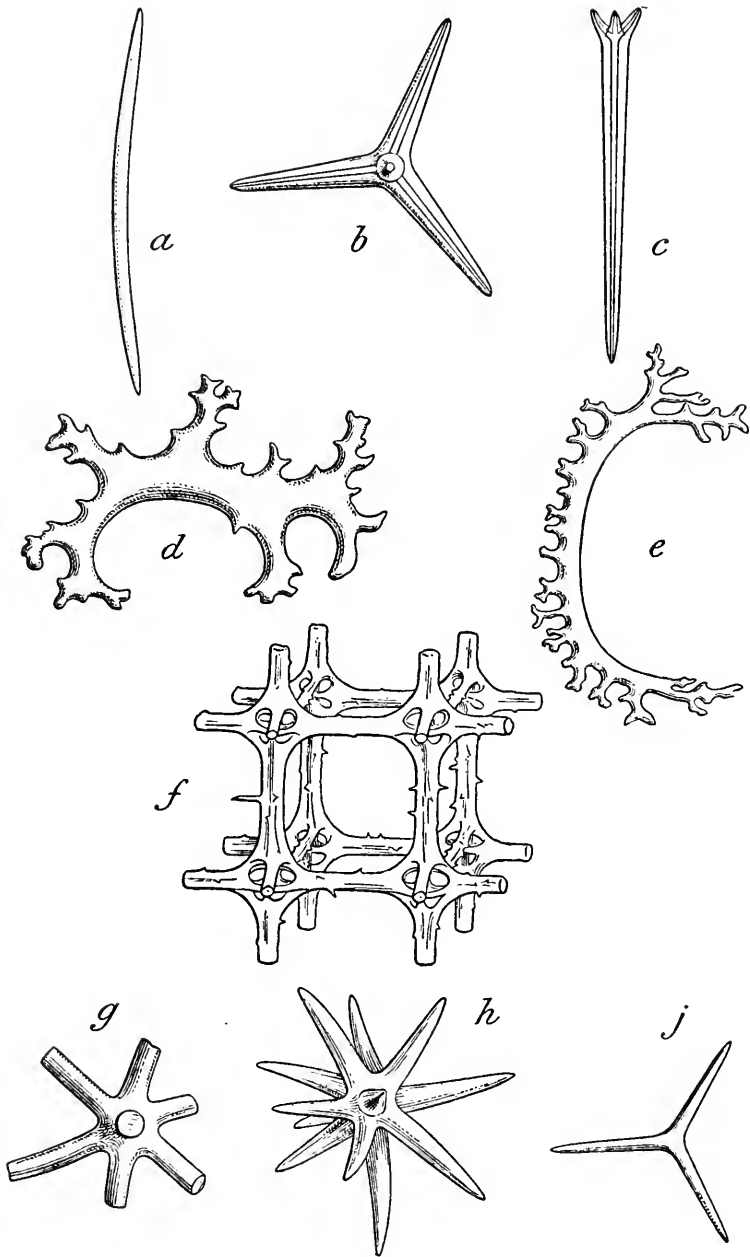

Fig. 103. Various types of sponge spicules. From Woods. *a-e*, are from Demospongiae, *f*, from a hexactinellid, *g* and *h*, from extinct groups of sponges, *j*, from Calcarea. *a*, With one axis (monaxon). *b* and *c*, With four axes (tetraxon: *b* is a "calthrops", *c* a "triaene" spicule). *d* and *e*, Irregular. *f*, With three axes (triaxon; four six-rayed spicules united as part of a continuous skeleton by additional deposits). *j*, A three-rayed compound spicule formed by the union of monaxons.

put it into communication with the water at many points, and the appearance of "subdermal cavities" and other complications in the outer part of the body.

The non-calcareous sponges fall into two very distinct classes—the *Hexactinellida*, in which there is always a siliceous skeleton of six-rayed spicules (Fig. 103f), the jelly is absent, and the flagellated chambers are thimble-shaped, as in the simpler Sycons; and the *Demospongiae*, in which the skeleton, if present, does not contain six-rayed spicules of silica, jelly is present, and the flagellated chambers are almost invariably small and rounded (Fig. 106C).

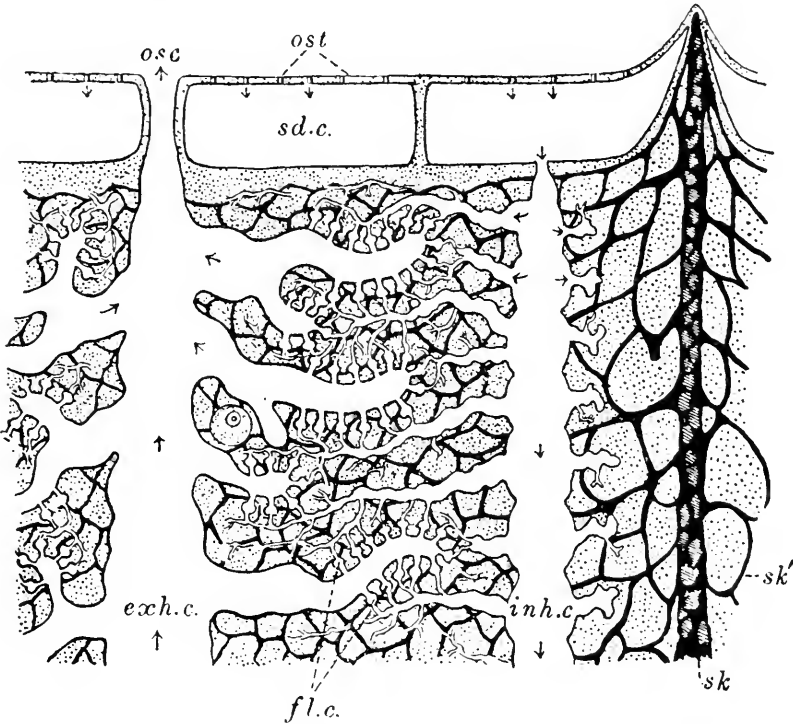

Fig. 104. A diagram of the structure of a bath sponge (*Euspongia*). From Borradaile. *exh.c.* exhalant canal; *inh.c.* inhalant canal; *fl.c.* flagellated chamber; *osc.* osculum; *ost.* ostia; *sd.c.* subdermal cavity; *sk.* one of the principal pillars of the skeleton, containing imbedded sand grains; *sk'* minor fibres of the skeleton.

Sponges have free larvae, of several different kinds, but all covered, wholly or in part, with flagellate cells, by which they swim. The remarkable feature of the metamorphoses by which these larvae become the fixed adults is that the flagellated cells pass into the interior, develop collars, and become the choanocytes (Fig. 106).

Asexual reproduction is found throughout the group. It takes place by the outgrowth and separation of external buds, or by the formation of internal buds or *gemmules*, enclosed in stout coats. In

some cases (Spongillidae) the gemmules are remarkable in that they originate as clumps of the amoeboid cells of the parent. They will stand freezing or drought, and carry the species through unfavourable conditions. The power of regeneration and repair is possessed by sponges in a high degree, and they can be propagated artificially by cuttings.

Sponges are found in all parts and at all depths of the sea. Only one family, the Spongillidae, occurs in fresh water, but its members are plentiful and widespread.

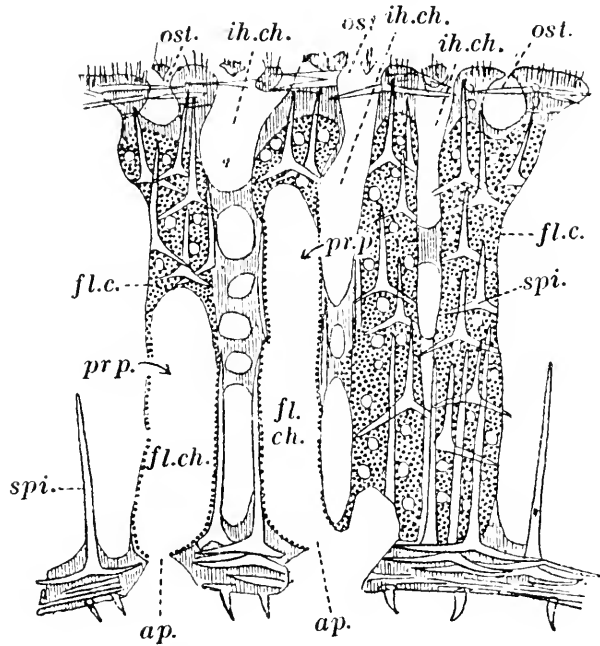

Fig. 105. Section of a portion of *Grantia extusarticulata*. Highly magnified. From Dendy. *ost.* openings of the inhalant canals (ostia); *ih.ch.* inhalant canal; *pr.p.* openings of inhalant canals into flagellated chamber (prosopyles); *fl.c.* flagellated or collar cells (choanocytes); *fl.ch.* flagellated chamber; *spi.* spicules; *ap.* exhalant opening (apopyle) of flagellated chamber.

The affinities, and therefore the systematic position, of the phylum Porifera have been the subject of much dispute. In that their bodies consist of many "cells", they might seem to be metazoa. But they differ from all members of that group in several important respects. In no metazoon are choanocytes found. In none is the principal opening exhalant. In none is there during development an inversion whereby a flagellated outer covering becomes internal. Lastly, and perhaps most significantly, in a sponge the "cells" are far less specialized and dependent upon one another than the cells of a metazoon. Many of them can assume various forms, becoming amoeboid,

collared, etc. Many are isolated in the jelly, and when they touch they are often not continuous. No nervous system co-ordinates their activities. Even the choanocytes, though the sum of their efforts produces a current, do not keep time in their working. In short, the Porifera are practically colonies of protozoa. Moreover, it would

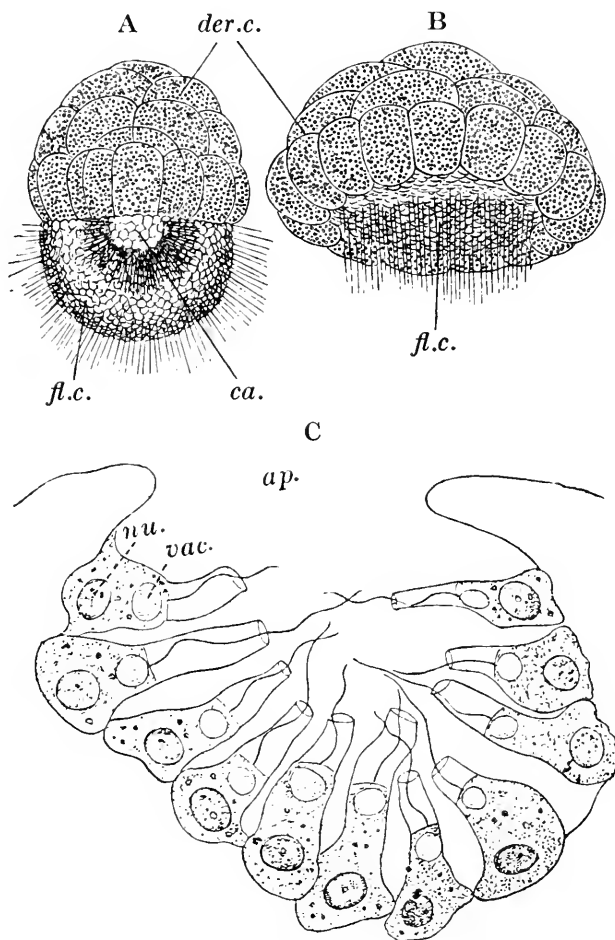

Fig. 106. A, Larva (*Amphiblastula*) of *Sycon raphanus*. B, The same with flagellated cells invaginating. After Schulze. *ca.* segmentation cavity; *der.c.* dermal cells; *fl.c.* flagellated cells. C, Section of flagellated chamber of *Spongilla lacustris*. From Vosmaer. *ap.* apopyle; *nu.* nucleus; *vac.* vacuole.

seem that they took origin from choanoflagellate mastigophora. Now opinion is, as we have seen, not unanimous that the Metazoa arose as colonies of protozoa, and in any case it is unlikely that they sprang from choanoflagellates. Thus the sponges, in spite of certain superficial resemblances to the Metazoa, have no real similarity to, and probably no genetic affinity with, that subkingdom. For this reason

it is best that, in a classification of animals, they should be given, under the name of Parazoa, the same rank as the Protozoa and the Metazoa.

### Class CALCAREA

Sponges with skeletons consisting solely of calcareous spicules; and with large choanocytes.

*Clathrina*. A meshwork of Ascon tubes. The nuclei of the choanocytes are at the bases of the cells. British.

*Leucosolenia*. A clump of erect Ascon tubes, each of which may be branched, connected at their bases. The nuclei of the choanocytes are apical. British.

*Sycon* (Fig. 100). A simple vase with a canal system of the second type, having the thimble-shaped outgrowths little adherent to one another. The nuclei of the choanocytes are apical. British.

*Grantia*. Differs from *Sycon* in that the outgrowths which contain the flagellated chambers adhere in many places and are covered by a cortex (Fig. 105). British.

*Leucandra*. Canal system of the third type (Fig. 101). Nuclei of choanocytes basal. British.

### Class HEXACTINELLIDA

Sponges with a purely siliceous skeleton composed of six-rayed spicules; with small choanocytes and thimble-shaped flagellated chambers; and without jelly, the soft parts of the body being united solely by a meshwork of trabeculae furnished by branching cells of the dermal layer.

A deep-sea group.

*Euplectella*, Venus' flower basket, and *Hyalonema*, the glass-rope sponge, have both been dredged in British waters. Both harbour various commensal crustaceans. On the rooting-tuft of long, fine spicules, which is the "glass-rope" of *Hyalonema*, grows an epizoic anemone of the genus *Epizoanthus*.

### Class DEMOSPONGIAE

Sponges whose skeleton, if present, does not contain six-rayed spicules of silica, and may be purely siliceous, or composed of silica and spongin, or of spongin alone; whose flagellated chambers have small choanocytes and are usually small and rounded; and which possess jelly.



*Cliona* (Monaxonida<sup>1</sup>). A cosmopolitan genus, which bores into the shells of molluscs and into calcareous rocks.

*Halichondria*, the crumb-of-bread sponge (Monaxonida). A common British littoral form, usually of encrusting growth.

*Spongilla* (Monaxonida). A member of the family of freshwater sponges mentioned on p. 124. Cosmopolitan.

*Euspongia*, the bath sponge (Keratosa). Medit., W. Indies, etc.

*Hippospongia* (Keratosa). A sponge of the same kind with a coarser texture due to the inclusion of much foreign matter in its skeleton.

*Oscarella* (Myxospongiae). British, has no skeleton.

<sup>1</sup> Orders of Demospongiae: *Tetractinellida*, with tetraxon spicules (Fig. 103); *Monaxonida*, with monaxons; *Keratosa*, with spongin skeleton; *Myxospongiae*, without skeleton.

## CHAPTER IV

# THE SUBKINGDOM METAZOA

The fundamental difference in histology which distinguishes the Metazoa from the Protozoa has already been described in Chapter II. Something must here be said concerning the main features of the organization of the Metazoa.

The simplest type of bodily architecture in this subkingdom is that with which the student is familiar in *Hydra*, where the body consists of a sac with one opening, and with the wall composed of two cellular layers and a layer of secreted jelly between them. The inner layer is the *endoderm*. It consists of cells specialized for the processes of digestion, and the cavity which it lines is for the reception of food. The outer layer is the *ectoderm*: by its cells relations with the environment are regulated. Some of these cells form a protective and retaining sheet; among them stand others which are sensitive; others—nerve-cells—lying below the sheet, are branched so as to serve for the transmission in various directions of the stimuli received by the sense cells: together they form a *nerve-net*. At the base of both ectoderm and endoderm there lie muscle fibres—which in *Hydra* are elongate contractile processes of the retaining cells but in other animals of this type are often whole cells that have left the surface. Lastly, from certain undifferentiated cells at the base of the ectoderm there are formed the generative cells.

When we compare this organization with that of a protozoon we observe that the cellular structure of the metazoon, primarily, perhaps, necessitated by its size (p. 8), has the following result: by isolating the units specialized for the performance of particular functions it (*a*) removes most of them from the direct action of the outer world, (*b*) makes it possible that groups of them should constitute independent organs, and (*c*) enables the relations of such organs, both with the environment and with one another to be regulated by intervening cells and internal media. Already in the simple case we have examined these facts are turned to advantage. Under the protection of the layer which remains in contact with the outer world there are established a special organ of digestion and a system for distributing stimuli which are received by distinct units on the surfaces. Other elements (muscular, genital) are beginning to separate. In the following pages we shall see this process of separation and differentiation carried much further. Its result is that the activities of the organism are less and less liable to interference from or suppression by the environ-

ment, either through the unregulated exchange of substances or by unregulated stimuli. We shall see also, how the machinery which is fashioned in this way varies in correspondence with the environment.

In the phylum to which *Hydra* belongs, the Coelenterata, the body is always of the type just described, whatever form the sac or its layers may assume, though the jelly may contain cells, sometimes plentiful, of various kinds—muscle fibres, skeleton forming cells, and amoeboid corpuscles—which have migrated into it from the ectoderm or endoderm. In all other metazoan phyla there is between ectoderm and endoderm a third layer, the *mesoderm*, which usually is more bulky than either of the other layers and forms the greater part of the body. The phyla which possess this layer are known as *Triploblastica*—three-layered animals—while the Coelenterata are *Diploblastica*. It is true that the mesoderm is partly foreshadowed by the cells which are present in the jelly of many coelenterates, but mesoderm is more plentiful than the cells in the jelly generally are, it contains important organs and usually definite systems of spaces (see p. 131), and its rudiment appears very early in the development of the individual.

Every triploblastic animal, however, passes through a stage—the *gastrula*—in which it consists only of ectoderm and endoderm. Save in this essential feature, the gastrulae of different animals may be extraordinarily unlike, and, especially when the animal is developed from a very yolky egg, they are sometimes very difficult to recognize as such; but where the gastrula is well formed, as in the familiar development of *Amphioxus* or in that of a starfish (Fig. 438), its two-layered wall may always be found to contain a cavity, the *archenteron*, which possesses a single opening, the *blastopore*. The ectoderm and endoderm are separated by a space, which is often a mere crack, but may be much wider, and contains a fluid or a slight jelly. This space is known as the *blastocoele*, and when, as in the cases cited above, the gastrula arises by the dimpling-in (invagination) of the wall of a one-layered hollow vesicle or *blastula*, the blastocoele begins as the cavity of the blastula.

The mesoderm, whose appearance converts the gastrula into a triploblastic body, is not a single entity, but contains components which originate in two different ways, namely:

(a) Cells which migrate from ectoderm or endoderm, or from mesoderm of the other kind, into the blastocoele; this kind of mesoderm (Fig. 438, *mch.*) is known as *mesenchyme*, and is comparable to the cells which invade the jelly of coelenterates.

(b) Cells which constitute the wall of the cavity known as the coelom. This kind of mesoderm is called *mesothelium*. In some cases, as in *Amphioxus*, the starfish, *Sagitta*, and the Brachiopoda (Figs. 462, 438, 430, 427 A), it arises as pouches of the archenteron which separate

from the latter, their cavity becoming the coelom and their wall the mesothelium. In other cases it arises as solid outgrowths or layers shed off from the wall of the archenteron, and coelomic cavities afterwards appear in it. This happens, for instance, in the tadpole. In yet other cases a single *pole cell* or *teloblast*, as in annelids (Fig. 196) and molluscs, or a group of a few cells, as in arthropods, separate, on each side of the embryo, from the rudiment of the endoderm, and multiply so as to form a band of cells in which coelomic cavities appear. A coelom which arises as a pouch from the archenteron is known as an *enterocoele*; one which arises in a mass of mesothelium is a *schizocoele*.

In the lower triploblastic phyla (Platyhelminthes, Nemertea, Nematoda, etc., p. 197) there is no mesothelium. Chaetognatha have no mesenchyme. In most phyla, both kinds of mesoderm develop.<sup>1</sup>

We must now consider the organs formed by each of the three layers.

i. *Endodermal organs*. After giving rise to mesoderm, the archenteron becomes the rudiment of the alimentary canal. Except in Platyhelminthes, its blastopore is in various ways replaced by two openings,<sup>2</sup> so that it has both mouth and anus. Its wall, the endoderm, forms the lining of the alimentary canal, except in those regions, known as *fore gut* or *stomodaeum* and *hind gut* or *proctodaeum*, which are formed by a tucking-in of the ectoderm at the mouth and anus. The endoderm also gives rise to the various diverticula of the mid gut, such as the liver and other digestive glands, the lungs of vertebrata, etc. A true stomach is an enlargement of the mid gut.

Digestion was perhaps originally entirely *intracellular* in the endoderm cells, and many of the lower animals still have intracellular digestion, though this is usually preceded by an *extracellular* process which by dissolving certain components of the food enables the remainder to be reduced to particles small enough to be taken up by the cells. In the annelids, arthropods (except certain ticks, p. 534), cuttlefishes, and Chordata digestion is entirely extracellular. The enzymes secreted vary with the food: in carnivorous animals such as cephalopods and starfishes they are principally proteases, in feeders on vegetable tissues they are largely carbohydrases, in omnivores such as the crayfish and cockroach and holothurians they are adapted to deal with all classes of food-stuffs. Considering the importance of cellulose both as a potential food-stuff and as cell walls which enclose more valuable foods, it is remarkable that cellulases should be rare (pp. 435, 559, 587).

Both intracellular ingestion and absorption are not always confined

<sup>1</sup> Mesenchyme is scanty in the lower Chordata.

<sup>2</sup> The most primitive way is probably that of *Peripatus* (p. 319), in which the middle of the blastopore closes and the ends become mouth and anus.

to the alimentary canal proper but may take place in digestive glands or "livers", as for instance in those of the mussel, the snail, and the crayfish, but not in those of cuttlefishes or vertebrates. It is said that in various bivalve molluscs and in holothurians amoeboid corpuscles pass through the endoderm, take up particles in the gut, digest them, and, returning, distribute the products. The presence of a cuticle in the ectodermal portions of an alimentary canal does not always prevent absorption there (e.g. in the fore gut of some insects). Finally it should be noted that some animals perform a part of their digestion *externally to the body*, as the starfish by extruding its stomach (p. 636), and various insects, mites, earthworms, etc. by pouring out saliva; and that in other cases bacterial or protozoan symbionts (pp. 68, 111) play a part in the digestion of food—particularly of celluloses—in the gut.

The food of all animals contains amino acids, usually as protein, for the manufacture of the proteins needed in the repair and growth of protoplasm. Much amino acid, however, is *deaminated*, the carbonaceous residue being oxidized, together with the carbohydrate and fat which the food usually also contains, for the liberation of energy, and the ammonia excreted in various forms by various organs presently to be mentioned.

ii. *Mesodermal organs*. Since mesothelium gives rise to mesenchyme, it is often difficult to distinguish between the two and to decide what part each plays in the formation of organs; but broadly speaking it can be said that the connective and endoskeletal, the vascular, and some muscular tissues arise from mesenchyme, while in coelomata the peritoneum and the organs derived from it—gonads (ovaries and testes), mesodermal kidneys, etc.—and the principal muscles arise from mesothelium.

Within the massive layer of mesoderm, cavities are necessary for sundry purposes. Channels must be provided for the transport of various materials—the products of the digestion of food, the gases of respiration, water, the waste products of metabolism, which are usually eliminated with the excess of water, and the substances known as hormones which are secreted by certain organs as messengers to regulate the activity of others. The germ cells, which are sheltered in this layer, must be given access to the exterior. Often there must also be spaces to give play to movements of the viscera. Such facilities are provided by two systems of cavities, the *primary and secondary body cavities*, of which either or both may be present.

(a) The *primary body cavity*, sometimes known as the *haemocoel*, is to be regarded, morphologically, as representing that part of the blastocoel which is not obliterated by the mesenchyme cells or by a solid matrix or fibres secreted by them. Its fluid contents, containing free mesenchyme cells ("corpuscles"), are the blood and lymph, and

it has usually the form of a branching system of vessels (“vascular system”) through which the fluid is caused to circulate by the contraction of muscular fibres in the wall of some portion of it which is known as a *heart*. In some cases, however, the haemocoel forms large “perivisceral” sinuses around the internal organs. It never contains germ cells or communicates with the exterior.

Since the haemocoel fluid is in intimate relation with the tissue, its composition is a matter of very great importance to the animal. It bears to the tissues much the same relation that the external medium bears to the body as a whole and is on that account often spoken of as an *internal medium*.<sup>1</sup> If it be changed the working of the organism is influenced. It is liable to be fouled by poisonous waste products of metabolism and these must be removed from it and excreted or so changed as to be harmless. It is liable to alteration by diffusion between it and the external medium, and in proportion as this can take place the animal will be at the mercy of its surroundings. To maintain it in a constant condition in respect of the substances which it might exchange with a particular external medium two agencies are at work—the guardianship, active or passive, of the protective sheet of ectoderm and of any cuticle or other covering which the latter may secrete, and the activity of the excretory organs, especially in the excretion of water. The effectiveness of these agencies varies. The independence of the body fluids from the external medium is least in some marine animals, such as echinoderms and certain molluscs: in these the fluids closely resemble sea water both in the ions present and in the total osmotic pressure. In a series of others, independence grows, and it is highest, in the sea, in teleostean fishes. In fresh water animals the composition of the blood is kept entirely different from that of the external medium. In land animals there is of course no question of the exchange of solutes, and unless the loss of water were reduced to a minimum life would be impossible. It is an interesting fact that, though the resemblance of the body fluids in fresh water and land animals to sea water is much less than that of marine animals, something of it still remains, no doubt because protoplasm came into being in sea water and still requires to be bathed by a fluid which somewhat resembles the latter. The principal differences are an increase in potassium and a decrease in magnesium and  $\text{SO}_4$  ions and a lower total osmotic pressure.

The blood is the principal means of transport within the body. A very important part of its freight is oxygen. Its capacity for

<sup>1</sup> The fluids of the secondary body cavity (coelomic fluids) are also internal media, but less intimate and therefore chemically less important than the blood. In echinoderms, however, they are probably more important than the fluid of the vestigial haemocoel (lacunar system, p. 629).

this gas, however, would be quite insufficient for it to maintain the metabolism of an active animal if the gas were carried in mere solution. This deficiency is met, when necessary, by the presence in the blood of *respiratory pigments*. These bodies are compounds of a protein with a nitrogenous pigment which contains a metal. They are related to one another, to chlorophyll, and to the colourless substance *cytochrome* which is very widely distributed in the protoplasm of animals and plants, where it plays a part in the regulation of oxidations. They form very labile addition compounds with oxygen, which they can thus take up in the organs of respiration and carry to the tissues, where they yield it up by dissociating under the lower oxygen tension, undergoing at the same time a change in colour. The most important of them are *haemoglobin*, which contains iron and is red, *chlorocruorin*, also containing iron, which is green, and *haemocyanin*, containing copper, which is blue when oxygenated. Haemoglobin is present in Vertebrata, where it is carried in the "red corpuscles", and sporadically in many invertebrates, as in the earthworm, where it is in solution in the plasma. Chlorocruorin is found in solution in the blood of various polychaete worms, haemocyanin in solution in the blood of the higher crustacea, the king-crab (*Limulus*), and various molluscs. Both haemoglobin and haemocyanin are slightly different compounds in different animals, and with these differences are associated differences in the pressure at which they take up or yield oxygen. Broadly speaking, the blood pigments of animals which live under conditions of low oxygen pressure take up the gas at a lower pressure than those which live under high oxygen pressure. On the other hand they do not maintain so high a pressure in the tissues. Independently of such differences, the haemocyanins are less efficient oxygen carriers than the haemoglobins. In tracheate arthropods, where air is brought direct to the tissues by a system of tubes, there are no blood pigments.

The blood of the higher invertebrates contains in solution a considerable amount of protein, of which the respiratory pigment, if present, is only a part. This protein is comparable with the organic ground substance of a skeletal tissue. It is not a food for the tissues but by maintaining the osmotic pressure of the blood it is of importance in regulating the distribution of water between that fluid and the tissues, and, since proteins combine with both acids and alkalies, it helps to neutralize excess of either of these. In vertebrates some of this protein provides the material for clotting, by which loss of blood or injury is prevented; but invertebrates, when they form a clot, do so from material furnished by corpuscles.

(b) The *secondary body cavity* or *coelom* is from the first completely surrounded and separated from the blastocoel by the mesothelium,

which is derived, as we have seen, from the endoderm. This cavity has various forms, but is rarely tubular and never possesses a heart. Usually it constitutes one or more large perivisceral spaces around the heart, alimentary canal, and other organs. It will be noted that the *perivisceral cavity* which surrounds the internal organs of most triploblastic animals, so that these organs are unaffected by the movements of the body wall and are able freely to perform movements of their own, may be either coelomic or haemocoelic, but is usually coelomic (Fig. 107 *a-c*). In the Arthropoda, where the perivisceral function of the coelom is entirely usurped by the haemocoel (*d-g*), the former space is reduced to small cavities in the gonads and excretory organs.

In animals which possess a coelom, the gonads are derived from its walls, and either the germ cells are shed into a coelomic perivisceral cavity or the gonad itself contains a cavity which is a separated portion of the coelom.

The coelom communicates with the exterior. The communication is usually made through organs belonging to one or other of the types known as "nephridia" and "coelomoducts", though it occasionally takes place through openings of other kinds, such as the dorsal pores of the earthworm and the abdominal pores of fishes.

Nephridia and coelomoducts are organs which meet the need for the passage to the exterior of products of organs derived from or imbedded in the mesoderm. Their characteristic features are as follows:

(*a*) The *nephridial system* is primarily an organ which serves the mesenchyme, though it may come to lie in the coelom, and in certain annelids communicates with that space. It is for the most part intracellular, and consists of tubes, often, at least, of ectodermal origin, usually branched and bearing at the end of each branch a *solenocyte* or *flame cell* (see p. 202). It may be continuous or divided into segmental units, the *nephridia*. Water, probably containing excreta, is shed by the protoplasm of the tubes, and passes out in the current set up by the action of the flame cells or by cilia.

(*b*) *Coelomoducts* are mesodermal passages which open at one end to the exterior and at the other usually into the coelom, though the coelomic opening may lead only into a minute vesicle of the coelom, or even be lost altogether. They may (1) be solely excretory, the excreta being shed into them by gland cells in their walls, or borne into them by a current of fluid from the coelom through the coelomic opening of the organ, or derived from both these sources (see p. 141); (2) combine excretion with the function of conducting the germ cells to the exterior; (3) be simply gonoducts, which was perhaps their original function.

Many annelida possess compound excretory organs formed by the



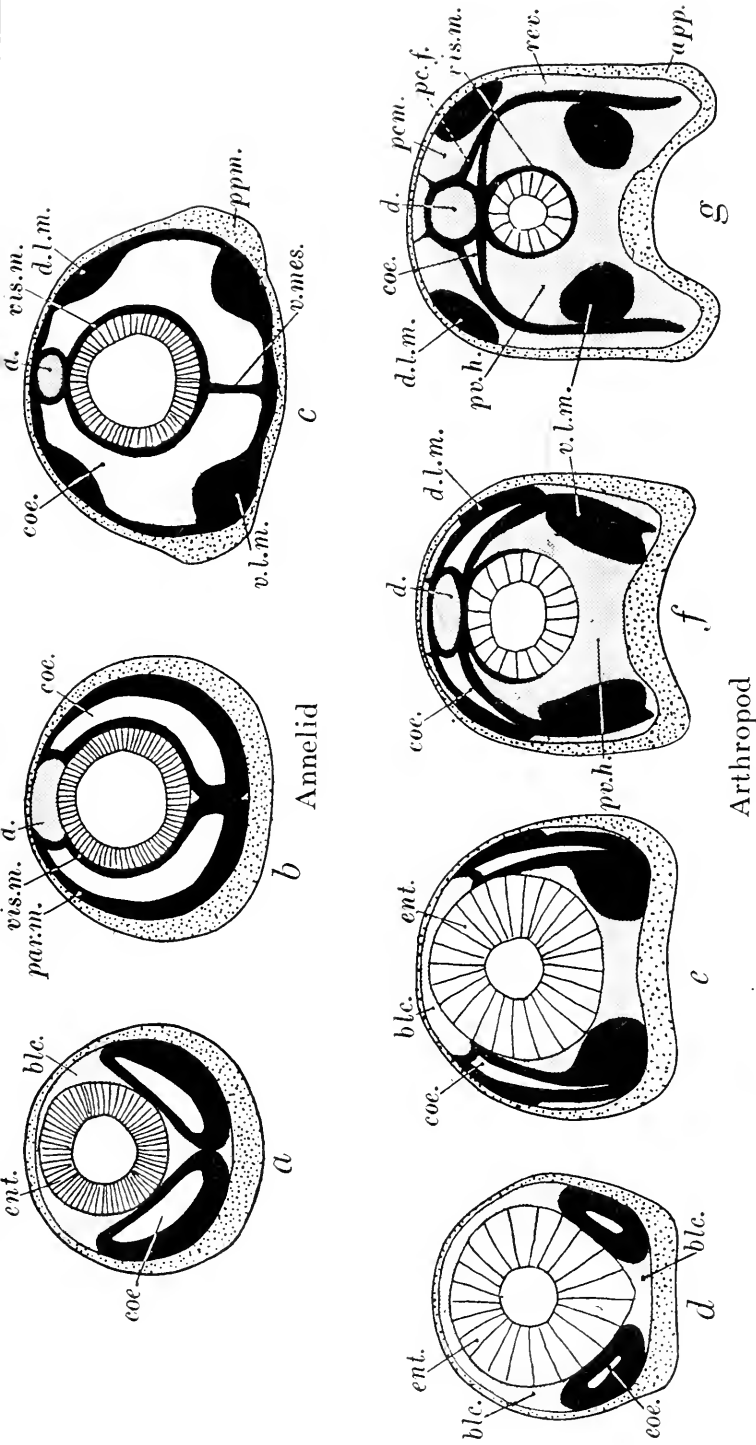

Fig. 107. Diagrams to show the development of the perivisceral cavity, dorsal blood vessel, and principal muscles in an annelid (a-c) and an arthropod (d-g). The skin is dotted, the mesothelium black, the endoderm shown by radial lines, and the blastocoel (haemocoel) finely stippled. The mesoderm segments (mesoblastic somites) grow upwards around the gut, and their upper ends come to enclose a part of the blastocoel and thus to form the dorsal blood vessel (a longer or shorter stretch of which, in the arthropod, becomes the heart). In the annelid the coelom expands to form the perivisceral cavity and the walls of the somites form the visceral and parietal musculatures and the mesenteries. In the arthropod the coelom shrinks by the approximation of the walls of the somites, the latter becoming a single sheet from which are developed the pericardial floor and the musculature, while the perivisceral cavity is formed from the haemocoel. *app.* base of limb; *blc.* blastocoel; *coe.* coelom; *d.* dorsal blood vessel; *d.l.m.* dorsal longitudinal muscle; *ent.* gut; *par.m.* parietal muscles; *pc.f.* pericardial floor; *pc.m.* pericardial muscle; *ppm.* site of parapodium; *pv.h.* perivisceral haemocoel; *rev.* vessel by which blood returns to pericardium; *v.l.m.* ventral longitudinal muscle; *v.mes.* ventral mesentery; *vis.m.* visceral musculature.

union in various ways of nephridia with coelomoducts or other mesodermal elements (see p. 276). In such cases the nephridia acquire a communication with the coelom, and excreta or germ cells may pass from it through them. In other groups, as in some crustacea, a coelomoduct is supplemented or in great part replaced by an ectodermal component, but there is no evidence that this component represents a nephridium.

iii. *Ectodermal organs.* The ectoderm gives rise to the epidermis (epithelium which covers the body), to certain glands, to the nephridia, to the principal external organs of sense, and to the nervous system (in nearly all cases; there are nerve cells under the endoderm of certain coelenterates, and a part of the nervous system of the Echinodermata is remarkable in being formed from the peritoneum and therefore mesodermal).

The *epidermis* with some underlying mesodermal connective tissue known as the *dermis* constitutes the *skin*. In invertebrates it is columnar or syncytial, in vertebrates it is stratified. In the lower invertebrates its cells are usually ciliated, which was probably the original condition. The cilia subserve locomotion, the taking of food, or respiration (p. 139). When unciliated its protective function is often increased by a *cuticle*. To it belong various glands, especially, in naked epithelia, mucous glands whose secretion is protective, in aquatic animals against parasites, in terrestrial against desiccation. Others form cuticular structures, cement, poisons, etc.

The *nervous system* was no doubt primitively situated immediately below epithelia, having arisen by specialization of epithelial cells for the transmission of impulses due to stimuli received upon the surface—for the most part, presumably, upon the ectoderm. In many cases (the Coelenterata, Echinodermata, Hemichordata, some annelids, etc.) it remains there, but usually it is in a deeper, more protected situation. All triploblastica possess a *central nervous system*. This arose as a condensation of the primitive nerve-net of branched cells, portions of which may remain unchanged. The central nervous system was formed in different positions in different animals. In those which have a long axis it has the form of cords along that axis. The cords may be paired or unpaired, lateral, ventral, or dorsal. Anteriorly they pass into an enlargement, the “brain” or cerebral ganglion, connected with the principal organs of distant sense. In Chordata the central nervous system is hollow, its removal from the surface being not, as usual, by separation from the epithelium, but by the folding-in of the strip of epithelium which it adjoins and which remains to line its cavity. A similar condition is seen in some echinoderms. From the central nervous system *nerves* proceed to various parts of the body.

The nerve-net is joined by processes from the bases of the sense cells. Probably at an early stage in the evolution of the Metazoa stimuli were transmitted only by such processes, running directly from the sense cells (*receptor* cells) to end against the muscle or other cells which are set in action through them (*effector* cells). This condition, however, is now rare, occurring only in the tentacles of some coelenterates: nearly always there are nerve-cells which have left the surface layer, whose processes continue those of the sense cells and so extend and complicate the system of communications. In the primitive condition of the nervous system, as seen, for instance, in *Hydra*, the nerve-cells have numerous similar branches, forming a network over which messages pass in all directions from any point of stimulation. That there is co-ordination in the action which results is due only to the fact that the messages do not evoke responses equally in all the effector cells.

The condensation of nerves and a central nervous system out of this network is due to a change in the form and arrangement of the elements of which it is composed. The change, which is already foreshadowed in certain parts of the bodies of coelenterates (p. 150), consists in processes of the nerve cells elongating in particular directions and thus forming paths of conduction which in the higher triploblastica are isolated by the loss of the rest of the network. As this system is perfected its elements become *neurones*—cells with one main process, the *axon* or *nerve fibre*, along which the impulse passes from the cell body. The axon ends by breaking up into a tuft of branches, the *terminal arborization*, from which a stimulus is given either to another nerve cell or to an effector cell. Thus instead of spreading in all directions the impulse is conducted to a definite destination: the interference of the environment in the affairs of the organism is regulated. The cell body may be a sense cell in the epithelium, or it may be internal. In the latter case it possesses other processes—the *dendrons*—which by fine branches—the *dendrites*—receive stimuli from the axons of other neurones. Two neurones at least are concerned in the transmission of an impulse. In the simplest case the axon of a sense cell (or of a cell whose dendrites receive stimuli from a sense cell)<sup>1</sup> transmits the impulse to a neurone whose axon conducts it to the effector cell. This process is known as a *reflex* and the arrangement of neurones as a *reflex arc*. The impulse is passed from the first neurone to the second in an exchange station—the central nervous system. The nerve fibres run to and from this station in bundles which are the nerves. This arrangement is not only, as we have seen, more

<sup>1</sup> In the Vertebrata the cell bodies of the afferent fibres from the receptors are moved far inwards to lie in the dorsal root ganglia, receiving impulses by a dendron nerve fibre which is longer than the axon.

precise but, since one efferent neurone can serve several afferent, more economical of fibres than the nerve-net. Usually, moreover, the system is complicated, and in the highest animals it is enormously complicated, by the branching of axons, which increases the number of efferent fibres an afferent fibre can affect, and by the intervention, in the central nervous system, of intermediate neurones between those which are directly afferent and efferent. By this the number of afferent fibres which an efferent fibre can serve is increased. For the efficient working of this system it is essential that impulses should pass over it in one direction only, and thus should not leak from one path to another and affect organs for which they were not destined. That is provided for in the following way. Where the terminal branches of an axon meet the dendrites of another neurone the two are not continuous but interlace without joining, making what is called a *synapse*. Their discontinuity makes an obstacle, over which impulses can pass in one direction only, from axon to dendrites. The mode of passage of impulses from the one to the other and again from efferent neurone to effector cell is not at present known. It is perhaps an electrical process, but it involves the production of a chemical that probably affects the sensitivity of the recipient cell. In that case the transmission of a nervous impulse includes a process which recalls that other mode of communication, mentioned above, in which the chemical messengers known as hormones are distributed through the vascular system.

Stimuli received from the nervous system, like other stimuli, may inhibit as well as cause activity. This is very important, because when an action is to be performed activity which hinders it must be abolished. Thus, for instance, a contracting muscle may by a reflex inhibit contraction in an opposing muscle: the circular and longitudinal muscles of the earthworm are an example of such a system (p. 261). A similar end is obtained in a different way in the muscles which open and close the claws of crabs and lobsters, where each muscle fibre has two nerve fibres, one excitatory and the other inhibitory, and impulses from the central nervous system pass simultaneously to the excitatory fibres of one muscle and the inhibitory fibres of the other. Further, one neurone may inhibit another, and thus inhibition may be effected not only through but in the central nervous system.

Concerning the way in which the central nervous system, which in the lowest animals that possess it is merely a relay station where impulses from the principal sense organs are multiplied and distributed, later takes on inhibitory functions, and later still develops "functional units" for co-ordination, and concerning the control of the latter by the brain, something is said on pp. 198, 261, 448

iv. Certain organs are formed in different animals from different layers. *Organs of respiration* may be covered or lined by ectoderm, as are the gills of crustaceans and annelids, the external gills of the tadpole, and the lungs of snails; or by endoderm, as are the gills of a fish or the lungs of vertebrates. The skin, when it is naked or covered only by thin cuticle is always respiratory, and in many small animals is the only organ of respiration. Cilia may keep water in movement over it so as to renew the supply of oxygen, and when there is a vascular system a rich blood-plexus may increase the efficiency of the skin, as in earthworms. In larger animals there are usually localized organs of respiration. In these the surface is increased by folding or branching either outwards or inwards, the blood supply is richer than elsewhere, and there is some means of constantly renewing the medium. Organs of aquatic respiration are usually projections, known as gills: the water around them is renewed, either by muscular movements of the body, of limbs which bear the gills or of structures in their neighbourhood, or by ciliary action. Organs of aerial respiration may be those that were originally used for aquatic respiration: this is especially the case when they are enclosed in a chamber which protects them; sometimes, as in snails and land crabs, such a chamber becomes itself converted into a respiratory organ by the vascularizing of its lining. In other cases, as in terrestrial vertebrates, there are developed for this function cavities in the body into which air is drawn. In order to prevent damage to the epithelium by desiccation, a layer of moisture is always maintained over air-breathing surfaces, either by exudation or by special glands or by water-retaining hairs, etc. Consequently aerial respiration is in the long run aquatic respiration, with the difference that the supply of oxygen in the layer of water over the respiratory epithelium is maintained not by renewal of the layer but by diffusion from adjacent air. It is maintained that on that account aerial respiration is less efficient than aquatic, and this argument is supported by the fact that the respiratory area of air-breathing animals is greater than that of related forms which have aquatic respiration.

What has been said in the foregoing paragraph does not apply to the tracheate arthropods, whose respiration does not take place through an epithelium with the intermediation of the blood, but by the bringing of air directly to the tissues by a system of fine ectodermal tubes—the tracheal system (p. 440).

The relative effect upon respiration of the pressures of carbon dioxide and of oxygen differs according as the animal is living in water or in air. In clean waters the pressure of carbon dioxide varies little, because any excess of the gas is removed by the formation of carbonates and bicarbonates, but the pressure of oxygen is easily lowered as

the amount in solution is used up. In air, on the other hand, free carbon dioxide will accumulate, but there is a large supply of oxygen. Consequently aquatic respiration will sooner be affected by changes in the pressure of oxygen in the medium, aerial respiration by changes in the pressure of carbon dioxide. In foul waters, however, free carbon dioxide may be present in such quantities as to be an important factor. In such waters, and in the habitat of many internal parasites, free oxygen may be practically absent. Many animals which live in such circumstances obtain energy by an anaerobic process, the complex molecules of carbohydrates being decomposed to form simpler ones without the intervention of free oxygen. To this end the animals in question lay up in their tissues large quantities of the starch-like substance glycogen of which carbohydrate stores in animals are usually composed. Thirty per cent. of the dry weight of an *Ascaris*, and nearly half that of a tapeworm, consist of this substance. The glycogen is converted into glucose (dextrose) and then decomposed, according to the following equations:

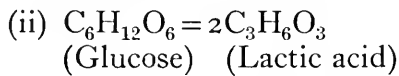
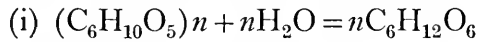

This process of course yields considerably less energy than would be obtained by total oxidation. Apparently, at least in many animals, it cannot go on indefinitely unless the lactic acid be removed. This may happen either by the acid being discharged into the surrounding fluid and swept away by movements of the latter (which would occur, for instance, in the host's intestine), or by an access of oxygen with which some of the lactic acid is oxidised so as to give energy for building the rest back into glycogen. In the latter case the process becomes ultimately aerobic. It is probable, indeed, that even in aerobic animals the process by which energy is liberated is at first anaerobic, but that this phase is quickly followed by one in which, by the use of oxygen, a part of the product is destroyed and the rest built back, so that the process as a whole appears aerobic. Thus anaerobic animals differ from those that are aerobic only in the length of time for which the anaerobic process goes on.

*Organs of excretion* are even more various, in kind and in origin, than those of respiration. If the removal of carbon dioxide from the body be disregarded, there are two processes to be considered here—the excretion of water and that of solids. In the lower aquatic animals, whose surface is in various degrees permeable to water, the removal of the latter from the body is, as we have seen, a matter of very great importance: it was probably the original function of the nephridial system and is an essential part of that of excretory coelomoducts. But

the removal of solids—both of solutes which have entered from without and of the nitrogenous products of metabolism—is also essential, and in most animals advantage is taken of the outgoing water to remove the solids. It is to provide for this as well as to meet the loss due to evaporation, that terrestrial animals must take in water by the mouth.

In coelenterates excretion probably takes place from the general surface of the ectoderm, and perhaps also from the endoderm. In triploblastic animals without a perivisceral cavity ectodermal ingrowths—the nephridia, mentioned above—permeate the mesenchyme and perform excretion. In the Nematoda there are lateral ducts in the ectoderm, which probably subserve excretion. In animals with a coelomic perivisceral cavity excreta are shed into the cavity (or carried into it by such cells as the “yellow cells” of the earthworm); and removed to the exterior by nephridia (which may, as in the earthworm, open to the coelom), by the mesodermal coelomoducts, or in other ways, as in echinoderms, which shed excreta from the coelomic fluid through the respiratory organs (gills, respiratory trees). In echinoderms also solid excreta, perhaps not nitrogenous, are removed by amoebocytes which pass to the exterior through the gills. In the Vertebrata the excretory portions of the coelom are in the adult separated, and imbedded as the Malpighian capsules in the mass of coelomoducts which forms the kidney. During its passage along the nephridial tube or coelomoduct the fluid containing excreta receives additional substances secreted by the walls of the tube; and in the terrestrial vertebrates, in which it originates as an exudation filtered out under blood-pressure in the Malpighian capsules, water and some of its solid contents are regained by absorption from it. In the Arthropoda, where the perivisceral cavity is haemocoelic, the excretory organs are still often coelomoducts (segmental organs of *Peripatus*, antennal and maxillary glands of crustaceans, coxal glands of arachnids): attached to or imbedded in these are vestiges of the coelom (end-sac). Instead of, or in addition to, these organs, tubular diverticula of the ectodermal or endodermal parts of the alimentary canal often perform excretion in this phylum (Malpighian tubes, certain of the “hepatic” coeca of crustaceans). In the insects the “fatty body” contains a temporary or permanent deposit of excreta removed from the circulation. In ascidians excreta are similarly laid up as concretions by mesodermal cells. Various other organs which are known or supposed to have an excretory function will be mentioned in later chapters. The nitrogenous excreta vary in chemical constitution in different animals. Their variety appears to depend partly on the fact that the products of the decomposition of protein, ammonia compounds, are toxic and accordingly, unless they can be speedily discharged from the body, are converted into such substances

as urea, guanin, and uric acid, which are relatively harmless. In aquatic animals, where plenty of water is available to carry off the excreta rapidly, the latter are principally ammonia compounds. In terrestrial animals it is necessary to expend energy in converting them into substances such as those mentioned above.

The only triploblastic animals which have a rigid *skeleton* of great importance are the Echinodermata and Vertebrata, in which it is internal and mesodermal, and the Arthropoda, in which it is a cuticle secreted by the ectoderm and is therefore primarily external, though ingrowths of it may form a kind of internal skeleton to which muscles are attached.

The *muscular system* is in coelenterates derived from ectoderm or endoderm, in triploblastica almost entirely from mesoderm, though some muscles of crustacea arise from ectoderm. In Coelomata fibres from the mesenchyme form only minor muscular structures, such as the walls of blood vessels; the great masses of muscle are mesothelial. In the lower animals the fibres mostly lie parallel to the layers from which they arose, forming a sheet in the gut wall and another, known as the *dermomuscular tube*, under the skin. In these sheets there is always a longitudinal and usually also a circular layer; sometimes diagonal fibres are added. The movements which such layers bring about are changes of size and shape of regions of the body or gut wall by the contraction of one set of fibres with relaxation of the other, their action being aided by the changes in turgor which are caused by the compression of the fluids they enclose. When there is a skeleton muscular action is different. The dermomuscular tube is now broken up into muscles which pull upon pieces of the skeleton and so move parts of the body. When the skeleton is internal and the body wall remains flexible, more or less of the dermomuscular sheet remains. It is lost when there is a stiff cuticle. The muscles of limbs are provided by outgrowth from the dermomuscular layer.

In the lower animals the muscular fibres are usually varieties of the unstriped kind. In other cases, chiefly in higher animals (vertebrates, *Amphioxus*, arthropods, part of the adductor muscle in the scallop, etc.) there appears a new type, the striped fibre, more swift and powerful in action but more dependent upon the nervous system; it has lost the power of automatic rhythmical contraction and of retaining without nervous stimuli a certain degree of contraction, known as "tone". Some striped fibres, however, retain one or other of these powers; thus the fibres of the heart of vertebrates contract automatically and those of the adductor of the claw of crabs and lobsters automatically maintain tone. Tone may also be maintained in striped fibres by the nervous system. In some cases (adductors of the scallop and of crustacean claws, spines of sea-urchins, etc.) a



muscle contains two sets of fibres, one of which by rapid contraction brings an organ into a certain posture, in which it is held by tonic contraction of the other (the "catch" fibres).

Most of the energy expended by an animal is liberated in its contractile tissues. It is obtained, normally from carbohydrates, by a process which, as we have seen (p. 140), is at first anaerobic and then aerobic (see also p. 662).

The rudiments of the *gonads* may be situated either in ectoderm, endoderm, or mesoderm. In Coelomata they always arise in mesothelium. However, since they are often recognizable as early in development as the layers, and the cells of which they are composed may migrate from one layer to another, and they do not form tissues, they are best regarded as an independent entity.

The body constituted by the elements described above has usually a bilateral *symmetry*, though this is rarely exhibited completely by all the systems. In the Coelenterata and Echinodermata, however, there is a radial symmetry. It is interesting to find that a sessile life, for which such symmetry seems particularly advantageous, is characteristic of the Coelenterata, and was probably adopted by the ancestors of all the Echinodermata. The terms *ventral* and *dorsal*, which belong by right respectively to those aspects of a bilateral animal which are normally turned to and from the ground or substratum, are sometimes conveniently applied to a pair of structures by which two sides may be distinguished in the body of an animal whose symmetry is predominantly radial. They should, however, never be applied to the oral and aboral aspects of such an animal.

Meristic repetition of organs of the body is common in Metazoa. It may, as in parts of the body of annelids, affect practically all systems, so that there is a complete *segmentation* of the body into similar *somites*, or may be confined to certain organs. In the latter case it is important to distinguish between (*a*) the repetition of single organs in an unsegmented animal, as the ctenidia and shell plates are independently repeated in the mollusc *Chiton*, and (*b*) the condition, presented for instance by the Vertebrata and by much of the body of many arthropods, in which a formerly more complete segmentation now affects only some of the systems to which it at one time extended. The student should beware of thinking that the segmentation of all animals which present the phenomenon is derived from that of a common ancestor. The strobilation of the Cestoda in preparation for the detachment of reproductive units is a very different matter from the segmentation of the Annelida, and that again is far from being, as is sometimes assumed, certainly the same thing as the segmentation of the Vertebrata.

The anterior end of a bilateral animal is the site of the principal

sense organs, of the "brain", and usually also of the mouth, and is often obviously differentiated as a *head*. In a segmented animal this *cephalization* may extend to one or more of the anterior somites; and these usually become part of the head, losing their individuality in the way mentioned in the preceding paragraph, and only betraying their existence by the presence of certain of their organs (ganglia, appendages, etc.).

In the process of *development* by which the body peculiar to the species is reconstituted from the ovum, the early stages are of necessity much unlike the adult; but because the general features must arise before the more special ones, and because general features are shared by animals, the young resembles other young animals which have reached the same stage. Since the more special a feature is the fewer are the animals which share it, as the young approaches the adult form the circle of other animals whose young it resembles narrows. Since the evolution of its species consisted in the appearance of the same special features, its development (ontogeny) roughly recapitulates its evolution (phylogeny), but its features at any moment are not those of the adult of some ancestor but those of the corresponding young stage of that ancestor, and it is only because that stage was preparing the features of its own adult that there is recapitulation of the latter. Not all features of young animals, however, are anticipatory of those of their adults. Some of them—the embryonic membranes of the higher vertebrates and the ciliated bands of echinoderm larvae for instance—are adaptations to the needs of the young only and disappear in the adult. Such features are said to be *caenogenetic*. In respect of them development in no sense recapitulates adult phylogeny. Now it is held that in some cases a young animal, becoming sexually mature at an early stage (as in the well-known instance of the axolotl which may breed as a tadpole), has cut out permanently its later stages and started a new course of evolution from a young stage of an ancestor. This is known as *neoteny*, and in it caenogenetic features may be taken up into the new adult form: it may, for instance, account for some of the peculiarities of the Larvacea (p. 679), the Cladocera (p. 362), and *Leucifer* (p. 415). A young animal which is developing within an egg shell or in the womb of its mother is known as an *embryo*: one which is feeding for itself is a *larva*. A stage which is larval in one animal has often become embryonic in another. Embryonic development is said to be "direct." Actually it is no more so than that which is larval. Caenogenetic features are found in both, those which are most conspicuous being in larvae organs of locomotion and feeding, in embryos the presence of yolk or means of obtaining from the mother the nutriment which the embryo cannot acquire from the outer world.

The yolk, which varies in amount in all phyla, is responsible for much of the difference between animals at corresponding stages, especially the youngest. The student will recall that from this cause the cleavage of the ovum which in *Amphioxus* is complete and equal, is in the frog complete but unequal and in the chick incomplete. The blastula has in *Amphioxus* a large cavity, in the frog a small one, in the crayfish (Fig. 202) is full of yolk, and in the chick is a disc upon the yolk. The mode in which the establishment of the two-layer stage (gastrulation) takes place is also partly affected by yolk, though evidently other factors are concerned. In the *Planula* (Fig. 152) it is by immigration, in *Amphioxus* and the crayfish by invagination, in the frog largely by overgrowth (epiboly), in the chick by delamination.

All these modes of development are repeated sporadically in various groups of Metazoa: thus the early stages of the mollusc *Paludina* and the crustacean *Leucifer* are analogous to those of *Amphioxus*, those of the squid and the scorpion, members of the same phyla, to those of the chick. On the other hand, certain features of cleavage are constant through whole phyla and groups of phyla. The cleavage of coelenterates and echinoderms is radial (Fig. 196, 1), that of chordates is bilateral, that of polyclads, nemertean, annelids, and molluscs is spiral (p. 281). Determinate cleavage, in which the part of the body to be formed by each blastomere is fixed from the first, as in the case described on p. 282, is common to the spirally cleaving groups but occurs in a quite different manner in the tunicates. Again, while the mesothelium of annelids, arthropods, and molluscs is laid down as a pair of ventral bands proliferated from behind, that of other coelomata arises from the wall of the definitive enteron (p. 129).

An important function of many larvae is the distribution of the species. This is often effected by their being planktonic. Among the larval types adapted to that existence is a series whose members have delicate tissues and a large blastocoele, whereby their buoyancy is increased, and strongly ciliated bands, often drawn out into processes, whereby swimming and feeding take place. To this series belong Müller's larva (Fig. 155), the *Pilidium* (Fig. 169), the trochospheres (Figs. 197, 374, 420), the *Actinotrocha* (Fig. 432), the *Dipleurulae* (Fig. 439), and the *Tornaria* (Fig. 466). The student should beware of supposing that these types are phylogenetically related. With one or two exceptions, their resemblance is probably an instance of convergent adaptation.

## CHAPTER V

### THE PHYLUM COELENTERATA

Metazoa, either sedentary or free-swimming, with primarily radial structure; the body wall composed of two layers of cells, the *ectoderm* and *endoderm*, and between these a layer secreted by them which is originally a structureless lamella (*mesogloea*) but usually contains cells derived from the primary layers; within the body wall a single cavity, the *enteron*, corresponding to the archenteron of the gastrula, having a single opening for ingestion and egestion, and often complicated by the presence of partitions or by the formation of diverticula or canals; digestion partly intracellular; the nervous system a network of cells; commonly with the power of budding, by which either free individuals or colonial zooids may be formed; and whose sexual reproduction typically produces an ovoidal, uniformly ciliated larva, known as the *planula*, which has at first a solid core of endoderm.

Thus defined, this phylum contains the whole of the diploblastic animals, that is, those in which the space (blastocoele) between ectoderm and endoderm is either devoid of cells, or contains only cells derived late in development by immigration from ectoderm or endoderm. Of such animals there are two very distinct stocks—the *Cnidaria*, characterized by muscular movements, which possess nematocysts (p. 148), and are reducible either to the polyp or to the medusa type (p. 150); and the *Ctenophora*, which retain the ciliary locomotion of the planula, are without nematocysts, and are not to be assigned either to the polyp or to the medusa type.

In the Coelenterata the Metazoa are at the beginning of their evolution and we have a primitive type with great potentialities, though these animals have also already acquired specialized features. The tissues consist of two single layers of cells, the ectoderm and endoderm, which constitute a thin body wall surrounding the central cavity (Fig. 108): the only increase in thickness and complexity of the body wall that is possible is by development of a gelatinous intermediate layer. Thus, while the typical polyps like *Hydra* have a very thin layer of this kind, it has become thicker, very much folded and penetrated by cells in the actinozoan polyps and exceedingly thick in the larger jellyfish, forming not only a kind of internal skeleton but even a reservoir of food

The principal type of cell found in the tissues, both ectoderm and endoderm, of the primitive coelenterate is the *musculo-epithelial* cell which is columnar in shape and only differs from similar epithelial

cells in the higher Metazoa in the fact that it is produced into one or two contractile fibres, which are imbedded in the mesogloea. Such a tissue unit resembles a protozoon in the fact that different parts of the cytoplasm carry on different functions although they are not separated by any partition from each other nor provided with separate nuclei. An endodermal cell of *Hydra* has an inner border which can be

produced into flagella, by means of which the fluid of the body cavity is kept in motion: or these may be retracted and the cell instead puts out pseudopodia to engulf particles of food. In the interior of the cell, beyond the border, the food is contained in vacuoles where it is digested, and finally the external border of the cell is produced into permanent cell organs,

the muscle fibres or tails already mentioned, in which the cytoplasm can contract with much greater force and rapidity than in any other part of the cell. Among the endodermal cells, however, some are met with

of a more specialized type: gland cells which pour into the cavity a digestive secretion (for the preparatory or extracellular digestion), and sense cells, found also in the ectoderm, which are thread-like, with a short projecting process. Both these kinds have no muscle tails.

A type of cell which is even more characteristic of the Coelenterata (except the Ctenophora) than the musculo-epithelial cell is the thread cell or *cnidoblast*. Though this would appear to have reached the highest peak of specialization it must be pointed out that within the limits of a single cell many functions are performed and a machinery developed which would be formed from a number of different kinds of cells in the higher Metazoa. A thread cell (Fig. 109) is formed from an undifferentiated *interstitial* cell<sup>1</sup>: part of the cytoplasm becomes

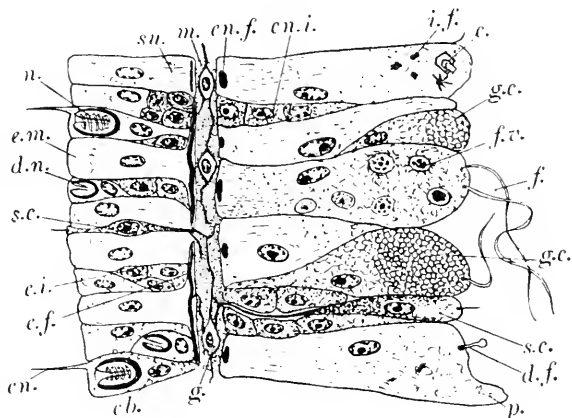

Fig. 108. Diagrammatic longitudinal section of the body wall of *Hydra*. From Manton. *c.* crystal; *cb.* cnidoblast; *cn.* cnidocil; *d.f.* developing flagellum; *d.n.* developing nematocyst; *e.f.* ectodermal muscle fibre; *e.i.* interstitial cell of ectoderm; *e.m.* ectodermal musculo-epithelial cell; *en.f.* endodermal muscle fibre; *en.i.* interstitial cell of endoderm; *f.* flagellum; *f.v.* food vacuole; *g.* nerve cell; *g.c.* gland cell; *i.f.* food inclusion; *m.* mesogloea; *n.* nematocyst; *p.* pseudopodium; *s.c.* sense cell; *su.* supporting cell.

<sup>1</sup> This is a type of cell which preserves an embryonic character and may develop into germ cells and musculo-epithelial cells as well as cnidoblasts.

glandular and forms a large vacuole, filled with a poisonous fluid and lined with a chitinous membrane, of complicated structure. The whole of this secreted body is called the *nematocyst*. Another part of the cytoplasm round the nematocyst develops muscular fibrillae, and by their contraction the "explosion" of the nematocyst is caused, an action so violent that the whole cell may be cast out of the animal as a consequence. The external part of the thread cell develops a short

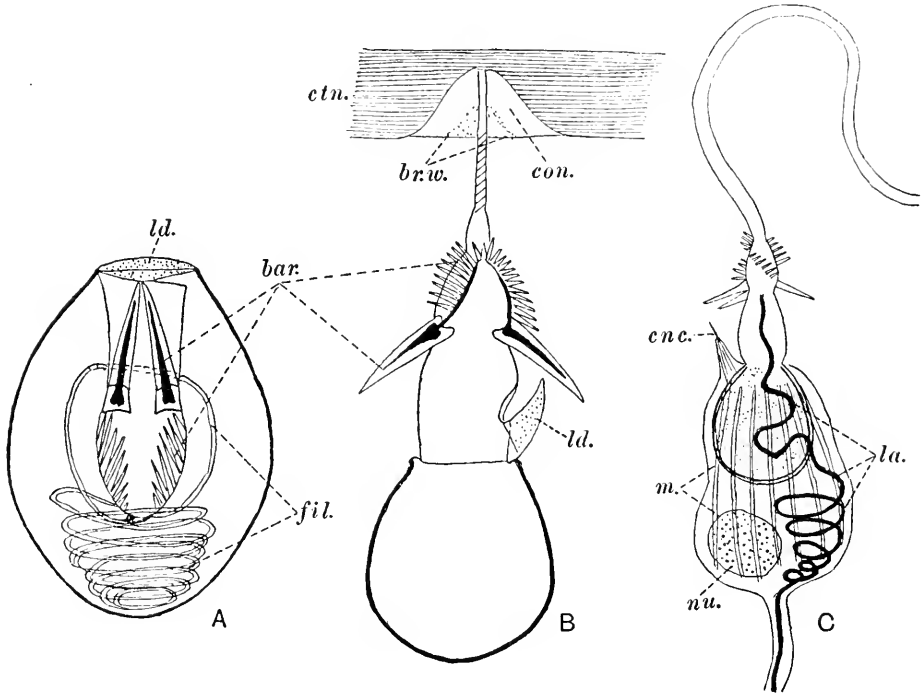

Fig. 109. Nematocysts of *Hydra*, large penetrating type. A, Undischarged. B, Discharged. From *H. attenuata*. After P. Schulze. C, Discharged but retained within its thread cell. After Will. *bar.* barbs; *br.w.* (stippled) wound in chitin (*ctn.*) of prey possibly caused by mechanical action of smaller barbs, the continuation (*con.*) being due to the solvent action of a fluid from within the nematocyst; *cnc.* cnidocil; *fil.* filament; *ld.* lid; *la.* lasso; *m.* muscular fibrils; *nu.* nucleus of thread cell.

sensory process, the *cnidocil*, which bores through the cuticle of the musculo-epithelial cell in which it lies and comes into contact with the water. The stimulation of these cnidocils, for example if the animal is touched by the appendage of a wandering crustacean, causes a disturbance which is transmitted through the body of the cnidoblast to the muscle fibres of the nematocyst to cause explosion, so that within a single cell we have the receptor and effector organs which are necessary for a very remarkable reflex action independent of the nervous system. Lastly, the nematocyst may be attached to the base

of the thread cell by the *lasso*, an organ which helps to restrain the force of the explosion. From the high degree of differentiation and the independence of action these cells might almost be considered as separate organisms within the coelenterate if their development were not to be traced from the interstitial cells.

The nervous system of coelenterates is one of their most characteristic organs, composed of cells of a special type which are only to be

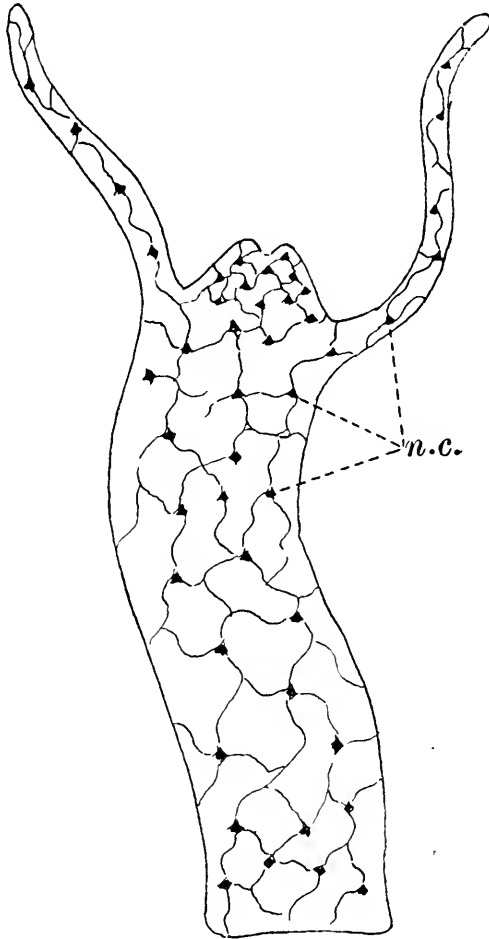

Fig. 110. Diagram of *Hydra* to show the nervous net. *n.c.* nerve cells.

demonstrated by difficult methods of staining. Over the surface of the mesogloea on both sides among the muscle tails there is spread a network of cells (Fig. 110) with very small cell bodies and many fine branches which appear to anastomose with each other and also connect with the sense cells in the ectoderm and endoderm. Synaptic junctions such as occur elsewhere in the Metazoa have, however, been recently demonstrated in the Scyphomedusae and so possibly

occur in the rest of the coelenterates. A sense cell is shown in Fig. 108 *s.c.* It has a rod-like process projecting from the surface and at its other end it ends in slender branches which join with those of the nerve cells. Such sense cells respond to touch and probably also to light and chemical stimuli. If a polyp is touched with a wire the disturbance is transmitted in all directions by the nerve net and results in a general contraction of the muscular system, which may last for long periods. In some cases coelenterate polyps are only capable of expansion in the absence of light.

This "nerve net" is the most primitive type of nervous system. The cells which compose it differ from the nerve cells of higher Metazoa in their simple structure, and above all in the fact that they are arranged in a diffuse fashion, and not aggregated along particular lines. This is at any rate true for the most primitive polyps: in the medusae and the more differentiated polyps the nerve cells tend to concentrate in special parts but not in such a fashion as to form any kind of a central nervous system.

Much of the interest of the coelenterates lies in the conflict between the two modes of life, an easy sedentary existence and a wandering or rather freely-drifting life which demands a larger measure of activity and a greater elaboration of structure and physiological development. The two types of individual which correspond to these modes of life are the Polyp and the Medusa. There are large divisions of the coelenterates in which only one type is present, while in the others they may even be united in the same species and the same colony of that species. A survey of the phylum is very largely concerned with the variations of these types and the combination of them in the life histories of the different coelenterates.

The polyp (Fig. 111 A) is an attached cylindrical organism with a thin body wall consisting of two single layers of ectoderm and endoderm separated by a narrow structureless lamella. At the free end an *oral cone* occurs and at its apex the mouth opening into the enteron. The oral cone (in the Hydrozoa) is surrounded by a number of tentacles, which are usually very extensible and armed with batteries of nematocysts, by which the living animals, on which the coelenterate feeds, are caught. Tentacles contain a prolongation of the endoderm which may form a tubular diverticulum of the enteron or a solid core. The medusa (Fig. 111 C) is a free-living organism differing from the polyp in the great widening of the body, especially along the oral surface, and the restriction of the enteron by the increase in thickness of the structureless lamella on the aboral side of the endoderm, so that while a central *gastric cavity* remains, the two endodermal surfaces have come together peripherally to form a solid two-layered *endoderm lamella* except along certain lines, where the *canal system* is developed



radiating from the gastric cavity. The oral cone becomes the *manubrium*; the rim which bears the original tentacles of the polyp is now separated widely from the mouth by differential growth and drawn downwards in the formation of the bell. Very often a secondary set of oral tentacles are developed on the manubrium. The radial symmetry of the polyp is more strongly emphasized in the medusa by the

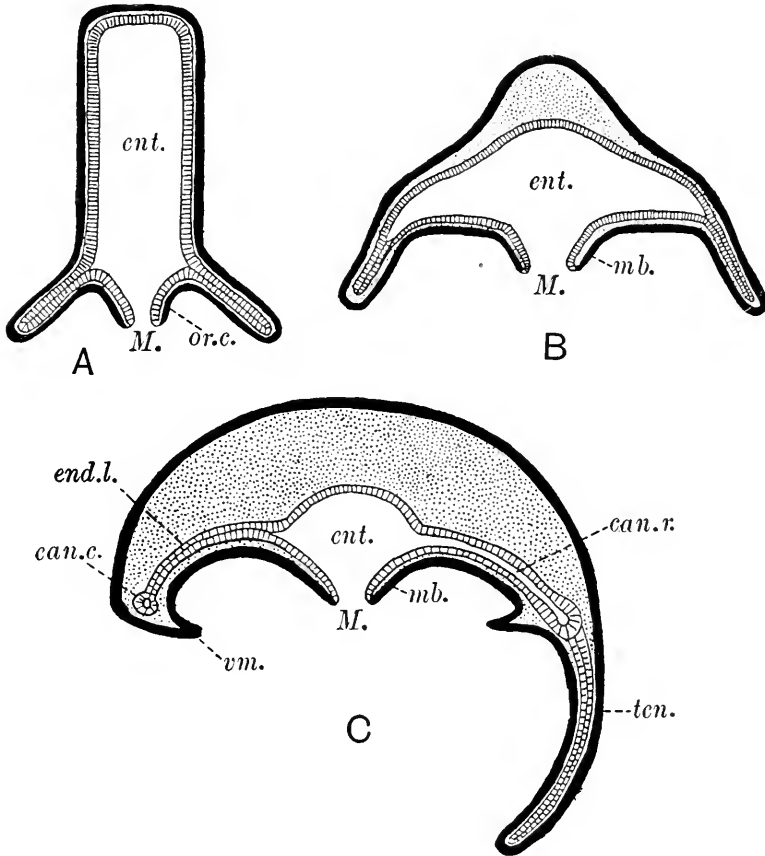

Fig. 111. Diagram to illustrate the relation between polyp and medusa. A, Polyp. B, An imaginary intermediate form. C, Medusa. Ectoderm black, endoderm cross-hatched, mesogloea stippled. *can.c.* circular canal; *can.r.* radial canal; *end.l.* endoderm lamella; *ent.* enteron; *M.* mouth; *mb.* manubrium; *or.c.* oral cone; *ten.* tentacle; *vm.* velum. The velum, present in many medusae, is absent in *Obelia*.

radial development of the canal system. The muscular system of the bell is greatly developed by the substitution of a type of cell in which the muscular processes form a long striated fibre while the epithelial part is greatly reduced; such a cell is capable of rapid rhythmical contraction. The nervous system may be partially concentrated to form a nerve ring and well-defined sense organs occur in connection with this. In this phylum, the lowest of the Metazoa, the gametes are

of the type which is found throughout that great animal division; the maturation divisions make their typical appearance here. Eggs and spermatozoa respectively are nearly always borne by different individuals or colonies. After fertilization the egg segments by equal divisions until firstly, a single layer of cells (ectoderm) arranged to enclose a central cavity constitutes the *blastula*. Then, by the migration of cells into this cavity, it becomes filled up with tissue (endoderm)

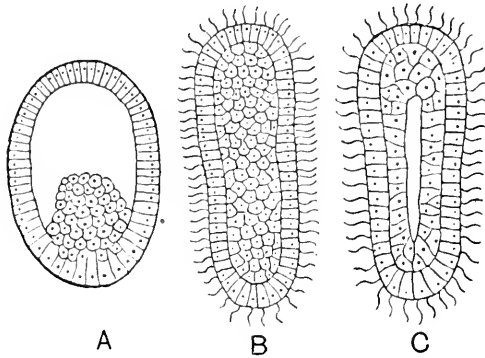

Fig. 112. Development of a hydroid polyp. After Merejkowsky. A, Formation of endoderm in the blastula, by budding from the pole. B, Planula with solid core of endoderm. C, Appearance of enteron; endoderm cells beginning to arrange themselves as a single layer.

while the ectoderm becomes ciliated. Such a larva with a solid core of endoderm is a *planula* (Fig. 112). It is capable of wide distribution by currents and may live for a considerable period before settling down. A split appears in the endoderm, the first appearance of the enteron, and the larva sinks to the bottom and attaches itself by one end. At the other end a mouth and tentacles appear and the creature becomes a polyp. There are a few exceptions to this in the phylum in which the egg develops directly into a medusa.

### SUBPHYLUM CNIDARIA

Coelenterata referable to two types, the fixed *polyp* and the free *medusa*; locomotion usually by muscular action; possessing nematocysts.

They are divided into the following classes:

**HYDROZOA.** Cnidaria, nearly always colonial; typically with free or sessile medusoid phase, arising as buds from the polyp-colony: no vertical partitions in the enteron; medusae with a velum and nerve ring; tentacles of polyp usually solid; ectodermal gonads; and an external skeleton.

**SCYPHOMEDUSAE.** Cnidaria in which the polyp stage is inconspicuous and may be absent altogether: the polyp, where present,

gives rise to medusae by transverse fission (strobilation); with vertical partitions (mesenteries) in the enteron of some forms and larval enteron of others; velum and nerve ring absent; endodermal gonads; and skeleton absent.

ACTINOZOA. Solitary or colonial cnidarian polyps without medusoid phase; vertical partitions (mesenteries) in the enteron; endodermal gonads; with or without a skeleton.

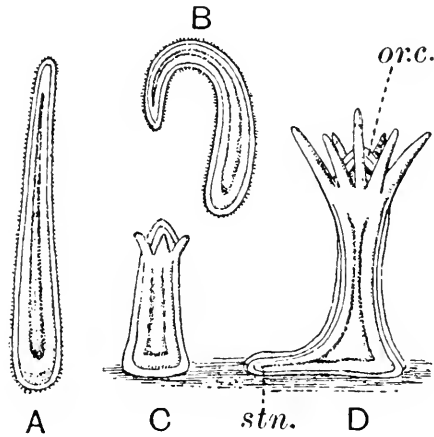

Fig. 113. The planula of a hydromedusan, *Clava squamata*. A and B, Swimming about in the sea. C, Coming to rest on a rock. D, Developing tentacles, oral cone and stolon. *or.c.* oral cone; *stn.* stolon. Magnified. From Allman.

### Class HYDROZOA

The most typical life histories of the "hydroids" are those in which the phenomenon of "alternation of generations" is presented. That is, there is a regular alternation of phases, hydroid colonies giving rise to free-swimming medusae and the fertilized eggs laid by the medusae each giving rise to a new colony of polyps. In the first two orders of the Hydrozoa, the Calyptoblastea and the Gymnoblastea, alternation of generations is well shown in the typical genera. As will be shown, there is a progressive suppression of the medusoid "generation" in other members of these orders. In the other orders there is, however, complete suppression of the polyp phase in the Trachomedusae and Narcomedusae, and in the Siphonophora remarkable colonies are found which appear to have originated by budding from a medusa.

The following orders are contained in the class:

*Calyptoblastea (Leptomedusae)*. Hydrozoa in which the coenosarc is covered by a horny perisarc, produced over the nutritive polyps as hydrothecae and over the reproductive individuals as gonothecae;

the medusae flattened, with gonads on the radial canals, and usually statocysts.

*Gymnoblastea* (*Anthomedusae*). Hydrozoa in which the coenosarc is covered by a horny perisarc which stops short at the base of the polyps and reproductive individuals; the medusae bud-shaped, the depth of the bell greater than the width, with gonads on the manubrium and eyes, but not statocysts.

*Hydrida*. Hydrozoa existing as solitary polyps without medusoid stage; tentacles hollow; without perisarc, the polyps being capable of locomotion; gastrula forms a resting stage encased in an egg shell.

*Trachylina*. Hydrozoa in which the medusoid is large and the hydroid phase minute. The latter either forms medusa buds or being represented by the planula larva metamorphoses into a medusa. Statocysts with endodermal concretions: generative organs lying on the radial canals or on the floor of the gastric cavity.

*Hydrocorallinae*. Hydrozoa existing as fixed colonies with an external calcareous skeleton into which the usually dimorphic polyps can be retracted.

*Siphonophora*. Hydrozoa existing as free-swimming, polymorphic colonies, without perisarc, derived by budding from an original medusiform individual.

The *Graptolithina* (see p. 169) are probably another order of the Hydrozoa and certainly belong to the class.

#### Orders CALYPTOBLASTEAE, GYMNOBLASTEAE, HYDRIDA

We will take as examples of these orders *Obelia*, belonging to the Calyptoblasteae and *Bougainvillea* to the Gymnoblasteae, both of which produce free-swimming medusae, and then describe *Tubularia* with its sessile gonophores. The series ends with *Hydra* (Hydrida).

In a colony of *Obelia* (Fig. 114) root-like hollow tubes (the *hydro-rhiza*) run over the surface of attachment, such as a seaweed, and from these spring free stems, which branch in a cymose fashion giving off the polyp heads (hydranths) on alternate sides. At the growing ends of the main branches are produced buds which develop into hydranths, and towards the base of the branches in the axils of the hydranths, polyps modified for reproduction, the *blastostyles*, occur. The whole system of tubes which connect up the individual polyps is the *coenosarc*, and it must be understood that the enteron or cavity of the colony is continuous and common to all its members. The rhythmical contraction of the hydranths causes currents which distribute the food obtained by some individuals to those parts of the colony where feeding is not taking place. As in all Calyptoblasteae the

coenosarc is completely invested by the cuticular secretion, the *perisarc*, composed of chitin and produced to form cups round the hydranths (*hydrothecae*) and the blastostyles (*gonothecae*). The hydranth of *Obelia*

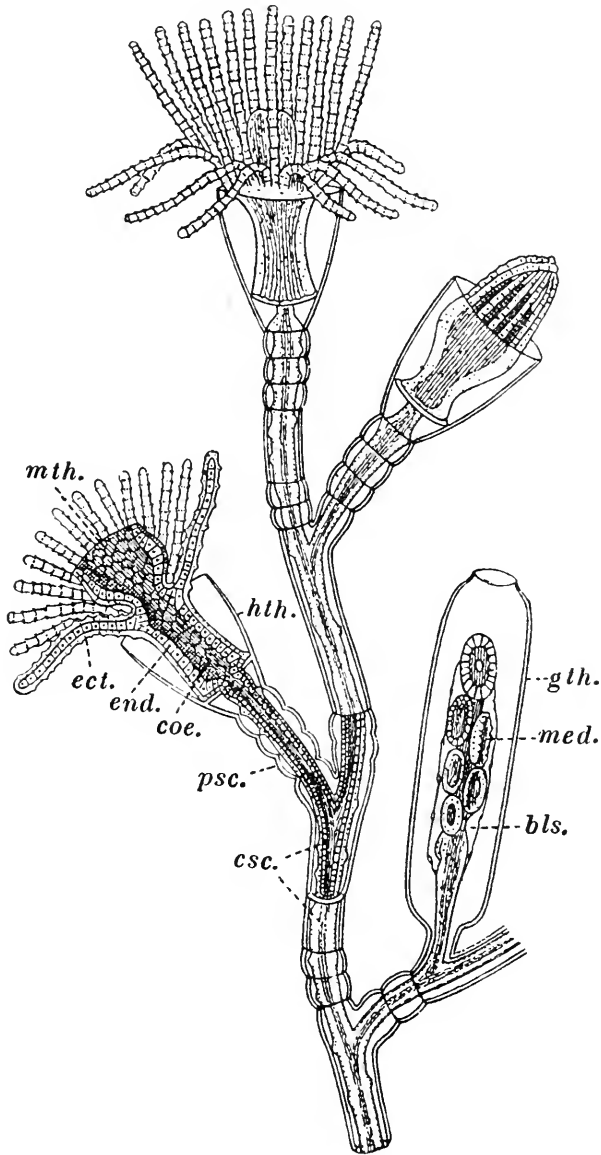
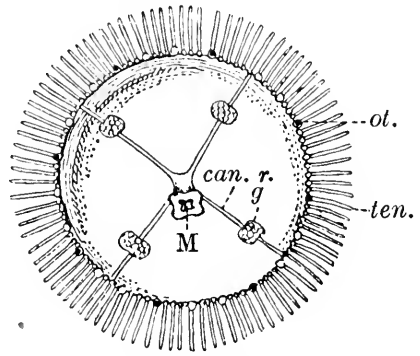

Fig. 114. Part of a branch of *Obelia* sp. To the left a portion is shown in section. After Parker and Haswell. *ect.* ectoderm; *end.* endoderm; *mt.* mouth; *coe.* coelenteron; *csc.* coenosarc; *psc.* perisarc; *hth.* hydrotheca; *bls.* blastostyle; *med.* medusa-bud; *gth.* gonotheca.

is an expansion of the coenosarc, ending in a prominent oral cone, surrounded by a single ring of rather numerous tentacles, which have a solid core of endoderm cells. The blastostyle has a mouth but no

tentacles; the body wall proliferates to form distinct individuals, the medusae. Those nearest the mouth of the gonotheca mature first, and they are liberated as they mature. The medusa of *Obelia* (Fig. 115), the type of the Leptomedusae, is like a shallow saucer, the middle of the concave (subumbrellar) surface being produced into a short manubrium. The rim of the medusa bell is furnished with a large number of short tentacles. Like all medusae belonging to the Hydromedusae, it has four radial canals, running from the gastric cavity to the circular canal. On the course of the radial canals and, at the end of a short branch, patches of the subumbrellar ectoderm are modified to form the gonads. The germ mother-cells originate in the



ectoderm of the manubrium, pass through the endoderm and along the radial canals to the gonads and then migrate into the ectoderm again. Only male or female germ cells are produced by each medusa. At regular intervals in the circumference are eight sense organs, the *statocysts*. They are tiny closed vesicles, lined with ectoderm and filled with fluid in which minute calcareous grains occur. The epithelial lining not only secretes these but is also sensory: the impact of the grains on the cells produces a stimulus which is transmitted through the nerves to the muscles, and if the position of the medusa should be abnormal the muscles contract in such a way as to right the bell of the animal.

Another characteristic of the hydrozoan medusa is the *velum* (which is practically absent in *Obelia*), a narrow internal shelf running inside the border of the subumbrellar cavity. This is largely composed of ectodermal circular muscles, separated by a horizontal partition of structureless lamella. At its base is a double nerve ring: the inner half of this is concerned with the subumbrellar musculature (and, in the *Trachylina* only, the outer with the sense organs).

The ripe ova are shed into the water by the rupture of the gonad, and fertilization takes place here. Segmentation leads to the formation first, of a hollow blastula, and from this, by the immigration of cells at one pole, the elongated planula larva (Fig. 112) with a solid core of endoderm is formed. It is ciliated and swims freely for a time, eventually settling down by its broader end, while the other end develops a mouth and tentacles surrounding it. The endoderm delaminates to

Fig. 115. Free-swimming medusa of *Obelia*. From Shipley and MacBride. *can. r.* radial canal; *g.* gonad; *M.* mouth at end of manubrium; *ot.* otocyst; *ten.* tentacles.

form the enteron. From the base of this first formed polyp there is an outgrowth along the surface of attachment which is the beginning of the hydrorhiza. From this the rest of the colony is developed.

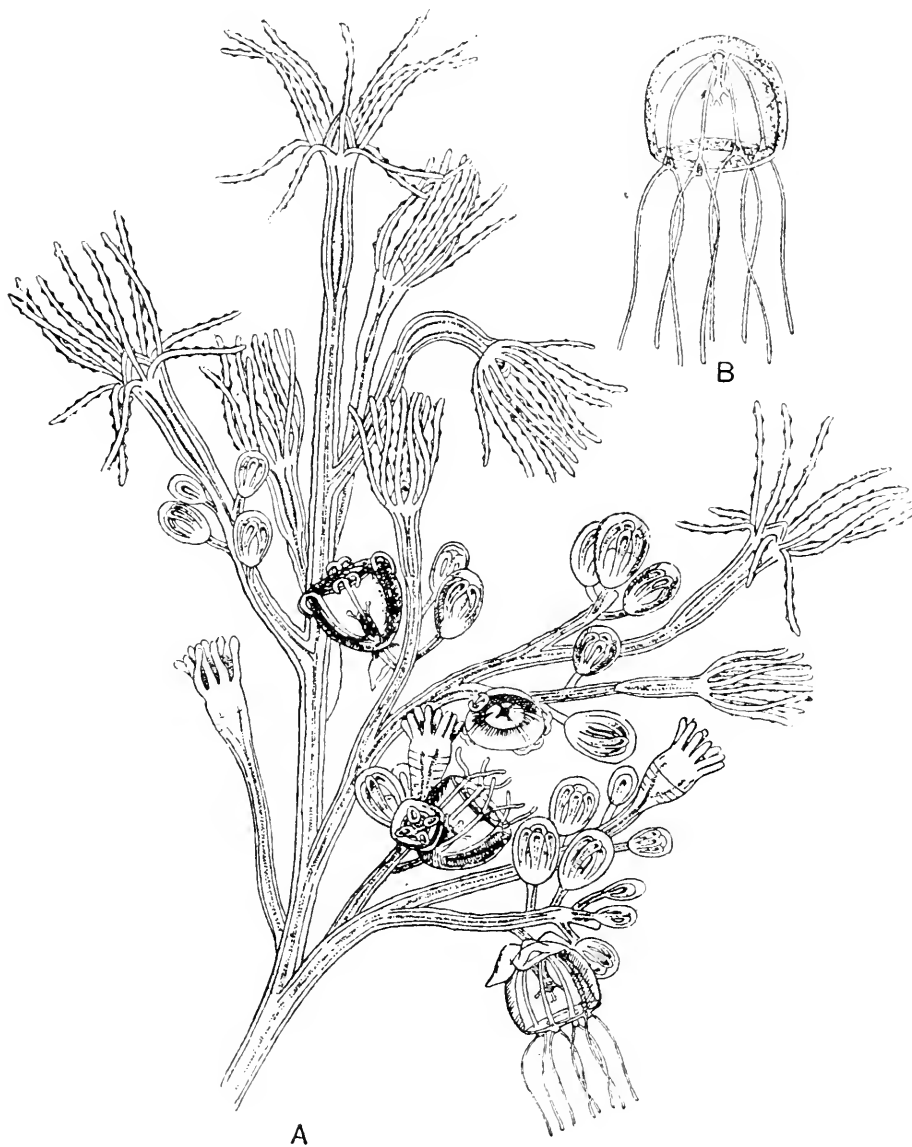

Fig. 116. *Bougainvillea fructuosa*,  $\times$  about 12. From Allman. A, The fixed hydroid form with numerous hydroid polyps and medusae in various stages of development. B, The free-swimming sexual medusa which has broken away from A.

In *Bougainvillea* (Fig. 116) the polyps belong to the gymnoblastic type to be described for *Tubularia*. The creeping hydrorhiza gives off branches, one of which is seen in the figure, and from these

numerous individuals are budded. Most of these are polyps (hydranths), distinguished from those of the Calyptoblastea by the fact that the perisarc stops short at the base of the polyp and does not form a hydrotheca. The medusoid individuals take their origin directly from the coenosarc each as a simple bud, within which is developed a single medusa which eventually divests itself of a thin covering, breaks from its stalk and swims away. Several may spring from the same stem, but this may also bear normal polyps. There is here no blastostyle, or polyp modified for budding off medusae, and this condition, in which polyps and medusae belong to the same grade of differentiation from the coenosarc, is possibly to be regarded as primitive, that of *Obelia* as secondary. In *Eudendrium* an intermediate stage occurs. Medusae are budded off from the stalk of a normal polyp, and as soon as this budding commences the polyp loses its tentacles, diminishes in length and may be said to become a blastostyle.

*Tubularia* (Fig. 117) occurs as a colony of large polyps with long stalks springing from a hydrorhiza of insignificant extent. At the base of the polyp the stalk forms a swelling; there the perisarc stops. There is an oral cone surrounded by a ring of tentacles and also a ring of larger (aboral) tentacles at the broadest part of the polyp. Both kinds of tentacles are solid, with an axis of vacuolated endoderm cells placed end to end, which have a skeletal value. In Fig. 118 part of the phenomenon of digestion is illustrated. A crustacean has been swallowed and lies in the stomach (s). After preliminary digestion a fluid mass of half-digested material is formed and, by alternate contraction of A the stomach and B the spadix (manubrium) of the gonophore together with the basal swelling of the polyp, the food is forced into contact with all the absorptive epithelium of the polyp and gonophore and also pipetted along the cavity of the stalk.

The reproductive individuals originate from hollow branched structures springing from the polyp itself between the oral and aboral tentacles. Each polyp has several of these branches, and from each branch a number of reproductive individuals arise. The branch is usually termed a *blastostyle*, although it is only part of an individual and not a modified polyp as in *Obelia*. Each of the buds it produces, however, has the structure of a medusa but remains attached to the parent polyp as long as it lives. Like the free-swimming medusa of *Bougainvillea* it conforms to the anthomedusan type, the depth of the medusa bell exceeding the width and the gonads being situated on the manubrium (spadix). This sessile medusa is called a *gonophore*. As seen in Fig. 119A, the radial and circular canals are formed as in *Obelia*, and four very short tentacles occur opposite the radial canals on the margin of the bell; but the entrance to the subumbrellar cavity



is very much constricted compared to *Obelia* or a free-swimming anthomedusa. Another modification is that the eggs, which are large and yolky, when liberated from the gonad are fertilized in the sub-umbrellar cavity and develop there through the planula stage into

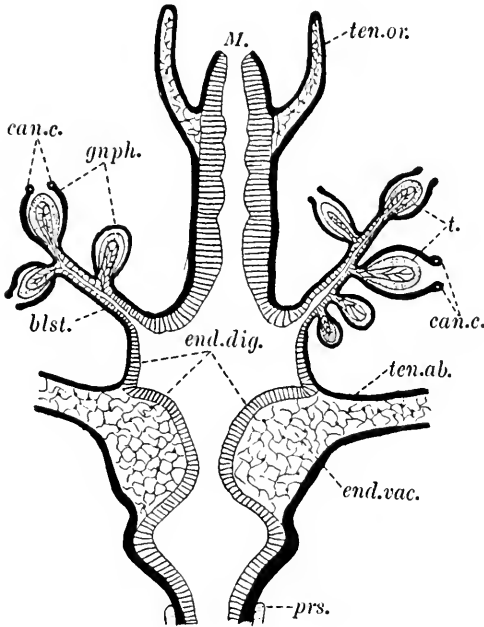

Fig. 117.

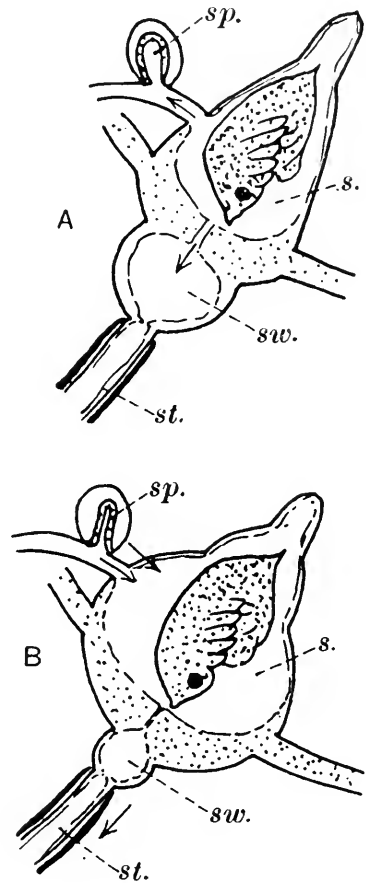

Fig. 118.

Fig. 117. Median vertical section through a polyp of *Tubularia*. *blst.* blastostyle; *can.c.* circular canal; *end.dig.* digestive endoderm; *end.vac.* vacuolated endoderm, forming supporting core of tentacles; *gnph.* gonophores; *M* mouth; *prs.* end of perisarc; *t.* testis; *ten.ab.* aboral and *ten.or.* oral tentacles. Slightly altered from Kukenthal.

Fig. 118. *Tubularia* with food. A, with stomach *s*, contracted and the basal swelling *sw* and the spadix of the gonophore *sp.* expanded. B, The reverse. *st.* cavity of stalk. Arrows denote direction of fluid movement. From Beutler.

an advanced larva called the *actinula* (Fig. 119B) which is really a polyp of *Tubularia* with a short stem. At this stage it makes its way out of the shelter of the gonophore and fixes by its aboral end. As a rule, only one of these large eggs can be produced at one time and

a ripe gonophore generally contains two larvae of different ages, one a planula and the other an actinula, which may be seen protruding from the aperture of the bell.

In such gonophores the neuromuscular structures of the bell are hardly developed at all, the mouth never opens and there are no evident sense organs. In the medusae called *Lizzia* and *Margellium*, common plankton forms whose polyp stages are not known, we see the normal anthomedusan type. In both of these there are a number of short tentacles, arranged in groups round the margin of the bell, and four double tentacles at the end of the manubrium. *Lizzia*

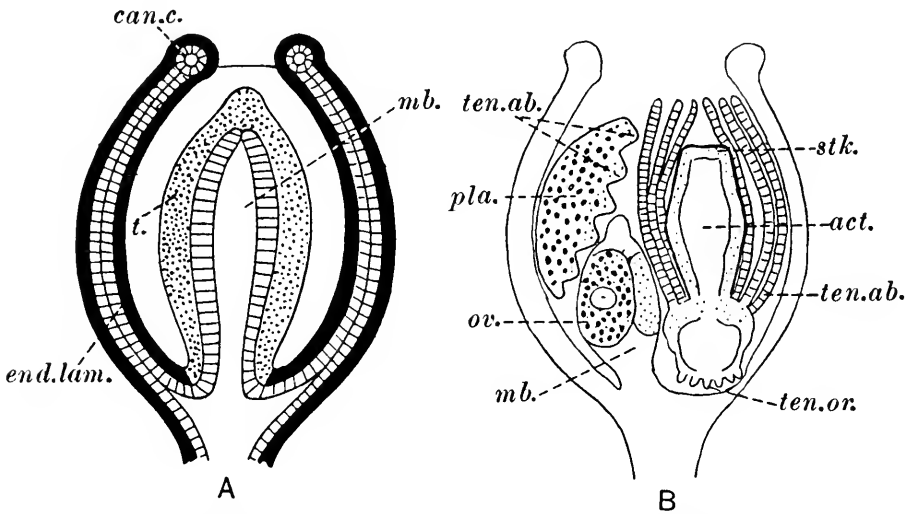

Fig. 119. Longitudinal sections through gonophores of *Tubularia*. A, Young male. B, Female with larvae. In B the details of tissues are omitted; in A ectoderm is black, endoderm cross-hatched. *end.lam.* endoderm lamella; *act.* actinula larva; *pla.* planula larva with rudiments of aboral tentacles; *mb.* manubrium; *ov.* ovum; *stk.* stalk of polyp. Other letters as in Fig. 117. Original.

possesses eight "eyes" (Fig. 120 I) which are little patches of ectoderm, in which some of the cells develop pigment while others elongate and end in rods. The latter are concluded to be the light-perceiving cells. There is also an outer enlargement of the cuticle which serves to concentrate light on the organ and may be called a lens. Though there is no direct evidence that these organs have a relation to light, they have in a simple form all the structural elements of the eye of higher animals. *Margellium* (Fig. 121) has no eyes but apparently suffers no disability from their absence: probably the light-perceiving cells are scattered over the general surface of the ectoderm. "Eyes" are however a general character of the Anthomedusa as "Ears" (as statocysts may be broadly termed) are of the Leptomedusa.

Among the hydroids with sessile medusoids or gonophores there are many forms in which the medusoid structure is lost, and a bud-like structure is found in which a transverse section shows simply

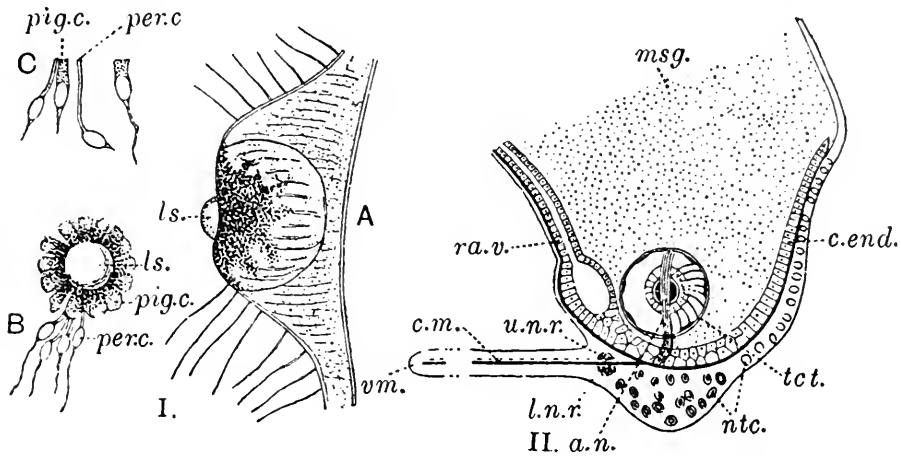

Fig. 120. I. A, Eye of *Lizzia koellikeri* seen from the side, magnified. B, The same seen from in front. C, Isolated cells of the same. From O. and R. Hertwig. *ls.* lens; *perc.* percipient cells; *pig.c.* pigment cells. II. Radial section through the edge of the umbrella of *Carmarina hastata* showing sense organ and velum. *a.n.* auditory nerve; *c.end.* continuation of endoderm along aboral surface; *c.m.* circular muscles of velum; *l.n.r.* lower nerve ring; *msg.* mesogloea; *ntc.* nematocysts; *ra.v.* radial canal running into circular canal, both lined by endoderm; *tct.* sense organ or tentaculocyst; *u.n.r.* upper nerve ring; *vm.* velum.

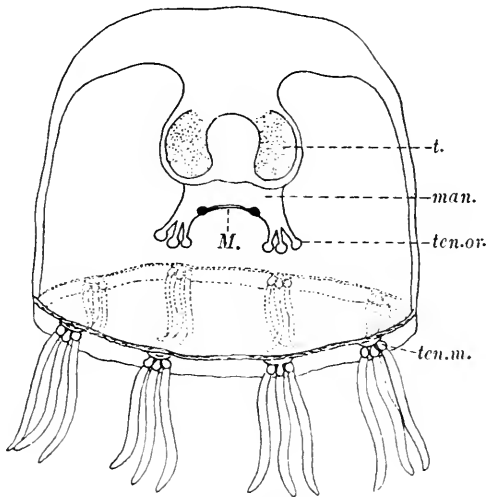

Fig. 121. *Margellium*, example of an anthomedusan. *M.* mouth; *man.* manubrium; *t.* testis; *ten.or.* oral and *ten.m.* marginal tentacles. Original.

successive layers of ectoderm with generative cells, structureless lamella and endoderm round an enteron which does not open by a mouth. In forms like this the migrations of germ cells, mentioned as

occurring in *Obelia*, are very noticeable. Thus in *Eudendrium* (Fig. 122 D) the germ cells are often to be distinguished making their way along the coenosarc towards developing gonophores. If this degeneration of medusae is followed to its conclusion, a stage is arrived at in which there are no special reproductive buds at all, but the generative cells occur in the body of the hydroid. This is the condition in *Hydra*, where the multiplication of the interstitial cells at different positions produces testes or ovaries. In the latter case each ovary contains a single egg of a size unusual in the Hydrozoa, which grows by the ingestion of its sister oocytes and the conversion of their protoplasm into yolk spherules as in *Tubularia*. This phenomenon appears to be a consequence of the habitat of the genus. As in so many other freshwater animals, a free-swimming stage is omitted from the early history and the period of larval development is passed in the shelter of the egg shell; when the gastrula stage has been arrived at and the yolk is mostly absorbed, development is suspended during a resting stage of three or four weeks. After this the young *Hydra* pokes its oral end out of the shell and, after creeping about for a short time, frees itself and develops a mouth and tentacles. Other characters which differentiate *Hydra* from the majority of hydroids are the solitary habit, which it shares with some Gymnoblasteria, the hollow tentacles and the complete absence of a stiff perisarc, this enabling the animal to execute its characteristic looping movements. It is often pointed out that the presence of a distinct migratory phase, the medusa, would entail a serious disadvantage on *Hydra*; it is suggested that the medusae might be swept out to sea and lost. *Hydra* usually lives in ponds and is therefore hardly subject to this danger, but at the same time the embryo in its horny egg shell is admirably fitted for dispersal, for example in mud on the feet of migratory birds. This modification of reproductive habits in *Hydra* is paralleled in the freshwater sponges with their gemmules, the freshwater polyzoa with their statoblasts and the cladoceran crustacea with their ephippial eggs. It must, however, be mentioned that a remarkable group of freshwater medusae occur which belong to the Trachylina, and a stage occurs in their life history which has sometimes been compared with *Hydra* and named a separate genus (*Microhydra*) of hydroid polyps. This is, however, an interesting case of convergence.

The following genera of Calyptoblastea may be shortly mentioned:

*Plumularia* (Fig. 122 A) with a creeping hydrorhiza, giving off plume-like branches, each of which bears a series of hydrothecae on one side only; hydrothecae small, so that the polyps cannot be completely retracted within them; beside the nutritive polyps a second smaller kind (nematophore), without mouth, but with long amoeboid

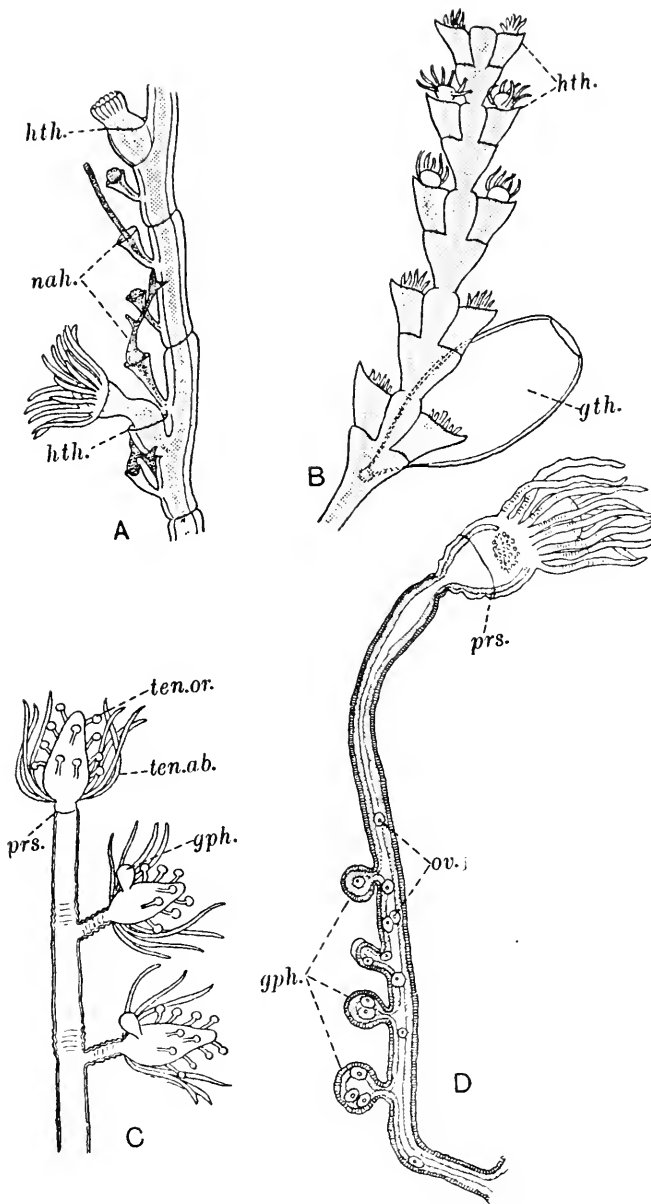

Fig. 122. Examples of Hydrozoa. A and B, Calyptoblastea. C and D, Gymnoblasteria. A, *Plumularia*, small portion of a branch showing nematophores. B, *Sertularia*, branch with opposite hydrothecae and gonotheca. C, *Pennaria*, tip of branch. D, *Eudendrium*, showing migration of germ cells into gonophores. *gph.* gonophores; *gth.* gonotheca; *hth.* hydrotheca; *nah.* nematophore; *ov.* migrating germ cells; *prs.* end of perisarc; *ten.ab.* aboral and *ten.or.* oral tentacles. A, after Allman; B and C, original; D, after Weismann.

processes which engulf decaying polyps, epizoic organisms like diatoms and protozoa and larvae of other epizoic forms.

*Sertularia* (Fig. 122 B) with a creeping hydrorhiza, more or less branching stems which bear opposite hydrothecae; hydrothecae large, so that the polyps can completely retract within them.

The following genera of Gymnoblasteria may also be mentioned:

*Cordylophora*, living in fresh or brackish water (Norfolk Broads), polyps with scattered filiform tentacles.

*Pennaria* (Fig. 122 C) with two kinds of tentacles, oral capitate and aboral filiform; nematocysts of very large size; medusae degenerate but become free when gonads are mature.

*Hydractinia*, with spreading plate-like perisarc covered by naked coenosarc, very often found coating a shell inhabited by a hermit crab; with spiral dactylozooids and sessile gonophores.

*Podocoryne*, as *Hydractinia*, but with free medusae.

The polyp forms of many medusae, both Antho- and Lepto-medusae, are unknown.

#### Order TRACHYLINA

This group consists of forms in which the medusoid develops directly from the egg and the polyp has either been reduced to a minute fixed individual or is represented only by the planula larva which metamorphoses into a medusa. The possession of sense tentacles with endodermal concretions is an important character. There are two suborders:

*Trachomedusae*. Trachylina with sense tentacles in pits or vesicles and with gonads situated in the radial canals; with marginal tentacles on the edge of the umbrella. Examples: *Geryonia*, *Limnocodium*, *Carmarina* (Fig. 120 II), *Limnocnida*.

*Narcomedusae*. Trachylina with sense tentacles not enclosed and marginal tentacles inserted some distance aborally from the edge of the umbrella; with gonads on the oral wall of the stomach. Example: *Cunina*.

The inclusion of the following freshwater forms in the order is provisional:

*Limnocnida* is a remarkable freshwater form found in the Central African lakes. Up till the present only male medusae have been found in Lake Tanganyika and female in Victoria Nyanza. Asexual reproduction by budding takes place from the margin of the bell. Other species occur in Rhodesia and the Indian rivers.

*Craspedacuta* (*Limnocodium*) was first known from the Victoria Regia tank in the Royal Botanic Gardens at Kew, but has now been discovered in various North American rivers and has even colonized

ponds and canals in England. It has a polyp-like stage, *Microhydra*, which has a certain likeness to *Hydra*.

### Order HYDROCORALLINAE

The forms included in this group are mostly associated with reef corals in tropical seas. The main part of the colony consists of a much branched hydrorhiza with frequent anastomoses. Instead of secreting a horny perisarc as the Calyptoblastea and the Gymnoblastera do, the ectoderm lays down an exoskeleton consisting of calcareous grains, which becomes bulky and solid. It may be either massive or encrusting or branching. From pits in the surface of the colony arise the

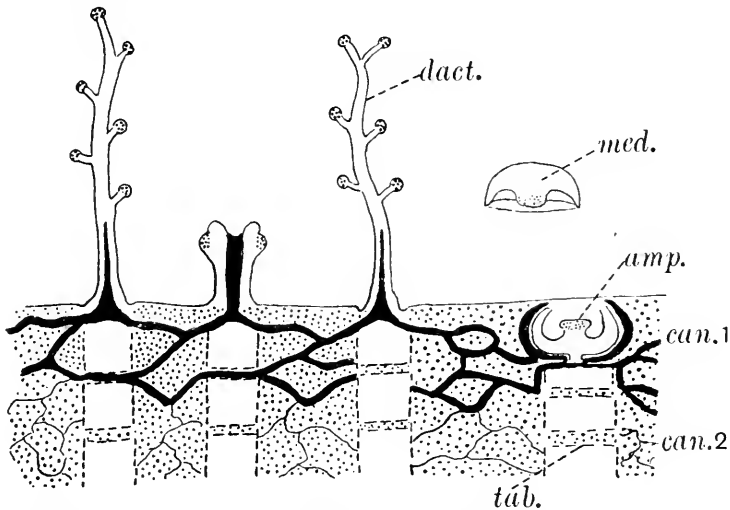

Fig. 123. Diagrammatic section through *Millepora* showing a gastrozoooid with a dactylozoooid (*dact.*) on each side of it and an ampulla (*amp.*) with a medusa enclosed in it; *can.1*, the living canals, shown in black, and *can.2*, the degenerating canals, shown as lines, constitute the hydrorhiza, and the skeleton is represented by stippling; *med.* a medusa just liberated; *tab.* tabulae in a gastropore. Slightly altered from Hickson.

polyps. These are of two types (Fig. 123). First there are the individuals of normal structure with a mouth surrounded by tentacles (*gastrozoooids*): these nourish the colony. Then there are the *dactylozoooids* which are much longer and more slender. They have no mouth but they possess scattered capitate tentacles and may form a ring round a gastrozoooid, in which case it is readily observed that their function is to catch prey and hand it to the central gastrozoooid for digestion. Besides the polyps there are the medusae, which, as in *Bougainvillea*, are budded directly off from the coenosarc: they are lodged in pits of the skeleton called *ampullae*, but their liberation has been observed in *Millepora*. It is supposed, however, that their free-living existence is very brief.

## Order SIPHONOPHORA

The Siphonophora are colonial animals which exhibit the maximum development of polymorphism found in the Coelenterata or indeed in any group of the Animal Kingdom. They are pelagic and each colony originates from a planula which metamorphoses to form a single medusiform individual (Fig. 124 B *nec.*<sup>1</sup> which later drops off from the colony), from the exumbrellar side of which springs a coenosarc tube budding off all the other members of the colony (Fig. 124 B *gst.* etc.). It usually happens that those which are developed first are needed to buoy up and propel the young colony. Consequently the first individual is either medusiform or else forms an apical float or *pneumatophore*, the epithelium of which secretes gas (Fig. 124 A *pn.*, B *nec.*<sup>2</sup>). There may also be formed from the ectoderm of the first formed individual an *oleocyst* containing a drop of oil. The succeeding medusiform individuals resemble the bell of an anthomedusa, with velum, musculature and canal system but lacking the manubrium, and they are called *nectocalyces*: while the most primitive siphonophores have only a single one there may be a series of them. Following these the coenosarc in one type of colony (Fig. 124 A) grows to a great length and buds off at intervals along its length similar assemblages of individuals. Such an assemblage is known as a *cormidium*, and may consist of (1) a shield-shaped *hydrophyllium* which covers the rest of the cormidium, (2) a *gastrozoid* resembling the manubrium of a medusa, with a mouth, and a tentacle usually branched, (3) a mouthless individual, the *dactylozoid*, with a tentacle usually of great length and provided with strong longitudinal muscles, and (4) a *gonozoid* (or individual bearing gonophores) which may or may not have a mouth. The gonophores often resemble those found in some of the Gymnoblastera like *Tubularia*. Such forms as those described above are the genera *Halistemma*, *Diphyes* and *Muggiaea*.

In other cases the coenosarc is not a linear stolon but a massive body from which are budded off innumerable cormidia, in which gastrozooids, dactylozooids and gonozooids are all crowded together to form a compact colony. In *Physalia* (Fig. 125 B), the "Portuguese man-of-war", there is an enormous cap-shaped pneumatophore which floats above the surface of the water. There are no nectocalyces, but the colony is borne hither and thither by the wind and countless numbers are cast up on the lee shores. The dactylozooids of *Physalia* hang suspended from the colony and form a drift net; when they are touched by a fish the nematocysts discharge and the fish is captured. The tentacles contract and the prey is drawn up until the gastrozooids can reach it. The lips of these are spread out over the surface of the fish until it is enclosed in a sort of bag in which it undergoes the first



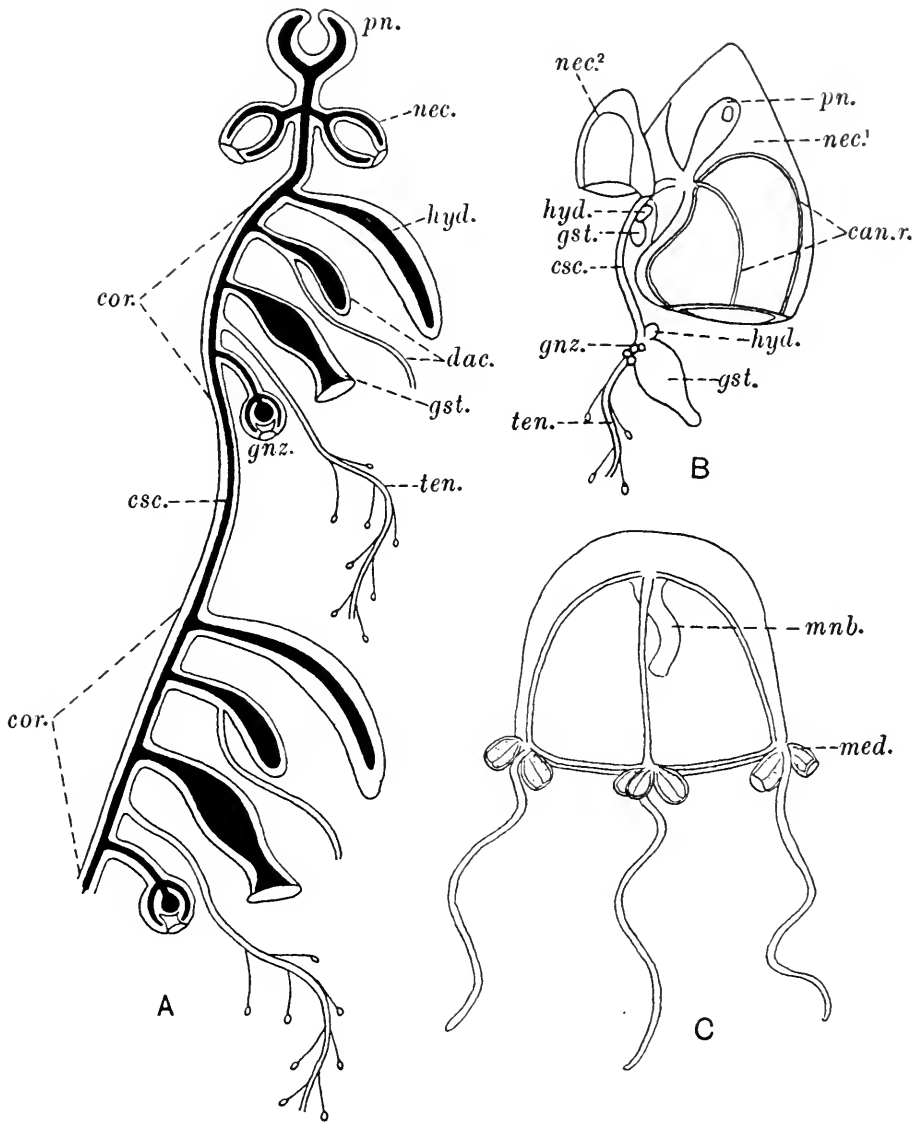

Fig. 124. Development of the siphonophore colony. A, Diagram of the possible combinations of individuals in a colony. The continuous gastrovascular system is shown in black. *pn.* pneumatophore; *nec.* nectocalyx; *hyd.* hydrophyllium; *gst.* gastrozoid; *dac.* dactylozoid with its tentacle; *gnz.* gonozooid; *cor.* cornidium; *csc.* coenosarc; *ten.* branched tentacle, sometimes springing from the base of the gastrozoid. B, Early stage of colony of *Muggiaea*, showing two generations of nectocalyxes, *nec.*<sup>1</sup>, *nec.*<sup>2</sup> *can.r.* the radial canals of the first nectocalyx. Other lettering as in A. *nec.*<sup>1</sup> is lost later and *nec.*<sup>2</sup> becomes the single permanent nectocalyx of the colony; *pn.* is really an oleocyst and not a pneumatophore. C, *Sarsia*, an anthomedusan, for comparison, showing budding of daughter medusae from the end of the radial canals. *mnb.* manubrium; *med.* daughter medusae. A, altered from Hertwig; B, after Chun; C, after Allman.

stage of its digestion. *Physalia* can catch and devour a full-grown mackerel, and the poison of its nematocysts is so virulent as to en-

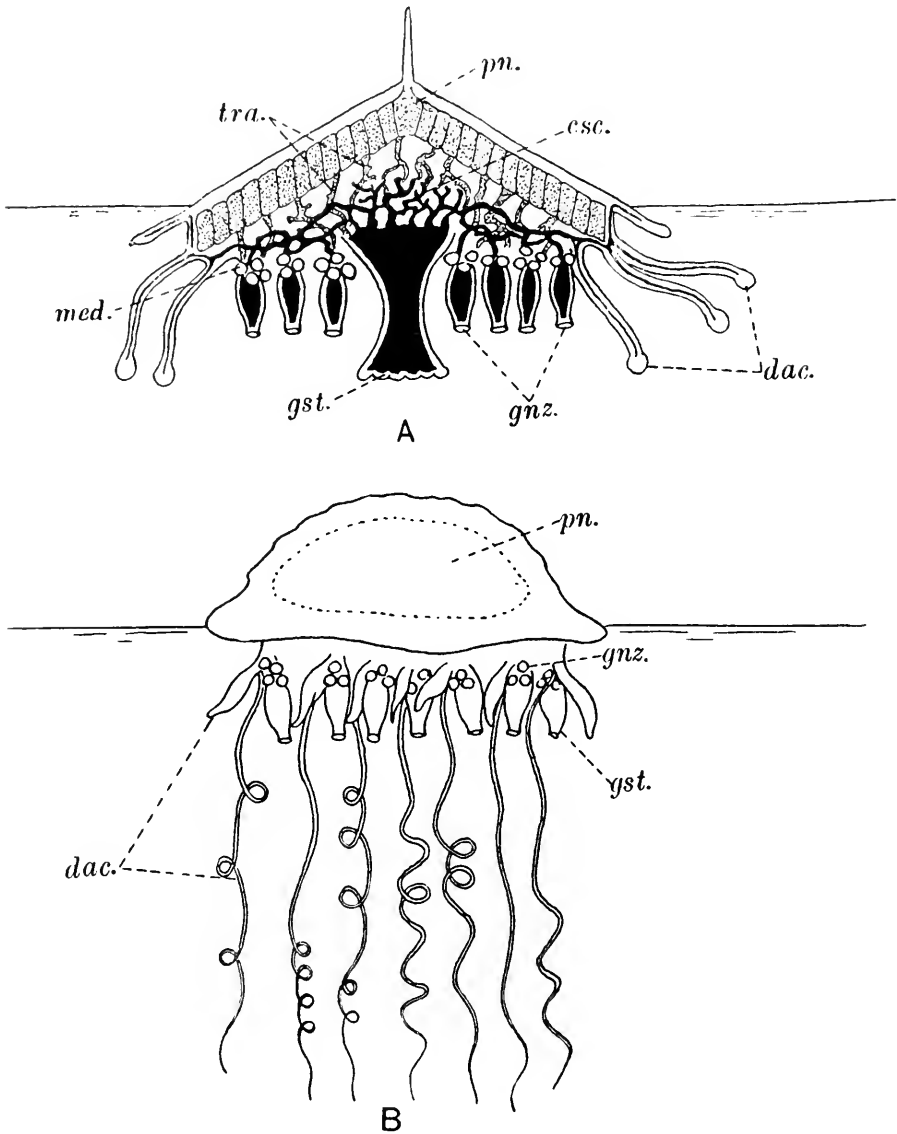

Fig. 125. Examples of Siphonophora. A, *Verella*. Altered from Haeckel. Vertical section, showing the cavity of the pneumatophore (stippled) and produced into branching gas tubes, the tracheae (*tra.*), and a network of endodermal tubes (black), which arise from the cavity of the gastrozoid and gonozooids (black); *med.* medusa buds. Other letters as in Fig. 124. B, *Physalia* showing the "drift net" arrangement of the tentacles of the dactylozooids.

danger human life. In *Verella* (Fig. 125A) the disc-shaped colony has a superficial resemblance to a single medusa. The pneumato-

phore consists of a chitinous disc containing a number of chambers and raised into a vertical ridge which forms a sail. On the under surface there is a single large gastrozoid in the centre, a larger number of gonozooids surrounding it and a fringe of dactylozooids at the margin. The gonozooids produce buds which actually escape as free medusae. The coenosarc consists of a mass of tissue which is traversed by endodermal tubes placing in communication the cavities of the gastrozoid and the gonozooids, and ectodermal tubes (tracheae) which are prolongations of the gas cavity of the pneumatophore. This tropical form is often brought in large numbers to the shores of Devon and Cornwall by the Gulf Stream.

The medusae and nectocalyces of the Siphonophora are very similar to the Anthomedusae. Medusae like *Sarsia* (Fig. 124 C) may bud off other medusae either from the bell or the manubrium, but the Siphonophora are probably not to be regarded simply as a colony of medusae connected by coenosarc. A further change has gone on in which organs have been displaced from their original position. The manubrium has come to lie outside the primary medusa bell, forming a gastrozoid (Fig. 124 B, *gst.*) at the beginning of the main coenosarc axis. No manubria corresponding with the medusa bells of the nectocalyces are present. In the cormidia the hydrophyllium which may be a modified bell, the gastrozoid and the tentacles may be quite separate from one another while the complete medusoid form is shown only by the fixed gonophores (Fig. 124 A and B).

In more specialized siphonophores owing to the shortening of the main axis the displacement of parts is more extreme and the component parts of the cormidia no longer recur in the typical groups, all kinds of organs being crowded together. Lastly, with the great development of the gas-secreting pneumatophore, the medusa bell is suppressed.

While the above description gives an impression of the order regarded as colonial animals the siphonophores must be primarily considered as coelenterates exhibiting growth variability to such an extent that the identification of the component structures as organs or individuals is difficult and of purely academic interest.

#### Order GRAPTOLITHINA

Extinct, probably planktonic, animals; if related to the Hydrozoa, the polyp generation is dominant, the medusoid generation unfossilized or possibly represented by the prosicula; the individuals are budded off from one another and remain in contact with the parent; there is no definite coenosarc; and the perisarc is produced round the polyps as hydrothecae.

Graptolites are represented in the earliest fossiliferous rocks, the Cambrian, Ordovician and Silurian. Though we know nothing of their soft parts, the exoskeleton was horny or chitinous and so may be well preserved. It resembles in general development that of the colonies of the Calyptoblastea, in that it was produced round the polyps to form definite hydrothecae. The graptolites, however, differ from calyptoblast hydroids because new individuals have the appearance of being budded off directly from older ones rather than from

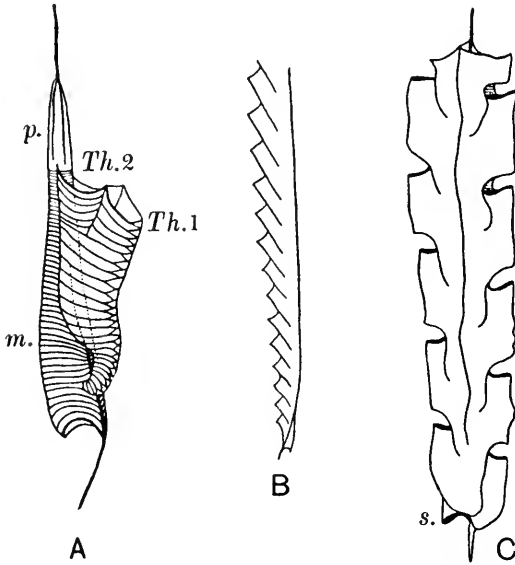

Fig. 126.

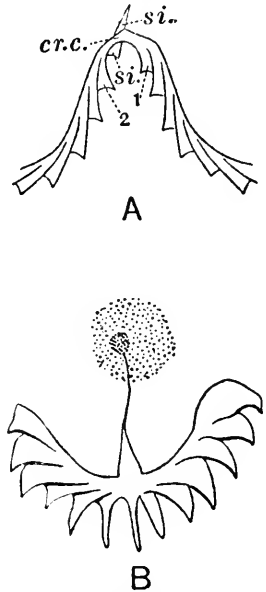

Fig. 127.

Fig. 126. A. Young colony of *Monograptus*, showing prosicula (*p.*), metasicula (*m.*) and developing hydrothecae 1 and 2, with growth-lines. After Kraft.  $\times 15$ . B. More mature colony of *Monograptus*.  $\times 2.5$ . C. Early part of the colony of *Climacograptus*, showing sicula (*s.*) partly enclosed by the early hydrothecae. After Wiman.  $\times 15$ .

Fig. 127. A, *Didymograptus v-fractus*. Ordovician. Early part of the poly-parry. After Elles. *si.* sicula; *c.r.c.* crossing-canal; 1, first hydrotheca; 2, second hydrotheca.  $\times 5$ . B, *Tetragraptus similis*. Lower Ordovician. Young form with virgula and disc. After Ruedemann.  $\times 4$ .

a common coenosarc. Each colony originates from a conical body called a *sicula*, the exoskeleton of the first formed individual, consisting of the *pro-* and *meta-sicula* (Fig. 126A). From the side of the metasicula a bud is formed, which develops into the first hydrotheca, and from this is produced the second, and so on. In this way a linear series of polyps is produced which are arranged in a slender lamella (*stipe*), the hydrothecae being in contact and the cavity of the colony being continuous. This is the simplest arrangement, and is seen in *Monograptus* (Fig. 126 A and B) where the hydrothecae are all on one

side of the stipe. In *Didymograptus* (Fig. 127) the second hydrotheca grows across the sicula to open on the opposite side, and the first and second hydrothecae go on budding independently, so that we have a colony with two stipes or branches. By another modification later, hydrothecae bud off two individuals instead of one, and colonies like *Tetragraptus* (Fig. 128) and *Bryograptus* are formed. In *Diplograptus* and *Climacograptus* (Fig. 126 C) there is a biserial stipe, either formed of two uniserial stipes growing back to back and thus separated by a

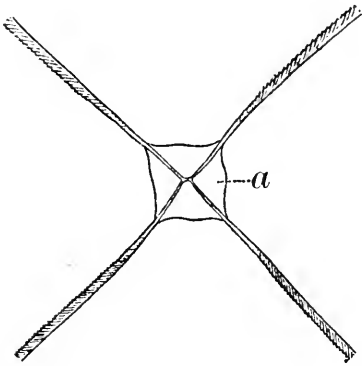

Fig. 128.

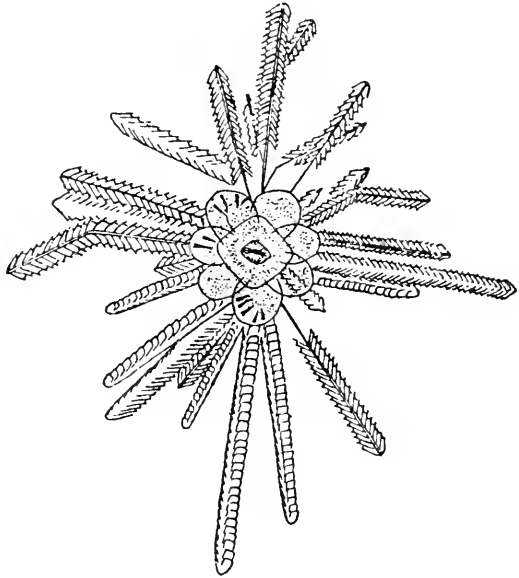

Fig. 129.

Fig. 128. *Tetragraptus*. Ordovician Rocks. *a*, central disc.  $\times \frac{1}{2}$ .

Fig. 129. *Diplograptus foliaceus* from the Utica Slate, New York.  $\times \frac{2}{3}$ . After Ruedemann. For description see text.

median septum, or as a result of alternate budding throughout the colony.

In the absence of a coenosarc the graptolites were not attached by a creeping hydrorhiza, such as occurs in *Calyptriblastea*. There was, however, a thread coming off from the end of the sicula which ended in a disc, by which it is supposed that the graptolites were attached to floating seaweed (Fig. 127 B). It is also possible that some graptolites were independent planktonic organisms with a pneumatocyst or other kind of float. Such a pneumatocyst appears to be shown in *Diplograptus* (Fig. 129) as a square central body from which a number of stipes radiate. There is also a circle of round bodies which are possibly gonophores, as they contain siculae. In any case the graptolites were true pelagic organisms and their floating habit gave them

a universal distribution in the Palaeozoic oceans. A series of life zones may be traced in the rocks which were there laid down, each characterized by a definite assemblage of graptolites, and these may be traced throughout the world. By a careful consideration of these graptolite successions the main line of evolution of the group has been worked out. It is now concluded that actual genetic relationship is best traced by the characters of the hydrothecae. The earlier forms have very simple hydrothecae, but the shape becomes gradually more complex. On the other hand the genera were usually founded on the number of branches or stipes in the colony, such as *Bryograptus* with many stipes in the Cambrian, *Tetragraptus* with four in the Lower Ordovician, and *Didymograptus* with two in Lower and Middle Ordovician. These genera succeed each other in geological age, and so we may suppose that they constitute an evolutionary series. In reality they constitute not one but several series. Thus there is the same type of hydrotheca (which we will call A) in *Bryograptus callavei*, *Tetragraptus hicksi* and *Didymograptus affinis*, while another type (B) is common to *B. retroflexus*, *T. denticulatus* and *D. fasciculatus*. The genera of graptolites as at present constituted are thus open to criticism; it would be more correct to classify all the species into hydrothecae of type A as one genus, and those into type B as another. In the genus *Monograptus*, which is the last and most abundant of the graptolites, though the form of the colony is simple, the hydrothecae vary tremendously, and it is obvious that we have here grouped together the descendants of many different genera undergoing comparatively rapid evolutionary changes.

Certain forms, whose relationship is not clear, occur very commonly at certain horizons in the Cambrian and Ordovician and less commonly in later rocks up to the Carboniferous and are grouped together as "dendroid" graptolites. It is possible that they are closely related to the Calyptoblastea. They differ from the "true" graptolites in showing polymorphism, the thecae being generally interpreted as having enclosed feeding individuals (corresponding to the thecae of the true graptolites), gonozooids (or perhaps protective individuals) and budding individuals.

#### Class SCYPHOMEDUSAE (SCYPHOZOA)

This class contains the common jellyfishes of temperate and colder seas, some of which are of extraordinary size, like *Cyanea arctica*, the diameter of whose disc is a couple of yards.

The simplest type of Scyphomedusae is found in the division known as the *Stauromedusae*, two members of which, *Haliclystus* and *Lucernaria* (Fig. 130), are not uncommon on the British coasts,

adhering to the blades of *Zostera* or *Laminaria*. It has a narrow stem arising from its exumbrellar surface, by which it attaches itself temporarily to seaweed. The edge of the bell is divided into eight

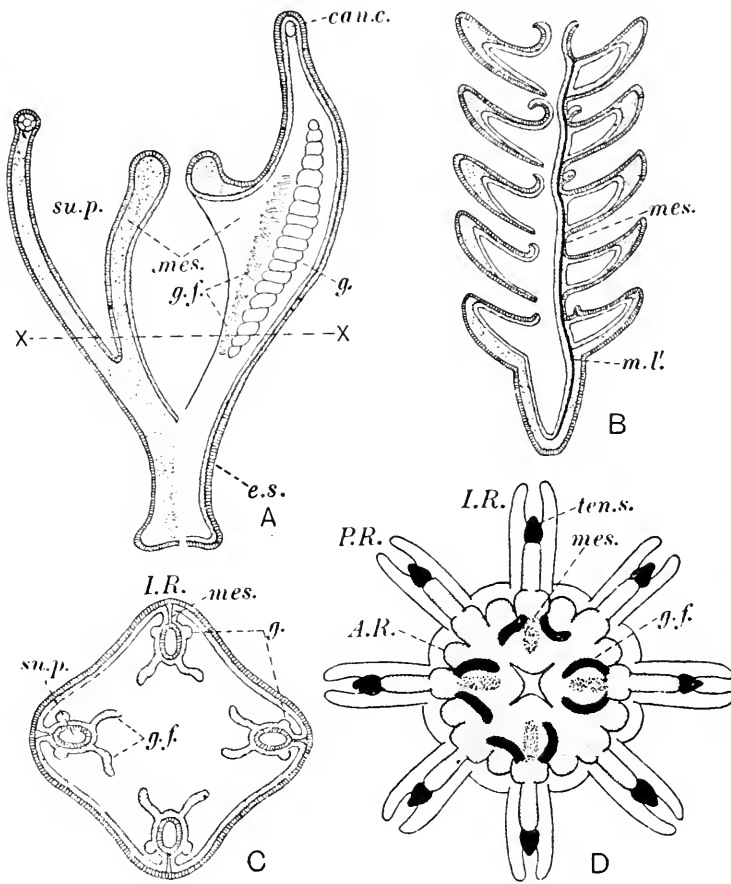

Fig. 130. Longitudinal sections through A, *Lucernaria* and B, a strobilizing scyphistoma of *Chrysaora*. In A the section passes through an interradius, on the left on the exact line of the mesentery so as to show the subumbrellar pit and on the right to one side so as to show the face of the mesentery. In B only the right side of the section passes through an interradius. C, Transverse section through *Lucernaria* along the line  $\times \times$  in A. D, Ephyra larva of *Aurelia*. *can.c.* circular canal; *g.* gonad; *g.f.* gastral filament; *e.s.* exumbrellar stalk; *mes.* mesentery; *m.l.* longitudinal muscle of mesentery; *su.p.* subumbrellar pit; *ten.s.* tentacle becoming later a tentaculocyst; *I.R.* interradius; *P.R.* per-radius; *A.R.* adradius with first indication of canal. A and C, altered from Bourne; B, after Herič; D, original.

lobes, on each of which are several short tentacles and the adhesive organs which are called *marginal anchors*.<sup>1</sup> There is no velum and tentaculocysts are absent. The manubrium is well developed and the

<sup>1</sup> Absent in *Lucernaria*.

mouth opens into a spacious gastric cavity which is divided by four partitions, the *interradial mesenteries*, into four broad chambers which are said to be *perradial*. The mesenteries are vertical walls projecting from the body wall and composed of endoderm with an internal layer of mesogloea. They have a free edge centrally, while on each side a vertical series of *gastric filaments* project into the enteron, and a parallel series of gonads stand nearer the body wall. The perradial chambers do not quite extend to the edge of the bell: a circular canal is cut off from the rest of the enteron. Also in the interradial position and penetrating the whole length of the mesentery is an ectodermal invagination, the *subumbral pit*.

The Stauromedusae only exist as individuals of this structural type, superficially more like a polyp than a medusa, but usually supposed to be a medusa, and the egg develops into an individual exactly resembling the parent.

The vast majority of the Scyphomedusae belong to the subdivision *Discomedusae*, which includes our type *Aurelia aurita* (Fig. 131), the commonest British jellyfish, but one whose distribution is world wide.

It has a similar external appearance to that of *Obelia*, save for the difference in size, the margin of the bell being surrounded by very numerous short tentacles. The manubrium is well developed and the corners of the mouth are drawn out into four long frilled lips along the inside of which are ciliated grooves leading into the gullet. The gullet is very short and opens into the endodermal stomach. This is produced into four interradial pouches in the lining of which the genital organs develop as pink horseshoe-shaped bodies. Parallel to the internal border of the gonads there is a line of *gastric filaments* which project freely into the lumen of the pouch. The endodermal cells of which they are composed contain batteries of thread cells which kill any living prey taken into the stomach. The gastric pouches of *Aurelia* occupy the position of the mesenteries of *Lucernaria*, and the *subgenital pits* occurring underneath the gonads and lined by ectoderm correspond to the subumbral pits of the simpler form. The broad perradial pouches in *Lucernaria* have disappeared owing to the great growths of the mesogloea and the restriction of the gastric cavity to a central position. There is, however, an extensive canal system running from the gastric cavity to the circular canal which is all that represents the former extension of the gastric cavity. It consists of eight branched and eight unbranched canals: four of the branched canals are interradial and four perradial: the eight alternating unbranched canals are called *adradial*.

In this elaborate "vascular" system there is a circulation of fluid produced by the cilia of the lining epithelium working in definite



directions (Fig. 132). The water drawn in by the mouth passes first into the gastric cavity and then the gastric pouches; thence by the adradial canals to the circular canal. It returns thence by the branched interradiial and perradiial canals to exhalant grooves on the oral arms. The whole circulation takes about twenty minutes, and it serves to maintain a constant supply of food to all parts of the body. Food

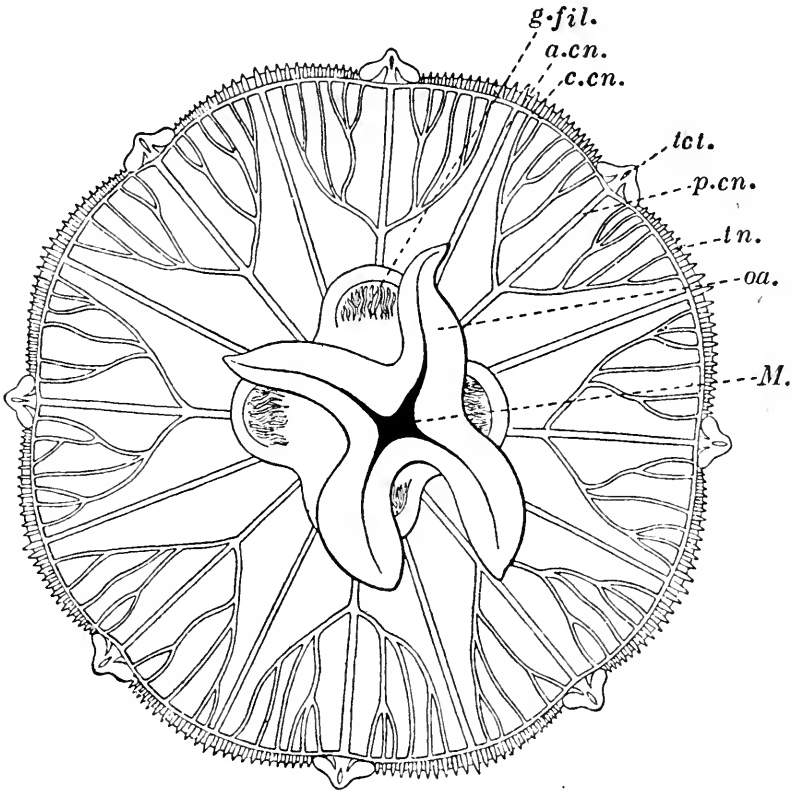

Fig. 131. *Aurelia aurita*. Somewhat reduced. From Shipley and MacBride. *M.* mouth; *oa.* oral arm; *tn.* tentacles on the edge of the umbrella; *p.cn.* one of the branching perradiial canals; there are four of these, and four similar interradiial canals; the perradiial canals correspond to the primary stomach pouches of the hydratuba, the interradiial to the pouches of the medusa; *a.cn.* one of the unbranched adradial canals; *c.cn.* the circular canal; *tct.* marginal lappets hiding tentaculocysts; *g.fil.* gastral filaments, just outside these are the genital organs.

undergoes its preparatory digestion in the stomach: the half-digested fragments are swept by the cilia on the round described above and may be ingested by any of the endodermal cells of the canal system and become available for local needs. The gastrovascular system thus at once fulfils the functions of the digestive and circulatory systems of higher animals.

The neuromuscular system is further developed than in even the medusoid individuals of the Hydrozoa. The muscles are ectodermal, and each cell is almost entirely converted into contractile protoplasm with a cross-striated pattern forming an elongated fibre; physiologically they are capable of rapid rhythmic contraction and not of slow tonic contraction like the muscle of a sea anemone (p. 193). The fibres

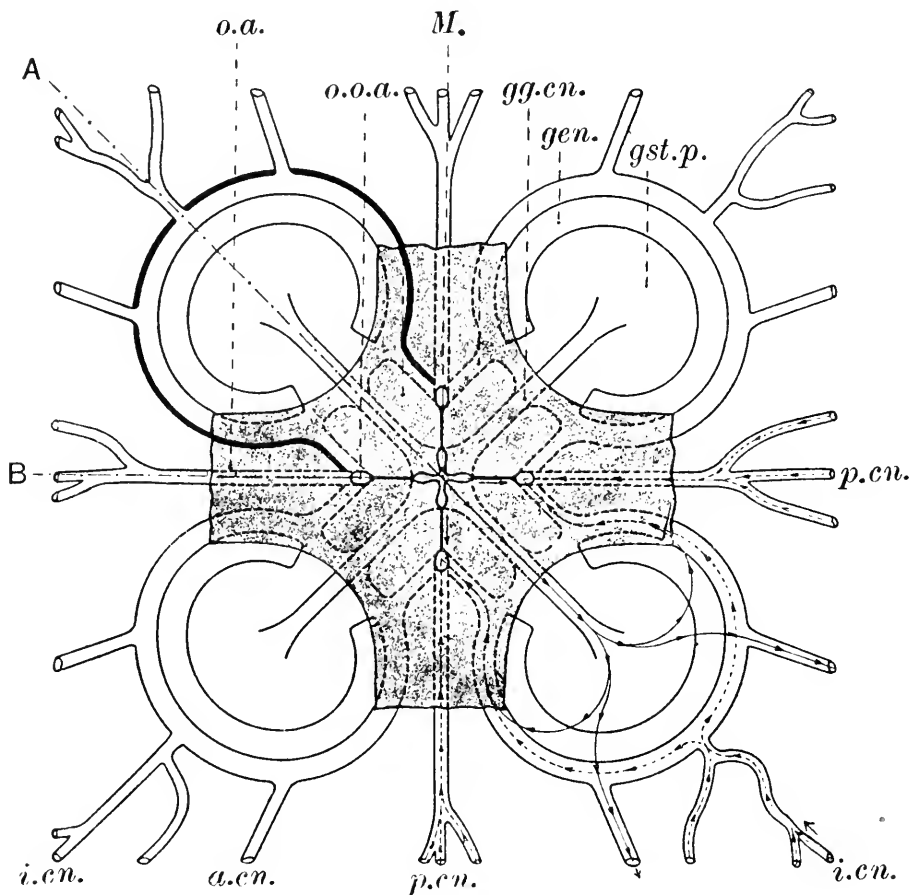

Fig. 132. Diagram showing the course of ciliary circulation (see arrows) in the genital pits and other organs of an adult *Aurelia*. After Widmark. A, interradius; B, perradius; *gen.* gonad; *gg.cn.* gastrogenital canal; *gst.p.* gastric pouch; *i.cn.* interradial canal; *o.o.a.* opening on oral arm. Other letters as in Fig. 131.

are arranged as a circular musculature over the peripheral part of the subumbrella. The nerve net is also confined to the ectoderm and is concentrated in the neighbourhood of the tentaculocysts. There is no true velum, but a *pseudovelum* consisting of an internal flange which is not occupied by muscles and a nerve ring as in the Hydrozoa.

The tentaculocysts are the characteristic sense organs of the

Scyphomedusae (but are present also in some Trachylina in the Hydrozoa). They are minute tentacles which project at the end of the interradial and perradial canals, which are continued into them. The edge of the bell projects over them as a hood. In each apical endoderm cell of the tentacle there is a crystal which according to some authors is calcium oxalate. On one side of the tentacle is a pigment spot which may be an ocellus, and near it are two pits lined with sensory epithelium and said to be olfactory. In the neighbourhood of these tentacles, then, all the senses appear to be localized. The tentaculocyst (Fig. 133) is made up of two parts, a club-shaped projection heavy at its distal end, and a pad of sensory epithelium immediately beneath it. If the medusa is tilted from the normal horizontal position the club of the highest tentaculocyst will press more firmly against its sensory pad, and the club of the lowest tentaculocyst less firmly.

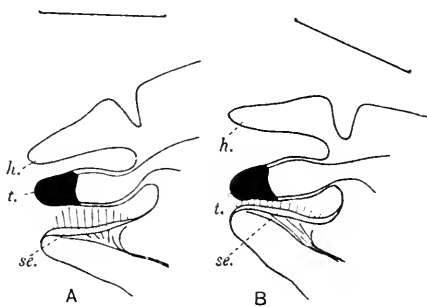

Fig. 133. Diagram of tentaculocyst of *Aurelia*: A, in horizontal position; B, with medusa tilted, the tentaculocyst *t* being pressed down upon the sensory epithelium *se.*; *h*, hood.

Whatever tentaculocyst is highest produces greatest stimulation: this alone controls the rate of beating of the bell, which has been shown to be 50 % greater than normal when the animal is tilted through 90°. Further the state of excitation of the highest tentaculocyst does not allow complete relaxation of the musculature of the section of the bell nearest to it between successive beats. This means that less water is driven downwards at each beat from the uppermost half of the bell than from the lower half, with the result that the bell automatically rights itself. The Scyphomedusae are excellent subjects for experiment, and if cut into ribbons will still live and their muscles function. If the tentaculocysts are cut out one by one the rhythmic movements of the bell continue until the last is removed when they suddenly cease. After that, drastic stimulation, tactile or chemical, is necessary to make the muscles contract.

The gonads are situated, as has been already stated, in the floor of the stomach, and the ripe gametes are liberated into the genital pouch.

The eggs are fertilized as soon as they become free by spermatozoa from another individual which are drawn into the mouth along with the food. They pass through the canals to the opening on the oral arms (Fig. 132, *o.o.a.*) and undergo the first stage of their development enclosed in pouches at the side of the oral grooves. Little opaque patches along the side of the lips are to be seen with a lens, and when dissected out they prove to be masses of planula larvae. The planula<sup>1</sup> is eventually set free, but soon attaches itself to stone or weed and develops into a small polyp, without perisarc, the *hydratuba*, which

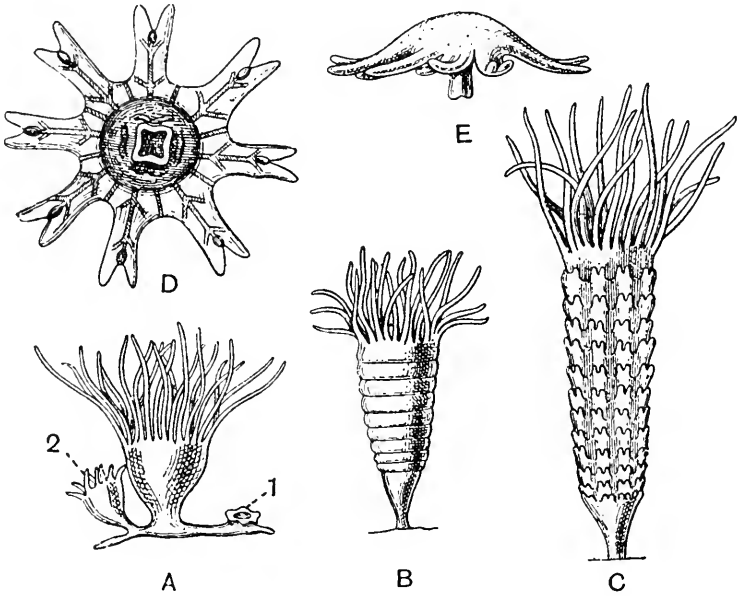

Fig. 134. Strobilation of *Aurelia aurita*. From Sars. A, Hydratuba on stolon which is creeping on a *Laminaria*. The stolon is forming new buds at 1 and 2. B, Later stage or scyphistoma,  $\times 4$ . The strobilation has begun. C, Strobilation further advanced,  $\times 6$ . D, Free-swimming ephyra stage, showing first appearance of unbranched adradial canals,  $\times 7.5$ , seen from below. E, The same seen in profile,  $\times 7.5$ .

eventually grows sixteen long and slender tentacles. Internally this stage has the same structure as *Lucernaria* with four interradial mesenteries, which are invaded by vertical ectodermal pits, and form perradial pouches between. At the base of the hydratuba a horizontal stolon grows out, and off this fresh hydratubae may be budded (Fig. 134 A). They may separate from the parent as in *Hydra*. During the winter the whole hydratuba is segmented by transverse horizontal furrows. This process is termed strobilation (Fig. 134 B). In each of the disc-like segments so produced, marginal growth at once begins,

<sup>1</sup> In *Aurelia* the formation of the planula sometimes takes place by invagination of the blastula.

eight notched lobes being formed, four of which are interradial and four perradial. In each notch there is a short tentacle and this becomes a tentaculocyst. Each lobe is provided also with two short lateral tentacles, but these disappear. A prolongation of the gastric cavity into each lobe indicates the beginning of the branched perradial and interradial canals, and at a little later stage the adradial canals also appear (Fig. 134D). The gastric filaments are also seen as four pairs in the interradial mesenteries.

The *Scyphistoma* is the name given to the segmented body and each of the segments is an *Ephyra* larva (Figs. 130D, 134). They lie upon each other like a pile of saucers, connected, however, by strands of tissue in which run the muscles of the interradial mesenteries continuous throughout the pile of individuals. These muscles contract violently at intervals until the communicating strands snap and one by one the ephyrae swim away. The ephyra develops into the adult by the filling up of the adradial notches in the margins as well as by the growth of the bell as a whole. The mesogloea increases enormously in thickness, causing the two layers of the endoderm to come together as a solid lamella except where the canals occur. The mesenteries lose their attachment and cease to exist as partitions with the collapse of the enteron, but their position is marked by the gastric filaments. The basal part of the scyphistoma remains and grows new tentacles, and after a resting period as a hydratuba may strobilate again.

The life history of the sessile form may thus be summarized. The hydratuba feeds and buds in the summer, continues to feed and stores food in the autumn but ceases to bud, strobilates in the winter, grows new tentacles in the spring and feeds and buds again. In this the Scyphomedusae show features in common with the life history of the hydroid colonies and the freshwater *Hydra*.

The Rhizostomeae are a division of the Scyphomedusae in which the four lips around the mouth are vastly developed and folded, and the central mouth itself is narrowed and in a number of forms entirely closed. It is replaced by thousands of small "sucking mouths" which lie along the course of the closed-in grooves of the lips. These lips now constitute organs of external digestion. Small copepods and even fish are enclosed by the lips, digested and the fluid absorbed through the "sucking mouths" which are too small to admit solid particles of any size. The young medusa of *Rhizostoma* still has a central mouth, but in the adult of that and other forms, e.g. *Pilema* here figured (Fig. 135), it is entirely closed. *Cassiopeia* is a semi-sedentary form, which lies with its exumbrellar surface upwards on the mud of mangrove swamps. The bell pulsates gently and brings in a constant stream of plankton organisms which are seized by the lips.

The mode of development described above is typical in the Scyphomedusae. There are, however, certain exceptions. In the genus *Pelagia* the medusa develops directly from the egg into an ephyra larva, and in *Cassiopeia* the hydratuba only produces a single ephyra at a time, a condition which is obviously primitive compared with *Aurelia*, "polydisc" strobilation being a secondary adaptation for the more effective spread of the species.

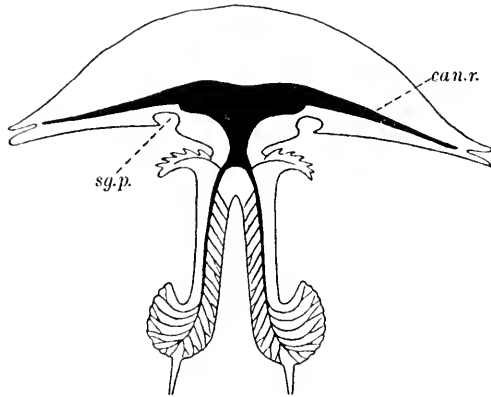

Fig. 135. Diagrammatic longitudinal section through *Pilema*. Enteron and its branches shown in black, many "sucking mouths" along the lips. *can.r.* radial canal; *sg.p.* subgenital pit.

### Class ACTINOZOA (ANTHOZOA)

Solitary or colonial coelenterates with polyp individuals only: coelenteron divided by mesenteries: stomodaeum present: genital cells derived from endoderm.

They are divided into the two orders Alcyonaria and Zoantharia.

#### Order ALCYONARIA

Actinozoa with eight mesenteries and eight pinnate tentacles; stomodaeum with a single siphonoglyph (ciliated groove); skeleton internal, consisting of spicules in the mesogloea, occasionally supplemented by an external skeleton; longitudinal muscles on the ventral faces of the mesenteries.

As a type of the order we will describe *Alcyonium digitatum*, "Dead men's fingers", a colonial form which occurs below low-tide mark, attached to stones, in various sizes and shapes, but usually in broad-lobed masses. A small portion or lobe of a colony is shown in Fig. 136, and it is seen that the polyps project in life from the general surface of the colony. The ectoderm, mesogloea and endoderm of the polyps

are of course continuous with the same layers in the coenosarc of the colony, but while the ectoderm is only a thin skin composed of a single layer of cells spread over the surface of the whole colony, the mesogloea is expanded to form a bulky mass of jelly which is traversed by the endodermal tubes of the polyps. These run parallel with each other without joining for considerable distances, but they are connected by other endodermal tubes which are much more slender, so that, like a hydroid colony, the alcyonarian colony has a common coelenteric system.

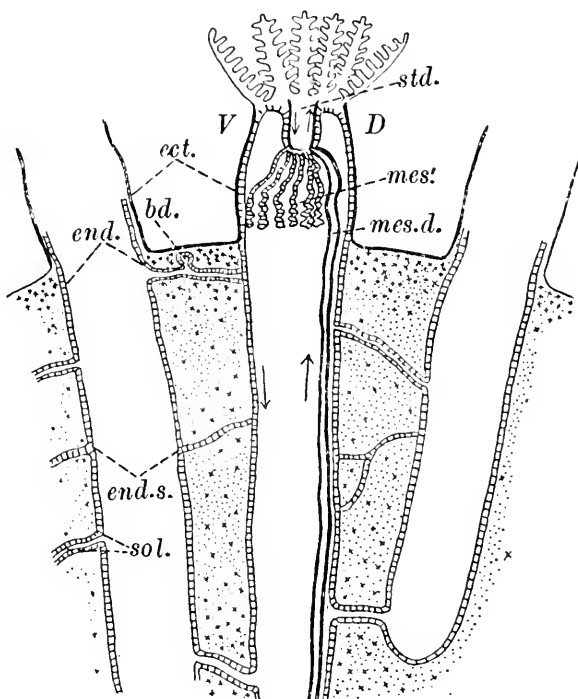

Fig. 136. Diagram of section through colony of *Alcyonium* showing extended polyps with pinnate tentacles and coenosarc. Original. The direction of water-circulation is shown by arrows. The mesogloea is indicated by dots and the spicules it contains by small crosses. *D*, dorsal and *V*, ventral sides of polyp; *bd.* endodermal bud which will give rise to a new polyp; *ect.* ectoderm; *end.* endoderm; *end.s.* and *sol.* solenia, solid endoderm strands; *mes.d.* the two dorsal mesenteries; *mes.'* the other mesenteries; *std.* stomodaeum.

The polyps are delicate and withdraw on the slightest stimulus, the oral disc with its crown of tentacles being pulled inside the enteron by the contraction of longitudinal muscles running in the mesenteries and attached to the oral disc. By a continuation of this contraction the whole column of the polyp is introverted ("turned outside in", as with the finger of a glove). This is the condition in which preserved colonies of *Alcyonium* are nearly always found, and tangential sections

through the superficial layers of the colony are rather difficult to interpret in consequence.

There is no oral cone in the actinozoan polyp, but the *mouth* is an elongated slit and is situated in the middle of a circular flattened area, the *oral disc*, which is surrounded by the tentacles. It does not open directly into the enteron but into a tube lined with ectoderm, the *stomodaeum* or *gullet*, which communicates with that cavity. The whole of the stomodaeum is ciliated, but at one end of it there is a groove which is lined with specially strong cilia which draw water in at the mouth. This is the *siphonoglyph*, and it is said to occupy a *ventral* position, but the student must be warned that there is no homology between surfaces so termed in the coelenterates and in the higher Metazoa.

Internally the enteron is divided up by eight vertical folds of the body wall, the *mesenteries*, which project so far into the cavity of the enteron that their upper parts join with the stomodaeum. Below the level of this organ they end in an enlarged free edge, the *mesenteric filament*. The foundation of the mesentery is the mesogloea, which is not much thicker here than in the body wall but is folded in the muscular region of the mesentery. On both sides it is covered with endodermal epithelium. While in the hydroid polyp there is little differentiation into regions, in the actinozoan polyp the endodermal cells specialized for various functions are arranged in strips of tissue occupying definite positions on the mesenteries. This may be seen in the sections of a polyp in Figs. 140 and 141. It must in the first place be explained that the presence of the siphonoglyph and the elongation of the stomodaeum are an indication that on the original *radial* symmetry of the polyp a bilateral symmetry has been imposed, and on each side of the axis of the stomodaeum the mesenteries correspond exactly in arrangement. Now the muscular endodermal cells are concentrated on the ventral side of each mesentery and into a narrow part of it to form a longitudinal retractor muscle. In the section below the siphonoglyph the mesenteric filament is seen, and this consists of different elements in the different mesenteries. One pair of mesenteries, which are "dorsal" in position, are distinguished from the rest in having a filament which is flattened in cross-section, and is covered by very large ciliated cells (Fig. 140 F). They work in concert with the cells of the siphonoglyph to produce a current of water which is drawn in at the mouth and flows right along the ventral side of the tubes through the system, bearing with it oxygen and food for the tissues which are contained in the depths of the colony. The cilia of the dorsal mesenteries are responsible for the return current which makes its way out of the polyp by the dorsal side of the stomodaeum. These two mesenteries are much longer than the rest, as may be seen



in Fig. 136, *mes.d.*, and their persistence throughout the endodermal tubes is necessary for the maintenance of the exhalant current. In contrast with this the remaining six mesenteries have rounded filaments covered with an epithelium consisting largely of gland cells. Also the germ cells arise near the free border (Fig. 140F). Small organisms caught by the tentacles and introduced into the enteron are embraced by these mesenteric filaments and held fast while the fluid from the glands brings about a disintegration and partial digestion of the tissues. Solid fragments of food resulting from this are ingested by individual endodermal cells and the digestion completed. Not only do the dorsal mesenteric filaments differ from the others in function but they are ectodermal while all the rest are endodermal.

The mesogloea of *Alcyonium* is invaded by cells from the ectoderm which form in their cytoplasm aggregations of calcium carbonate with a characteristic shape which are called spicules. As the spicules develop the secretory cells migrate into the deeper parts of the colony. They are present in such numbers as to give a certain quality of solidity to the colony, and on its death the spicules it contains remain behind as a not inconsiderable mass. The part which alcyonarians consequently play in the formation of coral reefs, though secondary, is not unimportant. The mesogloea, as has been mentioned above, is traversed by hollow strands of endoderm (*solenia*) which communicate between the polyp tubes and also by solid endodermal strands which may play some part in the secretion of the jelly of the mesogloea. From the solenia, where they approach the surface, small buds are formed which develop into new polyps.

The gonads are developed at the breeding season, from groups of endodermal cells near the filaments, but they only occur on the six ventral mesenteries. The eggs are comparatively large and pass very slowly up the enteron and out of the stomodaeum, being fertilized outside the polyp and developing into a planula larva. After a free-swimming period this fixes and becomes a single individual which by budding gives rise to a colony.

Variation in the Alcyonaria occurs mostly in the method of formation of the colonies and the skeleton. The simplest form is found in *Cornularia* and *Clavularia*. From the original polyp a creeping stolon with a single endodermal tube is given off, and this gives rise at intervals to polyp buds, which may in turn produce fresh stolons. The coenosarc of the colony thus forms a network like a hydroid colony. In *Alcyonium*, as already described, the elongated polyps are crowded together in bundles and fused along nearly the whole of their length, the ectoderm and mesogloea of adjacent polyps being continuous, and the endodermal tubes in frequent communication. The mesogloea

thickens enormously. In the red coral *Corallium rubrum* (Fig. 137) there is an upright branched colony with a rigid axis composed of spicules compacted together which is the precious coral of commerce. This is clothed by the delicate tissue of the coenosarc from which the short polyps arise and which contains a network of endodermal tubes, some of which run along the parallel grooves which are sometimes to be seen on the surface of a piece of precious coral. The mesogloea contains spicule-forming cells derived from the ectoderm, and these travel inwards and add their secretion to the central skeleton. This form occurs at considerable depths in the Mediterranean and the seas of Japan. Dimorphism, as described below for *Pennatula*, also occurs here.

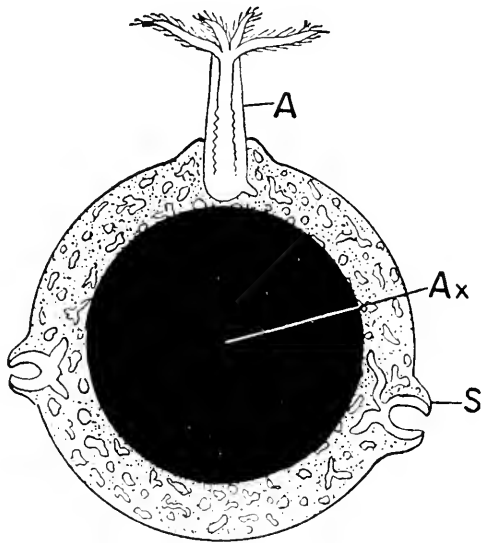

Fig. 137. Section transverse to the axis of *Corallium*. After Hickson. *A*, autozoid; *Ax*, skeletal axis; *S*, siphonozooid without tentacles. The ectoderm is indicated by the outer line, the mesogloea by stippling and the endodermal network (solenia) by the irregular spaces in the mesogloea.

The gorgonians (suborder *Gorgonacea*) also have upright branching colonies. The supporting axis has, however, an origin, different to the last, being horny and not calcareous and secreted by the ectoderm on what is really the outer surface of the animal. As secretion is confined to an invagination of the basal epithelium which burrows into the whole length of the colony, it appears to be an internal skeleton. The gorgonians are a remarkable feature in shallow tropical seas, forming groves and thickets which challenge comparison with the plant forms of the land (Fig. 138).

In *Pennatula* and its relations (suborder *Pennatulacea*) a single axial polyp grows to a relatively enormous length, sometimes as much

as three or four metres, and contains a long horny axis which is possibly endodermal. The secondary polyps are budded off from endodermal tubes which ramify in the much thickened mesogloea of the body wall of the primary polyp, and belong to two types of individuals, the normal *autozooids* which feed the colony and the *siphonozooids*, with reduced mesenteries and enlarged siphonoglyph, whose only function is to maintain the circulation of water in the canals of the colony. The autozooids in *Pennatula* are arranged in rows side by side to form

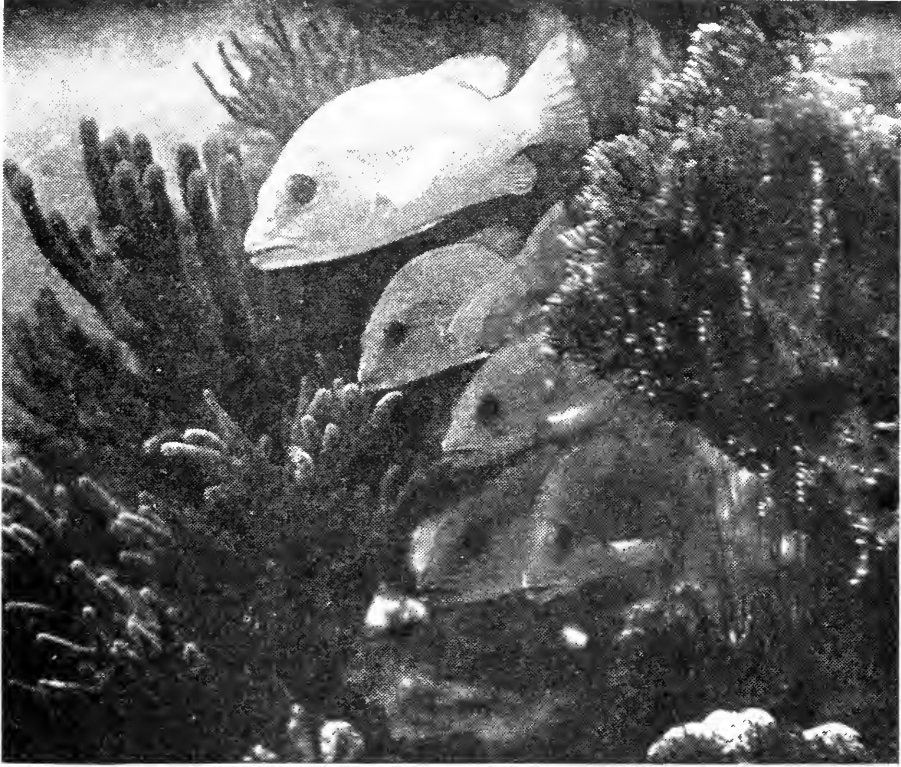

Fig. 138. Gorgonians (two species on the left) and hydrocorallines (on the right) growing on a coral reef in Florida. From an underwater photograph by Professor W. H. Longley.

equal and regular lateral branches on each side of the axis giving the colony its feather-like form, and the siphonozooids are mainly found on the back of the axis. A colony has a limited but remarkable power of movement and can burrow into sand or mud by its basal stalk.

In two genera, *Tubipora* (the organ-pipe coral) and *Heliopora* (the blue coral), which are widely distributed on coral reefs, a continuous calcareous skeleton is developed resembling that of reef corals. The polyps of *Tubipora* are elongated and parallel and connected by stony platforms which are traversed by the endodermal tubes. But while

in *Tubipora* there is an internal skeleton developed as in *Corallium*, by the fusion of spicules in the mesogloea, in *Heliopora* the skeleton is secreted by a layer of ectodermal cells and not composed of spicules. In *Heliopora* (Fig. 139) there are on the surface of the colony larger pits (thecae) occupied by the polyps and smaller pits which lodge tubular processes of the network of solenia: the same skeletal characters also occur in the fossil *Heliolites* which closely resembles it and was a dominant type in Palaeozoic coral reefs. *Tubipora* too has a Palaeozoic representative in *Syringopora*.<sup>1</sup>

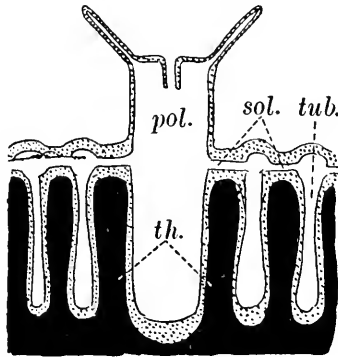

Fig. 139. Diagrammatic section through the edge of a colony of *Heliopora*. After Kukenthal. The skeleton is shown as deep black, the ectoderm and endoderm as lines and the mesogloea by stippling. *pol.* polyp; *sol.* network of solenia parallel to the surface of the colony; *tub.* vertical tubules arising from this network; *th.* theca.

### Order ZOANTHARIA

Actinozoa with mesenteries varying greatly in number, typically arranged in pairs, the longitudinal muscles of which face each other, except in the case of two opposite pairs, the *directives*, in which the muscles are on opposite sides; tentacles usually simple, six or some multiple of six in number; mesenteric filaments trefoil-shaped in section; stomodaeum with two ciliated grooves; typically a calcareous exoskeleton, but this may be entirely absent.

The coelenterate animals which are included in this group fall into two apparently different categories, the sea anemones, which are usually single individuals and never possess any kind of skeleton, and the madreporarian corals, which are usually colonial animals and always have an ectodermal exoskeleton. The polyps, however, may all be referred to the same type of structure, and the presence or absence of a skeleton or of the colonial habit are matters of secondary importance compared with this.

<sup>1</sup> The relationship between these recent alcyonarians and the Palaeozoic corals is denied by some authors.

In its main structural lines the zoantharian polyp resembles the alcyonarian type. The stomodaeum is elongated in the same plane but possesses two siphonoglyphs instead of one. There are tentacles which are hollow, unbranched, and often very numerous. The mesenteries are like those of *Alcyonium*, but their arrangement and the structure of the mesenteric filament is very different. Numbers and grouping of mesenteries vary greatly within the limits of the Zoantharia itself. The simplest form, and that most like *Alcyonium* (Fig. 140 A), is found in the small burrowing sea anemone, *Edwardsia* (Fig. 140 C). Here there are eight mesenteries with bilateral symmetry, as in *Alcyonium*. In six of these the longitudinal muscles are on the same side, facing ventrally, while the remaining pair have the muscles facing outwards and dorsally, so that the arrangement is different from that in the Alcyonaria.

In the typical sea anemone, such as *Actinia*, and in coral polyps, the mesenteries are arranged in cycles (or generations). There are six couples of primary mesenteries in the first cycle, and these are the largest and alone reach as far as the stomodaeum. In four of these pairs the muscles face each other; in the other two pairs, the directives, they face away from each other. The secondary mesenteries, which are much smaller, are situated in the spaces between two adjacent pairs (exocoeles), never between two members of a pair (entocoeles). Finally, there may be tertiary and even quaternary mesenteries, always in exocoelic spaces of the generation preceding, making third and fourth cycles. This "hexactinian" type, in which the mesenteries are present in multiples of twelve, is derived from that in *Edwardsia*, as may be seen in the development of some of the Zoantharia, for example another small burrowing anemone, *Halcampa*. In this there is first of all an *Edwardsia* stage (Fig. 140 C) with eight mesenteries. From this the hexactinian type is derived quite simply by the subsequent growth of four additional mesenteries with muscles on their dorsal faces. These belong to the first cycle and join up with the stomodaeum, and they arise in such positions as to complete, with pre-existing mesenteries, four pairs with muscles facing each other. These four mesenteries in *Halcampa* never develop a mesenteric filament, but the complete adult arrangement, as seen for instance in *Actinia mesembryanthemum*, the commonest of our British anemones, is given in Fig. 140 E. In such a form as *Peachia*, often used in laboratories on account of its simplicity, there are slight deviations from the type. There is no second siphonoglyph (sulculus) and the second cycle of mesenteries is incomplete, none of them having a mesenteric filament, while the pairs in two exocoeles are completely absent (Fig. 140 B).

The mesenteric filament of the Zoantharia (Fig. 141 B, C) is tre-

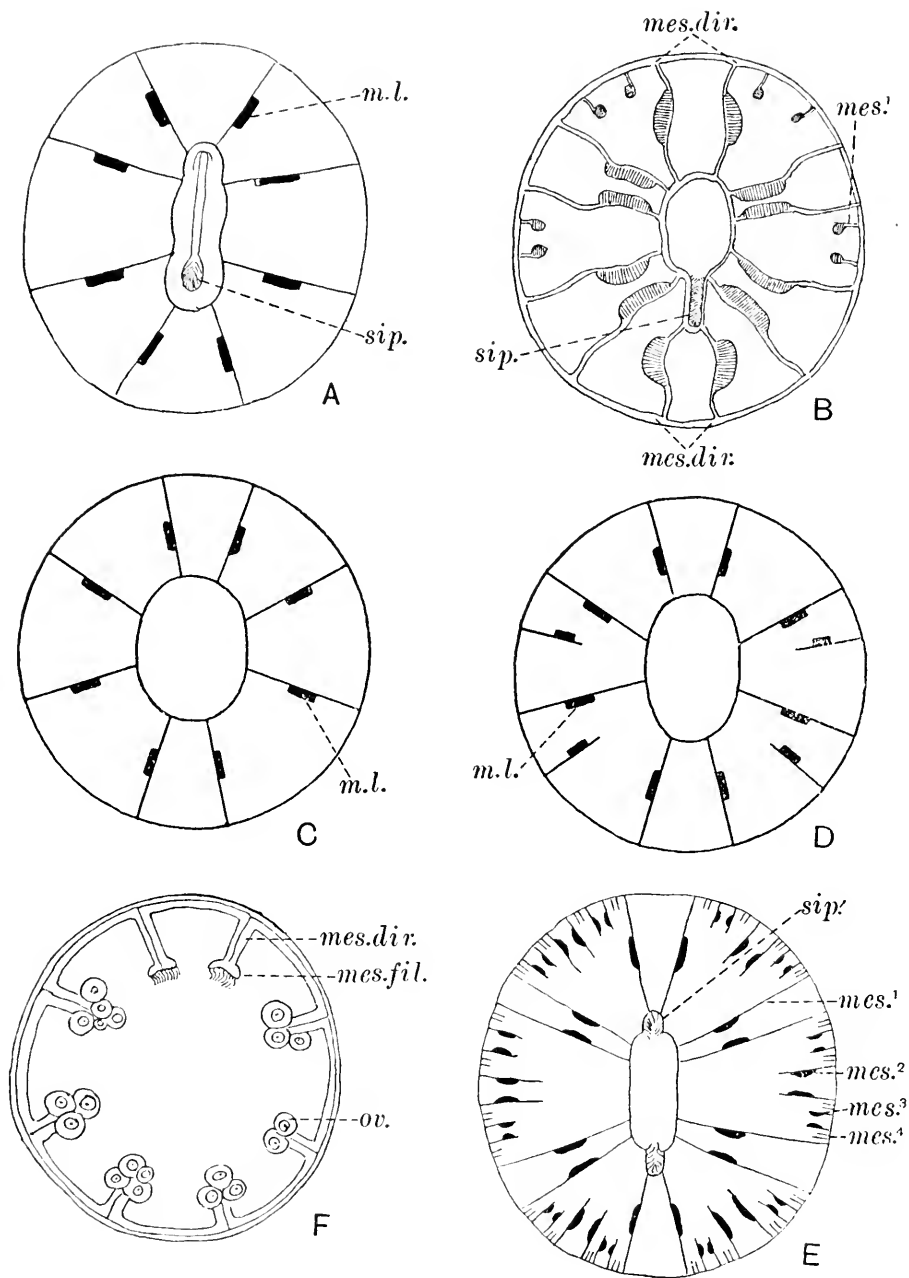

Fig. 140. Diagrammatic transverse section of corals and sea anemones. A, *Alcyonium*. B, *Peachia*. C, *Edwardsia*. D, *Aulactinia*. E, Typical actinian in the region of the stomodaeum. F, *Alcyonium* below the stomodaeum. *mes.<sup>1</sup>*, primary mesentery; *mes.dir.*, directive mesenteries; *mes.<sup>2</sup>*, *mes.<sup>3</sup>*, *mes.<sup>4</sup>*, secondary, tertiary and quaternary mesenteries; *mes.fil.*, ciliated mesenteric filaments; *m.l.*, longitudinal muscle; *ov.*, ovaries; *sip.*, siphonoglyph; *sip'*, sulculus. The direction of the top of the page is dorsal.

foil-shaped in section, and while the functions of digestion and water-circulation are in the Alcyonaria performed by different filaments, here they are performed by different parts of the same filament. Thus, near the stomodaeum, the central part of the filament of a sea anemone or coral is crowded with digestive gland cells and also with nematocysts, while the wings are covered with strongly ciliated epithelium which maintains a current. In the lower part of the mesentery the filament is exclusively digestive in function: the cells of

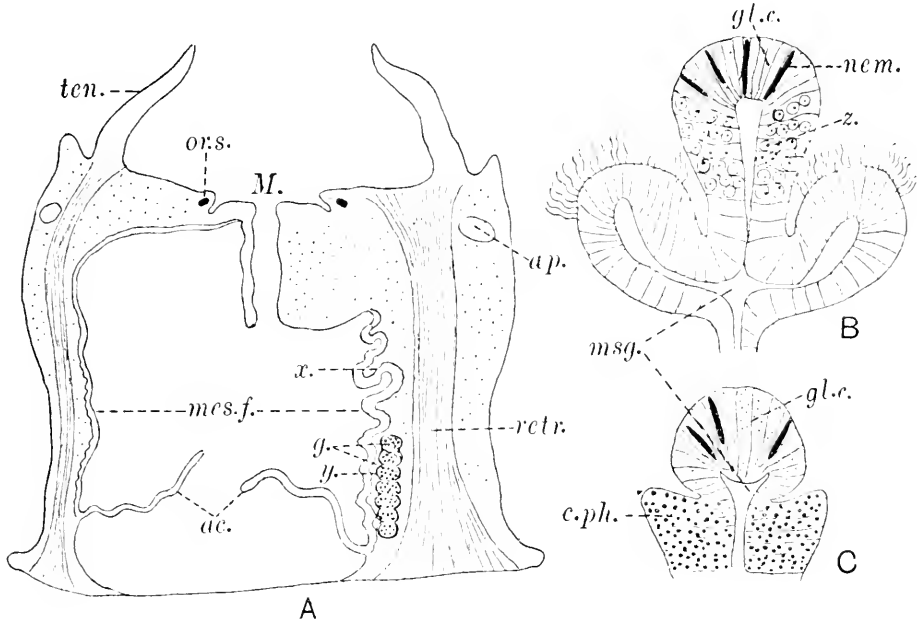

Fig. 141. A, Vertical section through a sea anemone showing primary (right) and secondary (left) mesenteries (dotted) from the endocoelic side. *ac.* acontia; *ap.* aperture in mesentery; *g.* gonads; *x.* ciliated region, and *y.* digestive region, of *mes.f.* mesenteric filament; *M.* mouth; *or.s.* oral sphincter; *retr.* longitudinal retractor muscle; *ten.* tentacle. B, Transverse section through the ciliated region of mesenteric filament at *x.* C, Similar section through the digestive region at *y.* *c.ph.* phagocytic cells filled with carmine and fish fragments; *gl.c.* gland cells; *nem.* nematocysts; *z.* zooxanthellae. After Stephenson.

the wings are phagocytic, as is shown by feeding with carmine. From the central part of the filament free threads called *acontia* are produced in some anemones, which are loaded with nematocysts and may be shot out of the mouth or of special pores in the body wall when the polyp is stimulated.

In the corals the skeleton is secreted by the ectoderm, but only by that part of it which forms the *basal disc*. A flat plate of calcium carbonate is laid down first of all by the whole of the disc, but almost at once the epithelium is thrown into radial folds and into a circular fold

which encloses them, and in these are formed vertical walls which rise from the plate; the circular wall is called the *theca* and the radial wall *septa* (Fig. 142 A). The latter are formed in spaces between the

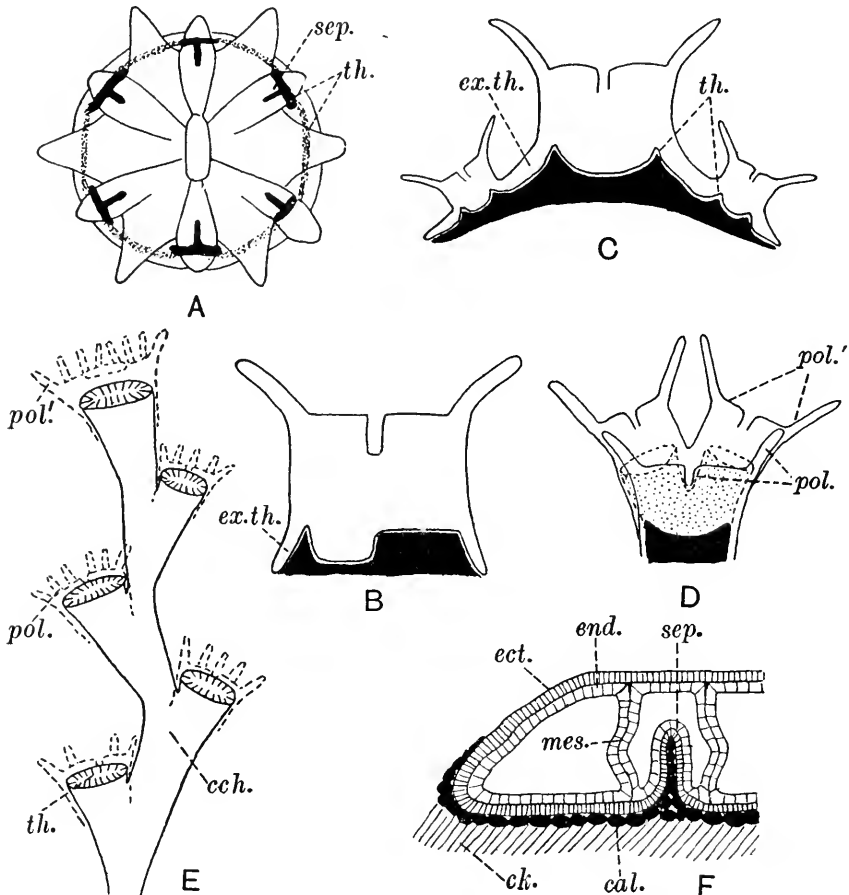

Fig. 142. Skeleton formation in the Zoantharia. A, Oral view of a young coral polyp with the beginning of the skeleton seen through the transparent tissues. B, Vertical section through a later stage. C, Development of a colony showing budding from the extrathecal zone. D, Division of a polyp. *pol.* polyp before division; *pol.* polyp after division and subsequent growth: skeleton of *pol.* shown in black (as in earlier diagrams) and that of *pol.* by stippling; *th.* theca; *sep.* first formed part of septum; *ex.th.* extrathecal portion of polyp or colony. E, *Lophohelia*. Skeleton of colony, soft parts indicated by dotting. *pol.* polyp; *pol.* polyp about to divide; *th.* theca with septa indicated; *cch.* coenenchyme. F, *Astroides*. After van Koch. Tangential section of young form fixed on cork (*ck.*). *ect.* ectoderm; *end.* endoderm; *cal.* granular secretion of calcium carbonate forming the basal disc; *mes.* mesentery; *sep.* septum.

mesenteries. The continued secretion by such a form as the English solitary coral *Caryophyllia* produces a cup of limestone, of which the tapering basal portion is solid but which has a shallow apical de-



pression, which is traversed by the radiating vertical septa and contains in the centre a more or less regular vertical rod, the *columella*. The depression always tends to become filled up by the secretory activity of the general surface of the basal disc, but the building up of the theca and septa keeps pace with this. It is difficult at first to realize that this is an exoskeleton and that in a massive structure like a brain coral the actual living tissue is a mere film on the surface of a great hemispherical mass of calcium carbonate which it has secreted. It is not surprising to learn that such colonies with a diameter of a yard or more have a life span of a hundred years or so.

With regard to the actual mechanism of lime secretion the view most generally held is that illustrated by Fig. 142 F, which shows a coral larva which has fixed upon a piece of cork. The skeleton as shown in a section is, when first laid down, a series of spheroidal masses of calcium carbonate, which thus appear to be a secretion of the ectoderm cells, issuing from the cells as a solution and immediately crystallizing out as irregular masses. Another suggestion is that ammonium carbonate excreted by the coral meets the calcium salts of the sea water and carbonate of lime is precipitated round the ectoderm; and still another, that calcium carbonate is stored up in the ectoderm cells and when the cells are full they drop out of the epithelium and are added to the skeleton.

Coral colonies exist in the most diverse shapes and forms (Fig. 143), from the slender tree-like colonies of many *Madrepora* to the massive rounded forms like *Porites*. Each colony is formed from a single planula which settles down and forms a polyp. From this first individual the hundreds of thousands of polyps in a large colony are formed by division or gemmation. An example of division is given in Fig. 142 D. In such a case when the polyp has reached a certain size the oral disc becomes elongated in the direction of the long axis of the mouth, tentacles and mesenteries increase in number, and finally a transverse constriction divides first the mouth, then the disc and lastly the whole polyp. The division of the polyp is followed by that of the theca. In the Meandrine corals (brain corals) the polyp elongates enormously and the mouth divides but not the theca, and so we get the curious thecae running more or less parallel to each other which recall the convolutions of the human brain. In *Lophohelia* (Fig. 142 E) division is equal, but while one of the polyps resulting from it continues to grow the other marks time; the axis of growth changes sides at each division and the result is a colony showing cymose branching.

In Fig. 142 B it is shown that part of the coral polyp overlaps the theca. It is this *extrathecal zone* which gives rise to young polyps when a colony is formed by gemmation (Fig. 142 C). The bud and the

parent remain connected by their extrathecal portions, and this constitutes the coenosarc of the colony. The gaps between the thecae of the colony are filled up by calcareous material secreted by the coenosarc and called *coenenchyme*.

*P.*

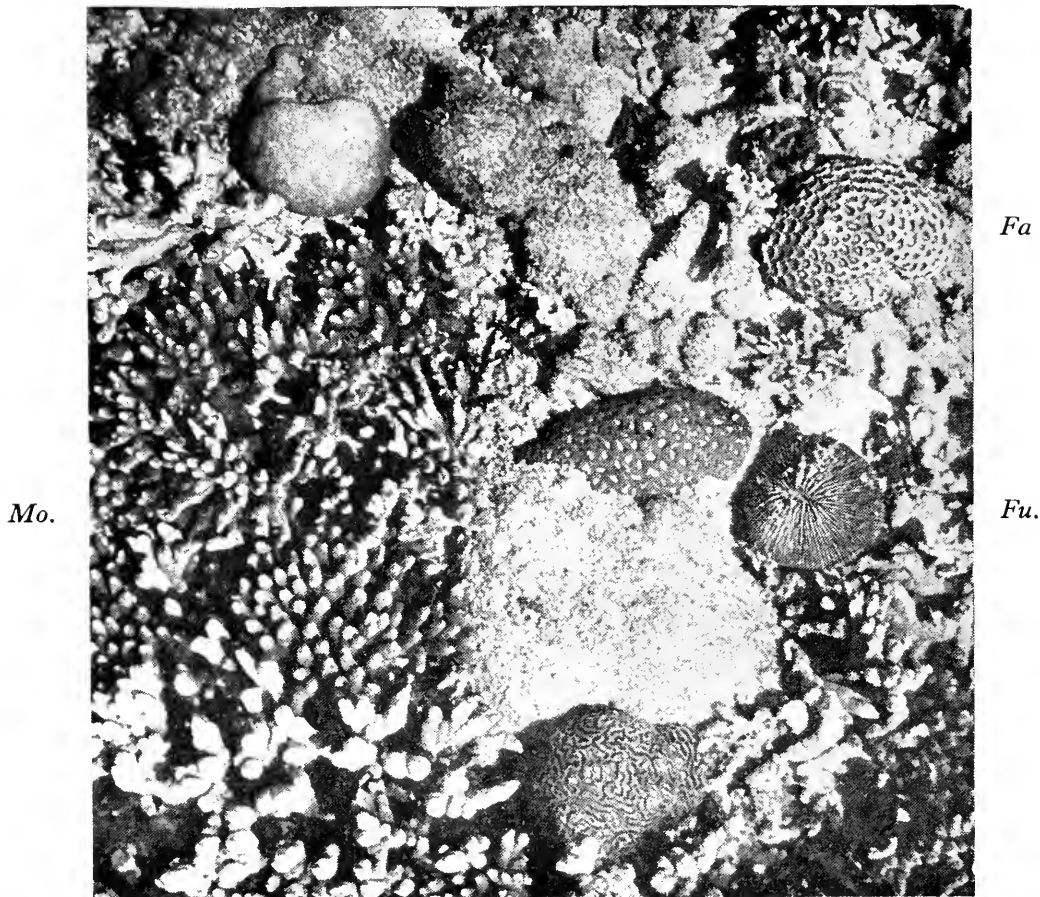

*M.*

Fig. 143. Photograph of a pool on a coral reef (Great Barrier Reef), showing various types of zoantharian corals. *Fa.* *Favia*, with circular thecae; *Fu.* the free coral *Fungia*, a single polyp; *M.* *Meandrina*, the brain coral; *Mo.* *Montipora*, a branched coral; *P.* *Porites*. (Photograph by Dr S. M. Manton.)

The polyps of the Zoantharia attain a higher physiological grade than those found elsewhere in the coelenterates. The sea anemones, like *Hydra*, in the absence of any external skeleton, are capable of locomotion, especially in the case of burrowing forms. The muscles of the body are arranged in such a way as to bring about many different kinds of movements. Thus, while the longitudinal muscles of the

mesenteries cause a longitudinal retraction of the polyp, the transverse muscles of the mesenteries in the neighbourhood of the stomodaeum open the mouth when they contract, and the longitudinal muscles of the tentacles when these are touched by particles of food contract so that the tentacle bends towards the mouth and helps to push the food inside it. The muscular system is for the most part under the control of the nerve net. Although there is no central nervous system the amount of contraction produced is proportional to the strength of the stimulus. If a sea anemone is violently stimulated, *e.g.* touched by a glass rod in any part the stimulus is transmitted to every muscle and the whole animal shrinks to a shapeless lump. The process of feeding is extremely complex and involves the action of the muscles, the cilia and the glands. In a sea anemone like *Metridium*, which lives on the minute animals of the plankton, when these approach the oral disc they are stunned by the nematocysts, snared by the mucus of the glands of the tentacles, transported by cilia to the tips of the tentacles, and pushed by the tentacles towards the mouth, which gapes to receive them. Most remarkable of all, the cilia of the lips, which normally maintain the outwardly flowing respiratory current, reverse their beat to sweep the food into the enteron. While there is this remarkable co-ordination of activities in feeding the nerve net preserves the individuality in action of the parts so that the severed tentacle of a sea anemone is able to execute movements just as if it was still in place on the appropriate stimulation. In another common anemone, *Tealia*, there are no cilia on the tentacles and oral disc, and feeding takes place entirely by the muscular movement of the tentacles.

Sea anemones and corals are often nocturnal, remaining contracted by day, expanding and feeding at night. In such corals as *Lobophyllum* the tentacles are capable of enormous extension. In the forms which feed by day like *Fungia* the tentacles are shorter and the food is collected more by the action of cilia on the tentacles and oral disc and less by the seizing of organisms by the arms and withdrawal to the mouth. A remarkable biological feature is the frequent presence of commensal algae (compare *Hydra viridis*) in the tissues (Fig. 141 B, z.). This is especially the case in reef corals, in which the most recent investigations show that the algae are of no nutritive value while the oxygen they liberate in the tissues has no relation to the needs of the coral. On the other hand the fact that they remove excreta from the coral tissues is of importance.

### SUBPHYLUM CTENOPHORA

Free and solitary Coelenterata; whose active locomotion takes place by ciliary action; which are not reducible either to the polyp or to the medusoid type; and are without nematocysts, but possess "lasso cells".

The Ctenophora, apart from certain aberrant forms, are globular, pelagic, transparent animals living in the surface waters of the sea. They are usually classed with the Coelenterata, but they differ from other members of that phylum in several important respects, notably in the entire absence of nematocysts.

Two British forms are easily procurable, *Pleurobrachia pileus* and *Hormiphora plumosa*. *Pleurobrachia pileus* is about the size of a small

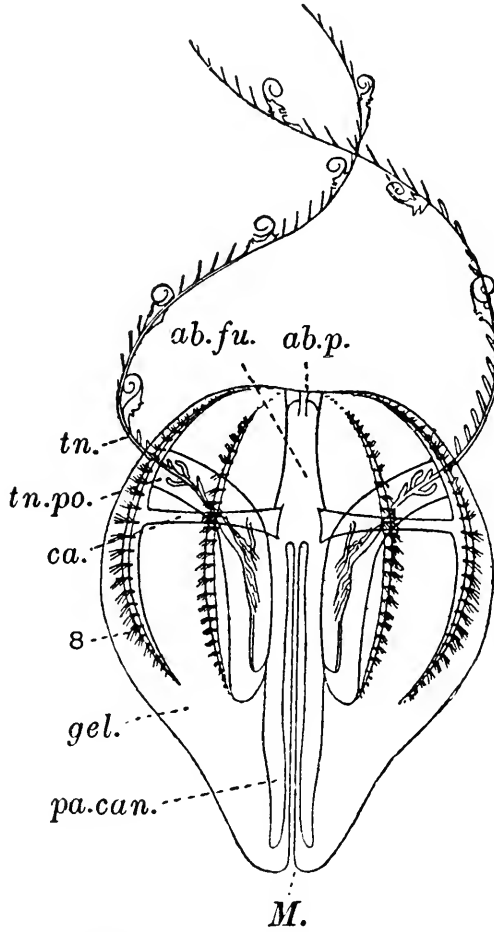

Fig. 144. *Hormiphora plumosa*. After Chun. Side view. *M.* mouth leading via stomodaeum into infundibulum; *ab.p.* aboral pole with sense organ; *ab.fu.* aboral funnel of infundibulum; *pa.can.* paragastric canal running towards oral pole; 8, one of the eight meridional comb plates; *ca.* one of the eight canals running towards 8; *tn.po.* a tentacular pouch; *tn.* a tentacle; *gel.* gelatinous material.

hazel nut, while *Hormiphora plumosa* (Fig. 144) is rather smaller. They are transparent and ovoid. At one pole is the mouth; the only other openings into the alimentary canal are two small pores near the sense organ. At the other pole is the sense organ marked as a small

spot lying in a slight depression. The surface of the body is beset by eight meridional rows of comb plates formed of strong cilia borne upon modified ectodermal cells. The general surface of the body is not ciliated.

On opposite sides of the body are two tentacles set in pouches. The tentacles have muscular bases and are capable of being protruded from the pouches or withdrawn again. They are usually about half as long again as the body when fully extended. The tentacles are armed with cells of a special type called "lasso cells" or colloblasts, which take the place of nematocysts. Each colloblast consists of a sticky head having at its base a spiral thread wound round a stiff central filament. The tentacles are used for catching the prey which is entangled by the sticky heads of the colloblasts.

The mouth leads through a stomodaeum lined with ectoderm into a space, the infundibulum, lined with endoderm. From the infundibulum four canals radiate outwards; each of these divides into two and then runs under the comb plates as the subcostal canals. Two more canals lead out from the infundibulum and run directly without branching to the base of the tentacles. There are also two paragastric canals running alongside the stomodaeum.

At the opposite pole to the mouth, the aboral pole, is the elaborate sense organ formed of small round calcareous bodies united into a morula. This morula is supported on four pillars of fused cilia and is covered by a roof also formed of fused cilia. Ciliated furrows lead out from the sense organ to the comb plates and are believed to assist in carrying stimuli to the comb plates from the sense organ.

The comb plates are the locomotor organs. When at rest the tip of a plate is directed towards the oral pole. In movement a rapid beat of the plate is directed aborally and the cilia then return slowly to rest. The ctenophore therefore moves slowly through the water with the oral end in front. Each plate of the comb beats in succession, the first plate to beat being the one at the aboral end and the remainder following in succession. This type of beating, which is common in ciliary movement, is termed "metachronal" (see p. 17). It gives the appearance of waves travelling down the comb from the aboral to the oral pole. Ordinarily all the eight rows of plates beat in unison, but interference with the aboral sense organ destroys this unison.

The main substance of the ctenophore, which fills the space between the ectoderm and the endoderm, is a gelatinous material in which are found strands of muscle. Immediately beneath the ectoderm lies a subcuticular layer of muscle and nerve fibres which, in appearance, closely resembles the arrangement found in the Turbellaria. It is important to note that the whole musculature of the Ctenophora is derived from the mesenchyme. There are no musculo-epithelial cells.

Ctenophores are hermaphrodite; the male and female gonads occur close to each other in the subcostal canals. Self-fertilization probably occurs. It is a remarkable fact that, if the first two segments of the dividing egg of a ctenophore be separated a half larva will develop from each segment. In the egg, therefore, the organ forming substances must be localized. If these half larvae be kept until generative organs develop, the missing half is then regenerated. In contrast to this behaviour in the Ctenophora, the separated blastomeres of the cnidarian egg as far as the sixteen-celled stage will develop each into a complete animal.

The Ctenophora are divided into two orders: (i) *Tentaculata*, possessing tentacles, to which the majority of forms belong; (ii) *Nuda*, without tentacles, to which belongs only the genus *Beroe*.

Most of the Tentaculata have the ovoid shape, similar to that seen in *Pleurobrachia*, but some are flattened in a peculiar manner. *Cestus Veneris*, Venus' Girdle, is flattened laterally and the body is drawn out into a narrow band, two inches wide and nearly a yard long. It is found in the surface waters of the Mediterranean.

The Platyctenea, a group of Tentaculata to which belong the forms *Coeloplana* and *Ctenoplana*, are flattened dorsoventrally. The flattening is produced by the expansion outwards of the stomodaeum so that the whole of the ventral surface corresponds to the stomodaeum of the normal types. *Ctenoplana* lives in the surface waters of the sea and retains traces of the swimming plates, but *Coeloplana* crawls over the rocks and seaweed, and resembles a turbellarian. It has lost the swimming plates and developed pigment, but it still retains the sense organ and the two tentacles. The gut system is irregularly branched and the muscular system is highly developed for crawling purposes. One member of the group, *Gastrodes*, is a parasite in the body of *Salpa*. Its chief interest, however, is in the larva, which is a planula, found nowhere else among the Ctenophora, and thus provides the strongest piece of evidence for the close relationship of the Ctenophora with the Coelenterata.

## CHAPTER VI

### THE ACOELOMATA: PLATYHELMINTHES

Under this title are grouped the phyla Platyhelminthes, Nemertea, Rotifera, Nematoda, Gastrotricha, Acanthocephala and Nematomorpha (the three last of which are very small groups). The animals contained in these are unsegmented forms with mesenchyme (p. 129) and the space between the gut and the body wall (when it exists) is a primary body cavity filled with fluid (e.g. Rotifera). The turgor of the body cavity fluid when present has a determining role in the preservation of the form of the body (e.g. Nematoda, and Rotifera). Generally speaking this space with its contained fluid plays the part of a circulatory system, but in the Nemertea the body cavity is reduced to a series of canals which constitute the first vascular system in the animal kingdom. This primary body cavity has no definite epithelial boundaries and so can be easily distinguished from a true coelom. It tends to be invaded by mesenchyme cells; in the Platyhelminthes these completely fill it, forming a characteristic tissue (parenchyma), and in the Nematoda the cavity appears to be also completely occupied by a very few enormous vacuolated cells: the vacuoles simulate a body cavity.

The excretory organ is of *nephridial* type (or it may be derived from this as in Nematoda). It is a canal, closed at the internal end, intracellular or intercellular, with some hydromotor arrangement which maintains a flow of fluid to the exterior. In the simplest cases there is a continuous ciliation of the inner wall of the canal (some Turbellaria). Usually, however, the ciliation has disappeared over most of the canal but is strengthened and differentiated in others; the characteristic units of the system, the flame cells, being now found. Flame cells may be situated in the course of the canal in some forms but usually constitute the *terminal organ* (Fig. 149). This system though usually spoken of as "excretory" is primarily concerned with the regulation of fluid content and is often absent in marine forms (e.g. Turbellaria Acoela, p. 213). A nerve net is usually present and from this are differentiated an anterior "brain" and some longitudinal nerves. The reproductive system is that in which differences between and within the groups principally occur: these differences are to be regarded as adaptations to the varying conditions of life.

## PHYLUM PLATYHELMINTHES

Free-living, bilaterally symmetrical, triploblastic Metazoa; usually flattened dorsoventrally; without anus, coelom or haemocoel; with a flame-cell system; and with complicated, usually hermaphrodite, organs of reproduction.

The name Platyhelminthes is given to a division of that heterogeneous collection of animals which in Linnaeus' time were called Vermes. The Vermes included everything that looked like a worm, but appearances have since been found to be deceptive and the collection has been broken up into separate phyla, one of which is the Platyhelminthes or flatworms. Of all the worm-like animals the flatworms are undoubtedly the most primitive, for they alone show relationships to the Coelenterata.

The phylum Platyhelminthes falls naturally into three classes: (i) Turbellaria, (ii) Trematoda, (iii) Cestoda.

Of these the Turbellaria are with few exceptions free-living, while the Trematoda and Cestoda are all, without exception, parasites. It is in the Turbellaria that we see most clearly the typical organization of a platyhelminth, for in the Trematoda and Cestoda the parasitic habit has induced a considerable departure from the structure of the free-living ancestor. In shape the Platyhelminthes are flattened, they are not segmented and do not possess a coelom. The ectoderm is ciliated in the Turbellaria, but the ciliation is lost in the two parasitic groups and there are further modifications. The gut, which is present only in the Turbellaria and Trematoda, has but one opening which serves both as mouth and anus, and in this respect reminds us of the Coelenterata. Between the ectoderm and the endoderm which constitutes the lining of the gut there exist a large number of star-shaped cells with large intercellular spaces forming a mass of *parenchymatous tissue*. The nervous system consists essentially of a network as in the Coelenterata, with the important difference that there is an aggregation of nerve cells at the anterior end which, in the free-living forms almost always takes the form of a pair of *cerebral ganglia*, and that certain of the strands of the network stretching backwards from these cerebral ganglia are often more distinct than others and merit the name of nerve cords (Fig. 145). There is, therefore, the beginning of a definite central nervous system. There are no ganglia other than the cerebral, but in the general nervous network nerve cells and nerve fibres are mixed together.

By operating on the animals in different ways it is possible to show what functions the different parts of the nervous system have. If the cerebral ganglion of a Polyclad is removed, the body of the animal



remains permanently quiescent after the operation. This state of quiescence is not however due to a loss of co-ordination in the motor system. Stimulation of the anterior end can evoke all the normal

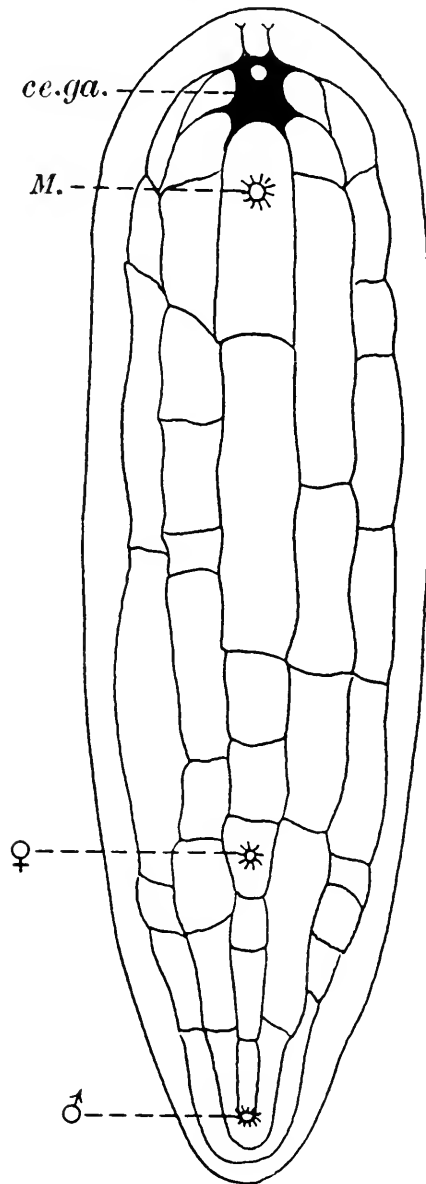

Fig. 145. The nervous system of Acoela, to show the nerve strands of the network. After Steinmann. *ce.ga.* cerebral ganglion (brain); *M.* mouth; ♂ and ♀, male and female openings respectively.

forms of locomotion, and this shows that the nerve net and not the cerebral ganglion is responsible for the correlation of the different parts of the musculature. The primitive central nervous system which

here takes the form of a cerebral ganglion is best regarded as a development in connection with the special sense organs, from which it receives stimuli. The cerebral ganglion functions as a relay system in which the stimuli received from the special sense organs are reinforced, often extended in time, and then passed on to the nerve net. When this sensory relay has been destroyed by removing the cerebral ganglia, the nerve net is no longer excited to bring the muscular system into action, although this may still be done by artificial stimuli.

Sense organs occur in adults only in the free-living Turbellaria, where they may take the form of eyes, otocysts, tentacles and ciliated

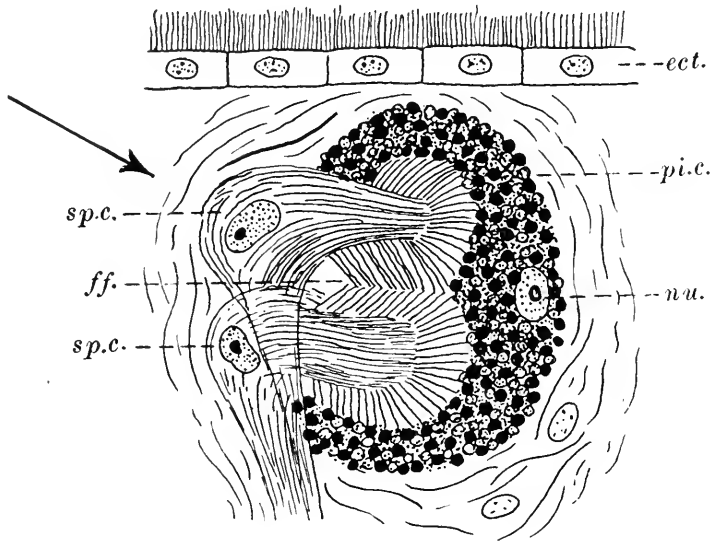

Fig. 146. Eye of *Planaria lugubris*. From Hesse Doflein. *ect.* ectoderm; *nu.* nucleus of pigment cell; *pi.c.* cup-shaped pigment cell forming retina; *sp.c.* special light-sensitive nerve cells with fibrillae (*ff.*) extending to retina. Arrow indicates line of vision.

pits in the ectoderm. They may also occur in the free stages in the life history of the Trematoda and Cestoda. The eyes occur on the dorsal surface where they are visible as dark spots. The retina is formed of cup-shaped cells, which are heavily pigmented. The interior of the cup is filled with special nerve cells, varying in number from two to thirty, the fibrillae of which touch the retina, and the fibres at the other end are joined together to form an optic nerve leading to the brain. There is no lens, but the ectoderm over the eye is not pigmented and so permits light to pass through it (Fig. 146). It should be noted that in this simple eye, as in the extremely complicated organ found in the vertebrates, the light has to pass through the sensory cells of the nervous system before it reaches the retina, for they are in

front of, not behind, the retina. This type of eye is easily seen and studied in the common freshwater planarians. In *Planaria lugubris*, the eye has only two sight cells, while in *Planaria lactea* there are thirty.

*Special sensory cells* which act as receptors for the appreciation of changes in the composition of the surrounding medium (chemo-sensory receptors) or to changes in the flow of water past the surface of the body (rheotactic receptors) are situated just below the ectoderm. Their endings project through the ectoderm and form the actual receptor organ. The taste receptors are spread uniformly over the

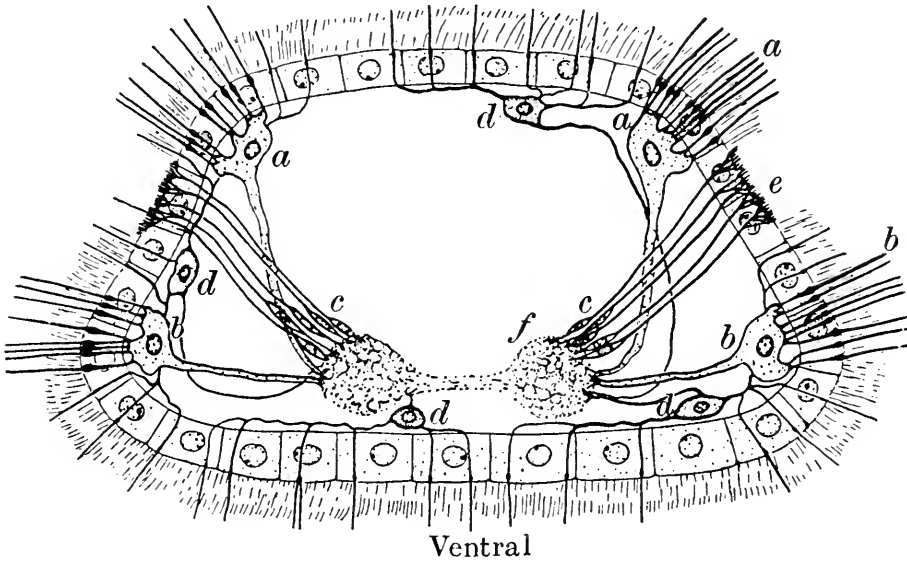

Fig. 147. Diagrammatic transverse section through the anterior end of a planarian at the level of the cerebral ganglion. After v. Gelei. *a* and *b* rheotactic sensory cells and their endings; *c* chemo-sensory cells and *e* their endings (where the endings of sensory cells of this type occur the cilia are absent); *d* taste cells and their endings; *f* the two cerebral ganglia in section.

surface of the body in the Rhabdocoelida, but tend to be more numerous near the mouth. The endings of the taste receptors project among the cilia and are of the same length as these. The rheotactic receptors are confined to certain areas; their endings project among the cilia and are slightly longer than these. Special chemo-sensory receptors with short nerve endings that project only just above the surface of the ectoderm occur in definite areas or grooves on the head. Here the cilia and rhabdites are absent. These areas are known as auricular organs. These sensory organs may also be sunk into pits, which as they are provided with long cilia for driving the water into them, are known as *ciliated pits* (see Fig. 150).

The *tentacles* are projections of the body wall near the anterior end. They are found in the Turbellaria only, but are not present in all these. When present they are quite distinct and have very long cilia which, by their motion, set up currents which pass the water over special sensory areas and so lead us to suppose that their use is for water-testing, or searching for food. Occasionally these tentacles may be sunk into pits.

A statocyst occurs in primitive forms of the Turbellaria. It is situated above the brain and suggests a connection with the Coelenterata where such sense organs are common, but as we know nothing of its nervous supply it is difficult to make a proper comparison.

An *excretory system* exists in nearly all Platyhelminthes. In the Acoela, however, it is absent. The excretory system usually consists of main canals, running down either side of the body (Fig. 148). The position of the openings of these main canals to the exterior varies. The main canals are fed by smaller branches which are ciliated, while the main canals are not. These smaller branches again branch many times and finally end in an organ known as a *flame cell* (Fig. 149). The large canals are often quite easily visible in living specimens, but the flame cell is exceedingly small and can only be seen in transparent forms as in the cercaria larvae of the Trematoda. The flame cell itself consists of a cell with branched processes extending amongst the parenchyma cells. Attached to the cell are a number of cilia which move together in the lumen of the canal with a flickering movement. It is from this flickering motion that the cell derives its name. It is generally believed that excretion of substances into the lumen of the tube is performed by the cells forming the wall of the tube itself. The flame cells represent concentrations of the originally complete ciliary lining of the canal and their function is to maintain a hydrostatic pressure which will cause the excreted substances to move down the lumen of the tube to the exterior (see also p. 197).

Movement in the Platyhelminthes is effected in two ways. The animal may creep over a surface by the motion of the ectodermal cilia, the surface being freely lubricated when necessary, as is the case in land forms, by the discharge of slime from the ectodermal slime glands. More rapid movement is effected by the general musculature of the body which causes a series of undulations to pass backwards along the flat body and urges it forward (Fig. 150). The *musculature* of a platyhelminth consists of a covering of muscle lying just below the ectoderm and composed of two layers, an outer circular and an inner longitudinal layer, except in the Cestoda and in the pharynx of the Turbellaria where the outer muscles are the longitudinal and the inner the circular.

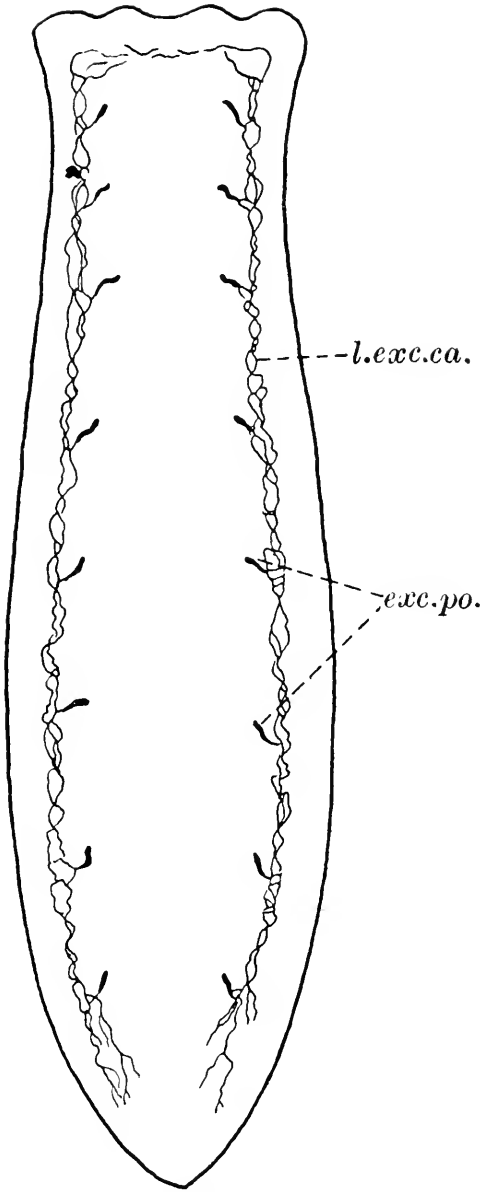

Fig. 148.

Fig. 148. The excretory canal system in *Dendrocoelum lacteum*. After Wilhelmi. *exc.po.* excretory pores opening to exterior; *l.exc.ca.* lateral longitudinal main excretory canals.

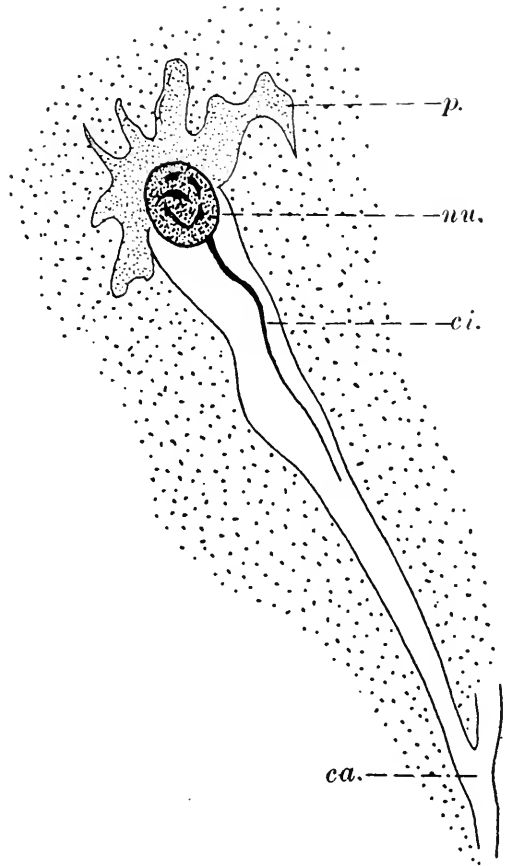

Fig. 149.

Fig. 149. Terminal organ of an excretory canal, the flame cell. After Wilhelmi. *ca.* excretory canal; *ci.* bundle of cilia forming the "flame"; *nu.* nucleus of flame cell; *p.* cytoplasm of flame cell.

Passing through the parenchyma and running dorsoventrally are strands of muscle which are attached at either end to the dorsal and the ventral muscle layers. The muscles themselves consist of fibres formed of a homogeneous transparent material that shows no trace of any structure. These fibres are produced by a special cell, the *myoblast*, which is often to be seen lying alongside the fibre it has produced.

The outer covering of a platyhelminth differs according to the group to which it belongs. In the Turbellaria the outer covering is formed of ectodermal cells. These are usually large and flat, sometimes with peculiar branched nuclei as in *Mesostomum*, or smaller and with round nuclei as in the majority of forms. Externally the cells are ciliated, the cilia being arranged in tracts over the surface of the body. Inside the cells are seen a number of crystalline, rod-shaped bodies,

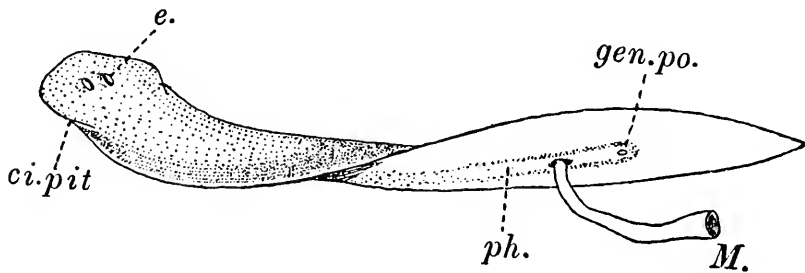

Fig. 150. *Planaria*,  $\times$  about 4. From Shipley and MacBride. *e.* eye; *ci.pit*, ciliated pits at side of head; *M.* mouth at end of protruded pharynx; *ph.* outline of the pharynx sheath into which the pharynx can be withdrawn; *gen.po.* generative pore.

known as *rhabdites*. Although much has been written about rhabdites their function remains obscure. They are a secretion, more or less firm, which dissolves and becomes liquid in contact with water. They are formed in special cells, lying either between the ectoderm cells or just beneath them in the parenchyma, and distributed thence to the ectoderm cells. Rhabdites are usually absent from the ectoderm cells in the neighbourhood of sense organs. It will be noticed that when Turbellaria are placed for preservation in an irritant fluid such as acetic acid the body becomes covered with an opaque white layer. Whether this opaque layer is produced from the rhabdites or from the slime glands which occur in certain regions of the body is not certain.

Immediately below the ectoderm lies the *basement membrane*. This is a thin transparent structureless layer, which probably assists in preserving the general shape of the body and serves as an attachment for the muscles which lie immediately beneath it.

The *basement membrane* is continuous over the body except where it is penetrated by the openings of gland cells. It is absent beneath the ectoderm overlying the sensory areas. In certain parts of the ectoderm, notably in the pharynx of the Tricladida, the nuclei of the ectoderm cells sink through the basal membrane and its underlying muscle layer and come to lie in the parenchyma attached to the cells by long strands of protoplasm (Fig. 151). In the Trematoda

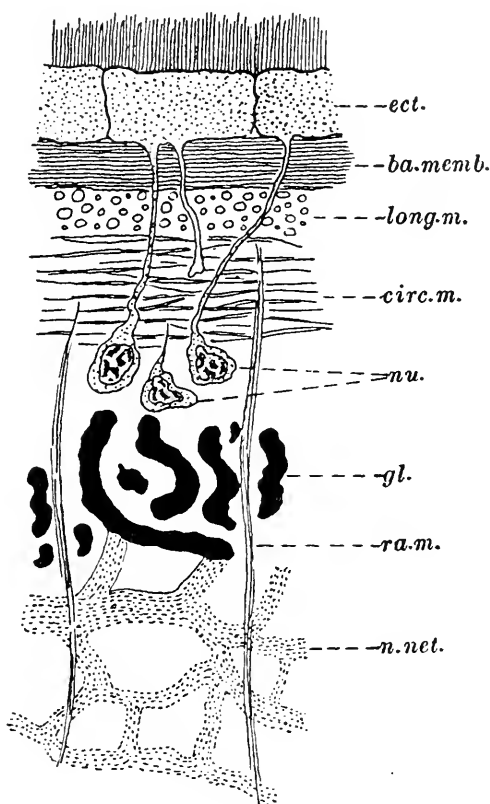

Fig. 151. Transverse section through the outer layer of pharynx of a triclad. Altered from Steinmann. *ba.memb.* basal membrane; *circ.m.* layer of circular muscles; *ect.* ectoderm; *gl.* glands; *long.m.* layer of longitudinal muscles; *n.net.* nervous network; *nu.* nuclei of ectoderm cells; *ra.m.* radial muscles.

and the Cestoda, the ectoderm cells have all sunk into the parenchyma, and the body is covered by a thick cuticle secreted by the ectoderm cells.

The *parenchyma* (also called the *mesenchyme*), which fills the interior of the body, is of very different structure in different Platyhelminthes. It is generally formed of cells with long irregular processes and much intercellular space. Within these cells are small granules and particles, which stain readily. Their appearance and number vary according to the state of health of the animal, whether it is starved or fed, and they

are probably, therefore, products of secretory activity formed after the assimilation of food and destined eventually to be converted into rhabdites or the slime which flows from the slime glands. The parenchyma is no mere padding tissue. It probably serves for the transport of food materials, and certain cells in it provide for the repair of lost parts of the body. These free cells of the parenchyma retain their embryonic condition and do not become vacuolated or branched. They are smaller than the branched cells of the parenchyma and scattered among them in normal circumstances, but when an injury occurs they migrate to the cut surface, where they collect in large numbers and proceed to regenerate the tissues lost by injury.

The *digestive system* of the platyhelminth differs entirely from that of the higher animals in that it is a sac with one opening only, which serves both for the entry of the food and the exit of the faeces, and not a tube with a mouth and anus serving separately for the entry and exit of food. In the simplest forms, in many of the Rhabdocoela, the sac is a straight wide tube with no diverticula (Fig. 152), while in others the gut is branched. In the Tricladida the gut has three main branches. A muscular structure lined by an inturning of the ectoderm surrounding the mouth forms the *pharynx*. The pharynx itself may lie in a pit of the ventral body wall, called the *pharynx pouch*, from which it can be protruded or withdrawn. The epithelial lining of the gut cavity consists of large cells without cilia, the cell walls of which are often difficult to distinguish. A muscular wall to the gut is present, but is so exiguous as to avoid identification in many forms, and it appears therefore as if nothing separates the cells of the gut from the parenchyma. It is possible for food substances to pass not only from the lumen of the gut into the cells lining it, but also from the parenchyma. Thus when Turbellaria are starved they can consume certain organs lying in the parenchyma (ovaries, testes, etc.) by passing these into the gut cells or into the lumen of the gut for digestion.

The Turbellaria are carnivorous and will eat small living crustacea or worms which are caught by the protrusion of the pharynx. A sticky secretion, derived from the slime glands and perhaps the rhabdites, is immediately poured over the prey, which is thus wrapped up in slime. If the object is small enough it is ingested whole into the gut. Here digestion proceeds. Fat is digested in the lumen of the gut, but the digestion of other substances takes place in vacuoles in the cells of the gut wall. Animals which have recently died are also eaten by Turbellaria, and an effective trap can be made by placing a freshly killed worm or a *Gammarus* or two in a jampot and lowering it to the bottom of the stream or pond. The Turbellaria are able to "scent out" the food, and all those within a wide area collect in the pot for



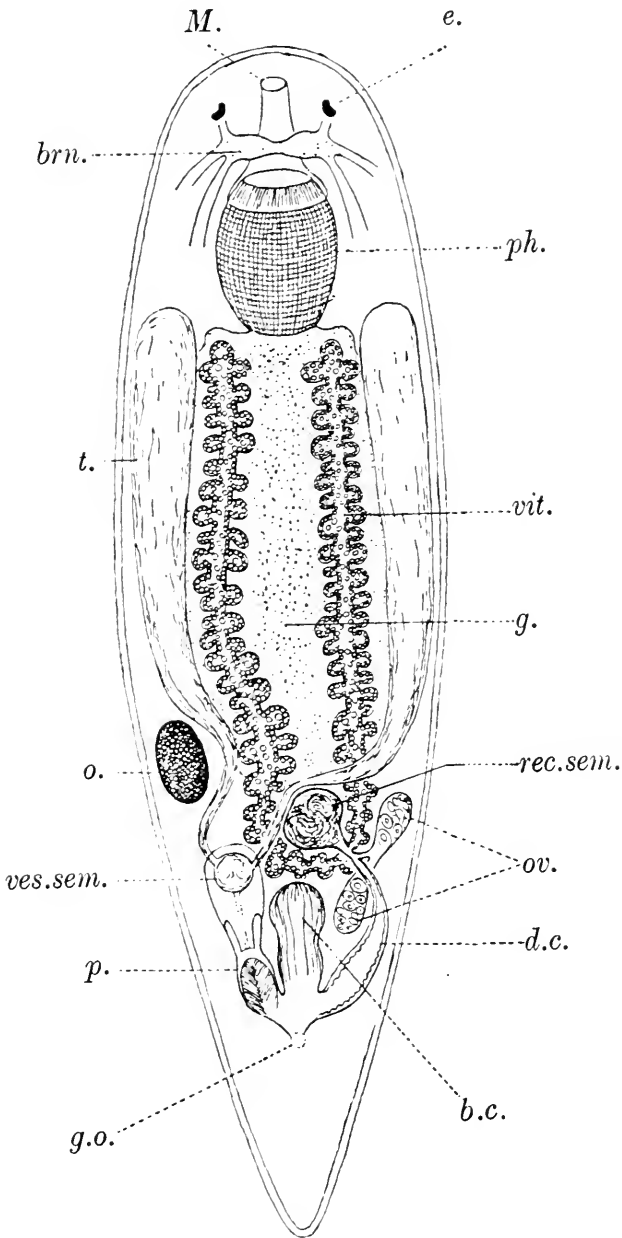

Fig. 152. *Dalyellia viridis*, dorsal view. From Bresslau. *brn.* brain; *b.c.* bursa copulatrix; *d.c.* ductus communis; *e.* eye; *g.* gut; *g.o.* opening of genital atrium to exterior; *M.* mouth; *o.* egg in parenchyma; *ov.* ovary; *p.* penis; *ph.* pharynx; *rec.sem.* receptaculum seminis; *t.* testis; *ves.sem.* vesicula seminalis; *vit.* vitellarium.

the feast. When the animal is too large to be ingested whole, the pharynx is attached to the prey and worked backwards and forwards with a pumping motion, while at the same time a disintegrating digestive fluid is poured out from the walls of the pharynx. Particles of food are thus pumped up into the gut cavity and digested in the same way as the living prey. In the Trematoda, also, the cells lining the gut have a certain limited power of amoeboid movement at their exposed edges, and intracellular digestion is apparently the usual method.

The Turbellaria are able to go without food for long periods, but during starvation they grow smaller and smaller. Stoppenbrink starved *Planaria alpina*, keeping them entirely without food, while as a control he kept a similar collection supplied with food. His results are given in the table below. The measurements are in millimetres.

Date	Fed				Starved			
	Largest		Smallest		Largest		Smallest	
	Lgth	Bdth	Lgth	Bdth	Lgth	Bdth	Lgth	Bdth
16. iii. 03	13	2	10	1	13	2	10	1
15. vi. 03	17	2.5	12	1 $\frac{1}{3}$	10	1 $\frac{1}{3}$	6	$\frac{2}{3}$
15. ix. 03	17	2.5	13	2	7	1	4	$\frac{1}{2}$
15. xii. 03	17	2.5	14	2	3 $\frac{1}{2}$	$\frac{1}{2}$	2 $\frac{1}{3}$	$\frac{1}{3}$

This reduction in size is accompanied by the absorption and digestion of the internal organs, which disappear in a regular order, the animal using these as food in the manner already described. The first things to go are the eggs which are ready for laying, then follow the yolk glands and the remainder of the generative apparatus. Finally the ovaries and the testes disappear, so that the animal is reduced to sexual immaturity. Next the parenchyma, the gut and the muscles of the body wall are reduced and consumed. The nervous system alone holds out and is not reduced so that starved planarians differ in shape from the normal forms in having a disproportionately large head end, the bulk of which is the unreduced cerebral ganglion. On feeding these starved forms will regenerate all the lost organs and return to the normal size, like Alice when she ate the right half of the mushroom.

It is in the *generative organs* that the Platyhelminthes show the greatest complexity of organization (Figs. 165, 166). With rare exceptions the Platyhelminthes are hermaphrodite. The *generative pore* is variably placed but it is usually to be found in the middle line of the ventral surface not nearer to the anterior or posterior end than

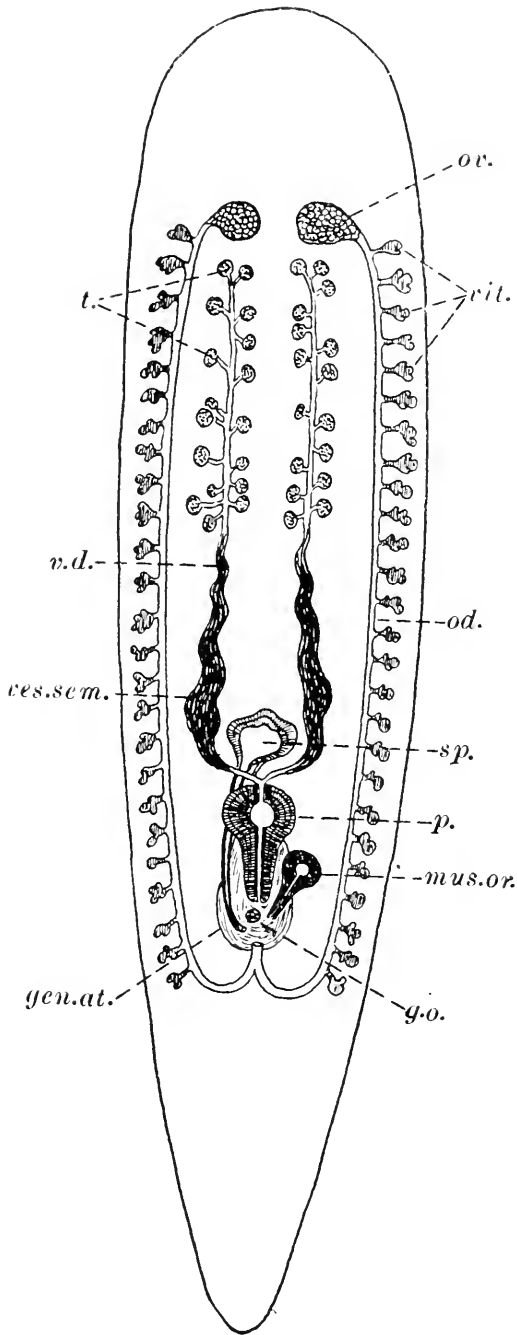

Fig. 153. Diagram of the genitalia of a planarian. After Steinmann. *g.o.* opening of genital atrium (*gen.at.*) to exterior; *mus.or.* muscular organ; *od.* oviduct; *ov.* ovary; *p.* penis; *sp.* stalked organ (bursa copulatrix); *t.* testis; *v.d.* vas deferens; *ves.sem.* vesicula seminalis; *vit.* vitellarium.

one-quarter or one-fifth the length of the body. This pore leads into a space known as the *genital atrium*. Into the genital atrium open the separate ducts leading from the male and female portions of the generative system, together with other accessory organs. The homologies of the various accessory portions of the generative organs in the three different groups are difficult to ascertain. Names are often used which were applied to organs before their homologies were ascertained, and this increases the confusion.

In studying the generative systems in actual specimens elaborate reconstruction from sections is often necessary, as the heavy pigmentation obscures them when the animal is viewed by transmitted light. In transparent specimens careful staining will bring to light most of the parts but it often requires considerable skill and practice to identify these parts.

The organization of the platyhelminth generative system may be reduced to a general plan as follows. The *testes* are round bodies, often very numerous, having a lining of cells which give rise to the spermatozoa. From the testes lead out ducts, the *vasa efferentia*, which, uniting, form the *vas deferens*. There are usually two vasa deferentia collecting the sperm from the testes on either side of the body. The ends of the vasa deferentia are often distended and act as *vesiculae seminales*. The vasa deferentia unite and lead into a pear-shaped bag with very muscular walls. This is the *penis*. At rest it opens into the genital atrium, but during copulation it is extruded through the genital pore to the exterior and pushed into the genital pore of another individual. The penis is usually seen very easily, being one of the most conspicuous parts of the genital apparatus.

The female portion of the generative system consists of the *ovary*, which produces the ova, and the *vitellarium*, which supplies the ova with yolk and a shell. The shell substance is liquid and hardens later. This division into ovarium and vitellarium (or "yolk gland" as it is sometimes called) occurs throughout the Platyhelminthes, but it is probably an elaboration of the more usual arrangement of forming the yolk in the ovary, an arrangement which occurs in the primitive Acoela and in the Polycladida. The ovaries discharge their ova into an *oviduct* which is enlarged near the point of this discharge and thus forms a *receptaculum seminis*. Here fertilization occurs. The oviduct next receives the opening of the *vitelline ducts*. After the opening of the vitelline ducts the duct continues as the *ductus communis*, and leads into the genital atrium. At the junction of the oviducts and vitelline ducts there is a thickening of the walls of the duct and certain glands, the "shell" glands, pour a secretion on to the egg which probably assists in hardening the shell. This thickening is indistinct in the Turbellaria but is very marked in the Trematoda,

and the structure there receives the name of *ootype*, because it is the place where the egg is shaped before being passed into the uterus for storage. In the Trematoda the ductus communis is long and coiled and serves for the storage of eggs. It is called the "uterus", but it is not of course homologous with the "uterus" of the Rhabdocoelida which will be described shortly, nor with the "uterus" of the Cestoda which is again probably a different organ.

The genital atrium receives not only the openings of the male and female organs but also certain accessory organs. In the Rhabdocoelida, of which *Mesostoma* is an example, there open out from the genital atrium on either side the paired *uteri* (Fig. 165, 1), in which the eggs are stored before laying. In *Dalyellia* (Fig. 152) the fertilized eggs pass into the parenchyma. There is another opening which leads into a short muscular receptacle, the *bursa copulatrix*. The bursa copulatrix receives the penis of another individual during copulation. Sperm is deposited here but remains only for a short time before being expelled by muscular contractions and received into the oviduct where it is collected near the ovary in the true receptaculum seminis. In the Tricladida the uterus and the bursa copulatrix are replaced by organs, the homologies of which are doubtful. These are the unpaired *stalked gland organ* and the unpaired *muscular gland organ*. The stalked gland organ is often called the "uterus" but it has not been observed to contain eggs. It is regularly present, whereas the muscular gland organ is often absent. It has recently been shown that the stalked organ serves as a bursa copulatrix and receives temporarily the penis and the sperm of another individual.

During copulation the ventral surfaces of two animals are applied together so that the genital openings lie opposite to each other. The penes are extruded through the genital opening of one copulant into the genital opening of the other. There is a mutual exchange of sperm. Since the ova are ripe at the same time as the sperm, and as, in many forms, there is only one common genital opening to the exterior, special precautions are necessary to prevent self-fertilization. To ensure that cross-fertilization shall take place a great elaboration of the structures surrounding the genital atrium has occurred, resulting in that complication of the genitalia, which is so characteristic of the Platyhelminthes.

In freshwater Tricladida copulation occurs fairly freely among animals kept in glass jars, where they are easily observed. When the penis is retracted its lumen is closed so that sperm cannot escape into the genital atrium, whence it might find its way up the oviduct (Fig. 154). When the penis is thrust out through the genital opening during copulation it is dilated on extrusion, so that the lumen is opened. This dilation also causes the penis to fill completely the

genital atrium and opening, so that the opening of the oviduct into the genital atrium is blocked and no sperm can enter or ova escape. At copulation the penis of one animal is squeezed past the penis of the other into the genital atrium. It cannot enter the oviduct, since this is blocked and so it is received into the stalked gland organ, where the sperm is temporarily deposited. After copulation is finished, the penes are withdrawn and the sperm is transferred from the stalked gland organ to the oviduct. The arrangement of the organs round the genital atrium in the Tricladida varies considerably. In *Bdellocephala*, for example, the penis is reduced and, when extruded, does not fill the genital atrium sufficiently to block the opening of the oviduct. In

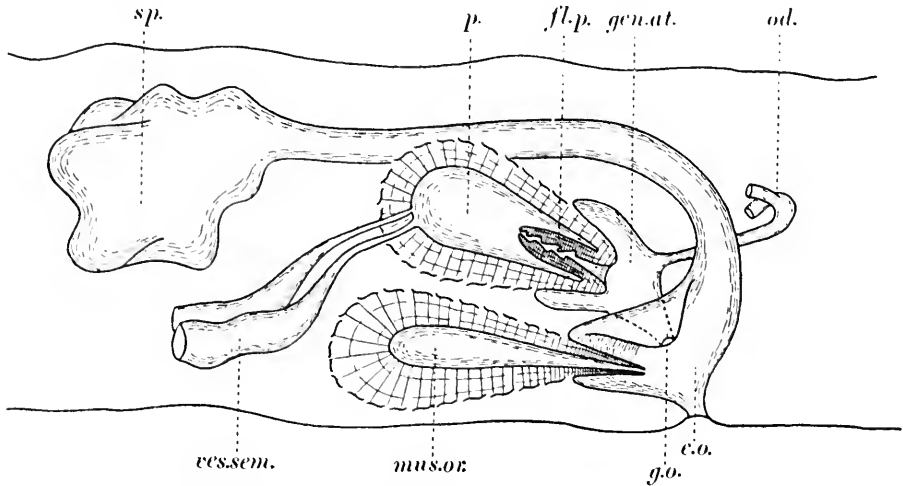

Fig. 154. Longitudinal vertical section through region of the genital atrium in *Dendrocoelum lacteum*. After Ulliyott and Beauchamp. *c.o.* common opening to exterior; *g.o.* opening of genital atrium (*gen.at.*); *fl.p.* flagellum of penis; *mus.or.* muscular organ; *od.* oviduct; *p.* penis; *sp.* stalked gland organ (bursa copulatrix); *ves.sem.* expanded portion of vas deferens forming a vesicula seminalis.

this case a flap of skin has developed which is drawn over the opening of the oviduct, when the penis is extruded.

After the sperm is transferred to the oviduct, it moves up to the receptaculum seminis at the top, near to the point of discharge of the ova. The ova are fertilized in the oviduct and then move down towards the genital atrium, receiving on the way the products of the vitellaria. On arrival in the genital atrium a cocoon is shaped and made ready to be deposited. When laid it is usually attached to weeds, sometimes by a stalk.

The parasitic Trematoda and Cestoda are unaffected by the seasons and are perpetually producing eggs. But in the Turbellaria the season of egg-laying varies. In some, for example *Dendrocoelum lacteum*, the generative system is in full working order all the year round,

in others, for example *Planaria alpina*, the eggs are only produced during the winter months. *Mesostomum* produces two kinds of eggs which are called "summer" and "winter" eggs. The "winter" eggs have a thick shell and are well supplied with yolk; they remain in the uterus and escape only with the death of the parent. The "winter" egg can remain dormant for a long period. The "summer" egg is very thin-shelled and has very little yolk. The development is very rapid and the young embryos are seen moving in the uterus of the parent seventy-two hours after the appearance of the eggs. They escape by the genital pore and their formation does not involve the death of the parent. The term "winter" and "summer" egg is not entirely apposite, for "winter" eggs are often found in midsummer. The "winter" egg is a method of carrying the species over unfavourable conditions which may develop in winter or in summer. The "summer" egg is a means for rapid multiplication when conditions are favourable.

Asexual reproduction occurs commonly in the Turbellaria. In *Microstoma lineare* the hinder end buds off new individuals which remain attached for some time so that chains of three or four individuals in different stages of development are often seen. Planarians undergo autotomy, cutting themselves in two by a ragged line which traverses the middle of the body. Lost parts are easily regenerated in the Tricladida and the group is a favourite one for experimental work on regeneration.

Having thus provided the reader with a general account of the organization of a platyhelminth it will now be possible for us to follow the systematic arrangement of the phylum, to define the divisions and to point out features of interest in various forms and life histories.

### Class TURBELLARIA

The Turbellaria may be defined as Platyhelminthes which are nearly all free living and not parasitic, which retain the enteron; which have a cellular, ciliated outer covering to the body; which usually have rhabdites; and which do not form proglottides. Suckers are very rarely present.

The systematic arrangement of the Turbellaria is based primarily on the structure of the gut. There are four orders: (i) Acoela, (ii) Rhabdocoelida, (iii) Tricladida, (iv) Polycladida.

#### Order ACOELA

In these the gut is not hollow but consists of a syncytium formed by the union of endodermal cells. There is no muscular pharynx. Primitive features are the nerve net and the fact that the germarium and vitellarium are not separated. *Convoluta roscoffensis* is the best

known member of this division. It lives between the tidemarks on sandy shores. Imbedded in the parenchyma are algal cells which live in a symbiosis (p. 47) with the Turbellarian. The photo-synthetic products of these algal cells provide a source of nourishment for the animal. *Convoluta henseni*, another member of this order, is a rare platyhelminth that has adopted a planktonic habitat.

#### Order RHABDOCOELIDA

In these forms (Fig. 152) the gut is straight and the mouth is near the anterior end. The gut may or may not have lateral pouches. In the more primitive members of this order, of which *Microstomum lineare* is a common example, found in fresh water, the germarium and the vitellarium are not separated. Another well-known member of this group is *Dalyellia viridis*, common in freshwater ponds in Britain and remarkable for the elaborate chitinous structure of the penis. *Mesostoma ehrenbergi* and *M. quadrangulare*, the latter X-shaped in cross-section, both occur in freshwater ponds. They are large and transparent and form the best objects for studying the structure of the group. *Plagiostomum lemani* is a form with side pouches to the gut.<sup>1</sup> It occurs at the bottom of deep lakes in temperate regions. *Otoplana* also has side pouches to the gut but is chiefly remarkable for possessing an otocyst overlying the brain.

The Rhabdocoelida occur in both fresh and salt water; marine forms are, however, very small.

#### Order TRICLADIDA

In this group the gut is divided into three main divisions with numerous lateral diverticula from each division. The mouth has shifted backwards to the middle of the body. There are three well-recognized divisions of this order, separated according to habitat: the *Paludicola* or freshwater forms, the *Maricola* or marine forms, and the *Terricola* or land forms. The *Paludicola* are all fairly large forms in contrast with the *Maricola* which are small, no more than 2-4 mm. long. To the *Paludicola* belong the three commonest freshwater Turbellaria in Britain: *Dendrocoelum lacteum*, a white form, *Planaria lugubris*, a black form, and *Polycelis nigra*, a rather smaller black form easily recognized by the ring of eyes round the anterior edge of the body. Perhaps the best known member of the *Maricola* is *Procerodes lobata* (= *Gunda segmentata*) in which the side diverticula of the gut are regularly arranged, with testes and excretory openings between them, giving the appearance of a segmented animal. The *Terricola* often reach a very large size—as long as 50 cm. They are often brightly

<sup>1</sup> These forms, with side pouches to the gut, are sometimes placed in a separate order called *Alloicoela*.



coloured with stripes down the dorsal surface. *Bipalium kewense* is a cosmopolitan tropical form that often turns up in greenhouses. It is often a foot long and is easily recognized by the axe-shaped head. *Rhynchodemus terrestris*, a small form 6–8 mm. long, is a British representative of this division. It is found in damp situations under the bark of decaying trees and fallen timber.

### Order POLYCLADIDA

These are entirely marine. The gut has many diverticula leading out from a not very conspicuous main stem. The mouth has shifted to the

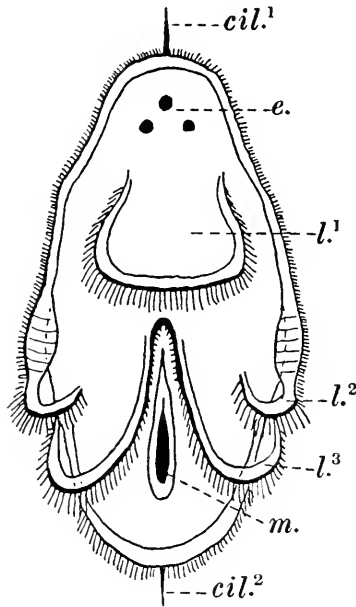

Fig. 155. Müller's larva of a Polyclad, *Cycloporus papillosus* Lang. Ventral view. *cil.¹* large cilium at anterior end; *e.* eyes; *l.¹* *l.²* *l.³* projecting lobes, the edges of which have cilia longer than those on the general body surface (there are eight of these lobes, there being one similar to *l.¹* and another pair similar to *l.³* on the dorsal surface); *m.* mouth; *cil.²* large cilium at posterior end. (Altered from Kükenthal.)

posterior end. The germarium and the vitellarium are combined into one organ but there are separate male and female openings. The ovum is entolecithal, i.e. it has the yolk inside it as in the Acoela. In all other Platyhelminthes the ovum is ectolecithal, i.e. it has no yolk inside it but is surrounded inside the egg shell with yolk cells, which break down when development begins. The early embryological stages in the development of the Polycladida resemble, as might be expected, those of the Acoela, but there are however four macromeres instead of two as in the Acoela. A further point of difference is that in the

Polycladida the entry of the ovum by the sperm takes place after the extrusion of the polar bodies, whereas in other Turbellaria this follows the entry of the sperm. These facts have inclined modern authorities to the belief that the Polycladida are more nearly related to the primitive Acoela than to the Rhabdocoelida and Tricladida.

A further point of interest in this group is that development is not direct. It leads to the production of a larva, known as "Müller's larva" (see Fig. 155), which is characterized by projecting processes and a band of cilia. As we have seen (p. 145), projecting processes (arms) and bands of cilia are characteristic of the larvae of many forms belonging to several phyla; but their presence is probably an adaptive feature and it is unwise to base phylogenetic speculations on them. "Müller's larva" is a planktonic, and therefore a distributive stage, in the life history. At metamorphosis, when the animal adopts the crawling progression of the adult, the larva loses the projecting arms and the bands of cilia, while at the same time it loses its rotundity, becoming flattened and elongated.

Some members of this group attain a considerable size, six inches or more in length. A small sucker is found in some forms behind the genital pore. *Thysanozoon*, a member of this order, has the dorsal surface covered with papillae into which run coeca from the intestine. In *Yungia* there are similar papillae also containing diverticula of the gut, some of which open to the exterior.

### Class TREMATODA

The Trematoda may be defined as Platyhelminthes which are parasitic (or, in *Temnocephalea*, epizoic); which retain the enteron; which in the adult have outside the ectoderm a thick cuticle; which have suckers; usually, but not always, a sucker on the ventral surface in addition to one surrounding the mouth; the ventral sucker is subdivided in some forms and may also be stiffened with a ringlike chitinous skeleton.

The Trematoda are linked to the Turbellaria by the little group of animals which constitutes the order *Temnocephalea* containing the genus *Temnocephala* and one or two others. These animals have a very discontinuous distribution and live attached to the surface of fresh-water animals, chiefly Crustacea. They do not feed on their host but use it as a resting place from which they catch rotifers, *Cyclops*, and other small water animals for food. The possession of five tentacles at the anterior end makes the group easily recognizable (Fig. 156). The epidermis is retained as a nucleated syncytium which secretes outside it a thick cuticle. In the region of the tentacles rhabdites occur. The mouth is anterior, the gut has the same shape as in the Rhabdocoela. There is a large sucker at the posterior end with the common male and female

opening in front of it. The nervous system is of the primitive network type, but the ovary and vitellarium are separate. Many authors place the *Temnocephalea* with the *Turbellaria*, basing their claims to be associated with this class rather than the *Trematoda* on the presence of some scanty cilia, rhabdites, a basal membrane and the absence of any chitinous thickening to the sucker and the absence of Laurer's canal. They are symbionts rather than parasites, which further distinguishes from the *Trematoda*, but their thick cuticle and their syncytial ectoderm are undoubtedly Trematodan in character.

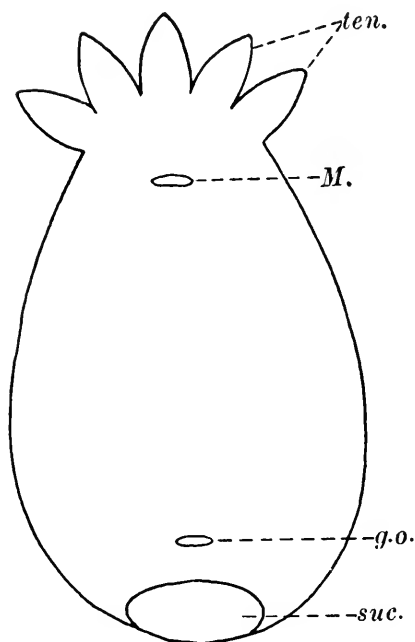

Fig. 156.

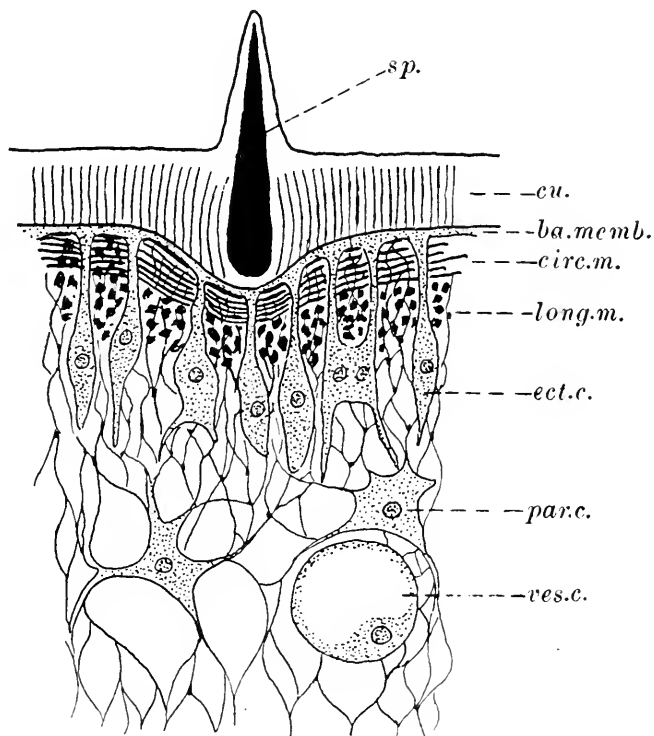

Fig. 157.

Fig. 156. *Temnocephala minor*,  $\times 12$ . After Haswell. *g.o.* genital opening; *M.* mouth; *suc.* sucker; *ten.* tentacles.

Fig. 157. Transverse section through body wall of a trematode. After Benham. *ba.memb.* basement membrane; *circ.m.* circular muscle layer; *cu.* cuticle; *ect.c.* ectoderm cell; *long.m.* longitudinal muscle layer; *par.c.* parenchyma cell; *sp.* spine; *ves.c.* vesicular cell (present in many trematodes).

The rest of the *Trematoda* are all parasitic but they resemble in general shape the *Turbellaria*. They have retained the mouth, which is anteriorly placed, and the gut, which, however, is bifid, a shape not found in the *Turbellaria*. As in the *Turbellaria*, the gut may have lateral diverticula which branch freely. The *Trematoda* have, however, lost the external ciliation of the *Turbellaria* (Fig. 157). The

ectoderm is represented by cells sunk into the parenchyma in much the same way as nuclei of the ectodermal cells in the pharynx of the Tricladida. But the outer portion of the cell is lost in the Trematoda and its place is taken by a thick *cuticle*, which is often armed with spines. Suckers are always present for attachment to the host and are of large size. The presence of these suckers and their shape makes it possible to divide the Trematoda proper into two orders: (i) Heterocotylea, (ii) Malacocotylea.

#### Order HETEROCOTYLEA

In the Heterocotylea there is a large posterior sucker stiffened with chitinous supports. It is often subdivided, as in *Octobothrium* or *Polystomum* (Fig. 158). In the Malacocotylea the sucker is not always posterior, it often moves forward on the ventral surface so that, as in *Fasciola*, it comes to lie one-third of the body-length from the anterior end. It is never provided with chitinous supports. All the Heterocotylea are ectoparasites with the single exception of *Polystomum* which occurs in the bladder of the common frog, of which from 3 to 10 per cent. are infected by it. They are confined to one host only. The Malacocotylea are all internal parasites and pass from one host to another at certain stages in their life history. In the Heterocotylea the excretory pores are paired and lie near the anterior end of the body, whereas in the Malacocotylea the excretory system discharges to the exterior through a single median pore placed at the posterior end of the body. In the Heterocotylea there are separate openings for the male and female portions of the generative system, while in the Malacocotylea there is but one common opening. In the Heterocotylea there is a pair of ducts leading from the ootype to the exterior independently from the male and female ducts, usually called the *vaginae*. The *vaginae* are inconspicuous as a rule, but in *Polystomum* their openings are very clearly marked by two prominences on either side of the body about one-fifth of the body-length from the anterior end (Fig. 158). Corresponding ducts do not occur in the Malacocotylea. The nervous system of the Heterocotylea is more primitive than that of the Malacocotylea, but in both groups it is stereotyped and does not vary as it does in the Turbellaria. In both groups it consists of a cerebral ganglion with six cords leading posteriorly. In the Heterocotylea there are irregular commissures between the cords, while in the Malacocotylea the commissures are few in number and regular.

*Life history of the Heterocotylea.* The usual habitat of this order is on the gills of fishes where they often live isolated. Self-fertilization must therefore be practised, but copulation has been observed in *Polystomum* and also in *Diplozoon*, where it is permanent. The members of this order probably cause considerable inconvenience

to their hosts, but the numbers infesting one host is seldom very considerable and they have no economic importance as parasites. The eggs when laid are normally attached to the body of the host, *Polystomum* being exceptional in laying the eggs in the bladder whence they

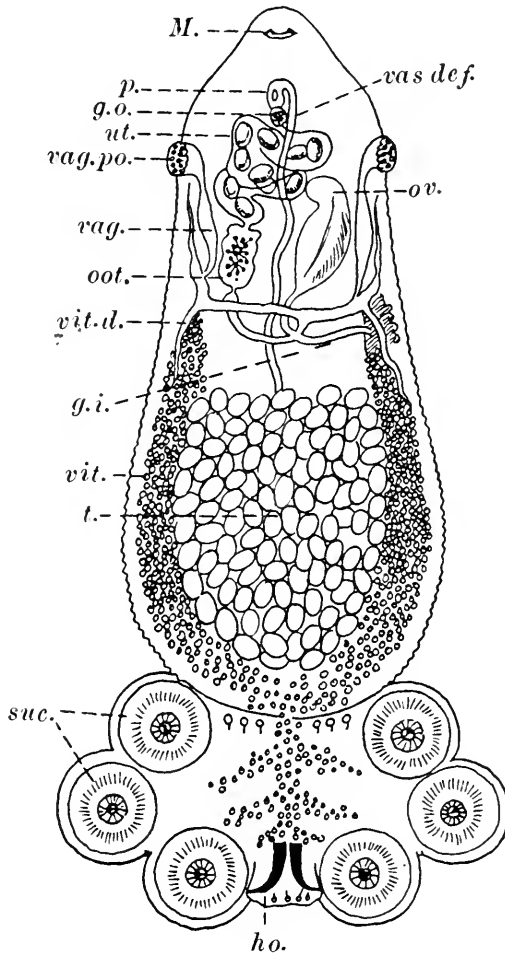

Fig. 158. *Polystomum integerrimum*, ventral view, showing the reproductive system. After Zeller. *g.i.* genito-intestinal canal; *g.o.* common genital opening; *ho.* hooklet; *M.* mouth; *oot.* ootype; *ov.* ovary; *p.* penis; *suc.* sucker; *t.* testis; *ut.* uterus with eggs inside it; *vag.* vagina; *vag.po.* vaginal pore; *vas def.* vas deferens; *vit.* vitellarium; *vit.d.* vitelline duct.

pass out to the exterior into water. The egg hatches as a larva with eyespots and a large ventral posterior sucker. It swims by means of cilia which are arranged in bands round the body. These larvae make their way to some particular spot on the host after being free-swimming for a time. As soon as they attach themselves the ciliary covering is cast off and the generative organs develop. The larva of *Polystomum*

seeks out a tadpole, dying within twenty-four hours if one is not found. If a tadpole is reached, the parasite fastens itself on to the gills, where its ciliary covering is cast and it then creeps into the bladder to wait for three years before becoming sexually mature. The larvae may, however, attach themselves to the external gills, where a copious supply of nourishment induces such rapid growth that the animal becomes sexually mature in five weeks and produces eggs. But it dies when the tadpole metamorphoses, and thus it never reaches the bladder. In *Diplozoon*, which lives attached to the gills of the minnow, the larvae attach themselves to the gills of the host, but they do not develop generative organs until they meet another larva. If such a meeting occurs the larvae fuse across the middle. After fusion the generative organs develop and the animals grow in such a manner that the vas deferens of one form is permanently connected to the genital atrium of the other. They thus remain throughout their lives in permanent copulation.

Another form which displays a variation of the usual type of history is *Gyrodactylus* which occurs on the gills of freshwater fish. In *Gyrodactylus* the ovary and the vitellarium are not separated, as is the general rule in the Trematoda, but constitute one organ. A single egg ripens at a time and, after fertilization, develops into an embryo in the uterus. Before the first embryo leaves the mother a second younger one appears inside it so that we thus have a condition of three generations one inside the other, and the conditions are such that the youngest embryo must develop without fertilization. This feature of the development of one larva with another without the agency of fertilization is common in the life histories of the Malacocotylea but *Gyrodactylus* is the one member of the Heterocotylea in which it occurs.

#### Order MALACOCOTYLEA

The life history of *Fasciola* (Fig. 159) may be taken as the type of life history commonly found in the group. For details of this life history the reader is referred to elementary textbooks.

In the Malacocotylea the adult is always, with rare exceptions, parasitic in some vertebrate host, the sporocyst and redia stages are always parasitic in a mollusc. Two hosts are always, and three may be necessary for complete development. Divergence from the type of life history recorded for *Fasciola* may come about by (i) a generation, the redia stage, being omitted, (ii) the sporocyst forming by budding a second generation of sporocysts within which the cercariae arise, (iii) the cercaria requiring to encyst in a host and to await this host being eaten by the final host before reaching sexual maturity as in the case of *Gasterostomum fimbriatum*, where the sporocyst develops in

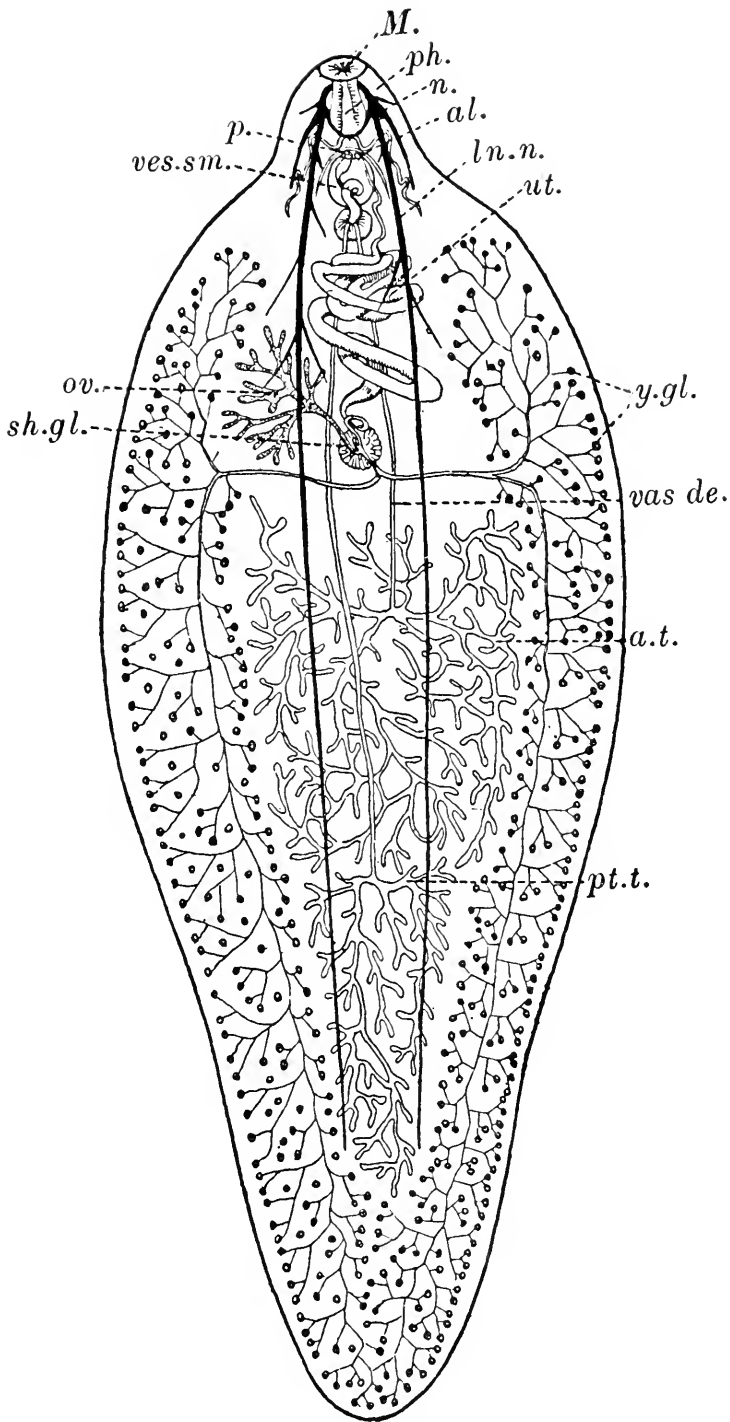

Fig. 159. Diagram of reproductive and nervous system of *Fasciola hepatica*,  $\times$  about 8. From Leuckart. *M.* mouth; *ph.* pharynx; *n.* nerve ring; *ln.n.* chief longitudinal nerve; *al.* beginning of alimentary canal; *p.* opening of penis; *ves.sm.* vesicula seminalis; *ut.* uterus; *ov.* ovary; *sh.gl.* shell gland; *a.t.* anterior testis; *pt.t.* posterior testis; *y.gl.* yolk glands; *vas de.* vas deferens.

the liver of *Anodon*, the cercaria encysts in the roof of the mouth of the roach and only reaches sexual maturity when the roach is swallowed by a perch.

In *Distomum macrostomum*, which is parasitic in the gut of thrushes, there is no free-living stage in the life history. The eggs, passed out with the faeces of the bird, are eaten by a snail, inside which the sporocyst develops. The sporocyst finds its way into one of the tentacles. It there develops pigment, being brightly coloured in bands of green and red, while its presence stops the snail from withdrawing this tentacle. Presumably this brightly coloured object attracts the bird which devours the snail and infects itself by setting free the cercariae from the sporocyst.

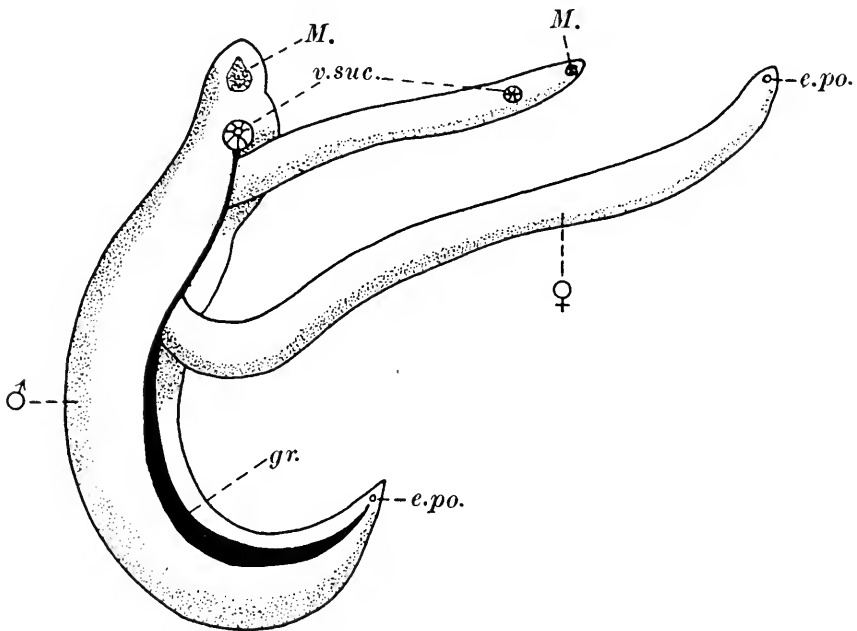

Fig. 160. *Schistosoma*: the male (♂) is clasping the female (♀) in the gynae-cophoral groove (*gr.*). *e.po.* excretory pore; *M.* mouth; *v.suc.* ventral sucker. After Fritsch.

*Schistosoma* (= *Bilharzia*) is a parasite of man, living as an adult in the abdominal veins (Fig. 160). It is long and thin and well adapted for this habitat. It is one of the rare examples of dioecious trematodes. The male, however, does not lose touch with the female once he has found her, but carries her permanently in a fold of the ventral body wall. The eggs are laid in the blood vessels and, being provided with a sharp spike, they lacerate the walls of the capillaries and pass into the bladder. Immediately the urine is diluted the miracidia hatch, but they wait for dilution before hatching. The second host is a water snail. The cercariae swim freely in the



water, and in districts in China and Egypt where the disease is common they swarm. Bathing, washing or drinking the infected water allows the cercaria to enter the final host. The cercariae penetrate the skin with great rapidity and, entering the blood system, make their way to the abdominal veins where they become mature. The disease can be prevented by strict sanitary measures in regard to water, and it can be cured by the administration of compounds of antimony to infected patients. That the disease is a very old one in Egypt is shown by the discovery of *Schistosoma* eggs in the kidneys of mummies of the twentieth dynasty (1250-1000 B.C.).

The hatching of miracidia from the egg of *Schistosoma* is dependent on the dilution of the urine by fresh water and this serves to emphasize the fact that the stages in the life history of all parasites are ultimately connected with environmental conditions. The egg of *Fasciola hepatica* does not hatch unless the pH of the water in which it is deposited is below 7.5, the optimum point apparently being about pH 6.5. If the eggs are kept in water more alkaline than pH 7.5 the embryo remains within the shell and eventually dies.

The identification of a cercaria with an adult is a task which requires great patience, and many cercaria are known which have not been as yet connected with an adult. Almost any mollusc, if dissected carefully under a hand lens, will provide specimens of rediae and cercariae, although infected specimens may be more common in some localities than in others. The tail of a cercaria is often an elaborate structure. Some have rings and chitinous stiffenings, while the well-known *Bucephalus* larva of *Gasterostomum* is a cercaria with a forked tail (Fig. 161).

### Class CESTODA

The Cestoda may be defined as endoparasitic Platyhelminthes in which the enteron is absent and the ciliated ectoderm has, in the adult, been replaced by a thick cuticle. In the parenchyma lime cells occur (see Fig. 162). Proglottides are usually formed.

The Cestoda as a group have felt the influence of the parasitic habit more than the Trematoda. They have dispensed altogether with a gut, there is no mouth, and they absorb their food through the skin. As they live always in the alimentary canal of vertebrates they are conveniently situated for this purpose and the amount of food available to them probably counterbalances the difficulties attendant on dispensing with the usual method of digesting and assimilating food. The ectoderm cells have sunk into the parenchyma after secreting a cuticle as in the Trematoda, but this cuticle is thicker and divided into layers. Immediately beneath the cuticle are the longitudinal muscles. The circular muscles are incomplete at the edges. In transverse

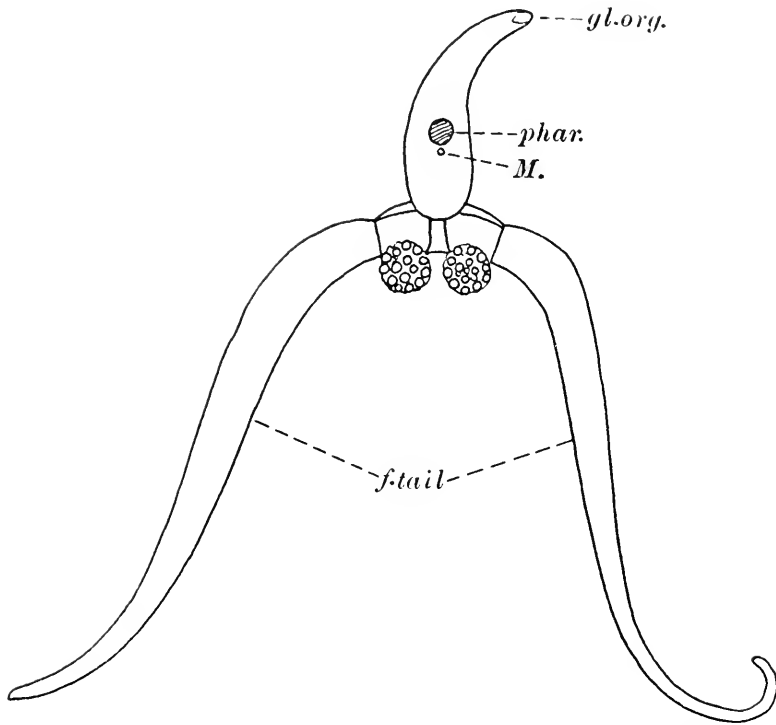

Fig. 161. *Bucephalus* larva (cercaria) of *Gasterostomum fimbriatum*. After Benham. *f.tail*, forked tail; *gl.org.* glandular organ; *M.* mouth; *phar.* pharynx.

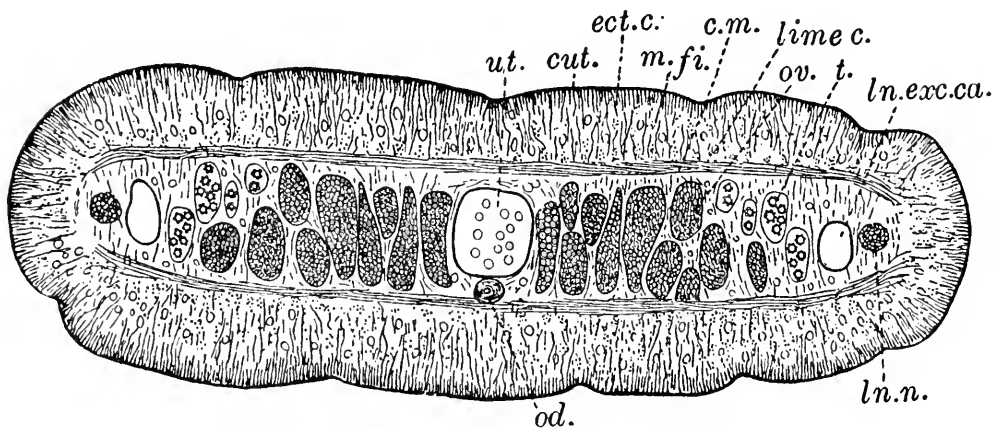

Fig. 162. Transverse section through a mature proglottis of *Taenia*,  $\times$  about 12. From Shipley and MacBride. *cut.* cuticle; *ect.c.* ectoderm cells sunk into the parenchyma; *m.fi.* longitudinal muscle fibres cut across; *c.m.* layer of circular muscles; *lime c.* lime cell; *ov.* ovary; *t.* testis with masses of germ cells forming spermatozoa; *ln.exc.ca.* longitudinal excretory canal; *ln.n.* longitudinal nerve cord; *ut.* uterus; *od.* oviduct.

sections the circular muscles appear to divide the parenchyma into two regions, an outer cortical zone, where occur the cut ends of the longitudinal muscle together with calcareous bodies, and an inner or medullary zone, where the generative system lies (Fig. 162).

The Cestoda may be divided into two orders: (i) Cestoda Monozoa, (ii) Cestoda Merozoa.

#### Order CESTODA MONOZOA

These are small forms which live in the gut of fishes, usually Elasmobranchs. They resemble a trematode in shape and in the fact that they do not form proglottides, but they have no gut. They have at one end a "frilled" organ which serves for attachment, and a small sucker at the other end. An example of this order is *Amphilina*. It is difficult from the structure to say which end is the anterior and which the posterior, for the nervous system consists of two cords running down either side of the body with a single similar commissure at either end. But when the animal moves it has the "frilled" organ in front so that is spoken of as the anterior end.

#### Order CESTODA MEROZOA

These are distinguished from the Cestoda Monozoa by the fact that they all have the power of budding and so reproducing asexually, resembling in this respect the turbellarian *Microstoma lineare*. The adult worm has a *scolex* which is provided with organs of fixation such as hooks, suckers or folds (Fig. 163). The scolex is usually buried in the intestinal mucosa of the host. Behind the scolex comes the *neck*, the most slender portion of the body, which may or may not be sharply marked off from the scolex. It is in the neck that asexual reproduction occurs, fresh segments being continually cut off and, as they grow larger, pushed by the formation of new segments away from the scolex. The segment so formed is called a *proglottis*. The proglottis is not truly comparable with the new individuals produced in *Microstoma lineare*. Through each proglottis run the excretory canals and the nervous strands which are common to all (Fig. 162). The proglottis when first cut off from the neck region is devoid of generative organs, but these develop as it becomes more mature. When the generative organs are mature, fertilization of the ova occurs, the ovaries and the testes disappear, and the uterus alone remains to store the eggs. When the proglottis reaches this stage it is "ripe" and breaks off to pass out with the faeces (Fig. 164). Despite its connection with the scolex, each proglottis must be regarded as an individual for it contains a full set of generative organs both male and female.

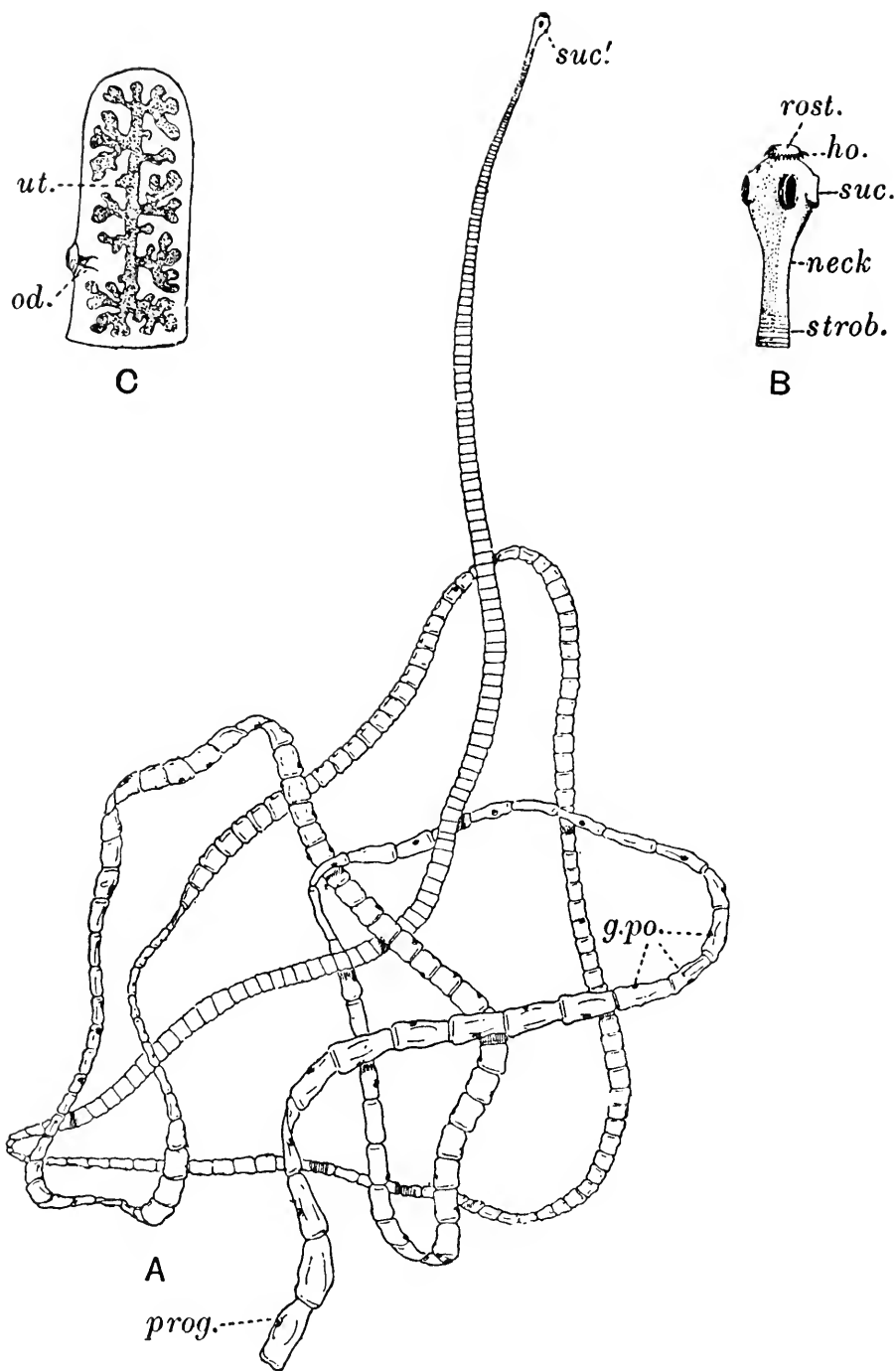

Fig. 163. *Taenia solium*. Slightly magnified. From Shipley and MacBride. A, Entire worm, showing head and proglottides. *suc.'* sucker on head; *g.po.* genital pores; *prog.* ripe proglottis. B, Head. *rost.* rostellum; *ho.* hooks; *suc.* suckers; *strob.* commencement of strobilization. C, Ripe proglottis broken off from worm. *od.* remains of vas deferens and oviduct; *ut.* branched uterus crowded with eggs.

The structure of the scolex is of importance for it forms the basis of the classification of the Cestoda Merozoa. In the tapeworms occurring in the gut of fishes the scolex may have two or four suckers and the neck may be sharply separated from the region where budding occurs. In these tapeworms the scolex is often armoured with chitinous projections and hooks, and the number of the proglottides is usually small. The tapeworms occurring in the mammals (*Cyclophyllidea*) are, with one exception, characterized by a head which bears four suckers at the sides, and, on a projection at the top, called the rostellum, is a crown of hooks.

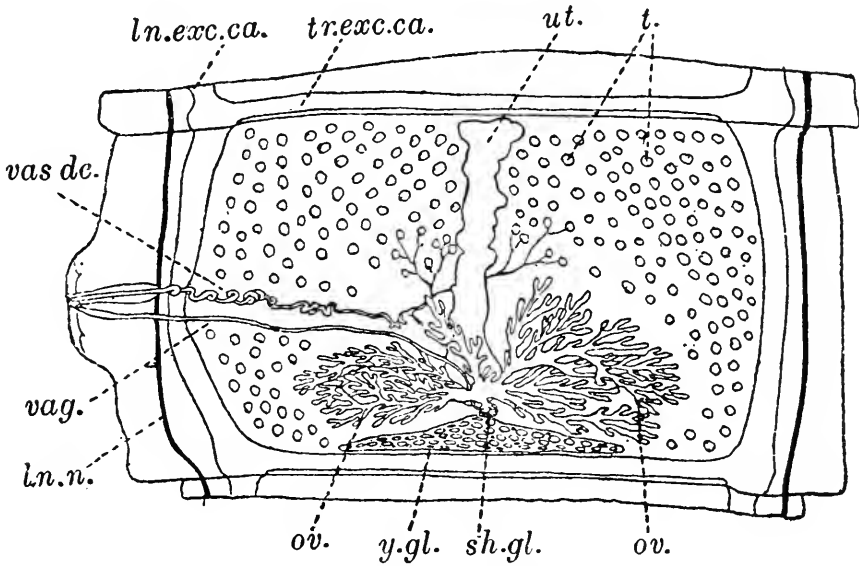

Fig. 164. Diagram of a ripe proglottis of *Taenia solium*,  $\times$  about 10. From Cholodkowsky. *ln.exc.ca.* longitudinal excretory canal; *tr.exc.ca.* transverse excretory canal; *vas de.* vas deferens; *vag.* vagina; *ov.* ovary; *y.gl.* yolk gland; *sh.gl.* shell gland; *ut.* uterus; *t.* testes; *ln.n.* longitudinal nerve.

As a general rule the more primitive cestodes are found in the lower vertebrates, while the advanced types are found in the mammals. The evolutionary stage of the parasite is therefore closely related to that of its host. A notable exception to this rule is *Dibothriocephalus latus*, the Broad Tapeworm of man, which belongs to a group of tapeworms occurring more commonly in the guts of fishes. The scolex of *Dibothriocephalus* has two suckers on either side of the head. These suckers are of the nature of flabby folds sharply distinct from the well-defined cuplike suckers of the Cyclophyllidea.

The generative organs are of the same type as is found generally throughout the Platyhelminthes. There is a single opening for both male and female organs. From the ootype there leads out a duct which

is called the *uterus* and is used for the storage of eggs, but it is doubtful whether it is homologous with the uterus of the Trematoda.

The life history of a cestode is a complicated combination of sexual and asexual reproduction. One, two or three hosts may be necessary. The egg passes to the exterior with the faeces. It contains inside it an embryo armed with six hooks called an "onchosphere". The egg case takes different shapes; in *Dibothriocephalus latus*, which is a more primitive type of cestode, the covering of the embryo is ciliated. In the Cyclophyllid tapeworms, which constitute the most advanced group of the Cestoda the ciliary covering is lost. In *Dipylidium caninum*, the adult of which occurs in the alimentary canal of the cat or dog, it is replaced by an albuminous coat with a chitinous lining inside, while in most of the other forms only the chitinous covering persists. The egg hatches as an onchosphere after being swallowed by the first host. The onchosphere then penetrates the wall of the alimentary canal using its hooks for this purpose and lodges somewhere in the peritoneal cavity of the host. Here it develops suckers and a scolex. In primitive forms such as *Dibothriocephalus*, the larval cestode rests inside the first host, a *Cyclops*, at a stage of its development known as the plerocercoid stage. This stage is ovate in shape and the generative organs are undeveloped and there are no signs of proglottides. The *Cyclops* is then eaten by a freshwater fish, after which the larva, or plerocercus, bores through the wall of the alimentary canal and rests in the body cavity where it grows still further, reaching the metacestode stage. Proglottides can be distinguished in the metacestode stage but the generative organs are not fully mature. Growth now ceases but the metacestode stage is often inconveniently large for the body cavity, causing it to bulge. Sticklebacks thus infected with the metacestode of *Schistocephalus gasterostei* are commonly found. The adult in this case reaches maturity when eaten by a bird. Man acquires *Dibothriocephalus latus*, a nearly related form, by eating pike infected with the metacestode. In the Cyclophyllidea the resting stage in the first host is the "bladder worm" (or cysticercus). The onchosphere on reaching its resting place becomes hollowed out into a ball filled with fluid. A depression then forms in the wall of the sphere and becomes an inverted scolex. In *Taenia serrata*, the common tapeworm of the dog, the bladder stage in the rabbit (to which the name *Cysticercus pisi-formis* was given before the connection with the adult was discovered) has but one head inverted into the cyst. In the bladder-worm stage of *Taenia coenurus*, which is found in the brain of the sheep and causes the disease known as "gid" or "staggers", many heads are formed and invaginated into the cyst so that multiple infection may

occur when a sheep is devoured and torn to pieces by dogs or wolves. In *Taenia echinococcus*, the adult of which lives in the alimentary canal of the dog and is remarkable for having but three proglottides, the cysticercus stage is found in domestic animals and also in man in countries where men live in close association with dogs. The cyst stage is very large and the bladder may contain a gallon or more of fluid. Such a cyst, known as a "hydatid", rapidly proves to be fatal. It is particularly dangerous and difficult to eradicate because the walls of the cyst have the power of budding off asexually daughter cysts. A still further development of asexual budding in the cysticercus stage occurs in *Staphylcystis*, where the onchosphere imbeds itself in the liver and then develops a stalk or stolon which buds off cysts which are detached and fall into the body cavity of the host.

Where the cysticercus is swallowed by the final host the head is everted from the bladder, the bladder is digested and proglottides forthwith make their appearance from the neck region of the scolex. So far as is known the production of proglottides continues for the duration of the life of the host.

The subdivision of the Cestoda Merozoa depends on the shape of the scolex. There are five divisions, the last of which contains the forms commonly found as adults in the alimentary canal of the Mammalia and is the only group of economic importance.

(i) Tetrphyllidea. The four suckers are usually stalked outgrowths of the scolex. Parasitic in fish, amphibia and reptiles. Onchosphere enters a copepod and develops into a larva known as a plerocercoid, in which condition it remains until the copepod is eaten, when it develops into the adult. Size moderate usually 20-30 cm. long but occasionally as small as 1 cm. or as large as 1 metre.

(ii) Diphyllidea. There are two suckers only and the scolex has a long neck armed with spines. There is only one family and one genus, *Echinobothrium*, which is found in the spiral intestine of Selachians. The larva, which is of cysticercoid form, is found in the prawn *Hippolyte*.

(iii) Tetrarhynchidea. These have four suckers each provided with a long spiniferous retractile process. The adult is parasitic in the alimentary canal of Elasmobranchs and especially Ganoids. The larva which may be of either the proceroid or cysticercoid type occurs in marine invertebrates of many kinds, fish and occasionally reptiles.

(iv) Pseudophyllidea. The scolex has two suckers which may be absent in some forms, there is no clearly marked neck and hooks are usually absent. Occasionally as in *Triaenophorus*, a common parasite of freshwater fish, the external divisions between the proglottides are indistinct and these are only indicated by the

regularly placed openings of the uterine birth pores. The majority of these are parasitic as adults in freshwater fishes, but *Dibothriocephalus latus* occurs in man and *Bothriotaenia* in birds. *Archigetes* is parasitic as an adult in body of tubilex, an oligochaete worm living in fresh water. The larva is a plerocercoid which in some forms, *Caryophyllaceus* and *Archigetes* develops gonads paedogenetically so that there is no adult with proglottides. These paedogenetic forms closely resemble the Cestoda Monozoa in appearance.

(v) Cyclophyllidea. The scolex bears four cup-shaped suckers and has a rostellum with a crown of hooks.

The Cyclophyllidea comprise the majority of the common tapeworms. Those infesting the gut of mammals all have a scolex closely resembling that of *Taenia* with four well-defined suckers and a circlet of hooks. Those found in the gut of fish have a more elaborate scolex. The number of proglottides varies considerably, the smallest number (3) is found in *Taenia echinococcus*, while many forms have hundreds of proglottides and are several yards in length. The proglottides never drop off before they are mature, as they may do in the other groups and develop generative organs later, consequently the separated proglottides always contain fully developed onchospheres. Two interesting forms may be mentioned. *Dipylidium caninum* is a tapeworm infesting the alimentary canal of dogs and cats. Each proglottis has a double set of generative organs with two separate generative openings, a feature which gives the animal its name, but which may occur in other forms. The first host is the flea, and puppies and kittens are early infected by catching and eating these insects. The mature proglottis has a double set of male and female generative organs with an opening on either side. *Hymenolepis nana* is one of the smallest tapeworms. The adult has ten to twenty proglottides and only measures half an inch in length. It occurs in children in certain places, particularly Lisbon and New York, where it is said to be increasing. It is remarkable among tapeworms for being the only one known to go through all its life history in one host. The embryos bore into the intestinal wall where they pass through the cysticercus stage and emerge again into the alimentary canal when adult.

The homologies of the various ducts of the genitalia of the Platyhelminthes (Figs. 165, 166) present great difficulties. While one or two, the oviduct and the vas deferens for example, are quite clearly homologous throughout, the homologies of others, particularly the accessory organs such as uterus, bursa copulatrix, vagina, are very doubtful. The "uterus" of the Trematoda is clearly the ductus communis of the Turbellaria greatly elongated and used for egg storage, while the



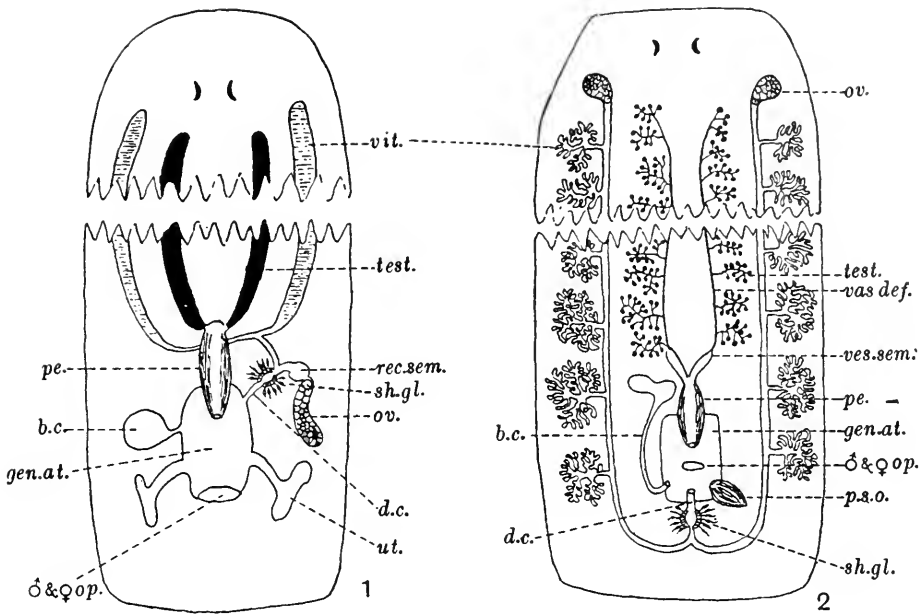

Fig. 165.

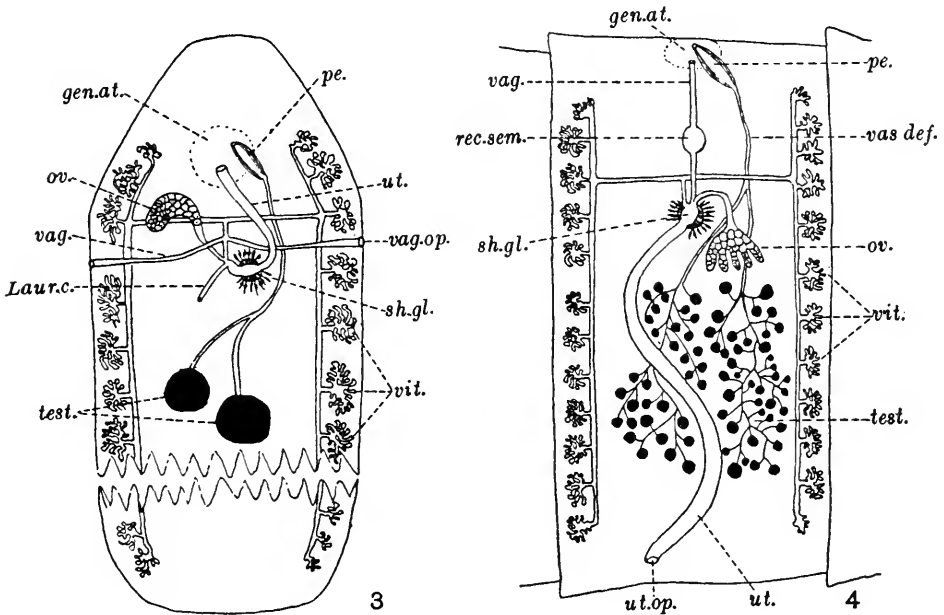

Fig. 166.

Figs. 165 and 166. Diagram of the arrangement of genital organs and ducts in the Platyhelminthes. 1. Rhabdocoelida. 2. Tricladida. 3. Trematoda, Heterocotylea. 4. Cestoda, Dibothriata. *b.c.* bursa copulatrix (stalked organ); *d.c.* ductus communis; *gen.at.* genital atrium; *Laur.c.* Laurer's canal; *ov.* ovary; *p.s.o.* pear-shaped (muscular) organ; *pe.* penis; *rec.sem.* receptaculum seminis; *sh.gl.* shell glands; *test.* testis; *ut.* uterus; *ut.op.* uterine opening to exterior; *vag.* vagina; *vag.op.* opening of vagina to exterior; *vas def.* vas deferens; *ves.sem.* vesicula seminalis; *vit.* vitellarium; ♂ & ♀ *op.* common opening of genital atrium to exterior.

vagina of the Cestoda is the same, but the relation of the "vagina" of the Heterocotylea or the "uterus" of the Cestoda remains at present obscure.

If the vagina of the Cestoda is homologous with the uterus of the Trematoda, the uterus of the Cestoda, which is a single duct, may correspond with the vagina of the Trematoda, which is however a paired structure. The homologies of the ducts in the Trematoda are further complicated by the presence of Laurer's canal, a duct leading out of the ductus communis and opening to the exterior in the Malacocotylea but into the gut in the Heterocotylea. The bursa copulatrix and the muscular pear-shaped organ, which open into the genital atrium in the Turbellaria, are accessory reproductive organs which are probably not represented in the parasitic forms. (See Figs. 165 and 166.)

## CHAPTER VII

# THE NEMERTEA ROTIFERA AND GASTROTRICHA

## PHYLUM NEMERTEA

Elongated flattened unsegmented worms with a ciliated ectoderm and an eversible proboscis lying in a sheath on the dorsal side of the alimentary canal, with which it is not connected; no perivisceral body cavity, the spaces between the organs being filled with parenchyma; alimentary canal with mouth and anus; excretory system with flame cells; a blood vascular system; gonads simple, repeated; sexes separate; sometimes a larval form (*Pilidium*).

The Nemertea in their general organization resemble the Platyhelminthes very strongly. In certain positive features they have advanced, e.g. in the development of a proboscis independent of the gut, in the presence of a vascular system, and a second opening, the anus, into the alimentary canal, but in the simplicity of the gonads and absence of hermaphroditism the Nemertea are less specialized than the Platyhelminthes. There can be no doubt, however, that the two phyla are very closely connected, although the presence of an anus and a vascular system is an enormous advance.

The *proboscis* (Figs. 167, 168) is the most characteristic organ of the nemerteans. It lies in a cavity (*rhynchocoel*), completely shut off from the exterior, which has muscular walls (the *proboscis sheath*), and is attached to the posterior end of the sheath by a retractor muscle which is really the solid end of the proboscis. The proboscis may be compared with the finger of a glove with a string tied to the inside of the tip; when the proboscis is at rest the string, i.e. the retractor muscle, keeps it turned inside out within the sheath; when the muscles of the proboscis sheath contract and press upon the fluid in the rhynchocoel the proboscis is everted, but never completely, because the retractor muscle keeps it from going beyond a certain point. At this point, in the Metanemertini, is a diaphragm cutting off the apical part of the proboscis cavity, and mounted on this is a spike or *stylet* with reserve stylets in pouches at the side (Fig. 168 C). This part of the cavity probably contains a poisonous fluid which is ejected through a canal in the diaphragm into wounds caused by the stylets. The proboscis in this class of nemerteans is thus a formidable weapon. In other nemerteans, though the stylet is not developed, the proboscis is prehensile and can be first coiled round its prey and then

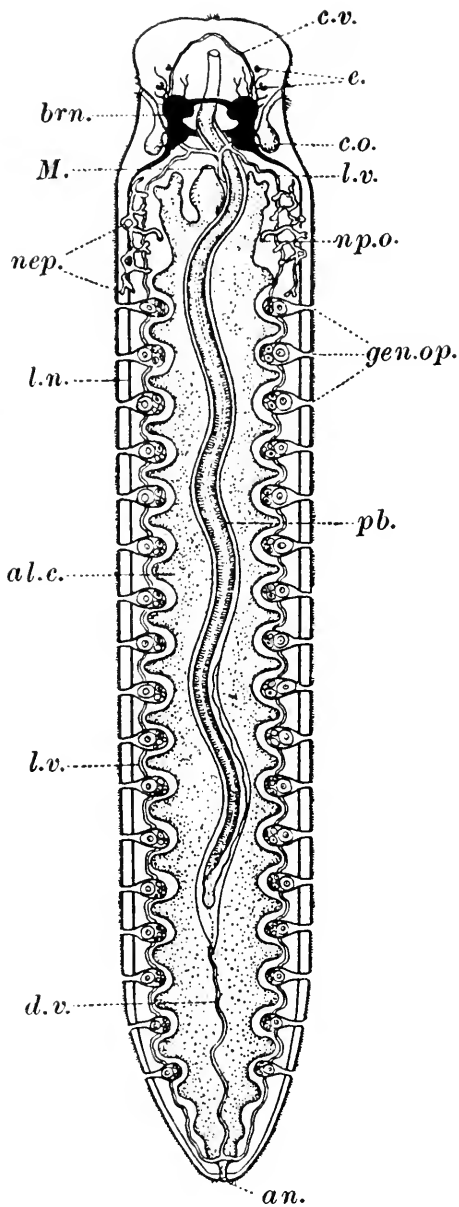

Fig. 167.

Fig. 167. Diagrammatic dorsal view of nemertine. From Kukenthäl. *al.c.* alimentary canal; *an.* anus; *brn.* cerebral ganglia; *c.o.* cerebral organ; *c.v.* connecting and *d.v.* dorsal vessel; *e.* eye; *gen. op.* genital openings; *l.v.* lateral vessel *l.n.* lateral nerve; *M.* mouth; *nep.* excretory system and *np.o.* one of its pores; *pb.* proboscis in the rhynchocoel.

Fig. 168. A, Longitudinal vertical section of a metanemertine to show the relation of the various cavities. After Benham. *brn.* cerebral ganglia; *int.* intestine; *int.d.* coecum; *pb.* proboscis; *pb.'* solid non-eversible part of the former, attached to the proboscis sheath and acting as a retractor muscle; *ps.* proboscis sheath; *rc.* rhynchocoel; *rh.* rhynchodaeum; *std.* stomodaeum; *st.* stomach. B, Transverse section of a palaeonemertine, passing through a pouch of the intestine on the right and an ovary on the left. After Coe. *ect.* ectoderm; *l.v.* lateral blood vessel; *l.n.* lateral nerve; *m.c.* circular muscles; *m.l.* longitudinal muscles; *ov.* ovary; *p.al.* pouch of intestine; *par.* parenchyma. Other letters as above. C, Proboscis of a metanemertine to show the diaphragm and the stylets *sy.* and *sy.'* After Bresslau.

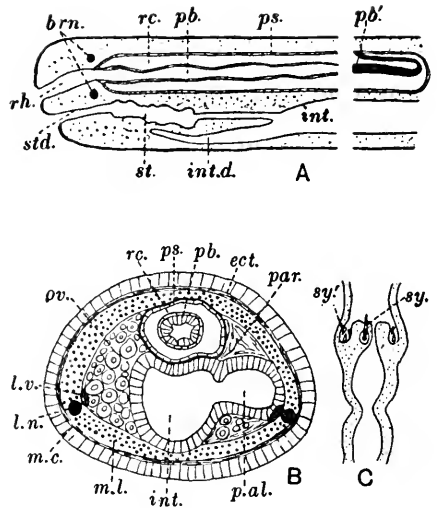

Fig. 168.

retracted to bring it within reach of the mouth. Some forms use the proboscis to aid in burrowing. The part of the proboscis in front of the brain is called the *rhynchodaeum*.

The ectoderm is completely ciliated: there are gland cells amongst the ciliated epithelium; within this are layers of, first, circular, and then longitudinal, muscles. There is a nerve net which in the most primitive nemerteans lies at the base of the ectoderm cells, in others between the circular and longitudinal muscles, and in the most advanced forms within both layers of muscle. While the nervous system is thus extremely primitive there are concentrations of the nerve net to form lateral nerve cords and a pair of *cerebral ganglia* above the mouth, each cerebral ganglion being divided into a dorsal and ventral lobe and connected by commissures above and below the proboscis sheath. The dorsal lobe is subdivided into an anterior and posterior part: the posterior part is in close relation with an ectodermal pit, the cerebral organ, which is situated in some forms in a lateral slit. As yet, however, the control of the movements of the organism is not dependent on the cerebral ganglia. There are occasionally eyes of simple structure.

Inside the muscle layers the body is filled with parenchyma like that of the Platyhelminthes (Fig. 168 B), but in it are one, two or three longitudinal vessels, connected together by transverse vessels with contractile walls, which constitute the vascular system. The blood is generally colourless, but has corpuscles which sometimes contain haemoglobin. The circulation is assisted by the movements of the body. It can hardly be supposed that the blood system, situated so deeply in the body, can be respiratory in function.

The alimentary canal is a straight tube, the mouth and anus being nearly or quite terminal. The excretory system is formed by a pair of canals situated laterally, each of which communicates with the exterior by one or several pores and gives off many branches, ending internally in flame cells like those of the Platyhelminthes. In some cases the end organs come into contact with the blood vessels. The generative organs are series of paired sacs alternating with the pouches of the mid gut and these each develop at the time of maturity a short duct to the exterior.

Most nemerteans develop directly, but in some a pelagic larva with a remarkable form of metamorphosis is found. This larva is known as the Pilidium (Fig. 169). A conical gastrula with a flattened base is first formed by invagination and it passes into the Pilidium by the following changes. A band of cilia round the base constitutes the *prototroch* and forms the locomotory organ of the larva; it is drawn out into two lateral lappets. An apical sense organ is formed by a thickening of the ectoderm. Two cells migrate into the blastocoele and

break up into a tissue called *mesenchyme*, which is partly converted into larval musculature and partly remains undifferentiated until needed as raw material for the adult organs. The gut is connected with the exterior by an ectodermal oesophagus, ending in a large mouth on the flattened base between the lappets. Thus a creature appears which has many resemblances to the trochosphere larva to be described later.

Inside this larva the young nemertean is produced (Fig. 169 A, B). Five ectodermal plates (imaginal discs) sink below the surface

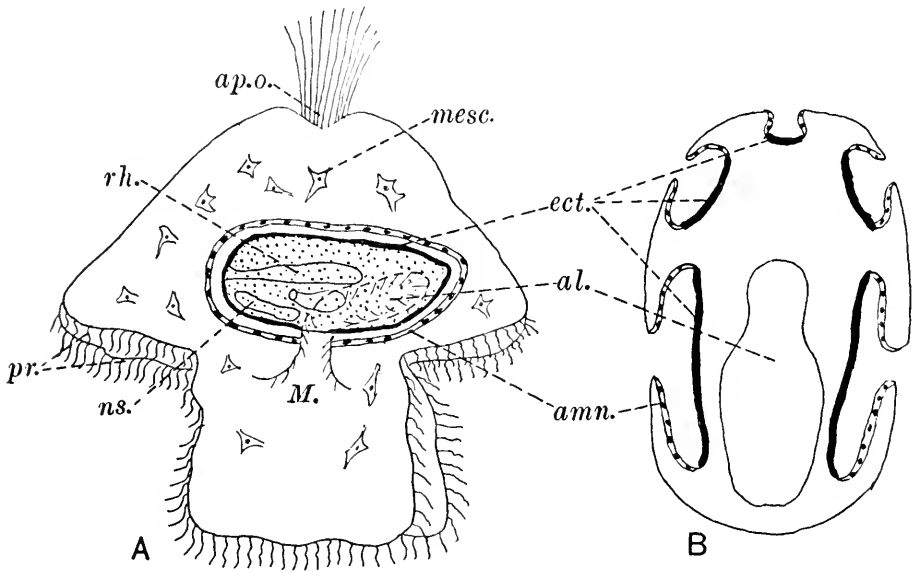

Fig. 169. Pilidium larva. A, Side view of late form enclosing young nemertean. After Korschelt and Heider. B, Frontal view of earlier stage showing the imaginal discs. The anterior unpaired invagination is continued to form the proboscis. After Burger. *al.* alimentary canal; *ap.o.* apical organ; *amn.* ectoderm of the amnion; *ect.* ectoderm of the adult; *M.* mouth; *mesc.* mesenchyme of Pilidium; *ns.* nervous system; *pr.* prototroch; *rh.* rhynchocoel.

and each forms the floor of a sac. Eventually these sacs join round the gut and a continuous cavity is formed separating the adult inside from the larval skin (sometimes known as the *amnion*) which is thus its protecting husk while it develops. The imaginal discs join together and form the secondary or adult ectoderm. The Pilidium continues to swim about with the little nemertean inside it, even when the organs of the latter are developed and cilia cover its surface so that the adult moves freely as if a parasite of the larva. At length it bursts through the tissues of the amnion and the latter sink like a discarded mantle.

The nemerteans are classified as follows:

PALAEONEMERTINI. Proboscis without stylets; cerebral ganglia and lateral nerves in the ectoderm or between the two layers of muscles. *Carinella*.

METANEMERTINI. Proboscis armed with stylets; lateral nerves within all the muscle layers. *Tetrastemma*, *Geonemertes*, *Malacobdella*.

HETERONEMERTINI. Proboscis without stylets; a second layer of longitudinal muscles outside the circular muscles; lateral nerve cords lie between the two. *Lineus*, *Cerebratulus*.

## PHYLUM ROTIFERA

Minute animals, unsegmented and non-coelomate, typically with a ciliated trochal disc for locomotion and food collection, a complete alimentary canal with anterior mouth and posterior anus, and a muscular pharynx with jaws of a special type; excretory system with flame cells joining the hind gut to form a cloaca; no blood system or respiratory organ; very simple nervous system; sexes separate, two kinds of eggs, one developing immediately without fertilization and the other, which is fertilized, thick-shelled and developing only after a resting period.

This group contains a large number of forms of great interest to the microscopist which are easily obtained from many kinds of fresh water. They are, generally speaking, the smallest of all metazoa. They vary little in structure and present a remarkable similarity to the trochosphere larva. It must be admitted that the Rotifera are on a lower stage of organization than the annelids and molluscs which possess this larva and may even be related to a common ancestor of these phyla. On the other hand, the Rotifera come near to the Platyhelminthes, the Gastrotricha and Nematodes.

An elastic external cuticle covers most of the body. Under this is a syncytial ectoderm; a continuous layer of muscles forming a body wall is absent (as in the Arthropoda), but isolated bands of muscle, chiefly longitudinal, traverse the body (or perivisceral) cavity (Fig. 171).

What is the true nature of the body cavity is a question which has never been properly answered. It is a wide space between ectoderm and endoderm, traversed by muscles, and is neither a coelom nor a haemocoel in the narrower sense, but probably only a derivation of the segmentation cavity of the gastrula (the blastocoel), as in the trochosphere larva. But they do possess a body cavity and not a solid parenchyma, and so differ from the Platyhelminthes. Their excretory system is, however, very similar to that of the latter phylum, and in the union of the excretory duct with the gut the rotifers resemble certain specialized trematodes.

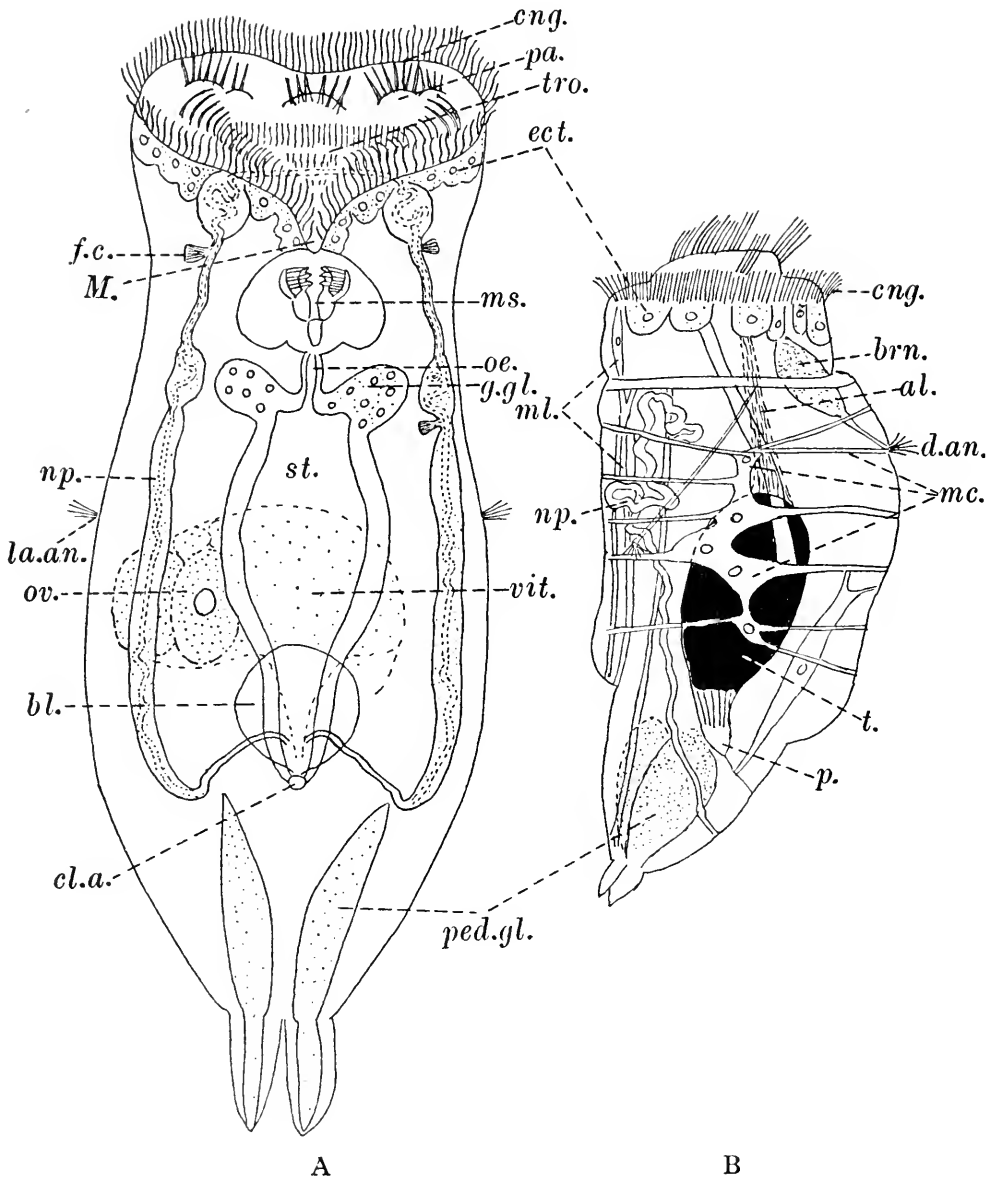

Fig. 170. *Hydatina senta*. A, Female, ventral view. Original. B, Male, side view. After Wesenberg Lund. *al.* rudiment of alimentary canal; *la.an.* lateral antenna; *bl.* bladder; *brn.* brain; *cng.* cingulum; *cl.a.* cloacal aperture; *d.an.* dorsal antenna; *f.c.* flame cell; *g.gl.* gastric gland; *ect.* syncytial ectoderm of trochal disc; *M.* mouth; *mc.* circular and *ml.* longitudinal muscle cells; *ms.* muscular mastax and trophi; *np.* nephridium, intracellular duct represented by double dotted line; *ov.* ovary; *oe.* oesophagus; *p.* penis retracted; *ped.gl.* pedal gland; *pa.* papillae with large cilia; *st.* stomach; *t.* testis; *tro.* trochus; *vit.* vitellarium.



Like the Nematoda they consist of a small number of cells and all the tissues, except the cells of the velum, may lose their cell boundaries and become syncytial. Not only is there a superficial resemblance to heterotrichous ciliates in the Protozoa but the tendency to the acellular condition carries this a step further.

*Hydatina senta* may be taken as a type of the group (Fig. 170).

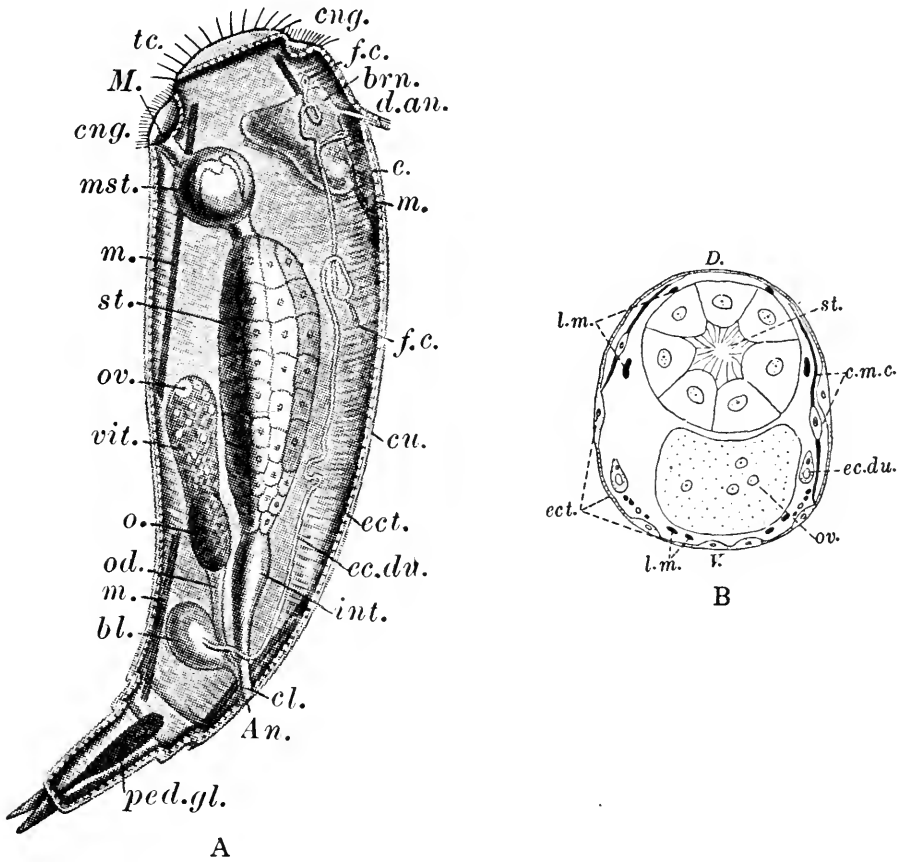

Fig. 171. A, Side view, diagrammatic, from Shipley and MacBride, and B, transverse section of a female rotifer. *An.* anus (cloacal aperture); *c.m.c.* circular muscle cell; *cu.* cuticle; *D.* dorsal; *e.* eye; *ec.du.* excretory duct (nephridium); *ect.* ectoderm; *int.* intestine; *l.m.* longitudinal muscle; *m.* muscle; *od.* oviduct; *tc.* trochus; *V.* ventral. Other letters as in Fig. 170.

The female is pear-shaped, the posterior end being the stalk. The anterior end is flattened and forms the *trochal disc*. This is, in many rotifers, bordered by a double ciliated ring, the *velum*, the outer part of which (the *cingulum*) is the original velum and is composed of strong cilia. The inner is called the *trochus*. Between the two rings, which are thus preoral and postoral respectively, is a ciliated groove in which is situated the mouth. The velum in life gives the impression

of revolving wheels, the reason for the scientific name of the group. In *Hydatina* the cingulum forms a complete ring and the trochus is reduced to a double transverse row of cilia; in the groove between them is situated a number of papillae on which are stiff cilia. (In *Copeus* and other creeping forms there are no trochus and cingulum but cilia cover the trochal region and part of the ventral surface. This is said to be a primitive arrangement.) The posterior end is called the *foot* and it terminates in a pincer-shaped appendage, on which open glands with a sticky secretion. By means of this apparatus the rotifer can anchor itself in the intervals of its free-swimming life. The *dorsal* surface of the rotifer is marked out by the position of the *cloacal aperture* just in front of the foot; on this surface immediately behind the velum is a sense organ, the *dorsal antenna*, and below it the *brain*. There are also two *lateral antennae*; all three are prominences bearing stiff sense hairs. Elsewhere the body is covered by a thin, smooth, transparent cuticle secreted by the ectoderm.

The food, which consists of micro-organisms of various kinds, is swept by means of the ciliary currents of the disc into the mouth and then through the oesophagus into the muscular pharynx or *mastax* which is provided with chitinous jaws, the *trophi*, which are in constant movement and, in *Hydatina*, masticate the food as it passes through. This first part of the alimentary canal is ectodermal and constitutes the *stomodaeum*. Then follows the endodermal *stomach*, lined with ciliated epithelium, in which digestion takes place.<sup>1</sup> Two *gastric glands* open into it anteriorly. A narrow *intestine* leads into the *cloaca*, into which the *excretory system* also opens. The latter consists of two lateral ducts, coiled at intervals, consisting of perforated cells placed end to end into which flame cells (vibratile tags) open frequently but irregularly. Anteriorly the ducts communicate by a transverse vessel just behind the disc and posteriorly they open into a pulsating vesicle which expels its contents into the cloaca. It has been calculated that in some species this bladder expels a bulk of fluid equal to that of the animal about every ten minutes.

The single ovary is a bulky organ: it is divided into a small *germarium* (the ovary proper) and a much larger *vitellarium* or yolk gland which occupies much of the space between the stomach and the body wall. The ovary is continued into a duct which opens into the cloaca.

The female is still the only individual known in many kinds of rotifers. It was not until 1848 that a male rotifer of any kind was described. In only a few species is the male equal in size and organization to the female. In all the rest there is a more or less pronounced sexual dimorphism. In *Hydatina* (Fig. 170 B) the male has no

<sup>1</sup> Digestion is usually extracellular, but in *Ascopus* and other rotifers it is intracellular.

alimentary canal, but the ciliated disc, musculature and excretory system are well developed. Usually the male is not only smaller but its ciliated disc and the alimentary canal are very much reduced and the excretory system may be absent. The chief organ is the large *testis*, usually filled with ripe spermatozoa, which opens by a median dorsal *penis* in many cases. Where the penis is absent the tapering hinder end may be inserted in the cloaca of the female. Finally, it may be mentioned that in one large family, the Philodinidae, which includes the genus *Rotifer*, no male has ever been found.

Two kinds of reproduction occur in the rotifers as in the cladoceran crustacea, but in this case there are two kinds of females, one of which always reproduces parthenogenetically, the eggs developing to form females (female producers), while the other may reproduce bisexually. In this second type (male producers) there are eggs, often smaller than the female eggs, which develop quickly by parthenogenesis into males. At various seasons after the appearance of these male eggs there are produced by the same individual also other eggs, distinguished by a thicker shell, and these have been fertilized by the spermatozoa of the just hatched males injected through the skin. These "resting" eggs are fertilized "male eggs" and they only develop after a dormant period into females.

The reproduction of a rotifer runs through a cycle in which at first only parthenogenesis occurs but which is terminated by sexual reproduction. In rotifers which are typical members of freshwater plankton, the cycles run to a time-table. There are "dicyclical" rotifers like *Asplanchna*, which have two sexual periods, one in spring and the other in autumn, while other forms like *Pedalion* are "monocyclical" and have only a sexual period in the autumn passing the winter as resting eggs. In rotifers like *Hydatina*, which inhabit puddles and ponds, the sexual periods are very frequent and begin soon after the resting eggs have hatched. The resting egg is a stage in which the species can survive when the puddle dries up. Sexual reproduction can be brought on in cultures by alteration of the external conditions.

Besides the environmental types which have been mentioned above as free-swimming and inhabiting larger and smaller bodies of water, the following rotifers may also be mentioned:

*Stephanoceros* and *Floscularia* (Fig. 172 bis) are sedentary forms which secrete a protecting gelatinous tube into which they can withdraw rapidly. *Melicerta* is another sedentary form which produces a tube formed out of mud particles or its own faeces.

*Callidina* and other genera are terrestrial forms which can remain for a great part of the year in a dried-up condition but come to life immediately when moistened by rain. Such forms are found, for

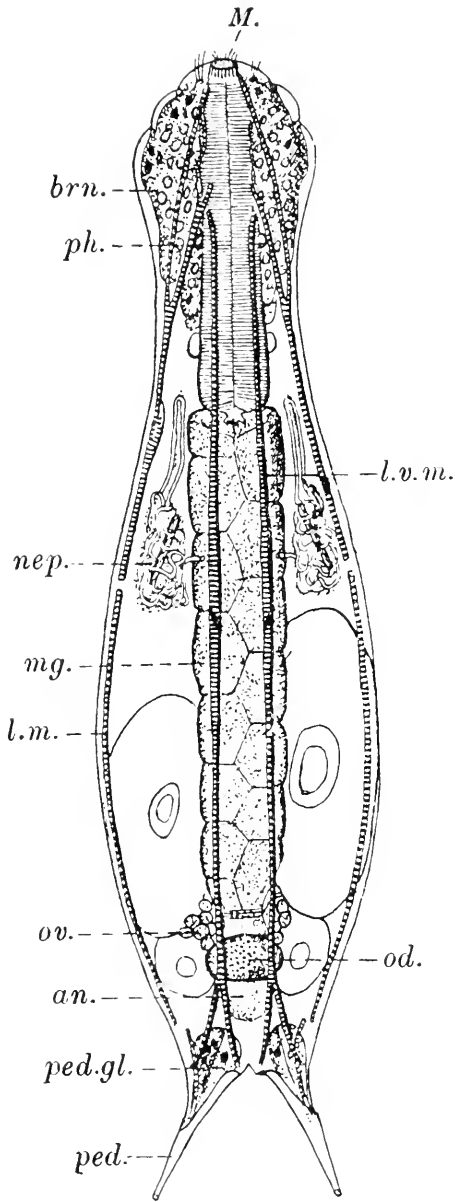

Fig. 172.

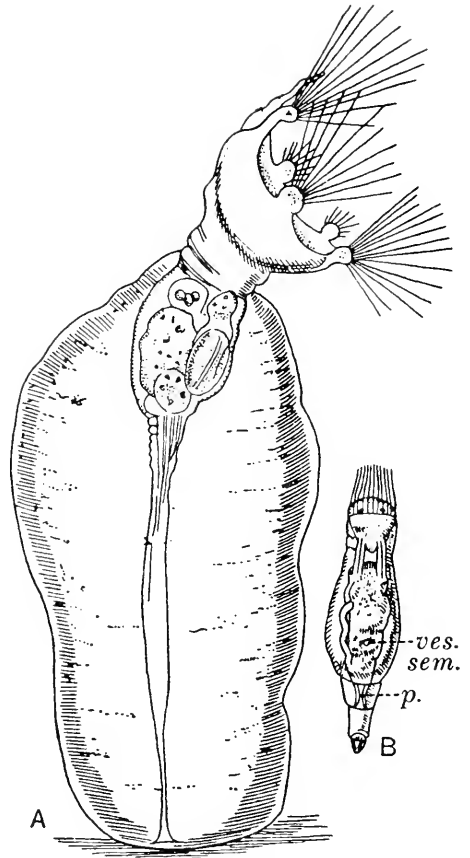

Fig. 172 bis.

Fig. 172. Ventral view of *Chaetonotus*. From Kukenthal. *an.* anus; *brn.* brain; *l.m.* longitudinal muscle; *l.v.m.* lateroventral muscle; *M.* mouth; *mg.* mid gut; *nep.* nephridium; *od.* oviduct; *ov.* ovary; *ped.* foot; *ped.gl.* pedal gland; *ph.* pharynx.

Fig. 172 bis. A, *Floscularia cornuta*. Female within its gelatinous tube. From Hudson. B, *F. campanulata* Male. *ves.sem.* vesicula seminalis; *p.* penis.

instance, in roof gutters and amongst moss. The group to which these forms belong is called the "bdelloid" or leech-like rotifers, because they not only swim, but progress by a looping method like that of *Hydra* or a leech.

## PHYLUM GASTROTRICHA

Minute wormlike, unsegmented animals, with certain tracts of the skin ciliated, the cuticle often forming bristles and scales; a non-cellular hypodermis, forming adhesive papillae, longitudinal muscle cells which do not form a continuous sheath; straight alimentary canal consisting of a muscular pharynx like that of the nematodes and a mid gut without diverticule; a pair of nephridia in freshwater representatives; a nervous system consisting of a cerebral ganglion and two lateral cords; hermaphrodite individuals in one division of the phylum (Macrodasyoidea) and parthenogenetic females in the other (Chaetonotoidea); the single female aperture opening near the anus, and the male aperture when present variable in position. Development direct and cleavage total.

These small animals (Fig. 172) are usually elongated and creep or swim by means of their cilia or move in a leech-like manner using their musculature. They feed on minute animals and plants which are sucked in by the pharynx.

The Gastrotricha have features in common with the Rotifera, such as the external ciliation, the bifid foot and the excretory system with flame cells, but in the character of the gut they recall the Nematoda.

## CHAPTER VIII

# THE NEMATODA, NEMATOMORPHA AND ACANTHOCEPHALA

## PHYLUM NEMATODA

Unsegmented worms, with an elongated body pointed at both ends; ectoderm represented by a thin sheet of non-cellular hypodermis, concentrated to form two *lateral lines* and to a less degree *dorsal* and *ventral midlines*, secreting an elastic cuticle, made of protein, not chitin, usually moulted four times in the life of the individual; cilia absent from both external and internal surfaces; a single layer of muscle cells underneath the hypodermis, divided into four quadrants, each muscle cell being elongated in the same direction as the body and composed of a peripheral portion of contractile protoplasm and a larger internal core of unmodified protoplasm which sends a process to a nerve; the space between the body wall and the gut sometimes filled by a small number of highly vacuolated cells, the vacuoles joining together and simulating a perivisceral cavity; excretory system consisting of two intracellular tubes running in the lateral lines; nervous system made up of a number of nerve cells rather diffusely arranged but forming a circumpharyngeal ring and a number of longitudinal cords of which the mid-dorsal and mid-ventral are the most important; sense organs of the simplest type; sexes usually separate, gonads tubular, continuous with ducts, the female organs usually paired, uniting to open to the exterior by a ventral vulva, the male organ single, opening into the hind gut, thus forming a cloaca, in a diverticulum of which lie the copulatory spicules; spermatozoa rounded and amoeboid, fertilization internal; alimentary canal straight and composed of two ectodermal parts, the suctorial fore gut and the hind gut and an endodermal mid gut without glands or muscles; segmentation of egg complete and bilateral in type, development direct, larvae only differing slightly from adult.

The nematodes appear to occupy an isolated position, but many of their characters, though more specialized, resemble those of the Platyhelminthes and Rotifera. They are certainly closely related to the Acanthocephala, Gastrotricha, and the Nematomorpha. One of their peculiar features is certainly secondary, namely the absence of cilia. There are in some nematodes cilium-like processes to the internal border of the endoderm cells; in one case active movement has been reported. The excretory canals, when the absence of flame cells is

taken into account, are seen to resemble those of the Platyhelminthes. Nearly all the other characters may be called primitive. The simplicity of organization, the absence of segmentation at all stages and a vascular system, the diffuse nature of the nervous system and the structure of the muscle cells are all signs of a lowly origin. But it is still maintained by some that these features are not primitive but degenerate and that the origin of the phylum is to be sought in the arthropods, probably in the parasitic forms of that group (the degenerate arachnids called linguatulids). If this view is taken it must be supposed that the parasitic nematodes are the most primitive members of the phylum and that some of their descendants became less and less parasitic, until entirely free-living forms came into existence. This would be an extraordinary reversal of evolution for assuming which at present there are no grounds.

The view taken in this book is that the free-living nematodes are ancestral to the parasitic forms and that there is no real connection between the arthropods and the nematodes. Not only do the nematodes present no indications of segments or appendages at any point of the life history but also the cuticle is of an entirely different chemical composition in the two phyla, and the loss of cilia most likely a phylogenetically recent phenomenon in the nematodes as in the parasitic platyhelminthes.

The anatomy of the nematodes is best known from the study of *Ascaris* which is one of the largest members of the group and the only one adapted for dissection in class. Full accounts of this form are given elsewhere, but the following points must be emphasized. In *Ascaris* (Fig. 173) there appears to be a wide space between the muscle layer and the endoderm cells, with no epithelial boundary walls, but on closer examination it is seen to be occupied by a very small number of greatly vacuolated cells, and what appears to be a continuous cavity is really the confluent vacuoles of adjacent cells, and so the term "intracellular" may be applied to it. This arrangement has not been verified in many other nematodes but connective tissue cells can usually be demonstrated in the space. They may be phagocytic; the enormous branched cells of *Ascaris* (Fig. 175), lying on the lateral lines, take up in their tiny corpuscle-like divisions such substances as carmine and indigo which are injected into the body.

A striking feature of the histology of *Ascaris* is the presence of greatly enlarged cells. Not only do the body cavity cells show this, but in the excretory system the greater part of the canal is contained in the body of one cell which divides into two limbs each running the whole length of the body on opposite sides.

As a simple type of nematode the genus *Rhabditis* (Fig. 174) will

be described, as it is seen alive as a transparent object under the microscope. Most species are free-living. They are obtained by allowing small pieces of meat to decay in moist earth. The larvae which exist in an "encysted" condition in the soil are attracted by the products of decay, and in a few days become sexually mature.

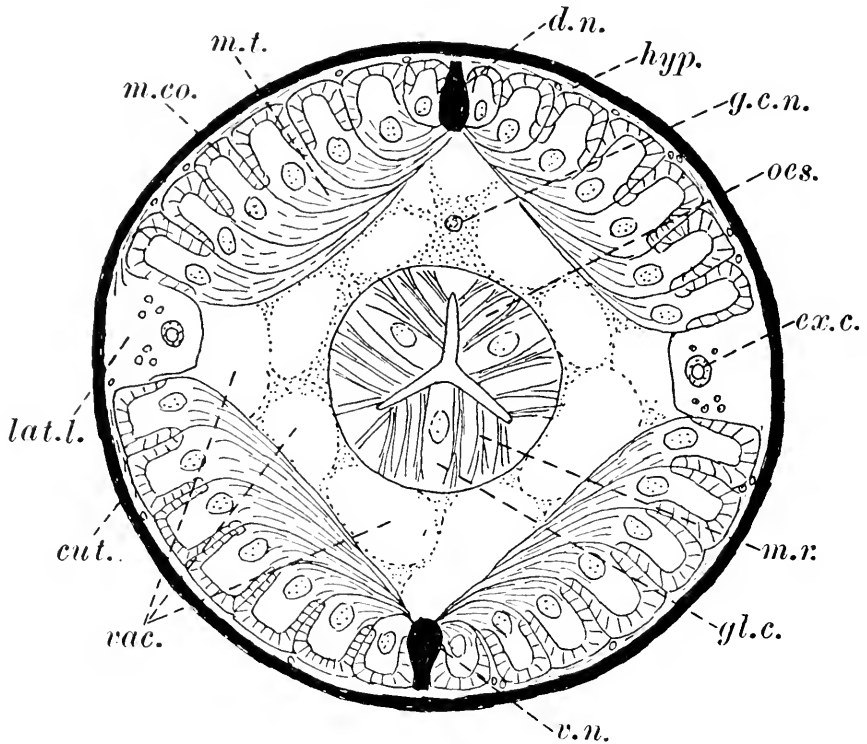

Fig. 173. Diagrammatic transverse section through *Ascaris* in the region of the oesophagus, showing the single large cell occupying the space between the body wall and the gut. Original. *cut.* cuticle; *d.n.*, *v.n.* dorsal and ventral nerves; *g.c.n.* nucleus of giant cell, cytoplasm dotted, vacuoles (*vac.*) shown as clear spaces; *ex.c.* excretory canal; *hyp.* hypodermis; *lat.l.* lateral line; *m.co.* contractile part of muscle cells; *m.t.* tails of the muscle cells running toward the nerves in the median lines; *oes.* oesophagus with three gland cells *gl.c.* and radiating muscles *m.r.* which increase the lumen of the oesophagus and cause suction. The number of muscle cells in each quadrant is much greater than in the drawing.

Great numbers of adults and young can then be scraped off the surface of the meat in the liquefied matter formed by bacterial decomposition.

It will be seen that the animal progresses by alternate contractions of the muscles on each side of the animal, which bend the animal into S-shaped curves and enable it to wriggle slowly through thick liquid or on soil. The cuticle which covers the body is thin, tenacious but elastic. It enables the animal to keep an almost constant round cross-



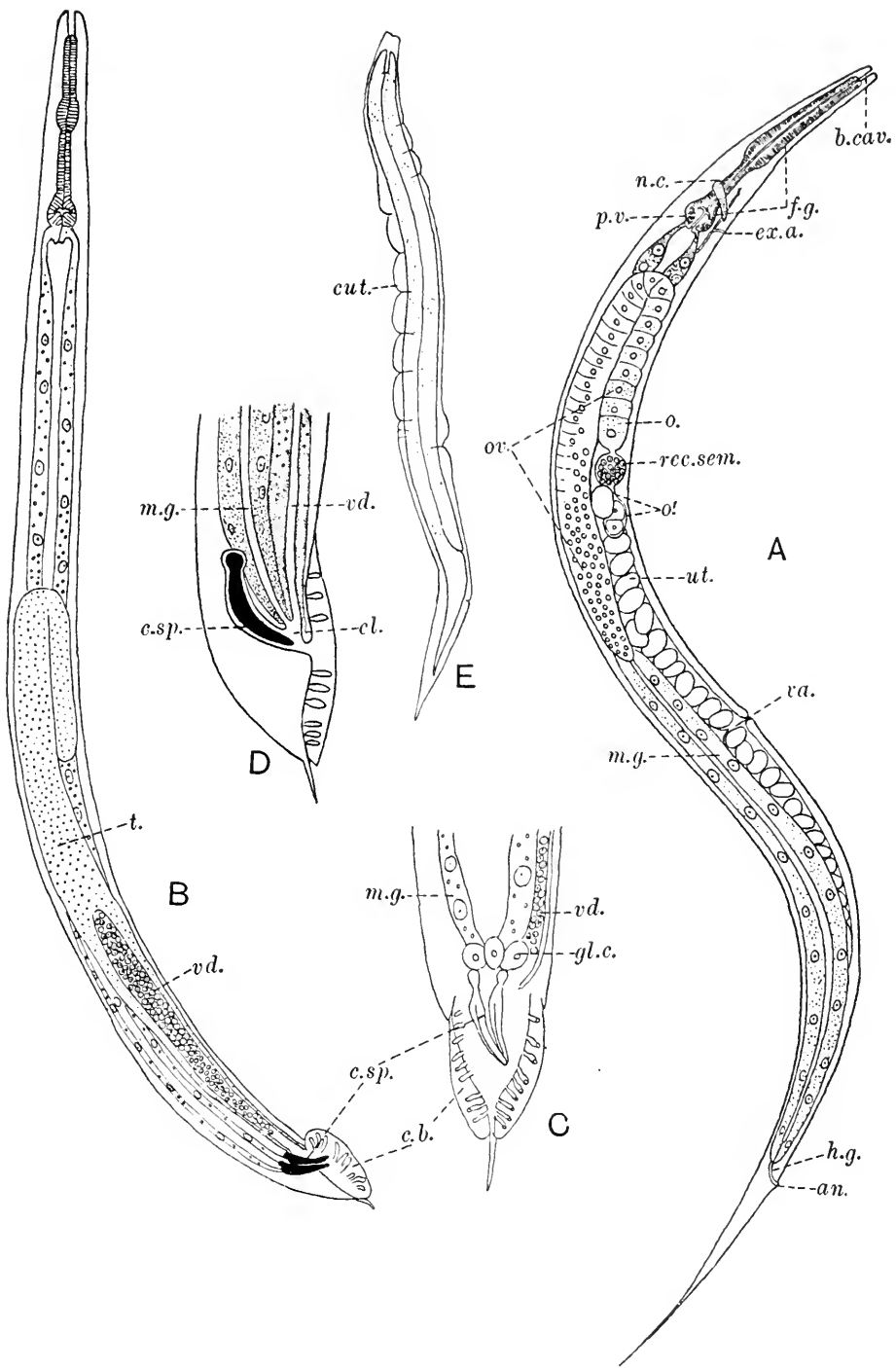

Fig. 174. *Rhabditis*. Altered from Maupas. A, Mature female. B, Mature male. C, Ventral view of hind end of male, slightly turned to one side so that the vas deferens is seen only to the right of the alimentary canal. D, Side view of hind end of male to show the relations of the cloaca. E, Encysted larva enclosed in the stretched skin (*cut.*) of the last moult. *an.* anus; *b.cav.* buccal cavity; *c.b.* copulatory bursa; *c.sp.* copulatory spicule; *cl.* cloaca; *ex.a.* excretory aperture; *gl.c.* gland cells; *f.g.* fore gut; *m.g.* mid gut; *h.g.* hind gut; *n.c.* nerve collar; *ov.* ovary; *o.* egg ready to be fertilized; *o'* eggs, one just fertilized, the other in the two-cell stage; *p.v.* pharynx with its valves; *rec.sem.* receptaculum seminis; *t.* testis; *ut.* uterus; *va.* vagina; *vd.* vas deferens.

section and length; in the presence of such a cuticle and the absence of circular muscles the peristaltic movements of a worm like *Lumbricus* are impossible. A cross-section through *Rhabditis* shows a similar structure to *Ascaris*, though the muscle cells are much less numerous (only two to each quadrant): each cell contains a number of contractile fibrils arranged in a different way to those in the *Ascaris* cell. The body cavity has not been investigated; that of *Ascaris* has therefore been described above.

The alimentary canal consists first of all of an ectodermal *fore gut* lined by cuticle in which the following parts can be distinguished: (1) a *mouth*, surrounded by *papillae*, opening into a narrow *buccal cavity*<sup>1</sup> with parallel sides, (2) an *oesophagus*, with muscular walls and a small number of unicellular glands, forming two swellings, the *oesophageal bulbs*. The posterior of these (the so-called *pharynx*) exhibits rhythmical pumping movements, caused by the contraction of the radial muscles which enlarge the cavity of the bulb and open the valve formed by the thickened cuticle. In this way the surrounding fluid is drawn into the oesophagus: no solid particles much larger than bacteria can be admitted through the narrow lumen. When the muscles relax and the cavity disappears the fluid is driven on into the *mid gut*. This is composed of a single layer of cells, which internally are naked but externally have a fine cuticle. These are entirely absorptive in function, gland cells being absent. There are no muscles, but the gut contents are circulated by the locomotory movements of the animal. The hind gut which follows is lined with cuticle and opens at the ventrally situated anus. Near the anus is a sphincter muscle, but there are also dilator muscles running from the hind gut to the body wall, and during the periodic contraction of these the gut contents are evacuated. The alimentary canal of the nematodes as thus seen in action represents a type simplified because the animal usually lives on food which has been split up into easily assimilable substances—in this case by bacterial action, in the case of *Ascaris* by the ferments of the living host—and this is passed with great rapidity through the alimentary canal by the pumping action of the oesophagus.

In addition there are easily seen in living *Rhabditis* the ventral *aperture of the excretory canal*, not far behind the mouth, and when the animal is compressed under the coverslip the coiled line of the excretory canal; the only part of the nervous system which can be so seen is the ring round the oesophagus.

The *genital organs* are of the type seen in *Ascaris* but simpler. In the female there are two tubular gonads bent once on themselves, discharging by a single genital aperture, situated about half-way between

<sup>1</sup> In some free-living nematodes which are carnivorous (e.g. *Mononchus*) the buccal cavity is very wide and rotifers and other animals are taken into it.

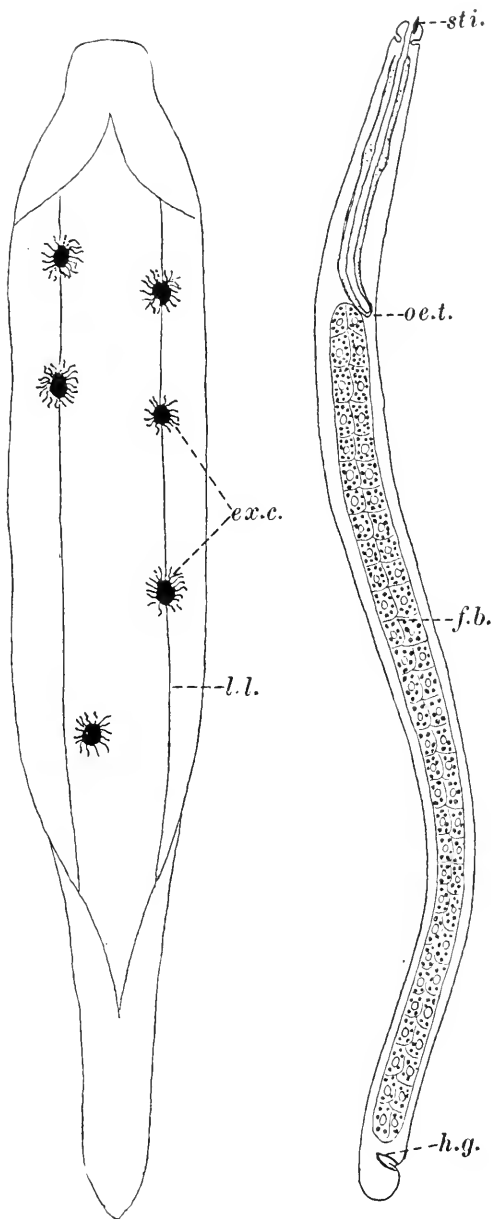

Fig. 175.

Fig. 176.

Fig. 175. Dissection of an Ascarid to show position of the branched excretory cells. *l.l.* lateral lines; *ex.c.* excretory cells. After Nasonow.

Fig. 176. *Mermis*. Showing the blindly ending oesophagus and the isolated mid gut, the cells of which are full of fat globules. *oe.t.* end of oesophagus; *f.b.* mid gut; *h.g.* hind gut; *sti.* stylet. Original.

the head and the tail. The *ovary* is a short syncytial tube, the nuclei becoming larger and larger and the centre of more definite and larger aggregations of cytoplasm and yolk nearer the uterus. Finally, there is a single ovum discharged at a time into the *oviduct*; as soon as this happens another ripens in its place. To reach the uterus the egg has first to pass through a portion of the oviduct (*receptaculum seminis*) filled with the amoeboid spermatozoa of the male. Fertilization takes place, a shell is formed and at the same time maturation proceeds. The two uteri join to form the median *vagina*. In this the fertilized egg develops and the young larva is formed and may hatch within the vagina. The stages of segmentation are seen nowhere with such ease or clearness as in a small transparent nematode of this kind.

The male, on the other hand, has only a single gonad. The apical testis is syncytial like the ovary. Nearing the vas deferens a zone may be seen of free spermatocytes and in the vas deferens itself can be seen large numbers of rounded spermatozoa. The genital duct opens into the gut to form a *cloaca*. This contains a dorsal pocket in which is secreted a chitinous apparatus consisting of two converging rods, the *copulatory spicules*, with a grooved connecting piece to hold the points together. The pocket has a special muscle which protrudes the spicules from the anus (cloacal aperture). To each side of this aperture is a lateral cuticular flange, supported by ribs, which meets its fellow at the root of the drawn-out tail. This acts as a sucker (*copulatory bursa*), by which the male retains its position on the body of the female until the spicules are thrust through the female aperture and keep the female and male apertures both apposed and open. Then by the contraction of the muscles of the cloaca the spermatozoa are expelled and passed into the vagina of the female. Here they become amoeboid and travel up the uteri so that they can meet the ova as the latter are discharged.

Besides the normal condition in which males and females are produced in equal numbers, many species of *Rhabditis* occur in which there is a remarkable disparity in numbers of the sexes. For a thousand females there may be only ten or twenty males, and they are lethargic in their sexual activities. The females, on the other hand, have developed a curious kind of hermaphroditism. When the gonad first becomes ripe a number of spermatozoa are produced. Afterwards the gonad produces nothing but eggs which are fertilized by the individual's own spermatozoa, and after these are exhausted nothing but sterile eggs are laid. Experiment has proved that in these animals self-fertilization may occur for an immense number of generations without any deterioration of the species.

In *Rhabditis*, as in the majority of nematodes, there are four moults. After the second moult the animal may remain within the loosely

fitting skin as a so-called "encysted" larva which possesses, however, the power of movement. The protection of the cast skin and possibly other factors enables this stage in the life history to resist desiccation and to remain in a state of dormant metabolism until some odour of decaying substances attracts the larvae and the opportunity of rapid reproduction is given for a brief period.

This third larval period is characteristically the period of wandering in many nematodes, and this is seen in a remarkable manner in the classical life history of *Ancylostoma* (Fig. 177). These animals live attached in the adult stage to the mucous membrane of the human small intestine, sometimes in such numbers as to present an aspect comparable to the pile of a carpet. They feed on the intestinal tissues and only accidentally rupture the blood vessels, causing anaemia in the host. The females are fertilized *in situ* and eggs are laid, which begin to segment before they pass out into the faeces. The rest of the life history may be shown as follows:

(1) First larval form (*rhabditoid*) with a buccal cavity like *Rhabditis*. This lives in the soil for three days before the first moult, which produces the

(2) Second larval form which moults after two days, the skin remaining as a cyst round this *strongyloid* larva (3). In this stage the animal becomes negatively geotropic and thigmotropic, ascending through the soil and being specially attracted to the moist skin of human beings. This they penetrate by way of the hair follicles, though occasionally the larva enters the gut by the mouth. In the former event, the minute larva is able to make its way through the skin to lymph spaces and to blood vessels, eventually being swept into the circulation by the vena cavae to the right auricle, thence to the right ventricle and then to the lung. In the pulmonary capillaries this career is ended and the larvae make their way into the alveolar cavities of the lung. They then travel by the bronchi and the trachea to the oesophagus and so to the intestine. Here the animal is freed from the second skin, producing the larva *without buccal capsule*. The third moult produces the last larval stage towards the fifth to seventh day and this is termed the larva *with provisional buccal capsule* (4).

Finally, about the fifteenth day the fourth moult produces the worm with the *definitive buccal capsule* (5), and in three to four weeks from hatching the parasite has become sexually mature and is attached to the epithelium of the intestine.

This most important human parasite shows in its earliest stages the structure and the free-living habit of the primitive form *Rhabditis*, and it is noteworthy that there are many species of the latter genus which have already become parasites.

It may, however, be supposed that a less specialized life history is

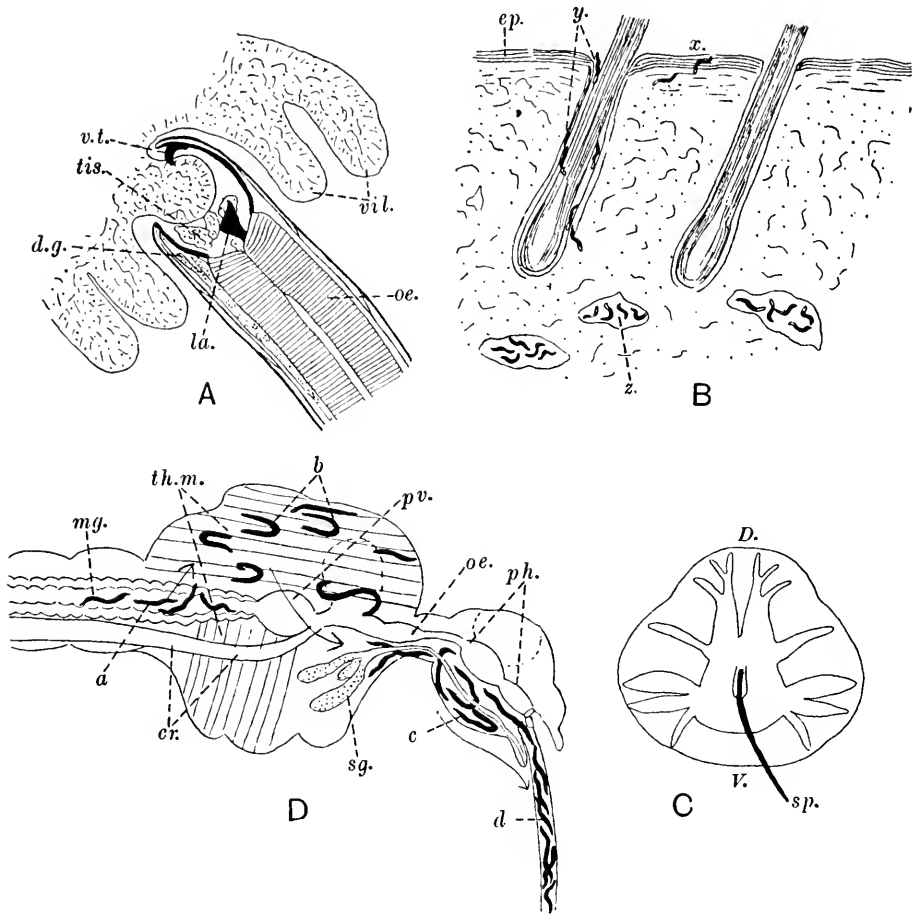

Fig. 177. Nematodes parasitic in man. A, B and C, *Ancylostoma*. After Looss. A, Adult worm attached to epithelium of small intestine of the host, with some of the tissue of the latter sucked into the buccal cavity of the worm. *d.g.* dorsal gland; *la.* lancet; *oe.* oesophagus; *v.t.* ventral tooth; *tis.* host tissue, lacerated by the lancets and partly digested; *vil.* villi of small intestine. B, Larvae penetrating the skin of mammal. *x.* through the horizontal fissures of the epidermis; *y.* along the hair follicles; *z.* larvae which have arrived in the lymph vessels of the subdermis; *ep.* epidermis. C, Copulatory bursa of adult male, spread out to show the arrangement of the rays. *D.* dorsal; *V.* ventral; *sp.* copulatory spicule. D, *Filaria bancrofti*, longitudinal vertical section through a mosquito (*Stegomyia*) to show wandering of the larvae. After Bahr. *a.* larvae just swallowed and now in the mid gut (*mg.*); some migrating through the gut wall; *b.* larvae developing in the thoracic muscles (*th.m.*); *c.* larvae which have finished development (8–15 days) migrating in the haemocoel of the head; *d.* larvae in the blood space of the labium, which they leave by rupturing the body wall when the mosquito bites; *cr.* crop; *ph.* pharynx; *pr.* proboscis; *sg.* salivary glands.

that of the species of *Oxyuris* in which the egg is swallowed by the host and the remaining stages of development take place in the gut. It is said that several successive generations of the parasite may occur within the same host. On the other hand, the wandering habit of nematodes is a fundamental character and even forms in the first stage of parasitism (facultative) may penetrate host tissues.

The life histories of the principal nematode parasites of man and domestic animals are summarized on pp. 254-5. They are arranged in a definite order passing from the simplest type in *Haemonchus* to the most specialized life histories in *Filaria*.

Two other classes of nematode parasites merit particular attention. They are, respectively, parasites of plants and insects.

*Plant parasites.* Nematodes are particularly fitted for a parasitic life in plants by reason of their form and activity and their capacity (at the end of the second larval stage) for resisting desiccation and other unfavourable conditions. They are small enough, as larvae, to obtain entrance through the stomata of leaves, and sometimes possess dart-like projections of the buccal lining which enable them to penetrate the cell walls of plants. They feed on cell sap and by their interference with the life of the host plant cause the formation of galls, wilting and withering of the leaves, and stunting of the plant.

*Tylenchus tritici* passes through a single generation in the course of the year, and infects wheat. The animal becomes adult when the grain is ripening and a pair, inhabiting a single flower, produce several hundred larvae. Instead of the grain a brown gall is produced, and in this the larvae (after moulting twice) may survive for at least twenty years. If the grain falls to the ground the larvae may remain there over the winter or may escape into the soil. When the corn begins to grow in the spring they enter the tissues of the plant and make their way up the stem to the flower, where they speedily mature. The great interest of this life history lies in the easy adaptation of the parasitic life history to the annual cycle of the wheat plant and the extreme capacity for survival in a dormant and desiccated condition until the right plant host becomes available. *Tylenchus devastatrix*, on the other hand, may pass through several generations in the year and attacks indiscriminately clover, narcissi bulbs and onions, and many other useful plants. *Heterodera* (Fig. 178 D) is a parasite of the roots of tomatoes, cucumbers and beets, and is remarkable because the female attaches herself in larval life to a rootlet from which she sucks a continuous flow of sap. She is fertilized by wandering males and grows enormously, becoming lemon-shaped. Inside the body thousands of larvae are produced, which escape into the soil and live there until the opportunity arises for infection of fresh roots.

## Life histories of nematode parasites

Adult	Eggs	Early larvae	Larval wanderings	Pathology
<i>Haemonchus</i> and other parasites of ruminants	Pass to exterior with faeces	Hatch in faeces and moult twice	Crawl up grass blades and remain there until swallowed by host: then develop <i>directly</i> in gut	Cause anaemia
<i>Ankylostoma</i> and other hook-worms	Pass to exterior with faeces	Hatch in soil and moult twice	Crawl up to surface, and infect host by passing through skin—venous system—heart—pulmonary artery—lung capillaries—cavity of lung—trachea—gut where they become adult	Cause anaemia in adult stage by destroying intestinal epithelium: inflammation of skin and lung in larval wanderings
<i>Enterobius (Oxyuris) vermicularis</i>	Female lays eggs in the neighbourhood of the anus. Eggs are swallowed by the host and develop directly in intestine			Irritation and inflammation of anus, occasional penetration into mucosa of small intestine and appendix where they cause inflammation
<i>Ascaris lumbricoides</i>	Pass to exterior with faeces and are eaten by new host	Hatch in intestine	Pass through intestinal epithelium into venous system—rest as in <i>Ankylostoma</i> : never by direct infection	Cause inflammation of lung in larval wanderings (in mass infections)
<i>Strongyloides stercoralis</i>	Pass to exterior and hatch (development <i>parthenogenetic</i> ) (1) at temperature 15–20° C., moult once; (2) at temperature 20–25° C., larva develops directly in faeces into <i>male</i> and <i>female</i> which produce eggs, hatching to larvae which moult once		Infects host through skin as in <i>Ankylostoma</i> Infects host through skin as in <i>Ankylostoma</i>	



<i>Trichinella spiralis</i>	In small intestine of man: females viviparous, penetrate into lymphatic spaces of intestinal wall and larviposit there	Larvae pass into blood system	Distributed by arterial capillaries to musculature—here they enter muscle cells and encyst. First host eaten by second: encysted larvae liberated by digestion and quickly mature in intestine	Cause great disturbance in traversing intestinal epithelium in mass infection, degeneration of muscle fibres
<i>Filaria bancrofti</i>	In lymphatic system of man	Larvae live in the blood (particularly showing themselves in the peripheral vessels during the night, but disappearing at dawn, <i>Microfilaria nocturna</i> )	Distributed to fresh hosts by mosquitoes which feed at night. In the stomach of the mosquito larvae lose their protective sheath; migrate through the gut wall into the thoracic muscles. After further development they pass into the proboscis of the mosquito and are reintroduced into the human host, where they rapidly mature	Adults are said to be the cause of elephantiasis
<i>Filaria loa</i>	In subcutaneous tissues of man, which it traverses very actively	Larvae live in the blood (appearing in it at early morning and disappearing in the evening, <i>Microfilaria diurna</i> )	Distributed to fresh hosts by the blood-sucking fly, <i>Chrysops</i> . Details similar to <i>F. bancrofti</i> in mosquito	Cause "Calabar swellings"
<i>Filaria medinensis</i>	In subcutaneous tissues of man	When ready to lay the female produces lesions or abscesses usually in the legs of the host. She protrudes her vagina when the skin of the host is in contact with water, liberating thousands of embryos into the water	Larvae penetrate skin of <i>Cyclops</i> and remain in body cavity. The <i>Cyclops</i> is swallowed by man and dies, but the larva is liberated and passes from the gut to the subcutaneous tissue where it becomes mature	Cause dracontiasis

*Insect parasites.* Four of these may be mentioned, though other life histories are also of great interest.

In *Mermis* (Fig. 176) a curious reversal of the typical nematode life cycle occurs. The sexual forms are all free-living either in the soil or fresh water. On summer days after showers the sexual forms of *Mermis nigrescens* exhibit a curious tropism, leaving their haunts two or three feet in the ground and crawling up the stems of plants, but disappearing when the sun grows warm. The eggs are laid in the ground and when the larvae hatch they pierce the skin of insect larvae

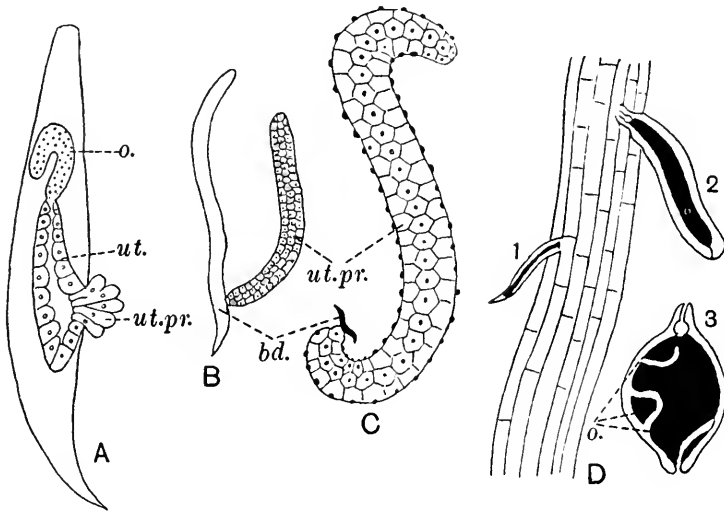

Fig. 178. Insect and plant parasites. A, *Atractonema*. Female showing the beginning of the prolapsus of the uterus, which has proceeded in *Spherularia*, B and C, until it is far larger than the rest of the worm. In C, the body is a minute appendage (*bd.*) of the prolapsed uterus (*ut.pr.*) not much longer than one of the greatly enlarged cells of the latter. D, *Heterodera*; 1 and 2, larvae attached to a rootlet with their heads imbedded in its tissues; 3, the full-grown female (on a smaller scale), removed from the plant. The alimentary canal is shown in black to emphasize that its growth causes the increase in size of the parasite. *o.* ovary; *ut.* uterus. A-C, after Leuckart; D, after Strubell.

and wander into the body cavity where they nourish themselves by absorbing fluid food through the cuticle. The mid gut has become a solid body, having no connection with the mouth and anus, and in it fat is stored up which serves as raw material for the production of eggs. When the animals become sexually mature they escape into the soil.

In *Tylenchus dispar* (a form which is thus placed in the same genus as the well-known plant parasites) the adult female and innumerable larvae are found in the body cavity of the bark beetle, *Ips*, during the winter. *Allantonema* has similar relations to another bark beetle, *Hylobius*. The female is enormously developed, the uterus and other

female organs occupy the whole of the body, the gut having entirely disappeared. In the spring the larvae (having undergone two moults) bore through the walls of the end gut and undergo further development in the "frass" (faeces of the beetle). The male develops precociously and fertilizes the female which, when it becomes mature, is still of normal proportions. After fertilization the females (only) infect the beetle larvae which by this time have appeared. Entrance is obtained by means of a "dart" exactly like the similar organ in the plant parasites. In the body cavity the female *Allantonema* grows rapidly, and when metamorphosis occurs and the mature bark beetle seeks another tree to form a new colony, it is full of larvae.

*Spherularia* (Fig. 178 B, C) is a parasite of the humble bee. In the summer the moss and soil near the bee's nest is inhabited by the sexually mature worms, and after fertilization has taken place the female wanders into the body cavity of the insect, as in the preceding life histories. Though the number of cells in the somatic tissues of the bee is said not to increase in number there is an enormous growth in size of the vagina which becomes prolapsed and forms eventually an organ many times the size of the rest of the body, which remains attached for some time but eventually disappears. The parasitized humble bees, after passing the winter in their nests, tend to emerge early. In the spring very often inactive bees may be caught which prove, on dissection, to contain one or more of these enormous sausage-shaped bodies, each of them full of eggs and larvae, which escape through the gut wall and become free-living.

*Atractonema* (Fig. 178 A), a parasite of the Cecidomyidae (p. 509), has a similar life history.

## PHYLUM NEMATOMORPHA

As in Nematoda but lateral line and "excretory" canal absent, nervous system consisting of a dorsal "brain" and a single ventral cord, genital ducts in both sexes opening into the hind gut to form a cloaca, development very characteristic—gastrulation by invagination and a larva with peculiar boring organ which infects insects.

In addition it should be mentioned that the alimentary canal is always more or less degenerate and the body cavity may either be occupied by parenchymatous tissue or by reduction of this becomes more or less empty of cells.

An example of this group is *Gordius robustus* with the following life history. The adults are found in brooks from October till May when they copulate. The sperm is not directly introduced into the cloaca, but placed in masses on the body near it. The eggs are laid in the water and the larvae soon hatch. By using the boring organ which they possess they find their way into the body cavity of crickets which

live near the water. There they remain and grow until the autumn when they leave the host and enter the water again as mature animals. Other forms have similar life histories. *Parachordodes* first infects chironomid larvae and then these are eaten by the second host, the beetle *Calathus* in which they grow to maturity.

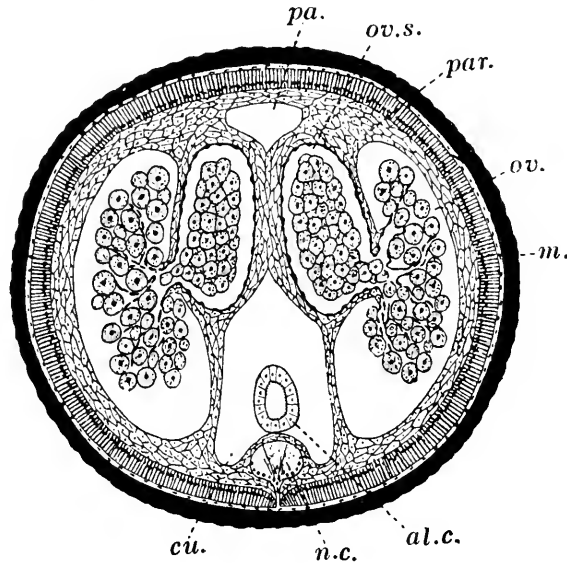

Fig. 179. Transverse section through *Parachordodes*. *al.c.* alimentary canal; *cu.* cuticle; *m.* muscular layer; *n.c.* nerve cord; *ov.* ovary; *ov.s.* ovarian sinus; *par.* parenchyma; *pa.* dorsal sinus.

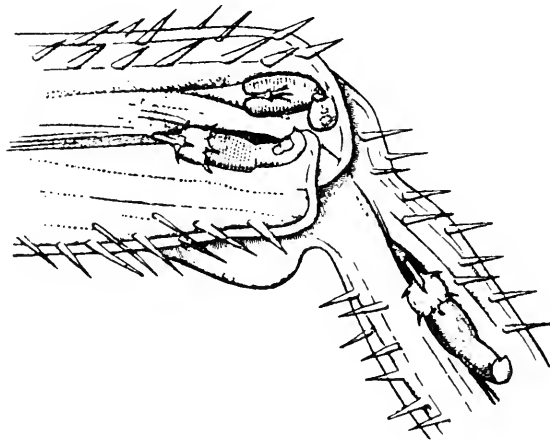

Fig. 180. Larvae of *Gordius* in the leg of an insect.

## PHYLUM ACANTHOCEPHALA

As in Nematoda, but possessing an eversible proboscis provided with hooks for attachment and glandular organs (the *lemnisci*), cuticle delicate, hypodermis containing a peculiar lacunar system, a layer of

circular muscles as well as longitudinal, nervous system consisting of a brain and two lateral cords, excretory organs, which when they occur are nephridia with modified flame cells; body cavity without parenchyma but traversed by a tubular organ, the *ligament*, containing gonads, eggs developing inside the body until the provisional hooks of

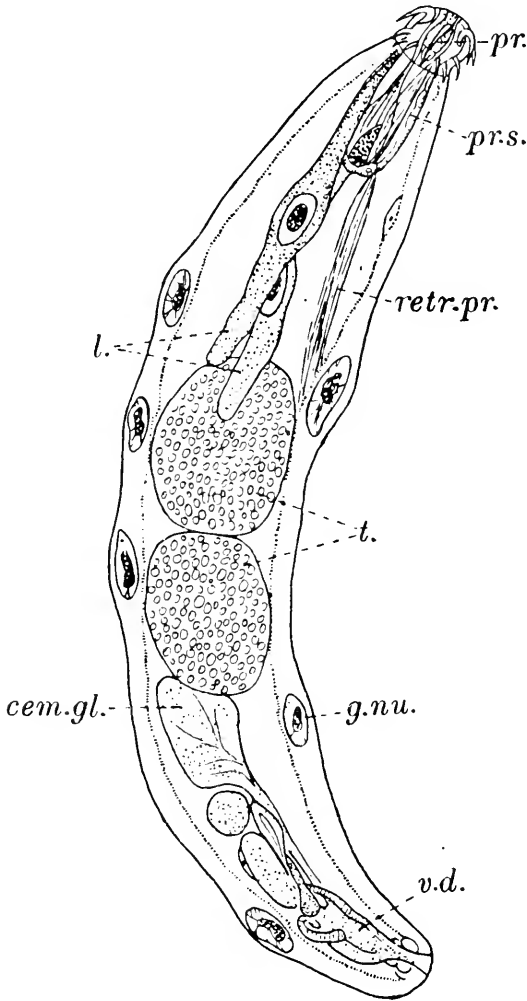

Fig. 181. *Neoechinorhynchus*. *cem. gl.* cement gland; *g.nu.* giant nucleus; *l.* lemnisci; *pr.* proboscis; *pr.s.* proboscis sheath; *retr.pr.* retractor muscle of proboscis; *t.* testis; *v.d.* vas deferens.

the pharynx are formed, larvae developing further when laid in water and eaten by a crustacean, becoming mature when eaten by a vertebrate after which the animals attach themselves to the wall of the intestine by their proboscis.

An example of these is *Echinorhynchus proteus*, the adult of which lives in ducks and the larvae in *Gammarus*.

CHAPTER IX  
THE PHYLUM ANNELIDA

Segmented worms in which the perivisceral cavity is coelomic; with a single preoral segment (prostomium); with a muscular body wall in which externally the elongated muscle cells are arranged with their longitudinal axes across the width of the worm (circular layer) while internally their axes are parallel to the length of the worm (longitudinal layer); with a central nervous system consisting of a pair of preoral ganglia connected by commissures with a pair of ventral cords which usually expand in each segment to form a pair of ganglia from which run nerves to all parts of the segment; with nephridia and coelomoducts; and the larva, if present, of the trochosphere type.

While the above definition is the only one that can be applied to all the annelids, typical representatives of the phylum can also be described as possessing a definite cuticle and bristles or *chaetae* composed of chitin, arranged segmentally, imbedded in and secreted by pits of the ectoderm (Fig. 182). The cuticle is thin and not composed of chitin, thus differing from that of the Arthropoda.

Four classes compose the phylum. Of these the largest and most typical is that of the Chaetopoda, which are well segmented, have a spacious perivisceral coelom and always possess chaetae. All these characters are primitive. The Archannelida is a small group characterized by small size, ciliation of skin, loss of external segmentation and often of chaetae. Several members of the group, however, like *Saccocirrus*, retain chaetae. It is almost certain that the archannelids are derived from the chaetopods by a process of simplification. The Leeches or Hirudinea are adapted to a specialized mode of life—ectoparasitism—and their whole organization is affected

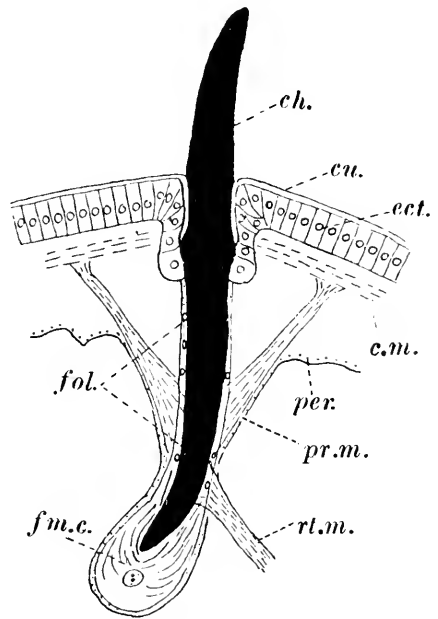

Fig. 182. Chaeta of *Lumbricus* in body wall. Altered from Stephenson. *cu.* cuticle; *ect.* ectoderm; *ch.* chaeta; *c.m.* circular muscles; *pr.m.* protractor and *rt.m.* retractor muscles; *per.* peritoneum; *fol.* follicle and *fm.c.* formative cell of chaeta (with nucleus).

by it. They retain the segmentation characteristic of the phylum in most of their organs but the coelom is usually much restricted and broken up into a system of small spaces and the chaetae are lost. In one primitive form, *Acanthobdella*, there are chaetae and a spacious perivisceral coelom in the anterior segments. In all leeches the anterior and posterior suckers and a hermaphrodite reproductive system, closely paralleled in a subdivision of the Chaetopoda, the Oligochaeta, show the specialization of the group. The Echiuroidea and Sipunculoidea are two groups of burrowing marine worms in which segmentation has been almost entirely suppressed in the adult but is sometimes shown in the larvae by mesoblastic somites or ganglion rudiments. Chaetae are lost except in a few forms, but a large perivisceral coelom is preserved.

### Class CHAETOPODA

Well-segmented Annelida, with chaetae and a spacious perivisceral coelom, usually divided by intersegmental septa.

In a typical chaetopod there is a distinct preoral region or *prostomium* and a postoral body composed of many segments. Each segment owes its distinctness to the development in the larva of a pair of mesoblastic somites which join round the gut, the cavities which develop in them becoming the perivisceral cavity of the adult segment. At the same time the larval ectoderm (epiblast) develops segmentally repeated organs: the *ganglia*, swellings in the continuous ventral nerve cords, the *nephridia* or excretory organs and the *chaetae*. In the Polychaeta, one of two orders into which the Chaetopoda are divided, the chaetae are borne in groups upon processes known as *parapodia*, whose projection from the body wall is due to the development of special muscles for moving the chaetae. In the other order, the Oligochaeta, there are no parapodia. The chief feature of the nervous organization is that the musculature of all parts of the body is co-ordinated by metamericly repeated intra- and intersegmental reflexes (Fig. 183). In each segment there is, for example, a correlation of the circular and longitudinal muscles by the segmental nerves which acts so that contraction of one brings about automatically relaxation of the other. Then there are nervous connections between adjacent segments which act so that excitation of a muscle layer in one segment leads to excitation of the same layer in the other segment. By the working together of the inter- and intra-segmental reflexes the normal peristaltic movement of *Lumbricus* and other chaetopods is brought about.

There is also a system of giant fibres, three in number, running along the whole length of the ventral nerve cord. These are responsible for the reactions which require immediate co-ordination of the whole

body in response to excitation of the higher centres, the supra- and subpharyngeal ganglia. The rapid contraction of the whole of the longitudinal musculature in response to a noxious stimulus is an example of this kind of reaction. On p. 200 it was shown that the primary function of the primitive central nervous system is that of a sensory relay. In the annelids there is added the second great function, that of inhibition. A *Nereis*, which has had the suprapharyngeal

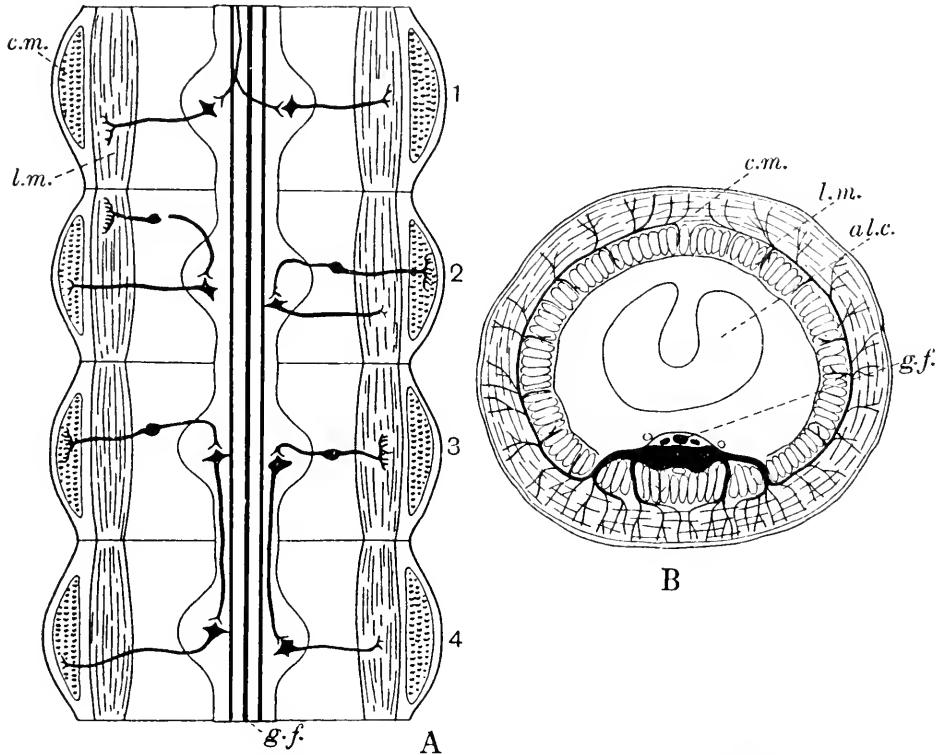

Fig. 183. A, Longitudinal and B, transverse sections of *Lumbricus* to show the musculature and its innervation. In A, segment 2 shows neurones constituting an intrasegmental reflex arc, segments 3 and 4 show those which make up an intersegmental arc. B shows the distribution in the body wall of two segmental nerves and their branches. *a.l.c.* alimentary canal; *c.m.* circular muscles; *g.f.* giant fibre; *l.m.* longitudinal muscles.

ganglia removed, moves about ceaselessly, showing that a function of the ganglia in the normal animal is the inhibition of movement. If the supra- and subpharyngeal ganglia are both removed then the animal is permanently quiescent, a condition like that of a polyclad turbellarian when the cerebral ganglia are removed.

The coelom is bounded by an epithelial layer, the *peritoneum*, which gives rise to the *gonads*, which in polychaets are usually developed in most of the segments, to the *yellow cells*, which play a part in the work of nitrogenous excretion, and to the *coelomoducts* by which the eggs



and sperm pass from the coelom to the exterior. In most of the polychaets the eggs are fertilized externally, forming a *trochosphere* larva, the method of reproduction thus conforming to that of other marine groups. In the terrestrial and freshwater oligochaets (as in leeches) fertilization is internal and the young hatch in a form resembling the parent. There is no doubt that the former mode of development is more primitive.

The *nephridia* are essentially tubes developed from the ectoderm which push their way inwards so that they project into the body cavity. In some polychaets they end blindly—this is the primitive condition. In the majority of chaetopods they have acquired an opening (*nephrostome*) into the body cavity itself. In some cases there is a partial fusion with a mesodermal element, the coelomoduct, so that a compound tube consisting mainly of ectoderm but partly of mesoderm exists (*nephromixium*). Nephromixia may take on the functions of coelomoducts where these do not exist independently. All types of tubes are termed here *segmental organs*.

The head and accompanying sense organs may be well developed, for instance, in some of the pelagic Polychaeta where the eyes are remarkably complex. In such cases the brain (prostomial ganglia) may attain a structure almost as complicated as in the higher arthropods. The head processes (tentacles, palps) vary greatly. While they may be very complicated in the Polychaeta, they are frequently absent in burrowing members of that group and invariably so in the Oligochaeta.

The blood system also varies greatly. In small forms it is absent altogether. Typically it consists of a dorsal vessel in which the blood moves forward, and a ventral vessel in which it moves backward and from which the skin is supplied with venous blood. The whole of the dorsal vessel (Fig. 201) is usually contractile: there may also be vertical segmental contractile vessels which are usually called "hearts". In some forms, for example *Pomatoceros* (Fig. 186 C), there are no separate dorsal and ventral vessels but a *sinus* round the gut: the peristalsis of the latter brings about the movements of the blood. While the whole of the skin is sometimes richly supplied with blood vessels and usually performs an important part in the aeration of the blood there are often branched segmented processes which may rightly be called *gills* (*Arenicola* (Fig. 189)): the alimentary canal is probably a respiratory organ too. While haemoglobin is often present in the blood, usually in solution, a related pigment, chlorocruorin, which is green, occurs in many tubicolous polychaets. The variable state of the mechanism of respiration is shown by the fact that one species of a genus (the polychaet, *Polycirrus*) may possess haemoglobin while another has no respiratory pigment.

The Chaetopoda are, in this work, divided into the following orders: (i) Polychaeta, (ii) Oligochaeta. To the latter, however, the Hirudinea are very closely related.

### Order POLYCHAETA

Marine Chaetopoda with numerous chaetae arising from special prominences of the body wall called parapodia; usually with a distinct head which bears a number of appendages; nearly always dioecious, with gonads extending throughout the body and external fertilization; with a free-swimming larva, the *trochosphere*.

The structure of the Polychaeta is very variable and dependent on the habit of life, both externally (especially the head appendages and parapodia) and internally (especially the segmental organs). The variation in methods of reproduction is also very characteristic. For these reasons an account will first be given of some of the very large number of families into which the Polychaeta are divided, in which a rough oecological grouping is adopted. A summary of the variation in segmental organs and reproductive habits follows at the end.

The *errant* Polychaeta with unmodified head and armed eversible pharynx (proboscis); fitted for an active life but often living in tubes; very often greatly modified in structure and physiology at the sexual season.

{ Eunicidae. *Eunice*, *Leodice*  
(the Palolo worm).  
Nereidae. *Nereis*.  
Syllidae. *Syllis*, *Myri-  
anida*.  
Phyllodocidae. *Eulalia*,  
*Asterope*.  
Polynoidae. *Aphrodite*,  
*Lepidonotus*, *Panthalis*.

The true *tubicolous* Polychaeta, much modified for the collection of microscopic food; anterior part of gut not eversible and jaws absent; inhabiting tubes which they rarely or never leave.

{ Chaetopteridae. *Chaeto-  
pterus*.  
Terebellidae. *Terebella*,  
*Amphitrite*.  
Serpulidae. *Pomatoceros*,  
*Filigrana*.  
Sabellidae. *Sabella*, *Spiro-  
graphis*.

The *burrowing* Polychaeta with reduced head; with proboscis.

{ Arenicolidae. *Arenicola*  
without jaws.  
Glyceridae. *Glycera* with  
jaws.

#### *The errant Polychaeta*

The external structure is known to the elementary student through the type *Nereis* (Fig. 184). The prostomium bears two kinds of

filiform, tactile appendages, the *tentacles* which are dorsal and the *palps* which are ventral; there are also one or two pairs of eyes upon it. The anterior part of the gut (*pharynx*) is eversible and serves for grasping food; its lining may be chitinized in places to form the jaws and paragnaths of *Nereis* or teeth as in *Syllis*. These are not necessarily

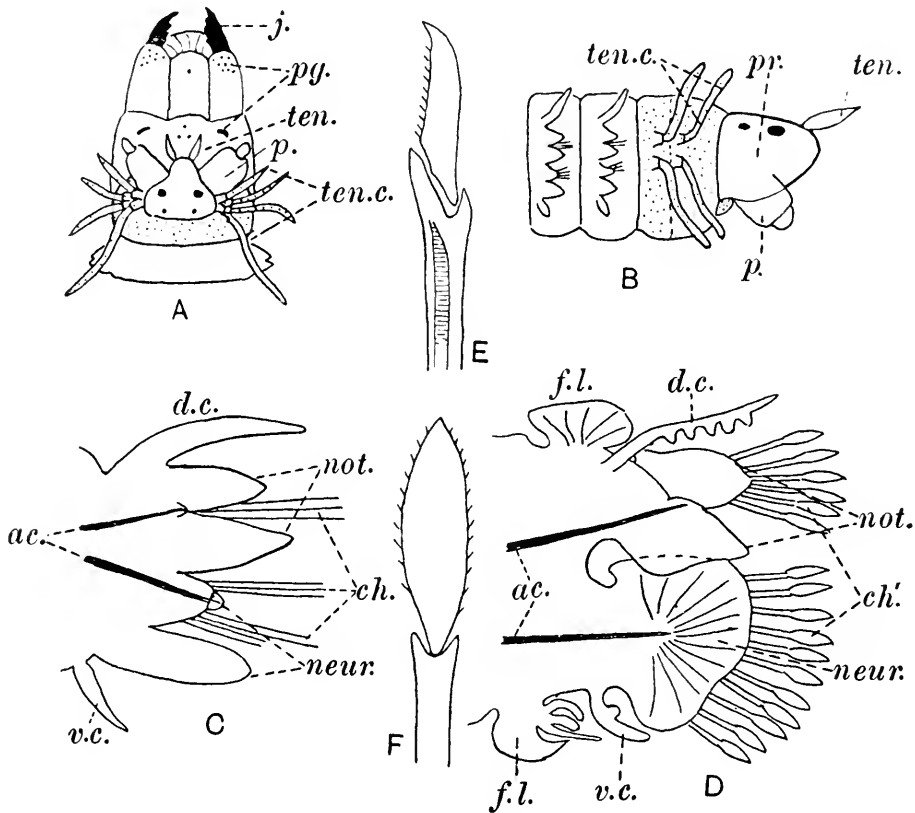

Fig. 184. *Nereis*. A, Dorsal view of head and first trunk segments with everted pharynx. B, Side view of same with pharynx retracted. C, Parapodium of unmodified type. D, Parapodium of *Heteronereis*. E, Example of unmodified compound chaeta. F, Oar-shaped compound chaeta of *Heteronereis*. The peristomium is stippled. *pr.* prostomium; *ten.* tentacle; *p.* palp; *ten.c.* peristomial cirri; *d.c.* dorsal cirrus; *v.c.* ventral cirrus; *not.* notopodium; *neur.* neuropodium; *f.l.* foliaceous outgrowths of parapodia; *ac.* aciculum; *ch.* chaetae; *ch.'* oar-shaped chaetae; *j.* jaws; *pg.* paragnaths.

the sign of a carnivorous habit but may be used for cutting up pieces of seaweed or boring in sponges.

The ordinary *trunk segment* has a double parapodium consisting of a dorsal *notopodium* and a ventral *neuropodium*, usually with rather different types of chaetae. A *dorsal cirrus* and a *ventral cirrus* are nearly always present; they are filiform structures but may be modified to form pectinate gills (*Eunice*) or plate-like elytra (Polynoidae).

From the conical noto- and neuropodia spring a bundle of chaetae; the chaetal sacs project into the coelom and each bundle is supported by an enlarged and wholly internal chaeta—the *aciculum*, which also forms the point of origin of the parapodial muscles. The chaeta are of two kinds, simple and compound.

The segment (or segments) just behind the mouth, forming the *peristomium*, is, however, much modified. There are no notopodia or neuropodia (except in occasional species, which retain chaeta-bearing

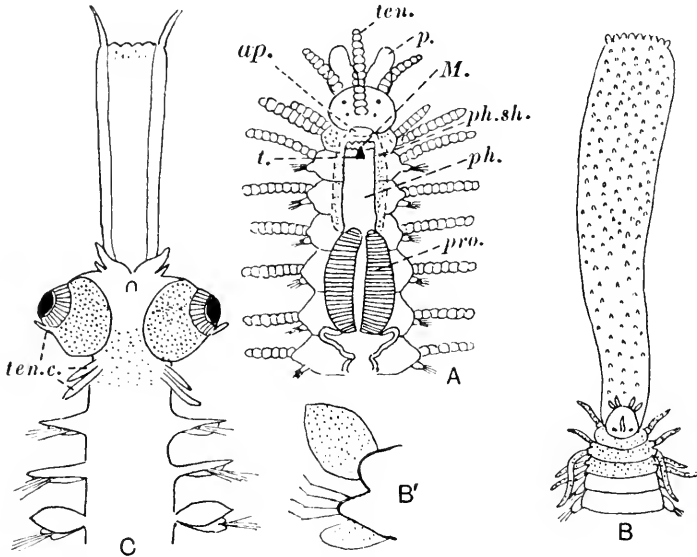

Fig. 185. Errant Polychaeta. Peristomial segments stippled to show extent of cephalization. Anterior end. A, *Syllis*, single peristomial segment; pharynx retracted in sheath. *ap.* aperture of pharynx sheath cavity; *M.* mouth; *p.* palp; *ph.* pharynx; *ph.sh.* cavity of pharynx sheath; *pro.* proventriculus; *t.* tooth; *ten.* tentacle. B, *Eulalia*, three peristomial segments and five pairs of tentacular cirri, pharynx protruded, covered with papillae. B', Parapodium with leaf-like dorsal and ventral cirri, notopodium only represented by dorsal cirrus neuropodium with compound chaetae. C, *Asterope*, head with five tentacles and three pairs of tentacular cirri (*ten.c.*); conditions in the head region largely governed by the presence of the enormous eyes. Pharynx protruded.

processes as a primitive feature). But the cirri remain as the *peristomial cirri* in pairs consisting of a dorsal and ventral member. In *Nereis* there are two pairs of peristomial cirri on each side, indicating the fusion of two segments to form the peristomium. In some families (Syllidae) (Fig. 185 A) this is constituted by a single segment, but usually two or more have been pressed forward towards the mouth and modified. This is the first indication of the process of *cephalization* carried much further in the arthropods and vertebrates.

The worms in this group used to be definitely classed as the

Errantia or free-swimming forms, but a great number of them (e.g. the Nereids) do live in tubes which, however, they can leave and reconstruct anew. The most beautiful example of tube building in the Polychaeta is furnished by *Panthalis*, a polynoid. In this the chaetal

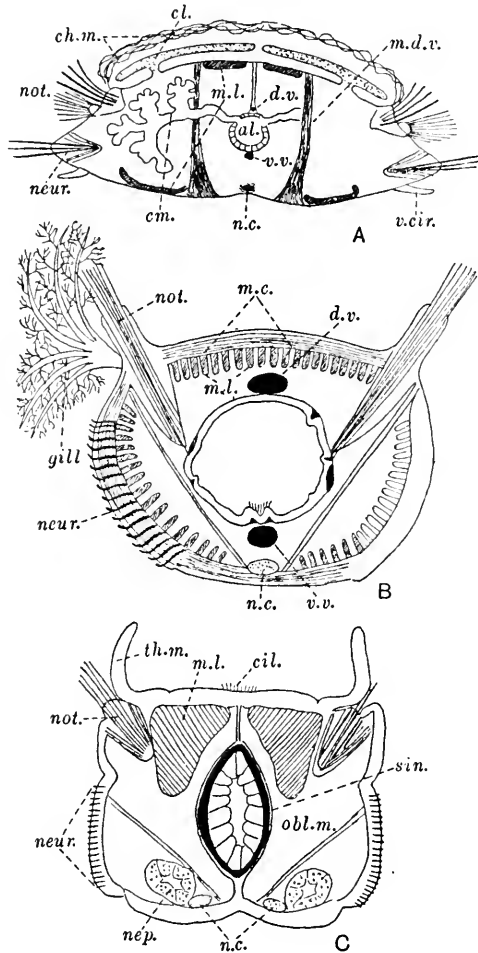

Fig. 186. Transverse sections through different types of Polychaeta. A, *Aphrodite*. After Fordham. B, *Arenicola*, middle region. After Ashworth. C, *Pomatoceros*, thorax. Original. *al.* alimentary canal; *cm.* coecum of mid gut; *ch.m.* matted notopodial chaetae; *cil.* ciliated groove; *d.v.* and *v.v.* dorsal and ventral blood vessels; *el.* elytron; *m.c.*, *m.d.v.*, *m.l.* circular, dorsoventral and longitudinal muscles; *obl.m.* oblique muscles; *nep.* nephridium; *neur.* neuropodium; *not.* notopodium; *n.c.* nerve cord; *sin.* sinus; *th.m.* thoracic membrane; *v.cir.* ventral cirrus.

pits of the notopodium produce not stiff bristles but plastic threads which are woven by the comb-like ventral chaetae and the shuttle-like action of the anterior parapodia into a continuous fabric which forms the lining of the mud-covered tube. *Aphrodite*, the sea mouse (Fig. 186 A), is a short, broad form which burrows in mud, and though it

does not form a separate tube it covers its back with a blanket made from interwoven chaetal threads similarly formed from the notopodium. Between this blanket and the back is a space into which water is drawn by a pumping action of the dorsal body wall, being filtered through the matted chaetae. In this there are special plate-like modifications of the dorsal cirri—the *elytra*—round which circulates the water from which they possibly obtain dissolved oxygen. In other polynoids (e.g. *Lepidonotus*, which lives under stones but does not burrow) the *elytra* can have no respiratory function but are probably protective, spreading over the whole or greater part of the back (sometimes bits of sand or shell are attached to special papillae). Not all the dorsal cirri are modified to form *elytra*: typical filiform cirri are placed on alternate segments. *Aphrodite* has remarkable segmental coeca of the alimentary canal in which takes place digestion of the fine food particles which pass a sieve at the junction with the intestine.

The diagnostic features of *Nereis* and other genera mentioned in the classification are given below.

*Nereis* (Fig. 184). Two tentacles, two palps; pharynx with two jaws and twelve groups of paragnaths; noto- and neuropodium each double; chaetae all compound; most species have a special sexual form (*Heteronereis*).

*Eunice*. Five tentacles, two palps; pharyngeal armature well developed; a single peristomial segment; gills in many segments; chaetae simple and compound.

*Eulalia* (Fig. 185 B). Five tentacles, no palps; pharynx very long with soft papillae only; three peristomial segments; dorsal and ventral cirri leaf-like; chaetae all compound.

*Asterope* (Fig. 185 C). Similar to *Eulalia* but a pelagic polychaet with transparent body and enormous eyes of complicated structure.

*Syllis* (Fig. 185 A). Three tentacles, two fused palps; pharynx enclosed in a pharynx sheath with a single conical tooth and a muscular *proventriculus* which functions as a pump; no notopodium.

*Autolytus* (Fig. 194 B). Like *Syllis* but pharynx long, with a circle of teeth; no ventral cirrus. *Myrianida* has similar characters.

#### *The true tubicolous Polychaeta*

Here the prostomium has become much smaller and its appendages enormously modified and increased. The peristomium may be produced into a collar which in some forms grows round the prostomium and encloses a funnel-like cavity at the bottom of which lies the mouth. The food consists of small animals or plants or organic debris and it is collected by ciliary mechanisms. In the terebellids (Fig. 187 A), serpulids (Fig. 188) and sabellids, the appendages of the head,

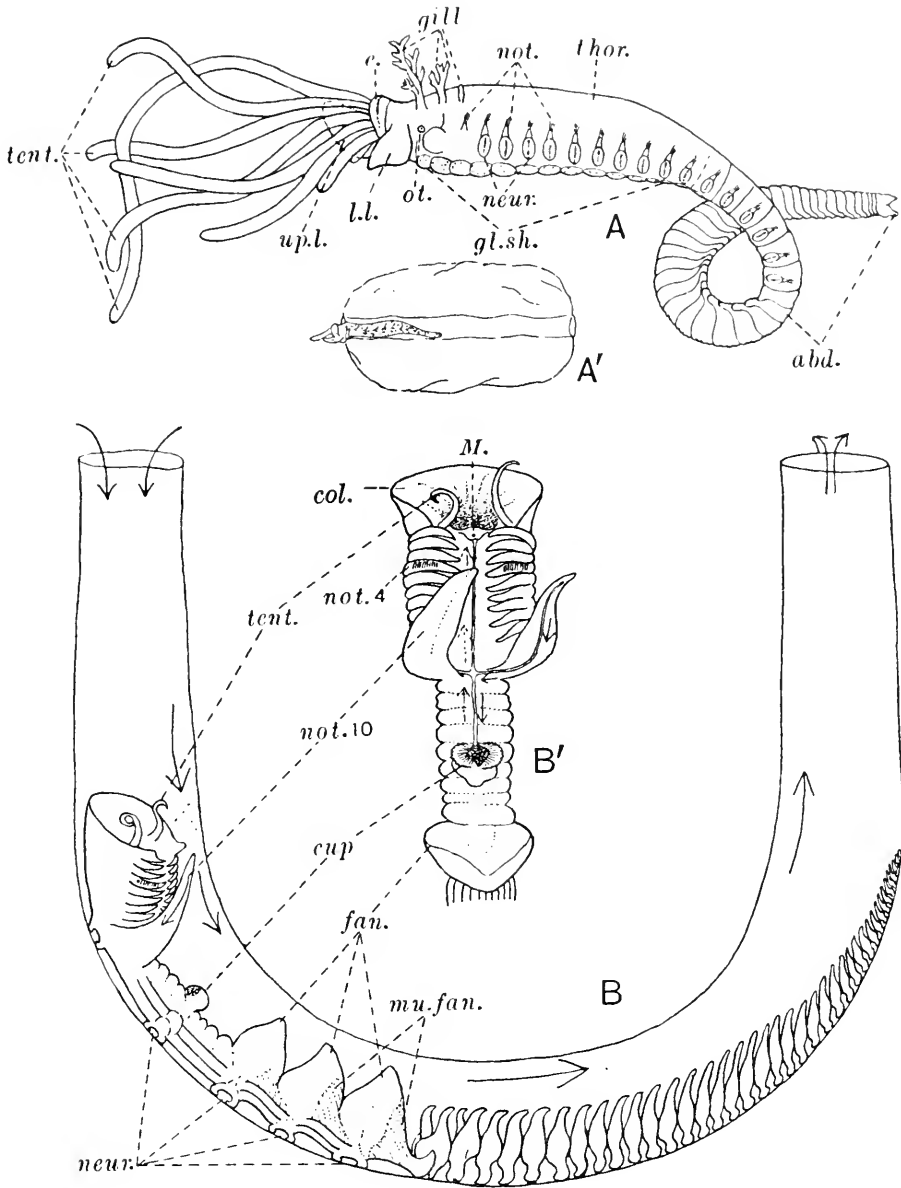

Fig. 187. Tubicolous Polychaeta. Terebellid (*Loimia*). A, Side view of young form taken from its tube. A', Side view of pelagic larva in its gelatinous case. After D. P. Wilson. *Chaetopterus pergamentaceus*. Original. B, Side view of worm in tube. Arrows show the direction of the water currents. B', Dorsal view of anterior part to show the ciliated grooves. Original. Arrows show the direction of the food currents. *abd.* abdomen; *col.* peristomial collar; *cup*, organ for forming foodballs; *e.* eye; *fan.*, *mu. fan.* muscles for moving fans; *gl.sh.* mucous glands; *M.* mouth; *neur.* neuropodia forming suckers for attachment of worm to tube; *not.* notopodia; *not. 4*, notopodia with enlarged chaetae in 4th chaetiferous segment; *not. 10*, food-collecting notopodia; *ot.* otocyst; *tent.* tentacle; *thor.* thorax; *up.l.* upper lip, the lower lip (*l.l.*) is a prominent structure to the right of the tentacles.

which probably correspond to tentacles, are very numerous. Each tentacle has a ciliated groove running from the tip to the mouth and along this minute particles may be seen to travel. In the terebellids these tentacles are extensible and capable of independent movement when separated from the body. In the serpulids and sabellids, they are rather stiff branched structures, which can, however, curl up when withdrawn into the tube; they sometimes bear eyes and sometimes are wonderfully pigmented.

Besides the food-collecting tentacles there are gills in the terebellids. These are branched processes, usually three pairs, situated just behind the head, full of circulating blood. In the serpulids and sabellids, there are no special respiratory organs but the whole surface of the body serves for the exchange of gases.

In the terebellids the tubes are composed of a soft cementing substance mixed with mud or a parchment-like material to which adhere sand grains, sponge spicules, foraminifera or fish-bones. It is usually porous (so that change of water can take place through it) and the animal occasionally leaves its shelter; there are at least two openings to the exterior. The tube of the chaetopterids is parchment-like but in the serpulids there is a groundwork of mucin in which carbonate of lime is laid down. In the latter family there is only one opening from which the crown of tentacles emerges but never any more of the body. The tentacles are violently withdrawn in obedience to any such stimulus as touch or change of illumination.

In all the types except *Chaetopterus* the body is divided into two regions, an anterior *thorax* and a posterior *abdomen*. The thorax is composed of segments in which the notopodium is a conical structure with capillary chaetae while the neuropodium is a vertical ridge in which are imbedded short-toothed chaetae called *uncini*, which only just project from the body wall. It is suggested that the notopodium assists movement up and down the tube while the neuropodia are braced against the tube and maintain the worm in position. In the abdomen the arrangement of the parapodia is different, and in the serpulids and sabellids the *uncini* become dorsal and the simple chaetae ventral (introversion).

In the serpulids (Fig. 188) the peristomium is similar to the other thoracic segments but it is produced into a *collar* which folds back over the ventral surface and sides and secretes successive hoop-shaped rings which are added to the tube. Other features are the *thoracic membrane*, a lateral frill possibly respiratory, and the *operculum*, a much enlarged and stopper-like branch of a tentacle which exactly closes the mouth of the tube when the animal is retracted.

The renewal of water round the body is of the utmost importance in respiration. It is brought about by undulatory movements of the



abdomen and sometimes by sharp rhythmic contractions and expansions of the body which pump the body in and out of the tube. The great development of the dorsal bands of longitudinal muscle seen in a transverse section of a serpulid (Fig. 186 C) is characteristic of the tubicolous worm. Another typical modification seen in the serpulids and sabellids is the *median ciliated groove*, which starts from the anus, runs along the ventral surface of the abdomen, turning on to the dorsal surface when the thorax is reached. It serves to conduct the faeces to the mouth of the tube.

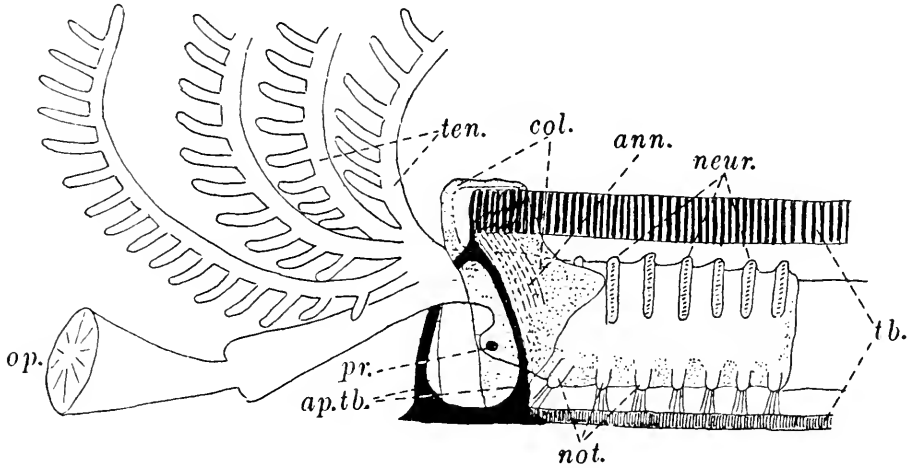

Fig. 188. Diagram of *Pomatoceros triqueter* in its tube. Original. The aperture of the tube is represented in black; the top and base of the tube are shown by vertical lines (*tb.*), the sides not represented so that the thorax can be seen within. The collar (*col.*) is shown by stippling, folded back over the top and sides of the tube; and the thoracic membrane also by stippling. The collar is transparent showing the prostomium and the lip of the tube beneath. The fact that the tube is composed of successive rings is indicated in the neighbourhood of the aperture (*ann.*). *ap.tb.* aperture of tube; *neur.* neuropodia; *not.* notopodia; *op.* operculum; *pr.* prostomium; *ten.* tentacle.

*Chaetopterus* (Fig. 187 B) is probably the most modified of all tubicolous worms. It lives in a parchment-like tube which is U-shaped with at least two apertures. There is a peristomial collar as in other tubicolous worms, but the tentacles are a pair of rudimentary processes. A very complicated mechanism exists for obtaining food, which can be observed by taking a live *Chaetopterus* from its tube and replacing it within a glass tube of the same calibre in an aquarium. The worm fits very loosely in its tube and there is plenty of room for a current of water to sweep through from end to end. Such a current is maintained by the rhythmical oscillation of the *fans* (fused notopodia) of the middle region. Food particles contained in the current are entangled in mucus secreted by the dorsal surface of the anterior region, and ciliated currents, working in grooves in the enlarged

notopodia of the tenth chaetiferous segment, carry these strings of mucus to the cup-shaped organ where they accumulate to form a ball of food which is carried forward in a dorsal groove to the mouth.

### *The burrowing Polychaeta*

*Arenicola marina* (Fig. 189) is the type of a burrowing polychaet and it has a rounded cross-section like an earthworm. In its division of the body into regions, the modification of the parapodia, and the internal anatomy it resembles the tubicolous worms. The prostomium is much reduced, however, without any appendages and there is an eversible pharynx, covered with minute papillae, which is the organ for locomotion through the sand as well as for feeding. In general form it thus resembles an earthworm: the chief obvious difference is the presence of gills and parapodia. It is divided into three regions: the anterior, consisting of the peristomium, an achaetous segment, and six segments which have a notopodium with capillary setae and a neuropodial ridge with chaetae resembling uncini (crotchets); the median, the segments of which have gills in addition; and the posterior, in which parapodia and chaetae are entirely lost.

The body wall consists of the typical circular and longitudinal muscle layers as in *Lumbricus*, and by their alternating contraction and expansion the peristaltic movements which are characteristic of the earthworm and other burrowing forms are carried out. In *Nereis* and other surface-living forms progression takes place in two ways. (1) By alternate flexing of the two sides swimming movements are brought about. The longitudinal muscles, which are arranged in four bundles, are much more important than the circular and are capable of rapid contraction. (2) By successive movement of the parapodia crawling movements occur (as in a centipede), the special parapodial muscles coming into action. In tubicolous forms peristalsis occurs, but the longitudinal muscles are even more important than in *Nereis* for the violent movements of contraction which withdraw the animal into its tube. They form a bulky dorsal mass and resemble the columella muscle of the gasteropod in their action (Fig. 186 C).

*Arenicola* is the most convenient polychaet type for dissection and therefore the following details of internal anatomy are given (Fig. 190). In several prominent features it differs from *Lumbricus* and also from *Nereis* or *Eunice*. The body cavity is spacious, it is not encroached upon by the longitudinal musculature, and the vertical septa which primitively separate the body cavities of the segments have nearly all disappeared. Only the three anterior septa and an indefinite number of the most posterior are preserved. In the greater part of the body the coelom is thus uninterrupted. In its general development the alimentary canal resembles that of the earthworm. The muscular

pharynx, however, is not well developed, the oesophagus is a thin-walled tube with no such development as the gizzard of the earthworm

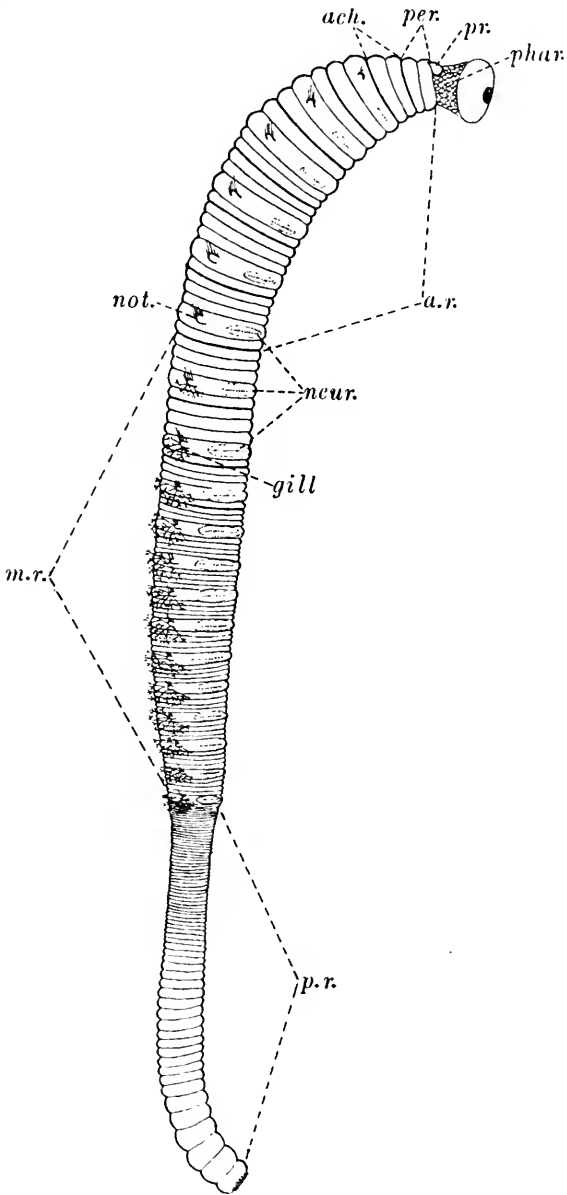

Fig. 189. *Arenicola marina*. Side view. After Ashworth. *ach.* 1st achaetous segment; *a.r.* anterior region; *m.r.* median region; *not.* notopodium; *neur.* neuropodium; *pr.* prostomium; *p.r.* posterior region; *per.* peristomium; *phar.* pharynx.

and it bears only a single pair of coeca. The intestine is the longest part of the gut, the seat of digestion and absorption, and it is invested by a layer of yellow cells. The blood system, which also contains

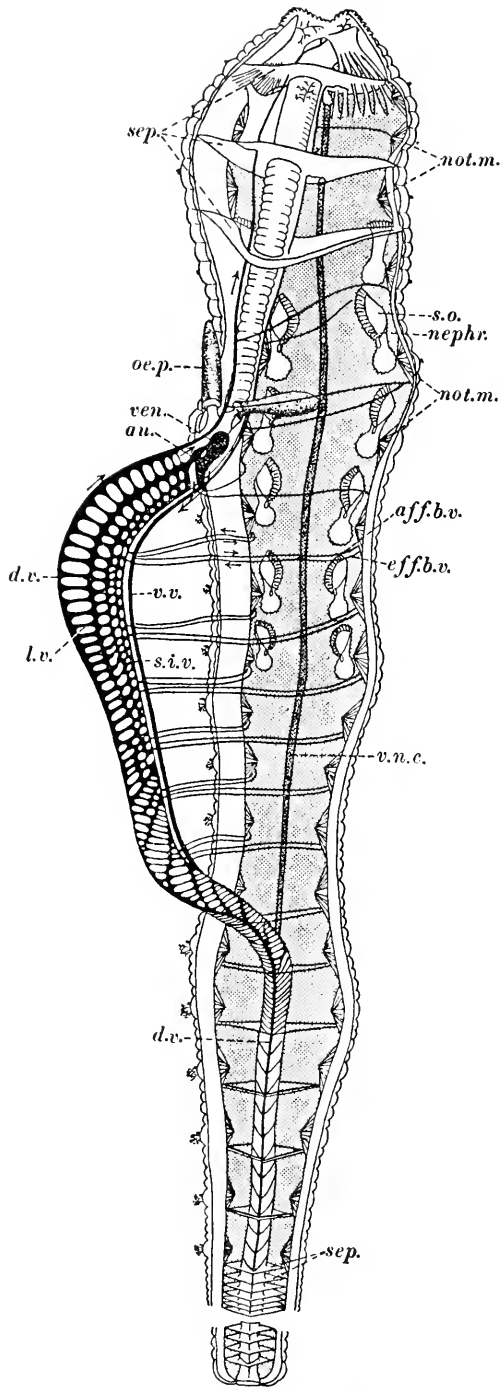

Fig. 190. General dissection of *Arenicola marina*. After Ashworth. *aff.b.v.*, *eff.b.v.* afferent and efferent vessels of gills and body wall; *au.* auricle; *d.v.*, *l.v.* dorsal and lateral blood vessels; *neph.* nephrostome; *not.m.* notopodial muscles; *oe.p.* oesophageal pouch; *sep.* septa; *s.o.* segmental organ; *s.i.v.* subintestinal blood vessel; *ven.* ventricle; *v.n.c.* ventral nerve cord; *v.v.* ventral blood vessel. The direction of the flow of blood is indicated by arrows.

haemoglobin in solution in the plasma, differs slightly from that of *Lumbricus*: there is a single pair of large *hearts*, each divided into a *ventricle* and *auricle* which connect the important lateral intestinal vessels from which the branches supplying the gills are derived with the ventral vessel.

The circulation for that region just behind the heart may be expressed as follows: lateral vessels→auricle→ventricle→ventral vessel→afferent vessel to body wall and gill→efferent vessel to subintestinal vessel→intestinal plexus→dorsal vessel or lateral vessel. The dorsal vessel does not communicate directly with the heart.

The segmental organs are, like the gills, only found in the middle region. They are prominent organs lying beneath the oblique muscles, remarkable for the large size of the nephrostome, the dark secretory bag-like portion, the cells of which contain insoluble excreta, and the small gonad which lies just behind it. In *Arenicola* as in *Lumbricus* the gonads are restricted to a small number of segments, but the reproductive cells are shed into the body cavity at maturity and completely fill it.

In *Glycera* the prostomium is narrow and conical, the tentacles being very small. It possesses a very large proboscis armed with four sharp teeth. The parapodia are reduced in size, and bear compound chaetae and in its internal structure too *Glycera* comes nearer to the errant worms than does *Arenicola*.

#### *The excretory and reproductive organs of the Polychaeta*

Now that a survey of the chief types of the Polychaeta has been made a brief description of the *segmental organs* found in the group will be given. These are tubes, repeated in successive segments, which serve to convey the excretory and generative products from the coelom to the exterior. They are primarily divided into *nephridia*, derived from ectoderm, and *coelomoducts*, formed from mesoderm. The typical nephridium is a closed tube, whose blind end projecting into the coelom is fringed with *solenocytes*, cellular organs which have a very close resemblance to the flame cell of Platyhelminthes and Rotifera. Such "closed" nephridia (protonephridia) are found in the Phyllodocidae, Glyceridae and Alciopidae. But in the majority of the Polychaeta and all Oligochaeta there is another type of "open" tube, which usually serves for the escape of excreta, and this possesses a small funnel or *nephrostome*. It may, however, take over the function of the coelomoduct and carry sperm or eggs to the exterior. In this case the nephrostome becomes wider and the tube more glandular. The familiar example of the open tube is the nephridium of *Lumbricus*, which is purely excretory. In this type

the tube consists of ectoderm: the funnel of the nephrostome in *Lumbricus* (and probably of other forms) is derived from a single ectodermal cell. The coelomoduct is entirely formed from mesoderm and usually has a wide coelomic funnel easily distinguished from the typical nephrostome. The oviducts and the sperm ducts of *Lumbricus* are coelomoducts. In a family of the Polychaeta called the Capitellidae there are coelomoducts in most segments of the body serving as gonoducts (Fig. 191 I, D). In the majority of Polychaeta they have

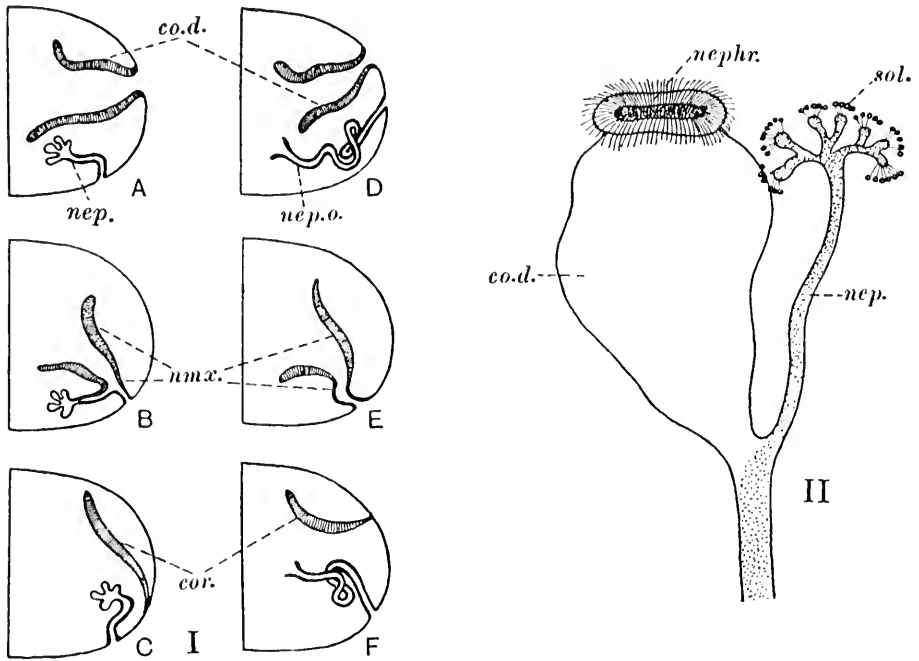

Fig. 191. Segmental organs of Polychaeta. After Goodrich. I, Transverse section (right half) of body segment showing combinations of nephridia and coelomoducts. A, Hypothetical. B, Phyllodocidae and Alciopidae. C, Nephthyidae and Glyceridae. D, Capitellidae. E, Capitellidae. F, Nereidae. *co.d.* coelomoduct; *cor.* ciliary organ; *nep.* "closed" nephridium; *nep.o.* "open" nephridium; *nmx.* nephromixium. II, Segmental organ of *Vanadis* (Alciopidae). *nephr.* coelomic funnel; *sol.* solenocytes.

however disappeared altogether and their function is otherwise performed.

There is in addition a type of organ called a *nephromixium* which is formed by the union of a nephridium and coelomoduct. In the Alciopidae the separate components of the nephromixium are clearly seen (Fig. 191 II). Here the union is with the closed nephridium but in the Capitellidae and many other polychaet families there are open nephridia and these have often an intimate fusion with the coelomoducts. Thus in one form of the Capitellidae shown in Fig.

191 I, E the funnel of the coelomoduct has completely fused round the opening of the nephridium.

In *Nereis*, *Nephtys* and *Glycera* the functional segmental organ is an open nephridium, but a rudiment of the coelomoduct, which does not open to the exterior, the so-called *ciliary organ*, occurs in each segment. In the majority of polychaets, however, the coelomoduct has disappeared altogether.

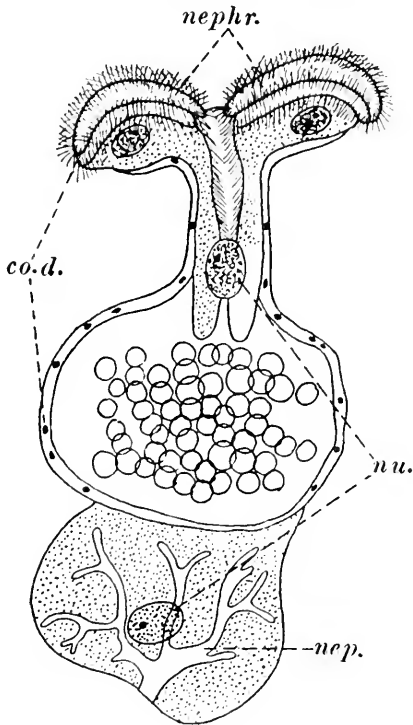

Fig. 192.

Fig. 192. Segmental organ of *Glossiphonia* (Hirudinea). After Oka. Showing mesodermal part with ciliated nephrostome and a single cell of the ectodermal part, with intracellular duct. *nu.* nucleus.

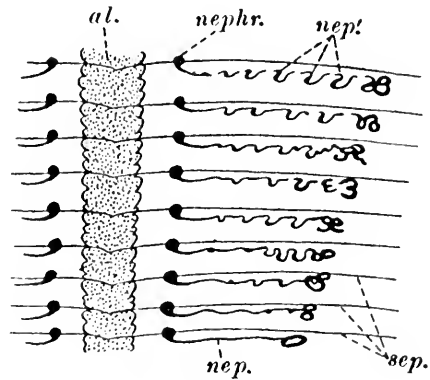
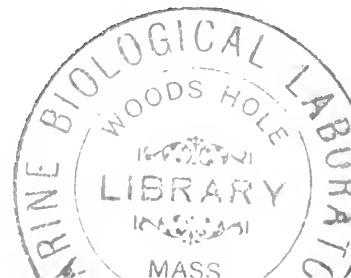

Fig. 193.

Fig. 193. Development of *Megascolides australis* (Oligochaeta). At the posterior end the nephridia are single; traced anteriorly they break up into a number of loops each of which becomes a separate micronephridium (*nep.'*). *al.* gut; *sep.* septa. Other letters as in Fig. 191 for both figures.

Then again there may be a great difference between the nephridia in different parts of the same worm. In the serpulids, terebellids and other families there are one to three pairs of long segmental organs situated anteriorly. In most of the segments behind there are short funnels in the body wall which are open nephridia but serve for the escape of the eggs and sperm. There is thus a division of labour between the segmental organs in tubicolous worms: the anterior are specialized for excretion, the posterior are genital ducts.



The closed nephridium appears to be the most primitive type of segmental organ and a survival of the time when the coelom had not yet developed. The open nephridium is far commoner in the Chaetopoda with their extensive coelomic cavities. The origin of the coelomoducts is doubtful. They may be thought to have arisen as genital ducts but now the nephridia often serve for the escape of the gametes.

The gonads in the polychaets are usually patches of the peritoneal epithelium, repeated in most of the segments, proliferating until a great number of the germ cells have been detached into the body cavity which they almost entirely fill and where they undergo maturation (Fig. 199 A). When ripe they reach the exterior usually through the segmental organs, but occasionally the body wall ruptures and so opens a way of escape.

Like so many other marine animals the polychaets thus liberate eggs and sperm freely into the sea, fertilization taking place externally. This habit is associated in many forms with the phenomenon of *swarming* in which a worm, usually crawling or burrowing on the sea bottom, when sexually mature rises to the surface and swims vigorously, eventually discharging its genital products and sinking to the bottom as suddenly as it rose. In most nereids this occurs irregularly through the summer months, but in at least two forms (*Leodice viridis*, the "Palolo" of the reefs of the Southern Pacific, and *Leodice fucata* of the West Indian reefs) the phenomenon (Fig. 194 E) has acquired the strictest periodicity. As the day of the last quarter of the October–November moon dawns the Pacific Palolo breaks off the posterior half of its body, already protruding from the mouth of its burrow in the coral rock, and these fragments rise to the surface in such quantities that the water writhes with worms and is later milky with the eggs and sperm discharged. Immediately afterwards the remaining anterior end begins to regenerate the missing portion, but a whole year elapses before the gametes are again ripe—even two days before spawning occurs fertilization cannot be brought about artificially. In the West Indian species the phenomenon is similar but takes place in the third quarter of the June–July moon.

In the syllids the phenomena of swarming are vastly more varied. The whole animal may produce germ cells and swarm. Usually however the gonads are confined to the posterior part of the body which is detached as a free-swimming unit; this often develops a head but never jaws and pharynx. It can live for some time but not feed. In the majority of forms a single bud is produced, but in *Autolytus* (Fig. 194 B) and *Myrianida* a *proliferating region* is established at the end of the original body and from this a chain of sexual individuals is budded off, the oldest being situated most posteriorly. The whole chain may be found swimming at the surface, the original worm dragging after



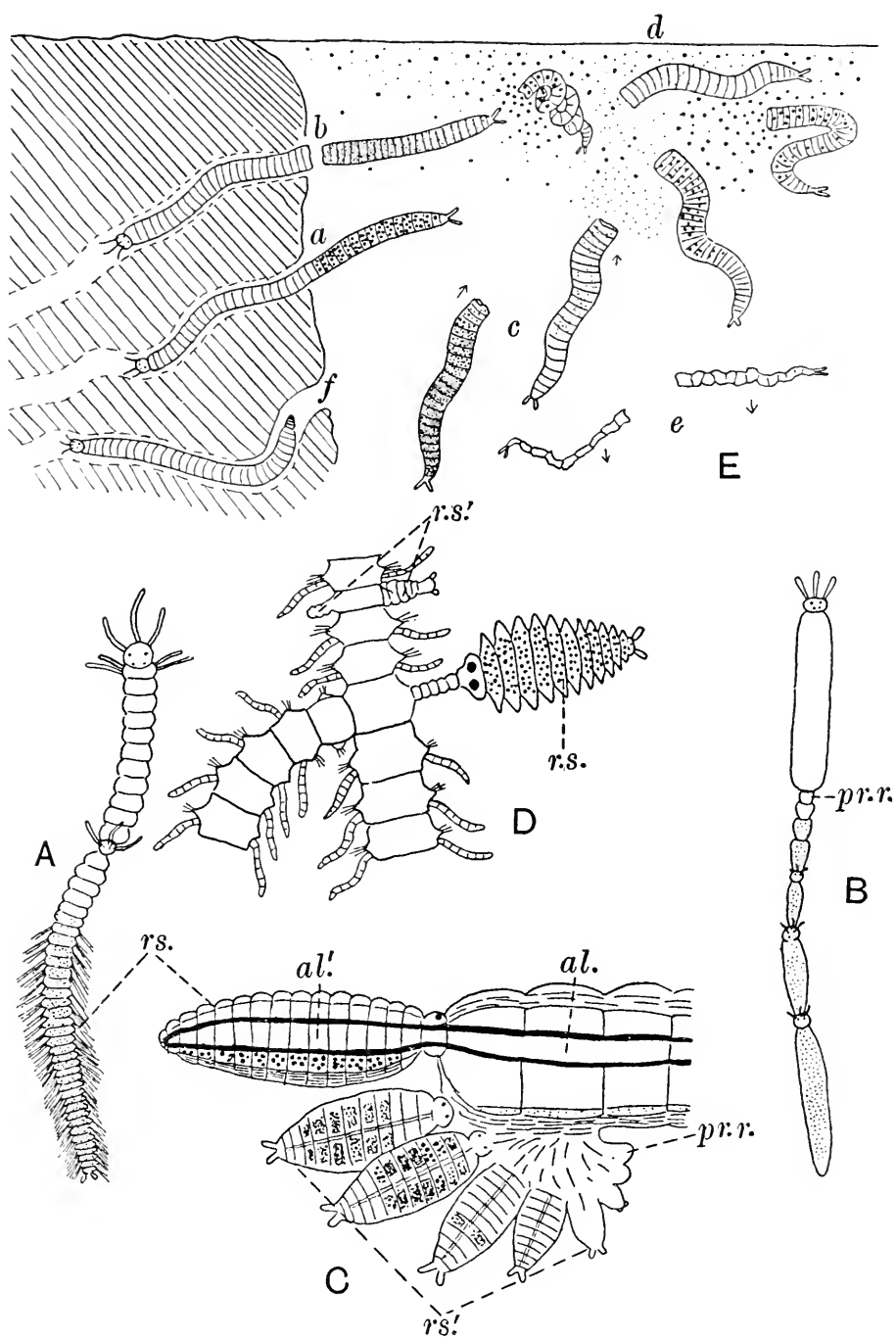

Fig. 194. Diagrams of reproduction in the Polychaeta. A-D, Syllidae. E, Eunicidae. A, *Syllis* with the posterior region forming a reproductive individual. B, *Autolytus* with a chain of reproductive individuals budded off successively from *pr.r.* a proliferating region. C, *Trypanosyllis gemmipara*, longitudinal section through the end of a budding stock showing two kinds of reproductive individual, *rs.* a single individual which contains *al.'* the continuation of the alimentary canal (*al.*) of the stock, and *rs.'* successive rows of individuals without alimentary canal formed from the proliferating cushion, *pr.r.* D, *Syllis ramosa*, showing branching of the asexual stock and budding of reproductive individuals, *r.s.*, *r.s.'* from parapodia of the stock. E, Diagram of the swarming of the Palolo worm, *Leodice*. *a*, mature female protruding posterior end from its burrow; *b*, male—the sexual part of which has just become detached; *c*, sexual fragments swimming up to the surface and *d*, discharging the eggs and sperm. In *e* they are emptied and sink to the bottom; *f*, parent worm regenerating the sexual region.

it the chain of sexual individuals which one by one detach and lead a short independent existence. In some species of *Trypanosyllis* (Fig. 194 C) the zone of proliferation is in the form of a cushion of tissue on the ventral surface of the last two segments and this produces not a linear series of buds but successive transverse rows, amounting to more than a hundred—the fully formed sexual individual possesses a head but no vestige of an alimentary canal. The extraordinary branching form, *Syllis ramosa* (Fig. 194 D), shows remarkable capacity for heteromorphic growth in the production of sterile side branches from the stock and reproductive buds.

In the syllid there is usually no notopodium during asexual life but during the maturation of the gonads the parapodium is reconstructed, a notopodium being formed from which spring bundles of long capillary swimming chaetae, while a corresponding development of new muscles takes place. Even greater is the change in the parapodia of the maturing nereids. The muscles of the asexual period break down and the fragments are digested by leucocytes before the new muscles are formed. The parapodium of the sexual form, the *Heteronereis*, is produced into membranous frills and contains a new type of oar-shaped chaeta (Fig. 184 D, F). The eyes become immensely larger and the animal itself very sensitive to light. The *Heteronereis* does in fact resemble those members of the Phyllodocidae and Alciopidae which have become permanently pelagic. The increase in the surface of the parapodia may be useful in swimming and floating: it has without doubt some connection with the increased gas exchange associated with an active life.

It is easy to see in the swarming habit an adaptation for securing fertilization of the greatest possible number of eggs. There are remarkable cases in the syllids (*Odontosyllis*) where the meeting of



Fig. 195. A *Heteronereis*. Photograph of specimen stained in borax carmine and mounted in Canada balsam. Notice the enormously developed eyes, long peristomial cirri, anterior unmodified trunk region, posterior modified region with parapodia sloping backwards and darker appearance owing to presence of gonads.

the sexes is facilitated by the exchange of light signals, and in the nereids the discharge of sperm may only be brought about by the influence of a secretion from the swarming female. Discharge of the gametes is nearly always followed by the death of the sexual individual.

The fertilized egg gives rise to an unsegmented larva, the trochosphere, which is described in the next section.

### *Development of the Polychaeta*

The cleavage of the egg in the Polychaeta and the Archiannelida, the polyclad Turbellaria, the Nemertea and the Mollusca follows almost exactly the same plan. Division occurs rhythmically, affecting the whole or greater part of the blastomeres at the same time. The first two divisions are equal, producing four cells (Fig. 196, 2) lying in the same plane, which are called *A*, *B*, *C*, *D*; each cell in its further cleavage resembles the others and gives rise to one of the *quadrants* of the embryo. *D* tends to be larger than the others and becomes the dorsal surface of the embryo, while *B* is ventral, *A* and *C* lateral. The next divisions (third, fourth and fifth) are unequal and at right angles to the first two and result in three *quartettes* of *micromeres* being divided off successively from the *macromeres* as *A*, *B*, *C* and *D* are then termed. The region in which the micromeres lie is the upper or *animal pole* of the embryo, while the macromeres form the *vegetative pole*. The micromeres are not directly over the macromeres from which they are formed but in one quartette they are all displaced to the right, while in the next they will be displaced to the left of the embryonic radius and the next to the right again. The cleavage is therefore said to be of *spiral* type and successive cleavage planes are at right angles. At a later period it is replaced by cleavage in which there is no alternation of the kind described above, and the result is that the embryo becomes bilaterally symmetrical.

The rest of the description is drawn from the Polychaeta but can be applied with slight modifications to the other groups.

The cells of the first three quartettes give rise to the ectoderm of the larva and of the adult. The sixth division, however, results in the separation from the macromeres of a fourth quartette which is composed of cells differing notably in size and density from those of the first three. Of the fourth quartette  $d^4$  (Fig. 196, 4) alone produces the mesoderm, while the other three,  $a^4$ ,  $b^4$  and  $c^4$ , reinforce the macromeres to form the endoderm. The mesoderm is, however; only in course of differentiation during larval life and a larval mesoderm or *mesenchyme* is produced from which particularly the musculature of the trochosphere is fashioned. The mesenchyme is derived from the inward projections of cells of the second and third quartettes.

*Gastrulation* (Fig. 196, 7). The amount of yolk in the macromeres determines the character of the cleavage within certain limits and the type of gastrulation. In forms like *Polygordius* with very little yolk the micromeres and macromeres are nearly the same size and gastrulation takes place by invagination; in *Arenicola*, *Nereis* and nearly all Polychaeta and Mollusca the micromeres are much smaller than the macromeres, and as they divide to form the ectoderm they grow round the massive macromeres and an "epibolic" gastrula is formed. The cells of the fourth (and fifth) quartettes approach each other from the two sides. The mesoblast cell ( $d^4$ ) begins to withdraw from the surface into the blastocoele, and the blastopore, that is the uncovered surface of the macromeres, becomes much smaller and slit-like. Eventually as gastrulation is completed the lips of the blastopore join in the middle, the same cells meeting each other in every case, leaving an anterior opening which becomes the mouth and a posterior, which closes, but in the neighbourhood of which the anus of the trochosphere arises later. The blastopore therefore represents the ventral surface of the larva. At the same time the macromeres withdraw into the interior to form a second cavity, the *archenteron*, bringing with them the cells of the fourth and fifth quartettes ( $a^4, b^4, c^4; a^5, c^5, d^5$ ). The *somatoblast* ( $d^2$ ) breaks up into a large number of cells to form the *ventral plate*.

The change from gastrula to trochosphere (Fig. 197) follows quickly and with little further cell division. The first quartette of micromeres have by this time been differentiated (Fig. 196, 5) into (1) the *apical rosette*, consisting at first of four small cells and becoming the *apical organ* of the trochosphere; (2) the cells of the so-called *annelid cross* which alternate with those of (1) and form the cerebral ganglia; (3) the *prototroch*, forming four groups of cells which constitute the preoral ciliated ring of the trochosphere; and (4) the intermediate girdle cells, forming most of the general ectoderm of the part in front of the prototroch, which is called the *umbrella*. The expansion of the *subumbrellar ectoderm*, i.e. that behind the prototroch, is due to the proliferation of a single cell in the second quartette of micromeres,  $d^2$  (the *somatoblast* (Fig. 196, 6)). It forms a plate which spreads from its originally dorsal position round the sides, the two wings uniting behind the mouth to form the *ventral plate*, becoming the ventral body wall. The descendants of this single cell thus make up nearly the whole of the subumbrellar ectoderm. Its sisters  $a^2, b^2, c^2$  give rise to the *stomodaeum* and are tucked in at the mouth at the close of gastrulation. This marks the completion of the alimentary canal. The young trochosphere now possesses a very thin outer epithelium, thickened in the region of the apical disc and the equatorial ring of cilia, the prototroch, and in the region of the ventral plate, which is

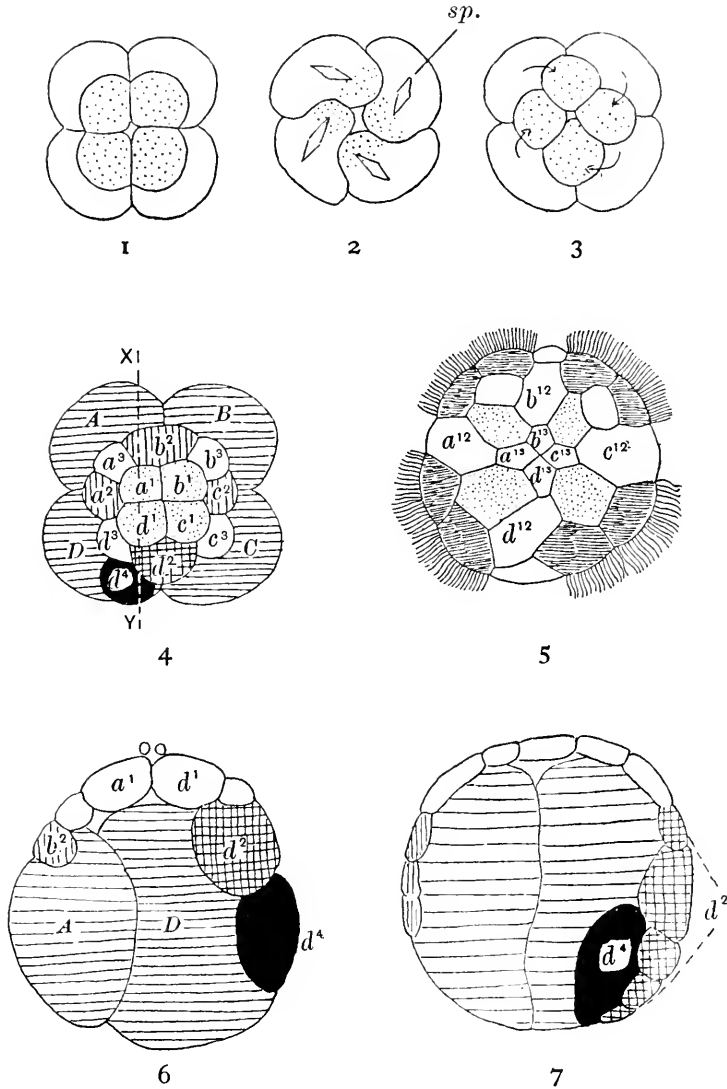

Fig. 196. Partly after Dawydoff. 1-3, Diagrams of radial and spiral cleavage. 4-7, Development of *Nereis*. 1, Eight-cell stage in a radial type, e.g. Echinoderm. 2, Spiral cleavage, four-cell stage just before cleavage, leading to eight-cell stage. *sp.* spindle. 3, Macromeres stippled. 4, Diagram of segmenting egg (*Nereis*), seen from the animal pole, showing the macromeres, the first three quartettes of micromeres and the mesoblast cell ( $d^4$ ) in the fourth quartette. 5, Later stage, also from animal pole, to show the rosette cells ( $a^{13}$ - $d^{13}$ ), the annelid cross (indicated by stippling), the four groups of prototroch cells (horizontal shading and cilia) and the intermediate girde cells ( $a^{12}$ - $d^{12}$ ). 6, Vertical section through the same stage as 4, along the line  $XY$ . 7, Vertical section through a later stage to illustrate gastrulation: cells derived from  $d^2$  (cross-hatched) growing over the macromeres, the mesoblast cell withdrawing into the interior.

the rudiment of a large part of the trunk of the adult worm. It will form ventral nerve cord, chaetal sacs and the ventral and lateral ectoderm of the trunk. The larval gut opens by a *mouth* in the equatorial region and consists of an ectodermal oesophagus (stomodaeum) opening into the endodermal *stomach* and an ectodermal *hind gut* opening to the exterior by an *anus*. The cavity between the ectoderm and the gut (blastocoele) is spacious and traversed by the pseudopodia-like processes of the mesenchyme cells, larval muscles and nerves, and also contains the two *larval nephridia*, each of which is composed of two hollow cells placed end to end, one of which contains a "flame" of cilia. They are descended from the first quartette of micromeres and sink in from the surface.

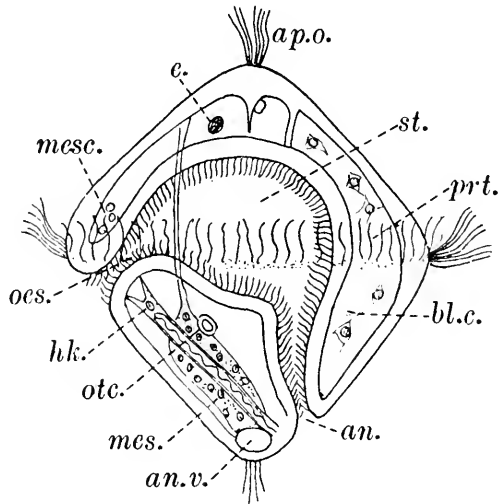

Fig. 197. Trochosphere larva of *Eupomatus*. Side view. After Shearer. *ap.o.* apical organ; *e.* eye; *prt.* preoral ciliated ring; *hk.* "head kidney", larval nephridium; *otc.* otocyst; *mes.* mesodermal band; *an.* anus; *an.v.* anal vesicle; *bl.c.* blastocoele; *mesc.* mesenchyme; *oes.* oesophagus; *st.* stomach.

The trochosphere drifts hither and thither in the sea, swimming feebly by the action of the cilia of the prototroch and sometimes also by secondary postoral rings of cilia (e.g. metatroch formed from cells of the third quartette). During this pelagic existence the rudiments of the adult worm continue their development—which is best traced in *Polygordius*—the apical organ develops into the *prostomium* of the adult with brain, tentacles and eyes, while the trunk rudiment formed by the proliferation of the ventral plate and the mesoblast cell grows backwards as an ever-lengthening cylindrical process containing the end gut. In the ectoderm of this is developed ventrally the rudiment of the ventral nervous system, while to the sides of this and internally are the mesodermal strips (derived from the single cell  $d^4$ ), which

show at once *metameric segmentation* (Fig. 198), first as pairs of solid blocks, then with cavities, to form the *somites*. Each of these box-like mesodermal segments has then an inner wall which is applied to the gut (splanchnic mesoderm) and an outer (somatic mesoderm) lying under the ectoderm. The right and left rudiments meet in the middle lane and are only separated by the *dorsal* and *ventral* mesenteries which are formed by their apposed walls, while the anterior and posterior borders of each segment are *septa*. At the same time the adult nephridia develop from ectoderm rudiments and the blood vessels differentiate in the septa and mesenteries.

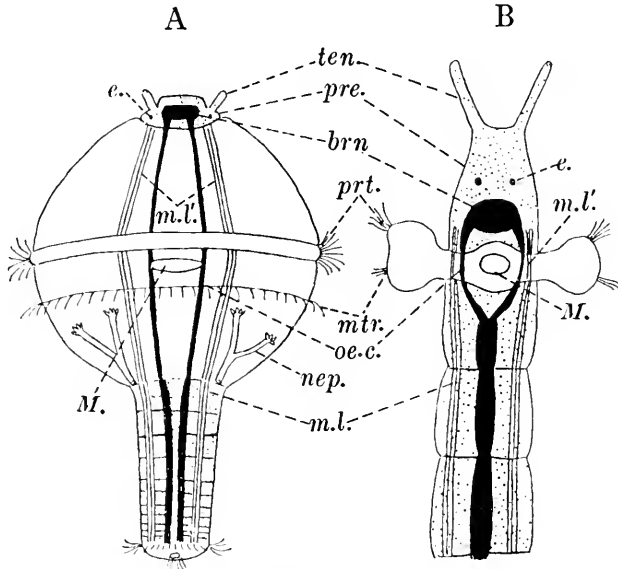

Fig. 198. Development of *Polygordius*. After Woltereck. A, Trochosphere with rudiment of prostomium and trunk. B, Metamorphosing larva with the prostomium and trunk brought close together by the contraction of the longitudinal muscles and the umbrella of the trochosphere shrivelled and about to be discarded. Three segments only of the trunk are shown. *brn.* brain; *e.* eye; *m.l.* longitudinal musculature; *m.l.'* part of the same which by contraction brings the prostomium and trunk rudiments into contact; *M.* mouth; *nep.* protonephridium with solenocytes; *pre.* prostomium; *prt.* prototroch; *mtr.* metatroch; *oe.c.* oesophageal commissure; *ten.* tentacle.

The advanced larva (Fig. 198 A) thus consists of two rudiments of the adult body, separated by the body of the larval trochosphere. They are joined by a pair of longitudinal muscles and of nerves, and in one species of *Polygordius* metamorphosis of the larva into the adult is brought about by the shrivelling up of the larval tissues and the drawing together and the union of the head and trunk assisted by the contraction of these muscles (Fig. 198 B). The larval mouth remains in the adult. After metamorphosis the animal sinks to the bottom and begins its adult life.

## Order OLIGOCHAETA

Chaetopoda, nearly all land and freshwater forms, with a comparatively small number of chaetae, not situated on parapodia, with prostomium distinct but usually without appendages; always hermaphrodite, the male and female gonads being few in number (one or two pairs), situated in fixed segments of the anterior region, the male always anterior to the female; with special genital ducts (coelomoducts) opening by funnels into the coelom, *spermathecae*, and a *clitellum* present at sexual maturity; with reproduction by copulation and cross-fertilization; eggs being laid in a cocoon, developing directly without a larval stage.

In addition the pharynx is not eversible and pharyngeal teeth (such as frequently occur in the Polychaeta) are absent, except in one small family, the Branchiobdellidae, which have ectoparasitic habits similar to the leeches and resemble them in some particulars of structure.

Though the chaetae are not borne on parapodia they are usually divided into two bundles or groups on each side which roughly correspond to the noto- and neuropodia. They may be classified into hair chaetae which are long and fine (dorsal chaetae of *Stylaria*) and shorter chaetae which are rod-like (*Lumbricus*) or needle-like. The point of the needle is single- or double-pronged. There is not, however, the great variety found in the Polychaeta.

Certain main features of the reproductive system (Fig. 199) are the salient characters of the group. Its members are, without exception, hermaphrodite, and with a single possible exception cross-fertilization only is possible. The restriction of the gonads to a few segments occurs also in some sabellids among the Polychaeta and in some archiannelids. The sexual cells are shed into the coelom either into the general coelomic cavity as in the Polychaeta or into special parts of it divided off from the rest (*seminal vesicles* of *Lumbricus*) where they mature. Spermathecae are usually present to contain the spermatozoa received from another worm in copulation. The clitellum is a special glandular development of the epidermis whose principal function is the secretion of the substance of the cocoon and the albuminoid material which nourishes the embryo. It is a secondary sexual character which is only present in the reproductive season in most Oligochaeta, but the earthworms (*Lumbricus*, *Allolobophora*) used in zoological laboratories in this country always possess it. Both the clitellum and the cocoon produced by it are found in the Hirudinea. It may also be mentioned that many oligochaets have special copulatory chaetae, sometimes hooked for grasping the other worm or with a sharp point for piercing it.

For the purposes of the elementary student it is probably best to recognize that the Oligochaeta contain two well-marked oecological



types, the "earthworm", a larger burrowing terrestrial form, and the aquatic oligochaet which is much smaller and simpler in structure. It is probable that the former type is the more primitive; the aquatic oligochaet shows many characters which resemble those of the archiannelids and are most likely due to a process of simplification. The reasons for the conclusion that the aquatic oligochaets are not the oldest of these groups are given below.

### *The Earthworms*

These are divided into a number of families of which the most important are the Lumbricidae, containing *Lumbricus* and *Allolobophora*, and the Megascotocidae which is the largest of all.

The primitive forms in all families resemble *Lumbricus* in the following characters. There are a large number of segments and each one is furnished with eight chaetae arranged in pairs and all on the ventral side of the worm. A series of *dorsal pores* is found along the back in the intersegmental grooves. The alimentary canal is characterized by a large muscular *pharynx* by which the food is sucked in, with many glands, the secretion of which is used in external digestion. The oesophagus in one part of its length gives rise to one or more pairs of diverticula, the cells of which secrete carbonate of lime (*oesophageal pouches* and *glands*). At the end of the oesophagus or the beginning of the intestine there is a thick-walled *gizzard* in which the food is masticated with the aid of the soil particles. The intestine has a dorsal ridge, the *typhlosole*, to increase the absorptive surface. The nervous, muscular and circulatory systems exist throughout the earthworms with little variation from the condition in *Lumbricus*.

The reproductive system (Fig. 199 C) consists essentially of two pairs of *testes* in segments 10 and 11 and one pair of *ovaries* in segment 13, followed by ducts which open by large funnels just behind the gonads and discharge to the exterior in the next segment in the case of the oviduct, and several segments behind in the case of the sperm duct. The testes, at least, are enveloped by *sperm sacs* (*vesiculae seminales*) which are outgrowths of the septa, and in the cavity of these the sperm undergo development. In some earthworms there are no sperm sacs and this condition, resembling that in the Polychaeta, is probably the earliest in the group. There are two pairs of *spermathecae* in the region in front of the testes. In the neighbourhood of the male external aperture there are *spermiducal (prostate) glands* which do not actually open into the sperm duct. A single pair of segmental organs (open nephridia) is present in each segment.

The variations which occur in more specialized members of all families are as follows. The chaetae may increase in number and come

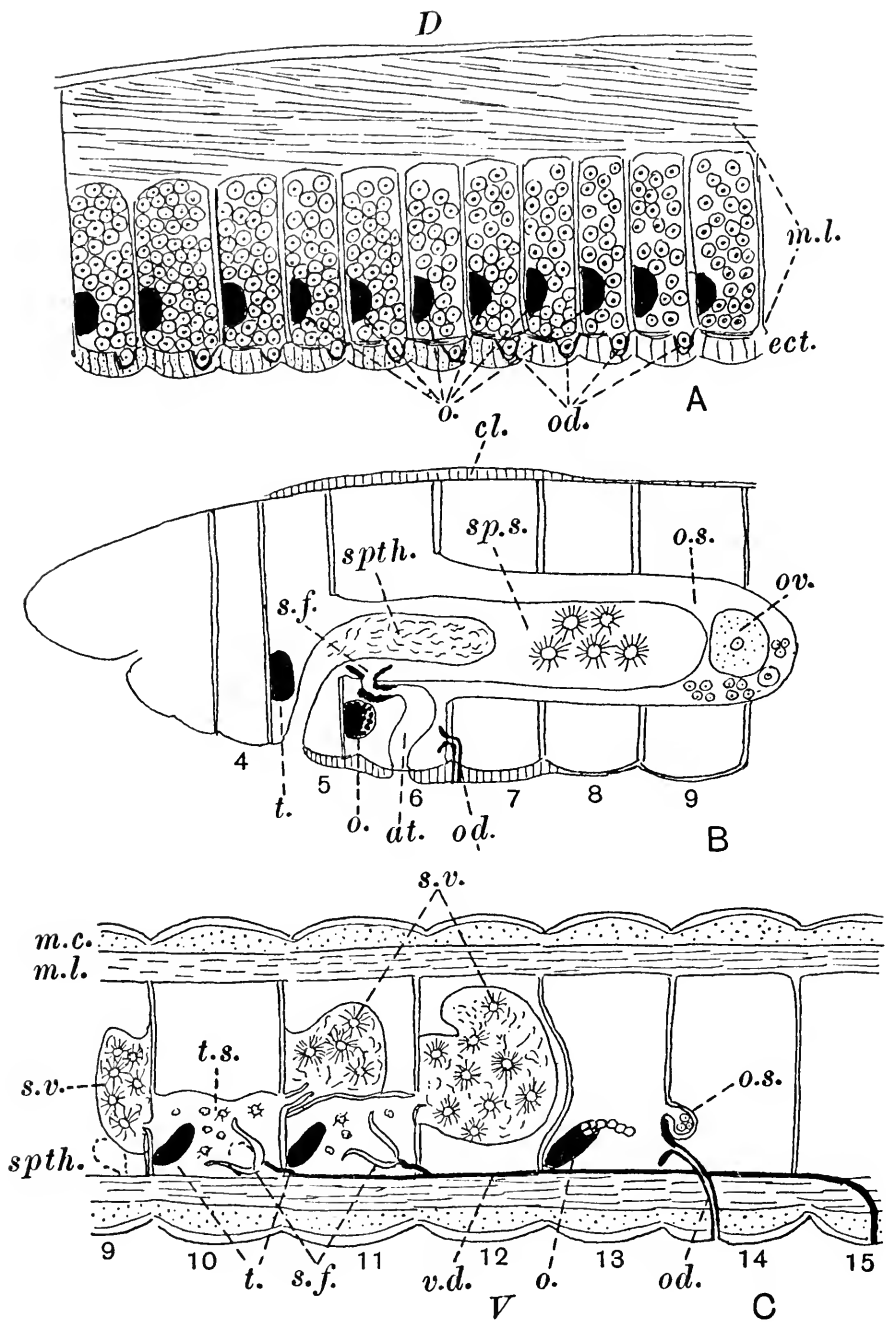

Fig. 199. Reproductive organs of the Chaetopoda. A, Polychaeta (longitudinal section of *Serpula intestinalis* to one side of the middle line). Original. Oligochaeta. B, Naididae, diagrammatic. After Stephenson. C, *Lumbricus terrestris*, diagrammatic. After Hesse. *at.* atrium; *cl.* clitellum; *ect.* ectoderm; *m.c.* circular and *m.l.* longitudinal muscles; *o.* ovary; *od.* oviduct; *o.s.* ovisac; *ov.* ovum; *s.f.* funnels of vas deferens; *sp.s.* sperm sac; *s.v.* seminal vesicle; *sph.* spermatheca; *t.s.* testis sac; *t.* testis; *v.d.* vas deferens. D, dorsal and V, ventral. The numbers are those of the segments, the vertical lines are septa.

to be arranged in a complete ring round the body (*perichaetine*). The dorsal pores may disappear. The oesophagus may lose its calciferous glands and the gizzard may be absent or develop into several. The reproductive organs vary in small but important particulars. There are nearly always two pairs of *testes* in segments 10 and 11 and one pair of *ovaries* in segment 13, but the testes may be reduced to a single pair. There are usually two pairs of *spermathecae* but the number varies and occasionally they are absent altogether. The *prostate glands* (of unknown function) are nearly always present in earthworms except in the Lumbricidae.

The simplest method of copulation in earthworms is that found in *Eutyphoeus*, where the end of the sperm duct can be everted to form a *penis*. This is inserted into the spermathecal apertures and the spermatozoa thus pass directly from one worm to another. It is obvious that the mechanism of copulation is far more complicated in the Lumbricidae. Here the worms come into contact along their ventral surfaces and each becomes enveloped in a mucous sheath. Close adhesion is secured between the clitellum of one worm and the segments 9 and 10 of the other, partly by embracing movements of the clitellum and partly by the chaetae of the same region being thrust far into the body wall of the partner. The sperm passes out of the male aperture and along the *seminal groove* to the clitellum; how it enters the spermathecae of the other worm has never been observed.

The cocoons are formed some time after copulation. The worm forms a mucous tube as in copulation. The cocoon is then secreted round the clitellum and finally the albuminous fluid which nourishes the embryo is formed between the cocoon and the body wall and the worm frees itself from the cocoon by a series of jerks. All three products, mucus, cocoon substance and albumen, are secreted by the clitellum and each probably by a distinct type of cell. The eggs are sometimes extruded and passed backwards into the cocoon while it is still in position on the clitellum but the spermathecae eject the spermatozoa when the cocoon passes over them.

The embryo of *Lumbricus* is illustrated in Fig. 200. The prototroch is absent but the gut and stomodaeum are developed early to absorb the albumen in the cocoon. There are two mesoblast pole cells at the hinder end which bud off the mesodermal strips: there are three ectodermal pole cells on each side, the ventralmost a *neuroblast* forming half the nerve cord and the two others *nephroblasts* giving rise to longitudinal rows of cells which divide up to form the nephridia.

A primitive kind of nephridium in the Oligochaeta is that described in *Lumbricus*, of which there is a pair for each segment, the nephrostome projecting through the septum and opening into the cavity of the segment in front. A great many modifications of this

arrangement exist especially in the Megascolecidae. Here, in addition to the type already described which is distinguished as a *meganephridium*, there are *micronephridia* of which enormous numbers may exist in a single segment (2500 in *Pheretima*). These are small tubes which may or may not open into the coelom by a nephrostome. They may exist in the same segment as a pair of meganephridia. There is

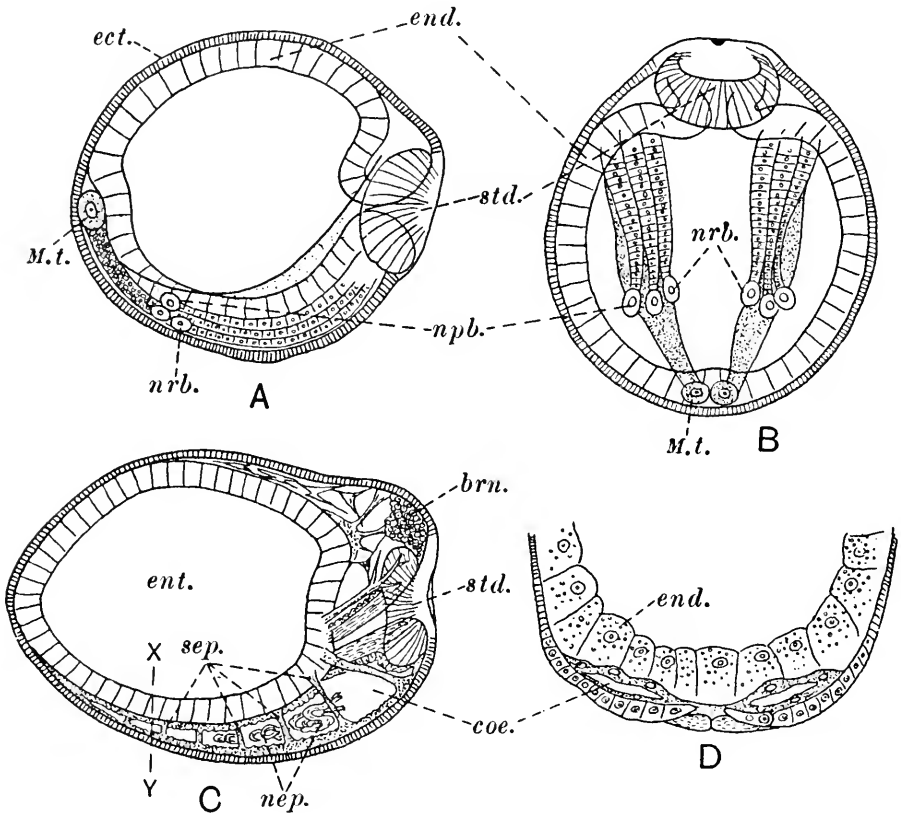

Fig. 200. Embryo of *Lumbricus foetidus*. After E. B. Wilson. A, Lateral view of an embryo in which the mesoblast is unsegmented. B, Ventral view of the same embryo. C, Longitudinal section of a later embryo a little to one side. D, Transverse section of ventral part of the same embryo along the line XY in C. *brn.* brain; *coe.* coelomic cavity of mesoblastic somites; *ect.* ectoderm; *end.* endoderm; *ent.* enteron; *M.t.* mesoblastic teloblast; *npb.* nephroblasts; *nrb.* neuroblasts; *nep.* nephridia; *sep.* septa; *std.* stomodaeum.

good evidence for supposing that an originally single meganephridium has been broken up into a multitude of micronephridia. In the development of the earthworm *Megascolides* the segmental organs first appear as cords of cells like meganephridia. These are thrown into a series of loops and each loop is separated from the rest as a micronephridium.

Other modifications are those in which the nephridia open into the alimentary canal instead of to the exterior. They may be *peptonephridia*, opening into the interior part of the alimentary canal; whether they have a digestive function is not known. On the other hand they may unite to form a longitudinal duct (or ducts) which discharges into the hind end of the intestine. Whether there is any physiological meaning for the variations in the segmental organs of the earthworms is entirely unknown.

There is a well-developed blood circulation. Blood flowing through the parietal and dorso-intestinal vessels of each segment is collected in the dorsal vessel. It is prevented from returning by an elaborate system of valves (Fig. 201). Waves of peristaltic contraction beginning at the hind end of the dorsal vessel and continued by the "hearts" press it forwards and ventralwards into the ventral vessel which is the main distributing channel.

### *The aquatic Oligochaets*

As a type of these, *Stylaria*, belonging to the family Naididae, will be shortly described (Fig. 202). This is a transparent worm rather less than a centimetre long found crawling on water weed. The prostomium bears minute eyes and is produced into a long filiform process. In most of the segments there are two bundles of chaetae on each side, the dorsal consisting of hair chaetae and needle chaetae, while the ventral has only "crotchets" with a double point. The first four segments have no dorsal bundles (incipient cephalization).

The alimentary canal is simpler in character than that of *Lumbricus*, a gizzard being absent. The intestine is ciliated and the action of the cilia brings in from the anus a current of water which probably assists respiration. The testes (Fig. 199 B) develop in segment 5 and the ovaries in segment 6, while a pair of spermathecae is found in the testis segment. The sexual cells develop in the seminal vesicle and the ovisac which are unpaired backward pouchings of septa 5/6 and 6/7 respectively. The male ducts open by a funnel on septa 5/6 and discharge into an *atrium*, which is lined by the cells of the *prostate*. While sexual individuals are often met with and can be recognized at once by the appearance of the opaque clitellum in segments 5-7, individuals reproducing asexually are much commoner. Chains of worms attached to one another may be found, and the existence of one or more *zones of fission*, where new segments are being formed and separation of two individuals will take place, is easily observed under the microscope.

*Stylaria* is a delightful object of study. The operation of many of the organs can be easily observed with a low power and the results

form a useful supplement to work with *Lumbricus* in understanding oligochaet organization.

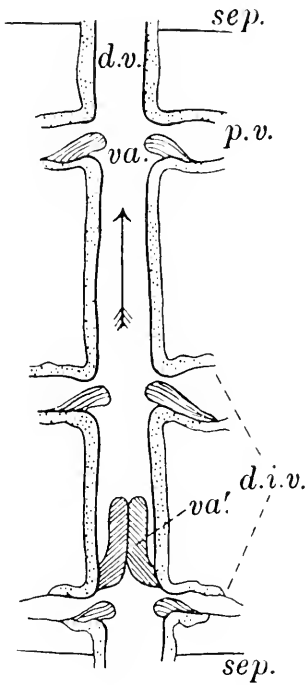

Fig. 201.

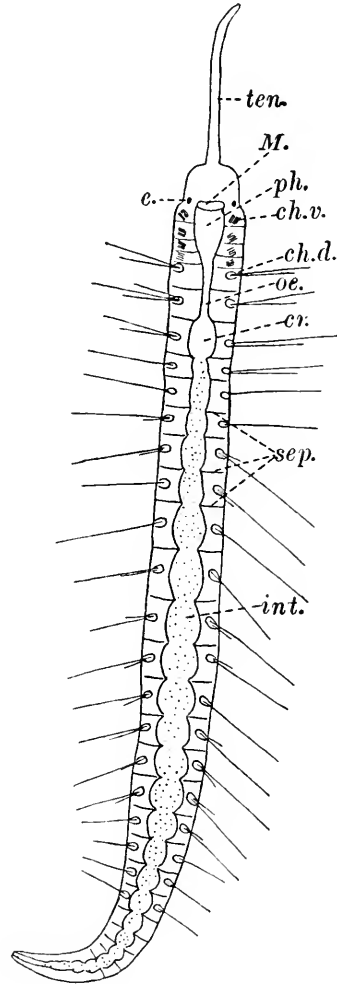

Fig. 202.

Fig. 201. Dorsal vessel of *Lumbricus* to show connections and valves. After Johnston. *d.v.* dorsal vessel; vessels leading to dorsal vessel; *d.i.v.* from sub-intestinal vessel, *p.v.* from subneural vessel (parietal vessel); *sep.* septum; *va.* valves open with dilation and *va\'* closed with contraction of the dorsal vessel.

Fig. 202. *Stylaria proboscidea*. Original. Dorsal view. *ten.* median prostomial process; *cr.* crop; *e.* eye; *M.* mouth; *ph.* pharynx; *oe.* oesophagus; *int.* intestine (stippled); *sep.* septum. The four anterior segments have hooked ventral chaetae (*ch.v.*) only, the rest with long dorsal hair chaetae (*ch.d.*) as well.

From the above account it will be seen that *Stylaria* differs from *Lumbricus* not only in its small size and transparency but also in the number and appearance of the chaetae—which give it a certain

resemblance to the Polychaeta. The reproductive organs, however, are entirely different from those of the latter group and it is in this system that the real contrast between polychaet and oligochaet lies.

The aquatic oligochaets when they are of small size often show reduction of the vascular system, ciliation of the under surface (in one form, *Aeolosoma*), and a nervous system of embryonic type. These are characters which may be primitive but, as in the archiannelids, so here, they are probably the results of simplification; it is generally agreed that the replacement of sexual by asexual reproduction is a secondary feature, and the frequency with which it is found in the aquatic Oligochaeta shows them to be, on the whole, specialized types.

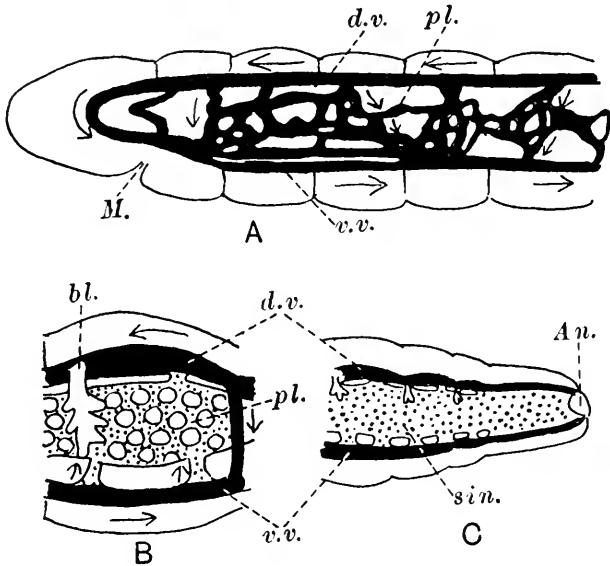

Fig. 203. Blood circulation in *Lumbriculus variegatus*. After Haffner. A, Head and anterior region showing dorsal and ventral vessels joined by a network of vessels round the gut. B, Single segment of the middle region with a much closer plexus. C, Posterior end with a continuous sinus round the gut connected at intervals with the dorsal and ventral vessels. *An.* anus; *bl.* blind contractile sac of the dorsal vessel (*d.v.*); *M.* mouth; *pl.* plexus; *sin.* sinus; *v.v.* ventral vessel.

Two common genera, *Tubifex* and *Lumbriculus*, are larger worms which in their appearance have more resemblance to earthworms. A brief description of them follows.

*Tubifex.* A small red worm with rather numerous chaetae in the dorsal and ventral bundles belonging to various types; without gizzard; testes and ovaries in segments 10 and 11 respectively.

It lives in the mud at the bottom of ponds and lakes with its head buried and its tail waving in the water; the latter movements are respiratory. They draw water from upper layers which contain more

oxygen: when the oxygen content of the water in general falls a greater length of the worm is protruded and its movements become more vigorous. A great deal of detritus passes through its alimentary canal so that *Tubifex* plays the same sort of part in fresh water that the earthworms play on land.

*Lumbriculus* resembles *Tubifex* superficially but has only eight chaetae in a segment, placed as in *Lumbricus*; chaetae double pointed; not often met with in sexual state but reproduces habitually by breaking up into pieces each of which regenerates the missing segments.

In this worm the primitive nature of the blood system is well seen (Fig. 203). At the posterior end there is a continuous *sinus* round the gut, in the middle region this becomes resolved into a dense plexus of capillaries and at the anterior end there is the beginning of a segmental arrangement.

### Class ARCHIANNELIDA

Small marine annelids with simplified structure, parapodia and chaetae being usually absent.

This group was founded to receive two genera, *Polygordius* and *Protodrilus*, which were formerly considered to be primitive forms from which the larger groups of annelids might be derived. From time to time other genera have been included which show some, but not all, of the characters which distinguish the original genera. The series of diagnoses of the best known genera given below starts with *Polygordius* and works back to forms which come very close to the Chaetopoda. There can be little doubt that the Archiannelida are derived from this latter group by the loss of some of its distinctive features (e.g. parapodia and chaetae), and retention of juvenile characters (ciliation and connection of nervous system with epidermis). These changes are also found within the limits of the Polychaeta, and if it was not that other characters link up its members the group might well be considered as a family of polychaets. *Dinophilus* comes late in the series because, though evidently related, it does stand rather apart. It has a superficial resemblance to a small turbellarian enhanced by the great reduction of the coelom.

*Polygordius* (Fig. 198 B) with elongated cylindrical body, head with two tentacles and ciliated pits; without parapodia or chaetae; with segments of the coelom separated by septa with a pair of segmental organs opening into each by nephrostomes; with longitudinal muscles in four quadrants, the circular muscles being usually absent; with a reduced vascular system and nerve cords lying in the epidermis; with a trochosphere larva, Fig. 198 A.



*Protodrilus*. As in *Polygordius* but with segmentation marked externally by ciliated rings and with a longitudinal ciliated groove in the middle of the ventral surface; with a ventral muscular pharyngeal sac; hermaphrodite.

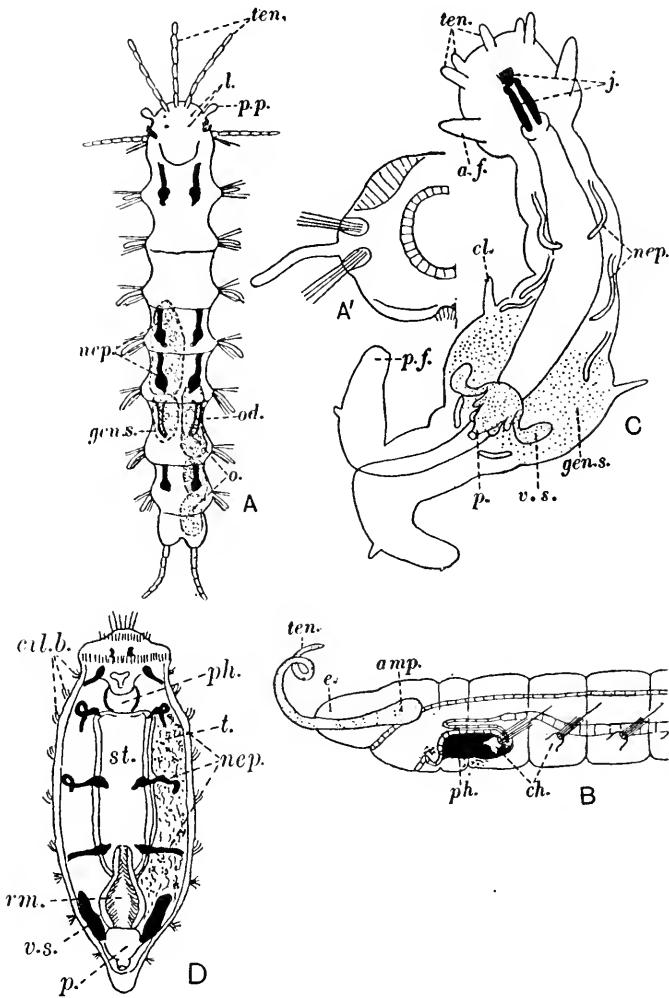

Fig. 204. Examples of the Archiannelida. A, *Nerilla*, dorsal view of female; A', parapodium. B, *Saccocirrus*, side view of anterior end. C, *Histriobdella*, dorsal view of male. D, *Dinophilus*, dorsal view of male. amp. ampulla of tentacle (*ten.*); a.f. anterior foot; ch. bundle of chaetae; cl. clasper; cil.b. bands of cilia; e. eye; gen.s. genital segment; j. jaw; l. eyes; nep. nephridia; o. ovary; od. oviduct; p. penis; ph. pharynx; p.f. posterior foot; p.p. palp; rm. rectum; st. stomach; v.s. vesicula seminalis; t. testis. A, B, after Goodrich; C, after Shearer; D, after Harmer.

A single species, *P. chaetifer*, has recently been discovered with four short chaetae in each segment.

*Saccocirrus* (Fig. 204 B). As in *Protodrilus*, but with chaetae

arranged in a single bundle on each side of each segment; with separate sexes, each with complicated genital apparatus, the females with spermathecae and males with a pair of protrusible penes in each segment behind the oesophagus.

*Nerilla* (Fig. 204 A). As in *Protodrilus*, but with two bundles of chaetae separated by a single cirrus on each side of each segment; three prostomial tentacles and a pair of palps; with separate sexes and a reduced number of genital segments (three in male, one in female), three pairs of sperm ducts uniting at a common median genital aperture, and two oviducts with separate genital apertures.

*Dinophilus* (Fig. 204 D) with very short flattened body consisting of only five or six segments, a ciliated ventral surface and ciliated ring in every segment; without septa, dorsal and ventral mesenteries, and a vascular system; with greatly reduced coelom and longitudinal muscles; five pairs of "closed" nephridia; separate sexes, male with median penis injecting spermatozoa into female through skin, female with eggs of two sizes, the smaller giving rise to males and the larger to females.

*Histriobdella*, which may be mentioned here (Fig. 204 C), is a parasite of the eggs of the lobster, having no chaetae but two pairs of "feet" by which it executes acrobatic movements. It resembles *Dinophilus* in its reduced coelom and musculature but has jaws, and from the structure of these it has been claimed that *Histriobdella* is a much modified polychaet belonging to the family Eunicidae.

The value of the Archiannelida to the elementary student of zoology is that they illustrate an evolutionary process which may be called simplification or reduction (but not degeneration), and which is not unlike the changes which parasitic forms have undergone.

### Class HIRUDINEA

Annelida with a somewhat shortened body and small, fixed number of segments, broken up into annuli and without chaetae (except in *Acanthobdella*) or parapodia; at the anterior and posterior ends several segments modified to form suckers; coelom very much encroached upon by the growth of mesenchymatous tissue and usually reduced to several longitudinal tubular spaces (sinuses) with transverse communications. Hermaphrodite, with clitellum. Embryo develops inside cocoon.

In the typical leeches the *constitution of the body* is remarkably constant. There is a prostomium and thirty-two body segments; an anterior sucker (in the centre of which is the mouth) is formed from the prostomium and the first two segments, and a posterior from the last seven. Both suckers are directed ventrally. The subpharyngeal

“ganglion” (Fig. 205 B) is composed of four single ganglia fused together and the posterior “ganglion” of seven. Between them lie twenty-one free ganglia, and the number of segments is estimated by summation of all the ganglia. The number of annuli to a segment varies in different forms.

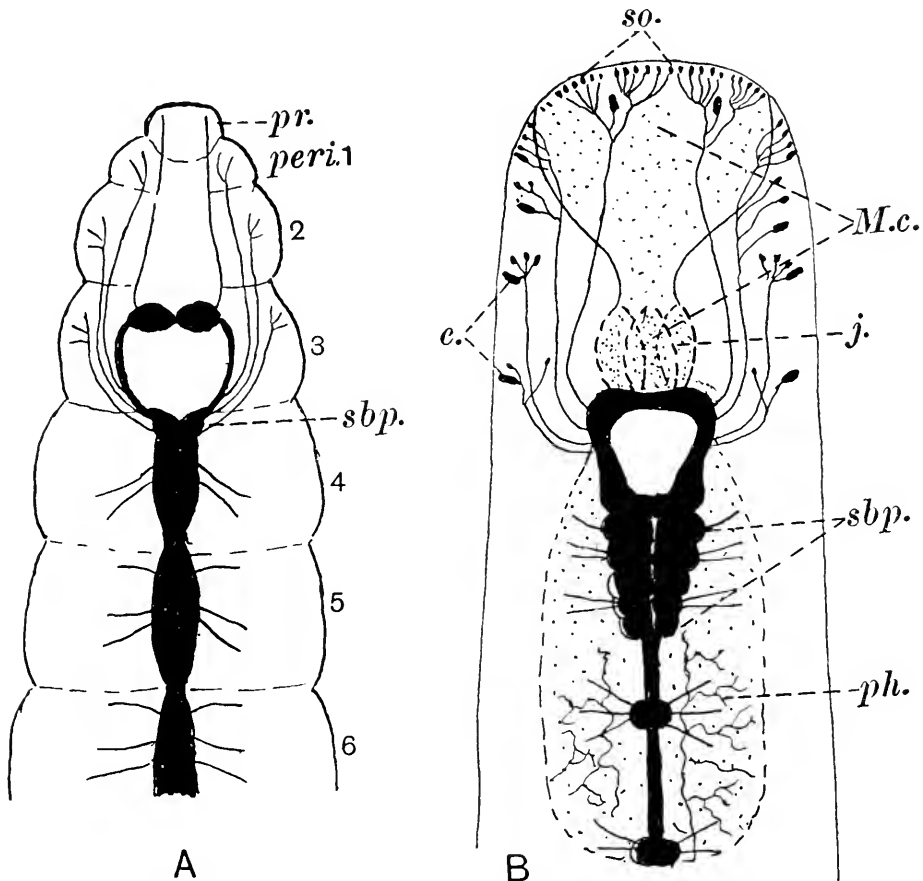

Fig. 205. Anterior part of nervous system in A, *Lumbricus*. After Borradaile. B, *Hirudo*. After Leydig. The brain in both consists of a single dorsal pair of ganglia belonging to the prostomium. In *Lumbricus* the subpharyngeal ganglion (*sbp.*) and lower part of the circumpharyngeal commissures give off nerves to segments 1 (*peri.*) peristomium, 2, 3 and so belong to three segments. In *Hirudo* the subpharyngeal mass consists of four (or five) pairs of ganglia fused together. *e.* eyes; *M.c.* mouth cavity; *j.* jaws; *pr.* prostomium; *ph.* pharynx (with network of visceral nerves); *so.* sense organs.

The *alimentary canal* is highly characteristic and consists of the following parts. (1) A muscular *pharynx* with unicellular salivary glands. In the Gnathobdellidae, which includes *Hirudo*, there are three chitinous plates or jaws. In the Rhynchobdellidae (Fig. 206), there is a protrusible *proboscis* surrounded by a *proboscis sheath*. (2) A short *oesophagus* follows, leading into (3) the *mid gut* (crop) which is

often provided with lateral coeca, varying in number, and is used for storing up the blood or other juices of the host. This is kept from coagulating by the ferment (anticoagulin) contained in the salivary secretion (*Hirudo*). In the mid gut a very slow digestion takes place, the blood appearing almost unchanged even after several months. (4) An *intestine*, which is also endodermal, and has, in *Hirudo*, a pair of diverticula. (5) A very short ectodermal *rectum* discharging by the anus, which is dorsal to the posterior sucker.

The *body wall* consists of a single layer of ectodermal cells between which blood capillaries penetrate, a dermis with pigment cells and blood vessels, and an outer circular and inner longitudinal layer of muscles. The muscle fibres have a characteristic structure, consisting

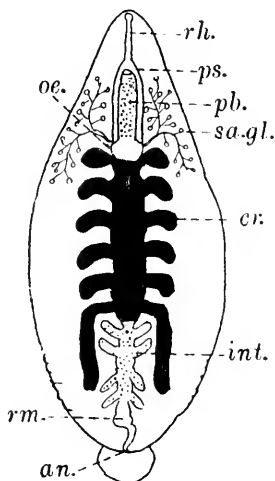

Fig. 206. *Glossiphonia* as example of the Rhynchobdellidae. Dorsal view. *an.* anus; *cr.* crop (black); *int.* intestine (stippled); *oe.* oesophagus; *pb.* proboscis; *ps.* proboscis sheath; *rh.* rhynchodaeum; *rm.* rectum; *sa.gl.* salivary glands.

of a cortex of striated contractile substance and a medulla of unmodified protoplasm. Inside the musculature are masses of mesenchymatous tissue: in the Gnathobdellidae this is pigmented and forms the *botryoidal tissue*, the cells of which are arranged end to end and contain intracellular capillaries filled with a red fluid.

The mesenchyme almost completely occupies the space which is the perivisceral cavity in the earthworm. There are, however, longitudinal canals, constituting the *sinus system*, and these represent the remnants of the coelomic spaces; there are always dorsal and ventral and often (e.g. *Glossiphonia*, Fig. 207 B) two lateral sinuses, and there are numerous transverse canals in each segment. Into this reduced coelom the nephrostomes open and the gonads are found in it. The

blood system consists of two contractile lateral vessels (and in the Rhynchobdellidae of dorsal and ventral vessels running inside the corresponding coelomic spaces). These vessels all communicate with

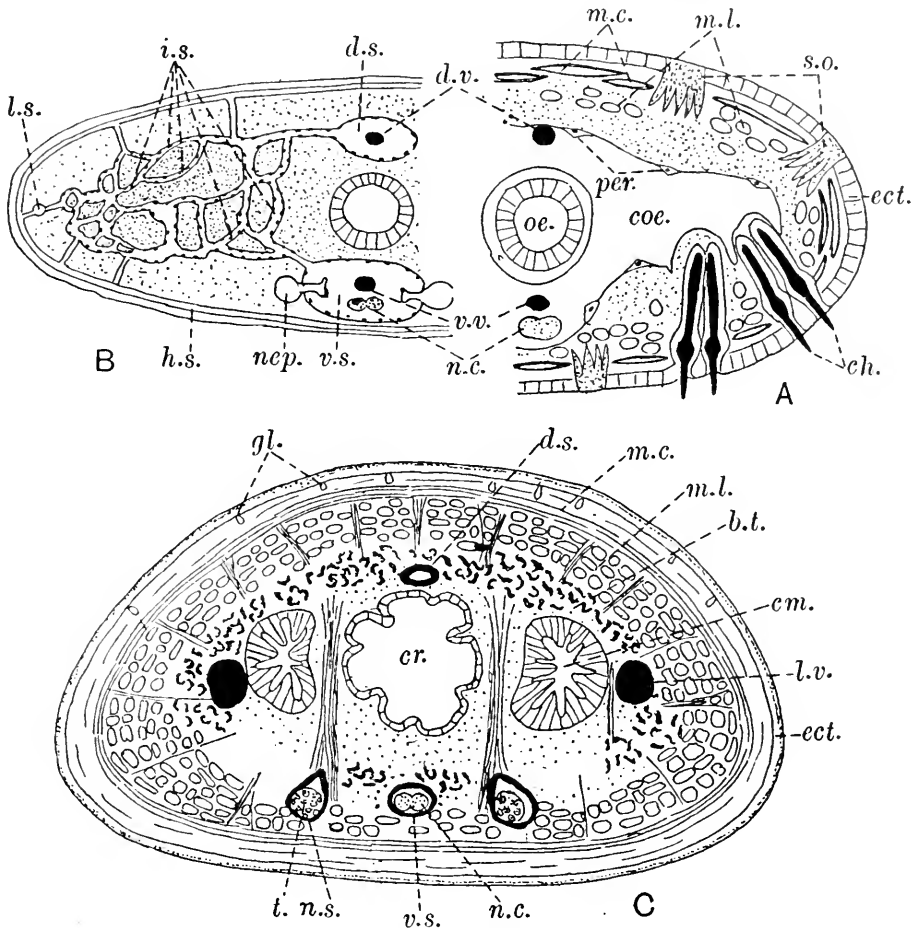

Fig. 207. Transverse sections of *Hirudinea* to show the progressive restriction of the coelom. A, *Acanthobdella*, B, *Glossiphonia*, C, *Hirudo*. In A the coelom (*coe.*) is continuous but encroached upon by growth of parenchyma (stippled). In B it is broken up into a system of sinuses. *d.s.* dorsal; *v.s.* ventral; *h.s.* hyperdermal sinus; *l.s.* lateral and *i.s.* a network of intermediate sinuses. In C the sinuses (outlined in black) are reduced in size, and there is no intermediate network. *n.s.* the nephrostomial sinuses, branches of the ventral sinus, contain the testes (*t*); botryoidal tissue (*b.t.*) is present; *ch.* chaetae; *cm.* coecum; *cr.* crop; *d.v.* dorsal, *l.v.* lateral, *v.v.* ventral blood vessel; *ect.* ectoderm; *gl.* glands; *m.c.* circular, *m.l.* longitudinal muscles; *nep.* nephridium; *n.c.* nerve cord; *oe.* oesophagus; *per.* peritoneum; *s.o.* sense organs.

one another. They also communicate with the sinuses of the coelom and with the capillaries of the botryoidal tissue, as has been shown by careful injection. This astonishing condition is unique, but a parallel may be drawn with the vertebrate in which the lymphatic

system communicates both with the coelom and the blood system. The peculiar functions of the lymphatic system are not shared by the botryoidal vessels which have no particular connection with the gut.

The *nervous system* is of the usual annelidan type but characterized by the fusion of ganglia anteriorly (Fig. 205) and posteriorly. There are segmental sense organs in the form of papillae, and on the head some of these are modified to form eyes and the so-called "cup-shaped organs".

The *nephridia* consist of two tubes, one ending in a nephrostome, the other with an external aperture; their lumina do not communicate (Fig. 192); the nephrostomes open into a branch of the ventral or the lateral sinus. The *testes*, of which there are often several pairs (nine in *Hirudo*), and the single pair of ovaries are also present as closed vesicles in the sinuses and are derived from the coelomic epithelium, but in distinction from the rest of the annelids they are continuous with their ducts. The separation of the genital part of the coelom from the rest, begun in the Oligochaeta, here becomes complete. The testes discharge into a common vas deferens on each side; the two vasa unite anteriorly to form a median penis. Similarly the two oviducts join and the eggs pass through a single albumen gland and vagina to the exterior. The spermatozoa, united in bundles, are deposited on the body of another leech and appear to make their way through the skin to the ovaries where fertilization occurs. The eggs are laid in cocoons, the case of which is formed by clitellar glands in the same way as in *Lumbricus*.

The Hirudinea may be divided as follows:

ACANTHOBDELLIDAE, a family intermediate between the Oligochaeta and the Hirudinea, containing the single genus *Acanthobdella*.

RHYNCHOBDELLIDAE, marine and freshwater forms, with colourless blood, protrusible proboscis and without jaws.

GNATHOBDELLIDAE, freshwater and terrestrial forms, with red blood without a protrusible proboscis but usually with jaws.

Family Acanthobdellidae.

*Acanthobdella* (Fig. 207 A), a parasite of salmon, is a link with the Oligochaeta. In it the specialized hirudinean characters are only partly developed. There is no anterior sucker but a well-developed posterior sucker formed from four segments. The total number of segments is twenty-nine compared with thirty-two in the rest of the group. There are dorsal and ventral pairs of chaetae in the first five body segments and the coelomic body cavity is a continuous perivisceral space, interrupted only by segmental septa as in the Oligochaeta. It is, however, restricted by the growth of mesenchyme in the body wall and split

up into a dorsal and ventral part in the clitellar region. The so-called testes (really vesiculae seminales) are tubes running through several segments, filled with developing spermatozoa and their epithelial wall is continuous with that of the perivisceral coelom, another primitive feature. The vasa deferentia, moreover, open into the testes by typical sperm funnels.

It is interesting to find that in the Branchiobdellidae, a family of the Oligochaeta, parasitic on crayfish, there is the same sort of leech-like structure: a posterior sucker, annulated segments, absence of chaetae and presence of jaws. But the condition of the coelom, nephridia and generative organs is so like that of the Oligochaeta that the family must remain in that group.

#### Family Rhynchobdellidae.

*Pontobdella*, parasitic on elasmobranch fishes.

*Glossiphonia* (Fig. 206), a freshwater leech feeding on molluscs like *Limnaea* and *Planorbis* and on the larvae of *Chironomus*; body ovate and flattened; hind gut with four pairs of lateral coeca; eggs laid in the spring, the young when hatched attaching themselves to the ventral surface of the body of the mother.

#### Family Gnathobdellidae.

*Hirudo*, the medicinal leech, at one time a common British species but now extinct; jaws armed with sharp teeth.

*Haemopsis*, the horseleech, common in streams and ponds, which it leaves to deposit its cocoons and in pursuit of prey; jaws armed with blunt teeth, which cannot pierce the human skin; a single pair of coeca in the mid gut.

This leech is carnivorous, devouring earthworms, aquatic larvae of insects, tadpoles and small fish. The land leeches of the tropics, of which *Haemadipsa* may serve as an example, live in forests and swamps and, mounted on leaves and branches, wait until a suitable mammalian prey presents itself.

The following classes, the Echiuroidea and the Sipunculoidea, were formerly classed together as the Gephyrea. There is, however, good reason for separating them in spite of their general similarity, which is possibly due to the fact that they are both composed of burrowing animals and have lost their segmentation.

### Class ECHIUROIDEA

Annelids which show few signs of segmentation, with a spacious coelomic cavity, a well-developed prostomium, a terminal anus, a single pair of ventral chaetae, sometimes several pairs of segmental organs, and in *Echiurus* a trochosphere larva in the nervous system of

which there appear to be as many as fifteen pairs of ganglionic swellings (Fig. 208).

*Echiurus*, with a spoon-shaped prostomium, two pairs of segmental organs and a trochosphere larva.

*Bonellia* (Fig. 209 A, B) with a prostomial proboscis bifurcated at

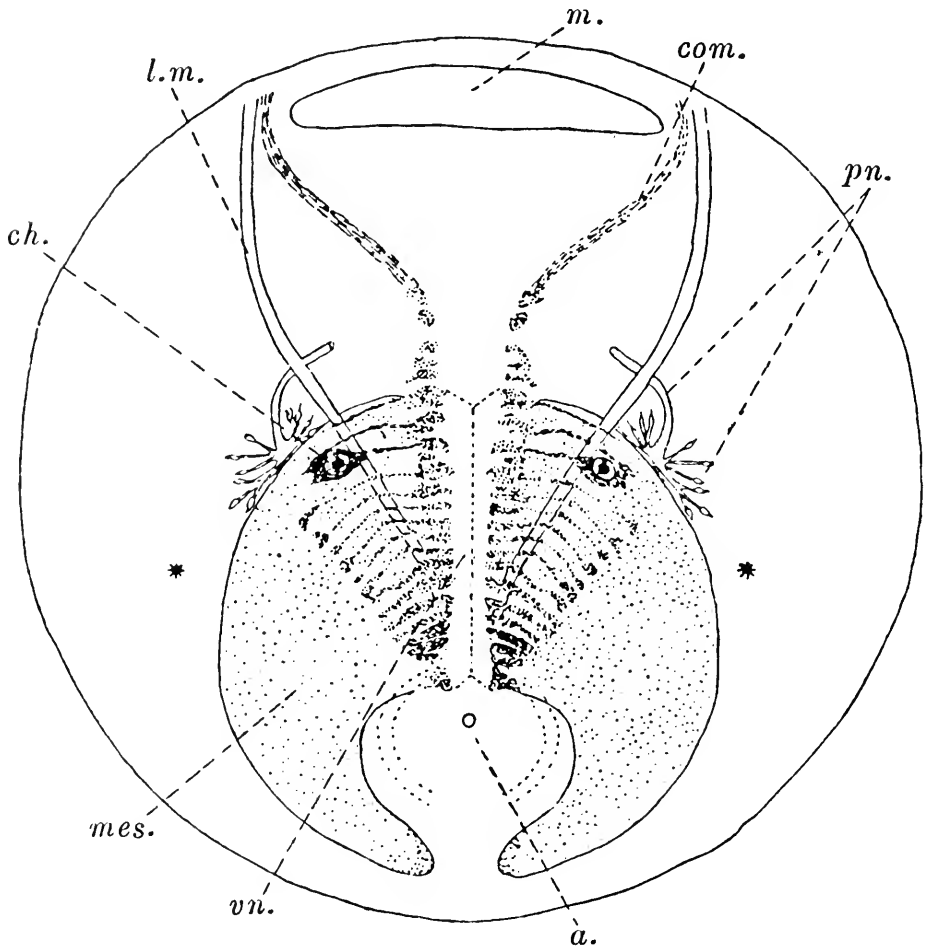

Fig. 208. *Echiurus*. Ventral view of larva to show segmentation of posterior end. After Baltzer. *a.* anus; *ch.* chaeta-forming cell; *com.* neural commissure; *l.m.* longitudinal muscle; *m.* mouth; *mes.* mesoderm; *pn.* larval nephridium with solenocytes; *vn.* ventral nerve cord composed of many neuromeres.

the end, capable of enormous elongation and extremely mobile; a single segmental organ (brown tube); the female is the typical individual and the males are reduced to small ciliated organisms, like a turbellarian, which live in the segmental organ of the female.

It is now known that larvae of *Bonellia* carry the potentialities of both sexes. If they develop independently they become females. If



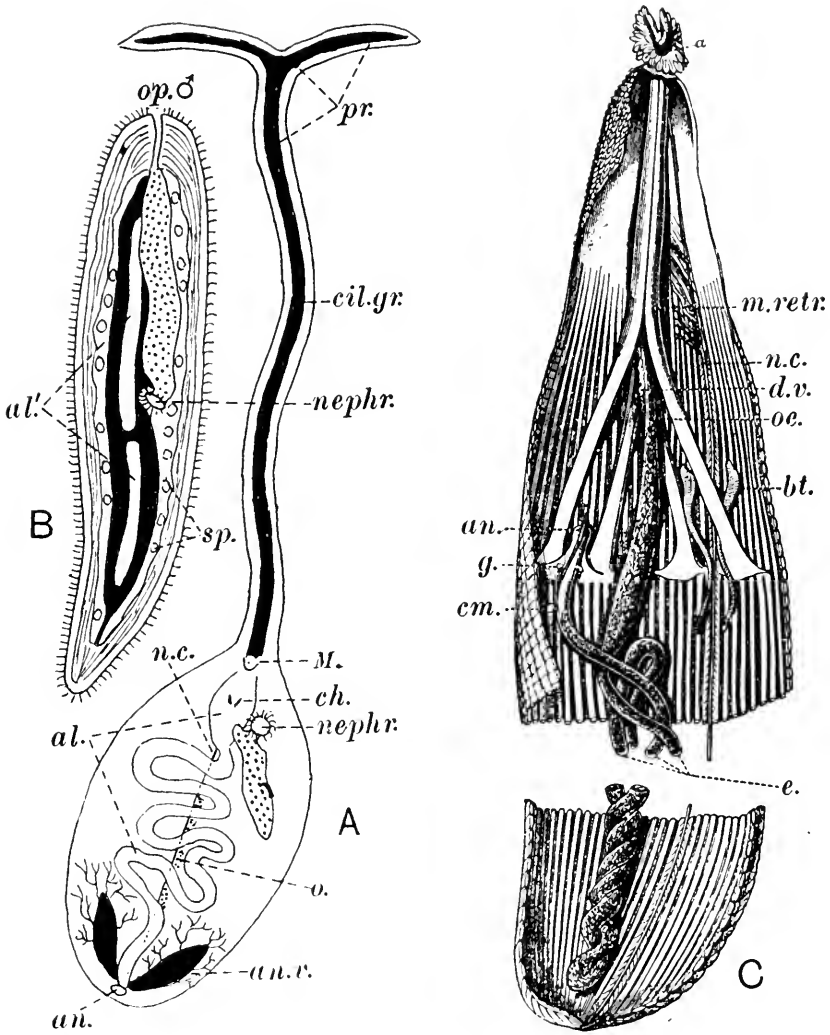

Fig. 209. *Bonellia viridis*. A, Female. B, Male from nephridium of female. After Spengler. C, *Sipunculus*. From Shipley and MacBride. *a.* frilled membrane surrounding the mouth; *al.* alimentary canal; *al'.* degenerate alimentary canal of male; *an.* anus; *an.v.* anal vesicle; *bt.* brown tube (nephridium); *ch.* position of chaetae; *cil.gr.* ciliated groove; *cm.* coecum of gut; *d.v.* dorsal blood vessel; *e.* cut ends of intestine; *g.* anal glands; *m.retr.* retractor muscle of anterior end; *M.* mouth; *n.c.* nerve cord; *neph.* nephrostome; *oe.* oesophagus; *o.* ovary; *op.♂* male reproductive aperture; *pr.* greatly enlarged prostomium; *sp.* spermatozoa.

they should come into contact with the body of the adult female, she exercises (probably through the action of some specific secretion) a largely repressive effect on further development, but a male gonad is formed.

*Thalassema*. The British representative, *T. neptuni*, has a single pair of segmental organs. In two Japanese species, *T. taenioides* and *T. misakiensis*, these have been greatly multiplied so that in the former there are 200 pairs rather irregularly arranged. From a consideration of these forms it appears that the multiplication of the segmental organs is a secondary phenomenon.

### Class SIPUNCULOIDEA

Annelids with a spacious uninterrupted coelomic cavity and few signs of segmentation: without prostomium in adult; chaetae always absent, anterior part of body invaginable into posterior part; anus dorsal and anterior; with a single pair of segmental organs (brown tubes); in *Phascolosoma* a trochosphere with three pairs of mesoblastic somites which soon disappear.

*Sipunculus* (Fig. 209 C) and *Phascolosoma* are British genera.

## CHAPTER X

# THE PHYLUM ARTHROPODA

Bilaterally symmetrical, segmented Metazoa; with, on some or all of the somites, paired limbs, of which at least one pair function as jaws; a chitinous cuticle, which usually is stout but at intervals upon the trunk and limbs flexible so as to provide joints; a nervous system upon the same plan as that of the Annelida; the coelom in the adult much reduced and replaced as a perivisceral space by enlargement of the haemocoel; without true nephridia, but with one or more pairs of coelomoducts as gonoducts and often as excretory organs; and (except in *Peripatus*) without cilia in any part of the body.

The Arthropoda have much in common with the Annelida, and must be regarded as derived from the same stock as the Polychaeta in that phylum. The key to most of their peculiar features is an increase in the thickness of the cuticle. This brings with it the necessity for joints; and the stout, jointed limbs can now be adapted for various purposes to which those of polychaetes were not convertible. Always at least one pair of them become jaws; with this is usually associated the specialization for sensory functions of one or two pairs which have come to stand in front of the mouth, and thus the process of cephalization, begun in the polychaetes, proceeds further here. Other limbs commonly become legs. In order to move the complex of hard pieces constituted by the jointed cuticle, the continuous muscular layer of the body wall of an annelid has become converted into a system of separate muscles; with this, and with the fact that turgescence of the body wall is no longer a factor in locomotion, is perhaps connected the replacement of the perivisceral coelom by a haemocoelic space. The loss of the nephridia which in annelids lie in the coelom is probably due to the reduction of that cavity. An interesting feature of difference between the Arthropoda and Annelida is the absence from the former phylum of the chetae, imbedded in and secreted by pits of the skin, which characterize the annelids; though bristles, formed as hollow outgrowths of the cuticle, are common on arthropods. This difference, too, may be connected with the difference in the stoutness of the cuticle. Lastly, it is perhaps that thick covering, hindering the loss of water by evaporation from the surface of the body and providing the skeleton which the lack of support from the medium necessitates, which has enabled arthropods very successfully to invade the dry land. Like those of all other phyla, their earliest known members, the trilobites, were aquatic. Of their surviving groups,

# SOMITES AND LIMBS

Somite	Onychophora	Arachnida Scorpionida	Trilobita
1...*	Preantennae	Embryonic	?
2...	Jaws	Chelicerae	Antennae
3...	Oral Papillae	Pedipalpi	1st biram. limbs
4...	1st pair of legs	1st pair of legs	2nd ,,
5...	2nd ,,	2nd ,,	3rd ,,
6...		3rd ,,	4th ,,
7...		4th ,,	5th ,,
8...		Embryonic††	
9...		Genital operc. ♀ ♂	
10...		Pectines	
11...		1st Lung books	
12...		2nd ,,	
13...		3rd ,,	
14...		4th ,,	
15...		No limbs	
16...		1st som. Metasoma	
17. .		2nd ,,	
8...		3rd ,,	
19...		4th ,,	
20...		5th ,,	
21...		...	
22...		...	
23...		...	
24...		...	
25...		...	
26...		...	
27...		...	
28...		...	
29...		...	
...	Last pair of legs ♀ ♂	...	
Postseg- mental region)	Embryonic	Telson	Telson

\* Eyes and frontal organs belong to a presegmental region which may have median

\*\* If the superlinguae be maxillules (see p. 463), the limbs behind them stand on

† Terga fused in *Scolopendra*, free in *Lithobius*. †† Chilaria in *Limulus*.

§ This somite appears to have no limbs, because the limbs of the 8th and 9th somites  
♂ indicates the position of the male opening, ♀ that of the female.

# OF ARTHROPODA

Crustacea Malacostraca	Insecta	Chilopoda ( <i>Scolopendra</i> )	Diplopoda (Julidae)
Embryonic	Embryonic	Embryonic	?
Antennules	Antennae	Antennae	Antennae
Antennae	Embryonic	Embryonic	Embryonic
Mandibles	Mandibles	Mandibles	Mandibles
Maxillules	(1st) Maxillae**	1st Maxillae	Embryonic
Maxillae	Labium (2nd Maxillae)	2nd Maxillae	Maxillae
(1st) Maxillipeds	1st pair of legs	Maxillipeds	Collum
2nd Thoracic limb	2nd „	1st pair of legs } †	1st pair of legs
3rd „	3rd „	2nd „	2nd „ ♀♂§
4th „	1st Abd. som.	3rd „	3rd pair of legs
5th „	2nd „	4th „	4th „
6th „ ♀	3rd „	5th „	5th „ } Many (20 to 100) double somites, each bearing two pairs of legs
7th „	4th „	6th „	
8th „	5th „	7th „	
1st Abd. limb	6th „	8th „	
2nd „	7th „	9th „	
3rd „	8th „ †	10th „	
4th „	9th „ (styles) ♂	11th „	
5th „	10th „ som.	12th „	
6th „	11th „ (cerci)	13th „	
...	...	14th „	
...	...	15th „	
...	...	16th „	
...	...	17th „	
...	...	18th „	
...	...	19th „	
...	...	20th „	
...	...	21st „ †	
...	...	Genital limbs ♀♂	
...	...	...	Limbless somite
Telson	Embryonic	Telson	Telson

mesoblast of its own, and may bear various ganglia which enter into the procerebrum. somites 6, 7, etc.

† *Lithobius* has 15 pairs of legs.  
have each moved forward one somite.

only one, the Crustacea, remain predominantly of that habit. No other invertebrate phylum has so large a proportion of terrestrial members.

A more detailed survey of the organization which we have now outlined, necessitates a brief exposition of the principal groups into which the phylum falls. One small section stands apart from the rest. The *Onychophora* have a thin cuticle, without joints; a continuous muscular body wall; eyes (p. 310) of annelid type; only one pair of jaws, which moreover are constructed on a different principle from those of other arthropods, biting with the tip and not with the base of the limb; and a long series of coelomoducts, of which the pair that are the oviducts are ciliated. Only in this group, too, does the first somite bear a pair of limbs: in all others that somite is an evanescent, embryonic structure without external representation in the adult. In all these respects the *Onychophora* show a lower degree of development of the peculiar features of arthropods than the rest of the phylum.

The remaining groups of the phylum fall into two sharply different sections, the *crustacean-insect-myriapod* section and the *arachnid* section. In the first of these sections, the first pair of limbs (those of the second somite) are antennae, the succeeding pair, if present, are also antennae, the third pair are mandibles, and behind these limbs are one or more pairs of additional jaws (maxillae). In the crustaceans and insects there is commonly a pair of compound eyes of a complex type peculiar to these animals. The trilobites belong to this section, but their appendages behind the first pair are undifferentiated. In the arachnid section none of the limbs have the form of antennae or mandibles, the first pair (chelicerae) being usually chelate, the second chelate, palp-like, or leg-like, and the third to sixth pairs leg-like, though often some of the postcheliceral limbs possess biting processes (gnathobases) on the first joint. The members of this section never possess true compound eyes of the crustacean-insect type.

The *Crustacea* differ from the *Insecta* and *Myriapoda* in possessing a second pair of antennae, and nearly always in being truly aquatic. The *Insecta* differ from the *Myriapoda* in possessing only three pairs of legs, and usually in the possession of wings.

The series of somites which, with small pre- and postsegmental regions, constitutes the body of an arthropod is marked out, by differences in width, fusions of somites, or features of the limbs, into divisions known as *tagmata*. In the *Onychophora*, *Crustacea*, *Insecta*, and *Myriapoda*, the foremost tagma is a short division, known as the *head*, which carries the antennae and mouth parts, and the rest of the body, known as the *trunk*, is often divided into two sections called *thorax* and *abdomen*. In the *Arachnida*, the foremost tagma is the *prosoma* ("cephalothorax"), and carries legs as well as the limbs

used in feeding, while the divisions, if any, of the hinder part of the body (*opisthosoma* or "abdomen") are known as the *mesosoma* and *metasoma*. It is important that the student should recognize that each of these divisions varies in size, and that consequently none of them comprises in all arthropods the same somites, so that, for instance, the thorax of an insect is a quite different entity from that of a crayfish. The most significant variation is that of the head, which, as the organization of its possessor becomes higher, increases in size, taking in behind somites whose appendages become jaws, while, by alteration in the position of the mouth, it adds others, whose limbs become antennae, to its preoral sensory complex. Thus, while the head of the Onychophora comprises only the first three somites, and only the first of these is preoral, in the Crustacea there are in the true head six somites (including the embryonic first somite), of which three are preoral, and thoracic somites, whose limbs (maxillipeds) function as jaws, are often united with the head.

The *paired limbs* of arthropods present an enormous variety of form, and attempts have been made to reduce them to a common type. Some of the evidence suggests an archetype with a nine-segmented axis bearing on the median side of the first segment a biting process (gnathobase) and on a more distal segment an outer branch (exopodite); but there are difficulties in the way of assuming this in all cases, and the problem is still far from solution.

The arthropod *cuticle* has a thin, impermeable, non-chitinous external layer (*epicuticle*) and a thick, elastic, permeable, lamellar inner layer (*endocuticle*), largely composed of chitin<sup>1</sup>, the outer lamellae usually hardened, often by salts of lime. From time to time during the growth of the animal, the hard outer layers of the cuticle are separated by solution of the inner layers by an enzyme, ruptured, and shed in a *moult* or *ecdysis*. A new cuticle which has formed under it then expands to accommodate the body.

The *nervous system* of arthropods contains, in typical instances, on two longitudinal ventral cords and in a dorsal brain, a pair of ganglia for each somite, but where the somites are fused there is often a fusion of their ganglia, and where they bear no limbs their ganglia may be absent. The *brain* is a complex structure composed of the ganglia of the somites which have become preoral (though in a few crustacea the antennal ganglion remains postoral), of paired ganglia for certain primitively preoral presegmental sense organs (eyes, frontal organs), and sometimes also of a median anterior element (*archicerebrum*, in the strict sense). The ganglia of the first somite are known as the *protocerebrum*; with the ganglia anterior to them they constitute the *procerebrum* (*archicerebrum* of Lankester). The ganglia of the second

<sup>1</sup> Chitin is an amino-polysaccharide which resists most solvent agents.

somite are the *deutocerebrum* or *mesocerebrum*; those of the third somite are the *tritocerebrum* or *metacerebrum*. The identity of some of these ganglia may be lost, even in development. Concerning the functions of the central nervous system something is said on p. 448.

The *eyes* of the Onychophora are a pair of simple, closed vesicles, each with its hinder wall thickened and pigmented and its cavity occupied by a lens secreted by the wall. The eyes of all other arthropods (Fig. 211) consist of one or more units each of which is in essence a cup, or a vertical bundle, of cells, over which the cuticle of the body forms a lens. The cells which compose the bottom of each cup are (except in the median eye of the Crustacea) arranged in a sheaf or sheaves called *retinulae*; in the midst of each retinula is a vertical rod, known as the *rhabdom*, secreted by the cells of the sheaf in vertical sections which, when they are distinct, are known as *rhabdomeres*. Each bundle-unit has one such retinula. Sometimes in the cups the retinulae are surrounded by cells which bear on their free ends short *rods* of the same nature as the rhabdomeres. The retinula cells contain pigment and there is a ring of strongly pigmented cells around the cup. The eye units occur (*a*) as single cups each with several retinulae (ocelli of insects, Fig. 211 C"), (*b*) as groups of similar cups placed contiguously (eyes of myriapods), (*c*) as eyes composed of a number of small cups, each with a single retinula, united together (lateral eyes of *Limulus*), (*d*) as true compound eyes (Fig. 212) composed of a number of bundles of cells, each bundle (*ommatidium*) complex in structure and containing two or more refractive bodies, but each probably representing a narrowed and deepened cup. Compound eyes of this type are found in crustaceans and insects. They vary much in detail, but essentially the structure of an ommatidium is as follows (Fig. 211 D). At its outer end is a transparent portion of the general cuticle of the body, usually thickened to form for the ommatidium a biconvex lens. Under this lie the epidermal cells which secrete it (*corneagen cells*): the lens is one of the facets of the eye. Under the corneagen cells comes a bundle of two to five *vitrellae* or crystal cells, grouped around a refractive body, the *crystalline cone*, which they have secreted. The vitrellae taper inwards and their apex is clasped by a second bundle of cells, four to eight in number, which together form the *retinula*. Like the vitrellae the retinular cells secrete in the axis of the ommatidium a refractive body. This is the *rhabdom*, and is made up of *rhabdomeres*, one for each of the cells. Each retinular cell passes at its base into a nerve fibre which pierces the basement membrane of the eye and enters the optic ganglia. Around each ommatidium, separating it from its neighbours, there are usually pigmented cells, known as *iris cells*. The eyes of arachnids, other than the lateral eyes of *Limulus*, simulate the ocelli of insects, but are



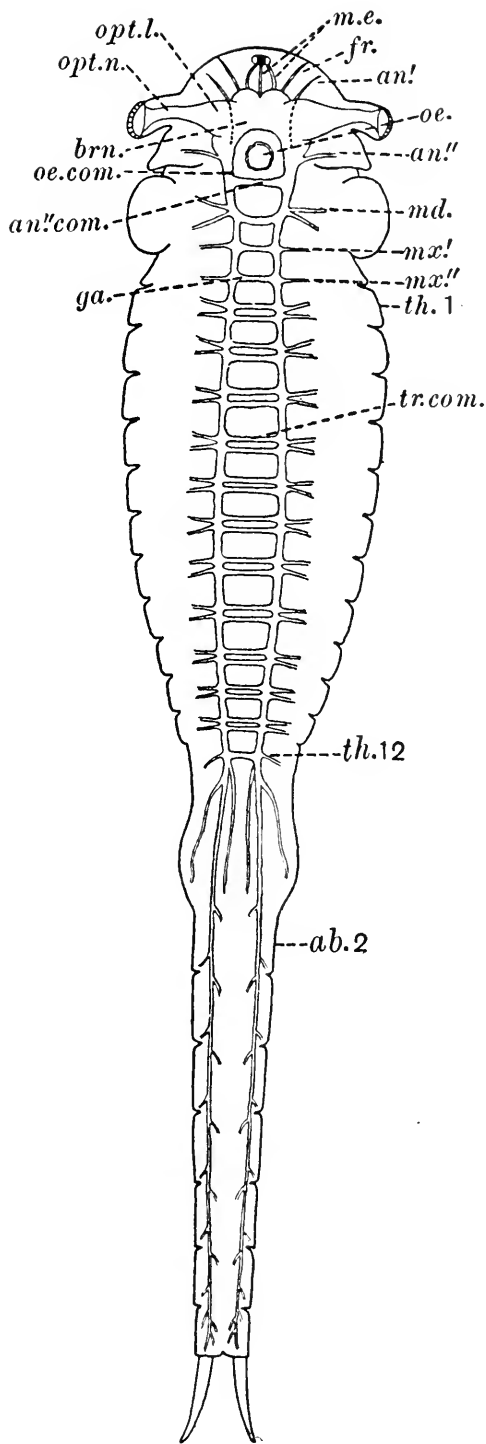

Fig. 210. A plan of the nervous system of *Chirocephalus*. *ab.2*, second abdominal somite; *an.'* antennular nerve; *an.''* antennary nerve; *an''.com.* commissure for fibres which unite antennary ganglia; *brn.* brain; *fr.* nerve to frontal organ; *ga.* ganglion of ventral cord; *m.e.* nerves to median eye; *md.* mandibular nerve; *mx.'* maxillular nerve; *mx.''* maxillary nerve; *oe.* oesophagus; *oe.com.* circumoesophageal commissure; *opt.l.* optic lobes; *opt.n.* optic nerve; *th.1*, first thoracic somite; *th.12*, nerve of last thoracic somite; *tr.com.* transverse commissure of ventral cords.

thought, from details of their structure, to have been formed by the degeneration of compound eyes resembling the lateral eyes of *Limulus*. The median eye of the Crustacea (Fig. 226) is composed of

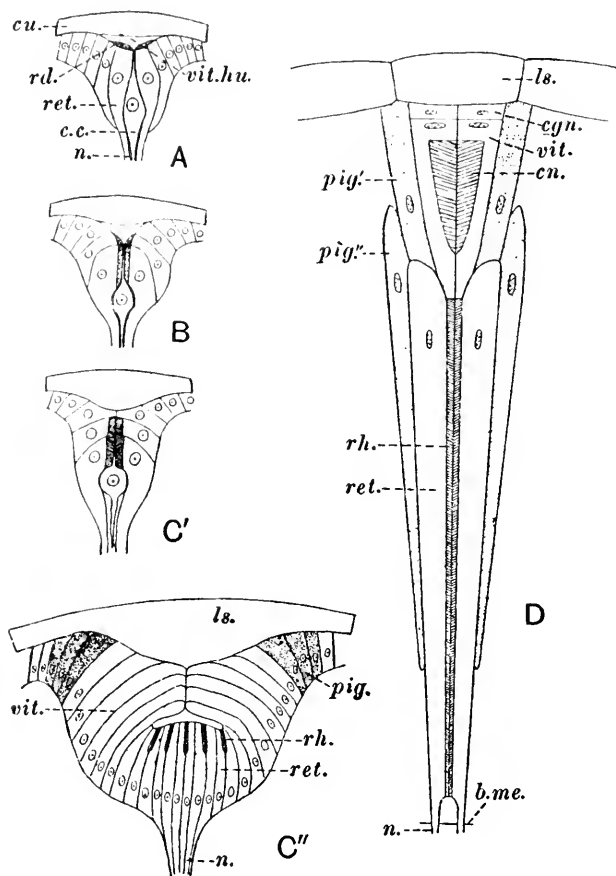

Fig. 211. Diagrams of a series of eyes of arthropoda. A, Hypothetical starting point of the series. B, Cells have sunk in to form a retinula. The units of the lateral eyes of *Limulus* are substantially in this condition. C', C'', Cells from the sides have closed in over the retinula. C', Hypothetical stage in the evolution of an ommatidium from a cup with a single retinula. C'', Actual condition of many ocelli of insects, etc.: the cup has several retinulae. D, An ommatidium. *b.me.* basement membrane of retinular layer; *c.c.* central cell; *cgn.* corneagen cells; *cn.* crystalline cone; *cu.* cuticle; *ls.* lens; *n.* nerve fibre; *pig.* pigmented cells which form a ring in the outer part of the ocellus; *pig.'* outer iris cells; *pig. ''* inner iris cells; *rd.* "visual rods"; *ret.* retinular cells; *rh.* rhabdona; *vit.* vitrellae; *vit.hu.* vitreous humour.

three cups, which may (some copepods) separate widely. The paired eyes probably do not, as has been suggested, represent a pair of appendages. The foremost, or preantennal, somite, to which they would in that case belong, possesses, in *Peripatus* and as a rudiment in

embryonic stages of centipedes and certain insects, an appendage which co-exists with the eye.

In most compound eyes, the pigment, both in reticular and in pigment cells, flows to and fro, being in dim light retracted towards the inner or outer ends of the cells so as to leave the sides of the ommatidia exposed, and in bright light extending so as to separate the ommatidia completely. In many diurnal insects it is permanently in the latter position. Vision takes place in two ways according to the situation of the pigment. When the latter is extended, in each omma-

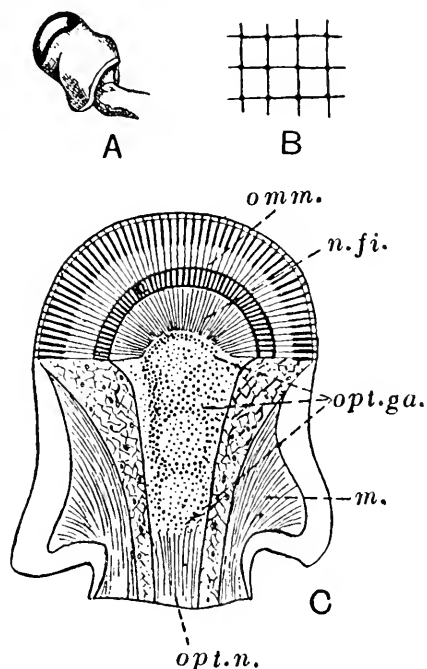

Fig. 212. The eye of *Astacus*. A, The left eye. B, A portion of the cornea removed, to show the facets. C, A longitudinal section of the eye. *m.* muscles which move the eye; *n.fi.* nerve fibres; *omm.* ommatidia; *opt.ga.* optic ganglion; *opt.n.* optic nerve.

tidium there falls on the retinula a narrow pencil of almost parallel rays. There is then *mosaic vision*, an *apposition image*, composed of as many points of light as there are ommatidia, being formed on the whole retinal layer. When the pigment is retracted, each ommatidium throws a complete image of the greater part of the field of vision, and the images together form a *superposition image*, falling in such a way that their corresponding parts are superposed. Superposition images are less sharp than apposition images, but are formed with less loss of light. Compound eyes are especially adapted for perceiving the movements of objects, owing to the way in which such movements affect a series of ommatidia in succession.

The *alimentary canal* of the Arthropoda possesses at its mouth and anus involutions of ectoderm, lined by cuticle, which are respectively the *stomodaeum* or *fore gut*, and *proctodaeum* or *hind gut*. These may be short, but in the higher Crustacea and Insecta form a considerable part, and sometimes nearly the whole, of the canal. The cuticular lining of fore and hind gut is shed at moulting. The lining of the fore gut sometimes provides teeth for triturating or bristles for straining the food. Digestion is extracellular, save in certain acarina.

The *respiration* of aquatic arthropods, other than those which are but little modified from terrestrial ancestors, is sometimes, if the animal be small, effected only through the general integument of the body, but usually takes place by means of *gills* (branchiae). These are nearly always external processes, known as *epipodites*, which stand on the bases of the limbs, and are often branched or folded. Among terrestrial arthropods, some of the Arachnida possess *lung books*, which are generally held to have arisen by the enclosure of gill books, such as those on the limbs of *Limulus*, each within a cavity of the ventral side of the body. The remainder of the terrestrial Arthropoda breathe by means of *tracheae*, which are tubular involutions of the ectoderm and cuticle which convey air to the tissues. In some arachnids tracheae are present as well as lung books. Usually tracheae are branched, and strengthened by a spiral thickening of their chitinous lining. The study of the phylogeny of the Arthropoda leads to the conclusion that a tracheal system has arisen independently in the Onychophora, the Arachnida, and the Insecta and Myriapoda. Among the Crustacea, tufts of tubes which resemble tracheae are found in the abdominal appendages of woodlice.

The *vascular system* is an "open" one. That is, be the arteries long or short, they end by discharging their blood not into capillaries in the tissues from which veins conduct it to the heart, but into perivisceral cavities, known as *sinuses*, which bathe various organs. From these sinuses the blood collects into a *pericardial sinus* ("pericardium"), part of the haemocoelic system, which surrounds the heart. The latter is a longitudinal dorsal vessel, perforated by *ostia* by which it receives its blood from the pericardial sinus. Among the consequences of the structure of the vascular system are a low blood pressure and liability to severe bleeding from wounds. The latter danger is met, especially in the Crustacea, by very rapid clotting of the blood. Haemoglobin is present in the plasma of certain of the lower crustaceans and a few insects, haemocyanin in *Limulus*, scorpions, and some spiders.

The *coelom* appears in the embryo as the cavities of a series of mesoderm segments ("mesoblastic somites", Fig. 352). It never assumes a perivisceral function, and in the adult is represented

only by the cavities of the gonads and of certain excretory organs and occasional vestiges elsewhere.

The *excretory organs* of arthropods are of very various kinds. True nephridia appear never to be present. *Coelomoducts* are present in a number of cases, though in the absence of perivisceral coelom they end internally each in a small coelomic vesicle or "end sac". These are found in the Onychophora in a long series of segmental pairs. In Crustacea there is either a pair of coelomoducts on the third (antennal) somite or a pair on the somite of the maxillae, or, rarely, both

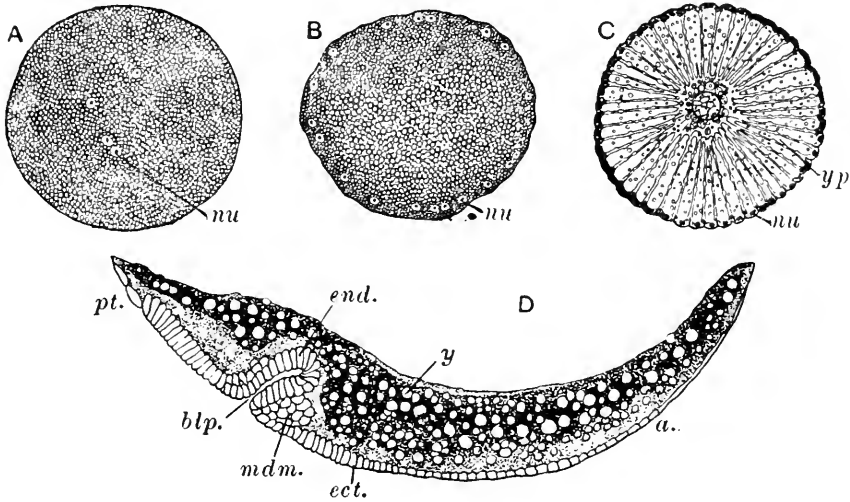

Fig. 213. Early stages in the development of *Astacus*. After Morin and Reichenbach. A-C Cleavage, D gastrulation. *a.* anterior end of embryo; *blp.* blastopore; *ect.* ectoderm; *end.* endoderm; *mdm.* mesoderm; *nu*, nuclei; *pt.* posterior end of embryo; *y*, yolk; *yp*, "yolk pyramids", due to the transitory appearance of divisions of the yolk corresponding to the superficial cells.

these pairs are present. In various crustaceans other glands, some ectodermal, some mesodermal, appear to have an excretory function, and sometimes replace both pairs of coelomoducts, which become vestigial. In arachnids, coelomoducts open on one or two of the pairs of legs. They are known as *coxal glands*, but are not homologous with the glands to which that name is applied in certain crustaceans. *Malpighian tubules* are tubular glands which open into the alimentary canal near the junction of mid and hind gut in the Arachnida, Insecta, and Myriapoda. In archnids they are of endodermal origin, but in insects and myriapods they are part of the ectodermal hind gut. It is interesting that the subphyla differ in the nature of their nitrogenous excreta. In the Crustacea these are principally ammonia compounds and amines, in the Insecta they are urates, in the Arachnida guanin.

Nearly all the *muscular tissue* of arthropods is composed of striped fibres, but in *Peripatus* only the fibres of the jaw muscles are striped, and among the higher groups certain exceptions to the rule are known (some visceral muscles, etc.).

The *gonads* are always, owing to the reduction of the coelom, directly continuous with their ducts, which are probably coelomoducts. These have no constant position of opening in the phylum. In the Crustacea they nearly always open at the hinder end of the thorax. In the Arachnida their opening is similarly near the middle of the body. In the Onychophora, Insecta, and centipedes they open near the hinder end, but in the remaining groups of the Myriapoda their opening is not far behind the head.

Typical features of the *embryonic development* are shown in Figs. 213, 316, and 352. The ova are generally yolky, and their cleavage is typically of the kind known as "centrolecithal", in which (Fig. 213) the products of division of the nucleus come to lie in a layer of protoplasm upon the surface of a mass of yolk which thus occupies the position of a blastocoele. The mode of gastrulation varies from invagination (Fig. 213 D) to obscure processes of immigration and delamination. The formation of the mesoblast as a pair of ventral bands (Fig. 316), proliferated in primitive cases from behind, has already been mentioned (p. 130). As in annelids (p. 285), the mesoblast bands segment, and in most cases the segments ("mesoblastic somites") develop coelomic cavities (Fig. 352). The haemocoele arises by separation of the germ layers. The heart is formed by the dorsal ends of the mesoblast segments approximating. The nerve cords are proliferated from the ventral ectoderm (Fig. 352 A). In spite of the yolky eggs, there is a great variety of larval stages, though direct development is also frequent. The series of somites, which in the adult is often obscured by the loss, obsolescence, or fusion of some of its members, is usually more distinct in the embryo or larva, where the presence of a somite which it is difficult or impossible to recognize at a later stage is frequently indicated by one or more of three criteria: a pair of segments of mesoblast (mesoblastic somites), a pair of segmental ganglia, and a pair of limbs or limb rudiments.

CHAPTER XI  
THE SUBPHYLA ONYCHOPHORA AND  
TRILOBITA

The two groups of animals with which this chapter deals both present in an apparently primitive condition features which are characteristic of the phylum Arthropoda. One at least of them existed in the Palaeozoic period. For these reasons, each of them has been regarded as giving indications concerning the ancestry of the Arthropoda. Whereas, however, the Trilobita are related rather closely to the Crustacea and more distantly to the other subphyla, the Onychophora are, as has been stated above, widely divergent from the rest of the Arthropoda. Some authorities, indeed, prefer to treat this group as an independent phylum. It must at least be regarded as representing a branch which parted at a very early date from the main arthropod stock. The trilobites are indisputable arthropods, on the line of descent which gave rise to the Crustacea and perhaps to other subphyla.

SUBPHYLUM *ONYCHOPHORA*

Tracheate Arthropoda with a thin, soft cuticle and a body wall consisting of layers of circular and longitudinal muscles; head not marked off from the body, consisting of three segments, one preoral, bearing preantennae, and two postoral, bearing jaws and oral papillae respectively, also with eyes which are simple vesicles; the remaining segments all alike, the number varying according to the species, each bearing a pair of parapodia-like limbs which end in claws and contain a pair of excretory tubules; stigmata of the tracheal system scattered irregularly over the body; cilia present in genital organs; development direct.

The animals which constitute this very important class are few in number and uniform in structure, all being placed in the genus *Peripatus* divided into many subgenera (Fig. 214). They are distributed discontinuously over the warmer parts of the world and occur in very retired positions which are permanently damp as, for instance, beneath the bark of dead trees and under stones. They have a superficial resemblance to other crawling animals which are found in the same places, like myriapods, slugs and earthworms, and until their anatomy was well known were classed, by different investigators, with all three of these. Certain of the characters of *Peripatus* such as the feebly developed sense organs, the simple structure of the jaws and feet and the soft skin may be linked with the environment in which they lurk

away from light and enemies. Yet it can hardly be doubted that the Onychophora are a division of the Arthropoda which has preserved more primitive features of an ancestral race than any other living

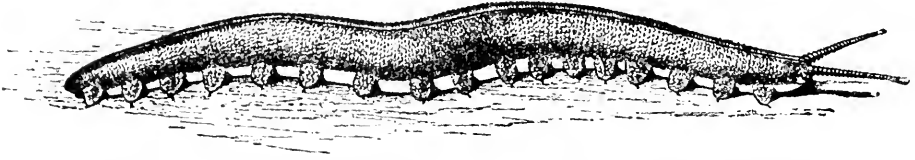

Fig. 214. *Peripatus capensis*,  $\times$  very slightly. From Sedgwick.

forms, terrestrial or aquatic. Such features are in all probability the thin cuticle, the muscular body wall, the annelid-like eye, the small number of head segments, the complete series of segmental excretory organs, the presence of cilia and possibly also the parapodia-like limbs.

The thinness of the cuticle is responsible for the absence of external segmentation (save for the repetition of the appendages). The head (Fig. 215) bears three pairs of appendages which are none of them

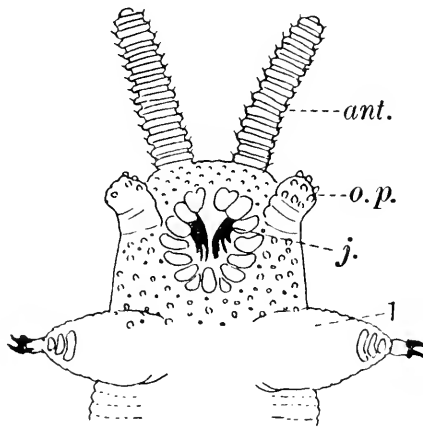

Fig. 215. *Peripatus capensis*, ♂. Ventral view of anterior end. *ant.* pre-antenna; *o.p.* oral papilla; *j.* jaw; 1, first trunk appendage. After Sedgwick.

very highly developed. While elsewhere in the arthropods the first segment is present in the embryo but disappears in the adult, here it persists and bears a pair of appendages which may be called *preantennae* (to distinguish them from antennae). They are rather long and very mobile, but not retractile like the tentacles of the slug. The next segment bears the jaws, which are not unlike enlarged claws of the trunk appendages and so bite with the tip and not the side. They are moreover tucked within the oral cavity. But they are borne on muscular papillae arising in the embryo and must without doubt be regarded as appendages.



The trunk appendages are short and conical, hollow, bearing at their distal ends spinose pads and a retractile terminal 'foot' with two recurved claws.

The adult body cavity is haemocoelic but the embryonic coelom is well developed. In the development of *Peripatus* just after the gastrula stage the blastopore becomes elongated, the anterior part

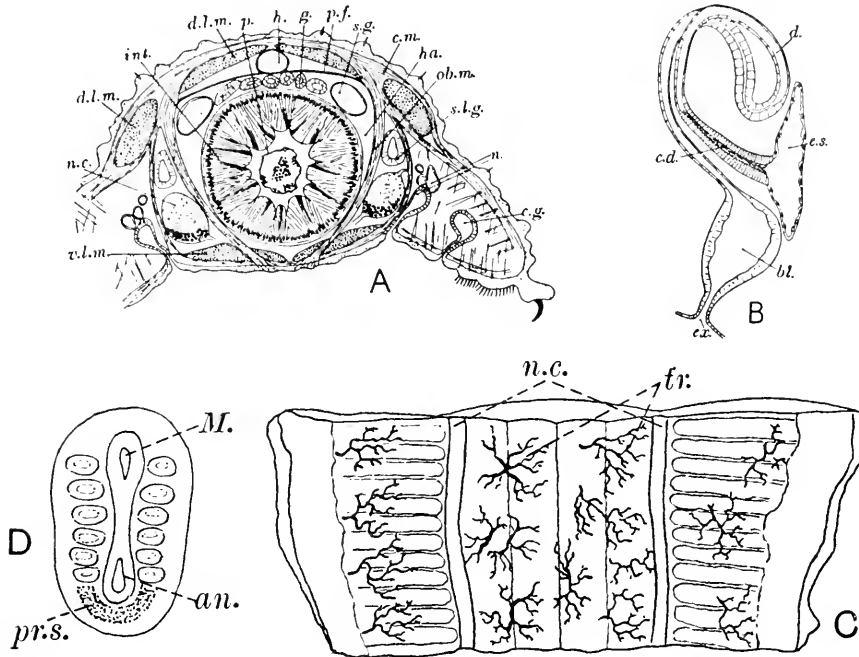

Fig. 216. A, Transverse section through *Peripatus*. *c.g.* crural gland; *c.m.* circular muscles; *d.l.m.* dorsal longitudinal muscles; *g.* genital organ; *h.* heart; *ha.* haemocoel; *int.* intestine containing *p.* peritrophic membrane; *n.* excretory tubule; *n.c.* nerve cord; *ob.m.* oblique muscles; *pf.* pericardial floor; *s.g.* slime gland; *s.l.g.* salivary gland; *v.l.m.* ventral longitudinal muscle. B, An excretory organ of *Peripatus*. *bl.* bladder; *c.d.* ciliated part of duct; *d.* duct; *e.s.* coelomic sac; *ex.* external aperture. C, Part of the ventral and lateral body wall of *P. capensis* to show irregular distribution of tracheae (*tr.*). D, Ventral view of embryo of *P. capensis* to show six pairs of mesoblastic somites. *pr.s.* primitive streak; and blastopore closed in the middle to form mouth (*M.*) and anus (*an.*). A and B, after Manton; C, after Moseley; D, after Balfour.

giving rise to the mouth, the posterior to the anus, while the median part closes (Fig. 216). Behind the blastopore is a primitive streak which forms the paired mesoblastic somites. The anterior pair move in front of the mouth and help to provide the mesoderm of the tentacular segment. None of the rest become preoral. In all segments the somites early acquire a cavity, the coelom, and later divide into two. Of these the ventral part migrates into the appendage as this is formed, and eventually becomes part of the segmental excretory

organ. The other part approaches its fellow in a mid-dorsal position to form the heart lying between them (cf. Fig. 352 A) and while in the anterior region it mostly disappears, those of the posterior segments fuse longitudinally to form two tubes which become the gonads (Fig. 217).

At the same time the gaps between the organs become filled with blood. A dorsal part of the haemocoel so formed is marked off by a partition as the pericardium. This contains the heart, a long tube with a pair of ostia in nearly every segment. There are, however, no other blood vessels, so that the condition of the circulatory system is by no means so advanced as in the higher Crustacea and the more primitive arachnids.

The possession of the perivisceral haemocoel almost diagnoses the group as arthropods, but it was the discovery of the tracheae which led to the inclusion of *Peripatus* in that phylum. The stigmata are scattered over the surface of the body most thickly on the sides and ventral surface, several occurring in each segment. Each stigma leads into a pit, penetrating the muscle of the body wall, from which arise bundles of minute air-containing tubes which end in the various organs of the body (Fig. 216 C). It can hardly be doubted that these tracheae are definitely arthropodan in type: their most significant difference from those of other forms is in their non-segmental character. Their irregular distribution is only possible because they originate as pits in soft skin; when once a cuticular exoskeleton has been established tracheae can only be excavated in the joints between segments. Probably then the Onychophora have never had a more definite cuticle than they possess at present; if they had, tracheae have been acquired since it was lost.

The alimentary canal consists of short ectodermal fore gut and hind gut and a very long endodermal mid gut, lined by a peritrophic membrane (p. 434) which is thrown off periodically. The fore gut consists of a buccal cavity into which open the large salivary glands and a muscular suctorial pharynx. The mid gut possesses no separate glands.

The excretory tubules (Fig. 216 B) are composed of a distal terminal bladder, a coiled secretory canal and a ciliated duct which opens into a much reduced coelomic vesicle. The bladder and probably the whole of the canal are formed from ectoderm, the rest from mesoderm. It can perhaps be said then that the tubule is a modified coelomoduct which has attained its present condition by the tucking-in of ectoderm at its external opening. The tubules form a complete series, but some of them have been converted into uses other than excretion. Thus the tubules corresponding to the oral papillae form the salivary glands and are much larger and more complex than in other segments. The anal glands and the gonoducts themselves have

the same origin. Only the tubules corresponding to the jaws and the first three trunk appendages disappear.

The sexes are separate in *Peripatus* and the gonads paired, but the ducts unite to form a median passage opening just before the anus. In the male the filiform spermatozoa are bound up in spermatophores in the upper part of the vas deferens; the lower part is muscular and ejaculatory in function. Fertilization is internal. The ovaries are embraced by a funnel, the receptaculum ovarum, which communi-

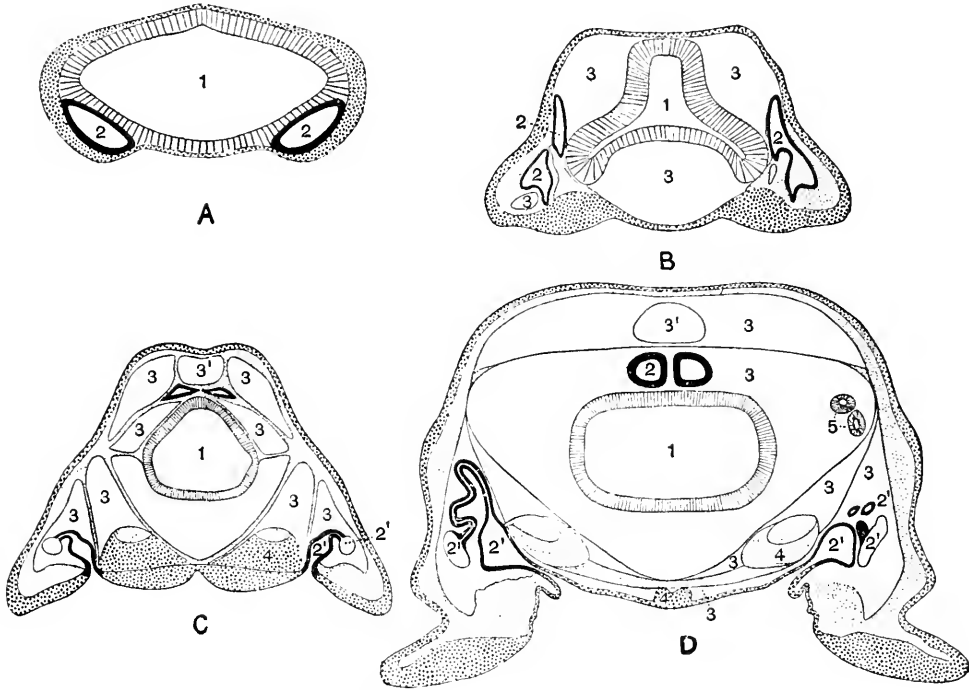

Fig. 217. Diagram of transverse sections through embryos of *Peripatus capensis* to show the haemocoel and the coelom in the following stages: A, before the haemocoel has appeared; B, when the somite has divided into dorsal and ventral parts; C, when these parts have separated and the heart is formed; D, at time of hatching. After Sedgwick. 1, alimentary canal; 2, coelom (cavity of mesoblastic somite, dividing into 2 cavity of gonad and 2, coelomic part of excretory tubule; in C and D the tubule is shown divided into 2', coelomic sac and 2', canal); 3, haemocoel, 3', heart.

cates with an oval receptaculum seminis. The eggs are fertilized then at the proximal end of the oviduct: they vary in size according to the species. In the larger, development takes place at the expense of the yolk and the secretions of the uterine wall; but the embryos from smaller eggs become attached to the uterine wall and a placenta is formed. Cilia have been described in parts of the genital tract.

There are other derivatives of the ectoderm, the crural glands (Fig. 216 A, *c.g.*), found on all the legs except the first and consisting

of a simple sac; and a single pair of slime glands discharging on the oral papillae, made up of a much branched secretory part and a large reservoir. The slime can be shot out and entangle an enemy. It is never used in obtaining food.

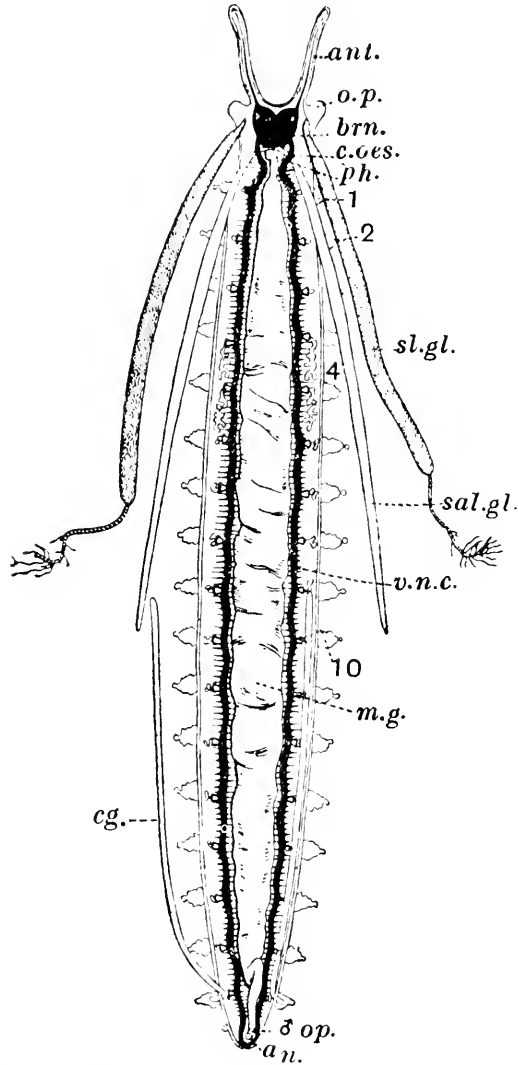

Fig. 218. *Peripatus capensis*, ♂, dissected to show the internal organs,  $\times 2$ . After Balfour. *an.* anus; *ant.* preantenna; *brn.* supraoesophageal ganglia; *c.oes.* circumoesophageal commissure; *c.g.* enlarged crural gland of last pair of legs; *m.g.* mid gut; *o.p.* oral papilla; *ph.* pharynx; *sal.gl.* salivary gland; *sl.gl.* slime gland; *v.n.c.* ventral nerve cord; 1, 2, 10, appendages of the trunk segments; 4, excretory tubule of the fourth segment;  $\delta$  *op.* male aperture.

The nervous system (Fig. 218) consists of a pair of supraoesophageal ganglia from which the preantennal nerves are given off, a pair of circumoesophageal commissures and two ventral cords which are widely

separated and connected by about ten transverse strands in each segment. There are slight enlargements in each segment which can be regarded as incipient ganglia, but the whole nervous system is primitive for an arthropod or even an annelid and can be best compared to that of *Polygordius* in the annelids or *Chiton* in the molluscs.

The Onychophora are not known as fossils, but all that has been said indicates that they came off from the main arthropodan stock at a very early stage when a typical haemocoel had been developed and cephalization had commenced, but when the epithelium had not finally specialized in the production of chitin and was still ciliated in places.

### SUBPHYLUM *TRILOBITA*

Palaeozoic Arthropoda with the body moulded longitudinally into three lobes; one pair of antennae; and, on all the postantennal somites, appendages of a common type which has two rami and a gnathobase.

The Trilobita were marine organisms and were very numerous in the Cambrian and Silurian but became extinct by the Secondary period. Their body was oval and depressed, and consisted of a head and a segmented trunk, of which the anterior somites were movable on one another, but the hindermost, in varying number, were nearly always united to form a tagma known as the *pygidium*. The body could usually be rolled up like that of a woodlouse. Along its whole length longitudinal grooves divided lateral *pleural* portions from a middle region. In the head, this middle region is known as the *glabella* and transverse furrows usually mark out more or less distinctly five somites. The pleural portions of the head are known as the *cheeks*, and each bears in most species a sessile compound eye. On each cheek a longitudinal *facial suture* divides an outer from an inner area, passing immediately internal to the eye. The posterolateral angles of the cheeks are often produced backward as spines. Under the head a large *labrum* or *hypostoma* projects backward below the mouth, behind which is a small *metastoma*.

The antenna is uniramous and multiarticulate and is the only preoral appendage. Since it is the foremost of five head appendages it has the same position as the antennule of the Crustacea, with which it is probably homologous. In that case it would seem likely that a true first somite had already, as in modern crustacea, become merged

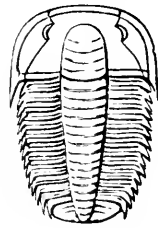

Fig. 219. *Olenus catarractes*, from the Lingula Flags. Natural size. From Woods.

in the anterior region of the head. Traces of a groove which exist in some species may perhaps indicate its existence.

The remaining limbs are all of one type, though there is a gradual progressive modification from one end of the series to the other. Each has two rami. Of these, one, usually held to be the outer ("exopodite"), bears a long fringe of bristles, while the other ("endopodite") is leg-like and divided into six joints. It is supposed by some authorities that the bristle fringe on the so-called exopodite was on the inner side of the limb, and was used for collecting food, like the fringes on

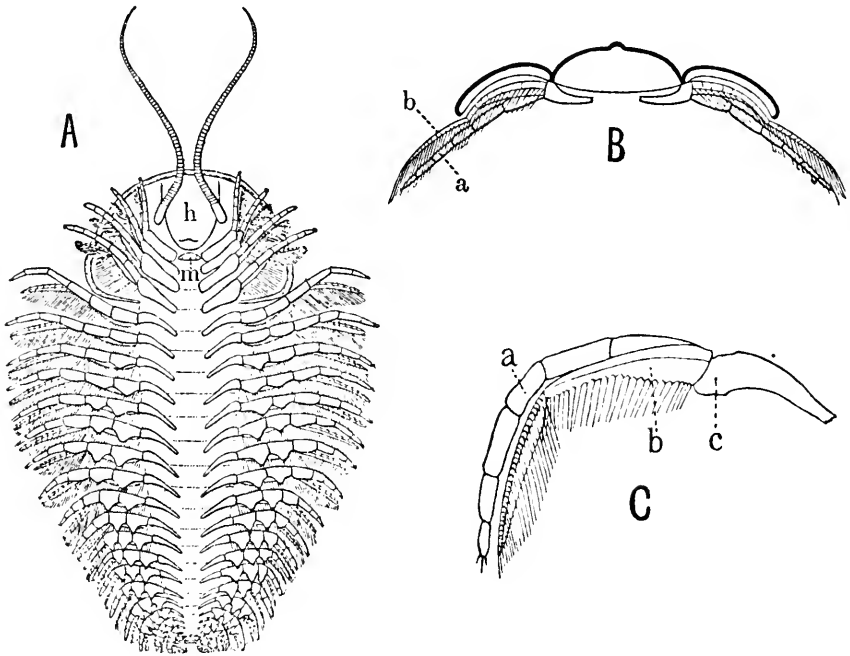

Fig. 220. *Triarthrus becki*, from the Utica Slate (Ordovician) near Rome, New York. After Beecher. A, View of the ventral surface showing appendages, etc. *h*, hypostome (labrum); *m*, metastoma.  $\times \frac{2}{3}$ . B, Diagrammatic section through the second thoracic somite. *a*, "endopodite"; *b*, "exopodite". C, Dorsal view of second thoracic leg. *a*, "endopodite"; *b*, "exopodite"; *c*, "protopodite" with gnathobase. Enlarged.

the trunk limbs of branchiopoda (p. 355), but this surmise is not generally accepted. From the basal portion of the limb a process for the manipulation of food, the *gnathobase*, projects towards the middle line. The configuration of the basal portion (protopodite), and the relation of the rami to it, are obscure. The telson is without limbs.

The Trilobita hatched as a larva, the *Protaspis*, which was sub-circular, and consisted, like the *Nauplius* larva of the Crustacea, principally of head. In its further development there appear, first the pygidium, and then free somites between the pygidium and the head,

new somites being added in front of the telson while those at the front end of the pygidium become free.

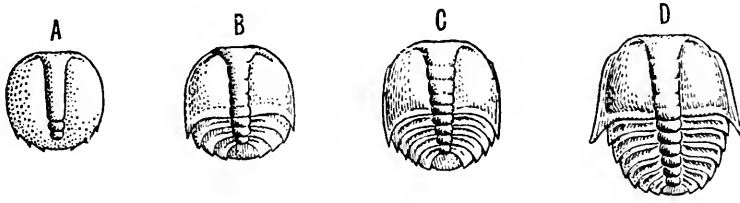

Fig. 221. Development of a trilobite. After Barrande. A–D, *Sao hirsuta*, Cambrian, Bohemia. A, Earliest stage (*Protaspis*),  $\times 12$ . B, Later stage, with three somites behind the head,  $\times 12$ . C, With more distinct glabella furrows and four somites behind the head,  $\times 12$ . D, With six somites behind the head,  $\times 10$ .

It is probable that the majority of the trilobites lived upon the sea-bottom in shallow to moderately deep water, but others appear to have been adapted to burrowing, pelagic, and deep-sea conditions.

## CHAPTER XII

### THE SUBPHYLUM CRUSTACEA

Arthropoda, for the most part of aquatic habit and mode of respiration; whose second and third somites bear antennae; and their fourth somite a pair of mandibles.

The Crustacea are essentially aquatic arthropods. That fact alone makes it possible that in them the same appendages should combine the functions of locomotion (by swimming), feeding (by gathering particles from the water), respiration (by exposing a thinly covered surface to the medium), and the reception of sensory stimuli. There is perhaps no extant crustacean in which all four functions are thus combined—unless we may regard the trunk limbs of the Branchiopoda (see below) as sense organs in a minor degree—but not uncommonly three, and perhaps usually two, are performed by the same limb. In the lowest members of the subphylum—the “phyllopod” Branchiopoda (such creatures as the fairy shrimp, *Chirocephalus*, shown in Fig. 236)—a long series of somites of the trunk bear similar appendages which all function alike in swimming, respiration, and the gathering of food. Evolution within the crustacean group appears to have proceeded mainly by the specialization, for particular functions, of particular appendages of an ancestor which possessed along the whole length of the body a numerous series of limbs, of which all, except probably the first pair (antennules), were as much alike and capable of at least as many functions as those which the Branchiopoda now possess upon the trunk. Such a condition existed in the Trilobita, but in all modern crustacea the appendages of the head are already specialized for various uses, and in most members of the group the specialization has gone farther. Moreover, it has taken place in more than one way. Limbs which in one crustacean are adapted to some particular function are in others specialized for quite different services.

Two other factors, added to, or perhaps consequent upon, the specialization of limbs, have taken part in bringing about the great variety of organization which exists in the Crustacea. One is a shortening of the body. As the efficiency of the limbs increases by specialization, there occurs a lessening of their number, and finally the reduction or loss of the somites whose limbs have thus disappeared. The reduction, which has occurred independently in every class, has taken place in the hinder part of the body, though as a rule the extreme hind end (telson) is relatively unaffected. The other factor is



the development, from the hinder part of the head, of a skin fold—the *carapace*—by which the important anterior region of the body is overhung and protected, and the setting up in the surrounding water of currents for purposes of respiration and feeding is facilitated. Not all crustaceans possess the carapace: in some it has perhaps never existed, others have discarded it. In those which have it, its extent varies: in extreme cases it encloses the whole body.

The transformation of the external make-up of the body is of course reflected in the internal organization, which shows corresponding concentrations of function and differentiation of the contents of somites.

On these general lines evolution has given rise to six *Classes* of crustacea. We must now briefly survey them. (1) In the *Branchiopoda* feeding is performed by the limbs of the trunk. In the “phyllopod” groups of this class, mentioned above, it is only on the head that differentiation among the appendages has proceeded to any considerable extent. Of the head limbs each, as we have seen, is specialized for some particular function, such as the service of the senses or the manducation of food. On the trunk the limbs, which are numerous, are still similar and all subserve at least the functions of feeding and respiration. In the order *Anostraca*, to which *Chirocephalus* belongs, there is no carapace, and the trunk limbs, whose similarity is very strong, retain the function of swimming. In the order *Notostraca* (Fig. 242), also phyllopodous, there is a carapace but it is wide and shallow and does not enclose the trunk limbs, and they are still used for swimming. A certain degree of differentiation exists between these limbs, the anterior pairs for instance being capable of clasping objects. In both the foregoing orders limbs have been dispensed with on some of the hinder somites. The remaining phyllopod group, the *Conchostraca* (Fig. 243), are united with the non-phyllopod group Cladocera as the order *Diplostraca*. In the members of that order (except a few aberrant cladocera) the carapace encloses the trunk limbs, which are not used for swimming, that function being taken over by the antennae. The Conchostraca alone among branchiopods retain limbs on all their trunk somites like the trilobites, but as in the Notostraca there is a certain degree of differentiation between the members of the series. In the *Cladocera* (Fig. 244), the highest group of the Branchiopoda, a compact and very efficient feeding apparatus is formed by some half-dozen pairs of limbs, the trunk is correspondingly shortened, and even so some of the hinder somites are limbless. In certain members of this group, such as the water-flea *Daphnia* there is a high degree of differentiation between the trunk limbs (Fig. 245). (2) A similar habit of body is even more strongly developed in the class *Ostracoda* (Fig. 248), which are

# SOMITES AND LIMBS

Somite	<i>Apus</i>	<i>Daphnia</i>	<i>Cypris</i>	<i>Cyclops</i>
1...	No limbs	No limbs	No limbs	No limbs
2...	Antennules	Antennules	Antennules	Antennules
3...	Antennae	Antennae	Antennae	Antennae
4...	Mandibles	Mandibles	Mandibles	Mandibles
5...	Maxillules	Maxillules	Maxillules	Maxillules
6...	Maxillae	Maxillae (ves.)	Maxillae	Maxillae
7...	Thor. limbs 1	Thor. limbs 1	Thor. limbs 1	Maxillipeds
8...	" 2	" 2	" 2♂♀	Thor. limbs 2
9...	" 3	" 3		" 3
10...	" 4	" 4		" 4
11...	" 5	—		" 5
12...	" 6	" 5		" 6 (c)
13...	" 7	Thor. som. 7♀		{ Thor. som. 7(d)♂♀ } <sup>a</sup>
14...	" 8	" 8		Abd. som. 1
15...	" 9	" 9		" 2
16...	" 10		No abdominal somites or limbs	" 3
17...	" 11 ♂♀			
18...	Abd. som. 1	No true abdominal somites. Last 3 somites (13-15) are limbless and called abdomen		
19...	" 2			
20...	" 3			
21...	" 4			
.....	2 to 5 pairs of limbs to each somite			
34...				" 17
35...				" 18
36...				" 19
37...			" 20	
38...	" 21		No limbs	
39...	" 22			
	Telson with rami	Telson ♂ with rami	Telson with rami	Telson with rami

“Abdominal” somites are those between the last genital somite and the telson. ♂ indicates female. *c*, uniramous and vestigial. *d*, genital operculum of female represents seventh

# OF CRUSTACEA

<i>Lepas</i>	<i>Nebalia</i>	<i>Gammarus</i>	<i>Astacus</i>	Somite
No limbs	No limbs	No limbs	No limbs	... 1
Antennules	Antennules	Antennules	Antennules	... 2
Lost in adult	Antennae	Antennae	Antennae	... 3
Mandibles	Mandibles	Mandibles	Mandibles	... 4
Maxillules	Maxillules	Maxillules	Maxillules	... 5
Maxillae	Maxillae	Maxillae	Maxillae	... 6
Thor. limbs 1 ♀	Thor. limbs 1	Maxillipeds	Maxillipeds I	... 7
„ 2	„ 2	Legs I	„ II	... 8
„ 3	„ 3	„ II	„ III	... 9
„ 4	„ 4	„ III	Legs I	...10
„ 5	„ 5	„ IV	„ II	...11
„ 6 ♂	„ 6 ♀	„ V ♀	„ III ♀	...12
	„ 7	„ VI	„ IV	...13
	„ 8 ♂	„ VII ♂	„ V ♂	...14
	Abd. limbs 1	Abd. limbs 1	Abd. limbs 1	...15
	„ 2	„ 2	„ 2	...16
	„ 3	„ 3	„ 3	...17
	„ 4	„ 4	„ 4	...18
	„ 5	„ 5	„ 5	...19
	„ 6	„ 6	„ 6	...20
	Abd. som. 7			...21
Telson with rami	Telson with rami	Telson	Telson	

No abdominal somites or limbs

the position of the male opening, ♀ that of the female. *a*, joined but distinct, *b*, fused in thoracic limb: the somite which bears it is often reckoned as the first abdominal.

very short-bodied and completely enclosed in a bivalve shell formed by the carapace. Whereas, however, in the Cladocera it is by trunk limbs that food is gathered, in the Ostracoda that function is performed by limbs of the head. The trunk limbs, which have lost the functions of swimming and respiration as well as that of feeding, serve relatively unimportant subsidiary purposes, and are reduced, at most, to two pairs. Some members of the class carry shortening to an extreme pitch by contriving to dispense with one or both of these pairs. (3) The members of the class *Copepoda* (Fig. 249) also feed by means of appendages on the head, though they use these differently from the Ostracoda. In contrast to that group they have no carapace, and they have retained a trunk of some ten somites, of which the first half-dozen bear limbs which are specialized organs of swimming. The hinder part of the trunk is without appendages, save a pair of styles on the telson, often shows coalescence of somites, and may become a mere stump. Some of those members of this class which are parasitic lose in the adult female the segmentation and most, or even all, of the appendages. (4) In the small class of parasites known as *Branchiura* (Fig. 254), which are sometimes placed in the Copepoda, but differ from that group in possessing compound eyes and in other important respects, there are carapace-like lobes at the sides of the head, but these do not enclose the trunk, and the general build of the body and the form and function of the thoracic limbs simulate those of a copepod. The abdomen is much reduced. (5) The class *Cirripedia* or barnacles, which as larvae attach themselves by their antennules to some object upon which they henceforward lead a sedentary life under the protection of a large, mantle-like carapace, bear, upon the same trunk somites as do the Copepoda, limbs which, like those of the latter group, are biramous. These appendages, however, are used, not for swimming, but for gathering food-particles from the water; while of the head appendages the antennae are absent and the others are much reduced and not used in gathering food. The least specialized members of this class are, in respect of segmentation and appendages, on a par with the best-segmented of the Copepoda. Most cirripedes, however, (the ordinary barnacles, Fig. 255) have lost the whole of the hinder (abdominal) region of the trunk. Others are deficient in the appendages of further somites, and the series ends with the sac-like parasites of the order *Rhizocephala* (Fig. 260). (6) The class *Malacostraca* (the highest crustaceans, including various "shrimps", slaters, sandhoppers, crayfishes, etc.) obtain their food with the limbs on the anterior region (thorax) of the trunk, and, in primitive cases in which it is gathered as particles, strain it from the water with the last pair of appendages of the head (the maxillae). The thoracic limbs retain also the function of locomotion and normally

are adapted for respiration by the presence upon them of gills, which are usually protected by a carapace of moderate size. Thus this region of the body of the Malacostraca is, in its own ways, as many-functioned as the corresponding part of the trunk of *Chirocephalus*. The Malacostraca maintain in typical cases (Figs. 269, 282) the swimming function of the limbs on the hinder portion (abdomen) of the trunk, and some of the class have found other uses (ovigerous, copulatory, etc.) for these appendages. Accordingly there is seldom any reduction in the fixed number of fourteen (or fifteen) trunk somites which, arranged always in a thorax of eight and an abdomen of six (or seven), characterizes the class. Nevertheless in all but one of the orders the abdomen has lost a somite, in the crabs (Fig. 284) and some others of the highest order (*Decapoda*) it is reduced, and in a few members of the class it is a limbless and unsegmented stump.

The name *Entomostraca* was formerly used in the classification of the subphylum, to distinguish from the Malacostraca a division containing all the other classes. Since, however, these differ from one another as widely as each of them does from the Malacostraca, the name is no longer used in classification but is only a convenient designation for the lower crustacean classes as a whole.

When feeding is restricted to a few limbs it is often, though not always, accomplished in some other way than by the original habit of gathering food in small particles. Continuous and automatic straining-out of such particles, which is practised (though in different modes) by the most primitive members of all classes except the Branchiura, is superseded in various members of different classes by the intermittent seizure, by particular limbs, of particles of some size, and this by the grasping of larger objects, which may lead to a predatory habit. Finally, either of these modes of feeding may be replaced in parasites by suction or absorption, through organs which do not always represent appendages at all. (Parasites, however, are not known among the Branchiopoda or Ostracoda.) Needless to say, each change in the mode of obtaining nutriment has entrained numerous alterations in organs other than those by which the food is actually taken, as in the means of locomotion, sense organs, weapons of offence, etc. On the other hand, adaptations to mere differences of habitat, in the Crustacea, as in other arthropods, are, as a rule, strikingly small. There is, for instance, remarkably little difference between a land crustacean and its nearest marine relatives. Pelagic genera, however, are sometimes considerably modified.

We must now proceed to review in more detail the common organization of the Crustacea and the variation which it presents throughout the group.

The *cuticle* of a crustacean is, save for the joints, usually stout

relative to the size of the animal, but is thinner and flexible in many parasitic genera. It is often strengthened by calcification, and in certain ostracods, barnacles, and crabs this gives it a stony hardness. In each somite there may or may not be distinguishable the dorsal plate or *tergite* (*tergum*) and ventral *sternite* (*sternum*) usual in arthropods. The tergite may project at each side as a *pleuron*.

There are embryological indications that the *body* should be regarded as containing, besides the *somites*, an anterior *presegmental region*, to which the eyes belong, corresponding to the prostomium of a worm, and a *postsegmental region* or *telson*, on which the anus opens. Each somite, except the first, which is purely embryonic, may bear a pair of *appendages*, though it is rarely that the appendages of all the somites are present at the same time. The somites never all remain distinct in the adult. Always some of them are fused together and with the presegmental region so as to form a head, and often there is also fusion of them elsewhere.

Nearly always the somites are grouped into three *tagmata*, differentiated by peculiarities of their shape or appendages, and known as the head, thorax, and abdomen. These, however, are not morphologically equivalent in different groups. The *head* always contains, besides the region of the eyes and the embryonic first somite, the somites of five pairs of appendages—two, the antennules and antennae, preoral; and three, the mandibles, maxillules, and maxillae, postoral. More somites are often included in the actual head, but as the additional appendages (maxillipeds) then usually show features of transition to those behind them, and as the fold of skin which forms the carapace first arises from the maxillary somite, the true head is held to consist only of the anterior portion of the body as far as that somite inclusive. There is evidence of an earlier head, carrying only the first three pairs of limbs which alone exist in the *Nauplius* larva, and still indicated in some cases (as in *Chirocephalus*, *Anaspides*, Fig. 269, and *Mysis*, Fig. 265) by a groove which crosses the cheek immediately behind the mandible. This *mandibular groove* is distinct from the true *cervical groove* which often (as in *Astacus*, Fig. 283) marks the boundary between head and thorax: the two grooves may co-exist, as in *Apus* and in *Nephrops*. The Crustacea, indeed, admirably illustrate the way in which the process of “cephalization” tends, in arthropods as in vertebrates, to extend backwards and to involve more and more segments. With it has gone a backward shifting of the mouth, which in the Crustacea now stands behind the third somite, with two pairs of appendages (antennules and antennae) in front of it. The commissure which unites the ganglia of the antennae still passes behind the mouth, and may usually be seen, as in *Astacus* (Fig. 225), crossing from one of the circumoesophageal commissures

to the other. The head of the Crustacea is unlike, and less specialized than, those of other arthropods in that its limbs are not entirely restricted to sensory and alimentary functions but often have also other uses, such as swimming, the setting up of currents, or prehension.

The head, though it varies in extent, is of the same nature throughout the group, being primarily, like the heads of other animals, the seat of the principal organs of special sense and of manducation. On the other hand, the two tagmata known as the *thorax* and *abdomen*, which usually can be recognized in, and together compose, the post-cephalic part of the body or *trunk*, vary much more in extent, and each of them has in the several groups no constant feature save its position relative to the other. The precise boundary between thorax and abdomen is sometimes difficult to fix. The names, as they are commonly used, are in this respect inconsistently applied, denoting in some groups limb-bearing and limbless regions, in others the sections of the trunk which lie before and behind the genital openings. For the sake of consistency we shall adopt the convention that the somite which bears the genital openings (or the hinder such somite when, as sometimes happens, the male opening is on a somite behind that of the oviduct) is always the last somite of the true thorax. In this sense, in certain cases (copepods, cladocera), somites which are commonly called abdominal are strictly to be reckoned as thoracic. In respect of segmentation the trunk varies from the condition of a limbless stump in certain ostracods to the possession of more than sixty somites in some of the Branchiopoda.

A structure very commonly found in crustaceans is the *shell* or *carapace*, a dorsal fold of skin arising from the hinder border of the head and extending for a greater or less distance over the trunk. Its size varies greatly. In the Ostracoda (Fig. 248) and most conchostracans (Fig. 243) it encloses the whole body, extending forwards at the sides so as to shut in the head. In other cases (cirripedes, Fig. 255, most cladocera, Fig. 244), it only leaves part or the whole of the head uncovered. In typical malacostraca it covers the thorax (Fig. 283), but in some it is a short jacket, leaving several thoracic somites uncovered (Fig. 272), and in some (the Syncarida, Isopoda, and Amphipoda, Figs. 269, 274, 278) it has disappeared. In the Anostraca (Fig. 236) and Copepoda (Fig. 249) it was perhaps never present. It may be a broad, flat shield over the back, as in *Apus* (Fig. 242), but is usually compressed, and in the Conchostraca and Ostracoda becomes truly bivalve, with a dorsal hinge. In the Cirripedia it is an enveloping mantle, usually strengthened by shelly plates (Fig. 257). In the Conchostraca, Ostracoda, Leptostraca, and Cirripedia it has an adductor muscle, but the adductors of these groups vary in position and are not homologous. The carapace may fuse with the dorsal side

of some or all of the thoracic somites (the Cladocera, most of the Malacostraca): such somites are not on that account alone to be regarded as included in the head, though they may become so. The *chamber* enclosed by the carapace is known in various cases by various names as gill chamber, mantle cavity, etc., and performs important functions in sheltering gills or embryos, directing currents of water which subserve feeding or respiration, etc. In front, the carapace is continuous with the dorsal plate which represents the terga of the head, the cervical groove, if present, marking the boundary between them. We shall apply the term *dorsal shield* to the structure composed of the dorsal plate of the head with the carapace, if the latter be present.<sup>1</sup> The dorsal plate of the head may be prolonged in front as a projection which is called the *rostrum* (Fig. 283, *rs.*).

A glandular patch or patches on the dorsal surface of the head, near its hinder limit, in many of the Branchiopoda, in *Anaspides*, and in the young stages of various other crustaceans, is known as the *dorsal organ* or *neck gland*. It is used by cladocera and conchostraca for temporary fixation. In other cases its function is not known. Possibly the organs to which this name is given are not all homologous. They must not be confused with the "neck organ" of branchiopods (see p. 342).

Of the *appendages* or *limbs* of the Crustacea, the first, or antennule, is a structure *sui generis*, not comparable in detail with any of the others. Typically it is uniramous, and though in many of the Malacostraca it has two rami, these are probably not homologous with the rami, described below, of other appendages. The remaining limbs may all be reduced to one or other of two types—the "biramous" limb usually so-called, to which most of them more or less clearly conform, and the *phyllopodium*, to which belong the trunk limbs of the Branchiopoda and some other appendages, chiefly maxillules and maxillae and notably the maxilla of the Decapoda. The name by which the first of these types is generally known refers to the fact that limbs which best represent it fork distally into two rami. Since, however, the phyllopodium possesses the same two rami, and bears them, though not as a distal fork, yet in the same way as a great number of limbs of the first type, it is well not to use a name which might imply that there is a constant difference in respect of the rami between the limbs of the two types. We shall therefore call the first type the *stenopodium*, referring to its usually slender form (Gk. στενός, narrow).

<sup>1</sup> These terms have been used in various senses. In the usage here proposed, when there is no carapace fold the dorsal shield is the dorsal plate of the head together with the terga of the somites (if any) that are fused with the head.



In the *stenopodium* (Figs. 222 D–G, 223) the two rami—an inner *endopodite* and an outer *exopodite*—are set upon a common stem, the *protopodite*. In many cases the protopodite bears also, on its outer

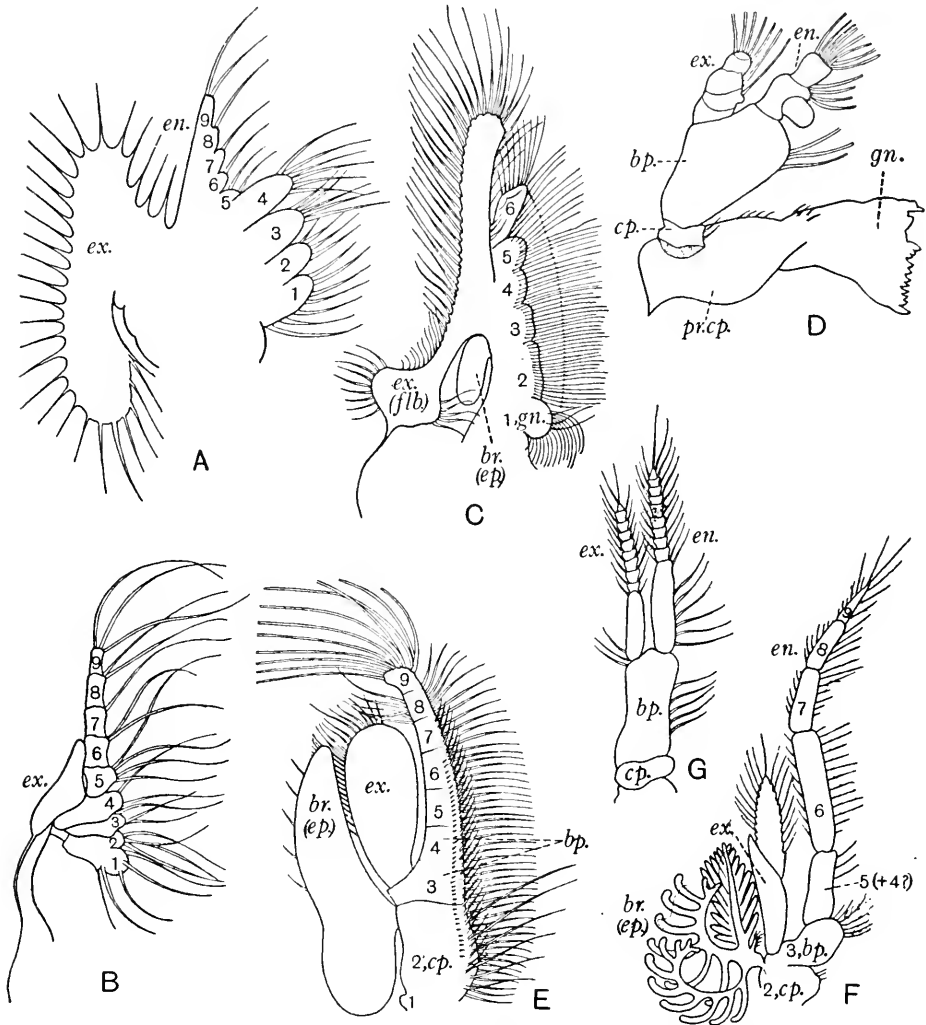

Fig. 222. Limbs of crustacea. Not drawn to scale. After various authors. A, Maxilla of *Mysis* larva of *Penaeus* (Decapoda). B, Maxilla of *Acanthosoma* larva of *Sergestes arcticus* (Decapoda). C, Second trunk limb of female *Cyclestheria hislopi* (Conchostraca). D, Mandible of *Calanus*. E, Thoracic limb of *Nebalia*. F, Mid-thoracic limb of an euphausiid. G, Swimmeret of the crayfish. *bp.* basipodite; *br.* branchia (epipodite); *cp.* coxopodite; *en.* endopodite; *ep.* epipodite; *ex.* exopodite; *flb.* flabellum (exopodite); *gn.* gnathobase; *pr.cp.* pre-coxa; 1–9, endites or segments of the limb.

side, one or more processes known as *epipodites* (Fig. 223, *ep.*). In limbs in which the type is most perfectly developed the two rami are subequal and are borne distally upon the protopodite (Fig. 222 G),

but in most cases the endopodite is the larger, and forms with the protopodite an axis, the *corm*, on which the exopodite stands laterally (Figs. 222 E, F, 223, 286). In a few instances the exopodite is the larger.

The *protopodite* most often has two joints, a proximal *coxopodite* and a distal *basipodite*. In certain cases, however (as in the antenna of the Mysidacea and *Asellus*, the last three thoracic limbs of the Stomatopoda, certain swimming limbs of the Branchiura (Fig. 254 B), and less clearly in many other instances), a basal joint, the *precoxa* or *pleuropodite*, precedes the coxopodite; moreover the basipodite may be divided into two joints—the *probasipodite*, which then usually bears the exopodite, and the *metabasipodite* or *preischiopodite*. This condition is seen most clearly on the thorax of the malacostracan genera *Anaspides* and *Nebalia* (Fig. 222 E), where the two components of the basipodite are separate in some limbs and fused in others; it is less obvious in other cases in which it occurs. Thus the full possible number of joints in the protopodite is four. Some authorities, however, prefer to regard the preischium as part of the endopodite, in which case the true protopodite has only three joints at the most. Epipodites, when they are present, are borne upon the precoxa (*proepipodites*) or coxopodite (*metepipodites*).

The *endopodite* is usually segmented. If the preischium be not reckoned to it, its maximum number of joints is five. These are found on the thoracic limbs in the subclass Eucarida of the Malacostraca as, for instance, in the crayfish, where they are named, in order from the base outwards, the *ischiopodite*, *meropodite*, *carpopodite*, *propodite*, and *dactylopodite*.

In the subclass Peracarida, however, the five joints to which the above names are usually given are not homologous with those so designated in the Eucarida. Here the true carpopodite and propodite have fused, but the preischiopodite, which in the Eucarida is probably fused with the ischiopodite, remains distinct, so that the distal part of the corm has still five joints.

With the four possible joints of the protopodite these segments of the endopodite make up a total of nine in the corm of the limb. Sometimes a subdivision of certain of the joints into many jointlets or *annuli* occurs. This may be seen in some of the thoracic limbs of mysidacea and of certain prawns (*Pandalus*, etc.) and in many antennae. A slender, many-jointed, terminal portion of either ramus is known as a *flagellum*. The *exopodite* is often unsegmented, but when segmented usually possesses a flagellum. It does not possess a standard number of joints. It is more often absent or reduced than is the endopodite.

The *phyllopodium* (Figs. 222 A, C, 224, 238), is a broader and flatter limb than the majority of stenopodia. Its cuticle is usually thin, and

then the shape of the limb is maintained largely by the pressure of blood within it. In these cases the flexibility is such that no joints are needed. There is in this limb an axial portion or corm which bears on the median side a row of lobes known as *endites*, and on the outer side one or more lobes known as *exites*. Of the latter the more distal, standing usually opposite the third or fourth endite from the base and often known as the *flabellum*, is the homologue of the exopodite of the biramous limb. Exites proximal to this are epipodites. That next to the flabellum is the *branchia* (metepipodite); any which may be pre-

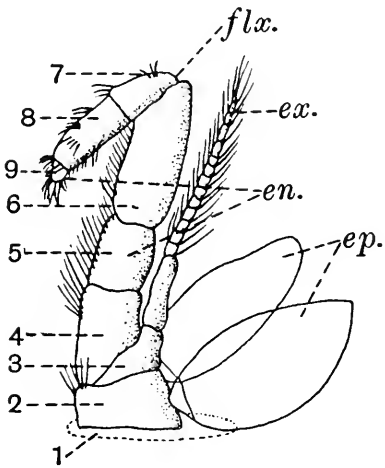

Fig. 223.

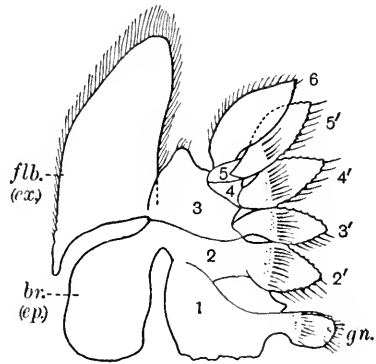

Fig. 224.

Fig. 223. The second thoracic limb of *Anaspides*. After Calman, with an addition. *en.* endopodite; *ep.* epipodite; *ex.* exopodite; *flx.* flexure of limb; 1, position of precoxa or pleuropodite, represented, according to Hansen, by an isolated area of chitination of the thoracic wall; 2, coxa or coxopodite; 3, basis or basipodite (probasipodite); 4, preischium or metabasipodite; 5, ischium or ischiopodite; 6, merus or meropodite; 7, carpus or carpopodite; 8, propus or propodite; 9, dactylus or dactylopodite (apical joint).

Fig. 224. Tenth thoracic limb of *Apus*. *br.* branchia; *flb.* flabellum; *gn.* gnathobase; *ep.* epipodite; *ex.* exopodite; 1-5, segments of the limb; 2'-5', endites; 6, last endite or apical lobe.

sent proximal to the branchia are *proepipodites* (Fig. 238, *pr. ep.*). The flabellum typically overhangs its attachment proximally as well as distally. In the latter direction it may extend so far as to form with the distal part of the corm a pair of equal rami (Fig. 222 C). The homology of the endopodite then becomes apparent. This ramus corresponds to that part of the corm of the phyllopodium which is distal to the insertion of the flabellum or exopodite. Of the *endites*, that which stands at the base of the limb is usually different in form from the rest and used in one way or another for manipulating the

food. It is known as the *gnathobase*. The most distal "endite" is the termination of the corm, and is better called the "apical lobe". It has often special functions. The number of the endites varies. In the Branchiopoda it is commonly six, but in the Anostraca (Fig. 238) there are indications of seven. It is greatest in the larval maxilla of certain decapoda (Fig. 222 A), where it is nine, which, as we have seen, is the maximum number of segments in the corm of the stenopodium. The suggestion, made by this fact, that the segmentation of the phyllopodium by endites corresponds with that which the corm of the stenopodium owes to the presence of joints, is strengthened by the fact that in some of the maxillae in question (Fig. 222 B), and in that of *Calanus* (Fig. 251), which also has nine segments, the limb is jointed and the joints fall between the endites or, where these are lacking, precisely complete their number. A less regular jointing of the same kind is present in some other phyllopodia (*Apus*, Fig. 224; etc.). In both kinds of limb, also, the position of the exopodite bears the same relation to the segmentation, being usually upon the third, occasionally upon the fourth segment, while epipodites stand on the first or second segment. Endites are rare on stenopodia, but a *gnathobase* is always present in the mandible (Fig. 222 D) and sometimes in other limbs, and a few other such processes occur.

A limb of either type may differ from that type in the lack of any of its parts. Notably the loss of the exopodite is liable to produce from either a *uniramous limb*. Moreover, though the two types are very distinct in cases in which they are perfectly developed, as in the swimmerets of *Astacus* (Fig. 222 G) and the trunk limbs of *Apus* (Fig. 224), there are many limbs which depart more or less from either type in the direction of the other—as, for instance, from the stenopodial type in the shape of the exopodite (Fig. 254 B), or, as stated above, in the relation of the latter to the rest of the limb, or from the phyllopodium in the proportions of the rami or the reduction of the endites.

The comparison just made between the phyllopodium and the stenopodium leaves untouched the question which of them is the more primitive, that is, more resembles the limbs of the ancestral crustacean. On this point there is an old and as yet unsettled controversy. As proof of the primitiveness of the stenopodium it is pointed out (1) that this limb is more widespread than the phyllopodium, (2) that it occurs in the *Nauplius* larva (p. 352), the early phyllopod *Lepidocaris* (p. 360), and the trilobites, in all of which it is likely to be primitive, (3) that it more nearly approaches the form of the majority of parapodia of the Annelida, from which the Crustacea are held to have taken origin. In demonstration of the ancestral nature of the phyllopodium it is urged (1) that typical stenopodia

with subequal rami borne distally upon a protopodite are comparatively rare and usually occur in highly specialized crustaceans (Copepoda, Cirripedia, Malacostraca), (2) that the biramous limbs of the *Nauplius* and *Lepidocaris* are not primitive but adaptive, the relations of the rami of the limbs of trilobites are problematical, and the admittedly primitive Branchiopoda possess phyllopodia, (3) that the unjointed, turgid, lobed phyllopodium more nearly resembles the parapodia of certain annelids in which the neuropodium is axial, than the stenopodium resembles the normal biramous parapodium.

Concerning the functions of particular members of the series of limbs, and the corresponding modifications of their structure, little can be said that would hold good throughout the subphylum. There is an immense variety in these respects. The *antennules* and *antennae* are primarily sensory, and perhaps usually possess something of that function when they are also capable of swimming, prehension, attachment, etc. In the *Nauplius* larva (Figs. 235, 258) the antennules are uniramous and the antennae biramous, and they normally retain these conditions in the adult. The *mandibles* always play, by means of their strong gnathobase, some part in preparing the food, whether by chewing or by piercing for suction, but the distal part of the limb (*palp*) may aid in locomotion or set up feeding currents. They generally lose in the adult the biramous condition which they have in the *Nauplius*. The *maxillules* and *maxillae* tend to be phyllopodia. The maxillules have usually the function of passing food to the mouth but may serve other ends. The maxillae have various functions in connection with feeding and respiration. The *limbs of the thorax* perform in various cases practically every function for which appendages are used. If a crustacean walks, it is usually by means of these limbs. Often in one or more of them the last joint can be opposed to the joint which precedes it, forming a *chela* (or a *subchela*), so that the appendage is adapted for grasping. Modification of the hinder thoracic or anterior abdominal limbs in connection with reproduction is common. *Abdominal limbs* are lacking save in certain of the Branchiopoda and most of the Malacostraca. When they are present they are commonly used for swimming, for setting up currents of water, or for carrying eggs and young.

Three elements of minor importance complete the external make-up of the Crustacea. In front of the mouth is a *labrum* or upper lip; behind the mandibles is a lower lip or *metastoma*, usually cleft into a pair of lobes known as *paragnatha*; and on the telson usually (but in no adult malacostracan except the Leptostraca, Fig. 267) is a pair of *caudal rami* forming the caudal *furca*.

Appendages which are lost are *regenerated* at subsequent moults; and the highest members of the group possess an elaborate mechan-

ism for *autotomy*—the breaking-off of limbs which have been injured or which have been seized by enemies.

An *internal skeleton* is usually present in the form of ingrowths of the cuticle, known as *apodemes*, which serve for the insertion of muscles. Sometimes (notably in the Decapoda, Figs. 233, *apo.*; 290, *enph.*) they unite to form a framework, the *endophragmal skeleton*. In the Notostraca, a mesodermal tendinous plate, the *endosternite*, lies under the anterior part of the alimentary canal.

The *nervous systems* of crustacea exhibit a very complete series of stages from the ideal arthropod condition (see p. 309), to the extremest concentration. That of the Branchiopoda (Fig. 210) is in a very primitive state, having the antennal ganglia behind the mouth as the first pair of the ventral ladder, distinct ganglia for the following somites, and widely separated ventral cords. In the lower members of the Malacostraca (*Nebalia*, some mysids, etc.), the antennal ganglia have joined the brain and the ventral cords are closer together, but otherwise the primitive condition is retained. In other crustaceans various degrees of concentration of the ventral ladder are found, beginning with the establishment of a suboesophageal ganglion for the somites of the mouth parts (Fig. 225, *s.oes.*), and ending in the formation, in the crabs (Fig. 290) and some other forms, of a single ventral ganglionic mass. In the Rhizocephala one ganglion (Fig. 261, *ga.*) supplies the whole body. The brain contains ganglia for the eyes (*optic lobes*), for the first or preantennular somite (*protocerebrum*),<sup>1</sup> and for the antennules (*deuto-* or *mesocerebrum*). Except in the Branchiopoda it also contains the antennal ganglia (*trito-* or *metacerebrum*). A *visceral* ("sympathetic") system is present. In its main features the functioning of the nervous system resembles that of insects (p. 446).

*Sense organs* are well developed in the free members of the group. *Eyes* are of two kinds, the *compound eyes*, of which a pair is usually present except in the Copepoda and adult cirripedes, and the *median eye*. Details of the structure of the compound eyes have been given above (p. 310). They may be sessile or stalked, and the latter condition has given rise to a theory that they represent a pair of appendages. Since, however, there are no somites corresponding to their ganglia and since at their first appearance in the embryo they are sessile, this view is not generally accepted (see also p. 312). The median eye (Fig. 226) is the eye of the *Nauplius* larva, and it persists in most adults, though it is generally vestigial in the Malacostraca. It consists of three pigmented cups, one median and two lateral, each

<sup>1</sup> As in other arthropods, the name *procerebrum* is given to the anterior part of the brain, composed of the protocerebrum, the optic lobes, and sometimes other ganglia which are not connected with paired limbs.

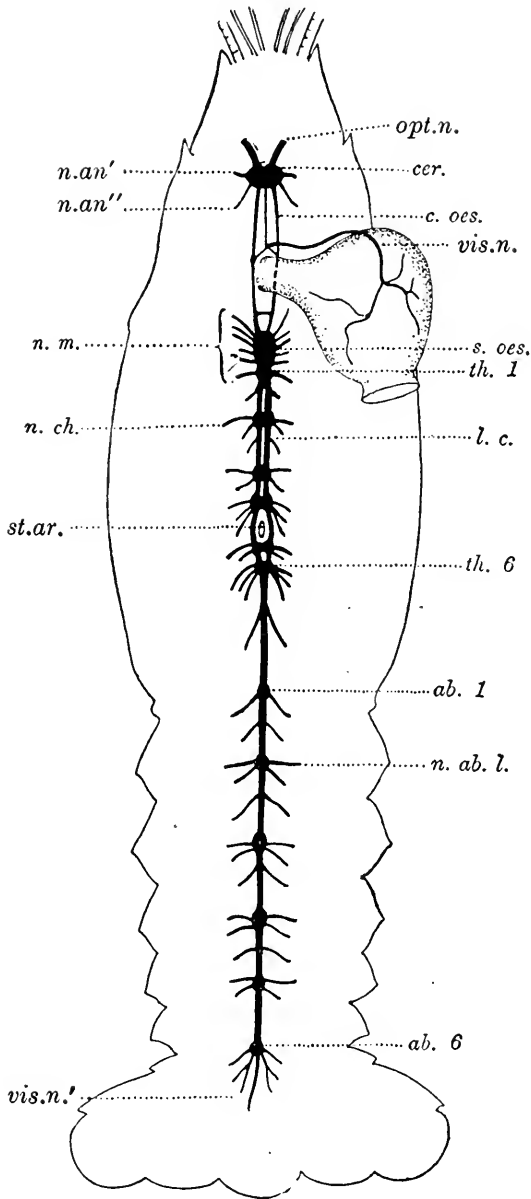

Fig. 225. A semidiagrammatic view of central nervous system of *Astacus*. From Borradaile. *ab. 1*, *ab. 6*, the first and sixth abdominal ganglia; *cer.* cerebral ganglion (brain); *c.oes.* circumoesophageal commissure; *l.c.* longitudinal commissures of ventral cord; *n.ab.l.* nerves to abdominal limbs; *n.an.'* nerve to antennule; *n.an.ii* nerve to antenna; *n.ch.* nerve to cheliped; *n.m.* nerves to limbs adjoining the mouth; *opt.n.* optic nerve; *s.oes.* suboesophageal ganglion; *st.ar.* sternal artery; *th. 1*, *th. 6*, first and sixth thoracic ganglia; *vis.n.* nerve to proventriculus; *vis.n.'* nerve to hind gut.

of which is filled with retinal cells whose outer ends are continued as nerve fibres. Thus the sense cells are inverted, as in the eyes of vertebrata. Sometimes each cup has a lens. In some of the Copepoda the lateral cups are removed from the median one and developed as a pair of lateral eyes. Senses other than sight are subserved by various modifications of the bristles which exist on the surface of the body and contain nerve fibrils in their protoplasmic contents. Most of these bristles are branched in various ways and have *tactile* functions, including that of appreciating the resistance of the water to movements. In the Decapoda and Syncarida on the basal joint of the antennule (Fig. 227) and in the Mysidae on the endopodite of the sixth abdominal appendage there is a pit whose wall bears such hairs while the hollow usually contains sand grains (most decapods) or a calcareous body formed by the animal (Mysidae). These organs are

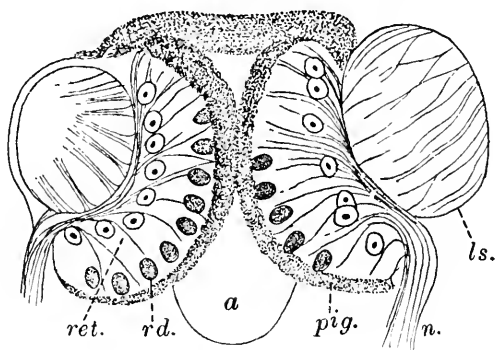

Fig. 226. A horizontal section through the median eye of *Cypris*. After Claus. *a*, position of the median (ventral-anterior) cup, which is not in the plane of section; *ls.* lens; *n.* nerve fibres; *pig.* pigment layer; *rd.* visual rod; *ret.* retinal cells.

*statocysts* for the sense of balance. *Olfactory hairs* or *aesthetascs* (Fig. 227 B, E) with delicate cuticle stand on most antennules and on many antennae. A pair of groups of cells, sometimes surmounted by setae, standing on the front of the head and known as *frontal organs*, are found in many crustaceans and are supposed to be sensory. They are present as two papillae in the *Nauplius* larva (Fig. 258, *ten.*). The *nuchal sense organ* or "neck organ" of many branchiopods is a group of cells on the upper side of the head containing refractive bodies and connected to the brain by a special nerve. Its function is unknown.

As is well known, most crustaceans are pigmented. The pigments are of various colours—red, orange, yellow, violet, green, blue, brown, black, etc., though not all are found in any one species. The majority of them are lipochromes, though the brown and black are melanins. For the most part they are contained in branched cells (chromato-



phores), but some of the blue, and perhaps of certain others, is diffused in the tissues. The chromatophores may lie in the epidermal layer, in the dermis, or in the connective tissue of deeper organs. Their

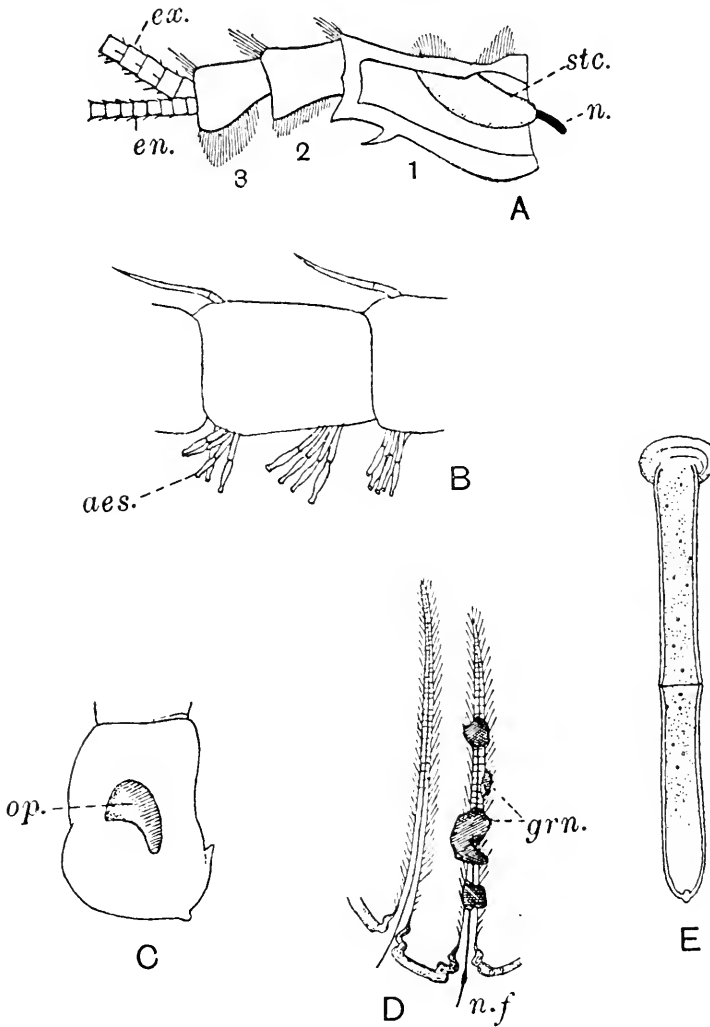

Fig. 227. The antennule of *Astacus*. A, The right antennule, seen from the median side with the basal joint opened and the flagella cut short. B, Two joints of the distal part of the outer flagellum, enlarged, after Huxley. C, The basal joint of the left antennule, from above. D, Two hairs from the statocyst. E, An aesthetasc. *aes.* aesthetasc; *en.* inner flagellum; *ex.* outer flagellum; *grn.* sand grains; *n.* nerve; *n.f.* nerve fibre; *op.* opening of statocyst, overhung by a fringe of hairs; *stc.* statocyst.

behaviour has been studied in various malacostracans. The pigment is often caused to expand or contract, which it does by flowing into and out of their processes. In this it is affected by light, responding both to intensity of illumination and to the nature of the background,

but only rarely to colour (wave-length). In light of high intensity or on a light-absorbing (e.g. dull black) background it expands; in light of low intensity or on a light-dispersing (e.g. dull white) background it contracts. Different pigments are affected to different degrees, and thus both the degree and the pattern of the coloration of a sensitive species (notably, for instance, of many prawns), changes with its surroundings—usually, in nature, in such a way as to render the animal inconspicuous. The response to intensity of illumination is due to direct action of the light upon the chromatophores and will thus take place even in blinded animals; the response to background depends upon the eyes. The eyes, however, do not act through nerves to the chromatophores, but by causing certain endocrine glands to pass hormones into the blood.

The *alimentary canal* (Figs. 233, 236, 244, 278, 289) is with very rare exceptions straight, save at its anterior end, where it ascends from the ventral mouth. The *fore gut* and *hind gut* (stomodaeum and proctodaeum), lined with cuticle inturned at the mouth and anus, leave a varying length of *mid gut* (mesenteron) between them. The intrinsic musculature, sometimes supplemented by extrinsic muscles running to the body wall, is strongest in the fore gut, whose lining sometimes develops teeth or hairs. In the Malacostraca (Fig. 228) these elements become a more complex proventriculus (“stomach”), with a “gastric mill” and a filtering apparatus of bristles which strains particles from the juices of the food, the mill and filter being often in separate “cardiac” and “pyloric” chambers. The mid gut usually bears near its anterior end one or more pairs of diverticula (“hepatic coeca”), which serve for secretion and absorption and may branch to form a “liver”. This gland, however, unlike the liver of vertebrates, forms all the enzymes necessary for the digestion of the food and absorbs from its lumen the products of digestion. It stores the reserves in the form of glycogen and fat. Occasionally there is an anterior median dorsal coecum. Coeca are also sometimes found at the hinder end of the mid gut: these are more often median. In a few cases the hind gut is absent and the mesenteron ends blindly. In the Rhizocephala and the monstrillid copepods (p. 374) the alimentary canal is absent throughout life, for these animals absorb through the skin during the parasitic period enough nutriment to last through an entire life history.

*Digestion* is extracellular. The fore gut is frequently the seat of mechanical processes, and sometimes of chemical action by juices secreted by the mid gut diverticula, but never of absorption. The latter process as well as most of the chemical work is performed by the mid gut, including the hepatic diverticula. In the hind gut the faeces are passed to the anus, being in some entomostraca sheathed in

a so-called "peritrophic membrane" composed of a mucoid substance secreted by certain cells of the epithelium.

The principal *excretory organs* of the Crustacea are two pairs of glands, known as the *antennal* and *maxillary glands*, which open (Fig. 233, *k.op.*) at the bases of the appendages from which they take their names. They are very rarely (*Lophogastridae*) both well developed at

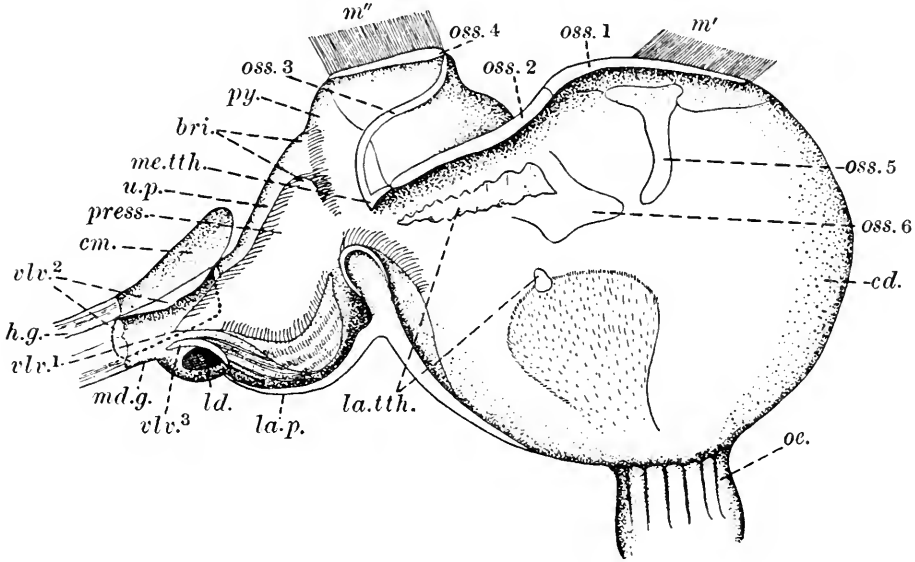

Fig. 228. The left-hand side of the fore gut and mid gut of *Astacus*, viewed from within. Semidiagrammatic. *bri.* bristles which form part of the filtering apparatus; *cd.* cardiac chamber of the "stomach"; *cm.* median dorsal coecum of the mid gut; *h.g.* hind gut; *ld.* opening of left liver duct; *la.p.* lateral, finely-filtering pouch of the pyloric chamber leading to opening of liver; *la.tth.* lateral teeth; *m', m''*, left anterior and posterior gastric muscles; *mdg.* mid gut; *me.tth.* median tooth; *oe.* oesophagus; *oss. 1-oss. 6*, cardiac, urocardiac, prepyloric, pyloric, pterocardiac, and zygo-cardiac ossicles—calcifications of the cuticle of the stomach which constitute the mechanism of the gastric mill: when the cardiac and pyloric ossicles are pulled in opposite directions by the contraction of the muscles *m'* and *m''* attached to them, the teeth are brought together; *press.* chamber which presses the liquid out of the food into the upper passage (*u.p.*) and the lateral pouches (*la.p.*); *py.* pyloric chamber; *u.p.* upper passage leading to mid gut; *vl.v. 1* one of a pair of valves which guide the faecal residue from the press into *vl.v. 2*, an enclosing valve which conducts it to the hind gut; *vl.v. 3* one of a pair of valves which guard openings of liver ducts.

the same stage in the same species, but one may succeed the other as a functional organ in the course of the life history: the antennal gland, for instance, is the larval excretory organ of the Branchiopoda, but the maxillary gland is that of the adult; and the Decapoda, whose adult kidney is the antennal gland, sometimes use as larvae the maxillary gland instead. The maxillary gland is the more widespread

as an adult organ, the antennary gland being functional in the adult only in certain of the Malacostraca. In the Ostracoda and Leptostraca both are vestigial in the adult. Each of these glands (Figs. 229–231) has an *end sac* and a *duct* leading from the end sac to the exterior. The end sac is always mesodermal and doubtless represents a vestige of the coelom. The duct is sometimes (in the Malacostraca probably

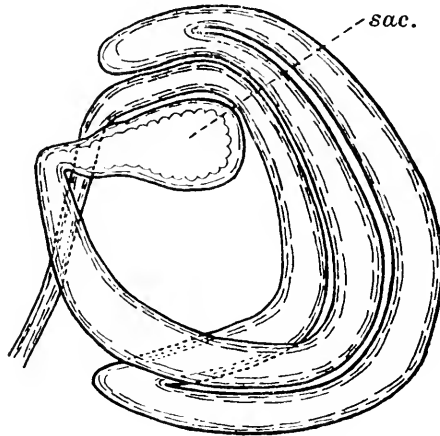

Fig. 229. The maxillary gland of *Estheria*. After Cannon. *sac.* end sac.

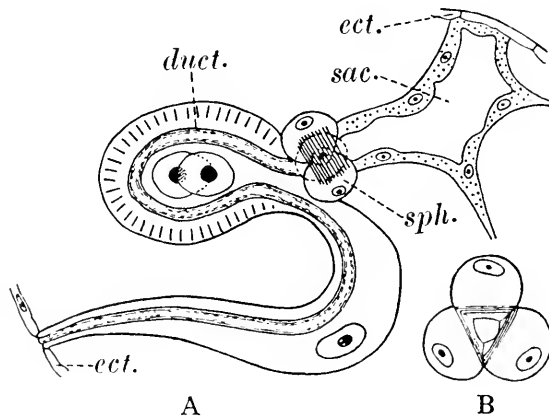

Fig. 230. Diagrams of the antennal gland of the early metanauplius of *Estheria*. After Cannon. A, The whole gland. B, The sphincter in section. *duct.* intracellular ectodermal duct; *ect.* ectoderm; *sac.* end sac (coelomic); *sph.* sphincter cells.

always) a multicellular, mesodermal structure, and sometimes intracellular and of ectodermal origin. At the junction of end sac and duct there is often a sphincter. The antennal gland of the Decapoda is usually very complicated. That of the crayfish lacks extensions of the bladder which lie among the viscera in many other genera, as in crabs. All the parts of the organs are excretory, and the function of the

sphincter of the end sac is perhaps to prevent the passage back into that vesicle, which secretes ammoniacal compounds, of poisonous products excreted in the duct.

These glands are probably the remaining members of a series of segmental excretory organs. Their mesodermal portions are no doubt

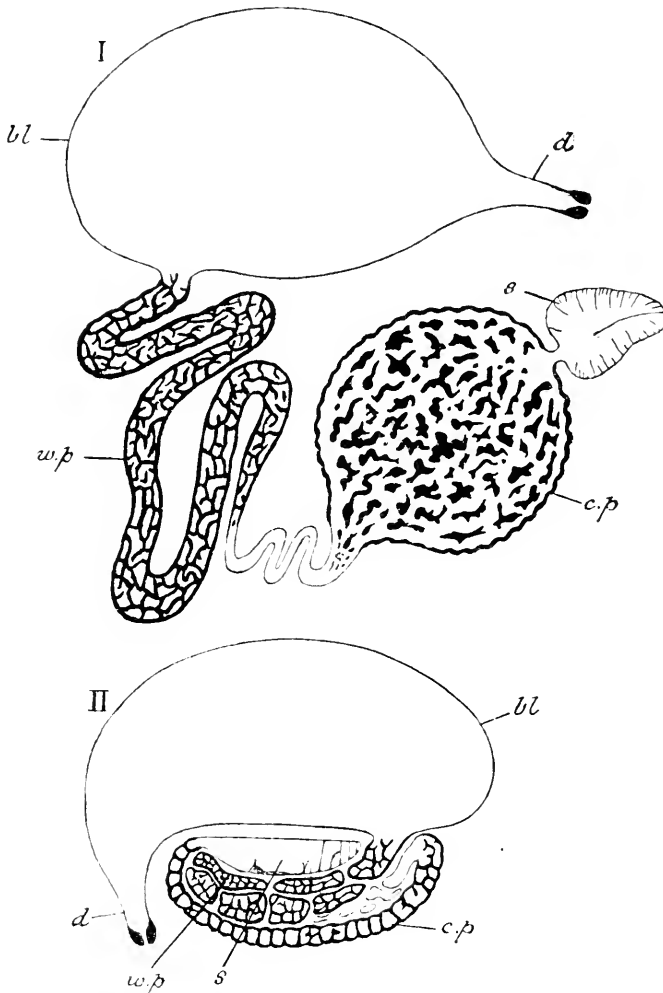

Fig. 231. Diagrams of the green gland of *Astacus*. From Parker and Haswell, after Marchal. I, The organ unraveled. II, A section of the organ with the parts in their natural positions. *bl.* bladder; *c.p.* cortical (green) portion of the gland; *d.* terminal duct; *s.* end sac; *w.p.* medullary (white) portion of the gland.

coelomoducts, homologous with those of the Annelida, their ectodermal portions probably are not the homologues of nephridia but represent ectodermal glands such as are common in the Crustacea. Various other glands, mostly of doubtful morphological significance, which occur in different crustaceans have been shown, or are sus-

pected, to have an excretory function. Thus, in *Nebalia*, eight pairs of ectodermal glands at the bases of the thoracic limbs are excretory, while in ostracods a pair of rather complex glands, also of ectodermal origin, which lie between the folds of the shell in the antennal region, may have a similar function. Excretion appears also sometimes to be performed by coeca of the mid gut—as by some of those of the barnacles and by the posterior pair of amphipods—or by cells of the epithelium of the mid gut itself.

*Respiration* in many of the smaller crustaceans, notably in the Copepoda, takes place through the general surface of the body. In forms with stouter cuticle or more bulky bodies this is supplemented or replaced by the use of special organs upon which the cuticle remains thin. The most important of such organs are the lining of the carapace, if that structure be present, and certain epipodites which are known as gills and in many of the Malacostraca have their surface increased by branching or folding (Figs. 222 F; 285; 287, 1, 2). In the Decapoda incorporation of the precoxa with the flank of the body has brought it about that some of the gills (proepipodites, p. 337), stand in that position and not upon the actual limbs (Fig. 232). Such gills are known as “pleurobranchiae”. In the Isopoda respiration is effected by the broad rami of the abdominal limbs. Renewal of the water upon the respiratory surfaces may be brought about by the movements of the limbs upon which they are located, but often certain appendages bear special lobes adapted to set up a current under the carapace and thus to flush the chamber in which the gills and the carapace lining are situated.

Some land crustaceans have no special adaptations for respiration in air. In others the gill chamber is adapted, by the presence of vascular tufts of the lining of the carapace, for use as a lung. The woodlice, which are terrestrial members of the Isopoda, are remarkable in approaching in their respiration the principle employed by normally terrestrial arthropods, for the integument of their abdominal limbs is invaginated to form branching tubes which resemble tracheae.

The *vascular system* is seen in its most primitive condition in the Branchiopoda Anostraca (*Chirocephalus*, Fig. 236). Here the *heart* (*h.*) runs the whole length of the trunk, situated above the gut in a blood sinus known as the *pericardium*, with which it communicates by a pair of ostia in each somite except the last. In front it is continued into the only *artery*, a short aorta, from which the blood flows direct into the *sinuses* of the head and thence through those of the trunk to the pericardium, eddies from a main ventral sinus supplying the limbs. In all other crustacea, except the Stomatopoda, the heart, if it be present, is in some degree shortened, and in the Malacostraca (Fig.

233) a system of arteries interposes between the heart and the sinuses, leaving the former by several vessels, which conduct the blood to the organs. In the Eucarida (Euphausiacea and Decapoda) the heart is shortened to a compact shape and has three pairs of ostia; in most of

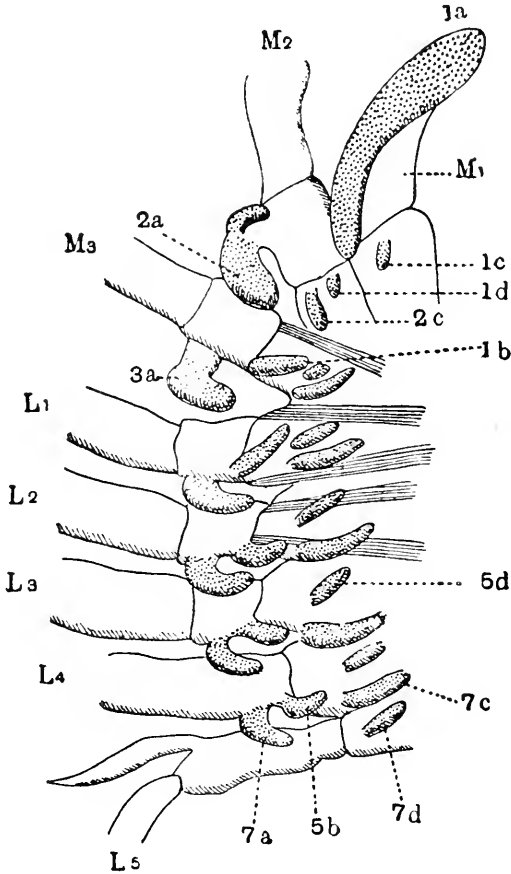

Fig. 232. Part of the left side of a late larva of the prawn *Penaeus* to show the origin of the gills. Slightly magnified. After Claus.  $L_1-L_5$ , the first to fifth legs;  $M_1-M_3$ , the first to third maxillipeds;  $1a, 2a, 3a, 7a$ , distal series of rudiments, standing upon the coxopodites; from these rudiments arise the mastigobranchiae (see p. 408), and on the second maxilliped a podobranch also;  $1b, 5b, 1c, 2c, 7c$ , members of two series of rudiments, standing where the membrane of the joint between the coxopodite and the body will develop; from these respectively the anterior and posterior members of pairs of arthrobranchiae arise;  $1d, 5d, 7d$ , members of a fourth series of rudiments, standing on the basal parts (precoxae) of the limbs; from this series will arise the pleurobranchiae, which, owing to the taking up of the precoxae into the body, will stand on the side of the thorax.

the Cladocera it is a sac (Fig. 244, *h.*) with only one pair. In the Cirripedia and many of the Copepoda and Ostracoda the heart is absent and the blood is kept in movement only by the movements of the body and alimentary canal. In the parasitic copepod *Lernanthropus* and

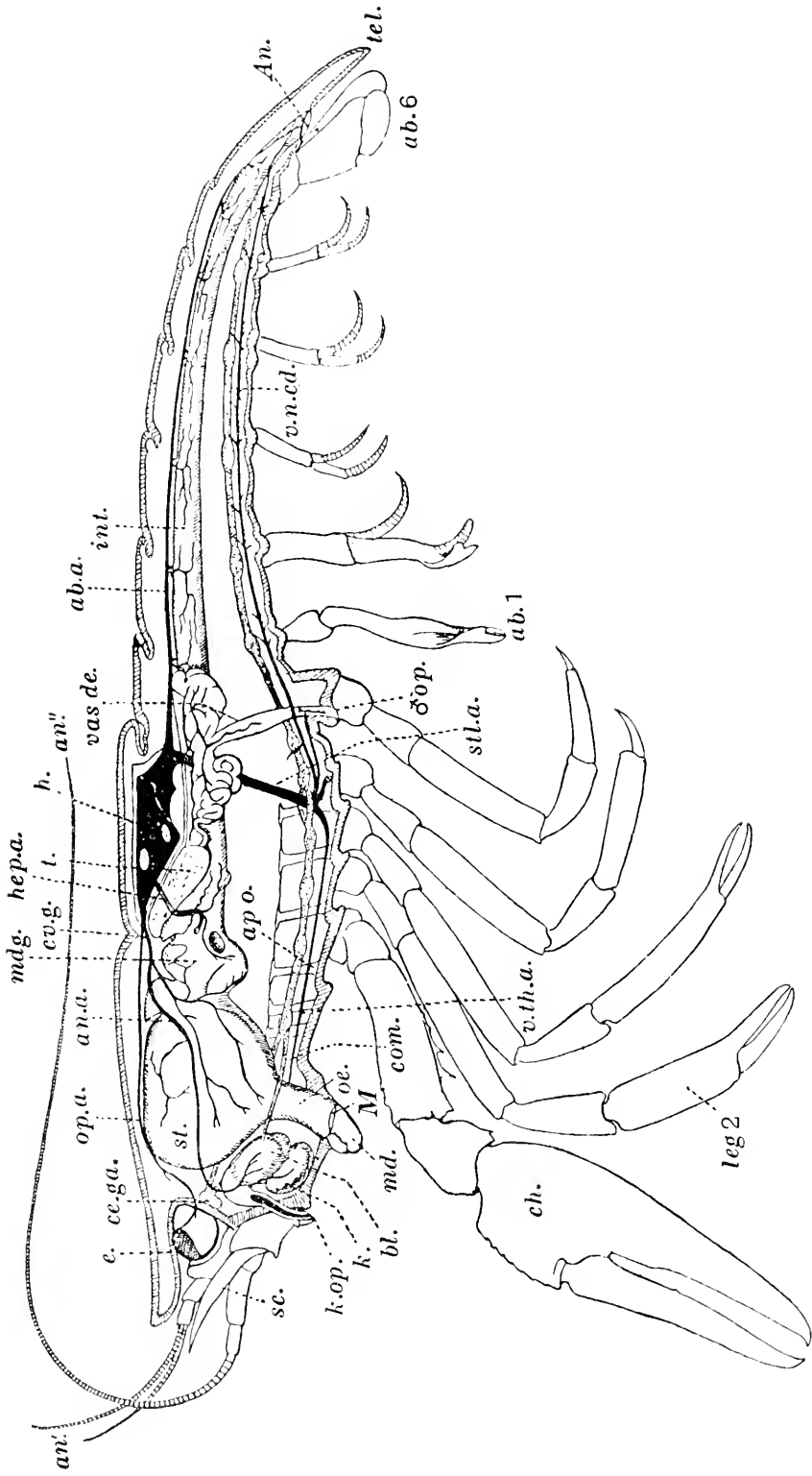

Fig. 233. *Astacus fluviatilis*, dissected from the left-hand side. From Shipley and MacBride. *an.*' antennule; *an.*' antenna; *md.* mandible; *M.* mouth; *sc.* scale of antenna; *An.* anus; *tel.* telson;  $\delta$  *op.* male genital opening; *ch.* chela; *leg 2*, first walking leg; *ab. 1*, the first abdominal appendage, modified for copulation; *ab. 6*, the last abdominal appendage; *oe.* oesophagus; *st.* "stomach"; *mdg.* mesenteron; *cv.g.* cervical groove; *int.* intestine; *ce.ga.* cerebral ganglion; *com.* nerve collar; *v.n.cd.* ventral nerve cord; *e.* eye; *h.* heart; *stl.a.* sternal artery; *ab.a.* dorsal abdominal artery (posterior aorta); *v.th.a.* ventral thoracic artery; *op.a.* ophthalmic artery (anterior aorta); *an.a.* antennary artery; *hep.a.* hepatic artery; *h. hep.a.* testes; *vas de.* vas deferens; *apo.* apodemes; *k.* kidney (green gland); *bl.* bladder; *k.op.* kidney opening. Ventral abdominal and left gastric arteries shown but not labelled.



some related genera there is a remarkable system of closed blood vessels without a heart.

The *blood* is a pale fluid, which bears leucocytes except in ostracods and most copepods. It contains in the Malacostraca the copper-containing respiratory pigment *haemocyanin* (p. 133). In various entomostraca, notably in *Lernanthropus*, just mentioned, haemoglobin has been found.

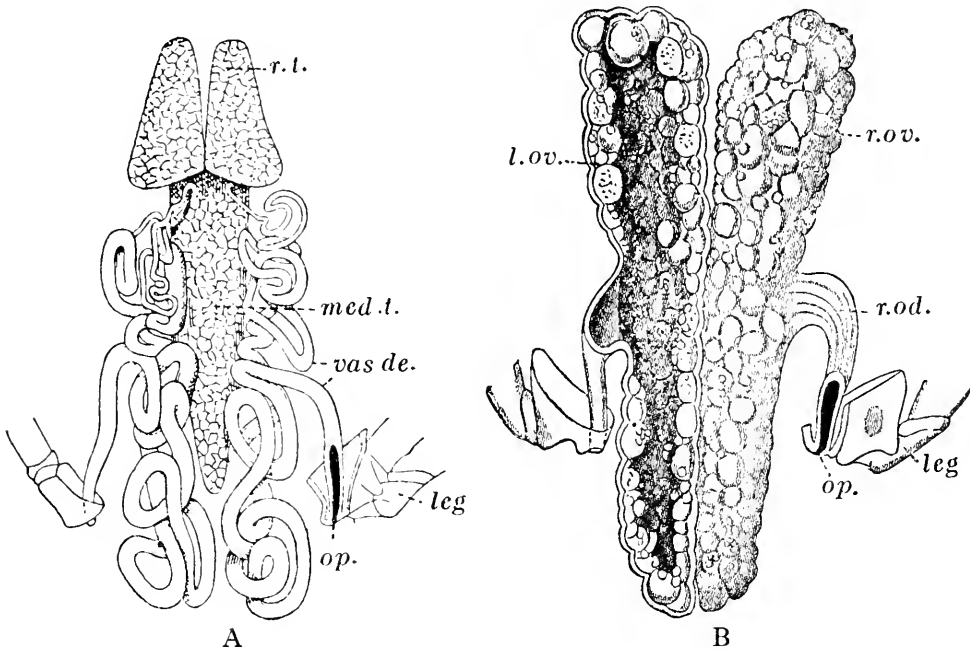

Fig. 234. A, Male reproductive organs of *Astacus fluviatilis*. From Howes. *r.t.* right anterior lobe of testis; *med.t.* median posterior lobe of testis; *vas de.* vas deferens; *op.* external opening of vas deferens; *leg.* right fourth ambulatory leg on which the vas deferens opens. B, Female reproductive organs of *Astacus fluviatilis*. From Howes. *r.od.* right oviduct: the left oviduct is shown partly opened; *r.ov.* right lobe of ovary; *l.ov.* left lobe of ovary with the upper half removed to show the ovarian cavity, which is the remains of the coelom and into which the ripe ova drop; *op.* external opening of oviduct; *leg.* right second ambulatory leg on which the oviduct opens.

As is usual with animals that are free and active, the *sexes* are separate in the great majority of the Crustacea, though the Cirripedia, which are sessile, certain of the parasitic Isopoda, and a few exceptional species in other groups, are hermaphrodite. Parthenogenesis takes place in many of the Branchiopoda and Ostracoda, and in these it is often only at more or less fixed intervals that sexual reproduction occurs. The male is usually smaller than the female and in some parasites is minute and attached to her body. He has often clasp-  
organs for holding his partner, and these may be formed from almost

any of the appendages. He may also possess organs for the transference of sperm: these may be modified appendages or protrusible terminal portions of the vasa deferentia. The *gonads* of both sexes (Fig. 234) are hollow organs from which ducts lead directly to the exterior. Primarily there is one gonad on each side, but they often unite more or less completely above the alimentary canal. The ducts usually open near the middle of the body, though the male openings of cirripedia and some cladocera are almost terminal and the female opening of cirripedia is on the first thoracic somite. Save in the Cirripedia, the Malacostraca, and some of the Cladocera, the ducts of the two sexes open upon the same somite.

The *spermatozoa* are very varied in form and often of complex structure; usually, but not always, they are immobile. They are transferred to the female, often in packets (*spermatophores*). The *ova* have usually much yolk, and meroblastic, centrolecithal cleavage (Fig.

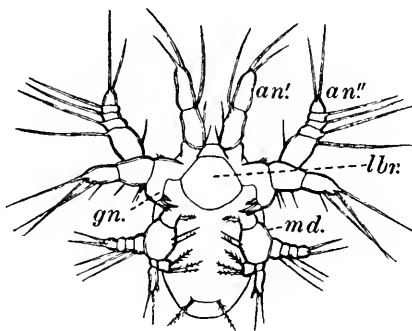

Fig. 235. A ventral view of the first *Nauplius* of *Cyclops*. After Dietrich. *an.'* antennule; *an.''* antenna; *gn.* gnathobase; *lbr.* labrum; *md.* mandible.

213 A-C), but sometimes are less yolky and undergo total cleavage. Gastrulation may be by invagination (Fig. 213 D) or by immigration. Occasionally the eggs are set free at laying, but in the great majority of cases they are retained for a time by the mother, either in some kind of brood pouch or adhering in some way to her body or appendages. *Development* is not infrequently direct, but in most cases involves a larval stage or stages.

Typically, the crustacean hatches as a *Nauplius* larva (Fig. 235), a minute creature, egg-shaped with the broad end in front, unsegmented, but provided with three pairs of appendages—the antennules, which are uniramous, and the antennae and mandibles, which are biramous and should each bear a gnathobasic process or spine directed towards the mouth, though those of the mandibles are often not developed at first. The antennal ganglia are as yet postoral (see p. 340). The median eye is the only organ of vision. A pair of frontal organs (p. 342) are present as papillae or filaments. There is a large

labrum. Fore, mid and hind guts can be recognized in the alimentary canal. Antennal glands may be present. This larva is found in some members of every class of the Crustacea, though among the Malacostraca only certain primitive genera possess it, and in the Ostracoda it is modified by having already at hatching a precociously developed bivalved carapace. In every class, however, it is also often passed over, and becomes an embryonic stage within the egg membrane or in a brood pouch, the animal hatching at a later stage, such as the *Metanauplius* and *Zoea* mentioned below, or even almost as an adult.

In the Branchiopoda and Ostracoda the *Nauplius* is transformed gradually into the adult, adding somite after somite in order from before backwards by budding in front of the telson, much as somites are added to the trochosphere in the development of annelids, while by degrees the other features of the adult develop. The early stages of this process, which possess more somites than the *Nauplius*, but have not yet the adult form, are known as *Metanauplii*. The carapace is often foreshadowed quite early by a dorsal shield, which later grows out behind and at the sides to assume the form which it has in the adult, and the appendages, at first mere buds, gradually take on their final shapes.

In most cases, however, the process just described is modified. (a) It makes a sudden great advance at one moult. In the Cirripedia the late *Nauplius* passes with a leap to the so-called *Cypris* larva, which has many of the features of the adult: a similar leap takes the copepod *Metanauplius* to the first "*Cyclops*" stage (p. 373) and those of Malacostraca to the *Zoea*. (b) Certain structures may be precociously developed. In those of the Malacostraca which have *Nauplii*, the *Metanauplius* is followed by stages, known as *Zoaeae*, in which the abdomen is well developed, while the thorax, though it already possesses in front a few pairs of biramous appendages, is still rudimentary in its hinder part. In these larvae also the last pair of abdominal limbs usually appears, or comes to functional development, before the others. *Zoaeae*, however, most often are not preceded by a free *Nauplius* but appear as the first free stage (Fig. 291 A). (c) Temporary retrogression of certain organs takes place during the development of some of the Malacostraca: this affects some of the thoracic limbs in certain Stomatopoda and the prawn *Sergestes*, abdominal swimmerets and the antennule in the prawn *Penaeus*.

### Class BRANCHIOPODA

Free Crustacea with compound eyes; usually a carapace; the mandibular palp very rarely present and then as a minute vestige; and at least four, usually more, pairs of trunk limbs, which are in most cases broad, lobed, and fringed on the inner edge with bristles.

The Branchiopoda are, on the whole, the most primitive class of the Crustacea. This is seen in the varying and usually large number of their somites, the usually small amount of differentiation in the series of limbs on the trunk, the vascular system of the lower members of the group (p. 348), and the nervous system of all (p. 340). Their mouth parts, on the other hand, are small and simple in structure, a condition in which they are not primitive but exhibit reduction. Nearly all of them are, like sundry other archaic animals, of freshwater habitat, and their characteristic mode of feeding is the taking, by means of setae upon their trunk limbs, of particles of detritus or plankton from suspension in the water.

The primary divisions of the class have been mentioned on p. 327. The most conspicuous differences between them are in the carapace, the compound eyes, the antennae, the trunk limbs, and the telson.

The *carapace* is very variously developed. In the Anostraca it is not present. The Notostraca have it as a broad, shallow cover over the back. In the normal Cladocera ("Calyptomera") it bends down at the sides to enclose the trunk as a shell, which forms a brood pouch over the back. In the two groups of aberrant Cladocera which (though they are probably not closely related) are together known as "Gymnomera" this shell has shrunk to a dorsal brood pouch leaving the trunk partly or wholly uncovered. In the Conchostraca it forms in the same way as in the Cladocera a shell, but here the head is usually enclosed as well as the trunk, and there is a distinct dorsal hinge of thin cuticle separating two valves which can be closed by an adductor muscle situated in the maxillary somite. Usually the carapace leaves the trunk free within it, but in the Cladocera it fuses with two—in *Leptodora* (p. 368) with all—of the thoracic somites.

The *antennae*, which in the *Nauplius* are biramous and natatory, retain this condition in the adult of those forms (Diplostraca) in which the enclosing carapace has deprived the trunk limbs of the swimming function, and also in the extinct *Lepidocaris* (Lipostraca). In the recent Anostraca the antennae are stout but uniramous and not natatory; in the male they are adapted to clasping the female. In the Notostraca, which apply the head to the ground in feeding, they are reduced to uniramous vestiges.

The *trunk limbs* (except in the aberrant Cladocera which constitute the Gymnomera) are phyllopodia (p. 336) which bear on the median side endites furnished with feathered bristles and on the outer side, besides the exopodite or flabellum, a thin-walled branchia and often also one or two proepipodites. With these appendages the Anostraca and Notostraca swim, and all members of the class breathe and gather food. Beating rhythmically forward and backward with a movement

which each pair starts a little earlier than the pair in front of it, they cause, by a pumping action which shall be described presently (p. 358), a flow of water into the median gully whose sides are formed by the two rows of limbs, thence outwards into the spaces between each limb and its neighbours in front and behind, and then backwards. This current brings with it the particles which serve for food, bathes the branchiae, and causes, in the Anostraca and Notostraca, forward movement of the body. As the water passes outwards, the food particles are, by the bristles on the endites, strained off and retained in the median gully. The apparatus varies in detail with the nature of the food. In the Notostraca, which feed mainly by stirring up, with the tips of their thoracic limbs, detritus on the bottom and then filtering it, the bristles on the endites are not adapted to straining out fine particles (which therefore escape with the outgoing current) but detain coarser particles. This is perhaps the primitive mode of feeding of the Branchiopoda, and may even be inherited from the Trilobites. In the Anostraca and Diplostraca there is a special apparatus for filtering off fine particles. This consists of a close set row of long, finely feathered setae, placed on the edge of the endites and so disposed as to cover the opening from the median gully to the space between the limb and its neighbour behind. Members of these orders which derive part or all of their food from detritus have various kinds of apparatus, composed of bristles, for removing the coarse particles and passing them backwards to be either swept away with the outgoing stream or broken up for food by the hinder members of the series of limbs. Finally, the material gathered is passed forwards to the mouth in a median "food groove" along the belly by a current whose causation is a matter of dispute. The feeding apparatus whose principles have just been described differs greatly in detail in different branchiopods, and reaches its highest complication in the tribe of cladocera known as Anomopoda, to which the common water-flea *Daphnia* belongs. Examples of it are described more fully below.

The Gymnomera have slender, mobile, jointed trunk limbs with which they manipulate the relatively large organisms which serve them for food.

The *telson* is in the Anostraca subcylindrical, with the caudal rami as elongate plates or styles; in the Notostraca it has the rami long and many-jointed, and is in *Lepidurus* produced backwards on the dorsal side as a plate. In the typical Diplostraca it is flexed ventrally and produced backwards laterally into a pair of strong, curved, toothed claws, and can be brought forward ventrally to clear the gully between the limbs. In the Gymnomera it has re-straightened.

The *compound eyes* are in the Anostraca stalked (in *Lepidocaris* they appear to have been absent). In the remainder of the class they are

sessile and covered by an invagination of the outer cuticle, which forms a shallow chamber over them.

*Artemia salina* (p. 359) and a few marine cladocera are the only members of the class whose habitat is not in fresh water.

Throughout the group, thick-shelled eggs capable of resisting drought or freezing are produced by sexual reproduction. Often there is also parthenogenesis, the eggs of which are usually thinner shelled than those that are sexually produced (see p. 367).

The name *Phyllopoda*, which is applied sometimes to the whole class and sometimes to its members exclusive of the Cladocera, is on account of this ambiguity best not employed in systematic nomenclature.

### Order ANOSTRACA

Branchiopoda without carapace; with stalked eyes; with antennae of a fair size but not biramous; with the trunk limbs numerous and all alike; and with the caudal rami unjointed, and flat or subcylindrical.

We may take as an example of this group, *Chirocephalus diaphanus* (Fig. 236), one of its two British representatives. This creature turns up from time to time in temporary pools of water in various districts. It is about half an inch in length, transparent, and almost colourless, save for the reddened tips of most of the appendages and of the abdomen, the black eyes, and often a green mass of algae in the gut. It is incessantly in motion, swimming on its back. Its delicate appearance, and the iridescent gleaming of the bristles on its appendages as they are moved have earned it the name of the fairy shrimp. The body is long, subcylindrical, and enlarged anteriorly to form the *head*, upon which the mandibular groove (p. 332) is conspicuous. The head has in front a *median eye* and a *neck organ* (p. 342), and bears at the sides: (a) the large, stalked *compound eyes*; (b) the *antennules*, slender, unjointed, and ending in a tuft of sense-hairs; (c) the stout *antennae*, triangular in the female but in the male (Fig. 237) elongate, two-jointed, and carrying on the inside at the base a complicated, lobed "frontal appendage" which comes into play when the limb is used for clasping the female; (d) the *mandibles*, whose bases are prominent at the sides of the head, while the remaining part of each of them is directed towards the mouth as a process with a blunt, roughened end. Below, the head bears (a) the large *labrum* which is directed backwards under the mouth; (b) the *paragnatha*, a pair of small, hairy lobes behind the mouth; (c) the *maxillules*, a pair of small triangular plates fringed by long bristles; (d) the *maxillae*, which are microscopic vestiges, each bearing three spines.

Behind the head come eleven *thoracic somites* which bear each a pair of phyllopodia. Fig. 238 shows that these possess all the typical

features of such limbs but are remarkable for the distal position of the exopodite and for the very long basal endite, which may be simply the gnathobase (p. 337) but probably represents also the

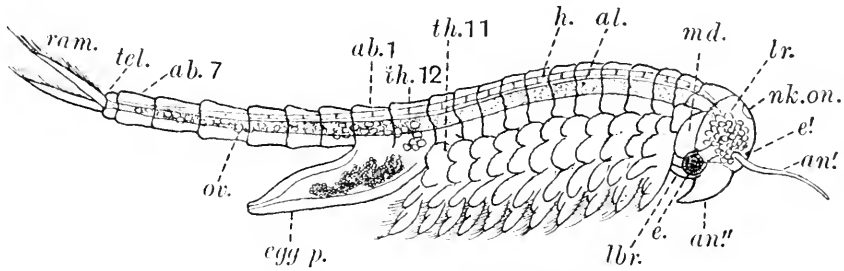

Fig. 236. A female of *Chirocephalus diaphanus*. The animal is seen from the right-hand side in the morphological position: normally it swims upside down. *ab. 1*, *ab. 7*, first and seventh abdominal somites; *al.* alimentary canal; *an.*' antennule; *an.*'' antenna; *e.* compound eye; *e.*' median eye; *egg p.* egg pouch; *h.* heart; *lbr.* labrum; *lr.* liver; *md.* base of mandible; *nk.on.* neck organ; *ov.* ovary; *ram.* ramus of caudal fork; *tel.* telson; *th. 11*, eleventh thoracic limb; *th. 12*, twelfth thoracic somite.

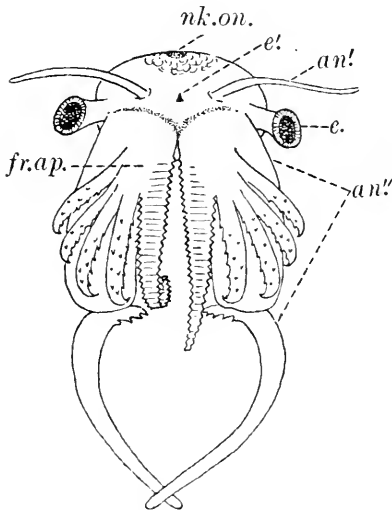

Fig. 237.

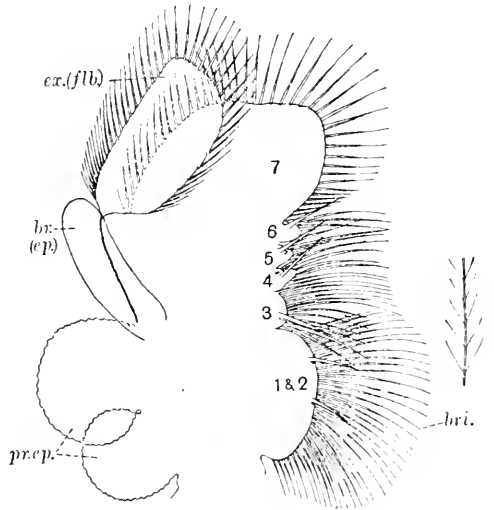

Fig. 238.

Fig. 237. A front view of the head of a male *Chirocephalus*. *an.*' antennule; *an.*'' antenna; *e.* compound eye; *e.*' median eye; *fr.ap.* frontal appendage; *nk.on.* neck organ.

Fig. 238. A thoracic limb of *Chirocephalus*, mounted flat. *br.* branchia; *bri.* bristles which strain out the food; *ep.* epipodite; *ex.* exopodite; *flb.* flabellum; *pr.ep.* proepipodites; 1-7, endites.

second endite. The fringe of long bristles on the median border is, in life, directed backwards, roughly at right angles to the main plane of the limb. The twelfth thoracic somite, upon which are

the genital openings, is fused ventrally with the first abdominal. In the male, it bears a pair of ventrolateral processes in each of which is the terminal portion of a vas deferens, with a protrusible penis which probably represents an appendage. In the female there is here a median, ventral, projecting egg pouch, which, like the penes, is held to represent a pair of limbs. The *abdomen* consists of seven simple, limbless somites and a telson which bears a pair of caudal rami as narrow, pointed plates, fringed with bristles.

The *alimentary canal* begins with a short, vertical fore gut, or oesophagus. This leads to a mid gut which continues as far as the telson, where it is succeeded by the hind gut or rectum. The mid gut is somewhat wider in the head, where it is known as the *stomach*, than in the trunk, where it is called the *intestine*. From the stomach proceeds a pair of sacculated diverticula ("liver"). The *food* consists partly of coarse detritus gathered by the trunk limbs from the bottom of the pool, and partly of small organic particles, especially unicellular algae, which are strained off from the water by the trunk limbs in the following manner (Figs. 239, 240). The space which exists between each limb and that behind it is enlarged at the forward stroke, which finishes with the limbs vertical, and narrowed at the back stroke, which ends with them roughly horizontal, lying against the body. During the forward stroke the enlarging of this space exerts a suction. The proepipodites, exopodite, and large distal endite are drawn back by the suction and pressed back by the resistance of the water, till they reach the limb behind and so convert the space just mentioned into a chamber which is closed except on the median side, where it is separated only by the backwardly directed bristle fringe from the median gully between the limbs of the right and left sides. From this gully, therefore, water is drawn into the chambers at the sides as they enlarge, particles which it contains being strained off by the bristles and remaining in the gully. The latter is of course replenished by the entrance of water from the ventral side. During the back stroke, the chambers, as they become smaller and the pressure of the water in them rises, open owing to this pressure lifting the structures which had closed them; and the water they contain is driven out and backward in two ventrolateral streams, the animal being driven forwards. Thus the same movement of the limbs serves both for the gathering of food and for swimming. The particles which are retained in the median gully are drawn dorsalwards because the suction of the side chambers is greatest where they enlarge most, at the bases of the limbs, and so get into a median food groove of the ventral surface. There they are carried forward to the mouth by a minor stream, which is said to be caused by the escape forwards at the bases of the limbs of some of the water contained in the lateral chambers at a certain



phase of the movement. The food is agglutinated by a sticky secretion produced by glands in the labrum, and pushed by the maxillules between the mandibles, which pound it and pass it into the mouth.

The *organs of excretion* are a pair of maxillary glands (p. 345), situated in the hinder part of the head and the first thoracic somite. They are wholly of mesodermal origin. The *nervous system* (Fig. 210) and the *vascular system* have been described above (pp. 340 and 348). The *gonads* are a pair of tubes lying one on each side of the alimentary canal in the abdomen, and are continuous in front each with a short duct. The vasa deferentia lead to the penes, the oviducts to a median

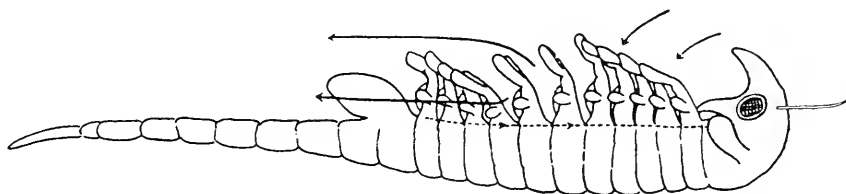

Fig. 239. A diagrammatic view of a *Chirocephalus* swimming on its back. The arrows show the direction of the currents set up by the action of the thoracic limbs, the dotted line the course of the gathered particles in the food groove.

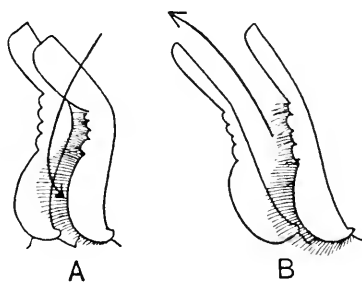

Fig. 240. Thoracic limbs of *Chirocephalus* seen from the median side in two phases of their action. A, The forward stroke: water is being drawn through the fringe of bristles into the space between the limbs, which is enlarging. B, The backward stroke: water is being driven backwards out of the space between the limbs, which is contracting.

uterus in the egg pouch. The eggs are enclosed in stout shells and will remain alive in dry mud for many months. The larva at hatching is a late *Nauplius* in which, though there are no appendages behind the mandibles, the trunk is already distinct from the head.

*Artemia salina*, the other British species of anostracan, occurs in various parts of Europe in salt lakes and marshes and in pans in which brine is being concentrated. It can endure a very high concentration of salt, and some of its minor features change with the degree of the concentration, so that it has been described under different specific names. It differs from *Chirocephalus* in having only six abdominal somites and in the form of the antennae of the male.

*Lepidocaris* (Suborder *Lipostraca*), a minute, blind, freshwater form from the Middle Devonian, was closely related to the Anostraca which survive (*Euanostraca*), but differed from them in the following, among other respects. It had biramous antennae which recall those of the Cladocera; a clasping organ on the maxillule of the male, instead of on the antenna; and the trunk limbs without branchiae and differentiated into two sets—the first three pairs adapted for gathering food, with gnathobase and with the last endite directed inwards and the exopodite lateral, and the remaining pairs adapted for swimming, with the last endite and the exopodite directed distally side by side at the end of the limb.

### Order NOTOSTRACA

Branchiopoda with a carapace in the form of a broad shield above the trunk; the compound eyes sessile and close together; the antennules and antennae much reduced; the trunk limbs numerous, the first two

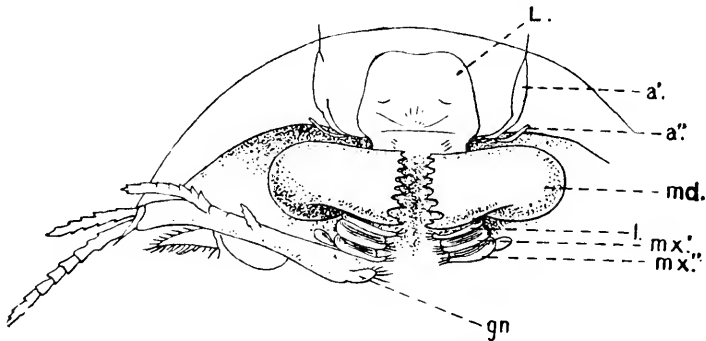

Fig. 241. A ventral view of the head region of *Lepidurus glacialis*. From Calman. *a.*' antennule; *a.*'' antenna; *gn.* gnathobase; *L.* labrum (turned forwards); *l.* paragnathum; *md.* mandible; *mx.*' maxillule; *mx.*'' maxilla.

pairs of them differing considerably from the rest; and slender, multi-articulate caudal rami.

This order contains only the genera *Apus* and *Lepidurus*, which differ in but minor features. *Apus cancriformis* (Fig. 242) is British, but is now very rarely found in these islands. The head is broad and depressed, flat below and arched above, and forms with the carapace a horseshoe-shaped structure, which bears the eyes above and the small antennules and antennae beneath, at some distance from the sharp front edge. There is a dorsal organ, which is not used for fixation, but no nuchal sense organ. From under the carapace the hinder part of the trunk projects backwards, ending in two long, jointed caudal rami. The genital opening is on the 11th of the trunk somites. Each of these bears a pair of limbs until the 13th (second of the abdomen) is reached, after which there are two to five pairs to a somite

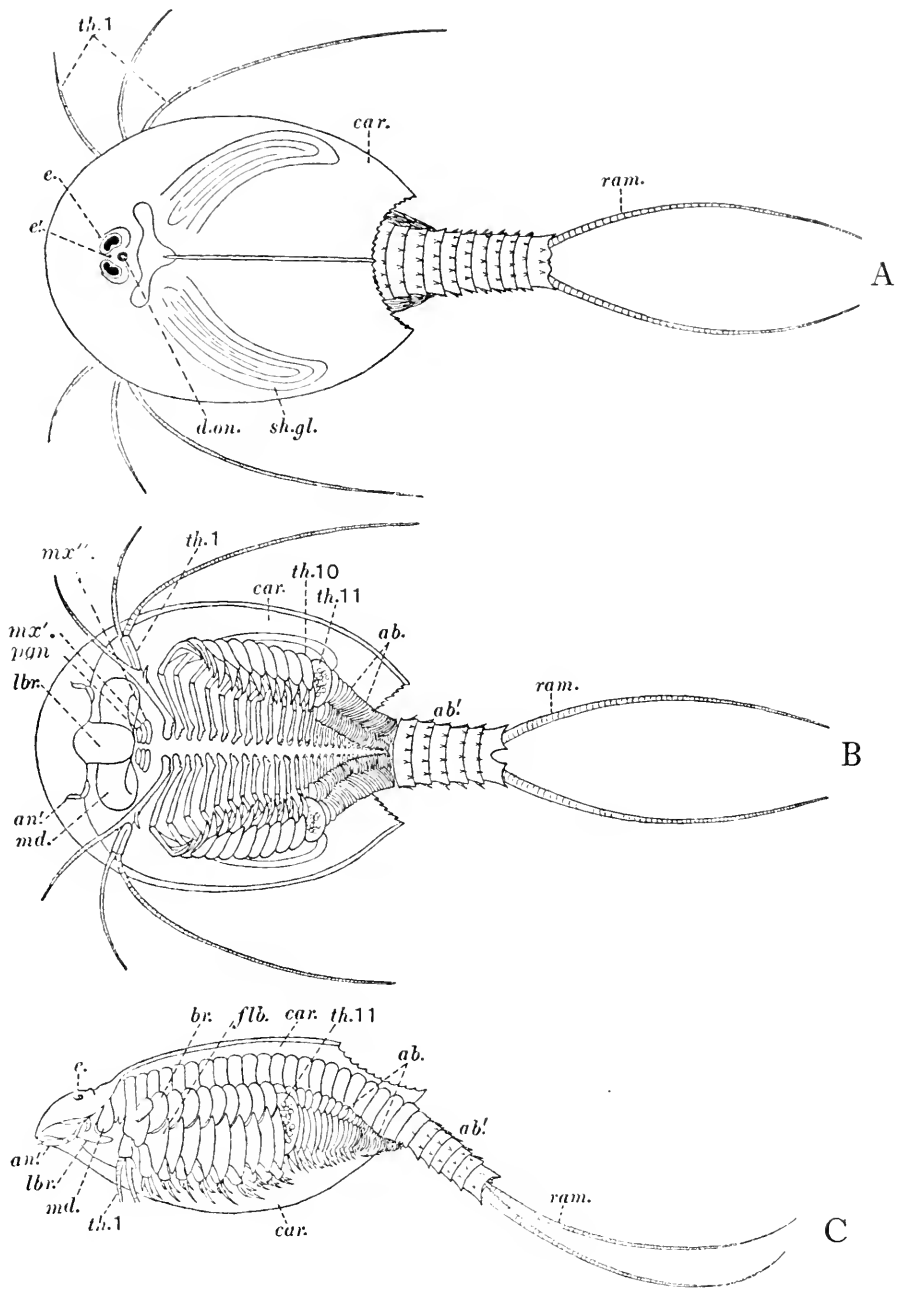

Fig. 242. *Apus cancriformis*. A, Dorsal view. *car.* carapace; *d.on.* dorsal organ; *e.* compound eye; *e'* median eye; *ram.* ramus of caudal fork; *sh.gl.* shell gland (maxillary gland) seen through the carapace; *th.1*, processes of the first thoracic limb. B, Ventral view. *ab.* abdominal limbs; *ab'* limbless somites of the abdomen; *an'* antennule; *car.* carapace; *lbr.* labrum; *md.* mandible; *mx'* maxillule; *mx''* maxilla; *p gn* paragnathum; *ram.* ramus of caudal fork; *th.1*, first thoracic limb; *th.10*, tenth thoracic limb; *th.11*, egg pouch on eleventh thoracic limb. C, Side view with the left half of the carapace cut away. *br.* branchia; *flb.* flabellum. Other letters as above.

as far as the 28th somite. Five limbless somites separate this from the telson. The first thoracic limb is a modified phyllopodium, with the endites slender and many-jointed, very long in *Apus* though shorter in *Lepidurus* (Fig. 241). The second thoracic limb is less modified in the same direction, the endites being shorter and unjointed. The remaining trunk limbs (Fig. 224) are normal phyllopodia: they decrease in size from before backwards, and those of the thorax have the endites well chitinized and mobile. Feeding is most often upon detritus (see p. 355), the flat underside of the head being applied to the bottom during the process, but the animals also devour the dead or living bodies of organisms, clasping them with their strong thoracic limbs and rasping fragments from them with the endites. The Notostraca swim well, but can also crawl with their thoracic limbs or clamber with the anterior pairs.

The limbs of the genital somite are in the female modified for carrying eggs, the flabellum fitting as a lid over a cup formed by the distal part of the axis. Males are rare, reproduction being normally by parthenogenesis.

#### Order DIPLOSTRACA

Branchiopoda with a compressed carapace which usually encloses the trunk and its limbs; the compound eyes sessile and apposed or fused; the antennae large and biramous; four to twenty-seven pairs of trunk limbs, often considerably differentiated; and the telson usually ending in a pair of curved claws.

##### Suborder CONCHOSTRACA

Diplostraca with 10–27 pairs of trunk limbs; the carapace provided with adductor muscle in the maxillary somite and with hinge, not fused with thoracic somites, and usually enclosing the head; and nearly always a *Nauplius* larva.

No member of this order is British.

The animals haunt the bottom and are mainly or exclusively detritus feeders, dealing differently with fine and coarse particles (p. 355).

*Estheria* (Fig. 243) is a common European genus. A thoracic limb of a related but exotic form is shown in Fig. 222 C.

##### Suborder CLADOCERA

Diplostraca with 4–6 pairs of trunk limbs; the carapace without hinge or adductor muscle, fused with two or more thoracic somites, and not covering the head; and without *Nauplius* larva (save in *Leptodora*).

The members of this suborder are the water fleas. They fall into four tribes. Of these, the first, known as *Ctenopoda*, show affinities

with the lower Branchiopoda in that their trunk limbs, of which there are six pairs, are all alike and all strain food from the water, the gnathobase projects, and the heart is elongate. The shell is well developed and covers the trunk limbs. *Sida*, which may be taken

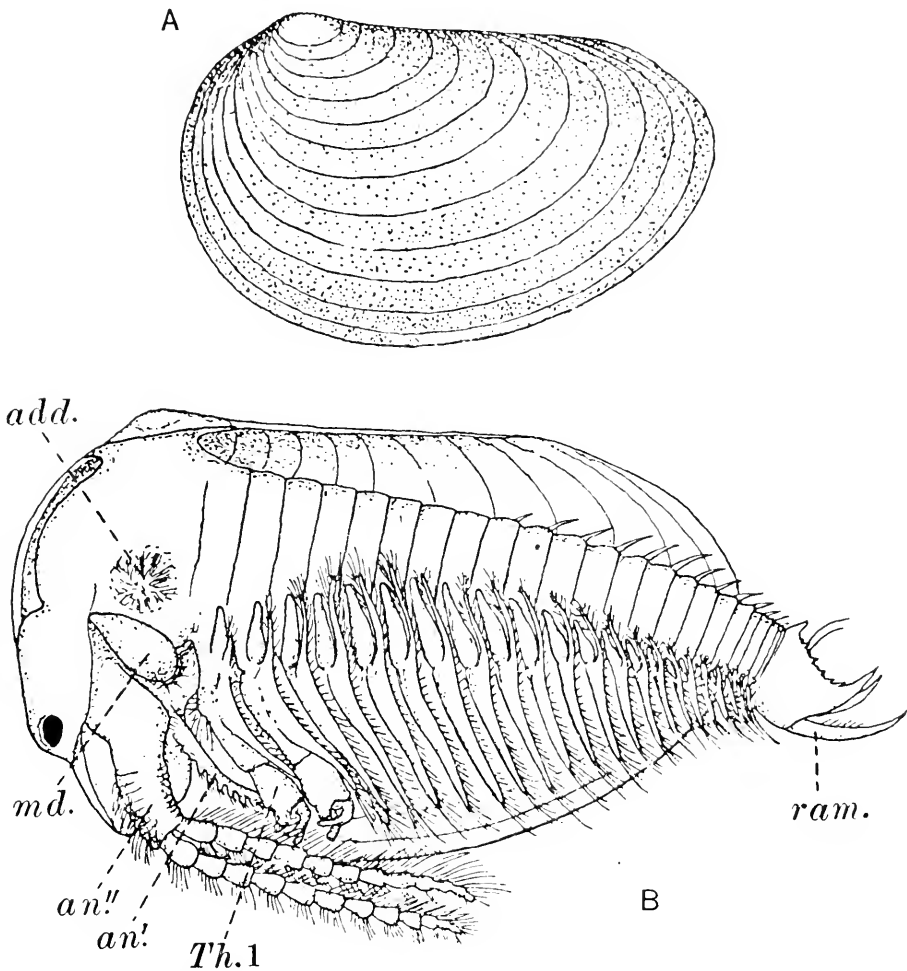

Fig. 243. *Estheria obliqua*. From Calman, after Sars. A, Shell of female, from the left side. B, Male seen from the side after removal of left valve of shell. *add.* adductor muscle; *an.'* antennule; *an.\"",* antenna; *md.* mandible; *ram.* caudal ramus; *Th. 1*, first thoracic limb.

among weeds in pools in various parts of Britain, is one of the Ctenopoda. *Penilia*, one of the few marine cladocera, is another.

The second tribe of the Cladocera, known as *Anomopoda*, contains most of the genera of the suborder. Its members retain a well-developed shell, but the trunk limbs, of which there are often only five, and sometimes only four, pairs, are highly differentiated for

various parts of the process of feeding, only some of them doing the actual filtering off of the food particles. The gnathobases of the filtering limbs do not project but are enlarged to bear most of the filter fringe. The heart is a short sac in the first two trunk somites.

*Daphnia* and *Simocephalus*, common British forms, found swimming in ponds and ditches, are examples of this tribe. *Simocephalus* (Fig. 244) differs from *Daphnia* in possessing a cervical groove (p. 332), and in lacking a median dorsal spine which in *Daphnia* stands on the hinder edge of the carapace. The following description applies to both genera. The *head* is bent downwards, so that the median eye and the small antennules are ventral to the antennae. A large, sessile compound eye, formed by the fusion of a pair, stands in front. Above it is a nuchal sense organ. Of the rami of the antennae one has four joints and the other three, and both bear long, feathered setae. The mouth parts are much like those of *Chirocephalus* (p. 356). The segmentation of the *trunk* is obscure. The first two somites are fused with the head, as is shown by the position of their appendages. Behind these are three fairly distinct limb-bearing somites (so that there are in all five pairs of trunk limbs), and then three that are limbless and hardly distinguishable and a telson, which is compressed and produced on each side of the anus into a toothed plate, bearing terminally a spine that may represent a furcal ramus. The third free somite is longer than the others and bears its limbs in the hinder part, which suggests that it is the fifth of the six pairs of *Sida* which is missing here. The limbless region is commonly known as the "abdomen". Two strong dorsal processes on it close the brood chamber behind.

The structure of the *trunk limbs* is shown in Fig. 245. Together they form a food-gathering mechanism which is very efficient because, instead of all working in the same way as those of the Anostraca, they are differentiated in adaptation to different parts of the task. The third and fourth pairs form a pumping and straining apparatus (Fig. 246) which in principle is the same as those formed by the limbs of *Chirocephalus*, but has for side walls the carapace, against which the proepipodites play, and is closed behind by a barrier formed by the fifth pair. The broad exopodites of the third and fourth pairs open and close the ventral side of the apparatus as they flap to and fro under the pressure of the water. The long, feathered bristles of the first and of the distal part of the second pair guard the ventral opening of the median gully and keep too large particles from being drawn into it. The complex set of bristles upon the large endite or "gnathobase" (which corresponds both to the first and to the second endite of the ideal series) in this limb play some part—exactly what is disputed—in bringing the food to the mouth. Glands in the labrum produce a sticky secretion as in *Chirocephalus*.

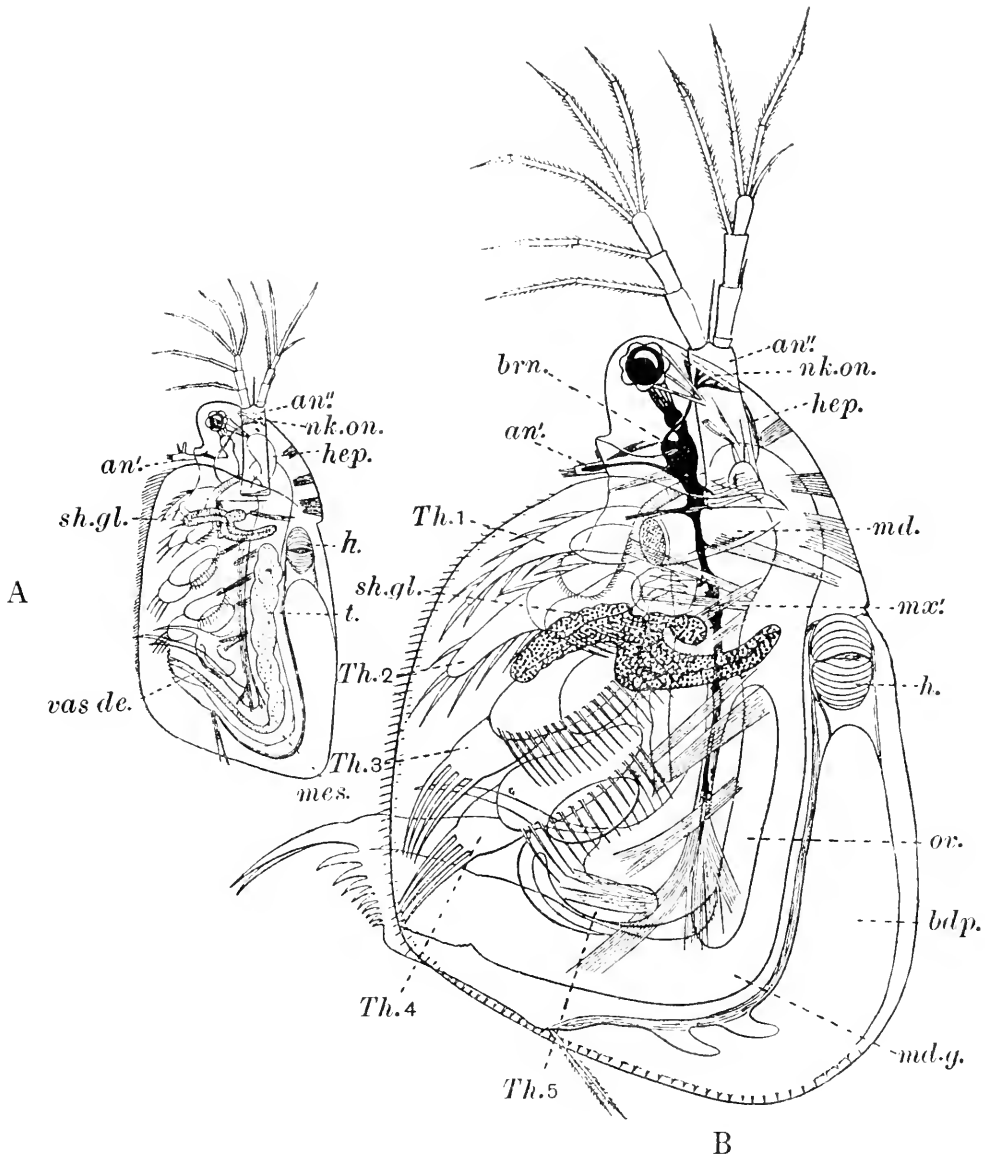

Fig. 244. A, Side view of male *Simocephalus sima*. Highly magnified. From Shipley and MacBride. *an'* antennules; *an''* antennae; *t.* testis; *vas de.* vas deferens; *hep.* hepatic diverticulum; *h.* heart; *sh.gl.* shell gland; *mes.* mid gut; *nk.on.* neck organ. B, Side view of female *Simocephalus sima*, magnified to the same extent as A. From Cunningham. *an'* antennules; *an''* antennae; *md.* mandibles; *mx.'* maxillules; *Th.1-5*, thoracic limbs; *hep.* hepatic diverticulum; *h.* heart; *ov.* ovary; *bdp.* brood pouch; *sh.gl.* shell gland; *brn.* brain; *md.g.* mid gut; *nk.on.* neck organ.

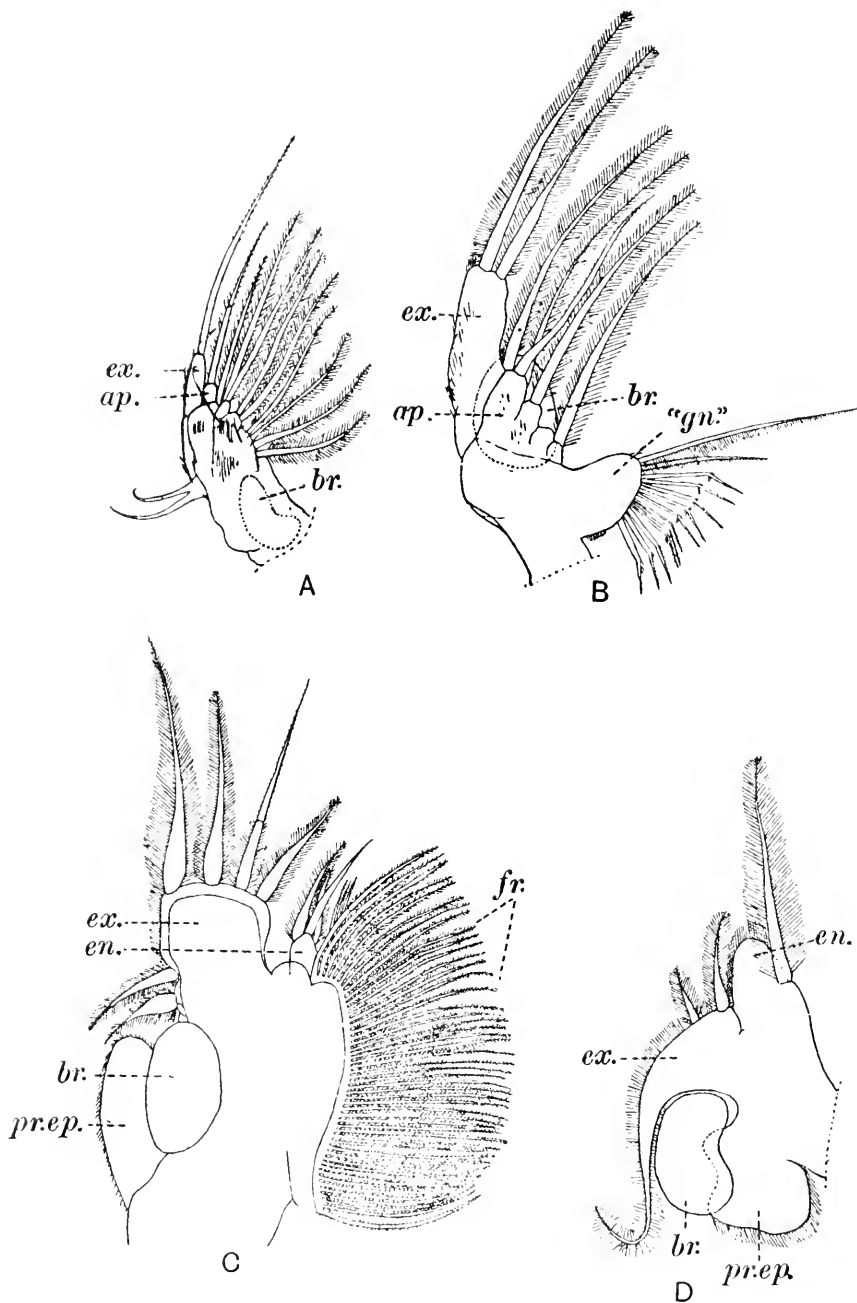

Fig. 245. Thoracic limbs of *Daphnia pulex*. After Lilljeborg. A, First. B, Second. C, Third. D, Fifth limb. *ap.* apical lobe of endopodite; *br.* branchia; *en.* endopodite, indistinctly divided, on the 3rd and 4th limbs, into three joints which are not shown; *ex.* exopodite; *fr.* fringe of bristles which strains out the food: normally this fringe stands vertical to the plane of the limb (see Fig. 246, *bri.*), but it has been mounted flat for drawing; the part of the limb upon which it stands probably corresponds to the gnathobase and two succeeding endites; "*gn.*" "gnathobase"; *pr.ep.* proepipodite.



The *alimentary canal* resembles that of *Chirocephalus* (p. 358), but the coeca are unbranched. The food on being swallowed passes direct to the middle part of the mesenteron, where it is digested, and then forwards to the anterior region and the coeca, where the digested products are absorbed and the indigestible residue sent backwards to be formed into faecal pellets in the hinder part of the mid gut. The *maxillary gland* lies in the carapace.

The *gonads* are simple, elongated sacs lying in the trunk and continuous with their ducts, which open in the male on the telson, in the female dorsally behind the last limb. The eggs are yolky. They are of two kinds, "summer" eggs which have relatively little yolk and de-

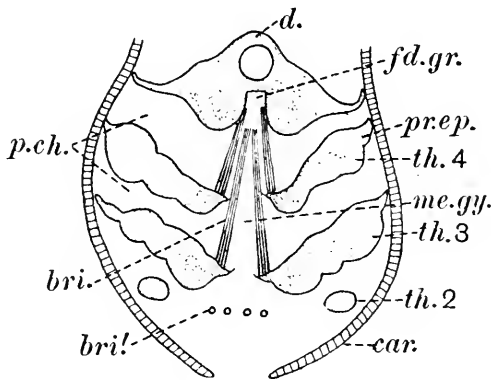

Fig. 246. A diagram of a transverse section through the thorax of *Daphnia*. After Storch. *bri.* bristles of the fringes which strain out the food; *bri.'* bristles of the second pair of thoracic limbs which guard the opening of the median gully; *car.* carapace; *d.* dorsal surface of the thorax; *fd.gr.* food groove; *me.gy.* median gully or filter chamber; *p.ch.* chambers between the limbs: the enlargement and contraction of these chambers by the movements of the limbs set up a pumping action by which water is caused to flow through the bristle fringes from the median gully; *pr.ep.* proepipodites, playing upon the carapace and closing the pumping chambers at their outer sides; *th. 2-4*, sections through the thoracic limbs, which being directed backwards are cut transversely: each limb underlies that behind it.

velop rapidly by parthenogenesis in the brood pouch of the mother, and "winter" eggs with much yolk which need fertilization and develop slowly. The winter eggs are fertilized in the brood pouch, but then the cuticle of the carapace, which has thickened, is thrown off as a case—the *ephippium*—in which they are contained. They go through the early stages of segmentation within a short time, but after this a period of quiescence sets in, during which they may be dried or frozen without injury. Sexual reproduction takes place at certain times only, normally twice a year. After the winter eggs develop in spring, there are for some half-dozen generations no males, and reproduction proceeds by parthenogenesis. Then, about May, a genera-

tion appears in which males are present. In this sexual and asexual reproduction go on side by side. The same thing occurs again in autumn or at other times when, in unfavourable circumstances, such as cold or starvation, males appear. It is interesting to note that, since parthenogenesis is never suspended by all the females, there is nothing to show that a sexual phase in the life cycle is necessary.

The normal cladocerans which compose the tribes Ctenopoda and Anomopoda are often united under the name *Calyptramera* in contrast to the remaining two tribes, which are known as *Gymnomera*. These are aberrant forms whose food consists of planktonic organisms relatively much larger than the particles upon which *Daphnia* feeds. Their carapace has shrunk till it forms only the brood pouch and leaves free the comparatively slender, prehensile trunk limbs with which the food is handled, and their eyes are prominent and adapted to sighting moving objects. They are often bizarre in form.

*Polyphemus*, a British freshwater genus, is an example of the Tribe *Onychopoda*. It has a long telson, but the head and "abdomen" are not elongate and the carapace does not fuse with the hinder part of the "thorax". The trunk limbs have gnathobases. In *Evadne* and *Podon*, marine members of the tribe, the telson is not elongate.

*Leptodora* (Fig. 247), the only member of the Tribe *Haplopoda*, is a pelagic inhabitant of certain fresh waters in Britain and elsewhere. The body is long and slender owing to elongation of the head and of the "abdomen", in which the segmentation is distinct. The fore part of the trunk bears six pairs of slender, jointed, uniramous limbs, without gnathobases. The carapace has fused with all the somites of this region and projects behind it as a brood pouch. The winter egg gives rise to a *Nauplius*, the only instance of a larva in the Cladocera.

### Class OSTRACODA

Free Crustacea, with or without compound eyes; with a bivalve carapace and an adductor muscle; a mandibular palp, usually biramous; and not more than two recognizable pairs of trunk limbs, these not being phyllopodia.

The small crustaceans which compose this class differ little in the general form of the body but show very great variety in that of their appendages. All their cephalic limbs are well developed and complex; the trunk limbs are uniramous and one or both pairs may be lost. The adductor is in the maxillulary somite. There is often a gastric mill and usually a pair or more of hepatic coeca: the latter and the gonads may (*Cypris*) extend into the shell valves. Both antennal and maxillary glands are present, both have ectodermal ducts, and both

are without opening in the adult. Other glands may be excretory. The *Nauplius*, if present, has a bivalve shell. There are among the ostracods freshwater and marine, pelagic and bottom-living forms. Parthenogenesis is common among them, and in some males have never been found.

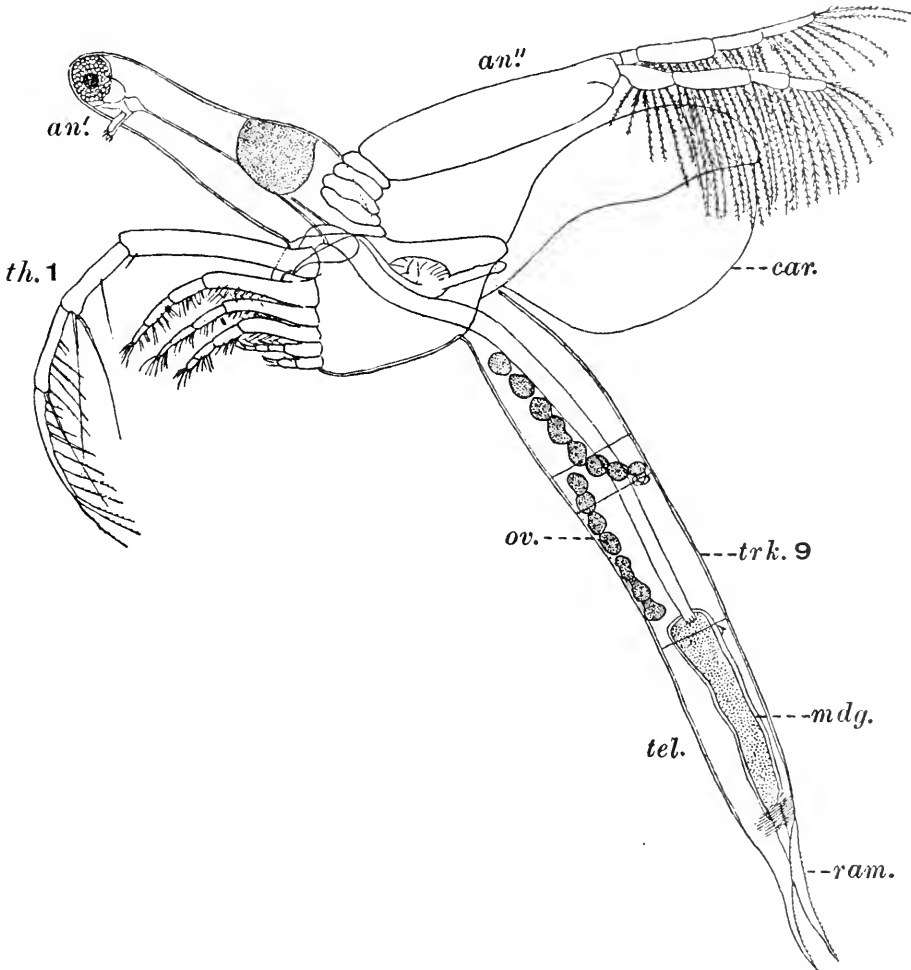

Fig. 247. A female of *Leptodora kindti*. After Lilljeborg. *an.'* antennule; *an.''* antenna; *car.* carapace; *mdg.* mid gut; *ov.* ovary; *ram.* ramus of caudal fork; *tel.* telson; *th. I*, first thoracic limb; *trk. 9*, ninth trunk somite.

*Cypris* (Fig. 248) is a common British freshwater genus. It swims well, by means of its antennae, but is not pelagic. It is omnivorous, feeding on algae, small animals, detritus, etc., and taking its food in various ways. Large objects are pushed into the shell by the antennae or pulled in by the mandibles, finer particles drawn in by the action of the epipodites of the maxillules (whose fan of setae is conspicuous in the figure), gathered by long bristles on the palps of the mandibles,

and passed towards the mouth by the endites and endopodites of the maxillules, assisted by the gnathobase of the maxillae. The first trunk limb is used in crawling, and the second in cleaning. *Cypris* lacks the compound eyes and the heart, which are found in some other members of the class—for instance in the marine *Cypridina*, which is also characterized by a large antennal exopodite, turned outwards in a notch of the shell for rowing.

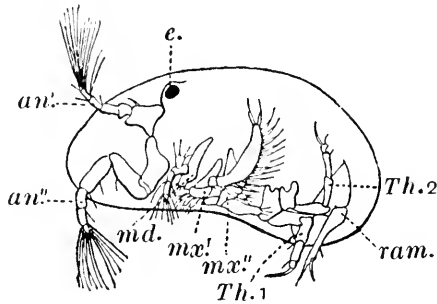

Fig. 248. Lateral view of *Cypris*. After Zenker. *an.'* antennules; *an.ʹʹ* antennae; *md.* mandibles; *mx.ʹ* 1st maxillae; *mx.ʹʹ* 2nd maxillae; *Th. 1*, *Th. 2*, thoracic limbs; *ram.* ramus of caudal fork; *e.* eye.

### Class COPEPODA

Free or parasitic Crustacea, without compound eyes or carapace; with biramous or uniramous palp, or with none, on the mandible; and typically with six pairs of trunk limbs, of which the first is always and the sixth often uniramous, the rest biramous, and none are situated behind the genital aperture (i.e. on the abdomen).

The *form of the body* varies greatly in the members of this class, from the pear-shaped or club-shaped free-swimming genera to the distorted, unsegmented, and sometimes even limbless adults of some of the parasites. In all cases in which the segmentation is complete the number of somites is the same—sixteen, including a preantennular somite but not the telson—throughout the group, but the actual tagmata, which do not conform to the limits of the head, thorax, and abdomen, are not uniform in all members of the class.

We shall take as an example of the group the little freshwater crustacean *Cyclops* (Fig. 249) which, though it is not one of the most primitive members of the Copepoda, is well segmented and can be obtained everywhere in ponds and ditches. The *shape* of this animal is that of a slender pear with a stalk. The front part of the pear is unsegmented; this is a compound head or “cephalothorax”, composed of the true head and the first two thoracic somites: beneath, in front, it bears a blunt projection, the rostrum. The rest of the broad

part of the body contains three somites, the third to fifth of the thorax. The cephalothorax and these free thoracic somites are produced at

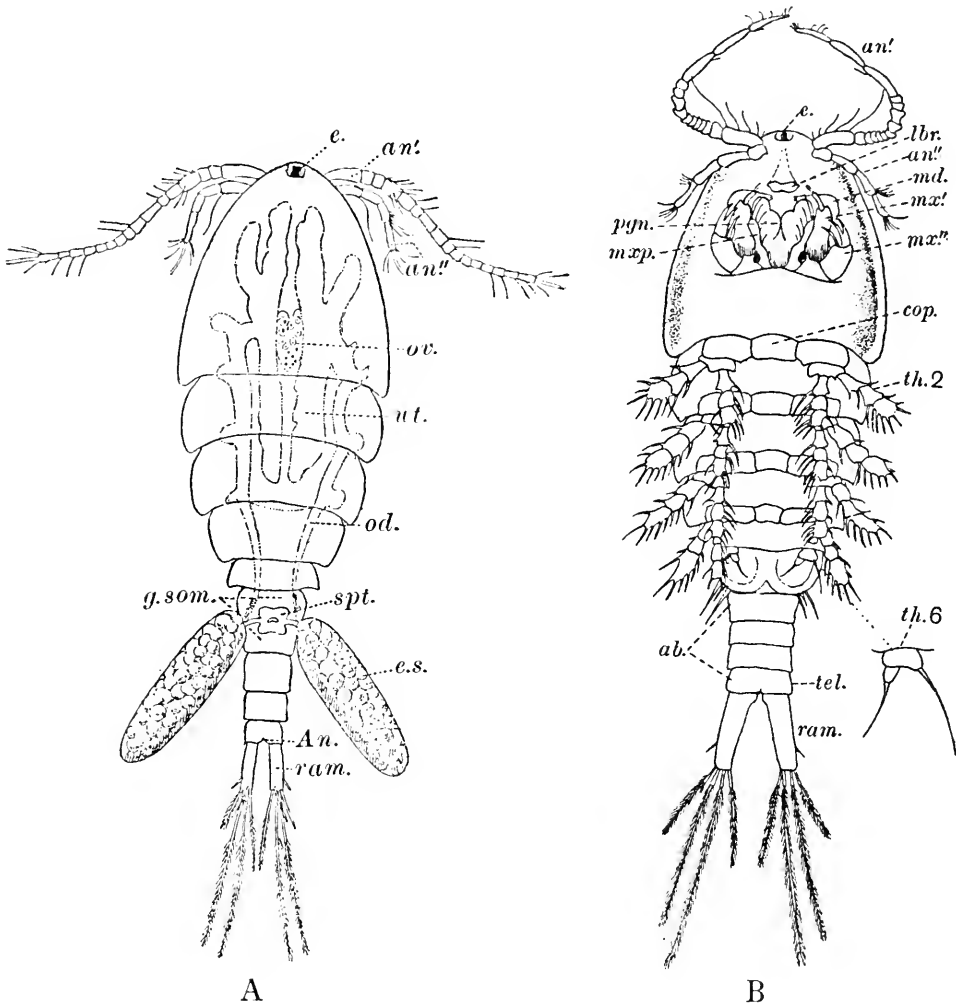

Fig. 249. *Cyclops*. A, Dorsal view of female. Partly after Hartog. *An.* position of anus; *an.'* antennule; *an.ii* antenna; *e.s.* egg sacs; *e.* eye; *g.som.* compound somite, consisting of the last thoracic (bearing the genital opening) and the first abdominal; *od.* oviduct; *ov.* ovary; *ram.* ramus of caudal fork; *spt.* spermatheca or pouch for receiving the spermatozoa of the male; *ut.* uterus: i.e. pouch of the oviduct into which the eggs pass before being shed. B, Ventral view of male. *ab.* abdomen; *an.'* antennule; *an.ii* antenna; *cop.* copula; *e.* eye; *lbr.* labrum; *md.* mandible; *mx.i* maxillule; *mx.ii* maxilla; *m xp.* maxilliped; *pgn.* paragnathum; *ram.* ramus of caudal fork; *tel.* telson; *th.2*, *th.6*, thoracic limbs.

the sides into low pleural folds. The stalk begins with a short somite which is united to, but distinguishable from, that which succeeds it. The next somite bears the genital openings and is therefore, on the

convention we have adopted (p. 333), the last somite of the true thorax, but is usually reckoned as the first of the abdomen; in the female it is fused with the somite which succeeds it. Two free abdominal somites and a telson, which bears two styliform, setose caudal rami, complete the body. The somites of the thorax bear limbs, which will be described presently. The limbs of the somite of the genital opening are present in the female only, and in her are reduced to the condition of small valves over the openings of the oviducts. The abdominal somites are without limbs in either sex. It will be seen that the actual *tagmata* of *Cyclops* are not the head, thorax, and abdomen, however the limit between thorax and abdomen be fixed, but are a cephalothorax of eight somites (including the preantennular), a mid-body (sometimes, but unsuitably, named the "metasome") of three somites, and a hind body or "urosome" of five somites and the telson.

On the head, the median eye is well developed. The *antennules* are long, uniramous, provided with sensory hairs, divided into seventeen segments, and in the male bent as hooks to hold the female. The *antennae* are shorter, slender, uniramous, and four-jointed. The *mandibles* (Fig. 250, *md.*) have a toothed blade (gnathobase) projecting towards the mouth and a papilla, bearing a tuft of bristles, which represents the palp. The *maxillules* have a large gnathobase and small endopodite and exopodite. The *maxillae* are uniramous. The *maxillipeds* (first pair of thoracic limbs) are also uniramous; they stand immediately internal to the maxillae. The 2nd to 5th *thoracic limbs*, of which the 2nd stands on the head, are biramous, with broad, flat, spiny rami (Fig. 249 B). The protopodites of each pair are united by a transverse plate or "copula" so that they move together in swimming. The *thoracic appendages of the 6th pair* are small and uniramous.

The *swimming* of *Cyclops* is of two kinds—a slow propulsion by the antennae and antennules, and a swifter progression brought about by the use of the swimming limbs (2nd to 5th pairs) of the thorax. In

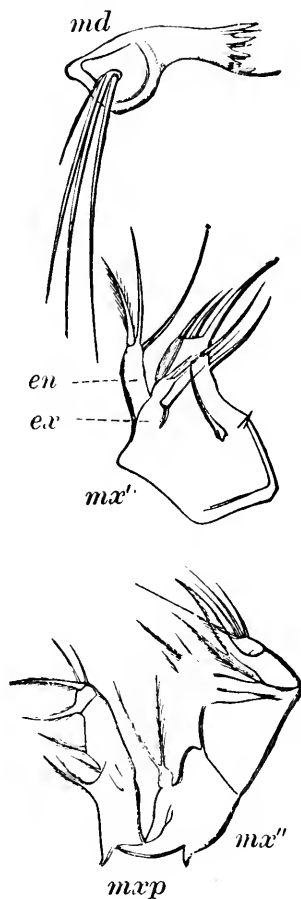

Fig. 250. Mouth parts of *Cyclops*. From Sedgwick, after Claus. *en.* endopodite; *ex.* exopodite; *md.* mandible; *mx.'* maxillule; *mx. ''* maxilla; *mxp.* maxilliped.

the more primitive, pelagic copepods (*Calanus*, etc.) which have biramous antennae and biramous palps on the mandibles, the antennules do not take part in swimming. Such copepods *feed* by an automatic straining of particles from the water, though their apparatus for this purpose (see below) is very different from that of the Branchiopoda. *Cyclops*, on the other hand, in a manner of which the details are not understood, seizes its food particles from time to time.

The *alimentary canal* is of much the same nature as that of *Chirocephalus* but without mid gut diverticula. It possesses well-developed extrinsic muscles, of which those that run from its anterior region to the adjoining body wall produce rhythmical displacements of the canal and so cause a movement of the blood, while the dilators of the rectum draw in water which is believed to subserve respiration. Special organs for *circulation* and *respiration* are wanting in *Cyclops*, though other copepods have a saccular heart. *Maxillary glands* are present—probably entirely mesodermal. The ventral cords of the *nervous system* are concentrated into a single ganglionic mass. The *gonads* are single median structures which lie above the gut in the first two thoracic somites. The ducts are paired. In the female a large, branched uterus adjoins the ovary on each side, communicating with the lateral opening on the urosome by an oviduct which at its termination receives a duct from the spermatheca. The latter is median, in the same segment as the oviducal openings, with a median entrance of its own. The male transfers his spermatozoa to the female in a spermatophore. The eggs when laid are cemented into a packet (egg “sac”) which hangs from the opening of the oviduct, and are thus carried until they hatch. The possession of a pair of such packets gives a characteristic appearance to the females of *Cyclops*, as to those of many other copepods. In some genera, however, there is a single median packet, and in a very few the eggs are laid into the water.

The larva hatches as a typical *Nauplius* (Fig. 235). This is succeeded by several *Metanauplius* stages, and then suddenly at a moult takes on the *first Cyclops* stage, which has the general form of the adult but lacks appendages behind the 3rd pair of swimming limbs and also the somites of the urosome. In five successive *Cyclops* stages the missing somites appear, the tale of limbs being meanwhile completed.

*Calanus*, which is marine and pelagic in all parts of the world, often occurring in enormous shoals which are an important item of food for fishes and whales, is in several respects more primitive than *Cyclops*, having the antennae and mandibular palps (Fig. 222 D) biramous, well-developed and biramous limbs on the 6th thoracic somite, and only one postcephalic somite in the cephalothorax. The 6th thoracic somite is included in the mid-body, not in the urosome. The primi-

tive custom of feeding by the automatic straining of food particles from the water is retained: the feeding current eddies from the swimming current which the antennae, mandibles, and maxillae set up, and is strained through a fringe of bristles on the maxillae (Fig. 251).

The *parasitic habit* has been adopted by members of very different families of copepods, and to very various degrees even by members of a single family. Every stage may be found between normal, free-living forms and the most degenerate parasites. Parasitic forms often have a suctorial proboscis, which is formed by the upper and lower lips enclosing mandibles adapted to piercing. Such a proboscis is not necessarily accompanied by a high degree of degeneration. The life histories of parasites are often complicated, and may involve remarkable changes of habit. Degenerate forms usually reach one of the

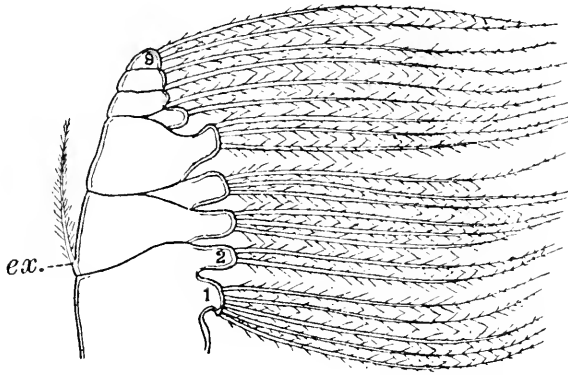

Fig. 251. The maxilla of *Calanus*. *ex.* small prominence which perhaps represents the exopodite; 1 and 2, endites representing the first two segments; 9, terminal segment.

*Cyclops* stages and may pass through them all before they begin to degrade. Often the male is less degenerate than the female: he may be free-swimming while she is sedentary, or may be much smaller and cling to her body. It is only possible here to mention a few of the numerous genera of these interesting parasites.

*Notodelphys*, commensal in the pharynx of ascidians, is clumsy bodied, and has a large dorsal egg pouch on the 5th and 6th thoracic somites, but can swim and is sometimes captured outside the host.

*Monstrilla* has a very remarkable life history. The adults of both sexes are free-swimming, as are the newly-hatched *Nauplii*, but the intermediate stages are parasitic in various polychaets, where they absorb nourishment by means of a pair of long, flexible processes which represent the antennae. In this stage they lay up a food supply for the entire life cycle, throughout which the animals are without functional mouth parts or alimentary canal.



*Chondracanthus* (Fig. 252), which infests the gills of various marine fishes, has in the adult stage a large female, whose body is produced into irregular, paired lobes and her appendages degenerate, though the mouth has not a proboscis but is flanked by the three pairs of minute, sickle-shaped jaws. The males are small, retain more of the

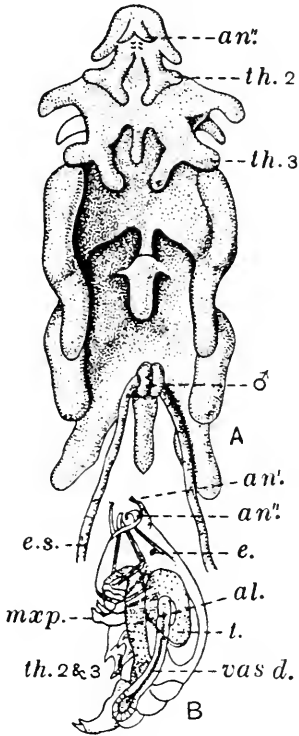

Fig. 252.

Fig. 252. *Chondracanthus gibbosus*. After Claus. A, Female. B, Male, more highly magnified. *al.* alimentary canal; *an.'* antennule; *an. ''* antenna; *e.* eye; *e.s.* egg "sac"; *mxp.* maxilliped; *t.* testis; *th. 2* and *3*, thoracic limbs; *vas d.* vas deferens; ♂, males attached to females.

Fig. 253. Stages in the life history of *Lernaea*. A, Metanauplius. B, First *Cyclops* stage. C, "Pupa". D, Sexual stage: coition. E, Ripe female. *an.'* antennule; *an. ''* antenna; *fix.* secretion of a gland by which fixation is effected; *hd.pr.* processes of the head of the female which are imbedded in the tissues of the host; *mxp.* maxilliped; *sip.* siphon; *th. 2*, second thoracic limb; *ram.* ramus of caudal fork.

copepod organization than the female, and cling by hook-like antennae to her body.

*Caligus*, ectoparasitic, mainly in the gill chambers of fishes, is clumsily built and has a suckorial proboscis, but retains the power of swimming. Its sexes do not differ greatly.

*Lernaea* (Fig. 253) hatches as a *Nauplius* and at the first *Cyclops*

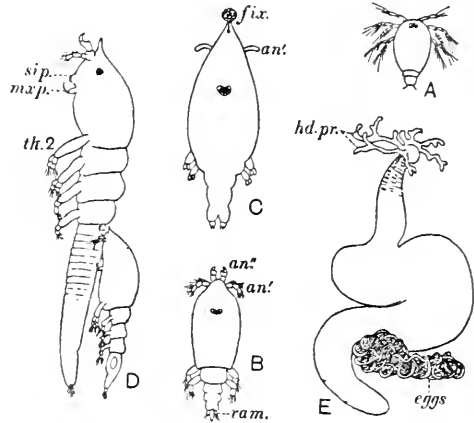

Fig. 253.

stage becomes parasitic on the gills of a flat fish, deriving nourishment from its host by means of suckorial mouth parts. Here it passes into a "pupal" stage in which the power of movement is lost and retrogressive changes have taken place. Presently it regains the power of swimming and leaves the host in an adult copepod stage. In this stage impregnation takes place. The male develops no further, but the female attaches herself to the gills of a fish of the cod family, where by a great development of the genital somite she becomes converted into a vermiform parasite, anchored into the host by processes that grow out from her head, and retaining only the now relatively minute appendages of the thorax.

In *Herpyllobius*, parasitic on annelids, the female is reduced to a mere sac, drawing nourishment from the host by rootlets and bearing minute males which are also sac-like.

*Xenocoeloma*, also parasitic on annelids, is represented in the host's body only by the gonads, which are hermaphrodite, and some muscles, enclosed in a cylindrical outgrowth of the host's epithelium which forms a body wall for the vestiges of the parasite and contains a gut-like prolongation of the host's coelom.

#### Class BRANCHIURA

Crustacea, temporarily parasitic on fishes; which possess compound eyes; a suckorial mouth; carapace-like lateral expansions of the head which are fused to the sides of the first thoracic somite; an unsegmented, limbless, bilobed abdomen with a minute caudal furca; and four pairs of thoracic limbs, which are biramous, with usually a proximal extension of the exopodite.

The members of this group in many respects superficially resemble the Copepoda, with which they are generally placed, but differ from that class in certain important features, notably in the possession of compound eyes, the lateral head-lobes, the opening of the genital ducts between the fourth pair of thoracic limbs, and the phyllopod-like proximal overhang of some of the thoracic exopodites (Fig. 254 B).

The carp-lice, as the Branchiura are called, are found both on freshwater and marine fishes. They are good swimmers. The females deposit their eggs on stones and other objects. The larvae differ little from the adult.

*Argulus* (Fig. 254), the principal genus, has a pair of suckers on the maxillae and a poison spine in front of the proboscis. *A. foliaceus* is common on freshwater fishes in Britain and the Continent.

#### Class CIRRIPEDIA

Fixed and for the most part hermaphrodite Crustacea; without compound eyes in the adult; with a carapace (except in rare instances) as

a mantle which encloses the trunk; with usually a mandibular palp, which is never biramous; and typically with six pairs of biramous thoracic limbs.

The great majority of the Cirripedia are extremely unlike the rest of the subphylum, and would not be recognized as crustaceans at all by the layman. The familiar members of the class are the ordinary barnacles (Thoracica). Besides these, however, it contains several groups of related organisms, of which the parasitic barnacles (Rhizocephala) are the best known. The Ascothoracica link the class to other crustaceans.

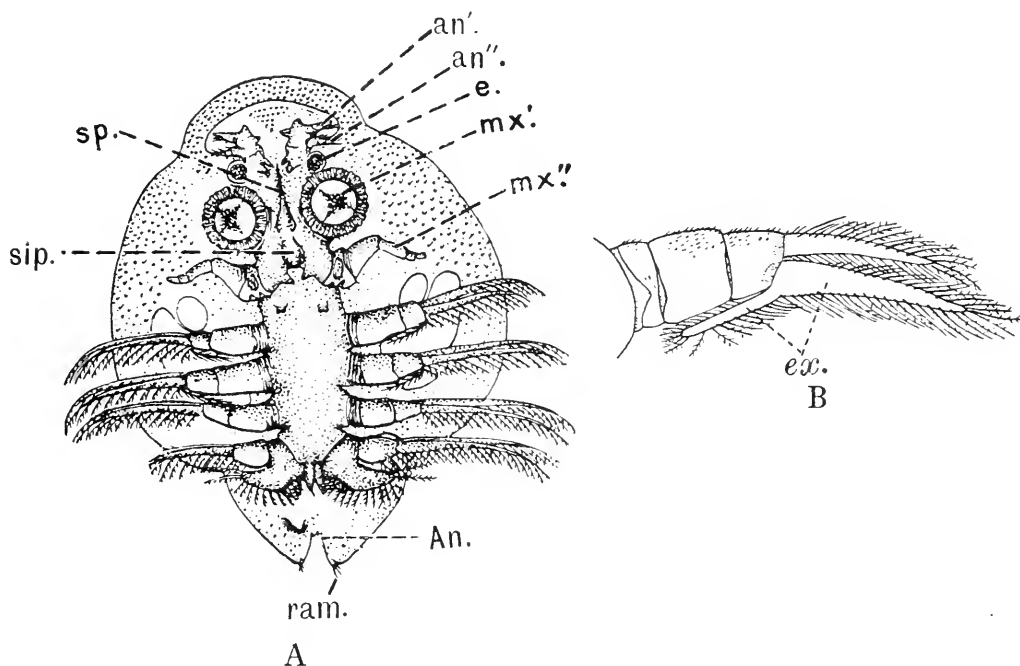

Fig. 254. *Argulus*. A, A ventral view of a female of *A. americanus*. From Calman, after Wilson. B, The second left swimming limb of *A. foliaceus*. After Hansen. An. position of anus; an.' antennule; an.'' antenna; e. paired eye; ex. exopodite; mx.' maxillule; mx.'' maxilla; ram. ramus of caudal furca; in some species the rami stand immediately on each side of the anus; sip. siphon, or suctorial proboscis; sp. poison spine.

### Order THORACICA

Cirripedia with an alimentary canal; six pairs of biramous thoracic limbs; no abdominal somites; and permanent attachment by the preoral region.

We shall take as an example of this group the common goose barnacle, *Lepas* (Figs. 255, 257 A), found all the world over on floating objects in the sea. It hangs by a stalk or *peduncle* which, as we shall see, represents the foremost part of the head, greatly elongated

but still bearing at its far end the vestiges of the antennules, imbedded in a cement by which it is held fast. The glands which produce the cement are contained in the peduncle, and open on the antennules.

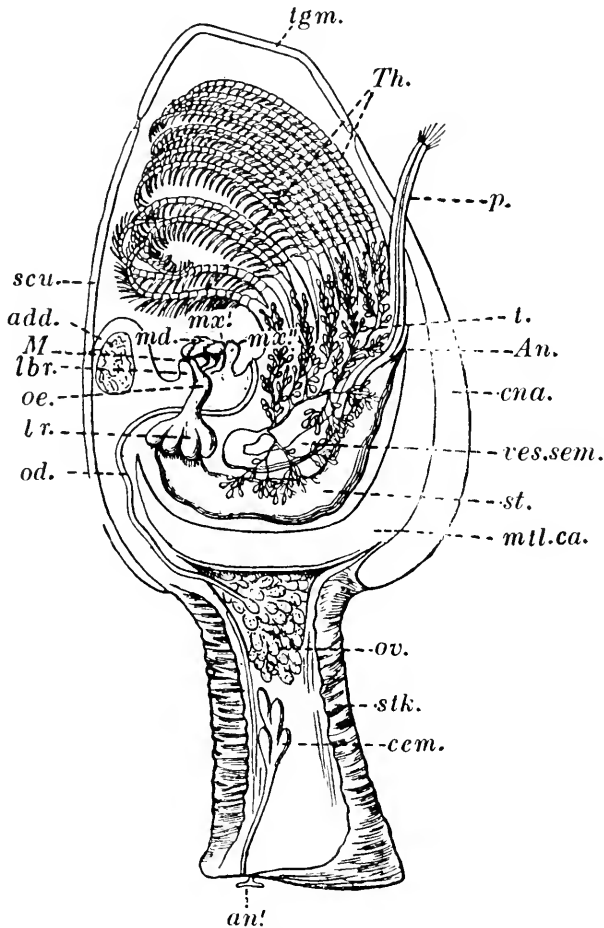

Fig. 255. A view of *Lepas anatifera*, cut open longitudinally to show the disposition of the organs. From Leuckart and Nitsche, partly after Claus. *stk.* stalk; *cna.* carina; *tgm.* tergum; *scu.* scutum; *an.* antennule; *md.* mandible with "palp" in front; *mx.* 1st maxilla; *mx.* 2nd maxilla; *Th.* the six pairs of biramous thoracic limbs; *lbr.* labrum; *M.* mouth; *oe.* oesophagus; *lr.* "liver" coeca; *st.* stomach; *An.* anus; *ov.* ovary; *od.* oviduct; *t.* testes; *ves.sem.* vesicula seminalis; *p.* penis; *cem.* cement gland and duct; *add.* adductor scutorum muscle, which closes the carapace; *mtl.ca.* mantle cavity, i.e. the space intervening between the carapace and the body.

The rest of the body is known as the *capitulum*, and is completely enclosed in the carapace or *mantle*, a fleshy structure strengthened by five calcified plates—a median dorsal *carina*, and on each side two known as the *scutum* and *tergum*. The scuta are anterior to the terga, that is, nearer to the peduncle. The mantle cavity opens by a long slit

on the ventral side. Within the mantle cavity lies the body, turned over on its back with the appendages upwards (or downwards, as the animal hangs) and connected with the peduncle and mantle only at the extreme anterior end, where there is a preoral *adductor muscle* by which the sides (*valves*) of the mantle can be drawn together and so the opening closed. The *antennae*, which should be somewhere in this region, are absent. The prominent *mouth* is overhung by a large *labrum*. At its sides stand the *mandibles*, which have a flat, toothed process towards the mouth and a large, uniramous, foliaceous *palp*, and the *maxillules*, simple structures with a fringe of strong bristles on the notched median edge. A pair of simple, hairy lobes, united by a median fold, which shut in the mouth and its appendages from behind, represent the *maxillae*. The six pairs of thoracic limbs or *cirri* have each two long, many-jointed, hairy rami, curled towards the mouth. They are successively longer from before backwards. A couple of filamentous epipodites ("gills") stand on the protopodite of the first pair. Behind the cirri stands a long median ventral *penis*, and behind this again is the *anus*, with a pair of vestigial *caudal rami*.

The animal *feeds* by thrusting out the cirri through the mantle opening and withdrawing them with a grasping motion, whereby particles are gathered from the water by the setae upon the limbs. If it be molested the motion ceases and the valves are drawn to. The *alimentary canal* has an oesophagus (stomodaeum) directed forwards from the mouth to the long wide stomach which bears several coeca around its commencement and tapers behind into an intestine. Complicated *maxillary glands* open on the maxillae. There is no *heart* or system of blood vessels. The *nervous system* has a suboesophageal ganglion, and a separate ganglion for each pair of cirri behind the first.

*Lepas* is hermaphrodite. The *ovaries* lie in the peduncle and the *oviducts* open on the bases of the first pair of thoracic limbs, much further forwards than is usual in crustacea. The *testes* are branched tubes which lie at the sides of the alimentary canal and in the basal parts of the cirri. Each *vas deferens* enlarges into a *vesicula seminalis* whose duct joins that of its fellow in the penis. Impregnation takes place by the penis depositing a mass of spermatozoa on either side of the mantle cavity of a neighbouring individual, near the opening of the oviduct. It is possible that isolated individuals may be self-fertilized. The ova undergo their early development within the mantle cavity of the mother attached in a flat mass, the *ovarian lamella*, by a glutinous secretion manufactured by the terminal enlargement of the oviduct, to a fold of the mantle which projects on each side from near the junction with the body and is known as an *ovigerous frenum*.

The young are set free as *Nauplii*, characterized, as are those of nearly all cirripedes, by a pair of lateral *frontal horns*, on each of which

opens a unicellular gland (see Fig. 258). These are processes of a dorsal shield which in later stages acquires other spines. After several moults the larva suddenly passes into the so-called *Cypris stage*. It is now enclosed in a bivalve shell with an adductor muscle, and possesses a pair of compound eyes. The antennules of this stage possess near their ends a disc on which opens the cement gland. The antennae have disappeared. There are six pairs of biramous thoracic limbs and a small abdomen of four somites. The *Cypris* larva becomes fixed by the discs on its antennules, and its body rotates within the shell, so

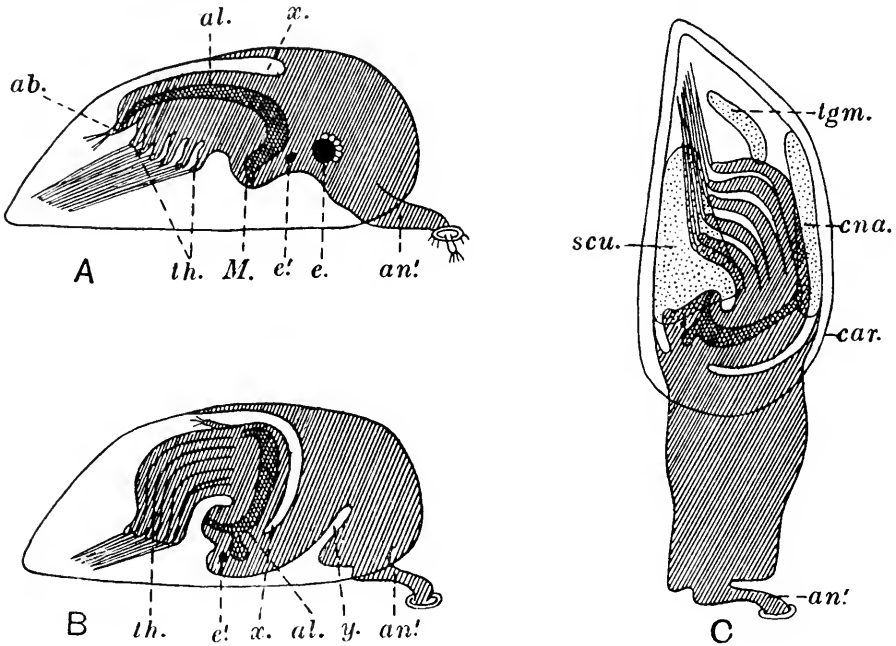

Fig. 256. Diagrams of three stages in the metamorphosis of *Lepas*. From Korschelt and Heider. A, The *Cypris* stage. B, The attached larva (pupa). C, The young *Lepas*. *ab.* abdomen; *al.* alimentary canal; *an.*' antennule; *car.* cuticle of carapace of larva, not yet shed; *cna.* carina; *e.* compound eye; *e.*' median eye; *M.* mouth; *scu.* scutum; *tgm.* tergum; *th.* thoracic limbs; *x.* origin of carapace fold; *y.* a ventral fold of the head.

that the ventral surface is directed backwards (Fig. 256 A, B). Now the shell and body are rotated upwards on the antennae so that the adult position is assumed (Fig. 256 C); meanwhile the shell plates appear, the preoral region elongates to form the peduncle, and the abdomen disappears.

*Scalpellum* (Fig. 257 C, D) attaches itself to fixed objects, usually in deep waters. It differs from *Lepas* in possessing a number of additional plates on the capitulum, and scales of a similar nature on the peduncle. It is more remarkable in possessing what are known as *complemental males*. A few species of the genus are composed entirely

of hermaphrodites as *Lepas* is. In most, however, some individuals are without female organs. These individuals are always smaller than those which possess ovaries, and live within, or at the opening of, the mantle cavity of the latter. In some species they almost perfectly

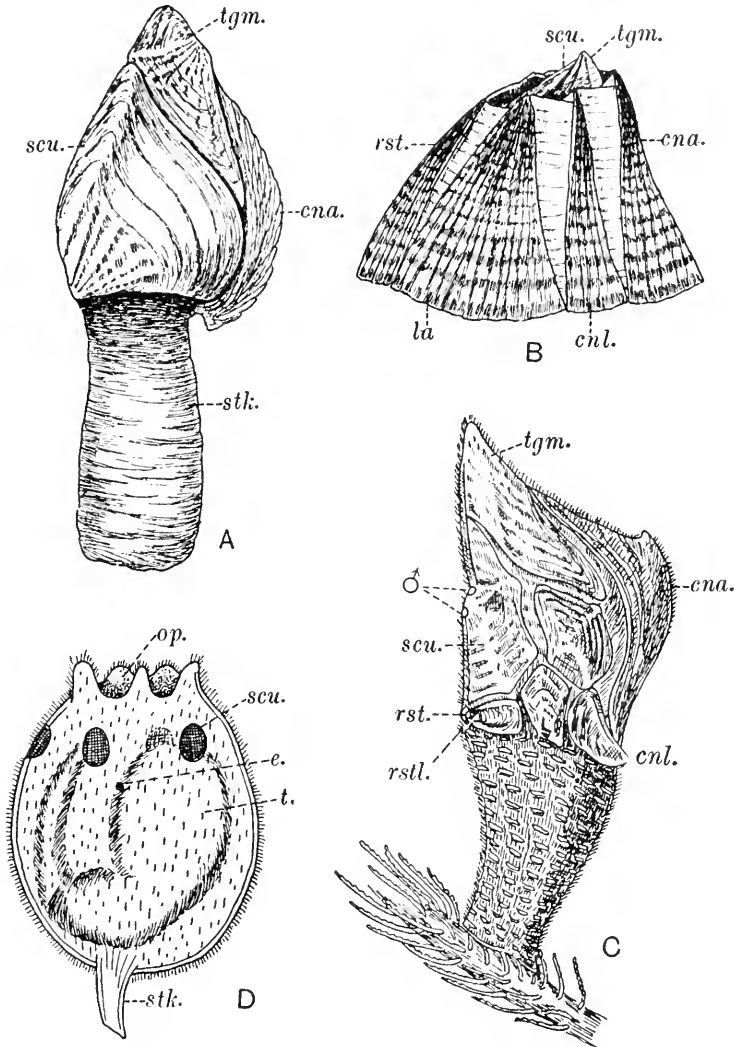

Fig. 257. Cirripedia Thoracica. A, *Lepas anatifera*. B, *Balamus*. C, *Scalpellum vulgare*. D, Male of the same, enlarged. A–C, after Darwin; D, after G. Smith. *cna.* carina; *cnl.* carinolateral; *e.* vestige of eye; *la.* lateral; *op.* opening of mantle cavity; *rst.* rostrum; *rstl.* rostralateral; *scu.* scutum; *stk.* peduncle; *t.* testis; *tgm.* tergum; ♂, dwarf males.

resemble these in organization, but usually they are more or less degenerate, being sometimes even without an alimentary canal. As a rule the more degenerate live within the mantle cavity of the partner, the less degenerate on its mantle edge. In certain species, which have

very degenerate males, the large individuals are without testes, so that the sexes are separate. The function of the complemental males is probably the effecting of cross-fertilization, for the species which possess them are of solitary habit. The phenomenon perhaps arose from the settling of young hermaphrodite individuals on the stalk of old ones, which is common in stalked barnacles.

*Balanus* (Fig. 257 B), the common acorn barnacle, differs from *Lepas* in the lack of a stalk, and in having an outer wall of skeletal plates homologous with some of the extra pieces on the capitulum of *Scalpellum*.

#### Order ACROTHORACICA

Cirripedia of separate sexes; with an alimentary canal; fewer than six pairs of thoracic limbs; and no abdominal somites; permanently sessile on the preoral region, in which the antennules are absent and the cement glands much reduced.

These are minute creatures whose females live in hollows which they excavate in the shells of molluscs, while the males are degenerate and have the same relation to the female as have those of the species of *Scalpellum* in which the sexes are separate.

*Alcippe*, British, lives in the columella of whelks, etc.

#### Order APODA

Hermaphrodite Cirripedia; without mantle, thoracic limbs or anus; whose body is divided by constrictions into rings.

*Proteolepas*, the only known member of the order, is a small, maggot-like animal found by Darwin in the mantle cavity of the stalked barnacle *Alepas*. The antennules, by which it is attached, and the mouth parts, are those of a cirripede. Since the mouth is terminal, at least some of the more anterior of the eleven rings cannot represent somites.

#### Order RHIZOCEPHALA

Cirripedia which are parasitic, almost exclusively on decapod crustacea; have at no time an alimentary canal; and in the adult neither appendages nor segmentation; make attachment in the larva by an antennule; and are in the adult fastened to the host by a stalk from which roots proceed into the host's tissues.

*Sacculina* (Figs. 258-261), parasitic on crabs, is the best known example of this group. Its life history is a very remarkable one. It starts life as a *Nauplius* (Fig. 258 A), with the characteristic frontal horns of cirripede *Nauplii* but without mouth or alimentary canal. The *Cypris* larva (Fig. 258 B) clings to a seta of a crab by one of its



antennules. The whole trunk, with its muscles and appendages, is now thrown off and a new cuticle formed under the old one, with a dart-like organ which is thrust through the antennule and the thin cuticle at the base of the seta of the crab into the body of the latter. Through the dart the remnant of the larva, a mass of undifferentiated cells surrounded by a layer of ectoderm, passes into the host's body cavity. Carried by the blood it becomes attached to the under side of the intestine (Fig. 259). There rootlets begin to grow out from it and eventually permeate the body of the crab to the extremities of the

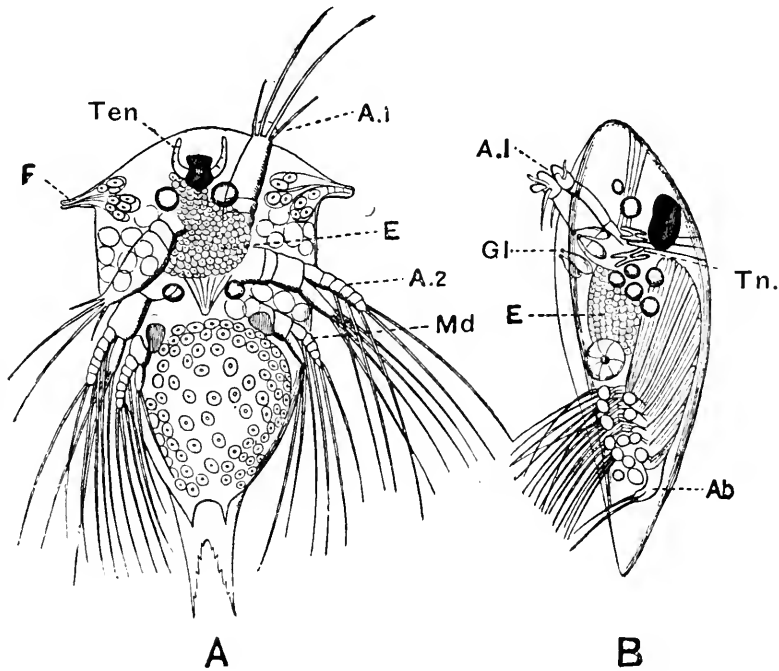

Fig. 258. Larval stages of *Sacculina*. From G. Smith. A, *Nauplius*, B, *Cypris*. A.1, antennule; A.2, antenna; Ab, abdomen; E, undifferentiated cells; F, frontal horn with gland cells; Gl, gland cells; Md, mandible; Ten, frontal tentacles (frontal organs); Tn, tendon.

limbs. Meanwhile a knob also grows from the mass; forms within itself a mantle cavity surrounding an internal "visceral mass" which contains the rudiments of genital organs and a ganglion; presses upon the ventral integument of the abdomen of the host, whose cuticle is thus hindered from forming at that spot; and consequently at the next moult of the crab comes to project freely under the abdomen, where it may be found in the adult condition.

The phenomenon known as *parasitic castration* is exhibited by crabs attacked by *Sacculina*. The moult at which the parasite becomes external produces a change in the secondary sexual characters in the

new cuticle. The male crabs have a much broader abdomen, reduced copulatory styles (these may disappear altogether), and abdominal swimmerets (which carry the eggs in the female, and are absent in the normal male). There is, in short, a marked tendency to the female type. In the female crabs there is also a change, but this is held to be not towards the male but towards the juvenile type. The gonads disappear, but cases have been observed in which the parasite has been killed and months afterwards what was probably an originally male crab has regenerated a hermaphrodite gonad. Parasitic castration is

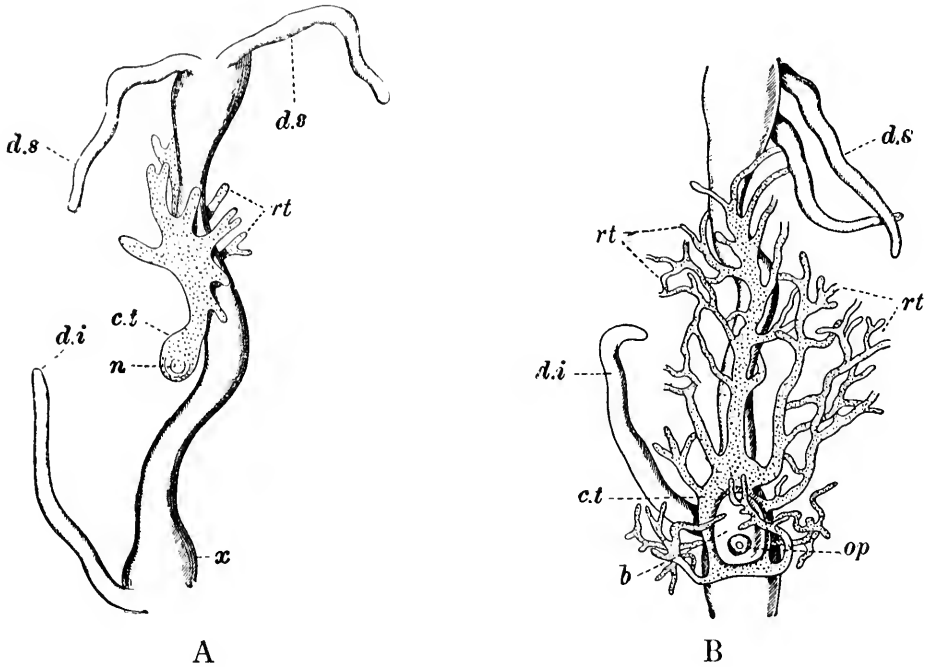

Fig. 259. Stages in the development of *Sacculina* upon the mid gut of a crab. From G. Smith. A, Early stage. B, Later stage. *b.* swelling caused by the body of the *Sacculina*; *c.t.* central tumour upon which the body arises; *d.i.*, *d.s.* inferior (posterior) and superior (anterior) diverticula of the gut of the host; *n.* "nucleus" or rudiment of the body of the *Sacculina*; *op.* opening of a cavity in the central tumour, the "perisomatic cavity", from which the definitive body eventually protrudes (not the mantle opening); *rt.* roots; *x.* final position of the parasite.

the most evident expression of a remarkable and at present ill-understood interference by the parasite with the general metabolism of its host.

*Thompsonia* (Fig. 262), parasitic on crabs, hermit crabs, etc., is an extraordinary case of extreme reduction by parasitism, in which an arthropod is degraded to the level of a fungus. The rootlets of the parasite are widely diffused through the host. Their branches in the

limbs give off sacs which become external at a moult of the host. These sacs contain neither ganglion, generative ducts, nor testes, but only a number of ova in a space of doubtful nature. When they are ripe the ova have become (probably by parthenogenesis) *Cypris* larvae, which are set free by the formation of an opening. There is no parasitic castration of the host.

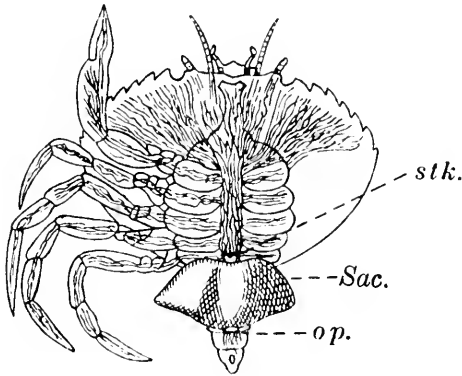

Fig. 260.

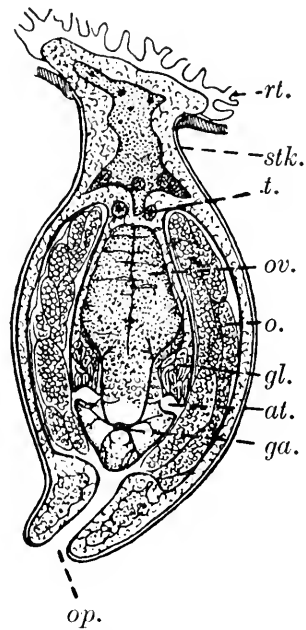

Fig. 261.

Fig. 260. A specimen of the shore crab (*Carcinus*) bearing a *Sacculina*. *op.* mantle opening; *Sac.* *Sacculina*; *stk.* stalk.

Fig. 261. A vertical section of *Sacculina* at right angles to the plane of greatest breadth. From Calman. *at.* atrium of oviduct; *ga.* ganglion; *gl.* colleteric gland opening into atrium; *o.* eggs in mantle cavity; *op.* opening of mantle cavity; *ov.* ovary; *rt.* roots; *stk.* stalk; *t.* testis.

### Order ASCOTHORACICA

Parasitic cirripedia, which have an alimentary canal from which diverticula extend into the mantle; six pairs of thoracic appendages; and a segmented or unsegmented abdomen; and are not attached by the preoral region.

These animals are parasitic and often imbedded in the tissues of their hosts. They are an early branch of the cirripede stock which has retained the abdomen, in some cases well segmented and provided with movable caudal rami, and has not the characteristic mode of fixation by the antennules, or frontal horns in the *Nauplius*.

*Laura* (Fig. 264), imbedded in the tissues of the antipatharian

*Gerardia*, has the mantle in the form of a very spacious sac with a narrow opening. Its abdomen has two somites and a telson.

*Synagoga* (Fig. 263), external parasite on *Antipathes*, has a bivalve mantle, from which usually protrudes the long abdomen of four somites and a telson. It is possible that this is an immature stage of an animal which is more retrograde when it is adult.

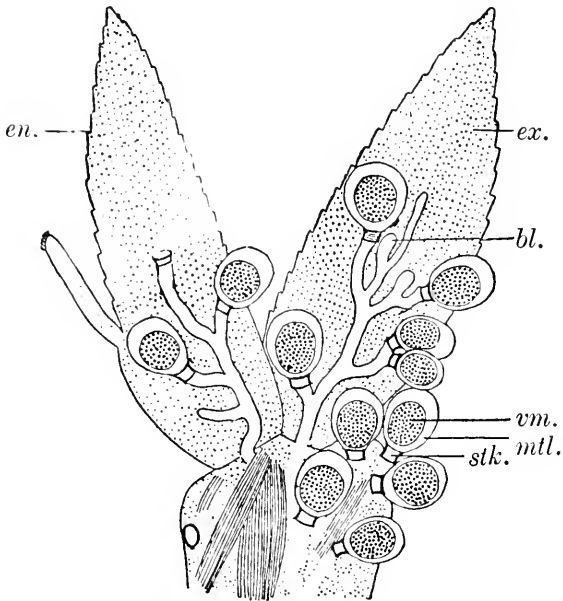

Fig. 262.

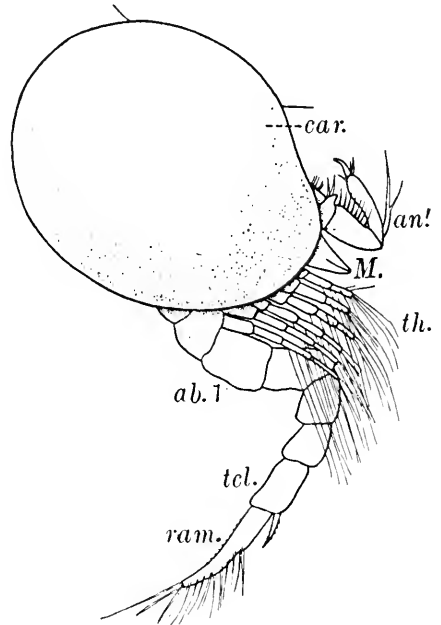

Fig. 263.

Fig. 262. An abdominal limb of the prawn *Synalpheus* infested by *Thompsonia*,  $\times 120$ . From Potts. *bl.* blind branch of root system which after further development will become an external sac; *en.* endopodite of limb of host; *ex.* exopodite of the same; *mtl.* mantle of sac; *stk.* stalk; *vm.* visceral mass, occupied entirely by the ovary.

Fig. 263. *Synagoga mira*. After Norman. *ab. 1*, first abdominal somite; *an.* antennule; *car.* mantle (carapace); *M.* mouth; *ram.* ramus of caudal fork; *tcl.* telson; *th.* thoracic limbs.

### Class MALACOSTRACA

Crustacea with compound eyes, which in typical members of the group are stalked; typically a carapace which covers the thorax; the mandibular palp, if present, uniramous; a thorax of eight somites and abdomen of six (rarely seven), all (except the 7th abdominal) bearing appendages; and a complex proventriculus.

The Malacostraca contain a very large number of species, which exhibit great diversity. Nevertheless they are capable of reference to a common type in respect of more features than the members of any

other group, though the Copepoda approach them in this. The *ideal malacostracan* has twenty somites, including the preantennulary and excluding the telson. Of these, six belong to the head (p. 332), eight constitute the thorax, and six the abdomen. This number is only departed from in the Leptostraca, which have an additional somite at the end of the abdomen. (In the embryos of Mysidacea such an additional somite is present, but in the adult it has fused with that which precedes it.) The female openings are always on the 6th thoracic somite, and the male on the 8th. A carapace encloses the thorax at

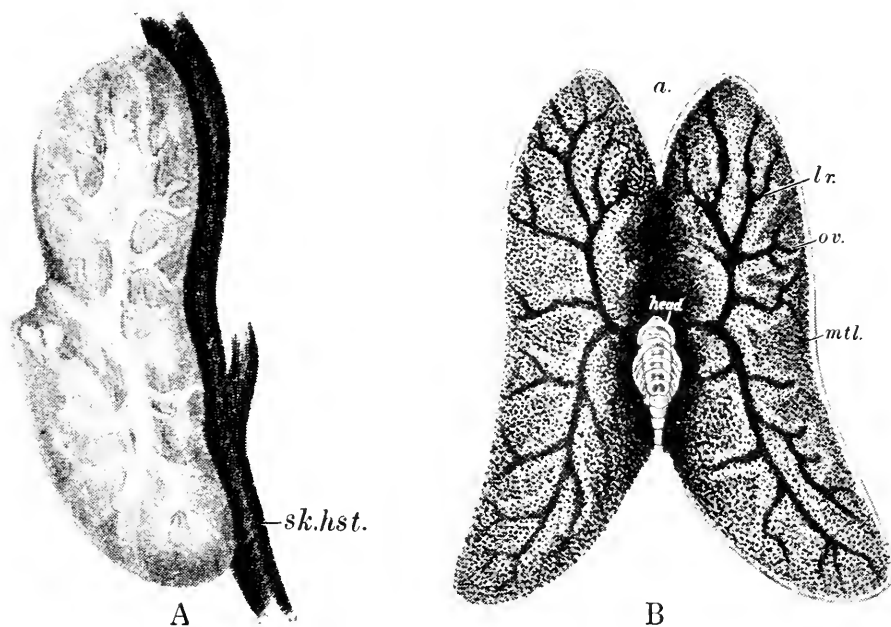

Fig. 264. *Laura gerardiae*. After Lacaze-Duthiers. A, The animal intact, attached to the skeleton of its host, after removal of the soft tissues of the latter. B, A view obtained by opening the mantle along the dorsal side. *a.* anterior end; *lr.* liver, branching in mantle; *mtl.* mantle; *ov.* ovary; *sk.hst.* skeleton of the host.

the sides. The median eye is vestigial in the adult, and the compound eyes stalked. The antennules are biramous, as they are in no crustacean of any other group. The antennae have a scale-like exopodite by extending which the animal keeps its body level in the water. The mandibles have uniramous palps and the part which projects towards the mouth is cleft into "incisor" and "molar" processes. The maxillules have two endites (on the first and third joints) and the maxillae four, grouped in twos. The thoracic limbs have a cylindrical, five-jointed endopodite (p. 336), used when the animal has occasion to walk or to grasp large particles of food, a natatory exopodite, and two

respiratory epipodites. The abdominal appendages are biramous; those of the first five pairs (*pleopods*) slender and fringed and used in swimming, those of the last pair (*uropods*) broad, turned backward, and forming with the telson a tail-fan, used in rapid backward movement. There are no caudal rami. (The Leptostraca are the only members of the class which possess these rami in the adult.) Food is chiefly collected as particles in a stream which is set up by the action of the maxillae and which passes forwards through a filtering fringe of bristles upon the median margins of those appendages.

This type is said to possess the *caridoid facies*. It is adapted primarily to swimming and is best exhibited in the small, prawn-like, pelagic forms, formerly classed together as *Schizopoda* but now distributed, as the orders Mysidacea (Fig. 265) and Euphausiacea, to the

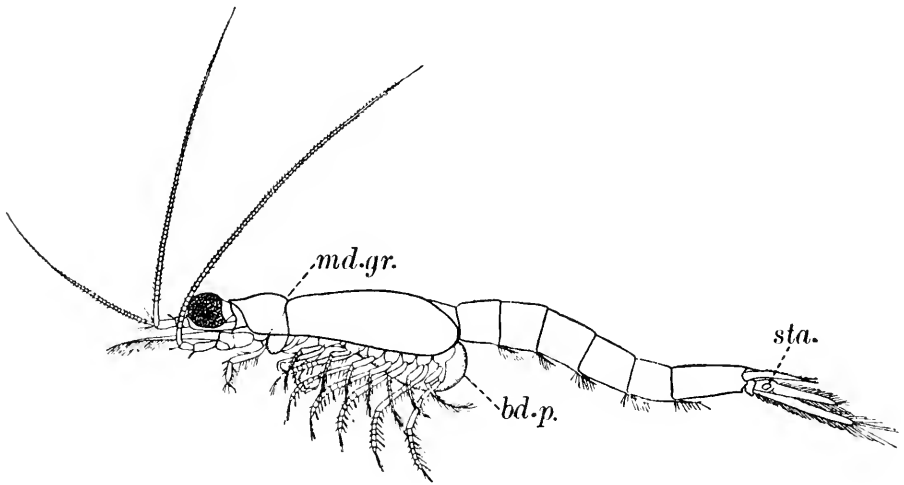

Fig. 265. A female of *Mysis relicta*. After Sars. *bd.p.* brood pouch; *md.gr.* mandibular groove; *sta.* statocyst.

two main subclasses of the Malacostraca (see below). Departures from it are many and important, and most of its features have disappeared more than once independently. Thus the carapace, the inner ramus of the antennule, the scale of the antenna, the mandibular palp, exopodites of thoracic limbs, etc., have been lost in various branches of the malacostracan tree. Only the number of the somites and the size of the tagmata are constant, save in the case of the Leptostraca already mentioned and in certain parasitic isopods. Departure from the caridoid facies is associated with the abandonment of the swimming habit for crawling or burrowing, and when that happens the animal ceases to gather food by filtration and adopts other modes of feeding, for which its limbs, and particularly the thoracic endopodites, become variously modified—as, for instance, by the development of chelae.

An exceptionally large number of members of this class have direct development. Of those which possess larvae only a few (*Euphausiacea*, a few of the Decapoda) hatch in the *Nauplius* stage. A special characteristic of the larval development of the Malacostraca is the occurrence of a *zoaeal* stage (p. 353), in which the carapace and tagmata are present, the abdomen is better developed than the hinder part of the thorax, and the animal swims by biramous maxillipeds. In crabs, hermit crabs, and some related families the *Zoea* is succeeded by a *Metazoea*, which differs from it in having uniramous rudiments of thoracic limbs behind the maxillipeds. In other forms with larval development there is at this stage a prawn-

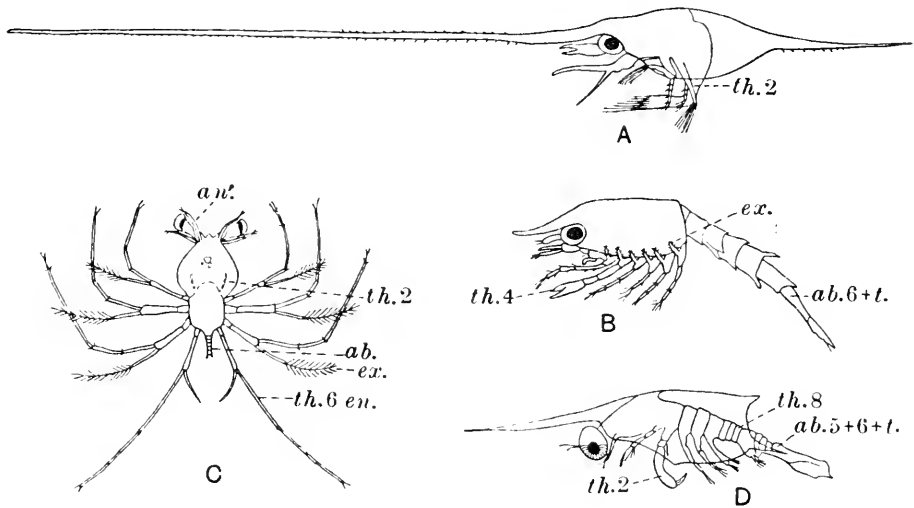

Fig. 266. Malacostracan larvae. A, *Zoea* of *Porcellana*. B, Schizopod of the lobster. C, *Phyllosoma* of *Palinurus*. D, Young *Erichthus* of a stomatopod. *ab.* abdomen; *an.* antennule; *en.* endopodite; *ex.* exopodite; *t.* telson; *th.* thorax. The numerals indicate the somites or their appendages.

like *Schizopod* larva ("Mysis" stage), with biramous limbs on all the thoracic somites, which is not always preceded by a *Zoea*.

The Malacostraca fall into two large groups and three smaller ones. Of the latter, the *Leptostraca* retain, in the hinder end of the abdomen, a primitive condition, which has been lost in the other groups. The *Stomatopoda* (Hoplocarida) stand alone in possessing two free pseudosomites in the anterior part of the head, certain peculiarities of the thoracic limbs, and peculiar gills on the abdominal appendages. The *Syncarida* unite certain features which are characteristic of other groups. The large groups *Peracarida* and *Eucarida* contain most of the members of the class. The former of these two divisions is characterized by possessing a brood pouch, formed by plates (*oostegites*) upon the thoracic limbs, in which the young undergo a direct development,

and by the freedom of some or all of the thoracic somites from the carapace. The Eucarida do not possess a brood pouch and usually have larval stages, their heart is a short chamber in the thorax, and their carapace fuses with the dorsal side of each thoracic somite. Independently in each of these two groups the caridoid facies has been lost to various degrees, so that the members of each can be roughly arranged in a series which, starting with prawn-like "schizopods", ends in the Peracarida with the woodlice and in the Eucarida with the crabs.

### Subclass *LEPTOSTRACA*

Malacostraca with a large carapace provided with an adductor muscle and not fused with any of the thoracic somites; stalked eyes; the

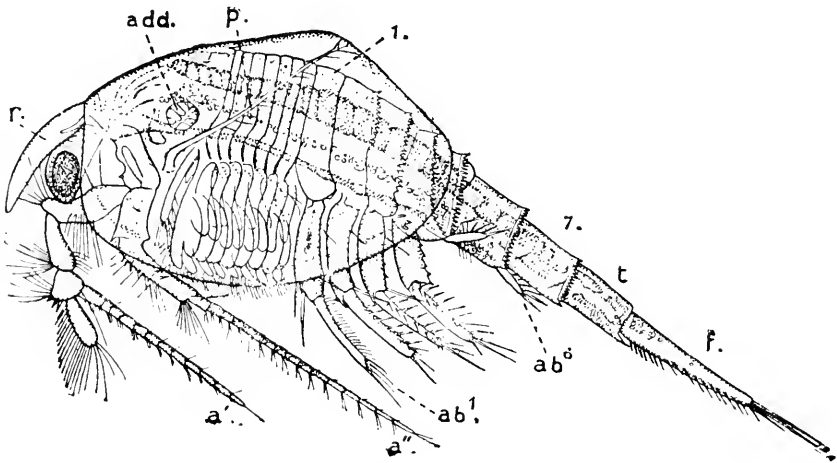

Fig. 267. A female of *Nebalia bipes*. From Calman, after Claus. *a.*' antennule; *a.*'' antenna; *ab.*<sup>1</sup> and *ab.*<sup>6</sup> first and sixth abdominal limbs; *add.* adductor muscle of carapace; *f.* ramus of caudal furca; *p.* palp (endopodite) of maxillule; *r.* rostrum; *t.* telson; 1, 7, first and seventh abdominal somites.

thoracic limbs all alike, without oostegites, biramous, and usually foliaceous; seven abdominal somites, of which the last bears no appendages; and caudal rami on the telson.

*Nebalia* (Fig. 267) is the commonest and typical genus of this group. *N. bipes*, the British species, may be found between tide-marks, under stones, especially in spots which are foul with organic remains. *Nebalia* has a rostrum, which is jointed to the head. The antennae have no scale, while the antennules are unique in possessing one. The carapace has an adductor in the region of the maxilla and encloses the four anterior abdominal somites. The thorax is short.



Its limbs (Fig. 222 E) are flat. Their endopodite is narrow and possesses five indistinct joints. Sometimes the long basipodite is divided and its distal region added to the endopodite as a preischium (p. 336). The exopodite is broad and there is a very large epipodite, which serves as a gill. (The related *Paranebalia*, however, has a slender exopodite with a flagellum, and a small epipodite.) The first four pairs of abdominal limbs are large and biramous, the fifth and sixth small and uniramous.

The *alimentary canal* possesses a proventriculus of relatively simple type, several pairs of simple mid gut coeca, and an unpaired posterior dorsal coecum. The *heart* is long, reaching from the head to the 4th abdominal somite. The *nervous system* is of primitive type (p. 340). The *excretory organs* have been alluded to on pp. 346, 348.

The animal *feeds* by straining particles from the water by means of an elaborate arrangement of setae of different kinds on the thoracic limbs, the necessary currents being set up by a pumping action of the same limbs. These work upon a principle similar to that employed by the Branchiopoda, the exopodites and epipodites acting as valves for pumping chambers between the limbs, but it is the *backward* stroke that enlarges the chambers, and they are closed by the *forward* flapping of their valves. *Development* is direct, the embryos being carried between the thoracic limbs of the mother, held in by the long setae on the limbs, but not glued to them like the eggs of the crayfish.

#### Subclass HOPLOCARIDA (STOMATOPODA)

Malacostraca with a shallow carapace which is fused with three thoracic somites and leaves four uncovered; two free pseudosomites on the head; stalked eyes; the first five thoracic limbs subchelate and

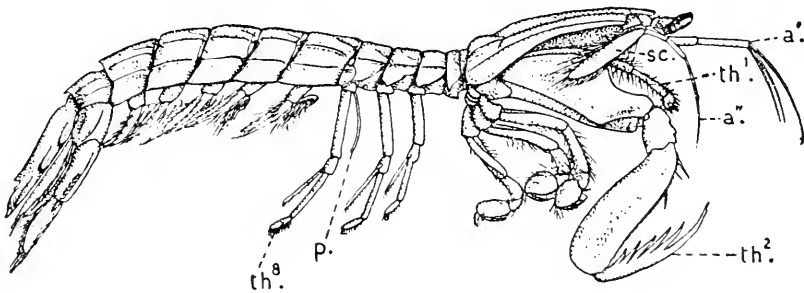

Fig. 268. A male *Squilla mantis*. From Calman. *a.*' antennule; *a.*'' antenna; *p.* penis; *sc.* scale (exopodite) of antenna; *th.*<sup>1</sup>, *th.*<sup>2</sup>, *th.*<sup>8</sup>, first, second, and last thoracic limbs.

the last three biramous; no oostegites; a large abdomen whose first five pairs of limbs bear gills on the exopodites, while the sixth forms with the telson a tail fan; and a large, branched "liver".

The *2nd thoracic limb* bears a large, raptorial subchela. The *alimentary canal* has a rather simple proventriculus and a large branched "liver"; the latter and the gonads extend along the large abdomen. In the *nervous system* eight pairs of ganglia are fused as the suboesophageal ganglion. The *heart* is very long, reaching from the head to the fifth abdominal somite. The *excretory organs* are maxillary glands. The *larvae* are pelagic and of the same general type as the *Zoea* but with a peculiar facies of their own (Fig. 266 D).

The members of the subclass are all marine, and for the most part live in burrows.

*Squilla* (Fig. 268) occurs in British waters.

#### Subclass *SYNCARIDA*

Malacostraca without carapace; with eyes stalked, sessile or absent; most of the thoracic limbs provided with exopodites and none of them chelate or subchelate; no oostegites; a tail fan; and simple coeca on the mid gut.

A small group of freshwater malacostracans with a combination of features which forbids their inclusion in either of the other subclasses. In typical genera, they possess most of the features of the caridoid

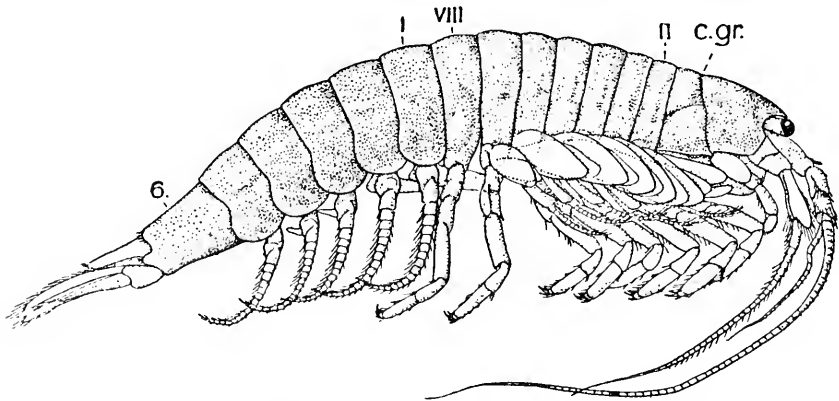

Fig. 269. *Anaspides tasmaniae*,  $\times 3$ . From Woodward. *c.gr.* mandibular or "anterior cervical" groove; II, VIII, second and eighth thoracic somites; 1, 6, first and sixth abdominal somites.

facies except the carapace; and the relatively slight differentiation of thorax from abdomen is a primitive character possessed by no other member of the class.

*Anaspides* (Figs. 223, 269), from pools at 4000 feet in Tasmania, is a normal member of the group.

*Bathynella*, from subterranean waters in Central Europe and England, small, degenerate, and eyeless, has various limbs reduced or absent and the first thoracic segment free.

Subclass *PERACARIDA*

Malacostraca whose carapace, if present, does not fuse with more than four thoracic somites; whose eyes may be stalked or sessile; and which possess oostegites; a more or less elongate heart; and a few simple coeca on the mid gut.

A large subclass, containing several orders, which range from the prawn-like Mysidacea, in which the caridoid facies (pp. 387, 388) is practically intact, to the Isopoda and Amphipoda (slaters and sandhoppers) in which the carapace is lost and other features are greatly modified. The important common characters which all these orders possess are the presence of oostegites and the retention of the young, which are directly developed, in a brood pouch formed by those organs. Certain peculiarities, however, of the mandibles, which bear behind the incisor process a movable structure known as the *lacinia mobilis*, of the thoracic limbs (p. 336), etc., are also possessed in common by the Peracarida.

## Order MYSIDACEA

Peracarida with a carapace which covers most or all of the thoracic somites; the eyes (when present), stalked; the scale of the antenna well developed; exopodites on most or all of the thoracic limbs, of which one or two pairs are maxillipeds; and a well-formed tail fan.

Small, usually pelagic crustaceans, most of which are marine, though a few occur as "relicts" or immigrants in fresh waters. They are mostly carnivorous, but take vegetable matter in the course of feeding. Small food particles are obtained in a current set up by the maxillae (p. 388) and when there are no gills also by a whirling action of the thoracic exopodites, and are strained off by the maxillae: large food masses are seized by the endopodites of the thoracic limbs.

*Mysis* (Figs. 265, 270), British, possesses a statocyst on the endopodite of each uropod, but has not the branched gills (thoracic epipodites) which are found in some of the Mysidacea (Lophogastriidae). Its respiration takes place through the thin lining of the carapace, under which a current is drawn from over the back by the action of the epipodites of the maxillipeds (first pair of thoracic limbs).

## Order CUMACEA

Peracarida with a carapace which covers only three or four thoracic somites but is on each side inflated into a branchial chamber and produced in front of the head to lodge the expanded end of the exopodite of the first thoracic limb; eyes (when present) sessile; no exopodite on the antenna or endopodite on the maxilla; three pairs of maxilli-

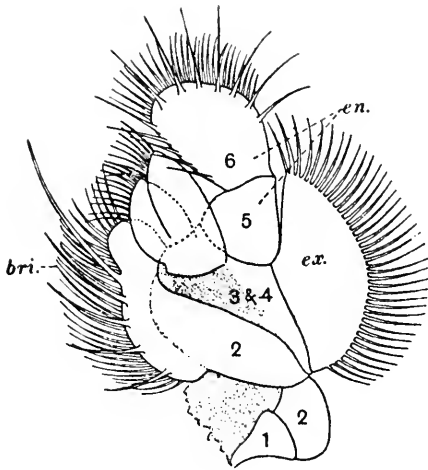

Fig. 270.

Fig. 270. Maxilla of *Mysis*. *bri.* bristles used in straining out the food; *en.* endopodite; *ex.* exopodite; 1-6, segments.

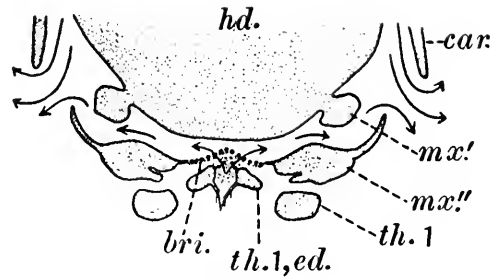

Fig. 271.

Fig. 271. Part of a transverse section through the hinder region of the head of *Hemimysis*. After Cannon and Manton. *bri.* bristles of the fringes on the maxillae by which food particles are strained out; *car.* the edge of the carapace; *hd.* head; *mx.'* base of maxillule; *mx. ''* section of maxilla; *th. 1*, section of first thoracic limb; *th. 1, ed.* section of endite of first thoracic limb.

The arrows show the direction of the currents. Note that the outgoing water from the food current joins that of the respiratory current, which comes down from under the carapace.

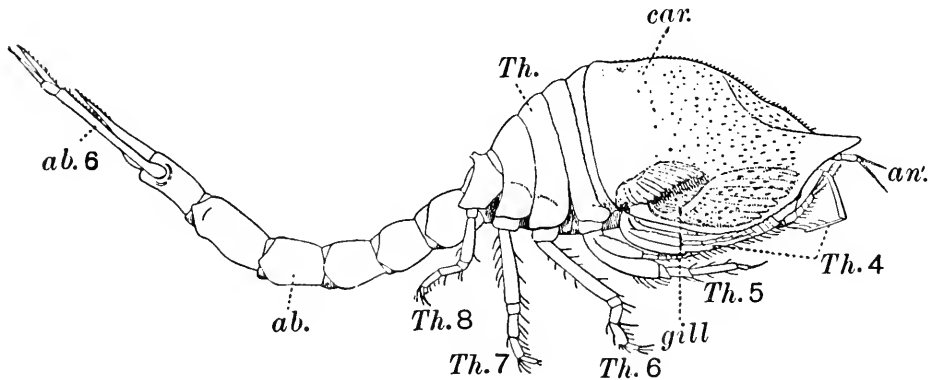

Fig. 272. Female *Diastylis stygia*. After Sars. *ab.* abdomen; *ab. 6*, appendage of the sixth somite of the abdomen; *an.* first antenna; *car.* carapace; *gill*, gill borne on first maxilliped and seen through the carapace; *Th.* free part of thorax; *Th. 4-Th. 8*, fourth to eighth thoracic limbs. The male has pleopods and long antennae.

pedes; a large epipodite, bearing a gill, on the 1st thoracic limb and natatory exopodites on some of the others; and slender uropods, which do not form a tail fan.

Small, marine organisms which live in mud or sand and are highly specialized, especially in their respiratory mechanism, for that habitat. The first thoracic exopodites form a valved exhalant siphon with the carapace lobes which lodge them.

*Diastylis* (Fig. 272) is a British genus.

#### Order TANAIIDACEA

Peracarida with a very small carapace, covering only two thoracic somites, with which it fuses; eyes (if present) on short, immovable stalks; a small scale, or none, on the antenna; thoracic exopodites absent or vestigial, a branchial epipodite on the maxilliped; and slender uropods, which do not form a tail fan.

Small, marine crustaceans, usually inhabiting burrows or tubes, which are in an intermediate condition between the Cumacea and Isopoda in respect of the loss of the caridoid facies.

*Apseudes* (Fig. 273 A), and *Tanais*, which differs from it in having short, uniramous antennules and uropods and no antennal scale, and lives in a mass of fibres it secretes, are British genera.

#### Order ISOPODA

Peracarida without carapace; with sessile eyes; the body usually depressed; the antennal exopodite absent or minute, the thoracic limbs without exopodites, the first pair modified as maxillipeds, the remainder usually alike; the pleopods modified for respiration, and the uropods usually not forming a tail fan. (Any of these features may be absent in the adults of parasitic forms.)

The Isopoda are a large group and exhibit much variety. We will study as an example *Ligia*, the shore slater (Fig. 274), found just above tidemarks in Britain and most parts of the world. This creature has a depressed, oval *body*, the cephalothorax, formed by fusion of the 1st thoracic somite with the true head, lying in a notch on the anterior edge of the 2nd somite of the thorax. Two large, sessile compound eyes take up the sides of the head. The abdomen continues the outline of the thorax, and its 6th somite is fused with the telson. The *antennules*, which are usually short in isopods, are here minute. The *antennae* are of a good length, which is due to the elongation of the two joints which precede the flagellum. The *mandibles*, unlike those of most isopods, lack the palp, but otherwise they are complicated, having between the incisor and molar processes a row of spines and

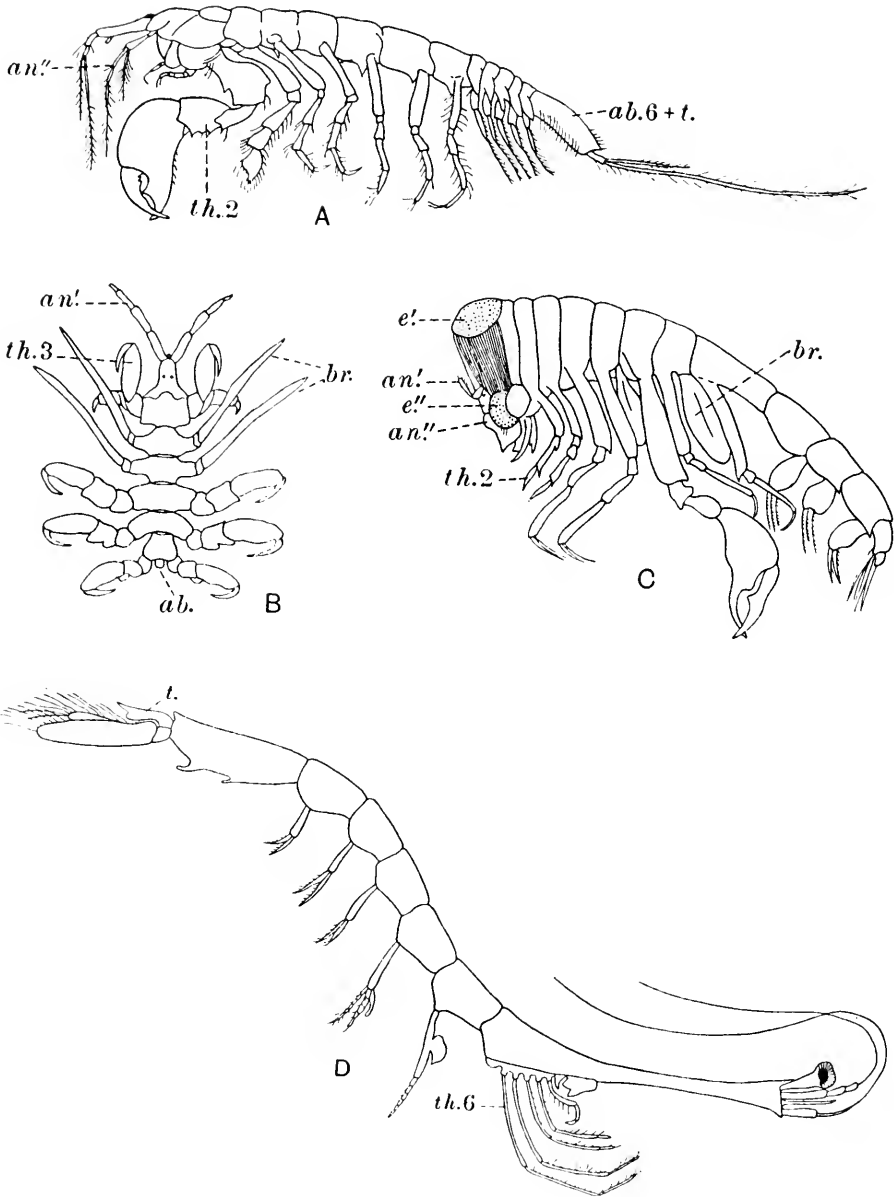

Fig. 273. Malacostraca. A, *Apsydes*; B, *Cyamus*; C, *Phronima* ♀; D, *Leucifer* ♂. *ab.* abdomen; *an.'* antennule; *an.ii* antenna; the antennae of *Cyamus* are minute and those of *Phronima* ♀ reduced to a tubercle containing the green gland; *br.* gill; *e.', e.ii* the two sections of the eye of *Phronima*; *t.* telson; *th.* thorax. The numerals indicate somites or their appendages.

the movable structure known as the *lacinia mobilis* (Fig. 275 A, *la.mo.*) which is characteristic of the Peracarida. The maxillules and maxillae are less well developed than those of most isopods. The *maxillipeds* are broad and close the mouth region from behind. The rest of the *thoracic limbs* are uniramous and leg-like. Their coxopodites are fused with the body, so that the brood pouch plates (oostegites) of the female, which are epipodites of the legs, seem to arise from the sterna. The first five pairs of *abdominal limbs* are broad, with plate-like, respiratory endopodite and exopodite. The endopodite of the second pair of the male is produced into a copulatory style. The uropods have slender, styliform rami. The *alimentary canal* has an elaborate proventriculus, adapted, not to chew the food, but to press the juices

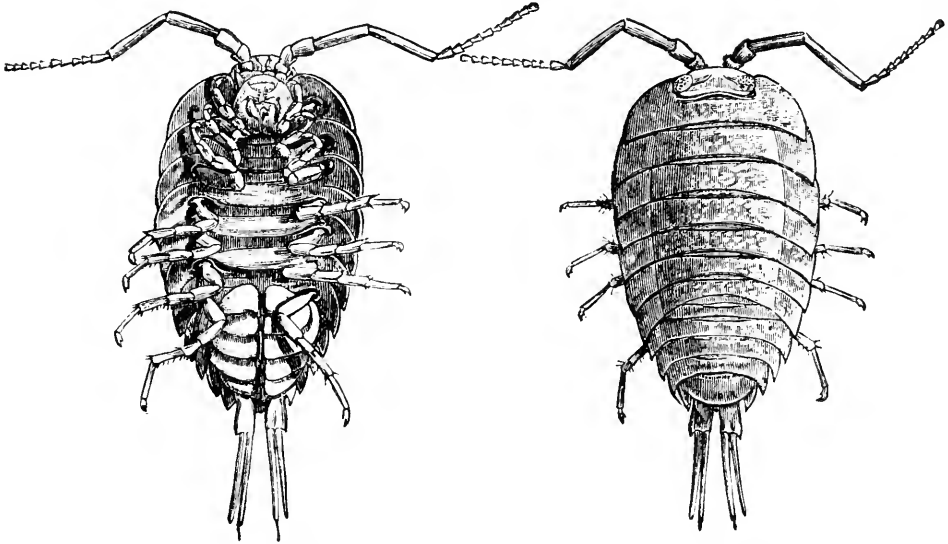

Fig. 274. Dorsal and ventral views of *Ligia oceanica*.  
From the *Cambridge Natural History*.

out of it and to strain off solid particles from them; and there are three pairs of mid gut coeca. The *heart* lies in the hinder part of the thorax and in the abdomen, where blood returns from the respiratory limbs to the pericardium. The *nervous system* has a concentration of ganglia in the abdomen as well as one for the mouth parts. The *gonads* are paired, and the testes bear three follicles, characteristic of the Isopoda (see Fig. 276 A). The young when set free from the brood pouch resemble the adult but lack the last pair of legs. *Ligia* is omnivorous, but chiefly eats *Fucus*. It gnaws with its mandibles, feeding hurriedly at low tide.

*Armadillidium*, the common woodlouse, is more completely terrestrial in its habits than *Ligia*. Its antennae and uropods are short and thus permit the body to roll up into a ball in the familiar manner.

The air tubes on the abdominal limbs have been alluded to on p. 348.

*Asellus* (Fig. 276 A), the hog slater, is a common freshwater crustacean. It differs from *Ligia*, among other ways, in having all the abdominal somites fused, a flagellum on the antennule, a palp on the mandible, and free coxopodites on the legs.

*Idotea*, common among weeds, etc., on the British coast, differs from *Ligia* in having the last four abdominal somites fused with the telson and the uropods turned inwards as valves to cover the pleopods.

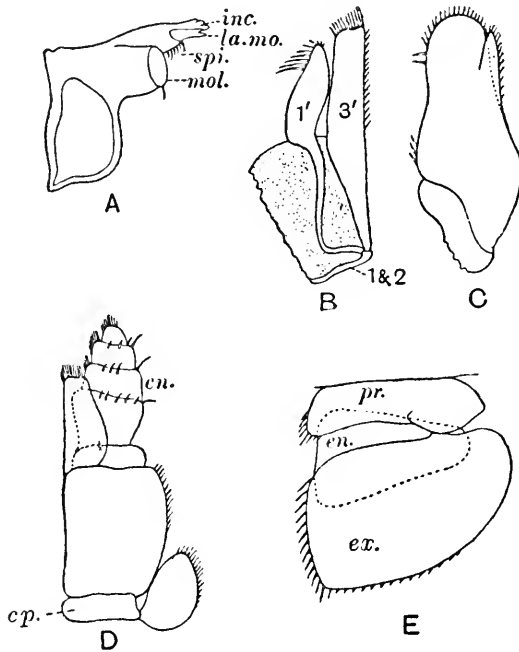

Fig. 275. Limbs of *Ligia*. A, Mandible. B, Maxillule. C, Maxilla. D, Maxilliped. E, Third abdominal limb. *cp.* coxopodite; *en.* endopodite; *ex.* exopodite; *inc.* incisor process; *la.mo.* lacinia mobilis; *mol.* molar process; *pr.* protopodite; *spi.* spine row. 1 & 2 first two joints, fused; 1', 3', endites.

Many of the Isopoda are *parasitic*. Among these there is found every grade from well-organized temporary parasites to some which are as adults mere sacs of eggs. *Aega* (Fig. 276 B), a fish louse, has the ordinary isopod form, though heavily built, and with piercing mouth parts and some of the legs hooked. Its broad uropods form a tail fan. *Bopyrus* (Fig. 277 A), in the gill chamber of prawns, with dwarf males, is more degenerate but still recognizable as an isopod. *Cryptoniscus* (Fig. 277 B), a "hyperparasite" on members of the Rhizocephala and a protandrous hermaphrodite, is extremely degenerate. Many of these parasites produce parasitic castration (see p. 383).



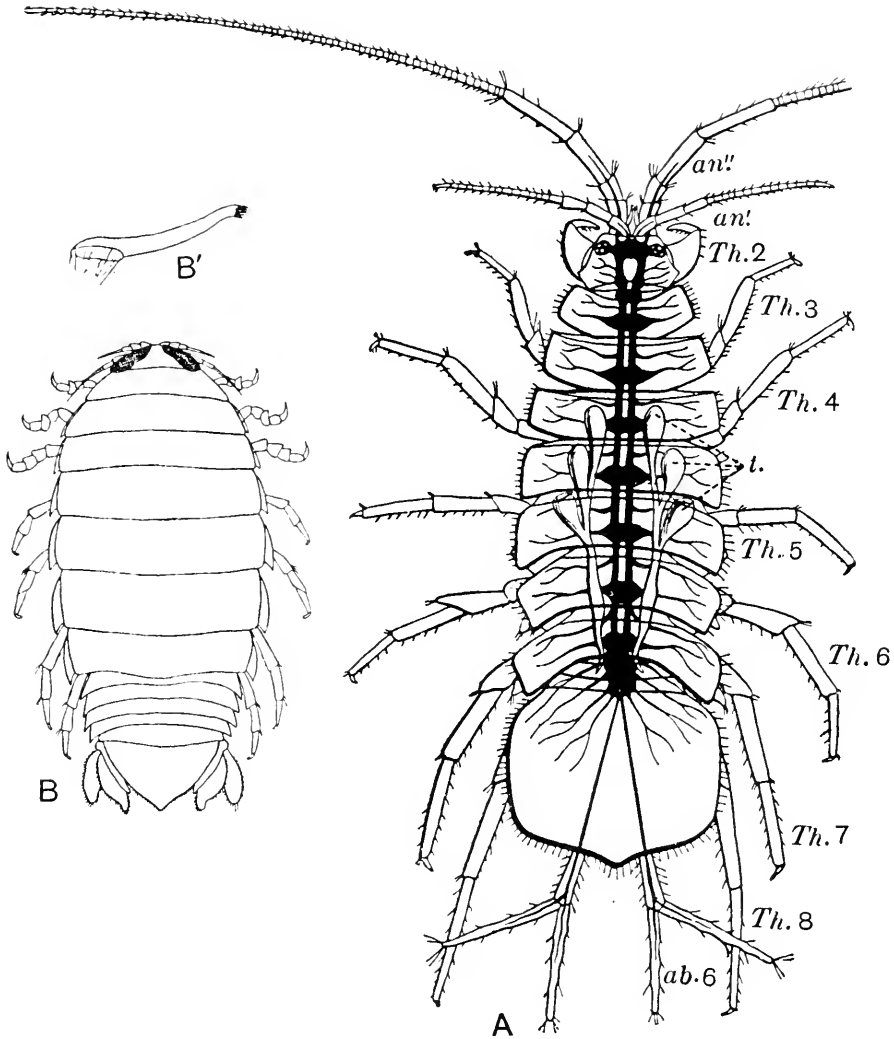

Fig. 276. A, *Asellus aquaticus*. Male viewed from above. From Leuckart and Nitsche. *an.'* antennule; *an. ''* antenna; *ab. 6*, the last pair of abdominal limbs; *t.* testes with their efferent canals: the nervous system is shown in black; *Th. 2-8*, thoracic limbs. B, *Aega psora*. B', Maxillule of the same. All after Sars.

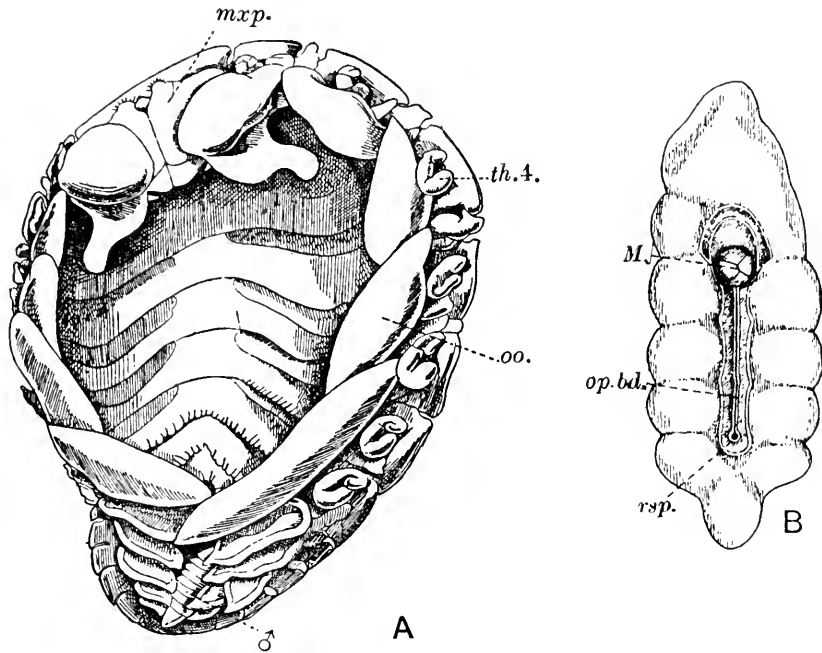

Fig. 277. A, *Bopyrus fougerouxi*: a female in ventral view. From the *Cambridge Natural History*, after Bonnier. *mxp.* maxilliped; *th.4.* fourth thoracic limb (third leg); *oo.* oostegite; ♂, male attached to female. B, *Cryptoniscus paguri*: ripe female stage in ventral view. After Fraisse. *M.* mouth; *op.bd.* line along which brood pouch will open; *rsp.* one of two openings through which a respiratory current passes to and from brood pouch.

### Order AMPHIPODA

Peracarida without carapace; with sessile eyes; the body usually compressed; no antennal exopodite; the thoracic limbs without exopodites, the first pair modified as maxillipeds, the remainder of more than one form, the second and third usually prehensile; the pleopods when fully developed divided into two sets, the first three pairs with multiarticulate rami, the last two resembling the uropods, which do not form a tail fan.

We will take as an example of this order *Gammarus* (Figs. 278–280), of which closely related species occur in Britain in fresh waters and between tidemarks in the sea. The *body* of this animal is compressed and elongated, with the 1st thoracic somite fused to the head and no sharp distinction between the thorax and abdomen, which are of nearly equal length. At the sides of the head are pleural plates. The pleura of the thorax are short; but large, hinged coxal plates on the legs take their place. All the segments of the abdomen are free. The telson is deeply cleft. The antennules have two flagella; the uniramous

antennae are much like those of *Ligia*. The mandibles have the same parts as those of *Ligia*, with a palp. The maxillules, maxillae, and maxillipeds are shown in Fig. 279. The maxillipeds are united by the fusion of their coxopodites. The first two pairs of legs are subchelate, the third and fourth pairs are turned forwards and help the subchelae in feeding, the last three pairs are turned backwards and used when the animal crawls on its side. The first three pairs of abdominal limbs

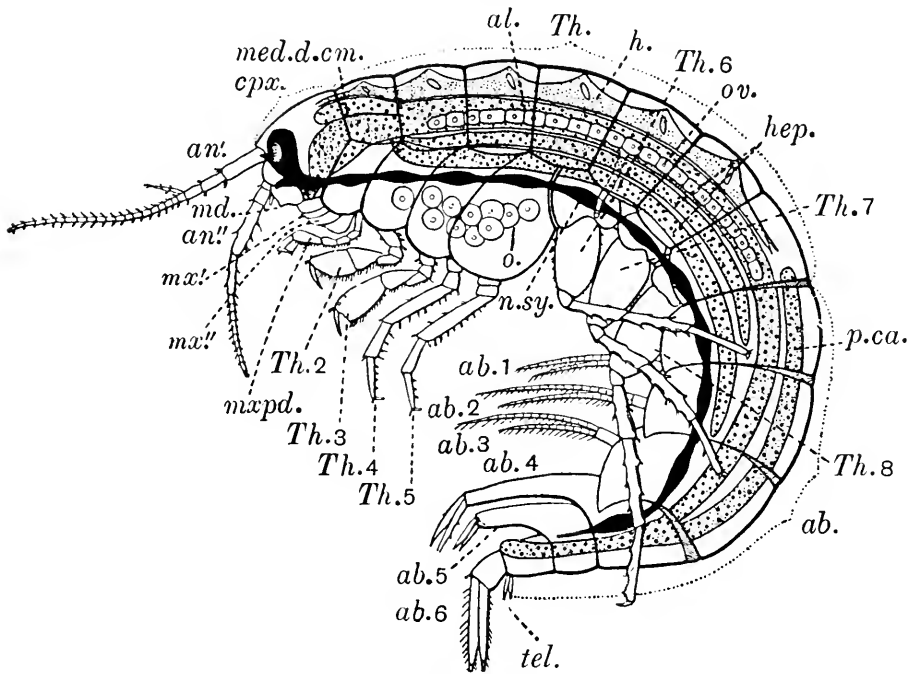

Fig. 278. *Gammarus neglectus*. Female bearing eggs seen in profile. From Leuckart and Nitsche, after G. O. Sars. *cpx.* cephalothorax; *Th.* free thoracic somites; *ab.* the six abdominal somites; *an.'* antennule; *an.'" data-bbox="36 544 850 694"/>*

are used in swimming and to direct water towards the gills, the last three pairs are used together to kick the ground in jumping. Simple gills (epipodites) are found on the coxopodites of the legs, and oostegites on those of the third to fifth pairs in the female (Fig. 280). The *alimentary canal* has a single-chambered but complex proventriculus, two pairs of "hepatic" coeca, and a pair of coeca at the hinder end of the mid gut which have been supposed to be *excretory*. The principal organs of excretion are antennal glands. The *heart* extends from

the 7th to the 1st thoracic somite. The *young* are born with all their legs. The females with young are carried by males. After they have

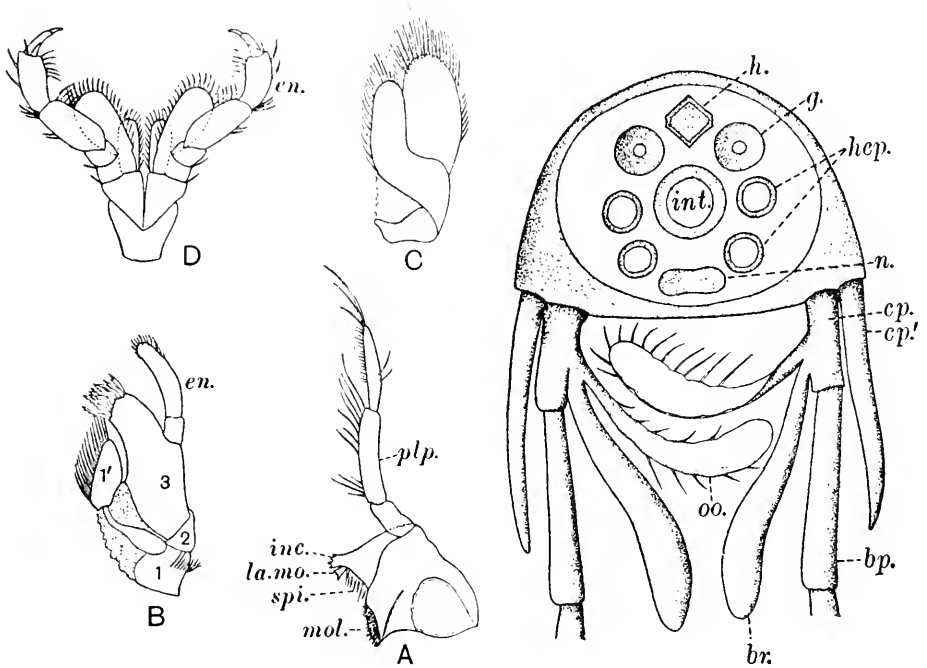

Fig. 279.

Fig. 280.

Fig. 279. Mouth parts of *Gammarus*. A, Mandible. B, Maxillule. C, Maxilla. D, Maxillipeds. *en.* endopodite; *inc.* incisor process; *la.mo.* lacinia mobilis; *mol.* molar process; *plp.* palp; *spi.* spine row; 1-3, segments of limb.

Fig. 280. A diagram of a transverse section through the thorax of *Gammarus*. *br.* branchia; *bp.* basipodite; *cp.* coxopodite; *cp.'* coxal plate; *g.* gonad; *h.* heart; *hep.* "hepatic" coeca; *int.* intestine; *n.* nerve cord; *oo.* oostegite.

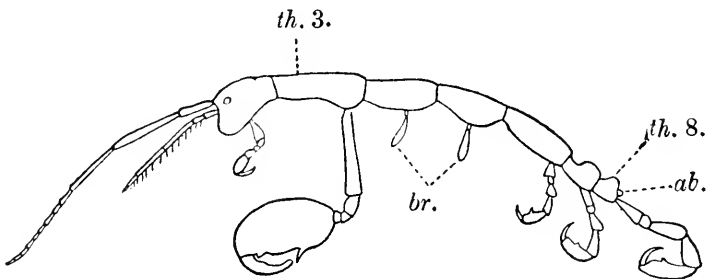

Fig. 281. *Caprella grandimana*. From the *Cambridge Natural History*, after P. Mayer. *ab.* abdomen; *br.* gills; *th. 3.*, *th. 8.*, thoracic somites.

parted with the young they moult and are immediately re-impregnated. When the cuticle has set they are liberated.

*Caprella* (Fig. 281), slender-bodied and living upon seaweeds, hydroids, etc., has two thoracic somites in the cephalothorax, no legs

on the 4th and 5th thoracic somites, all the remaining legs subchelate, and the abdomen reduced to a minute stump.

*Cyamus*, the whale louse (Fig. 273 B), is a *Caprella* with a short, wide body, adapted to its habit and habitat.

*Phronima* (Fig. 273 C), marine and pelagic, often inhabiting pelagic tunicates, jellyfish, etc., is transparent and has a large head with immense eyes.

### Subclass *EUCARIDA*

Malacostraca with a carapace which is fused with all the thoracic somites; stalked eyes; no oostegites; a short heart situated in the thorax; and a large, branched "liver".

The differences between the two orders which compose this subclass are not great. The small, prawn-like Euphausiacea are not far from the lower genera of the true prawns, members of the Decapoda.

### Order EUPHAUSIACEA

Eucarida in which the exopodite of the maxilla is small; none of the thoracic limbs are maxillipeds; there is a single series of gills, and these stand upon the coxopodites of thoracic limbs; and there is no statocyst.

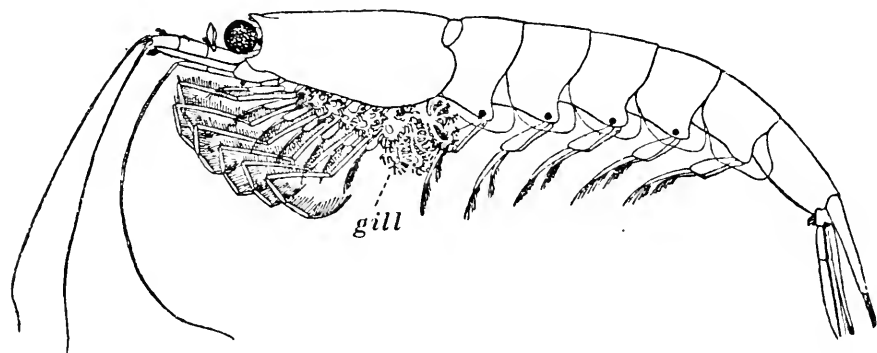

Fig. 282. *Nyctiphanes norvegica*. Slightly magnified. From Watasé. The black dots indicate the phosphorescent organs.

The Euphausiacea are marine and pelagic, and at times form an important part of the food of whales. Like many pelagic animals they possess (in nearly all species), phosphorescent organs, which in this case are complex and situated on various parts of the body. They are filter feeders. Most (perhaps not all) are hatched as *Nauplii*, and subsequently pass through stages of the *Zoea* type.

*Nyctiphanes* (Fig. 282) is a British example of the group.

## Order DECAPODA

Eucarida in which the exopodite (scaphognathite) of the maxilla is large; three pairs of thoracic limbs are more or less modified as maxillipeds, and five are "legs"; there is usually more than one series of gills, of which some (*podobranchiae*) stand upon the coxopodites of thoracic limbs, others (*arthrobranchiae*) upon the joint-membranes at the bases of the limbs, and others (*pleurobranchiae*) upon the sides of the thorax; and a statocyst is usually present in the proximal joint of each antennule.

The Decapoda owe their name to the condition of the hinder five pairs of thoracic limbs, which are adapted for locomotion, typically by walking but sometimes by swimming. Often, however, as in the crayfish, one of these pairs bears large chelae and is incapable of the locomotory function: others may also be incapacitated for it, as, for instance, the two small hinder pairs of the hermit crabs (Fig. 292). Only in some of the lower genera is there any vestige of the exopodite upon these five pairs.

This order contains the most highly organized crustaceans. Among its members there is great diversity in the habit of body and in the form of the appendages, but two principal types can be observed. In the first or *macrurous type* the caridoid facies is in the main retained, the body is long and subcylindrical or somewhat compressed, the abdomen is long and ends in a tail fan, the appendages are usually slender, and any of the legs may be chelate. An example of this type, the common crayfish, *Astacus* (Figs. 283; 212, 213, 222 G, 224, 226, 227, 231, 233, 234, 286), is described in most textbooks of elementary zoology. The second or *brachyurous type*—which is not confined to the Brachyura *sensu stricto* but occurs independently in various members of certain groups, known collectively as the Anomura, that are intermediate between the macrurous divisions of the order and the Brachyura—has the cephalothorax greatly expanded laterally and more or less depressed, while the abdomen is reduced and folded underneath the cephalothorax. In it the appendages are as a rule shorter and stouter than in macrurous forms, and only the first pair of legs has a true chela.

The suborders *Penaeidea* (primitive prawns), *Caridea* (prawns and shrimps), *Astacura* (crayfishes and lobsters), and *Palinura* (crawfishes and bear-crabs) are macrurous. They are for the most part swimmers, though some of them, as the *Astacura* and *Palinura*, do more walking than swimming. The suborders *Anomura* and *Brachyura* are walkers, though some of the crabs have their own ways of swimming by means of flattened legs. The Brachyura proper are distinguished from other brachyurous forms by the occurrence in nearly

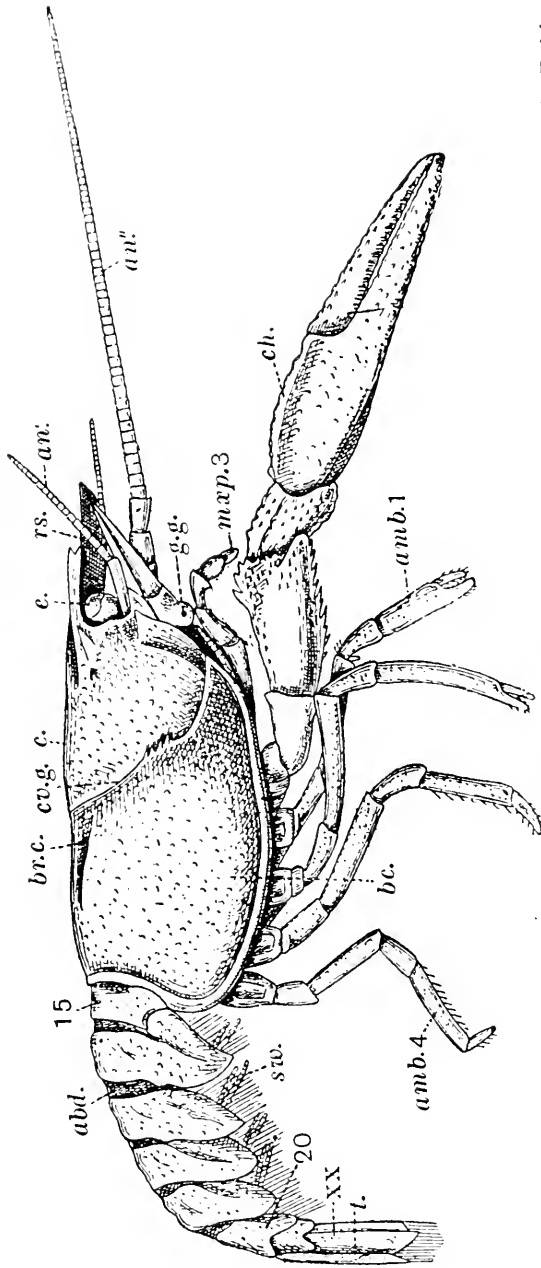

Fig. 283. The common crayfish, *Astacus fluviatilis*, seen from the side. From Shipley and MacBride. *abd.* abdomen; *amb. 1.* first walking leg; *amb. 4.* fourth walking leg; *an.* first antenna or antennule; *an.* second antenna; *bc.* branchiostegite; *br.c.* branchiocardiac groove; *c.* carapace; *ch.* chela; *cv.g.* cervical groove; *e.* eye; *g.g.* opening of green gland; *m.x.p. 3.* third maxilliped; *rs.* rostrum; *st.v.* swimmerets; *t.* telson; *15*, first segment of abdomen; *20*, last segment of abdomen; *xx*, the last appendage.

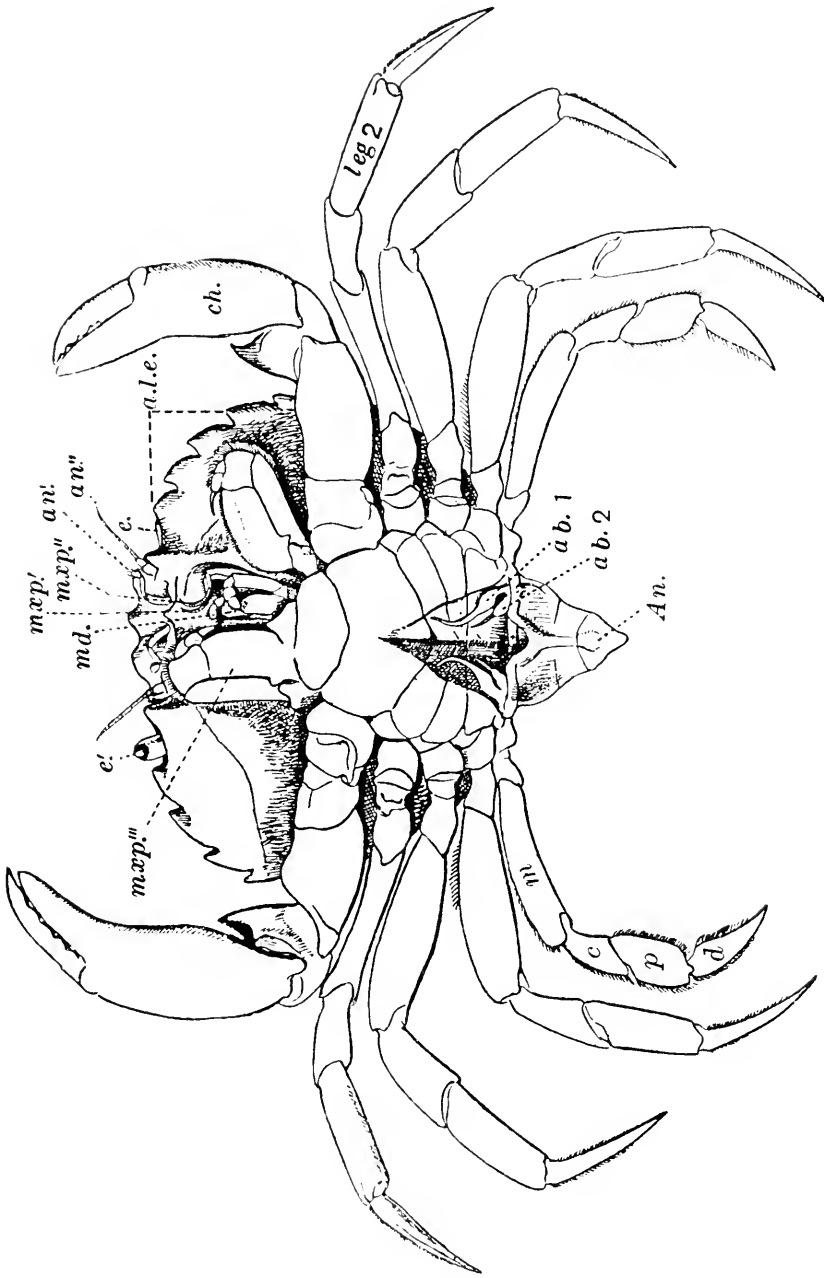

Fig. 284. The shore crab, *Carcinus maenas*, ventral aspect. From Shipley and MacBride. The abdomen is turned back. *An.* position of anus; *ab. 1*, *ab. 2*, 1st and 2nd abdominal limbs which are modified in connection with reproduction; *a.l.e.* anterolateral edge; *an'* antenna; *an''* antennule; *c.* carpopodite; *ch.* chela or great claw (1st leg); *d.* dactylopodite; *e.* left eye reclining in its orbit; *e'* right eye erected; *leg 2*, 1st ambulatory limb; *m.* meropodite; *md.* mandible; *m.p.'* 1st maxilliped; *m.p.'''* 2nd maxilliped; *m.p.'''* right 3rd maxilliped in normal closed condition: its fellow is turned outwards; *p.* propodite.



all the latter of well-formed uropods, which the true crabs do not possess, and by a fusion of the edge of the carapace with the epistome, a sternal plate which lies in front of the mouth (see p. 410).

As an example of the Brachyura we shall describe *Carcinus maenas*, the common shore crab of Britain (Figs. 284, 285, 287-291). The depression to which is due the difference in shape between the cephalothorax of this typical crab and that of a crayfish or prawn has brought it about that in a transverse section (Fig. 285) the carapace

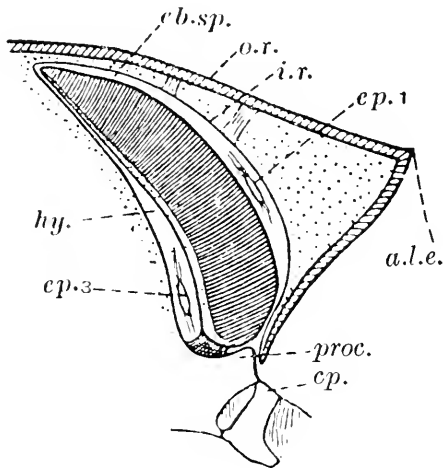

Fig. 285.

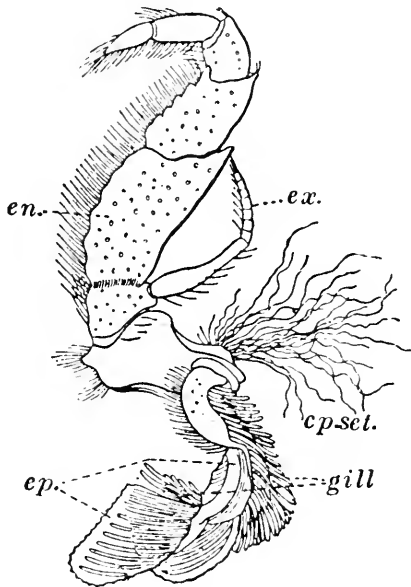

Fig. 286.

Fig. 285. Diagram of a transverse section through a branchial chamber of *Carcinus maenas*. From Borradaile. *a.l.e.* anterolateral edge; *cp.* coxopodite; *eb.sp.* epibranchial space; *ep. 1*, mastigobranch (distal part of epipodite) of the first maxilliped; *ep. 3*, mastigobranch of the third maxilliped; *hy.* hypobranchial space; *i.r.* inner layer of branchiostegal fold; *o.r.* outer layer of the same; *proc.* process of flank of thorax, which meets branchiostegite and separates two of the openings above the legs into the chamber.

Fig. 286. The left third maxilliped of *Astacus*. *cp.set.* coxopoditic setae; *en.* endopodite; *ep.* epipodite; *ex.* exopodite.

has at the sides (where, as the branchiostegite, it covers the gills), not an arched profile but runs out almost horizontally and is then bent in, at an angle (*a.l.e.*) which is more acute in the anterior part of the body than in the hinder part, to end against the flank above the coxopodites of the legs. At the angle, the branchiostegite, viewed from above, describes the lateral part of the outline of the body. That outline begins between the eyes, where in the crayfish the rostrum stands, with the *front*, a low, three-toothed lobe. On each side of this is the *orbit*, an excavation of the surface of the head for the reception of the

eye. From the orbit the notched *anterolateral edge* curves outwards and backwards as a crest on the branchiostegite, forming with its fellow and the front a semicircle. From each end of the semicircle a slightly concave *posterolateral edge* carries the outline slanting inwards to the short, transverse *posterior edge* of the carapace.

To return to the transverse section: the thin inner layer of the fold which makes the branchiostegite is not so much drawn out as the stout outer layer, so that a considerable space is left between them. In the hinder region the two layers are not very widely separated, and there are in this space only blood channels and connective tissue, but anteriorly branches of the liver and gonad intrude there. The edge of the branchiostegite fits close against the flank of the thorax and the exopodites of the maxillipeds, leaving however the following openings: (1) small slits, one above each leg, (2) a large opening in front of the coxopodite of the chela, (3) a still larger opening in front of the mouth. These openings lead to and from the *gill chamber*. In the flattening of the body, the lateral wall of the thorax has come to face in great part upwards, so that the gills instead of being directed vertically from their attachments, are directed more or less horizontally inwards over the convex, mound-like inner wall of the gill chamber. The *gills* are of the kind known as *phyllobranchiae*. That is, the axis of each, instead of bearing filaments as in the gills of the crayfish (*trichobbranchiae*), has on either side a row of plates, set close like the leaves of a book. The podobranchiae stand out from the base of an epipodite, which bears also a slender process known as a *mastigobranchia*. In the crayfish the gill lies along this and is fused with it (Fig. 286). The first maxilliped has a mastigobranchia without a podobranchia. The gill series of *Carcinus* is shown in the following table:

	Mxpd I	Mxpd II	Mxpd III	Leg I (Cheliped)	Leg II	Leg III	Leg IV	Leg V	Total
Podobranchiae Anterior	—	1	1	—	—	—	—	—	2
Arthrobranchiae Posterior	—	1	1	1	—	—	—	—	3
Arthrobranchiae	—	—	1	1	—	—	—	—	2
Pleurobranchiae	—	—	—	—	1	1	—	—	2
Mastigobranchiae	(1)	(1)	(1)	—	—	—	—	—	(3)
Total	(1)	2+(1)	3+(1)	2	1	1	—	—	9+(3)

The mastigobranchiae lie in the gill chamber, that of the first maxilliped in the *epibranchial space* above (external to) the gills and

those of the second and third maxillipeds in the *hypobranchial space* below the gills. Their function is the cleaning of the gills.

In front, the gill chamber narrows to an *exhalant passage*, which contains the scaphognathite and leads to the large anterior opening. The scaphognathite, working to and fro, drives water out of this opening and so draws in a current through the other apertures. The opening in front of the chela can be closed by a flange on the coxopodite of the third maxilliped, and so the current can be regulated. The

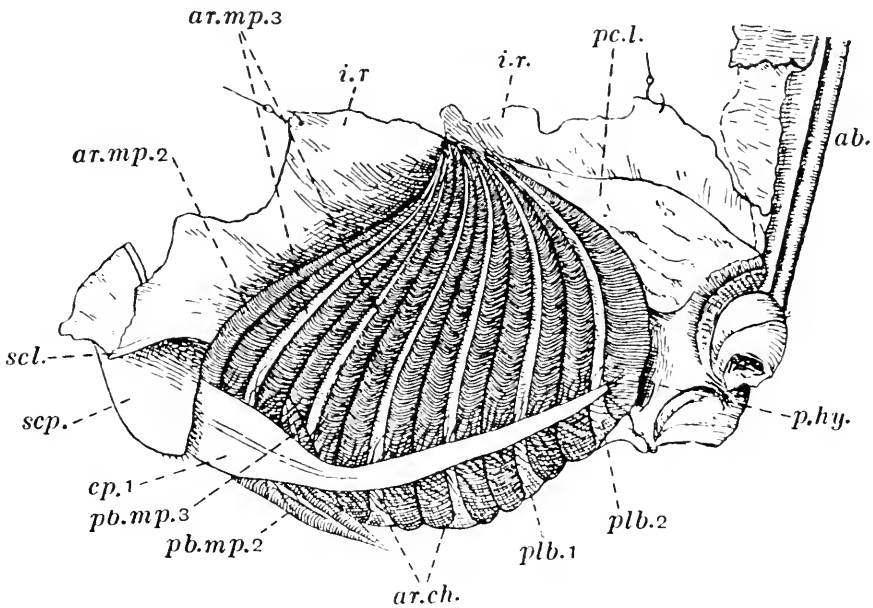

Fig. 287. A dorsal view of the organs in the left branchial chamber of *Carcinus maenas*. From Borradaile. *ab.* abdomen; *ar.ch.* arthrobranchs of the cheliped; *ar.mp.2*, arthrobranch of the second maxilliped; *ar.mp.3*, arthrobranchs of the third maxilliped; *ep.1*, base of the mastigobranch of the first maxilliped; *i.r.* inner layer of the branchiostegal fold, reflected; *pb.mp.2*, *pb.mp.3*, podobranchs of the first and second maxillipeds; *pc.l.* pericardial lobe, a thin fold of the body wall, of undetermined function; *plb.1*, *plb.2*, first and second pleurobranchs; *p.hy.* posterior opening of the hypobranchial chamber; *scl.* sclerite which keeps open the entrance to the exhalant passage; *scp.* scaphognathite.

water which enters this opening is prevented from taking a short cut to the exhalant passage by a large expansion of the base of the mastigobranch of the first maxilliped, which directs it under the gills. The current from the openings over the legs also passes under the gills. All the water then passes upwards through the gills into the epi-branchial space above them and so to the exhalant passage. Thus the gills are thoroughly bathed.

Owing to the width of the body the *sterna* are more easily distinguished than in the crayfish. Those of the maxillary to second

maxillipedal somites are fused into a triangular mass. In front of the mouth the plate known as the *epistome* represents the mandibular and antennal sterna. From this a ridge extends to the median rostral tooth, separating two sockets in which stand the antennules. A downward process from the front, abutting on the basal joint of the antenna, separates each of these sockets from the orbit of its side. The two-jointed *eyestalk* arises close to the median line and passes through a gap between the frontal process and the antennal base to enlarge within the orbit.

The *abdomen* is reduced to a flap, turned forwards and closely applied to the sterna of the thorax. Its ventral (upper) cuticle is thin. It is broader in the female than in the male, in which its 3rd to 5th somites are fused. Two small knobs on the 5th thoracic sternum, fitting into sockets on the 6th somite of the abdomen, lock the two together as by a press button.

The *antennules* have short flagella and can fold back into the sockets mentioned above. The *antennae* also have a short flagellum. They have no exopodite (scale) and their coxopodite is represented by a small operculum over the opening of the antennary ("green") gland. The *mouth parts* are shown in Fig. 288. In the *mandibles*, the biting edge (incisor process) is toothless and the molar process reduced to a low mound behind the biting edge. The palp is stout and the first two of its three joints are united. The *maxillules* and *maxillae* have the usual endites well developed. The scaphognathite of the maxilla is shaped to fit the exhalant passage of the gill chamber. The *maxillipeds* have epipodites produced into long, narrow mastigobranchs, fringed with bristles which brush the gills. The flagella of their exopodites are turned inwards and the endopodite of the first of them is expanded at the end and helps to border the exhalant opening for the respiratory current. The third pair are broad and enclose the mouth area from below. The *legs* lack an exopodite and have the usual joints (p. 336) in the stout endopodite, but the basipodite and ischiopodite are united. The first leg has a strong chela: concerning the physiology of its muscles something is said on pp. 138, 142. The others differ from those of the crayfish chiefly in that none of them are chelate. The animal, as is well known, walks sideways with them. *Abdominal limbs* are present in the female only on the 2nd to 5th somites. On a short, one-jointed protopodite they bear two long, equal, simple rami, covered with setae to which, as in other decapods, the eggs are attached by a covering secreted by dermal glands. In the male, the abdomen bears limbs only on its first two somites, and they are uniramous and adapted for transferring the sperm, the endopodite of the second working as a piston in a tube formed by that of the first.

In *feeding* the food is seized by the chelae, which place it between

Of the various examples of the order which are mentioned below, all except *Leucifer*, *Birgus*, and *Gecarcinus* occur in British waters.

The most aberrant member of the Decapoda is the minute, pelagic *Leucifer* (Fig. 273 D), which has a very slender, macrurous body with an extremely elongate head, long eyestalks, no limbs on the last two thoracic somites, no chelae, and no gills. Like the normally built prawn *Penaeus* and the rest of the group (Penaeidea) to which both belong, *Leucifer* starts life as a *Nauplius*.

*Leander*, the common prawn, one of the Caridea, is macrurous like the crayfish, but built for swimming rather than walking, with phyllobranchiae, and with chelae only on the first two pairs of legs.

*Crangon*, the shrimp, is related to *Leander* but has a broader and flatter body, a very small rostrum, and the first leg subchelate.

*Nephrops*, the Norway lobster, one of the Astacura, differs from the crayfish in minor points, among others in having the podobranchs free from the mastigobranchs.

*Homarus*, the lobster, differs from *Nephrops* in size, form of chelae, etc.

*Palinurus*, the crawfish or spiny lobster, one of the Palinura, differs from the crayfishes and lobsters in having a small spine in place of the rostrum, no antennal scale (exopodite), and no chela on any leg. It has a peculiar broad, thin schizopod larva, the *Phyllosoma* (Fig. 266 C).

*Eupagurus* (Fig. 292), the hermit crab, one of the Anomura, lives in the empty shells of gastropod molluscs. It has a large, soft abdomen, containing the liver and gonads, twisted to fit into the shell, and without appendages on the right side, save for the uropods, of which both pairs are present, roughened, and serve to hold on the shell. The first three pairs of legs are as in a crab, the last two small and chelate.

*Birgus*, the robber crab, is a hermit crab which has grown too large to use the shells of molluscs, and has accordingly re-developed abdominal terga. It lives on land in the Indopacific region, and is adapted to aerial respiration by the presence of vascular tufts on the lining of the gill chambers. Its *Zoetae* are marine.

*Lithodes*, the stone crab (Fig. 293), is by origin a hermit crab, but has lost the habit of living in shells and so thoroughly taken on the build of the true crabs that only some asymmetry of the abdomen and a few other minor points of structure betray its ancestry, even the uropods being absent.

*Galathea*, the plated lobster, another of the Anomura, is lobster-like but has the abdomen bent under the thorax, and the last leg small and slender and folded into the gill chamber.

*Porcellana*, the china crab, related to *Galathea*, has a form of body

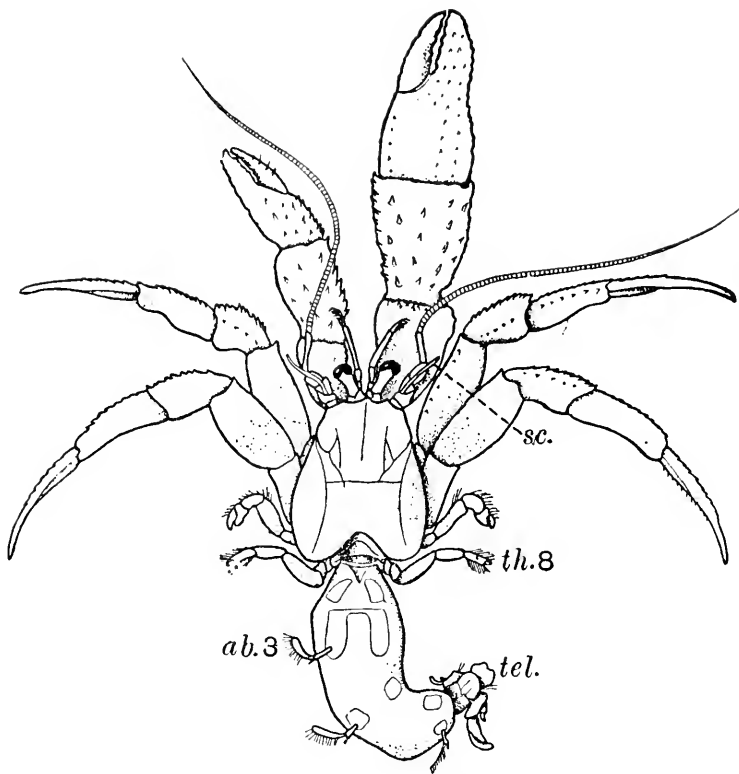

Fig. 292. *Eupagurus bernhardus*, ♂. *ab. 3*, third abdominal limb; *tel.* telson; *th. 8*, last thoracic limb; *sc.* scale of antenna.

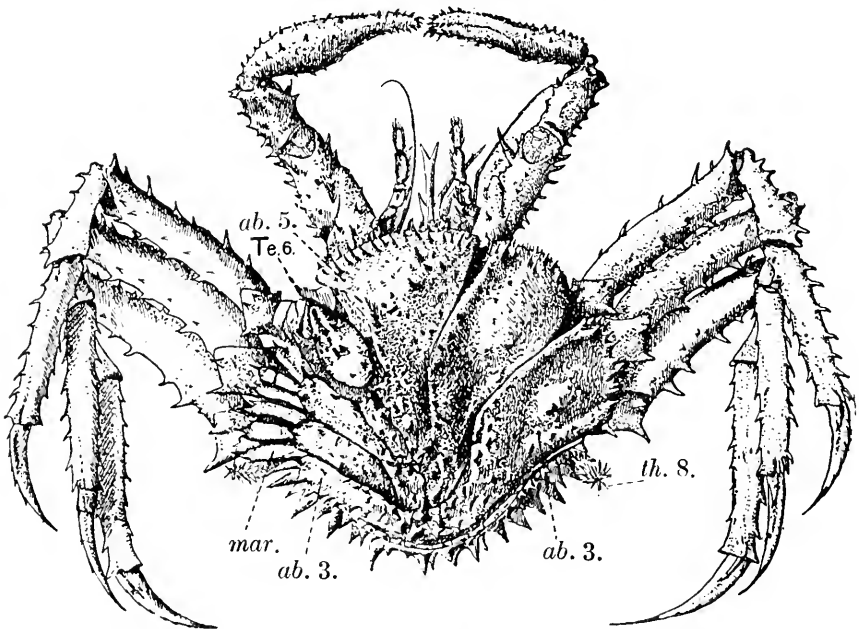

Fig. 293. *Lithodes maia*, ♀, in ventral view. From the *Cambridge Natural History*. *ab. 3*, lateral plates of the third abdominal somite; *ab. 5.* left lateral plate of the fifth abdominal somite; *mar.* marginal plate; *Te. 6.* telson and sixth abdominal somite, fused; *th. 8.* brush-like last thoracic limb.

resembling that of the true crabs, but possesses uropods. Fig. 266 A shows its remarkable *zoaea*.

*Cancer*, the edible crab, is a member of the Brachyura, nearly related to *Carcinus* but more heavily built, without the slight powers of swimming possessed by the latter, and differing in other small points.

*Gecarcinus*, containing land crabs of the tropics, differs from *Carcinus* and *Cancer* in the shape of the third maxillipeds, which gape, the sternal position of the male opening, and the highly vascular lining of its swollen gill chambers. Its *Zoaeae* are marine.

*Maia*, the spiny spider crab, is narrow in front, with bifid rostrum and feeble chelae, and a habit of decking itself with seaweed for concealment.

## CHAPTER XIII

### THE SUBPHYLUM MYRIAPODA

Land-living tracheate arthropods, usually elongated, with numerous leg-bearing segments; a distinct head with a single pair of antennae, a palpsless mandible and at least one pair of maxillae; tracheal system with segmentally repeated stigmata, tracheae usually anastomosing; eyes, if present, clumps of ocelli; mid gut without special digestive glands, hind gut with Malpighian tubules; young hatching at a stage resembling the adult but possessing fewer than the adult complement of segments.

It has long been recognized that the group Myriapoda as defined above contains two chief divisions which are here treated as classes, one of which, the Chilopoda, is more closely related to the Insecta than the other, the Diplopoda. It is, however, convenient to retain the group, though the similarity of the chief members is probably more superficial than natural.

*Classification.* Chilopoda (Opisthogoneata), centipedes; Diplopoda, millipedes (with two smaller classes, the Symphyla and the Pauropoda, these form the Progoneata, all distinguished by having the genital opening near the anterior end of the body).

#### Class CHILOPODA

Carnivorous arthropods with the genital opening situated at the hind end of the body (opisthogoneate); body segments all similar (at least in the more primitive members of the division), body usually flattened dorsoventrally; ocelli present, head bears also antennae and three pairs of jaws (mandibles and two pairs of maxillae); the 1st body segment bears a pair of poison claws; the rest, each a single pair of ambulatory limbs, except the last two, which are legless; blood system consists of a dorsal heart and a ventral vessel connected by an anterior pair of aortic arches; tracheae typically branch and anastomose and have a spiral lining; gonads dorsal to gut.

The type used for the study of this division is the centipede, *Lithobius* (Fig. 294), which is found under bark and stones, and is a much more active creature than the millipede, *Iulus*, which is found in the same situation. The chitinous exoskeleton is flexible and is moulted frequently. The body is flattened dorsoventrally and the legs in each pair are widely separated. The head consists of six segments all represented by coelomic sacs in the embryo which disappear in the



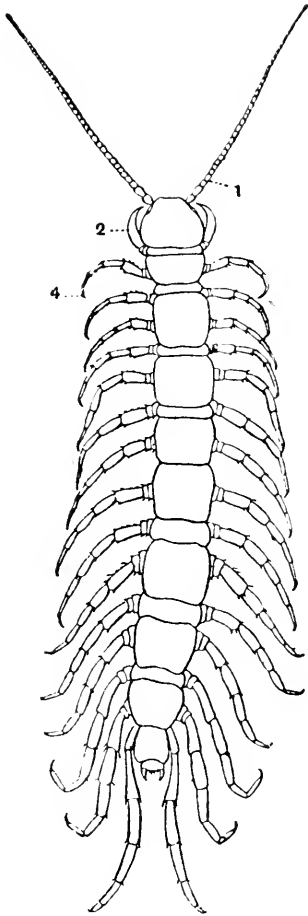

Fig. 294.

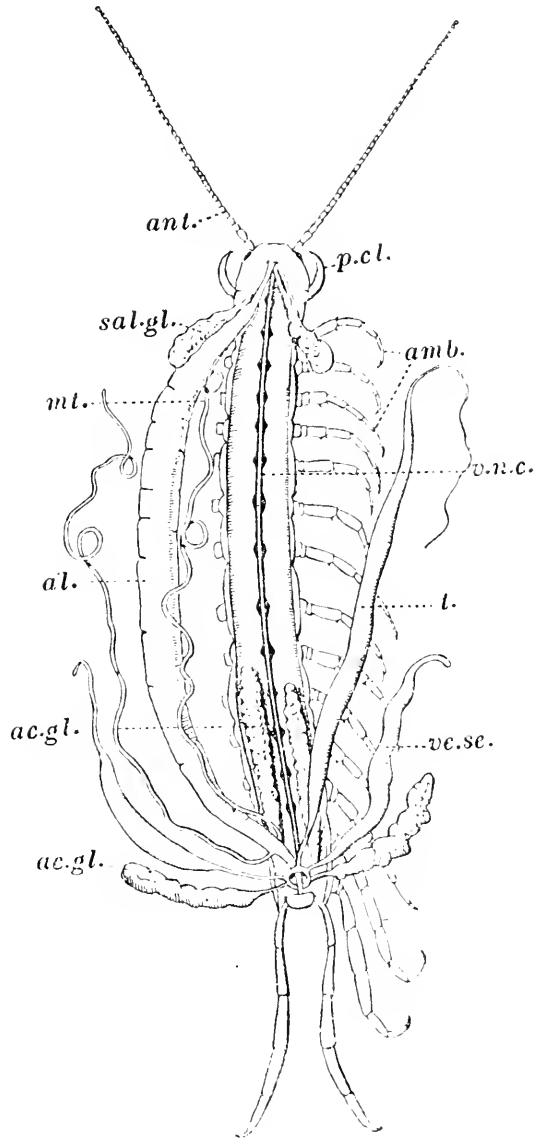

Fig. 295.

Fig. 294. *Lithobius forficatus*. Dorsal view of whole animal. 1, antenna; 2, maxilliped; 4, pair of walking legs.

Fig. 295. *Lithobius forficatus*, ♂. Dissected to show internal organs. *ant.* antenna; *amb.* walking legs; *ac.gl.* accessory glands; *al.* alimentary canal; *mt.* Malpighian tubules; *p.cl.* poison claw; *sal.gl.* salivary gland; *t.* testis; *ve.se.* vesicula seminalis; *v.n.c.* ventral nerve cord.

Both from Shipley and MacBride.

adult, including a *preoral* and (between the antennae and the mandibles) an *intercalary*. All segments except the first are originally postoral but in development the mouth moves back and comes to lie between the mandibles. The number of head segments is the same as in the embryo insect and the crustacean, and a remarkable homology may be observed between the chilopod and insect head appendages. Thus

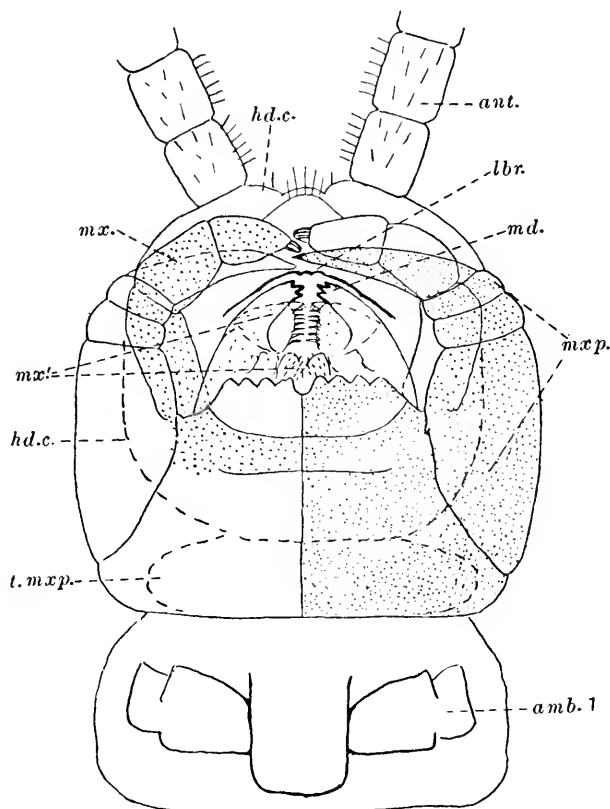

Fig. 296. *Lithobius forficatus*. Original. Ventral view of head and two succeeding segments in a specimen boiled in potash and mounted in Canada balsam. On the right of the observer the maxilliped, and the sternum belonging to it, is lightly stippled: on the left the maxilla is more coarsely stippled. *ant.* antenna; *amb. 1*, base of the first ambulatory appendage; *hd.c.* head capsule; *lbr.* labrum; *md.* mandible; *mx.* maxilla; *mx'.* first maxilla; *mxp.* maxilliped (poison claw); *t.mxp.* tergum of the maxilliped.

the antennae are jointed mobile appendages varying in length; the mandibles are toothed plates without palps, the 1st maxillae consist of a basal portion bearing inner and outer lobes, while the 2nd maxillae are usually fused together to form a sort of labium and possess a palp-like jointed structure (Fig. 296). The difference between the mouth parts of an orthopteran insect and a chilopod lies in the reduction in size of the two pairs of maxillae in the latter, which

is possibly connected with the great development of the first pair of trunk appendages as maxillipeds, which are four-jointed, the distal joint being a sharp claw perforated by the opening of the poison gland, while the proximal joint is enlarged and meets its fellow in the middle line to form an additional lower lip.

The body segments in *Lithobius* number eighteen. Of these, the 1st carries the poison claws (maxillipeds), the 17th the genital opening and usually a pair of modified appendages, the *gonopods*, and the last (telson), which is greatly reduced in size and not seen in Fig. 297, the anus, while the 2nd to 16th have each a pair of seven-jointed walking legs. Each segment has a broad tergum and sternum and between them a soft pleural region with a few small chitinous sclerites and the stigmata. In *Lithobius* and the group of chilopods to which it belongs, the terga are alternately long and short (Fig. 294). Only the segments which have long sterna have stigmata, but all have walking legs. In other centipedes, e.g. *Scolopendra* (see Table, pp. 306-7), the terga are equal throughout.

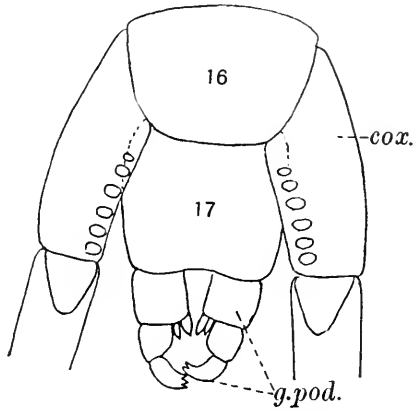

Fig. 297. *Lithobius forcificatus*, ♀. Hind end, ventral side. 16, last segment bearing ambulatory legs; *cox.* coxopodite of last leg; 17, pre-genital segment, bearing *g.pod.* gonopods.

The alimentary canal consists of a short fore gut into which open two or three pairs of salivary glands, a very long mid gut without any associated glands, and a short hind gut into which open a pair of Malpighian tubules.

The vascular system is better developed than in insects. The heart runs the whole length of the body and possesses in each segment not only a pair of ostia but also lateral arteries. It ends anteriorly in a cephalic artery and a pair of arteries which run round the gut and join to form a supraneural vessel. The arteries branch and open into haemocoelic spaces. There is a pericardium and below it a horizontal membrane, perforated and provided with alary muscles as in insects. In the respiratory system the tracheae branch and anastomose and possess a spiral thickening, but in the remarkable form *Scutigera* the stigmata are unpaired and dorsomedian in position and the tracheae are unbranched and simple in structure.

The reproductive organs (Fig. 295) consist of an unpaired ovary or testis, with a duct which divides into two and passes round the end gut to open by the median genital opening. There are two pairs of

accessory glands and in the male two vesiculae seminales. Spermatozoophores are formed but it is doubtful whether copulation occurs. *Lithobius* lays its eggs singly and buries them in the earth. The young are hatched with seven pairs of legs.

The nervous system comprises a cerebral ganglion supplying the antennae and the eyes, a suboesophageal ganglion giving branches to the other head appendages and the maxillipeds, and a ventral chain with a pair of ganglia in each leg-bearing segment.

### Class DIPLOPODA

Arthropods with the genital opening situated on the 3rd segment behind the head (progonate); trunk segments arranged in an anterior region (*thorax*) of four single segments and a posterior region (*abdomen*) of double segments, each with two pairs of legs; body usually cylindrical; skeleton strengthened by a calcareous deposit; ocelli present, head bears also short club-shaped antennae, mandibles and a single pair of maxillae; vascular system well developed as in Chilopoda; tracheae arise in tufts from tracheal pouches, do not anastomose;

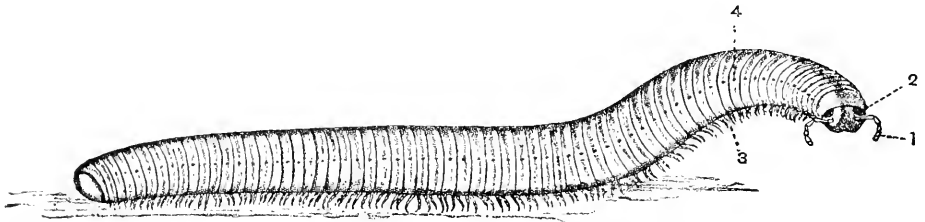

Fig. 298. *Iulus terrestris*, sometimes called the "wire-worm",  $\times$  about  $3\frac{1}{2}$ . From Koch. 1, antennae; 2, eyes; 3, legs; 4, pores for the escape of the excretion of the stink glands.

gonads ventral to gut; young hatch usually in a stage with three pairs of legs and development takes place gradually.

Though the head of the adult millipede appears to have fewer segments than that of the Chilopoda a study of the embryo shows that there are really the same number. An intercalary segment exists between the antennal and mandibular segments and behind the mandibles a pair of rudimentary appendages appear but soon vanish. These are the first maxillae: the second maxillae (labium) persist in the adult.

*Iulus* is one of the commonest genera of millipedes. It is vegetarian. It has an elongated body, consisting of a large number of segments (up to seventy), which can be rolled into a ball. The head (Fig. 299 A) carries a pair of short antennae with seven joints. The labrum is continuous with the front of the head and is a toothed plate; the mandibles, which have no palp, bear a movable tooth and

a ridged and toothed plate; behind them is an organ known as the *gnathochilarium* (Fig. 299 C), which, in structure and position, recalls

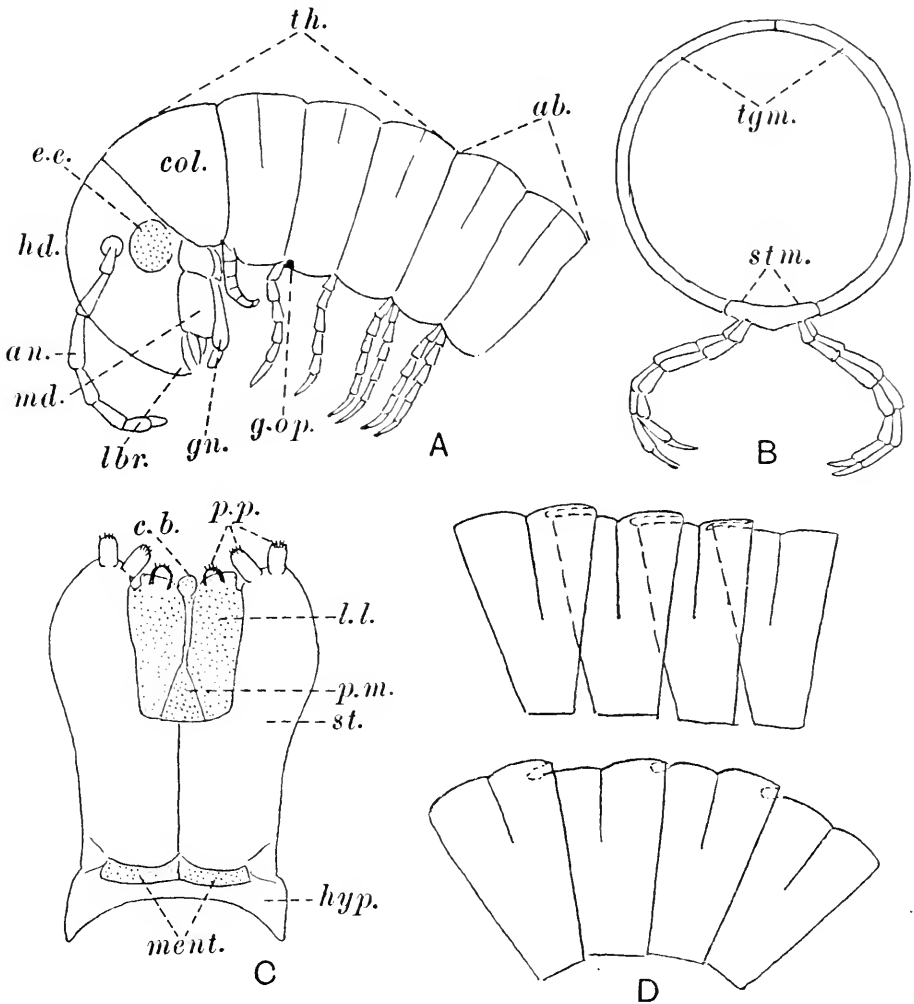

Fig. 299. *Iulus terrestris*. A, Side view of anterior end. *an.* antenna; *ab.* abdomen; *col.* collum (1st thoracic segment); *e.e.* clump of ocelli; *gn.* gnathochilarium; *g.op.* genital opening (on basal joint of 2nd pair of legs); *hd.* head; *lbr.* labrum; *md.* mandible; *th.* thorax. B, A segment detached from the rest. *stm.* sternum; *tgm.* tergum. C, Gnathochilarium seen from inner side. (The parts—basilar plate—which it is suggested may belong to the segment of the collum are stippled.) *c.b.* central body; *hyp.* hypostoma; *l.l.* lamellae linguae; *ment.* mentum; *p.m.* promentum; *p.p.* palps; *st.* stipes. D, Diagram of four rings seen in side view (above) when the animal is stretched out straight; (below) when it is coiled in a spiral. The dorsal part of the ring is clearly seen to be longer than the ventral. A, B and C, original; D, after Kukenthal.

the labium of insects and, like it, is formed by the junction of paired appendages, the principal part of it by the appendages of the labial

segment. Also a postlabial segment contributes to it forming the *basilar plate*. The tergite of this segment, however, forms what is apparently the first segment after the head. This is known as the *collum*; there are no stigmata and no separate appendages, though the first pair of legs appears to belong to it they are those of the second segment. The next three have a single pair of ambulatory legs apiece, a pair of ganglia and a pair of stigmata, and in the embryo a pair of coelomic sacs. These four segments may be said to constitute the *thorax*, though, as related above, the first takes part in the formation of a head structure. The genital openings are situated in the basal joint of the second pair of legs, which appear to arise from the second segment, but really belong to the third.

Behind this is the *abdomen* consisting of an indefinite number of double segments (up to a hundred in *Iulus*). The exoskeleton of a body segment consists of a tergum and two sterna. In the double segment of *Iulus* (Fig. 299 B) the sclerites of two segments are fused together to make a continuous ring. The sterna carry two pairs of stigmata and legs. In the embryo there are two pairs of coelomic sacs; there are two ostia in the heart and two pairs of ganglia. In *Iulus* the sterna are much shorter than the terga and also much narrower so that the legs come off very close together; also the terga are narrower in front so that they can be telescoped into the terga in front. The diagram here given (Fig. 299 D) shows that this relation occurs when the diplopod body is straightened out; when the animal rolls up the adjacent rings are completely disengaged.

The stigmata are elongated slits, which can be closed by a valve, and they communicate with a tracheal pocket from which spring two thick bunches of unbranched tracheae. These are of two sorts; one long and slender, the other shorter and thicker with a spiral lining. In other millipedes (*Glomeris*) the tracheae may become much longer and branch but they never anastomose.

The circulatory system is in a stage of development higher than that of the insects. The alimentary canal bears a pair of long Malpighian tubules arising from the hind gut.

The legs consist of the same elements as in the insect, but the tarsus is divided into three joints, the last of which carries a claw. In the male the first leg is modified for copulation and in the 7th segment there is an auxiliary copulatory apparatus, consisting of processes used for transferring sperm into the vagina of the female. These processes may occur together with legs and so are not homologous with them. There are no similar organs in the female. The generative glands are unpaired with ducts opening on the 3rd body segment. The eggs are yolked and are laid after copulation in a nest made of hard earth. The mother keeps watch over them before hatching.

## CHAPTER XIV

### THE SUBPHYLUM INSECTA (HEXAPODA)

Tracheate Arthropoda in which the body is divided into three distinct regions, the head, thorax and abdomen. The head consists of six segments and there is a single pair of antennae; the thorax consists of three segments with three pairs of legs and usually two pairs of wings; the abdomen has typically eleven segments and does not possess ambulatory appendages; genital apertures situated near the anus (Fig. 300).

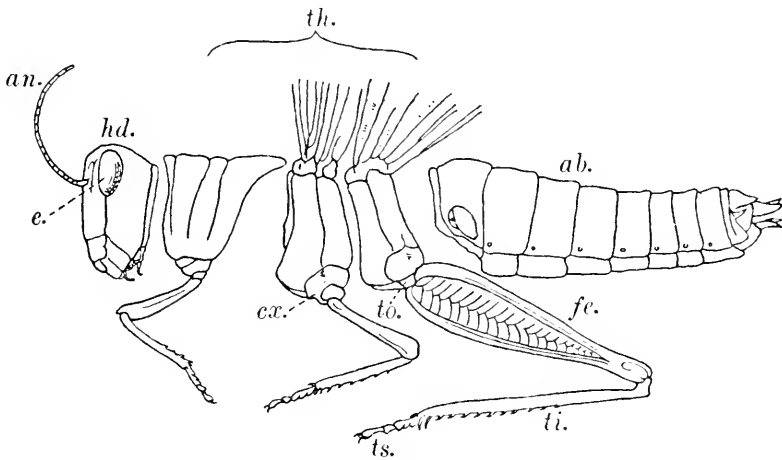

Fig. 300. Lateral view of a grasshopper to show external segmentation typical of insects. From Metcalf and Flint. *ab.* abdomen; *an.* antenna; *cx.* coxa; *e.* eye; *fe.* femur; *hd.* head; *th.* thorax; *ti.* tibia; *tö.* trochanter; *ts.* tarsus.

The head is enclosed by an exoskeleton which consists of several plates or sclerites, both paired and unpaired, united together, having no clear relation to the segmentation of the head. The segments are indicated by the paired appendages, the ganglia of the nervous system (neuromeres) and the coelomic sacs which can be demonstrated in sections of the embryo but which disappear later. Thus the six segments are indicated by the evidence which follows:

<i>Segment</i>	<i>Neuromere</i>	<i>Appendage</i>
Preantennal	Protocerebrum	—
Antennal	Deutocerebrum	Antenna
Intercalary	Tritocerebrum	Embryonic
Mandibular	Mandibular ganglion	Mandible
Maxillary	Maxillary ganglion	Maxilla
Labial	Labial ganglion	Labium

In the embryos of most generalized insects only, are coelomic sacs present in all head segments.

In addition to compound eyes there are simple eyes or ocelli, of two kinds. Lateral ocelli are usually the sole type of eye in larval insects and represent the larval counterparts of the compound eyes which function in the adult. Dorsal ocelli on the vertex of the head of adult insects are structures distinct from the lateral and co-exist with compound eyes. The ocellus consists of a single cornea, a transparent area of cuticle which usually forms a lens-like body, the cells which secrete it, and the visual cells arranged in groups, the retinulae, having in the centre the optic rod or rhabdome. The compound eyes (as described more fully in the section on the Arthropoda) possess a cornea which is divided into a number of facets; corresponding to each facet is a group of visual cells, the *ommatidium*. The current theory of mosaic vision states that each ommatidium, isolated from its neighbours by a coat of pigment, conveys to the retinula at its base only such rays of light as travel parallel to the axis of the ommatidium. The total impression is that of a mosaic composed of as many separate pictures as there are ommatidia, every picture different from its neighbours, but all combining to form a single "coherent" picture. The compound eye has probably the advantage that it can detect movements of the smallest amplitude. It gives, however, only a vague idea of the details of objects, for there is no focussing apparatus and only objects very close to the eye can be perceived clearly. In some insects the eye is divided into two parts: a dorsal with coarse facets which probably only serves to detect variation in illumination, and a ventral with finer facets which gives fairly definite images of objects. Possibly in some insects the first function is in night vision the second by day. It must also be mentioned that experiments show that many insects can distinguish colours. The development of flower colour and pattern is generally supposed to have taken place simultaneously with that of the aesthetic senses of insects.

The *antennae* are a pair of appendages consisting usually of many joints. They are sometimes filiform but may show complicated variations in structure. In all cases they carry sense hairs, particularly those which serve an olfactory function; it is well known that in some insects the removal of the antennae or coating them with paraffin wax destroys the olfactory sense, but this is not always the case.

The mouth is bordered dorsally by the *labrum*, a median plate or sclerite which is underlain by the membranous roof of the mouth—the *epipharynx*.

The first two pairs of mouth parts, mandibles and first maxillae, lie at the sides of the mouth, while the second maxillae, invariably fused together, bound the mouth posteriorly, and are known as the



*labium*. Such a fusion characterizes the maxillipeds of certain Crustacea. The primitive and generalized condition is, undoubtedly, that which is found in insects which feed on solid food, e.g. the Cockroach or *Machilis*. The mandible which is rarely jointed, represents the toothed basal segment of an, originally, jointed limb, and corresponds in form and function, to that of Crustacea, but never possesses a palp (Fig. 301). Each first maxilla is articulated to the head by a

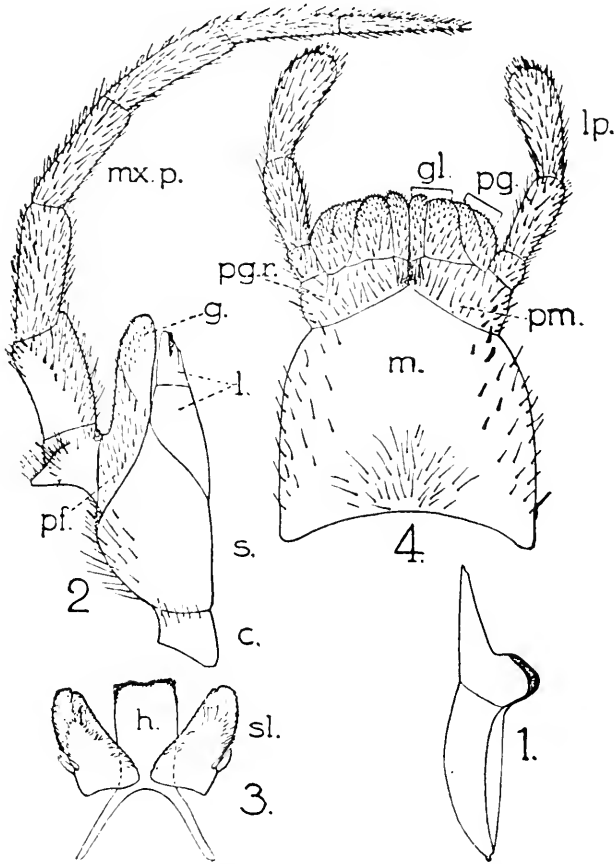

Fig. 301. Mouth parts of *Machilis (Petrobius) maritimus*. After Imms. 1, Mandible. 2, Maxilla. 3, Hypopharynx (*h.*) and superlinguae (*sl.*). 4, Labium. *c.* cardo; *g.* galea; *gl.* glossa; *l.* lacinia; *lp.* labium; *m.* post mentum; *mx.p.* maxillary palp; *pf.* palpi; *pg.* paraglossa; *pm.* prementum; *pgr.* palpiger; *s.* stipes.

basal segment, the *cardo*. The succeeding segment, the *stipes*, carries an outer palp bearing sclerite, and distally, bears two lobes, inner spiny *lacinia*, and outer hood-like *galea*. In the labium, the basal plates corresponding to *cardo* and *stipes* of the two sides, are fused to form the *submentum* and *post mentum*. The more distal *prementum* bears a palp at either side and a number of lobes, typically four, between

them, known collectively as the *ligula*. Where there are four as in the Cockroach, the two median *glossae* are defined from the outer *para-glossae*. Each of these lobes is further divided into two in *Machilis* (Fig. 301). Arising from the floor of the mouth is a small sclerite, the *hypopharynx*, which bears the salivary aperture. A pair of sclerites, *superlinguae*, are normally fused to the sides of the hypopharynx.

Fig. 302 indicates the similarity between the insectan and crustacean mouth parts. Such an attempt at a comparison is only possible with the more generalized mouth appendages of the Insecta.

With the evolution of different feeding habits, the structure of the mouth parts, just described, has been departed from in a variety of ways. Comparative and embryological study, however, clearly reveals a uniformity of plan throughout, and the student must realize that the modifications to be met with in bugs, butterflies, bees and flies are

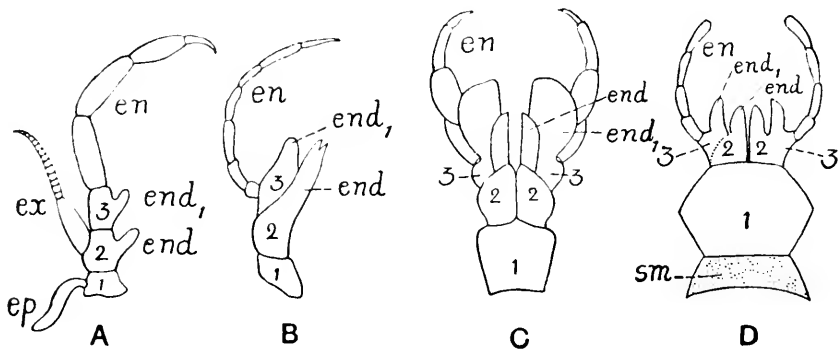

Fig. 302. To show the resemblance between the insectan maxilla and labium and the biramous limb of the Crustacea. From Imms, after Hansen. A, Biramous crustacean appendage. B, Insectan maxilla. C, Maxillipeds of a Gammarid crustacean. D, Insectan labium. *end.*, *end.*<sub>1</sub> endites; *en.* endopodite; *ep.* epipodite; *ex.* exopodite; *sm.* submentum.

all referable to the basal plan as exemplified in the mouth parts of *Blatta* or *Machilis*.

The *thorax* is separated from the head by a flexible neck region usually containing *cervical sclerites*, which, however, have not any segmental value. It consists of three segments—the prothorax, which carries a pair of legs but no wings, the mesothorax and the metathorax, which each bear a pair of legs and, typically, wings. The legs are made up of five main segments, the *coxa* and *trochanter* (both of which are small), the *femur* and *tibia* (which form the greater part of the limb), and the *tarsus* (which is usually further subdivided into a number of joints, and ends in a pair of claws with a bifid cushion between them called the *pulvillus*). Of the many adaptations exhibited by the legs of insects the jumping type found in grasshoppers, the digging type in the mole-cricket *Gryllotalpa*, the swimming type in the water beetles like

*Dytiscus*, the prehensile type in the fore legs of the praying insect *Mantis* may be mentioned, in addition to the ordinary running type as seen in a cockroach. Modifications for the production or reception of sound as in the Orthoptera and for the collection of food (the combs and pollen baskets of bees) are also familiar.

The *wings* of an insect are thin folds of the skin flattened in a horizontal plane, arising from the region between the tergum and pleuron. A section of a wing bud shows two layers of hypodermis, the cells of which are greatly elongated (Fig. 320). Into the blood space between the layers grow tracheae, and when in a later stage the two layers of hypodermis come together and the basement membranes meet and fuse, spaces are left round the tracheae which form the future longitudinal wing veins. These spaces contain blood and sometimes a nerve fibre during development. The cuticle round the veins is much thicker than in the general wing membrane, so that the veins are actually a strengthening framework for the wing. The number and arrangement of the veins is highly characteristic of the different groups. Though the majority of insects possess wings there are important orders which are wingless. Some such as those to which the fleas and lice belong are secondarily so, because of their parasitic habit. Others, however, constituting the large division Apterygota, are primitively wingless, and these, both on morphological and palaeontological evidence, must be regarded as the most ancient types known.

Among many orders of insects, there has developed a tendency for the two pairs of wings to act as one. This is accomplished by various devices which couple the fore and hind wings together, on each side. In the scorpion flies, e.g. *Panorpa*, bristles project back from the posterior or *jugal* lobe of the fore wing to overlies the anterior border of the hind wing. Corresponding bristles to these constituting the *frenulum*, project forwards from the anterior border of the hind wing, and overlies the posterior border of the fore wing. In most Lepidoptera, frenular bristles of the hind wing are held in position by a group of curved setae forming a *retinaculum* on the fore wing. The two wings of a side, in Hymenoptera are coupled by a row of hooks—the *hamuli*—on the anterior border of the hind wing, engaging in a fold of the posterior border of the fore wing.

In other orders, we find one pair of wings diverted to uses other than flight, the latter operation, then, being dependent on one pair of wings. The fore wings, for instance, of Orthoptera and of Dermaptera, are protective to the more delicate folding flight wings, behind them. The *elytra*, or fore wings of beetles, are similarly protective, and are held passively extended while the second pair of wings propel the animal through the air. In the males of Strepsiptera, the anterior,

and in the male Coccid bugs and all Diptera, the posterior wings are minute structures, flight being performed by the remaining pair, which are normally developed. Thus, either by linking two pairs of wings together, or by dispensing with one pair, flight is commonly brought about by one functional unit on each side of the body. The variations in form, consistency, and size of the wings are briefly dealt with under the different orders.

Simple up-and-down movements of the wings are sufficient to account for the elementary phenomena of insect flight. In moving through the air the anterior margin remains rigid but the rest of the membrane yields to the air pressure; so that when the wing moves downward it is bent upwards (cambered); as the wing moves upward the membranous part is bent downwards, therefore, by becoming deflected the wing encounters a certain amount of pressure from behind which is sufficient to propel it. The faster the wings vibrate the more they are cambered, the greater the lateral pressure and the faster the flight. Smaller insects have as a rule a greater rate of wing beat. Thus a butterfly may make only 9 strokes a second while a bee makes 190 and a housefly 330. The wing muscles of insects thus contract immensely faster than those of any other animals. It is interesting to note that the intracellular respiratory pigment, cytochrome, occurs in high concentration in them.

To bring about wing movement *direct* muscles attached to the wing base and others called *indirect* inserted on the body wall are employed.

The extent to which direct and indirect muscles are present varies. In the Odonata a direct musculature is strongly developed, the muscles being attached to the intucked wing base. In the specialized orders Lepidoptera, Diptera and Hymenoptera, indirect muscle action is responsible for most of the movement and those muscles attached directly to the wing base serve for folding the wing to a position of rest as well as for flight purposes.

Fig. 303 represents diagrammatically the condition in the winged aphides. The thorax is a box whose roof is capable of being arched and flattened by longitudinal and dorsoventral muscles respectively. Since the wing base has two points of attachment, (i) to the pleural plate, and (ii) to the edge of the tergum, the wing operates as a lever of the second order. The arching of the tergum raises the wing base and depresses the wing, while a flattening of the tergum depresses the wing base and raises the wing.

The *abdomen* consists of a series of segments less differentiated than those of the head and thorax. The number is eleven, as seen to be present in the embryo insect (with the addition of a transient telson) and in primitive groups (Thysanura and Odonata). In other groups, the 11th segment is represented by the *podical plates* which

bear the *cerci anales* (as for instance in the cockroach). In specialized insects the apparent number of abdominal segments may be greatly reduced.

In insect embryos rudiments of appendages are borne on each of the abdominal segments, but these rudiments disappear in the adult except in the Apterygota. Only those which become the cerci anales in the 11th segment are frequently retained. In the 8th and 9th

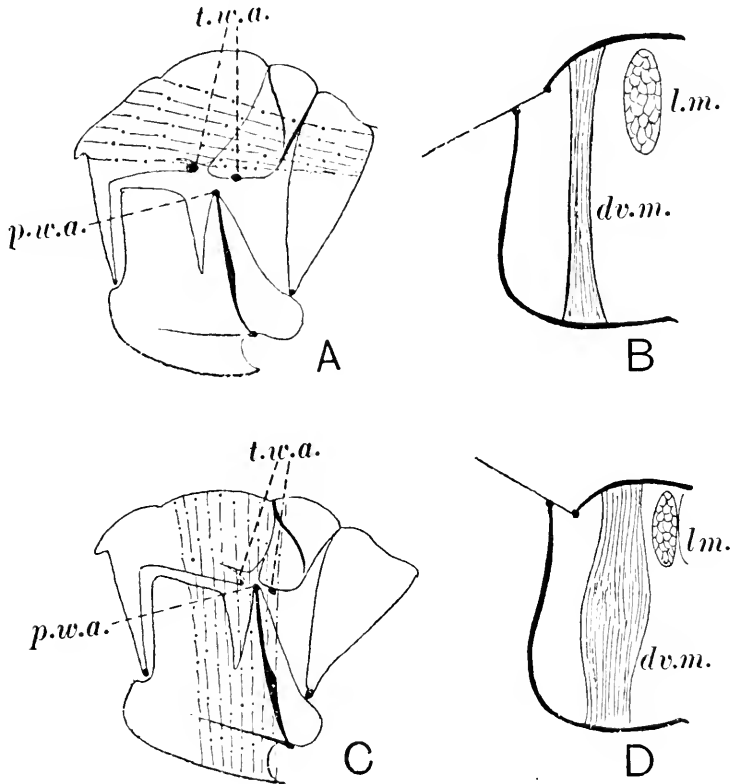

Fig. 303. To illustrate the mechanism of wing movement in an Aphid. Wing depression: A, left side view of mesothorax; B, transverse section. Wing elevation: C, left side view of mesothorax; D, transverse section. *dv.m.* dorsoventral muscles; *l.m.* longitudinal muscles; *p.w.a.* pleural wing attachment; *t.w.a.* tergal wing attachment. Effective muscles shown by dotted lines in A and C. After Weber.

segments in the female and the 9th segment in the male there are paired structures known as *gonapophyses* which perform various reproductive functions (oviposition in the female, copulation in the male). It is highly probable that these are modified appendages.

The *alimentary canal* (Fig. 304) varies greatly in length; in many larvae it is no longer than the animal itself, but in certain types of insects like the Homoptera, which feed on plant juices, it is much coiled and may be several times the length of its possessor. It consists

of an ectodermal stomodaeum or fore gut, an endodermal mid gut and an ectodermal proctodaeum or hind gut. The fore gut consists of (a) the *buccal cavity* succeeded by (b) the *pharynx*, which may be muscular and form a pumping organ (Fig. 328 A), (c) the *oesophagus*, which has a posterior dilatation, the *crop*. This functions as a food reservoir and may have a diverticulum enormously developed in sucking insects to store the liquid food. Lastly there is (d) the *pro-*

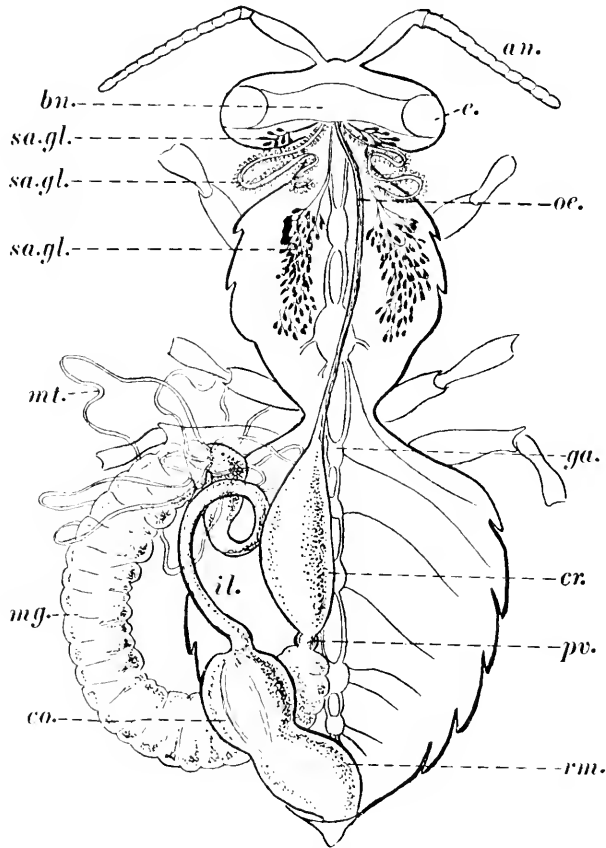

Fig. 304. General view of internal organs of *Apis mellifica* as seen from above; musculature and tracheal system not shown. From Carpenter. *an.* antenna; *bn.* brain; *co.* colon; *cr.* crop; *e.* eye; *ga.* ganglion; *mg.* mid gut; *mt.* Malpighian tubule; *oe.* oesophagus; *rm.* rectum; *sa.gl.* salivary glands (three types are shown); *pv.* proventriculus; *il.* ileum.

*ventriculus* or *gizzard*, most typically developed in insects which eat hard food as in the Orthoptera. The chitinous lining of the fore gut is here greatly thickened and the sphincter muscles in this region control the passage of food between fore gut and mid gut. Into the buccal cavity discharge the *salivary glands* (Fig. 304), which may as in the cockroach have a very similar function to those of the mammal, in producing enzymes for the digestion of carbohydrates. In other

insects, however, they are specialized in ways which are mentioned later. Such glands are usually associated with the labium; in some insects, however, mandibular and maxillary glands are found.

The *mid gut* (Fig. 305) is lined by a layer of cells frequently all similar, which perform almost the whole task of digestion and ab-

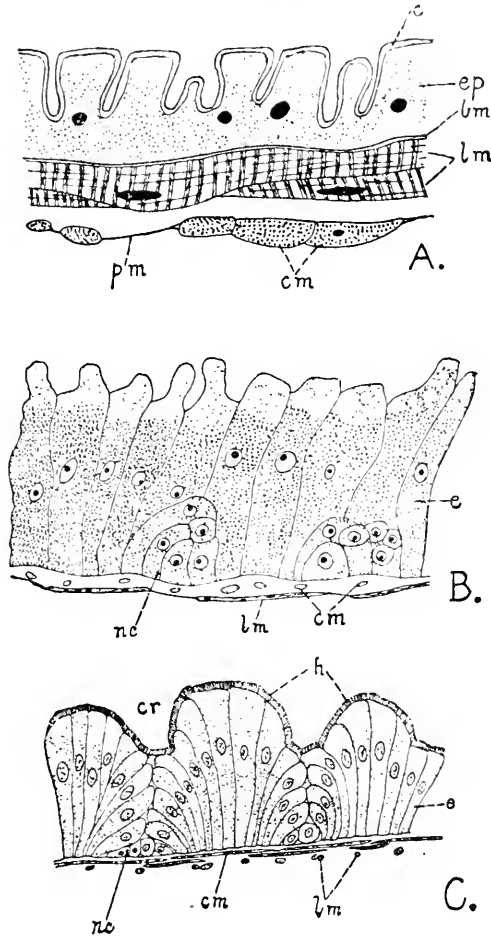

Fig. 305. A, Longitudinal section of wall of oesophagus of a termite. B, Longitudinal section of mid gut of termite in secretory phase. C, Transverse section of mid gut of *Blatta* in resting phase. After Imms. *bm.* basement membrane; *c*, chitinous intima; *cm.* circular muscle; *cr.* crypt; *ep.* cellular layer; *e.* enteric epithelium; *h.* striated hem; *lm.* longitudinal muscles; *nc.* group of regenerative cells; *pm.* peritoneal membrane.

sorption of all classes of foodstuffs. While secreting, the cells break down and their contents are discharged into the gut cavity. In the absorptive phase the border of the cells has a striated appearance. The same cell may be capable of both absorption and secretion, but the epithelium as a whole often passes through rapid cycles which necessitate the constant supply of fresh cells. These are found (Fig. 305) in

the troughs of folds or bottoms of pits into which the mid gut epithelium is thrown. In many insects the surface is increased by the formation of long diverticula, the *pyloric caeca*, the cells of which are not in any way different from the rest of the epithelium. These vary greatly in number. Though the mid gut epithelium has not an internal chitinous lining there is a curious chitinous tube, free in its cavity, the *peritrophic membrane*, which is, however, secreted by special cells of the pro-ventricular region (which may be ectodermal). Its function and place in digestion are not understood.

In certain cases, however, the mid gut is differentiated into functional regions. The first part of the mid gut of the tsetse fly, for instance, is concerned with water absorption which reduces the meal of blood to a viscid mass. Digestion of the food takes place in a region behind this, and in the lowest region of the mid gut absorption is effected. These functional regions are histologically distinct. In the cockroach in which no such histo-physiological distinction exists between the several parts of the mid gut, it appears that much digestion takes place in the crop to which place the enzymes from other parts may have to pass to meet the food before its further passage backwards. The so-called gizzard has been shown in this case to act not only as a triturating organ, but as a complicated sphincter guarding against the passage of any but the finest particles from the crop to the mid gut. After digestion has proceeded in the crop as the result of salivary and other secretory activity, the food passes through the gizzard, there to be triturated; and so on to the mid gut to meet the enzymes produced by the walls of this part of the gut. Resorption of the digested food takes place in the mid gut as well as in the hind gut. The hind gut begins where the Malpighian tubules enter the alimentary canal and is usually divided into a *small intestine* or *ileum*, a *large intestine* or *colon*, in both of which the chitinous lining is sometimes folded and produced into spines, and a short globular *rectum*. In most insects rectal glands in the form of thickened patches of epithelium occur. These have been shown to absorb water from the faeces and therefore play a most important part in water conservation.

Though the digestive enzymes of insects in the main belong to the same classes as those of mammals there are many significant differences. An omnivorous insect like the cockroach produces all the classes of enzymes except that represented by pepsin which is peculiar to vertebrates. Then also the enzymes of insects appear to work in a rather more acid medium than do the enzymes of mammals. Finally the specialization in feeding habits in insects is responsible for the absence of enzymes which are not wanted and either the acquisition of enzymes not generally found in the Animal Kingdom or the formation of a symbiotic partnership.



Thus when we compare the cockroach with such forms as the tsetse fly (*Glossina*) and the blow-fly *Calliphora*, we find these latter deficient in certain enzyme classes, the former in carbohydrases, the latter in tryptases and peptidase. The evolution of the habit of feeding on blood (which consists so largely of proteins) involves the loss of the enzymes which digest carbohydrates and fats. Similarly the blow-fly which exists on a diet in which carbohydrates are predominant has to a certain extent lost its proteolytic and lipolytic enzymes.

This principle has an even wider application. In the leaf-mining caterpillars of the Lepidoptera, certain species are restricted to the upper and others to the lower parenchymatous layer of the leaf. If an egg of one species is accidentally deposited in the wrong layer of the leaf, death of the larva ensues owing to its inability to digest the proteins of that layer. Thus each species, it is said, has enzymes which are specialized in the narrowest degree for digestion not only for the proteins of a single plant but for those of a particular part of that plant (all others being unsuitable). Sucking forms, like *Aphis*, explore different regions of the plant tissue and it may perhaps be inferred that they have a wider range of enzymes than the leaf-miners.

Most interesting of all is the relation of phytophagous insects to cellulose, which is incapable of digestion by any vertebrate. Only a few wood-boring beetle larvae (*Cerambycidae*) have been shown to possess an enzyme which digests cellulose. The great majority of insects do not possess a cellulase and as all plant cell contents are contained within cellulose envelopes, it is clear that digestion can only follow when either protoplasm is released by mechanical injury of the cell-wall or the enzymes are able to penetrate the cell-wall and act upon the contained protoplasm. In lepidopterous caterpillars, which digest vegetable protoplasm with much greater success than do mammals, the latter explanation has been shown to be true.

The insects which live on wood (excluding the *Cerambycidae*) can be divided into two classes: (1) those, like bark beetles, which feed on fungi, growing in their tunnels, and (2) those which harbour symbiotic organisms in special parts of their alimentary canal. In the latter class may be mentioned the wood-boring larvae of certain crane-flies and of death-watch beetles (e.g. *Xestobium*). In these cases the supposed symbiotic organism is the yeast, *Saccharomyces*. How it assists in the assimilation of wood is not known. On the other hand, those of the termites which eat wood in normal life always contain the flagellates belonging to *Trichonympha* and other genera (p. 68) living free in the intestine. The absolute dependence of certain termites on the flagellate is shown by the fact that when the flagellate fauna is removed (which can be done without harming the termite by heating to 40°) the termites will starve although they continue to

eat their usual diet. Since the trichonymphids are known to digest wood inside their own bodies, it is probably only indirectly that the termites benefit from the wood, the flagellates being their immediate source of food. Termites will live on a diet of cellulose (e.g. cotton wool) but not when the last traces of nitrogenous material have been removed.

The majority of so-called saprophagous insects are really phytophagous, in that they feed on yeasts, and micro-organisms effecting the decomposition of the decaying matter. The house-fly is probably such a case. Blow-fly larvae feeding on decaying meat do, however, employ proteolytic enzymes, and to this extent are truly saprophagous, as is also the dung beetle *Geotrupes*. The flesh-fly *Lucilia*, though saprophagous in this way, still requires the microflora of the decaying food to complete a diet suitable for full development, these organisms supplying the vitamins necessary for growth.

The great range of environments occupied by insects as a whole is largely an expression of their diverse feeding habits, and few materials have escaped their attentions. In addition to the foods mentioned above, may be noted keratin, which undergoes fermentative digestion in the larval gut of the clothes-moth *Tinea biselliella*. Silk can be utilized as the sole diet of the museum beetle *Anthrenus museorum*, the amino-acids in this case supplanting both fats and carbohydrates.

The saliva of various insects shows great variety according to their habits; thus the larva of the tiger-beetle (*Cicindela*), the flesh-eating larvae of flies, e.g. *Sarcophaga*, and the aquatic larva of *Corethra*, pour their saliva, which contains a proteolytic enzyme, on their food and suck up the products of digestion (*external digestion*). Bees, with their reliance on pollen and honey as food, have four different kinds of salivary glands. These probably serve different purposes such as to invert sugars, to ensure preservation of food by adding formic acid, and to predigest pollen in the manufacture of "bee bread" on which the young are fed. The proportion of carbohydrate to fat and protein in the food after the early stages of feeding, determines whether a larval bee shall become a queen (fertile female) or a worker (sterile female). The former is fed throughout on a richer protein diet prepared from pharyngeal glands while the latter has its diet changed to pollen and nectar containing a higher carbohydrate content. In wood-boring larvae the secretion of a mandibular gland softens the wood and thus assists mastication, while, in caterpillars, silk production is the main function of labial glands.

The principal excretory organs are the *Malpighian tubules*, opening into the anterior end of the hind gut, and therefore are just as much ectodermal structures as the nephridia of annelids. The proof of their function is the presence of crystals, which can be identified micro-

chemically as uric acid, inside the cells and in the lumen of the tubule. A mass, mainly of uric acid, is found in the hind gut of pupating insects, having been deposited there by the tubules. But in addition nitrogenous end products are found in the *nephrocytes* (cells found commonly associated with the fat body and the pericardium), the *fat body* and the hypodermis in quantities which increase with age, and in the hollow wing scales of certain butterflies, e.g. *Pieridae*, so that it appears that the mechanism of the Malpighian tubules for ridding the body of the insect of nitrogenous excreta is by no means efficient.

Of non-nitrogenous excretory products may be mentioned the carbonates of calcium, potassium and magnesium. Calcium carbonate may be excreted in the integument, but in many cases it is eliminated by the Malpighian tubules, either gradually, e.g. *Drosophila*, or expelled *en masse* by way of the blood and the hypodermis during pupation, e.g. *Ascidia*, the celery fly. In this latter example the recrystallization of the compound on the inner wall of the puparium (see p. 509) may serve to strengthen the weakness of the latter.

To the majority of insects the matter of water conservation is of considerable importance. It is interesting, therefore, to find that in a blood-sucking bug (*Rhodnius*) the proximal part of the Malpighian system is concerned with the withdrawal of water from the lumen of the tubules, and its return to the body cavity. In this insect, the distal parts of the tubes secrete into their lumen potassium and sodium urate, water and base returning to the blood through the walls of the proximal parts of the tubes (Fig. 306). A circulation of water and base exists, therefore, within the system, similar to that obtaining in the vertebrate kidney.

The *circulatory system*. There is, first, a *heart*, primitively consisting of thirteen chambers, each corresponding to a segment, with a pair of ostia guarded by valves precluding outflow, at the base of each chamber. The blood is driven forward in these by muscular action of the heart wall, and passes into an anterior aorta which opens into the general body cavity in the head region. The haemocoelic body cavity is very spacious and the blood bathes all the organs. There is a dorsal horizontal diaphragm perforated by many holes, which separates off the *pericardium* in which the heart lies, and attached to this are paired *alary* muscles, the outer ends of which are inserted in the terga (Fig. 307). By their contraction the passage of blood from the body cavity into the pericardium and heart is facilitated. Though the circulatory system is usually simple, accessory vessels are known, which direct blood backwards along the nerve cord and upwards towards the pericardium in the metathorax (in the moth *Protoparce*)

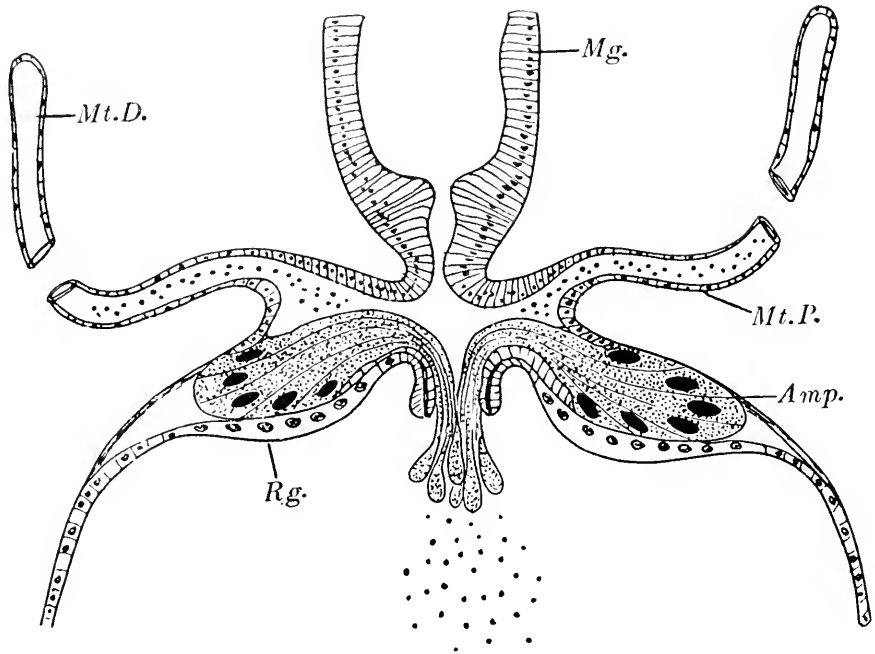

Fig. 306. Diagram of a longitudinal section through the gut of *Rhodnius prolixus* to show the entrance of Malpighian tubules. *Amp.* ampulla in wall of hind gut, the long cells of which project into the rectum and withdraw water from the excretory matter; *Mg.* mid gut; *Mt.D.* distal part of Malpighian tubule at which place water and excretory matter enter the tube; *Mt.P.* proximal part of Malpighian tubule from which water is returned to the body cavity, leaving the excretory material in a granular state; *R.g.* rectal gland in wall of rectum. Modified after Wigglesworth.

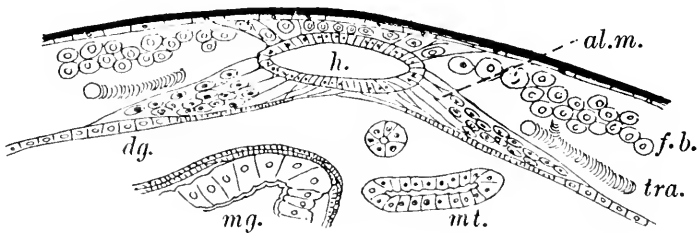

Fig. 307. Transverse section through dorsal part of the abdomen of *Apis mellifica* to show attachment of heart to the body wall and to the diaphragm by the alary muscles (*al.m.*). After Snodgrass. (The insertion of the alary muscles in the tergum is not shown.) *dg.* diaphragm; *f.b.* fat body; *h.* heart; *mg.* mid gut; *mt.* Malpighian tubule; *tra.* trachea.

Further, in certain insects accessory hearts are present which assist in the circulation through special regions (in the thorax of the beetle *Dytiscus* and in the bases of the legs of *Aphids* where they propel blood through the wings and legs of these forms respectively). The much reduced system is on the whole greatly in contrast with the complex arrangements of the decapod Crustacea and of such Arachnids as *Limulus* and the Scorpions where the respiratory pigment haemocyanin renders the blood of the greatest importance in respiration. The part played by blood in respiration introduces a topic which can only adequately be considered with the tracheal system next to be described. In anticipation of that account it may suffice to note the following points. The walls of the tracheae are freely permeable to gases and there must therefore occur an exchange of gases between the blood and the air in the air in the tracheae. In some insects the walls of air sacs within the tracheal system become intucked so as to form "inverted tracheae" through which blood circulates, thus giving rise to an organ which may act as a veritable lung, e.g. *Sphinx* and *Crabro*. Though these facts suggest a special oxygen-carrying function for the blood, it appears that its oxygen capacity is no greater than can be accounted for by physical solution. Haemocyanin does not occur and to this fact must be put down the rather vestigial nature of the blood system in insects. Haemoglobin occurs in a few, e.g. the larva of the midge *Chironomus*, the male apparatus of the water bug *Macrocorixa* and in certain tracheal cells of the horse-fly *Gastrophilus*. This pigment may be derived from intracellular cytochrome and its occurrence be of the nature of a chemical accident of little functional significance. On the other hand it may serve, as it appears to do in *Chironomus*, as a means of enabling the animal to utilize oxygen when this occurs only at low tensions in the surrounding medium. The occurrence of chlorophyll invariably owes its origin to the food plant. Of the several kinds of blood cells which exist, perhaps those which play an important part in the histolysis of larval tissues during the pupation of holometabolous insects, e.g. the blow-fly *Calliphora*, are of most interest.

Associated with the blood are the following cellular tissues, the *fat body*, the *nephrocytes*, the *oenocytes*, the *corpora allata*, and in various beetles, the *photogenic organs*. The fat body consists of closely adherent cells, in the vacuoles of which products of digestion are stored up. Fats, albuminoids and glycogen occur in this way. In addition are found urates showing that this organ serves for excretion. Oenocytes occur as bunches of large cells close to the spiracles in the abdomen and develop as hypodermal invaginations in these places. The corpora allata arise similarly in the mandibular segment and subsequently come to lie above the oesophagus behind

the brain. These small compact glands are probably hormonal in function though the precise nature of them (as of oenocytes) awaits elucidation.<sup>1</sup> Photogenic organs, found in the glow-worm larva and the female beetle *Lampyris*, possess a rich supply of tracheae and produce light by the oxidation of luciferin by the enzyme luciferase.

In the insects the *tracheal system* characteristic of terrestrial Arthropoda attains its most complete development. The ectodermal tubes of the system form a network of which every part is in communication

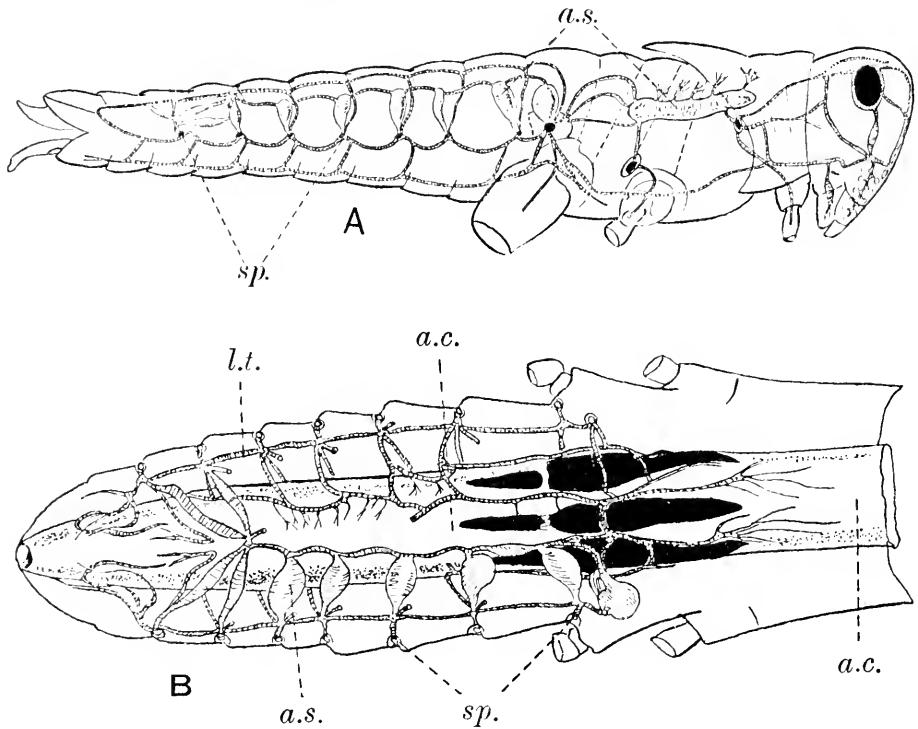

Fig. 308. Tracheal system of the locust, *Dissosteira carolina*. Modified from Vinal. A, Side view. B, Dorsal view, the lower half to show air sacs, the upper half to show tracheal supply to the alimentary canal. *a.c.* alimentary canal; *a.s.* air sacs; *l.t.* longitudinal trunk; *sp.* spiracles.

with every other part. Typically it communicates with the exterior by two pairs of openings called *stigmata* or *spiracles* on the thorax and eight pairs on the abdomen (Fig. 308). The main branches leading from the stigmata not only divide into finer capillaries leading to the adjacent organs but communicate by means of lateral trunks with each other. The capillaries or *tracheoles* never end blindly in the blood but always in the cells of the body, whether muscular or glandular or connective tissue, so that normally the oxygen is conveyed directly

<sup>1</sup> It has recently been shown in *Rhodnius* that they act as ductless glands controlling metamorphosis.

to the latter without the intervention of the blood. These end tubes, as may be seen in Fig. 309, are of the smallest calibre and their lumen is intracellular. The chitinous lining, which in the main tracheae is strengthened, forming the spiral threads which prevent collapse of the tubes, in the tracheoles is thinned down so much that gaseous diffusion can take place easily between the cell fluid and the lumen of the tube.

The system is further elaborated to secure regular circulation of air in the main passages. Thus the stigmata are oval slits which can be closed and opened in various ways—usually by valves operated by

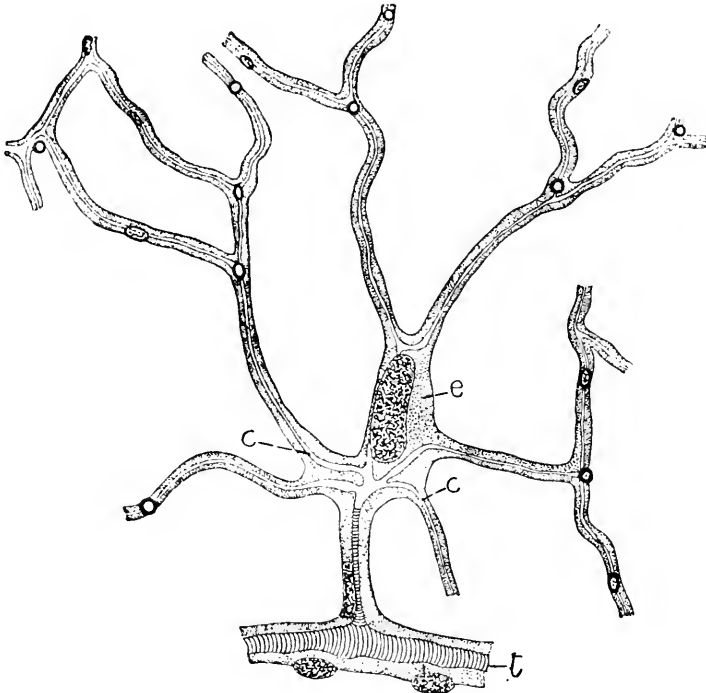

Fig. 309. Tracheal end cell and tracheoles from silk gland of caterpillar, *Phalera bucephala*. From Imms, after Holmgren. *c.* tracheoles; *e.* end cell; *t.* trachea.

special muscles. Respiratory movements can easily be observed in such insects as wasps and grasshoppers. They are effected by the alternate contraction of the abdomen in its vertical axis by *tergo-sternal muscles* and recovery to the original form usually by the elasticity of the abdominal sclerites. Abdominal contraction with open spiracles results in expiration, but if the spiracles are closed the air already in the system will be forced into the finer capillaries where the oxygen pressure is thus increased.

In some Orthoptera it has been found that certain stigmata are normally inspiratory and others expiratory. Thus, in various grass-

hoppers (Fig. 308), the first four pairs are open at inspiration and closed in the expiratory phase, while the last six pairs are open in the expiratory phase and closed at inspiration. It follows that an air circulation through the main trunks is set up, aiding considerably in the diffusion of gas through the whole system. Air sacs (as mentioned above) in the form of thin-walled diverticula of the main tracheae occur in many insects (Fig. 308), particularly those, such as bees, migratory locusts and house-flies, with the power to fly for prolonged periods. These also assist considerably in the circulation of air through the tracheal system owing to the ease with which they can be compressed.

Thus to assist respiration in typical insects a neuro-muscular mechanism has been evolved which ensures some control of the ventilation of the tracheal system. Spiracular closing mechanisms and compressible air sacs are important in this process. But though a circulation of air certainly does take place in some, there are forms, such as lepidopterous larvae, which exhibit no respiratory movements and so, it may be inferred, possess no means of ventilating the air tubes. Forces of diffusion have been shown to be adequate to supply oxygen to the tissues of such examples as have no ventilating mechanism. These same forces will also explain the transfer of oxygen from the wider to the narrower air-containing tracheae. With regard to the ultimate problem concerning the way in which the air reaches the cell, modern theory on insect respiration assumes that the blind ends of the tracheolar tubes are bounded by a membrane which is impermeable to lactic acid and such metabolites. Each tracheole contains a variable amount of fluid, the height of the column of which is determined in a state of equilibrium by hydrostatic pressure and capillarity on the one hand and by forces of osmotic pressure in the tissue fluids and of atmospheric pressure on the other. If now the osmotic pressure of the tissue fluids, for any reason, increases, water will then be absorbed from the tracheole tubes and the column of air will be made to extend more deeply into the tissue. It has been shown that muscular activity of insects is associated with such withdrawal of water from the tracheoles. The evidence points to the conclusion that the change from glycogen to lactic acid which accompanies muscle contraction would provide the necessary osmotic changes to withdraw water from the tube and so bring the column of air to the tissues when and where their need is greatest (Fig. 310). From the air column, thus brought deeply into the tissues, the oxygen must diffuse into the surrounding tissue fluids.

The control of respiratory movements by nerve centres is of interest. Though each nerve ganglion of the ventral chain serves as a centre for the respiratory movements of its own segment, there are



certain regions of the nervous system which exercise a controlling influence over the respiratory activity of the insect as a whole. One example will serve to illustrate this point. The nymph of the dragon-fly *Libellula* pumps water for respiratory purposes into its rectum. In the natural state it responds to changes in oxygen content of water

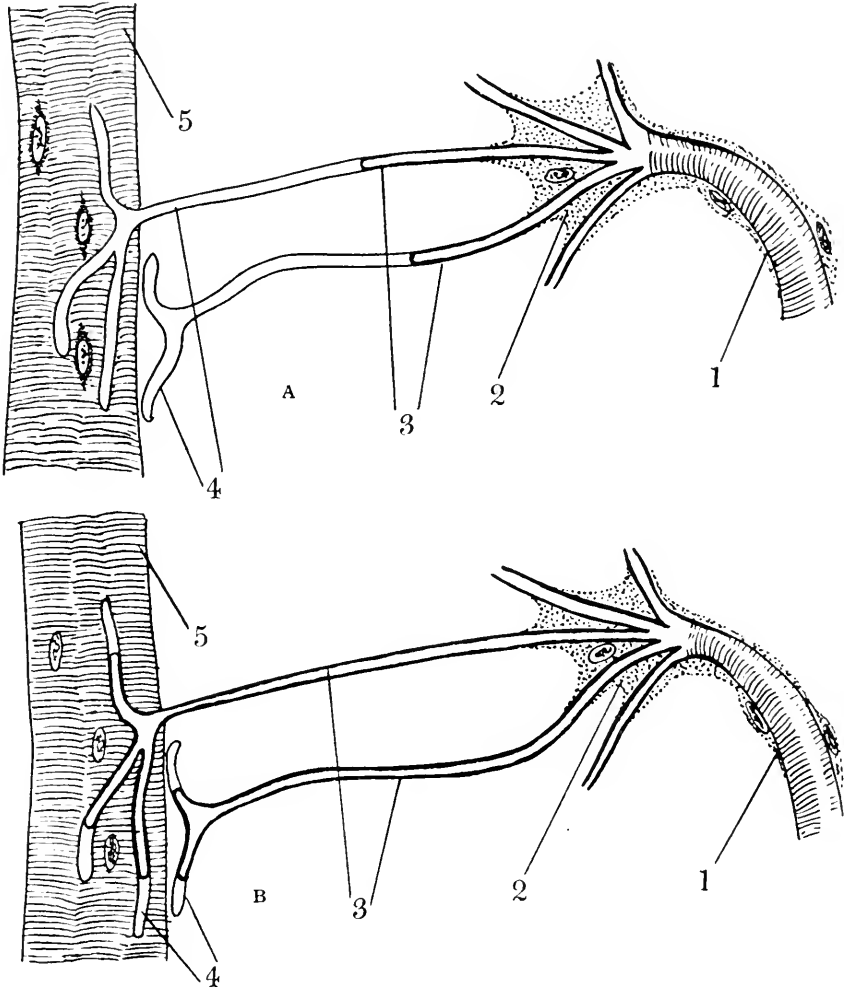

Fig. 310. Diagrams to illustrate the theory of tracheal respiration. A, Tracheole ending in resting muscle; B, In active muscle. 1, trachea; 2, tracheole cell; 3, parts of tracheoles containing air; 4, parts of tracheoles containing liquid; 5, muscle. After Wigglesworth.

quite readily, by increasing the rate of its respiratory movements, when there is oxygen lack; reducing such movements in water saturated with oxygen. When however the prothoracic ganglion is destroyed, respiratory movements continue evenly, without reference to the oxygen tension of the water.

There are thus primary respiratory centres, each responsible for movement in its own segment, and specially localised secondary centres, which can influence those movements in accordance with the demands for oxygen. The site of the secondary centre varies in different animals, but never appears to lie in the head. Just as secondary centres respond to oxygen lack, so have they been shown to respond to the influence of carbon dioxide.

Though the above remarks would apply to the majority of insects, there are many stages of reduction in the group, culminating in the wingless *Collembola*, many of which have no tracheae at all, gaseous exchange taking place through the skin.

Aquatic insects fall into two physiological groups. The first is distinguished by direct breathing, at least one pair of functional

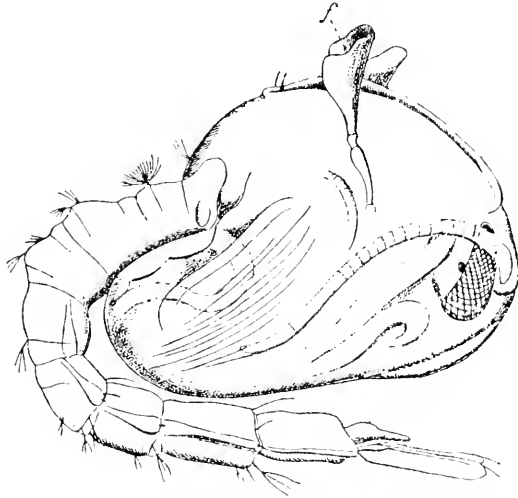

Fig. 311. Pupa of *Anopheles maculipennis*. After Nuttall and Shipley.  
f. respiratory funnel.

spiracles being retained. In the water beetle *Dytiscus* the abdominal spiracles communicate with a supply of air under the elytra which is renewed when the beetle comes to the surface: in the larva of the mosquito the spiracles are open to the air while the animal is suspended from the surface film (Fig. 312).

The second group includes the early stages of the Odonata, Plecoptera, Ephemeroptera and Trichoptera. These have no functional spiracles but breathe by means of tracheal gills—expansions of the body wall through whose thin walls respiratory exchange between the animal and the water is effected according to the laws of diffusion (Fig. 333). They are usually external but in certain dragonfly nymphs (*Aeschna* and *Libellula*) the rectal wall is raised into such gills and respiration is effected by pumping water in and out through the anus.

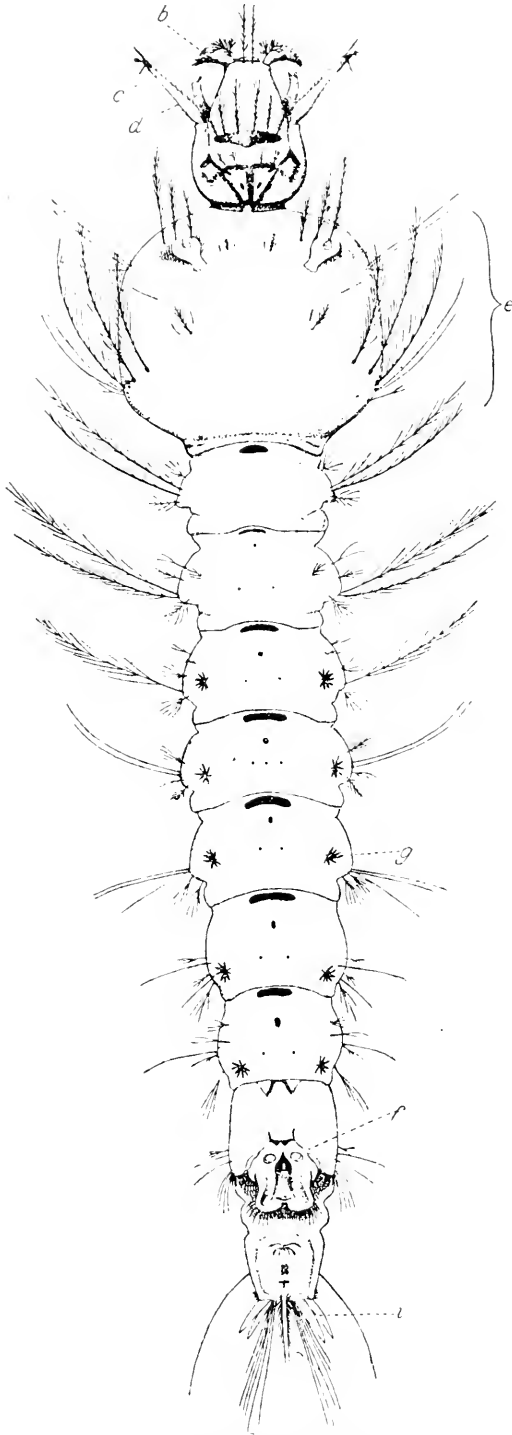

Fig. 312. Larva of *Anopheles maculipennis*. After Nuttall and Shipley.  
*b.* feeding brush; *c.* antenna; *d.* maxilla; *e.* thorax; *f.* spiracles; *g.* palmate hairs for suspending from surface film; *l.* anal gills.

Certain larvae show an even more complete adaptation to life in water in that though they possess a tracheal system this is entirely closed from the exterior and in their early stages it is filled with fluid. Such forms respire of necessity by a process of simple diffusion through the general integument, e.g. *Chironomus* and *Simulium*.

*Reproduction.* The sexes of insects are separate, *Icerya purchasi*, a remarkable exception, being the only known self-fertilizing hermaphrodite in the class. The usual method of reproduction is by deposition of yolky eggs following copulation. The egg, except in many parasitic Hymenoptera, is richly supplied with yolk and invested with a vitelline membrane and further protected by a hard shell or *chorion*. The chorion exhibits different degrees of external sculpture and it is perforated at some point or points to allow of sperm penetration. The spermatozoa, which are of the filiform type, may be transmitted to the female in the form of a spermatophore. Though insects are on the whole prolific creatures capable of producing large numbers of eggs, a few cases are met with where females only lay a few eggs in the course of their life. Thus, in the viviparous tsetse flies, a single egg is passed to the uterus about every nine or ten days. The larva is there nourished by special "milk" glands till it is fully fed when it is passed out for immediate pupation. Viviparity and reduced egg production are here obviously associated with one another. In a large number of cases reproduction is effected without the intervention of the male. This phenomenon of *parthenogenesis* is best seen in the aphides or plant lice where several generations resulting in the production of parthenogenetic females are passed through. The racial advantage accruing from this greatly increased reproductive capacity is obvious.

Parthenogenesis is in certain cases, e.g. among the family Cecidomyiidae of the order Diptera, found to occur in larval forms. In *Miastor*, a form living in decaying wood and bark, reproduction in this manner (*paedogenesis*) occurs for the greater part of the year. These larvae contain prematurely-developed ovaries from which as many as thirty larvae may grow. In summer, larvae occur which are morphologically different from the paedogenetic forms. These summer larvae pupate and the small midge-like flies which emerge lay four or five large eggs; from these a further series of paedogenetic larvae arises.

Among a few of the parasitic Hymenoptera, e.g. some Chalcididae, the phenomenon of *polyembryony* has been observed. This consists in the development of more than one embryo from a single egg. In *Copidosoma gelechiaae*, which parasitizes a caterpillar living on the goldenrod *Solidago*, a hundred or more embryos may result from the deposition of a single egg.

*Organs of reproduction* (Fig. 313). In the male the *testes* are usually small paired organs lying more or less freely in the body cavity. The extent to which they are divided into *follicles*, and the form of follicle, vary in different orders. Thus, in the Diptera, each testis is unifollicular, while in the Orthoptera a multifollicular condition prevails. Each follicle is divided into a *germarium* or formative zone, a zone of growth and maturation, and a zone in which spermatids are transformed into spermatozoa. In multifollicular testes the connection between each follicle and the main duct is known as the *vas efferens*

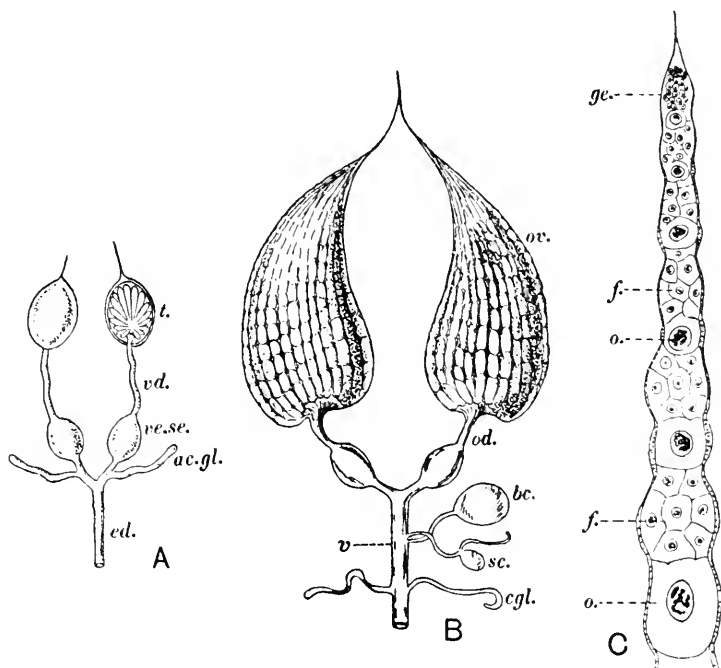

Fig. 313. Diagram of reproductive organs of A, a male, and B, a female honey bee. C, Longitudinal section of an ovariole of *Dytiscus marginalis*. A and B after Comstock. *ac.gl.* accessory gland; *bc.* bursa copulatrix; *cgl.* colleterial gland; *ed.* ejaculatory duct; *f.* follicle cells; *ge.* germarium; *ov.* ovary; *od.* oviduct; *o.* ovum; *sc.* spermatheca; *t.* testis (multifollicular); *vd.* vas deferens; *v.* vagina; *ve.se.* seminal vesicles.

and each testis leads to the median *ejaculatory duct* by a *vas deferens* which is swollen at some point to form a *seminal vesicle*. The ejaculatory duct opens between the 9th and 10th abdominal sterna in association with the external genital plates (*gonapophyses*) of copulatory significance. Accessory glands of various kinds and little understood function are usually found associated with the genital ducts.

The female organs (Fig. 313) consist of *ovaries*, *oviducts*, *spermathecae*, *colleterial glands* and a *bursa copulatrix*.

Each ovary consists of a number of *ovarioles*, corresponding to the testicular follicles of the male. Reduction of the ovary to a single ovariole occurs in such insects as *Glossina*, the tsetse fly, where the minimal number of eggs is produced.

Each *ovariole* (Fig. 313) is tubular and contains zones corresponding to those met with in the follicle of the testis. In addition to the developing ova, nutritive cells are found in association with the latter. Such cells are concerned with the transference of yolk to the growing ova and they or other cells may entirely encircle the ova, round which they secrete the chorion or outer egg shell.

The ovarioles forming an ovary are connected together anteriorly in the body cavity by their peritoneal coverings, known at this point as terminal filaments, and these are attached either to the body wall or the pericardial diaphragm, thereby maintaining the ovary in position.

The *oviducts* leading from the ovaries unite in the middle line to form a common duct which widens to form the *vagina* immediately before reaching the exterior on or between the 8th, 9th and 10th abdominal sterna.

*Colleterial glands* providing fluid for the formation of an *ootheca* (a case surrounding the eggs), or a sticky secretion for fastening eggs to surfaces, usually open into the vagina. The pouch for the reception of spermatozoa is the *spermatheca*. It is an ectodermal invagination, lined by chitin and provided with a muscular coat. The spermatheca opens into the vagina or into the *bursa copulatrix*, this being an invagination of the body wall around the genital aperture adapted for receiving the intromittent organ of the male.

The *nervous system* of insects (Fig. 314) consists of a dorsal *brain* and a ventral double chain of ganglia connected by longitudinal and transverse commissures. The anterior three pairs of ganglia of the ventral chain are always fused to form the *suboesophageal ganglion*, the nerves from which supply the mouth parts. The suboesophageal ganglion is united by *paraoesophageal* connectives to the brain.

The brain consists of three pairs of closely fused ganglia which supply the eyes, antennae and labrum respectively (see p. 425). In addition to this is the *sympathetic* system (Fig. 314 B, C) which supplies the muscles of the alimentary canal and of the spiracles.

In the insects, and indeed the arthropods in general, there has been a great advance over the stage of nervous organization in the annelids. The complex nature of the appendages and the necessity of co-ordinating groups of these for locomotion, feeding and so on, has led to the association of special parts of the nervous system with these functions. We will call each such part a "functional unit". Each functional unit is to some extent self-regulating and is not dependent

for its autonomous action on the higher centres. For example a decapitated wasp can still walk and if a limb be removed from one side, compensating movements of the remaining five legs enable the animal to walk in a straight line. But the working together of the functional units concerned, into different reactions, is controlled by the brain,

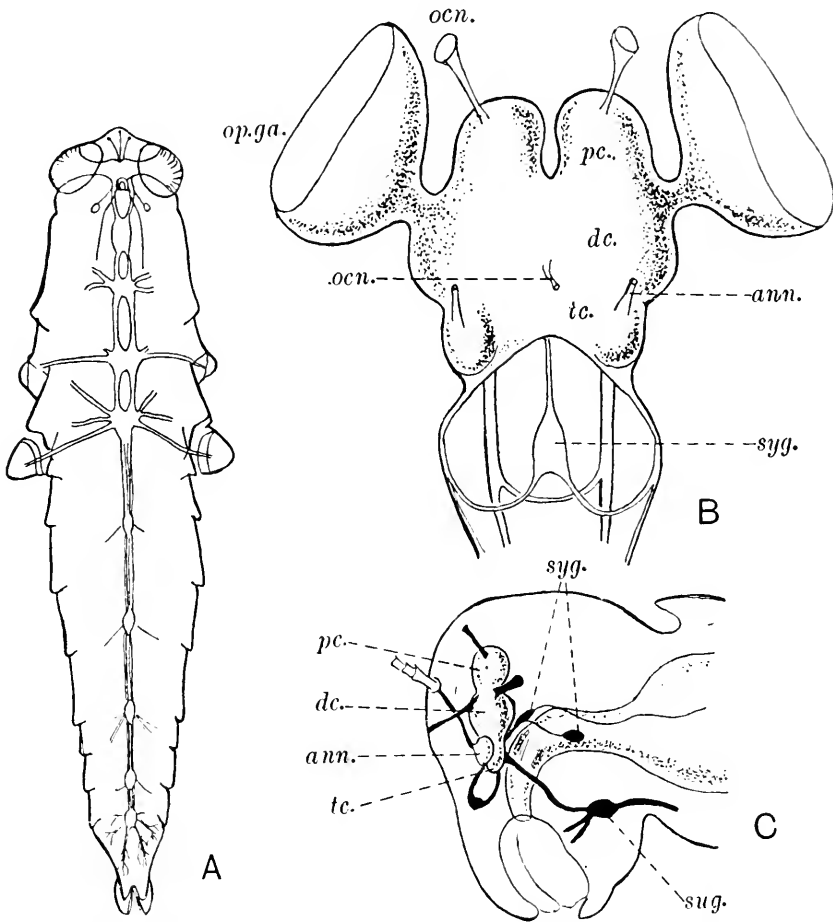

Fig. 314. Nervous system of a grasshopper. After Uvarov. A, Ventral chain. B, Brain and associated nerves. C, Optical section through head. *ann.* antennary nerve and ganglion; *dc.* deutocerebrum; *ocn.* ocellar nerve; *op.ga.* optic ganglion; *pc.* protocerebrum; *sug.* suboesophageal ganglion; *syg.* sympathetic ganglia; *tc.* tritocerebrum.

and the inhibitory character of that control is shown when the ganglia are removed. A "decerebrate" bee will try to fly, walk, feed and polish its abdomen all at the same time. This is because no inhibition is being exercised on the functional units, which themselves remain intact in spite of the removal of the higher centres.

*Sense organs.* There can be no doubt that insects perceive stimuli similar to those causing sensations in ourselves. They are sensitive,

to the waves of light and sound, to changes of temperature, to chemical stimuli by contact or at a distance, e.g. as in the sensations of taste and smell, and to tactile impressions. The sensory equipment is complicated, and the solution of the functional problem which many of its parts present is not made easier by the fact that though the principle of the reaction may be the same as in ourselves, insects often react to stimuli of an amplitude which is beyond our receptive capacity. For instance, they do react to pitches of sound which the human organ cannot detect, and though they do not appreciate the full spectrum in colour vision, they can perceive ultra-violet rays.

No matter what the sense organ may be, the fundamental element is the *sensilla*. In the case of a simple sensory hair (*trichoid sensilla*) the following elements are present: a trichogenous cell which gives rise to the seta; a hair membrane cell which produces the fine membrane at which the seta is articulated to the body wall, and a bipolar nerve cell which lies within the trichogenous cell (Fig. 315). Such sensillae are generally tactile, though in certain cases olfactory, gustatory and heat-perceiving functions have been shown to rest in them. Olfactory sensillae commonly occur on the antennae. These are generally *placoid* (with plate-like cuticle covering the sense cell) or *coelocomic* (where the covering plate is thin and sunk in a depression below the surface) (Fig. 315). But though the antennae are usually olfactory in function, this sense is also located elsewhere, since removal of the antennae does not entirely inhibit olfactory sensation.

The power of insects to diffuse scents from special glands is well known. These serve for defence, or to attract the sexes to each other, and their prevalence, and wide distribution throughout the class, postulate the existence of an olfactory sense. In moths the faculty possessed by males of discovering the exact position of unpaired females is of so astonishing a character that many observers have disbelieved the olfactory explanation, and resorted to theories of etheric wave-transmission. The production of a volatile chemical is clear, however, in those cases where male moths have assembled at an empty box in which a female had been recently housed. It is comparatively simple to demonstrate the existence of a taste sense in insects. Preferences for sugar to other substances in solution can readily be shown in a feeding butterfly. To find however, for example as in *Pyrameis*, the red-admiral butterfly, that the taste organs lie in the feet, is perhaps sufficient reason for using the term *chemo-tactile*, for a sense which has no exact parallel in our own experience. Taste organs occur also in the mouth, and on the palps of the mouth-parts.

Many insects, such as grasshoppers and cicadas, are provided with sound receptors known as tympanal organs, with which are incorporated *chordotonal* sensillae. Each of the latter consists of a sense



cell, to one end of which is attached a nerve fibre. To the other end is connected a rod or *scolopale* which ends in an apical thickening or is free to vibrate in the fluid protoplasm of an enveloping cell. The whole structure is attached to the hypodermis by covering cells at one end and by a ligament at the other (Fig. 315 D).

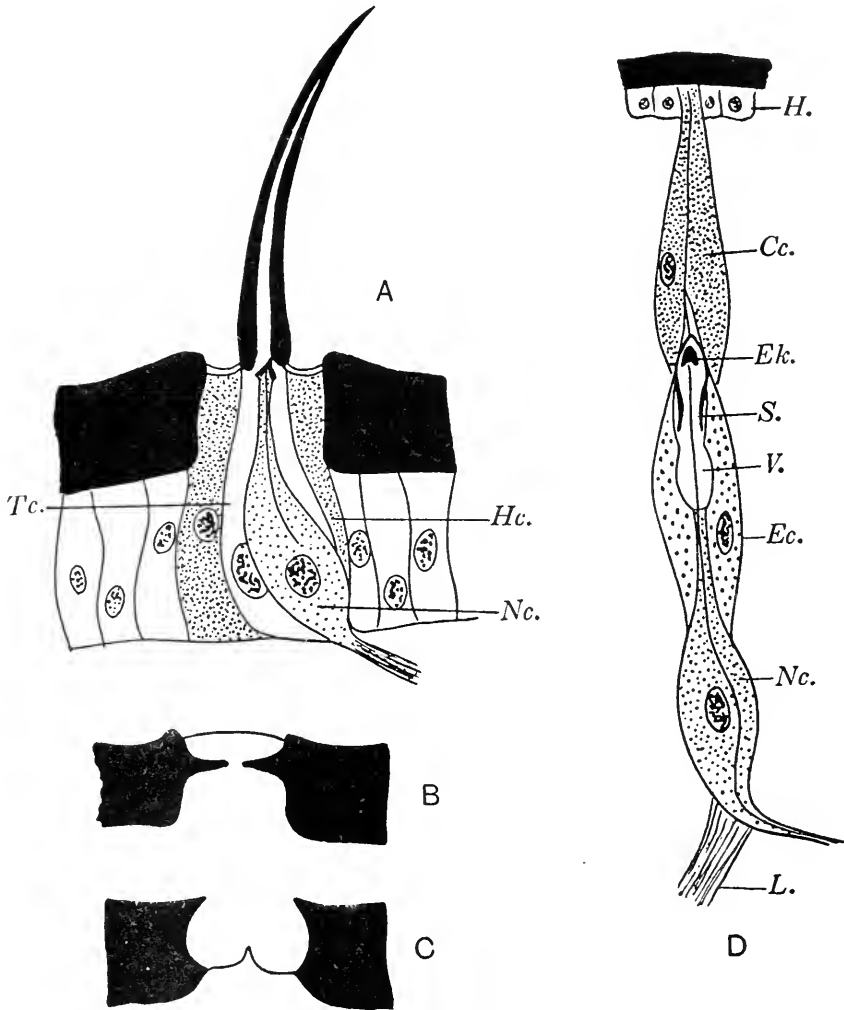

Fig. 315. Insect sensillae. A, Trichoid sensilla. B, Placoid sensilla. C, Coeloconic sensilla. *Tc.* trichogenous cell; *Hc.* hair-membrane cell; *Nc.* nerve cell. D, Chordotonal sensilla. *Cc.* cap cell to scolopale; *Ec.* enveloping cell; *Ek.* end knob of scolopale; *H.* hypodermis; *L.* ligament of attachment; *Nc.* nerve cell; *S.* scolopale and *V.* its fluid filled vacuole. A, modified from Eltringham after Snodgrass. B, modified from Imms after Hess. C and D from Imms.

Scolopale sensillae of this type may or may not be associated with a tympanum or ear drum. When they are, as in cicadas and grasshoppers, there is clear evidence of response to sound waves set up by sound-producing organs possessed by themselves.

In the numerous cases in which no tympanum capable of responding to sound waves exists, a precise function is not clearly indicated. According to some, they may act as rhythmometers, i.e. co-ordinators of the rhythmical movements of the insect's body. A more probable function is that of perceiving vibratory stimuli from without.

The organs of vision have been dealt with in Chapter x, and it is perhaps enough to mention that the ommatidia of which the compound eye is built up, are specialized sensillae of hypodermal origin, essentially similar to those already mentioned.

*Embryology.* Though Arthropod eggs vary in the amount of yolk contained within them they are for the most part yolky and are *centrolecithal* in type (p. 316). To this feature must be ascribed those distorting influences which make Arthropod development so different from that of other invertebrates.

Among insects it is only in the primitive Apterygota and in many parasitic Hymenoptera that are found small, comparatively yolkless eggs which undergo total cleavage. But though these may represent the primitive condition, they cannot be taken as typical of modern insects.

The typical yolky egg is provided with a vitelline membrane and a stout chorionic shell which is commonly sculptured. After fertilization, incomplete cleavage sets in, a process involving only the successive mitoses of nuclei. In this early stage, therefore, the egg is a syncytium of very yolky cytoplasm in which lie the cleavage nuclei. These wander to the peripheral cytoplasm, there to form an outer cellular layer or blastoderm (Fig. 316 A and B). In this latter, occurs a thickening, thus separating embryonic from extra-embryonic blastoderm and in its relation to the yolk the embryo now resembles an inverted chick embryo, but, as might be expected, its method of differentiation is highly different.

Gastrulation proceeds as follows. From the middle line of this embryo certain cells pass inwards towards the yolk by invagination, by proliferation or by their overgrowth by cells of the germ band lateral to them. This enclosed cell mass is mesoderm (together with endoderm in certain cases). The plate left outside constitutes the ectoderm (Fig. 316 C and D). In such cases where endoderm is not included in the enclosed mass as above, this layer rises from growth centres, anterior and posterior, at the places where the stomodaeum and proctodaeum will appear or already have differentiated. The result in any of these cases is a three-layered embryo relegated to the ventral side of the egg, i.e. beneath the yolk. It consists of a layer of outer ectoderm, within which is the mesoderm from which segmental somites develop. Against the yolk lies the endoderm destined to form the mid gut. The mesoblastic somites give rise on their upper borders

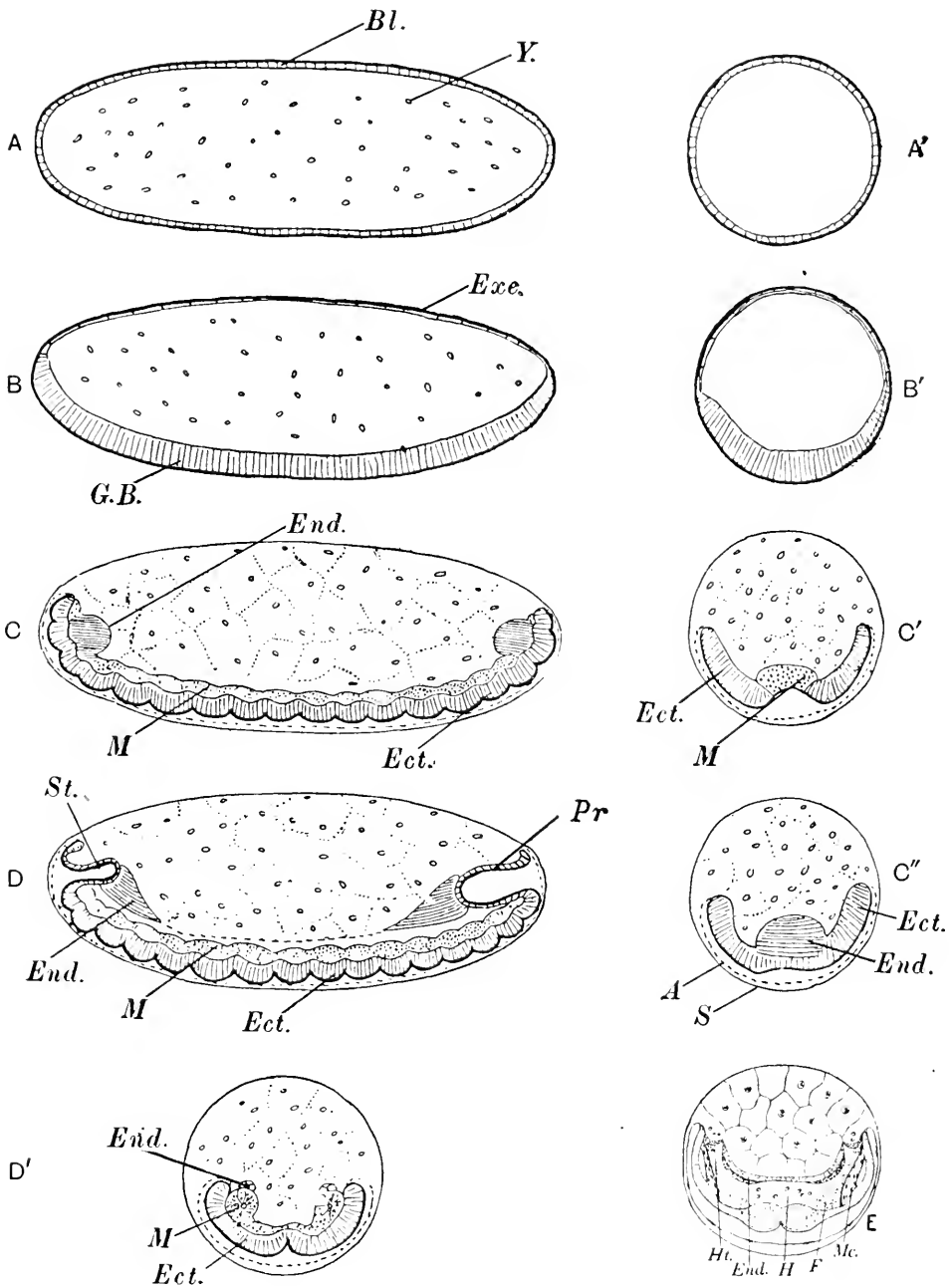

Fig. 316. To illustrate the main features of insect embryology. A, B, C, Sagittal sections. A', B', C', Transverse sections through corresponding stages. D, Sagittal section of embryo with germ layers present. C'', Transverse section through C-stage embryo in mouth region. D', Transverse section through D-stage embryo. E, Transverse section through older embryo with haemocoel between endoderm and ectoderm (in which nerve cord is developing). The mesoblastic somite on each side has given rise to the gutter-like heart rudiment, to the fat-body and to the muscles of body wall and gut. Embryonic membranes, the amnion *A* and the serosa *S* cover the embryonic rudiment. *Bl.* blastoderm; *Ect.* ectoderm; *End.* endoderm; *Exe.* extra-embryonic blastoderm; *F.* fat-body; *G.B.* germ band; *Ht.* haemocoel; *Ht.* heart rudiment; *M.* mesoderm; *Mc.* muscles; *Pr.* proctodaeum; *St.* stomodaeum; *Y.* yolk. After Eastham.

to the heart rudiments, and on their outer and inner borders to the muscles of body wall and gut respectively. The lower border of each somite breaks down to form fat-body. In so doing the coelomic cavity disappears, and, minute as it always was, becomes continuous with those spaces arising by separation of the germ layers from each other, viz. the haemocoel. This latter as in all Arthropods constitutes the main body cavity (Fig. 316 E).

*Metamorphosis.* Insects, like all other arthropods, attain their maximum size by undergoing a succession of moults or ecdyses. The number of moults which an insect passes through is fairly constant for the species, and the form assumed by the animal between any two ecdyses is termed an *instar*. The animal's existence is thereby made up of a succession of instars, the final one being the adult. In the simplest and most generalized insects the several instars are very similar to one another and only differ from their appropriate adults in the absence of wings and the incomplete development of the reproductive system. Where the adult is primitively wingless, as in silver fish and springtails (Fig. 323), the change from young to adult is so slight as to be ignored, and metamorphosis, involving only a development of the reproductive system, is conveniently regarded as being absent. The insect orders falling in this category are grouped under the heading *Ametabola*.

In winged insects, however, the winged adult is in sharp contrast to the wingless young stage. Such forms are said to undergo a *metamorphosis* (Fig. 341). The degree of metamorphosis varies considerably, irrespective of wings, in winged insects according as the young stages resemble their adults or not. A growth stage of a cockroach, for instance, possesses the general appearance of the adult. On the other hand the young stage of a housefly is a grub and has no resemblance to the final instar with its wings, elaborate body form and mouth parts (Fig. 349).

Metabolous insects, those passing through a distinct metamorphosis, are therefore further divided into two subclasses, (i) the *Heterometabola*, e.g. the cockroach, and (ii) the *Holometabola*, e.g. the fly. A classification of insects based on degree of metamorphosis is therefore possible and such a basis for classification is used in all modern systems.

The orders composing the Heterometabola are the Orthoptera, Dermaptera, Hemiptera, Isoptera, Embioptera, Psocoptera, Anoplura, Thysanoptera, Plecoptera, Ephemeroptera, Odonata, Mallophaga, the last three orders being sometimes classed as Hemimetabola owing to the young stages being aquatic and distinguished from the adults by the possession of features adapting them to life in water. The young stages of all the Heterometabola, however, strongly re-

semble their adults in body form, type of mouth parts, and the possession of compound eyes, and are known as *nymphs* (Fig. 317).

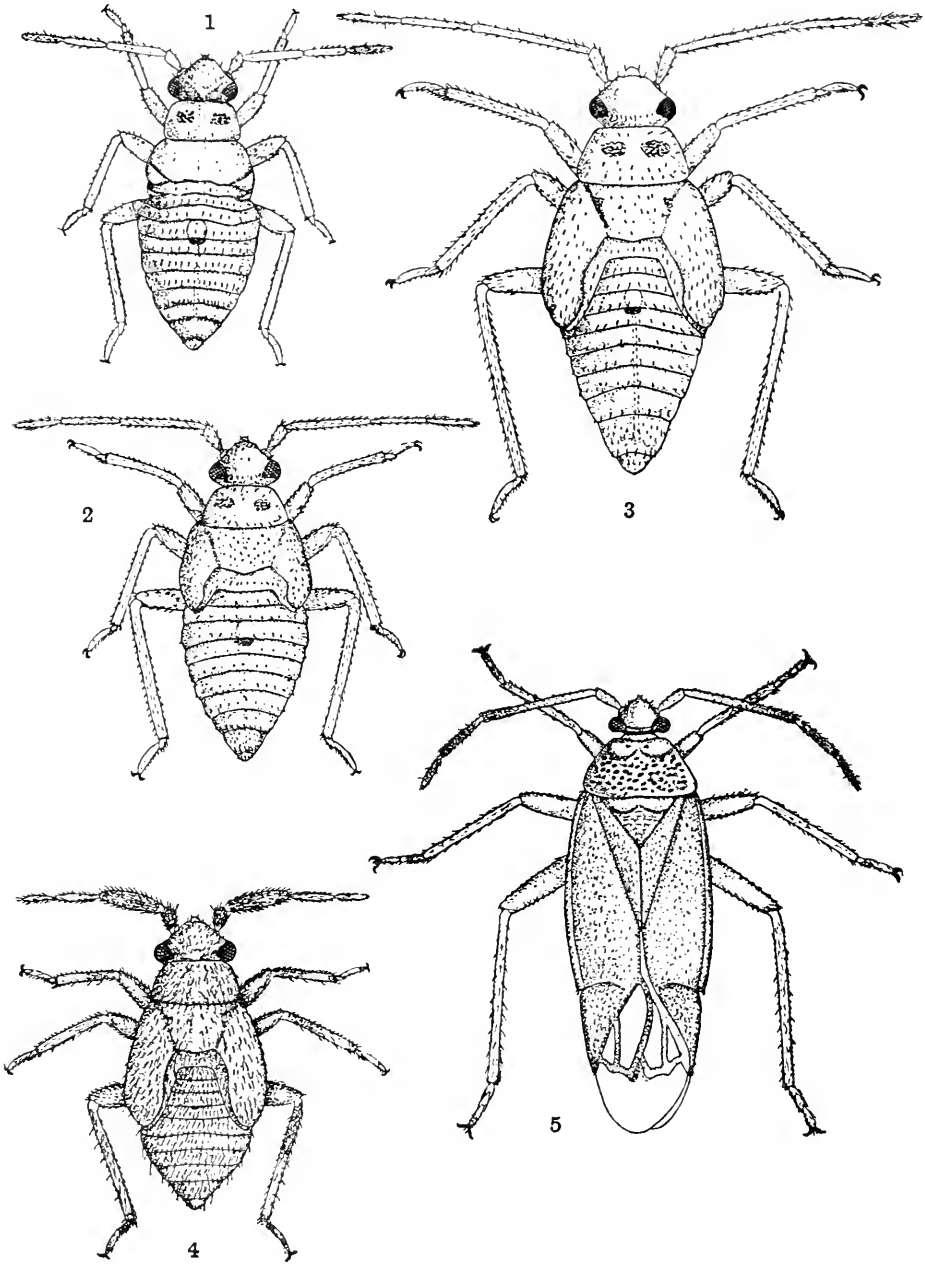

MAH del

Fig. 317. Metamorphosis of a capsid bug (*Plesiocaris vagicollis*). After Petherbridge and Hussain. 1-4, nymphal instars; 5, imago.

The orders composing the Holometabola are the Neuroptera, Mecoptera, Trichoptera, Lepidoptera, Coleoptera, Strepsiptera,

Hymenoptera, Diptera, and Aphaniptera. The young stages of these are known as *larvae* and differ from their adults in body form, mouth parts, and the absence of compound eyes. So great is the difference between the larva and the adult that an instar known as the pupa has been specialized to bridge the gulf (Fig. 341). This stage, one of apparent rest, is actually one of great physiological and developmental activity, and it is here that many larval tissues, e.g. the muscles and the alimentary canal, are broken down by phagocytic or other action and the new adult tissue is built up from many growth centres, generally known as *imaginal discs*. A less obvious prepupal instar is also present, enabling the change from larva to pupa to be effected.

It may reasonably be assumed that metamorphosis of the Holometabola has arisen through larval and adult specialization going on concurrently but in opposite directions, and it is not surprising to find among the orders composing this group, as for instance in many Coleoptera, larvae which are rather nymph-like in that they are well chitinized and possess well-developed legs, and mouth parts resembling those of the adults (Fig. 318A).

The forms of larvae vary considerably and indicate to a great extent the degree of metamorphosis passed through. A *campodeiform* larva (Fig. 318A) is one strongly resembling certain members of the ametabolous Thysanura and possesses well-developed legs, biting mouth parts, antennae and cerci, e.g. many Coleoptera. An *eruciform* larva (Fig. 318B) is fleshy and thin-skinned, its legs are often in the form of supporting struts rather than organs of active locomotion, and there are no cerci. Further, *prolegs* are often found on the abdomen, e.g. caterpillars of Lepidoptera and sawflies (Fig. 344). A *grub* (Fig. 318C) is an apodous larva which in other respects resembles the eruciform type, e.g. certain Diptera, Coleoptera and Hymenoptera.

Pupal modifications are also found; thus the *exarate* type, characteristic of the Hymenoptera, Mecoptera, Neuroptera, is that in which the cases, in which the adult appendages lie, are free of any attachment to the body (Fig. 341). In *obtect* pupae (Fig. 338), wing and leg cases are fused to the body wall, e.g. most Lepidoptera and Diptera. In the most specialized Diptera the last larval skin is retained as a barrel-shaped *puparium* over the pupa within. Such protected pupae are called *coarctate* (Fig. 349).

In the Heterometabola the development of adult form is a gradual process and the appendages, including mouth parts, antennae and legs, grow directly into those of the adult. Wings in such forms develop gradually as external dorsolateral extensions of the meso- and metathoracic body wall (Fig. 317). All the Heterometabola have such a wing development and therefore the alternative name *Exopterygota* is often given to the group.

Larvae of the Holometabola on the other hand possess, for the most part, mouth parts having a form and mode of working different from that of their adults, their legs are reduced in size and complexity or even absent, and they show no sign of external wing growth. It is in the pupal stage that adult appendages appear for the first time on the surface.

Though the many forms of larvae may be regarded as adaptive modifications of a primitive type (for example the eruciform larva as

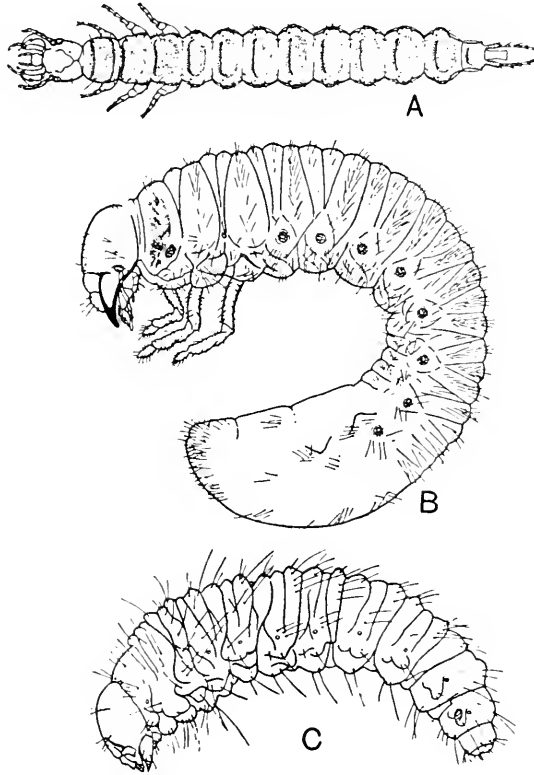

Fig. 318. Types of coleopterous larvae. A, Campodeiform larva of *Pterostichus*, Carabidae (original). B, Eruciform larva of *Melolontha*, Scarabaeidae (original). C, Legless larva of *Phyllobius urticae*, Curculionidae. After Rymer Roberts.

an adaptation to a sedentary life among abundant food) their origin may be explained by reference to embryology. In the development of insects a germ band lies ventral to the yolk and this undergoes development from before backwards progressively, into segments which bear limbs. At an early stage (Fig. 319 A), the cephalo-thoracic segments and appendages may be present while the abdomen is as yet unsegmented. A little later (Fig. 319 B), the abdomen becomes segmented and later still (Fig. 319 C), on these segments embryonic

legs occur. Finally these abdominal embryonic legs disappear and the insect may then hatch with thoracic legs only (Fig. 319 E). These

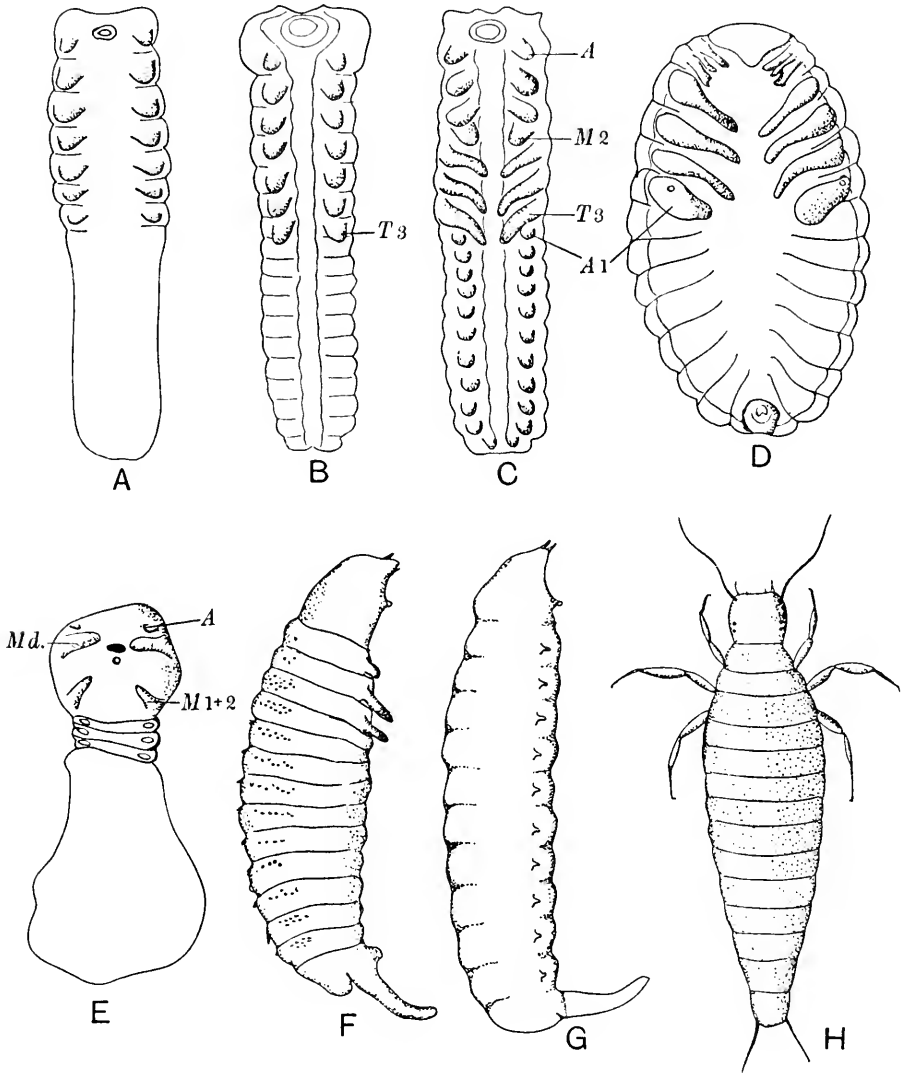

Fig. 319. To illustrate the principles of Berlese's theory. A, B and C are 3-, 3½- and 4-day embryos of *Hylatoma berberidis* in the Protopod oligomero, Protopod polymero and Polypod stages of development. D is the Oligopod stage of *Melolontha*. Corresponding with these are the early larval forms, E, of *Platygaster* (protopod), F and G of *Figites anthomyiarum* (protopod polymero and polypod respectively) and H, of *Sitaris* (campodeiform or oligopod). A, B, C and D, after Graber; E, after Kulagin; F and G, modified after James; H, after Korschelt and Heider. A, antenna; A1, first abdominal leg; Md. mandible; M2, second maxilla; M1+2, first and second maxillae; T3, metathoracic leg.

stages are known as the *Protopod oligomero* (imperfectly segmented abdomen), *Protopod polymero* (segmented abdomen), *Polypod* (with



abdominal legs), and *Oligopod* (thoracic legs only) stages respectively. It is noteworthy that among larvae there are forms resembling these different stages. Thus the first stage larva of *Platygaster* is in a Protopod condition (Fig. 319 E). The first stage larva of *Phaenoserphus* is in a Polypod state. The first two stages in the larval life history of the Cynipid *Figites* resemble Protopod and Polypod embryonic stages respectively (Fig. 319 F, G). The Campodeiform larvae of Carabid beetles, of certain Trichoptera, and of the Neuroptera, resemble the final Oligopod stage of embryonic development (Fig. 319 H). Because of facts of this nature, it has been suggested by Berlese in a theory which now carries his name, that the moment of eclosion from the egg, perhaps decided by the amount of yolk, is one of significance in determining the form of the larva. Thus in the Holometabola, the stage in which hatching occurs corresponds with one or other of the embryonic phases alluded to. Some insects hatch as veritable embryos, i.e. as protopod, others as polypod, or oligopod larvae. A fourth larval form, the apodous grub of Diptera, of many Hymenoptera and of some Coleoptera may be derived by degeneration from the preceding oligopod stage.

The theory further maintains that in Heterometabolous insects, the above stages, with the exception of the Apodous, are always passed through in the egg, and emergence from the egg in these insects occurs as a nymph which has thus reached in embryonic life a higher stage of differentiation than any larva.

The natural corollary of this theory is that certain if not all of the nymphal stages of the Heterometabola correspond to the prepupal and pupal instars of the Holometabola.

The development of adult appendages in the larva is only one of the many aspects of metamorphosis. The wings which suddenly appear in the pupa of the butterfly grow gradually through each of the five larval instars, but instead of growing externally as in the Heterometabola (Exopterygota) they arise as outgrowths from the bottom of intuckings of the body wall. In other words an accommodating fold of the body wall forming a sac, opening at the surface by a minute pore, hides the growing wing bud within it and this is the main difference between *endopterygote* and *exopterygote* development.

At pupation the sac carrying the wing disc or bud at its base becomes straightened out by contraction of its walls and the wing bud is thereby brought to view. Similar limb buds are to be found for the adult legs and mouth parts, which always grow in association with the corresponding larval organs. Such buds are known collectively as *imaginal discs* and their existence characterizes all endopterygote insects (Fig. 320).

*Fossil record.* Though the insects form an undoubted natural group—all its members being referable to some generalized form, possessing among other things mouth parts similar to those of the cockroach,

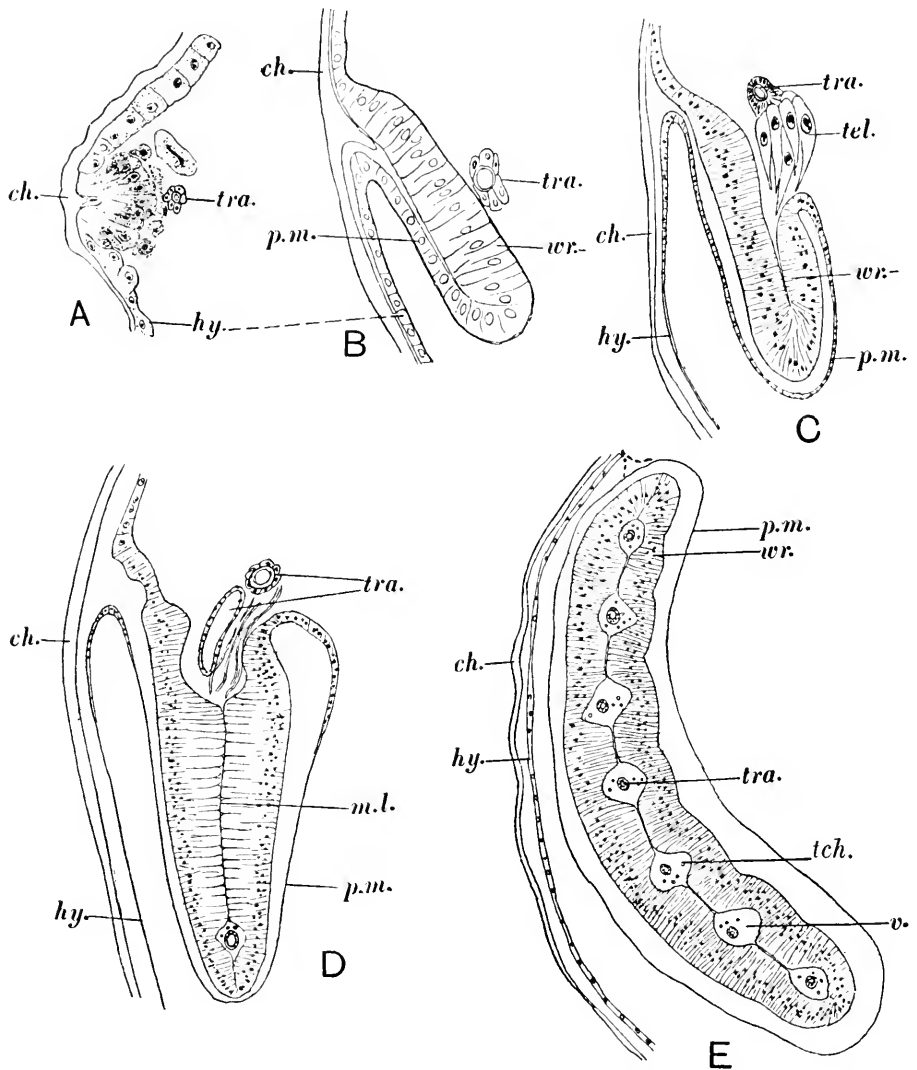

Fig. 320. The internal development of a wing in the larva of the butterfly *Pieris rapae* as seen in transverse sections. A, Instar 1. B, Instar 2. C, Instar 3. D and E, Instar 5. *ch.* chitin; *hy.* hypodermis; *m.l.* middle lamella; *p.m.* peripodal membrane; *tch.* tracheoles within the veins; *tel.* tracheole cells; *tra.* trachea; *v.* vein; *wr.* wing rudiment.

efficient for chewing solid food, an 11-segmented abdomen, a 3-segmented thorax and a 6-segmented head, and two pairs of membranous wings carrying parallel longitudinal veins with a reticulum of cross veins between them—the orders are clearly defined. They are not

easily linked together by intermediate forms and the story of evolution within the subphylum consists rather of disjointed sentences than a continuous theme. The two divisions already mentioned, however, the Exopterygota and Endopterygota, are natural groups which we may for convenience call the "generalized" and the "specialized" respectively. The former have for the most part biting mouth parts (the Hemiptera forming an important exception), while the latter have their mouth parts modified in many remarkable ways enabling them to tap sources of food forbidden to the others, such as the internal fluids of plants and animals and the deeply hidden nectar of modern flowering plants. Moreover, the life cycle in these two divisions is very different, the exopterygote (hemimetabolous) insects having a gradual metamorphosis with external wing growth and the endopterygote (holometabolous) forms having a complex metamorphosis with internal wing growth and a pupal stage intercalated in the life history to bridge the gulf between dissimilar larvae and adults.

From a morphological study alone one is driven to the conclusion that the insects with biting mouth parts and simple metamorphosis are the most primitive—i.e. more nearly resembling the ancestral forms than the Endopterygota. It is of great interest therefore to find that the palaeontological record, though discontinuous, supports the conclusions drawn from comparative anatomical investigations.

The first records of insects are to be found in rocks of the Devonian period. Here they consist of remains which, though fragmentary, suggest that wingless insects similar to our present-day Apterygota abounded then. If they were as soft-bodied as those we know to-day the poverty of the record can well be understood and it is fairly certain that thysanuroid insects similar to the silver fish *Lepisma* existed throughout the Devonian age.

There is abundant evidence, however, that winged insects existed in the Carboniferous period. There were insects with prominent meso- and metathoracic wings, with lateral wing-like expansions on the prothorax, and shorter pleural processes on the abdomen. The order Palaeodictyoptera in which such forms have been placed has given rise to much speculation as to the origin of wings, one idea being that wings are hyper-developments, on the appropriate segments, of lateral processes which occurred on all segments behind the head.

In rocks of the same period have been found forms so similar to our modern cockroaches that it is difficult not to place them in the same family, mouth parts and wing venation being almost identical in the ancient and modern types. Since such forms have existed from the Carboniferous till to-day the student making his first essay into the intricacies of entomology by dissecting the cockroach should keep

in mind that he is dealing with a very ancient type—a real aristocrat among insect species!

In both the Ephemeroptera and Odonata we find many generalized characters—in the mouth parts and the reticulate wing venation—and these orders had their origin in the Permian, when forms assigned to the two orders *Protphemeroptera* and *Protodonata* abounded. Even as early as this, these orders had taken to a nymphal aquatic existence. In the Permian rocks we find primitive dragonflies, stoneflies and Hemiptera of which the Heteroptera with their characteristic half-horny anterior wings appear to be the more recent development.

Up to this stage none of the important endopterygote orders had made their appearance.

The mandibulate Mecoptera form an order which is more generalized in structure among the Endopterygota, and Permian Mecoptera from Kansas and New South Wales have been discovered which have wing features that link up five of the important higher orders, the Diptera, Trichoptera, Lepidoptera, Neuroptera and Mecoptera.

The highly specialized Hymenoptera make their first definite appearance in the sawfly form in the Jurassic, but remains from the Permian have been described as *Protohymenoptera*. These had two pairs of wings of equal size without coupling apparatus and a venation of a generalized hymenopteran type.

Hymenoptera of the specialized kinds—the bees, wasps, ants—are found first in the Tertiary period. In the same way we find nematoceran Diptera (craneflies, etc.), in the Upper Lias, but not till the Tertiary age do we find forms more nearly resembling our highly organized blowflies, etc. Little can be said here of the Lepidoptera except that they occur in the Tertiary period.

The Coleoptera are far older geologically than the Diptera, Lepidoptera and Hymenoptera. Already there were water beetles, weevils and the leaf-eating chrysomelids in the Triassic, and recognizable beetle remains, though scarce, have been extracted from the Upper Permian. This is not without interest, since the Coleoptera as we know them to-day possess, particularly in their mouth parts, a number of features which place them in the generalized category.

Now if we consider the order of events hinted at in the above brief account, it will be seen that though the ancestors of the Hymenoptera, Diptera and Lepidoptera may have existed in the Permian, the latter age with the Carboniferous was essentially one of insects with incomplete metamorphosis and with no feeding mechanism for dealing with flowering plants. It has been suggested that the change from the perpetual warmth and humidity of the Carboniferous to the transitional epoch of the Permo-Carboniferous with its glacial con-

ditions may have accounted for the onset of metamorphosis, the pupal stage being evolved for the purpose of surviving cold periods while in a quiescent state.

The most interesting fact, however, is that the main evolution of our specialized bees, flies and butterflies coincided in point of time with the evolution of the flowering plants to which by their manner of feeding they are now on the whole so inseparably bound.

### Class APTERYGOTA

Primitively wingless insects carrying on the abdomen a varying number of paired appendages other than the external genitalia and cerci. Metamorphosis slight or absent.

#### Order THYSANURA (Bristle-tails)

Biting mouth parts (Fig. 301); antennae many-jointed; compound eyes present; abdomen of eleven segments, some or all of which bear styliform appendages which probably represent the coxites of limbs no longer present; anal cerci usually jointed, rarely (e.g. *Japyx*) in the form of forceps.

*Lepisma saccharina* (Fig. 321), the common "silver fish" which inhabits dwellings of man, and *Machilis (Petrobius) maritimus*, found above high-tide mark along the sea shore and estuaries, are common examples. In *Machilis* (Figs. 322, 301) interesting features are presented by the well-developed *superlinguae* and the jointed mandibles both of which are primitive characters. The *superlinguae* in *Machilis* are paired structures attached to the hypopharynx and possess inner and outer lobes and a palp-like process. This superficial resemblance to maxillae gave considerable weight to the view that an additional head segment was involved. Embryological evidence in support of this conclusion is of a doubtful nature, and the most acceptable view to take is that the *superlinguae* are processes attached to the hypopharynx and perhaps homologous with the paragnaths of Crustacea.

#### Order COLLEMBOLA (Springtails)

Small wingless insects with biting mouth parts deeply withdrawn into the head; compound eyes absent; 6-segmented abdomen which often carries three pairs of highly modified appendages serving the purposes of adhesion and jumping; a tracheal system is commonly absent and there are no Malpighian tubules; metamorphosis absent.

Four-jointed antennae, ocelli and postantennal sensory organs are characteristic features of the head.

There are no tarsi on the legs, claws being borne by the tibiae. The 1st abdominal segment carries a *ventral tube* which is moistened by a glandular secretion from behind the labium poured down a ventral

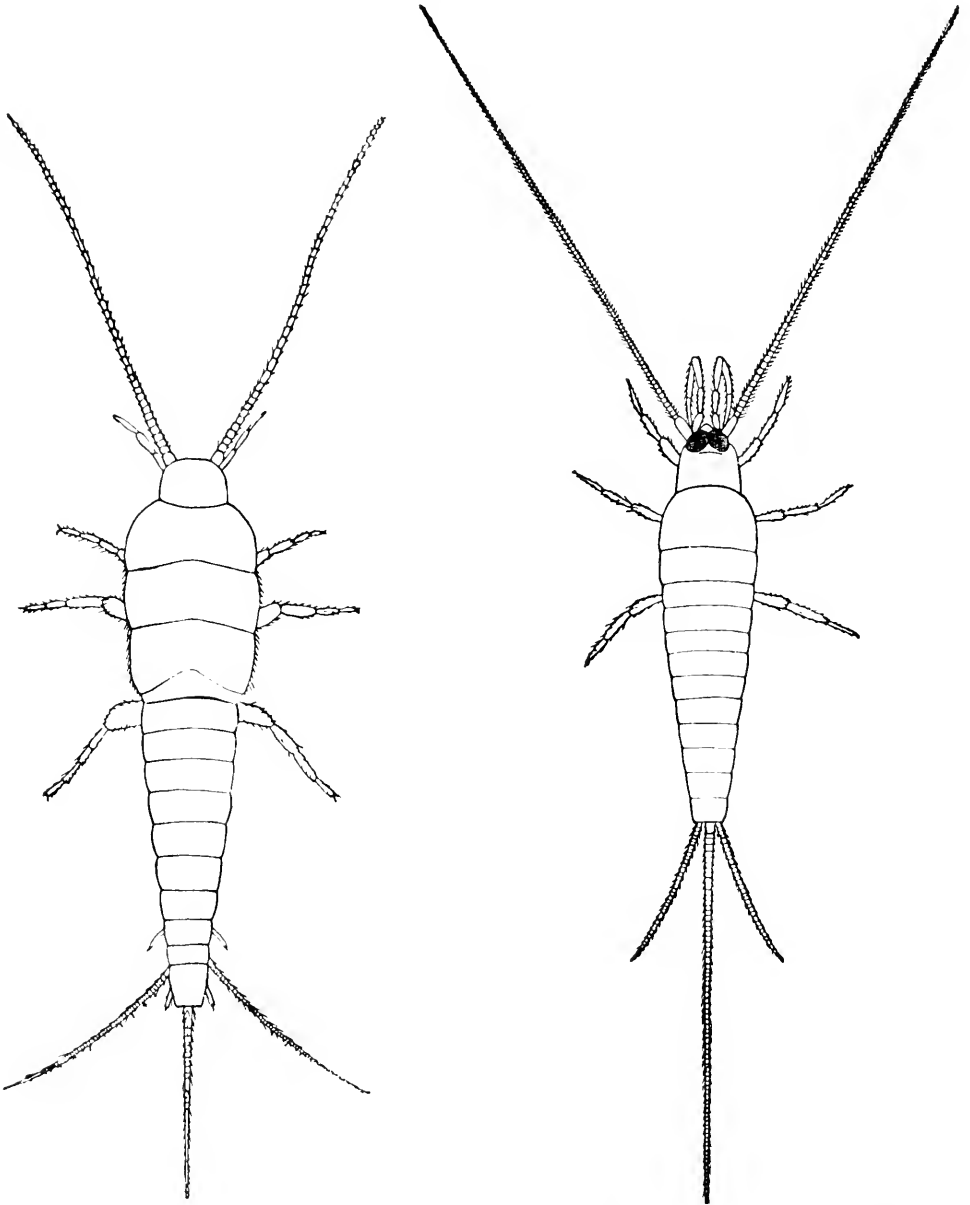

Fig. 321. *Lepisma saccharina*.  
From Imms, after Lubbock.

Fig. 322. *Machilis (Petrobius) maritimus*.  
From Imms, after Lubbock.

groove running along the middle of the thorax. This ventral tube, regarded as adhesive, is formed by the fusion of the embryonic appendages of this segment. On the ventral side of the 3rd segment, the

nearly complete fusion of a pair of appendages has resulted in the formation of the *hamula*, which engages the *furcula* prior to leaping. The latter is a forked structure representing a pair of limbs of the 4th segment (Fig. 323). By contraction of the extensor muscles of the furcula the latter is pulled down out of contact with the hamula and the animal is propelled forwards into the air.

The absence of tracheae is a secondary feature due to the small size of the animals rendering surface respiration sufficient for their mode of life.

Collembola have a wide distribution. They are found along the sea shore between tidemarks and submerged by each tide, e.g. *Anurida maritima*. Common aquatic forms are denizens of fresh waters, e.g. *Podura aquatica*. They have been reported to be so

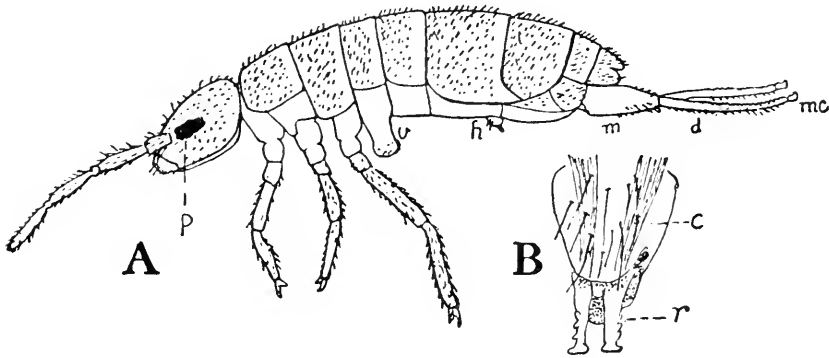

Fig. 323. A, *Axelsonia* (Collembola). B, Hamula of *Tomoceros* showing *c.* basal piece, and *r.* its rami. From Imms, after Carpenter and Folsom. *p.* ocular pigmented area; *v.* ventral tube; *h.* hamula; *m.*, *d.* and *mc.* caudal furcula.

abundant in Arctic zones as almost to cover the snow, and in Europe sometimes to be present in such large numbers that the progress of railway trains is impeded owing to their having prevented the wheels from gripping the rails.

### Order PROTURA

Minute insects without wings, eyes or antennae; with piercing mouth parts deeply inserted in the head capsule; with abdomen of twelve segments, the first three of which bear papillae.

This is a small group of doubtful affinities. Its members are found in decaying organic matter. The fact that on hatching the abdomen is 9-segmented and that subsequent moults bring about the full number of segments is regarded by some authorities as sufficient ground for their inclusion in a class distinct from the Insecta. An example is *Acerentomum doderoi* of Europe.

## Class PTERYGOTA

## Subclass EXOPTERYGOTA

## Order ORTHOPTERA

Insects with generalized biting mouth parts; *ligula* 4-lobed, consisting of inner paired glossae and outer paraglossae; fore wings rather narrow and somewhat hardened (*tegmina*); hind wings membranous; abdomen usually with jointed cerci of short or moderate length; ovipositor generally present.

This order comprises terrestrial insects of large size which have great powers of running and jumping. There are many flightless species in all the families (cf. the female of *Blatta orientalis*).

The main structural features are exemplified by *Periplaneta*, the cockroach. Its generalized character is shown by the character of the mouth parts, the nervous system (six abdominal ganglia), the circulatory system (heart with thirteen chambers, three in the thorax and ten in the abdomen), and the obvious ten segments of the abdomen.

The order is divided into two sub-orders, the *Cursoria* in which the legs are of approximately equal size and the *Saltatoria* in which the last pair of legs are modified for jumping (Fig. 324). The former consists of the Blattidae (cockroaches) which are swift-running, omnivorous forms, usually tropical in their distribution, the Mantidae (praying insects), which are carnivorous, with modified raptorial fore legs, and the Phasmidae (stick and leaf insects), some of which are immensely elongated and attenuated to resemble sticks or twigs, while others have laminar expansions of the skin that give the animal a resemblance to leaves, which is closer in the female than in the male. The female phasmid at any rate is almost motionless, and the habit of feigning death is commonly developed in the family. All these characters help to protect the female from observation in the plants which it frequents and of which it eats voraciously.

In the *Saltatoria* there are the Acridiidae (locusts and short-horned grasshoppers), the Locustidae (long-horned grasshoppers), and the Gryllidae (crickets). The latter include a form remarkably adapted for a burrowing life, namely *Gryllotalpa*. Nearly all these insects are vegetarian, and in the Acridiidae, while the species commonly live a solitary existence and are harmless, under certain conditions a form with a gregarious and migratory instinct develops in countless numbers which invade cultivated districts causing incalculable harm.

Thus in the case of *Locusta migratoria*, when environmental conditions favour an increase in numbers, there is an inevitable trend towards the production of swarming migrants, i.e. the gregarious



phase. The subsequent decline in numbers leads to the production of solitary non-migrants, i.e. the solitary phase. The two phases differ morphologically, biologically and in distribution so distinctly as to have been regarded as distinct species. Between them are transient individuals which form a series with no fixed characters,

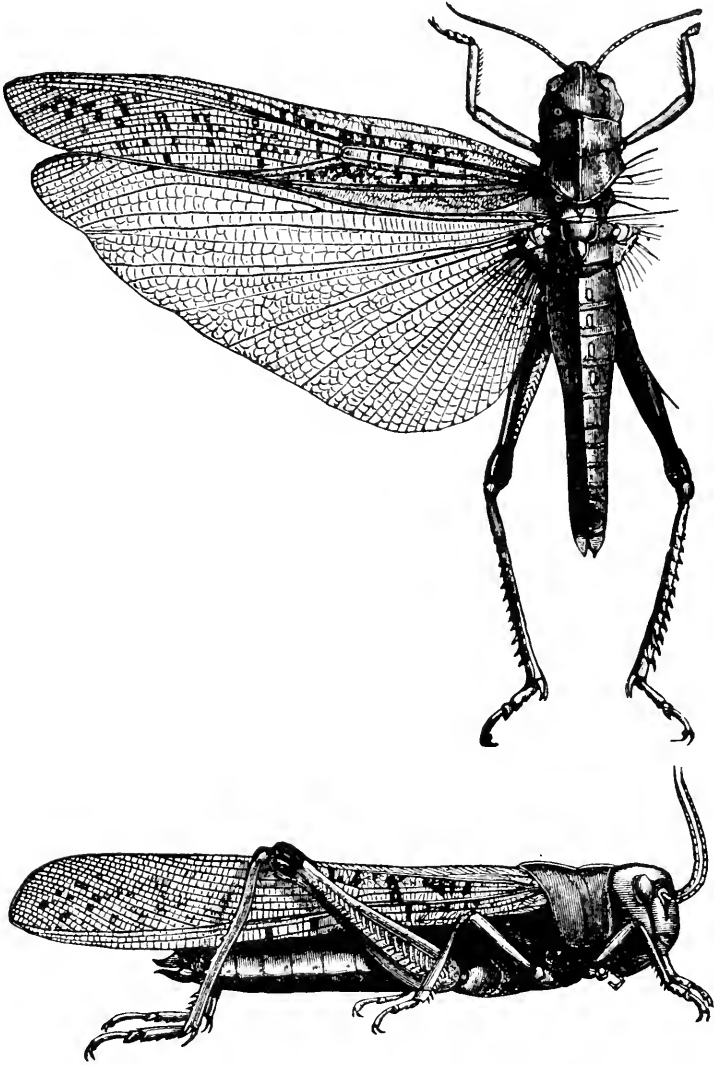

Fig. 324. *Pachytylus migratorius*. A grasshopper. Natural size.  
From Shipley and MacBride.

merging imperceptibly into the gregarious phase at one end and into the solitary phase at the other.

A very characteristic feature of the Saltatoria is the possession of stridulating organs. In one type, exhibited by the cricket *Gryllus*, a file on one of the anterior wings is rubbed over a scraper on the other.

In another type, e.g. *Locusta*, a row of pegs on the hind limb is rubbed against a thickened area of the fore wing. Where there are organs for producing sound, there are also organs for perceiving it. These are *tympana*, chitinous ear drums, which can be set in vibration and then affect special auditory sense organs. The auditory organs may be found on the front tibiae or on the 1st abdominal segment. The posterior wings of the Saltatoria possess many parallel longitudinal veins with a network developed between these by numerous cross veins. They fold in a fan-like manner, a line of folding, the *anal suture*, separating a prominent posterior "anal" area of the wing from the main part of the wing in front. Besides the fully winged forms, like locusts, there are found in the several families all stages of wing reduction to mere scales as in certain stick insects, or to their complete absence as in *Grylloblatta*.

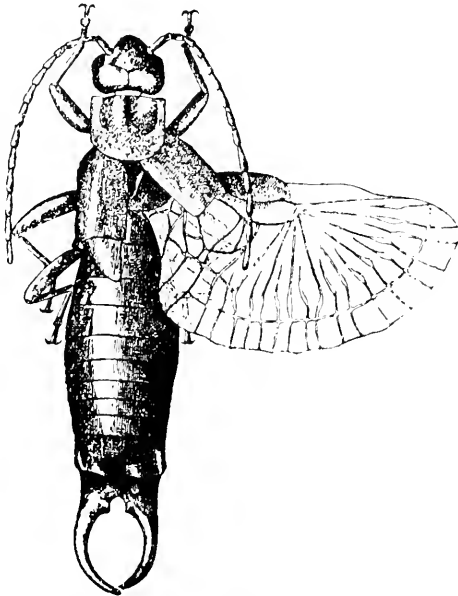

Fig. 325. *Forficula auricularia*. Male. From Imms, after Chopard.

#### Order DERMAPTERA

Insects with biting mouth parts; ligula two-lobed; fore wings modified to form short leathery tegmina; cerci unjointed, always modified into *forceps*; metamorphosis slight.

The common earwig, *Forficula auricularia* (Fig. 325) is the best example of this small but definite order. It comprises a number of small, usually nocturnal insects, omnivorous in diet. The female deposits the eggs in the soil, remains with them until they hatch, and even protects them afterwards. The hind wings have a characteristic venation and fold up along transverse as well as longitudinal furrows,

thus contrasting with the Orthoptera. When unfolded, the wing presents the appearance of a half wheel, the "spokes" radiating backwards from the anterior border, which is greatly strengthened. The large posterior membranous portion corresponds to the anal wing area of Orthoptera, that part corresponding to the anterior area of the latter order having been greatly strengthened by the coalescence of a number of longitudinal veins. The forceps are organs of defence and offence. In *Labidura* they are used for seizing the small animals on which this form lives.

#### Order ISOPTERA (Termites or White ants)

Social and polymorphic insects with biting mouth parts; four-lobed ligula; wings very similar, elongate and membranous, capable of being broken off along a line at the base; cerci short; metamorphosis slight.

The animals of this order abound everywhere in the tropics. Like the true ants they have types of individuals (castes), specialized for the purpose of reproduction, labour and defence (Fig. 326). The termite community usually contains a dealated *royal pair*, the king and queen, who are the founders of the colony, and also supplementary reproductory individuals of two kinds: (a) winged, which normally serve for the formation of new colonies, and (b) wingless, which become capable of reproduction if occasion demands. There is usually a vast number of sterile wingless individuals belonging to two castes, the *workers* and *soldiers*. The termite nests may be merely series of burrows in trees, dry timber or in the ground, or they may be huge mounds made of earth cemented together with the saliva of the termites. Those living in the ground excavate the soil of the tropics, turning it over and enriching it just as earthworms do in temperate regions.

Their food consists chiefly of wood and other vegetable matter and many species are extremely harmful, e.g. *Neotermes*, which damages structural timbers, and *Calotermes militaris*, which bores into and does much harm to tea plants in Ceylon.

The winged sexual forms in several colonies usually swarm at the same time so enabling intercrossing between members of different colonies to take place, and of the countless numbers a few individuals escape the attacks of birds and other animals and alight and cast their wings.

A single pair forms a new colony first of all by making a small burrow, the *nuptial chamber*. The first formed young are mostly workers, and having themselves been tended to maturity by their parents take over the nursing of the young. The queen becomes

enormous and helpless and is fed by the workers; she lays eggs at an incredible rate, up to a million eggs a year, it is said.

It is now known that digestion and growth of wood-eating termites can only go on when there is a protozoan fauna of trichonymphs (p. 67) and other flagellates in the hind gut. The fragments of wood

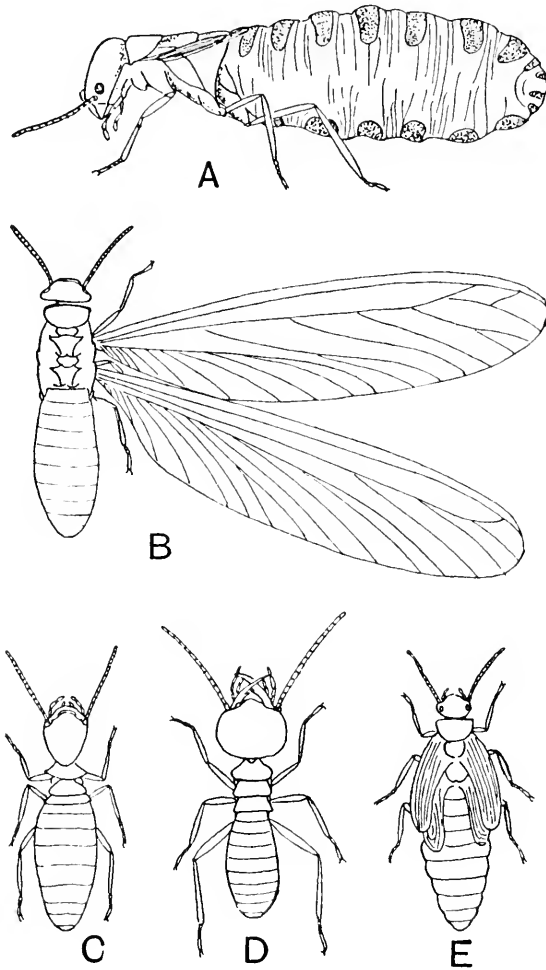

Fig. 326. *Hamitermes silvestri* Hill. Tropical Australia. After Tillyard. A, Neoteinic queen. B, Winged male. C, Worker. D, Soldier. E, Nymph.

are ingested by the Protozoa and converted into sugars, being largely stored up in the form of glycogen. The flagellates seem to form the main food source to the termites, the wood having been already digested within them.

Termites may forage by night for plant food and the genus *Termes* also cultivates in its nest *fungus gardens*. The fungus which grows on

a bed of chewed vegetable matter serves as the food for the royal pair and the nymphs.

The workers and soldiers differ from the sexual individuals, not only in their sterility, but also in having more powerful mandibles. In the soldiers the head can produce a protective secretion and the mandibles are greatly specialized for defence (Fig. 326). Both these castes consist of males and females, though secondary sexual characters are not very marked.

If, as is stated, slight caste differences are already apparent in the newly hatched young, caste-formation cannot be a matter of nutrition.

#### Order PLECOPTERA (Stoneflies)

This is a small order of mandibulate insects with a heterometabolous metamorphosis. Though in possession of two pairs of well-developed wings, they are weak fliers and do not move far from their aquatic breeding grounds. Prominent, elongate antennae and cerci are characteristic features, as also are the three-jointed tarsi. According to some authorities the wing venation represents a primitive type. Much variation in venation is, however, found in the order.

The nymphs are always aquatic, for the most part inhabiting swift-flowing streams with stony beds. They possess the antennal and cercal features of the adult and breathe by means of gill tufts in various positions. In some cases gill vestiges are found on adults though these are not aquatic. Like most aquatic insects, they have a wide distribution, the most generalized families being found in southern, the most specialized in northern, regions. *Perla maxima* is a common species found in European streams.

#### Order EMBIOPTERA

Small insects with elongated and flattened bodies; two pairs of similar wings with reduced venation; females apterous; cerci two-jointed, generally asymmetrical in male; metamorphosis absent in female, slight in male.

These insects are widely distributed in the warmer parts of the world. Many are gregarious, living in tunnels formed of silk produced by tarsal glands, e.g. *Embia major* from the Himalayas.

#### Order PSOCOPTERA (Booklice)

Small insects, either winged or wingless; with biting mouth parts; thoracic segments distinct; wings with reduced venation from which cross veins are largely absent; metamorphosis slight.

These insects are to be found on bark and leaves of trees and feed on lichens and dry vegetable matter. The eggs are laid on the bark

or leaves and covered by a protecting sheath of silk by the female, e.g. *Peripsocus phaepterus*.

*Atropus pulsatoria*, the booklouse, is found in damp dark rooms and feeds on the paste of book bindings, wallpaper, etc.

#### Order ODONATA (Dragonflies)

Predaceous insects with biting mouth parts; two similar pairs of wings with characteristic reticulate venation; prominent eyes and small antennae; elongated abdomen with accessory male genitalia on the 2nd and 3rd sternite; metamorphosis heterometabolous; nymphs aquatic, possessing a modified labium known as the mask.

The members of this order are large insects, and in the Carboniferous period genera existed which had a wing expanse of two feet. They are strong and rapid fliers, catching their food in the form of small insects, on the wing. The forwardly directed legs play an important part in catching the prey and holding it while it is masticated by the mouth parts.

The thorax has a peculiar obliquity of form, the pleural sclerites being directed downwards and forwards at each side with the result that the leg bases are carried forwards towards the mouth and the wing bases backwards.

The wings (Fig. 327) have a complex venation of a reticular nature, characteristic features being a *stigma* or chitinous thickening of the wing membrane near the apex, a *nodus* or prominent cross vein at right angles to the first two longitudinal veins, and a complex of veins near the wing base known as the *triangle*, Fig. 327. There is no coupling apparatus. All the mouth appendages are strongly toothed, maxillae and labium assisting the mandibles more efficiently in mastication than in most insects with biting mouth parts.

Though the male pore is on segment 9 of the abdomen, the copulatory apparatus is found in the sternal region of segments 2 and 3. Before copulation, spermatozoa are transferred to this apparatus. The male then grasps the female in the region of the prothorax by means of his posterior abdominal claspers. While in flight in this tandem position the female turns her abdomen down and forwards and receives sperm from the accessory copulatory apparatus of the male. Dragonfly eggs are laid in water or on water weeds. The nymphs breathe by means of tracheal gills and are of two kinds: (i) those with external gills in the positions of cerci anales and caudal filaments—*Zygoptera*, (ii) those with gills on the walls of the rectum—*Anisoptera*. In the latter case water is pumped in and out through the anus, and this action may be made use of in locomotion—the sudden expulsion of water causing a rapid forward movement on the

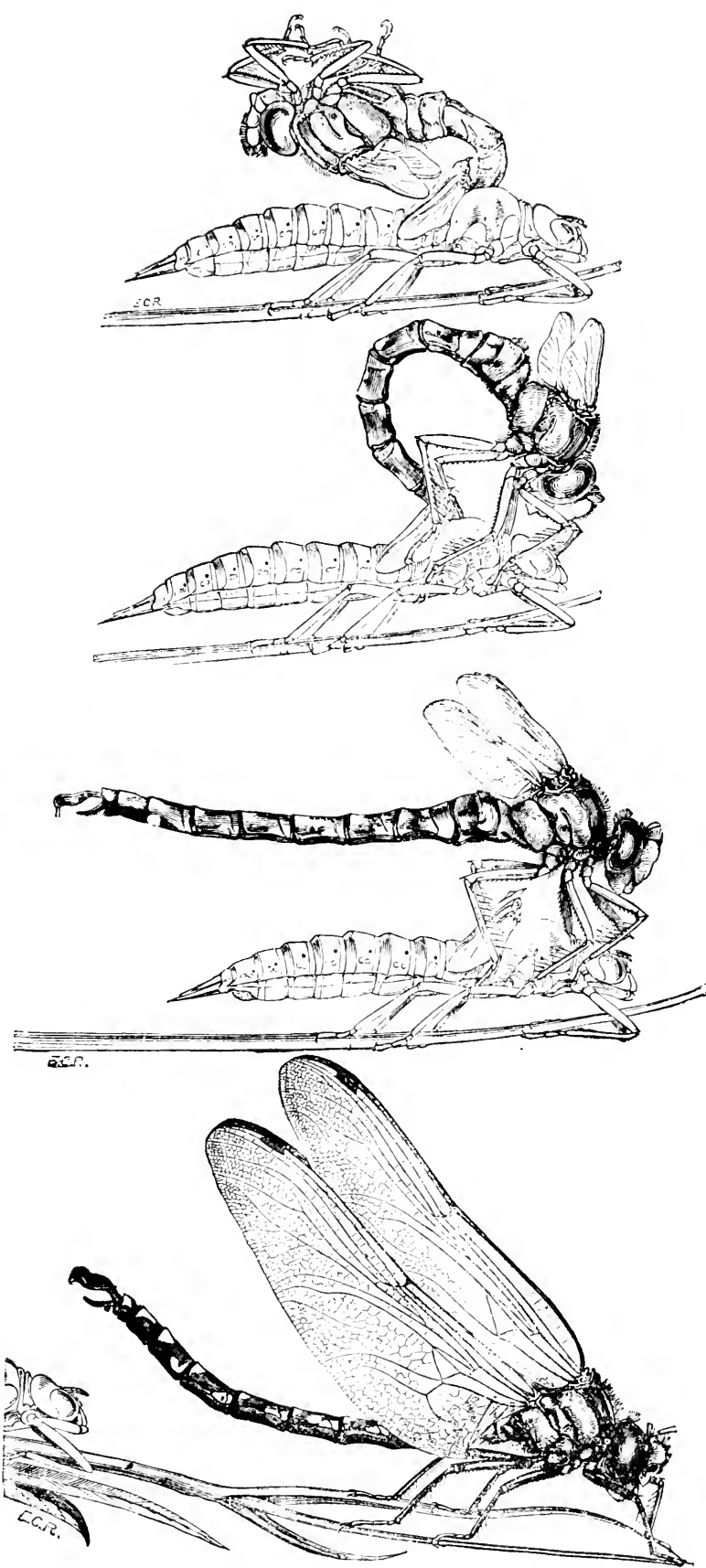

Fig. 327. The emergence of the dragonfly *Aeschna cyanea*. After Latter.

part of the nymph. The nymphs are, however, on the whole slow-moving creatures, lurking well camouflaged among water weeds while in wait for their prey. The main difference between the mouth parts of the nymph and imago concerns the labium. In the adult this has normal proportions, but in the nymph the mentum and submentum are elongated and capable of being shot out rapidly from the folded resting position, so impaling the prey, e.g. a tadpole, on the *labial hooks*.

#### Order HEMIPTERA or RHYNCHOTA (Bugs)

Mouth parts for piercing and sucking; palps absent; labium forming an incomplete jointed tube which receives dorsally two pairs of slender stylets (maxillae and mandibles); wings usually two pairs, the anterior harder than the posterior; metamorphosis gradual.

The existence of this large order of insects has largely been dependent on the store of easily obtainable food which exists in the sap of flowering plants and the mouth parts form an efficient mechanism for obtaining this. There are, however, families like the *Reduviidae* and *Cimicidae* (bed bugs) and the various water bugs (e.g. *Nepa*, water scorpion, and *Notonecta*, back-swimmer) which feed on animal juices. On either count they are of immense economic importance, not only for the damage which the loss of sap and blood causes to the host organism, but also because they open the way for bacterial infection and carry the agent of such diseases as "mosaic disease" among cultivated plants and trypanosomiasis among mammals.

The antennae are usually short. The labium projects from the head as a rostrum which is jointed, and dorsally grooved to carry the stylets (Fig. 328). At its base the groove does not exist but the labrum roofs over an enclosed space. The stylets are modified mandibles and maxillae which are withdrawn at their base into divergent pockets in the head, but converge and interlock as they pass into the space between the labrum and labium and into the groove of the latter, in which they fit tightly; where the inner pair of stylets (the maxillae) meet together there are left two narrow channels, of which the dorsal serves for the inward passage of the food juices and the ventral for the outward flow of the saliva (Fig. 328). At rest the rostrum is bent beneath the body, and when the insect feeds it is extended forward and the stylets projected to penetrate the host tissues (Fig. 328). In some plant-feeding species the stylets are immensely long and very slender and it is difficult to explain the mechanism by which they are forced into the tissues as far as the vascular bundles, but the mechanical insertion of the stylets is greatly assisted by a solvent action of the saliva which appears to loosen the plant cells from one another and to allow the stylets to pass between. In *Aphis rumicis*



the phloem cells of the plant are eventually pierced and their contents sucked out. The pumping action is performed by the muscles of the pharynx.

This order comprises a large number of families which in the following scheme of classification are arranged in two suborders, the *Heteroptera* and the *Homoptera*. The *Heteroptera* have wings which are horny distally, but membranous apically (Fig. 331). The pro-

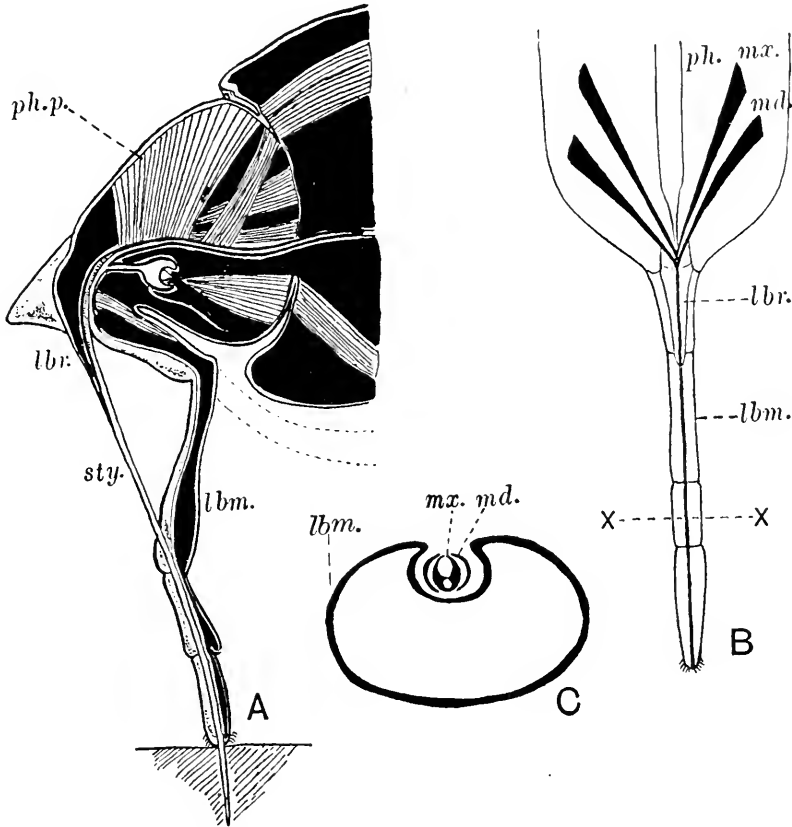

Fig. 328. Mouth parts of the Hemiptera. A, Sagittal section through head of *Graphosoma italicum*. After Weber. B and C, Diagrams of mouth parts and adjacent region of the head. C is a transverse section across B at the point  $\times \text{---} \times$ . After Imms. *lbm.* labium; *lbr.* labrum; *md.* mandible; *mx.* maxilla; *ph.* pharynx; *ph.p.* muscles of pharyngeal pump; *sty.* stylets.

boscis is terminal and free. In the *Homoptera* the fore wings have a homogeneous texture and are often membranous. The head is ventrally flexed so as to bring the base of the proboscis into contact with the anterior coxae (Fig. 329).

There are two tribes of insects within the *Heteroptera*, (a) those which are aquatic and whose antennae are obscure, the *Cryptocerata*, and (b) mostly terrestrial forms with conspicuous antennae, the *Gym-*

*nocerata*. The former are noteworthy for their numerous adaptations to aquatic life. They commonly lay their eggs in the tissues of submerged plants. Many, e.g. the water boatman, *Corixa*, and backswimmer, *Notonecta*, have powerful legs fringed with hairs which, by the simultaneous movement as members of pairs, propel the animals through the water as oars do a boat. They breathe air at the surface film, making use either of a terminal abdominal tube (*Nepa*) or of unvettable hairs between which air is trapped to enable the animal to breathe during its periods of complete immersion (*Notonecta*).

Among the Gymnocerata may be mentioned the bed bug, *Cimex*, an ectoparasitic insect, with vestigial wings, flattened body and prominent claws. It inhabits human dwellings, and its retiring habits coupled with its power to fast for long periods make it a difficult creature to eradicate when once it is established. The shield bugs (*Pentatomidae*) are phytophagous. The mesothoracic tergum is greatly enlarged to extend at least as far over the abdomen as the junction between the horny and membranous parts of the wing when these are at rest. The red bugs (*Pyrrhocoridae*) are also phytophagous. Certain species, e.g. of *Dysdercus*, are known as "stainers" from their habit of feeding on cotton-bolls into which they inject a micro-organism responsible for the appearance of a red stain on the fibre. The *Capsidae* are almost exclusively phytophagous, some of their members being very serious pests of our English orchard trees and shrubs. *Plesiocoris*, until recent times restricted to such trees as willow, now attacks black currant bushes, apple trees, etc. An exception to this phytophagous habit is found in *Cyrrtohinus mundulus* which sucks the eggs of the sugar cane hopper, *Saccharicida*, so effectively controlling this pest in Hawaii. In the family Reduviidae are many forms which transmit trypanosomiasis, in the tropics, e.g. *Rhodius prolixus*.

The extent to which the head flexure has brought the point of emergence of the rostrum into the thoraco-sternal region forms the basis for the separation of the Homoptera into two tribes. The least modified from the heteropterous condition in this respect are the *Auchenorhyncha* (Fig. 329 B). These are all active animals and though the rostrum is close to the thorax it clearly arises from the head. Here belong the cicadas, frog hoppers, tree hoppers, and leaf hoppers.

*Cicada septendecim* is an example with a life cycle which may last as long as seventeen years. Eggs are deposited in holes in the twigs of trees. From here the newly hatched nymphs fall to the ground, into which they burrow to feed on the tree roots. A stage resembling the pupa of holometabolous insects is passed through before final emergence.

The second tribe is known as the *Sternorhyncha*. In these forms the rostrum appears to arise from between the fore limbs. The antennae

are well developed and do not possess a terminal spine (*arista*)—a feature characteristic of the first series. To this group belong the

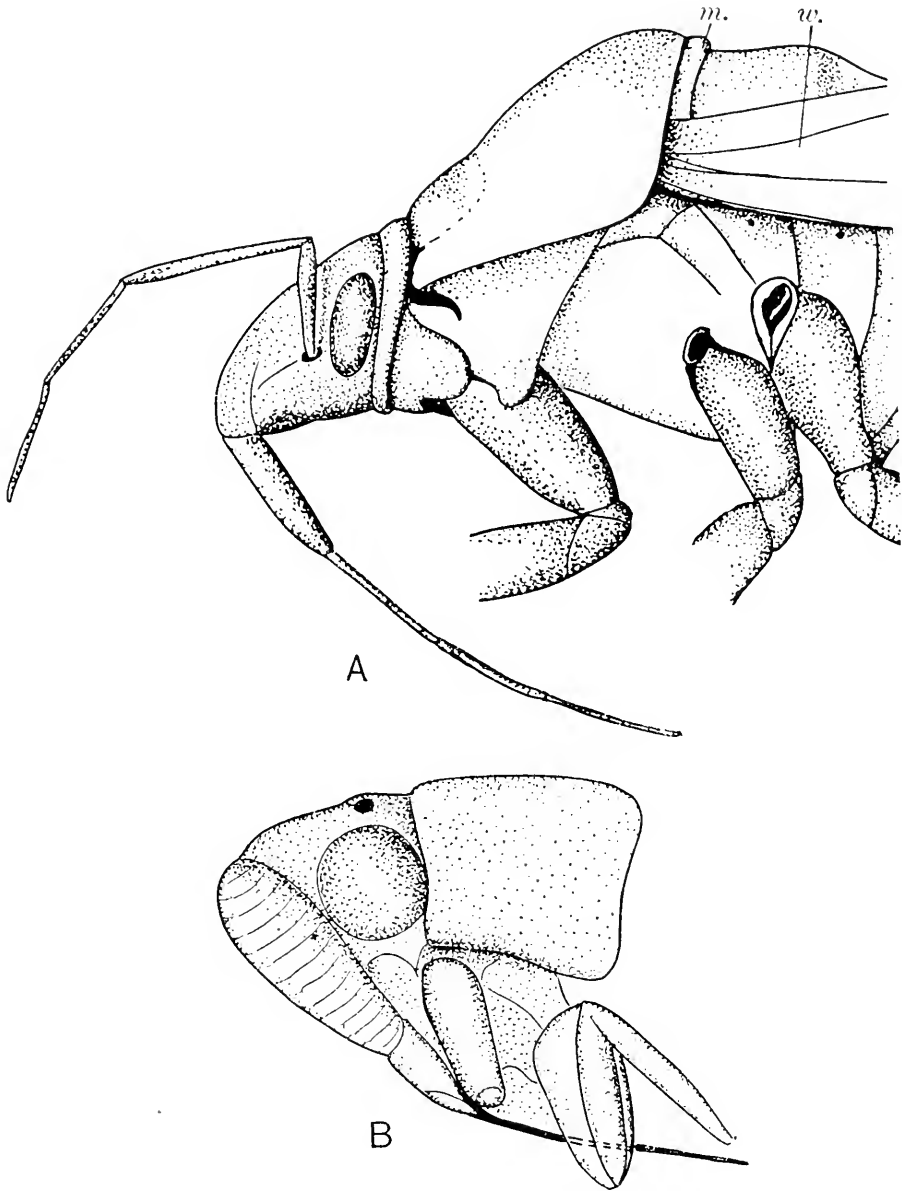

Fig. 329. Lateral views of proboscides of Rhynchota to illustrate the difference between the Heteropterous condition (A), and the Homopterous condition (B). A, *Deraeocoris fasciolus*, modified after Knight. B, *Zammaria tympanum* (Cicadidae). *m.* mesothorax; *w.* wing.

scale insects, *Coccidae*. Females of these are wingless, often scale-like, and devoid of legs. The winged males have atrophied mouth

parts and the second pair of wings are reduced to short clawed structures. Well-known examples are *Pseudococcus* the mealy-bug, *Tachardia lacca* the lac-insect of commerce and *Aspidiotus perniciosus* the San José scale-insect of citrus trees.

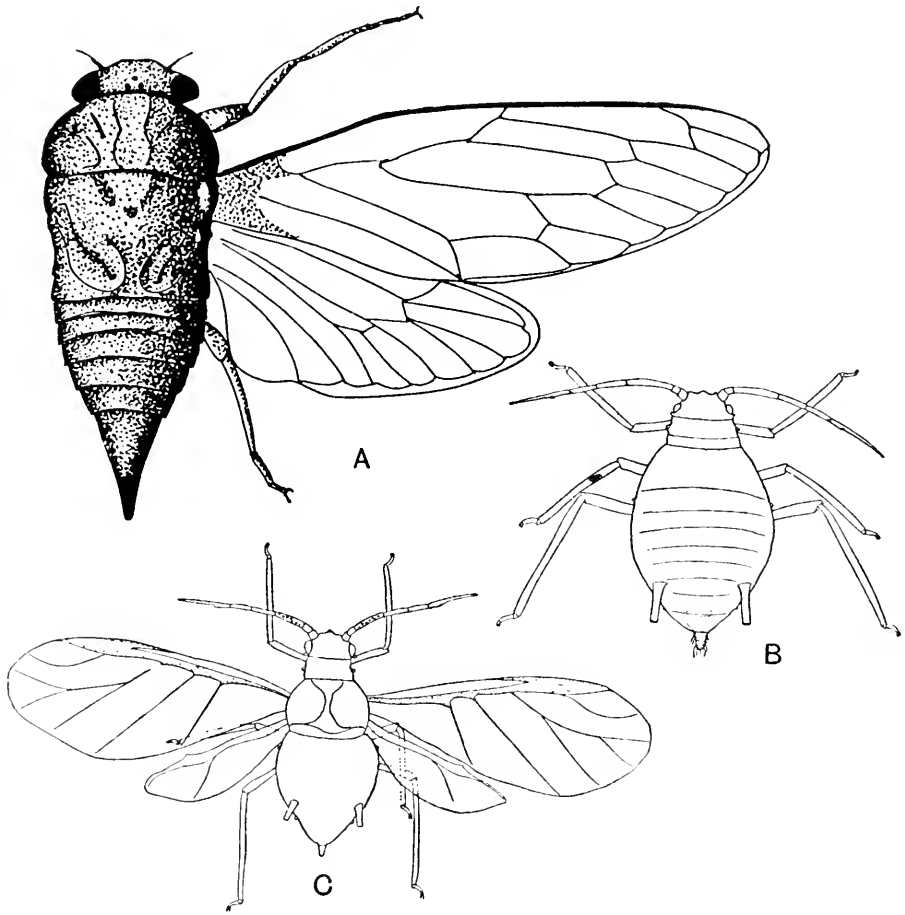

Fig. 330. Types of Rhynchota. A, *Macrotrista angularis* (Homoptera, Cicadidae). B, *Aphis rumicis* (apterous viviparous female). C, Winged viviparous female of same. B and C, after Davidson.

The plantlice (*Aphididae*), Fig. 330, notable for their wide distribution and for their prolific reproduction, have transparent wings and a two-jointed tarsus, that of the Coccidae being one-jointed. Wax-secreting cornicles are borne dorsally in the abdomen.

In the last family the reproductive phenomena are of immense scientific importance. A comparatively simple life cycle is that of *Aphis rumicis*. The winter is passed on the spindle tree *Euonymus* as eggs laid in the autumn after the fertilization of females. In spring

these eggs hatch, giving wingless parthenogenetic females which produce young viviparously. A variable number of these parthenogenetic generations is passed through in the summer and then winged parthenogenetic females occur which migrate to another host (the bean or other plants), and there reproduce, giving rise to generations of parthenogenetic females which eventually produce winged females which migrate back again to the primary host, the spindle tree *Euony-*

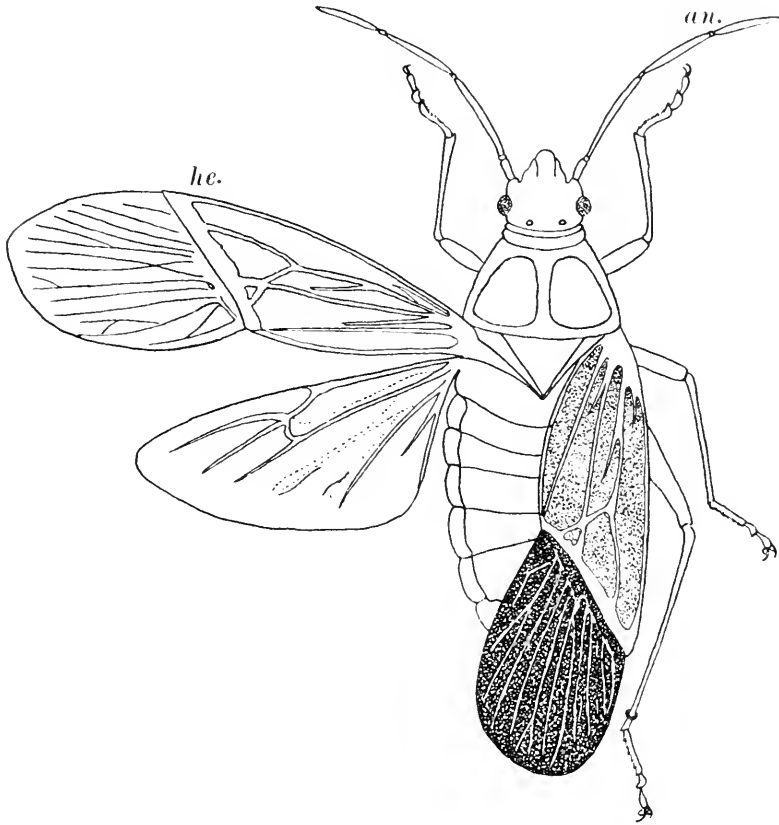
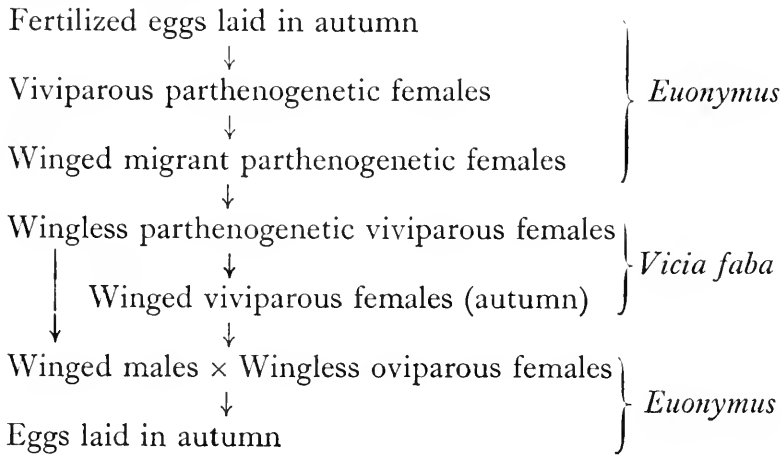

Fig. 331. External anatomy of *Leptocoris trivittatus* with wings spread on one side. After Essig. *an.* antenna; *he.* hemelytron.

*mus*. This generation gives rise to oviparous females which copulate with winged males, migrants from the secondary host plant.

In other forms, such as *Phylloxera vastatrix*, the notorious pest of vineyards, the life history is immensely complicated and involves migrations between root and stem of the host plant. The reproductive capacity of these insects is most remarkable and is fortunately offset by the number of enemies which they possess.

The following summary will assist in the understanding of the life cycle of *Aphis rumicis*:



The cyclical reproductive phenomena in aphides as just described raise important problems relating to the intrinsic differences between sexual and parthenogenetic individuals, and to the environmental conditions governing the occurrence of these phases in any life cycle.

Fertilized eggs produce only strictly parthenogenetic females. These multiply by diploid parthenogenesis, i.e. the eggs retain the full complement of chromosomes and are not capable of fertilization. Eventually come individuals capable of bearing sexual forms, *sexuparae*. The sexual forms arising from these produce germ cells undergoing normal reduction and which are therefore haploid. It follows then that fertilization will restore diploid parthenogenesis. Sexual differences are indicated in the chromosomes; the female of *Aphis saliceti* possessing six, of which two are sex chromosomes; the male only five, one only being a sex chromosome. Sexual reproduction leads however only to the production of parthenogenetic females and not to males and females in equal numbers, as might be expected. This appears to be due to the fact that in the maturation of sperms, those with only two chromosomes die. Fertilization therefore is always between sperms and ova each with three chromosomes, of which in each case two are normal chromosomes (*autosomes*) and one is a sex chromosome *X*. The capacity of females with six chromosomes to produce male offspring with only five is due to the fact that in the maturation of male-producing parthenogenetic eggs, reduction in the number of chromosomes only affects the sex (*X*) chromosomes, one remaining in the egg, the other going to the polar body. In this way a parthenogenetic female with six chromosomes, i.e.  $4 + XX$ , gives rise to males with only five, i.e.  $4 + X$ .

A complete analysis of the environmental conditions governing the onset of sexual phases after a period of parthenogenetic reproduction is yet to be made. Food, temperature and light seem to be important, and of these a reduction of the last mentioned factor seems to be associated with the production of sexual winged individuals.

Though the order contains insects for the most part harmful to man and his property, a few are useful in that they yield the dyestuffs Kermes (females of *Kermes ilicis*) and Cochineal (*Dactylopius coccus*), and the resin stick-lac (*Tachardia lacca*). The usually harmful plant-sucking habit is being put to good use in Queensland where the coccid bug, *Dactylopius tomentosus*, is employed against the prickly pear cactus with considerable success.

#### Order EPHEMEROPTERA (Mayflies)

Vestigial mouth parts reduced from the biting type; wings membranous with a reticulate venation; the hinder pair small; caudal filament and cerci very long (Fig. 332). The nymphs are aquatic and an active winged stage known as the subimago occurs before the last moult yields the adult.

The eggs are laid in water, either scattered over the surface or attached to stones, etc., by the female, which enters the water for the purpose.

The nymphs at first possess no gills but subsequent instars bear on the abdomen movable tracheal gills (Fig. 333), which may be branched or lamellate, exposed or protected in a branchial chamber. The body form varies with the habits. Thus inhabitants of fast-flowing streams have flattened bodies with legs provided with strong clinging claws, e.g. *Ecdyonurus*. Those which live in clear still water have a stream-lined form for rapid movement, e.g. *Chloeon*, while burrowing types have fossorial legs, e.g. *Ephemera*, and are often provided with protective gill opercula, e.g. *Caenis*. The

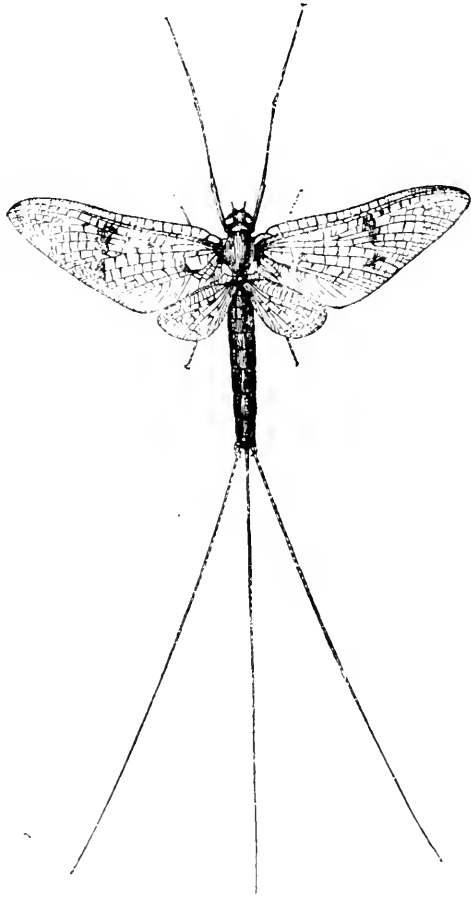

Fig. 332. *Ephemera vulgata*.  
From Imms.

mouth parts are of the biting type, and the two-jointed mandibles and well-developed superlinguae are features of importance. The nymphs are essentially herbivorous. Nymphal life is usually of long duration:

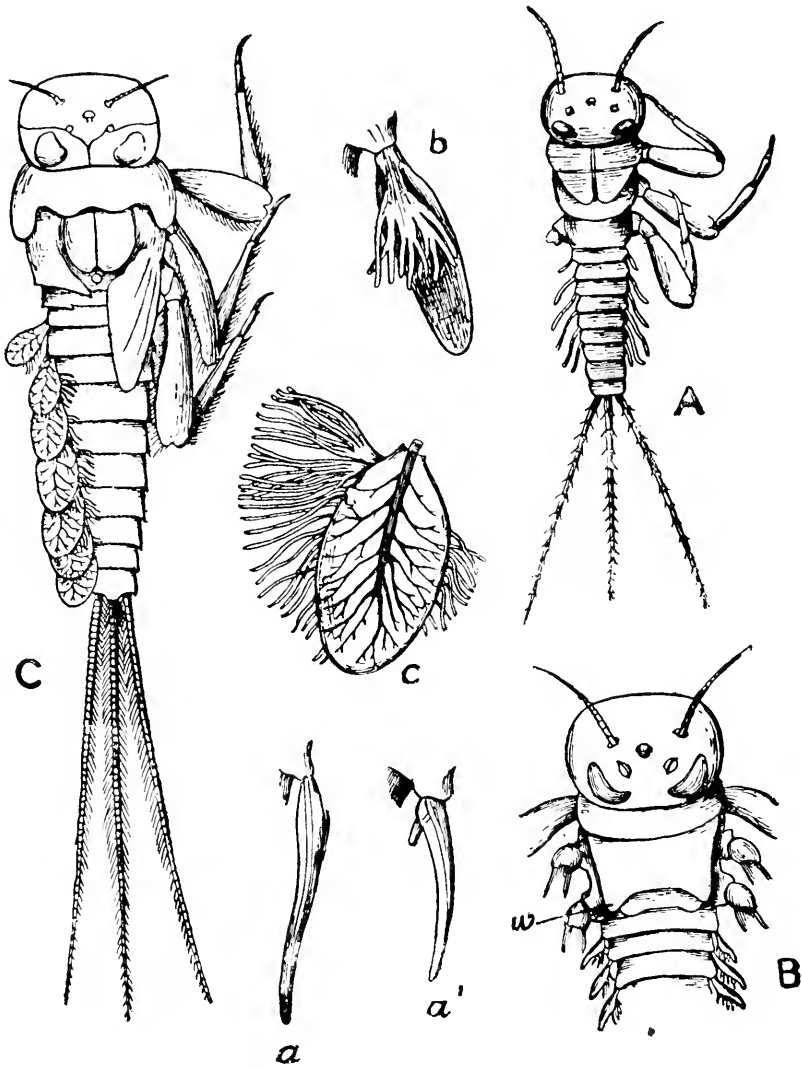

Fig. 333 Nymphal instars of *Heptagenia*. After Imms. A, Third instar. B, Seventh instar. C, Eighth instar. *a*, *a'*, *b* and *c*, gills belonging to these instars respectively; *w*, wing rudiment.

as many as twenty-three instars may occur. In order to emerge, the fully fed nymph creeps out of the water on to a plant stem. A moult gives rise to the winged subimago stage. This flies away and after a period which varies, according to the species, from a few minutes to about twenty-four hours, a final moult yields the adult which enjoys,



as the name of the order implies, a similarly short life. In the adult the mouth parts are vestigial, no feeding is done, and the alimentary canal, full of air, serves no longer for digestion.

Economically these insects are of importance in so far as they constitute a proportion of the food of freshwater fishes, the adults being caught by fish during their nuptial dance, and the nymphs being devoured by bottom-feeding fish.

#### Order MALLOPHAGA (Biting lice)

These insects are ectoparasites of birds (less frequently of mammals). Their reduced eyes, flattened form and tarsal claws are features correlated with this mode of life. Unlike the Anoplura they have no piercing mechanism and devour with biting mouth parts small particles of feathers, hair, or other cuticular matter.

The common hen louse, *Menopon pallidum* (Fig. 334), may be taken as an example. The head is semicircular in form and articulates with a prothorax which is freely movable on the rest of the body, a tagma formed by the fusion of the meso- and metathorax with the abdomen. The mouth is placed ventrally on the head and surrounded by biting mandibles and less prominent 1st and 2nd maxillae.

Eggs are laid separately on feathers or hairs and the life cycle is completed in about a month—the young instars resembling the adult in form and habit.

The various families of biting lice are strictly confined to particular groups of birds, indicating that evolution of the parasites has proceeded concurrently with that of their bird hosts.

#### Order ANOPLURA (Sucking lice)

Ectoparasites of mammals, with mouth parts adapted for piercing the skin and sucking the blood of their hosts. The eyes are ill-developed or absent. The single-jointed tarsus carries a large curved claw admirably adapted for clinging to the host. The thoracic segments are fused, and a flattened abdomen of nine segments possesses large pleural areas allowing the body to swell on feeding.

The minute mouth parts are accommodated at their bases in a stylet sac which is a diverticulum ventral to the pharynx. There are two stylets of which the dorsal is a paired structure, the halves of which maintain contact with each other distally to form a half-tube which is completed by the ventral stylet. This also consists of two elements. Between the dorsal and ventral stylets lies the salivary duct which appears to be a modification of the hypopharynx. The stylet complex can be sufficiently everted so as to make contact with the skin. Into

the wound is poured the salivary fluid, and the mouth funnel is thrust in to enable the blood to be sucked up by the pharyngeal pump. Embryological evidence tells us that the 1st maxillae unite to form the dorsal stylet, the ventral being formed by the labium. A pair of mandibles also develops but these remain in a rudimentary and unchitinized condition.

*Pediculus humanus*, the body louse (Fig. 335), is associated with the spread of many diseases, such as typhus and relapsing fever. The disease known as trench fever, prevalent in all war areas during the Great War, has also been shown to be transmitted by this insect.

Eggs are laid attached to hairs of the body or clothing, and the three instars passed through before attainment of the mature state closely resemble the adult.

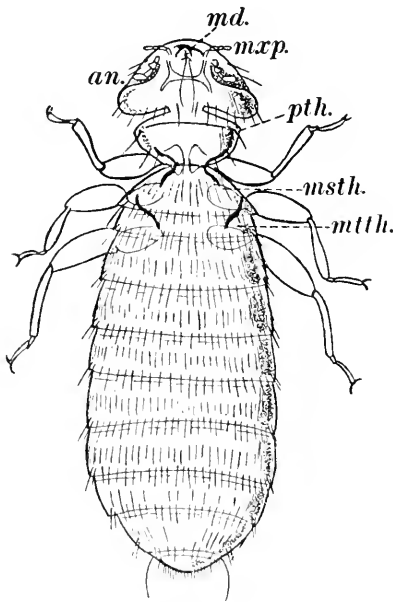

Fig. 334.

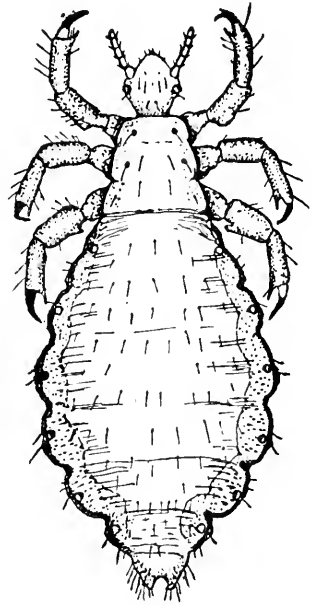

Fig. 335.

Fig. 334. Hen louse, *Menopon pallidum*. Dorsal view, showing biting mandibles by transparency. *an.* antenna; *md.* mandible; *mxp.* maxillary palp; *pth.* prothorax; *msth.* mesothorax; *mtth.* metathorax.

Fig. 335. Body louse, *Pediculus humanus*. After Imms.

The louse has been found to lay about ten eggs daily, depositing in all about three hundred. Temperature plays a big part in controlling the development of these animals. Under average conditions, the life cycle is completed in about three or four weeks.

## Order THYSANOPTERA (Thrips)

Minute insects with asymmetrical piercing mouth parts; prothorax large and free; tarsus two- or three-jointed with terminal protrusible vesicle; two pairs of similar wings, provided with a fringe of prominent long hairs, veins few or absent; metamorphosis slight, including an incipient pupal instar.

These insects are for the most part plant feeders, a few being carnivorous. They are regarded as serious pests in that they rob the plant of sap. They also often cause malformations and in some cases inhibit the development of fruit. Parthenogenesis is of frequent occurrence. In the case of the pea thrips, *Kakothrips robustus*, the eggs are inserted in the stamen sheath of the flower and the nymphs emerging feed on the young fruit, inhibiting its growth. Later they feed on the soft tissues of pea pods, causing scar-like markings. The nymphs leave the plant and bury themselves deeply in the ground, where they remain till the following spring, when they pupate. Common thrips of importance are *Taeniothrips inconsequens* of pears and *Anaphothrips striatus* of grasses and cereals.

## Subclass ENDOPTERYGOTA

## Order NEUROPTERA

(Alder flies, lacewings, antlions)

Rather soft-bodied insects with biting mouth parts; two similar pairs of membranous wings held in a roof-like manner over the body when at rest. The wings have a primitive type of venation, a distinguishing feature being the ladder-like arrangement of veins along the anterior border. The abdomen is without cerci. The larvae are invariably carnivorous—campoideiform, with biting or suctorial mouth parts. Aquatic larvae usually possess abdominal gills.

The alder fly, *Sialis*, may be taken as an example with an aquatic larva. In June and July the adults fly rather sluggishly in the neighbourhood of water. They lay eggs in clusters on grass blades and leaves overhanging water, and the larvae on hatching

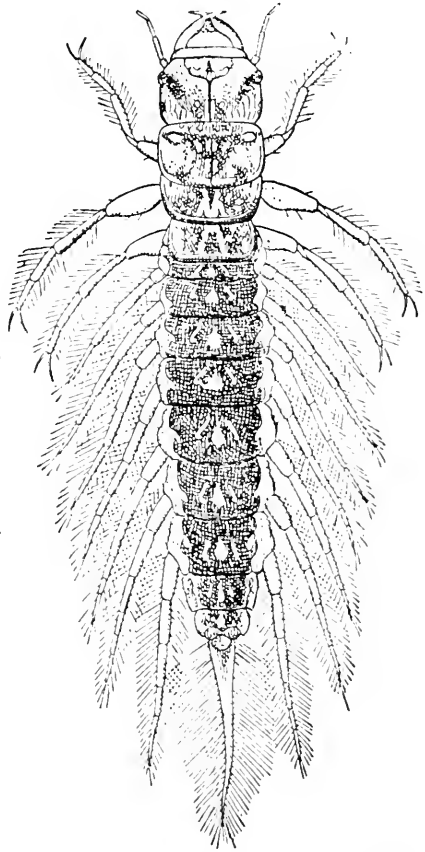

Fig. 336. Larva of *Sialis lutaria*.  
From Imms, after Lestage.

fall into the water. In this larva (Fig. 336), more than in any other, the paired segmented tracheal gills on the abdomen show a great resemblance to paired limbs. Pupation takes place in the moist earth near the water's edge. The larva of *Sialis* differs from those of the majority of Neuroptera in that its mouth parts are of the biting type, whereas in antlion larvae and the larvae of lacewings, etc., the mouth parts are adapted for piercing the skin and sucking the juices of animal prey. For this purpose, the points of the mandibles and maxillae are used for piercing, and the mandibles, being grooved, form with the closely fitting maxilla a tube up which the fluid is drawn. The carnivorous habit of neuropterous larvae plays an important part in insect pest control, for example, larvae of lacewing flies feed largely on aphides.

#### Order MECOPTERA (Scorpion flies)

A small order of insects distinguished by their vertically directed and elongated head capsule carrying the biting mouth parts at its end; two pairs of similar wings with a simple venation in which a number of cross veins divide the whole area into a number of nearly equal rhomboidal cells.

The male genitalia are prominent and the terminal segments of the abdomen carry them in a dorsally curved position in the manner of the scorpion's tail. The eruciform larvae are caterpillar-like and may possess prolegs on all segments of the abdomen. This feature, together with the presence of a large number of ocelli on the head (there may be twenty or more on each side), readily distinguishes these larvae from those of the Lepidoptera.

*Panorpa communis*, the common English scorpion fly, lays eggs in crevices in the soil and the larvae hatching from these feed on decaying organic matter. Pupation occurs in an earthen cell and the life cycle is an annual one. Much information is still wanting on the life histories of the members of this order.

#### Order TRICHOPTERA (Caddis flies)

Medium-sized insects with bodies and wings well clothed with hairs; mandibles vestigial or absent; maxillary and labial palps well developed; two pairs of membranous wings, with few cross veins and held in a roof-like manner when at rest.

The eruciform larvae are aquatic and usually live in cases formed of such material as particles of wood, sand, small shells, etc. A pair of hooked prolegs on the last abdominal segment which assists in adhering to the case is a characteristic feature.

The eggs are laid in or near water and the larvae quickly cover

themselves with some foreign substance (Fig. 337), building a form of tube from the wide end of which the head projects. Respiration is effected by tracheal gills generally found on the abdomen, water currents being passed through the tubular case by the undulatory movements of the body. The larvae may be herbivorous or carnivorous. Pupation usually takes place within the case after the openings to the case have been closed by silk. The pupa is provided with large mandibles by means of which it releases itself before the emergence of the adult. The free pupa swims to the water's edge by means of its mesothoracic legs and shortly afterwards the adult emerges. Common caddis flies are *Phryganea*, *Limnophilus* and *Rhyacophila*.

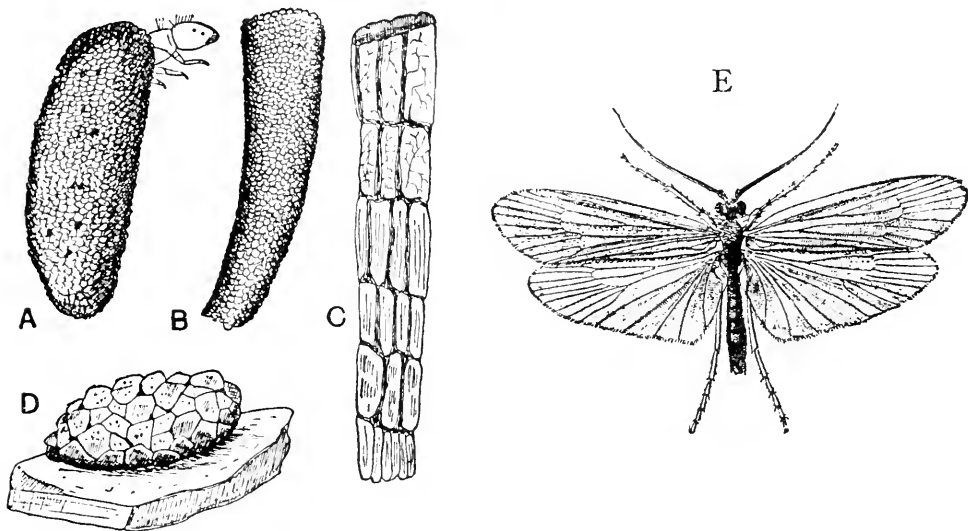

Fig. 337. A, B, C, D, Cases of Trichoptera. A, *Hydroptila maclachlani*. B, *Odontocerum*. C, *Phryganea*. D, *Hydropsyche*, pupal case. E, *Halesus guttatipennis*. After Imms.

#### Order LEPIDOPTERA (Butterflies and moths)

Mouth parts of the imago usually represented only by a sucking proboscis formed by the maxillae; two pairs of membranous wings, clothed with flattened scales, as also is the body; metamorphosis complete; larvae eruciform with masticating mouth parts, with three pairs of legs on the thorax and often five pairs of prolegs on the abdomen; pupae obtect, either enclosed in a cocoon or an earthen case, or free.

The imagines live on the nectar of flowers, and to absorb this a highly specialized proboscis has been formed from the greatly elongated galeae of the maxillae, each being grooved along its inner face and locked to its neighbour (Fig. 338). The laciniae are atrophied and the maxillary palp is usually much reduced. The mandibles are

nearly always absent and the labium is represented by a transverse plate and a pair of three-jointed palps.

Each half of the proboscis is a tube in itself into which passes blood from the head, and also a trachea and a nerve. Across the cavity of this tube there pass a number of diagonal muscles, the contraction of which causes the whole organ to roll up into its characteristic position beneath the head and thorax (Fig. 339). How the proboscis is extended is not fully understood; in all probability, blood pressure plays an important part.

The length of the proboscis in many cases corresponds to the depth of the corolla of the flower which the species frequents, and in the *Sphingidae* (hawkmoths) is greater than that of the body. Sometimes

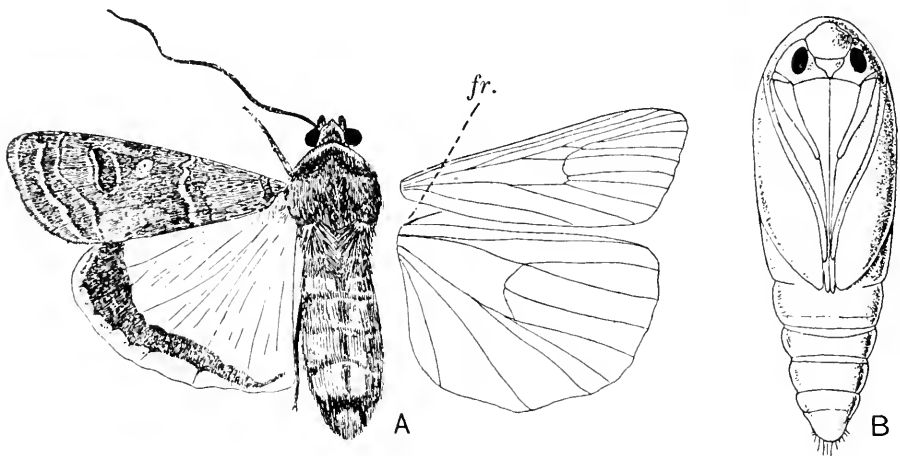

Fig. 338. A, *Tryphaena pronuba*, with venation and frenulum (*fr.*); ♂ condition on right. Original. B, Obtect pupa of *Platyhedra gossypiella*. After Metcalf and Flint.

the organ is reduced or absent and the animal does not then feed in the adult state at all.

The beginnings of the proboscis can be traced in primitive forms. In the *Micropterygidae* there are biting mandibles and maxillae of the type usually found in insects which masticate their food: in *Micropteryx* there is no proboscis, the animal feeding on pollen; in *Eriocrania* the mandibles are non-dentate, the laciniae are lost and the galeae form a short proboscis.

The characteristic feature of the wings is the clothing of scales (Fig. 338). These latter are formed by enlarged hypodermal cells, and their main function appears to be the presentation of colour due either to striation of the surface causing interference colours, or in lesser degree to the pigment they contain (like the uric acid of the Pieridae). There also occur "scent scales" which may have a sexual

significance. Several methods of wing coupling have been developed independently in the order. In addition to the type already referred to on p. 429 and consisting of *frenulum* and *retinaculum*, there is the further method met with in the ghost moths in which a jugal lobe from the fore wing engages the anterior border of the hind wing. In other forms there is neither frenulum nor jugum and the wings are

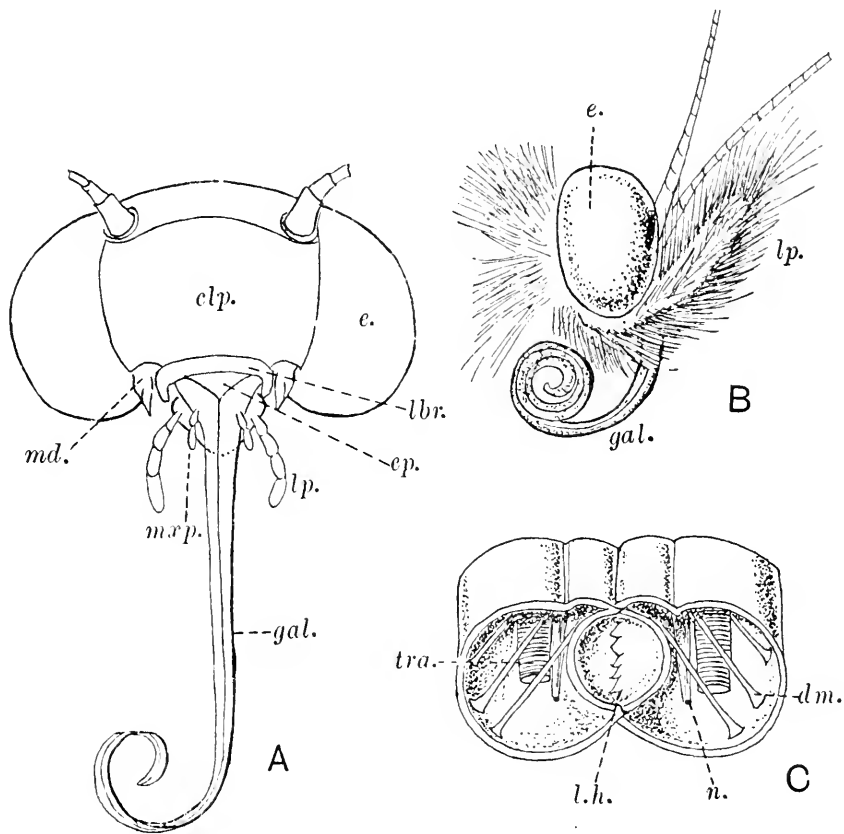

Fig. 339. Head and proboscis of a moth. A, Front view. B, Side view. After Metcalf and Flint. C, Transverse section of proboscis. After Eltringham. *clp.* clypeus; *dm.* diagonal muscles; *e.* eye; *ep.* epipharynx; *gal.* galea; *lbr.* labrum; *l.h.* locking hooks; *lp.* labial palp; *md.* mandible; *mxp.* maxillary palp; *n.* nerve; *tra.* trachea.

coupled by a considerable overlap of the two wings of a side, e.g. the butterflies (*Papilionina*).

In the females of certain Lepidoptera the wings are totally lost and the animals are confined to the food plant on which they spend their larval life. The male is attracted to the female, under these circumstances, by scent.

Lepidopterous larvae (Fig. 344 A-C) have three thoracic and ten abdominal segments with nine pairs of spiracles situated on the pro-

thorax and first eight abdominal segments. The mandibles are typically strong and dentate; the maxillae are stumpy and consist of a cardo, stipes and single maxillary lobe with a two- or three-jointed palp: the labium has a large mentum, a prementum bearing a median spinneret and small two-jointed palps.

The thorax bears three pairs of legs, and the abdomen five pairs of prolegs on segments 3-6 and 10. Such prolegs are different from the typical insect limbs, being conical and retractile with hooks on the apex (Fig. 344 C). In many families there are less than five pairs of prolegs, and in *Micropteryx* there are eight pairs.

These larvae feed almost exclusively on flowering plants (exceptions being the Lycaenid caterpillars which are carnivorous, feeding on aphides or entering ants' nests and devouring the larvae). Their digestive enzymes are modified for dealing with plant tissues.

The pupa, which is disclosed after the last larval moult, is usually protected by a cocoon previously prepared by the larva. In the case of Tortrix moths the cocoon is largely composed of leaves drawn together by silk strands. In others, e.g. the silkworm moth, *Bombyx mori*, it is composed of silk and from it the silk of commerce is prepared. Agglutinated wood particles form a hard cocoon in the puss moth, *Dicranura*. In *Pieris*, the pupa is naked and attached to the substratum by the hooked caudal extremity, the *cremaster*, and by a delicate girdle of silk about its middle. In the most primitive forms (e.g. Micropterygidae) the pupae are free, their segments are free to move and the appendages are not fused to the body. Obtect pupae, in which only few segments are movable and the appendages are fused to the sides of the body, are most common, e.g. *Platyhedra* (Fig. 338 B). Free or incompletely free pupae often emerge from the cocoon before the emergence of the adult.

Lepidoptera are almost invariably harmful in the larval stage, few plants being free from their attacks, and some of the world's most serious insect pests, such as the cotton bollworm, *Platyhedra gossypiella*, and the gypsy moth, *Porthetria dispar*, are included in this order.

The order is divided into two suborders. In suborder I, *Homonera*, the fore and hind wings have venations which are almost identical. To this primitive feature may be added that of the included family Micropterygidae whose mouth parts are mandibulate and the structure of whose maxillae and labium are easily comparable with those of the cockroach.

The ghost moths or swifts (*Hepialidae*) are also included in this suborder. These nocturnal insects have vestigial mouth parts and short antennae. Their jugate type of wing coupling has already been described. In certain species, e.g. *Hepialus humuli*, the female searches



for the male prior to mating. The larvae live in the ground and are white and hairless.

The second suborder, *Heteroneura*, is more specialized in that the venation of the hind wing has undergone reduction and so presents a venational form very different from that of the *Homoneura*. Here are included the vast majority of moths and all butterflies. Since the families are distinguished largely on venational characters no attempt will be made to deal with them in a classificatory scheme.

Among the numerous families of this suborder may be mentioned the Tineid moths—small species still retaining maxillary palpi and possessing narrow fringed wings, with a frenular bristle on the hind wing for coupling purposes. *Tinea biselliella* is one of the clothes moths whose larvae can live on the keratin of woollen goods.

The goat moths (*Cossidae*) are large moths without maxillary palps and with a frenular coupling apparatus. These are nocturnal, and lay their eggs on trees. Their larvae tunnel in timber, e.g. *Cossus*.

*Ephestia* the flour moth and *Plodia* the meal moth are most important as pests of stored products, while *Chilo* is a form whose larva bores into the shoots of the sugar cane in India. *Galleria* the wax moth inhabits beehives in most parts of the world, having become artificially distributed. These belong to the family *Pyralidae*.

Hawk moths (*Sphingidae*) are large stoutly-built moths whose fore wings are much larger than the hind ones. A further feature is the obliquity of the outer margin of the wings. The proboscis is long and the antennae, which are thick, end in a hooked tip. The larvae have ten prolegs and usually bear an upturned spine or process on the back of the last segment.

Of slender build are the geometer moths (*Geometridae*). They are weak in flight and a coupling mechanism is not always present on the wings. Some species, e.g. *Cheimatobia* the winter moth, are wingless as females. The family gets its name from the fact that in most of the larvae, prolegs are borne by segments six and ten of the abdomen only. Such larvae, in consequence, walk by looping the body, bringing the hind segments near to the thoracic and so appear to be measuring distances along the surface walked upon.

The owl moths or *Noctuidae* are the most dominant family of the order. They usually fly at night and to this fact is related their sombre colouring which assimilates the insects to their surroundings when resting during the day. The larvae are almost hairless, and in such forms as pupate in the ground the pupa is naked. *Tryphaena pronuba* (Fig. 338) is a common species whose larvae devour roots. The larvae of nearly related species known as cut worms and army worms rank among the worst insect pests of North America.

In the above mentioned forms, collectively known as moths, the

antennae taper to a point and the frenular coupling apparatus is common. The remainder forming the superfamily *Papilionina* may be grouped for convenience as butterflies, whose antennae are clubbed and on whose wings there does not occur a frenulum.

Here are found the Whites, e.g. *Pieris*, the larvae of many of which are restricted to a cruciferous diet, and the Blues and Coppers in which the metallic colouring on the wings and the larvae tapering towards both extremities are distinguishing features. There are also the Swallow-tails, e.g. *Papilio*, in which the hind wings are commonly extended into tail-like prolongations. Finally may be mentioned the skippers, so-called because of their erratic darting flight quite distinct from the sustained flights of other forms.

#### Order COLEOPTERA (Beetles)

Biting mouth parts; fore wings modified to form horny *elytra* which meet along the mid-dorsal line; hind wings membranous—folded beneath the elytra—often reduced or absent; prothorax large and mobile; mesothorax much reduced; metamorphosis complete, larvae (see p. 457) campodeiform or eruciform or, more rarely, apodous.

In the larvae the head is well developed (Fig. 318) and the mouth parts are of the biting type, resembling those of the adults. The most primitive larvae are those of the *campodeiform* type (found for instance among the *Cicindelidae* (tiger beetles), *Carabidae* (ground beetles) and the *Staphylinidae* (rove beetles)). They are very active in movement and often predaceous, with well-developed antennae and mouth parts, and chitinized exoskeleton. In the *eruciform* type (Fig. 318 B), found among plant-eating forms like the lamellicorn beetles, the legs are shorter, and the animal much less active in its search for food, the body bulkier and cylindrical. Finally there is the *apodous* type which is found in the *Curculionidae* (the weevils), in which not only are the thoracic legs lost but the antennae and mouth parts are reduced (Fig. 318 C). The apodous and eruciform larvae usually live inside the soft tissues of plants or beneath the soil attached to roots.

The relation which these larval forms bear to one another is indicated by the larval stages passed through in the life history of the oil beetle, *Meloë*, the larvae of which are parasitic on solitary bees of the genus *Andrena*. The first instar is known as the *triungulin*. This is an active campodeiform larva which attaches itself to its host after searching actively for it. The second instar which is enclosed with an abundance of honey in the cell of the bee is intermediate in form between the campodeiform and the eruciform types, legs being present, but very small. The third stage is a legless maggot. From this series it may be inferred that the form of larva in Coleoptera is related to the ease or difficulty with which food is obtained.

In such a large order of insects it is to be expected that all manner of habit and food will be found. Beetles occur in large numbers in water, soil, and plant tissues. Circumscribed environments like dung, rotting vegetation, wood and fungi are never without prominent coleopteran associations. A large number, such as many coccinellids (lady birds), carabids, e.g. *Carabus violaceus*, and staphylinids, e.g. *Ocypus olens*, are carnivorous and to this extent useful insects. On the other hand, among the phytophagous forms are to be found some of the most serious agricultural pests, the boll weevil, *Anthonomus grandis*, causing so much damage to the cotton crop in America that it has

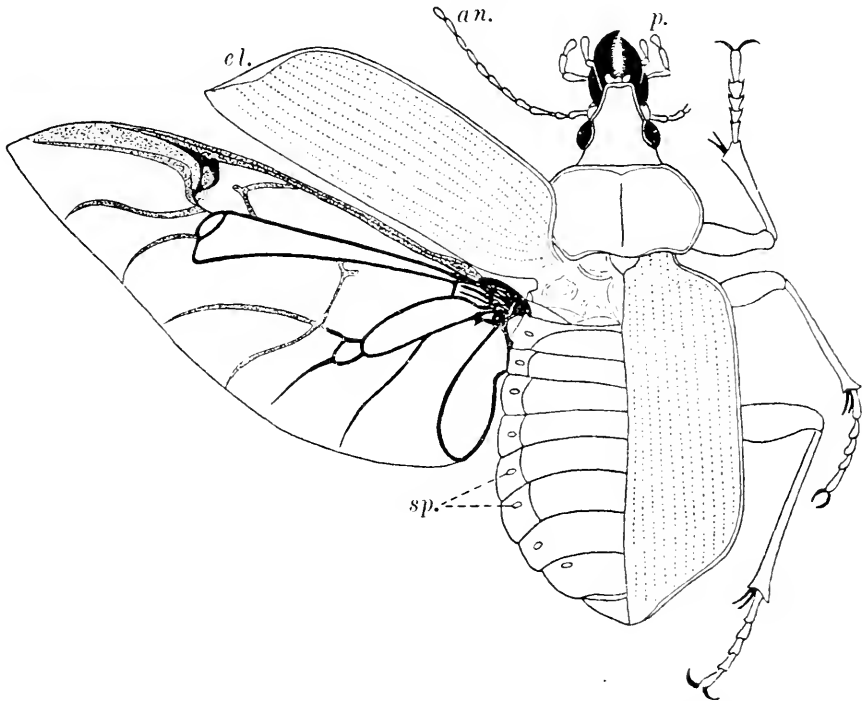

Fig. 340. External anatomy of *Calosoma semilaeve*, with left elytron and wing extended. After Essig. *an.* antenna; *el.* elytron; *p.* palp; *sp.* spiracles.

been seriously proposed to cease growing cotton for a period of time in order to eradicate this pest. A large number cause considerable damage to timber, probably the most notable being *Xestobium rufo-villosum*, the death-watch beetle, destructive to structural timber.

The order falls into two suborders, the *Adephaga* and the *Polyphaga*.

The *Adephaga* are distinguished by filiform antennae, a five-jointed tarsus and a larva of the campodeiform type, with a tarsus bearing two claws.

To this group belong those families including the large water beetle *Dytiscus*, the ground beetles *Carabus* and *Calosoma* (Fig. 340), the tiger beetle *Cicindela*, and the aquatic whirligig beetles *Gyrinus*.

The second suborder, the *Polyphaga*, includes a large number of families grouped into several superfamilies the members of which show much variation. There is a tendency towards reduction in the number of tarsal joints from five to three, and though some forms possess filiform antennae, clavate (clubbed), geniculate (elbowed),

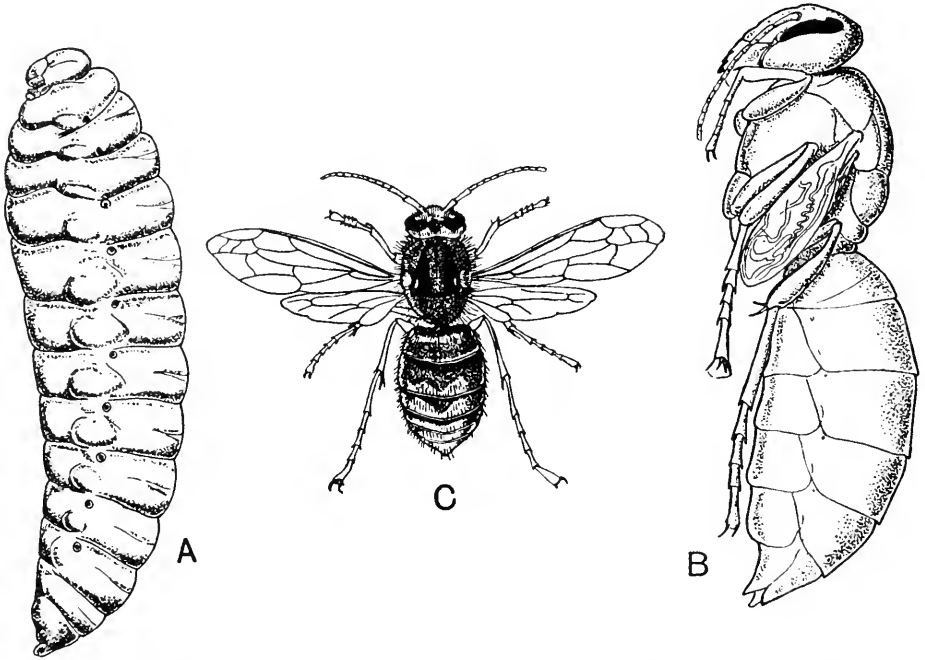

Fig. 341. The hornet, *Vespa crabro*. A, Larva. B, Pupa. C, Adult ♂.

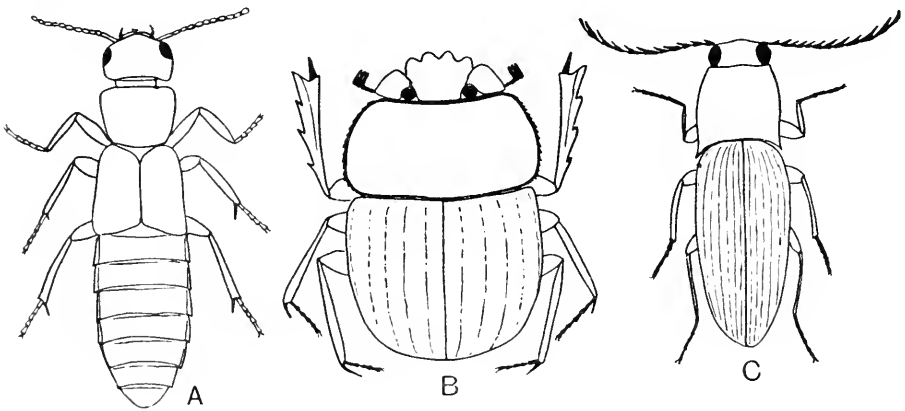

Fig. 342. Three types of Coleoptera. A, *Ocypus olens* (Staphilinidae). B, *Scarabaeus Thomsoni* (Scarabaeidae). C, *Corymbites cupreus* (Elateridae).

and lamellate (segments extended to form a “book” of closely arranged leaves or lamellae) antennae occur, as in the *Coccinellidae*, *Curculionidae* and *Scarabaeidae* respectively. Larvae vary from the

campodeiform to the legless grub, but where a tarsus is present it invariably carries only one claw.

The *Staphylinidae* range from carnivorous to phytophagous forms, and, as adults, are characterized by the short elytra which leave the abdomen exposed. The larvae are campodeiform, closely resembling those of ground beetles, e.g. *Ocypus* (Fig. 342 A). *Meloidae* or oil beetles also have short elytra but these being wider at the base than is the prothorax are readily distinguished from members of the staphilinid group. The interesting changes undergone by their larvae during metamorphosis have already been mentioned.

The *Chrysomelidae* or leaf beetles are exclusively phytophagous. Their bodies are rounded and smooth, and are often high-coloured with a metallic lustre. Antennae of these beetles are filiform and relatively short (e.g. *Phyllotreta*, the flea beetle).

Weevils belonging to the family *Curculionidae* are easily distinguished by their greatly extended head, forming a rostrum at the end of which mouth parts are borne. *Anthonomus grandis* the cotton boll weevil of America, and *Ceuthorrhynchus* the turnip gall weevil, are typical examples. The larvae are apodous.

The chafer beetles (*Scarabaeidae*), Fig. 342 B, have lamellate antennae. Their legs are often fossorial and bear four-jointed tarsi. Characteristic of these is the fat bodied eruciform larva, almost incapable of movement, and which feeds on roots, e.g. *Melolontha* (Fig. 318). *Aphodius* is a dung beetle whose larva develops in the faecal matter of farm animals.

The family *Coccinellidae* (ladybirds) is of extreme importance, its members being carnivorous in young and adult stages, aphids and scale insects figuring very largely in their diet. The beetle is smooth and rounded, with head concealed beneath the prothorax. The four-jointed tarsus appears to possess only three joints, owing to the small concealed third joint, e.g. *Coccinella* of Europe. *Novius cardinalis* is a classical example of a predatory insect being used in the biological control of the scale-insect, *Icerya purchasi*, of citrus trees.

#### Order HYMENOPTERA (Bees, wasps, ants, sawflies, etc.)

Mouth parts adapted primarily for biting and often secondarily for sucking as well; two pairs of membranous wings coupled together by hooklets fitting into a groove, hind wings smaller; 1st segment of the abdomen fused to the thorax, and a constriction behind this segment commonly found; an ovipositor always present, modified for piercing, sawing, or stinging; metamorphosis holometabolous; larvae generally legless, more rarely eruciform, with thoracic and abdominal legs; pupae exarate, protected generally by a cocoon.

This order is remarkable for the great specialization of structure exhibited by its members; for the varying degrees to which social life has developed, and for the highly evolved condition which parasitism has reached.

Specialization of structure is evidenced in the mouth parts of the

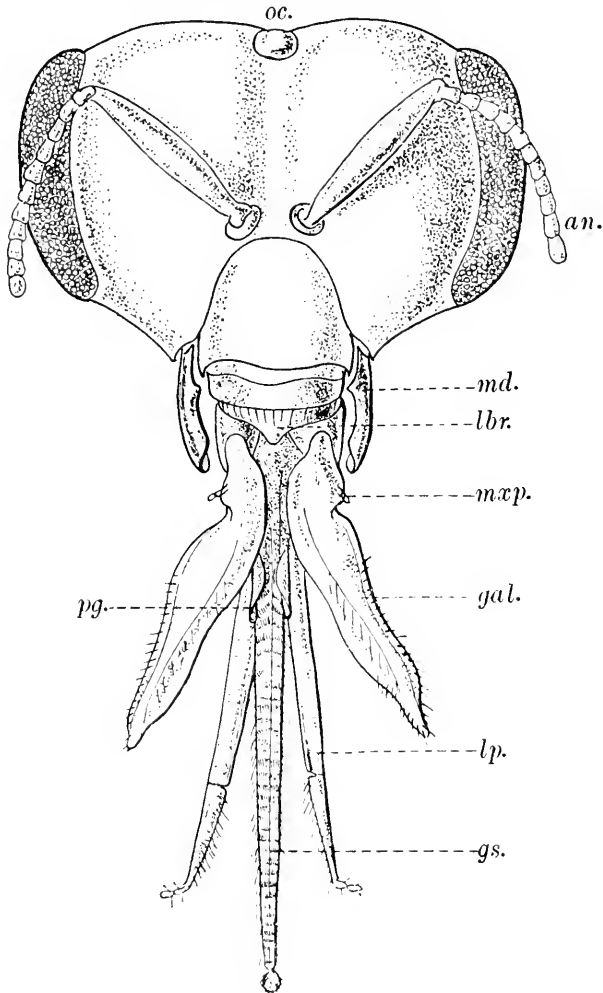

Fig. 343. Head and extended mouth parts of the honey bee, *Apis mellifica*. After Cheshire. *an.* antenna; *gal.* galea; *gs.* glossa; *lbr.* labrum; *lp.* labial palp; *md.* mandible; *mxp.* maxillary palp; *oc.* ocellus; *pg.* paraglossa.

Hymenoptera. The biting mouth parts of the phytophagous and carnivorous sawflies closely resemble those of the cockroach. In the wasps, e.g. *Vespa*, which are predaceous, the mouth parts are adapted for licking as well as for biting. The maxillary laciniae are reduced but the galeae are enlarged into broad setose membranous lobes which absorb juices. A correspondingly large bilobed glossa occurs on the labium.

The next important line of evolution is that concerned with the development of a mechanism for obtaining juices from deeply placed nectaries of flowers. For this purpose, e.g. in *Apis*, the honey bee (Fig. 343), a complicated tubular proboscis is formed. The glossae of the labium have become fused and elongated, the paraglossae remaining small. The labial palps enclose the fused glossae (median

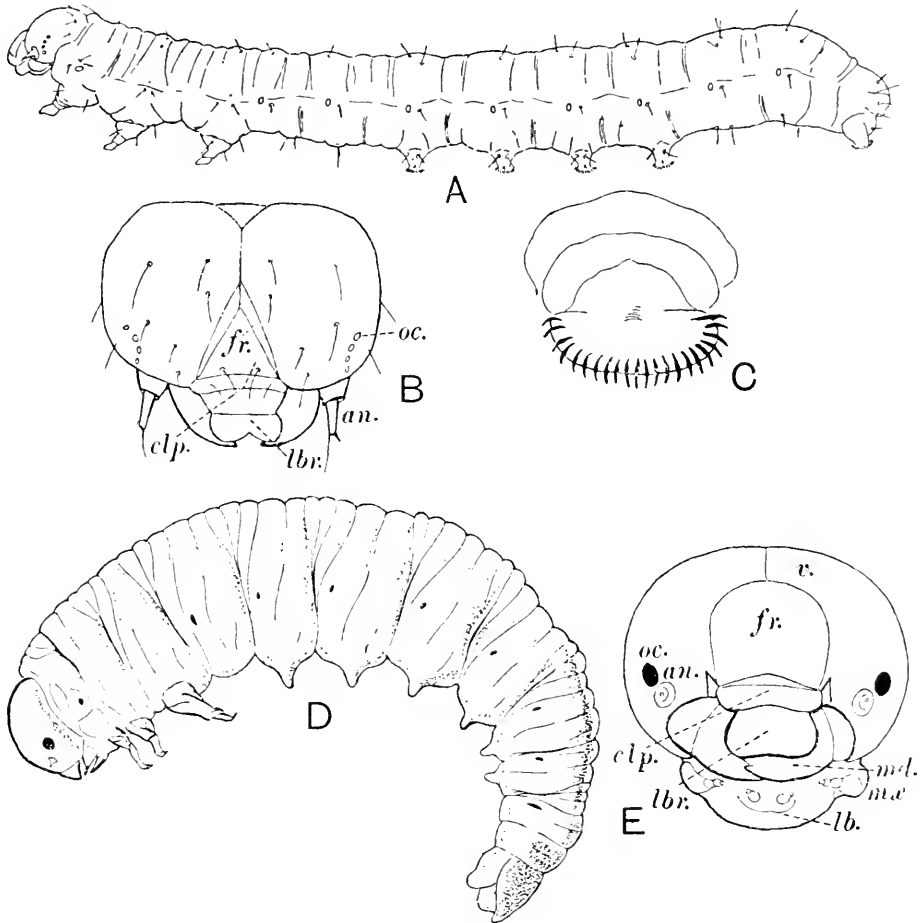

Fig. 344. Caterpillar of Lepidoptera, A, B, C, and of Hymenoptera, D, E. A, Larva of *Tryphaena pronuba*. B, Its head capsule. C, An abdominal leg. D, Larva of apple sawfly, *Hoplocampa testudinea*. E, Head capsule of latter. *an.* antenna; *clp.* clypeus; *fr.* frons; *lb.* labium; *lbr.* labrum; *md.* mandible; *mx.* maxilla; *oc.* ocellus; *v.* vertex.

lobes of the labium), they being concave on their inner surfaces. Outside these the large hood-like galeae of the maxillae form an additional enclosing jacket.

The glossa is grooved along its dorsal surface and fluid passes up this by capillarity, assisted by movements of the proboscis. It is finally pumped up by pharyngeal action, the labial palps and maxil-

lary glossae undoubtedly playing an important part in maintaining a complete tube. The mandibles are now no longer biting organs but tools used for manipulating material such as pollen and wax. Such a feeding mechanism is the climax in an evolutionary process which has involved in succession the fusion of the glossa lobes, as in the sawflies, the lengthening of the basal joints of the labium and maxilla as in *Colletes*, and finally the elongation of the glossa, e.g. *Apis* and *Bombus*.

The highly complex *social life* found in the bees, ants and wasps, in which caste development is a feature of prime importance, is foreshadowed in the interesting behaviour of solitary wasps and bees. The supply of food to the larva by *progressive feeding*, instead of *mass provisioning*, appears to enable the parent to become acquainted with its offspring, and this establishment of family life may be regarded as the forerunner of the complex social state of higher forms.<sup>1</sup> A second important feature in the development of social life has been the phenomenon of *trophallaxis*. Among wasps, for instance, the worker taking food to a grub receives in turn a drop of saliva from the grub. This is eagerly looked for by the workers, and it is suggested that it is the mutual exchange of food between young and adult which engenders in the adult an interest in the welfare of the colony. A third important feature in social development has been the exploitation of a particular form of food material which can be obtained in large quantities, e.g. pollen and honey.

The phenomenon of parasitism (Fig. 345) is highly developed in the Hymenoptera; Ichneumons, Chalcids and Proctotrypids being almost entirely parasitic. Almost all orders of insects are affected by the activities of these very important insects, egg, larval, pupa, and adult stages being parasitized.

From the foregoing it will be seen that some of the most important insects are included in this order. The sawflies are important as agricultural pests. Flower-visiting bees are of great value in the pollination of flowers. Carnivorous wasps do good by devouring other insect pests such as aphides, while to a large extent the parasitic Hymenoptera are useful in checking the depredations of phytophagous insects.

Two main types of larvae are found in this order, the legged larva of the sawflies (Fig. 344D) and the legless form of bees, wasps and ants (Fig. 341A). The sawfly larva has a superficial resemblance to the lepidopterous caterpillar, but is distinguished by its single pair of

<sup>1</sup> In English species of the wasp *Odynerus* the egg is laid in a cell and sufficient caterpillars stored to serve as food for the whole of the larval life (*mass provisioning*). Certain African species of this genus supply their growing larvae from day to day with fresh caterpillars (*progressive feeding*).



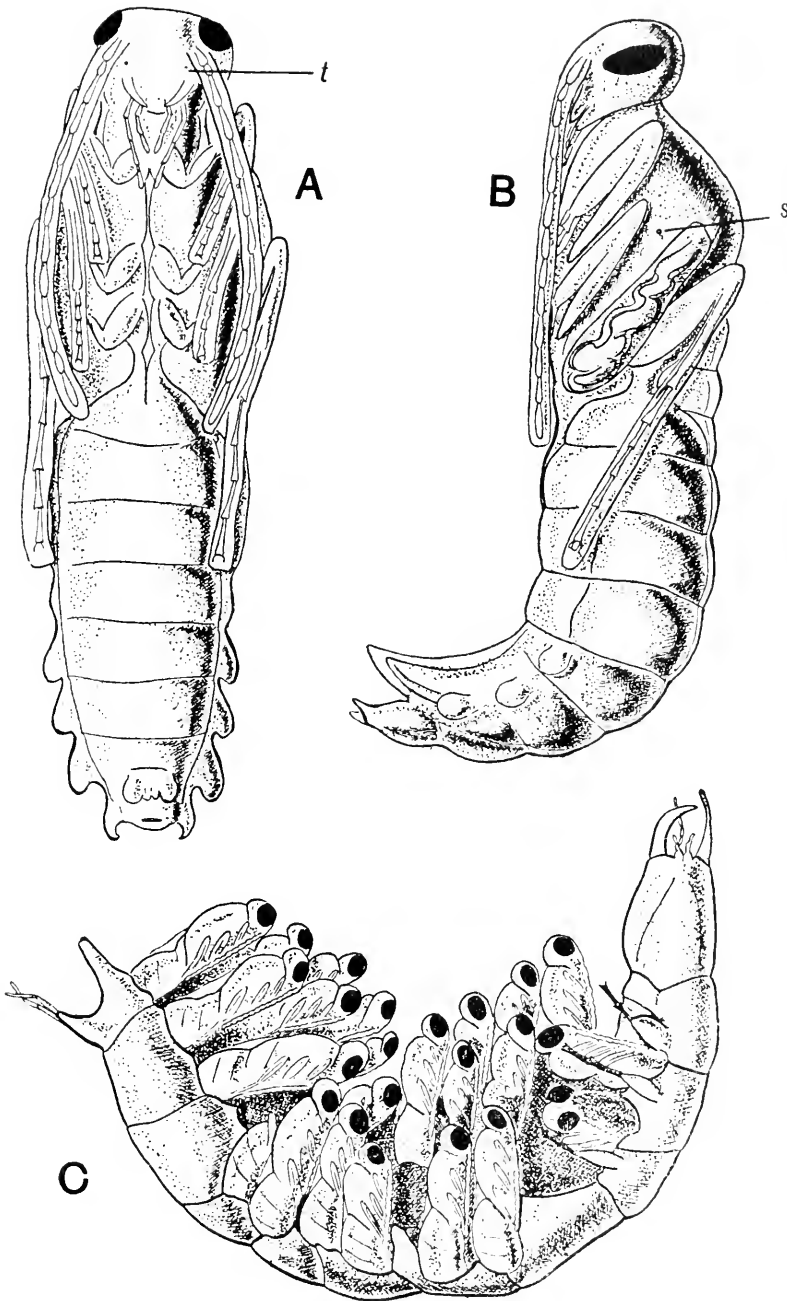

Fig. 345. A and B, Exarate pupae of *Phaenoserphus viator*. C, Pupae of same projecting from empty skin of host, the ground beetle larva, *Pterostichus*. After Eastham. s, spiracle; t, invagination to form tentorium.

ocelli and the absence of crotchets or spines on the abdominal legs. The prolegs of the abdomen occur on different segments in the two forms under consideration as reference to Fig. 344 clearly shows.

The order falls naturally into two suborders, the *Symphya* and the *Apocrita*.

Suborder I, the *Symphya*, includes those species with the most generalised form, both as adults and as larvae. None of them show the highly specialised habits and instincts which characterize most of the remaining suborder, and with few exceptions they are phytophagous. The first abdominal segment is not perfectly fused to the metathorax nor is the fusion accompanied by the constricted waist so characteristic of the remaining Hymenoptera (Fig. 346 D). The ovipositor is used in oviposition as a saw or drill for piercing plant tissues. The trochanter is two-jointed. Larvae are eruciform (Fig. 344 D) and in addition to thoracic legs, certain of the abdominal segments often carry prolegs devoid of distal spines or crotchets.

To this group belong the wood-wasps, the ovipositors of which are used as a drill for perforating growing timber, in which the eggs are laid. The six-legged, strong-headed larva bores through the wood (in the case of *Sirex gigas*, this stage lasts as long as two years), pupation occurring near the surface of the affected timber, from which the adult bites its way out. The sawflies (Fig. 346 D), with saw-like ovipositors, are most important as agricultural pests, and are distinguished from the wood-wasps by their softer bodies, their smaller size, and by the presence of two apical spurs on the anterior tibiae, e.g. *Nematus ribesii* the gooseberry sawfly.

The second suborder, the *Apocrita*, includes all the remaining Hymenoptera. The second abdominal segment is invariably constricted to form a narrow waist or petiole, the first segment being firmly amalgamated with the thorax (Fig. 346). Larvae are apodous when full grown.

Ichneumon flies (Fig. 346 A) are distinguished by their slender curved antennae, and by the stigma on the wing. The ovipositor is long and issues far forwards beneath the abdomen. The larvae of Lepidoptera and of sawflies are their commonest hosts. *Rhyssa* parasitizes the larvae of *Sirex*.

Cynipid flies have similarly slender antennae, but by the absence of the stigma on the wing, and by their reduced venation are easily distinguished from the foregoing. Many of these are plant gall-formers, e.g. *Neuroterus* responsible for oak galls, and *Rhodites* for the pin-cushion galls of roses. Others, e.g. *Eucoila*, are parasitic on fly larvae.

Chalcid wasps (Fig. 346 B) also have a venation of the wing which is so reduced as to present no closed cells. The antennae are geniculate

or elbowed. Though most of these small wasps are parasites, e.g. of lepidopterous and dipterous larvae, and of homopterous nymphs, a

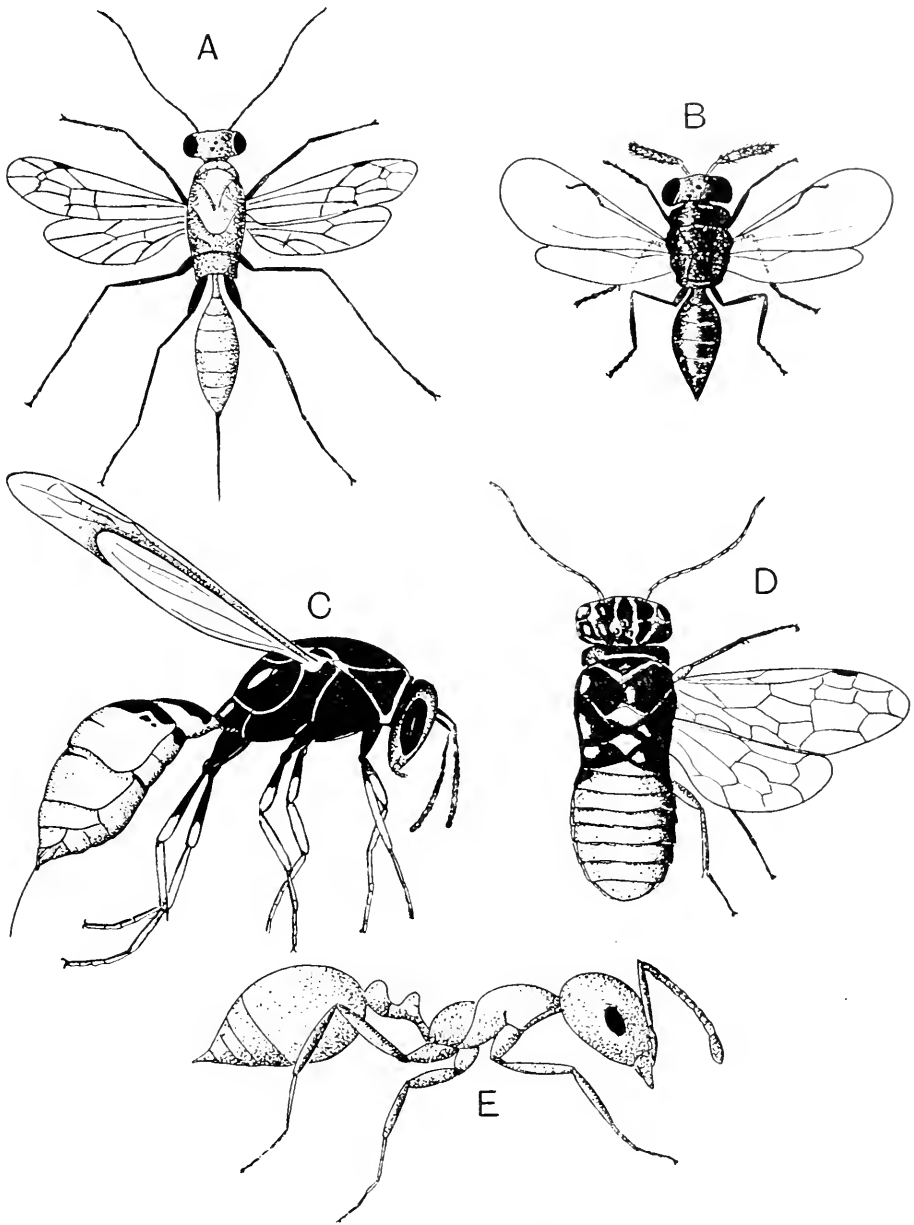

Fig. 346. Types of Hymenoptera. A, *Cryptus obscurus* (Ichneumonoidea); B, *Bruchophagus funebris* (Chalcididae), after Howard. C, *Polistes aurifer* (Vespidae), after Essig. D, *Pamphilus* sp. (Tenthredinidae), original. E, *Monomorium minimum* (Formicidae), after Essig.

few feed as larvae on plant tissues such as *Harmolita* which produces galls on grasses.

In ichneumons, chalcids and cynipids the ovipositor issues far forwards beneath the abdomen, and these insects differ in this feature from the *Proctotrypidae* in which the ovipositor is terminal. Dipterous larvae are often parasitized by these insects, as are also the eggs of Orthoptera and Hemiptera. Many hyper-parasites, i.e. parasites of other parasites, occur in this family. *Phaenoserphus* is parasitic on carabid beetle larvae (Fig. 345), and *Inostemma* is an egg-parasite of dipterous gall midges.

Whereas parasitism is a character, largely though not wholly, common to the foregoing families, the ants, wasps and bees next to be considered show a tendency, in varying degrees, towards the development of the social habit.

The ants (*Formicoidea*) are social, polymorphic insects in which two segments are involved in the formation of the abdominal petiole. Further, this petiole is always characterized by the possession of one or two nodes (Fig. 346 E). The females are endowed with a well-developed sting, the modified ovipositor. Polymorphism reaches its highest degree of complexity in this group, as many as twenty-nine morphologically different castes having been recognized. Some of these are pathological phases due to infection by parasites, e.g. Nematode worms or other Hymenoptera. In such colonies as produce winged forms of both sexes, mating takes place during a nuptial flight in which several colonies in one neighbourhood indulge at the same time. This ensures intercrossing between individuals from different colonies. The females then cast off their wings and start colonies in the ground, each one for itself. The workers are sterile females, whose power to lay eggs in certain circumstances may return. For instance, when a colony loses a queen several workers may, under the influence of suitable diet, take her place. In addition to the environmental complexity which a social existence involves, the lives of ants are further complicated by association with other organisms. Some, e.g. certain myrmecine ants, have adopted an agricultural habit, living on fungi which they specially cultivate. Others gather seeds from which they destroy the radicle to prevent germination, special chambers or granaries in the nest being constructed for their storage. The pastoral habit characterizes others, a symbiotic relation being set up with such insects, e.g. Aphides, as exude fluids which are palatable to the ants. In addition to associations of this kind there are numerous others of an indifferent or little understood nature, but which may range from the symbiotic to the parasitic. Finally may be mentioned the slave-makers; *Formica sanguinea*, for instance, captures from the colonies of *F. fusca*, pupae which on emergence serve as slaves in the colony which has adopted them.

The wasps of the super-family *Vespoidea* are both social and

solitary in habit. In these, the abdominal petiole is smooth (Fig. 346 C) and, in species with a worker caste, this is always winged. The prothoracic tergum extends back towards the wing base. Among solitary species may be mentioned *Odynerus* which stores with caterpillars its nest in which its larvae are developing. Pompilid wasps are exclusively predatory on spiders. Certain forms have adopted the "Cuckoo" habit, laying their eggs in the nests prepared and provisioned by other species. Thus the ruby wasp *Chrysis* usurps the nest of *Odynerus*. *Mutilla* behaves similarly towards many solitary bees and wasps and has been bred out from the puparia of the tsetse fly. Social wasps, e.g. *Vespa*, live in nests commonly constructed of paper obtained in the form of wood pulp by these insect architects. The larvae living in closely arranged cells on horizontal combs are fed on insect food gathered by the workers. In early summer, our common social wasps are useful in the control of such insects as plant lice, etc. Later in the season, however, their liking for sweet fruits may make them a nuisance both in the garden and in the home. In autumn the colony perishes, fertilized females being the only survivors. *Vespa germanica* and *Vespa vulgaris* are common English wasps. *Vespa crabro* is the Hornet (Fig. 341).

Closely resembling these are those wasps belonging to the superfamily *Sphecoidea*, the distinctive feature of which is the possession of a prothoracic tergum which does not extend back as far as the wing bases. These are all solitary predaceous forms, which sting their prey and so paralyse it before placing it in the larval cells which have been previously prepared, e.g. *Sphex*. A tendency towards the social habit is exhibited by *Bembex* which leaves its larval cells open and so can provision its young from day to day on small flies.

The super-family *Apoidea* includes the social and solitary bees. Distinctive of bees are the dilated hind tarsi and the plumose hairs of the head and body to which pollen adheres. Inner metatarsal spines of the posterior legs comb the body hairs free of pollen, this being then transferred to the outer upturned spines (pollen basket) of the hind tibia of the opposite side. These legs are further adapted by possession of special spines for the manipulation of wax plates when being removed from the abdomen. The median glossa is also characteristic and in certain solitary forms, e.g. *Anthophora* and all the social bees, e.g. *Apis* and *Bombus*, is greatly elongated along with the parts other than the mandibles for gathering nectar from deep-seated nectaries of flowers. Larvae are fed exclusively on pollen, nectar and salivary fluids. *Megachile*, the leaf cutter, is a solitary bee which makes cells of neatly cut leaf fragments. Each cell containing an egg is stored with honey and pollen. Such cells are commonly made in the walls of houses, the mortar being removed for this purpose.

*Andrena* constructs burrows in the ground and, though solitary, is usually found in groups of individuals occupying a common terrain which may include a "village" of several hundred nests. *Nomada* has adopted the "cuckoo" habit.

*Bombus* enjoys a social existence similar to that of *Vespa* in that only impregnated females survive the winter.

The colony of the Honey bee *Apis mellifica* has more permanence, only the males dying off in the autumn to leave the rest of the colony to hibernate. The nest is of wax, an exudation from abdominal glands of the worker (sterile female), and a material known as *propolis* of vegetable origin serves to fasten parts of the nest together and to render the whole weatherproof.

The workers are graded according to age into *nurses*, who see to the welfare of the larvae by incorporating salivary juices with their food, *ventilators* who by wing-fanning set up currents in the nest or hive to reduce the temperature and to evaporate the honey, *scavengers* or *cleaners*, and *foragers* who collect pollen and nectar. The changes from nursery work to house work and to field work are necessitated by changes in glandular capacity as age increases. Though the density of the population of the colony determines to some extent when a queen with a number of workers will depart from the hive as a swarm, it appears that this event is also dependent on the relative proportions of the above age-groups among the working caste.<sup>1</sup>

#### Order DIPTERA (Flies)

Insects with a single pair of functional wings, the hind pair represented by stumps (halteres) (Fig. 347); mouth parts suctorial and sometimes piercing or biting, usually elongated to form a proboscis; prothorax and metathorax small and fused with the large mesothorax; metamorphosis complete, larvae eruciform and always apodous, the head frequently being reduced and retracted; pupa either free or enclosed in the hardened larval skin (puparium).

This is a very large and highly specialized order of insects. The imagines are mostly diurnal species, feeding on the nectar of flowers, but a number are predaceous, living on other insects (e.g. the robber flies), while some, e.g. Tachinids, are parasites. A further development which takes place in several families is the acquisition of blood-

<sup>1</sup> In Bees, Wasps and Ants, haploid parthenogenesis results in the production of males. A fertilized (diploid) female has control over the fertilization of eggs which she lays. If an egg is fertilized by sperm from the spermatheca a female (diploid) offspring develops. If not, a male offspring (haploid) develops. Whether the young female produced in the former case becomes a worker (sterile) or a queen (capable of fertilization) depends on nutrition. Contrast this with diploid parthenogenesis in Aphids (p. 480).

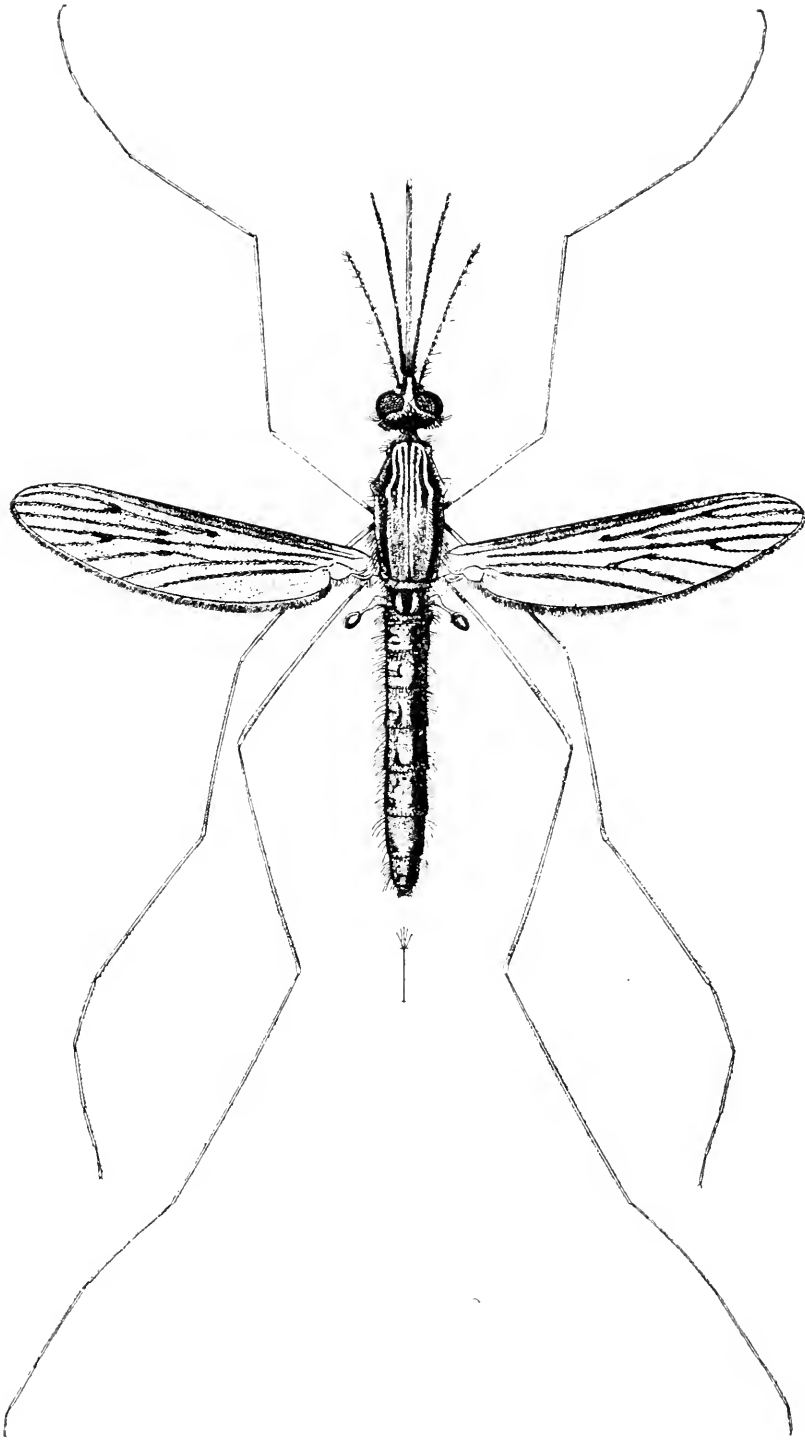

Fig. 347. *Anopheles maculipennis*, ♀. After Nuttall and Shipley.

sucking habits. The representatives of this oecological class are of great importance because they harbour and transmit pathogenic organisms, causing such diseases as malaria, sleeping sickness, elephantiasis, yellow fever and some cattle fevers.

The several kinds of mouth parts which have been developed in the Diptera have departed widely from the primitive biting type. There is always a proboscis formed principally by the elongated labium, ending in a pair of lobes, the *labella*. This labium serves as a support and guide to the remaining mouth parts which are enclosed within it (Fig. 348).

The most complete system is to be found in the gadflies, e.g. *Tabanus* and *Chrysops*. Within the groove of the labium are to be found a pair of mandibles and a pair of maxillae, sword-like piercing organs by means of which the wound through the skin of mammals is made. Into the wound so formed is inserted a tube composed of the *epipharynx*, an elongated chitinization of the roof of the mouth to which the labrum is fused, and the *hypopharynx*, a corresponding elongation of the mouth floor. The blood passes into this tube, being drawn up by the pharyngeal pump within the head. The hypopharynx carries a duct down which the salivary fluid is passed. Besides this, the proboscis of a gadfly can be used for taking up fluids exposed at surfaces. Such exposed fluid is drawn into small channels, the *pseudotracheae*, which converge to a central point on the underside of the labellar lobes. There it meets the distal end of the epi-hypopharyngeal tube, up which it passes.

The mouth parts of the female mosquito (Fig. 348 A) in principle differ from those described above only in the absence of a pseudotracheal membrane on the labellar lobes and the more slender and elongated labium. Mandibles are absent in the males, maxillae being represented only by palps in this sex. The housefly *Musca* (Fig. 348 D, E, F) has lost all piercing mechanism, mandibles being absent, maxillae only being represented by the palps, and the mouth parts consist of a folding labium with highly developed pseudotracheal membrane on the labellar lobes and prominent epi-hypopharyngeal tube. *Musca* feeds largely on fluid matter but in the presence of soluble solid food, e.g. sugar, solution is effected by regurgitating alimentary fluid on it. By means of small chitinous teeth situated round the point to which the pseudotracheae converge, surfaces of solids can be scraped so enabling enzymes in the regurgitated fluids to act rapidly.

The tsetse fly, *Glossina* (Fig. 348 B), also possesses no mandibles and only the palps of the maxillae. It does, however, feed on mammalian blood after piercing the skin. In this form the whole labium is rigidly chitinized; the labellar lobes, from which all traces of pseudotracheae have disappeared, are small and provided with



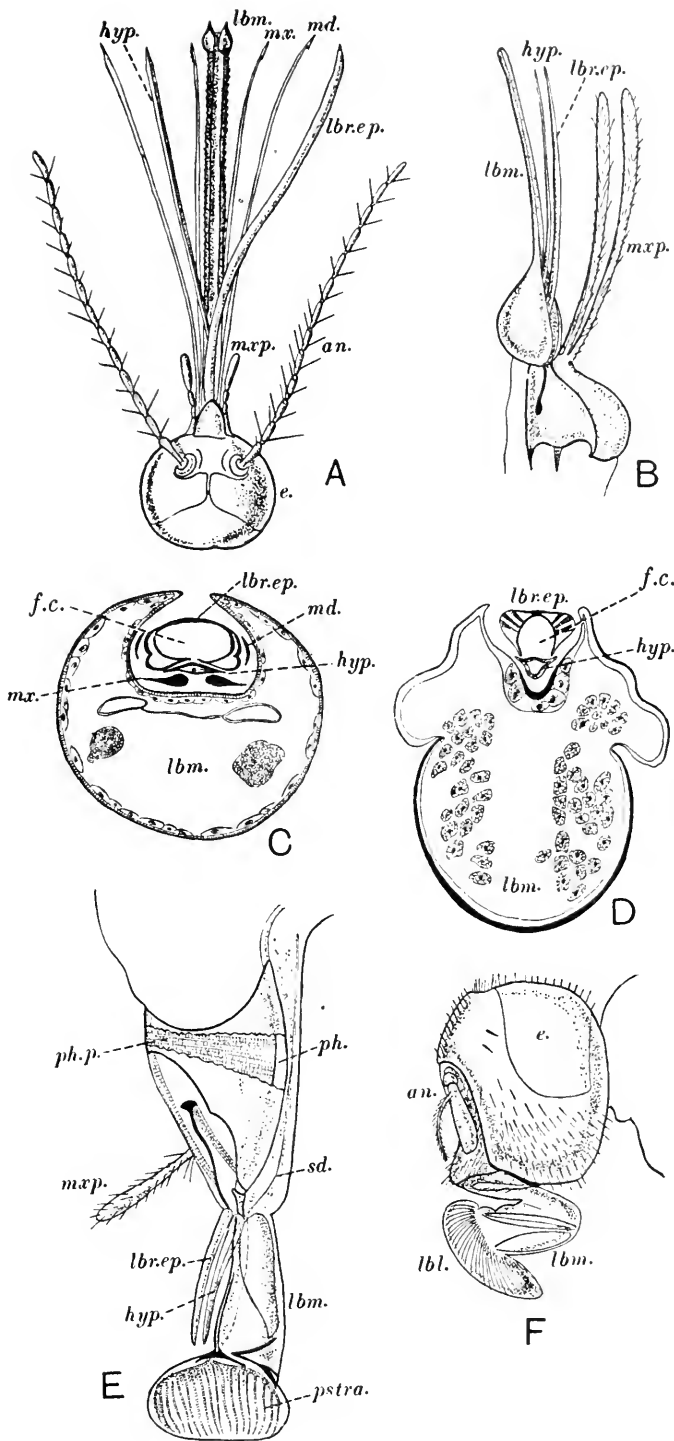

Fig. 348. Types of mouth parts of the Diptera. A, *Culex pipiens*, ♀. B, *Glossina submorsitans*. C, Transverse section through proboscis of *Culex*. D, Transverse section through proboscis of a muscid fly. E, Proboscis of a muscid fly, extended and with left labellar lobe removed. F, Proboscis of a muscid fly, half folded. *an.* antenna; *e.* eye; *f.c.* food channel; *hyp.* hypopharynx; *lbm.* labium; *lbl.* labellum; *lbr.ep.* labrum-epipharynx; *md.* mandible; *mx.* maxilla; *mxp.* maxillary palp; *ph.* pharynx; *ph.p.* pharyngeal pump; *pstra.* pseudotracheae; *sd.* salivary duct. A-D, after Patton and Cragg; E, F, original.

chitinous teeth which make the wound. Thus a second kind of blood sucking mechanism has been evolved from a form like *Musca*, which only possessed the faculty of sucking fluid from surfaces.

The larvae of Diptera are among the most specialized in the Insect Kingdom. Legs have been entirely lost, and the head and spiracular system have undergone varying degrees of reduction. Thus the most generalized larvae are at the same time *eucephalous*, i.e. with complete head capsule, and *peripneustic*, i.e. with lateral spiracles on the ab-

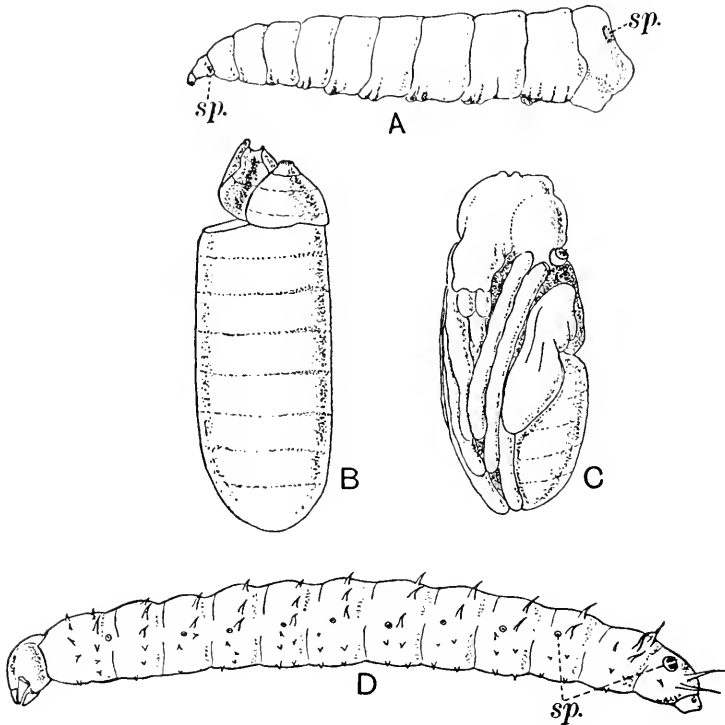

Fig. 349. Early stages of the Diptera. A, Larva of *Musca domestica*. Acephalous amphipneustic type. B, Empty puparium of *Musca domestica*. C, Pupa of *Musca domestica* removed from puparium. D, Larva of *Bibio* sp. Eucephalous peripneustic type. A, B, and C after Hewitt; D, original. *sp.* spiracle.

domen, e.g. *Bibio* (Fig. 349D). In the most specialized forms, on the other hand, we find the acephalous larva whose head capsule is entirely wanting. Such acephalous larvae may be either *amphipneustic*, with only prothoracic and posterior abdominal spiracles, or *metapneustic*, where only two spiracles are retained at the posterior end of the body. The first instar larva of *Musca* is metapneustic, subsequent instars being amphipneustic (Fig. 349A).

The eucephalous larva develops into an exarate pupa from which the adult emerges by a longitudinal slit on the thorax. The pupa

resulting from the acephalous larva, on the other hand, is coarctate, the last larval skin being retained as a protective *puparium*, tracheal connections maintaining contact between the pupa within and the larval skin outside it. Final emergence of the fly in this case clearly involves two processes, (a) the liberation of the fly from its pupal skin, and (b) its further liberation from the puparium. The latter splits transversely (Fig. 349 B), the top being thrust away by an eversible head sac, the *ptilinum*, which such flies possess. The features of metamorphosis just described are characteristic of many flies and by defining one of the suborders constitute an important basis of modern classifications (Fig. 349 C).

The suborder *Orthorrhapha* includes all those flies which are liberated by means of a longitudinal split in the mid-dorsal line of the pupal case. Such flies possess no ptilinum. Many of these, the *Nematocera*, have slender antennae and usually pendulous maxillary palpi. Their larvae are eucephalous with horizontally biting mandibles and their pupae are free. To this series belong the Crane-flies (Fig. 350 A), the larvae of which often damage cereal crops by devouring their roots. The *Culicidae* (Fig. 347) are the gnats and mosquitoes, the piercing proboscis of which has already been described. They are further distinguished by their wings which are fringed with scales. Both larvae and pupae are aquatic, the former being metapneustic, the latter propneustic (with anterior spiracles only). With the blood-sucking habit of these flies has evolved an association with certain organisms which when transmitted to man cause disease. *Anopheles* is concerned with the transmission of malaria. *Stegomyia* transmits the causative organism of Yellow Fever while *Culex fatigans*, a widely distributed tropical form, is a carrier of the thread-worm *Filaria bancrofti*, the cause of elephantiasis.

Nearly related to these are the *Chironomidae* (midges), the mouth parts of many of which are not adapted for piercing and sucking. A few of these, however, do suck blood, e.g. the midges of the genus *Forcipomyia*, whose larvae breed, some in water, others behind the bark of trees.

The *Cecidomyiidae* (Fig. 350 C) are the gall-midges distinguished by their beaded antennae adorned with whorls of setae. The larvae of a few of these are parasitic. Some are predaceous, but others, forming a large majority, are phytophagous, forming galls in plant tissues, e.g. of grasses. *Contarinia pyrivora* is the pear midge, the larvae of which develop in the flowers of the pear so as to abort fruit production. *Miastor* lives behind tree bark in the larval state and as mentioned above is noteworthy for the phenomenon of paedogenetic parthenogenesis.

Another family of blood-sucking flies, known as the *Simuliidae*,

consists of small flies with a hump-backed appearance and with broad wings. The spindle-shaped larvae live in running water and are characterized by the possession of prothoracic prolegs and an anal pad provided with setae by means of which they cling to rocks etc. in the

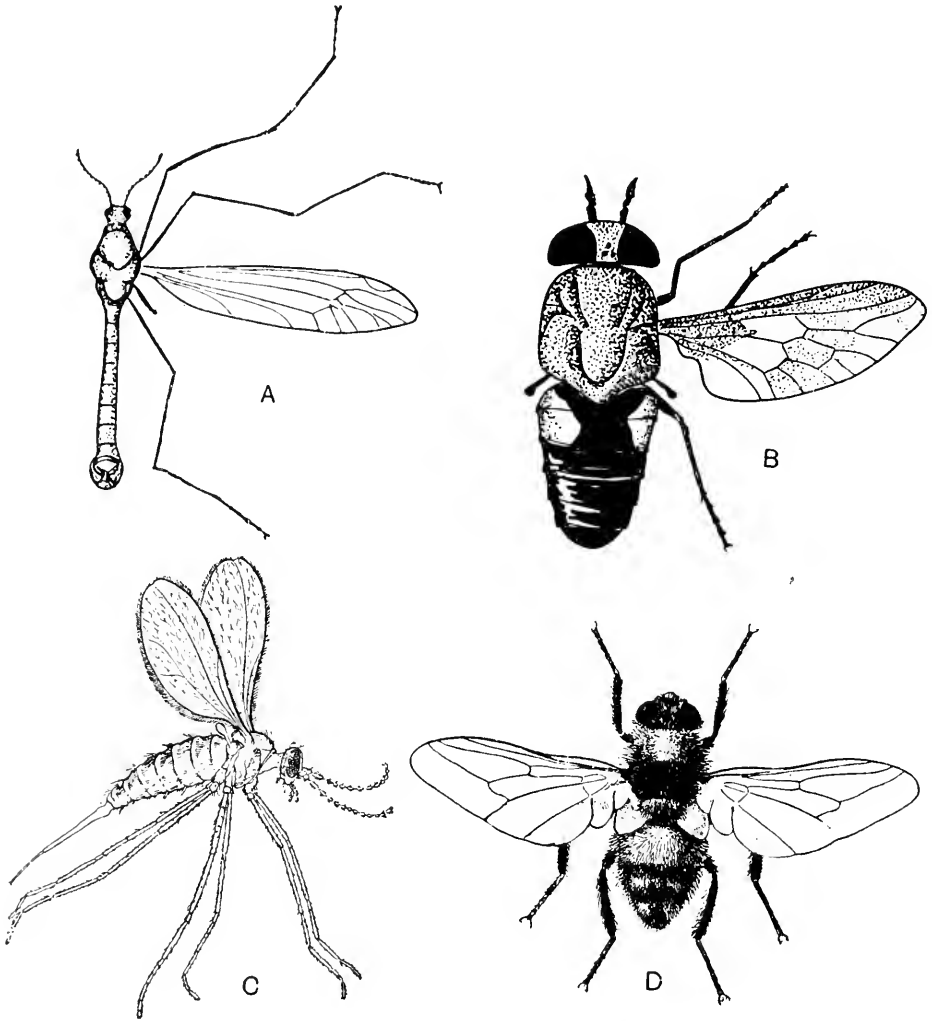

Fig. 350. Types of Diptera. *Tipula ochracea* (Tipulidae). B, *Chrysops caecutiens* (Tabanidae). C, *Contarinia nasturtii* (Cecidomyiidae). D, *Hypoderma bovis* (Cyclorrhapha, Oestridae). C, from Smith after Taylor; D, from Smith after Theobald.

rapidly flowing water of their environment. Still included in the suborder Orthorrhapha are the flies with short antennae, the Brachycera. Though included in this scheme with the Orthorrhapha their venational characters indicate a close relation with the Cyclorrhapha. In general, the basal joints of the antennae are larger than the terminal

ones, these being reduced in number as compared with the nematoceran condition. The maxillary palpi are porrect (not pendulous). Their larvae are hemi-cephalous with vertically biting mandibles and the pupae are free and spiny. From this vast assemblage of flies we may mention the *Tabanidae* or gad-flies (Fig. 350 B). These flies, to the mouth parts of which reference has already been made, are of stout build and possess large eyes occupying a large part of the head surface. Though a few transmit disease organisms (*Chrysops dimidiata*, the vector of the worm *Filaria loa* is responsible for Calabar swelling in the natives of West Africa), the majority are harmful chiefly through the annoyance which their bites occasion. Tabanid eggs are usually laid on the leaves of plants overhanging water and their carnivorous larvae are either aquatic or ground dwellers. The robber flies (*Asilidae*) are large bristly flies with a backwardly directed proboscis. They feed on all kinds of insects which they paralyse with their salivary fluid, and their legs, being strong and provided with powerful claws, are well adapted for grasping the prey.

The *Empidae*, flies of more slender build, exhibit similar habits. Their larvae are terrestrial as are also those of the preceding family.

Suborder *Cyclorrhapha*. These flies emerge from a pupa which is enclosed in the last larval skin or puparium and the commonly transverse or circular split in the latter, for release of the adult, gives the name to this suborder. It is therefore really a larval feature which establishes the position of these flies in the classification.

The antennae are three-jointed, the last of which is greatly enlarged, carrying a dorsal spine or *arista*. The maxillary palpi are one-jointed and porrect. A crescentic suture on the head lies above and encloses the bases of the antennae. This, known as the *frontal suture*, is a narrow slit along the margins of which the wall of the head is invaginated to form the ptilinal sac, the eversion of which enables the adult to emerge from the puparium. The extent to which the frontal suture is developed and the ptilinum persists, varies. The Syrphidae, for instance, have usually no persistent ptilinum and the frontal suture is not well-developed. All larvae have a vestigial head, and are either amphi- or metapneustic.

The *Syrphidae* (hover-flies) form an important family of brightly coloured flies, whose most obvious mark of distinction is the possession of a false longitudinal vein lying about the middle of the wing. Their larvae are amphipneustic, leathery grubs, some of which devour Aphidae (*Syrphus*), others living in decaying material being saprophagous (*Eristalis*), others again being phytophagous (*Merodon*, the bulb-fly).

The remainder may be considered under the heading of muscid flies. The frontal suture is prominent and the ptilinum persists. Many

families are included here, to some of which belong such serious agricultural pests as the frit-fly of oats, *Oscinus frit*, and *Chlorops taeniopus* the gout-fly of barley. In such cases, the larvae bore into the growing shoot, or into the stem. Larger and better known are the saprophagous house-fly *Musca* and the blow-fly *Calliphora*. The larva of *Hypoderma lineatum* is parasitic in the bodies of cattle causing "warbles" on the backs of affected animals, while *Gastrophilus equi*, the bot-fly, is parasitic as a larva in the alimentary tract of horses.

The *Tachinidae* are important as parasites, chiefly of larval Lepidoptera. Thus *Ptychomyia remota* is responsible for the very effective control of the Levuana moth, *Levuana iridescens*, of Fiji.

Blood-sucking muscids are important, e.g. *Glossina*, as the vector of trypanosomiasis causing sleeping sickness of man and cattle disease in Africa. The tsetse flies are pupiparous, larvae being nourished by special glands opening into the genital tract. The larvae are deposited as soon as fully grown and pupate immediately.

A number of members of this order present a greatly modified structure resulting from an ectoparasitic habit. They are known as the Pupipara, being similar in their viviparity to *Glossina*. The following examples may be quoted. *Hypobosca* is a winged leathery fly with body dorso-ventrally compressed, and is an ectoparasite of cattle. *Melophagus* is a wingless species, similarly associated with sheep, familiarly known as the sheep tick. *Nycteribia* is a wingless form parasitic on bats.

#### Order APHANIPTERA (Fleas)

Wingless insects, ectoparasitic on warm-blooded animals; laterally compressed with short antennae reposing in grooves; piercing and sucking mouth parts, maxillary and labial palps present; coxae large; tarsus five-jointed; larva legless; pupa exarate, enclosed in a cocoon.

These insects are perfectly adapted to an ectoparasitic existence by their laterally compressed bodies, prominent tarsal claws, well-developed legs suitable for running between the hairs of their host and for jumping, and by their mouth parts (Fig. 351). They only exhibit slight relationship to one other order, viz. Diptera, by their metamorphic features and to a less degree by their mouth parts.

The mouth parts consist of a pair of long serrated mandibles, a pair of short triangular maxillae with palps, and a reduced labium carrying palps. There is a short hypopharynx and a larger labrum-epipharynx reminiscent of the Diptera. The labial palps, held together, serve to support the other parts, a function which is performed by the labium in the Diptera. In piercing, the mandibles are most important and the blood is drawn up a channel formed by the two mandibles

and the labrum-epipharynx. The thoracic segments are free and there are never any signs of wings. Though the eggs are laid on the host they soon fall off and are subsequently found in little-disturbed parts of the haunts of the host. Thus in houses they come to lie in dusty carpets and unswept corners of rooms. In a few days the larvae hatch and feed on organic debris. The legless and eyeless larva possesses a well-developed head and a body of thirteen segments. At the end

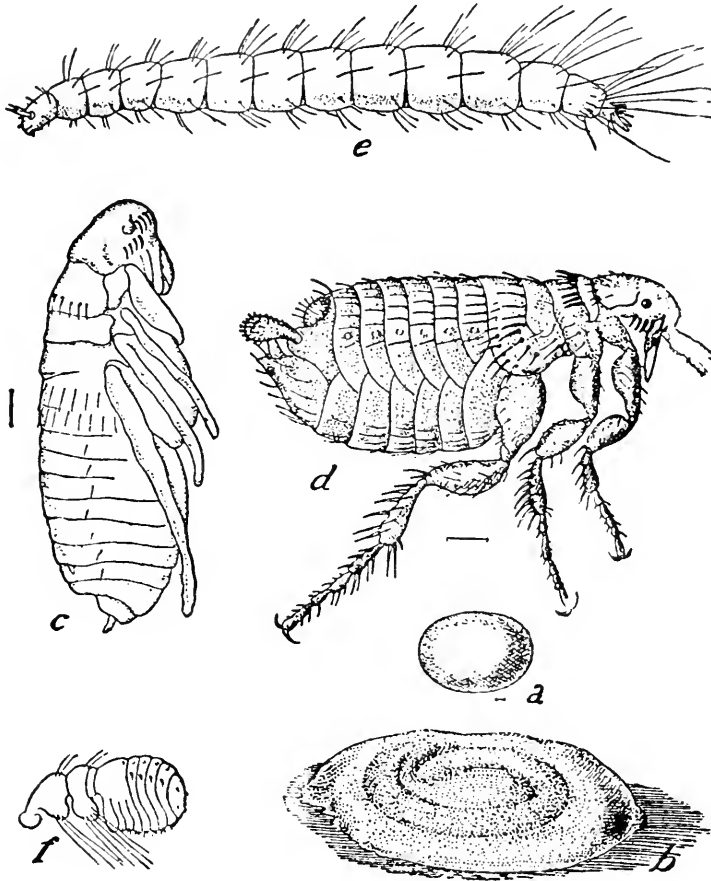

Fig. 351. The life history of the flea, *Ctenocephalus canis*. From Imms, after Howard. *a*, egg; *b*, larva in cocoon; *c*, pupa; *d*, imago; *e*, larva of flea, *Ceratophyllus fasciatus*; *f*, antenna of imago.

of the third larval instar a cocoon is spun and the creature turns to an exarate pupa from which the adult emerges, the whole life cycle occupying about a month in the case of *Pulex irritans*.

*Pulex irritans* is the common flea of European dwellings, but by far the most important economically is the oriental rat flea, *Xenopsylla cheopis*, which transmits *Bacillus pestis*, the bacillus of plague from the rat to man. It appears that this bacillus lies in the gut of

the flea and the faeces deposited on the skin of the host are rubbed into the wound by the scratching which follows the irritation from the bite.

*Ceratophyllus fasciatus*, the European rat flea, also transmits the plague organism as also can *Pulex irritans*, but since the latter does not live successfully on rats, it is never likely to prove a source of trouble.

#### Order STREPSIPTERA

Small parasitic insects, allied to the Coleoptera, with winged, free-living males and larviform females, which never leave the interior of their host.

*Stylops* causes great modification of its host, the bee (*Andrena*).



## CHAPTER XV

### THE SUBPHYLUM ARACHNIDA

Arthropods with fully chitinized exoskeleton; the anterior part of the body (prosoma), never divided into head and thorax, consisting of six adult segments, the first (preoral) with prehensile appendages (chelicerae) usually three-jointed, the second (postoral) with appendages either sensory or prehensile (pedipalps) and the remaining four ambulatory; the posterior part (opisthosoma) consisting of thirteen segments and a telson in the most primitive forms but tending to become shortened, the first (pregenital) segment differing from the rest, the second bearing the genital opening; respiratory mechanisms of various types usually developed in the anterior part of the opisthosoma; coxal glands of coelomic origin in the 2nd to 5th prosomatic segments; larval forms absent except in *Limulus*.

As has been pointed out in the introduction to the Arthropoda, the Arachnida are distinctly marked off from the rest of the phylum by the character of their appendages and especially by their chelicerae which furnish so strong a contrast to the sensory antennae, elsewhere found in the phylum. Moreover, nowhere else (except perhaps in trilobites) are true jaws absent, the prolongation of the basal joint of the anterior limbs toward the mouth (gnathobases) serving the arachnids for mastication. In the divisions of the group is found the greatest diversity in form, for though by no means active creatures, arachnids have become adapted to many kinds of environment.

Besides the segments enumerated in the preamble, there is in the embryo of most arachnids a *precheliceral segment* (Fig. 352 B, C). The variation in the segments of the prosoma is confined to minor details, the chelicera preserving much the same characters throughout the group, only losing a joint in the Araneae, and being either chelate or subchelate; the pedipalp, however, varies according to its function, being chelate in the scorpion and the Pedipalpi, which seize their prey by means of it, modified for purposes of fertilization in the spiders, and merely an ambulatory appendage in *Limulus*. In most forms the tergites of the segments are fused together, but in the Pedipalpi and the Solifugae the last two prosomatic segments are entirely free.

It is in the opisthosoma and its segments that the greatest amount of variation can be seen. The *pregenital segment* (Fig. 352 B, C) is always developed in the embryo, but tends to disappear in the adult. Thus in the Palpigradi, Pedipalpi and Pseudoscorpionidea it forms a distinct segment; in *Limulus* it is represented by a pair of rudi-

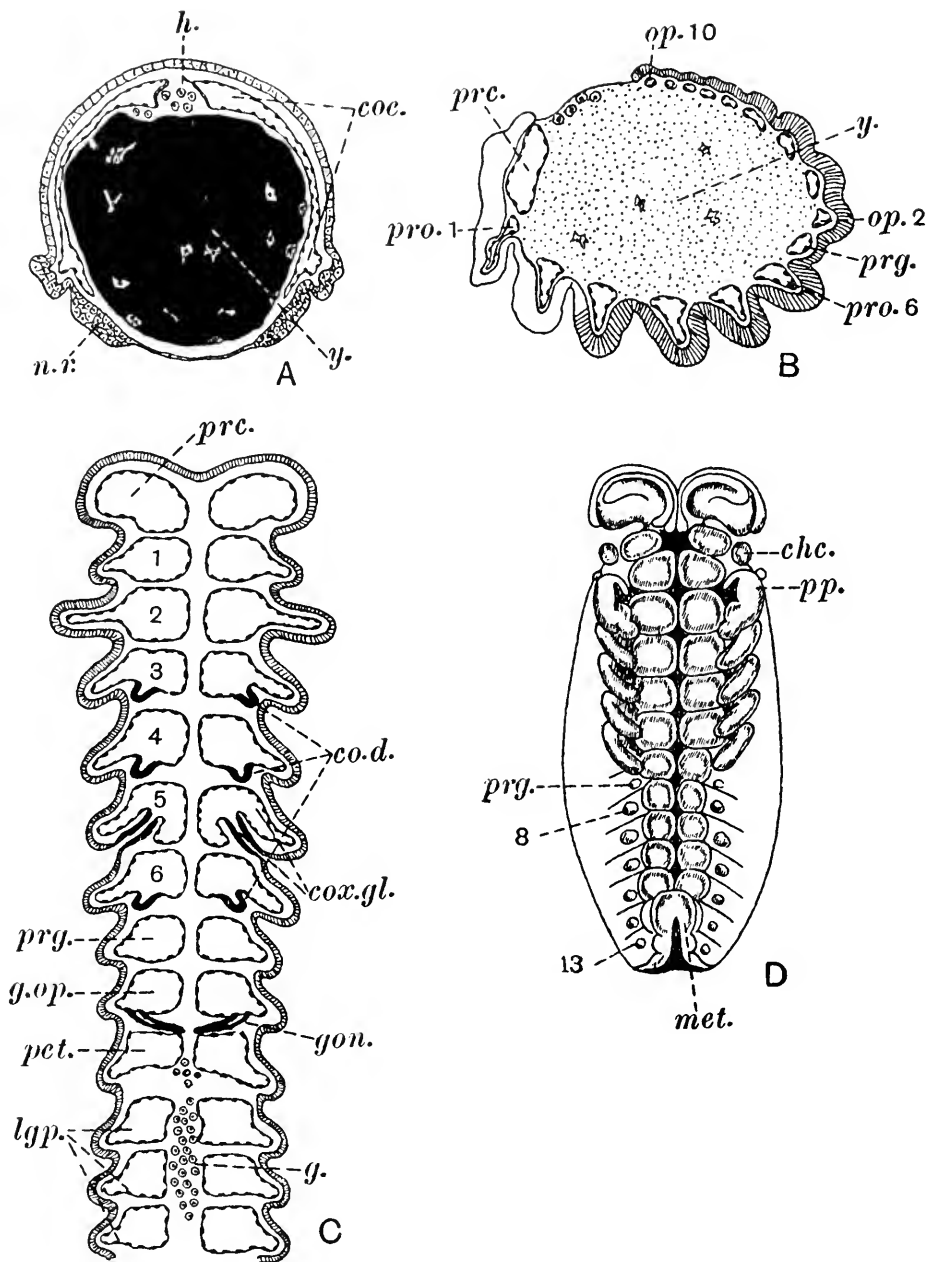

Fig. 352. The development of the Arachnida. A, Transverse section of a spider embryo (*Theridium*), after Morin, showing the coelomic sacs (*coe.*) and the formation of the heart (*h.*). *n.r.* nerve rudiment; *y.* yolk with contained cells. B, Sagittal section of a spider embryo after Wallstabe. Coelomic sacs of *prc.* precheliceral segment, *pro. 1*, *pro. 6*, first and last limb-bearing segments of the prosoma, *prg.* pregenital segment, *op. 2*, second, and *op. 10*, tenth segment of the opisthosoma. C, Diagram of the scorpion embryo, altered from Dawydoff. Coelomic sacs of *prc.* precheliceral segment; 1-6 limb-bearing segments of the prosoma; *prg.* pregenital segment; *g.op.* segment of genital operculum; *pet.* segment of pectines; *lgp.* segments of first three lung books; *co.d.* coelomoducts which never reach the exterior; *cox.gl.* coxal glands; *gon.* gonoducts; *g.* gonad. D, Embryo of the scorpion *Buthus carpathicus*, after Brauer. Stage showing *chc.* the chelicerae; *pp.* pedipalps; the four other appendages of the prosoma; *prg.* the pregenital segment and appendages; 8, appendage forming genital operculum, succeeded by those which form the pectines and the lung books; 13, last of these; *met.* metasoma.

mentary appendages, the *chilaria*; it is entirely missing in the adult scorpions. In addition to this segment there is a maximum of twelve segments and a terminal appendage, the telson, which is attained only by the embryo scorpions and the eurypterids; the Palpigradi and Pseudoscorpionidea have one less. In all these cases, there is a differentiation of the segments into two regions, the meso- and metasoma. In *Limulus* there are six segments only, but in the related extinct genus, *Hemiaspis*, there are three more. The Solifugae show ten. In the spiders, mites and phalangids, the body is much shortened; the phalangids have the anterior segments united to the prosoma. Lastly, the telson may be a sting in the scorpions, a jointed sensory flagellum in the Palpigradi, a fin in some eurypterids or a digging stick in others and in *Limulus*.

A typical feature is the suctorial alimentary canal. The mouth is usually narrow and situated just behind the chelicerae; only in *Limulus* has it moved backwards, become enlarged and surrounded by the basal joints (gnathobases) of all the prosomatic appendages; in the scorpions the appendages of the 2nd-4th segments form gnathobases; the Palpigradi and Solifugae have no gnathobases. In all arachnids, except *Limulus*, the food is fluid and is drawn through a narrow oesophagus into a sucking stomach and thence into a straight mid gut, which is by far the longest part of the gut, and receives the openings of the digestive coeca; often, as in scorpions, there are several of these, segmentally repeated, very much branched and forming a compact "liver"-like organ. There may be important salivary glands entering the fore gut as in the scorpions. Posteriorly the mid gut, except in *Limulus*, gives off Malpighian tubules. The hind gut is short.

The respiratory organs of the Arachnida are distributed as follows. (1) "Gill books" in the aquatic form, *Limulus*, and probably in the extinct eurypterids. (2) "Lung books" in the terrestrial scorpions and Pedipalpi. (3) A combination of lung books and tracheae in the spiders. (4) Tracheae alone in the Solifugae, Pseudoscorpionidea, Phalangida and Acarina. (5) Lastly, in the Palpigradi, smaller acarines and other forms, there are no special respiratory organs and exchange of gases takes place through the skin.

As the Arachnida apparently form a natural group, efforts have been made to derive these various methods of respiration one from the other. The gill books (Fig. 353) are stated to be the most primitive respiratory organs. They are piles of leaflets, in which blood circulates, attached in each segment to the posterior face of freely oscillating plates, which are possibly appendages, resembling the abdominal appendages of the Isopoda which are also respiratory in function. There is a special muscular mechanism for opening and shutting the leaflets in the water and thus facilitating gaseous exchange. In the

lung books of the scorpion there are also parallel leaflets, which are sunk into pits with a confined opening (pneumostome). The air circulates between these leaflets, but there is no evidence that air is actively pumped in and out of the lung. Gaseous exchange then appears to be entirely due to diffusion. In spiders, however, a complicated system of muscles has been described which bring about expiration by compressing the lung. Inspiration follows by the elasticity of the chitin lining.

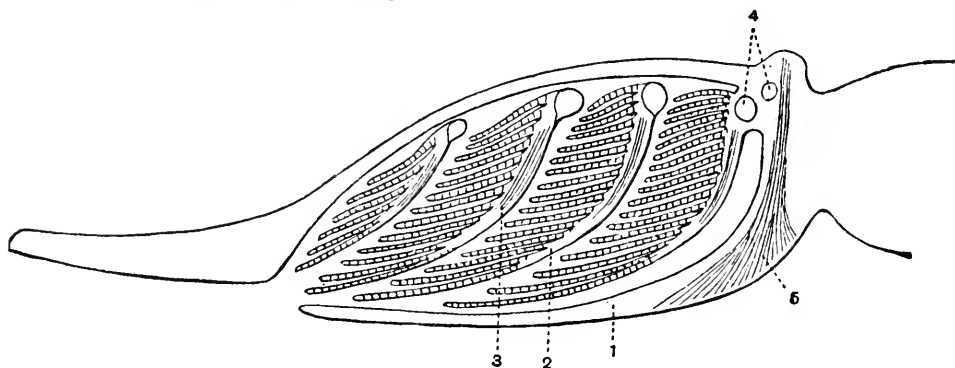

Fig. 353. Longitudinal section through the opisthosoma of *Limulus*, showing four of the five gill books. From Shipley and MacBride. 1, operculum; 2, second gill book; 3, muscle which moves the gills up and down; 4, blood vessels; 5, muscle which raises the operculum.

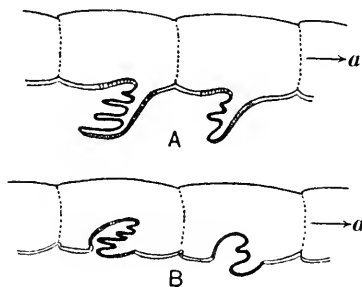

Fig. 354. Diagram of respiratory organs of the Arachnida. After Kingsley. A, Two segments with appendages (gill books), bearing leaflets on their posterior face as in *Limulus*. B, Appendages partly (right) and wholly (left) withdrawn into pits of the ectoderm so that the flat appendage forms the floor of the pit and the leaflets are internal. a. anterior.

It is generally supposed that the lung books of scorpions are derived from gill books by the withdrawal of the leaflets into special pouches, the lungs (Fig. 354). The appendages or plates disappear or form the floor of the lung and the leaflets appear as folds of the lining. Lung books, according to this view, are organs which, originally intended for aquatic use, have been slightly adapted for terrestrial life, but while the scorpions in their long history have shown no capacity for further

development, the rest of the Arachnida have developed the typical arthropod tracheal system. The spiders, at least, have passed through a primitive lung-book stage from which they have not all emerged. In fact they show all the stages of replacement of lung books by tracheae, which actually arise as diverticula of the lung itself. Thus we have the following stages in the spiders:

(1) Two pairs of lung books and no tracheae in the families Atypidae, Liphistiidae and Aviculariidae.

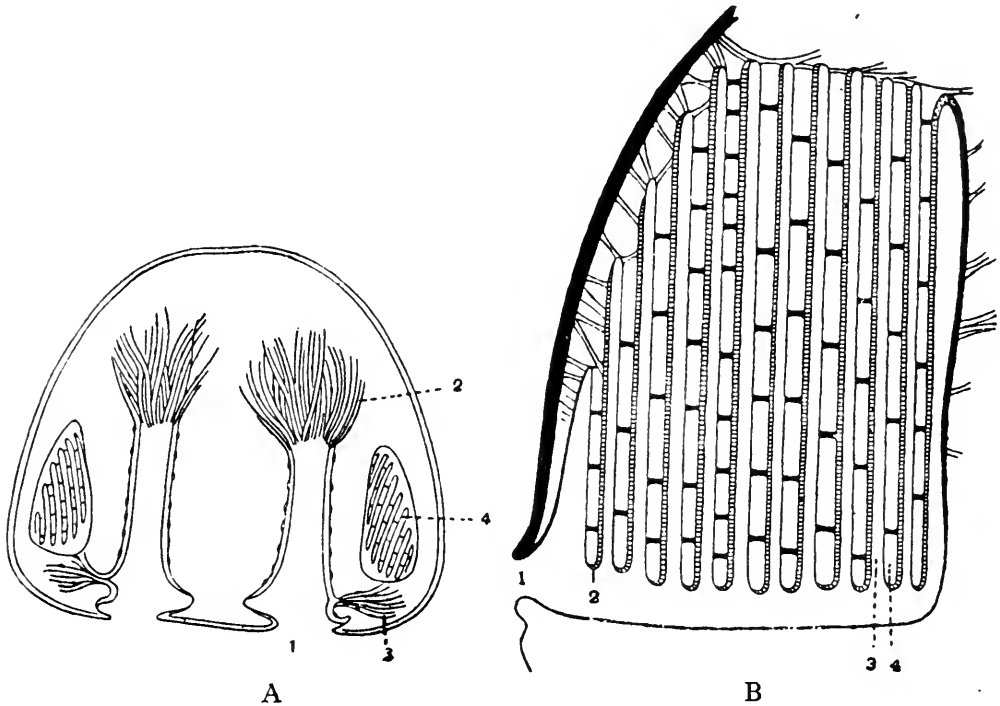

Fig. 355. Respiratory organs of spiders. After MacLeod. A, Horizontal section through the opisthosoma of *Argyroneta*. 1, stigma opening into a cavity from which arise bundles of 2, terminal and 3, lateral tracheae; 4, lung book with leaflets in section. B, Longitudinal section through lung book of a spider. 1, pneumostome or stigma; 2, free edge of leaflet; 3, air space between leaflets; 4, blood space within leaflet.

(2) An anterior pair of lung books and a posterior pair of stigmata, opening into tracheae, in the majority of families.

(2a) An anterior pair of lung books, the posterior pair of stigmata and tracheae having entirely disappeared, in the family Pholcidae.

(3) Two pairs of stigmata, both opening into tracheae, in the family Caponiidae.

These form a complete series. The adherents of the theory that lung books have given rise to tracheae claim that, on the whole, those spiders which have two pairs of lung books are the most primitive

in other respects. It may be pointed out, however, that there is also a connection between the degree of development of tracheae in a family and the activity of its members. In inert forms, there may be reduction or even total loss of the tracheal system.

In all the forms in which lung books or gill books are present, there are processes in the embryo which can be identified as rudiments of appendages, on the anterior abdominal segments (Fig. 352 D). On the posterior border of these processes, leaflets develop at the same time as an invagination forms the lung cavity above them, so that the limb itself forms part of the floor of the cavity. On the whole then, embryology may be said to show the origin of lung books from gill books, and the comparative anatomy of spiders indicates that lung books have been replaced by tracheal systems. But there lie outside this series arachnid groups, like the Acarina, with tracheal systems of a different kind, which can only be derived with difficulty from the respiratory system of the other forms and may have had a separate origin.

In the arachnids, the mesoblast is formed as two lateral bands which segment into somites, just as does the same tissue in the annelids. The somites correspond with the external segmentation and in each one of them appears a coelomic cavity. This is best seen in the scorpions (Fig. 352 C) and the spiders (Fig. 352 B). They are formed near the ventral surface and extend on the one hand into the appendage and on the other towards the dorsal middle line, where the extensions from the two sides meet and form the heart between them. They also form diverticula varying in the different groups, which are the remains of a complete series of metamericly segmented coelomoducts. In the scorpions, the embryo (Fig. 352 C) shows five pairs of these, in segments 3, 4, 5, 6 and 8. In only one case, that of segment 5, do the coelomoducts reach the external surface, and persist in the adult as a pair of excretory organs, the *coxal glands*. In segment 8 they grow towards the middle line and form the mesodermal part of the gonoducts. The other coelomoducts disappear and the coelomic sacs are resolved into mesenchyme which fills up the spaces of the body and forms the muscles, the blood and the fat body. In *Limulus* there are also a pair of coxal glands, which in development arise from the coelomic somites of no less than six segments, of which only segment 5 sends out a duct opening to the exterior.

### Class SCORPIONIDEA

Arachnids with the prosoma covered by a dorsal carapace; the opisthosoma divided into a mesosoma and metasoma distinct from one another, containing twelve segments and a telson; chelicerae

and pedipalps both chelate; four pairs of walking legs; the first mesosomatic segment carries the genital operculum, the second the pectines, and the next four each a pair of lung books; the metasoma comprises segments reduced in size to form a flexible tail for wielding the terminal sting (the telson) and bears no appendages. Viviparous.

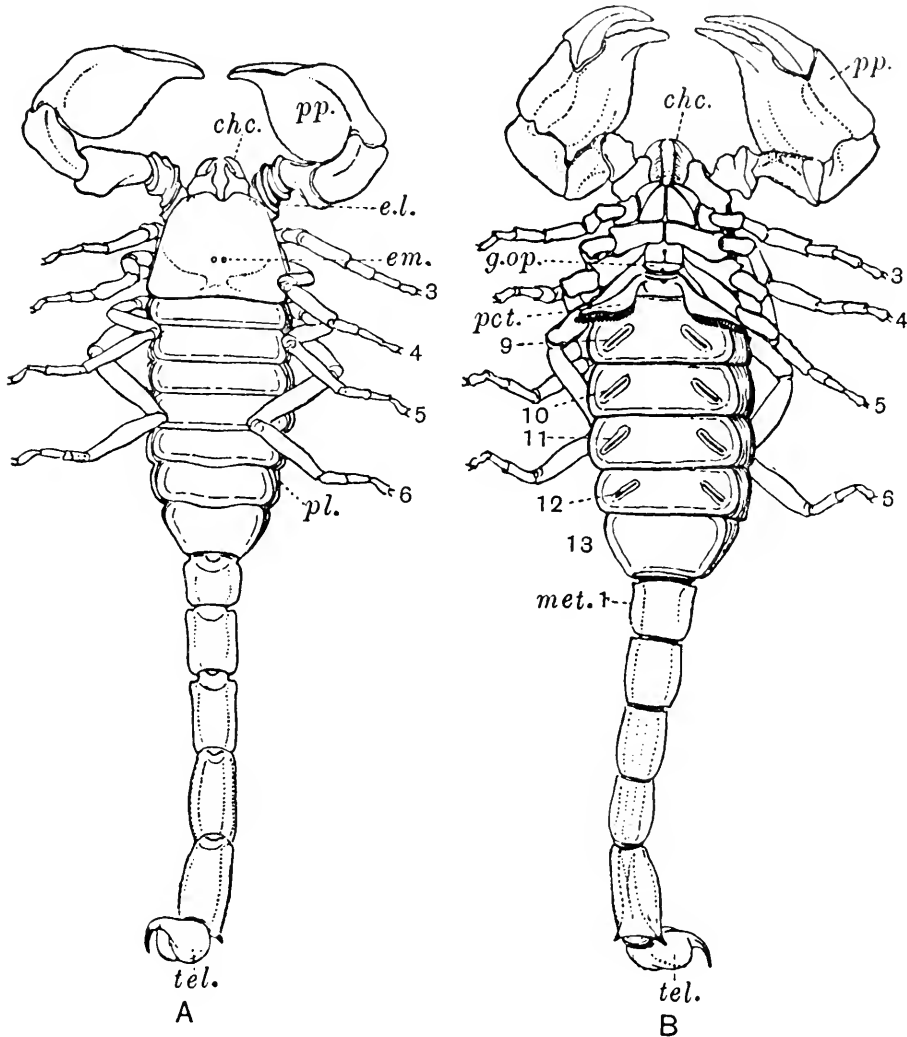

Fig. 356. *Scorpio swammerdami*,  $\times \frac{3}{2}$ . From Shipley and MacBride. A, Dorsal, B, Ventral view. *chc.* chelicera; *pp.* pedipalp; *e.l.* lateral and *e.m.* median eyes; *g.op.* genital operculum; *pct.* pectines; 3, 4, 5, 6, walking legs of the prosoma; 9, 10, 11, 12, stigmata of right side; 13, last segment of mesosoma; *pl.* soft tissue of pleura; *met. 1*, first segment of metasoma; *tel.* telson.

The tergum of the prosoma bears a group of lateral eyes near the anterior border and a pair of median eyes, but some scorpions are blind. On the ventral surface there are inward projections from the

basal joints of the pedipalps and the first two pairs of walking legs, which are masticatory in function (gnathobases). The walking legs are six-jointed and end in double claws. Between the basal joints of the last pair is a plate, the *metasternite*, which represents the fused sterna corresponding to these limbs; the sterna of the other prosomatic segments are not represented. At the beginning of the mesosoma there is in the embryo a pregenital segment with two limb rudiments. This disappears without leaving a trace in the adult. The two succeeding segments bear appendages: (1) the *genital operculum*, a small plate covering the openings of the genital ducts, which is formed by the union of two rudiments of appendages; (2) the *pectines*, flap-like structures attached by a narrow base with a distal border of chitinous spines like the teeth of a comb. They are tactile in function and derived from embryonic limb rudiments. There are no other exclusively sensory organs (except the eyes) on the body of the scorpion, but there are sense hairs scattered over the surface and more numerous on the pedipalps than elsewhere.

The lung books are found on segments 3–6 of the mesosoma. The 7th segment is without any external segmental organs. As has been already mentioned, there are, in the embryo, seven pairs of mesosomatic appendages (Fig. 352 D), those on the embryonic pregenital segment and on the six succeeding segments. Of these the 4th–7th never develop to more than papillae, but folds develop on their posterior surface and the skin behind is tucked in to form the lung sacs. When the sacs are complete, the folds become the leaves of the lung book. In the internal space of these folds, the blood circulates and is presumably aerated; it contains the respiratory pigment, haemocyanin. The circulatory system of the scorpion is remarkably complete (Fig. 357). The heart consists of seven chambers (in the 7th–13th segments), into each of which a pair of ostia opens and from each there leave a pair of lateral arteries. In addition, there is an anterior and a posterior aorta, the former dividing into many branches in the prosoma, and one of these passes backwards as a supraneural artery. The arteries end in tiny vessels and many of these communicate with the special ventral sinus, which supplies blood to the lung books. Muscles run from the roof of this to the floor of the pericardium, and when they contract the ventral sinus enlarges and draws venous blood into it. When they relax, blood is forced into the lung books, whence it is returned to the pericardium by segmental vessels.

A minute mouth opens into the pharynx which is suctorial, with elastic walls which can be drawn apart by muscles. A short oesophagus succeeds, and into this open the salivary glands. The endodermal mid gut is long and narrow and receives throughout its course several pairs of ducts which lead from the digestive glands. These





together form a bulky mass, filling up the dorsal part of the mesosomatic body cavity. The food passes into the cavity of these to be digested. It consists mainly of insects, which are chewed by the gnathobases and the juices sucked up by the action of the pharynx. The beginning of the short hind gut is marked by the Malpighian tubules.

The nervous system consists of a supraesophageal ganglion which supplies the eyes, a large suboesophageal complex which gives branches to all the adult appendages, and two ventral cords which bear ganglia in the last seven segments.

The sexes are separate and the gonads constitute a network. The spermatozoa are filiform and fertilization is internal, being preceded by a courtship, described in lively fashion by Fabre as *danse à deux*. Scorpions are viviparous. Sometimes the eggs are rich in yolk and the young develop entirely at its expense; in *Scorpio* and other genera the eggs are small and yolk is entirely absent. In this case the young develop in lateral sacs of the uterus, attached to the mother by a kind of *placenta*. The young, when hatched, are sometimes carried on the mother's back.

The earliest scorpions are found in the Silurian, and it is of considerable interest that the first genus, *Palaeophonus*, was a marine animal. It closely resembles the terrestrial scorpions, except in its shorter and broader limbs without claws, and in the absence of stigmata.

#### Class EURYPTERIDA

Extinct aquatic arachnids resembling the scorpions in the number and arrangement of the segments of the adult; the division of the abdomen into meso- and metasoma is not quite so marked; chelicerae short and three-jointed, chelate; the next four segments bear appendages which are often similar (but the pedipalps may be chelate); in the last (6th) prosomatic segment the appendages are always larger than the rest and are broad and paddle-shaped; first and second pairs of mesosomatic appendages unite to form the genital operculum; the first five mesosomatic segments bear indications of leaf-like branchiae; metasoma ends in a structure (telson) of variable form; mouth has moved backwards and is surrounded by gnathobases of all the limbs.

The great interest of this group lies in its similarity to the scorpions. There was, however, much more variety in external structure in these aquatic arachnids and they sometimes attained a length of six feet. Not only is there fundamental agreement in the segmentation and the division into meso- and metasoma, but also in characters like the shape and usually the size of the chelicerae, and the telson, which in primitive eurypterids has a recurved sting-like form. *Slimonia* (Fig. 358 B)

has a slightly modified telson. In one eurypterid (*Glyptoscorpius*) structures have been described which correspond to the pectines in position and structure. If this is substantiated, it constitutes a remarkable resemblance in detail.

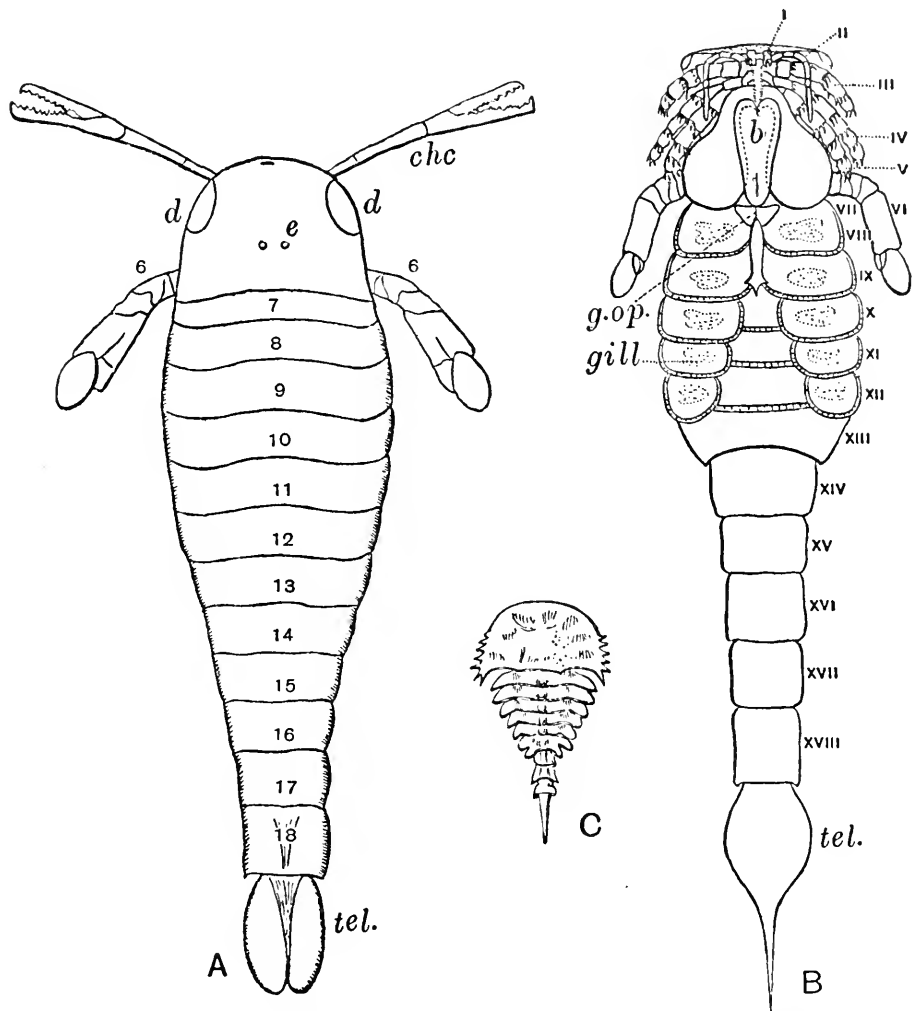

Fig. 358. Diagram of extinct Arachnida. A, *Pterygotus osiliensis*, dorsal view. After Schmidt. B, *Slimonia* (restoration of ventral surface by M. Laurie). C, *Hemiaspis limuloides*, dorsal surface. From Woods. All Silurian forms. Segments and appendages numbered to correspond; Arabic numerals in *Pterygotus* and Roman in *Slimonia*. *chc.* chelicerae (segment 1); *b.* metastoma; *d.* compound eyes; *e.* simple eyes; *g.op.* genital operculum; *tel.* telson.

A few special characters may be mentioned here. On the ventral surface a structure called the *metastoma* is seen which possibly represents the pregenital segment. Branchiae undoubtedly existed, but their exact nature is not known. Possibly the sterna of the segments

which carried them were membranous and the branchiae were tucked in under them. There are five pairs and the first of these corresponds in position to the pectines of the scorpion (except possibly in *Glyptoscorpius*). Thus, when the ancestors of the scorpions became terrestrial, we may suppose that the first pair of respiratory appendages remained external and took on a sensory function, while the rest helped to form the lung books.

Minute forms with incompletely developed abdomen and enlarged eyes have been found which are thought to be the pelagic larvae of eurypterids. The adults were in all probability carnivorous forms, which crept and swam and sometimes burrowed at the bottom of shallow seas. In *Pterygotus* (Fig. 358 A) and *Eurypterus* there are adaptive modifications of the telson for swimming and burrowing respectively.

### Class XIPHOSURA

Aquatic arachnids with a broad prosoma divided by a hinge from the opisthosoma in which the first six segments are present and fused together dorsally; they bear six pairs of biramous appendages, of which the first form an operculum on which the genital apertures open and the remaining five carry the gill books; chelicerae of usual arachnid type, pedipalps not distinguished from the four pairs of ambulatory appendages which follow; mouth far back surrounded by *gnathobases* of all the postoral limbs; caudal spine present possibly representing the lost abdominal segments as well as the telson; pregenital segment represented by rudimentary appendages, the *chilaria*.

*Limulus* (Figs. 359, 360), which is the sole living representative of the group, is evidently more affected by specialization than either the scorpions or eurypterids, and it is on this account that the attempts which have been made to indicate the king crab as an ancestral form to higher groups have usually been regarded as ingenious but illusory. It is essentially a shore-living, burrowing animal. Like a crab, its carapace is compact, dorsoventrally flattened and expanded laterally, so that the animal can shovel its way under sand and mud. Its legs are tucked under the carapace and the hinder pair kick out the sediment behind. To protect the gill books from this rough treatment, the operculum completely covers the appendages which bear them. But *Limulus* has not lost its tail, and an observer, watching the creature in an aquarium, will contrast it unfavourably for grace and efficiency with a crab. Its swimming movements, principally brought about by the flapping of the abdominal appendages, are slow and clumsy, and we can hardly consider it except as a sedentary animal.

The chelicerae are small, chelate and three-jointed, as is usual in

In all the others the appendages almost meet in the middle line, but remain distinct. From the posterior surface of the exopodite arise about two hundred branchial leaflets. The appendages are provided with muscles by which the flapping movements are made which propel the animal in a leisurely way through the water and circulate water amongst the leaflets.

The mouth occupies a subcentral position under the carapace, surrounded by the gnathobases. Worms and small molluscs from the shore mud are seized by the chelae and, after mastication by the gnathobases, stuffed into the mouth, which leads to the fore gut consisting of an oesophagus and a chitin-lined "stomach"; the mid gut is long and into it open two pairs of ducts from the digestive glands. These glands are very well developed and fill up much of the space inside the cephalothorax. There are no Malpighian tubules and no salivary glands in *Limulus*.

The circulatory system is very complete and like that of the scorpion in its main lines. A unique feature is the complete investment of the ventral nervous system by an arterial vessel which corresponds to the supraneural vessel of the scorpion.

The nervous system is of a very concentrated type. The supra-oesophageal ganglia supply the eyes and are fused with the ganglia of all the succeeding segments as far as the opercular segment to form a ring round the oesophagus. From this a double ventral cord extends into the opisthosoma, swelling into ganglia in each of the "gill-book" segments. Median and lateral eyes (p. 310) are present.

The coxal (brick red) glands arise from six segments in the embryo and open on the fifth pair of legs.

The reproductive organs consist of a network of tubules communicating with the exterior by paired ducts opening on the genital operculum. The eggs are laid far up on the shore at spring tides in holes dug for them by the mother, and the male, which comes ashore clinging to the carapace of the female, spreads the sperm over them, a method of fertilization very similar to that of the frog. The eggs are heavily yolked and the young hatch as a planktonic larva in a condition resembling the adult but with an opisthosoma showing separate segments and without the caudal spine. The larva, which swims by means of the abdominal appendages, as in the adult, has been called the "Trilobite" stage, because of an extremely superficial likeness to that group.

While *Limulus* has existed since the Trias without any modification, it is of considerable interest that in the Palaeozoic very similar animals occur, in which there are three additional segments and a rather shorter caudal spine, indicating that the latter organ has been formed at the expense of the posterior opisthosomatic segments. These animals are *Hemiaspis* (Fig. 358 C) and *Bunodes*.

## Class ARANEIDA

Arachnids with prosoma covered by a single tergal shield but head marked off by groove; opisthosoma ("abdomen") separated by waist, soft, rarely having any trace of segmentation, two to four pairs of *spinnerets* and several kinds of spinning glands; chelicerae two-jointed, subchelate; pedipalps modified in male for transmission of sperm.

In the embryo spider, the segmentation of the opisthosoma is indicated by the presence of coelomic cavities of which there are ten (Fig. 352 B); there are also five pairs of rudimentary appendages, the first of these disappears, the next two assist in forming the lung books, and the fourth and fifth become the spinnerets. When more than two pairs of spinnerets are present the additional ones are split off from pre-existing spinnerets. Embryology thus shows that the existing forms with apparently unsegmented opisthosoma are descended from ancestors with nearly the full number of segments typical of arachnids.

The chelicerae (Fig. 364) contain a poison gland in the basal joint. Spiders have developed to an extreme the tendency, so common in the arachnids, towards adopting a carnivorous diet. While most of the spiders on account of their size can only obtain suitable supplies of food from insect life, some are able to attack larger forms, even birds in the case of *Mygale*. Besides the poison glands which cause the immediate death of the prey, there are salivary glands in the under lip which produce a proteolytic ferment. A fly which is caught by a spider is pressed against the mouth by the gnathobases of the pedipalps, a drop exudes from time to time and in a couple of hours the morsel of flesh has been *externally* digested and the resulting fluid sucked into the spider's alimentary canal by the pulsations of the "stomach", the chitinous exoskeleton of the prey remaining as an empty husk. This method of feeding is a leading characteristic of the group.

The diagram (Fig. 361) shows the main features of the anatomy of the spider. The oesophagus, after dilating into the sucking stomach, is succeeded by the mid gut which immediately sends out two main lateral branches forward with coeca running into the limbs. It passes back through the opisthosoma and gives place to the hind gut where the Malpighian tubules are given off. The main feature is the digestive gland which is a dorsal diverticulum of the mid gut, richly branched and filling the opisthosoma on each side of the heart. In this the latter stages of digestion take place. The hind gut is short and dilated into a stercoral pocket where faeces accumulate. The heart is situated in a distinct pericardium in the opisthosoma, has three pairs of ostia, and gives off an anterior and a posterior aorta and three lateral arteries on each side. In contrast to the scorpion and *Limulus* there are no definite

arterioles, but the blood is finally collected into sinuses which feed the lung books when these are present.

The nervous system is more concentrated than in the scorpion, consisting of a supraoesophageal ganglion supplying the eyes (Fig. 363) and a suboesophageal complex supplying the rest of the body. Two non-ganglionated nerves pass backwards to the opisthosoma.

The diagram (Fig. 361) shows a lung book opening in the anterior part of the opisthosoma and the details of the structure are exhibited in Fig. 355. The "leaves" of the book are seen to be thin plates with an internal space for the circulation of the blood. They are dotted with short chitinous spines (not seen) and fused with the walls of the lung. The cavity of the lung only communicates by a narrow opening

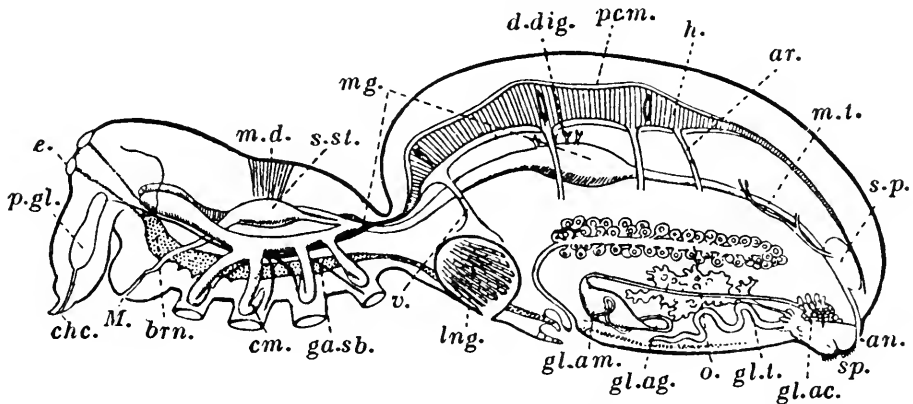

Fig. 361. Diagram of a spider, *Epeira diademata*, showing the arrangement of the internal organs,  $\times$  about 8. From Warburton. *an.* anus; *ar.* artery; *brn.* brain; *chc.* chelicera; *cm.* caecum of mid gut in ambulatory limb; *d.dig.* ducts of digestive gland; *e.* eye; *ga.sb.* suboesophageal ganglion; *gl.ac.*, *gl.ag.*, *gl.am.*, *gl.t.* aciniform, aggregate, ampulliform and tubuliform glands; *h.* heart with three ostia; *lng.* lung book; *M.* mouth; *m.d.* dorsal muscle of sucking stomach; *mg.* mid gut; *m.t.* Malpighian tubule; *o.* ovary; *p.gl.* poison gland; *pcm.* pericardium; *sp.* spinneret; *s.p.* stercoral pocket of hind gut; *s.st.* sucking stomach; *v.* vessel bringing blood from lung book to pericardium.

with the outside air. Respiratory movements for the renewal of the pulmonary air have not been recorded by most observers and the method of respiration cannot be very efficient. In this diagram (Fig. 361) the tracheae are not shown, but in Fig. 355 A a horizontal section through the opisthosoma is shown in which the same ingrowth has given rise to a lung book and a bundle of tracheae. The character of the tracheae is well seen. They spring from a long pocket in parallel series and do not branch as in the insects, but they have the typical structure, strengthened by a spiral ridge of the chitinous lining. This form (*Argyroneta*) shows a richly developed tracheal system, but in other forms, particularly spiders with slow movements, the number

of tracheae is much reduced, even to a single pair from each stigma. The variations in the development of the tracheae are recorded in the opening section on the Arachnida (p. 519).

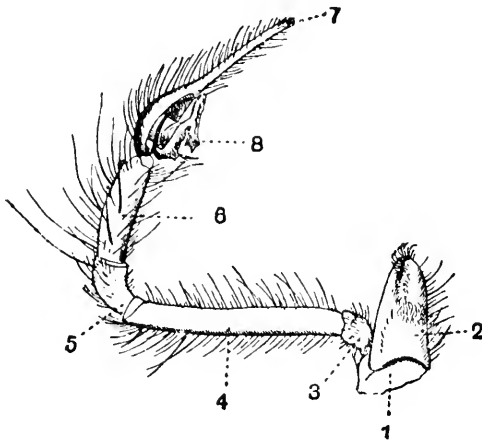

Fig. 362.

Fig. 362. Pedipalp of *Tegenaria guyonii*, the large house spider. From Shipley and MacBride. 1, coxa; 2, gnathobase, the so-called maxilla; 3, trochanter; 4, femur; 5, patella; 6, tibia; 7, tarsus; 8, palpal organ.

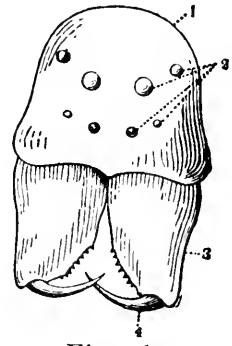

Fig. 363.

Fig. 363. Front view of head of *Tetrrix denticulata*. From Warburton. 1, head; 2, eyes; 3, basal joint of chelicerae; 4, claw of chelicerae.

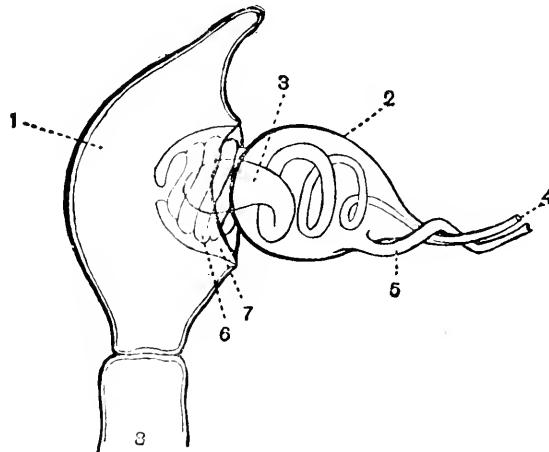

Fig. 364. Diagrammatic view of expanded palpal organ. From Shipley and MacBride. 1, tarsus; 2, bulb; 3, vesicula seminalis, and 4, the opening of its duct which is protected by 5, the conductor; 6, haematodocha which is distended with blood when the palpal organ is expanded; 7, alveolus; 8, tarsus.

The *spinning glands* are shown in the diagram in the ventral part of the abdomen. In a web spinner like *Epeira*, there are five types of glands of diverse structure and function, all opening by minute pores on the spinnerets. Thus the *ampulliform glands* supply the radial lines



of the webs, and the spiral lines are made by the *aggregate glands* which furnish the viscid fluid which covers them. The egg cocoon is formed by the *tubuliform glands* and these glands are absent in the males. The *aciniform glands* manufacture the cords which are wrapped round the prey caught in a web, and the *pyriform glands* make the attachment discs by which a silk thread is anchored to the ground. Such a spider as this is well adapted for its sedentary life in a web. It has immensely long legs compared to the size of the body and on the ground moves slowly and uncertainly. But its legs end in claws and spines, by which it not only can cling with absolute safety to the elastic threads of the web, but which it also uses to weave the threads of silk as they come out of the spinnerets. Thus the web spinners represent the greatest specialization of the group; there are, however, other forms like the wolf spiders (*Lycosidae*) and the jumping spiders (*Salticidae*), which are just as predaceous as the *Epeiridae* but by no means so sedentary. They run swiftly after their prey or jump suddenly on it. They may only possess two ampulliform glands which secrete a "drag line" which they leave behind them as they move. The web spinner relies almost entirely on its sense of touch and the vibration of the lines of the web affecting the tactile hairs of the limbs is the guide to the entangled prey. Eyes, though present, are not efficient. But the hunting spiders find their victims by sight and have a remarkable range of vision. This is not only used in the pursuit of food but also in the elaborate courtships which are characteristic of these two families, during which the male executes the most fantastic dances.

The generative apertures are found between the aperture of the anterior pair of lung books and the spinnerets. Fertilization is internal and before the male is ready to fertilize the female the sperm must be transferred to his modified pedipalps (Fig. 362). The terminal joint of these is greatly enlarged and contains a complicated tubular vesicular seminalis. A drop of seminal fluid is emitted either on to a small web spun by the male or on some surface like a leaf and the palps are then applied to the fluid and the seminal vesicle charged. After this courtship begins, and at the close the palps are inserted into the genital opening of the female; the spermatozoa are stored in spermathecae. The eggs are laid in a cocoon.

#### Class ACARINA (Mites and ticks)

Arachnids with a rounded body with no boundary between the prosoma and the opisthosoma; basal segments of the pedipalps united behind the mouth; no gnathobases to the four walking limbs.

These forms are usually minute except in the case of the parasitic

ticks. They are, variously, scavengers, ectoparasites on all sorts of plants and "hangers on" of all sorts of animals, but in the last case they become, by the modification of the chelicerae and pedipalps, blood-sucking parasites.

In the most free-living of them, like the aquatic and predatory Hydrachnidae, the chelicerae are clawed piercing weapons and the pedipalps leg-like with sensory hairs. The chelate condition of the chelicerae may be seen in the cheese mite, *Tyroglyphus* (Fig. 366), which is a typical saprophyte living on cheese only when it has begun to decay. The pedipalps are here no longer leg-like.

In a tick like *Argas* (Figs. 365 A, 367, 368), the pedipalps are sensory, but the chelicerae and the median *hypostome* are elongated and converted into serrated cutting tools; a sucking channel is formed between these. The mouth is usually minute and leads into a sucking pharynx and then into an endodermal stomach which gives rise to caeca in the ticks, where there are also salivary glands of large size opening into

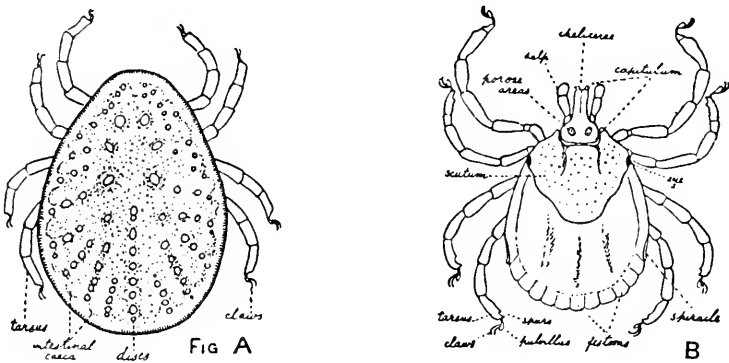

Fig. 365. Dorsal surface of A, *Argas* (Argasidae) and B, *Amblyomma*, ♀ (Ixodidae). From Nuttall and Warburton. The Argasidae are distinguished by the leathery skin, diversified by discs which mark the insertion of muscles; the Ixodidae by the hard scutum, which covers the whole body of the male and the anterior part of the body in the female (B).

the pharynx. The saliva is said to contain an anticoagulin, as in leeches, and this renders easier the gradual digestion of the blood which is taken into the stomach. A remarkable phenomenon without parallel in the Arthropoda is the occurrence of intracellular digestion in some acarines. The cells of the stomach put out pseudopodia and the blood plasma is taken into vacuoles where it is digested.

The circulation is extremely degenerate. No heart has been observed with certainty and the blood system is lacunar in mites, but in the tick, *Argas*, there is a single-chambered pulsating vessel with a pair of ostia and an aorta running forward to a periganglionic sinus. The respiratory organs are tracheae, long and convoluted. These open

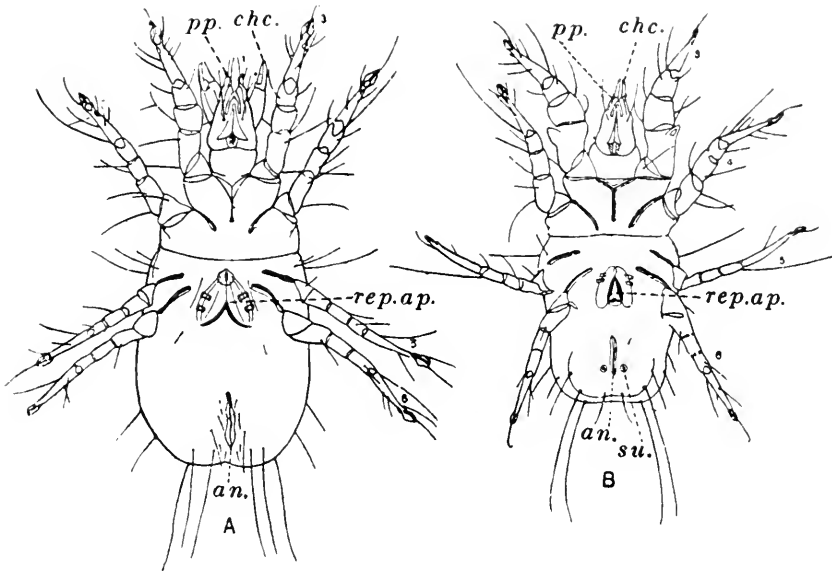

Fig. 366. *Tyroglyphus siro*, seen from the ventral side. A, Female. B, Male. Magnified. From Leuckart and Nitsche. *an.* anus; *chc.* chelicerae; *pp.* pedipalps; 3, 4, 5, 6, first, second, third and fourth walking legs; *rep.ap.* reproductive opening, flanked by two suckers on each side; *su.* suckers at side of anus.

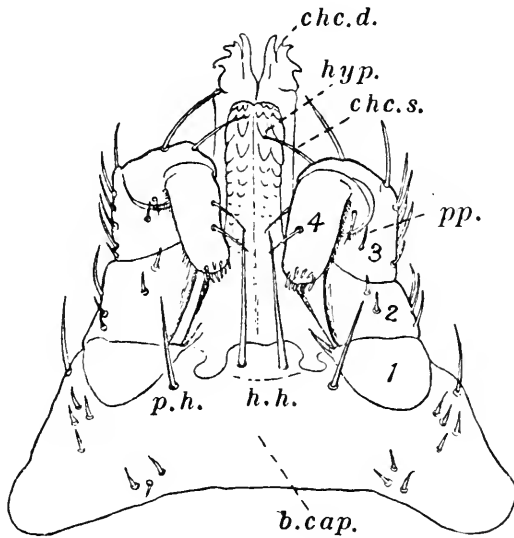

Fig. 367. Ventral view of capitulum (false head) of *Argas persicus*, ♂. From Nuttall. *b.cap.* basis capituli; *chc.d.* digit, and *chc.s.* shaft of chelicera; *hyp.* hypostome; *pp.* four-jointed "palp" (pedipalp); *p.h.*, *h.h.* postpalpal hair, posthypostomal hair.

by stigmata, the position of which varies in the main divisions of the group. In the Notostigmata there are four pairs of dorsal stigmata in the first four opisthosomatic segments; in the Cryptostigmata, four pairs of stigmata at the bases of the four walking legs; in the rest there

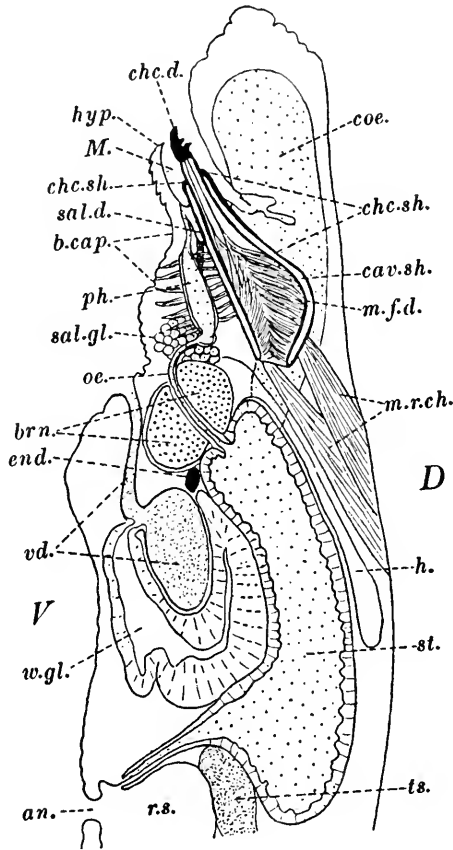

Fig. 368. *Argas persicus*, ♂. Median longitudinal section showing the proboscis, alimentary canal and reproductive systems. Altered from Nuttall. The chelicerae are seen within the cheliceral sheath (*chc.sh.*). They are thrust forward by the contraction of dorsoventral body muscles (*m.r.ch.*) and cut their way into the host by the digits (*chc.d.*) which are moved by their flexor muscles (*m.f.d.*). The barbed hooks of the hypostome (*hyp.*) are thrust into the wound and keep the tick in place. *an.* anus; *b.cap.* basis capituli; *brn.* concentration of nervous system; *cav.sh.* cavity of cheliceral sheath; *coe.* caecum of the stomach; *end.* endosternite; *h.* heart; *M.* mouth cavity; *oe.* oesophagus; *ph.* pharynx with radiating muscles; *r.s.* rectal sac; *st.* stomach; *sal.d.*, *sal.gl.* salivary duct and gland; *ts.* testis; *vd.* vas deferens; *w.gl.* white (accessory) gland.

is a single pair of stigmata in varying positions, in front of the chelicerae (Prostigmata), between the chelicerae and pedipalps (Stomatostigmata), between the pedipalps and 1st walking legs (Heterostigmata), the 2nd and 3rd legs (Parastigmata), the 3rd and 4th (Mesostigmata),

and behind the 4th legs (Metastigmata). If we regard the opisthosomatic position of the breathing organs as primitive it is difficult to see how these varying arrangements have come to pass in the acarines.

The life history of the parasitic forms is of great interest, especially that of the *ticks* or Metastigmata. These are divided into the Ixodidae (Fig. 365 B) and Argasidae. The former live permanently on one host; the life of *Boophilus bovis*, attached to the cow, is only interrupted by the necessity of moulting and reproduction. Though compelled to withdraw its mouth parts when the skin is being cast, the tick plunges them into the host again at the same place, as soon as possible after the completion of the process. In many other cases the ticks fall off before every moult and have to seek a new host afterwards. The argasids, however, in the full-grown state, make only short visits to the host to suck blood, lasting for a few hours. In these last cases the young can go without food for months and the full-grown tick for years. In the course of several of these meals the six-legged larva develops into an eight-legged nymph which becomes sexually mature only after further development. Copulation may take place several times, spermatophores being inserted, but the sperm in these can only escape and reach the ovary after the female again feeds. But in all cases when fertilization of the eggs has once occurred, the female falls to the ground and after laying her eggs dies.

Many kinds of ticks carry disease, e.g. in both the following cases caused by *Spirochaeta*, Texas fever of cattle (*Boophilus annulatus*) and the relapsing fever of man (*Ornithodoros moubata*). Also certain small parasites of the blood corpuscles (*Piroplasma*), in severe diseases of cattle, are carried largely by *Rhipicephalus*.

### Class PHALANGIDA

Arachnids with prosoma covered by a single tergal shield and united to the opisthosoma by its whole breadth; opisthosoma always segmented; chelicerae three-jointed and chelate; pedipalps leg-like; two simple eyes.

These creatures, with their enormous elongated legs, are familiar objects in the summer; the active predaceous forms are supposed to live for a single season only, but some representatives are slow-moving and live longer. They feed on insects and other arthropods and suck their juices. The walking legs have the same number of joints as spiders, but the tarsus is multiarticulate. The opisthosoma contains at least ten segments. The animal breathes by tracheae and there are two stigmata on the first sternum of the opisthosoma, opening on each side of the reproductive aperture from which emerges a long pro-

trusible process, which is an *ovipositor* in the female, a *penis* in the male.

The Notostigmata mentioned above (p. 536) are forms transitional between the acarines and the phalangids.

### Class PANTOPODA (PYCNOGONIDA)

Arachnida, in which the opisthosoma has disappeared, with the exception of the pregenital segment which bears legs on which the genital pore opens.

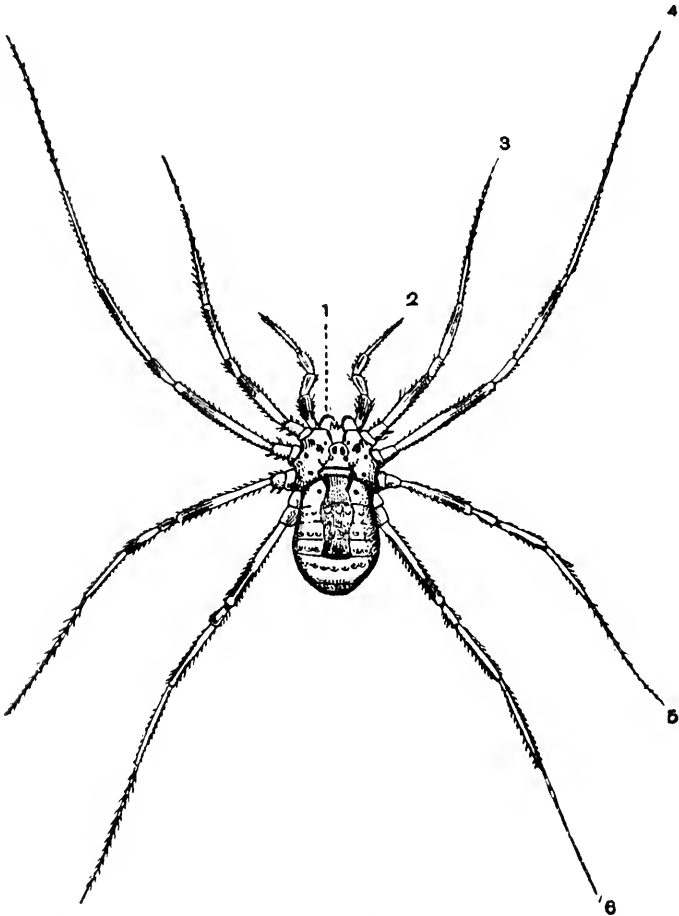

Fig. 369. A phalangid, *Oligolophus spinosus*, adult ♂, × 2. 1, chelicerae; 2, pedipalps; 3, 4, 5, 6, walking legs. From Shipley and MacBride.

These extraordinary animals, e.g. *Nymphon* (Fig. 370A), are all marine and semisedentary, crawling slowly over seaweed and sedentary animals. They consist of the following regions: (1) the *proboscis*, a prolongation of the prosoma with the mouth at the tip; (2) four segments fused together bearing four eyes, the chelicerae, the pedi-

palps, the *ovigerous legs* which are present in both sexes and the first pair of walking legs; (3) three free segments bearing the remaining pairs of walking legs. The body is usually very small while the legs are enormously elongated. They have eight joints. The proboscis contains a sucking pharynx preceded by a filter of chitinous hairs which prevents any but fluid food from proceeding further. The small stomach gives off digestive coeca which extend into the legs and other appendages. The common British form, *Pycnogonum littorale*, is found firmly attached by the terminal claws of the legs to the sides of sea anemones into which it inserts the proboscis and sucks the juices. There is a dorsal heart with three pairs of ostia; respiration is cutaneous. The nervous system consists of supraoesophageal ganglia and a ventral chain with suboesophageal and three or four other ganglia.

The sexes are separate and the males carry the eggs on the ovigerous legs. The gonads, like the alimentary canal, are branched and open on the 4th segment of the legs (the last pair of legs in *Pycnogonum* or all four pairs in *Phoxichilidium femoratum*). In the latter species the larvae are hatched as six-legged creatures, which form cysts in the polyps of the gymnoblast hydroid, *Coryne*.

Four small classes, Pseudoscorpionidea, Pedipalpi, Solifugae and Palpigradi, are undoubtedly arachnids, but can merely be mentioned here.

The two small classes following have been associated with the arachnids but no sufficient reason can be advanced for this. They both exhibit simplicity of structure; in the case of the Pentastomida this is due to parasitism, but in the Tardigrada some of the traits of primitive arthropods may be preserved. In some ways the Tardigrada resemble *Peripatus* and their development is said to be of a very primitive type. But the size and specialized habitat incline the author to regard this as a case of "simplification" such as is met with in the Archannelida (p. 294).

### Class TARDIGRADA

Minute arthropods with four pairs of stumpy legs ending in claws, with oral stylets and a suctorial pharynx, without definite circulatory or respiratory systems.

Representatives of this group, e.g. *Macrobiotus* (Fig. 370B), are found, for instance, in moss and in the sediment of rain gutters. They are minute and often very transparent animals, with a thin and flexible cuticle. The body is usually short and flattened; the tardigrades have been compared to the tortoises among the vertebrates, from their slow and awkward gait. The mouth opens into a tube in

which work the two chitinous stylets; a suctorial pharynx, the wall of which is composed of radiating muscular fibres, follows. Into the pharynx opens a pair of salivary glands. The animals pierce the wall of plant cells with the stylets and suck the sap by the action of the pharynx. Then comes a narrow oesophagus leading into a capacious stomach, and lastly the rectum, which is joined by two short tubes which probably represent Malpighian tubules, and by the duct of the gonad.

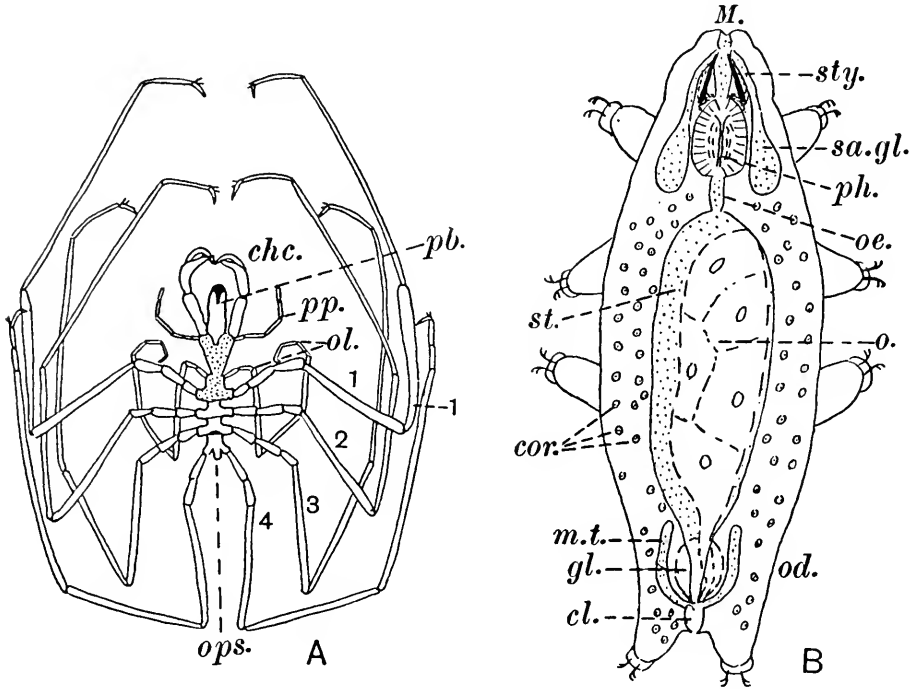

Fig. 370. A, *Nymphon*, an example of the Pantopoda. After Mobius. *pb.* proboscis with mouth; *chc.* chelicera; *pp.* pedipalp; *ol.* ovigerous leg; 1, 2, 3, first three ambulatory legs; *ops.* opisthosoma bearing, 4, last pair of ambulatory legs. Fusion of first four segments indicated by stippling. B, *Macrobiotus*, ♀, dorsal view. Modified from Greeff. *cl.* cloaca; *cor.* corpuscles in body cavity; *gl.* dorsal accessory gland; *M.* mouth; *m.t.* Malpighian tubule; *od.* oviduct; *oe.* oesophagus; *o.* ovary; *ph.* suctorial pharynx; *sa.gl.* salivary glands; *st.* stomach; *sty.* stylets.

The perivisceral cavity contains no connective tissue cells but is crowded with numerous rounded corpuscles and traversed by bands of longitudinal muscle. The nature of the cavity is not known but the existing account of the embryology describes pairs of coelomic pouches arising as outgrowths of the archenteron, as in the echinoderms.



The legs resemble the appendages of *Peripatus* and each is terminated by two forked claws. The last pair are terminal and the anus opens between them. The nervous system consists of suprapharyngeal, subpharyngeal and four pairs of trunk ganglia, the latter corresponding to the appendages.

Physiologically the Pantopoda are interesting in their capacity for resisting desiccation. Like the rotifers and nematodes with which they are associated in habitat they shrivel up with loss of water, absorbing it again and returning to life at the next rain.

### Class PENTASTOMIDA

Elongated vermiform parasites with a secondary annulation and two pairs of claws at the sides of the mouth; without respiratory or circulatory systems.

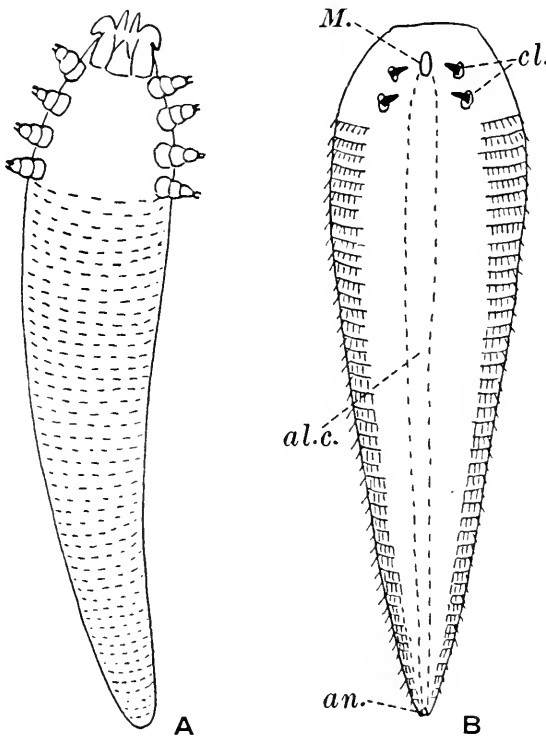

Fig. 371. A, *Demodex folliculorum*, ventral view. After Blanchard. A mite living in the hair follicles of man and domestic animals. B, *Linguatula taenioides*. After Leuckart. Ventral view, at the stage when it is eaten by the second host. *al.c.* alimentary canal; *an.* anus; *cl.* claws; *M.* mouth.

The commonest example, *Linguatula taenioides*, lives in the nasal passages of carnivorous mammals; the larvae, in which the claws of

the adult are borne on prominences which may be called limbs, live in other mammals, chiefly herbivorous. The eggs are passed out of the host, the larvae climb on to plants and are eaten by hares or rabbits; they traverse the wall of the gut and encyst in other tissues, often the liver. After a period of growth they wander once more through the body; they may at this stage be eaten by the second host and after wandering through the body reach the nasal passages. The larvae do resemble certain parasitic mites (Fig. 371 A) and for that reason the group has been classed with the arachnids.

## CHAPTER XVI

### THE PHYLUM MOLLUSCA

Unsegmented coelomate animals with a *head* (usually well developed), a ventral muscular *foot* and a dorsal *visceral hump*; with soft skin, that part covering the visceral hump (the *mantle*) often secreting a shell which is largely calcareous, and produced into a free flap or flaps to enclose partially a *mantle cavity* into which open the anus and the mesoblastic kidneys (usually a single pair); a pair of *ctenidia* (organs composed of an axis with a row of leaf-like branches on each side, contained in the mantle cavity, originally used for breathing); having an alimentary canal usually with a buccal mass, radula and salivary glands, and always a stomach into which opens a *digestive gland* or

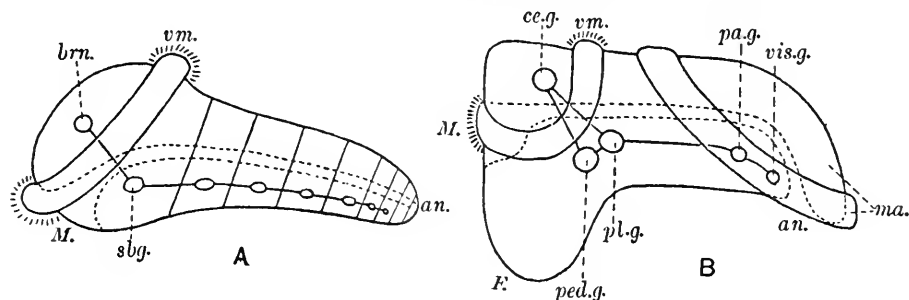

Fig. 372. Comparison between annelidan and molluscan organization. Side views of A, post-trochosphere larva of Annelida with segmenting trunk; B, veliger larva of *Paludina* (Mollusca) before torsion. After Naef. Alimentary canal shown by stippling. *an.* anus; *brn.* brain or suprpharyngeal ganglion of annelid; *ce.g.* cerebral ganglion of Mollusca; *F.* foot; *M.* mouth; *ma.* mantle; *ped.g.* pedal, *pl.g.* pleural, *pa.g.* parietal, *sb.g.* subpharyngeal, *vis.g.* visceral ganglia; *vm.* velum.

*hepatopancreas*; with a blood system consisting of a *heart*, a median ventricle and two lateral auricles, arterial system and venous system often expanding into a more or less extensive haemocoel, with haemocyanin as respiratory pigment; a nervous system consisting of a circumoesophageal ring, often concentrated into cerebral and pleural ganglia, pedal cords or ganglia and visceral loops; coelom, varying in development, but always represented by the *pericardium*, the cavity of the kidneys (which communicates with the pericardium), and the cavity of the gonads; often with larvae of the *trochosphere* type.

While we do not know exactly what the ancestral molluscs looked like, we can make a very shrewd guess at their structure. They possessed the molluscan characters given in the definition above and

they resembled the diagrammatic creature shown in side view in Fig. 349A. They had a head with tentacles, a flat creeping foot, a conical visceral hump covered by a mantle which possibly contained numerous calcareous spicules and not a complete shell, and a posterior mantle cavity into which opened the median terminal anus and the common apertures of the kidneys and the gonads, and which also

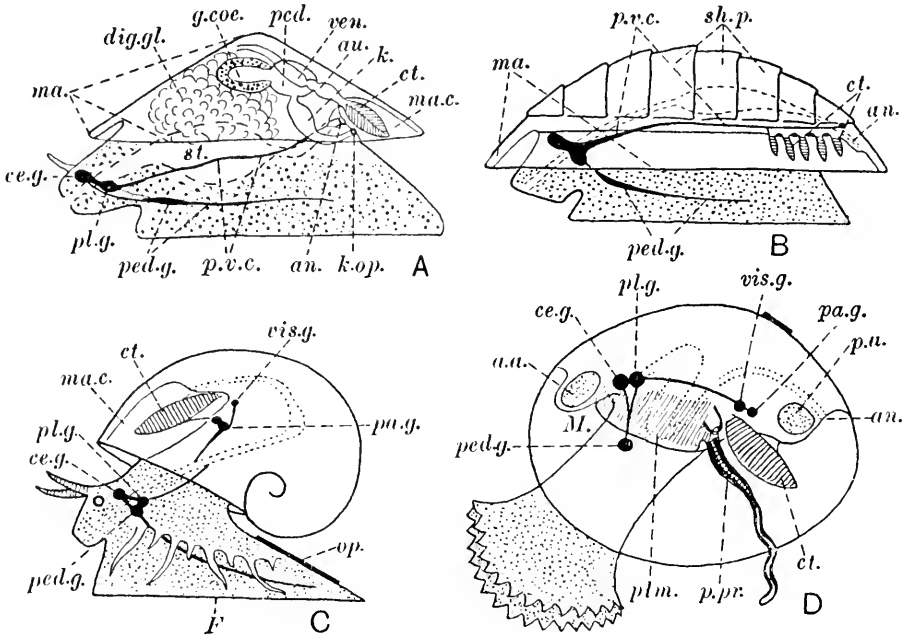

Fig. 373. Types of Mollusca. Side view. Partly after Naef. A, Ancestral mollusc. B, Amphineura. C, Gasteropoda. D, Lamellibranchiata (*Nucula*, a primitive type). The head-foot is stippled to contrast with the visceral hump and mantle. The course of the alimentary canal is indicated by double dotted lines. In A the mantle cavity has its original posterior position, in C it has become anterior, while in B and D it has extended forward on both sides of the body, becoming very spacious in D. *a.a.* anterior adductor muscle; *an.* anus; *au.* auricle; *ce.g.* cerebral ganglion; *ct.* ctenidium; *dig.gl.* digestive gland; *F.* foot; *g.coe.* genital coelom; *k.* kidney; *k.op.* kidney opening; *M.* mouth; *ma.* mantle; *ma.c.* mantle cavity; *op.* operculum; *p.a.* posterior adductor muscle; *pa.g.*, *ped.g.*, *pl.g.* parietal, pedal, pleural ganglia; *plm.* palp-lamella; *p.pr.* palp-proboscis; *pcd.* pericardium; *p.v.c.* pleurovisceral (palliovisceral in B) commissure; *sh.p.* shell plates; *st.* stomach; *ven.* ventricle; *vis.g.* visceral ganglia.

contained the ctenidia. In the alimentary canal the fore gut formed a muscular body, the buccal mass, and a radula (p. 557) and the mid gut an oesophagus, stomach and digestive glands and intestine. The heart had a median ventricle and a pair of auricles. The perivisceral coelom reduced by the development of an extensive haemocoel (p. 556) is represented by the pericardium with which communicates in front

the cavity of the gonads and at the sides the two coelomoducts ("kidneys"). In the nervous system there were as in annelids and arthropods, a circumoesophageal commissure or brain which may or may not have been ganglionated, ventral pedal cords, a visceral commissure coming from the pleural part of the brain, and a pallial commissure in the mantle edge. From this beginning diverged the different groups which we know to-day. The chitons (Amphineura), which have departed least from the ancestral structure, became elongated but limpet-like forms (Fig. 373 B), their visceral hump being protected by eight shell plates, their mantle cavity extended all round the foot while instead of a single pair of ctenidia many such pairs arose. The Gasteropoda remained as short creeping forms (Fig. 373 C); they are characterized by the growth of the visceral hump dorsally, but unequally so that it has coiled in a spiral (which is covered by a single shell). This caused a readjustment of the visceral hump which has revolved (usually to the right) on the rest of the body through  $180^\circ$  (torsion) and the mantle cavity is now anterior. The Lamellibranchiata (Fig. 373 D) are flattened from side to side, the whole body being covered by two mantle lobes secreting two shell valves united by a median hinge. The ctenidia inside the greatly enlarged mantle cavity have developed into huge organs of automatic food collection and so the head, rendered unnecessary and withdrawn into the mantle cavity, has become vestigial. Similarly the foot has lost its flat sole and has to be extended out between the valves to move the animal.

In the Cephalopoda, though there is an unequal growth of the visceral hump relative to the rest of the body, as in gasteropods, it is coiled in a plane spiral, but there is no torsion, the mantle cavity remaining posterior. The primitive forms in the group (Fig. 402 A) have an external shell which is divided into chambers, and those behind the body chamber contain gas. This has had a great effect on the development of the group, for by diminishing the specific gravity of the animals it has enabled them to become more or less free-swimming. They have tended, with the loss of the shell, to become more and more efficient swimmers, and this is associated with the development of their predatory habits. The anterior region shows a kind of transformation new to the molluscs in its partial modification into circumoral prehensile tentacles for seizing food. Lastly, and in connection with all these changes, the brain and sense organs have become enormously developed and the cephalopods are seen to be one of the most progressive groups of invertebrates.

Characteristically the ectodermal epithelium of the mantle secretes a *shell* in the Mollusca and in most of them the method of secretion is the same. The original shell is laid down by the mantle of the veliger larva (Fig. 374 B), but all extension takes place by secretion at

its edge (Fig. 377). The outer shell layer, *periostracum*, formed of horny conchiolin, is first produced in a groove and then the *prismatic*

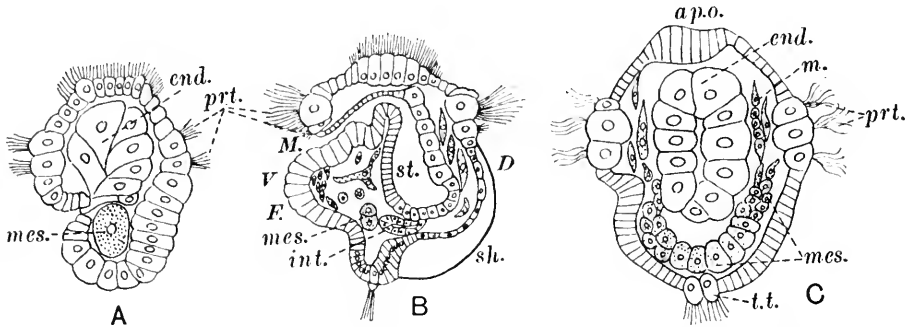

Fig. 374. *Patella coerulea*. A, Trochosphere larva, sagittal section. B, Early veliger larva, sagittal section. C, Veliger larva, frontal section to show mesoderm bands. After Patten. *ap.o.* apical organ; *end.* endoderm; *F.* foot; *int.* intestine; *M.* mouth; *mes.* mesoblast pole cell and derivatives; *m.* embryonic muscle cells; *prt.* prototroch; *sh.* shell; *st.* stomach; *t.t.* telotroch; *D* and *V* dorsal and ventral.

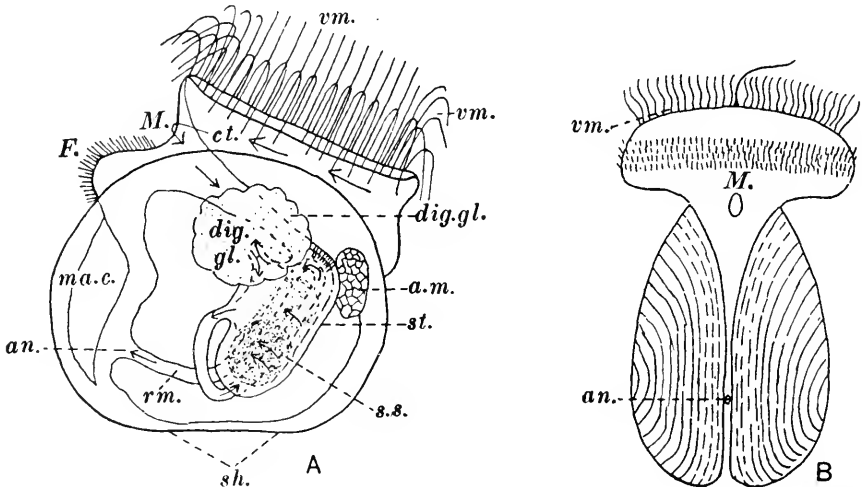

Fig. 375. Veliger larvae. A, *Ostrea edulis*, side view. After Yonge. Ciliary currents shown by arrows. Suspended material is thrown by the action of the large cilia of the velum on to the ciliated tract, *ct.*, imbedded in mucus and carried to the mouth, *M.*, then through the oesophagus into the stomach, *st.* The style, shown by stippling, projects from the style sac, *s.s.*, in which it rotates; many particles are imbedded in this. After leaving the stomach the material passes through the coiled intestine (dotted) and by the rectum, *rm.*, out into the mantle cavity, *ma.c.* Other letters: *an.* anus; *a.m.* adductor muscle; *dig.gl.* digestive gland; *F.* foot; *sh.* shell; *vm.* velum. B, *Dreissensia*, ventral view. After Meisenheimer.

layer, largely consisting of calcite or arragonite, is secreted underneath it by the cells of the thickened edge. The innermost *nacreous layer* (also mostly  $\text{CaCO}_3$ ) is, however, formed by the cells of the whole of

the mantle, and under such conditions as occur in the formation of pearls this general epithelium is capable of secreting any of the three shell layers.

In the Mollusca the development of the trochosphere takes place in a fashion identical with that described for the annelid. In the diagram given here for *Patella*, we see the completion of gastrulation and the appearance of the ciliated rings of the trochosphere (Fig. 374 A); also the single large cell which gives rise to the mesoderm. Then in Fig. 374 B we see the early veliger with an internal organization similar to the annelid, with apical organ, larval nephridia and prototroch. The figure shows, however, organs which are not present in the annelid. On the dorsal side between the prototroch and the anus the larval ectodermal epithelium forms the rudiment of the *mantle* and even at this early age secretes the first *shell*. On the ventral side, there is a prominence which is the *foot* (formed by the union of two rudiments). The single mesoderm cell gives rise first of all to two regular mesoderm bands; and by the development of a cavity in each of these, right and left coelomic sacs are formed; then instead of segmenting as in the annelid, these largely break up into single cells, some elongating and becoming muscle cells (Fig. 374 C). It is because there is never any commencement of segmentation in the embryonic mesoderm in molluscs that we have the strongest grounds for believing that molluscs never had segmented ancestors. The trochosphere is followed by a second free-swimming stage, the *veliger* (Fig. 375), in which the prototroch develops into an organ, the *velum*, of increased importance, which serves not only for locomotion but also for feeding, the cilia creating a current which brings particles into the mouth. In the veliger stage the foot increases in size and the shell often becomes coiled in the Gasteropoda.

### Class AMPHINEURA

Mollusca with an elongated, bilaterally symmetrical body, the mouth and anus at opposite ends; with a head, without tentacles or eyes, tucked under the mantle, which occupies the whole of the dorsal surface, and contains various kinds of calcareous spicules imbedded in cuticle, sometimes united to form continuous shells; a flattened foot sometimes reduced; a nervous system (Fig. 398 A) without definite ganglia, the ganglion cells being evenly distributed along the length of the nerve cords, and composed of a circumoesophageal commissure and two pairs of longitudinal cords (*pedal* and *palliovisceral*), each pair united by a posterior commissure dorsal to the rectum; a radula; usually a trochosphere larva.

POLYPLACOPHORA. Shore-living amphineura with flat foot which

occupies the whole ventral face of the body; mantle containing eight transverse calcareous plates as well as spicules; in the mantle groove which runs entirely round the body there is a more or less complete

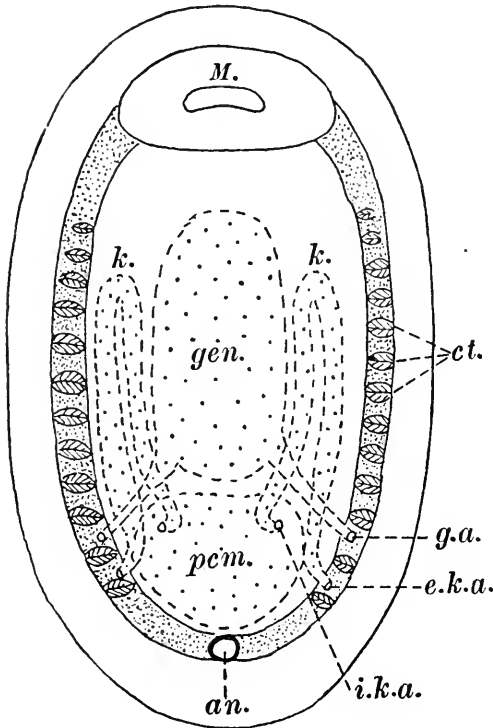

Fig. 376.

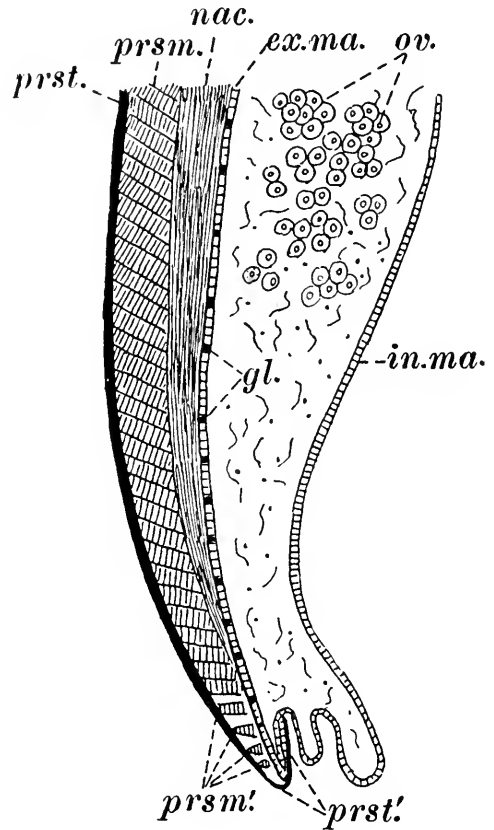

Fig. 377.

Fig. 376. Ventral view of *Chiton* to show external and internal bilateral symmetry. Mantle cavity finely stippled, the divisions of the coelom, shown above the foot, coarsely stippled. *an.* anus; *ct.* ctenidia; *e.k.a.* external kidney aperture; *i.k.a.* internal kidney aperture; *gen.* gonad; *g.a.* genital aperture; *k.* kidney; *M.* mouth; *pcm.* pericardium.

Fig. 377. Vertical section through the edge of the mantle of *Mytilus*. *ex.ma.* external, *in.ma.* internal surface of mantle; *gl.* gland cells; *nac.* nacreous layer; *prsm.* prismatic layer of shell; *prsm.'* prisms arising at external border; *prst.* periostracum; *prst.'* periostracum arising in a fold of the mantle; *ov.* ova in the mantle tissue. After Field.

row of ctenidium-like gills on each side, *Chiton* (Figs. 373 B, 376), *Craspedochilus*.

APLACOPHORA. Worm-like Amphineura in which the foot is absent or represented by a median ridge in a ventral groove and the mantle correspondingly enlarged. No shell plates but spicules only. Mantle



cavity perhaps represented by a small cloacal chamber at the posterior end, gills present (*Chaetoderma*) or absent (*Neomenia*).

*Craspedochilus* is a small mollusc found underneath stones between tidemarks. It looks like an elongated limpet and has exactly the same habits, browsing on small algae and returning after excursions to a centrally situated home. In dorsal view there are seen the eight shell plates which articulate with one another and allow the animal to roll up like a woodlouse. Each plate is composed of two layers, the upper or *tegmentum* and lower or *articulamentum*. Both are calcareous, but the *tegmentum* is traversed by parallel canals containing ectodermal tissue which end on the surface in remarkable sense organs; some of these have the structure of eyes (the *aesthetes*). Young individuals, which possess a full equipment of *aesthetes* are negatively phototropic. As, however, the valves become corroded and covered with encrusting organisms they become indifferent to light. The part of the mantle which surrounds the shells is called the *girdle* and this contains the spicules which are characteristic of the Amphineura as a whole.

On the ventral surface is seen the *head*, which does not project from under the shelter of the mantle. It bears no eyes and no tentacles, and is separated from the foot by a narrow groove. The mantle groove is shallow, running completely round the animal and containing a varying number of branchial organs, each of which resembles a *ctenidium*. There may be only six on each side crowded together at the posterior end, or they may occupy the whole groove from the head to the anus. It is probable that the forms with a small number of branchiae are the most primitive, and from the fact that the branchiae are graded in size it seems likely that one of them (the largest) is the original one and the others are derived from it. At any rate the repetition of the branchiae does not mean that the chitons were once metamericly segmented animals. There is no trace of any segmentation of the mesoblast in the larva and there is no correspondence between the numbers of the shell plates and of the branchiae.

The mantle groove also contains the *anus* in the middle line posteriorly, on each side, the renal apertures just in front of it, and the genital apertures a little further forward. In this entire symmetry of the various apertures the chitons differ from any living gasteropods.

The internal anatomy presents the features attributed above to the ancestral molluscs. Another feature which is probably primitive is the uniform distribution of nerve cells in the nerve cords and the consequent absence of ganglionic enlargements. The cords are connected by many commissures which form a nerve plexus (Fig. 398 A).

A point of great interest is the palaeontological antiquity of the group, forms with eight shell valves occurring in the Ordovician.

The Aplacophora are simplified forms, often worm-like in appear-

ance. Besides the primitive character found in the chitons they have others, one of which is the free communication of the parts of the coelom. The gonads open into the pericardium and a pair of coelomoducts (probably corresponding to the kidneys) convey the gametes from the pericardium to the exterior. The radula varies greatly, all stages from absence to a type with several transverse rows of teeth being found. This condition may also be considered as primitive.

### Class GASTEROPODA

Mollusca with a distinct head bearing tentacles and eyes, a flattened foot, and a visceral hump which exhibits the phenomenon of torsion in various degrees and is often coiled; always exhibiting bilateral asymmetry to a certain extent; typically with a shell secreted in a single piece; nervous system with cerebral, pleural, visceral and usually pedal ganglia and a visceral loop; a radula; often a trochosphere larva.

We can safely say that the Gasteropoda are descended from symmetrical unsegmented ancestors (p. 543), and that the most prominent differences among their present-day representatives are due to the varying degrees in which they exhibit the phenomena of torsion. The ancestors of the Gasteropoda had not been affected by torsion. They possessed a symmetrical body with a straight alimentary canal ending in a posterior anus. On each side of this was a ctenidium, that is, a breathing organ composed of an axis with a row of leaf-like branches on each side. The ctenidia may have been free on the surface when they first arose, but they were soon contained in the posterior mantle cavity which developed with the visceral hump.

Many characters belonging to the primitive mollusc are still preserved in the gasteropods, the head with tentacles, the nervous system with cerebral, pleural, and pedal ganglia, the radula, the ventricle with two auricles and the two kidneys. Lastly, there is a flat creeping foot and a visceral loop formed by a connective from each pleural ganglion uniting with its fellow in the neighbourhood of the ctenidia.

In the alimentary canal of molluscs there is a tendency for digestion and resorption to be confined to a dorsal diverticulum of the alimentary canal which develops into the digestive gland (liver). The growth of this causes the formation of a projection, the *visceral hump*, and a looping of the alimentary canal. This projection grows until it falls over, and this is the first step in the coiling of the visceral hump which is such a characteristic feature of the gasteropods. Growth proceeds until, in the snail, for instance, the visceral hump would, if uncoiled, be longer than the whole of the body. Owing, however, to the fact that one side of the hump grows faster during development than the

other, the whole organ is twisted into a compact spiral which can be arranged so as not to interfere with the balance of the animal while crawling.

In all gasteropods with coiled shells the mantle cavity is anterior, the opening directed forward and the coiling of the visceral hump is directed posteriorly. But in the development of these forms from the larva (Fig. 378) the mantle cavity first makes its appearance behind the visceral hump, and at a particular stage the visceral hump rotates in a counter-clockwise direction through an angle of  $180^\circ$  on the rest of the body (Fig. 378 D). This is what is known as *torsion*, and as shown above it is entirely distinct from the coiling of the visceral hump which precedes it, though it may have been necessitated by the

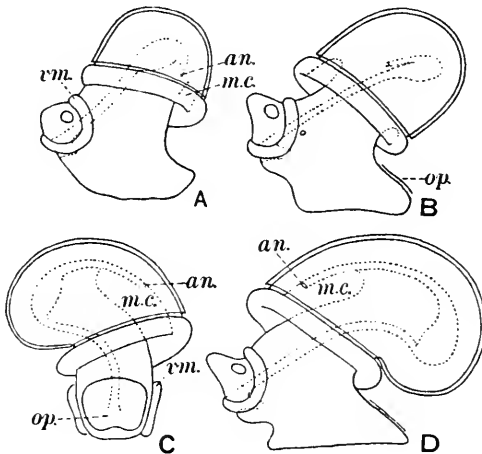

Fig. 378. To show torsion in *Paludina vivipara*. After Naef. Embryos seen from the side (A, B, D) and behind (C). A, Almost symmetrical stage, with mantle cavity behind but anus twisted a little to the right. B, Stage showing  $90^\circ$  of torsion, mantle cavity and anus to the right. C, Torsion at almost the same stage as B. D, Stage showing  $180^\circ$  of torsion and the adult condition. *an.* anus; *m.c.* mantle cavity; *op.* operculum; *vm.* velum.

antecedent phenomenon. Only the narrow neck of tissue (and the organs which pass through it), between the visceral hump and the rest of the body, is actually twisted; but the orientation of the mantle cavity and its organs is changed (Fig. 379). Before torsion the ctenidia and the anus point backwards, the auricles are behind the ventricle. After torsion the ctenidia project forward, the auricles are in front of the ventricle; the mantle cavity opens just behind the head. The uncoiled visceral loop has been caught in the twisting and one connective laid over the other, one passing over the intestine and the other underneath, but both coming together near the anus and completing a figure of eight. The whole process takes only two or three

minutes in *Acmaea* so that it can hardly be brought about by differential growth. Muscular contractions must play their part.

The large majority of gasteropods belong to the order which exhibits torsion in full development. It is called Prosobranchiata, because of the anterior position of the gills, or Streptoneura, because of the coiled visceral loop. The periwinkles, whelks and limpets of our shores, the freshwater *Paludina*, and many others belong to it. The order may, however, be divided into two groups, a primitive one in which the two ctenidia and consequently the two auricles are preserved (*Diotocardia* represented by *Patella*, *Fissurella* and *Haliotis*) (Fig. 380 A–C), and a more specialized one in which the right (primitive left) gill, its auricle and even the right kidney have disappeared

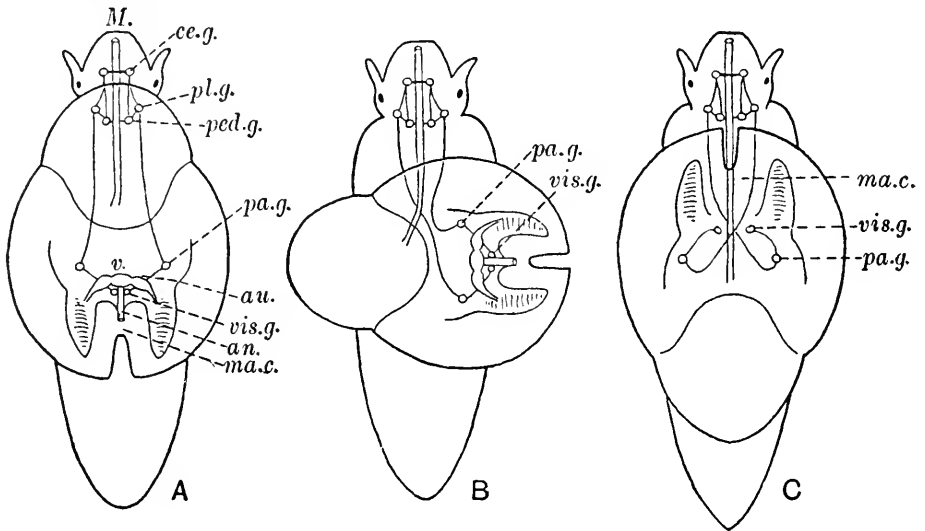

Fig. 379. Diagram to illustrate torsion, when seen from above. A, Ancestral gasteropod. B,  $90^\circ$  of torsion. C, Torsion completed ( $180^\circ$ ). After Naef. an. anus; au. auricle; ce.g. cerebral ganglion; M. mouth; ma.c. mantle cavity; pa.g. parietal, ped.g. pedal, pl.g. pleural, vis.g. visceral ganglia; v. ventricle.

(*Monotocardia*, represented by *Littorina*, the periwinkle, and *Buccinum*, the whelk) (Fig. 380 D). Some of the *Diotocardia*, like *Trochus*, are in an intermediate state in which, though the right gill has disappeared, there is still a rudiment of the corresponding auricle. Besides this fundamental difference, there are others. For example, in the *Monotocardia*, special generative ducts are developed (cp. also the penis of the male *Buccinum*), while in the *Diotocardia*, the generative organs open to the exterior through the right kidney.

It is possible that the disappearance of the organs of one side is to be regarded as the consequence of the processes concerned in torsion and that in the *Diotocardia* the phenomenon cannot be regarded as having reached its climax. On the other hand, there is a large division

of gasteropods called the Opisthobranchiata which show that the changes occurring in torsion are to a certain extent reversible. They

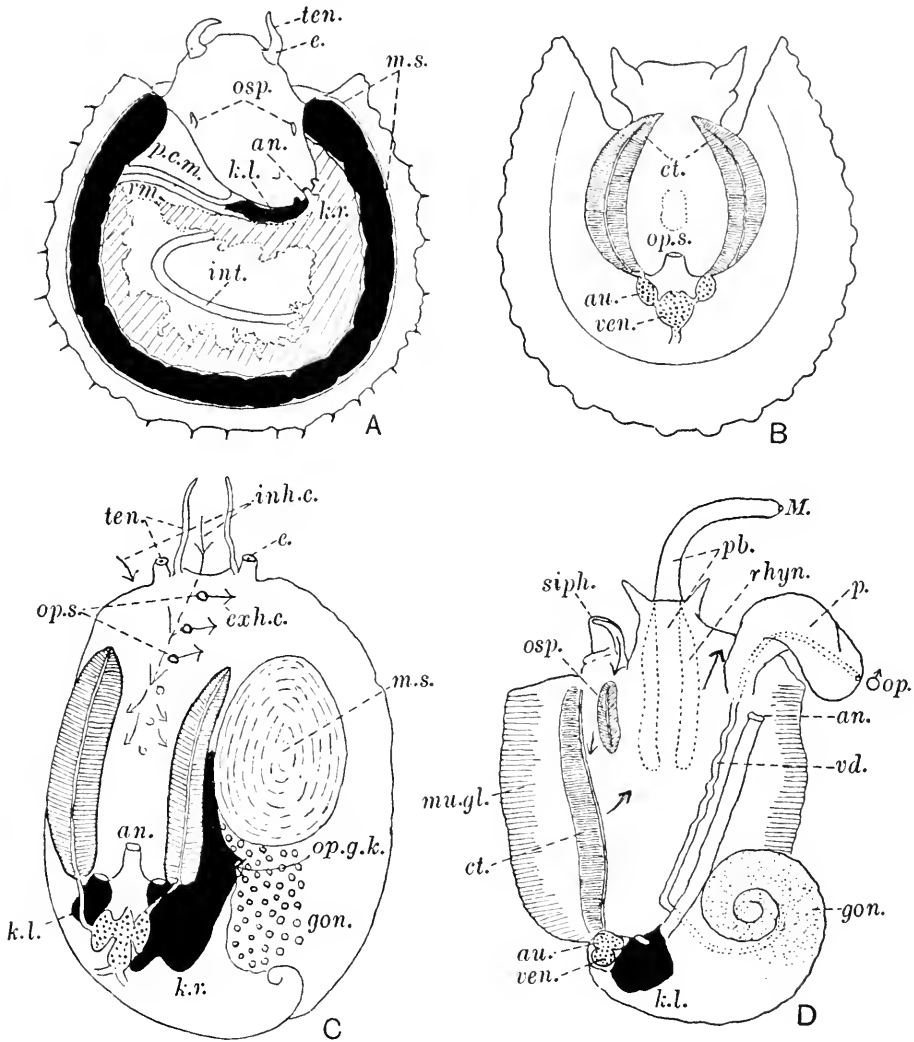

Fig. 380. Mantle cavities of streptoneurous gasteropods. A, *Patella*, ctenidia absent. B, *Fissurella*, ctenidia equal; kidneys unequal, like those of *Patella*. C, *Haliotis*, right ctenidium smaller; ciliary currents shown by arrows, exhalant shown emerging from the three most recently formed holes in the shell. D, *Buccinum*, male, with single set of pallial organs. an. anus; au. auricle; ct. ctenidium; e. eye; exh.c. exhalant current; gon. gonad; inh.c. inhalant current; k.l. left, and k.r. right, kidney; M. mouth; m.s. shell muscle; mu.gl. mucous glands; op.s. opening from mantle cavity through shell; osp. osphradium; op.g.k. opening from gonad into kidney; p. penis; pb. proboscis; p.c.m. pericardium; rhyn. rhynchocoele; siph. siphon; ten. tentacles; vd. vas deferens; ven. ventricle; int. intestine; ♂op. male aperture; rm. rectum.

have the ctenidium pointing backwards, the auricle behind the ventricle and the visceral loop untwisted and symmetrical. There are

some forms (*Bullomorpha* (Fig. 387 C, D)) included in the Opisthobranchiata which possess a complete coiled shell, but show only  $90^\circ$  of torsion, so that the anus and the ctenidium point laterally instead of anteriorly. The visceral loop also shows untwisting and the forms in this division are thus supposed to show partial reversion of torsion or *detorsion*. Forms like this pass into the typical opisthobranchs with complete detorsion, in which the shell is reduced or lost, the ctenidium directed posteriorly and the visceral loop is completely untwisted (*Aplysia* (Fig. 388 A)). The Opisthobranchiata, it is plainly seen, are derived from the Monotocardia amongst the Streptoneura, since they have only a single ctenidium, a single auricle and a single kidney. They have not attained to complete bilateral symmetry, because the mantle cavity is still on the right side where yet present (tectibranchs), and the anus and genital aperture both open there.

The disappearance of the shell and the consequent uncoiling of the visceral hump, if not the cause of detorsion, is a constant accompaniment of the phenomenon. When it is complete, the mantle cavity and even the ctenidium may disappear and we arrive at the group known as the Nudibranchiata. In forms like *Eolis* (Fig. 388 C) their descent is shown by the fact that they possess a veliger larva with a coiled visceral hump which undergoes torsion (which reverses later). The adult shows evidence of streptoneurous ancestry in the presence of the anus at the right-hand side. In *Doris* (Fig. 388 B) the anus and renal aperture are median, but the genital aperture is still situated on the right side.

The last division of the Gasteropoda is the Pulmonata, which is usually united with the Opisthobranchiata to form the group Euthyneura. But "euthyneury" or symmetry of the nervous system (more particularly the "visceral" part of it) is arrived at in different ways in the two divisions. In the Opisthobranchiata, as shown above, it is by detorsion. In the Pulmonata, however, the shell is retained and the visceral hump coiled in typical members of the group (land snails). But the visceral loop is shortened and untwisted at the same time (Fig. 387 A, B), and finally it is incorporated with its ganglia into the circumoesophageal nerve collar, so that the nervous system becomes symmetrical. The most primitive members of the Pulmonata still show a twisted visceral loop which is beginning to shorten. All the group have lost the ctenidium but they retain the single auricle which shows them to be derived from the Monotocardia. This was brought about by a chain of circumstances involving migration from sea to shore.

The type of the Gasteropoda which is usually given for dissection is *Helix* (either *H. aspersa*, the common English garden snail, or *H. pomatia*, the edible snail). It possesses many features which are common to the whole of the Gasteropoda, but as has been seen above,

the order Pulmonata to which *Helix* belongs is the most specialized and probably the latest developed division. *Helix* is a terrestrial animal breathing by a kind of lung, while the majority of gasteropods are marine animals breathing by gills, and besides the complications which this involves, the reproductive system is hermaphrodite with the most elaborate provision of glands and ducts which serve to produce eggs well stored with nourishment and are arranged so as to assure cross-fertilization. In the account of *Helix* which follows an attempt is made to distinguish clearly between the purely gasteropod features and the adaptive features which belong to the Pulmonata.

The body of a snail is composed of three regions, the head, foot and visceral hump. The visceral hump is all that part which is covered by the shell when the animal is expanded, while the head and the foot make up the remainder outside the shell. There is no boundary between the latter two regions. The German zoologists refer to the whole as the "Kopffuss" (the "head foot"), and this can be retracted as a whole within the shell by the action of the *columella muscle* (Fig. 381). The foot is particularly characteristic of the Gasteropoda. It possesses a flat ventral surface underlain by longitudinal muscle fibres. If a snail is observed crawling up a pane of glass, a series of rippling waves of contraction of very small amplitude are seen to pass regularly over the surface of the foot. They are co-ordinated by the action of a nervous network, such as occurs in the lower invertebrates (Fig. 110). The gliding movement of a snail indeed resembles that of a turbellarian, and we actually find that in some marine gasteropods the surface of the foot is clothed with cilia, which beat in unison, though they are perhaps capable of inhibition by the central nervous system. In most water snails, however, the foot moves by muscular contraction. To fit this kind of movement for passing over a hard dry surface, there is in the snail a copious secretion of slime from a *pedal (mucous) gland* which runs dorsal to the foot and opens just ventral to the mouth. As soon as the slime emerges it is spread out as a smooth bed of lubricating fluid along which the snail moves.

There are two pairs of *tentacles* on the head of the snail. The first are shorter and are supposed to be the seat of the sense of smell; the second bear a pair of simple eyes (Fig. 409B) at their tip. Both are hollow and have attached to the inside of the tip a muscle whose contraction turns them outside in. The *mouth* is a transverse slit just ventral to the first pair of tentacles. On the right side of the body not far below and behind the second pair of tentacles is the *reproductive aperture*. On removing the shell, the junction of the visceral hump with the rest of the body is seen anteriorly as a thickened collar which is the edge of the mantle and the seat of secretion of the principal layers of the shell. It is fused to the head of the snail except for a

round hole on the right side which is the *aperture of the mantle cavity* or *pneumostome*. In the marine gasteropods the mantle cavity has a wide opening to the exterior, though a part of the mantle border (*siphon*) is modified to form a special channel by which fresh water for breathing may be drawn in by the action of the cilia clothing the gill. But in the air-breathing pulmonates where the cavity is converted into a lung, the injury of delicate respiratory tissues by evaporation must be avoided, and a pumping mechanism for renewal of air established. The restriction of the respiratory aperture is one of the necessary modifications. If a section is drawn across the lung of a snail it will be seen that the mantle forms the roof of the cavity and is covered with ridges in which run pulmonary veins converging towards the auricle. The floor of the cavity is arched and has a layer of muscles, which contract rhythmically. When they contract, the arch flattens and air is drawn in and at the limit of contraction a valve slides across the pneumostome. When the muscles relax, the cavity decreases in size and exchange of gases with the blood in the roof vessels is facilitated by the increase of pressure of the contained air. Then the pneumostome opens and air is expelled; the subsequent contraction of the floor muscles brings in a fresh supply. This "breathing" is not so regular or so frequent as in a vertebrate; moreover, it may cease altogether in the winter when the snail hibernates.

In dissection, a cut is made underneath the collar and another under the rectum and the roof of the mantle cavity turned back so as to show the pericardium enclosing the ventricle and single auricle, and the kidney, which is a yellow organ consisting of a number of folds covered by cells containing uric acid. The ureter is a thin-walled tube which runs along the right border of the mantle cavity parallel to the rectum and opens just behind the pneumostome and above the anus. Here again is a difference from the marine gasteropods in which the anus and kidney aperture discharge inside the mantle cavity, faeces and urine being swept away by the respiratory current. The pericardium and the kidney represent the coelom in the snail and, as is usual in Mollusca, their common derivation is shown by the connection of the cavities by the *renopericardial canal*. The coelom, though thus represented, does not constitute the perivisceral cavity. On cutting the floor of the mantle cavity and continuing the cut forward towards the mouth a large body cavity is revealed which contains the anterior part of the alimentary canal and the greater part of the reproductive organs. This is a haemocoel almost as well developed as that of arthropods. Its connection with the rest of the blood system and the general course of the circulation may be briefly described here as follows: the ventricle pumps arterial blood through a single aorta which soon divides into an anterior aorta



supplying the buccal cavity and a posterior which supplies the visceral hump. The terminal branches of these arteries eventually communicate with the general haemocoel (stippled in Fig. 381) and this discharges into the *circulus venosus* leading to the lung and heart.

The alimentary canal (Fig. 382) commences with the *buccal mass*. On the roof of the mouth is a small transverse bar, the *jaw*, and in conjunction with this works the *radula*, which is a strip of horny basement membrane on which are fastened many rows of minute recurved

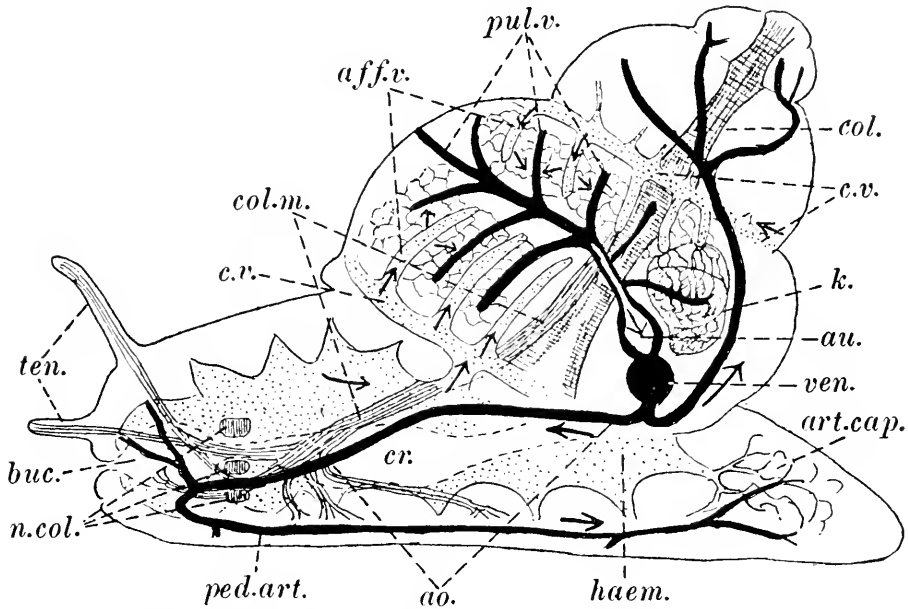

Fig. 381. *Helix pomatia*. Diagram of the circulation and haemocoelic spaces. The pulmonary veins, ventricle and arteries are shown in black; the veins and haemocoelic spaces are indicated by stippling. Only a few of the arteries are shown and a small portion of the arterial capillary network in the posterior part of the foot. The course of the columella muscle and its branches is indicated. The direction of the blood flow is shown by arrows. *aff.v.* afferent veins; *ao.* aorta; *art.cap.* arterial capillaries; *au.* auricle; *buc.* buccal mass; *col.* columella, *col.m.* columella muscle; *cr.* crop; *c.v.* circulus venosus; *haem.* haemocoelic spaces; *k.* kidney; *n.col.* nerve collar; *ped.art.* pedal artery; *pul.v.* pulmonary veins; *ten.* tentacles; *ven.* ventricle.

teeth. It is formed in a ventral diverticulum of the buccal cavity called the *radula sac* (Fig. 383) in which proliferating tissue is constantly producing transverse rows of cells called *odontoblasts*, each of which helps to form a tooth, and other cells which secrete the basement membrane. The whole radula is pressed forward by the new growth so that fresh surfaces are constantly coming into use as the old part is worn away. The radula is supported by masses of tissue, resembling cartilage, which also serves for the attachment of muscles, and the whole forms the rounded organ which is the *buccal mass*.

The buccal cavity is succeeded by the *oesophagus*, which widens out into the *crop*, which in life contains a brown liquid secreted by the "liver". On the side of the crop are the branching white *salivary glands*, which empty their secretion by two ducts running forward into the buccal cavity. The secretion is partly mucus, partly digestive fluid containing an enzyme acting on starch. The crop is succeeded

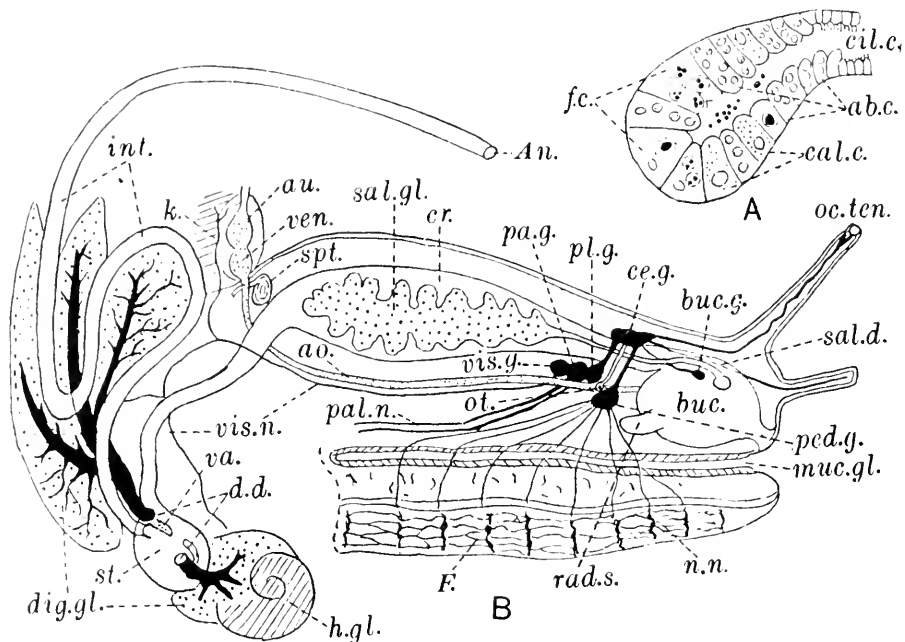

Fig. 382. *Helix pomatia*. A, Section of alveolus of the digestive gland. *ab.c.* absorptive cells; *cal.c.* calcareous cells; *cil.c.* ciliated cells of liver tube; *f.c.* ferment cells. After Meisenheimer. B, Diagrammatic side view of animal dissected to show the alimentary canal and nervous system. Original. *An.* anus; *ao.* aorta; *au.* auricle; *buc.* buccal mass; *buc.g.* buccal ganglion; *ce.g.* cerebral ganglion; *cr.* crop; *dig.gl.* digestive gland; *d.d.* openings of digestive ducts (the ducts represented by black lines); *F.* foot; *h.gl.* hermaphrodite gland; *int.* intestine; *k.* kidney; *muc.gl.* mucous gland; *n.n.* nerve net in surface of foot; *oc.ten.* oculiferous tentacle; *ot.* otocyst; *pa.g.*, *ped.g.*, *pl.g.* parietal, pedal and pleural ganglia; *pal.n.* pallial nerve; *rad.s.* radula sac; *sal.d.* salivary duct; *sal.gl.* salivary gland; *spt.* spermatheca (duct broken off short); *st.* stomach; *va.* valves directing food into digestive ducts; *ven.* ventricle; *vis.g.*, *vis.n.* visceral ganglia and nerve.

by the *stomach*; this is imbedded in the *digestive gland* (liver), which occupies most of the visceral hump. The "liver", though apparently solid, is composed of a number of tubes and the end portion (*alveolus*) of each tube is glandular; the rest is ciliated and serves to introduce small fragments of food into the active alveolus. The alveoli contain cells of three kinds, secretory, resorptive and lime-containing (Fig.

382 A). The secretory cells produce the brown fluid found in the crop; this contains a ferment which dissolves the cellulose of plant cell walls and liberates the protoplasmic contents, no portion of which is digested in the crop or stomach. But these contents in the form of small granules are actually introduced into the alveoli of the liver and there taken up and digested by the resorptive cells which possess intra-

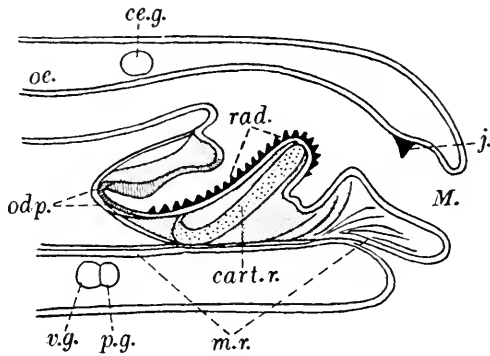

Fig. 383. Vertical longitudinal section through head of *Helix*. After Meisenheimer. *cart.r.* cartilaginous support of radula; *ce.g.* cerebral ganglion; *j.* jaw; *M.* mouth; *m.r.* muscles of radula; *odp.* odontophore (radula sac); *oe.* oesophagus; *p.g.* pedal ganglion; *rad.* radula; *v.g.* visceral ganglion.

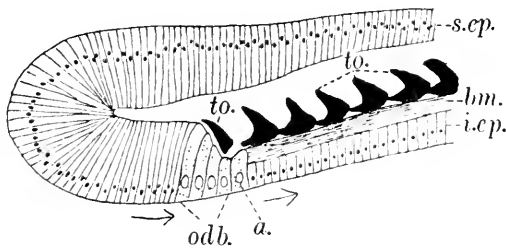

Fig. 384. Vertical longitudinal section through the radula sac of *Helix pomatia*. After Meisenheimer. *odb.* four rows of odontoblasts secreting a tooth, *to.*; *a.* the most anterior row of odontoblasts which, together with the basal epithelium, *i.ep.*, of the radula sac, secrete the basal membrane, *bm.*, to which the teeth, *to.*, are attached. As the odontoblasts complete the secretion of a tooth they are succeeded by fresh cells from the epithelium of the radula sac, *s.ep.*, pressing forward in the direction of the arrow and themselves reinforce the basal epithelium.

cellular proteolytic enzymes.<sup>1</sup> A combination of extra- and intracellular digestion is highly characteristic of Mollusca, but in the possession of a cellulose-dissolving ferment *Helix* stands almost alone

<sup>1</sup> In carnivorous gasteropods digestion follows a different course. The glands of the alimentary canal secrete proteolytic enzymes and the digestion of protein takes place in the stomach and not in the cells of the digestive gland (see *Murex*, p. 566).

in the Animal Kingdom, and may be indeed said to be physiologically adapted to a plant diet (cp. *Teredo*, p. 587). The intestine runs from the stomach, within the liver, and then as the rectum in the roof of the mantle cavity.

The reproductive organs are extremely complicated (Fig. 385 A), but a function has been assigned to each part of what appears to the elementary student as an unmeaning tangle of tubes. Eggs and sperm are produced in the same follicle of the *ovotestis*, a small white gland

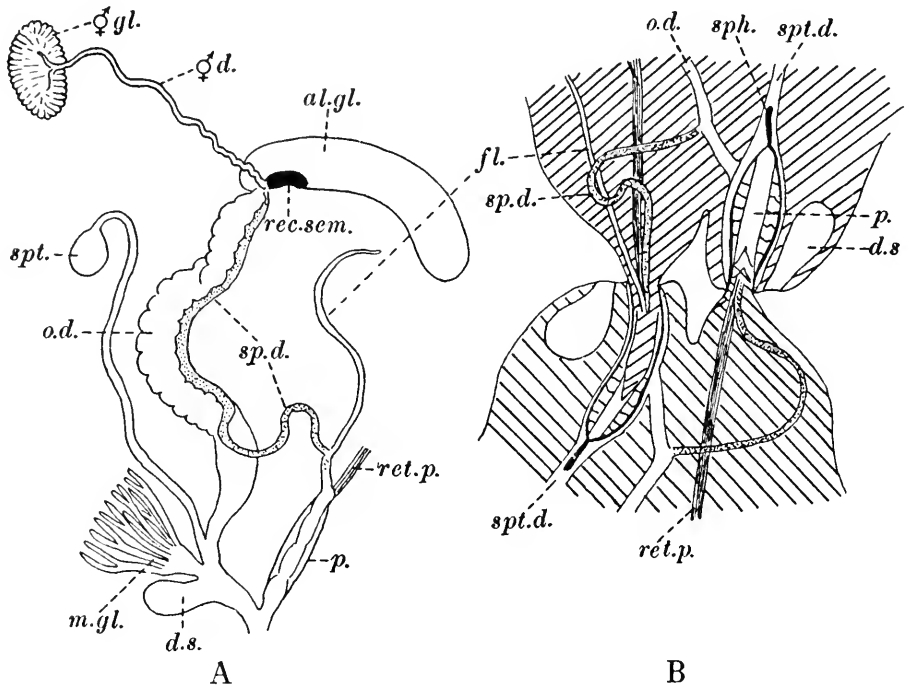

Fig. 385. *Helix pomatia*. A, Reproductive organs. B, Section through the copulatory organs of two mating snails at the moment of the transference of the spermatophores. After Meisenheimer. The organs of the two individuals are indicated by shading sloping in different directions. *al. gl.* albumen gland; *d. s.* dart sac; *fl.* flagellum; *m. gl.* mucous glands; *o. d.* oviduct; *p.* penis; *rec. sem.* receptaculum seminis; *ret. p.* retractor muscle of the penis; *sph.* spermatophore; *spt.* spermatheca; *spt. d.* spermathecal duct; *sp. d.* sperm duct; ♂ *gl.* hermaphrodite gland (ovotestis), and ♂ *d.* duct.

in the apex of the visceral hump. But while ripe sperm is found throughout a large part of the year, mature eggs only occur for a very short space indeed. Both eggs and sperm pass from the ovotestis to the albumen gland through the *hermaphrodite duct*, the terminal portion of which is a pouch (*receptaculum seminis*) where sperm is stored and fertilization is said to occur. After fertilization, the eggs enveloped in albumen from the gland enter the rather voluminous female duct, which runs almost straight to the exterior. They then

receive a calcareous shell secreted by the epithelium of the duct. The terminal portion of the duct is the thick-walled muscular *vagina*, into which open the *mucous glands*, the *dart sac* and the *spermathecal duct*. The sperm, on the other hand, passes down a male duct which is at first only partly separate from the female duct, the cavity of both ducts being in communication until the male duct leaves the company of the female duct altogether, slips under a muscle, and joins the *penis* at its junction with the slender *flagellum*. In this latter the spermatozoa are compacted together and enclosed in its secretion to form *spermatophores*. The penis is muscular and has a special *retractor penis* muscle also attached to it. Both vagina and penis open into a common *genital atrium*, with an opening to the exterior far forward on the right side.

Cross-fertilization is the rule in nearly all species of *Helix* but cases of self-fertilization have been known. Usually, however, there is reciprocal fertilization, preceded by a remarkable preparatory event in which two snails approach each other and evert the genital atrium so that the male and female apertures appear externally. The dart sac mentioned above contains a calcareous sculptured weapon, the dart, which can be secreted anew very quickly by the epithelium of the sac. This is propelled by the muscles of the sac out of the female aperture when the other snail is almost in contact—in fact the two darts are launched almost simultaneously, with such force that they pierce the body wall, traverse the cavity and are found imbedded in various internal organs. Some time after this drastic stimulation, the two snails approach each other again and reciprocal fertilization takes place, the penis of each individual being inserted in the vagina of the other (Fig. 385 B). The following account of further events has been given and shows, as in the earthworm, the remarkable complexity of the arrangements which are made to prevent self-fertilization in such common hermaphrodites. The foreign spermatophores find their way up the spermathecal duct to the terminal *spermatheca*, where the chitinous covering of the spermatophore is dissolved, and the spermatozoa set free. These now retrace their path to the junction with the female duct and then move up that duct to the fertilization pouch. Fertilization takes place in May or June but the eggs are not laid till July. It is said that the foreign sperm remains in the pouch during this time, and that immediately before ovulation the sperm produced by the individual itself degenerates within the hermaphrodite duct so that the eggs pass down the duct without any danger of being self-fertilized and meet the foreign sperm at the end. After fertilization, the egg cell passes down the oviduct where it is enveloped with such quantities of albumen that the diameter of the albumen envelope is 20–30 times that of the egg cell itself. In the outer layer of albumen

a skin appears, and in this crystals of calcium salts are laid down which aggregate to form a definite shell. The eggs are laid in July and August in small holes in the earth and hatch after about twenty-five days of development.

In the autumn the snail loses its appetite and hides, often in company with large numbers of its fellows, under leaves, making a small hole in the ground with its foot and shell in which it lies with the aperture upwards. The head and foot are withdrawn into the shell

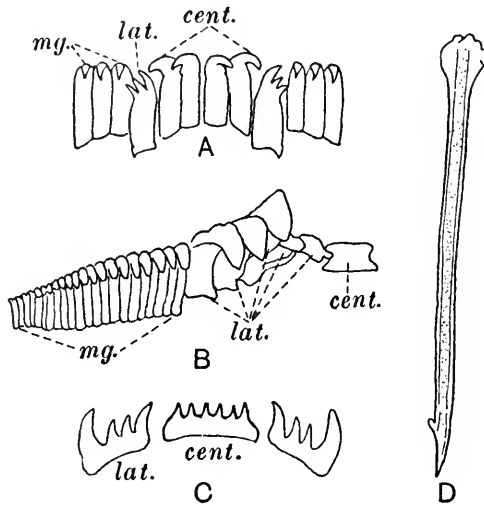

Fig. 386. Radula of various types. A, Docoglossate (*Patella*). Stout teeth used for rasping encrusting layer of algae off rocks: radula of relatively enormous length; the teeth are quickly worn away. B, Rhipidoglossate (*Haliotis*). Lateral and central teeth as in *Patella*, used in browsing on algae growing on stones. The marginals, of which only about half are shown, are probably used as a sieve to prevent fragments of food of too great size entering the oesophagus. C, Rachiglossate (*Buccinum*). Teeth of carnivorous type, with sharp cusps. D, Toxiglossate (*Conus*). Specialization of carnivorous type, in which only two teeth (laterals) remain in each row, are hollow, and are used as poisoned daggers, carrying the secretion of the salivary glands. *cent.* central, *lat.* lateral, *mg.* marginal teeth.

and the edges of the mantle approximate to form an almost complete disc filling up the aperture, leaving only a small hole for breathing. They secrete a membrane (*epiphragma*) mostly composed of  $\text{Ca}_3(\text{PO}_4)_2$ . Several such membranes may be found behind each other. In this winter sleep the snail remains for about six months; respiratory movements are carried on slowly and the heart beats sink from about 10–13 to 4–6 per minute. The rate of heart beat is closely dependent on the temperature, and at a temperature of  $30^\circ \text{C}$ . is from 50 to 60 beats per minute.

## Order STREPTONEURA (PROSOBRANCHIATA)

Gasteropoda which exhibit torsion, nearly always with a shell and an operculum, with a visceral loop twisted in the form of a figure of eight, the mantle cavity opening anteriorly, the ctenidia in front of the heart, and separate sexes.

*Classification*

Suborder DIOTOCARDIA (ASPIDOBANCHIATA). Streptoneura always with two auricles and sometimes two ctenidia, the ctenidia with two rows of leaflets (aspidobranch), and the genital products discharging to the exterior by means of the right kidney.

These are divided into two main tribes according to the characters of the radula:

RHIPIDOGLOSSA possessing a radula composed of rows of numerous narrow teeth diverging like the ribs of a fan. *Haliotis*, *Fissurella*.

DOCOGLOSSA possessing a radula with rows consisting each of a few strong teeth, very long and used for browsing on the algal covering of stones. *Patella*, *Acmaea*.

Suborder MONOTOCARDIA (PECTINIBRANCHIATA). Streptoneura with a single auricle and ctenidium, the ctenidium always with one row of leaflets (pectinibranch), with a single osphradium resembling an aspidobranch gill, the gonads with separate ducts opening far forward in the mantle cavity and in the male forming a penis.

These are divided into four tribes, each with a distinct type of radula, of which three are mentioned below:

RACHIGLOSSA: predatory animals; radula with not more than three teeth in a row; always with a siphon. *Buccinum*, the whelk. *Purpura* feeds largely on barnacles. *Nassa*.

TAENIOGLOSSA: radula normally with seven teeth in each row. *Natica* feeds on shell fish. *Littorina*, the periwinkle, amphibious. *Strombus* progresses by leaping. *Paludina* and *Ampullaria*, fresh water.

This tribe also includes a pelagic section, the Heteropoda (*Pterotrachea*). The rest are called the Platypoda.

TOXIGLOSSA: radula with two elongated teeth in each row; a poison gland. *Conus* (Fig. 386 D).

Suborder *DIOTOCARDIA*

*Haliotis*, the ormer (Figs. 380C, 390A), is a greatly flattened gastropod which lives between tidemarks, as far north as the Channel Islands, browsing on seaweed and eating all kinds of dead organic material. It can move with considerable speed (5-6 yards a minute),

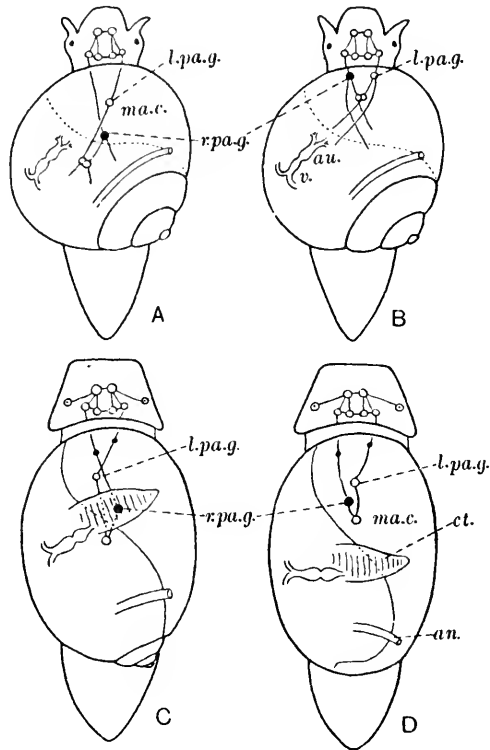

Fig. 387. To illustrate origin of euthyneury in the Pulmonata, A, B, and the Opisthobranchiata, C, D. After Naef. A, *Chilina*. The left parietal ganglion (*l.pa.g.*) has moved forward owing to the shortening of its plural connective. B, A pulmonate belonging to the Basommatophora. The corresponding connective on the other side has shortened also, the visceral loop has become untwisted and the nerve ganglia are concentrating. C, *Actaeon*, with short spire and broad shell mouth, ctenidium and anus pointing to the right. D, *Bulla*, showing slightly greater detorsion without spire, the shell mouth opening to the right and anus pointing posteriorly: left parietal ganglion drawn over right connective so that visceral loop is untwisted. *an.* anus; *au.* auricle; *ct.* ctenidium; *l.pa.g.* left, *r.pa.g.* right parietal ganglion; *ma.c.* mantle cavity; *v.* ventricle.

but adheres very firmly to stones. The mantle cavity is very spacious and contains two ctenidia, the left being rather the larger, each with two rows of filaments. The mantle has a slit which runs in the roof of the mantle cavity, its position being shown by a row of holes in the shell which serve for the escape of the exhalant current. The anus opens



at the posterior end of the mantle cavity and the two kidneys on each side of the anus. There is a well-marked visceral loop and the pedal nerve centres have the form of long cords in which ganglion cells are evenly distributed. The gonad has no ducts but the genital cells are discharged into the right kidney. The radula has numerous marginal teeth arranged in a fan-like manner (rhipidoglossate type).

*Fissurella*, the keyhole limpet (Fig. 380 B), is so-called because of the hole which perforates the mantle and the apex of the shell. It possesses two equal ctenidia. The visceral hump and shell are completely uncoiled, but in other respects it resembles *Haliotis* and possesses the same type of radula.

*Patella*, the limpet (Fig. 380 A), represents a type of complete adaptation to life on an exposed coast between tidemarks. Its conical shell only shows coiling in its early stages and offers the minimum of resistance to the waves. As in the above forms there is no operculum, but the mollusc cannot be detached from rocks without using great force, owing to the enormous power of the pallial muscles which press the shell against the rock. The mantle cavity is restricted anteriorly and the ctenidia have disappeared, though the *osphradia* connected with them are present as minute yellow specks. But a secondary mantle cavity extends all round between the foot and the mantle and contains a series of folds which are known as *pallial gills*. In the related *Acmaeidae* there are various stages of the loss of the ctenidia and their replacement by pallial gills. The enormously elongated radula is composed of very strong teeth and there are a small number of marginals (docoglossate type). This type of radula is suited for the feeding habits of the limpet, which scrapes the crust of minute algae off the surface of rocks. Limpets have a remarkable "homing" sense, returning after excursions for food to the same spot, which may be marked by a depression in the rock.

#### Suborder *MONOTOCARDIA*

*Buccinum*, the whelk (Fig. 380 D), lives between low-water mark and 100 fathoms. It is active and carnivorous, feeding on living and dead animals, which it grasps by means of its foot. It has a remarkable and highly developed proboscis which can be retracted within a proboscis sheath. The true mouth is situated at the end of the proboscis. The radula (of the rachiglossate type) is used for rasping away flesh, but it can even bore holes in the carapace of Crustacea.

There is only a single ctenidium with a single row of filaments. This is the primitive right member of the pair, though situated on the left of the mantle cavity. A very prominent organ is the bipectinate *osphradium*, which is easily mistaken for a ctenidium. There is a

single kidney which is not used for the passage of the genital products. The gonads have separate ducts and in the male there is a penis.

The eggs are laid in capsules which usually contain several hundred and the capsules are attached to each other, forming the sponge-like masses so often flung up by the tide.

*Murex* is nearly related to *Buccinum* and also carnivorous. It has been recently shown that the salivary glands and the "liver" all contain the same proteolytic enzymes. These have been separated by adsorption and found to comprise a proteinase, a carboxy-polypeptidase, an aminopolypeptidase and a dipeptidase. These are just such enzymes as occur in the vertebrates and the higher crustacea, but in contrast to vertebrates in *Murex* there is no division of labour amongst the digestive organs.

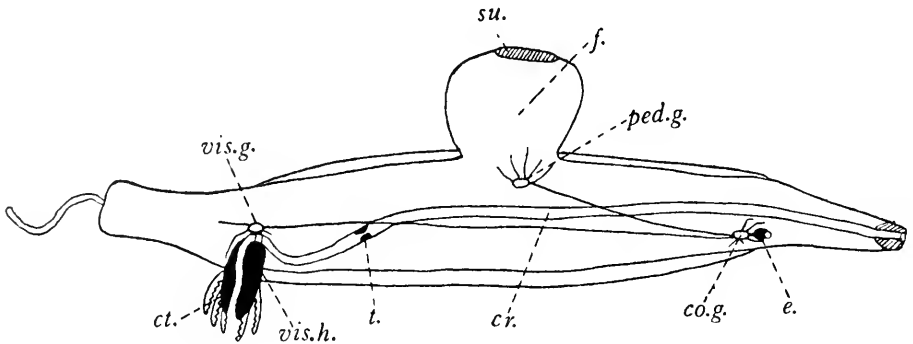

Fig. 388. *Pterotrachea*. *co.g.* cerebral ganglion; *cr.* crop; *ct.* ctenidium; *e.* eye; *f.* foot (fin); *ped.g.* pedal ganglion; *su.* sucker; *t.* teeth which prevent large particles of food from passing before digestion; *vis.g.* visceral ganglion; *vis.h.* visceral hump.

*Littorina*, the periwinkle, is interesting because it exhibits tendencies toward a terrestrial habit which is reflected in its structure. In certain species the filaments of the ctenidium are extended over the roof of the mantle cavity to form a kind of vascular network not unlike that in *Helix* and other pulmonates. *Littorina rudis* lives almost at highwater mark and spends more of its life in air than in water.

The structure of this form is very similar to *Buccinum* but it has no proboscis and is not carnivorous.

*Paludina*, on the other hand, is a freshwater form of common occurrence in this country which still preserves the ctenidium and so must be regarded as a direct immigrant from sea water into fresh water. It possesses a kind of uterus in which embryos of relatively enormous size are developed.

*Pterotrachea* (Heteropoda) (Fig. 388) is an inhabitant of the open sea with many adaptations to pelagic life. It is laterally compressed; the tissues are transparent except for the digestive gland and peri-

cardium compressed into a small visceral hump. The animal swims ventral surface uppermost, using its foot as a fin. The *sucker* is a rudiment of the crawling surface. It is predaceous, seizing worms and other animals with its radula and swallowing them whole.

### Order OPISTHOBRANCHIATA

Hermaphrodite gasteropods which are descended from Streptoneura which have undergone torsion but themselves show a reversal of torsion (detorsion); with the mantle cavity, where present, tending to occupy a posterior position again, the shell to become smaller, internal or entirely absent and the single ctenidium to disappear and be replaced by accessory respiratory organs or by the whole external surface becoming a respiratory organ.

The opisthobranchs are classified as follows:

**TECTIBRANCHIATA.** Opisthobranchiata which often have a shell and nearly always a mantle cavity and ctenidium. *Actaeon*, *Bulla*, *Aplysia*, *Cavolinia*.

**NUDIBRANCHIATA.** Opisthobranchiata usually of slug-like habit which have neither a shell, nor a mantle cavity, nor a ctenidium. *Eolis*, *Doris*.

*Aplysia* (Fig. 389A), the sea hare, is found crawling on seaweeds which form its food. The younger forms occur in rather deeper water and are red in colour, matching the red algae on which they occur, while the larger individuals, between tidemarks, devour green seaweeds such as *Ulva* and are olive-green. The head possesses two pairs of tentacles, the anterior being large and ear-like (hence the animal's name), while those of the second pair are olfactory in function and have each a simple eye at their base. From the sides of the foot in the posterior region rise two upwardly directed flaps, the *parapodia*: by using these the animal can swim. The mantle is reflected over the shell so as to cover all except a small area and the mantle cavity lies to the right of this with the ctenidium pointing backwards, while the anus is at the posterior end. In the walls of the mantle cavity are unicellular glands which secrete the purple pigment ejected by the animal when it is molested. There is a single generative aperture and a single duct for the sperm and ova but a *seminal groove* runs forward from the aperture to the head and reciprocal fertilization is impossible. The only internal characters which need be mentioned are the nervous system, with its well-developed but perfectly symmetrical visceral loop, and the alimentary canal which, in front of the stomach, is dilated into a *crop*, lined with horny plates, in which the seaweed is masticated before digestion.

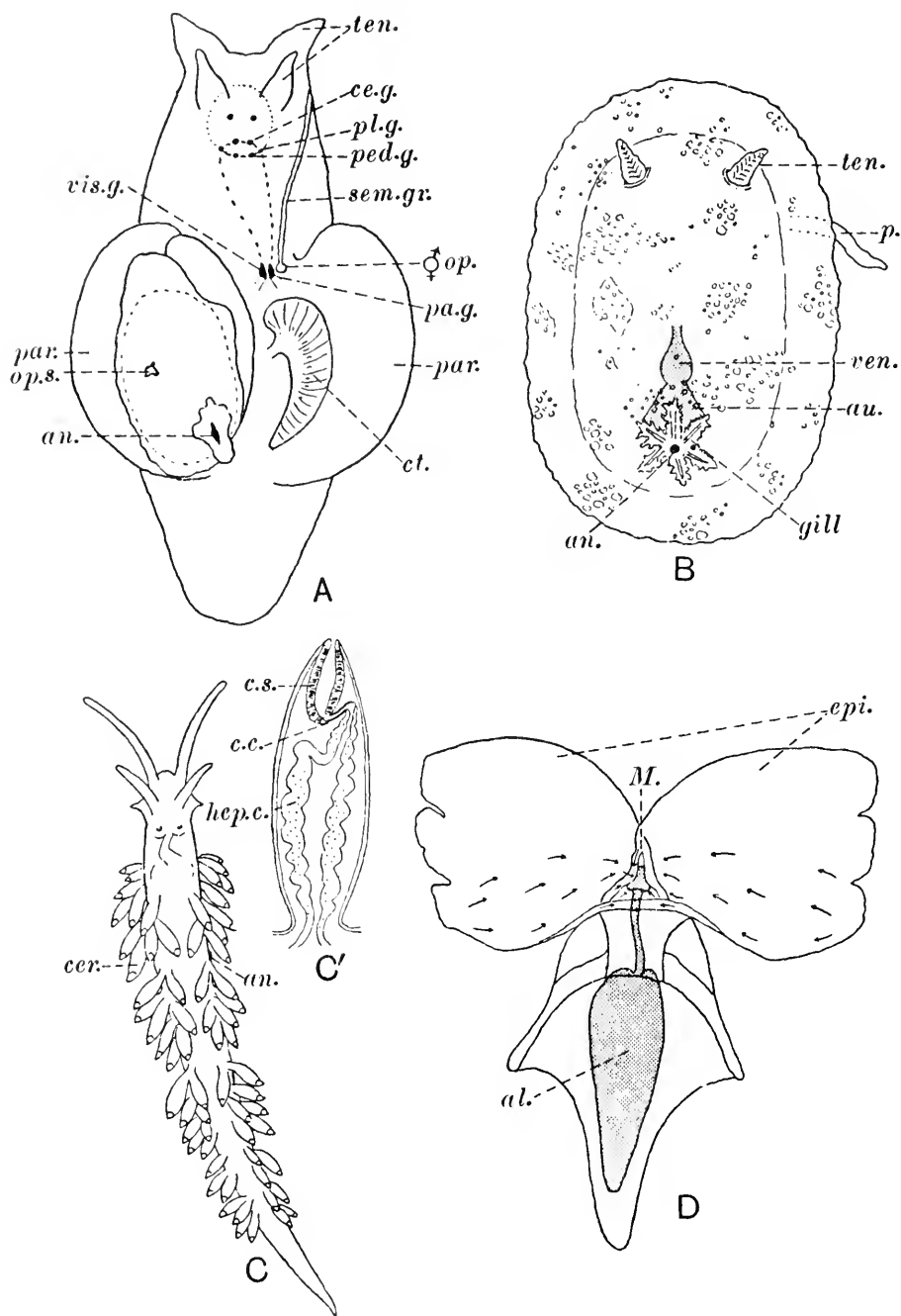

Fig. 389. Opisthobranchiate molluscs, in dorsal view. A, *Aplysia*, with parapodia (*par.*) turned to the side to show the mantle cavity; nervous system and buccal mass indicated by dotted lines. B, *Doris*, with position of heart indicated beneath the mantle. C, *Eolis*. After Alder and Hancock. C', One of the cerata of *Eolis*, shown in section. *c.c.* ciliated canal communicating with *hep.c.* the hepatic caecum, a diverticulum of the intestine; *c.s.* cnidosac, opening to the exterior and containing numerous nematocysts ingested in its cells. D, *Cavolinia* with alimentary canal (*al.*) seen through the transparent tissues and the direction of the ciliated currents on the epipodia indicated by arrows. After Yonge. Other letters: *al.* alimentary canal; *an.* anus; *au.* auricle; *ce.g.* cerebral ganglion; *cer.* cerata; *ct.* ctenidium; *epi.* epipodia; ♀ *op.* genital aperture; *op.s.* opening of shell sac; *p.* penis; *pa.g.* parietal, *pl.g.* pleural, *ped.g.* pedal ganglia; *par.* parapodia; *sem.gr.* seminal groove; *ten.* tentacles; *vis.g.* visceral ganglion; *M.* mouth; *ven.* ventricle.

*Cavolinia* (Fig. 384D) is an example of the *Pteropoda* (sea butterflies), a special group of the Opisthobranchiata which are modified for pelagic life. They usually have a transparent uncoiled shell in the form of a quiver or a vase, from the aperture of which projects the foot in the form of two fins, the epipodia. By the slow flapping movement of these the pteropods progress through the water. There are ciliated tracts on the fins, and by the action of the cilia on these, small organisms are sifted from the water and collected in the mouth, the radula assisting in swallowing. *Limacina* is a pteropod with a coiled shell.

*Eolis* (Fig. 384C) is a nudibranch which possesses a series of dorsal processes (the *cerata*), which contain diverticula of the digestive gland, each of which opens to the exterior at the tip of the process. The animal feeds on hydroids or sea anemones, and while most of the food is digested or passes out of the anus, the nematocysts are collected in terminal sacs in the cerata and when the animal is irritated they are ejected and everted. This is a unique example of the use in defence by one animal of the offensive weapons of another. The cerata are often brilliantly coloured and experiments with fish show that sea slugs are avoided on account of their "warning" patterns.

*Hermaea* is another nudibranch with similar cerata, which have not, however, openings to the exterior. The animal feeds on green algae (Siphonales). The radula, in each row of which there is only a single sharp tooth, forms a saw by which the cell wall of the alga is opened. Then by dilatation of the buccal cavity the fluid protoplasm is sucked out.

*Doris* (Fig. 384B), the sea lemon, a short flattened nudibranch, sluggish in movement, which feeds on incrusting organisms like sponges. There is a tough mantle, which is usually pigmented and often resembles the feeding ground, and is reinforced by calcareous spicules. Anteriorly there is a single pair of short tentacles and posteriorly a median anus surrounded by a tuft of accessory gills. In front of the anus is the median kidney aperture. The nervous system is centralized round the oesophagus, and the generative aperture occurring on the right side is the only external organ which is asymmetrical.

#### Order PULMONATA

Hermaphroditic gasteropods, most of which exhibit torsion and have a shell (but no operculum), but which have a symmetrical nervous system, the symmetry being due to the shortening of the visceral connectives and the concentration of the ganglia in the circum-oesophageal mass; with a mantle cavity which has become a lung, without a ctenidium, but with a vascular roof and a small aperture

(pneumostome); with a single kidney; without a larva, development being direct from an egg richly supplied with albumen.

The Pulmonata are thus classified:

BASOMMATOPHORA. Pulmonata with eyes at the base of the posterior tentacles. *Limnaea*, *Planorbis*.

STYLOMMATOPHORA. Pulmonata with eyes at the tip of the posterior tentacles. *Helix*, *Arion*, *Testacella*.

A few members of the Basommatophora are marine but these are all shore forms and breathe air. The group, like the Opisthobranchiata, must have been derived from the Streptoneura Monotocardia, as they possess a single kidney. While they are usually united with the Opisthobranchiata to form the Euthyneura, which includes all forms in which the visceral loop is untwisted, there is no real justification for the establishment of the group, for the "euthyneurous" condition is one which has been arrived at in two different ways, by detorsion in the Opisthobranchiata and by shortening of the visceral commissures in the Pulmonata. The important characters of the Pulmonata are those associated with the assumption of the terrestrial habit, namely the existence of the lung and the physiological characters correlated therewith. So strongly impressed are these that in almost all the forms which have secondarily returned to water (to fresh water as a rule), the lung continues to function as such and never contains water. *Limnaea*, for example, may be observed in an aquarium to approach the surface of the water at frequent intervals, expel a bubble of air from the lung and protrude the pneumostome through the surface film for a fresh supply. There are, however, a few species (*Limnaea abyssalis*) which live at great depths in lakes, and here the mantle cavity is full of water.

The other general characters of a pulmonate have been given at the beginning of the chapter in the description of *Helix*. They include the concentrated nervous system (it will be seen in Fig. 390B that the visceral loop of *Limnaea* is not so much shortened as that of *Helix*; in other respects also it is a more primitive form), the complicated reproductive system, with its adaptations for cross-fertilization, and the digestive tract, specialized for the consumption of vegetable food. *Helix*, as has been seen, is thoroughly adapted for this purpose, but in the case of some of the slugs there is an exception to the general rule in the development of the carnivorous habit. This culminates in such a form as the predaceous *Testacella*, which pursues earthworms underground and seizes them with the aid of the strong recurved teeth of the radula which can be thrust out of the mouth, the everted buccal cavity forming a huge proboscis. When the worm is swal-

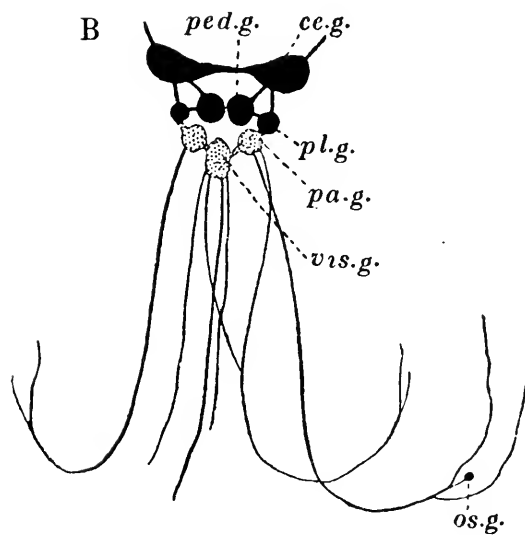
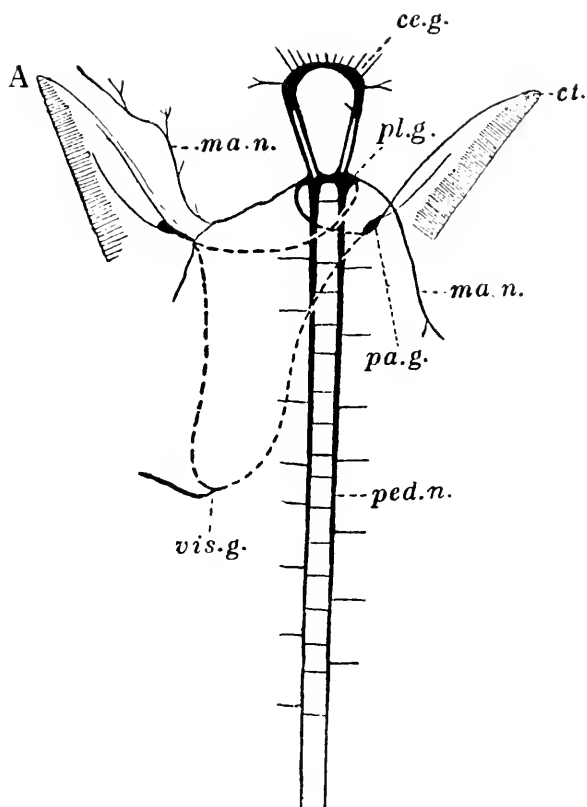

Fig. 390. Comparison of gasteropod nervous systems. From Shipley and MacBride. A, *Haliotis tuberculata*. B, *Limnaea peregra*. *ce.g.* cerebral ganglia; *ct.* ctenidium; *ma.n.* nerve to mantle; *os.g.* osphradial ganglia; *pa.g.*, *ped.g.*, *pl.g.* parietal, pedal and pleural ganglia; *ped.n.* non-ganglionated pedal nerves of *Haliotis* connected by commissures; *vis.g.* visceral ganglia.

lowed it is digested in a large crop by the action of the juices of the digestive gland.

The reduction of the shell is shown in the slugs, some of which, like *Testacella*, have a small cap-like shell, which cannot possibly contain the visceral hump, while others have an internal horny disc like the shell of *Aplysia* and still others none at all. The mantle cavity of slugs opens by a pneumostome but there are no respiratory movements as in *Helix*. In other respects the organization of the slugs is very similar to that of snails.

The details of reproduction and development are uniform throughout the group, but in some snails like *Bulimus*, the amount of albumen added as food for the developing embryo is so great that the egg is the size of a bantam's egg.

### Class SCAPHOPODA

Bilaterally symmetrical Mollusca with a tubular shell open at both ends, a reduced foot used for burrowing, a head with many prehensile processes, a radula, separate cerebral and pleural ganglia; ctenidia absent and circulatory system rudimentary; and a trochosphere larva.

This is a small group of molluscs which in some ways stands between the Gasteropoda and the Lamellibranchiata. They are greatly specialized for burrowing. Thus the shell is tubular and perforated at the apex. The foot emerges from the wider opening, while the apex remains above the surface of the sand when the animal is burrowing, and serves alike for the entrance of water into and its exit from the mantle cavity. The head is proboscis-like in form and has none of the usual sense organs, but in *Dentalium* (Fig. 391), the one common genus, there are extensible filaments, the *captacula*, with sucker-like ends, which arise from the dorsal side of the head and serve partly as sense organs and partly for seizing the food. The foot is conical and can be protruded for use as a digging organ.

There is a well-developed radula, a mantle, which in the larva is produced into two lobes (which fuse later), a nervous system with separate cerebral and pleural ganglia and a symmetrical visceral loop. The kidneys are paired; they do not have an opening into the perivisceral coelom. These characters, with the exception of the first and last, bring the Scaphopoda near to the primitive lamellibranch. In the two following morphological features the group is so specialized that it stands apart from any other division of the Mollusca.

There are no ctenidia, respiration taking place by means of the mantle. The circulatory system is remarkably simplified and there is no distinct heart.



The gonad discharges into the right kidney as in the *Diotocardia* among Gasteropoda.

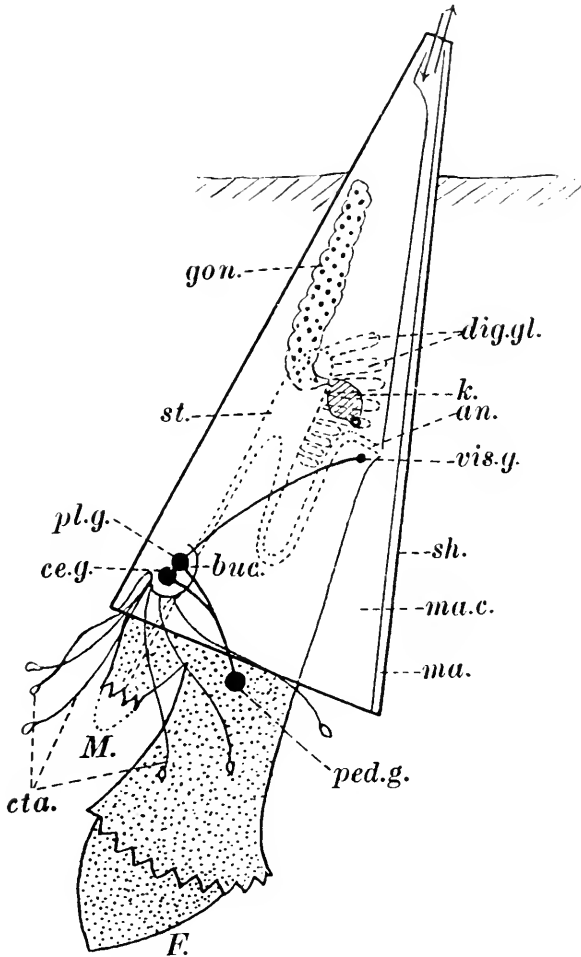

Fig. 391. Diagram of the structure of *Dentalium*. Altered from Naef. Head and foot stippled. *an.* anus; *buc.* buccal mass, with radula; *ce.g.* cerebral ganglion; *cta.* captacula; *dig.gl.* digestive gland; *F.* foot; *gon.* gonad, communicating with the cavity of the left kidney (*k.*); *M.* mouth; *ma.* mantle; *ma.c.* mantle cavity; *pl.g.* pleural ganglion; *ped.g.* pedal ganglion; *sh.* shell; *st.* stomach; *vis.g.* visceral ganglion. The mollusc is represented buried in sand, except for the perforated narrow end, through which both the inhalant and exhalant currents (shown by arrows) flow.

### Class LAMELLIBRANCHIATA

Mollusca in which typically the body is bilaterally symmetrical, much compressed from side to side and completely enveloped by the mantle which is divided into two equal lobes; each lobe secretes a shell valve, the two valves being joined dorsally by a *ligament* and *hinge* and closed ventrally by the contraction of one or two transverse *adductor muscles*

the head is rudimentary, eyes, tentacles and radula being absent; there is a pair of *labial palps* with the mouth situated between them; the foot is ventral, without a crawling surface but usually wedge-shaped and adapted for progression in mud or sand; there are two ctenidia in the mantle cavity, often greatly enlarged and with a complicated structure; their cilia, together with those of the labial palps, form a mechanism for the collection of small food particles; the sexes are nearly always separate, and there is a trochosphere and a veliger larva in the marine forms.

The development of the ctenidia (Fig. 392) is the outstanding morphological and physiological character of the lamellibranchs. The arrangement of the shell valves, which allows the mantle cavity to extend the whole length of the body, also makes possible a great extension of the ctenidia. The axis increases in length and the branches on each side not only increase in length, becoming *filaments*, but also turn up at the ends so that there is a *descending* and an *ascending limb*. The limbs of adjacent filaments are connected together by *ciliary junctions* (*Mytilus*), or by growth of tissue (*Anodonta*), so that thus all the filaments are joined together to form *gill plates*, each gill plate consisting of two *lamellae* formed from all the ascending and all the descending limbs respectively. The lamellae are united by cords of tissue which constitute the *interlamellar concrescences*. The extent to which the gills are welded together to form continuous plates is the distinction between the three main groups of the Lamellibranchiata, the *Protobranchiata* (*Nucula*), the *Filibranchiata* (*Mytilus*) and the *Eulamellibranchiata* (*Anodonta*). But even in the last-named group there are left occasional holes through which water passes into the *interlamellar spaces* then into the *epibranchial space* dorsal to the gills.

Belonging to the same physiological system are the *labial palps*, two folds, one in front of the mouth and one behind, which are turned backwards and prolonged on each side of the visceral mass so as to form two pairs of richly ciliated triangular flaps, embracing the anterior end of the ctenidia, and enclosing a groove which leads to the mouth.

In the anterior part of the mantle cavity the axis of the gill is attached to the side of the animal dorsal to the foot, which here forms a vertical partition dividing the cavity into a right and left half. The mantle cavity continues behind the foot, however, and here the up-turned ends of the inner rows of filaments of both ctenidia are united so that the mantle cavity is now divided by a horizontal partition into an upper or epibranchial cavity and a lower main cavity. The former opens at the *dorsal siphon*, the latter at the *ventral siphon*. A constant current of water is maintained during activity, entering by the ventral siphon, passing through the gill lamellae, and leaving by the dorsal.

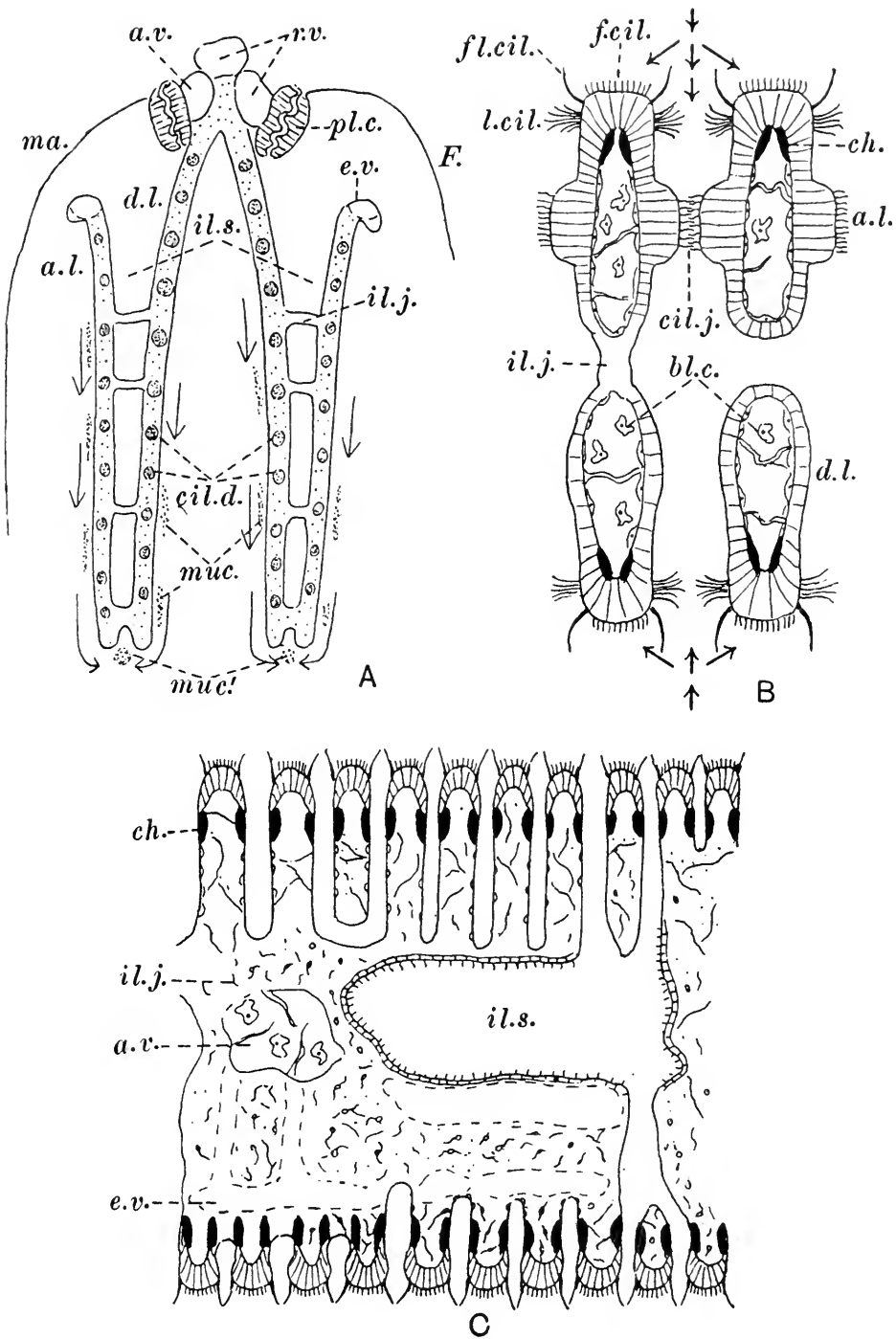

Fig. 392. The ctenidia of the Lamellibranchiata. A and B, *Mytilus*. C, *Anodonta*. A, Vertical transverse section through ctenidium of one side. *a.v.* afferent vein; *a.l.* ascending, *d.l.* descending limb of filament; *cil.d.* ciliated discs; *e.v.* efferent vein; *F.* foot; *il.s.* interlamellar space; *il.j.* interlamellar concrescence; *ma.* mantle; *muc.* mucus travelling ventrally (in direction of arrows) and *muc.'* collected in the food groove; *pl.c.* plicate canals; *r.v.* renal veins. B, Horizontal section through two adjacent filaments. *bl.c.* blood cells; *ch.* chitinous rods; *cil.j.* ciliary junction; *f.cil.*, *fl.cil.*, *l.cil.* frontal, latero-frontal, lateral cilia. The arrows denote the direction of the food current and the path of the food particles it contains. C, Horizontal section through a gill. Lettering as above.

From this the animal separates its food in the form of minute plants and fragments of organic debris. The current can easily be demonstrated by pipetting a suspension of carmine particles in the neighbourhood of the siphons, and the details of the process worked out by observing the motion of the coloured granules over the surfaces of the mantle cavity when one of the shells and its mantle lobe have been removed. In this way the direction of the ciliary currents of the ctenidia which transport the food particles can be demonstrated (Fig. 393). On entering the wide mantle cavity the velocity of the inhalant current is checked, and the heavier particles sink down and are taken up by the ciliary currents of the mantle which run towards the posterior region in the neighbourhood of the siphons. The main ingoing current with the smaller particles of carmine is drawn over the surface of the ctenidium and impinges against the individual filaments. Their structure and the distribution of the groups of cilia which all perform different functions is shown in the diagram of a transverse section through a ctenidium (Fig. 392 B). That the main current of water is drawn into the mantle cavity at all is the result of the activity of the *lateral cilia*. When the current which they have drawn to the ctenidium impinges on its surface the large *latero-frontal cilia* perform their task of deflecting the particles on to the face of the filaments where they come under the influence of the *frontal cilia*, which produce a constant stream down over the surface of the ctenidium towards its ventral edge. During the passage the particles in the stream become entangled in mucus, and on reaching the edge the string-like masses of food and mucus are directed by other cilia along the edge in the direction of the mouth, travelling partly in the "food groove". When the labial palps are reached the collected material may, according to its nature, either be swept straight into the mouth or come under the influence of cilia working along rejection paths which direct it away from the mouth and toward the outgoing circulation on the mantle (Fig. 393 B).

This complicated but well co-ordinated ciliary mechanism is nearly always working when the lamellibranch is covered with water, and the amount of water which passes through the mantle cavity of a single mussel is surprisingly large. But it must be remembered that this current also serves the purpose of respiration, though the exchange of gases takes place through the medium of the mantle rather than the ctenidia. At low tide the animal must close its shell and CO<sub>2</sub> accumulates within the mantle cavity. This chemical change depresses ciliary activity and finally brings the cilia to rest, so that the store of oxygen in the tissues is conserved. When the tide rises, however, the cilia immediately resume activity.

Though the majority of the lamellibranchs have the power of

movement it is thus seen that they feed in the manner of a sedentary organism, and it is not surprising that there are many fixed and burrowing forms among them.

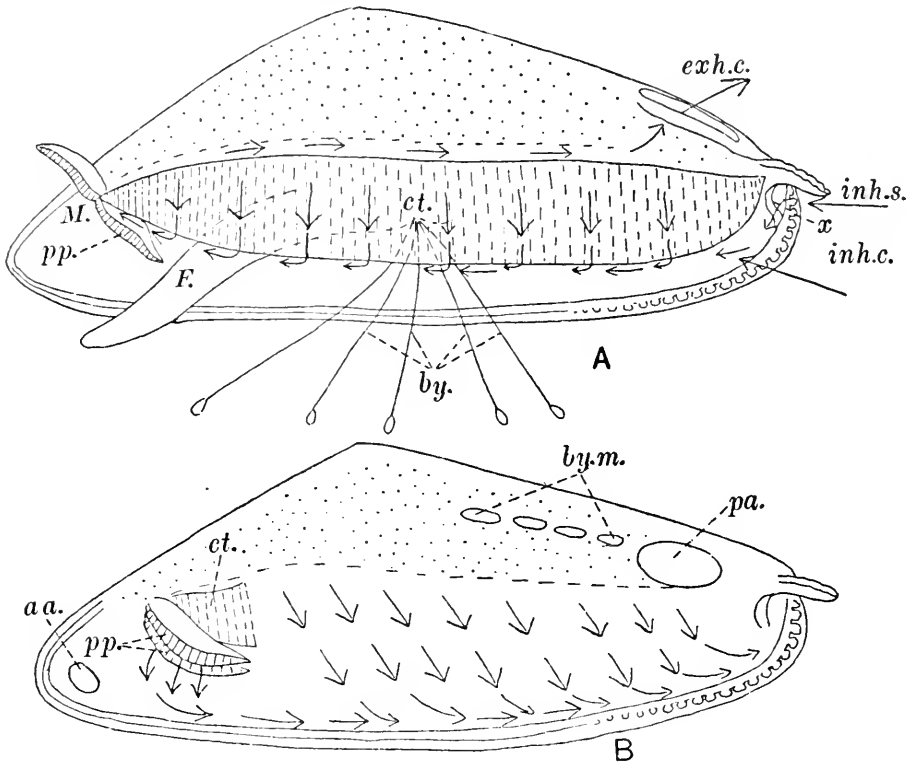

Fig. 393. Diagrams to show ciliary currents of *Mytilus*. Adapted from Orton. A, Food currents with left lobe of mantle removed to show the outer lamella only of the left gill, and the two palps of the left side separated and not embracing the front end of the gill as they normally do in life. The vertical arrows represent the currents caused by the frontal cilia, those at the bottom of the gill the main food current running to the mouth and that at the top of the gill the exhalant current. *x* represents a curtain which prevents the inhalant current from directly impinging on the surface of the gill, an opportunity being thus afforded for a preliminary rejection of particles. *by.* byssus threads; *ct.* outer lamella of left ctenidium; *exh.c.* course of exhalant current shown by arrows in the epibranchial chamber, the roof of which is indicated by dots; *F.* foot; *inh.s.* left lip of inhalant siphon; *inh.c.* inhalant current; *M.* mouth; *pp.* palps. B, Rejection currents. *Mytilus* with foot and the gills removed so as to show the interior of the right lobe of the mantle. The direction of the currents caused by the cilia is shown by arrows. The palps of the left side and the anterior end of the outer left gill remain and the rejection current marked by three parallel arrows is shown. The collector current runs along the groove under the mantle edge to the pouch *x*. *aa.* anterior adductor muscle; *by.m.* muscles of the byssus; *pa.* posterior adductor muscle. Other letters as above.

A short oesophagus leads directly into the *stomach*, which is a wide sac receiving on each side the ducts of the *digestive gland* which is

similar to that of *Helix*, but contains only one kind of cell. This cell takes up the finely divided food which reaches the gland and digests it by intracellular ferments. The *intestine* runs into the foot and makes one or more loops, eventually returning to near the hind end of the stomach. It then passes through the pericardium where it is usually surrounded by the ventricle, ending as the *rectum*. The peculiarity of the digestive system is the presence of a diverticulum of the intestine, the cells of which secrete a *crystalline style* (Fig. 394); some cilia in the diverticulum rotate this and others move it forward so that at its free end, projecting into the stomach against a structure called the *gastric shield*, it is constantly worn away and the style material mixed with the contents of the stomach. It is composed of protein to which is adsorbed an amylolytic ferment and it may be broken down and re-formed periodically. There is no doubt that this represents a special

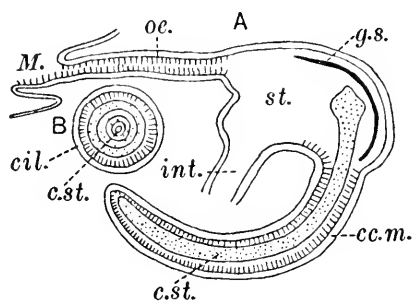

Fig. 394. A, Section of part of the alimentary canal of *Donax*. *cc.m.* caecum of the intestine containing *c.st.* crystalline style; *g.s.* gastric shield; *int.* intestine; *M.* mouth; *oe.* oesophagus; *st.* stomach. B, Transverse section across the caecum showing *cil.* ciliated epithelium and *c.st.* crystalline style composed of concentric layers of material. After Barrois.

provision for the digestion of carbohydrates and it is also found in some gasteropods. For the rest, digestion of proteins and absorption take place in the digestive gland, the cells of which have a surprising power of taking up solid particles. In the oyster, it may be mentioned, there is an extraordinary abundance of leucocytes which wander here, there and everywhere, through the body. It has been shown that they enter the stomach and ingest diatoms and other food particles there, speedily digesting them and wandering over the body afterwards, so that they play a unique part in the transport of food.

The lamellibranchs are most conveniently classified by the structure of their ctenidia. We have firstly three groups which can be arranged in an evolutionary series, showing the ctenidia to become larger, more complex and solid organs. Lastly there is an isolated group, the Septibranchiata, in which the habit of life has completely changed and the ctenidia have practically disappeared:

PROTOBRANCHIATA	<i>Nucula.</i>
FILIBRANCHIATA	<i>Mytilus, Pecten.</i>
EULAMELLIBRANCHIATA	<i>Ostrea, Cyclas, Cardium, Mya, Anodonta.</i>
SEPTIBRANCHIATA	<i>Poromya, Cuspidaria.</i>

In Fig. 395 A, B, the difference is seen between the Protobranchiata with their short and simple filaments and the next two groups in which each filament is greatly elongated and upturned so that descending and ascending limbs can be distinguished. The contrast between the Filibranchiata and the Eulamellibranchiata is expressed by Fig. 392, in which a transverse section through a "gill" is shown, showing the component filaments separate in the first case, save for the ciliary junctions, united in the second. Lastly, in Fig. 395 C, it is seen that in the Septibranchiata, the ctenidia are replaced by a horizontal muscular partition (which moves up and down like the piston of a pump)

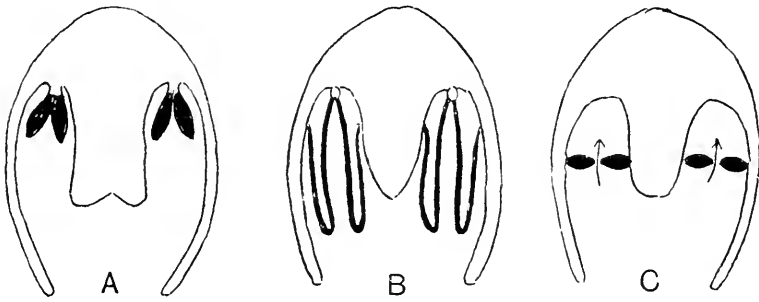

Fig. 395. Vertical sections of Lamellibranchiata to show different stages of development of the ctenidia. A, Protobranchiata. B, Filibranchiata and Eulamellibranchiata. C, Septibranchiata. The arrows in C show the direction of the flow of water through the "diaphragm", when the latter moves downwards. After Sedgwick, from Lang.

with apertures connecting the ventral and dorsal divisions of the mantle cavity.

The ciliation of the filaments is the same in all the first three divisions. Even in the *Protobranchiata*, the ciliary apparatus for food-collecting has been developed as in the rest of the group, and it has been pointed out that there are ciliated discs, adjacent pairs of which act as ciliary junctions and hold the filaments together to form lamellae. There is, moreover, a subdivision of the mantle cavity into inhalant (ventral) and exhalant (dorsal) chambers in spite of the small size of the ctenidia.

The blood system of the lamellibranchs is best explained by reference to that of *Mytilus*, the common mussel (Fig. 396). Here the heart, as in *Anodonta*, consists of a *ventricle* surrounding the rectum and two *auricles*, each of which opens into the ventricle by a narrow canal and is attached by a broad base to the wall of the pericardium

over the insertion of the ctenidia into the mantle. A single vessel, the *anterior aorta* (a *posterior aorta* is also present in *Anodonta*), leaves the ventricle, dilates into an aortic bulb and then divides into many arteries. Of these, the most important are the *pallial arteries* going to the mantle and the arteries forming part of the visceral circulation (the *gastrointestinal*, *hepatic* and *terminal* arteries, the last named supplying the most anterior part of the body including the foot). The arteries break up into a network of vessels in all the tissues and these

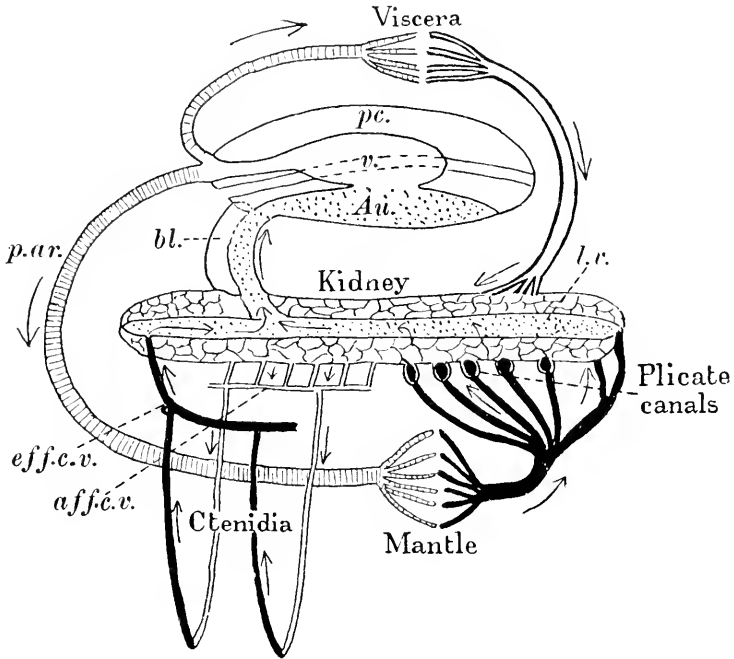

Fig. 396. Diagram of the circulation in *Mytilus* to show the greater importance of the part of the system in the mantle and plicate canals. Of the blood returned from the viscera a much smaller proportion is sent through the ctenidia. Slightly altered from Field. *Au.* auricle; *bl.* bladder of kidney opening into the pericardium; *aff.c.v.* afferent, *eff.c.v.* efferent ctenidial vein; *l.v.* longitudinal vein of kidney; *p.ar.* pallial artery; *pc.* pericardium; *v.* ventricle with rectum, represented by a dotted line, passing through it.

join to form veins and sinuses which are largely situated on the inner side of the mantle and the superficial parts of the body. The skin, being bathed in water and devoid of any cuticular covering which might hinder diffusion, is a general organ of respiration and the mantle is the most important part of it. Most of the blood from the *pallial circulation* is returned to the network of vessels in the kidney through the ribbon-like organs, known as *plicate canals*, which extend along the mantle just above the insertion of the ctenidium.



The visceral vessels likewise return blood to the kidney network so that practically the whole of the blood passes through the excretory organ and is purified. A part of the blood from the kidney network enters the *ctenidial circulation*, discharging into the longitudinal *afferent branchial vein*, which gives off to each filament a vessel which descends one side and ascends the other. The ascending vessels join to form a longitudinal efferent vessel, which discharges into the longi-

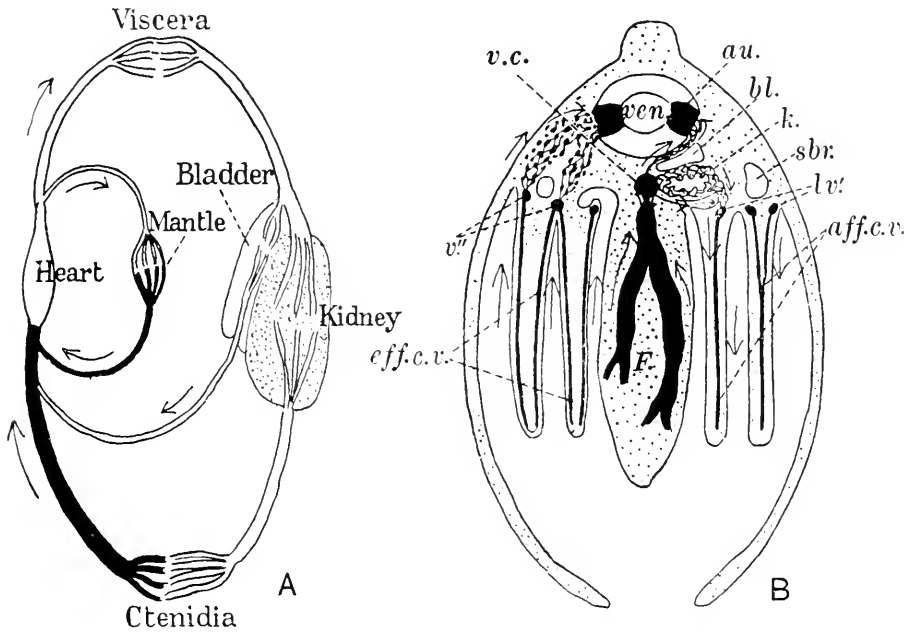

Fig. 397. Circulation of *Anodonta*. A, Simplified diagram to show the course of the blood, indicating the relative importance of the various branches. Vessels returning arterial blood to the heart shown in black. B, Transverse section of *Anodonta* to show part of the course of the circulation. In the foot, *F.*, the veins run into the vena cava cut in section, from which a small part of the blood is returned direct to the auricle in the dorsal wall of the bladder, *bl.*, the rest through the kidney, *k.*, longitudinal afferent vessels, *lv.*, and thence to the afferent system of vessels in the ctenidium, *aff.c.v.* On the other side the efferent system of vessels, *eff.c.v.*, is shown returning blood to the longitudinal vessels at the base of the ctenidia, *v.*, from which it passes to the auricle, *au.*, through an irregular system of blood spaces. The pallial circulation is not shown here. *sbr.* epibranchial space; *v.c.* vena cava; *ven.* ventricle.

tudinal vein of the kidney. Into this longitudinal vein is collected the blood from the kidney network in general and by this channel blood is returned into the auricle. It will be seen that the branchial circulation is not important in *Mytilus*; in *Anodonta* (Fig. 397) it is more developed.

In *Anodonta* (Fig. 397) where the foot is larger than in *Mytilus* and movement more continuous the pedal artery is more impor-

tant than the visceral arteries. The veins from the foot and the viscera join to form a *pedal sinus* and this opens into the *vena cava*. The junction of these is marked by a sphincter muscle (Keber's valve). This sphincter is closed when the foot is extended. The relaxation of the muscles and the pumping of the blood into the sinuses of the foot bring about the swelling of the foot. When the foot is retracted the blood is largely contained in spaces in the mantle. The *pallial* circulation is maintained during movement when the visceral circulation is interrupted as described above.

While the Protobranchiata have a nervous system with four distinct pairs of ganglia (Fig. 373 D) in the remainder of the class the number is reduced to three by the fusion of the cerebral and pleural ganglia (Fig. 398 B).

The sexes are usually separate in the Lamellibranchiata, but some species of *Ostrea* and *Pecten* are always hermaphrodite, while this condition is frequent in *Anodonta*. In the Protobranchiata the gonad discharges into the kidney, but in most forms there is a separate generative aperture. While most marine forms and the freshwater *Dreissensia* have trochosphere and veliger larvae, some lamellibranchs incubate the embryos within the ctenidia, and in the family Unionidae, which includes *Anodonta*, the larvae are much modified (*Glochidium*). When they are ripe the mother liberates them if a fish swims near her, and they attach themselves to the gills or fins and become encysted there. After a parasitic life which varies greatly in length they escape from the cyst as young mussels.

### Order PROTOBRANCHIATA

The best-known representative is *Nucula* (Fig. 373 D). It has a shell of very characteristic appearance with numerous teeth on the hinge line and a foot which, when fully extended, has a flat ventral surface which has been compared with that of the gasteropod. But instead of creeping by means of it the animal uses it for burrowing; it is folded up (as is seen in the diagram), and thrust into the mud, then opened out and used as a holdfast, and the contraction of the retractor muscles draws the body below the surface. While the surface of the ctenidium is so small that the organ is of little use for feeding, the *labial palp* is enormous and divided into three parts. One of these is a kind of proboscis which is thrust out of the shell and collects food by ciliary currents. This is sorted and forwarded to the mouth by the other two parts without the intervention of the ctenidium.

The nervous system has distinct cerebral and pleural ganglia and the gonads have retained their original connection with the kidneys. These and some less important characters show that *Nucula* and its

relations are probably the most primitive of living lamellibranchs. The specialization of the labial palps has had as its consequence the partial suppression of the ctenidia, which remain in an undeveloped condition. In this respect the Protobranchiata can hardly be held to resemble the ancestral lamellibranch.

### Order FILIBRANCHIATA

*Mytilus* (Fig. 393). While the majority of lamellibranchs are semi-sedentary, the sea mussel has developed the sedentary tendency and marks a half-way stage to the oyster which remains fixed through

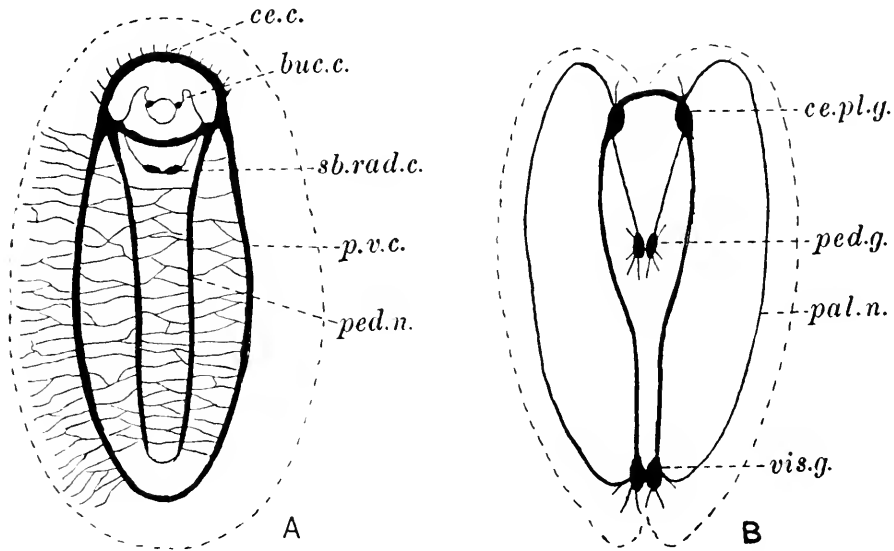

Fig. 398. Nervous system of A, *Chiton*, B, a lamellibranch. Dorsal views. The outline of the mantle edge is indicated by a dotted line. *buc.c.* buccal commissure and ganglia; *ce.c.* cerebral commissure; *ce.pl.g.* cerebro-pleural ganglion; *pal.n.* pallial nerve; *ped.g.*, *ped.n.* pedal ganglion and nerve; *p.v.c.* palliovisceral commissure; *sb.rad.c.* subradula commissure; *vis.g.* visceral ganglion.

adult life. The mussel lives in association in *beds* between tidemarks where the conditions are favourable. The very extensible *foot* is tongue-like in shape with a groove on the ventral surface which is continuous with the *byssus* pit posteriorly. In this a viscous secretion is poured out which enters the groove and hardens gradually when it comes into contact with sea water. The tip of the foot is pressed against the surface to which the mussel attaches itself, and in a cup-like hollow which ends the groove the attachment plate is formed at the end of the byssal thread. When one byssal thread has been formed the foot changes its position and secretes another thread in another place. The byssus thus consists of a mass of diverging threads arising

from the byssus pit and by means of it the animal is firmly attached to stones or other mussels. But mussels, particularly when young, creep about both by using the cup at the tip of the foot as a sucker and also by forming a path of threads along the surface of the substratum, as can be easily seen in the laboratory. While the development of the byssus is the most outstanding characteristic of the mussel, it may also be mentioned that a pair of simple eyes are developed, anterior

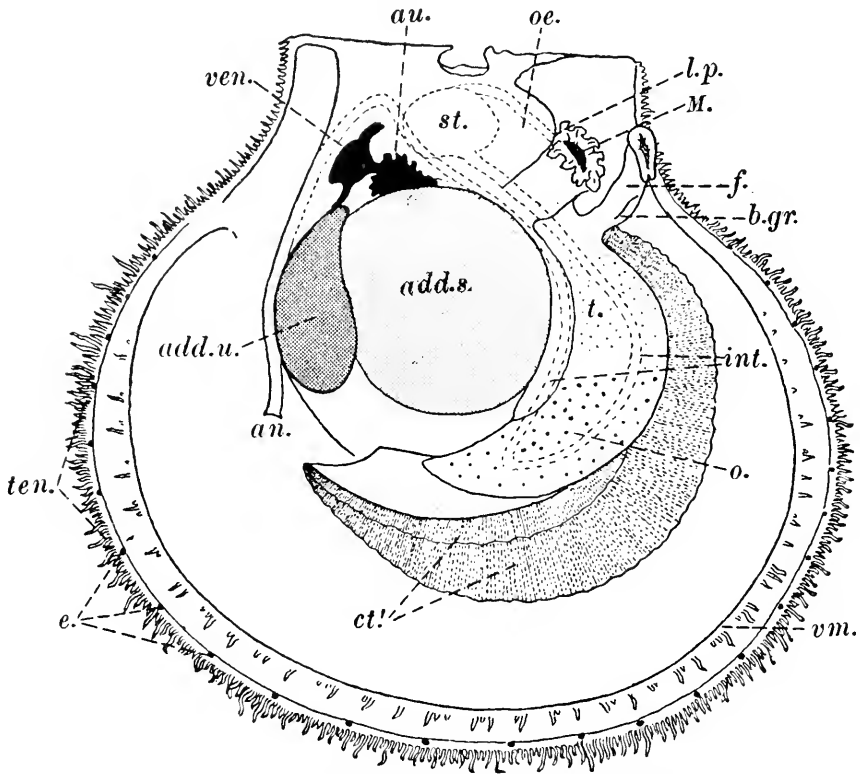

Fig. 399. *Pecten maximus*, general anatomy, right valve and ctenidium removed. After Dakin. *add.u.* unstriped and *add.s.* striped adductor muscle; *an.* anus; *au.* auricle; *b.gr.* byssal groove; *ct.* descending and ascending lamella of left ctenidium; *e.* eye; *f.* foot; *int.* intestine; *l.p.* labial palp; *M.* mouth; *o.* ovary; *oe.* oesophagus; *st.* stomach; *t.* testis; *ten.* tentacles of mantle; *ven.* ventricle; *vm.* velum.

to the inner ctenidial lamella; these are an inheritance from the larval mussel. The invasion of the mantle by the generative organs is another peculiar point. In the breeding season the aeration of blood in the mantle is reduced and the plicate canals (Fig. 396) become the chief organ of respiration.

*Pecten* (Fig. 399). There are two common British species, *P. maximus* and *P. opercularis*, which are commonly known under the name of "scallops". The animal is found free and it moves not by

the ordinary lamellibranch method but by swimming. The two valves are unequal, the right being larger and more convex, and the animal rests on this valve; in *P. opercularis* the valves are almost equal. In swimming the valves open and close very rapidly, forcing out the water between them. Usually the water is forced out dorsally on each side of the hinge line and the animal moves with the free ventral border forward; but on sudden stimulation the current passes out directly ventrally and the hinge line becomes anterior. There is a single large adductor muscle: this is divided into two parts and the larger of these serves for the rapid contractions which cause swimming movements; the fibres are transversely striated; the smaller part has fibres which are capable only of strong long-continued contraction and keep the valves closed. (Cp. Chapter IV, p. 143.)

The foot is very much reduced, but it has nevertheless a distinct function, that of freeing the palps and gills from sharp and disagreeable foreign material; in the larva it is used actively in locomotion. The ctenidia, while resembling the typical filibranch gill of *Mytilus* in general, differ in the possession of two kinds of filaments and in the vertical folding of the gills. The larger *principal* filaments lie at the bottom of the troughs between successive folds and the descending and ascending limbs of each principal filament are connected by a sheet of tissue, the *interlamellar septum*. In one species, *Pecten tenuicostatus*, there are organic connections between filaments instead of ciliary junctions only, and the existence of this condition is a valid criticism of the classification of the lamellibranchs by ctenidial structure.

*Pecten* is hermaphrodite. The ovary has a very vivid pink colour when the eggs are ripe. The testis lies behind it and is cream-coloured. The remaining feature to be noted is the presence of a large series of *stalked eyes* (Fig. 409 D), of a very complicated structure, at regular intervals all round the mantle.

#### Order EULAMELLIBRANCHIATA

*Anodonta* (Figs. 392 C, 397). Many of the characters of this freshwater genus are described above.

*Ostrea* (Fig. 400). In this form the adult is always fixed by the left (the larger) valve. As in *Pecten*, there is only one adductor muscle (the posterior) in the adult (but the spat possesses two equal muscles), and this is divided into two parts, one with striated the other with non-striated fibres. The foot has disappeared entirely; the two auricles are fused together. Of great interest are the reproductive habits: it has been established that individuals of *O. edulis* function alternately as males and females. Spawning tends to take place at full moon as

in some echinoderms. Another point of physiological importance is the great part which leucocytes play in digestion; the lumen of the alimentary canal is invaded and diatoms and similar bodies ingested, digested and transported by the leucocytes into the connective tissue.

A figure of the veliger larva of *Ostrea* is given (Fig. 375 A) to show the ciliary currents by which food is obtained, the crystalline style, which is revolved by the action of the cilia of the style sac, and the foot, which is lost in the adult.

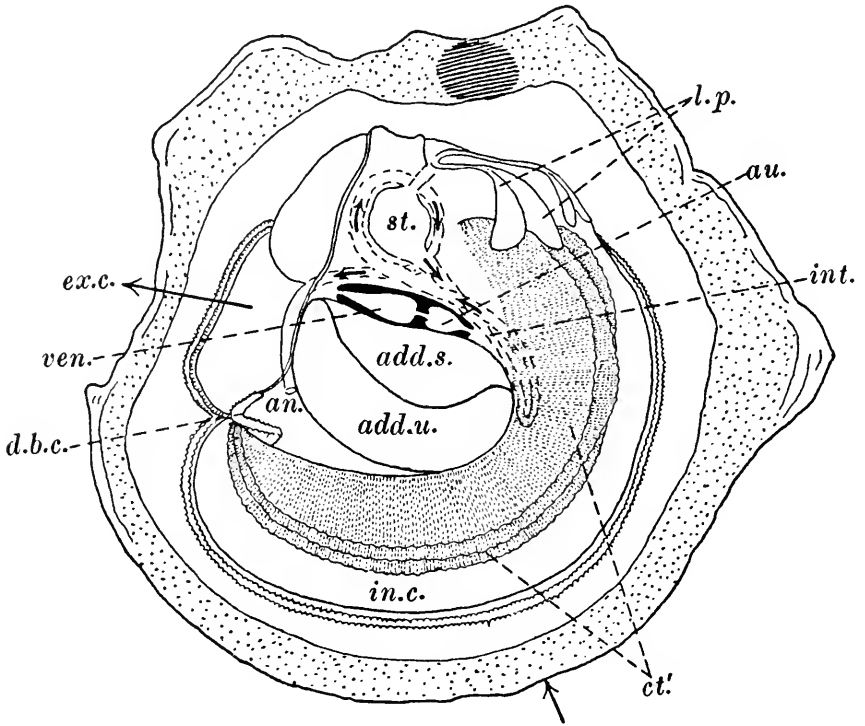

Fig. 400. *Ostrea edulis*, general anatomy, right valve and mantle removed. After Yonge. Lettering as in Fig. 374; in addition: *in.c.* inhalant and *ex.c.* exhalant chamber; *d.b.c.* division between above chambers. Arrows indicate direction of currents.

*Teredo* (Fig. 401) is the most specialized of the boring lamellibranchs. While most lamellibranchs burrow in mud, others tend to work in consolidated sediments such as *Pholas* in chalk and sandstone, and *Saxicava* in the hardest limestone. *Teredo* and *Xylophaga* bore in wood. The latter makes shallow pits, but *Teredo*, working with extraordinary speed, excavates long cylindrical tunnels (sometimes as much as a foot in a month or two). The wood is reduced to sawdust by the rotatory action of the two shell valves, in which the adductor muscle fibres maintain a rhythmical contraction. The sawdust is swallowed by the animal and is largely retained in a relatively

enormous caecum of the stomach, but a great deal of the material passes into the cavity of the digestive gland and is there ingested by the epithelial cells. There is no doubt that *Teredo* has developed enzymes which are almost unique in the Animal Kingdom, which digest cellulose and hemicellulose. The structure of the animal is remarkable for the extraordinarily long siphons and mantle cavity; while the mantle often lays down a calcareous lining to the tube and always a pair of calcareous valves, the pallets, which close the mouth of the tube when the siphons are retracted. The foot

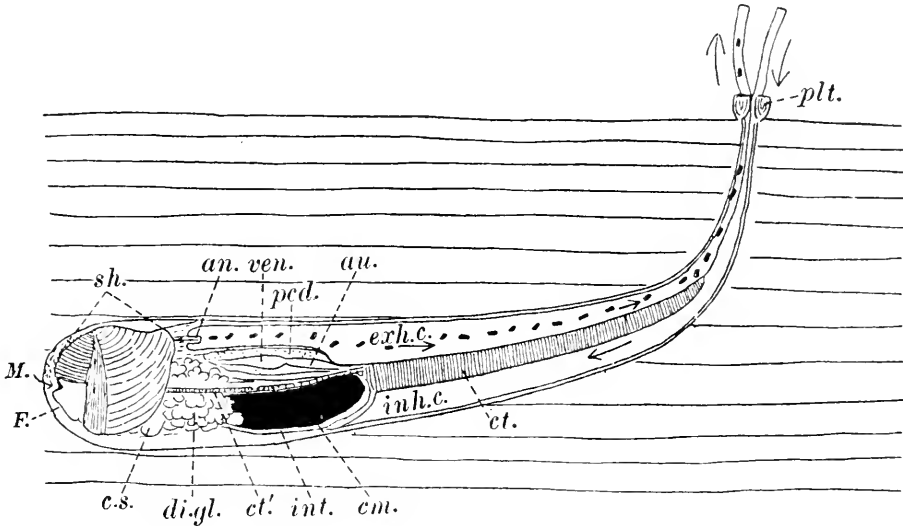

Fig. 401. *Teredo*, represented boring in wood. The sawdust formed by the rotatory movement of the shell valves, *sh.*, is shown entering the mouth, *M.*, and the faecal pellets of undigested wood are shown as black masses in the exhalant chamber, *exh.c.* Other letters: *an.* anus; *au.* auricle; *ct.* ctenidium; *ct. int.* continuation of ctenidium as a ciliated ridge over the visceral mass; *cm.* caecum of stomach filled with wood; *c.s.* position of crystalline style sac; *di.gl.* digestive gland; *F.* foot; *int.* intestine; *inh.c.* inhalant current; *pcd.* pericardium; *plt.* palette; *sh.* left valve of shell; *ven.* ventricle. Original.

is very much reduced. A constant current into and out of the mantle cavity is maintained by ciliary action, and the ctenidia, though so greatly modified and elongated, constitute a collector mechanism; but it does not seem that diatoms obtained in this way form any part of the normal food of the creature, which exists almost entirely on the carbohydrates furnished by wood which also contains small quantities of proteins.

### Class CEPHALOPODA (SIPHONOPODA)

Bilaterally symmetrical Mollusca with a radula and a well-developed head which is surrounded by a crown of mobile and prehensile tentacles, sometimes held to be part of the foot, which certainly forms the

*funnel* or *siphon*, a muscular organ, originally bilobed, used for the expulsion of water from the mantle cavity; one or two pairs of typical ctenidia; coelom sometimes exceedingly well developed, the genital part being continuous with the pericardium; typically a chambered shell in the last chamber of which the animal lives, though in most modern representatives it is reduced and internal or wholly absent; nervous system greatly centralized and eyes of great size and often complex type; eggs heavily yolked and development direct.

The Cephalopoda fall into two groups, in one of which (Tetrabranchiata) there are two pairs of ctenidia and a well-developed external shell, while the members of the other (Dibranchiata) have one pair of ctenidia and either one internal shell or none at all. Of the Tetrabranchiata *Nautilus* is the only living member; of the Dibranchiata, *Sepia*, a common form in the Mediterranean and elsewhere, is a convenient type. The organization of the group will best be understood from a description of these examples. As *Sepia* is the more easily obtained we shall describe it first and in more detail, though it is in many respects less primitive than *Nautilus*.

#### Order DIBRANCHIATA

Cephalopoda with a single pair of ctenidia and kidneys; shell internal, enveloped by the mantle and in various degrees of reduction; 8–10 tentacles; the two halves of the funnel only seen in the embryo; chromatophores present; eyes of complex structure.

##### *Classification*

Suborder DECAPODA. Dibranchs with ten tentacles and with a well-developed coelom. Internal shell consisting of phragmocone, rostrum and proostracum or very much simplified.

- (1) Tribe BELEMNOIDEA. Fossils from Mesozoic rocks which have given rise to the following tribes:
- (2) Tribe SEPIOIDEA. Decapoda with specially modified 4th pair of tentacles which can be retracted into pits; eyes with a cornea, internal shell sometimes with phragmocone bent ventrally; fins not united posteriorly; shore and bottom living forms. *Spirula*, *Sepia*, *Sepiola*.
- (3) Tribe OEGOPSIDA. Decapoda with anterior chamber of eye open; tentacles usually all alike; suckers often modified to form hooks; shell only represented by a horny gladius; strong swimmers. Includes many abyssal forms with phosphorescent organs; some gigantic forms, like *Architeuthis*, 60 feet long.



- (4) Tribe MYOPSIDA. Decapoda with a cornea in the eye, a simple gladius, specially elongated 4th pair of tentacles, not retractile into pits; fins united posteriorly; shore forms. *Loligo* (Fig. 411 D).

Suborder OCTOPODA. Dibranchs with eight tentacles and a reduced coelom. *Octopus*, *Argonauta*, *Opisthoteuthis*.

*Sepia officinalis*<sup>1</sup> is a shallow-water form, in which the shell has become internal. The general disposition of the organs remains much as it would be if the animal inhabited the last chamber of a shell like that of *Nautilus* (cf. Fig. 402 A and B). The whole body is cylindrical. At one end, which would have projected from the shell, is the head with the mouth in the centre and the two relatively enormous eyes at the sides. Round the mouth are the tentacles (arms) for seizing prey which are often considered to be part of the foot. Four pairs of these are short and stout and covered with suckers on their inner surface. The fourth pair (counting from the dorsal surface) are long and can be retracted into large pits at their base; there are suckers only at their free end. The left hand member of the fifth pair in the male is slightly modified by suppression of the suckers. At one side, called posterior, is the mantle cavity, and protruding from its opening is the funnel, which is the remaining part of the foot. The visceral hump is the conical apex of the animal. Instead then, of being protrusible like that of a lamellibranch or used for gliding like that of a gasteropod, the main part of the cephalopod foot is greatly modified for respiratory purposes. In view of the fact that there is no boundary between the head and the foot in molluscs, discussion as to whether the tentacles are part of the head or the foot is difficult and unimportant.

The shell has become internal and is a rather substantial plate which acts as an endoskeleton. The absence of a rigid envelope has made it possible for the mantle to become very mobile and to develop thick muscular layers, circular muscles running round the mantle cavity and longitudinal running towards the apex of the hump. When the latter contract and the former relax the mantle cavity enlarges and draws in water which circulates round the ctenidia; when the reverse action takes place the first effect of the contraction of the circular muscles is to draw the mantle lobe tight round the neck and then, when the contraction reaches its height, the water is expelled through the funnel. In rest these movements are gentle and rhythmic and only effect the change of water necessary for respiration. At the same time the animal is usually swimming slowly forward by the undula-

<sup>1</sup> This description of the structure and habits of *Sepia* applies generally to all the well-known Decapoda.

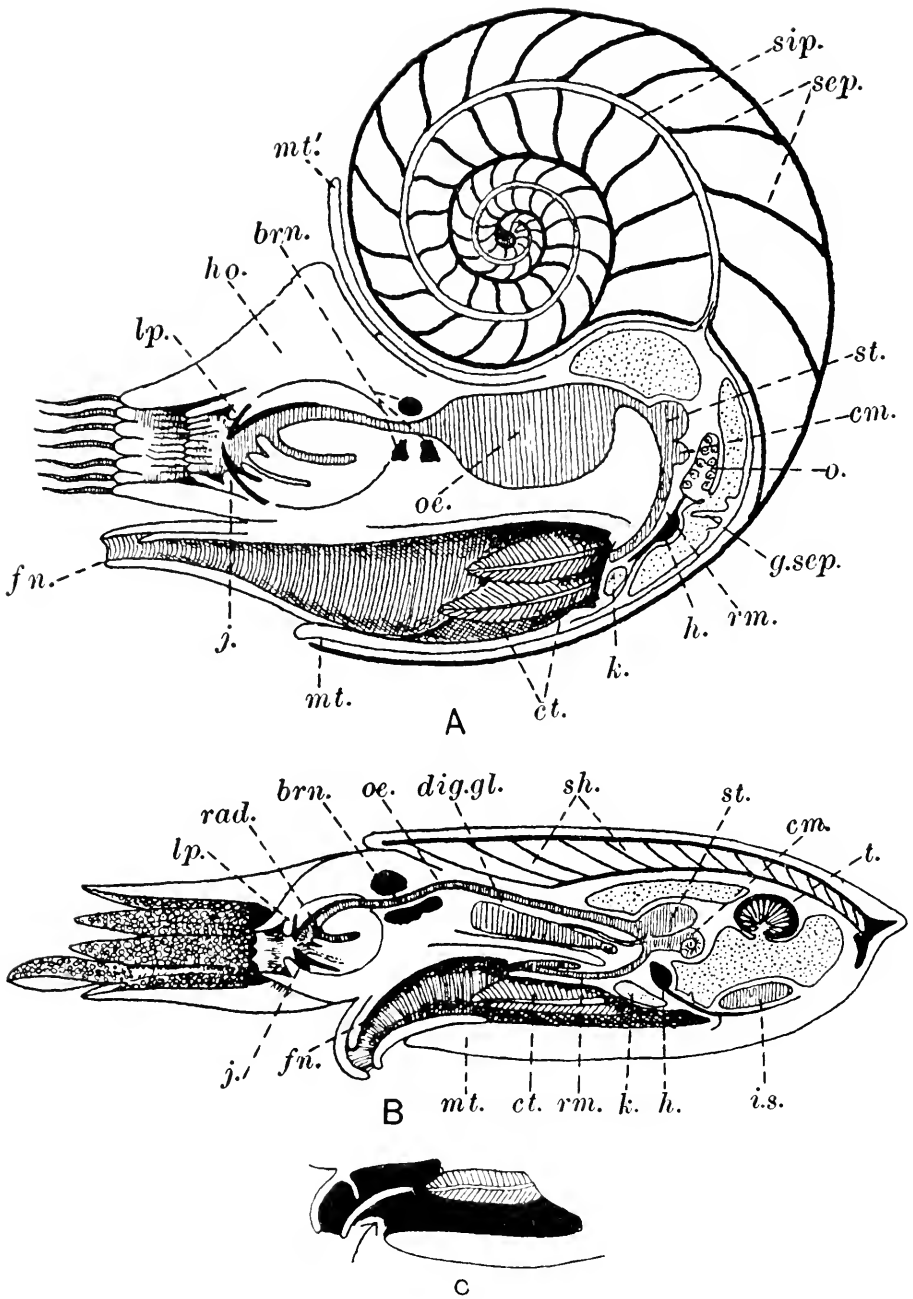

Fig. 402. Diagrammatic median sections through A, *Nautilus* and B, *Sepia* for comparison of the organization of the Tetrabranchiata and Dibranchiata respectively. Altered from Naef. *brn.* brain; *cm.* caecum; *ct.* ctenidia; *dig.gl.* digestive gland; *fn.* funnel; *g.sep.* genital septum; *h.* heart; *ho.* hood; *i.s.* ink sac; *j.* jaws; *k.* kidney; *lp.* lips; *mt.* mantle; *mt.'* dorsal extension in *Nautilus*; *o.* ovary; *oe.* oesophagus; *rad.* radula; *rm.* rectum; *sep.* septa; *sh.* shell; *sip.* siphuncle; *st.* stomach; *t.* testis. *Sepia* is shown in the expiratory position with the mantle pressed against the funnel, and the valve of the latter flat against its wall. In the inset C, the inspiratory phase is seen with the mantle relaxed to allow the entry of water as shown by the arrow, and the valve of the funnel opened so as to prevent the passage of water.

tory movement of the lateral fins. But if *Sepia* is alarmed or excited the muscles contract violently and the spasmodic ejection of water through the funnel causes the animal to dart quickly backwards. Equally by turning the funnel backward it can move quickly forward. Not only is the mantle highly muscular but the dermis contains large cells filled with pigment, the *chromatophores*, which can be dilated by the contraction of radiating muscle fibres attached to the cell wall. By alternate contraction and expansion of the chromatophores, waves of colour are made to pass rapidly over the surface of the animal. The colour change which is brought about in this way may be to a certain extent a response to the character of the background but it is also stated to be the expression of emotions.

*Sepia* swims with the longest axis horizontal, the upper flattened surface is that under which the shell lies and the lower the mantle-cavity surface. These surfaces are *dorsal* and *ventral* respectively and the mouth and tentacles are anterior. All round the mantle in the horizontal plane rises a horizontal fin by which the gentler swimming movements are effected.

When the mantle cavity is opened as shown in Fig. 403, the *funnel* is seen with its narrow external and wide internal openings, and at the base of it two sockets which fit corresponding knobs on the mantle. This locking arrangement ensures that the mantle fits tightly on the neck and so that all water is expelled by the funnel. At the anterior end of the visceral hump is seen the central *anus* at the end of a long papilla, so placed as to discharge the faeces directly into the cavity of the funnel, the shorter *renal papillae* immediately on each side, and on the left side only the *genital aperture*, also at the end of a long papilla. More posterior still are the large and typical *ctenidia*.

On the face of the visceral hump in mature animals the accessory genital glands are seen through the skin; the chief of these are the shell-forming *nidamental glands* of the female which occupy a considerable area. Between these and in front of them are the *accessory nidamental glands*. Posterior to them is the *ink sac*, usually seen through the integument from which a narrow duct runs ventral to the rectum, opening into it a short distance behind the anus. The first step in dissection is to strip off the skin and then dissect out the gland and its duct as carefully as possible. It usually contains a large amount of the ink, which is composed of granules of melanin pigment formed by the oxidation of the aminoacid tyrosin by the agency of an enzyme, tyrosinase. This substance is ejected into the mantle cavity and through the funnel to form a "smoke cloud" when the animal is attacked.

The next stage in dissection is the opening up of the kidneys by cutting through the thin outside wall. It will at once be seen that the

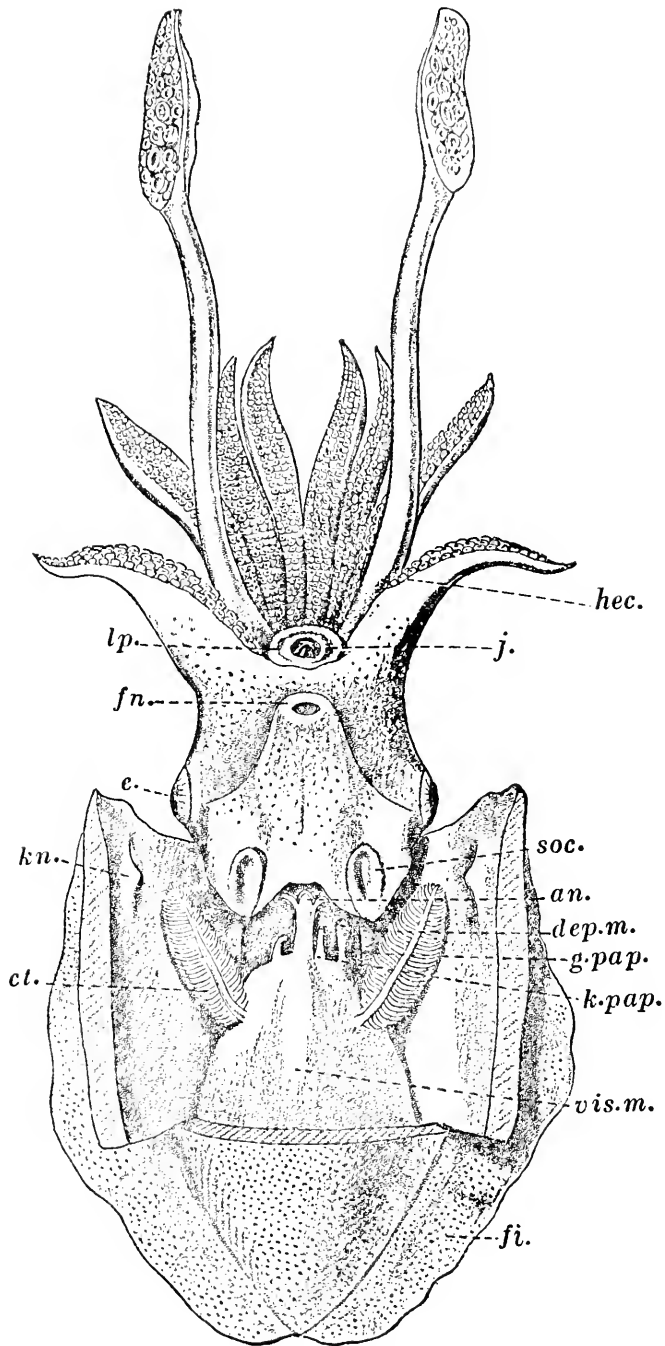

Fig. 403. Ventral view of male of *Sepia officinalis* with mantle cavity opened to expose its contents. *an.* anus; *dep.m.* depressor muscle of the funnel; *e.* eye; *fi.* fin; *g.pap.* genital papilla; *hec.* hectocotylized arm; *j.* jaw; *k.pap.* papilla bearing external aperture of kidney; *kn.* cartilaginous knob on mantle which fits into the socket, *soc.*; *vis.m.* visceral mass. Other letters as in Fig. 402. From Shipley and MacBride.

cavity of the organ contains a large amount of spongy excretory tissue, developed round the veins which run straight through the kidney. Just inside the renal papilla is a small rosette which carries the *renopericardial aperture*. This leads into the long narrow *renopericardial canal* running in the outer wall of the kidney and opening posteriorly into the *pericardium*, a wide space lying behind the kidneys which is

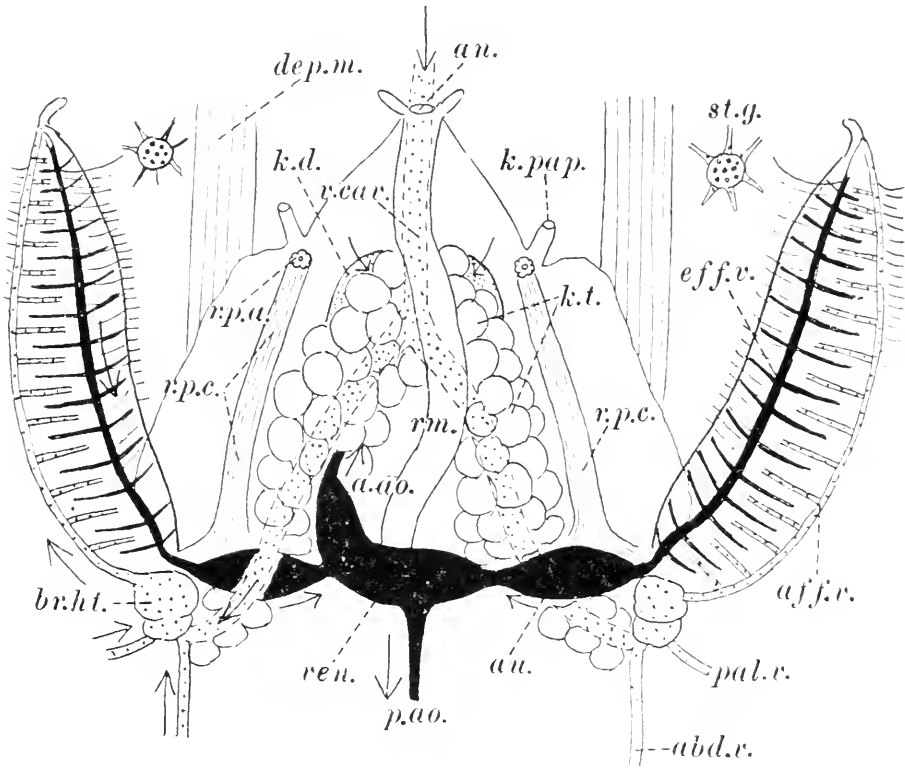
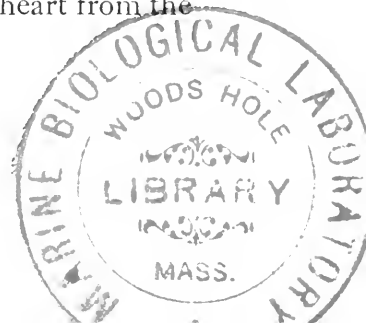

Fig. 404. *Sepia officinalis*. Dissection from the ventral side to show kidneys and blood vessels. Arrows show the direction of flow of blood. *abd.v.* abdominal vein; *a.a.o.* anterior aorta; *au.* auricle; *eff.v.* efferent branchial vein; *br.ht.* branchial heart; *eff.v.* efferent branchial vein; *k.d.* opening into dorsal sac of kidney (see arrow); *k.t.* excretory tissue surrounding the vena cava; *pal.v.* pallial vein; *p.a.o.* posterior aorta; *r.p.a.* opening into kidney cavity of the renopericardial canal, *r.p.c.*; *st.g.* stellate ganglion; *ven.* ventricle; *v.cav.* vena cava. Other letters as in Figs. 402, 403. Original.

only separated by an incomplete partition from the still more spacious *genital coelom* occupying the apex of the visceral hump (Fig. 405).

The median ventricle and the two lateral auricles are spindle-shaped bodies arranged in a line at right angles to the longitudinal axis of the body. Arterial blood is sent to the body from the ventricle by an *anterior aorta* running dorsal to the oesophagus towards the head and a *posterior aorta*; venous blood returns to the heart from the



head by a very important vessel, the *vena cava*, which splits in the kidney region into two *branchial veins*, which run to the so-called *branchial hearts*, special muscular dilatations which pump blood through the capillaries of the ctenidia. The blood which is oxygenated there is sucked out of the ctenidium by the expansion of the auricle. Blood is also returned directly to the branchial heart from the mantle by the abdominal veins (and a smaller pair), and by the unpaired genital and ink sac veins which run first into the right branchial vein.

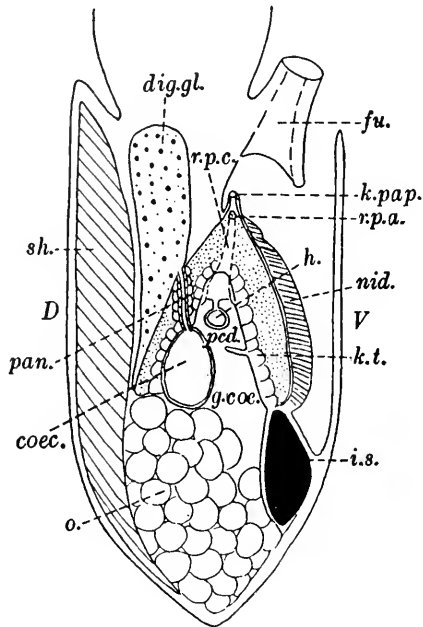

Fig. 405. Vertical section of *Sepia officinalis* to show the relation of the divisions of the coelom. After Grobben. *coec.* coecum; *dig.gl.* digestive gland ("liver"); *fu.* funnel; *g.coe.* genital coelum; *h.* heart; *i.s.* ink sac; *k.pap.* external opening of kidney; *k.t.* excretory tissue; *nid.* nidamental gland; *o.* ova; *pan.* "pancreatic" tissue surrounding the duct of the digestive gland; *pcd.* pericardium; *r.p.a.* opening into the kidney of the renopericardial canal, *r.p.c.*; *sh.* shell; *D*, dorsal; *V*, ventral.

In describing the alimentary system it must first be mentioned that *Sepia*, as a type of the Decapoda, possesses ten tentacles of which the fourth pair are longer than the others. These two tentacles have a slender stem and a swollen terminal portion to which the suckers are confined. Each tentacle can be rapidly extended and attached to the living prey, and with equal rapidity retracted into a pit near the mouth, thus bringing the food into the reach of the other tentacles, which hold it while it is being devoured. Round the mouth are frilled lips and just within it are the characteristic *beaks*, corresponding to the jaws of the gasteropod, which bite upon each other. The *buccal*

mass is large and contains a well-developed radula and is traversed by the narrow oesophagus. Just within the buccal mass is the first pair of *salivary glands* and immediately in front of the digestive gland is the second pair, which produce not a digestive juice but a poison. In *Octopus*, which lives largely upon crabs, the prey is seized and bitten by the beaks, a drop of the poisonous saliva entering at the same time by the punctures in the carapace and causing almost immediate death. This is true of *Sepia* also which lives upon prawns and shrimps. The food is bitten into pieces by the jaws—sometimes of considerable size—and passed down the oesophagus (which though narrow is capable of considerable distension) to the muscular, non-

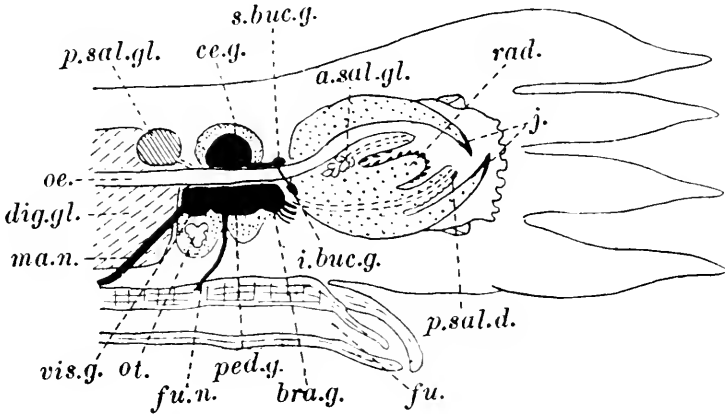

Fig. 406. Vertical section through head of *Sepia officinalis* showing buccal mass (coarsely stippled) and brain (black) surrounded by the cartilaginous skull (finely stippled). *a.sal.gl.* anterior salivary gland; *bra.g.* brachial ganglion with brachial nerves coming off from it; *ce.g.* cerebral ganglion; *dig.gl.* "liver"; *fu.n.* nerve to funnel (*fu.*) coming off from pedal ganglion; *j.* beaks; *ma.n.* mantle nerve; *oe.* oesophagus; *ot.* otocyst; *ped.g.* pedal ganglion; *p.sal.d.*, *p.sal.gl.* posterior salivary duct and gland; *rad.* radula; *s.buc.g.*, *i.buc.g.* superior and inferior buccal ganglia; *vis.g.* visceral ganglion. Original.

glandular *stomach*. Here it is mixed with the secretion from the digestive gland and the digested food passes to the spiral *coecum*. This contains an elaborate ciliary mechanism which removes solid particles from the coecum, leaving only liquid products of digestion to be absorbed there. The digestive gland consists of a solid bilobed gland ("liver") and a more diffuse and spongy part ("pancreas"). Both are enzyme-producing, but the "pancreas" (which in *Sepia* is suspended in the kidney sac) is also partly excretory. The single duct opens into the coecum, but a groove guides its secretion into the stomach. The "liver" is the principal "storage organ" for food reserves; it seems probable that these only reach the gland from the blood-stream, and that food is all absorbed in the alimentary canal,

and does not enter the liver. In this respect the cephalopods appear to differ from the majority of invertebrates.

The nervous system of *Sepia* is of great interest from the large size and intimate association of the ganglia round the oesophagus, which form a genuine "brain" (Figs. 407, 408) in which special centres for the co-ordination of vital activities and for the simple reflex actions have alike been detected. In contrast to vertebrates there is a concentration of nerve cells in the brain, only a few outlying ganglia being present. For the protection of this large nervous mass a "skull" has been developed composed of a tissue very similar to cartilage, which also forms the supports of the fins and tentacles. The nerve net found in the foot of gasteropods is absent.

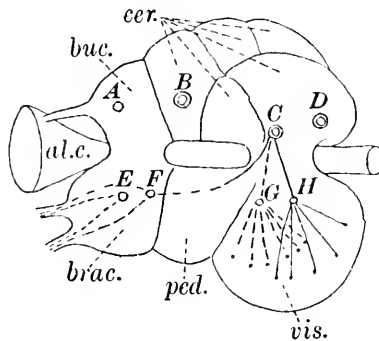

Fig. 407. Lateral view of the brain of a cephalopod (*Eledone?*) to show the localization of function. After Buddenbrock. *al.c.* alimentary canal; *buc.* buccal ganglion; *cer.* the different divisions of the cerebral ganglion; *brac.* brachial ganglion; *ped.* pedal ganglion; *vis.* visceral ganglion; the various reflex centres *A* for biting, *B* for swallowing, *C* for swimming forward, *D* for creeping and climbing, *E* for closing and *F* for relaxing the suckers, *G* for in-breathing and *H* for out-breathing.

The brain consists of the following ganglia: dorsally the *cerebral* or *supraoesophageal*, ventrally (1) the *pedal*, divided into the brachial (the motor centre for the tentacles) in front and the *infundibular* (supplying the funnel) behind, and (2) the *visceral* supplying the mantle and the visceral hump. The cerebral ganglia are much more differentiated than any of the others. They can be divided into separate regions which co-ordinate the movements of organs for the performance of such complicated actions as feeding, swimming and creeping. In the visceral ganglia there are also two sharply defined centres which control the movements of the whole mantle in in-breathing and out-breathing respectively as well as numerous small centres, the stimulation of which causes contraction of small muscle patches in the mantle, while in the brachial ganglia there are separate centres for gripping by the suckers and for letting go.



From the cerebral ganglia there run forward a pair of nerves which end at the border of the buccal mass in a pair of *superior buccal* ganglia; a circumoesophageal commissure links up these with the *inferior*

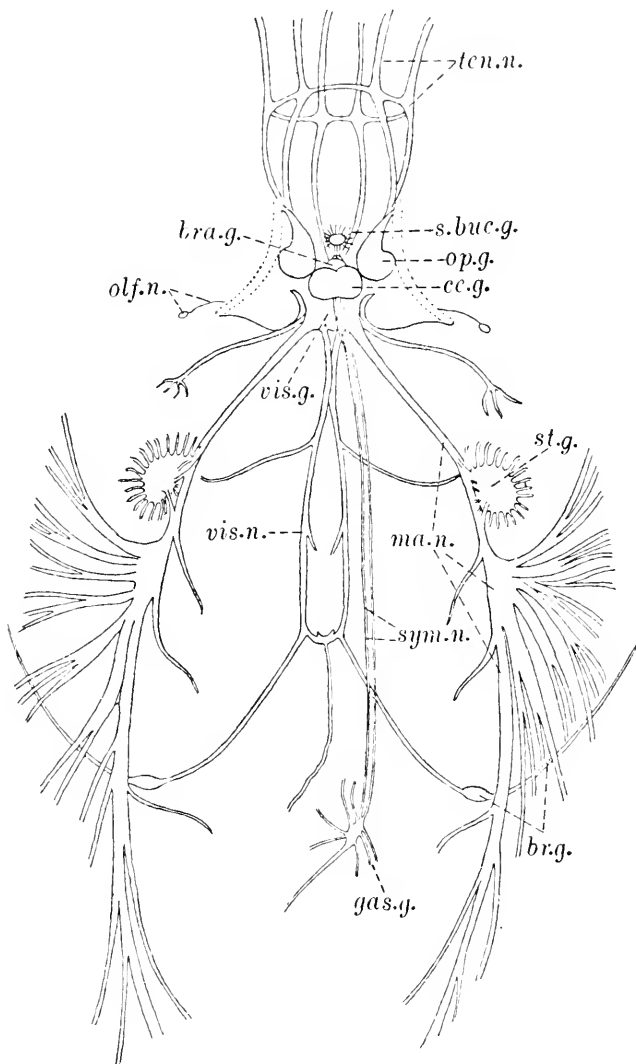

Fig. 408. Nervous system of *Sepia*. After Hillig. *bra.g.* brachial ganglion; *br.g.* brachial ganglion and nerve; *ce.g.* cerebral ganglion; *gas.g.* gastric ganglion; *ma.n.* mantle nerve; *olf.n.* olfactory pit and nerve; *op.g.* optic ganglion; *s.buc.g.* superior buccal ganglion; *st.g.* stellate ganglion; *sym.n.* sympathetic nerve; *ten.n.* brachial nerves; *vis.g.*, *vis.n.*, visceral ganglion and nerve.

*buccal*. From the visceral ganglia there is a pair of nerves running to the very prominent *stellate ganglia* in the mantle; there is also a visceral loop which sends off branches to the gills and a sympathetic loop ending in the *gastric ganglion* between the stomach and the caecum.

The infundibular ganglion gives off a pair of nerves to the funnel and the brachial ganglia a separate nerve, which carries a ganglion on its course, to each arm.

In the dissection of the nervous system a general view of the different parts of the brain is best obtained by making a longitudinal vertical section with a sharp scalpel. Such a section is shown in Fig. 406. Afterwards the dissection of the nerves coming away from the brain can be carried out.

*Sepia* possesses very large eyes (Fig. 409 C), similar in their structure and development to those of a vertebrate. In the embryo, the eye originates as an ectodermal pit, the lining of which forms the retina and the contents of which become the vitreous humour. The pit closes up and at the point of closure the interior part of the lens is formed. Later appears a circular fold which forms the iris, limiting the pupil of the eye and forming an outer eye chamber which is finally enclosed by the growth of a cornea. The external half of the lens is formed at the same time. A special ciliary muscle regulates the position of the lens. When it is relaxed the eye is focussed on the distance: when it contracts, increasing the pressure of the vitreous humour and so pushing the lens forward, the eye is focussed on near objects.

The ovaries and the testes are simply parts of the wall of the coelom. The ova are cells of large size; they are nourished by other peritoneal cells, the *follicle cells*, which surround the ova and pass on food from the special blood supply. The surface of contact between these cells and the egg is increased by folding. When ripe the ova escape into the genital coelom and pass into the genital duct. This has a terminal glandular enlargement and there are also the nidamental glands, unconnected with the genital ducts, which have already been mentioned. These secrete an elastic substance which forms the egg envelope.

The sperm pass similarly into the genital coelom and then by a very small aperture into the sperm duct which is modified to form in turn the seminal vesicle, the prostate gland and the terminal reservoir, called Needham's sac. All these play their part in the formation of the remarkable spermatophores, elastic tubes which by an elaborate arrangement burst and liberate the spermatozoa after copulation. The spermatophores are passed directly from the extended genital papilla into the funnel and then on to one of the arms (the *hectocotylus*) which is modified for the purpose of transferring the sperm to the female. In *Sepia*, the modification shows itself only by the suppression of some rows of suckers at the base of the arm, but in other forms it is profoundly modified. In *Octopus*, the end of the arm is spoon-shaped and the arm is extended so as to enter the mantle cavity of the female. In other octopods, a cyst, in which the spermatophores are stored, is formed at the end of the arm; from it a long

filament is protruded. In *Philonexis* and *Argonauta* the modified arm is charged with spermatozoa, inserted into the mantle cavity of the female and then detached. This arm was described by early observers as a parasitic worm and named *Hectocotylus*.

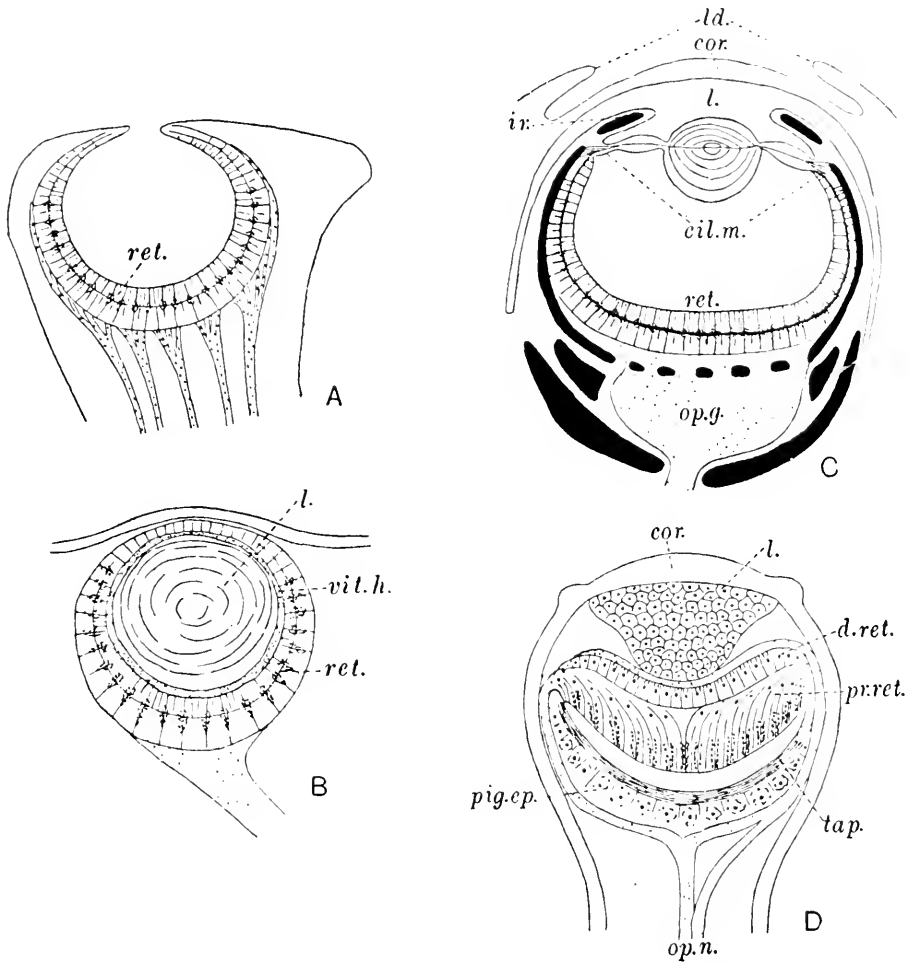

Fig. 409. Eyes of Mollusca. A, *Nautilus*. B, *Helix*. C, *Sepia*. D, *Pecten* (inverted type). *cil.m.* ciliary muscle; *cor.* cornea; *d.ret.* distal and *pr.ret.* proximal layers of the double retina of *Pecten*; *ir.* iris; *l.* lens; *ld.* eyelids; *op.g.*, *op.n.* optic ganglion and nerve; *pig.ep.* pigmented epithelium; *ret.* retina; *tap.* tapetum; *vit.h.* vitreous humour. In *Sepia* the cartilage is shown in black.

*Other Dibranchiata.* The members of this group are classified in two suborders, whose members respectively possess, like *Sepia*, ten arms (*Decapoda*), or, like *Octopus*, only eight (*Octopoda*). In no member of either division is there any known form in which the shell is external; in all cases the shell is more or less rudimentary or, in the case of the *Octopoda*, entirely absent. There is a well-known and

extremely numerous fossil group, the Belemnitoidea (Fig. 410 B), in which impressions of the entire creature show the internal shell, the ink sac, and the ten arms beset with hooks. The shell consists of a chambered *phragmocone*, protected by a thickened *guard*, and with an anterior plate, the *proostracum*. It may well have been derived from a nautiloid form like *Orthoceras* (Fig. 410 A), as may be seen in the accompanying series of diagrams, in which the soft parts are of course partly conjectural. In a rare living form, *Spirula* (Fig. 410 C'),

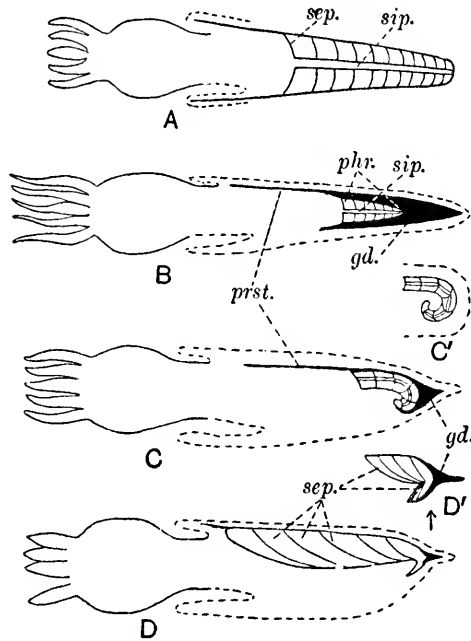

Fig. 410. Series of Cephalopoda to illustrate the evolution of the internal shell. After Naef. A, *Orthoceras*, Palaeozoic. B, *Belemnites*, Mesozoic. C, *Spirulirostra*, Tertiary. C', *Spirula* and D, *Sepia*, living. (D', enlargement of posterior end of D.) The reflection of the mantle over the shell is indicated by a dotted line. This is incomplete in *Orthoceras*, but the shell is completely internal in the rest. *gd.* guard; *phr.* phragmocone; *prst.* proostracum; *sep.* septa; *sip.* siphuncle.

the chambered shell is reduced, but not quite so much as is the case in the belemnites. It is coiled and there is no guard or proostracum. Both are, however, present in the related fossil *Spirulirostra* (Fig. 410 C). Finally, in *Sepia* (Fig. 410 D) the guard is represented by the minute *rostrum* and, according to one interpretation, one side of the phragmocone has expanded to cover the surface of the proostracum, the septa forming the oblique calcareous partitions of the cuttle bone, while the other side forms a minute lip in which the septa are crowded together (Fig. 410 D'). The siphuncle (p. 602) is a short wide funnel in between the two sides.

In *Loligo* there is only a horny *pen*, which represents the proostracum, while in the Octopoda there is no skeleton at all.

The Dibranchiata are specialized in two ways. The first is for a pelagic life; their bodies become elongated, fins develop and they become transparent. They may, exceptionally, develop such speed in

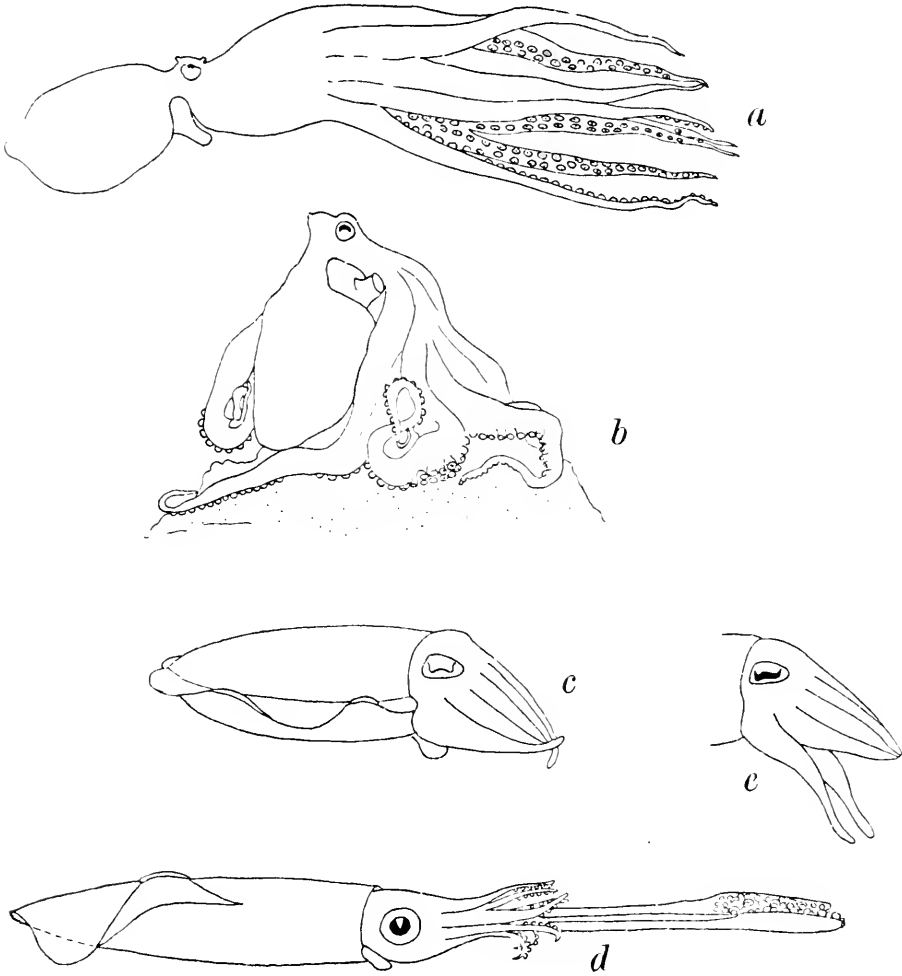

Fig. 411. External appearance of Dibranchiata. *a*, *Octopus* swimming backward. *b*, *Octopus* asleep. *c*, *Sepia* swimming gently. *d*, *Loligo* in the act of catching prey. *e*, *Sepia* becoming active.

the water that they take off from the surface and glide for considerable distances through the air, in the manner of the flying fish, aided by their spreading fins (*Todarodes sagittarius*). *Loligo* (Fig. 411 *d*) is a well-known example of the pelagic type and may be seen in aquaria swimming in troops, keeping their distances and turning with military precision.

The second mode of specialization is for a semisedentary life on the bottom. In this the body is short and the arms, which are much larger and more mobile than in the other type, are used for crawling. *Octopus* (Fig. 411 a) hides itself among stones and seeks its prey only at night. *Sepia* and *Sepiola*, though capable of active movement, spend long periods of rest half-covered with sand, assuming by means of chromatophore expansion brown ripple-marking on their mantles. The most sedentary form is the flattened *Opisthoteuthis*, which is almost radially symmetrical and has a remarkable resemblance to a starfish; the arms are all joined together and form a suctorial disc by which the animal applies itself to a rock.

### Order TETRABRANCHIATA

Cephalopoda with well-developed calcareous shells. Living forms with two pairs of ctenidia and kidneys; arms very numerous, without suckers; eye simple; chromatophores absent; funnel in two halves.

Suborder NAUTILOIDEA, with membranous protoconch, central siphuncle and simple suture line, e.g. *Nautilus*, *Orthoceras*.

Suborder AMMONOIDEA, with calcareous protoconch, marginal siphuncle and usually complicated suture line, e.g. *Phylloceras*, *Baculites*.

A brief description of *Nautilus*, the only surviving cephalopod with an external chambered shell, must be given here. The shell is coiled in a plane spiral; the earliest formed portion was membranous and is represented by a small central space. In the ammonoids there is a calcareous chamber, the *protoconch*, in this position. Succeeding this are the numerous *chambers*, separated from each other by the curved *septa*, each one marking a stage in the animal's growth. As the shell is added to, the animal moves forward and from time to time shuts off a space (the chamber) behind it by the secretion of a new septum. The terminal *living chamber* is much larger than the rest and is occupied by the body of the animal. All the others contain gas (which differs from air in its smaller proportion of oxygen); by means of this the heavy shell is buoyed up in the water and the animal can swim freely. The septa are perforated in the middle and traversed by the *siphuncle* which is a slender tubular prolongation of the visceral hump. It contains blood vessels and probably secretes gas into the chambers to maintain a constant pressure.

The relations of the different parts of the body in *Nautilus* are easily compared with those in *Sepia* (Fig. 402). The shell coils forward over the neck of the animal (exogastric); the mantle cavity is posterior as in all cephalopods. In other words differential growth of the vis-

ceral hump is not here associated with torsion. The *mantle* is thin and adheres to the shell; it cannot therefore be associated with the respiratory and locomotory movements. The "head foot" is produced into two circles of *arms* which are very numerous; they are retractile and adhesive but have no suckers. The anterior part of the region where it touches the shell is very much thickened to form the *hood*, and when the animal is retracted into the living chamber the hood acts as an operculum. The third region of the head foot is the *funnel*, here composed of two separate lobes.

The other principal points in which *Nautilus* differs from the rest of the living cephalopods are as follows:

(1) There are *four* ctenidia and *four* kidneys, without renopericardial apertures. The pericardium opens independently to the exterior by a pair of pores. The fact that in the most primitive cephalopod now existing there is a kind of segmentation of the body cavity and mantle organs has been taken to support the origin of the cephalopods from a metamerically segmented ancestor. This "segmentation" may, however, be secondary. Certainly the absence of a renopericardial connection is not a primitive feature. There is nothing to prove that the fossil chambered-shell cephalopods had four ctenidia and four kidneys.

(2) There are very simple eyes (Fig. 409A) consisting of an open pit with no lens, the surface of the retina being bathed by sea water. This appears to be a primitive feature, but *Nautilus* is nocturnal and the eyes may have undergone reduction.

(3) There is no ink sac in *Nautilus*, nor apparently in the other forms grouped in the Tetrabranchiata.

*Nautilus* lives at moderate depths on some tropical coasts. It either swims near the bottom or crawls over the rocks, pulling itself along by its arms like *Octopus* (Fig. 411 b). The gentler swimming movements are caused by the contraction of the muscles of the funnel only; the more violent movements are probably caused by the animal suddenly withdrawing into the shell, thus expelling the water from the mantle cavity. It is nocturnal and gregarious and a ground feeder.

The chief interest of *Nautilus* lies in the fact that it is the sole living representative of a vast multitude of cephalopods with external chambered shells which flourished between the earliest Cambrian and the late Cretaceous period, a space of time embracing much the longest part of the history of life on the earth. After being the dominant type of marine invertebrate in the Mesozoic they suddenly became extinct, and the Cephalopoda are now mainly represented by the Dibranchiata with their internal shells.

The Tetrabranchiata are divided into two groups, the nautiloids and the ammonoids. The first of these contains *Nautilus* and other

forms which agree with it in the position of the siphuncle and the shape of the septum. They reach their maximum development in the early Palaeozoic, where the dominant forms have straight shells like *Orthoceras* and *Actinoceras*, which were sometimes as much as 8 feet long. It is difficult to suppose that shelled animals of this size were anything other than sedentary organisms. There is a tendency for the shell to become coiled in other forms, exhibiting itself first in

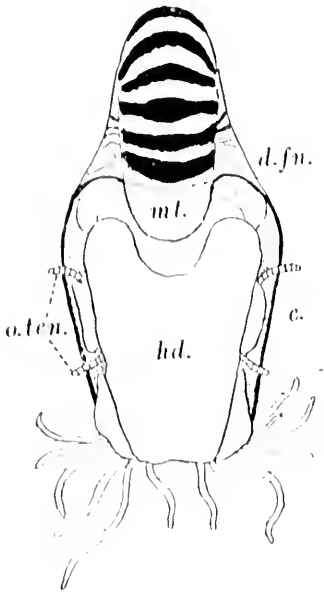
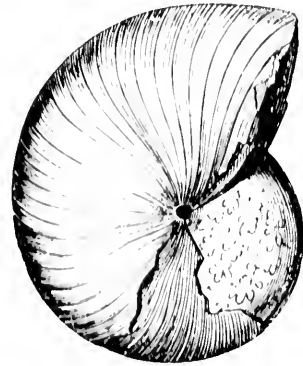

Fig. 412.



A



B

Fig. 413.

Fig. 412. *Nautilus macromphalus* adhering to the substratum by means of its tentacles in a vertical position. It usually lies horizontally. After Willey. The shell shows alternate light and dark bands which resemble "ripple-marking". *d.fn.* dorsal muscular attachments of the funnel; *c.* eye; *hd.* hood; *mt.* mantle; *o.ten.* ophthalmic tentacles.

Fig. 413. A, *Phylloceras heterophyllum*, from the Lias; a part of the shell has been removed to expose the sutures,  $\times \frac{1}{4}$ . B, Suture line of *Phylloceras heterophyllum*, from the Lias: the arrow indicates the position of the siphuncle and points towards the aperture of the shell. From Woodward. Natural size.

slightly curved forms like *Cyrtoceras*, then in loosely coiled forms like *Gyroceras* and finally in the closely coiled *Nautilus*. There is also the reverse tendency, and in *Lituites* the young shell is closely coiled but in adult life it straightens out completely.

The ammonoids appeared first of all in the middle of the Palaeozoic but reached their zenith in the Mesozoic. From the beginning of the Trias onward new families, genera and species are ceaselessly evolved. These are differentiated by the shape and sculpture of the shell



whorls, but particularly by the patterns of the *suture line*, that is, the junction line of the septum and the outer shell (Fig. 413). These patterns reach the greatest complexity. A great deal of interest attaches to the fact that in these characters the earlier formed chambers of an ammonoid individual usually differ from those of the adult shell (Figs. 413, 414, 415). There may, in fact, be several changes in the life of an individual and the succession of such changes has been recorded as evidence for tracing the descent of particular ammonoids. The most striking manifestation of the phenomenon is afforded by

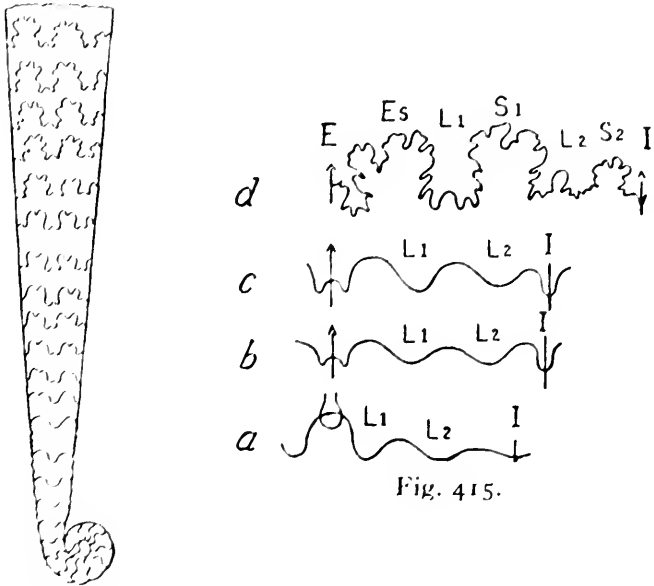

Fig. 414.

Fig. 414. *Baculites chicoensis* Chalk. After Perrin Smith.

Fig. 415. Suture lines of *Baculites* to show the variation in development at different ages. *a*, first, *b*, second and *c*, sixth suture lines of *B. chicoensis*; *d*, adult septum of *B. capensis*; *E*, external lobe; *Es*, external saddle; *I*, internal lobe; *L*<sub>1</sub>, *L*<sub>2</sub>, first and second lateral lobes; *S*<sub>1</sub>, first lateral saddle; *S*<sub>2</sub>, internal (dorsal) saddle. *a-c* after Perrin Smith, *d* after Spath.

ammonoid stocks, particularly in the Cretaceous, in which the approach of extinction is heralded by "uncoiling" in various stages. In *Scaphites* the shell is coiled in youth but later straightens out and finally hooks back. In *Baculites* (Fig. 414) only the very earliest chambers form a coiled shell; nearly the whole of the shell is straight. But the suture lines, though tending to become simplified, show the type of the family from which the uncoiled form is derived, and it is possible to show quite definitely that such genera as "*Scaphites*" and "*Baculites*" are not natural but polyphyletic; both scaphoid and baculoid forms occur in different lines of descent.

## CHAPTER XVII

# THE MINOR COELOMATE PHYLA

## PHYLUM POLYZOA<sup>1</sup>

Coelomate unsegmented animals, always sedentary and nearly always colonial; with a circumoral ring (*lophophore*) of ciliated tentacles, and a U-shaped alimentary canal; usually with a ciliated free-swimming larva; asexual reproduction by budding.

The ordinary individuals in a colony of polyzoa at first sight resemble hydroid polyps—in their general shape, size and circle of tentacles. Closer inspection shows that they are triploblastic animals. In the majority of the Ectoprocta each individual consists of two distinct parts, the *zoecium* or body wall and the *polypide*, consisting of the alimentary canal, the tentacles and the tentacle sheath (which contains the tentacles when contracted). The polypide can be entirely retracted within the zoecium and, as will be seen below, has a much shorter life than the latter.

The form chosen for illustration, *Plumatella* (Fig. 416), belongs to an order (Phylactolaemata) of the Ectoprocta in which the lophophore is not a simple circle, as is the case in the other order, the Gymnolaemata, but is horse-shoe-shaped. A small ridge, the *epistome*, overhangs the mouth in this group but not in the Gymnolaemata. The mouth opens into the *oesophagus* which passes into a capacious *stomach* with a *caecum* which is attached by a strand of mesoderm, the *funiculus*, to the body wall. From the upper end of the stomach, the *intestine* runs to the anus which is situated just outside the lophophore. The food, consisting of small organisms like diatoms and protozoa, is collected by the cilia of the lophophore and transported through the whole of the alimentary canal by cilia.

The body cavity (also in all Ectoprocta) is a true coelom containing a colourless fluid, and the cells which line it give rise to the germ cells. Polyzoa are hermaphrodite; the testes are formed on the funiculus and the ovary on the body wall. When the germ cells are ripe the so-called *intertentacular organ* often appears; this is a tube which opens within the lophophore and serves for the escape of the genital products. Part of the coelom is shut off from the rest by an incomplete septum, as the *ring canal* which is prolonged into the tentacles. The intertentacular organ opens internally into this.

The *nervous system* is represented by a single ganglion, situated

<sup>1</sup> Often called Bryozoa.

between the mouth and the anus, and many nerves chiefly supplying the tentacles and gut. There are no special sense organs. No trace of a *vascular system* exists.

A remarkable phenomenon very characteristic of the Polyzoa is the formation of the *brown body*. Tentacles, gut, in fact the whole of the

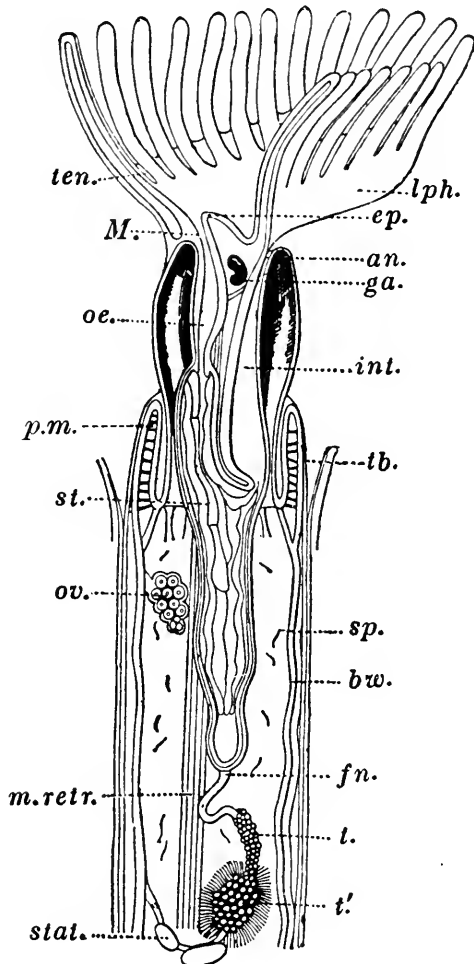

Fig. 416. View of right half of *Plumatella fungosa*, slightly diagrammatic. After Allman and Nitsche. *an.* anus; *bw.* body wall; *ep.* epistome; *fn.* funiculus; *ga.* ganglion; *int.* intestine; *lph.* lophophore; *M.* mouth; *m.retr.* retractor muscles of polypide; *oe.* oesophagus; *ov.* ovary; *p.m.* parietal muscles; *sp.* spermatozoa; *st.* stomach; *stat.* statoblast; *t.* testis; *t.'* the same, more mature; *tb.* wall of tube; *ten.* tentacles.

polypide, degenerates and forms a brown, compact mass. A new polypide is regenerated from the zoecium and the brown body often comes to lie in the new stomach and is evacuated through the anus. This periodical renewal of the individual is a normal process in most polyzoa. It was formerly explained as due to the accumulation of

excreta in the absence of specific excretory organs. It can, however, be hardly doubted that animals so small and with so great an area of epithelium in contact with the water are able to rid themselves of excreta in a simpler fashion.

As triploblastic metazoa with a centralized nervous system the Polyzoa possess a more efficient contractile mechanism than the hydroids. The most prominent feature of this is the parietal system of muscles which circle round the body wall. By their contraction the internal pressure is raised and the polypide protruded. The retractor muscle which runs from the lophophore to the opposite end of the zoecium has an opposite action to the parietal system. The Polyzoa are fascinating but exasperating objects under the microscope: they emerge with infinite caution from the zoecium and withdraw with incredible rapidity. With the lophophore a flexible part of the body wall is also invaginated and this is called the *tentacle sheath*.

The colonies of polyzoa differ greatly from those of hydrozoa in their habit and this is largely due to the absence of a connecting *coenosarc*. They are often incrusting like *Membranipora* and *Flustra* (hence the name of "sea mats"), with all their zooecia packed closely together in a single layer; they may also be slender or massive; in the latter case they have a superficial resemblance to the actinozoan corals. While the outer layer of the body wall is often horny or flexible it frequently becomes incrustated with calcium carbonate and thus rendered rigid.

In the incrusting Polyzoa, especially the Cheilostomata, the zooecia are rigid boxes, in contact with one another along all four sides and with the substratum at the bottom. These are usually strongly calcified and only the top of the box, the *frontal surface*, is flexible (Fig. 417 A, B). The parietal muscles, which in primitive polyzoa formed a continuous layer of circular muscles as in Chaetopoda, here form detached groups running from the side walls through the coelom to the frontal surface. When the muscles contract the latter is depressed and the lophophore is protruded. The process of calcification may extend to the frontal membrane and the mechanism of protrusion has then to be altered. In one large group of the Cheilostomata, there is a membranous diverticulum of the ectoderm under the calcareous frontal surface. This is called the *compensation sac* (Fig. 417 C); to its lower surface the parietal muscles are attached. When they contract and the tentacles are extruded the sac fills with water, and when they relax the sac empties.

Polymorphism is a feature of polyzoan as it is of hydrozoan colonies. Perhaps the most remarkable modifications are to be seen in the individuals known as *vibracula* and *avicularia* of such forms as *Bugula* (Figs. 418 A, 419). The vibracula are nothing more than long bristles

which are capable of movement and often act in concert throughout a part of the colony, sweeping backwards and forwards over the surface, preventing larvae and noxious material from settling on the colony. The avicularia resemble the head of a bird, possessing a movable mandible which is homologous with the operculum of an unmodified polyp, and this is provided with powerful muscles. The avicularia suddenly snap their jaws and enclose as in a vice small roving animals which touch them, particularly the larvae of incrusting animals. In the most primitive cases, an avicularium is found in the same position in the colony as an ordinary zoecium and may even possess a func-

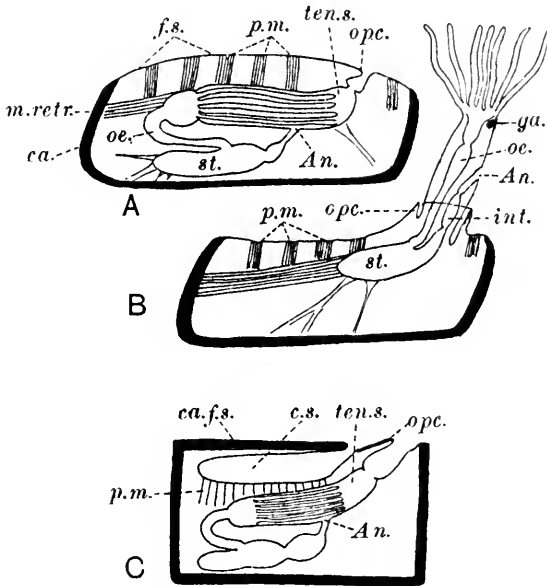

Fig. 417. Protrusion of the polypide in two types of cheilostomatous Polyzoa. *Membranipora*. After Harmer. A, With polypide retracted. B, With polypide protruded. C, A form with a calcareous frontal wall. *An.* anus; *ca.* calcareous cuticle of zoecium; *c.s.* compensation sac; *f.s.* frontal surface; *ga.* ganglion; *int.* intestine; *oe.* oesophagus; *opc.* operculum; *m.retr.* retractor muscle of polypide; *p.m.* parietal muscles; *st.* stomach; *ten.s.* tentacular sheath.

tional polypide. Further evolution led to displacement of the avicularia so that they became appendages of other zoecia, situated near the orifice. The two kinds of modified individuals thus perform tasks which in the Hydrozoa are allotted to the dactylozooids and in the Echinodermata to the pedicellariae.

Most of the Polyzoa are marine and are amongst the most familiar objects of the beach. A complete division, the Phylactolaemata, are freshwater. The marine forms possess a variety of free-swimming larvae, which are of the trochosphere type. In the Phylactolaemata, certain internal buds called *statoblasts* are formed from lens-shaped

masses of cells on the funiculus and are enclosed by chitinous shells. The polypides die down during the winter and in the spring the statoblasts germinate and produce new colonies.

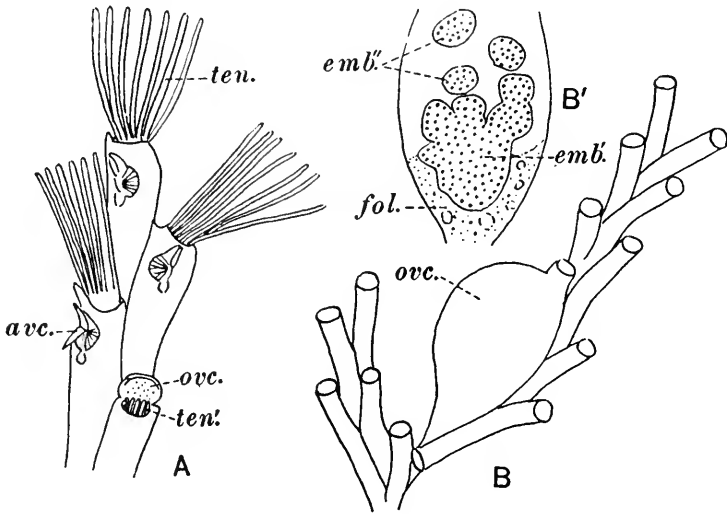

Fig. 418. Polymorphism of Polyzoa. After Harmer. A, *Bugula*. Portion of a colony. *avc.* avicularium; *ovc.* ovicell; tentacles of ordinary individuals, *ten.* protruded, *ten.'* retracted. *Crisia*. B, Portion of colony with ovicell (*ovc.*), surface view. B', Section through ovicell to show *emb.* primary embryo; *emb.''* secondary embryos; *fol.* follicular tissue.

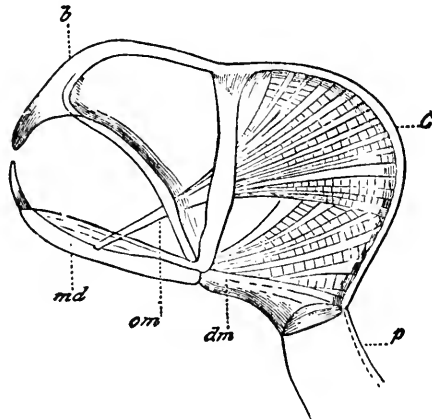

Fig. 419. An avicularium of *Bugula*. Magnified. From Hincks. *b.* beak; *C.* chamber representing the body cavity of the modified individual; *dm.* muscle which opens, *om.* muscle which closes the mandible on the beak; *md.* mandible, the operculum of the modified cell; *p.* stalk.

The free-swimming larvae may be assigned to the "trochosphere" type. In most cases they are much modified and only the larvae of the Entoprocta and the *Cyphonautes* larva among the Ectoprocta possess an alimentary canal and are able to feed. The *Cyphonautes* is,

then, the typical form (Fig. 420). It possesses a bivalve shell, each valve being triangular. The *apical organ* and *ciliated ring* (corresponding to the prototroch) can be seen projecting from between the valves, and in addition there are various characteristic organs, such as the *internal sac*, by which attachment is effected, prior to metamorphosis, and the *pyriform organ* of unknown function. On attachment the alimentary canal degenerates and the first individual of the colony is formed from a polypide bud consisting of an internal layer of

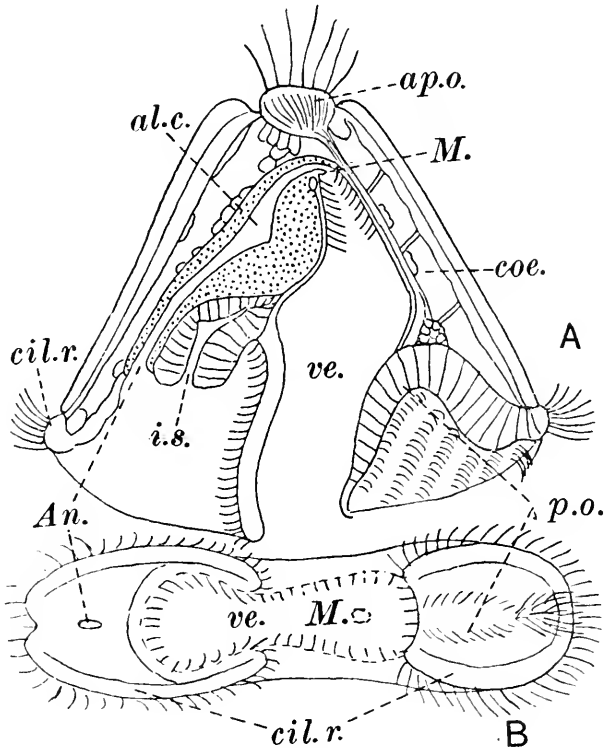

Fig. 420. *Cyphonautes* larva seen A, in side view, B, in oral view. *al.c.* alimentary canal; *An.* anus; *ap.o.* apical organ; *cil.r.* ciliated ring; *coe.* coelom; *i.s.* internal sac; *M.* mouth; *p.o.* pyriform organ; *ve.* vestibule.

ectoderm and an external of mesoderm. The ectoderm gives rise to the tentacles and tentacle sheath, the ganglion and the alimentary canal of the new polypide. A polypide bud which develops in exactly the same way is formed in the course of regeneration after the formation of a brown body. In the Endoprocta the larva fixes by its oral surface and undergoes metamorphosis into the adult in the course of which the mouth rotates upwards (compare Cirripedes, Fig. 256). The alimentary canal does not degenerate.

In the Cyclostomata it is probable that the fertilized egg never de-

velops into a single individual but always into a large number by what is known as *embryonic fission*, such as occurs in the parasitic Hymenoptera. A much modified zoecium, the so-called *ovicell*, serves as a brood pouch and in that the *primary embryo* is formed and attached to follicular tissue which supplies nourishment. Masses of cells are nipped off to form the *secondary embryos* each of which becomes a free-swimming larva.

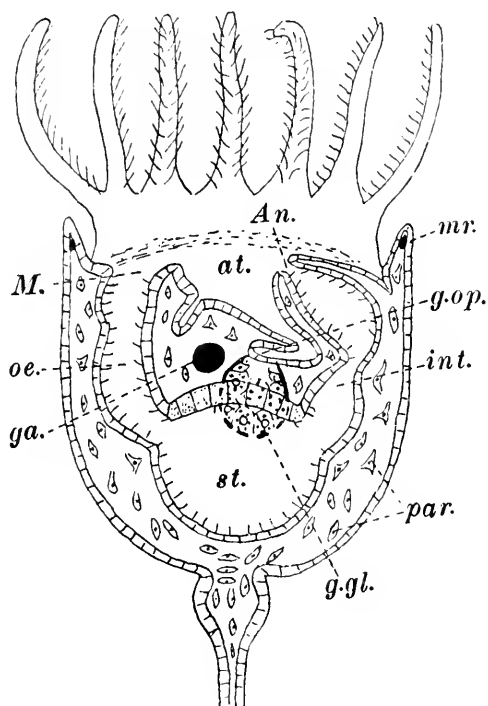

Fig. 421. Section through an endoproctous polyzoan. Altered from Ehlers. *An.* anus; *at.* atrium; *ga.* ganglion; *g.gl.* gonad; *g.op.* genital opening; *int.* intestine; *M.* mouth; *mr.* sphincter muscle of circular flap of body wall; *oe.* oesophagus; *par.* parenchyma; *st.* stomach.

### Classification

Class ENDOPROCTA (Fig. 421). Simple and archaic polyzoa in which the anus is situated inside the lophophore; without coelom, the space between gut and body wall being filled with parenchymatous tissue; with non-retractile tentacles which can be covered by a circular flap of the body wall, provided with a sphincter muscle; with a pair of protonephridia ending in flame cells, and gonads with a duct of their own; with a trochosphere larva. *Pedicellina*, *Loxosoma*.



Class ECTOPROCTA. Polyzoa with anus outside the lophophore; with a coelomic body cavity and a lophophore retractile into a tentacle sheath; without definite excretory organs.

Order Phylactolaemata. Freshwater Ectoprocta with a horseshoe-shaped lophophore, an epistome and statoblasts. *Plumatella*, *Cristatella*.

Order Gymnolaemata. Ectoprocta mostly marine, with a circular lophophore, without an epistome, with various types of trochosphere larva.

Suborder *Cyclostomata* with tubular zooecia, aperture without operculum, embryonic fission characteristic. *Crisia*.

Suborder *Cheilostomata*, with aperture of zooecium closed by an operculum. *Bugula*, *Flustra*, *Membranipora*.

Suborder *Ctenostomata* with aperture of zooecium closed by a folded membrane when the lophophore is retracted. *Alcyonidium*.

It is possible that the Endoprocta should be separated from the Ectoprocta as a distinct phylum and associated with forms like the rotifers.

## PHYLUM BRACHIOPODA

Coelomate unsegmented animals with a bivalve shell which is always attached, the valves being respectively dorsal and ventral in position; a complex ciliated circumoral organ, the *lophophore*, which maintains a circulation of water in the mantle cavity and leads food currents to the mouth.

The group contains only marine animals with a strong but superficial resemblance to the lamellibranchs among the Mollusca. In the Palaeozoic and Mesozoic it was more abundantly represented than the Mollusca, but at the present day it contains but few genera and species. Of the former *Terebratula* and *Waldheimia* (in which the valves meet to form a hinge and which belong to the Testicardines) are found in deep water off our own coasts. Examples of hingeless forms (Ecardines) are *Crania* which occurs abundantly in shallow water in the West of Ireland, and *Lingula*, which is not found in Britain, but in the tropics is sometimes exceedingly abundant in mud between tidemarks.

In such forms as *Waldheimia* and *Terebratula* (Figs. 422, 423), the ventral shell valve is larger than the dorsal and has a posterior beak or *umbo* perforated by a round aperture through which passes the *stalk* for attachment to a stone or rock. Each valve is secreted by a corresponding *mantle flap*, but in a way which differs from the corresponding process in the Mollusca. The mantle epithelium is produced

into minute papillae which traverse the substance of the shell. The cells, of which the papillae are composed, are often of a minutely

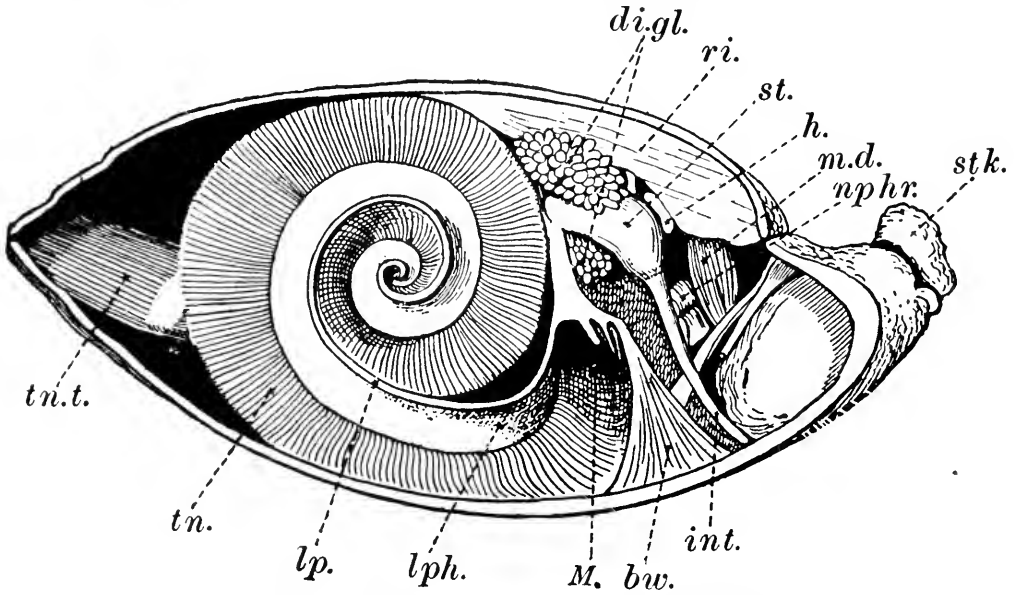

Fig. 422. Longitudinal section of *Magellania* (*Waldheimia*) slightly to the left of the middle line. After J. J. Lister. *bw.* body wall; *di.gl.* digestive gland; *h.* heart; *int.* intestine; *lp.* dorsal lip of *lph.* lophophore; *M.* mouth; *m.d.* muscles running from dorsal valve to ventral; *nphr.* nephrostome; *ri.* vertical ridge on dorsal valve; *st.* stomach; *stk.* stalk; *tn.* tentacles of lophophore; *tn.t.* terminal tentacles.

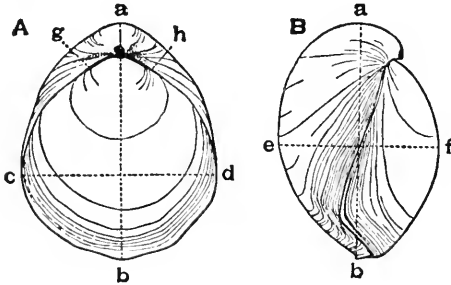

Fig. 423.

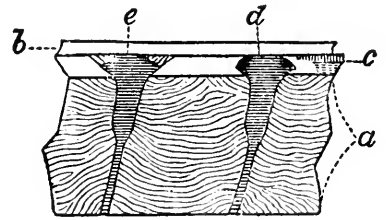

Fig. 424.

Fig. 423. *Terebratula semiglobosa*, Upper Chalk. A, Dorsal; B, Lateral view. *a*, posterior; *b*, anterior; *a-b*, length; *c-d*, breadth; *e-f*, thickness; *g-h*, hinge line,  $\times \frac{2}{3}$ . From Woods.

Fig. 424. Vertical section of shell of *Magellania* (*Waldheimia*) *flavescens*. *a*, prismatic layer; *b*, periostracum; *c*, outer calcareous layer; *d*, *e*, canals traversing the calcareous layers, containing the mantle papillae in life. After King.

branching type which resemble the bone corpuscles of vertebrates. It must be supposed that the papillae are concerned with the secretion and growth of the shell. Each valve (Fig. 424) is composed of an outer

layer of organic material (*periostracum*), under which is a thin layer of pure calcium carbonate and a thick inner *prismatic layer* composed mainly of calcareous but partly of organic material. The shell valves are opened and closed by a muscle system which is much more complicated than that of the lamellibranchs.

The hinge line is posterior and the mantle cavity is thus anterior. On opening the shells it is seen to be largely occupied by a complicated organ known as the *lophophore* of which a description follows. The *mouth* is placed in a transverse groove which is bounded, dorsally by a continuous lip and ventrally by a row of tentacles. The groove is enormously extended and its boundaries drawn out laterally into two *arms* which are often coiled spirally in these and other members of the phylum. The tentacles are long and may be protruded from the shell opening. The cilia on the tentacles and on the mantle sur-

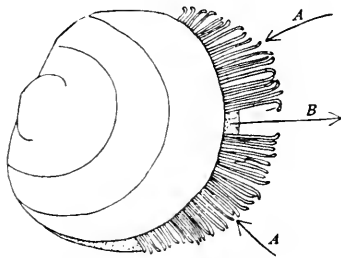

Fig. 425.

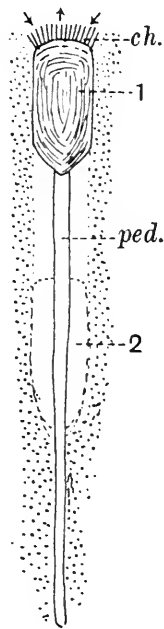

Fig. 426.

Fig. 425. *Crania* attached to a stone in the act of feeding with protruded tentacles. *AA*, ingoing, *B*, outgoing currents. After Orton.

Fig. 426. *Lingula* in positions of life in mud (indicated by stippling). 1, feeding position with peduncle (*ped.*) extended; 2, position when peduncle is contracted; *ch.* chaetae fringing entrance to shell. Arrows indicate currents.

faces produce two ingoing currents of water at the sides opposite the two arms of the lophophore; the outgoing current is central, between the two arms (Fig. 425). This ciliary mechanism is similar to that of the lamellibranch ctenidium. On each side the current of water is

directed between the tentacles of the lophophore, and the smaller and lighter particles suspended in it are sieved away and pass into the ciliated buccal groove and so towards the mouth. Heavier particles drop on to the ventral mantle lobe and are removed by outgoing ciliary currents and sudden clapping movements of the valves. When the ingoing currents have passed between the spirals of the lophophore they unite in the median dorsal part of the mantle cavity and become the outgoing current. The lophophore of Testicardines is supported by calcareous processes of the dorsal valve (the *brachial skeleton*) which assumes diverse and diagnostic forms in the different genera.

The mouth leads into a ciliated alimentary canal. There is a *stomach* into which opens the *digestive gland* composed of branching tubes in the cavity of which most of the digestion takes place. In *Waldheimia* the *intestine* ends blindly, but in *Lingula* and *Crania* there is an *anus*. The coelom is spacious and divided into a right and left half by a dorsoventral mesentery; transverse mesenteries also exist. It is prolonged into the lophophore and tentacles and into the mantle as the *pallial sinus*. A pair of segmental organs, short tubes with large nephrostomes, which also function as generative ducts, are situated in the coelom; their external openings are at the sides of the mouth. The generative organs are developments of the coelomic epithelium and eggs and sperm alike dehisce into the body cavity. The sexes are usually separate in the brachiopods.

The blood system is very little developed and consists only of a longitudinal vessel in the dorsal mesentery, in one region of which a contractile vesicle may be distinguished as the *heart*, and a number of vessels running forward to the mouth and backward to the mantle and generative organs; all end blindly.

The nervous system mainly consists of a supraoesophageal and a suboesophageal ganglion in front of and behind the mouth respectively, connected by circumoesophageal connectives. A nerve runs to each tentacle but no special sense organs are known.

*Lingula* (Figs. 426, 427 H) is a persistent form, which has lived since the earliest period of which we have an organic record, the Cambrian, in precisely the same stage of development, if we can judge from the hard parts. It lives in mud or sand and has a very long contractile stalk by which it roots itself and can withdraw from the surface. The opening of the shell is usually situated near the surface and the mantle secretes chaetae, like those of annelids, which project from the anterior border, and with the help of mucus and the mantle border form inhalant siphons at the side and an exhalant siphon in the middle. The shell valves are equal in size and horny in consistency, being composed of alternating layers of chitin and calcium phosphate.

*Crania* (Fig. 425) is a form without a stalk. The ventral valve is flat

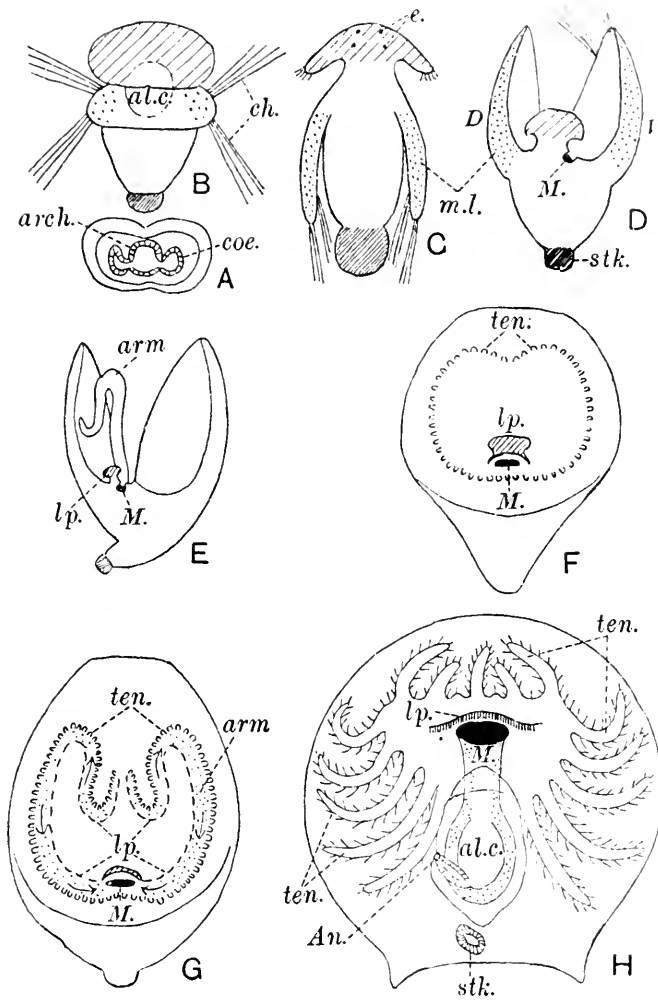

Fig. 427. Development of Brachiopoda. A, Section of larva at end of gastrulation showing the two coelomic pouches originating from the archenteron. B, Larva divided into three regions. C, Differentiation of the preoral region (oblique shading) and mantle lobes (stippling). D, Turning forward of mantle lobes and shrinking of preoral region. E, Appearance of the arms of the lophophore (one shown), preoral region now represented by lip. F, Internal view of dorsal valve showing the first stage in development of lophophore as a tentacular ring. G, Further development by extension of the dorsal lip and the division of the ring into two arms. The ciliated groove is indicated by stippling and the movement of food to the mouth by arrows. H, Larva of *Lingula*, corresponding to F. *al.c.* alimentary canal; *An.* anus; *arch.* archenteron; *arm*, one arm of the lophophore; *coe.* coelomic pouch; *lp.* dorsal lip; *M.* mouth; *m.l.* mantle lobe; *stk.* stalk; *ten.* tentacles; *ch.* chaetae; *e.* eyes. Altered from Delage and Herouard, after various authors.

and fixed by its whole surface to a rock; the dorsal valve is conical. The tentacles of the lophophore are protruded from the shell margin.

The Brachiopoda have free-swimming larvae which are usually divided into three regions, an anterior like the preoral region of the trochosphere, a median region in which the two lobes of the mantle are early produced, and a posterior one, hidden by the mantle lobe, which becomes the stalk (Fig. 427 B). The mantle lobes develop four bundles of chaetae (Fig. 427 C), and then turn forward to envelop the anterior region (Fig. 427 D). This now begins to develop the lophophore (Fig. 427 E, F, G) and shell valves form on the mantle lobes, while the posterior region grows into the stalk.

The coelom develops as a pair of pouches or a single pouch from the archenteron (Fig. 427 A). Though the presence of mantle lobes, the presence of chaetae and the resemblance of the larva to a trochosphere relates the Brachiopoda to the annelid-mollusc stock, there is no evidence of segmentation and they cannot come very close to the Annelida; but possibly are nearer to the Mollusca. On the other hand the enterocoelic development of the body cavity suggests affinities to the echinoderms and chordates.

### *Classification*

ECARDINES. Brachiopoda having shells with no hinge, no internal skeleton, and alimentary canal with an anus. *Lingula, Crania*.

TESTICARDINES. Brachiopoda having shells with hinge and internal skeleton, without anus. *Terebratula, Waldheimia*.

## PHYLUM CHAETOGNATHA

Coelomate animals with an elongated body divided into three regions, head, trunk and tail, and with lateral and caudal fins; head with a pair of eyes and two groups of chitinous teeth and jaws; cerebral ganglion and ventral ganglion (in the trunk) connected by circumoesophageal commissures; body wall containing a layer of longitudinal muscle cells of peculiar type arranged in four quadrants; alimentary canal straight; no localized excretory or respiratory organs or vascular system; hermaphrodite and cross-fertilizing; free-swimming larva.

The structure of an individual of this small and homogeneous group is shown in Fig. 428. Very little need be added to the definition. The muscles are of a primitive type, each elongated cell consisting of a core of unmodified cytoplasm and an outer shell ring of contractile substance; they have thus some resemblance to those of the nematodes. The chaetognaths are, however, capable of executing very rapid movement by suddenly contracting these longitudinal muscles and are able to pounce upon and capture their food, which

consists of diatoms, copepods and larvae of various kinds including fishes, in fact of most of their planktonic neighbours. These are seized by the hook-like jaws and swallowed whole.

The coelom is well developed with a distinct epithelial lining, and it is divided into two halves by a complete median and vertical mesentery, and also by two transverse septa into three chambers corresponding to the head, the trunk and the tail. Of these the head cavity is mainly occupied by the jaw muscles, while in the trunk and tail cavities are developed the ovaries and the testes respectively. The *ovaries* (Fig. 429) are elongated solid organs attached laterally to the body wall. Traversing each ovary on its inner side is a duct with a blind anterior end (*oviduct*); this encloses a second duct (*sperm pouch*) also with a blind anterior end and with indefinite walls, containing sperm derived from another animal. Both ducts open into a small bulblike *seminal receptacle* with an external aperture just in front of the second septum. The maturing egg is fertilized by a spermatozoon which passes into the ovary from the second duct and the zygote then passes through the wall of the oviduct and then to the exterior.

There is a solid *testis* in each half of the tail cavity and from these sperm mother cells are constantly budded off into the coelom, which is thus filled with sperm in all stages of development. The sperm passes into *vasa deferentia*, which are long tubes with a small internal opening behind the testes and a terminal dilatation, the *vesicula seminalis*, which opens to the exterior.

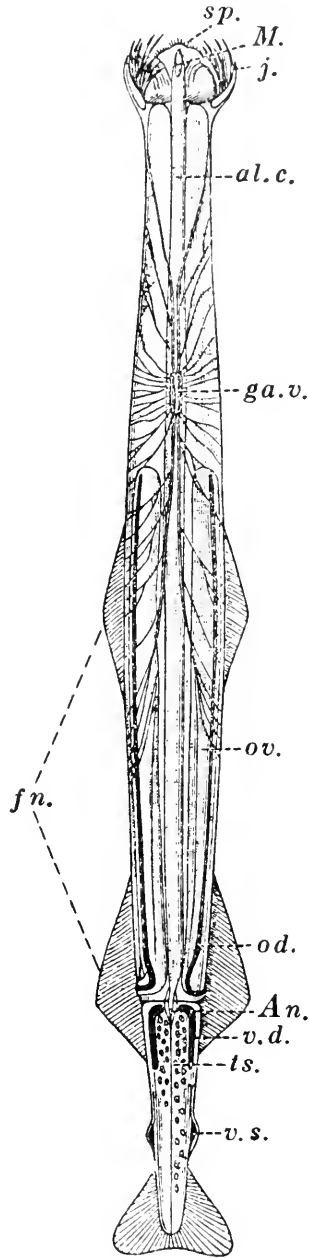

Fig. 428. *Sagitta hexaptera*. Ventral view,  $\times 3\frac{1}{2}$ . After O. Hertwig. *al.c.* alimentary canal; *An.* anus; *fn.* fins; *ga.v.* ventral ganglion; *j.* jaw; *M.* mouth; *od.* oviduct; *ov.* ovary; *sp.* spines; *ts.* testis; *v.d.* vas deferens; *v.s.* vesicula seminalis.

The eggs are laid in the sea and develop rapidly, passing through typical blastula and gastrula stages, after which the coelom is developed as a pair of anterolateral pouches of the archenteron (Fig. 430 A). After gastrulation two cells become very prominent. These are the mother cells of the generative organs. The primary coelomic cavity is

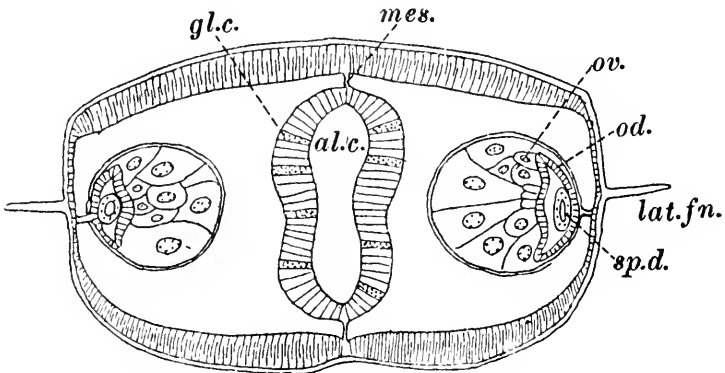

Fig. 429. Transverse section through middle of trunk of *Sagitta bipunctata*. After Burfield. *al.c.* alimentary canal (intestine); *gl.c.* gland cells (the cells which are not stippled are absorptive cells); *lat.fn.* lateral fin; *mes.* mesentery; *od.* oviduct; *ov.* ovary (covered by endothelium); *sp.d.* sperm pouch.

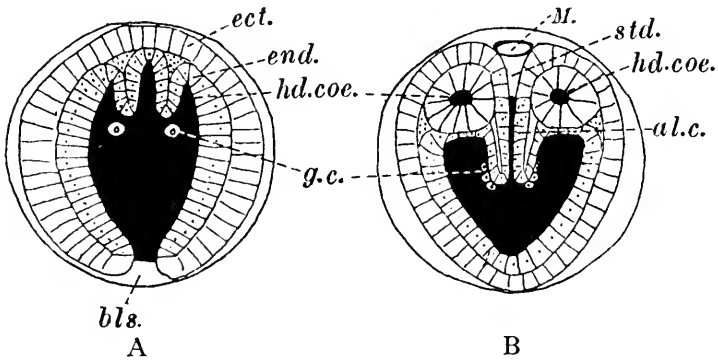

Fig. 430. Larvae of *Sagitta* showing formation of coelomic pouches from the archenteron. After Burfield. In A the pouches still open into the archenteron. In B the pouches forming the head coelom have completely separated off from the archenteron and the archenteric folds have grown back so as partly to separate off the second pair of pouches. *al.c.* alimentary canal; *bls.* blastopore; *ect.* ectoderm; *end.* endoderm; *g.c.* genital cells; *hd.coe.* head coelom; *M.* mouth; *std.* stomodaeum.

divided up first of all by the separation of the head cavity (Fig. 430 B) and at a later stage by a second septum between trunk and tail, which divides the genital cells, which now number four, into an anterior pair, the mother cells of the ovaries, and a posterior pair, those of the testes.



*Sagitta bipunctata* is one of the most characteristic and cosmopolitan members of the plankton and is a typical pelagic organism

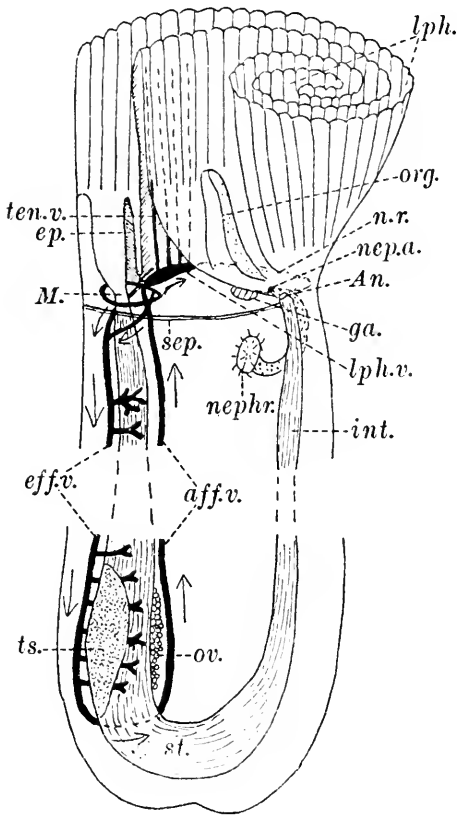

Fig. 431.

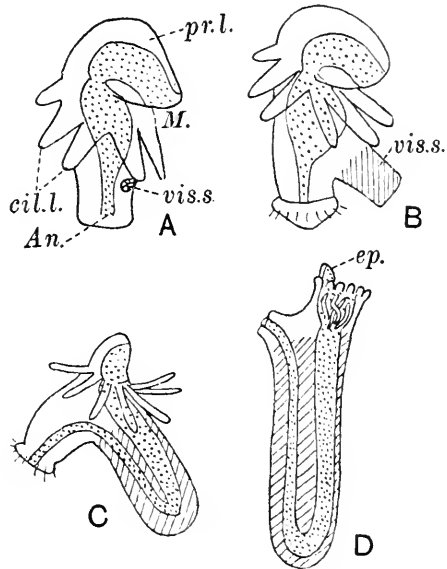

Fig. 432.

Fig. 431. *Phoronis*. Altered from Delage and Herouard. Sagittal section to show half the lophophore, the alimentary canal, one of the nephridia and most of the vascular system. The middle part of the section is omitted. *An.* anus; *aff.v.* afferent and *eff.v.* efferent vessels; *ep.* epistome; *ga.* ganglion; *int.* intestine; *lph.* lophophore; *lph.v.* lophophoral vessel giving off a branch to each tentacle; *nep.a.* nephridial aperture; *nephr.* nephrostome; *n.r.* nerve ring; *ov.* ovary; *org.* lophophoral organ (paired); *sep.* septum between two divisions of the coelom; *st.* stomach; *ts.* testis; *ten.v.* tentacular vessel.

Fig. 432. *Actinotrocha* and its metamorphosis into the adult. After various authors. A, *Actinotrocha* larva with ciliated lobes (*cil.l.*) and rudimentary visceral sac (*vis.s.*). B, Visceral sac evaginated. C, Growth of visceral sac and decrease in size of preoral lobe (*pr.l.*). D, Metamorphosis: mouth and anus approximate, preoral lobe becomes epistome (*ep.*), ciliated lobes of larva are seen in the mouth and new tentacles are beginning to grow. *An.* anus; *M.* mouth. Alimentary canal shown by stippling, visceral sac by oblique shading.

with its glassy transparent body and its powers of vertical migration; off the coast of California it lives at a depth of 15-20 fathoms during

the day and the greater part of the night, but at sunrise and sunset it rises to the surface, the light intensity and temperature there being at an optimum for the species at those times.

The Chaetognatha are a very early offshoot of the coelomate stock and cannot very well be compared to any other phylum. While it is tempting to liken the tripartite division of the coelom in Chaetognatha with that in echinoderms and protochordates, it must be realized that in *Sagitta* the two transverse septa arise at different times and for different reasons. There is, however, a true tail here which is elsewhere found only in the Chordata and the development of the body cavity is enterocoelic.)

The fossil, *Amiskwia*, occurring in the Cambrian, has been assigned to this group, but it appears to differ from the living forms in the absence of a septum between trunk and tail and in the presence of tentacles on the head.

### PHYLUM PHORONIDEA

Coelomate unsegmented animals, sedentary, hermaphrodite and tubicolous, with a horseshoe-shaped lophophore, an epistome, a vascular system with haemoglobin, and two excretory organs.

This is a very small group: the genus *Phoronis* (Fig. 431) includes most of the species. They are all marine animals, usually of inconsiderable size, and like all sedentary forms they have a free-swimming larva; this is called an Actinotrocha and it can be referred to the trochosphere type. It passes into the adult by a remarkable metamorphosis which is illustrated in Fig. 432.

*Phoronis* has a strong resemblance to a polyzoan like *Plumatella* but it differs from such a form in the presence of a vascular system and in other respects.

## THE PHYLUM ECHINODERMATA

Coelomate animals; bilaterally symmetrical as larvae, radially symmetrical as adults; whose dermis contains calcareous ossicles; whose coelom in the larva consists of three segments, and in the adult forms a perivisceral cavity and several intricate systems of spaces, one of the latter being a water vascular system which pushes out the surface of the body as a series of delicate tentacles, the podia or tube feet; whose vascular system is represented by strands of lacunar tissue; whose principal nervous system remains in contact with the ectoderm from which it arose (though it may be invaginated with the latter); which have no nephridia; and whose gonads discharge direct to the exterior by special ducts.

The group includes the animals familiarly known as starfishes (Asteroidea), brittle stars (Ophiuroidea), sea urchins (Echinoidea), sea cucumbers or trepangs (Holothuroidea), and sea lilies (Crinoidea) (Fig. 435).

The great unlikeness between these animals and all other coelomata is chiefly due to the radial symmetry which they assume at metamorphosis and which distorts all their systems of organs to its own mould. The radii, which are nearly always five in number, diverge from the mouth. The surface of the body upon which the mouth lies is known as the *oral* or *ambulacral*, the opposite surface as the *aboral* or *abambulacral*. The terms "ventral" and "dorsal" should not be applied to these surfaces, for they correspond not to the ventral and dorsal but to the left and right sides of the larva. The anus, if present, lies usually on the aboral side, but in the Crinoidea it lies on the oral side. The alimentary canal runs a straight or devious course from mouth to anus. The other systems consist each of a ring around the axis which passes through the mouth and the middle of the aboral side, and a tube or cord along each radius. The *radii* are constituted by the presence of the radial members of the various systems. The areas between the radii are known as *interradii*. Most of the systems lie close under the ambulacral surface, and the tube feet project from it, forming radial bands known as the *ambulacra*. In the Asteroidea and Crinoidea the tube feet of each ambulacrum stand on either side of an *ambulacral groove* at the bottom of which lies the highly nervous strip of epithelium which is the radial "nerve cord". In the other classes the ambulacral groove is roofed in, forming an *epineural canal* over the nerve cord. In the Asteroidea, Ophiuroidea and Crinoidea

the body is prolonged as *arms* in the direction of the radii, and the ambulacral and abambulacral surfaces are subequal in extent. On the other hand, in the spherical or cushion-shaped Echinoidea and the sausage-shaped Holothuroidea, the body is compact, and the ambulacral surface extends over most of it, leaving only in the Echinoidea a small, and in the Holothuroidea a minute, aboral area opposite to

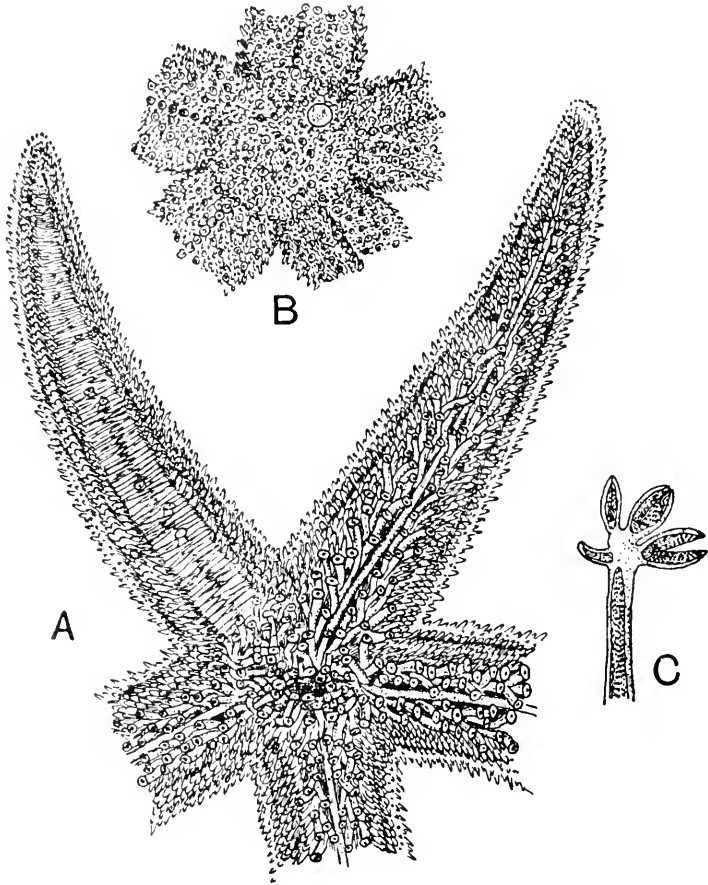

Fig. 433. *Asterias rubens*. A, Part of an oral view: in one of the arms shown the adambulacral spines have closed over the ambulacral groove; in the others, the radial nerve can be seen. B, An aboral view of the disc, showing the madreporite. C, The tip of an adambulacral spine, showing pedicellariae.

the mouth (Fig. 434). Externally and internally the symmetry is never quite perfect. At best the presence of the madreporite (see below), or of the anus, or of a genital opening, differentiates one of the interradial, and in some echinoids and holothurians a new and conspicuous bilateral symmetry has developed, and affects a number of organs.

In life, the Crinoidea are fastened to the ground by a stalk which arises from the middle of their aboral surface, and, though a few of them break free when they are adult, the mouth is directed upwards by them all. The other existing groups (Eleutherozoa) are free. In the Asteroidea, Ophiuroidea, and Echinoidea the mouth is directed downwards. The Holothuroidea apply one side of the long body to the ground, so that the mouth is directed horizontally (Fig. 435).

The *tube feet* (*podia*), whose function was perhaps originally a sensory or food-collecting one, are (or some of them are) in the

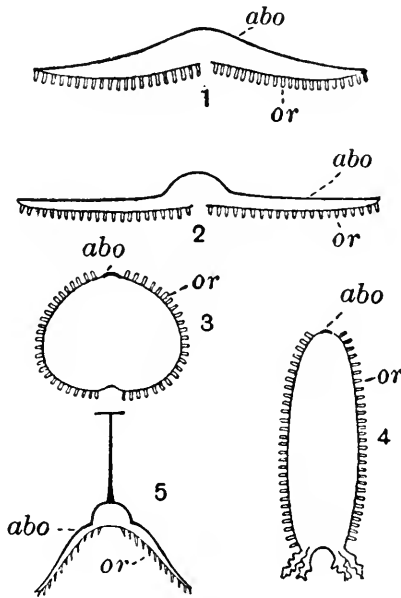

Fig. 434. Diagrams to show the relative extent of the oral and aboral surfaces, and to compare the form of body, in the several classes of the Echinodermata. All the diagrams are in the same morphological position. From Borradaile. 1, Asteroidea. 2, Ophiuroidea. 3, Echinoidea. 4, Holothuroidea. 5, Crinoidea. *abo*. aboral surface; *or*. oral surface.

Asteroidea, Echinoidea, and Holothuroidea adapted, by the presence of suckers at their ends, to walking. Probably they always subserve respiration, and in the "irregular" echinoids some of them are modified for this function. They may also be modified for seizing food. They are protruded and retracted by alterations of the pressure of the fluid within them by the action of the water vascular system (see below).

The *epidermis* is usually ciliated, but not in ophiuroids or, except in the ambulacral groove, in crinoids. Usually, also, it contains gland cells and sense cells, the latter with their bases prolonged into fibrils which enter a plexus, formed by them and by branched nerve cells,

among the bases of the epithelial cells—a nerve-net. The characteristic *ossicles* of the dermis may be scattered, so as merely to impart a leathery consistency to the skin, or united by muscles as a skeleton, or firmly apposed so as to constitute an armour. Some of them usually project as *spines*, over which the epidermis may presently wear away. *Pedicellariae* (Figs. 433 C, 449) are sets of two or three spines arranged to bite together as pincers. They are of various types, often complicated, but only occur in asteroids and echinoids.

The *alimentary canal* differs greatly in the several groups. It is axial in the Asteroidea and Ophiuroidea, coiled in the other classes. It possesses various diverticula in different cases, but not large glands

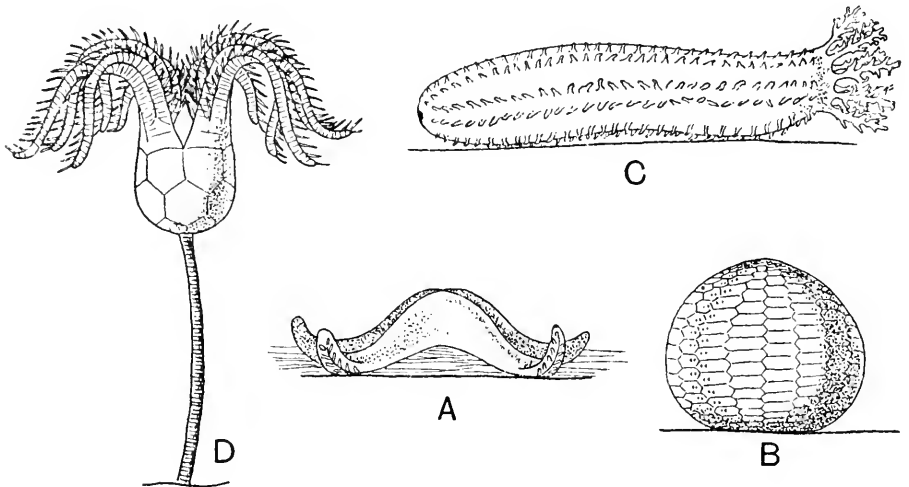

Fig. 435. Representatives of classes of the Echinodermata, in their natural positions. A, A starfish (Asteroidea). B, The shell of a sea urchin (Echinoidea). C, A holothurian. D, A sea lily (Crinoidea).

like those which are common in other phyla. The anus is lacking in the Ophiuroidea and a few asteroids, and when present is more or less excentric except in the Holothuroidea.

The *coelom* of the adult is present as several distinct systems of spaces, of which the following are the most important: (1) the large *perivisceral cavity* in which lie all the principal viscera; (2) the *perihæmal system*, consisting of a *radial vessel* (in asteroids divided longitudinally by a vertical septum in which lies the principal “blood” strand) along each radius, and a *ring vessel* around the mouth, all lying immediately above the main nerve cords; (3) the *aboral sinus system* enclosing the genital rachis and gonads (see below); (4) the *water vascular system* (Fig. 436), which lies above the perihæmal system, and consists of a *ring* around the mouth, a tube, known as the *stone canal* because its wall is frequently calcified, leading to an open-

ing known as the *madreporite* (see below), a *radial vessel* along each radius, and *lateral branches* from the radial vessels to the tube feet, which, when the latter are used for walking, possess swellings known as *ampullae*, by whose contractions the feet are extended; (5) the *madreporic vesicle*, an inconspicuous cavity of morphological importance (see below); (6) the *axial sinus*. This is a space which varies greatly in its development. It is conspicuous in the Asterozoa, small in the Echinozoa and Ophiurozoa, very small in the Holothurozoa, merged in the perivisceral cavity in the Crinozoa. It communicates with the exterior (or, as will be seen, in most holothurians with the coelom) by a pore or set of pores situated in one of the interradial spaces. This opening constitutes the *madreporite*. The stone canal opens into the axial sinus just below the madreporite, and so the latter serves as the opening of the stone canal. In the Asterozoa and Echinozoa the madreporite is a conspicuous structure on the aboral side, pierced by many pores. In the Ophiurozoa it is on the oral side, and has one pore, or only a few pores. In most of the Holothurozoa it becomes detached, in the course of development, with its tiny axial sinus, from the body wall, and hangs into the perivisceral cavity, with which, instead of with the exterior, it now makes communication, by a number of pores. In this group, by meristic repetition, there may be several or many stone canals, each with an "internal madreporite". In the Crinozoa, the stone canals, of which there are several, end each by a single opening into the perivisceral cavity, and the latter communicates by a number of pores with the exterior.

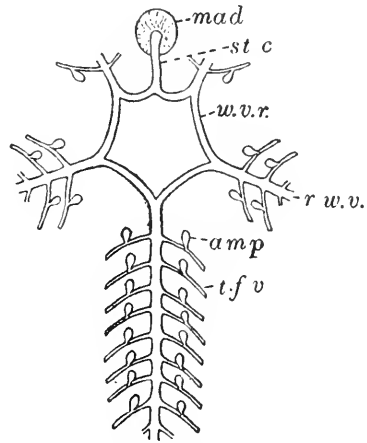

Fig. 436. A diagram of the water vascular system of a starfish. From Borradaile. *amp.* ampulla; *mad.* madreporite; *r.w.v.* radial water vessel; *st.c.* stone canal; *t.f.v.* vessel of tube foot; *w.v.r.* water vascular ring.

In the bilateral larva (*Dipleurula*), the coelom (Fig. 437) is present as three pairs of sacs, of which the first is preoral. The second pair is connected by a passage with the first: the third is independent. In outline, the relation between these sacs or segments of the larval coelom and the coelomic spaces of the adult is as follows: the perivisceral cavity of the adult is formed by the fusion of the main portions of the hinder pair; the aboral sinus system becomes separated from the perivisceral cavity; the perihæmal system arises as outgrowths from the left hinder cavity (in some cases it receives a component also from the left anterior cavity); the water vascular system ("hydro-

coele”) is formed by the transformation of the left second cavity (the right second cavity disappearing); the axial sinus is the persistent left anterior cavity, its madreporite being derived from a “water pore” which puts that cavity into communication with the exterior. The opening of the stone canal into the axial sinus is the remains of the connection between the left anterior cavity and the left second cavity, which latter, as we have seen, becomes the water vascular system. The madreporic vesicle is budded off from the right anterior cavity (the rest of which disappears); in the larva this vesicle pulsates; it probably represents the pericardium of the Hemichorda, which retains its contractile function in the adult (pp. 667, 668).

All echinoderms except the Holothuroidea possess a peculiar structure known as the *axial organ*, composed of connective and lacunar (“vascular”) tissue, with cells derived from the genital rudi-

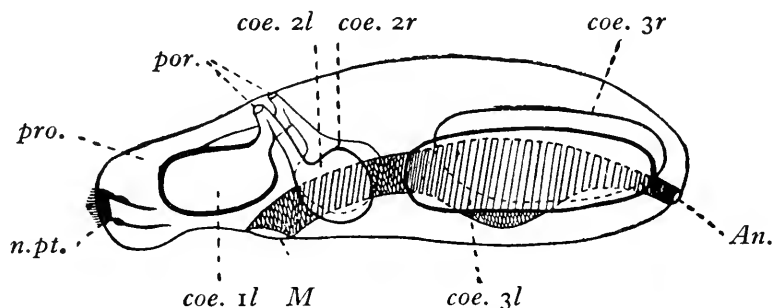

Fig. 437. A diagram of the arrangement of the coelom in the ideal *Dipleurula*. From Sedgwick. *An.* anus; *coe. 1l.* left anterior coelom; *coe. 2l.* left middle coelom; *coe. 2r.* right middle coelom; *coe. 3l.* left hinder coelom; *coe. 3r.* right hinder coelom; *M.* mouth; *n.pt.* neural plate on apex of preoral lobe; *por.* water pores (only the left of these normally appears; it becomes the madreporite); *pro.* preoral lobe or prostomium.

ment, known as the *genital stolon*. The axial organ adjoins the axial sinus where the latter is present; in the Crinoidea it lies in the axis of the body. Its function is unknown; it has been regarded as a heart for the lacunar system on account of contractions which it is said to perform, and as an organ of excretion because in echinoids it takes up carmine injected into the body cavity. Of *excretion* in the echinoderms little is known. It appears to be performed by the wandering out, through the walls of the gills, of amoeboid cells laden with granules of excreta, by the organs of respiration, and by the intestine, but no constant and conspicuous organs subserve it alone. There are no nephridia. The nitrogenous excreta consist largely of ammonia compounds and contain practically no urates.

*Respiration* is performed through a variety of structures, some of which expose the coelomic fluid to the external water, while others



carry the water into the body and expose it to the fluid in the coelom. To the first class belong the podia, and the "gills" of asteroids and echinoids; to the second belong the "genital bursae" of ophiuroids and the respiratory trees of holothurians.

The *vascular system* of other animals is represented in the Echinodermata by a system of strands of a peculiar *lacunar tissue*, containing intercommunicating spaces which have no epithelioid lining. Ultimately, this system is of the same nature as the blood vessels (haemocoel) of other animals, since both are systems of spaces derived from the blastocoel and filled by a fluid matrix containing free cells; but in appearance, and probably in the mode of its functioning, it is very different. A ring of lacunar tissue surrounds the mouth, lying in or immediately above the perihæmal ring and giving off in each radius a strand or "vessel" which similarly lies above the radial perihæmal canal. Another portion of the system lies in the axial organ and connects the oral ring with an aboral ring, which accompanies the genital rachis (see below) and sends strands to the gonads. In the Echinoidea and Holothuroidea two strong "dorsal" and "ventral" vessels from the oral ring accompany the alimentary canal, running on opposite sides of that organ and giving off a plexus of branches which ramify on it, and in holothurians also in a perforated fold of the peritoneum. A "vascular" plexus is also present on the alimentary canals of other groups. Contractions are said to have been observed in parts of the system, but it is very doubtful whether anything in the nature of a regular circulation takes place in it, though it probably maintains communication by diffusion between various parts of the body.

With rare exceptions, the sexes of echinoderms are separate. The *genital organs* are remarkable for their simplicity. They possess neither organs of copulation, nor accessory glands, nor receptacles for the retention of ova, nor a reservoir for the storage of sperm in either sex, and they discharge direct to the exterior and not, as is usual in coelomate animals, through the coelom or through ducts proper to that cavity. Nevertheless they arise in ontogeny from the coelomic wall. The genital system consists, except in the Holothuroidea, of the *genital stolon*, a collection of cells in the axial organ; the *genital rachis*, a ring connected with the stolon (aborally in the Asteroidea, Ophiuroidea, and Echinoidea, orally in the Crinoidea); the *gonads* proper, which are sacs or tubes, often branched, borne upon long or short branches of the rachis and varying in number in the different groups; and the short *ducts*, lacking in the Crinoidea. In the Holothuroidea there is only one gonad, which lies in the "dorsal" interradius and has a duct in the dorsal mesentery and a vestigial stolon lying upon the duct, but no rachis.

The *nervous system* consists of networks of fibrils and nerve cells

underlying various epithelia, though in places denser and, by the parallel arrangement of the fibrils, modified into "nerves". It is remarkable not only for remaining in this primitive condition, but for being partly derived from mesodermal epithelia. It is in three parts: (1) the *ectoneural system* underlying the whole ectoderm as a plexus (see p. 625) and thickened (*a*) along each ambulacrum as a *radial nerve*, (*b*) around the mouth as a *nerve ring*, which connects and has been found by experiment to co-ordinate the radial nerves (*a* and *b* are, with a strip of epithelium, removed from the surface of the body save in asteroids and crinoids), (*c*) as branch *nerves* to such structures as tube feet, spines, etc.; (2) the *deep oral system* underlying the mesodermal epithelium of the perihæmal vessels and having a distribution similar to that of the ectoneural system but less extensive than the latter and in particular defective in the Echinoidea; (3) the *aboral or apical system*, also mesodermal in origin, developed from the peritoneum of the aboral body wall. This system is best developed in the Crinoidea, where it is removed from the general peritoneum and enclosed in the ossicles. Here it has the form of a nerve along each arm and a complex central station in the "chambered organ" (see below). In the Asteroidea it runs as a cord above the peritoneum of each arm, the cords meeting in the middle. In the Ophiuroidea and Echinoidea it is a ring in the aboral sinus. It is not found in the Holothuroidea. The mesodermal nervous systems are principally motor, innervating the muscles which move the internal skeleton: through connecting fibres they receive stimuli from the ectoneural system.

The Echinodermata are poorly provided with *sense organs*. There is a general sensitiveness of the epithelium of the body, at least to tactile stimuli, which is heightened in the podia and in the *terminal tentacle* which stands at the end of each radial water vessel in the Asteroidea, Ophiuroidea, and Echinoidea. The olfactory sense is perhaps also located in the podia or in some of them, especially in those that are situated around the mouth and in the Holothuroidea are developed into tentacles. An eye-spot is situated at the base of each terminal tentacle in the Asteroidea, and certain holothurians possess statocysts in the skin.

All echinoderms are marine in habitat. Few of them are pelagic: none are parasitic. Only the Crinoidea are fixed, and some of these are only temporarily so.

The majority of members of the phylum have free, pelagic *larvæ*; though some, as *Asterina*, pass a considerable time in the egg membrane and have larvae which are not pelagic; and a few, chiefly polar or deep-sea species, keep the young in brood pouches until they have the adult form. The eggs of the species which possess pelagic larvae

are small; the others larger and more yolky in proportion to the lateness of the stage at which they are set free. Fertilization takes place in the sea or in brood pouches. Cleavage (radial, Fig. 196, 1) is total and forms a hollow, one-layered blastula (Fig. 438A). This, by invagination or unipolar ingrowth, forms a gastrula with a wide blastocoel into which typical mesenchyme cells wander from the wall of

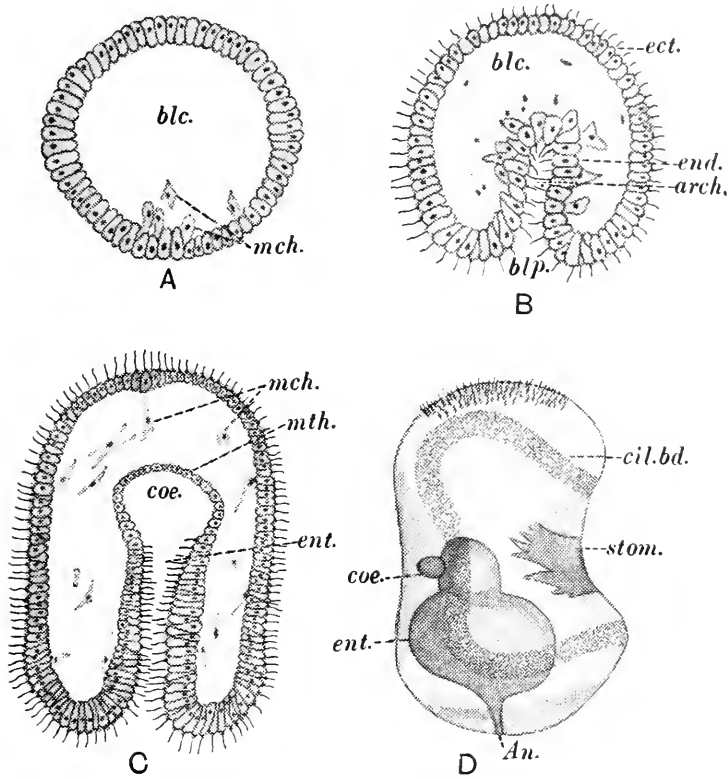

Fig. 438. Stages in the development of *Asterias vulgaris*. After Field. A, Section of blastula. B, Section of gastrula. C, Section of older gastrula. D, Three days' larva from the right-hand side. *An.* anus; *arch.* archenteron; *blc.* blastocoel; *blp.* blastopore; *cil.bd.* ciliary band; *coe.* rudiment of coelom; *ect.* ectoderm; *end.* endoderm; *ent.* enteron; *mch.* mesenchyme; *mth.* mesothelium; *stom.* stomodaeum.

the archenteron. The blastopore becomes the anus, and the mouth is formed by the breaking through of a stomodaeum. Meanwhile the archenteron has budded off, at the anterior end, a vesicle which, by processes that differ in detail in different cases, will give rise to the three segments of the coelom described above (p. 627). The future ventral side of the larva becomes concave. The larva is now known as the *Dipleurula*. The cilia which uniformly covered the blastula become sparse over most of the body but, except in the Crinoidea, grow

stronger and more numerous in a *longitudinal band* around the ventral concavity. This band is the organ of locomotion. Growing more rapidly than the rest of the ectoderm, it becomes thrown into folds, the *larval arms* (which have nothing to do with the arms of adult echinoderms), whose length and arrangement differ so as to characterize a special type of larva in each class (Fig. 439). In the *Auricularia* larva of the Holothuroidea the body is elongate and the band lengthens fore and aft and outlines a strong *preoral lobe*. The *Bipinnaria* of the Asteroidea resembles the *Auricularia* in general features, but in it the

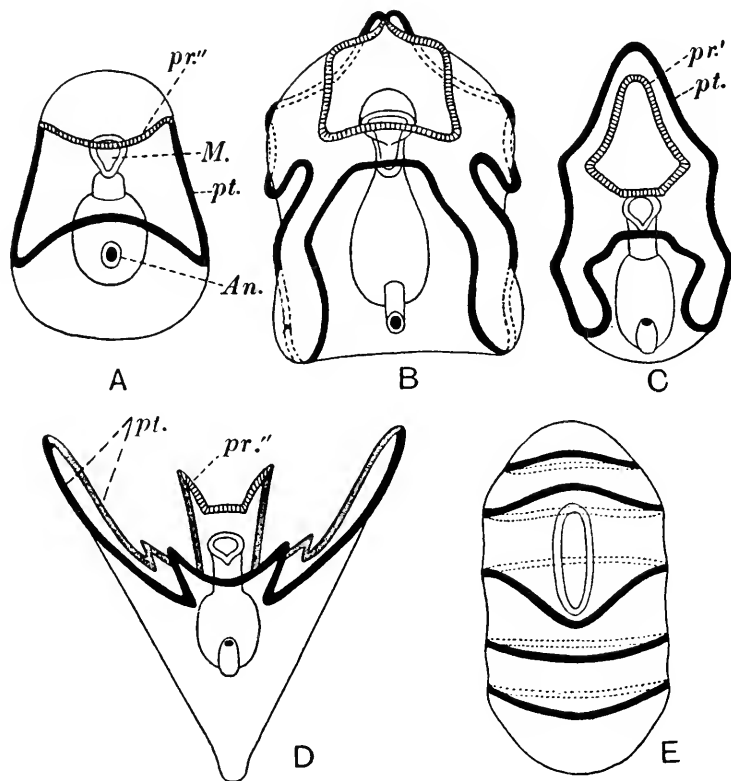

Fig. 439. Diagrams of echinoderm larvae. The postoral part of the early ciliated band is drawn heavily (except where remote), the preoral part cross-hatched. A, Early stage with simple continuous band. B, *Auricularia*. C, *Bipinnaria*. D, *Pluteus*. E, Crinoid larva. An. anus; M. mouth; pr.' preoral band; pr.'' corresponding part of continuous band; pt. postoral band.

border of the preoral lobe separates completely from the rest of the longitudinal band. In the *Plutei* of the Ophiuroidea and Echinoidea the band remains continuous, but forms only a small preoral lobe, and the postanal region of the body develops greatly, while the slender arms are supported by calcareous rods. The *Pluteus* of the Ophiuroidea (*Ophiopluteus*) has a different appearance from that of the sea urchins

(*Echinopluteus*), owing to the fact that the former of these larvae has fewer arms than the latter and that in it the arms known as the "posterolateral arms" are the largest and are directed forwards, whereas these arms, if they are present in the *Echinopluteus*, are there small and directed outwards or backwards. The larva of the Crinoidea has no longitudinal band, but five rings of strong cilia around the body. In the development of the Holothuroidea the *Auricularia* is succeeded by a stage known as the *pupa*, in which the longitudinal band breaks up and rearranges itself into a series of five transverse rings somewhat resembling those of the crinoid larva. The *Bipinnaria* of the Asteroidea is succeeded by a *Brachiolaria* which differs from it in possessing in the preoral region three processes by which the larva can hold fast to objects.

The larvae become transformed into adults by a *metamorphosis* which differs in the several classes. In all it involves an alteration of the position of the mouth, which in groups other than the Crinoidea is removed to the left side, and in the Crinoidea to the posterior end, taking with it the coelomic cavities of the left side. The fate of the several divisions of the larval coelom has been described above (p. 627). In the Crinoidea and Asteroidea the larva becomes fixed by the preoral lobe at the time of metamorphosis, a *fixation disc* developing for the purpose. In crinoids the fixation persists, at least until the adult is completely formed. In starfishes it is only temporary.

The fixation of the sea lilies, and the fact that starfishes are fixed when the bilateral symmetry of the larva changes to the radial symmetry of the adult, are interesting facts in view of the fixation which is general in the other great group of radially symmetrical animals, the Coelenterata. Radial symmetry is essentially the symmetry of a sessile animal, which is in the same relation with its surroundings on all sides, whereas bilateral symmetry is that of a travelling animal, which needs differentiation not only of the upper side from that which faces the ground, but also of the fore from the hind end. It is likely that at one time all echinoderms were fixed, and that those which are now free retain the radial symmetry of their sessile ancestors. This supposition is supported by the fact that the earliest known fossil members of the phylum were fixed.

For the rest, the Dipleurula and its metamorphosis suggest that the early sessile echinoderms were descended from a free, bilateral ancestor; and the close resemblance between the *Auricularia* and the *Tornaria* larva of *Balanoglossus*, together with the history of the coelom (see p. 660), and the nature of the nervous system, indicate an affinity between that ancestor and the Enteropneusta.

## Class ASTEROIDEA

Star-shaped or pentagonal Echinodermata; whose arms contain caeca of the alimentary canal, and are usually not sharply marked off from the disc; which have an aboral madreporite; open ambulacral grooves; and usually both suckers on the tube feet, and pedicellariae.

The *ossicles* (Fig. 440) of the body wall of a starfish may, as in the familiar *Asterias*, constitute a toughening meshwork, or may have the form of more closely set plates, but are not united to form a continuous shell. Along the sides of the arms run two rows of strong pieces, the *supero- and infero-marginal ossicles*, which are hidden in *Asterias* but in many genera appear on the surface. The ossicles bear *spines*, which vary much in size and shape and arrangement, being often longer than the stumpy structures on the back of *Asterias*. Around and between the spines are usually *pedicellariae* of various

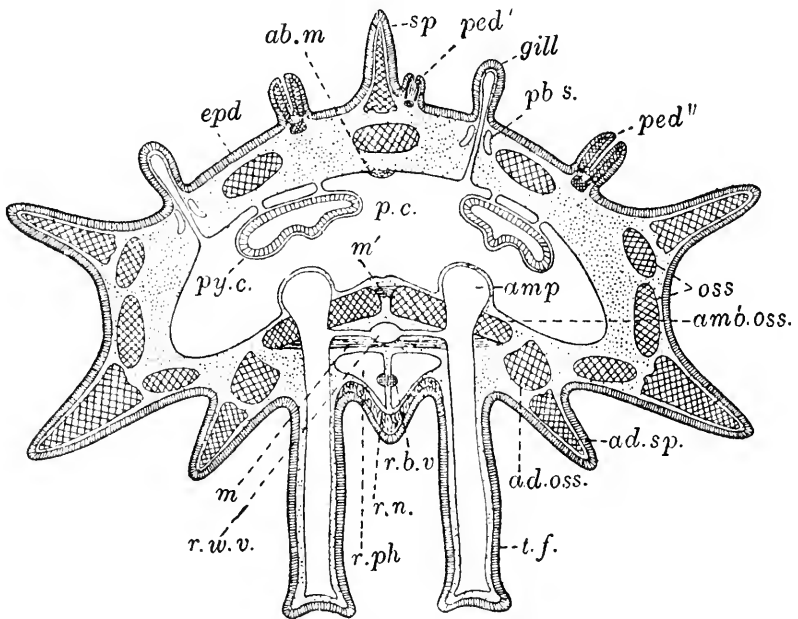

Fig. 440. A diagram of a transverse section of the arm of a starfish. From Borradaile. *ab.m.* muscle which straightens the arm; *ad.oss.* adambulacral ossicle; *ad.sp.* adambulacral spine; *amb.oss.* ambulacral ossicle; *amp.* ampulla of tube foot; *m.* muscle which opens the ambulacral groove; *ped.'* one of the small pedicellariae with crossed jaw ossicles; *ped.''* one of the large pedicellariae whose jaw ossicles are not crossed; *r.b.v.* radial "blood vessel"; *t.f.* tube foot. Other letters as in Fig. 441.

kinds, the most perfect of which is the *forcipulate*, found in *Asterias*, which has a basal ossicle: its jaws may be *straight* or *crossed*. Over interspaces between the ossicles arise delicate, hollow outgrowths, the *gills*, into which the perivisceral cavity is prolonged. Above each

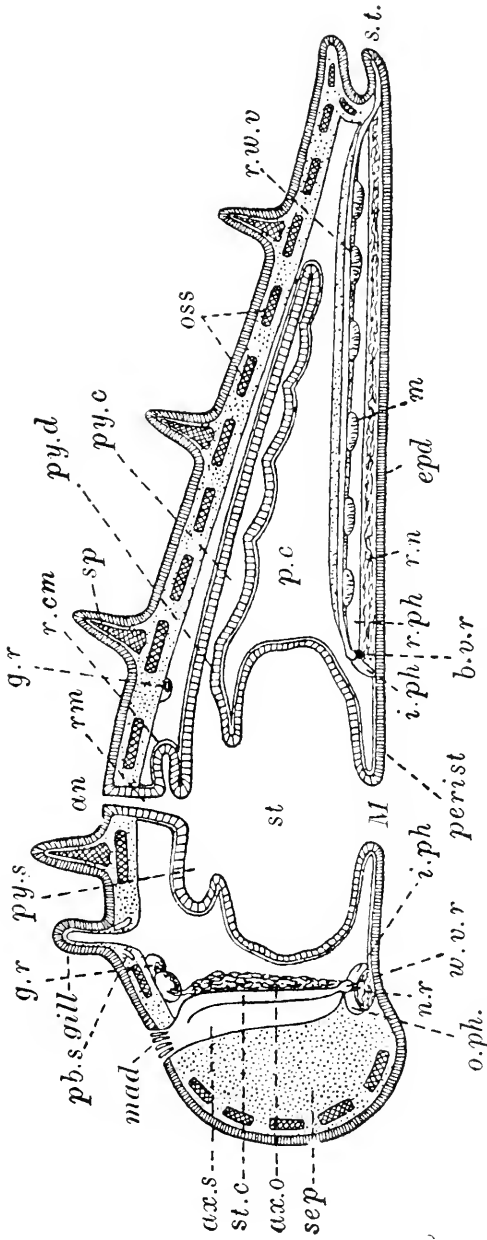

Fig. 441. A diagram of a section of a starfish passing through the madreporic interradius and along the opposite arm, a little to one side of the septum of the radial peribranchial vessel. From Borradaile. *an.* anus; *ax.o.* axial organ; *ax.s.* axial sinus; *b.v.r.* so-called blood vascular ring; *epd.* epidermis; *gill*, *g.r.* genital rachis, in an aboral coelomic ring sinus; *i.ph.* inner peribranchial groove; *M.* muscle; *m.* one of the muscles that narrow the ambulacral groove; *mad.* madreporite; *n.r.* nerve ring; *o.ph.* outer peribranchial ring; *oss.* ossicles; *p.c.* perivisceral cavity; *pb.s.* peribranchial sinus; *perist.* peristome; *py.c.* pyloric caecum; *py.d.* pyloric duct; *py.s.* pyloric sac; *r.cm.* radial coelomic ring; *rm.* rectum; *r.n.* radial nerve; *r.ph.* radial peribranchial groove; *r.w.v.* radial water vessel; *s.t.* stomach; *st.c.* stone canal; *w.v.r.* water vascular ring.

ambulacral groove runs a double row of large, transversely placed, *ambulacral ossicles*, movable upon one another by muscles. Each has a smaller *adambulacral ossicle* at its outer end. *Adambulacral spines* stand on the adambulacral ossicles. In *Asterias* they are long, and bear groups of large pedicellariae of the kind with uncrossed jaws. They can be turned inwards to protect the ambulacral grooves.

The *mouth* leads through a short *oesophagus* (Fig. 441) into a large sac-like *stomach*, with two retractor muscles in each arm. Above is a five-sided *pyloric sac*, from each angle of which, separately or, as in *Asterias*, by a short common duct, arises a pair of branched *pyloric caeca*, which are slung, each by a double mesentery, from the roof

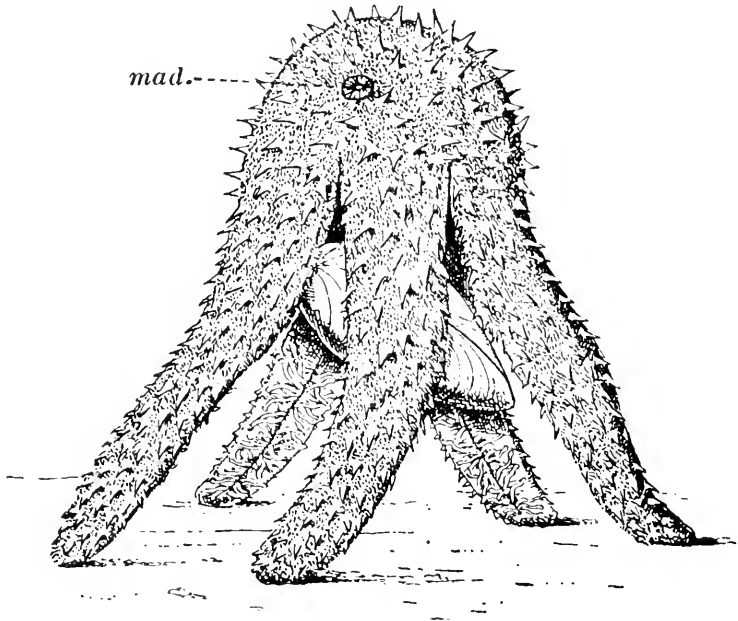

Fig. 442. *Echinaster sentus*, in the act of devouring a mussel.  
From Shipley and MacBride. *mad.* madreporic plate.

of an arm: the epithelium of these secretes the digestive ferments and stores nutriment. From the pyloric sac a short, conical *rectum*, bearing in *Asterias* two glandular *rectal caeca*, rises to the anus, which is slightly excentric, in the interradius which is next, clockwise, after that of the madreporite. Animals of any kind that can be seized serve for *food*, and usually the stomach can be extruded to envelop and digest prey which are too large to be swallowed. Some species clasp bivalves with their arms (Fig. 442) and pull them open with the tube feet so that the everted stomach can be applied to the soft parts of the mollusc.

In each interradius a stiff septum projects into the perivisceral



cavity between the arms. To the septum in the interradius of the madreporite is attached a sac, the axial sinus, and into this, so as to appear to lie in it, project the axial organ and the stone canal, whose wall is calcified and infolded so as to increase its surface. Orally, the stone canal joins the water vascular ring, which bears nine small

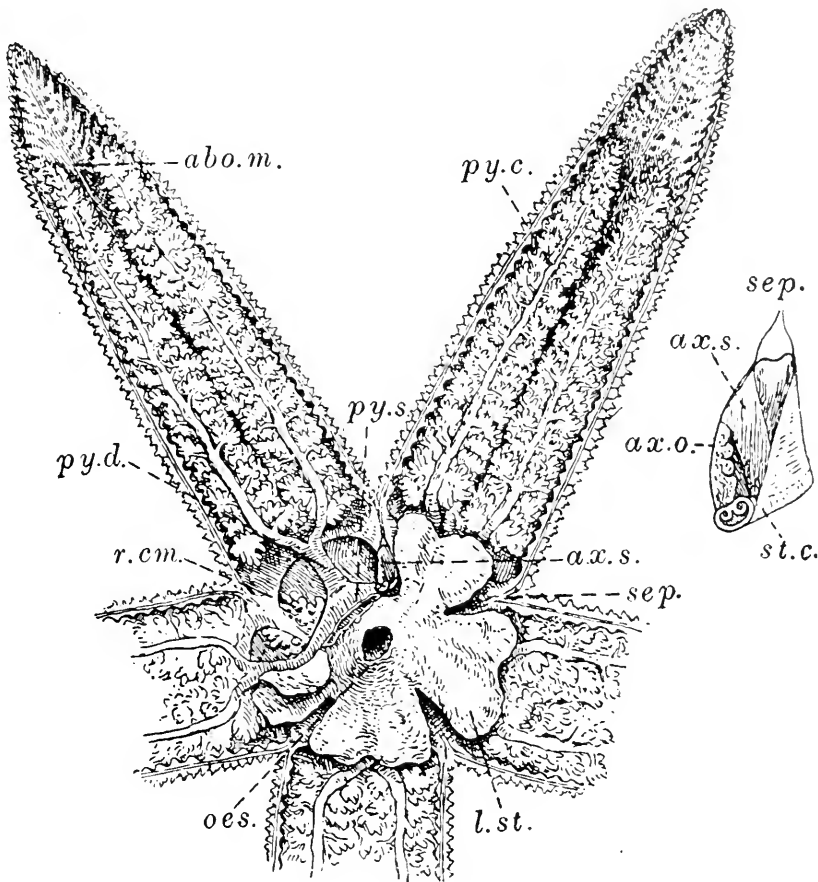

Fig. 443. Part of the aboral half of a starfish (*Asterias rubens*) removed, with the alimentary canal, from the rest of the body, and viewed from within. One lobe of the stomach has been cut away, and another partly turned back. The detached figure represents an enlarged view of the axial sinus and adjoining structures. From Borradaile. *abo.m.* aboral muscle; *ax.o.* axial organ; *ax.s.* axial sinus; *l.st.* one of the lobes of the stomach; *oes.* oesophagus; *py.c.* pyloric caecum; *py.d.* pyloric duct; *py.s.* pyloric sac; *r.cm.* rectal caecum; *sep.* septum; *st.c.* stone canal.

*Tiedemann's bodies*, of gland-like structure, and often, but not in *Asterias*, several stalked sacs, the *Polian vesicles*. The radial water vessel of each arm lies under the ambulacral ossicles, and between them and the radial nerve is the perihæmal vessel, divided by a septum in which runs the "blood vessel". The *gonads* are ten in

number, shaped like bunches of grapes and varying in size with the season. They are attached to the body wall by their ducts, which open one on each side at the base of each arm.

*Asterias* (Figs. 433, 436, 440, 441, 443). A typical member of the class. Its principal features have been mentioned above. British.

*Astropecten*. Without anus; without suckers on the tube feet; and with conspicuous marginal ossicles. Lives on a bottom of hard sand, into which it burrows, and upon which its tube feet are adapted to walk. British.

*Asterina*. With the arms short and wide, so that the body is pentagonal; and without pedicellariae. Has a shortened development, with a larva which is not a *Bipinnaria*. British: between tidemarks.

*Brisinga*. With numerous, long, slender arms, sharply distinct from the disc, which is small. A deep-sea genus.

### Class OPHIUROIDEA

Star-shaped Echinodermata; whose arms are sharply marked off from the disc and do not contain caeca of the alimentary canal; with madreporite on the oral side; ambulacral groove covered; tube feet without suckers; and no pedicellariae.

The special features of the organization of a brittle star are connected with the fact that the animal moves, not by means of its tube feet, but by pushing and pulling upon surrounding objects with its arms. In adaptation to this the arms are sharply distinct from and freely movable upon the disc, on the underside of which they are inserted. They are armoured by *skeletal plates* (Figs. 444, 445), in an upper, two lateral, and an under series. The epidermis is vestigial; there is a strong cuticle; spines on the side plates give grip; and the under plates, covering in the ambulacral groove, which is thus converted into an *epineural canal*, protect the nerve cord during the movements of the arm. The ambulacral ossicles of each pair fuse to form one of a series of vertebrae, which articulate by an arrangement of knobs and sockets and can be moved upon one another in various directions by four muscles. The large vertebrae reduce the perivisceral cavity in the arm to a canal, in which there is no room for caeca of the alimentary canal. The *nerve cord* bears ganglia corresponding to the muscles between the vertebrae and formed by increase of the coelomic (deep oral) component of the cord. The perihæmal vessel is shallow and not divided by a septum. The *tube feet* have no suckers and no ampullae and are often provided with warts of sense cells.

The *alimentary canal* (Fig. 446) is a mere bag, not protrusible through the mouth, which is armed with an arrangement of spines

serving as teeth. The food of some species consists of animals captured by the arms: others shovel mud into the mouth with the adjacent tube feet and digest the food it contains. There is no anus. The *madreporite*, aboral in the young, becomes oral in the adult

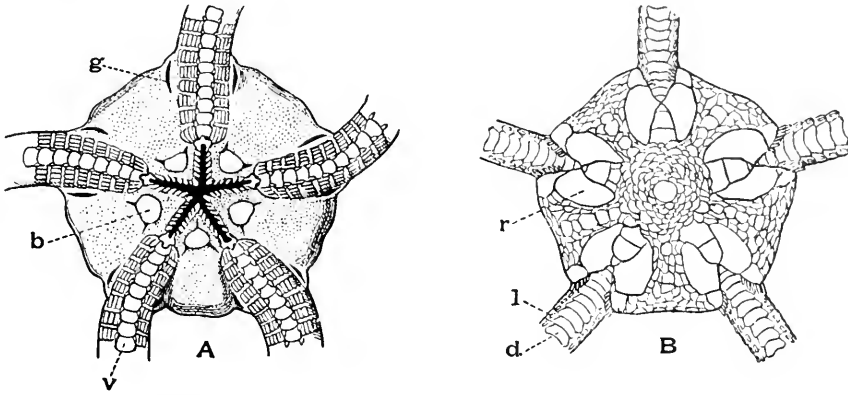

Fig. 444. A, *Ophiura*. Oral surface of disc and part of the arms. B, *Ophioglypha*. Aboral surface. From Woods. *b*. buccal plates; *d*. upper ("dorsal") plates of arms; *g*. genital slits; *l*. lateral plates of arms; *r*. radial plates; *v*. under ("ventral") plates of arms.

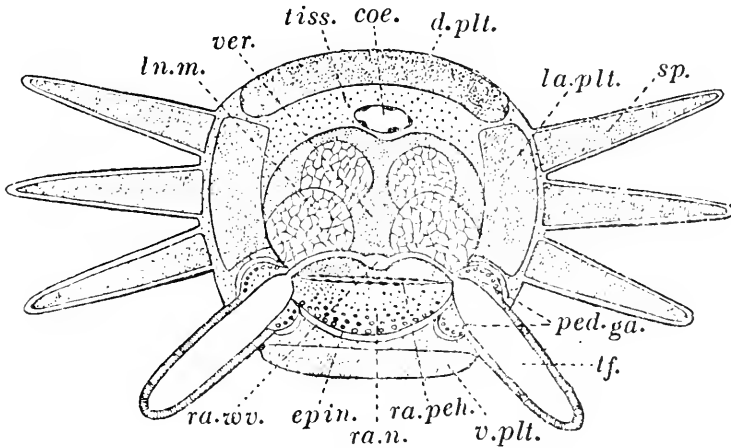

Fig. 445. A section through an arm of an ophiuroid. Diagrammatic, magnified. From Shipley and MacBride. *coe.* coelom; *d.plt.* upper plate; *epin.* epineural canal; *la.plt.* lateral plate; *ln.m.* longitudinal muscle; *ped.ga.* pedal ganglion; *ra.n.* radial nerve cord; *ra.pch.* radial perihæmal canal; *ra.wv.* radial water vascular canal; *sp.* spine; *tf.* tube foot; *tiss.* soft tissue supporting plates; *ver.* "vertebra"; *v.plt.* under plate.

because the disc, growing independently of the arms; and faster aborally, comes to overhang in the interradial. In coming over, the madreporite brings with it the axial sinus, stone canal, axial organ and madreporic vesicle, which are all orally placed. The gonads open, not directly to the exterior, but into *genital bursae*, of which one opens

on each side of the base of each arm (Fig. 444 A, g). The ectoderm lining the bursae retains its cilia and causes currents which subserve respiration.

*Ophiura*, *Ophiocoma*, *Ophiothrix*, *Amphiura*. British genera, separated by relatively unimportant differences, which are chiefly evident in the ossicles and spines. *Amphiura* is hermaphrodite and viviparous.

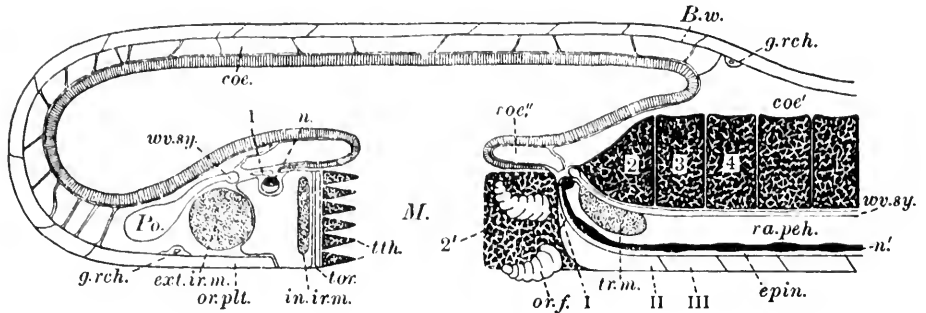

Fig. 446. A diagram of a section of an ophiuroid, passing through an interradius and part of the opposite arm. *B.w.* body wall; *coe.* coelom; *coe.'* coelom of the arm; *coe''*. periesophageal sinus; *epin.* epineural canal; *ext.ir.m.* external interradial muscle; *g.rch.* genital rachis lying in the aboral sinus; *in.ir.m.* internal interradial muscle; *M.* mouth; *n.* nerve ring; *n'* radial nerve; *or.f.* oral tube foot; *or.plt.* oral plate; *Po.* Polian vesicle; *ra.peh.* radial periaemal canal; *tth.* teeth; *tor.* ossicle known as torus angularis; *tr.m.* transverse muscle; *wv.sy.* water vascular system: to the left the circumoral ring, to the right the radial vessel; 1, 1st ambulacral ossicle, which is displaced into an interradius and known as a "peristomial plate"; 2, 3, 4, 2nd to 4th ambulacral ossicles which form "vertebrae"; 2', extension of first vertebra towards an interradius; i, ii, iii, 1st to 3rd under ("ventral") plates.

### Class ECHINOIDEA

Globular, cushion-shaped, or discoidal Echinodermata, without arms; with small abambulacral area, in which lies the madreporite; ambulacral grooves covered; tube feet ending in suckers; numerous long spines; and pedicellariae.

The characteristic form of body of the Echinoidea is such as would result if the arms of a starfish were drawn up into the body by shrinkage of the aboral surface.

We shall describe the anatomy of this group by an account of a typical member of it—*Echinus esculentus*, a large species common in Britain. This animal (cf. Fig. 447) has the shape of a sphere with one side flattened, slightly polygonal in equatorial outline. In the middle of the flattened side is the mouth. Under the delicate, ciliated epidermis an armour, the shell or *corona*, composed of dermal plates firmly sutured together, encloses most of the body, but at the two poles there are leathery areas, the *peristome* around the mouth, and the *periproct* in which the anus lies excentrically. The corona (Fig.

448) is composed of twenty meridional rows of plates, two in each radius (ambulacrum), and two in each interradius. The plates of the ambulacra are distinguished by the presence on them of the pores for the tube feet. These pores are in pairs, since each ampulla communicates with its tube feet by two canals. Thus water can circulate in and out of the tube feet and respiration is facilitated. At the aboral pole each radius ends in a single *ocular plate*, which bears the opening of the terminal tentacle, and each interradius in a *genital plate* which abuts upon the periproct and bears the opening of a gonoduct. One of the genital plates bears also the madreporite. All the plates are studded with bosses of various sizes, to which articulate the concave

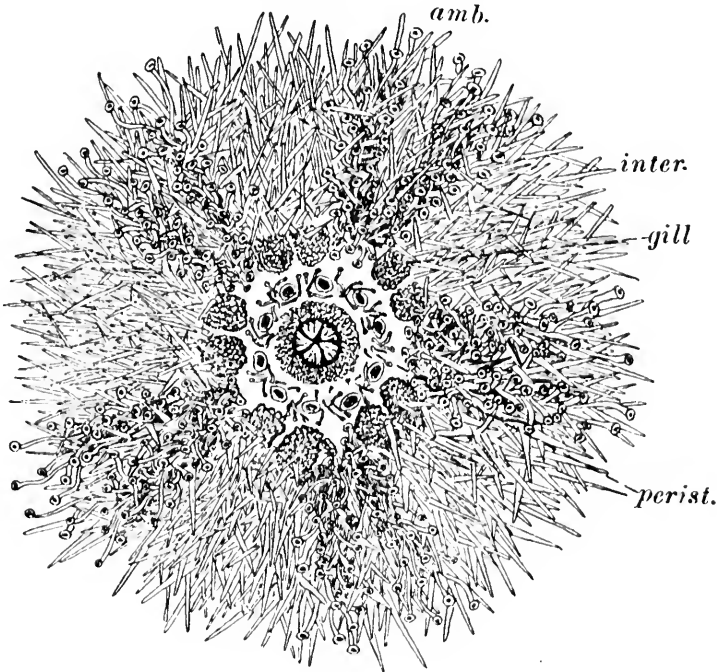

Fig. 447. *Echinus miliaris* from the oral side. *amb.* ambulacrum; *gill*, gill; *inter.* interambulacrum; *perist.* peristome.

bases of the large and small spines and the pedicellariae. The spines, unlike those of starfishes and brittle stars, which are moved with the ossicles under them, have muscles of their own. These are in two sets, an outer one which causes movements, and an inner "catch" muscle (p. 143) which holds the spine firmly in position. On level ground the spines take part at times in locomotion, the animal using them like stilts. The pedicellariae (Fig. 449), which have three jaws, are of several kinds. *Gemiform* pedicellariae have stiff stalks and globular heads with a poison gland in each jaw. The *tridactyle* kind have a flexible stalk and long jaws. The *ophiocephalous* kind are smaller and have a flexible stalk and broad, toothed jaws. The *trifoliate* pedicellariae

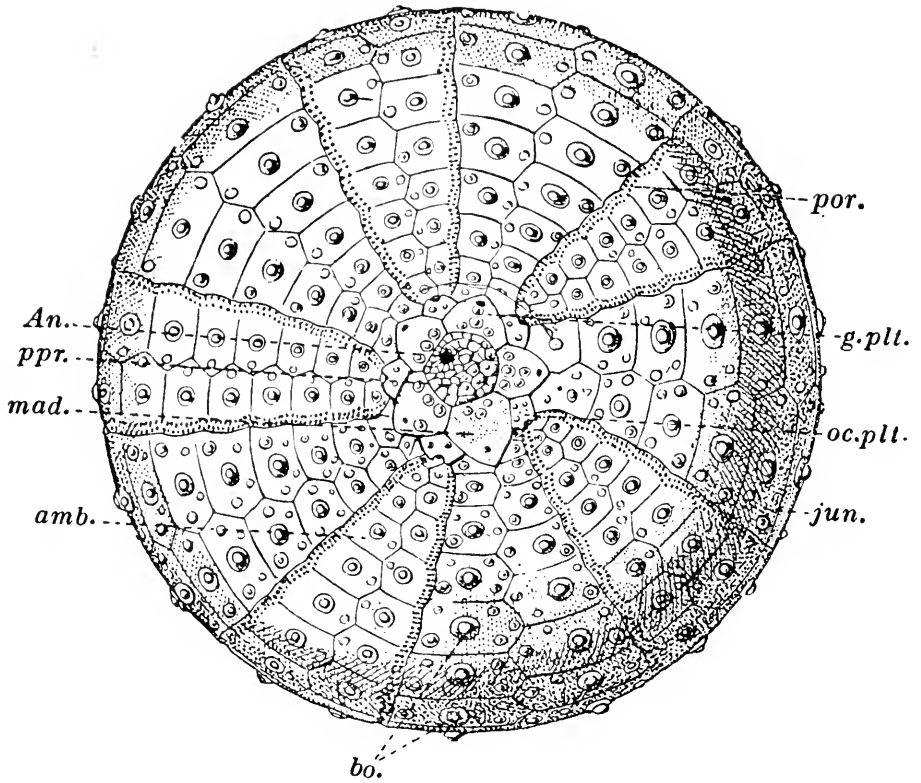

Fig. 448. A diagram of an aboral view of the dried shell of an *Echinus*. The spines, pedicellariae and tube feet have been removed. From Shipley and MacBride. *amb.* ambulacrum; *An.* anus; *bo.* bosses which bear the spines; *g.plt.* genital plate with genital pore; *jun.* line of junction of ambulacral and interambulacral plates; *mad.* madreporic plate; *oc.plt.* ocular plate; *por.* pores through which tube feet protrude; *ppr.* periproct (leathery skin around anus).

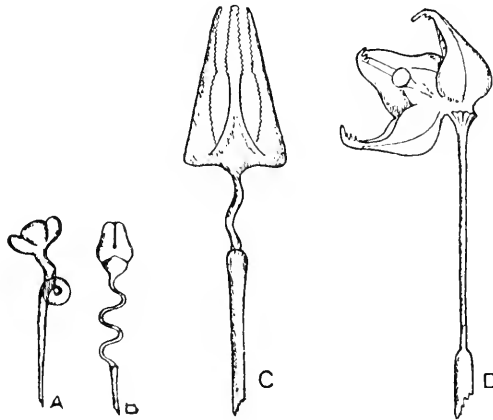

Fig. 449. Pedicellariae of *Echinus miliaris*. Enlarged, but not accurately to scale. A, Trifoliate. B, Ophiocephalous. C, Tridactyle. D, Gemmiform.

are the smallest and have very flexible stalks and broad, blunt jaws. It is said that the gemmiform kind are weapons of defence against large foes, the tridactyle against small, the ophiocephalous seize small animals for food, and the trifoliolate destroy debris. The peristomial edge of the corona is indented in each interradius by two notches, where stand the *gills*—delicate, branched outgrowths of the body wall, each containing a cavity which is continuous with the lantern coelom

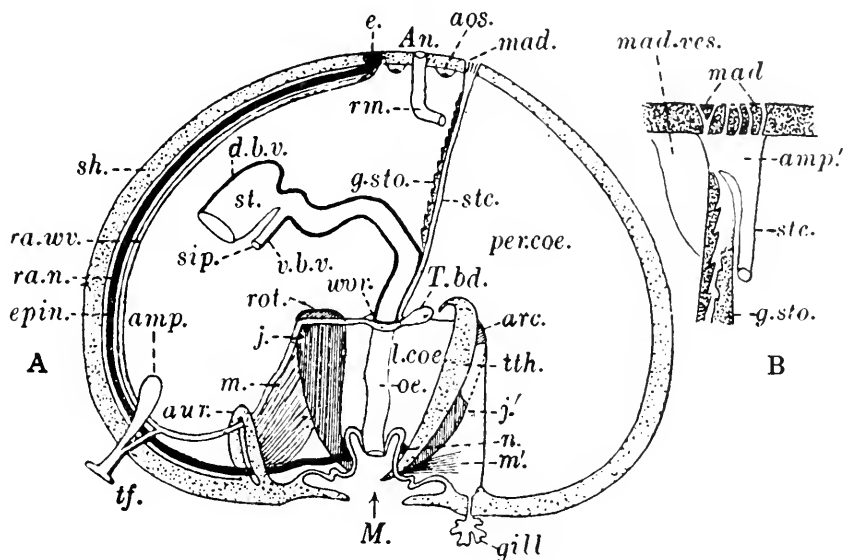

Fig. 450. A diagram of a vertical section of *Echinus*, passing on the left through a radius and on the right through an interradius. Certain structures not immediately in the plane of section are shown. A, Whole section. B, The region of the madreporite. *amp.* ampulla of tube foot; *amp.'* madreporic ampulla; *An.* anus; *aos.* aboral sinus, with genital rachis; *arc.* arch ossicle of jaw; *aur.* auricula; *d.b.v.* "dorsal blood vessel"; *e.* pigment spot in ocular plate; *epin.* epineural canal; *g.sto.* genital stolon; *gill*, external gill; *j.* jaw (not strictly in section); *j.'* lower part of the same; *l.coe.* lantern coelom; *M.* mouth; *m.* muscle (protractor) which pulls down the jaw and protrudes the tooth; *m.'* muscle (retractor) which pulls back the jaw; *mad.* madreporite; *mad.res.* madreporic vesicle; *n.* nerve ring; *oe.* oesophagus; *per.coe.* perivisceral coelom; *ra.n.* radial nerve; *ra.wv.* radial water vessel; *rm.* rectum; *rot.* rotula (the compass which overlies this is omitted); *sh.* shell (corona); *sip.* siphon; *st.* stomach; *stc.* stone canal; *T.bd.* Tiedemann's body ("Polian vesicle"); *tf.* tube foot; *tth.* tooth; *v.b.v.* "ventral blood vessel"; *wvr.* water vascular ring.

(see below). Ten little plates on the peristome around the mouth carry openings for the ten short, stout, sensory *buccal tube feet*, the proximal pair of podia in each radius.

The mouth, which is surrounded by five strong, slightly projecting, chisel-shaped, interradiial teeth, leads into a relatively narrow oesophagus, whose lower part is enclosed in a framework, known as *Aristotle's lantern* (Figs. 450, 451), which supports the teeth. The

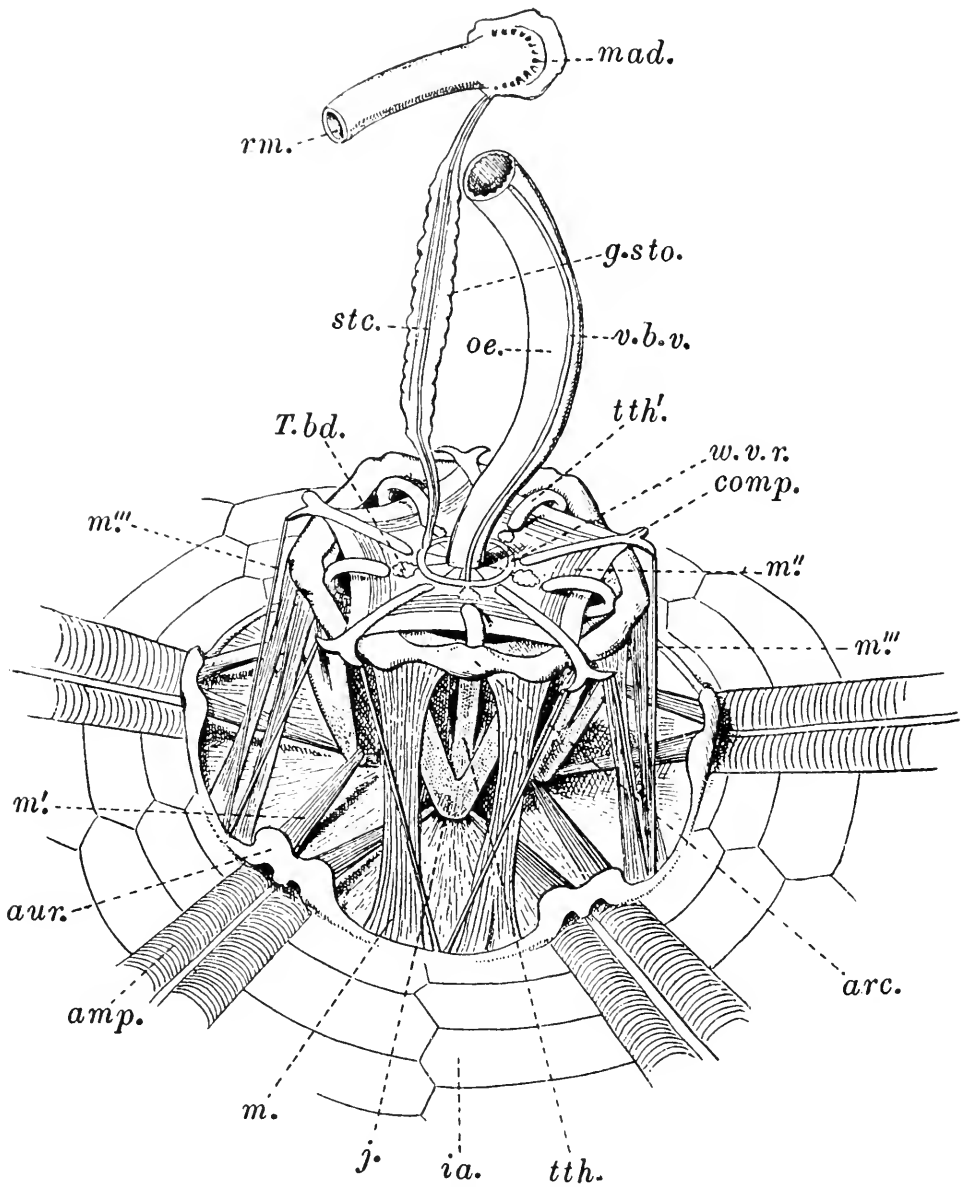

Fig. 451. Aristotle's lantern of *Echinus esculentus*. From Shipley and MacBride. *amp.* ampullae of tube feet; *arc.* arch of jaw; *aur.* auricula; *comp.* compass; *g.sto.* genital stolon; *ia.* interambulacral plates of shell; *j.* jaw; *m.* protractor muscle of jaw; *m.'* retractor of jaw; *m.ii* elevator of compass; *m.iii* depressors of compasses; *mad.* madreporite; *oe.* oesophagus; *rm.* rectum; *stc.* stone canal; *T.bd.* Tiedemann's body ("Polian vesicle"); *tth.* tooth; *tth.'* soft upper end of tooth; *v.b.v.* "ventral blood vessel"; *w.v.r.* water vascular ring. The rotulae, which underlie the compasses, are not seen.



lantern consists of five composite *jaws*, each clasping a *tooth*, and five radial pieces, known as *rotulae*, which unite the jaws aborally. The teeth can be moved outwards and inwards by muscles running from the jaws to radially placed arches, known as the *auriculae*, which arise from the inside of the corona near the lantern. Under each auricula, which perhaps represents a pair of ambulacral ossicles, runs a radial nerve, with its epineural canal, and the radial perihæmal canal, "blood vessel", and water vessel. Within the lantern is a space, known

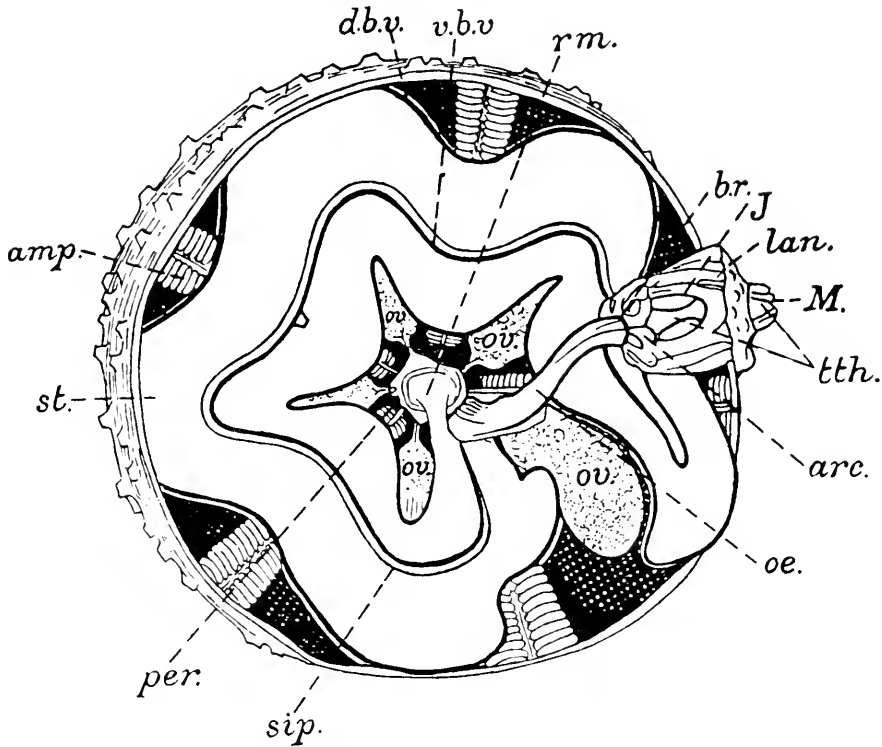

Fig. 452. An oral view of a sea urchin, with part of the shell removed to show the course of the alimentary canal. After Cuvier. *amp.* ampullae at base of tube feet; *arc.* arch; *b.r.* "blood" ring; *d.b.v.* "dorsal blood vessel"; *J.* jaw; *lan.* lantern of Aristotle (displaced); *M.* mouth surrounded by five teeth (*tth.*); *oe.* oesophagus, coiled intestine and rectum; *ov.* ovaries with oviducts; *per.* fold of peritoneum supporting genital rachis; *rm.* rectum; *sip.* siphon; *st.* stomach; *v.b.v.* "ventral blood vessel".

as the *lantern coelom*, which is an enlarged perihæmal ring. Muscles, running from the auriculae to slender ossicles, known as *compasses*, which overlie the rotulae, can raise and depress the roof of the lantern, and thus pump the fluid of its coelom into and out of the gills. In some urchins, but not in *Echinus*, pouches of the lantern coelom project upwards into the perivisceral cavity. These are known as *Stewart's organs* or *internal gills* and when they are present external gills are often lacking.

The *oesophagus* enlarges into a flattened tube, the *stomach* (Fig. 452),

which runs horizontally round the body in a clockwise direction as viewed from below, suspended from the shell in festoons, by strings of tissue. At its beginning, there is a short *caecum*, and it is accompanied by a small, cylindrical tube, the *siphon*, which opens into it at either end. From its distal end a tract similar to it, the *intestine*, returns in the opposite direction and then ascends as the narrower *rectum* to the anus. The food consists chiefly of seaweed.

The *water vascular ring* has five Tiedemann's bodies. It is situated above the lantern, and the radial vessels run downwards and outwards from it between the jaws and under the auriculae and then

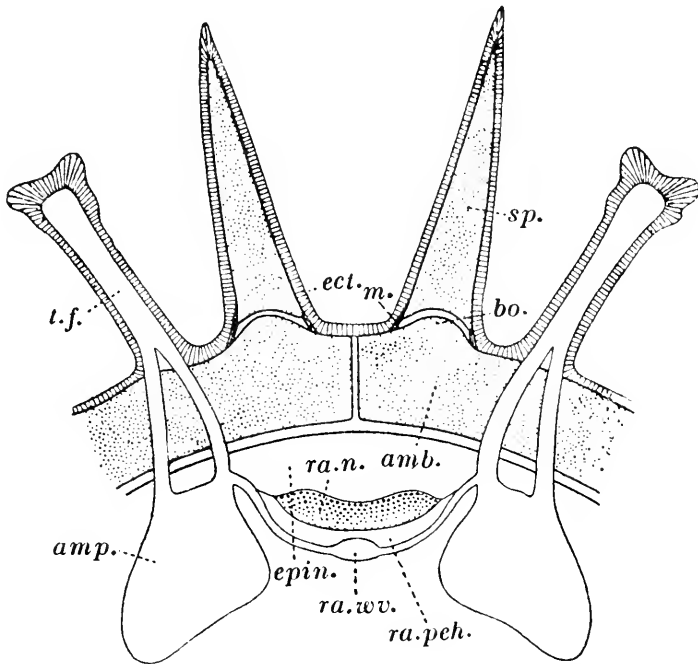

Fig. 453. A diagram of a section across a radius of *Echinus*. From Shipley and MacBride. *amb.* ambulacral plate; *amp.* ampulla; *bo.* boss for articulation of spine; *ect.* ectoderm; *epin.* epineural canal; *m.* muscles which move the spine; *ra.n.* radial nerve cord; *ra.pch.* radial periaemal canal; *ra.wv.* radial water canal; *sp.* spine; *t.f.* cavity of tube foot.

meridionally under the radial plates of the corona, to end each in the pigmented tentacle of an ocular plate. Each is accompanied in its course under the shell by the radial nerve cord, epineural canal, and periaemal canal (Fig. 453). It is said that a small radial "blood vessel" (not shown) runs between the periaemal canal and water vessel. From the water vascular ring the stone canal, which is not calcified, ascends vertically to the madreporite, accompanying the axial organ, which surrounds the small *axial sinus*. Under the

madreporite, however, the sinus is free and enlarged and forms an "ampulla" into which the stone canal opens.

The oral ring of the *lacunar system* lies below the water vascular ring. The features of this system have been described on p. 629. The *gonads* are five large masses hanging into the perivisceral cavity from the region of the genital plates. The rachis is degenerate in the adult.

*Echinus* is an example of the *regular sea urchins* (order *Endocyclica*). The class contains two other orders, *Clypeastroida* and *Spatangoida*, known collectively as the *irregular urchins* (*Exocyclica*), in which the anus, with its periproct, is displaced from the apical position which it occupies in the regular forms, and lies in an interradius, known as the *posterior interradius*, so that the body, which is considerably or very much flattened, has a marked bilateral symmetry. The madreporite remains in position and extends over the region vacated by the periproct. In most of the irregular urchins (though not in certain primitive forms known as *Holactypoida* or *Protoclypeastroida*) the aboral parts of the ambulacra are expanded to an oval shape (petaloid) and bear flattened, respiratory tube feet. These peculiarities are associated with the habit, possessed by typical members of both orders, of living partly or wholly buried in sand (see below).

#### Order ENDOCYCLICA

Echinoidea in which the mouth is central, the anus remains within the apical area, and the ambulacra are not petaloid.

*Echinus* (Figs. 447-453). A typical example, described above.

#### Order CLYPEASTROIDA

Echinoidea in which the mouth is central and furnished with a lantern, the anus outside the apical area, the dorsal parts of the ambulacra nearly always petaloid, and the body usually much flattened.

The members of this order live at or near the surface of the sand, and walk by means of the tube feet, which are very numerous. They extract food from the sand, which they shovel into the mouth by means of the teeth.

*Clypeaster*. A typical member of the group, of large size, widespread in tropical waters.

*Echinocyamus*. Small, oval, and not extremely flattened. *E. pusillus* is a British species.

#### Order SPATANGOIDA

Echinoidea in which the anus and often also the mouth are excentric, the lantern has disappeared, the dorsal parts of the ambulacra are petaloid, and the body cushion-shaped or heart-shaped.

Typical members of this order live buried at some depth in the sand and move, not by means of their tube feet, but by ploughing their way with numerous, curved, flattened spines. In such forms the body has a heart-shape, owing to the depth of the anterior ambulacrum, which differs from the rest and has special tube feet, capable of great elongation and provided with fringed discs. These gather sand rich in food, which is then pushed into the mouth by stout buccal tube feet.

*Spatangus* and *Echinocardium* (Fig. 454) are typical members of the order, found in British waters. *Echinocardium* comes into shallower water than *Spatangus*, burrows deeper, and differs in respect of the arrangement of the spines.

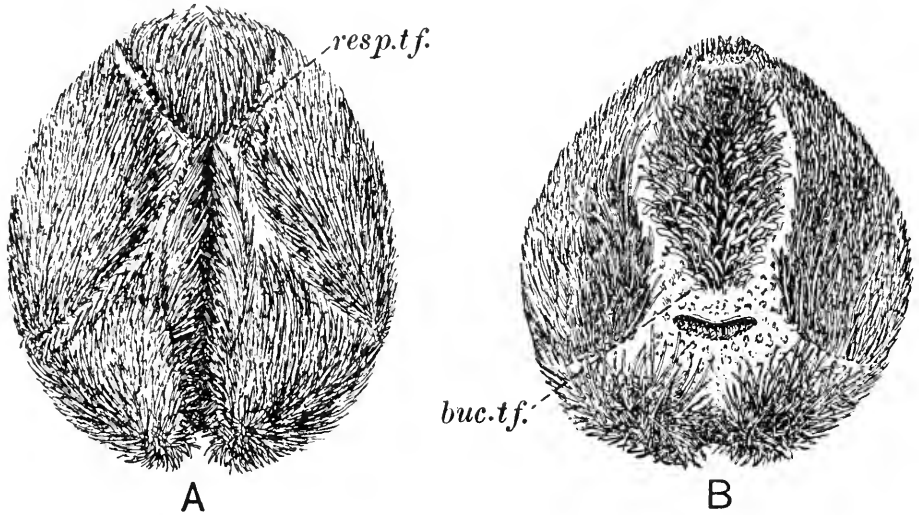

Fig. 454. *Echinocardium cordatum*. A, From the aboral; B, From the oral side. *buc.tf.* buccal tube feet, where the ambulacra converge upon the mouth; *resp.tf.* respiratory tube feet at the side of a petal: both kinds much contracted.

### Class HOLOTHUROIDEA

Sausage-shaped Echinodermata, without arms; without recognizable abambulacral area; usually without external madreporite in the adult; with the ambulacral grooves covered; some of the tube feet modified into tentacles around the mouth, and some or all of the rest, if present, provided with suckers; a muscular body wall containing very small ossicles; no spines; and no pedicellariae.

The typical *form of body* of the Holothuroidea is well seen in the members of the widely distributed genus *Holothuria* (Fig. 457 B), to which the familiar British "cotton spinner" belongs. It is such as would result if in a regular echinoid the ossicles were reduced and the body drawn out in the oro-anal axis, the madreporite with the

gonad which adjoins it being displaced along their interradius to a position not far from the mouth, and the other gonads lost. As has been explained on p. 627, the madreporite usually becomes internal. It is so in *Holothuria*.

Owing to the presence in one interradius of the primary madreporite and the gonad, the body always possesses a rudimentary *bilateral symmetry*. In many cases, as in *Holothuria*, this symmetry becomes conspicuous owing to the fact that the animal constantly applies to the ground the three radii of the side opposite to the madreporic interradius, and this side becomes differentiated as "ventral" from the "dorsal" side which contains the madreporic interradius with the two radii which adjoin it. The differentiation consists in a more or less marked flattening of the ventral side and the loss, or

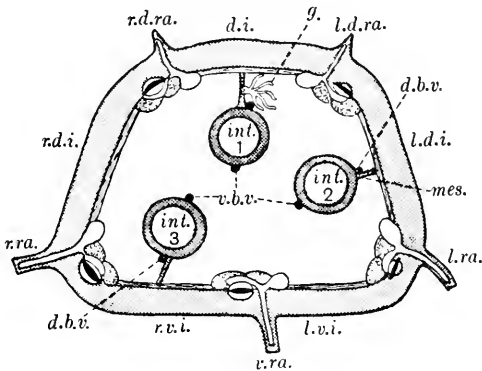

Fig. 455. A diagram of a transverse section of a holothurian. *d.b.v.* dorsal "blood vessel"; *d.i.* dorsal interradius; *g.* gonad; *int.* 1, 2, 3, the three stretches of the intestine; *l.d.i.* left dorsal interradius; *l.d.ra.* left dorsal radius; *l.ra.* left radius; *l.v.i.* left ventral interradius; *mes.* mesentery; *r.d.i.* right dorsal interradius; *r.d.ra.* right dorsal radius; *r.ra.* right radius; *r.v.i.* right ventral interradius; *v.b.v.* ventral "blood vessel"; *v.ra.* ventral radius.

conversion into pointed sensory papillae, of the tube feet on the dorsal side. The tube feet may be confined to the radii or may, as in *Holothuria*, spread over the interradii, obliterating externally the radial arrangement, though internally the radial structures retain their position.

The *tentacles* may be much branched (*dendritic*), provided with lateral branches only (*pinnate*), or, as in *Holothuria*, furnished only with a terminal circle of short branches, which themselves branch (*shield-shaped*). Shield-shaped tentacles are retractile owing to the presence of ampullae. Dendritic tentacles do not possess ampullae but are withdrawn by means of *retractor muscles* inserted into the radial pieces of the calcareous ring around the oesophagus (see below), which pull in the tentacular crown as a whole. Pinnate tentacles are withdrawn by retractor muscles or by ampullae or by both.

In the *body wall*, under the dermis, which contains minute ossicles of a form characteristic of the species, there are transverse muscles between the radii and longitudinal muscles under the radii. The radii contain the same structures as in the Echinoidea. Only one tube runs from the radial water vessel to each tube foot.

The *alimentary canal* (Fig. 456) is slung to the body wall by a mesentery. It runs (except in *Synapta*) an S-shaped course, looping almost the whole length of the body—backwards in the mid-dorsal interradius, forwards in the left dorsal interradius, and finally backwards in the right ventral interradius to the anus. It starts as an *oesophagus*, enclosed in a *calcareous ring* of ten ossicles, five radial and five interradiial, which has been thought to represent the auriculae and lantern of an echinoid. The oesophagus is followed by a short muscular region known as the *stomach*, this is succeeded by a thin-walled intestine which forms the greater part of the canal, and finally there is a short, wide *cloaca*. Into the latter usually open two long, branched *respiratory trees*, whose ramifications end in thin-walled ampullae through which water, when pumped in by contractions of the cloaca, passes into the body cavity, carrying oxygen to the coelomic fluid, and so to the organs. In *Holothuria* and a number of other genera the lower branches of the respiratory trees are converted into *Cuvierian organs*, tubes covered with a sticky substance which in sea water elongate and form a mass of sticky threads. When the animal is attacked or otherwise irritated a violent contraction of the muscles of the body wall sets up in the perivisceral cavity a pressure which ruptures the cloaca and drives out the Cuvierian organs (and often subsequently the rest of the alimentary canal). The enemy is entangled by the sticky threads. Except in the Dendrochirotae, the food is extracted from sand or mud which is shovelled into the mouth by the tentacles. Dendrochirotae entangle small organisms on their sticky tentacles and, putting the latter one by one into the mouth, contract upon them and, by drawing them out, strip off the catch.

The *axial organ* is represented only by a cord-like genital stolon near the gonoduct. The *aboral sinus* and *vascular ring*, *genital rachis*, and *apical nervous system* are absent. The *lacunar system* consists of an oral ring, radial “vessels”, “dorsal and ventral vessels” of the alimentary canal, and a plexus on the latter. In the middle part of the intestine of *Holothuria* and many other genera, the “dorsal vessel” hangs from it on a perforated fold of the peritoneum, but remains connected with it by a plexus known as the *rete mirabile*. In perforations between the strands of this plexus the branches of the left respiratory tree are entangled. The condition of the *water vascular system* is that described on p. 627; for that of the genital system see p. 629.

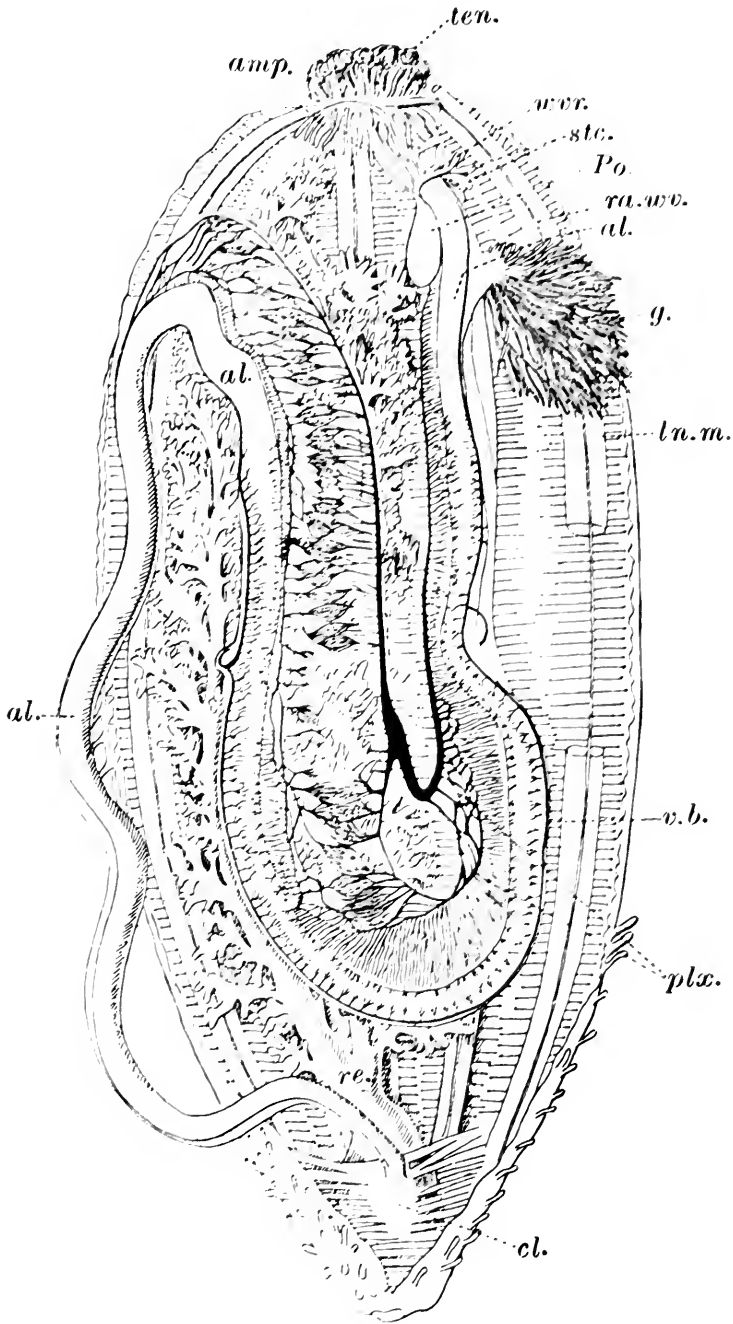

Fig. 456. A view of *Holothuria tubulosa*, somewhat diminished. The animal is opened along the left dorsal interradius and the viscera are exposed. After Ludwig. *al.* alimentary canal; *amp.* ampullae of tentacles; *cl.* cloaca; *g.* reproductive organ; *ln.m.* radial longitudinal muscle partly cut away; *plx.* dorsal "blood plexus"; *Po.* Polian vesicle; *ra.wv.* radial water vessel; *v.b.* ventral "blood vessel"; *re.* respiratory trees; *stc.* stone canals; *ten.* tentacles; *wvr.* water vascular ring.

The Holothuroidea are divided into six orders. Of these the Aspidochirotae and Dendrochirotae contain between them the bulk of the members of the class.

#### Order ASPIDOCHIROTAE

Holothuroidea with shield-shaped tentacles; no retractor muscles, but tentacle ampullae; podia on the trunk; the madreporite internal; and respiratory trees.

*Holothuria* (Figs. 456, 457 B).

#### Order PELAGOTHURIDA

Holothuroidea of pelagic habit; with shield-shaped tentacles; no retractor muscles, but large tentacle ampullae which push out the body wall; no podia on the trunk; the madreporite external; and no respiratory trees.

*Pelagothuria* (Fig. 457 E). The only pelagic holothurian. The animal swims by a webbed circle of projections caused by the enlargement of the tentacle ampullae.

#### Order ELASIPODA

Deep-sea, benthic Holothuroidea with shield-shaped tentacles; no retractor muscles or tentacle ampullae; podia on the trunk; the madreporite external or internal; and no respiratory trees.

*Deima* (Fig. 457 F, F').

#### Order DENDROCHIROTAE

Holothuroidea with dendritic tentacles; retractor muscles but no tentacle ampullae; podia on the trunk; the madreporite internal; and respiratory trees.

*Cucumaria* (Fig. 457 A). Body pentagonal, with two rows of tube feet on each radius and usually no other podia except the tentacles. British.

#### Order MOLPADIDA

Holothuroidea of burrowing habit; with slightly pinnate or unbranched tentacles; tentacle ampullae, and sometimes also retractor muscles; without podia on the trunk; with respiratory trees; and with internal madreporite.

*Trochostoma* (Fig. 457 C).

#### Order SYNAPTIDA (PARACTINOPODA)

Holothuroidea of burrowing habit; with pinnate tentacles whose ampullae are vestigial; with retractor muscles; without radial water vessels, or podia on the trunk; or respiratory trees; and with internal madreporite.

*Synapta* (Fig. 457 D). Ossicles anchor-shaped. British.



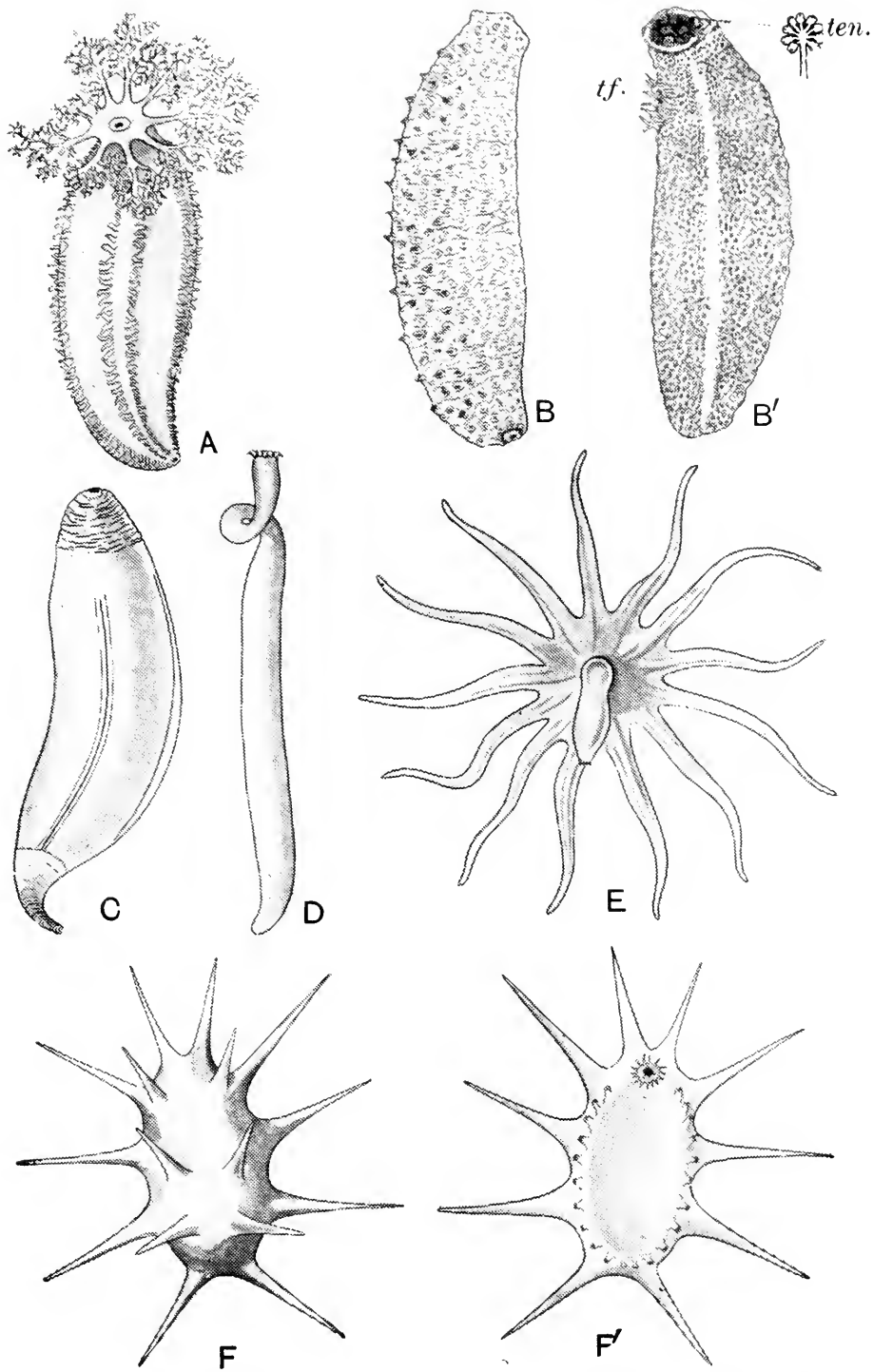

Fig. 457. Examples of the orders of the Holothuroidea. A, *Cucumaria* (Dendrochirotae). B, *Holothuria* (Aspidochirotae) in dorsal view. B', The same, in ventral view, with one tentacle enlarged. The bare strip does not represent an interradius. C, *Trochostoma* (Molpadida). D, *Synapta* (Synaptida). E, *Pelagothuria* (Pelagothurida). F, *Deima* (Elasipoda) in dorsal view. F', The same, in ventral view. *ten.* tentacle, enlarged; *tf.* some of the tube feet, extended.

## Class CRINOIDEA

Echinodermata with branched arms; the oral surface directed upwards; attachment during the whole or part of their life by a stalk which springs from the aboral apex; suckerless tube feet; and open ambulacral grooves; and without madreporite; or spines; or pedicellariae.

The majority of the members of this class are extinct, and of those that survive the typical, stalked forms (Fig. 461) live in deep water

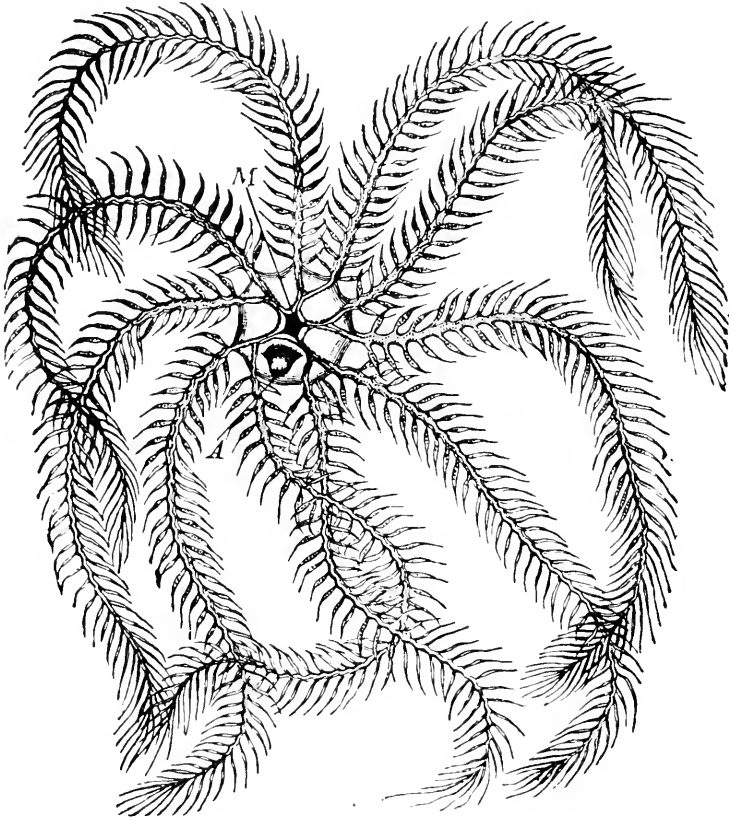

Fig. 458. *Antedon bifida* in oral view. From Sedgwick, after Claus.  
A. anus; M. mouth.

and are less familiar than the shallow water feather stars (*Antedon* and *Actinometra*) which, when they are adult, break off from their stalks and swim by waving their arms. It will therefore be convenient to choose one of the latter to illustrate the anatomy of the group. *Antedon rosacea*, the common feather star, may be dredged in ten fathoms of water off the coast of England. Its body is composed of a small central region or *calyx* and five pairs of long, slender *arms*, each bearing a double row of alternate branchlets known as *pinnules*. On

the convex aboral side, the calyx bears in the middle a knob, formed by the *centrodorsal ossicle*, which is the stump of the stalk and is fringed with numerous slender, jointed *cirri*, each ending in a small hooked claw and used for temporary attachment.

The flat top of the calyx is covered with a leathery *tegmen*, in the middle of which is the *mouth*, while the *anal papilla* stands in one of the interradii. Five *ambulacral grooves* start from the mouth, where

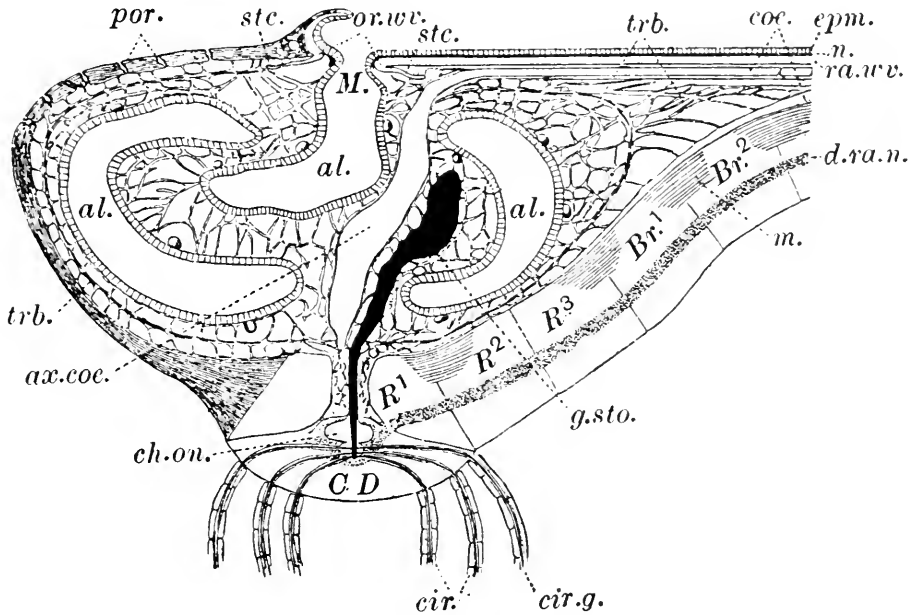

Fig. 459. A transverse section through the disc and base of an arm of *Antedon rosacea*. After Ludwig. *al.* various sections of alimentary canal; *ax.coe.* axial part of perivisceral coelom, free from trabeculae; *Br*<sup>1</sup>, *Br*<sup>2</sup>, first and second brachial plates; *CD.* centrodorsal piece; *ch.on.* "chambered organ" in centre of aboral nervous system; *cir.* cirri; *cir.g.* branches of chambered organ and genital stolon in cirri; *coe.* coelomic canals of arm; *d.ra.n.* radial nerve of aboral nervous system; *epm.* epithelium of ambulacral groove; *g.sto.* genital stolon; *M.* mouth; *m.* muscles connecting radial and brachial plates; *n.* nervous layer of ambulacral groove; *or.wv.* circumoral water vascular ring, giving off, on the left in the figure, a canal to one of the tube feet around the mouth; *por.* pore canals; *R*<sup>1</sup>, *R*<sup>2</sup>, *R*<sup>3</sup>, first, second and third radial plates; *ra.wv.* radial water canal; *stc.* stone canals; *trb.* trabeculae traversing the coelom.

they are separated by five low triangular flaps, the *oral valves*, and radiate across the tegmen, each running to one of the pairs of arms, to supply which it bifurcates. The groove on each arm gives a branch to each pinnule. Along their whole course the grooves bear a row of finger-shaped podia on each side, and they and the podia are ciliated. Down this system a current set up by the cilia conveys particles

gathered from the water to the mouth for food. The podia can only serve for respiration and to increase the ciliated surface: they are not prehensile, and it is said that only those around the mouth are sensory.

Everywhere except in the grooves, the ectoderm is vestigial and cuticulate like that of the Ophiuroidea. The dermis, which on the oral side is merely leathery, contains on the aboral side a *skeleton* of large ossicles. This consists of: (1) the *centrodorsal*; (2) the small *rosette* (formed by the fusion of five larval pieces known as basals), which is internal and roofs a cavity, presently to be described, in the centrodorsal; (3) in each radius, three *radials*, of which the first is usually not visible externally; (4) in each arm, a row of *brachials*; (5) in each pinnule, a row of *pinnularies*; (6) in each cirrus, a row of *cirrhals*, which are hollow. The ossicles of the appendages of the body are movable upon one another by muscles.

The *alimentary canal* consists of a short, vertical *oesophagus*, a wide *stomach*, curved horizontally around the axis of the calyx and bearing two long diverticula and some low pouches, and a short *intestine*, which ascends to the anus.

The perivisceral *coelom* (Fig. 459) of the calyx is traversed by numerous calcified strands (*trabeculae*). In the arms there are present (1) a pair of *subtentacular canals*, (2) aboral to these, a *genital canal*, (3) aboral to this again, a *coeliac canal*, which is derived from the right posterior coelom of the larva. All these canals lead from the perivisceral cavity. It is said that there is a tiny perihæmal vessel in each arm but no oral perihæmal ring. There is no genital ("aboral") ring sinus. In the hollow of the centrodorsal ossicle lies what is known as the *chambered organ* (Fig. 459, *ch.on.*). This consists of five radial compartments, derived from the larval right posterior coelom; its wall is richly nervous and constitutes the centre of the *aboral* or *apical nervous system*. From the centre issue five interradial nerves, which branch and form a complicated plexus (Fig. 460) with a co-ordinating circular commissure, and from this plexus radial nerves supply the arms and pinnules. Nervous prolongations of the chambered organ also pass down the cirri. The whole of this system is enclosed in the ossicles of the adult, but it originates from the wall of the adjacent coelom. It controls the movements of the animal. If it be destroyed they cease; but the *ectoneural system* (which has the same arrangement as that of a starfish) can be cut away without affecting the movements.

The *axial organ* lies in the axis of the body. Starting as a slender strand in the centre of the chambered organ where the walls of the chambers meet, and enlarging in the perivisceral cavity, it narrows again orally, where it is continuous with a circular *genital rachis*. From this again *genital cords* pass down the arms in the genital canals

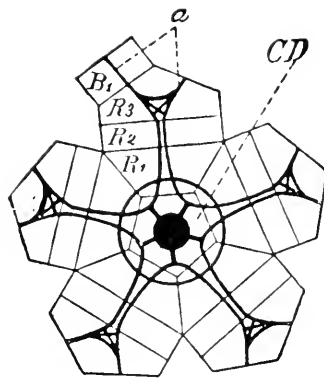
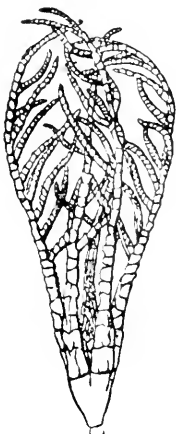
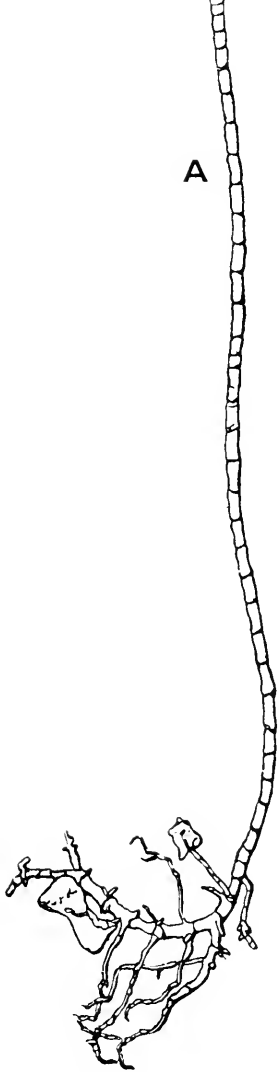

Fig. 460. A diagram of the apical nervous system of *Antedon*. From Sedgwick, after Ludwig. *a*, axial cords of the arms; *B*<sub>1</sub>, first brachial ossicle; *CD*, centro-dorsal; *R*<sub>1</sub>, *R*<sub>2</sub>, *R*<sub>3</sub>, radials.



**B**

**C**

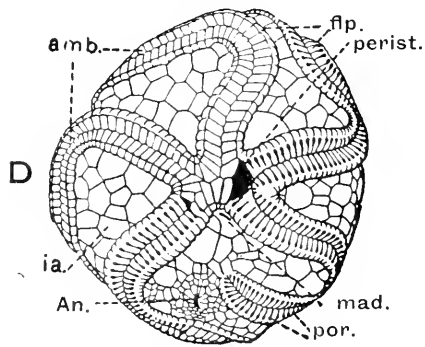
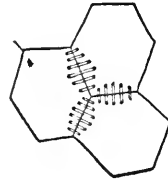
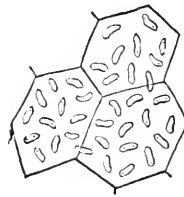

Fig. 461. Pelmatozoa. A, *Rhizocrinus*,  $\times$  about  $2\frac{1}{4}$ . From Sars. B, Thecal plates of a cystoid with diplopores. C, Plates with pore-rhombs. D, *Edriaster bigsbyi*. After Bather. *amb.* ambulacra on which the covering plates remain; *An.* anus; *flp.* flooring plates of ambulacra; *ia.* interambulacrum; *mad.* madreporite; *perist.* peristome; *por.* pores (for tube feet?).

and so reach the pinnules, where they enlarge into *gonads*. The genital cells are dehisced by rupture when ripe. The *lacunar system* has an oral ring and "vessels" from this to a plexus on the stomach and to the lacunar tissue of the axial organ. It is doubtful whether radial vessels are present.

The *water vascular ring* closely surrounds the mouth, and from it numerous stone canals open without madreporites to the perivisceral cavity, which in turn communicates by many isolated pores, lined by cilia, with the exterior. This arrangement is due to the fusion of the larval axial sinus with the perivisceral cavity and subsequent multiplication of stone canals and pores (see p. 627). There are no ampullae, but the diameter of the canals can be varied by muscular strands which traverse them.

Two other recent crinoids may be mentioned here. *Pentacrinus* is a deep-water form with a long, jointed stalk, bearing whorls of cirri at intervals. The adult, like *Antedon*, breaks free and swims by waving its arms, but trails its stalk behind it. *Rhizocrinus* (Fig. 461) has a jointed stalk without cirri except at the distal end, where some branching root-cirri are developed. By these the animal is permanently rooted. It is found at great depths in the Atlantic.

## EXTINCT CLASSES

Echinoderms belonging to several groups now extinct are numerous as fossils in Palaeozoic rocks. They are all sessile by the aboral side, a fact whose significance has been mentioned above (p. 633). Their body wall contains an armour (*theca*) of plates, in which mouth, anus, and madreporite can often be identified. These echinoderms are usually classified with the Crinoidea as *Pelmatozoa*, in contrast to the free members of the phylum, which constitute the *Eleutherozoa*.

The following are the groups referred to in the foregoing paragraph:

AMPHORIDEA. The most primitive echinoderms. Body sac-like, its skeleton showing no food grooves or other traces of the ambulacral system. *Aristocystis*, Ordovician.

CARPOIDEA. Stalked, and with secondary bilateral symmetry owing to compression upon a plane in which lie mouth, madreporite, and anus. Two food grooves on the theca have been described. Sometimes there are two arm-like spines at the ends of the oral edge. *Trochocystis*, Cambrian; *Placocystis*, Silurian.

THECOIDEA (EDRIOASTEROIDEA). Cushion-shaped, without stalk or arms. Five food grooves, provided with covering plates, radiate from the mouth. *Stromatocystis*, Cambrian; *Edrioaster* (Fig. 461), Ordovician.

CYSTOIDEA. Body sac- or vase-shaped, with stalk, and with food grooves, either on the theca (epithecical) or on special ossicles (exotheical). The grooves may be carried partly or wholly by *brachioles*—arm-like

processes of the oral side of the body. The plates of the theca are hexagonal, and bear pores, either in pairs (*diplopores*) or in diamond patterns (*pore-rhombs*). The members of the group fall into two divisions as follows:

DIPLOPORIDA, with diplopores and epithecal grooves. *Eucystis*, Ordovician.

RHOMBIFERA, with pore-rhombs and exothecal grooves. *Echino-sphaera*, Ordovician; *Lepadocrinus*, Silurian.

BLASTOIDEA. Highly organized forms, typically with ovoid, stalked body. Certain plates of the theca (basals, radials, deltoids, lancets, etc.) are uniform in arrangement throughout the group. The ambulacra are bordered by rows of pinnule-like brachioles, and at the sides of the ambulacral grooves run elongated internal pouches, the *hydrospires*, which open to the exterior at the oral end by *spiracles*. *Pentremites*, Carboniferous.

## CHAPTER XIX

### THE PROTOCHORDATA

Most of the members of the phylum Chordata do not come within the scope of this book. But, though a position in that phylum is accorded by all authorities to the Tunicata and by many also to the Hemichorda, it is often convenient to treat of both these groups with the other invertebrate animals, and we shall take that course. It will be well, however, first to indicate what are the features which the groups in question share with the other chordate animals—the Vertebrata proper, and the Cephalochorda (*Amphioxus*), which are usually studied with the Vertebrata. The Chordata are bilaterally symmetrical, coelomate metazoa which have in common certain fundamental features stated in the following paragraphs.

(1) With the single exception of the minute, sessile *Rhabdopleura*, every member of the group possesses, at least in its early stages, lateral perforations from the pharynx to the exterior which are known as *gill clefts* or, by the name which is applied to those of them which in vertebrata do not bear gills, as *visceral clefts*. Moreover, the gill clefts of the Cephalochorda, the Hemichorda (except *Cephalodiscus*), and many tunicates, have the further resemblance that the perforations which originate them are subsequently divided by tongue bars, so that each gives rise to two of the definitive clefts. It is probable that the original function of the “gill” clefts was the filtering off of food from water taken in through the mouth. This function they still retain in the lower members of the phylum (*Balanoglossus*, *Amphioxus*, tunicates, many fishes), though something of a respiratory function is perhaps always superadded to it.

(2) In all the Chordata the *central nervous system* (*a*) arises from a median dorsal strip of ectodermal epithelium from which it never parts, (*b*) is, except in the trunk cord of *Balanoglossus* and the whole central nervous system (ganglion) of *Cephalodiscus* and *Rhabdopleura*, removed from the surface of the body, by invagination or by overgrowth of the epithelium at its sides, so as to form a tube, lined by its persistent epithelium. These features of the nervous system of the Chordata have analogies in that of the Echinodermata (pp. 624, 630).

(3) The common features of the *coelom* of the Chordata are more obscure. The coelom of the Hemichorda and the Cephalochorda arises, as in the Echinodermata (p. 631), by pouches of the archenteron forming three segments, of which the anterior (the *proboscis cavity* or *head cavity*) is at least in its beginning median and com-



municates on the left side (and in the Hemichorda often on both sides) by a pore with the exterior. In the Hemichorda the three segments retain their entity throughout life: the first does not divide into lateral halves, the second (collar cavities) acquires a pair of pores to the exterior, the third (trunk cavities) does not undergo transverse division. In the Cephalochorda, the first divides into two halves, of which the left, by the opening out of its pore, becomes Hatschek's pit in the ectodermal depression known as the wheel organ, the second forms the first mesoderm segment (mesoblastic somite) and some cavities around the mouth, the third subdivides to form all the mesoderm segments except the first. In the Vertebrata the coelom forms as a split in a mass of mesoderm, though there are indications that the mesoderm rudiment should be regarded as a solid pouch arising in

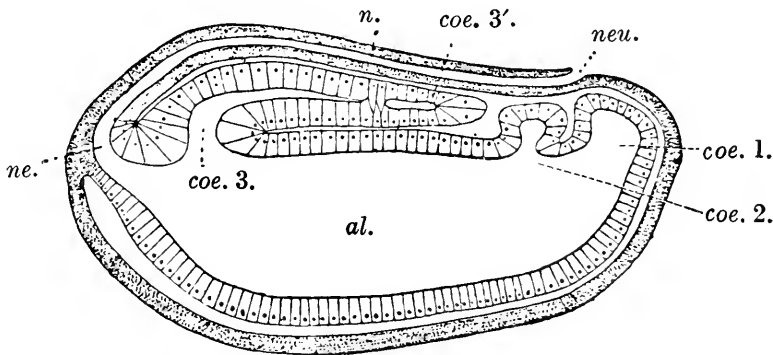

Fig. 462. A diagrammatic longitudinal section of an embryo of *Amphioxus*. From Shipley and MacBride. *al.* alimentary canal; *coe. 1.* anterior coelom or head cavity; *coe. 2.* middle coelom (collar cavity), which becomes first mesoblast segment ("mesoblastic somite"); *coe. 3.* hinder coelom (trunk cavity); *coe. 3'* mesoblast segment dividing off from *coe. 3*; *n.* neural canal; *ne.* neurenteric canal; *neu.* neuropore.

the same position as the hollow pouches of the Cephalochorda. The head cavity is represented by the premandibular segment of the embryo, a median structure with an opening to the exterior in the form of a communication with the ectodermal invagination for the pituitary body. Certain peculiarities of the mandibular segment indicate that it is the homologue of the first mesoderm segment in the Cephalochorda and so of the collar cavity. The remaining segments must represent those of the Cephalochorda and so the trunk cavity of the Hemichorda. In the Tunicata the mesoderm arises as a solid mass in the same position as the pouches of the Cephalochorda, but the coelom, except for certain doubtful vestiges, is non-existent.

(4) Except in the Hemichorda, the *notochord*, a skeletal rod which arises from the endoderm of the median dorsal line of the gut, runs the whole, or a considerable part, of the length of the body. In the

Hemichorda the dorsal side of the gut at the anterior end, over the mouth, forms a skeletal outgrowth into the proboscis. This outgrowth has received the same name as the notochord, on the theory that it represents the anterior portion of that structure.

(5) With the exception of the Hemichorda, all the Chordata possess the *tail*, a postanal prolongation of the body in the direction of its main axis, without viscera, but containing extensions of the other principal organs—muscles, nerve cord, notochord, and, in the Vertebrata, backbone. A true tail is found only in the Chordata. In them it is a very important organ, used primarily in locomotion and maintaining position, though it may become an organ of prehension or a weapon.

An interesting biochemical confirmation of the morphological finding that these subphyla, including the Hemichorda, are a unity, lies in the fact that all of them possess a phosphagen<sup>1</sup> which is a compound of creatin, whereas the phosphagen of non-chordate animals is a compound of arginin. Moreover these two phosphagens have been found together, on the one hand, in the lantern muscles of a sea urchin, a member of that invertebrate phylum which shows most affinity with the Chordata (p. 2); and on the other hand in *Balanoglossus*, the chordate which shows most affinity to the Echinodermata.

### SUBPHYLUM *HEMICHORDA*<sup>2</sup>

Chordata without tail, atrium, or bony tissue; with notochord restricted to the preoral region; central nervous system partly or wholly on the surface of the body; and three primary segments of the coelom retained in the adult in corresponding, externally visible regions of the body, the foremost of which is preoral.

This small group contains the *Enteropneusta*, burrowing worms of the genus *Balanoglossus* and related, slightly different genera, and the *Pterobranchia*, the remarkable little organisms *Cephalodiscus* and *Rhabdopleura*, which live at considerable depth in the sea, in tubular houses which they secrete for themselves by their proboscis.

The *body* of *Balanoglossus* (Fig. 463) has a conical preoral lobe, the *proboscis*, which behind, by a narrow stalk, joins the short, wide *collar* region. This overhangs in front the stalk of the proboscis and behind the beginning of the long *trunk*. Each of these regions contains one of the three segments of the coelom, the proboscis segment undivided,

<sup>1</sup> A *phosphagen* is a labile compound of an aminoacid with phosphoric acid. It is intimately associated with muscular contraction, being broken down during activity and reconstituted during rest. This is a more immediate source of energy than glycolysis.

<sup>2</sup> Some authors give the name *Enteropneusta* to the whole of this subphylum.

the collar and trunk segments each in two lateral halves. (The trunk cavities send forward into the collar a pair of "perihæmal" prolongations at the sides of the dorsal blood vessel, mentioned below.) A pair, left and right, or a single, left, *proboscis pore* opens at the base

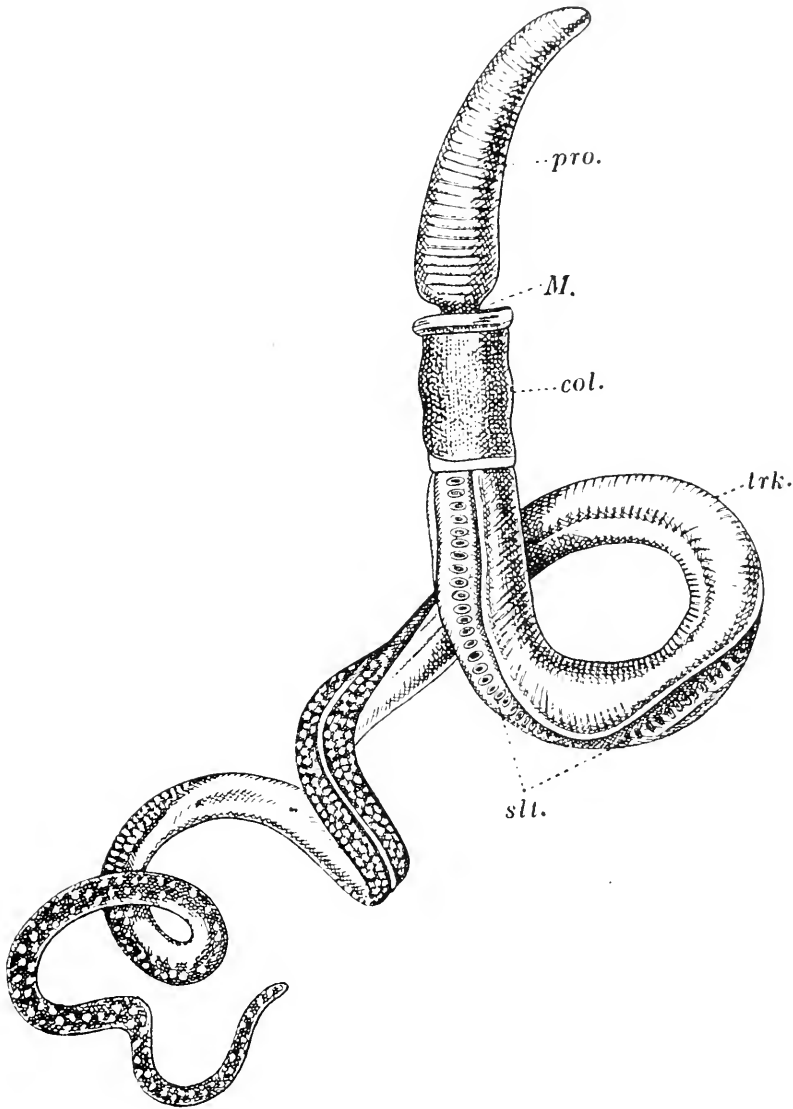

Fig. 463. A *Dolichoglossus kowalevskii*,  $\times 1$ . From Spengel.  
*col.* collar; *M.* mouth; *pro.* proboscis; *slt.* gill slits; *trk.* trunk.

of the organ. The mouth opens on the ventral side, between the overlap of the collar and the proboscis stalk. A pair of *collar pores* open backward from the collar cavities into the first gill pouch (see below). Dorsolaterally on the first part of the trunk is on each side a row of

numerous small gill openings; these lead into deep pouches which communicate with the pharynx each by a tall opening virtually divided into two by a tongue bar, which hangs from the dorsal side but does not quite join the ventral side as do the tongue bars in *Amphioxus*. In the region of the gills, and a little way behind it, the trunk is somewhat flattened above or has a pair of lateral ridges or folds, known as the *genital pleurae* because when they are present the gonads lie in them. Behind this *branchiogenital* region the trunk becomes more cylindrical and tapers gradually, as the *abdominal region*, to the *anus*, which is terminal.

The proboscis and collar are used in *burrowing*. They are distended by the taking in of water by the action of cilia in the tubes leading to the pores, and contracted by muscles in the body wall, the water being thus driven out. The proboscis first enters the mud and the collar follows and, by distending, gives a purchase for drawing forward the trunk.

The body is covered by a ciliated *epithelium*, with gland cells and at its base a net of nerve fibrils to which processes of epithelial cells contribute. This net is thickened along the dorsal and ventral median lines of the trunk in the form of *nerve cords*, which are united by a ring thickening immediately behind the collar. The dorsal cord alone is continued into the collar, and here it is somewhat thicker and is invaginated to form a tube, by which arrangement it is protected during the movement of this prominent part of the body. On the stalk of the proboscis the cord communicates with the general net on that organ. There are no special sense organs. No *dermis* interposes between the epithelium and the muscles of the body wall.

The *alimentary canal* (Fig. 464) is straight. From the *buccal cavity* in the collar, the hollow *notochord* (see p. 661) projects forward into

---

Fig. 464. A diagram of a median longitudinal vertical section of a typical member of the Enteropneusta.

With the exception of the branchial blood vessels, structures which are not median are shown by interrupted lines.

*aff.br.*, *aff.i.*, *aff.ph.*, *aff.pro.* afferent vessels to gill clefts, intestine, pharynx, and proboscis; *ce.n.sy.* central nervous system in collar; *cm.* coecum of notochord; *col.* collar; *col.ca.* collar cavity (mesentery lacking here); *d.b.v.* dorsal blood vessel; *d.b.w.v.* vessel from dorsal body wall; *d.rt.* "dorsal root"; *eff.br.*, *eff.glo.*, *eff.i.*, *eff.pro.* efferent vessels from gill clefts, glomerulus (cut short), intestine, and proboscis; *glo.* glomerulus; *h.* heart; *lat.ph.v.* lateral pharyngeal vessel; *m.* muscles of proboscis; *M.* mouth; *mes.d.col.*, *mes.d.trk.*, *mes.v.col.*, *mes.v.trk.* mesenteries, dorsal and ventral, of collar and trunk; *nch.* notochord; *p.p.* proboscis pore; *pcm.* pericardium; *pro.* proboscis; *pro.ca.* proboscis cavity; *sep.* proboscis septum; *sk.* notochord skeleton; *sk'*. process of *sk.* at side of mouth; *sl.* gill slit; *trk.* trunk; *trk.ca.* trunk cavity (at point where mesentery is lacking); *v.b.v.* ventral blood vessel; *v.b.w.v.* vessel to ventral body wall.

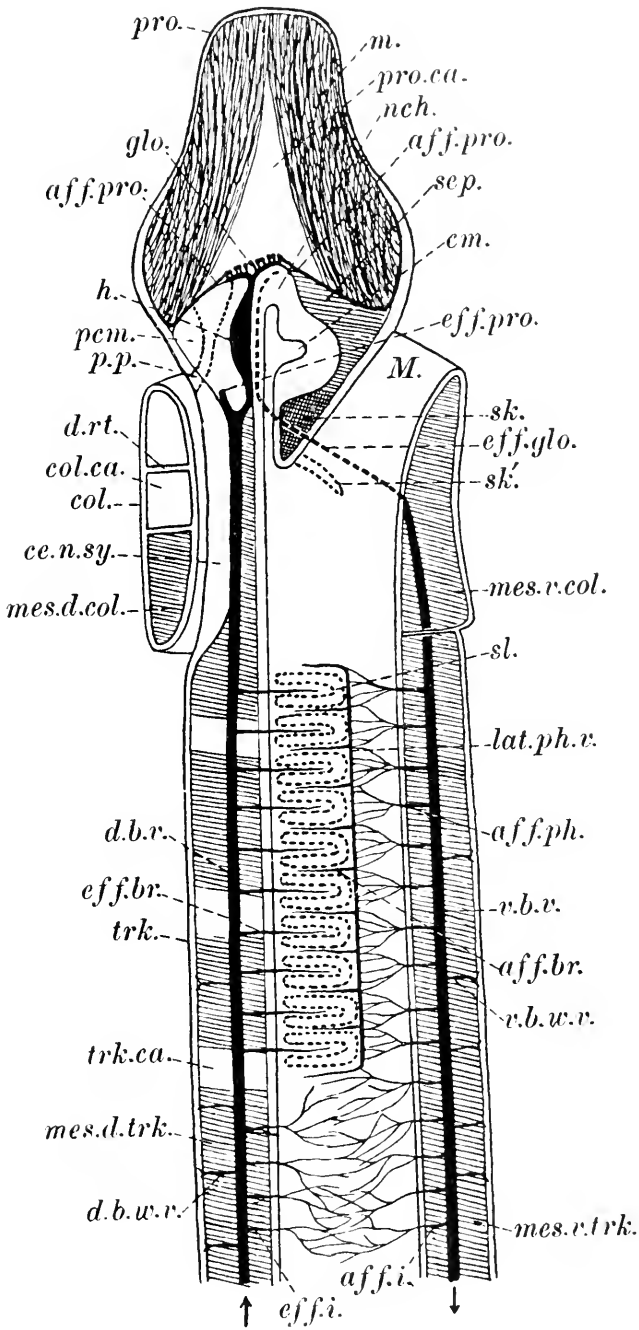

Fig. 464. (Legend on previous page.)

the hinder part of the proboscis, strengthening the neck of that structure and supporting a group of organs (heart, pericardium, glomerulus), which form with it the *proboscis complex*: at its root is a skeletal thickening of its basement membrane. Backwards, the buccal cavity leads into the *pharynx*, from which the gill slits open.

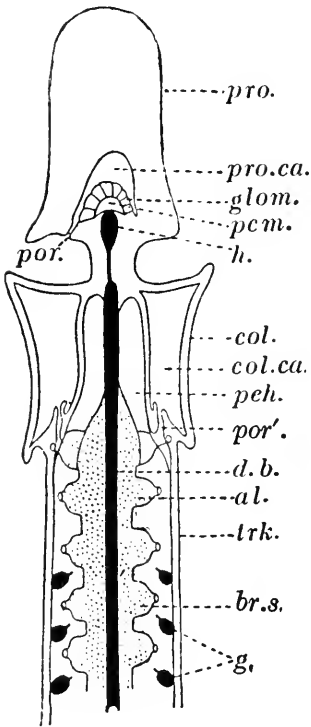

Fig. 465.

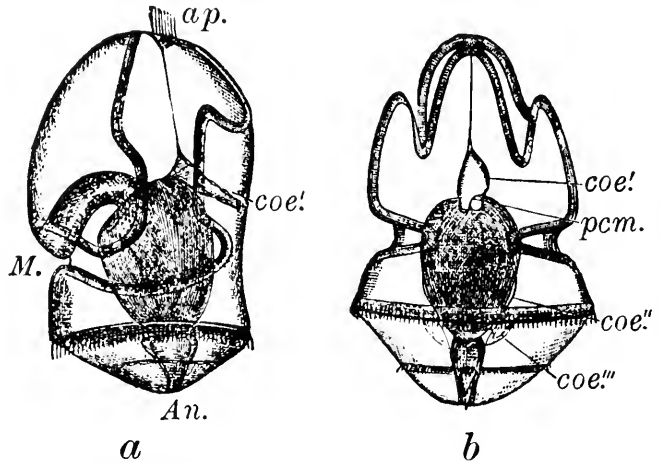

Fig. 466.

Fig. 465. A longitudinal horizontal section through *Glossobalanus*. Diagrammatic. From Shipley and MacBride. *al.* alimentary canal; *br.s.* branchial sac with external opening; *col.* collar; *col.ca.* collar cavity; *d.b.* dorsal blood vessel; *g.* reproductive organs; *glom.* glomerulus; *h.* heart; *pcm.* pericardium; *peh.* periahaemal cavity; *por'*. collar pore; *por.* proboscis pore; *pro.* proboscis; *pro.ca.* proboscis cavity; *trk.* trunk.

Fig. 466. A *Tornaria* larva. From Sedgwick, after Metschnikoff. *a.* From the left-hand side. *b.* From the dorsal side. The larva is in the regressive stage, and numerous secondary foldings of its ciliated rings have been lost. *An.* anus; *ap.* apical sense plate; *coe.'* rudiment of anterior (proboscis) coelom; *coe.''*, *coe.'''* rudiments of right middle (collar) and hinder (trunk) coeloms; *M.* mouth; *pcm.* pericardium.

In most species there is a ventral gutter, below the gill slits, leading to the intestine, which lies in the abdominal region. Along this gutter passes the mud which the animal swallows for food, excess of water leaving by the gill slits, which thus act as a straining apparatus.

The *blood vessels* are for the most part mere crevices between the

basement membranes of the ectoderm, endoderm, and mesoderm, which otherwise are everywhere in contact, having no mesenchymatous connective tissue between them. A *dorsal vessel* above the alimentary

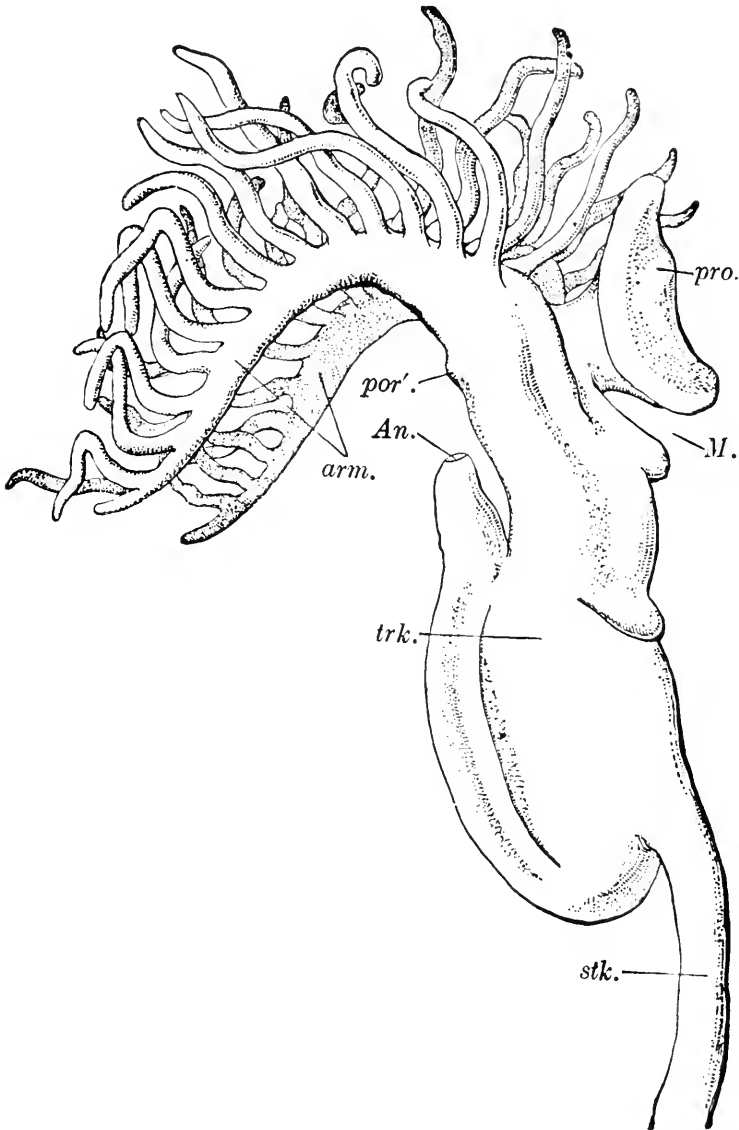

Fig. 467. A zooid of *Rhabdopleura normani* removed from its tube and seen from the right-hand side. From Lang. *An.* anus; *arm.* arms; *M.* position of mouth; *por.'* position of collar pore; *pro.* proboscis; *stk.* stalk; *trk.* trunk.

canal widens over the notochord in the hinder part of the proboscis into a space known as the *heart*. This is covered by a vesicle known as the *pericardium*, whose lower wall, contracting, communicates pulsations to the blood. From the heart the blood passes into a plexus

contained in an organ known as the *glomerulus*, which is formed by a puckering of the hinder wall of the proboscis cavity around the end of the notochord. It is thought that this organ acts as a kidney, taking waste matters from the blood and throwing them into the proboscis cavity, whence they are expelled through the proboscis pores when the organ contracts. From the glomerulus the blood is gathered into two vessels which lead backwards one on each side to a *ventral vessel* below the gut. From this vessel is supplied a plexus in the wall of the alimentary canal, including the bars between the gill openings. From this plexus blood passes to the dorsal vessel. The blood flows forwards in the dorsal vessel and backwards in the ventral.

The sexes are separate. The gonads are mere sacs lying at the sides in the anterior region of the trunk. When they are ripe, openings break through from them to the exterior. Though they have no connection with the coelom of the adult, they are developed from the coelomic wall.

In most species the egg is small, and development passes through a pelagic larval stage known as the *Tornaria* (Fig. 466), which closely resembles the *Auricularia* larva of holothurians (p. 632), but differs in possessing a perianal band of cilia in addition to the longitudinal band, and in the presence of a couple of eyespots in the patch of epithelium which bears the apical tuft of cilia. The larva presently sinks to the bottom and undergoes a gradual transformation into the adult, retaining its original symmetry. The pulsating vesicle, which in echinoderms becomes the madreporic vesicle of the adult (pp. 627, 628), is in *Balanoglossus* the rudiment of the pericardium. In some species the egg is larger and there is no *Tornaria* stage. In all, however, cleavage of the ovum is complete and gastrulation is by invagination.

*Cephalodiscus* and *Rhabdopleura* (Fig. 467) are minute animals in which, owing to a protrusion of the ventral surface, the body is vase-shaped and the gut drawn down into a **U**, so that the anus opens upwards. The collar bears in *Rhabdopleura* two and in *Cephalodiscus* several, hollow, branched *arms* which by means of cilia collect the food of the animal. On the forepart of the trunk are in *Cephalodiscus* the single pair of gill clefts and the pair of gonadial openings, in *Rhabdopleura* only a gonadial opening on the right side. On the belly is a peduncle which bears buds. In *Cephalodiscus* these become free; in *Rhabdopleura* they remain in continuity with the parent so that a colony of zooids is formed. Both genera have all the characteristic features of *Balanoglossus*, save that *Rhabdopleura* has no gill clefts or glomerulus, and that in both the dorsal nerve patch of the collar is not invaginated.



SUBPHYLUM *TUNICATA* (*UROCHORDA*)

Chordata without coelom, segmentation, or bony tissue; with a dorsal atrium in the adult; notochord restricted to the tail, which is present in the larval organization only; the central nervous system removed from the surface of the body and in the adult degenerate; and a test, usually largely composed of a substance (tunicin) related to cellulose.

In the adult form, the members of this group are extraordinarily unlike the rest of the phylum. They have lost all the characteristic features of chordate animals except the gill clefts, and are rather shapeless objects which lead a sluggish existence by means of an organization of a low grade. Most of them are sessile, and there is no doubt that this habit has established the peculiarities of the group.

We shall describe the organization and life of the Tunicata by giving an account of a typical example, *Ciona intestinalis* of the British coasts, one of the simple "ascidians". The adult of this animal (Fig. 468) is a subcylindrical sac, which reaches a height of several inches, sometimes nearly a foot, seated by the blind posterior end upon some solid object on the bottom, and at the other bearing two openings, a terminal *mouth* or *branchial opening* and an *atrial opening*, seated on a tubular projection a little way below the mouth. This projection, which marks the dorsal side of the animal, is known as the *atrial siphon*. Beyond its origin the body narrows as the *oral siphon* towards the mouth. The latter is surrounded by eight small lobes with red pigment spots between them. The atrial opening has six lobes. Both apertures can be narrowed and virtually closed. When the animal is in water and has them open a current may be seen to set in at the mouth and out at the atrial opening. By sudden contractions of the body water may be forced out of both of them.

The body is covered by a tough, translucent *test*, remarkable for being composed largely of tunicin, a substance closely related to cellulose, and therefore not to be expected in an animal. The test is a cuticular secretion of the ectoderm, but contains cells of mesodermal origin which have wandered into it, and ramifying tubes in which blood circulates, which enter it at a point near the base of the sac. Below the test lies the true body wall or *mantle*, which contains numerous longitudinal and transverse strands of muscle by which the shape of the body can be altered, and sphincters around the openings, where test and mantle are tucked in for a short distance.

The *alimentary canal* (Fig. 469) begins as a tube, the *stomodaeum* or *buccal cavity*, lined by the inturned test. This leads to the very large *pharynx*, a cirlet of *tentacles* standing at the junction. A short *prebranchial zone* of the pharynx lies between the tentacle ring and the *peripharyngeal band*—a couple of ciliated ridges, which run round

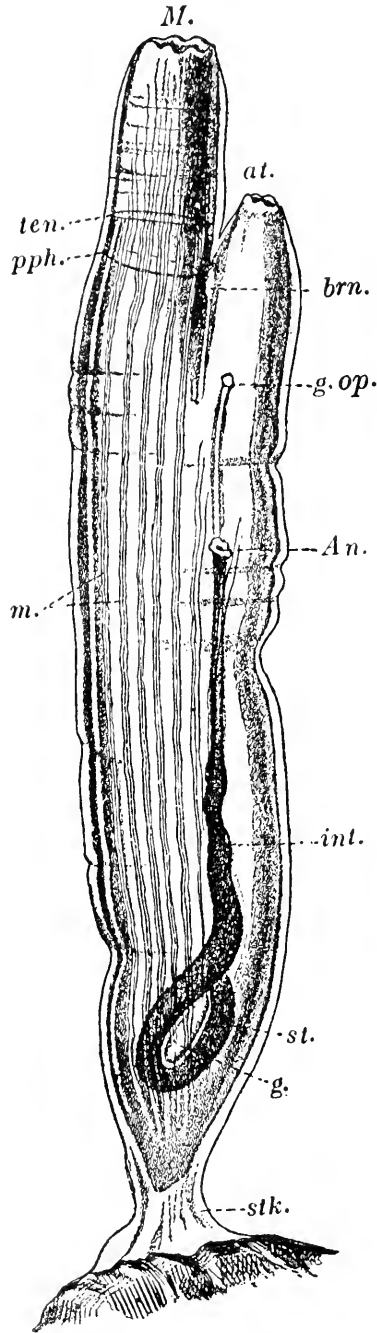

Fig. 468. *Ciona intestinalis*. From Shipley and MacBride. The live animal seen in its test; some of the organs can be seen, as the test is semitransparent. *An.* anus; *at.* atrial orifice; *brn.* brain; *g.* reproductive organs; *g.op.* genital openings; *int.* intestine; *M.* mouth; *m.* muscles; *pph.* peripharyngeal ring; *st.* stomach; *stk.* stalk attached to a rock; *ten.* tentacular ring.

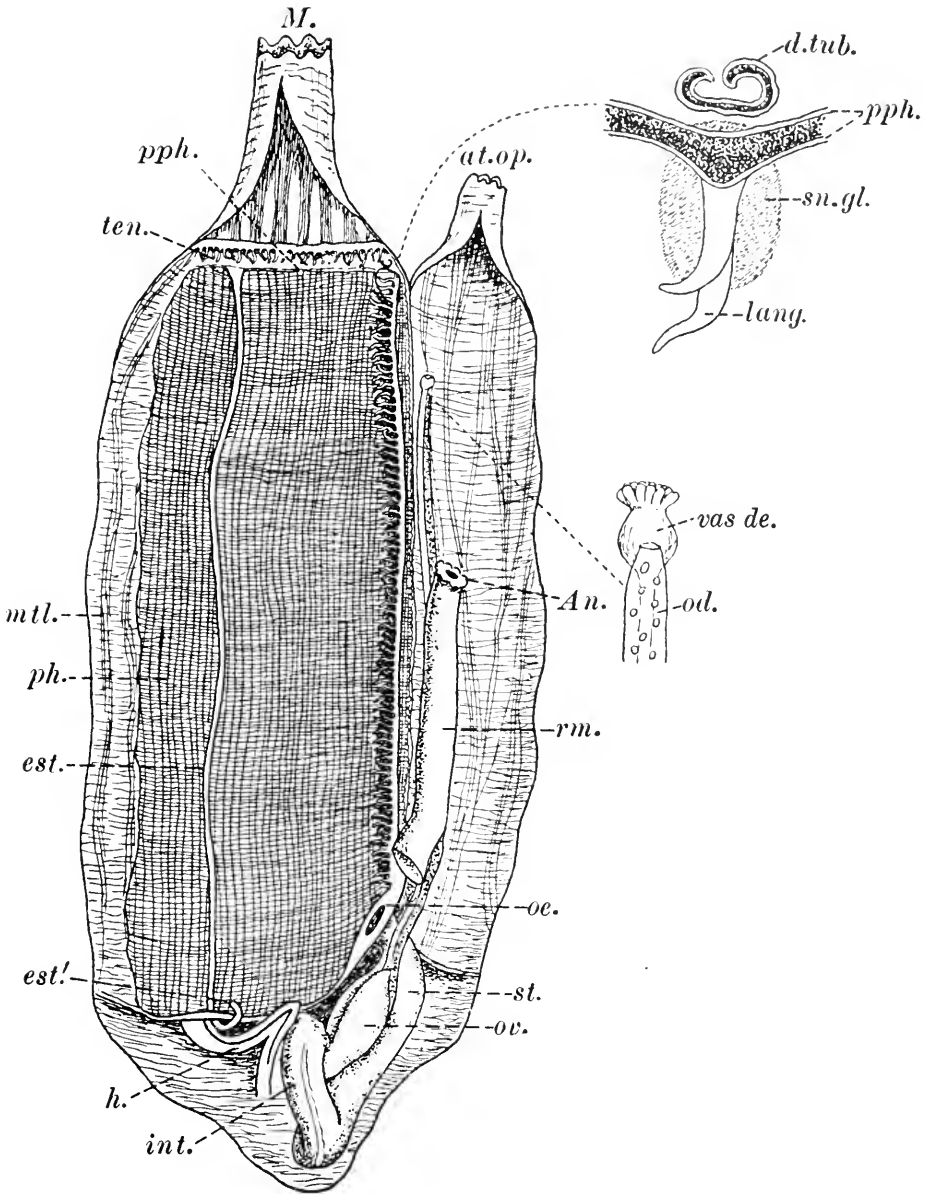

Fig. 469. *Ciona intestinalis* dissected from the left side. The atrial cavity and the pharynx have both been opened by longitudinal incisions, and part of the intestine cut away. An. anus; at.op. atrial opening; d.tub. dorsal tubercle; est. endostyle; est.' caecum of the same; h. heart; int. intestine; lang. languet; M. mouth; mtl. mantle; od. oviduct; oe. opening from pharynx to oesophagus; ov. ovary; ph. pharynx; pph. peripharyngeal ridges and groove; rm. rectum; sn.gl. subneural gland; st. stomach; ten. tentacles; vas de. vas deferens.

the pharynx, with a groove between them. In the dorsal middle line of the prebranchial zone stands the *dorsal tubercle*. This is the protuberant, horseshoe-shaped opening of a *ciliated funnel* which receives the duct of a *subneural gland* that lies under the brain. The function of the gland is unknown. The funnel is innervated from the brain and is supposed to be sensory.

The rest of the pharynx constitutes the spacious *branchial chamber*. The lateral walls of this chamber consist of a basket work, formed by the subdivision of the original gill clefts. The openings of the basket work (Fig. 470) are known as *stigmata*. They are longitudinally elongate and stand in transverse (dorsoventral) rows. Between them are *transverse* and *longitudinal bars*. The inner surface of this basket

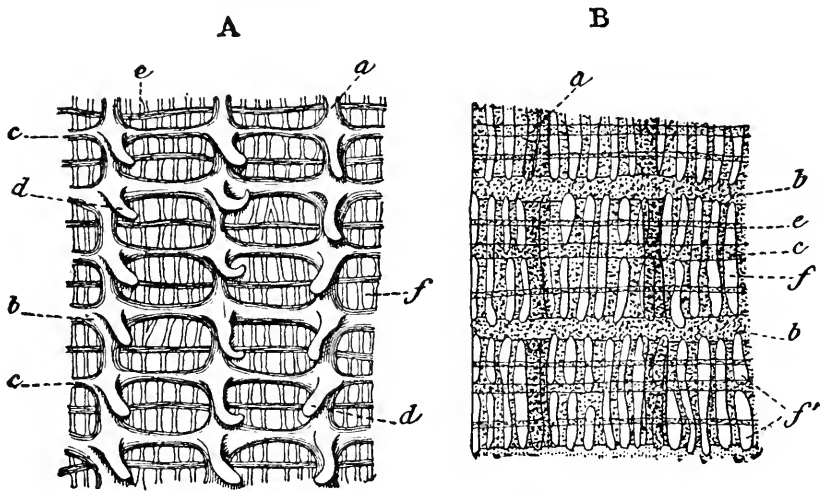

Fig. 470. Portions of the pharyngeal wall of *Ciona intestinalis*. From Sedgwick, after Vogt and Yung. A, From within. B, From the outside. *a*, internal longitudinal bar; *b*, transverse bars of the first order; *c*, transverse bars of the second order; *d*, papillae; *e*, transverse bars of the third order; *f*, *f'*, stigmata.

work is crossed by *internal longitudinal bars*, slung from it and bearing papillae which project into the branchial cavity. All the bars of this apparatus are hollow and contain blood. The epithelium which covers them is ciliated, the cilia being longer on the sides of the stigmata. Ventrally the basket-work walls are separated by a narrow, longitudinal, imperforate tract known as the *endostyle*. This is folded into a groove (Fig. 471) lined by an epithelium which is glandular and ciliated in alternate longitudinal strips, arranged in a manner similar to those in the endostyle of *Amphioxus*. To right and left a ciliated strip runs beside the groove. Posteriorly the groove passes into a caecum and the lateral ciliated strips curve up, as the *retropharyngeal band*, to the opening of the oesophagus, which is dorsal at the hinder

end. Anteriorly, the same strips are continuous with the posterior peripharyngeal ridge, on each side of a gap in the latter. Dorsally, the lateral walls are separated by a *hyperpharyngeal band*, from which there hangs down into the branchial cavity a row of processes, the *languets*, which are curved to one side.

The stigmata lead, not directly to the exterior, but into a cavity, the *atrium*, which opens externally at the atrial opening, is lined by ectoderm, and is placed dorsally like a saddle upon the branchial chamber, surrounding the latter completely except (a) in front, and (b) in the median line ventrally, posteriorly, and for a short distance from the front end dorsally. The atrium is crossed by vascular trabeculae from the branchial basket work to the mantle. Its median dorsal

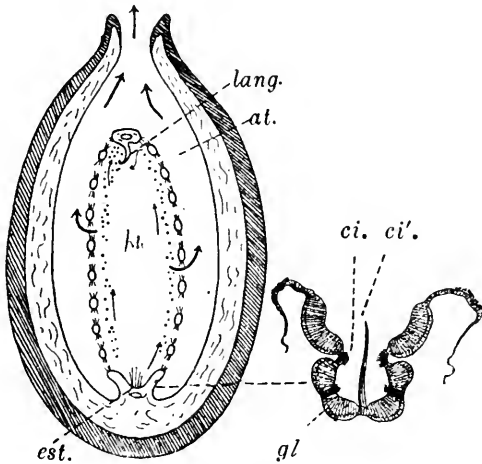

Fig. 471. A diagram of a transverse section of *Ciona*, with an enlarged view of the endostyle. The thick arrows show the course of the main current, the thin arrows that of the food particles. *at.* atrium; *ci.*, *ci.'* short and long cilia; *est.* endostyle; *gl.* gland cells; *lang.* languet.

part is known as the *cloaca*, the parts at the sides of the branchial chamber as the *peribranchial* cavities. One important difference between this atrium and that of *Amphioxus* should be noted. The atrium of the Cephalochorda is ventral: that of the Tunicata is dorsal.

By the apparatus just described the animal feeds. The working of the cilia at the sides of the stigmata drives water through the latter, from the pharynx to the atrium, whence it passes out by the atrial opening as the current which has already been mentioned. This results in water being drawn in through the mouth to replenish the pharynx. Mucus secreted by the gland cells of the endostyle is by the cilia of that organ passed on to the inner face of the branchial basket work, over which by further ciliary action it is passed to the dorsal languets. These receive it with their curved ends, slung in which it is

worked backwards as a rope to the oesophagus. As it passes over the pharyngeal wall particles brought in with the current through the mouth are entangled in it, to be carried to the hinder part of the alimentary canal and there digested if they be fit for food. A similar function is performed by mucus which passes dorsalwards along the peripharyngeal band.

The short *oesophagus* leads backwards to a fusiform *stomach*. From this an *intestine*, whose ventral wall projects inwards as the typhlosole does on the dorsal side of the intestine of the earthworm, loops forwards to become the *rectum*, which runs a straight course half-way along the atrium, lying near the dorsal side of the pharynx. The epithelium of the digestive part of the alimentary canal is ciliated, and a gland ramifies in the wall of the stomach, into which it opens by a duct. The faeces are cast out by the outgoing current from the atrium.

The stomach and intestine lie in a section of the body known as the *abdomen*, which is behind (basal to) the region (called the *thorax*) in which the pharynx and atrium are situated. The viscera just mentioned are enclosed in a perivisceral space, known as the *epicardial cavity*, which is of a very peculiar kind, since it is formed by two thin-walled outgrowths from the pharynx, one on each side of the retropharyngeal band. Epicardial diverticula of the pharynx are found in many tunicates (p. 677), but it is only in *Ciona* that they expand and form a perivisceral cavity, applying their walls as a peritoneum to the contained organs. In this cavity lies also the *heart*, a V-shaped tube placed in the intestinal loop, near the hinder end of the endostyle. The heart has no proper wall but is formed by the folding-in of one side of the tubular *pericardium*, which on this side is muscular. The other *blood vessels* also have no walls of their own, but are mere vacuities between various structures. In these respects the Tunicata resemble the Hemichorda (see p. 666). Each end of the heart is continuous with a blood vessel. The vessel from one end runs forwards under the endostyle and communicates with the blood spaces in the branchial bars: these in turn join a vessel, in the hyperpharyngeal band, which gives off branches to the digestive organs, gonads, and body wall. To these same organs runs the vessel from the opposite end of the heart. The course of the circulation is remarkable. The heart for several beats drives the blood towards one end and then reverses its action. Thus the blood passes, at one time, like that of a fish, through the gills to the rest of the system, and at another in the opposite direction. The plasma is colourless, but contains nucleated corpuscles, some of which are of various colours owing, remarkably enough, to the presence of compounds of vanadium.

The animal is a hermaphrodite. The *ovary* lies between the stomach

and intestine as a compact mass; the *testis* ramifies over the stomach and intestine. The *genital ducts* run side by side along the rectum and at some distance beyond its end open into the cloaca. The vas deferens is the narrower, and has a patch of red excretory cells around its enlarged end, where it opens by a rosette of small pores. Fertilization takes place in the water, and the spermatozoa will not unite with ova from the same individual.

The *central nervous system* is reduced to a single elongated solid ganglion (brain) on the dorsal side between mouth and atrial opening. From its ends nerves are given off. There are no organs of special sense unless the pigment spots between the lobes of the mouth be functional for the perception of light.

Not the least striking feature of the remarkable organization which has just been described is the absence of any space that can with certainty be identified as *coelom*. Epicardium, pericardium, the cavities of the gonads, and even those of the closed excretory vesicles that lie around the intestine in many ascidians have been held to be of that nature, but there is no uncontroversial evidence on this point concerning any of them. Nephridia are also absent. *Excretion*, so far as is known, is performed only by the cells mentioned above, which store urates as solid concretions.

So far, the student will have seen little ground for regarding *Ciona* as a chordate animal. When, however, we turn to consider its *life history*, no doubt remains upon this point. The *eggs* are small, though they contain some yolk; their cleavage is total and at first nearly equal. The *early stages* of development much resemble those of *Amphioxus*, but differ in that the cells which are to form the rudiments of various organs are very early recognizable (determinate cleavage), and that the mesoderm, which arises from the sides of the archenteron, does so, not as pouches, but as clumps of cells. Eventually there is formed a *larva*, about a quarter of an inch in length, which is known as the *Appendicularia* larva, and often as the "ascidian tadpole". This creature (Fig. 472 A) has a *tail* about four times as long as its *trunk*. In the tail are a notochord, a hollow dorsal nerve cord, a muscle band on each side, and a few mesenchyme cells. Dorsal and ventral median flaps of the test serve as fins, the tail being a swimming organ. In the trunk, notochord and muscle bands are lacking, and along with the alimentary canal the brain and pericardium are found. The mouth lies dorsally at some little distance from the front end. It leads through a short oesophagus into a large pharynx, in which the endostyle is already well developed. There is no branchial basket work, but on each side a gill slit leads from the pharynx into an ectodermal pouch, which in turn opens dorsolaterally. Later the two pouches become united above the pharynx and thus the atrium comes into existence.

Meanwhile the gill clefts increase in number by the breaking through from the pharynx of new clefts and the subdivision of existing clefts, in the course of which they pass through a **U**-stage with tongue bars. (The basket work is ultimately established by the formation across each gill cleft of longitudinal bars which divide it into stigmata.) From the pharynx leads the rest of the alimentary canal, which early shows rudiments of oesophagus, stomach, and intestine, the latter curving dorsally and eventually opening into the left half of the atrium.

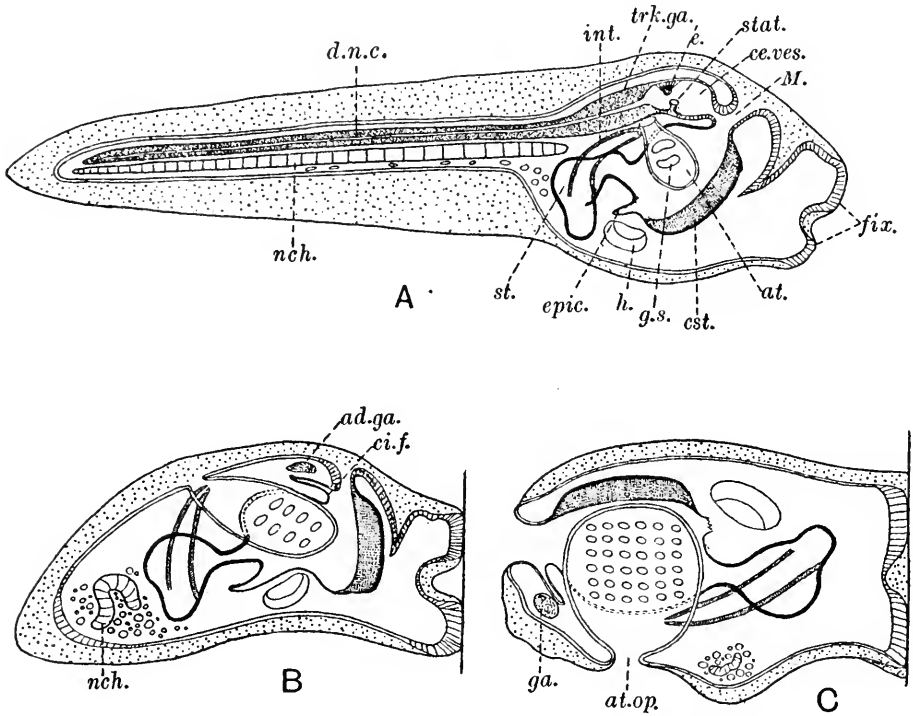

Fig. 472. Diagrams of the metamorphosis of an ascidian larva. A, The larva at the time of fixation. B, Midway in the metamorphosis. C, The metamorphosis completed. *ad.ga.* adult ganglion; *at.* right rudiment of the atrium; *at.op.* atrial opening; *ce.ves.* cerebral vesicle; *ci.f.* ciliary funnel; *d.n.c.* dorsal nerve cord; *e.* eye; *epic.* epicardium; *est.* endostyle; *fix.* fixation papillae; *ga.* ganglion; *g.s.* gill slits; *h.* heart; *int.* intestine; *M.* mouth; *nch.* notochord; *st.* stomach; *stat.* statolith; *trk.ga.* trunk ganglion.

The dorsal nerve tube of the tail is in the trunk enlarged to form the brain. The hinder part of this is thick-walled and is known as the *trunk ganglion* (it does not become the "ganglion" of the adult). The anterior part is larger than the trunk ganglion and for the most part thin-walled, and is known as the *cerebral vesicle*. Dorsally on the right it is differentiated to form the eye, a cup whose cavity is directed inwards, filled with pigment. On the floor a stalk projecting into the vesicle carries a concretion, the *statolith*, probably a sense organ for



balance. Presently the vesicle acquires an opening into the dorsal side of the pharynx, near the mouth. The *pericardium* arises towards the end of larval life as an outgrowth from the ventral side of the pharynx. It does not form the heart until metamorphosis. The front end of the body is a prominent *chin*, and bears three *fixation papillae* of glandular cells. Except for the tips of these papillae, the animal is entirely covered with test, which even closes the mouth, so that feeding is impossible. After swimming for a short time, the larva fixes itself to some solid object by the papillae, and proceeds to undergo a metamorphosis (Fig. 472 B, C), by which it assumes the adult form. The tail is devoured from within by phagocytes. By growth in the region between the chin and the mouth, the latter and the atrial opening are shifted back until they point upwards from the region of fixation. Meanwhile, the central nervous system degenerates, save for certain portions of the cerebral vesicle, which forms from its hinder region the ganglion of the adult and from its ventral and anterior region the subneural gland and the ciliated funnel; the pharynx develops in the way described above; the heart is formed; the epicardial diverticula grow out from the pharynx; and the gonads arise from a mass of mesoderm.

*Ciona* is a solitary animal. Some other tunicates resemble it in this respect, but a large number establish by budding *colonies* of zooids, each zooid having the essential features of an individual of *Ciona*. In a few cases (*Perophora*, Fig. 476), the zooids are free from one another save at their bases, where they are united by the stolon from which they were formed. In most genera, however, the zooids of a colony are imbedded in a common test, with only the mouths and cloacal openings at the surface (Figs. 473, 477). In such cases the original connection between the zooids is lost, though their atrial openings usually join in a common cloaca. In the pelagic genera *Salpa* and *Doliolum* and their relatives buds are formed but, instead of remaining together as a colony, eventually become free and lead a solitary existence.

*Budding* is accomplished in various ways. (a) It most often takes place from a *stolon*, which is a median ventral, tubular outgrowth of the visceral (abdominal) region of the parent, usually containing an inner tube that consists of the united distal portions of the two epicardial diverticula of the pharynx, and some mesenchyme cells in a blood space between this tube and the stolon wall. The epicardial tube will form the alimentary canal of the buds. Often it also forms the atrium and the nervous system. In the class Thaliacea, however (see below), the stolon is more complex and contains special tubes or strands of cells for the atrium and gonads and sometimes also for the nervous system. (b) In other cases (*Perophora* and *Clavelina*) the stolon con-

tains, not an epicardial tube, but a longitudinal septum of mesoderm; and the internal organs of the bud are formed by the complication of a vesicle which arises by the hollowing out of a mass of mesoderm that comes into being in a swelling at the end of the stolon. (c) In *Botryllus* and its allies budding is effected in yet another way. These

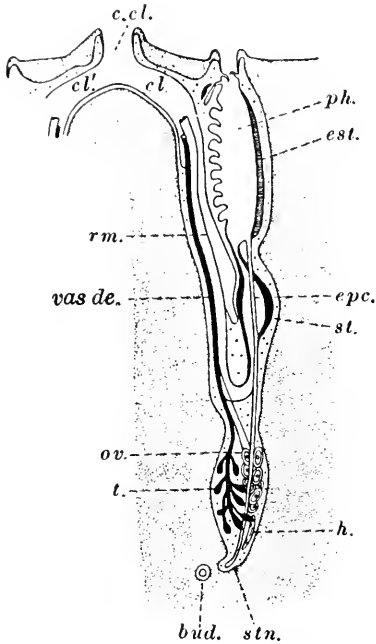

Fig. 473.

Fig. 473. A diagram of a zoid, with a portion of one of its neighbours, imbedded in an ascidian colony. The shaded area is the common test. *bud.* newly formed bud; *c.cl.* common cloaca; *cl., cl.'* cloacas of two zoids; *epc.* epicardium; *est.* endostyle; *h.* heart; *ov.* ovary; *ph.* pharynx; *rm.* rectum; *st.* stomach; *stn.* stolon; *t.* testis; *vas de.* vas deferens.

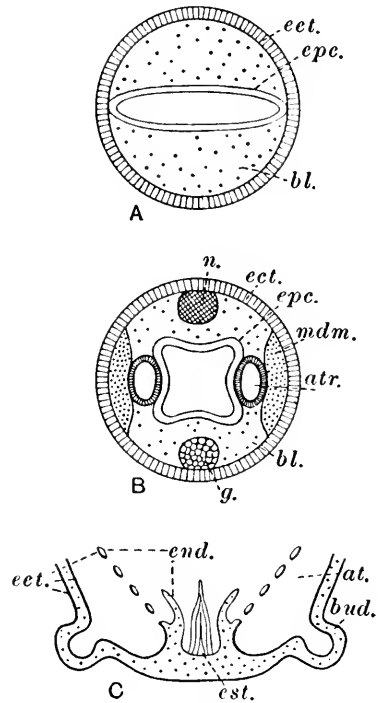

Fig. 474.

Fig. 474. Diagrams of the budding of tunicates. A, transverse section of the stolon of a zoid such as that shown in Fig. 473; B, similar section of stolon of *Pyrosoma* or *Salpa*; C, part of a transverse section of a zoid of *Botryllus*. *at.* atrium; *atr.* tube from which atrium is formed; *bl.* blood space; *bud.* bud arising; *ect.* ectoderm; *end.* endoderm; *epc.* epicardium; *est.* endostyle; *g.* strand from which gonads are formed; *mdm.* mesoderm strand; *n.* strand from which ganglia are formed.

genera, which, unlike *Ciona* but like most solitary ascidians, possess no epicardium (epicardial diverticula), form their buds by paired outgrowths that are of quite a different kind from the stolon, for they arise from the atrial wall and each contains an inner vesicle which is a prolongation of the epithelium that lines the atrium of the parent: this vesicle forms the internal organs as well as the atrium of the bud.

It should be noticed that in budding the origin of the organs takes place without regard to the germ layers from which they arise in the development of the ovum, for the endodermal inner tube of ordinary stolonial budding often forms atrium and nervous system, which should be of ectodermal origin, and the ectodermal (atrial) inner vesicle of the "pallial" budding of *Botryllus* forms the alimentary canal, which should be endodermal, while in *Perophora* and *Clavelina* all these organs arise from a mass of mesoderm.

A zooid which arises by budding is known as a *blastozooid* (*blastozoite*): one which arises from an ovum is an *oozooid*. The oozooid, which in the Thaliacea differs considerably from the blastozooid, has always lost the power of sexual reproduction. In the Salpida and Doliolida the blastozooid has lost the power of budding, so that there is a regular alternation of generations.

The Tunicata fall into three *classes*. Of these, one, the *Larvacea*, only comprises a few little animals which spend the whole of their lives in the larval condition, developing genital organs and reproducing without metamorphosis. The other two classes both attain the adult form, but whereas in one of them—the *Ascidiacea*—the animals are sedentary and have both branchial and atrial openings directed away from the substratum, the members of the other—the *Thaliacea*—are pelagic and swim by driving water out of the atrial opening, which is at the opposite end of the body from the mouth.

### Class LARVACEA

Tunicata in which the sexually mature form retains the organization of the larva.

The test is not composed of tunicin. It forms a remarkable "house" that does not adhere to the animal, which from time to time leaves it and secretes a new one. The habitat is pelagic, and food is filtered from the water by an apparatus which forms part of the house and through which water is caused to flow by the movements of the tail.

The organization of the animal differs from that of the ascidian larva described above in various points, of which the following are the most important. Gonads are present in the hinder region of the body: nearly always they are hermaphrodite and protandrous. The tail is attached to the ventral side, near the hinder end of the body. The two simple gill clefts open ventrolaterally directly to the exterior. The intestine also opens directly to the exterior, ventrally or on the right-hand side. The brain is a compact fusiform ganglion, and the existence of a cavity in it or in the nerve cord is doubtful. There is no eye and a statocyst lies beside the brain on the left. In certain of these respects the animal resembles the larva of *Doliolum* (Fig. 483 A).

The Larvacea are now generally regarded as an instance of neoteny (p. 144).

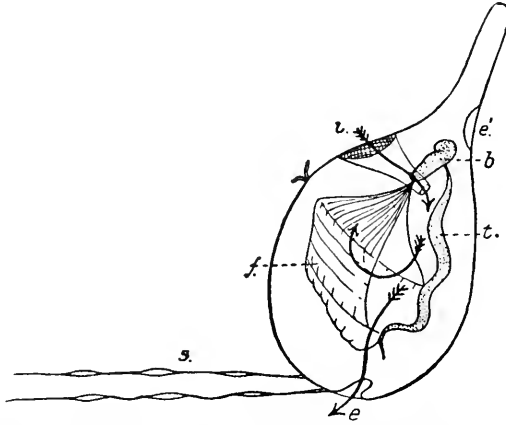

Fig. 475. *Oikopleura albicans* in its house. Magnified. From Borradaile. *b.* the body of the animal; *t.* its tail. Movements of the tail cause water to enter through two funnels (*i*) provided with gratings by which coarse particles are strained out. The water is directed (curved arrow) through a filtering apparatus (*f*) which removes food particles: these are sucked out of the filter by the animal. When the pressure rises sufficiently, the water opens a spring door (*e*) at the broad end and passes out (wavy arrow), driving the house in the opposite direction. The animal can escape by pushing open a door (*e'*) at the base of the beak. It does not return, but secretes a new house. *s.* streamers on the house.

*Oikopleura* (Figs. 43A, 475). Common in British waters.

### Class ASCIDIACEA

Tunicata in which the adult is sedentary and has no tail; a degenerate nervous system; an atrium which opens dorsally; a stolon (if any) of simple structure; and several gill clefts, which are nearly always divided into stigmata by external longitudinal bars.

The colonial members of this group are known as "compound ascidians" and are sometimes classed together as *Ascidiae compositae*. But they are not of one origin; some of them have stolonial budding and dorsal languets and are related to such solitary forms as *Ciona*; the others, with pallial budding and a continuous *dorsal lamina* in place of the languets, are related to solitary forms, such as *Ascidia*, which have no epicardium and possess a dorsal lamina.

*Ciona* (Figs. 468-471). Described above.

*Clavelina*. Resembles *Ciona* in general features but has a stolon and forms clusters of individuals by the breaking off of buds from the ends of the stolon branches; the stolon has a mesodermal septum; the zooids and their tests are free from one another.

*Polyclinum*. As *Clavelina*; but the stolon contains an epicardial tube; and the zooids are imbedded in a common test with only the branchial and atrial openings at the surface.

*Ascidia*. Solitary; without epicardium; with the viscera at the side of the body, not in an abdomen; with dorsal lamina in place of languets. British.

*Perophora* (Fig. 476). Colonial; the zooids are free from one another but connected at their bases by a stolon with a mesodermal septum; and have dorsal lamina and viscera at the side as in *Ascidia*.

*Botryllus* (Fig. 477). Colonial; the zooids imbedded as in *Polyclinum*; but with pallial budding; and with dorsal lamina, and viscera at the side.

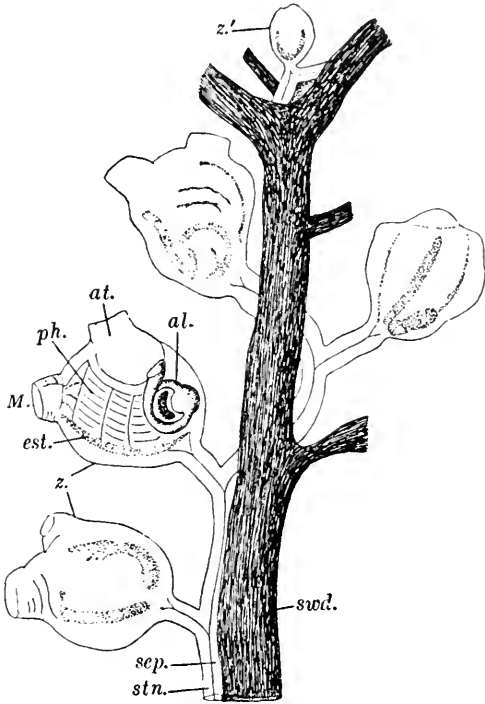

Fig. 476.

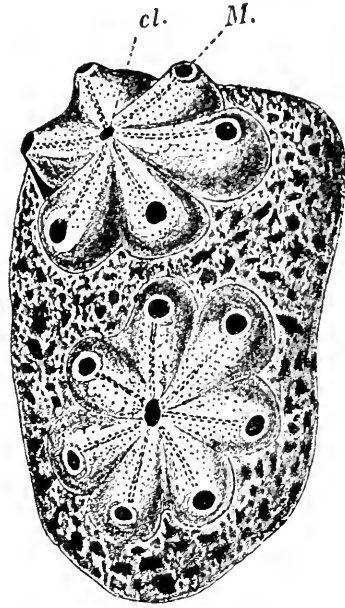

Fig. 477.

Fig. 476. Part of a colony of *Perophora*. After Lister, with modifications. *al.* alimentary canal; *at.* atrium; *est.* endostyle; *M.* mouth; *ph.* pharynx; *sep.* septum of stolon; *stn.* stolon; *swd.* seaweed on which the colony is growing; *z.* zooids; *z'.* young zooid.

Fig. 477. Two groups of individuals of *Botryllus violaceus*. Magnified. After Milne Edwards. *cl.* opening of common cloaca of the group; *M.* mouth opening.

### Class THALIACEA

Pelagic Tunicata in which the adult has no tail; a degenerate nervous system; an atrium which opens posteriorly; a stolon of complex structure; and gill clefts which are not divided by external longitudinal bars.

Thus defined, the group includes the Pyrosomatida (Luciae), which are transitional from the Ascidiacea, with which they are usually placed, though by their essential peculiarities they belong

here. The three orders of the class differ considerably, though two of them (*Pyrosomatida* and *Salpida*) are more nearly related to one another than either is to the third (*Doliolida*).

In all, the *muscular strands* of the mantle are arranged as rings which encircle the barrel- or lemon-shaped body. These are complete, but feeble and present at the ends of the body only, in *Pyrosoma*, strong but usually incomplete ventrally and convergent dorsally in

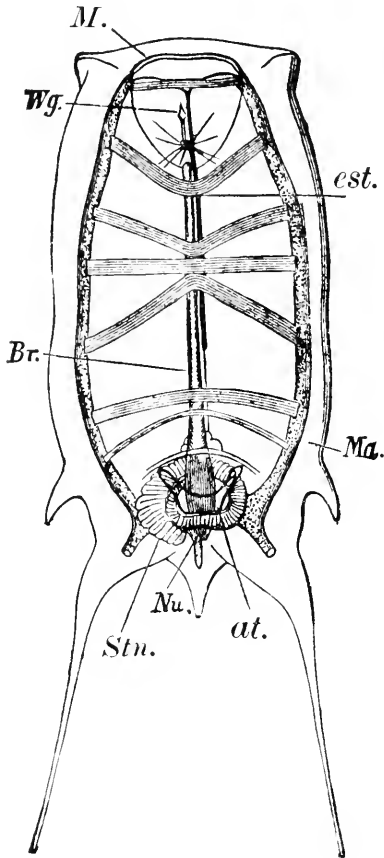

Fig. 478.

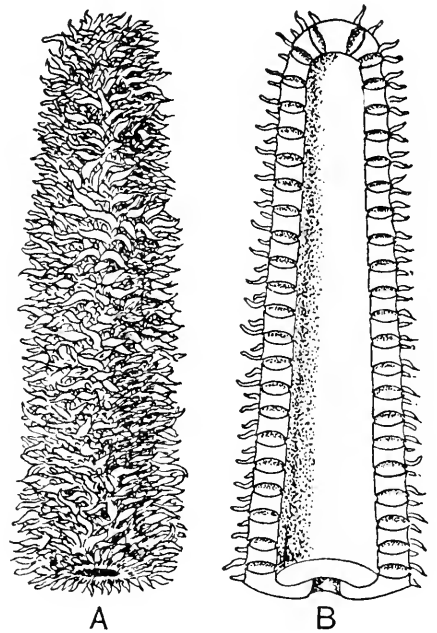

Fig. 479.

Fig. 478. The asexual form (oozoid) of *Salpa democratica-mucronata*. From Sedgwick, after Claus. *at.* atrial opening; *Br.* "gill" (hyperpharyngeal band); *est.* endostyle; *M.* mouth; *Ma.* test; *Nu.* "nucleus"; *Stn.* stolon; *Wg.* ciliated pit.

Fig. 479. *Pyrosoma*. A, A colony. B, The same cut open longitudinally.

the *Salpida* (Fig. 478), strong, complete and regular in the *Doliolida* (Fig. 483). Their contractions cause (in *Pyrosoma*, assist) the locomotion of the animal by driving water from the atrial opening—in the *Salpida* and *Doliolida* direct to the exterior, in *Pyrosoma* (Fig. 479) into the lumen of a cylindrical colony and thence through the

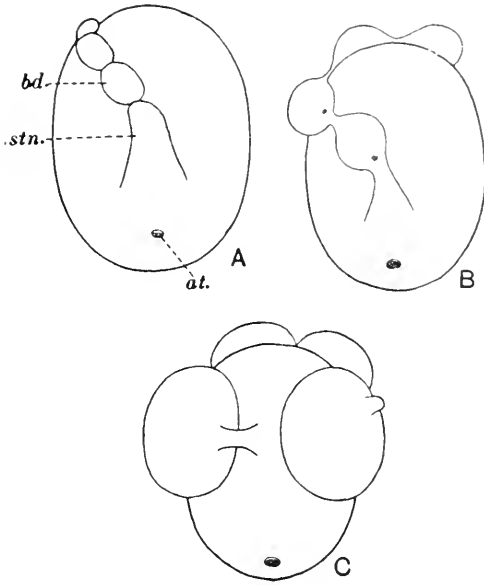

Fig. 480. A diagram of the budding of the first individuals of a colony of *Pyrosoma* by the cyathozoid. A, B, C, Successive stages. *at.* atrial opening of cyathozoid; *bd.* bud; *stn.* stolon.

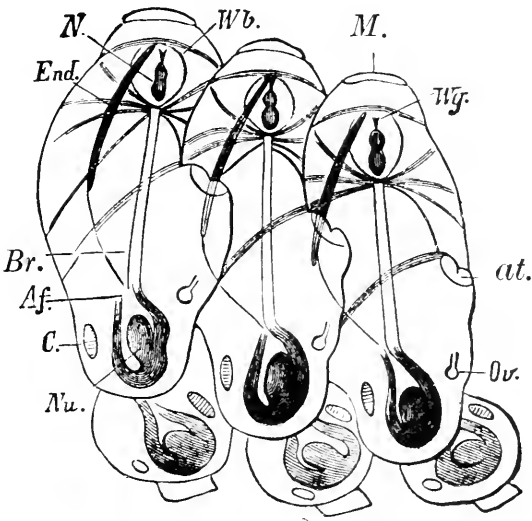

Fig. 481. The end of a stolon of *Salpa democratia-mucronata*, showing part of chain of young sexual individuals (blastozooids) about to be set free. From Sedgwick, after Claus. *at.* atrial opening of a zooid; *Af.* anus; *Br.* "gill"; *C.* heart; *End.* endostyle; *M.* mouth; *N.* ganglion; *Nu.* "nucleus"; *Ov.* ovary; *Wb.* peripharyngeal band; *Wg.* ciliated funnel.

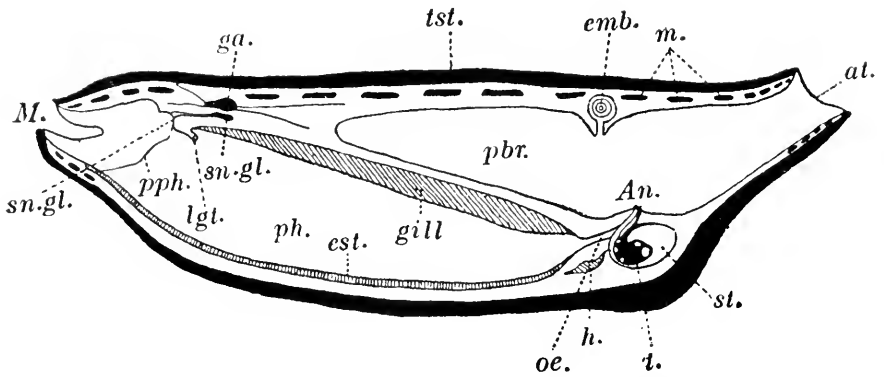

Fig. 482. A semidiagrammatic view of left side of *Salpa*. From Herdman. *An.* anus; *at.* atrial aperture; *emb.* embryo in ovisac; *est.* endostyle; *gill*, "gill" (hyperpharyngeal band); *ga.* nerve ganglion; *h.* heart; *lgt.* the single languet; *M.* branchial aperture; *m.* muscle bands; *oe.* oesophagus; *pbr.* peribranchial cavity; *ph.* pharynx; *pph.* peripharyngeal band; *sn.gl.* subneural gland; *st.* stomach; *t.* testes; *tst.* test.

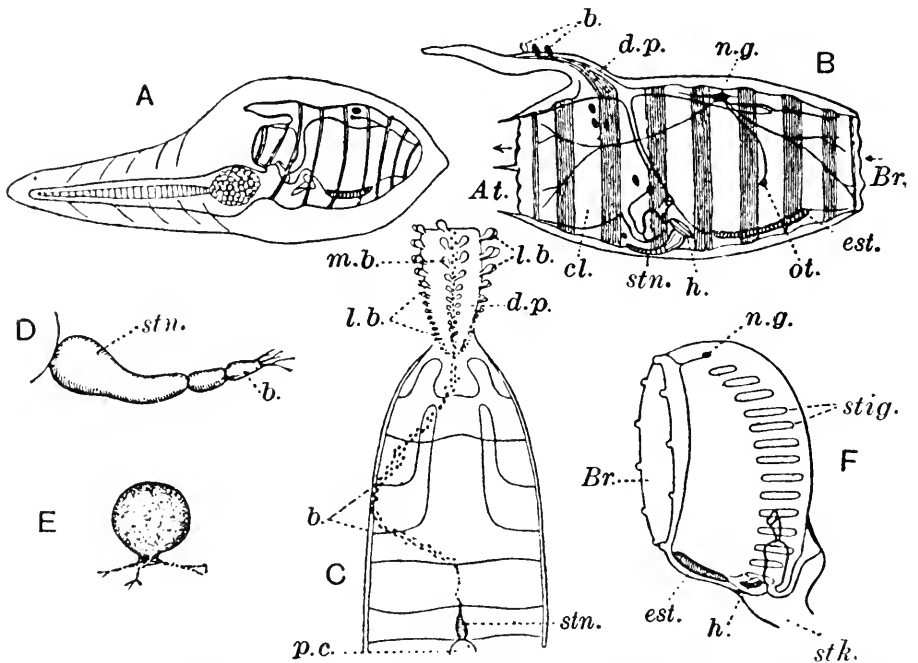

Fig. 483. *Doliolum* and its life history. From the *Cambridge Natural History*, after Uljanin and Barrois. A, The larva, from the right-hand side. B, The same view of the adult asexual individual (oozoid). C, Dorsal view of the hinder region of an older oozoid, more highly magnified. D, Stolon, more highly magnified. E, Probud est in migration, more highly magnified. F, Gasterozoid. *At.* atrial opening; *b.* probuds; *Br.* branchial opening; *cl.* cloaca; *d.p.* dorsal process (cadophore); *est.* endostyle; *h.* heart; *l.b.* lateral buds; *m.b.* median buds; *n.g.* nerve ganglion; *ot.* otocyst; *p.c.* pericardial cavity; *stig.* stigmata; *stk.* stalk; *stn.* stolon.



single external opening of the latter. The *gill clefts* are in *Pyrosoma* numerous (up to fifty), tall dorsoventrally, and crossed by internal, though not by external, longitudinal bars. In the *Salpida* the first-formed cleft persists and becomes in the adult a single gigantic opening which occupies the entire side of the pharynx. The *Doliolida* have a varying number (few in the oozoid, more numerous in the blastozoid) of short openings.

In *Pyrosoma* and the *Salpida* the egg is retained long in the parent: in *Pyrosoma* it is yolky and meroblastic; in the *Salpida* the embryo is nourished through a placenta. Development is direct, the tailed larval stage being omitted; and the buds formed by the oozoid on its stolon (which has a single epicardial tube) hang together for some time as a chain. In *Pyrosoma* this chain (of four zooids) coils into a circle around the body of the degenerate oozoid (*cyathozoid*, Fig. 480), and its members then bud in such a way as to form a cylindrical colony, closed at one end, composed of blastozoids. This is the form in which the animals pass their free existence, the oozoid never leaving the body of its parent. In the *Salpida* oozoid and blastozoids are alike well developed and free swimming, and the blastozoids, of which there is a long chain, though they may coil into a circle (*Cyclosalpa*), are incapable of budding and eventually break away in groups (Fig. 481). In the *Doliolida* there is a tailed larva, and the buds formed on the stolon (in which the epicardial tubes remain separate) break free one by one, though they subsequently make attachment to a dorsal process of the mother, by whom they are carried for some time.

#### Order PYROSOMATIDA (LUCIAE)

Thaliacea which have no larval stage; whose oozoid is degenerate and retained within the parent; whose stolon contains a single epicardial tube; and whose blastozoids at first form a short chain, but subsequently by budding constitute a cylindrical colony of ascidian-like individuals.

*Pyrosoma* (Fig. 479). The only genus. The colonies vary in length from an inch or two to several feet, and are phosphorescent, from which fact the generic name is derived.

#### Order SALPIDA (HEMIMYARIA)

Thaliacea which have no larval stage; whose oozoid is well formed and free; whose pharynx has no lateral walls, owing to enlargement of the primary pair of gill clefts; and whose blastozoids are incapable of budding, but adhere as a chain from which they eventually break free in groups.

All that is left of the walls of the branchial chamber (Fig. 482) is the endostyle and a dorsal (hyperpharyngeal) bar, known as the "gill", which runs in a slanting direction along an immense internal cavity formed by the confluence of the branchial and atrial chambers through the absence of lateral branchial walls. The animal is as transparent as glass, save for a small, coloured "nucleus" where the stomach and intestine are situated.

*Salpa* (Figs. 478, 481). The chain of blastozooids is band-like.

*Cyclosalpa*. The chain of blastozooids forms rings.

#### Order DOLIOLIDA (CYCLOMYARIA)

Thaliacea which have a tailed larval stage; whose oozoid is well formed and free; whose pharynx has several stigmata on each side; and whose blastozooids break free one by one from the stolon as buds which subsequently make attachment to a dorsal process (cadophore) of the parent, by whom they are carried for some time.

The larva has the barrel-shaped body of the adult with a tail attached ventrally at the hinder end: it lies free in its test. Dorsally behind it has already the rudiment of the cadophore. In the adult oozoid the cadophore elongates, as the buds, wandering round the body from the ventral stolon, begin to settle down and develop. The bodies which break off from the stolon are known as *probuds*. They travel by the pseudopodial activity of certain of their ectoderm cells, and on arriving upon the cadophore divide several times to form the definitive buds. These fasten themselves in a lateral and a median row on each side. Eventually they grow into individuals of three kinds, which co-operate in a remarkable manner. Those of the lateral row become *gasterozooids* which gather food for the community, those of the median row *phorozooids* which act as nurses, and others *gonozooids* carried by the phorozooids. The latter presently break free with their charges, which are ultimately liberated to reproduce sexually.

*Doliolum* (Fig. 483).

# I N D E X

Names of genera and species are printed in italics.

The figures in thick type refer to illustrations upon the pages indicated. References to details of illustrations are only given in special cases.

When the first of several figures after a word is followed by a semicolon it indicates the principal reference to the subject.

An asterisk (\*) signifies that some of the series of figures which immediately follow it refer to particular genera only.

Reference to the summaries of the characteristics of the groups is only made when information there given is not to be found elsewhere.

Where the passage referred to extends over more than one page, as a rule only the first page is indicated.

- Abambulacral surface, 623  
Abdomen, of Arachnida, *see* Opisthosoma; of Arthropoda, 308; of Crustacea\*, 308, 330, 331, 332, 333, 353, 358, 360, 364, 368, 370, 372, 380, 385, 386, 387, 389, 395, 400, 403, 404, 410, 415; of Insecta\*, 308, 430, 457, 458, 460, 483, 486; of *Iulus*, 424; of Polychaeta, 270  
"Abdomen" of Tunicata, 674, 677  
Abdominal limbs, of Crustacea\*, 328-9, 331, 339, 360, 388, 391, 397, 401, 410, 415; of Insecta, 431, 458, 459, 463, 465; of *Iulus*, 424  
Abdominal region of *Balanoglossus*, 664  
Aboral aspect, side, or surface, 143; of Echinodermata, 623  
Aboral sinus system, 626, 627, 650  
Acantharia, 80, 81  
*Acanthobdella*, 300; 261, 296, **299**  
Acanthobdellidae, 300  
Acanthocephala, 258; 197, 244  
*Acanthocystis*, 40  
*Acanthometra*, 81; *elastica*, **82**  
*Acanthosoma*, **335**  
Acarina, 533; 517, 520  
Accessory nidamental gland, 591  
Acephalous larva, 508  
*Acerentomum doderoi*, 465  
Aciculum, 266  
*Acineta*, 116; 8, **9**; *grandis*, **9**; *lemnarum*, **9**  
*Acmaea*, 552, 563  
Acmaeidae, 565  
*Acoela*, 213, 215  
Acoelomate Triploblastica, 197  
Acontia, 189  
Acrothoracica, 382  
*Actaeon*, **564**, 567  
*Actinia*, 187; *mesembryanthemum*, 187  
*Actinoceras*, 604  
*Actinometra*, 654  
*Actinomma*, 81  
Actinomyxidea, 102; 100  
*Actinophrys*, 83; 27, 33 n.; *sol*, **84**, **85**  
*Actinosphaerium*, 86; 10, 20, 23, 28, 33, 40, 42, 83; *eichhorni*, **23**, **42**  
*Actinotrocha* larva, 622; 145, **621**  
Actinozoa, 180; 153  
*Actinula* larva, 159  
Actipylaea, *see* Acantharia  
Adambulacral ossicles, 636  
Adambulacral spines, 636  
Adductor muscles, of Cirripedia, 379; of claws, 142; of Conchostraca, 354; of Crustacea, 333; of Lamellibranchiata\*, 142, 573, 585; of Leptostraca, 390  
*Adelea*, 89  
Adephaga, 493  
Adoral wreath, 104  
*Aega*, 398; *psora*, **399**  
*Aeolosoma*, 293  
*Aeschna*, 444; *cyanea*, **473**  
Aesthetascs, *see* Olfactory hairs  
Aesthetes, 549  
Afferent branchial vein, 581  
Afferent canals, *see* Inhalant canals  
Agametes, 37  
Agamogony, 37; 88

- Agamonts, 36  
*Aggregata*, 89; **24**, 43  
 Alary muscles, 437, **438**  
 Alciopidae, 276, **276**  
*Alcippe*, 382  
 Alcyonaria, 180  
*Alcyonidium*, 613  
*Alcyonium*, 181; **181**, **188**; *digitatum*, 180  
*Alepas*, 382  
 Algae, Symbiotic, 47, 193  
 Alimentary canal, 130; of *Antedon*, 656; of Arachnida, 517; of Araneida, 530; of *Arenicola*, 272; of *Argas*, 534; of Arthropoda, 314; of Asteroidea, 636; of *Balanoglossus*, 664; of Brachiopoda, 616; of *Carcinus*, 412; of Chaetognatha, 618; of *Chirocephalus*, 358; of *Ciona*, 669; of Crustacea, 344; of *Cyclops*, 373; of *Daphnia*, 367; of Echinodermata, 626; of *Echinus*, 643; of *Gammarus*, 401; of Gastrotricha, 243; of *Helix*, 557; of Hirudinea, 297; of Holothuroidea, 650; of Insecta, 431; of *Iulus*, 424; of Lamellibranchiata, 578; of *Lepas*, 379; of *Ligia*, 397; of *Limulus*, 529; of *Lithobius*, 421; of Mollusca, 544, 550; of *Nebalia*, 391; of Nematoda, 248; of Nematomorpha, 257; of Nemertea, 235; of Oligochaeta, 287; of Ophiuroidea, 638; of Pantopoda, 539; of *Peripatus*, 320; of *Phoronis*, **621**; of Polyzoa, 606; of Pterobranchia, 668; of Rotifera, 240, 241; of Salpida, 685; of Scorpionidea, 522; of *Sepia*, 594; of Stomatopoda, 398; of *Stylaria*, 291; of Tardigrada, 539; of *Testacella*, 572; of the trochosphere, 282. *See also* Digestive system  
*Allantonema*, 256  
*Allogramma*, 76; 68; *oviformis*, 77  
 Alloiocoela, 214 n.  
*Allolobophora*, 286, 287  
 Alternation of generations, *see* Life cycle  
 Alveolar layer, 105  
 Alveoli, of digestive gland, 558; of protoplasm, 12  
*Amblyomma*, **534**  
 Ambulacra, 623  
 Ambulacral grooves, 623; 636, 655  
 Ambulacral ossicles, 634, 638, 645  
 Ambulacral surface, 623  
 Ametabola, 454. *See also* Apterygota  
 Aminoacids, 20, 52, 57, 131  
*Amiskwia*, 622  
 Amitoses of Protozoa, 24  
 Ammonoidea, 602, 604  
 Amnion, Insect, **453**; Nemertean, 236  
*Amoeba*, 69; 13, 19, 20, 28, 38; *discooides*, **70**; *dubia*, 70, **70**; *proteus*, 69; 19, **23**, 26, 36, 42, **70**  
 Amoebina, 68  
 Amoeboid movement, 15  
 Amoebulae, 38  
*Amphiblastula* larva, **125**  
*Amphilinea*, 225  
 Amphineura, 547  
 Amphinucleoli, 22  
*Amphioxus*, 129, 142, 145, 660, **661**, 672, 673, 675. *See also* Cephalochorda  
 Amphipneustic, 508  
 Amphipoda, 400  
*Amphitrite*, 264  
*Amphiura*, 640  
 Amphoridea, 658  
 Ampulla of stone canal, 647  
 Ampullae, of Hydrocorallinae, 165; of tube feet, 627  
*Ampullaria*, 563  
 Anaerobic animals, 140  
 Anal papilla, 655  
 Anal suture, 468  
*Anaphothrips striatus*, 485  
*Anaspides*, 392; 332, 334, 336, **337**; *tasmaniae*, **392**  
 Ancestral group of Protozoa, 44  
*Ancylostoma*, 254; 251, **252**  
*Andrena*, 492, 504, 514  
 Animal Kingdom, 1; 45  
 Animal pole, 281  
 Anisogamy, 31; **32**, 46, 56-8 (*passim*), 88. *See also* Gametes  
 Anisoptera, 472  
 Anisospores, 80  
 Annelid cross, 282  
 Annelida, 260; 1, 2  
 Annuli, of crustacean limbs, 336; of leeches, 297  
 Annulus of dinoflagellates, 54  
*Anodonta*, 574, **575**, 579, 580, 581, **581**, 582, 585  
 Anomopoda, 363; 355, 368

- Anomura, 404  
*Anopheles*, 509; *maculipennis*, 505;  
**444, 445**  
*Anoplophrya*, 107; *prolifera*, 108  
 Anoplura, 483  
 Anostraca, 356; 327, 354, 355, 360  
*Antedon*, 654, **657**; *bifida*, 654;  
*rosacea*, 654; **655**  
 Antennae, 306-7, 308, 309; First, of  
 Crustacea, *see* Antennules; of  
 Crustacea (second pair)\*, 327,  
 328-9, 332, 336, 339, 342, 354,  
 356, 359, 360, 362, 364, 369, 372,  
 373, 379, 380, 387, 390, 395, 397,  
 401, 410; of Insecta\*, 426, 463,  
 471, 474, 475, 476, 490, 492, 494,  
 495, 500, 509, 510, 511, 512; of  
 Myriapoda\*, 420, 422; of Trilo-  
 bita, 323; so called, of Rotifera,  
 240; of *Peripatus*, *see* Preantennae  
 Antennal glands, 345; **346**, 401, 414  
 Antennules, 326; 328-9, 332, 334,  
 339, 342, 356, 360, 364, 372, 378,  
 380, 382, 383, 385, 387, 388, 390,  
 395, 400, 410  
 Anterior aorta, of Araneida, 530; of  
*Carcinus* (ophthalmic artery), **412**;  
 of *Helix*, 556; of Insecta, 437; of  
 Lamellibranchiata, 580; of Scorpio-  
 nidea, 522; of *Sepia*, 593  
 Anterior cervical groove, **392**  
 Anterolateral edge, 408  
 Antheridia, 58, **59**  
 Anthomedusae, 154; 158, 160, **161**,  
 164. *See also* Gymnobiastea  
*Anthonomus grandis*, 493, 495  
*Anthophora*, 503  
 Anthozoa, *see* Actinozoa  
*Anthrenus museorum*, 436  
*Antipathes*, 386  
*Anurida maritima*, 465  
 Anus, 130; of Amphineura, 549; of  
*Balanoglossus*, 664; of Brachiopoda,  
 616; of Echinodermata\*, 623, 626,  
 631, 636, 639, 640, 647; of Echiuroi-  
 dea, 301; of Gasteropoda, 551; of  
 Gastrotricha, 243; of *Haliotis*, 564,  
 565; of *Helix*, 556; of *Lepas*, 379;  
 of Mollusca, 544; of Nemertea, 233,  
**234**; of Opisthobranchiata\*, 544,  
 567, 569; of *Peripatus*, 319; of Poly-  
 chaeta, 284; of Pterobranchia, 668;  
 of *Sepia*, 591; of Sipunculoidea,  
 304. *See also* Alimentary canal  
 Aorta, of Anostraca, 348; of *Helix*,  
 556. *See also* Anterior aorta,  
 Posterior aorta  
 Aperture, *see* Opening  
 Aphaniptera, 512  
 Aphididae, 478  
 Aphids, 439  
*Aphis*, 435; *rumicis*, 478; 474, **478**,  
 480; *saliceti*, 480  
*Aphodius*, 495  
*Aphrodite*, 267; 264, **267**, 268  
 Apical lobe, 338  
 Apical nervous system, of Crinoidea,  
 656; of Echinodermata, 630; of  
 Holothuroidea, 650  
 Apical organ, 282, 284, 611  
 Apical rosette of trochosphere, 282  
*Apis*, 497, 498, 503; *mellifica*, **432**,  
**438, 496**, 504  
 Aplacophora, 548  
*Aplysia*, 567; 554, **568**, 572  
 Apocrita, 500  
 Apoda, 382  
 Apodemes, 340  
 Apodous larvae, *see* Larvae  
 Apoidea, 503  
 Apoplastid phytomastigina, 47  
 Apopyles, 120  
 Appendages, Paired, *see* Limbs  
 Appendicularia larva, 675  
 Apposition image, 313  
*Apseudes*, 395, **396**  
 Apterygota, 463; 429, 431, 452  
*Apus*, 360; 328, 332, 333, **337**, 338,  
 362; cancriformis, 360; **361**  
 Aquatic oligochaets, 291  
 Arachnida, 515; 308  
 Araneida, 530  
*Arcella*, 72; 12, 28, **28**, 43, 68; *discoi-*  
*des*, **73**  
 Archenteron, 129; of polychaete em-  
 bryo, 282  
 Archiannelida, 294; 260  
 Archicerebrum, of Lankester, *see*  
 Procerebrum; *sensu stricto*, 309  
*Archigetes*, 230  
*Architeuthis*, 588  
 Arenaceous shells, 75  
*Arenicola*, 272; 263, 264, **267**, 275,  
 282; *marina*, 272; **273**, **274**  
*Argas*, 534; **534**; *persicus*, **535**, **536**  
*Argonauta*, 589, 599  
*Argulus*, 376; **377**; *americanus*, **377**;  
*foliaceus*, 376; **377**

- Argyroneta*, 531; **519**  
*Arion*, 570  
*Arista*, 477, 511  
*Aristocystis*, 658  
 Aristotle's lantern, 643; of *Echinus esculentus*, **644**  
*Armadillidium*, 397  
 Arms, of Brachiopoda, 615; of Crinoidea, 654; of Dibranchiata, 589, 594, 599, 600, 602; of Echinodermata, 624, 632; of Echinoderm larvae, 632, 633; of Pterobranchia, 668  
*Artemia salina*, 356, 359  
 Arterial system, of Araneida, 531; of *Carcinus*, 414; of *Helix*, 556; of Lamellibranchiata, 579; of *Lithobius*, 421; of Malacostraca, 348; of Scorpionidea, 522. *See also* Aorta, Vascular system  
 Artery, Antennary, Dorsal abdominal (posterior aorta), Gastric, Hepatic, Ophthalmic (anterior aorta), sternal, Ventral abdominal, Ventral thoracic, of Crustacea Decapoda, **350, 412, 413**; Cephalic, Supraneural, of Chilopoda, 421; Gastrointestinal, Hepatic, Pallial, Terminal, of Lamellibranchiata, 580; Lateral, Supraneural, of Arachnida\*, 522, 529, 530; Pedal, of Mollusca\*, **557, 581**. *See also* Aorta  
 Arthrobranchiae, 404  
 Arthropoda, 305; 1, 2, 317  
 Articulamentum, 549  
*Ascaris*, 245; **246**, 248; *lumbricoides*, 254  
*Ascidia*, 681; 680  
*Ascidia* (Insecta), 437  
 Ascidiacea, 680; 679  
 Ascidiæ compositæ, 680  
 Ascidian tadpole, 675; **676**  
 Ascon grade, 120  
*Ascopus*, 240 n.  
 Ascothoracica, 385; 377  
*Asellus*, 398; 336; *aquaticus*, **399**  
 Asexual reproduction, 5; of Aquatic oligochaetes\*, 293, 294; of Metazoa, *see* Budding, Strobilation; of Porifera, 123; of Protôzoa, *see* Agamogony, Schizogony, Sporogony; of Turbellaria, 213  
*Aspidiotus perniciosus*, 478  
 Aspidobranchiata, *see* Diotocardia  
 Aspidochirotæ, 652  
 Aspirigera, *see* Holotricha  
*Asplanchna*, 241  
 Astacura, 404  
*Astacus*, 404; **315**, 329, 332, 338, **341, 343, 345, 347, 407**; *fluviatilis*, **350, 351, 405**  
*Asterias*, 638; 634, 636, 637; *rubens*, **624, 637**; *vulgaris*, **631**  
*Asterina*, 638; 630  
 Asteroidea, 634; 623  
*Asterope*, 268; 264, **266**  
 Astomata, 107  
*Astroides*, **190**  
*Astropecten*, 638  
*Atractonema*, **256, 257**  
 Atrial opening, 669, 677, 679  
 Atrial siphon, 669  
 Atrium, Genital, *see* Genital atrium; of Cephalochorda, 677; of Tunicata\*, 673, 675, 677, 678  
*Atropis pulsatoria*, 472  
 Auchenorhyncha, 476  
*Aulactinia*, **188**  
*Aulactinium*, **83**; *actinastrum*, **82**  
*Aurelia*, 174-80, **176, 177**; *aurita*, 174; **175**; Strobilation of, 178, **178**  
 Auricles, of *Arenicola*, 275; of Gasteropoda, 552; of Lamellibranchiata, 579; of Mollusca, 544; of *Sepia*, 593  
 Auriculæ, 645  
 Auricular organs, 201  
*Auricularia* larva, 632; **632**, 668  
 Autogamy, 33; 83  
*Autolytus*, 268; 278  
 Autosomes, 480  
 Autotomy, 340  
 Autozooids, 185  
 Avicularia, 608  
*Axelsonia*, **465**  
 Axial filament, 15  
 Axial organ, 628; of Crinoidea, 656; of Holothuroidea, 650  
 Axial sinus, 627; of Echinoidea, 646  
 Axon, 137, 138  
 Axopodia, 14, 15  
 Axostyles, 17  
*Babesia*, *see* *Piroplasma*  
*Bacillus pestis*, 513  
*Baculites*, 605; 602, **605**; *capensis*, **605**; *chicoensis*, **605**  
*Badhamia*, 86

- Balanoglossus*, 662; 633, 660  
*Balantidium*, 109; 20; *entozoon*, 109  
*Balanus*, 382; **381**  
 Basal disc, 189  
 Basal granule, 15  
 Basal ossicles, 656  
 Basement membrane, 204  
 Basilar plate, 424  
 Basipodite, 336  
 Basommatophora, 570  
*Bathynella*, 392  
*Bdellocephala*, 212  
 Bdelloid rotifers, 243  
 Beaks of Cephalopoda, 594  
 Beds, Mussel, 583  
 Behaviour, 38; of Protozoa, 38  
*Belemnites*, **600**  
 Belemnoida, 588, 600  
*Bembex*, 503  
 Berlese's theory, 459; **458**  
*Beroe*, 196  
*Biblio*, 508; **508**  
 Bilateral cleavage, 145  
 Bilateral symmetry, 633; of Actinozoa, 182; of Ciliata, 8; of Echinoderm larvae, 623, 627, 633; of Echinoidea, 624, 647; of Holothuroidea, 624, 649; of Metazoa, 143  
*Bilharzia*, see *Schistosoma*  
 Binary fission of Protozoa\*, 28; 36, 45, 54, 70, 72, 74, 80, 83, 85, 86, 98, 115  
*Bipalium kewense*, 215  
*Bipinnaria* larva, 632; **632**  
 Biramous limb, see *Stenopodium*  
*Birgus*, 415  
 Bladder worm, see *Cysticercus*  
 Blastocoele, 129; 1, 131, 133, 237  
 Blastoidea, 659  
 Blastopore, 129, 130 and n.  
 Blastostyles, 154  
 Blastozoite, see *Blastozoid*  
 Blastozoid, 679; 685  
 Blastula, 129, 145; of Coelenterata, 152; of Echinodermata, 631; of *Obelia*, 156  
*Blatta*, 428, **433**, 466; *orientalis*, 466  
 Blepharoplast, 15 n.  
 Blood, 131, 132, 133; of *Arenicola*, 273, 275; of Chaetopoda, 263; of *Ciona*, 674; of Crustacea, 351; of Insecta, 439; of Scorpion, 522  
 Blood vessels, see Arterial system, Artery, Vascular system  
 "Blood vessels" of Echinodermata, see Lacunar system  
*Bodo*, 63; *saltans*, **62**; *sulcatus*, Chemophobotaxis of, **39**, 40  
 Body, of Amphipoda, 400; of *Arenicola*, 272; of *Balanoglossus*, 662; of *Cephalodiscus* and *Rhabdopleura*, 668; of Crustacea, 332; of Ctenophora, 195; of Echinodermata\*, 623, 640, 648; of Isopoda, 395; of Medusa, 150; of Metazoa, 128; of polyp, 150; of Porifera, 117; of Protozoa, 8; of Tubicolous Polychaeta, 270. See also Symmetry  
 Body cavity, of Nematoda, 245; Perivisceral, see Perivisceral cavity; Primary, see Haemocoel; Secondary, see Coelom  
 Body wall, of Hirudinea, 298; of Holothuroidea, 650; of Metazoa, 128, 129; of polyps, 150; of Rotifera, 237  
*Bombus*, 498, 503, 504  
*Bombyx mori*, 490  
*Bonellia*, 302; *viridis*, **303**  
*Boophilus annulatus*, 537; *bovis*, 537  
*Bopyrus*, 398; *fougerouxii*, **400**  
*Bothriotaenia*, 230  
*Botryllus*, 681; 678, **678**, 679; *violaceus*, **681**  
 Botryoidal tissue, 298  
*Bougainvillea*, 157; 158, 165; *fructuosa*, **157**  
 Brachial ossicles, 656  
 Brachial skeleton, 616  
*Brachiolaria* larva, 633  
 Brachioles, 658  
 Brachiopoda, 613; 2; Development of, **617**  
 Brachyura, 404, 407  
 Brachyurous type, 404  
 Brain, 136; 138, 144; of Acanthocephala, 259; of Acoelomate Triploblastica, 197; of Arthropoda, 309; of Branchiopoda, 340; of *Ciona*, 675; of Crustacea, 340; of Insecta, 448, 449; of Nematomorpha, 257; of Polychaeta, 264; of *Sepia*, 596, **596**. See also Ganglion, Cerebral  
 Branchia, of Phyllopodium, 337, 354; of *Salpa*, see "Gill"  
 Branchiae, see Gills  
 Branchial chamber, 672

- Branchial hearts, veins, 594  
 Branchial opening, 669  
 Branchiobdellidae, 286, 301  
 Branchiogenital region, 664  
 Branchiopoda, 353; 326, 327, 331, 334, 340  
 Branchiura, 376; 330, 331  
 Breathing, *see* Respiratory movements  
*Brisinga*, 638  
 Brown body, 607  
*Bruchophagus funebris*, **501**  
*Bryograptus*, 171; 172; *callavei*, 172; *retroflexus*, 172  
 Bryozoa, name for Polyzoa, 606 n.  
 Buccal capsule, 251  
 Buccal cavity, of *Balanoglossus*, 664; of *Helix*, 557; of Insecta, 432; of Nematoda, 248; of Tunicata, 669. *See also* Alimentary canal  
 Buccal mass, 557; of *Helix*, 557; of *Sepia*, 594-5  
 Buccal tube feet, 643  
*Buccinum*, 565; 552, **553**, **562**, 563  
 Budding, of Alcyonaria, 183; of *Cysticerci*, 229; of *Hydratuba*, 178; of Hydrozoa\*, 152, 154, 156, 158, 161, 164, 165, 166, 169; of Madreporaria, 191; of *Microstoma*, 213; of Polychaeta, 278; of Protozoa\*, 28, 72, 83, 114, 115; of Pterobranchia, 668; of *Stylaria*, 291; of Tunicata\*, 677, **678**, 680, 681, **683**, **684**, 685. *See also* Colonies  
*Bugula*, 608, **610**, 613  
*Bulimus*, 572  
*Bulla*, **564**, 567  
*Bunodes*, 529  
 Bursa copulatrix, of Insecta, 447, 448; of Turbellaria, 211, 230, 232  
*Buthus*, Internal anatomy of, **523**; *carpathicus*, Embryo of, 516  
 Byssus pit, 583
- Caddis flies, *see* Trichoptera  
 Cadophore, 686  
 Caeca, Mesenteric, *see* Mes. caeca  
 Caecum, of Echinoidea, 646; of Polyzoa, 606; of *Sepia*, 595  
*Caenis*, 481  
 Caenogenetic features, 144  
 Calabar swellings, 255  
*Calanus*, 373; **335**, 338, **374**  
*Calathus*, 258
- Calcarea, 126; 120  
 Calcareous ring in Holothuroidea, 650  
*Caligus*, 375  
*Callidina*, 241  
*Calliphora*, 435, 439, 512  
*Calosoma*, 493; *semilaeve*, **493**  
*Calotermes militaris*, 469  
 Calymma, 80  
 Calyptoblastea, 153; 154, 162, 172. *See also* Leptomedusae  
 Calyptomera, 354, 368  
 Calyx, 654  
 Campodeiform larva, 456, 459; of Coleoptera, 492, 493, 495  
 Canal system, of Medusae, 150, 151, 156, 174; of Sponges, 119, 120, **121**  
*Cancer*, 417  
 Capillitium, 86  
 Capitellidae, 276  
 Capitulum, 378  
*Caprella*, 402; *grandimana*, **402**  
 Capsidae, 476  
 Captacula, 572  
*Carabus*, 493; *violaceus*, 493  
 Carapace, 333; 327; of Branchiopoda, 327, 354; of Calyptomera, 354; of *Carcinus*, 407; of Cirripedia, 330, 333; of Cladocera, 327, 354, 362; of Conchostraca, 327, 333, 354; of Gymnomera, 354; of *Lepas*, 378; of *Leptodora*, 368; of Malacostraca, 334, 388; of *Nebalia*, 390; of Ostracoda, 330, 333; of Peracarida, 393  
*Carchesium*, 111; *epistylidis*, **113**  
*Carcinus*, **385**, 408, 417; *maenas*, 407; **406**, **407**, **409**, **411**, **412**, **413**, **414**  
*Cardium*, 579  
 Cardo, 427  
 Caridea, 404  
 Caridoid facies, 388  
 Carina, 378  
*Carinella*, 237  
*Carmarina*, **161**, 164  
 Carotin, 47  
 Carpoidea, 658  
 Carpopodite, 336  
*Carteria*, 57; 48, **48**  
*Caryophyllaceus*, 230  
*Caryophyllia*, 190  
 Cases of Trichoptera, 487  
*Cassiopeia*, 179, 180  
 Catch fibres, 143



- Caudal furca (rami), 339, 355, 358, 360, 364, 372, 379, 388, 390
- Cavolinia*, 569; 567, **568**
- Cecidomyiidae, 509
- Cells, 7; assuming various functions, 128; Corneagen, 310; Flame, 202; 134, 197, **203**, 235, 240, 243, 275; Interstitial, 147 and n.; Iris, 310; Lasso, 193, 195; Musculo-epithelial, 146; of Porifera, 117, 118, 124; Pole, 130, 289; Sensory, 128, 147, 149, 201, *see also* Sense organs; Somatic of Volvocina, 10, 58; Thread, 147; Yellow, 262. *See also* Choanocytes, Myoblast, Oenocytes, Pinacocytes, Porocytes, etc.
- Cellular animals, 7; structure, 124, 128
- Cellulases, 130, 435, 559, 587
- Cellulose, 12, 56, 86, 130, 131
- Central capsule, 80
- Central nervous system, 136; 137, 138, 199; of Annelida, 262; of Chordata, 660; of Tunicata, 675. *See also* Brain, Ganglion, Nervous system
- Centrodorsal ossicle, 655; 656
- Cephalization, 144; of Crustacea, 332; of Polychaeta, 266
- Cephalochorda, *see Amphioxus*
- Cephalodiscus*, 668; 660, 662
- Cephalopoda, 587
- Cephalothorax, of Arachnida, *see* Prosoma; of Brachyura, 404; of Copepoda, 370, 371, 372; of *Ligia*, 395
- Cerambycidae larvae, 435
- Cerata, 569
- Ceratium*, 54; 36; *macroceras*, **55**
- Ceratophyllus fasciatus*, 514; **513**
- Cerci anales, 431
- Cerebral ganglia, *see* Brain; Ganglion, Cerebral
- Cerebral organ, 235
- Cerebral vesicle, 676, 677
- Cerebratulus*, 237
- Cervical groove, 332
- Cervical sclerites, 428
- Cestoda, 223; 198; Merozoa, 225, 227; Monozoa, 225, 230
- Cestus Veneris*, 196
- Ceuthorrhynchus*, 495
- Chaetae, 260, **260**; 305; of *Acanthobdella*, 300; of Archannelida\*, 294, 295, 296; of Chaetopoda, 261; of Echiuroidea, 301; of Oligochaeta\*, 286-94 (*passim*); of Polychaeta\*, 265-72 (*passim*); of brachiopod larva, 618
- Chaetoderma*, 549
- Chaetognatha, 618; 2
- Chaetonotus*, **242**
- Chaetopoda, 261; 260
- Chaetopterus*, 264, 270, 271; *pergamentaceus*, **269**
- Chambered organ, 656; 630, **655**
- Chambers, of cephalopod shells, 602; of Foraminifera shells, 75
- Cheeks of Trilobita, 323
- Cheilostomata, 613; 608
- Cheimatobia*, 491
- Chela, 339
- Chilaria, 517, 526
- Chilina*, **564**
- Chilo*, 491
- Chilomonas*, 52
- Chilopoda, 418
- Chirocephalus*, **311**, 326, 327, 331, 332, 348, **357**, 359, **359**, 364, 367, 373; *diaphanus*, 356, **357**
- Chironomidae, 509
- Chironomus*, 439; 301, 446
- Chitin, 309 n.; 260
- Chiton*, 548; 143, **548**, **583**
- Chlamydomonas*, 56; 20, 28, 29, **29**, 30, 31, **32**, 33, 38, 46, 57; *angulosa*, **29**; *brauni*, 31, **32**; *euchlora*, 31; *longistigma*, **29**; *media*, **32**; *steini*, 31
- Chlamydospores, 38
- Chloeon*, 481
- Chlorocruorin, 133; 263
- Chloromonadina, 54; 49
- Chlorophyll, 47
- Chloroplasts, 47; 19 n.
- Chlorops taeniopus*, 512
- Choanocytes, 117; 118, 119, 120, 123, 124, 125, 126
- Choanoflagellata (Choanoflagellidae), 65
- Chondracanthus*, 375; *gibbosus*, **375**
- Chondrioderma*, 86; *difforme*, **87**
- Chonotricha, 114; 26, 33
- Chordata, 660; 2
- Chorion, of egg of Insecta, 446
- Chromatophores, of Cephalopoda, 591; of Crustacea, 343, 344; of Phytomastigina\*, 47; 18, 30, 46, 50-6 (*passim*)
- Chromidium, 28

- Chromoplasts, *see* Chromatophores  
of Phytomastigina
- Chrysamoeba*, 50; *radians*, 51
- Chrysaora*, 173
- Chrysidella*, 52; *schaudinni*, 53
- Chrysis*, 503
- Chrysomelidae, 495
- Chrysomonadina, 50; 20, 63
- Chrysops*, 506; 255; *caecutiens*, 510;  
*dimidiata*, 511
- Cicada septendecim*, 476
- Cicindela, 436, 493
- Cilia, 13; of Ciliata, 104, 105; of  
*Ciona* pharynx, 672, 673; of Coe-  
lenterata, 174, 182, 189, 193; of  
mollusc gills, 556, 576; of Turbel-  
laria, 201, 202, 204. *See also* Epi-  
dermis
- Ciliary junctions, 574
- Ciliary organ, 277
- Ciliata, 102; 109, 110
- Ciliated band, of *Dipleurula*, 631-2;  
of *Tornaria*, 668
- Ciliated funnel, *see* Dorsal tubercle
- Ciliated pits, 201; 204
- Ciliated ring, *see* Ciliated band,  
Metatroch, Prototroch, Velum
- Ciliophora, 102; 24, 26, 33, 44
- Ciliospores, 38
- Cimex*, 476
- Cimicidae, 474
- Cingulum, 239
- Ciona*, 680. *See also* *C. intestinalis*;  
*intestinalis*, 669; 670, 671, 672
- Circulation of blood, 132; in Ano-  
straca, 348; in Araneida, 530; in  
*Arenicola*, 275; in Arthropoda,  
314; in *Balanoglossus*, 667-8; in  
Chaetopoda, 263; in *Ciona*, 674;  
in Copepoda, 373; in Echino-  
dermata, 629; in Entomostraca,  
349; in Insecta, 437; in Malaco-  
straca, 349; in Mollusca\*, 556, 579;  
in Nemertea, 235; in Ostracoda,  
349; in Scorpionidea, 522. *See also*  
Vascular system
- Circulation of food, in *Alcyonium*,  
183; in *Aurelia*, 174; in *Daphnia*,  
364, 367; in *Obelia*, 155
- Circulatory system, *see* Vascular  
system
- Circulus venosus, 557
- Circumoesophageal connectives, *see*  
Nervous system
- Cirrhial ossicles, 656
- Cirri, of Crinoidea, 655; of Protozoa,  
17; of Thoracica, 379
- Cirripedia, 376; 330, 333, 349, 351,  
352, 353
- Cladocera, 362; 144, 327, 354
- Classification, vii, 1, 2; of Brachio-  
poda, 618; of Cephalopoda, 588;  
of Demospongiae, 127; of Gastero-  
poda, 563; of Hemiptera, 475-6;  
of Lamellibranchiata, 579; of  
Myriapoda, 418; of Opistho-  
branchiata, 567; of Polychaeta, 264;  
of Polyzoa, 612; of Protozoa, 44; of  
Pulmonata, 570; of Radiolaria, 76
- Clathrina*, 126
- Clathrulina*, 86; 12, 15
- Clava squamata*, 153
- Clavelina*, 680; 677, 679
- Clavularia*, 183
- Cleaners, *see* Scavengers
- Cleavage of ovum, affected by yolk,  
145; Centrolecithal, 316, 352, 452;  
Determinate, 145, 675; of Archi-  
annelida, Polychaeta, Polyclada,  
Mollusca, Nemertea, 281; of Ar-  
thropoda, 316; of *Balanoglossus*,  
668; of *Ciona*, 675; of Coelenterata,  
151, 196; of Crustacea, 352; of  
Ctenophora, 196; of Echino-  
dermata, 283, 631; of *Pyrosoma*,  
685; Radial, 283; Spiral, 281
- Climacograptus*, 170, 171
- Cliona*, 127
- Clitellum, 286; 289, 291
- Cloaca, of Holothuroidea, 650; of  
Nematoda, 250; of Rotifera, 240;  
of Tunicata, 673
- Clypeaster*, 647
- Clypeastroida, 647
- Cnidaria, 152; 146
- Cnidoblast, 147
- Cnidocil, 148
- Cnidospordia, 100
- Coarctate pupae, 509; 456
- Coccidae, 477
- Coccidia, 89
- Cocciomorpha, 88
- Coccinellidae, 495; 494
- Coccinella*, 495
- Coccolithophoridae, 50
- Coccoliths, 50
- Cocoons, of earthworms, 289; of In-  
secta\*, 490, 495, 513; of spiders, 533

- Codosiga*, 65; 8; *umbellata*, 65  
 Coelenterata, 146; 1, 129, 196  
 Coeliac canal, 656  
 Coelom, 133; 2, 129, 130, **135**, 141; of  
*Acanthobdella*, 300; of Annelida,  
 260; of Archiannelid genera, 294,  
 296; of *Arenicola*, 272; of Arthro-  
 poda, 314; of *Balanoglossus*, 662;  
 of Brachiopoda, 616, 618; of  
 Cephalochorda, 660; of Chaeto-  
 gnatha, 619; of Chaetopoda, 260,  
 262; of Chordata, 660; of Cri-  
 noidea, 656; of Crustacea, 346;  
 of *Dipleurula*, 627; of Echino-  
 dermata, 626, 633; of Echiuroidea,  
 261; of Hemichorda, 660, 661; of  
 Hirudinea, 261, 298, 299, 300; of  
 Mollusca, 543; of *Peripatus*, 319;  
 of Polyzoa, 606; of *Sepia*, 593; of  
 Sipunculoidea, 261; of Snail, 556; of  
 Tunicata, 661, 675; of Vertebrata,  
 661. *See also* Pericardium  
 Coelomoducts, 134; 140, 141; of  
 Arthropoda, 315; of Chaetopoda,  
 262; of Crustacea, 347; of Mol-  
 lusca, 545; of Polychaeta, 275, 276,  
 277  
*Coeloplana*, 196  
 Coenosarc, of Calyptoblastea, 153; of  
 Polyzoa, 608  
*Colacium*, 52  
 Coleoptera, 429; three types of, **494**  
 Coleopterous larvae, **457**  
 Collar, of *Balanoglossus*, **662**; of *Chae-*  
*topterus*, 270; of Choanoflagellata,  
 65; of Pterobranchia, 668  
 Collar cavities, 661; of *Balano-*  
*glossus*, 663  
 Collar cells, *see* Choanocytes  
 Collar pores, 663; of *Balanoglossus*,  
 663  
 Collembola, 463; 444  
 Colleterial glands, 447, 448  
*Colletes*, 498  
*Collinia*, 107; 33 n.  
 Colloblasts, *see* Lasso cells  
*Collozoum*, 81; *inermis*, **41**  
 Collum, 424  
 Colon, *see* Large intestine  
 Colonies, of Alcyonaria, 180, 183; of  
*Carchesium*, 111; of Hydroids\*, 153,  
 154, 157, 158, 162, **163**, 164, 165;  
 of Polyzoa, 606, 608; of Protozoa,  
 8; of *Rhabdopleura*, 668; of Si-  
 phonophora, 166, **167**, 168, 169; of  
*Syllis ramosa*, 280; of Tunicata,  
 677, 680, 685; of Volvocina, 57, 58;  
 of Zoantharia, 186  
*Colpidium*, 109  
*Colpoda*, 109; 42; *steini*, **108**  
 Columella muscle, 555  
 Compasses, 645  
 Compensation sac, 608  
 Complemental males, 380  
 Compound ascidians, 679  
 Compound eyes, *see* Eyes  
 Conchostraca, 362; 327, 333, 354  
 Conjugants, 33  
 Conjugation, 6, 30. *See also* Syngamy  
*Contarinia nasturtii*, **510**; *pyrivora*,  
 509  
 Contractile vacuoles, 20; of *Euglena*,  
 52; of Heliozoa, 83; of Protozoa, 22  
*Conus*, **562**, 563  
*Convoluta roscoffensis*, 213; 48, **48**, 57;  
*henseni*, 214  
 Copepoda, 370; 330, 333  
*Copeus*, 240  
*Copidosoma gelechia*, 446  
*Copromonas*, 52; 31; *subtilis*, **53**  
 Coprozoic Protozoa, 43; 31  
 Copulatory bursa, 250; spicules, 250  
*Corallium*, **184**, 186; *rubrum*, 184  
 Corals, of Alcyonaria, 185; of Hy-  
 drocorallinae, 165; of Madre-  
 poraria, 186, 189-92; of Polyzoa,  
 608  
*Cordylophora*, 164  
*Corethra*, 436  
*Corixa*, 476  
 Corm, 336  
 Cormidium, 166  
*Cornularia*, 183  
 Corona, 640  
 Corpuscles, 131. *See also* Blood  
 Cortex, of Ciliata, 105; of Porifera,  
 120; of Protozoa, 13  
*Corticata*, 44  
*Corymbites cupreus*, **494**  
*Coryne*, 539  
 Cossidae, 491  
*Cossus*, 491  
 Cotton spinner, *see* *Holothuria*  
 Course of circulation, *see* Circulation  
 of blood  
 Coxa, 428  
 Coxal glands, of Arachnida\*, 520,  
 529; of Arthropoda, 315

- Coxopodite, 336  
*Crabro*, 439  
*Crangon*, 415  
*Crania*, 616; 613, **615**, 618  
*Craspedacuta*, 164  
*Craspedochilus*, 549; 548  
*Cremaster*, 490  
 Crinoidea, 654; 623  
*Crisia*, **610**, 613  
*Cristatella*, 613  
*Crithidia*, 64; **62**, **63**, 64  
 Crop, of Gasteropoda, 558; of Insecta, 432; of Opisthobranchiata, 567  
 Crutchets, 291  
 Crural glands, 321  
 Crustacea, 326; 308  
 Crustacean-insect-myrriapod section, 308  
 Cryptocerata, 475  
 Cryptomitoses, 25  
 Cryptomonadina, 50; 49, **53**  
*Cryptomonas*, 50; *ovata*, **53**  
*Cryptoniscus*, 398; *paguri*, **400**  
*Cryptus obscurus*, **501**  
 Crystal cells, *see* Vitrellae  
 Crystalline cone, 310  
 Crystalline style, 578  
*Ctenidia*, 543; of Cephalopoda\*, 588, 591, 603; of *Chiton*, 549; of Gasteropoda\*, 550, 551, 552, 553, 554, 564, 565, 567; of Lamellibranchiata\*, 574, **575**, 576, **577**, 578, 579, 582, 585, 587; of Mollusca, 543  
 Ctenidial circulation of Lamellibranchiata, 581  
*Ctenocephalus canis*, **513**  
 Ctenophora, 193; 146  
 Ctenoplana, 196  
 Ctenopoda, 362; 368  
 Ctenostomata, 613  
*Cucumaria*, 652; **653**  
*Culex fatigans*, 509; *pipiens*, **507**  
 Culicidae, 509  
 Cumacea, 393  
*Cunina*, 164  
 Cup-shaped organs, 300  
 Curculionidae, 494, 495  
 Cursoria, 466  
*Cuspidaria*, 579  
 Cuticle, 2, 5, 131, 132, 136; of Annelida, 260; of Arthropoda, 309; of Crustacea, 331; of Nematoda, 245; of Protozoa, 12; of Rotifera, 237; of Trematoda, 218  
 Cuvierian organs, 650  
*Cyamus*, 403; **396**  
*Cyanea arctica*, 172  
*Cyathomonas*, 52; 14, 46; *truncata*, **53**  
 Cyathozoid, 685; **683**  
*Cyclas*, 579  
*Cyclestheria hislopi*, **335**  
 Cyclomyaria, *see* Doliolida  
 Cyclophyllidea, 230; 227  
*Cycloporus papillosus*, **215**  
*Cyclops*, 370; 216, 228, 255, 328, **352**, **353**, **371**, **372**  
 "Cyclops" larvae, 373; 353, 374, 375  
 Cyclorhapha, 511  
*Cyclosalpa*, 686; 685  
*Cyclospora*, 32  
 Cyclostomata, 613  
*Cyphonautes* larva, 610; **611**  
*Cypridina*, 370  
*Cypris*, 369; 328, **342**, 368, **370**  
 "Cypris" larva, 380; 353, **380**, 382, **383**, 385  
*Cyrrtohinus mundulus*, 476  
*Cyrtoceras*, 604  
*Cysticercus*, 228; 229, 230; *pisiformis*, 228  
 Cystoflagellata, *see* Noctiluca  
 Cystoidea, 658  
 Cysts, 22; 12. *See also* Gamocysts, Oocysts, Sporocysts  
 Cytostome, 19; 104  
  
*Dactylopius coccus, tomentosus*, 481  
 Dactylopodite, 336  
 Dactylozooids, 165; 166  
*Dalyellia viridis*, 214; **207**  
*Daphnia*, 364; 327, 328, 355, **367**; *pulex*, **366**  
 Dart, 257  
 Dart sac, 561  
 Dead men's fingers, *see* *Alcyonium digitatum*  
 Deamination, 131  
 Death, 5  
 Decapoda, Cephalopoda, 588, 599; Crustacea, 404; 331  
 Deep oral nervous system, 630  
*Deima*, 652; 653  
*Demodex folliculorum*, **541**  
 Demospongiae, 126; 123  
 Dendrites, 137  
 Dendritic tentacles, 649

- Dendrochirotae, 652; 650  
*Dendrocoelum lacteum*, 203, 212, 212,  
 214  
*Dendrocometes*, 116; 33 n.; *paradoxus*,  
 108  
 Dendroid graptolites, 172  
 Dendron, 137  
 Dense nuclei, 23  
*Dentalium*, 572; 573  
 Depression, 35  
*Deraeocoris fasciolus*, 477  
 Dermal layer, 117  
 Dermaptera, 468; 429  
 Dermis, 136  
 Dermomuscular tube, 142  
 Determinate cleavage, 145, 675  
 Detorsion, 554  
 Deutocerebrum, 310, 340  
 Deutomerite, 95  
 Development, 144. *See also* Embry-  
 ology, Larvae, Life cycle  
*Diastylis*, 395; *stygia*, 394  
*Dibothriocephalus*, 227, 228; *latus*,  
 227, 228, 230  
 Dibranchiata, 588  
*Dicranura*, 490  
 Dicyclical rotifers, 241  
*Didymograptus*, 171; 170, 172; *affinis*,  
 172; *fasciculatus*, 172; *v-fractus*,  
 170  
*Diffugia*, 74; 12; *urceolata*, 74  
 Digestion, 130; by Acarina, 534; by  
*Alcyonium*, 183; by *Arenicola*, 273;  
 by Arthropoda, 314; by *Aurelia*,  
 175; by Coelenterata, 147; by  
 Crustacea, 344; by *Daphnia*, 367;  
 by *Helix*, 558-60; by Insecta, 434-  
 6; by Lamellibranchiata, 577-8;  
 by Oligochaeta, 287; by *Ostrea*,  
 586; by *Physalia*, 167; by Proto-  
 zoa, 19; by Rotifera, 240; by *Tere-  
 do*, 587; by Turbellaria, 206; by  
 Zoantharia, 189. *See also* Alimen-  
 tary canal, Circulation of food,  
 External digestion  
 Digestive caeca, *see* Digestive gland  
 Digestive gland, 130, 131; of Arach-  
 nida\*, 517, 522, 529, 530; of  
 Brachiopoda, 616; of Mollusca\*,  
 543, 558, 569, 577, 595. *See also*  
 Liver, Mesenteric caeca  
 Digestive system, of *Alcyonium*, 182;  
 of *Aurelia*, 174; of Ctenophora,  
 195, 196; of Medusae, 150; of  
 Platyhelminthes\*, 206, 213, 214,  
 216, 217, 223; of Zoantharia, 187.  
*See also* Alimentary canal, Enteron  
*Dimorpha*, 83; *mutans*, 84  
 Dimorphic shells, 76  
*Dinamoebidium*, 55  
*Dinobryon*, 50; *sertularia*, 51  
 Dinoflagellata, 54; 49, 50 n., 80  
*Dinophilus*, 296; 294, 295  
 Dinophysinae, 54  
*Dinothrix*, 55  
 Diotocardia, 564; 552, 563  
 Diphyllidea, 229  
*Diphyes*, 166  
*Dipleurula*, 631; 145, 627, 628  
 Diploblastica, 129. *See also* Coelen-  
 terata  
*Diplograptus*, 171; *foliaceus*, 171  
 Diplomonadina, 65, 66, 67  
 Diplopoda, 422  
 Diplopores, 659  
 Diploporida, 659  
 Diplostraca, 362; 327, 354, 355  
*Diplozoon*, 218; 220  
 Diptera, 504; 430, 508, 510  
*Dipylidium caninum*, 228, 230  
 Direct wing muscles, 430  
 Directives, 187  
 Discomedusae, 174  
*Dissosteira carolina*, 440  
*Distephanus*, 50; *speculum*, 51  
*Distomum macrostomum*, 222  
 Division of protozoan nuclei, 24  
 Docoglossa, 563  
*Dolichoglossus kowalevskii*, 663  
 Doliolida, 686; 679, 682, 685  
*Doliolum*, 686; 677, 679, 684  
*Donax*, 578  
*Doris*, 569; 554, 567, 568  
 Dorsal and ventral, 143; aspects of  
 bilateral animals, 143; aspects of  
 Ciliata, 103; aspects of Holothu-  
 roidea, 649; aspects of *Sepia*, 591;  
 "blood vessels" of Echinoidea and  
 Holothuroidea, 629, 643, 650;  
 mesenteries of Alcyonaria, 182;  
 structures in radial animals, 143  
 Dorsal antenna, 240  
 Dorsal blood vessel, of Arthropoda,  
*see* Aorta; of *Balanoglossus*, 667;  
 of Chaetopoda, 263, 275; of  
 Rhynchobdellidae, 299  
 Dorsal "blood vessels" of Echino-  
 dermata, 629, 643, 650

- Dorsal cirrus, 265; lamina, 680; organ, 334; pores, 287; shield, 334 and n.; siphon, 574; tubercle, 672  
 "Dorsal" plates of Ophiuroidea, **639**  
 Dorsolateral antennae, 240  
 Drag line, 533  
*Dreissensia*, **546**, 582  
 Drift net of *Physalia*, 166  
*Drosophila*, 437  
 Ductus communis, 210, 211, 230  
*Dysdercus*, 476  
*Dytiscus*, 429, 439, 444, 493; *marginalis*, **447**
- Earthworms, 287  
 Ecardines, 618  
*Ecdyomurus*, 481  
 Ecdysis, *see* Moulting  
*Echinaster sentus*, **636**  
*Echinobothrium*, 229  
*Echinocardium*, 648; *cordatum*, **648**  
*Echinocyamus*, 647; *pusillus*, 647  
 Echinodermata, 623; 2, 136, 142, 143  
 Echinoidea, 640; 623  
*Echinopluteus*, 633  
*Echinorhynchus proteus*, 259  
*Echinosphaera*, 659  
*Echinus*, 647. *See also E. esculentus*; *esculentus*, 640, **644**; *miliaris*, **641**, **642**  
 Echiuroidea, 301; 261  
*Echiurus*, 302; 301, **302**  
 Ectoderm, 128; 1, 129, 130, 132, 136, 139, 141, 142, 143, 146, 150, 152, 156, 176, 183, 201, 204, 235, 237, 244, 281, 282  
 Ectoneural system, 630; of Crinoidea, 656  
 Ectoplasm, 12; 19, 44, 68, 70, 76, 95, 102, 104, 105  
 Ectoprocta, 613; 611  
*Edrioaster*, 658; *biggsbyi*, **657**  
 Edrioasteroidea, *see* Thecoidea  
*Edwardsia*, 187; **188**  
 Effectors, 137, 138  
 Efferent canals, *see* Exhalant canals  
 Egg sac, 373  
 Eggs and Egg laying, of Arachnida\*, 524, 529, 533; of Arthropoda, 316; of *Balanoglossus*, 668; of Chaetognatha, 619, 620; of *Ciona*, 675; of Cnidaria\*, 152, 156, 159, 162, 174, 178, 183; of Crustacea\*, 352, 356, 359, 362, 367, 373, 376, 379, 385, 410; of Ctenophora, 196; of *Dinophilus*, 296; of Echinodermata, 630, 631; of Hirudinea, 300; of Insecta\*, 452, 468, 471, 472, 476, 478, 481, 483, 484, 485, 486, 491, 500, 503, 504 n., 511, 513; of *Iulus*, 424; of Myriapoda\*, 422, 424; of Mollusca\*, 555, 561, 566, 572, 585, 598; of Nematoda\*, 250, 254, 255, 256, 257, 259; of Oligochaeta, 289; of Pantopoda, 539; of *Peripatus*, 321; of Platyhelminthes\*, 210, 212, 215, 219, 220, 222, 228; of Polychaeta, 275; of Rotifera, 241; of Thaliacea, 685  
*Eimeria*, 89; 96; *schubergi*, **27**, 89, **90**  
 Ejaculatory duct, 447  
 Elasipoda, 652  
*Eledone*, **596**  
 Eleutherozoa, 658; 625  
 Elytra, of Coleoptera\*, 429, 492, 495; of Polychaeta, 268  
*Embia major*, 471  
 Embioptera, 471  
 Embryo, 144  
 Embryology (*s. str.*), 145; of Arachnida, **516**, 520; of Arthropoda, 316; of *Asterias*, 631; of Brachiopoda, **617**, 618; of Chaetognatha, 619, **620**; of Chordata, 660; of *Ciona*, 675; of Coelenterata\*, 152, 156, 162, 178 n., 196; of Crustacea, 352; of Echinodermata, 631; of Insecta, 452, **453**, 457, **458**, **459**; of *Lumbricus*, 289, 290; of *Peripatus*, 321; of Polyzoa, 611; of Tardigrada, 450; of Thaliacea, 685; of trochospheres, 281  
 Embryonic fission, *see* Polyembryony  
 Enchylema, 12  
 End gut, *see* Hind gut  
 End sac, 315, 346  
 Endites, 337, 338  
 Endocyclica, 647  
 Endoderm, 128; 1, 129, 130, 136, 139, 141, 142, 143, 281; of Coelenterata\*, 146, 147, 150, 152, 155, 158, 161, 174, 181, 182, 183, 195. *See also* Enteron  
 Endoderm lamella, 150; 179  
 Endomixis, 35; 26  
 Endophragmal skeleton, 340  
 Endoplasm, 13

- Endopodite, of Crustacea, 335; 336, 337; of Trilobita, 324; of Xiphosura, 528. *See also* Limbs
- Endoprocta, 612
- Endopterygota, 485
- Endopterygote wing-formation, 459
- Endosome, 22
- Endosternite, 340
- Endostyle, 672, **673**, 675
- Entamoeba*, 70; **71**; *coli*, 70; *dysenteriae*, *see E. histolytica*; *histolytica*, 70; 43, **71**
- Enterobius vermicularis*, 254
- Enteron, 146, 150, **151**, 154, 157, 161. *See also* Archenteron, Digestive system
- Enteropneusta, 662 and n.; 2, **665**
- Entocoeles, 187
- Entodiniomorpha, 110
- Entodinium*, 111; *caudatum*, **108**
- Entomostraca, 331
- Envelope cells, 100
- Environment, 3; 129
- Enzymes, Digestive, 130; 344, 434, 558, 559, 566
- Eolis*, 569; 554, 567, **568**
- Epeira*, 532; *diademata*, **531**
- Epheolota*, 116; *gemmipara*, **115**
- Ephemera*, 481; *vulgata*, **481**
- Ephemeroptera, 481; 444
- Ephestia*, 491
- Ephippium, 367
- Ephyra larva, 179; **173**
- Epibolic gastrulation, 145, 282
- Epibranchial space, of Decapoda, 408; of Lamellibranchiata, 574
- Epicardial cavity, 674; diverticula, 674, 677; tube, 674, 677, 678
- Epicardium, *see* Epicardial cavity, etc.
- Epicuticle, 309
- Epidermis, 136; in the several phyla, *see* names of phyla. *See also* Ectoderm
- Epimerite, 95
- Epineural canal, 623; of Echinoidea, 646; of Ophiuroidea, 638
- Epipharynx, 426. *See also* Mouth parts of Insecta
- Epiphragma, 562
- Epipodites, 314, 335, 336, 337. *See also* Gills of Crustacea, Metepipodites, Oostegites, Proepipodites
- Epistome, of Decapoda, 410; of Polyzoa, 606
- Epistylis*, 111
- Epizoanthus*, 126
- Equitant whorls, 76
- Erichthus* larva, **389**
- Eriocrania*, 488
- Erystalis*, 511
- Eruciform larvae, 456; 457; of Coleoptera, 492, 495; of Symphyta, 500
- Estheria*, 362; **346**; *obliqua*, **363**
- Euanostraca, 360
- Eucarida, 403; 389, 390
- Eucephalous larva, 508; 509
- Eucoila*, 500
- Eucystis*, 659
- Eudendrium*, 158; 162, **163**
- Eudorina*, 58; **10**
- Euglena*, 52; 21, 22, 38, 43, 46; *gracilis*, 42, 52; *viridis*, 40, 45, 52, **53**
- Euglenoid movement, *see* Metaboly
- Euglenoidina, 52; 20, 49, **53**
- Euglypha*, 74; 12; *alveolata*, **14**; **73**
- Eugregarinaria, 95; 88
- Eulalia*, 268; 264, **266**
- Eulamellibranchiata, 579; 574, 585
- Eumitoses, 25
- Eunice*, 268; 264, 265, 272
- Eupagurus*, 415; *berrhardus*, **416**
- Euphausiacea, 403; 388, 389
- Euplectella*, 126
- Eupomatus*, Trochosphere of, **284**
- Eurypterida, 524
- Eurypterus*, 526
- Euspongia*, 127; 121, **122**
- Euthyneury, 554, 570
- Eutyphoeus*, 289
- Evadne*, 368
- Evolution, 3, 4, 5, 144
- Exarate pupae, 456
- Excreta, *see* Excretion
- Excretion, 134; by Arthropoda, 315; by Crustacea, 345-7; by Echinodermata, 628; by Metazoa, 134, 140; by Mollusca, 556; by Protozoa, 20; by Tunicata, 675. *See also* Excretory organs
- Excretory organs, 140; 3, 134; of Arachnida, 315, 520; of Arthropoda, 315; of *Balanoglossus*, 668; of Crustacea, 315, 345; *see also* Antennal glands, Maxillary glands; of Insecta, 315, 436; of Metazoa, 140; of Myriapoda, 315; of Nematoda, 245, 248; of Nemer-

- Excretory organs (*cont.*)  
 tea, 235; of Onychophora, 315, 320; of Platyhelminthes, 202; of Polychaeta, 275; of Rotifera, 241. *See also* Coelomoducts, Coxal glands, Glomerulus, Kidneys, Malpighian tubules, Nephridia
- Exhalant canals of Porifera, 120
- Exhalant passage of *Carcinus*, 409
- Exiters, 337
- Exocoeles, 187
- Exocyclica, 647
- Exogamous syngamy, 31
- Exopodite of Crustacea, 335, 336, 337; of Trilobita, 324; of Xiphosura, 528. *See also* Limbs
- Exopterygota, 466; 456
- Exopterygote development of wings, 459
- External digestion, by Araneida, 530; by Insecta, 436; by Oligochaeta, 287; by Rhizostomeae, 179; by Turbellaria, 208
- External medium, *see* Medium
- Extracellular digestion, 130; 147
- Extrathecal zone, 191
- Exumbrellar surface, 173, 179
- Eyes, Compound, 310, **313**; Crustacean median, 340, **342**; of Arachnida\*, 310, 521, 529, **532**, 533; of Arthropoda, 310, **312**; of Ascidian tadpole, 676; of Chaetognatha, 618; of Chaetopoda, 263, 265, 268, 280, 291; of Crustacea\*, 310, **313**, 340, 355, 356, 364, 372, 376, 380, 387, 395; of Hirudinea, 300; of Hydrozoa, 160, **161**; of Insecta, 310, 426, 452; of Mollusca\*, 549, 555, 570, 584, 598, **599**, 603; of Myriapoda\*, 417, 422; of Nemer-  
 tea, 235; of Onychophora, 310, 317; of Polychaeta, 263, 265; of Trilobita, 323; of Turbellaria, 200, **200**. *See also* Eye-spots
- Eye-spots, of Asteroidea, 630; of Protozoa, 17
- Eyestalk, 410
- Facial suture, 323
- Falciform young, 38; 95
- Fasciola*, 220; 218; *hepatica*, **221**, 223
- Fat body, 437, 439
- Favia*, **192**
- Feeding, of Actinozoa\*, 183, 193; of Arachnoidea, 517, 522, 529, 530, 534, 539; of Asteroidea, 636; of *Balanoglossus*, 666; of Brachio-  
 poda, 615, 616; of Branchiopoda\*, 354, 356, 358, **359**, 362, 364, **367**; of *Carcinus*, 410; of Cephalopoda, 594; of Chaetognatha, 619; of *Chaetopterus*, 271; of Chordata, 660; of Ciliata, 104; of *Ciona*, 674; of Copepoda, 373; of Crinoidea (*Antedon*), 656; of Crustacea, 326-7, 331; of *Cypris*, 369; of Diotocardia\*, 565; of Echinoidea\*, 646, 647, 648; of Errant Polychaeta\*, 265; of Filter-feeding Malacost-  
 raca\*, 388, 391, 393, 403; of Gastrotricha, 243; of Holothu-  
 roidea\*, 650; of Holozoic Mastigo-  
 phora\*, 46, 49, 52, 54, 63, 64, 65, 68; of *Hydatina*, 240; of Hydro-  
 corallinae, 165; of Lamellibran-  
 chiata\*, 574, 576, **577**, 582, 587, **587**; of *Lepas*, 379; of Monoto-  
 cardia\*, 565; of Nematoda, 248; of Nemertea, 233; of *Oikopleura*, 680; of Ophiuroidea, 639; of Opis-  
 thobranchiata\*, 567, 568; of *Phy-  
 salia*, 166, 168; of Polyzoa, 607; of  
 Protozoa, 19; of Pulmonata\*, 570;  
 of *Sarcodina*\*, 70, **77**, 83, 86; of  
 Streptoneura, 564, 565, 566, 567;  
 of Suctorina, 115; of *Temnocephala*,  
 216; of *Trilobita*, 324; of Tubi-  
 colous Polychaeta, 268, 270; of  
 Turbellaria, 206; of *Veliger*, 586;  
 of Zoantharia, 193
- Feet, of *Histriobdella*, 296; of Ony-  
 chophora, 319
- Female gametes, 31; of Metazoa, *see*  
 Eggs; of Porifera, 118; of Proto-  
 zoa, 31, 33, **85**, 89-96 (*passim*)
- Femur, 428
- Figites*, 459; *antomyiarum*, **458**
- Filaria*, 253; *bancrofti*, 255; **252**, 509;  
*loa*, 255, 511; *medinensis*, 255
- Filibranchiata, 579; 574, 583
- Filograna*, 264
- Filopodia, 14
- Finger-and-toe disease, 86
- Fission, of Metazoa, *see* Budding,  
 Strobilation; of Protozoa, *see*  
 Fission of Protozoa
- Fission of Protozoa\*, 28; Binary, 28,  
 29, 36, 45, 52, 54, 70, 72, 74, 80, 83,



- Fission of Protozoa\* (*cont.*)  
 85, 86, 115; by budding, 28, 29, 72, 83, 115; Longitudinal, 29, 45, 54; Multiple, 28, 36, 54, 64, 70, 72, 88, 89, 93, 95; Oblique, 45; Pseudotransverse, 29, 29, 45; Radial, 29, 29, 58; Repeated, 28, 29, 45, 54, 57; Transverse, 29. *See also* Plasmotomy
- Fissurella*, 565; 552, **553**, 563
- Fixation disc, 633
- Fixation papillae, 677
- Flabellum, 337
- Flagella, 15
- Flagellata, *see* Mastigophora
- Flagellated chambers, 119
- Flagellisporos, *see* Flagellulæ
- Flagellulæ, 38
- Flagellum, of Crustacean limbs, 336; of *Helix*, 561
- Flame cells, *see* Cells, Flame
- Flatworms, *see* Platyhelminthes
- Floscularia*, 241, **242**
- Flustra*, 608, 613
- Follicle cells, 598
- Follicles, Gonadial, 447, 560
- Food, 131. *See also* Feeding
- Food groove, of Branchiopoda, 355; of Chirocephalus, 358; of Lamellibranchiata, 576
- Foot, Molluscan, 544, 547; of Amphineura\*, 547, 548; of Cephalopoda\*, 589, 603, of Gasteropoda\*, 545, 550, 555, 567, 569; of Lamellibranchiata\*, 547, 581, 582, 583, 585, 587; of Scaphopoda, 572
- Foot of *Hydatina*, 240
- Foragers (Bee workers), 504
- Foraminifera, 72; 20, 68
- Forceps, 468, 469
- Forcipomyia*, 509
- Forcipulate, 634
- Fore gut, *see* Stomodæum
- Forficula auricularia*, 468; **468**
- Formica fusca*, 502; *sanguinea*, 502
- Formicoidea, 502
- Fossil Arachnida\*, 524, 529; Branchiopoda\*, 613, 616; Cephalopoda, 600, 603; Chaetognatha (*Amiskwia*), 622; Corals, 186; Echinodermata, 633, 658; Foraminifera, 76; Graptolithina, 169; Insecta, 460; Lipostraca, 360; Polyplacophora, 549; Radiolaria, **80**; Trilobita, 325
- Frenulum, 429, 489, 492
- Frilled organ, 225
- Front of *Carcinus*, 407
- Frontal appendage, 356; cilia, 576; horns, 379; organs, 342; surface, 608; suture, 511
- Frontonia leucas*, **106**
- Functional nervous unit, 448
- Fungia*, 193; **192**
- Fungus gardens, 470
- Funiculus, 606
- Funnel, of Cephalopoda\*, 589, 591, 603; of segmental organs, 275, 276, 277
- Furca, caudal, *see* Caudal furca
- Furcula, 465
- Galathea*, 415
- Galea, 427
- Galleria*, 491
- Gametes, 31; 6; of Ciliophora, 33; of Cnidosporidia, 100; of Foraminifera\*, 72, 74, 76, **79**; of Heliozoa\*, 31, **85**, 86; of Mastigophora, 45; of Metazoa, *see* Eggs, Spermatozoa; of *Monocystis*, 31, 97; of Mycetozoa, 38, 86; of *Opalina*, 107; of Protozoa, 31, 33, 36, 38; of Radiolaria, 80; of Telosporidia\*, 88-97; of Volvocina\*, 31, **32**, 38, 45, 56-8
- Gammarus*, 400; 107, 114, 116, 259, 329, **402**; *neglectus*, **401**
- Gamocysts, 22; 94
- Gamogony, 37
- Gamonts, 36; **37**, 88-97, 100
- Ganglia, of Ophiuroidea, 638; of ventral cord, 261, 309, 373, 414, 422, 448, 524, 529, 539, 541
- Ganglia, System of, *see* Nervous system
- Ganglion, Antennal, 309, 340; Branchial, 596; Cerebral (Supraoesophageal), 136, 198, 235, 322, 422, 524, 529, 539, 541, 550, 572, 582, 596; *see also* Brain; Gastric, 597; Inferior buccal, 597; Infundibular, 596, 598; of *Ciona*, 675, 677; of Rhizocephala, 340, 383; Pedal, 550, 596; Pleural, 550, 572, 582; Prostomial, *see* Cerebral; Suboesophageal, 296-7, 340, 379, 422, 434, 524, 529, 531, 539, 541; Superior buccal, 597; Supraoesophageal, *see* Cerebral; Trunk, of *Appendicularia* larva, 675; Visceral, 596

- Gasteropoda, 550  
*Gasterostomum*, 223; *fimbriatum*, 220, 224  
 Gasterozooids, of Doliolida, 686; 684; of Siphonophora, 166, 169  
 Gastral layer, 117  
 Gastric cavity, 150; filaments, 174; glands, 240; mill, 344; shield, 578  
*Gastrodes*, 196  
*Gastrophilus*, 439; *equi*, 512  
 Gastrottricha, 243; 197, 237, 244  
 Gastrovascular system, 175  
 Gastrula, 129; of Echinodermata, 631; of Polychaeta, 282  
 Gastrulation, 145; 129; of Arthropoda, 316; of *Aurelia*, 178; of Crustacea, 353; of Echinodermata, 631; of Insecta, 542; of Nematomorpha, 257; of Nemertea, 235; of *Obelia*, 156; of Polychaeta, 282; 283  
*Gecarcinus*, 417; 415  
 Gemmules, 123  
 Generative organs, General morphology of, 131, 134, 143; of Amphineura, 548; of Arachnida\*, 524, 529, 533, 537; of Archiannelida\*, 294, 296; of Arthropoda, 316; of *Balanoglossus*, 664, 668; of Brachiopoda, 616; of Chaetognatha, 619; of Chaetopoda, 262, 288; of Chilopoda, 421; of Cnidaria\*, 156, 174, 177, 183; of Crustacea\*, 351, 352, 359, 362, 367, 373, 376, 379, 385, 397, 414, 415; of Ctenophora, 196; of Diplopoda, 424; of Echinodermata, 629, 637-8, 639, 647, 658; of Hirudinea, 300, 301; of Insecta, 447, 447; of Lamellibranchiata\*, 582, 584, 585; of Nematoda, 248; of Nemertea, 235; of Oligochaeta\*, 286, 287, 289, 291, 293; of Onychophora, 321; of Opisthobranchiata, 567, 569; of Platyhelminthes\*, 208, 215, 218, 225, 227, 230, 231; of Polychaeta, 262, 275, 278; of Pulmonata, 560, 570; of *Rhabditis*, 248; of Rotifera, 240, 241; of Scaphopoda, 573; of *Sepia*, 598; of Streptoneura\*, 552, 565, 566; of Tunicata, 674-5, 679  
 Generative pore, *see* Generative organs  
 Genital aperture, opening, organs, system, *see* Generative organs  
 Genital atrium, of *Helix*, 561; of Platyhelminthes, 210; of *Stylaria*, 291  
 Genital bursae, 629, 639; canal, 656; coelom, 593; cords, 656; ducts, *see* Gonoducts; operculum, 522; plate, 641; pleurae, 664; stolon, 629. *See also* Axial organ  
 Genital rachis, 629; of Crinoidea, 629, 656; of Echinoidea, 629, 647  
 Geometridae, 491  
*Geonemertes*, 237  
*Geotrupes*, 436  
 Gephyrea, 301  
*Gerardia*, 386  
 Germarium, 447; 240  
 Germs (gametes), *see* Gametes; of Cnidosporida, 100  
*Geryonia*, 164  
*Giardia*, 67; *intestinalis*, 67  
 Gid, 228  
 "Gill" of *Salpa*, 686  
 Gill books, 517; 314, 526, 527, 529  
 Gill chamber of Decapoda, 408  
 Gill clefts, of ascidian tadpole, 675; of *Balanoglossus*, 660, 664, 666; of *Cephalodiscus*, 660, 668; of Chordata, 660; of Thaliacea, 681, 685; of Tunicata, 660, 672, 675, 676, 685  
 Gill filaments, lamellae, plates, 574  
 Gill pouches, slits, *see* Gill clefts  
 Gills, of Arthropoda, 314; of Asteroidea, 629, 634; of Crustacea\*, 348, 379, 391, 393, 394, 401, 403, 404, 408, 409; *see also* Epipodites; of Echinodermata, 629; of Echinoidea\*, 629, 643, 645; of *Limulus*, 314, 517, 526, 527, 529; of Mollusca, *see* Ctenidia; of Polychaeta\*, 263, 270, 275; of Salpida, 685; Tracheal, *see* Tracheal gills  
 Girdle of Polyplacophora, 549  
 Gizzard, of Earthworms, 287; of Insecta, *see* Proventriculus  
 Glabella, 323  
 Glands, Aciniform, 533; Aggregate, 533; Ampulliform, 532; Antennal, *see* Antennal glands; Maxillary, *see* Maxillary glands; Mucous, 561; Oesophageal, 287; of alimentary canal, *see* Alimentary canal, Digestive gland, Liver;

- Glands (*cont.*)  
 Pedal, 535; Prostate, *see* Prostate glands; Pyriform, 533; Shell of Platyhelminthes, 210; Spermiducal, *see* Prostate glands; Spinning, 532; Tubuliform, 533  
*Globigerina*, 76; 40; *bulloides*, **13**  
 Globigerinidae, 76  
*Glochidium*, 582  
*Glomeris*, 424  
 Glomerulus, 668  
 Glossae, 428  
*Glossina*, 506; 435, 448, 512; *submorsitans*, **507**  
*Glossiphonia*, 301; **277, 298, 299**  
*Glossobalanus*, **666**  
*Glycera*, 275; 264, 277  
 Glycogen, 140; 20, 72  
*Glyptoscorpis*, 525; 526  
 Gnathobase, 309; in Arachnida\*, 517, 522, 527, **532**; in Crustacea\*, 338, 357, 363, 364, 368; in Trilobita, 324  
 Gnathobdellidae, 300; 297  
 Gnathochilarium, 423; **423**  
 Gonads, 131, 134, 143; of Arthropoda, 316; of *Balanoglossus*, 668; of Chaetopoda\*, 262, 278, 286; of Coelenterata\*, 156, 174, 183, 196; of Crustacea\*, **351**, 352, 359, 367, 373, 397, 414; of Echinodermata\*, 629, 637, 639, 647, 658; of Nemertea, 233. *See also* Generative organs  
 Gonapophyses, 431, 447  
 Gonoducts, 134, 275. *See also* Generative organs  
 Gonophore, 158  
 Gonopods, 421  
 Gonothecae, 155  
 Gonozooids, of Doliolida, 686; of Siphonophora, 166  
*Gordius robustus*, 257  
 Gorgonacea, 184  
*Grantia*, 126; *extusarticulata*, **124**  
*Graphosoma italicum*, **475**  
 Graptolites, 172  
 Graptolithina, 169; 154  
*Gregarina*, 98; *cuneata*, **27**; *longa*, **97**  
 Gregarinidea, 93; 88  
 Grub, 456; 459  
*Grylloblatta*, 468  
*Gryllotalpa*, 466; 428  
*Gryllus*, 467  
 Guard, 600  
 Gullet, of Metazoa (Oesophagus), *see* Alimentary canal; of Phyto-mastigina, 46, 49; of Protozoa\*, 19; 46, 49, 50, 52, 103-4, 107, 109  
*Gunda segmentata*, *see* *Procerodes lobata*  
 Gymnocerata, 476  
 Gymnoblastera, 154; 157, 162, 164. *See also* Anthomedusae  
 Gymnolaemata, 613  
 Gymnomera, 368; 354, 355  
*Gymnomyxa*, 44  
 Gymnospores, 38  
 Gymnostomata, 107  
*Gyrinus*, 493  
*Gyroceras*, 604  
*Gyrodactylus*, 220  
  
*Haemadipsa*, 301  
 Haematochrome, 47; 57  
*Haematococcus*, 57; 33, 42; *lacustris*, **56**  
 Haemocoelae, 131, 134; of Arthropoda, 314; of Echinodermata, 132, 629; of *Helix*, 556; of Insecta, 437, 454; of Mollusca, 543; of *Peripatus*, 319, 320; of Rotifera, 237. *See also* Vascular system  
 Haemocyanin, 133; 351, 439, 522, 543  
 Haemoglobin, 133; 235, 263, 314, 439  
*Haemogregarina*, 89  
*Haemonchus*, 253, 254  
*Haemopsis*, 301  
*Haemoproteus*, 91  
 Haemosporidia, 91; 88  
*Halcampa*, 187  
*Halesus guttatipennis*, **487**  
*Halichondria*, 127  
*Haliclystus*, 172  
*Haliotis*, 564; 552, **553, 562**, 563; *tuberculata*, **571**  
*Halistemma*, 166  
*Hamitermes silvestri*, **470**  
 Hamula, 465  
 Hamuli, 429  
 Haplopoda, 368  
 Haplosporidia, 102  
*Haplosporidium*, 102; 25; *limnodrili*, **25**  
*Harmolita*, 501  
 Hatschek's pit, 661

- Head, 144; of Arthropoda, 308, 309; of Chaetopoda, 263; of Crustacea\*, 308, 309, 332, 334, 356, 360, 362, 364, 368, 370, 372, 377, 387, 389, 395, 400; of Insecta\*, 308, 425, 463; of Mollusca\*, 544, 549, 550, 555, **559**, 567, 572, 589; of Myriapoda\*, 308, 418, 420, 422; of Onychophora, 308, 309, 318; of Trilobita, 323, 324
- Head cavity of Chordata, 660
- Head foot, 555, 589, 603
- Head kidney, **284**
- Heart, 132; of Arachnida\*, 520, 522, 530, 534, 539; of Arthropoda, 314; of *Balanoglossus*, 667; of Brachiopoda, 616; of *Ciona*, 674, 677; of Crustacea\*, 348, 363, 364, 370, 373, 390, 391, 392, 397, 401; of Insecta, 437; of Mollusca\*, 544, 550, 551, 553, 554, 556, 572, 579, 593
- Hearts, Branchial, 594; of *Arenicola*, 275; of Chaetopoda, 263; of Oligochaeta, 291
- Heat, 4
- Hectocotylus*, 598
- Heliolites*, 186
- Heliopora*, 186, **186**
- Heliosphaera*, 81; *inermis*, **81**
- Heliozoa, 83
- Helix*, 554; **559**, **599**; *aspersa*, 554; *pomatia*, 554, **557**, **558**, **559**, **560**
- Helkesimastix*, 59 n.
- Hemiaspis*, 517; 529; *limuloides*, **525**
- Hemichorda, 662; 628, 660, 661
- Hemimetabola, 454
- Hemimyaria, *see* Salpida
- Heminysis*, **394**
- Hemiptera, 474; **454**, **475**, **477**, **478**
- Hepatic caeca, diverticula, *see* Mesenteric caeca
- Hepatopancreas, *see* Digestive gland
- Hepialidae, 490
- Hepialus humuli*, 490
- Heptagenia*, Nymphal instars of, **482**
- Hermaea*, 569
- Hermaphrodite duct, 560
- Hermaphroditism, of Chaetognatha, 619–20; of Crustacea\*, 351, 376, 379, 381, 382, 398; of Ctenophora, 196; of Gastrotricha, 243; of Hirudinea, 296; of *Icerya*, 446; of Mollusca\*, 555, 567, 582, 585; of Nematoda, 250; of Oligochaeta, 286; of Platyhelminthes, 208; of Polyzoa, 606; of *Protodrilus*, 295; of Protozoa, 33; of Tunicata\*, 674, 679. *See also* Mutual fertilization
- Herpetomonas*, 64
- Herpyllobius*, 376
- Heterocotylea, 218
- Heterodera*, 253; **256**
- Heterometabola, *see* Exopterygota
- Heteronemertini, 237
- Heteronereis*, 268; **265**, 280, **280**
- Heteroneura, 491
- Heteropoda, 566
- Heteroptera, 475
- Heterotricha, 109
- Hexactinellida, 126; 123
- Hexactinian, 187
- Hexamitus*, 66; 10; *intestinalis*, **11**
- Hexapoda, *see* Insecta
- Hind gut, *see* Proctodaeum
- Hinge of Lamellibranchiata, 573
- Hippospongia*, 127
- Hirudinea, 296; 260
- Hirudo*, 301; 297, **297**, 298, **299**, 300
- Histriobdella*, 296; **295**
- Holactypoida, 647
- Hologametes, 31
- Hologamy, 31; 6
- Holomastigina, 60
- Holometabola, *see* Endopterygota
- Holophytic nutrition (Photosynthesis), 18–19 n.; 1, 44, 45; of Phytomastigina\*, 18, 40, 46, 48, 49, 52, 54; of Protozoa, 1, 18, 44
- Holophytic Protozoa, *see* Holophytic nutrition
- Holothuria*, 648, 652, **653**; *tubulosa*, **651**
- Holothuroidea, 648; 623, **649**, **653**
- Holotricha, 106
- Holozoic nutrition, 18–19 n.; of Phytomastigina\*, 46, 49, 52, 54; of Protozoa, 18, 42; of Zoomastigina, 46. *See also* Digestion, Feeding
- Holozoic Protozoa, *see* Holozoic nutrition
- Homarus*, 415
- Homoneura, 490
- Homoptera, 475; 431, 476
- Hood of Tetrabranchiata, 603
- Hoplocampa testudinea*, **497**
- Hoplocarida, *see* Stomatopoda

- Hormiphora plumosa*, 194, **194**  
 Hormones, 131; 138, 344, 440  
 Houses, of Larvacea, 679; of Protozoa, 12; of Pterobranchia, 662  
*Hyalonema*, 126  
 Hyaloplasm, 12 n.  
 Hydatid cyst, 229  
*Hydatina*, 240, 241; *senta*, **238**, 239  
*Hydra*, 162; 48, 111, 128, 146, 147, **149**; *attenuata*, **148**  
*Hydractinia*, 164  
 Hydranths, 154, 155, 158. *See also* Polyps of Hydrozoa  
*Hydratuba*, 178  
 Hydrida, 154. *See also Hydra*  
 Hydrocoele, *see* Water vascular system  
 Hydrocorallinae, 165; 154  
 Hydroids, *see* Hydrozoa  
 Hydrophyllium, 166  
*Hydropsyche*, **487**  
*Hydroptila maclachlani*, **487**  
 Hydorrhiza, 154  
 Hydrospires, 659  
 Hydrothecae, 155, 162, 164, 172  
 Hydrozoa, 153, **163**  
*Hydrurus*, 50; **51**  
*Hylatoma berberidis*, **458**  
*Hylobius*, 256  
*Hymenolepis nana*, 230  
 Hymenoptera, 495; 430, 456, **501**  
 Hymenostomata, *see* Vestibulata  
 Hypermastigina, 65, 67  
 Hyperparasitism, by Cryptoniscus, 398; by Hymenoptera, 502  
 Hyperpharyngeal band, 673  
*Hypobosca*, 512  
 Hypobranchial space, 409  
*Hypoderma lineatum*, 512; *bovis*, **510**  
 Hypopharynx, 428; 463, 483, 506  
 Hypostoma, *see* Labrum  
 Hypostome, 534  
 Hypotricha, 111; 104  
  
*Icerya purchasi*, 446, 495  
*Ichthyophthirius*, 107  
 Ideal malacostracan, 387  
 Ideal mollusc, 544  
 Idiochromatin, 26  
*Idotea*, 398  
 Ileum, *see* Small intestine  
 Imaginal discs, 459  
 Imperforate Foraminifera, 75  
  
 Incisor process, 387  
 Indirect wing muscles, 430  
 Infero-marginal ossicles, 634  
 Inhalant canals, 119  
 Inhibition, 138  
 Ink sac, 591  
*Inostemma*, 502  
 Insecta, 425; 308  
 Instar, 454  
 Intercalary segment, 418, 420, 422, 425  
 Interlamellar concrescences, 574; septum, 585; spaces, 574  
 Internal environment, 3 n.  
 Internal gills, *see* Stewart's organs  
 Internal longitudinal bars, 672  
 Internal madreporite, 627  
 Internal medium, 132; 3 n. *See also* Blood  
 Internal sac of Polyzoa, 611  
 Internal skeleton, of Alcyonaria\*, 183-6 (*passim*); of Crustacea, 340; of Echinodermata\*, 626, 634, 638, 640, 643, 650, 656; of Metazoa, 130; 142; of Porifera, 118, 121, 123; of Protozoa, 7, 12, 17; of Triploblastica, 142  
 Interradial mesenteries, 174  
 Interradial of Echinodermata, 623  
 Intertentacular organ, 606  
 Intestine, *see* Alimentary canal  
 Intracellular body cavity, 245  
 Intracellular digestion, 130; 147, 206, 208, 240, 534, 559, 578  
 Invertebrata, 1; 2  
*Ips*, 256  
 Irregular echinoids, 647; 625  
 Ischiopodite, 336  
 Isogamy, 31; 46, 56, 74, 88. *See also* Gametes  
 Isopoda, 395  
 Isoptera, 469  
 Isospores, 80  
*Iulus*, 422; 418; *terrestris*, **422**, **423**  
  
*Japyx*, 463  
 Jaws, of Arthropoda, 308, 309; *see also* Mouth parts; of Chaetognatha, 618; of Echinoidea, 645; of *Helix*, 557; of Onychophora, 308, 318; of *Sepia* (beak), 594  
 Jelly, of Coelenterata, *see* Structureless lamella; of Porifera, 118, 123  
 Jugal lobe, 429

- Kakothrips robustus*, 485  
 Karyogamy, 30 n. *See also* Syngamy  
 Karyolymph, 12  
 Karyosome, 23, 24  
 Keratosa, 127 and n.; 121  
*Kermes ilicis*, 481  
*Kerona*, 111  
 Kidneys of molluscs, 556; 545, 550, 552, 554, 565, 566, 570, 572, 573, 580, 581, 582, 591, 603. *See also* Renal openings  
 Kinetonucleus, 17. *See also* Parasomal body  
 Labial hooks, 474  
 Labial palps, of Insecta, *see* Mouth parts of Insecta; of Lamellibranchiata, 574; of Protobranchiata, 582  
*Labidura*, 469  
 Labium (Second maxillae of Insecta), *see* Maxillae  
 Labrum, of Crustacea, 339; of Insecta, 426; of Trilobita, 323. *See also* Mouth parts  
 Lacinia, 427  
*Lacinia mobilis*, 393; 397  
 Lacunar system, 629; of Antedon, 658; of Echinoidea, 629, 647; of Holothuroidea, 629, 650  
 Lacunar tissue, 629  
*Lambliia*, *see* *Giardia*  
 Lamellibranchiata, 573  
*Lampyrus*, 440  
 Languets, 673  
*Lankesterella*, 91; 90  
 Lantern coelom, 645  
 Large intestine of Insecta, 434  
 Larvacea, 679; 144  
 Larvae, *Actinotricha*, 621, 622; *Actinula*, 159; *Amphiblastula*, 125; *Appendicularia*, 675; Argulid, 376; *Auricularia*, 633, 668; *Bipinnaria*, 632; *Brachiolaria*, 633; Crinoid, 633; "Cyclops", 373; 353, 374, 375; *Cyphonautes*, 610, 611; "Cypripis", 380; 353, 382, 385; *Dipleurula*, 631; 627; Echinoderm, 630, 632; *Echinopluteus*, 633; *Ephyra*, 179; *Erichthus*, 389; Euphausid, 403; *Glochidium*, 582; Insect, 456; *see also* names of orders; *Megalopa*, 414; *Metanauplius*, 353, 373; *Metazoea*, 389; Müller's, 145, 215, 216; "Mysis", *see* Schizopod; *Nauplius*, 352; *see also* *Nauplius* larvae; Nematode, 251-9 (*passim*); *Ophiopluteus*, 632; of Brachiopoda, 618; of *Gordius*, 257, 258; of Pantopoda, 539; of Pentastomida, 541, 542; of Porifera, 123; *Phyllosoma*, 415; *Pilidium*, 235; *Planula*, 152; *see also* *Planula* larva; *Pluteus*, 632; *Protaspis*, 324; Rhabditoid, 251; Schizopod, 389; Stomatopod, 392; *Tornaria*, 668; 633; "Trilobite", of *Limulus*, 529; Trochosphere, 282; *see also* Trochosphere larva; *Veliger*, 546, 547, 582; *Zoea*, 353; *see also* *Zoea* larvae  
 Larval arms of Echinodermata, 632  
 Larval nephridia, 284  
 Lasso cells, 193  
 Lasso of nematocyst, 148  
 Lateral cilia, 576  
 Lateral lines of Nematoda, 244  
 Latero-frontal cilia, 576  
*Laura*, 385  
*Laura gerardiae*, 387  
 Laurer's canal, 217, 232  
*Leander*, 415  
 Legs, of Arachnida\*, 308, 521, 527, 533, 537; of Arthropoda, 305; of Insecta\*, 308, 428, 464, 466, 481, 490, 492, 495, 503, 511, 512; of Malacostraca\*, 397, 398, 401, 402, 403, 404, 410, 415; of Myriapoda\*, 421, 424; of Onychophora, *see* Feet  
*Leishmania*, 64  
 Lemnisci, 258  
*Leodice*, 264; 279; *fucata*, 278; *viridis*, 278  
*Lepadocrinus*, 659  
*Lepas*, 377; 329, 379, 380; *anatifera*, 378, 381  
*Lepidocaris*, 360; 338, 339, 354, 355  
*Lepidonotus*, 264, 268  
 Lepidoptera, 430, 435  
*Lepidurus*, 360; 355, 362; *glacialis*, 360  
*Lepisma*, 461; *saccharina*, 463; 464  
*Leptocoris trivittatus*, 479  
*Leptodora*, 368; 354, 362; *kindti*, 369  
 Leptomedusae, 153; 156, 160, 164.  
*See also* Calyptoblastea  
*Leptomonas*, *see* *Herpetomonas*  
 Leptostraca, 390; 333, 346, 388, 389  
*Lernaea*, 375; 375

- Lernanthropus*, 349, 351  
*Leucandra*, 126; 120; *aspersa*, 120  
*Leucifer*, 415; 144, 145, 396  
*Leucochrysis*, 50  
*Leucon* grade, 120  
*Leucosolenia*, 126  
*Levuana iridescens*, 512  
*Libellula*, 443, 444  
*Lieberkühnia*, 74; 68, 72; *wagneri*, 74  
Life cycle, 8; of Actinomyxidea, 100; of Aphididae, 478; of Cecidomyiidae, 446; of Cestoda, 228; of Cladocera, 367; of Cnidosporidia, 100, 101, 102; of Coccidia\*, 89, 90, 91; of Coccidiomorpha, 88; of Coelenterata, 150; of Doliolida, 684; of Foraminifera, 72; of Gregarinidea\*, 93, 94, 95, 96, 98; of Haemosporidia\*, 89, 90, 91; of Hydrozoa\*, 153, 155-66 (*passim*); of Malacocotylea\*, 220, 223; of Mycetozoa, 86; of Neosporidia, 87; of Piroplasmidea, 98, 99; of Polythalamia, 72, 76, 79; of Radiolaria, 80; of Rotifera, 241; of Scyphomedusae\*, 178, 178, 180; of Sporozoa, 87; of Telosporidia, 88; of Trypanosomidae, 64; of Tunicata, 677  
Life history, of Alcyonaria, 183; of Arthropoda, 316; of ascidians, 675; of Brachiopoda, 616; of Chaetognatha, 620; of Copepoda, 373; 374, 375, 376; of Crustacea\*, 352; of Echinodermata, 630; of Heterocotylea, 218; of Insecta, 454; *see also* names of orders; of Leptostraca, 391; of Malacostraca, 389; of Mollusca, 545; of Nematoda\*, 251-7; of Nemertea, 235; of *Pelagia*, 180; of Peracarida\*, 393, 397, 402; of Polychaeta, 282; of Polyzoa, 610; of Porifera, 117; of Protozoa, 38; of Siphonophora, 166; of Trilobita, 324. *See also* Embryology, Larvae, Life cycle  
Ligament of Acanthocephala, 259  
Light, 4, 38, 40, 47  
*Ligia*, 395; 398; *oceanica*, 397  
*Ligula*, 428  
*Limacina*, 569  
*Limax amoebae*, 43; 69  
Limbs, of Arachnida, 308, 575; of Arthropoda, 305, 306-7, 309; of Crustacea, 326, 327, 328-9, 330, 334; of Onychophora, 317, 319; of Trilobita, 324. *See also* Abdominal limbs, Antennae, Antennules, Legs, Mandibles, Maxillae, Maxillules, Mouth parts, Pleopods, Thoracic limbs, Trunk limbs, Uropods  
*Limnaea*, 301, 570; *abyssalis*, 570; *peregra*, 571  
*Limnocoidea*, 164  
*Limnocodium*, *see Craspedacuta*  
*Limnophilus*, 487  
*Limulus*, 526; 306 n., 310, 312, 515, 517, 518, 520; *polyphemus*, 527, 528  
*Lineus*, 237  
*Linguatula taenioides*, 541, 541  
*Lingula*, 616; 615, 617, 618  
Linin, 12  
Lipostraca, 360; 354  
*Lithobius*, 418; 89, 306 n., 307 n.; *forficatus*, 419, 420, 421  
*Lithocampe tschernyschevi*, 80  
*Lithocircus*, 83; *annularis*, 49  
*Lithodes*, 415; *maia*, 416  
*Littorina*, 566; 552, 563; *rudis*, 566  
*Lituities*, 604  
Liver, 130, 131; of Arachnida, 517; of Crustacea\*, 344, 358, 391, 403, 414; of *Helix*, 558, 560; of *Sepia*, 595. *See also* Digestive gland, Mesenteric caeca  
Living chamber of *Nautilus*, 602  
*Lizzia*, 160; *koellikeri*, 161  
*Lobophyllum*, 193  
Lobopodia, 14  
Locomotion of Protozoa\*, 15, 83  
*Locusta*, 468; *migratoria*, 466  
*Loimia*, 269  
*Loligo*, 589, 601, 601  
Longitudinal band, *see* Ciliated band  
Longitudinal fission of Protozoa\*, 29; 45, 54  
*Lophohelia*, 191; 190  
Lophophore, of Brachiopoda, 615; of Polyzoa, 606  
*Loxodes*, 107  
*Loxosoma*, 612  
*Lucernaria*, 172; 173, 178  
Luciae, *see* Pyrosomatida  
*Lucifer*, *see* *Leucifer*  
*Lucilia*, 436  
Lumbricidae, 287, 289

- Lumbriculus*, 294; 293; *variegatus*, **293**  
*Lumbricus*, 287; **260**, 261, **262**, 275, 276, 286, 289, **292**, **297**; *foetidus*, **290**; *terrestris*, **288**  
 Lung, 555, 556, 557, 570  
 Lung books, 314, 517, 518, 521, 522, 530, 531  
*Machilis (Petrobius) maritimus*, 427, **427**, 428, 463  
*Macrobiotus*, 539, **540**  
*Macrocorixa*, 439  
 Macrogametes, *see* Female gametes  
 Macromeres, 281, 282  
*Macrotrista angularis*, **478**  
 Macrurous type, 404  
 Madreporic vesicle, 628; 627, 639  
 Madreporite, 627; 624, 628, 639, 641, 646, 648, 649, 652, 658  
*Magellania flavescens*, **614**  
*Maia*, 417  
*Malacobdella*, 237  
 Malacocotylea, 220; 218  
 Malacostraca, 386; 330, 344, 346, 348, 351, 352  
 Malaria, 91  
 Malaria parasite, *see Plasmodium*  
 Male eggs of Rotifera, 241  
 Male gametes, 31; of Metazoa, *see* Spermatozoa; of Porifera, 118; of Protozoa\*, 31, 32, 33, 85, 89, 93, **96**  
 Mallophaga, 483  
 Malpighian capsules, 141  
 Malpighian tubules, 315; 141; of Arachnida\*, 315, 517, 524, 530, 540; of Insecta, 315, 434, 436, 437, **438**; of Myriapoda\*, 315, 421, 424  
 Mandibles, 308; of Crustacea, 308, 332, 339, 352; of Insecta, 308, 426, 427; of Myriapoda\*, 308, 420, 422. *See also* Mouth parts  
 Mandibular groove, 332  
 Mandibular palps, 339, 369, 372, 373, 379, 387, 388, 395, 401, 410, 412  
*Mantis*, 429  
 Mantle, of Brachiopoda, 613, 615, 616, 618; of Cirripedia\*, 330, 333, 377, 378, 386; of Mollusca\*, 544, 545, 547, 549, 555, 556, 564, 565, 567, 569, 572, 580, 582, 584, 587, 589, 591, 603; of Tunicata, 669, 682  
 Mantle cavity, or groove, of Brachiopoda, 615, 616; of Cirripedia\*, 378, 379, 383; of Mollusca\*, 544, 545, 549, 550, 551, 554, 556, 564, 565, 566, 567, 572, 574, 576, 579, 587, 589, 591, 602  
 Mantle flap or fold, *see* Mantle  
 Manubrium, 150-1, 156, 158, 160, 166, 169, 173, 174  
*Margellium*, 160; **161**  
 Marginal anchors, 173  
 Maricola, 214  
 Mass provisioning, 498 n.  
 Mastax, 240  
*Mastigamoeba*, 60; *aspera*, **62**  
 Mastigobranchiae, 408  
 Mastigophora, 45; 8, 44, 46  
 Maxillae (Both pairs of), 308; 306-7; of Crustacea, 308; of Insecta, 426-7; 307, 308, 427, **428**; of Myriapoda\*, 307, 308, 420, 422. *See also* Mouth parts  
 Maxillae, First, of Crustacea, *see* Maxillules, Mouth parts  
 Maxillae, Second, of Crustacea, 332, **335**, 339, *see also* Mouth parts  
 Maxillary glands, 345, **346**, 359, 367, 373, 379, 392  
 Maxillipeds, 307; of Crustacea\*, 332; 328-9, 372, 393, 397, 401, 403, 404, 410; of *Lithobius*, 421  
 Maxillules, 332, 339, 379, 410. *See also* Mouth parts  
*Meandrina*, **192**  
 Mecoptera, 486  
 Medium, 3, 132. *See also* Internal medium  
 Medusa, The, 150, **151**, 152  
 Medusae, of Hydrozoa\*, 153, 156, 158-62 (*passim*), 165, 166, 169; of Scyphozoa\*, 174, 179, 180  
*Megachile*, 503  
 Megachromosomes, 26  
*Megalopa* larva, 414, **414**  
 Megalospheric form, 76  
 Meganephridium, 290  
 Meganucleus, 26; 24, 33, 35, 44, 107, 110, 115  
 Megascolecidae, 287, 290  
*Megascolides*, 290; *australis*, **277**  
 Melanin(s), 591; 91, 342  
*Melicerta*, 241  
*Meloë*, 492  
 Meloidae, 495



- Melolontha*, 457, 458, 495  
*Melophagus*, 512  
 Membranellae, 17, 104  
*Membranipora*, 608, 609, 613  
*Menopon pallidum*, 483; 484  
 Mentum, 427  
*Mermis*, 256; 249; *nigrescens*, 256  
*Merodon*, 511  
 Merogametes, 31, 89  
 Meropodite, 336  
 Merozoites, *see* Schizozoites  
 Mesenchyme, 129; 130 and n., 131, 134, 142, 197; of Acoelomata, 197; of Ctenophora, 195; of Echinodermata, 631; of Hirudinea, 298; of Nemertea, 236; of Platyhelminthes, 205; of trochosphere, 281  
 Mesenteric caeca, of *Aphrodite*, 268; of Arachnida\*, 315, 517, 534, 539; of Crustacea\*, 344, 358, 367, 379, 391, 392, 393, 397, 412; of Echinodermata\*, 626, 636, 646, 656; of Insecta, 434. *See also* Digestive gland, Liver  
 Mesenteric filaments, 182, 187  
 Mesenteries, of Actinozoa, 182, 187, 188, 190; of Holothuroidea, 650; of Polychaeta, 285; of Scyphozoa, 174, 178  
 Mesenteron (Mid gut), 130; of Crustacea\*, 344, 358, 367, 412; of Hirudinea, 297; of Insecta, 433; of Nematoda, 248  
 Mesoblast, *see* Mesoderm  
 Mesoblastic somites, *see* Mesoderm segments  
 Mesocerebrum, *see* Deutocerebrum  
 Mesoderm, 129; 1, 131, 134, 142, 143; in the trochosphere, 281, 285; of Arachnida, 520; of Arthropoda, 316; of Chordata, 661, 675; of Insecta, 452. *See also* Mesenchyme, Mesoderm segments, Mesothelium  
 Mesoderm segments (Mesoblastic somites), 316; 135; of Annelids, 285; of Arachnida, 516, 520; of Arthropoda, 314, 316; of Chaetopoda, 261, 285; of Chordata, 661; of Onychophora, 319  
 Mesogloea, *see* Structureless lamella  
 Mesosoma, 309, 517, 522, 524  
*Mesostoma*, 211; 204; *ehrenbergi*, 214; *quadrangulare*, 214  
 Mesothelium, 129; 131, 133, 135, 142, 143. *See also* Mesoderm segments  
 Metabasipodite, *see* Preischiopodite  
 Metabola, *see* Pterygota  
 Metaboly, 17, 52  
 Metacerebrum, *see* Tritocerebrum  
 Metacestode stage, 228  
 Metachronal rhythm, 17; 195  
 Metameric segmentation, 285  
 Metamorphosis, *see* Life history  
*Metanauplius* larva, 353, 373  
 Metanemertini, 237; 233  
 Metapneustic, 508; 509, 511  
 Metasicula, 170  
 Metasoma, 309, 517, 521, 524  
 Metasome, 372  
 Metasternite, 522  
 Metastoma, of Crustacea, 339; of Eurypterida, 525; of Trilobita, 323  
 Metatroch, 284  
 Metazoa, 128; 1, 7, 8, 27, 35, 45, 124  
*Metaxoaea* larva, 389  
 Metepipodites, 336, 337. *See also* Branchia  
*Metridium*, 193  
*Miastor*, 446, 509  
 Microchromosomes, 26  
*Microfilaria diurna*, 255; *nocturna*, 255  
 Microgametes, *see* Male gametes  
*Microhydra*, 165; 162  
 Micromeres, 281  
 Micronephridia, 290  
 Micronuclei, 26; 33, 34, 35, 107, 110, 115  
 Micropterygidae, 488, 490  
*Micropteryx*, 488, 490  
 Microspheric form, 76  
 Microsporidia, 102  
*Microstoma lineare*, 214; 213  
 Mid gut, *see* Mesenteron  
 Mid-gut caeca, *see* Mesenteric caeca  
 Milk glands of tsetse fly, 446  
*Millepora*, 165, 165  
 Mitoses of Protozoa, 24  
 Molar process, 387  
 Mollusca, 543; 1, 2; Types of, 544  
 Molpadida, 652  
*Monas*, 63; 16, 42, 46; *vulgaris*, 62  
 Monaxonida, 127 and n.  
 Monocyclical rotifers, 241  
*Monocystis*, 97; 12, 31, 37, 38, 96, 97; *lumbrici*, 97; *magna*, 97

- Monograptus*, 170; **170**, 172  
*Monomorium minimum*, **501**  
*Mononchus*, 248 n.  
 Monopylaea, 80  
*Monosiga*, 65; *brevipes*, **65**  
 Monothalamia, 72  
 Monotocardia, 563; 552, 565  
*Monstrilla*, 374  
*Montipora*, **192**  
 Mosaic disease, 474  
 Mosaic vision, 313  
 Motile organs of Protozoa, 14  
 Moulting, 250, 257, 309, 373, 454  
 Mouth, Position and shape of, in  
 Arthropoda, 309; in ascidian tadpole, 675, 677; in *Balanoglossus*, 663; in Brachiopoda, 615; in Chilopoda, 420; in Coelenterata\*, 150, 151, 152, 160, 161, 165, 166, 174, 179, 182, 191, 194; in Echinodermata\*, 623, 625, 631, 640, 647, 655; in *Helix*, 555; in Hirudinea, 296; in *Hydatina*, 239; in Insecta, 426; in *Lepas*, 379; in *Peripatus*, 319; in Platyhelminthes\*, 198, 214, 215, 216, 217; in Protozoa\*, 19, 103, 107; in Trilobita, 323; in Triploblastica, 130, 144  
 Mouth, *see also* Alimentary canal  
 Mouth parts (limb-jaws and lips), of Arthropoda, 305, 308; of Crustacea\*, 308, 339, 354, 356, 364, 369, **372**, 374, 379, 387, 397, **398**, 401, **402**, 410, **411**; of Insecta\*, 308, 426, **427**, **428**, 463, 465, 466, 468, 469, 471, 472, 474, **475**, **477**, 481, 483, 485, 486, 487, **489**, 490, 492, 496, 506, **507**, 509, 511, 512; of Myriapoda\*, 308, **420**, 422; of Onychophora, 318  
 Mucous glands of *Helix*, 561  
*Muggiaea*, 166, **167**  
 Müller's larva, 216; 145, **215**  
*Multicilia*, 60  
 Multiple fission of Protozoa\*, 28, 36, 54, 64, 72, 76, 88, 89, 93, 95  
*Murex*, 566; 559 n.  
*Musca*, 506, 508, 512; *domestica*, **508**  
 Muscle(s), Alary, 437, **438**; Adductor, *see* Adductor muscles; Columnella, 555; Retractor, *see* Retractor muscles. *See also* Musculature  
 Muscle fibres, 128, 142; of Arthropoda, 316; of Chaetognatha, 618; of Coelenterata\*, 147, 151, 176; of Nematoda, 244; of *Pecten*, 585; of *Peripatus*, 316; of Platyhelminthes, 204  
 Muscular gland organ, 211  
 Musculature, of Actinozoa\*, 182, 187, **188**; of Arthropoda, 305; of ascidian tadpole, 675; of Asterozoa, **634**; of Brachiopoda, 615; of Cephalopoda, 589; of Chaetognatha, 618; of Chaetopoda, 261, **262**, 266, 272; of *Ciona*, 669; of Crinozoa, 656; of Ctenophora, 195; of Echinozoa, 641, **644**, 645; of Gasteropoda, 555; of gill books and lungs, 517, 518; of Hirudinea, 298; of Holothurozoa, 649, 650; of Medusae, 151, 156, 176, 179; of Metazoa, 142; of Nematoda, 244, 246; of Nemertea, 235; of Onychophora, 308, 317; of Ophiurozoa, 638, **639**; of Polyzoa, 608; of Platyhelminthes, 202; of Rotifera, 237; of Thaliacea, 682; of the trochosphere, 285; of wings, 430, **431**  
 Mutations, 36  
*Mutilla*, 503  
 Mutual fertilization, by Ciliophora, 33; by *Helix*, 561; by Oligochaeta, 289; by Platyhelminthes, 211  
*Mya*, 579  
 Mycetozoa, 86; 8, 11  
*Mygale*, 530  
 Myoblast, 204  
 Myonemes, 17  
 Myophrisks, 81  
 Myopsida, 589  
*Myriamida*, 268; 264, 278  
 Myriapoda, 418; 308  
 Mysidacea, 393; 387, 388  
*Mysis*, 393; 332, **394**; *relicta*, **388**  
 "Mysis" larva, *see* Schizopod larva  
*Mytilus*, 583; **548**, 574, **575**, **577**, 579, **580**, **581**  
*Myxobolus*, 100; 43  
 Myxospongiae, 127 and n.  
 Myxosporidia, 100  
 Nacreous layer, 546  
*Naegleria*, 69; 25; *bistadialis*, **69**; **23**  
 Narcomedusae, 164; 153

- Nassa*, 563  
*Nassellaria*, *see* Monopylaea  
*Natica*, 563  
*Nauplius* larvae, 352; 324, 332, 338, 339, 340, 342, **352**, 354, 359, 368, 373, 374, 375, 379, 382, **383**, 385, 389, 403, 415  
 Nautiloidea, 602, 603  
*Nautilus*, 602; 588, **590**, 599, 604; *macromphalus*, **604**  
*Nebalia*, 390; 329, **335**, 336, 340, 348; *bipes*, 390, **390**  
 Neck of Cestoda Merozoa, 225  
 Neck gland, *see* Dorsal organ; organ (Nuchal organ), 342; 334, 356, 364  
 Nectocalyces, 166  
 Needham's sac, 598  
 Nematocysts, 148; 150, 166, 189, 569  
 Nematoda, 244; 2, 130, 141, 197  
 Nematomorpha, 257; 197, 244  
*Nematus ribesii*, 500  
 Nemertea, 233; 130, 197  
*Neoechinorhynchus*, **259**  
*Neomenia*, 549  
 Neosporidia, 100; 87, 88  
 Neoteny, 144  
*Neotermes*, 469  
*Nepa*, 474, 476  
 Nephridia, Nephridial system, 134; 136, 140, 141, 197, 261, 275-8, **277**, 300  
 Nephrocytes, 437; 439  
 Nephromixia, 263, 276  
*Nephrops*, 415; 332  
 Nephrostome, 263; 275, 276, 289, 290  
*Nephthys*, 277  
*Nereis*, 268; 262, 264, **265**, 272, 277, 282, **283**  
*Nerilla*, 296; **295**  
 Nerve-cord, *see* Nervous system  
 Nerve fibre, 137 and n.; 138  
 Nerve net, 128, 136, 137, 138, 150; of acoelomate Triploblastica, 197; of *Balanoglossus*, 664; of Coelenterata\*, 149, 176, 195; of Echinodermata, 626, 629; of Platyhelminthes, 198, 217; Origin of centres and nerves in\*, 136, 137, 150, 197, 198, 630, 664  
 Nerve rings, of Echinodermata, 630; of Medusae, 151, 152, 153, 156, 176  
 Nerves, 137; 136. *See also* Nervous system  
 Nervous system, 136; 5, 128, 142; of Acanthocephala, 259; of Annelida\*, 260; 1, 261, 287, 289, 294, 300; of Arachnida\*, 524, 529, 531, 539; of Arthropoda, 300; of Brachiopoda, 616; of Chaetognatha, 618; of Chordata, 660; 2; of *Ciona*, 675, 676, 677; of Coelenterata\*, 149, 151, 156, 176, 195; of Crustacea\*, 340; **311**, 373, 379, 383, 391, 392, 397, **413**, 414; of Echinodermata, 629, 638, 646, 650, 656; of Gastrotricha, 243; of Hemichorda, 664, 668; of Insecta, 448; of *Lithobius*, 422; of Mollusca\*, 545, 549, 550, 554, 555, 570, **571**, 572, 582, 596; of Nematoda, 245; of Nematomorpha, 257; of Nemertea, 235; of Onychophora, 322; of Platyhelminthes\*, 198, **199**, 217, 225; of Polyzoa, 606; of Rotifera, 237  
 Neurones, 137  
 Neuropodium, 265  
 Neuroptera, 485  
*Neuroterus*, 500  
 Nidamental glands, 591  
*Noctiluca*, 55; 48, **56**  
 Noctuidae, 491  
*Nodosaria*, 76; *hispidia*, **13**  
 Nodus of Odonata, 472  
*Nomada*, 504  
 Non-cellular animals, 7  
 Notochord, 661; of ascidian tadpole, 675; of Hemichorda, 662, 664  
*Notodelphys*, 374  
*Notonecta*, 474, 476  
 Notopodium, 265  
 Notostraca, 360; 327, 354, 355  
*Novius cardinalis*, 495  
 Nuchal sense organ, *see* Neck organ  
*Nucleariae*, 72  
 Nuclei, in Metazoa and Protozoa, 7, 27; of pansporoblasts, 100; of Protozoa, 22, **23**; Plurality of, in Protozoa, 10; Position of, in choanocytes, 126  
 Nucleoli, 22  
 "Nucleus", of Rhizocephala, **384**; of Thaliacea, 686  
*Nucula*, 582; 544, 574, 579  
 Nuda, 196  
 Nudibranchiata, 567; 554  
*Nummulites*, 76; *laevigatus*, **75**

- Nuptial chamber, 469  
 Nurses, 504  
 Nutrition, 17; of Mastigophora, 46; of Phytomastigina, 46, 47, 49; of Protozoa, 17, 18; of symbionts, 48. *See also* Holophytic nutrition, Holozoic nutrition, Saprophytic nutrition  
*Nycteribia*, 512  
*Nyctiphanes*, 403; *norvegica*, 403  
*Nyctotherus*, 109; *cordiformis*, 109  
*Nymphon*, 538, 540  
 Nymphs, 455  
  
*Obelia*, 154; **151, 155, 156**, 158  
 Oblique fission, 45  
 Obtect pupae, 456, 490  
*Ochromonas*, 50; 47, **51**, 63  
*Octobothrium*, 218  
*Octomitus*, *see* *Hexamitus*  
 Octopoda, 589; 599  
*Octopus*, 589, 595, 598, 599, **601**, 602  
 Ocular plate, 641  
*Ocypris*, 495; *olens*, 493, **494**  
 Odonata, 472; 430, 444  
 Odontoblasts, 557  
*Odontocerum*, **487**  
*Odontosyllis*, 280  
*Odynerus*, 498 n., 503  
 Oegopsida, 588  
 Oenocytes, 439, 440  
 Oesophageal bulbs, 248  
 Oesophageal pouches, 287  
 Oesophagus, *see* Alimentary canal  
*Oikomonas*, 63; *termo*, **62**  
*Oikopleura*, **43**, 680; *albicans*, **680**  
*Olenus cataractes*, **323**  
 Olfactory hairs, 342  
 Oligochaeta, 286; 261, 263, 301  
*Oligolophus spinosus*, **538**  
 Oligopod stage, **458**, 459  
 Oligotricha, 110  
*Olythus*, 117; **117**  
 Ommatidium, 310; 426  
 Onchosphere, 228, 229, 230  
 Onychophora, 317; 308. *See also* *Peripatus*  
 Onychopoda, 368  
 Oocysts, 22; of Gregarinidea\*, 94, 95, 97  
*Oodinium*, 55; 43; *poucheti*, **43**  
 Oogamy, 31, 46  
 Ookinete, 91, 93, 98  
 Oostegites, 389; 393, 397, 401  
 Ootheca, 448  
  
 Ootype, 211  
 Oozoid, 679; 685  
*Opalina*, 106; 10, 28, 43, 107; *ran-arum*, **11, 27, 106**  
 Opalinidae, *see* Prociliata  
 Opening (Aperture), Atrial, *see* Atrial opening; Excretory, *see* Excretory organs, Renal openings; Genital, *see* Generative organs; of Mantle cavity, *see* Mantle. *See also* Anus, Mouth, Oscula, Ostia, Pneumostome, Pores  
 Operculum, 270  
*Ophiocoma*, 640  
*Ophioglypha*, **639**  
*Ophiopluteus*, 632  
*Ophiothrix*, 640  
*Ophiura*, **639**, 640  
 Ophiuroidea, 638; 623, 625, 626, 627, 629, 630, 632  
*Ophryocystis*, 94; *mesnili*, **95**  
 Opisthobranchiata, 567; 553, **568**  
 Opisthosoma, 309; 515, 528, 530, 537. *See also* Mesosoma, Metasoma  
*Opisthoteuthis*, 602; 589  
 Optic lobes of Crustacea, 340  
 Oral aspect (side, or surface), 143; of Echinodermata, 623  
 Oral cone, 150; 155, 158; disc, 182; siphon, 669; valves, 655  
 Organisms, 4  
*Ornithodoros moubata*, 537  
*Orthoceras*, 600; **600**, 604  
 Orthoptera, 466; 429, 432, 454  
 Orthorrhapha, 509, 510  
*Oscarella*, 127  
*Oscinus frit*, 512  
 Oscula, of Porifera, 117, 119, 120; of Radiolaria, 80, 83  
 Osphradia, 565  
 Ossicles, of Echinodermata, 626; Adambulacral, 636; Ambulacral, 636, 638, 645; Basal, 656; Brachial, 656; Centrodorsal, 655, 656; Cirrhal, 656; Infero-marginal, 634; of Holothuroidea, 648, 650; Pinnular, 656; Radial, 656; Rosette, 656; Supero-marginal, 634. *See also* Auriculae, Skeletal plates  
 Ossicles, System of, in Asteroidea, 634; in Crinoidea, 656; in Echinoidea (plates), 641; in Holothuroidea (calcareous ring), 649, 650; in Ophiuroidea, 638

- Ostia, of heart, 314, 349, 421, 437, 522, 530; of sponges, 119
- Ostracoda, 368; 327, 331, 333, 346, 349, 351, 353
- Ostrea*, 585; 579, 582; *edulis*, 546, 585, 586
- Otocyst, *see* Statocysts
- Otoplana*, 214
- Ova, 6. *See also* Eggs
- Ovarian lamella, 379
- Ovarioles, 448
- Ovary, *see* Generative organs
- Ovicell, 612
- Oviducts, *see* Generative organs
- Ovigerous frenum, 379; legs, 539
- Ovipositor, of Insecta\*, 431, 466, 495, 502; of Phalangida, 538
- Ovotestis of *Helix*, 560
- Oxidation, 131; 140, 143
- Oxyuris*, *see Enterobius vermicularis*
- Pachytylus migratorius*, 467
- Paedogamy, 83
- Paedogenesis, 446
- Paired limbs, *see* Limbs
- Palaemonemertini, 237
- Palaephonus*, 524
- Palinura, 404
- Palinurus*, 415; 389
- Pallial arteries and circulation of Lamellibranchiata, 580
- Pallial budding, 679; gills, 565; sinus, 616
- Palliovisceral cords, 547
- Palmella, 47
- Palolo worm, *see Leodice viridis*
- Palps, Labial, *see* Labial palps; Mandibular, *see* Mandibular palps; of Acarina, *see* Pedipalps; of Polychaeta\*, 265, 268
- Paludicola, 214
- Paludina*, 566; 145, 543, 552, 563; *vivipara*, 551
- Pamphilus*, 501
- Pancreatic tissue, 594
- Pandalus*, 336
- Pandorina*, 57; 46, 57
- Panorpa*, 429; *communis*, 486
- Pansporoblasts, 100
- Panthalis*, 267; 264
- Pantopoda, 538
- Papilio*, 492
- Papilionina, 489, 492
- Parabasal body, 17
- Paracordodes*, 258, 258
- Paractinopoda, *see* Synaptida
- Paragaster, 117
- Paraglossae, 428
- Paragnatha, 339. *See also* Mouthparts
- Paramecium*, 109; 12, 14, 15, 18, 21, 21, 27, 28, 34, 42, 43, 104 and n., 106, 116; *aurelia*, 35; *caudatum*, 21, 34, 42
- Paramitoses, 25
- Paranebalia*, 391
- Paraesophageal (Circumoesophageal) connectives, *see* Nervous system
- Parapodia, of *Aplysia*, 567; of Polychaeta\*, 261, 264-75 (*passim*)
- Parasites, 5. *See also* Parasitic habits
- Parasitic castration, by Isopoda, 398; by Rhizocephala, 383
- Parasitic habits, of Acanthocephala, 259; of Acarina\*, 534, 537; of Anoplura, 484; of Aphaniptera, 512; of Branchiobdellidae, 301; of Ciliata\*, 106, 107, 109, 110, 111; of Cirripedia, 382; of Copepoda, 374; of Crustacea, 331; of *Cyamus*, 403; of Dinoflagellata, 54; of Diptera, 512; of *Entamoeba*, 70; of Hemiptera, 476; of Hirudinea, 300-1; of *Histiobdella*, 296; of Hymenoptera\*, 498-502 (*passim*); of Isopoda, 398; of Mallophaga, 483; of Nematoda\*, 245-57 (*passim*); of Nematomorpha, 257; of Pentastomida, 541; of *Plasmodiophora*, 86; of Platyhelminthes\*, 198, 216; of Polymastigina\*, 66; of Protozoa, 43; of Sporozoa\*, 87; of Trypanosomidae, 63
- Parazoa, *see* Porifera
- Parenchyma, Parenchymatous tissue, 205; 197, 198, 206, 225
- Parthenogenesis, 6; of Crustacea\*, 351, 362, 367, 369; of Gastrotricha, 243; of Insecta\*, 446, 479, 480, 485, 504 n.; of Protozoa, 33; of Rotifera, 241
- Parthenogonidia, 58
- Patella*, 565; 547, 552, 553, 562, 563; *coerulea*, 546
- Peachia*, 187; 188
- Pecten*, 584; 142, 579, 582, 599; *maximus*, 584, 584; *opercularis*, 584, 585; *temuicostatus*, 585

- Pectines, 522, 525  
 Pectinibranchiata, *see* Monotocardia  
 Pedal cords, 545, 547, 565; sinus, 582  
*Pedalion*, 241  
 Pedicellariae, 626; Crossed, 634; Gemmiform, 641, **642**; Ophiocéphalous, 641, **642**; of Asterozoidea, 634; of Echinozoidea, 641; Tridactyle, 641, **642**; Trifoliate, 641, **642**; Uncrossed, of Asterozoidea, 634  
*Pedicellina*, 612  
*Pediculus humanus*, 484; **484**  
 Pedipalpi, 512  
 Pedipalps, 515, 522, 524, 530, **532**, 533, 534, 539  
 Peduncle, *see* Stalk  
*Pelagia*, 180  
*Pelagothuria*, 652; **653**  
 Pelagothurida, 652  
 Pellicle, 12; 49, 105, 106  
 Pelmatozoa, 658; **657**  
*Pelomyxa*, 72; *palustris*, **71**  
 Pen of *Loligo*, 601  
 Penaeidea, 404  
*Penaeus*, **335**, **349**, 353, 415  
*Penilia*, 363  
 Penis, *see* Generative organs  
*Pennaria*, 164; **163**  
*Pennatula*, 184  
 Pennatulacea, 184  
*Pentacrinus*, 658  
 Pentastomida, 541; 539  
 Pentatomidae, 476  
*Pentremites*, 659  
 Peptonophridia, 291  
 Peracarida, 393; 336, 389  
*Peranema*, 52; **12**, 20, 22, 46; *trichophorum*, **53**  
 Perforate Foraminifera, 75  
 Peribranchial cavities, 673  
 Pericardial sinus, *see* Pericardium  
 Pericardium, of Arthropoda, 314; of Cephalopoda, 593; of *Ciona*, 674, 677; of Crustacea, 348; of Enteropneusta, 667; of Insecta, 437; of Mollusca, 543; of Snail, 556  
 Perichaetine, 289  
 Perihæmal coelom of Enteropneusta, 663; system of Echinodermata\*, 626; 637, 638, 645, 656  
 Periostracum, of Brachiopoda, 615; of Mollusca, 546  
*Peripatus*, 317; 130 n., 141, 305, 312, 316, **319**, 539; *capensis*, **318**, **319**, **321**, **322**  
 Peripharyngeal band, 669  
*Periplaneta*, 466  
 Peripneustic larva, 508  
 Periproct, 640  
*Peripsocus phaepterus*, 472  
 Peripylaea, 80  
 Perisarc, 155  
 Perisomatic cavity, **384**  
 Peristome, of Ciliata, 104; of Echinozoidea, 640  
 Peristomial cirri, 266  
 Peristomium, 266; 268, 272  
 Peritoneum, 131, 136, 262, 278  
 Peritricha, 111; 104  
 Peritrophic membrane, of Crustacea, 345; of Insecta, 434; of Onychophora, 320  
 Perivisceral cavity, 134, 141; of *Acanthobdella*, 300; of Arthropoda, 314; of Chaetopoda, 261; of *Ciona*, 674; of Echinodermata, 626; of Mollusca, 543; of Rotifera, 237. *See also* Coelom, Haemocoel  
*Perla maxima*, 471  
 Pernicious malaria, 93  
*Perophora*, 681; 677, 679, **681**  
 Perradial, 174  
*Petrobius maritimus*, **464**  
*Phaenoserphus*, 459, 502; *viator*, **499**  
*Phaeococcus*, 52  
 Phaeodaria, *see* Tripylaea  
 Phaeodium, 83  
 Phalangida, 537  
*Phalera bucephala*, **441**  
 Pharynx, *see* Alimentary canal  
*Phascolosoma*, 304  
*Pheretima*, 290  
 Philodinidae, 241  
*Philonexis*, 599  
*Phlebotomus*, 64  
 Phobotaxis, 38  
*Pholas*, 586  
 Phoronidea, 622  
*Phoronis*, 622; **621**  
 Phorozooids, 686  
 Phosphagen, 662 and n.  
 Phosphorescent Protozoa, 20  
 Photogenic organs of Insecta, 439  
 Photosynthesis, *see* Holophytic nutrition  
*Phoxichilidium femoratum*, 539  
 Phragmocone, 600

- Phronima*, 403; **396**  
*Phryganea*, 487, **487**  
 Phylactolaemata, 613; 609  
*Phyllobius urticae*, **457**  
 Phyllobranchiae, 408  
*Phylloceras*, 602; *heterophyllum*, **604**  
 Phyllopoda, 356  
 Phyllopodium, 336; 334  
*Phyllosoma* larva, 415  
*Phyllotreta*, 495  
*Phylloxera vastatrix*, 479  
*Physalia*, 166; **168**  
 Phytomastigina, 46; 59  
 Pieridae, 437  
*Pieris*, 490, 492; *rapae*, **460**  
 Pigments, Blood, 133; *see also* Chlorocruorin, Haemocyanin, Haemoglobin; of Crustacea, 342; of Haemosporidia, 91; of Lepidoptera, 488; of Phytomastigina, 47. *See also* Chromatophores, Melanins  
*Pilema*, 179; **180**  
*Pilidium* larva, 235; 145, 233, **236**  
 Pinacocytes, 117  
 Pinnate tentacles, 180, 649, 652  
 Pinnulary ossicles, 656  
 Pinnules, 654  
*Piroplasma*, 98, **99**, 537  
 Piroplasmidea, 98; 88  
 Placenta, of Onychophora, 321; of Salpida, 685; of Scorpionidea, 524  
*Placocystis*, 658  
*Plagiostomum lemani*, 214  
*Planaria*, **204**; *alpina*, 208, 213; *lactea*, 201; *lugubris*, 201, 214  
*Planorbis*, 301, 570  
*Planula* larva, 152; 1, 145, 146, 156, 178, 183, 196  
 Plasmodia, 11, 86  
*Plasmodiophora*, 86  
 Plasmodium, 36  
*Plasmodium*, 91; 38, 43; *falciparum*, 93; *malariae*, 93; *vivax*, **92**, 93  
*Plasmodroma*, 44  
 Plasmogamy, 30 n.  
 Plasmotomy, 29, 83, 100, 107  
 Plastin, 22, 23, 24  
 Plastogamy, 36; 30 n.  
*Platygaster*, **458**, 459  
 Platyctenea, 196  
*Platyhedra*, 490; *gossypiella*, 490; **488**  
 Platyhelminthes, 198; 2, 130, 197, 215, 230  
 Plecoptera, 471; 444  
*Pleodorina*, 58; *californica*, **10**; *illinoensis*, **10**  
 Pleopods, 388. *See also* Abdominal limbs of Crustacea  
*Plesiocaris vagicollis*, **455**  
*Plesiocoris*, 476  
*Pleurobrachia*, 196; *pileus*, 194  
 Pleurobranchiae, 348; 404  
 Pleuron, 332  
 Pleuropodite, *see* Precoxa  
 Plicate canals, 580  
*Plodia*, 491  
*Plumatella*, 606, 613, 622; *fungosa*, **607**  
*Plumularia*, 162; **163**  
*Pluteus* larva, 632; **632**  
 Pneumatophore, 166  
 Pneumostome, of Arachnida, 518; of Pulmonata\*, 556, 570, 572  
 Podia, *see* Tube feet  
 Podical plates, 430  
 Podobranchiae, 404  
 Podocoryne, 164  
*Podocyrtes schomburgki*, **80**  
*Podophrya*, 115  
*Podura aquatica*, 465  
 Pole capsules, 14, 100  
 Polian vesicles, 637; **640**, **651**  
*Polistes aurifer*, **501**  
*Polycelis nigra*, 214  
 Polychaeta, 264; 261, 263  
*Polycirrus*, 263  
 Polycladida, 215  
*Polyclimum*, 680  
 Polydisc strobilation, 180  
 Polyembryony, of Hymenoptera, 446; of Polyzoa, 612  
 Polyenergic nuclei, 26  
*Polygordius*, 294; 282, 284, 285, **285**  
*Polykrikos*, 54; 10, **55**; *schwarzi*, **55**  
 Polymastigina, 65  
 Polyp, The, 150; **151**, 152, 153  
 Polyphaga, 493, 494  
*Polyphemus*, 368  
 Polypide, 606  
 Polyplacophora, 547  
 Polypod stage, 458, **458**  
 Polyps, of Anthozoa, 180-93 (*passim*); of Hydrozoa\*, 153, 154-66 (*passim*); of Scyphozoa\*, 174, 178, 180  
*Polystomella*, 76; 31, 38, 42, 75, **79**; *crispa*, **23**, **78**  
*Polystomum*, 218; 219; *integerrimum*, **219**

- Polythalamia, 74; 72  
*Polytoma*, 56; 20, 29, 30, 33, 40, 46;  
     *uvella*, 23, 30  
 Polytricha, 109  
 Polyzoa, 606; 2  
*Pomatoceros*, 263; 264, 267; *triqueter*,  
     271  
*Pontobdella*, 301  
*Porcellana*, 415; 389  
 Pore plate of Radiolaria, 80  
 Pore-rhombs, 659  
 Pores, Collar, *see* Collar pores; Dorsal,  
     *see* Dorsal pores; of Porifera, 117;  
     Proboscis, *see* Proboscis pore;  
     Water, 658, *see also* Madreporite  
 Porifera, 117; 1, 125  
*Porites*, 191; 192  
 Porocytes, 118  
*Poromya*, 579  
*Porthetria dispar*, 490  
 Portuguese man-of-war, *see Physalia*  
 Posterior aorta, of Araneida, 530; of  
     *Astacus*, 350; of *Carcinus*, 412; of  
     *Helix*, 557; of Lamellibranchiata,  
     580; of Scorpionidea, 522; of  
     *Sepia*, 593  
 Posterior interradius of Echinoidea,  
     647  
 Posterolateral arms of *Plutei*, 633  
 Posterolateral edge of *Carcinus*, 408  
 Postsegmental region of Crustacea,  
     332  
 Preantennae, 318; 306  
 Preantennal somite, 306, 318, 425  
 Prebranchial zone, 669  
 Precheliceral somite (segment), 515;  
     516  
 Precoxa, 336  
 Pregenital somite (segment) of Arach-  
     nida, 515; 516  
 Preischiopodite (Preischium), 336  
 Prementum, 427  
 Preoral lobe of Echinodermata, 632  
 Preoral region, of Annelida, 260; *see*  
     *also* Prostomium; of Arthropoda,  
     308; of Crustacea, 331, 332; of  
     Echinodermata, *see* Preoral lobe;  
     of Enteropneusta, *see* Proboscis.  
     *See also* Presegmental region,  
     Preoral somites  
 Preoral somites, of Arachnida, 515;  
     of Arthropoda, 309; of Chilopoda,  
     420; of Crustacea, 332; of Ony-  
     chophora, 319  
 Presegmental region of Crustacea,  
     332  
 Primary body cavity, *see* Haemocoel  
 Primary embryo, 612  
 Prismatic layer, of Brachiopod shell,  
     615; of Molluscan shell, 546  
 Probasipodite, 336  
 Proboscis, of Acarina, 534, 537; of  
     *Bonellia*, 302; of Branchiura, 377;  
     of *Buccinum*, 565; of Chaetopoda,  
     264; of Enteropneusta, 662; of  
     Hemiptera, 475; of Lepidoptera,  
     487; of Nemertea, 233; of Panto-  
     poda, 538, 539; of Rhyncho-  
     bdellidae, 297; of Suctorial Cope-  
     poda, 374, 375, 376  
 Proboscis cavity, of *Balanoglossus*,  
     662, 668; of Chordata, 660  
 Proboscis complex of *Balanoglossus*,  
     666; pore of *Balanoglossus*, 663  
 Proboscis sheath, of *Buccinum*, 565;  
     of Nemertea, 233; of Rhyncho-  
     bdellidae, 297  
 Probuds, 687  
 Procererebrum, 309, 340 n.  
*Procerodes lobata*, 214  
 Prociliata (Opalinidae), 106; 26, 33  
 Proctodaeum, 130; of Arthropoda,  
     314; of Crustacea, 344; of trocho-  
     sphere, 284  
 Proctotrypidae, 502  
 Proepipodites, 336; 337, 348, 354,  
     358, 364  
 Progressive feeding, 498 n.  
 Prolegs, 456, 490, 491, 500, 510  
 Proliferating region, of Syllidae, 278;  
     of Tapeworms (neck), 225, 227  
 Proostracum, 600  
 Propodite, 336  
 Propolis, 504  
*Proroden*, 107; *teres*, 110  
 Proscicula, 170  
 Prosobranchiata, *see* Streptoneura  
 Prosoma ("Cephalothorax" of Ar-  
     achnida), 308, 515, 521, 526, 530,  
     533, 537  
 Prosopyles, 120  
 Prostate glands, of Oligochaeta, 287,  
     289, 291; of *Sepia*, 598  
 Prostomium, of Annelida, 260; of  
     Chaetopoda\*, 261, 264, 268, 272,  
     284, 291; of Echiuroidea\*, 301,  
     302; of Hirudinea, 296; of Sipun-  
     culoidea, 304



- Protaspis* larva, 324, **325**  
*Proteolepas*, 382  
 Protephemeroptera, 462  
 Protobranchiata, 582; 574, 579  
 Protocerebrum, 309, 340  
 Protochordata, 660  
 Protoclypeastroida, 647  
 Protococcaceae, 47  
 Protocdnch, 602  
 Protodonata, 462  
*Protodrilus*, 295; 294; *chaetifer*, 295  
 Protohymenoptera, 462  
 Protomerite, 95  
 Protomonadina, 63  
*Protoparce*, 437  
 Protoplasm of Protozoa, 11  
 Protopod stages (oligomero, polymero), 458, **458**  
 Protopodite, 324, 335, 336, 372, 379  
 Prototroch, of *Cyphonautes*, 611; of *Pilidium*, 235; of trochosphere, 282  
 Protozoa, 7; 1, 126  
 Protozoa and Metazoa, Connection between, 45  
 Protura, 465  
 Proventriculus, of *Carcinus*, 412; of Crustacea, 344; of Earthworms, see Gizzard; of Insecta, 432; of *Gammarus*, 401; of *Ligia*, 397  
*Pseudococcus*, 478  
 Pseudocolonies of Protozoa, 11  
 Pseudonavicellae, 95  
 Pseudophyllidea, 229  
 Pseudopodia, 14; of Amoebina, 68, 69; of Foraminifera, 72, 74; of Heliozoa, 83; of *Hydra*, 147; of *Mastigamoeba*, 60; of Mycetozoa, 86; of Radiolaria, 76, 80  
 Pseudopodiospores, see Amoebulae  
 Pseudotracheae, 506  
 Pseudotransverse fission, 29; **29**, 45  
 Pseudovelum, 176  
 Psocoptera, 471  
 Pterobranchia, 662  
 Pteropoda, 569  
*Pterostichus*, **457**, **499**  
*Pterotrachea*, 566; 563, **566**  
 Pterygota, 466  
*Pterygotus*, 526; **525**; *osiliensis*, **525**  
 Ptilinum, 509, 511  
*Ptychomyia remota*, 512  
*Pulex irritans*, 513; 514  
 Pulmonata, 569; 554  
 Pulvillus, 428  
 Pupa, 456; 490, 508, 509, 511, 513  
 "Pupa", of Holothuroidea, 633; of *Lerneae*, 375  
 Pupae, Coarctate, Exarate and Obtect, 456; 509  
 Puparium, 456, **508**, 509, 511  
 Pure lines, 36  
*Purpura*, 563  
*Pycnogonum littorale*, 539  
 Pygidium, 323  
 Pyloric caeca, of Asteroidea, 636; of Insecta, 434  
 Pyloric chamber, 344; sac, 636  
 Pyralidae, 491  
*Pyrameis*, 450  
 Pyrenoids, 47; 56, 57  
 Pyriform organ, 611  
*Pyrosoma*, 685; 682, **682**, **683**  
 Pyrosomatida, 685; 681, 682  
 Pyrrhocoridae, 476  
 Quadrant, 281  
 Quartan ague, 93  
 Quartettes, 281  
 Rachiglossa, 563  
 Radial "blood vessel", 629, 637, 645, 650, 658; nerve (aboral), 656; nerve (ectoneural), 630, 637, 645, 646; ossicles, 656; periaermal vessel, 626, 637, 638, 645, 656; water vessel, see Water vascular system  
 Radial cleavage, **283**; 145, 631  
 Radial fission, 29; **29**, 58  
 Radial symmetry, 633; 143; of Actinozoa, 182; of Cnidaria, 151; of Echinodermata, 623, 633  
 Radii of Echinodermata, 623; **646**, 649  
 Radiolaria, 76; **41**, 43  
 Radula, 557; 544, 550, 565, 567, 569, 570, 572, 595; sac, 557  
 Receptaculum seminis, see Spermatheca  
 Receptors, 137  
 Rectal caeca, 636  
 Rectum, see Alimentary canal  
 Reduction division, 27, 37, 88  
 Reduvidae, 476  
 Reflex arc, 137  
 Reflexes, in Metazoa, 137; in Protozoa, 38  
 Regeneration, in Crustacea, 339; in Turbellaria, 213

- Regular sea urchins, *see* Endocyclica  
 Relation of Protozoa to their Environment, 40  
 Relicts, 393  
 Renal openings (apertures, papillae) of Mollusca, 544, 549, 556, 565, 591  
 Renopericardial openings (apertures, canals), 556; 572, 593  
 Repeated fission of Protozoa\*, 28; 29, 45, 54, 57  
 Reproduction, 5. *See also* Asexual reproduction, Sexual reproduction; of Protozoa, *see* Fission  
 Reproductive aperture, organs, *see* Generative organs  
 Reserve materials, 5, 20  
 Respiration, 4, 139; of Arthropoda, 314; of Crustacea, 348; of *Cyclops*, 373; of Lamellibranchiata, 576; of Protozoa, 22; of Tubiculous Polychaeta, 270. *See also* Respiratory movements, Respiratory organs  
 Respiratory movements, of *Aphrodite*, 268; of Arachnida, 517; of Branchiopoda, 355; of *Carcinus*, 409; of Crustacea, 348; of *Cyclops*, 373; of Gasteropoda, 556; of Insecta, 441; of *Mysis*, 393; of Pulmonata, 556, 572; of Tubiculous Polychaeta, 270; of *Tubifex*, 293  
 Respiratory organs, 139; of Arachnida, 517; of Arthropoda, 314; of Branchiopoda, 354; of Chaetopoda, 263; of Crustacea, 348; of Echinodermata, 628; of Holothuroidea, 650; of Lamellibranchiata, 576; of *Ligia*, 397. *See also* Gills, Lung, Tracheae  
 Respiratory pigments, *see* Pigments, Blood  
 Respiratory trees, 629, 650  
 Resting cysts, 22; eggs, 241, *see also* Winter eggs; phase of *Phytomastigina*, 47  
 Rete mirabile, 650  
 Retinaculum, 429, 489  
 Retinulae, 310  
 Retractor muscle(s), of penis, 561; of proboscis, 233; of stomach, 636; of tentacles, 649  
 Retral processes, 76  
 Retropharyngeal band, 672  
*Rhabdammina*, 76; 12; *abyssorum*, 13  
 Rhabdites, 204  
*Rhabditis*, 245; 247  
 Rhabditoid larva, 251  
 Rhabdocoelida, 214; 201  
 Rhabdoliths, 50  
 Rhabdom, 310  
 Rhabdomeres, 310  
*Rhabdopleura*, 668; 660, 662; *normani*, 667  
*Rhipicephalus*, 537  
 Rhipidoglossa, 563  
 Rhizocephala, 382; 330, 377  
*Rhizochrysis*, 50  
*Rhizocrinus*, 658; 657  
 Rhizomastigina, 60; 69  
 Rhizoplasts, 17  
 Rhizopoda, *see* Sarcodina  
 Rhizopodia, 14, 15  
*Rhizostoma*, 179  
 Rhizostomeae, 179  
*Rhodites*, 500  
*Rhodnius*, 437, 440 n.; *prolixus*, 476, 438  
 Rhombifera, 659  
*Rhyacophila*, 487  
 Rhynchobdellidae, 300; 297, 298  
 Rhynchocoel, 233  
 Rhynchodaeum, 235  
*Rhynchodemus terrestris*, 215  
 Rhynchota, *see* Hemiptera  
*Rhyssa*, 500  
 Ring canal of Polyzoa, 606  
 Rings (Nervous, Water vascular, etc.) of Echinodermata, 623; 626, 630. *See also* Nervous system, Water vascular system, etc.  
 Ripe proglottis, 225; 227  
 Ripple-marking, 604  
 Rods of eyes of Arthropoda, 310  
 Rosette ossicle, 656  
 Rostellum, 227  
 Rostrum, of Cephalopoda, 600; of Crustacea\*, 334; 370, 390, 407, 415; of Hemiptera, 474, 476  
*Rotifer*, 241  
 Rotifera, 237; 2, 197, 244  
 Rotulae, 645  
 Royal pair, 469; 471  
*Sabella*, 264  
*Saccharicida*, 476  
*Saccocirrus*, 295; 260, 295

- Sacculina*, 382; **383, 384, 385**  
*Sagitta*, 622; 129, **620**, *see also* Chaetognatha; *bipunctata*, **620**, 621; *hexaptera*, **619**  
 Salivary glands, of Arachnida\*, 522, 530, 534, 540; of *Helix*, 558; of Hirudinea, 297; of Insecta, 432; of *Lithobius*, 421; of Onychophora, 320; of *Sepia*, 595  
*Salpa*, 686; 196, 677, **678, 684**; *democratica-mucronata*, **682, 683**  
 Salpida, 685; 679, 682  
 Saltatoria, 466  
*Sao hirsuta*, **325**  
 Saprophytic nutrition, 19 n.; of Phytomastigina\*, 46, 47, 49, 52, 54, 57; of Protozoa, 20, 42  
 Saprophytic Protozoa, *see* Saprophytic nutrition  
 Saprozoic, *see* Saprophytic  
*Sarcocystis*, 102; *lindemanni*, **103**  
 Sarcodina, 68; 44, 49  
*Sarcophaga*, 436  
 Sarcosporidia, 102  
*Sarsia*, 169; **167**  
*Saxicava*, 586  
 Scallops, *see* *Pecten*  
*Scalpellum*, 380; *vulgare*, **381**  
*Scaphites*, 605  
 Scaphopoda, 572  
*Scarabaeus Thomsoni*, 494  
 Scarabeidae, 494, 495  
 Scent scales, 488  
*Schellackia*, 91; 90  
*Schistocephalus gasterostei*, 228  
*Schistosoma*, 222; **222**  
*Schizocystis*, 93; **94**  
 Schizogony\*, 88; 37, 89, 91, 93, 94  
 Schizogregarinaria, 93  
 Schizopod larva, 389  
 Schizopoda, 388  
 Schizozoites\*, 88; 37, 89, 93  
 Sclerotium, 86  
 Scolex, 225; 227  
*Scolopendra*, 306 n., 307, 421  
*Scorpio*, 524; *swammerdami*, **521**  
 Scorpionidea, 520  
 Scutigera, 421  
 Scutum, 378  
 Scyphistoma, 179  
 Scyphomedusae, 172; 152  
 Scyphozoa, *see* Scyphomedusae  
*Scytomonas*, *see* *Copromonas*  
 Secondary body cavity, *see* Coelom  
 Secondary embryos, 612  
 Segmental organs, 275. *See also* Coelomoducts, Nephridia  
 Segmentation, 143; of Annelida, 260, 261; of Arthropoda, 308, 309; of Cestoda, 225; 143; of Chordata, 660; of Vertebrata, 143; 661; suggested by certain organs in Mollusca, 549, 603  
 Segmentation of the ovum, *see* Cleavage  
 Segments of the body, *see* Somites  
 Self-fertilization, 250, 561  
 Seminal groove, of Oligochaeta, 289; of Opisthobranchiata, 567  
 Seminal receptacle of *Sagitta*, 619  
 Seminal vesicles (Vesiculae seminales), of Chaetognatha, 619; of Insecta, 447; of Oligochaeta, 286, 291; of Platyhelminthes, 210  
 Sense organs, of Araneida, 533; of ascidian tadpole, 676; of Chaetopoda, 263, 265; of Coelenterata\*, 147, 149, 156, 160, **161**, 164, 177; of Crustacea, 340; of Echinodermata, 630; of Hirudinea, 300; of Insecta, 449; 426; of Mollusca\*, 549, 555; of Onychophora, 317; of Platyhelminthes, 200; of Protozoa, 17; of Rotifera, 240. *See also* Eyes  
 Sensillae, 450, **451**  
*Sepia*, 589; 588, **590, 597, 599**, 600, **601**, 602; *officinalis*, 589; **592, 593, 594, 595**  
 Sepioidea, 588  
*Sepiola*, 588, 602  
 Septa, of Chaetopoda\*, 261, 272, 285, 291, 294; of shell of Tetrabranchiata, 602, 604; of Zoantharia, 190  
 Septibranchiata, 579  
*Sergestes*, 353; *arcticus*, **335**  
*Serpula intestinalis*, **288**  
*Sertularia*, 164; **163**  
 Sexual congress, *see* Sexual differences and sexual behaviour, Mutual fertilization  
 Sexual differences and sexual behaviour, of Arachnida, 524, 529, 533, 537; of Archannelida, 296; of *Balanoglossus*, 668; of *Bonellia*, 302; of Cephalopoda, 598; of Coelenterata, 152; of Crustacea\*, 351, 356, 358, 362, 372, 373, 374, 375, 376, 381, 382, 383, 397, 402, 410;

- Sexual differences and sexual behaviour (*cont.*)  
of Echinodermata, 629; of Insecta\*, 446, 469, **470**, 472, 479; of Myriapoda, 422, 424; of Nematoda, 250; of Onychophora, 321; of Pantopoda, 539; of Polychaeta, 278; of Protozoa, 32; of Rotifera, 240.  
*See also* Generative organs
- Sexual reproduction, 6; of Metazoa, *see* Generative organs; of Protozoa, 30. *See also* Life history
- Sexuparae, 480
- Shape of body, *see* Body
- Shell of Crustacea, *see* Carapace
- Shell of Echinoidea, *see* Corona
- Shell glands, of Crustacea, *see* Maxillary glands; of Platyhelminthes, 210
- Shell ligament, 573
- Shell types, Arenaceous, 75; Imperforate, 75; Perforate, 75
- Shells, of Brachiopoda, 613; of Crustacea, *see* Carapace; of Foraminifera\*, **13**, 72, 74, 75, **75**, 76; of Mollusca\*, 545, 547, **548**; 549-605 (*passim*); of Protozoa, 12
- Shield-shaped tentacles, 649
- Sialis*, 485; *lutaria*, **485**
- Sicula, 170; 171
- Sida*, 363
- Silicoflagellata, 50
- Silicoflagellidae, *see* Silicoflagellata
- Silver fish, *see* *Lepisma saccharina*
- Simocephalus*, 364; *sima*, **365**
- Simuliidae, 509
- Simulium*, 446
- Sinus system of Hirudinea, 298
- Sinuses, Haemal, of Arachnida\*, 522, 531; of Arthropoda, 314; of Crustacea, 348; of *Helix*, 556; of Lamellibranchiata, 580; of *Lumbri-culus*, **293**, 294; of *Pomatoceros*, etc., 263
- Siphon, of Echinoidea, 646; of Gasteropoda, 556; of suctorial Crustacea, *see* Proboscis
- Siphonoglyphes, 182
- Siphonophora, 166; 154, **167**, **168**
- Siphonozooids, 185
- Siphons of Lamellibranchiata, 574
- Siphuncle, 602; 600
- Sipunculoidea, 304; 261, 301
- Sipunculus*, **303**, 304
- Sirex gigas*, 500
- Sitaris*, **458**
- Size of Protozoa, 8
- Skeletal plates, of Echinoidea, 641; of Ophiuroidea, 638
- Skeletogenous layer, 117
- Skeleton, External, *see* Corals, Cuticle, Perisarc, Shell; Internal, *see* Internal skeleton
- Skin, 136
- Skull of Cephalopoda, 596
- Slimonia*, 524; **525**
- Small intestine of Insecta, 434
- Social life, of Hymenoptera, 498, 502; of Isoptera, 469
- Soldiers of Isoptera, 469; 471
- Solenia, 183
- Solenocyte, 275; 134
- Somatoblast, 282
- Somite, First, of Arthropoda, 306-7, 308, 309, 318, 319, 332, 420, 425, 515
- Somites (body segments), Series of, in Arthropoda, 306-7, 308; in Crustacea, 328-9; in Polychaeta\*, 266, 268, 270, 272. *See also* Tagmata
- Somites, mesoblastic, *see* Mesoderm segments
- Spatangoida, 647
- Spatangus*, 648
- Sperm pouch of Chaetognatha, 619
- Sperm sacs, *see* Seminal vesicles
- Spermatheca (Receptaculum seminis), of *Helix*, 561; of Insecta, 447; of Nematoda, 250; of Platyhelminthes, 210
- Spermatric atrium, 291
- Spermatophores, of Crustacea, 352; of *Helix*, 561; of *Peripatus*, 321; of *Sepia*, 598
- Spermatozoa, 6; of Crustacea, 352; of Hirudinea, 300; of Nematoda, 250
- Spermiducal glands of Oligochaeta, 287
- Sphaeractinomyxon*, 102
- Sphaerella*, *see* *Haematococcus*
- Sphaerophrya*, 116; 115; *sol*, **108**
- Sphecoidea, 503
- Spherularia*, 257; **256**
- Sphex*, 503
- Sphingidae, 491
- Sphinx*, 439

- Spicules, of Alcyonaria\*, 183, 184, 186; of Porifera, 118, 120, **122**, 123; of Radiolaria\*, 80, 81, 83
- Spines, of Echinodermata, 626; of Echinoidea, 641; of Ophiuroidea, 638; of Starfish, 634
- Spinnerets, 530; 532
- Spiracles, of Arthropoda, *see* Stigmata; of Blastoidea, 659
- Spiral cleavage, 281; 145
- Spirochona*, 114; 43; *gemmipara*, **114**
- Spirographis*, 264
- Spirostomum*, 110; 40; *ambiguum*, **110**
- Spirula*, 600; 588, **600**
- Spirulirostra*, 600; **600**
- Sponges, *see* Porifera
- Spongilla*, 127; *lacustris*, **125**
- Spongillidae, 124
- Spongin, 121
- Spongioplasm, 12
- Sporangium, 86
- Spore cases, 38; 94, 98, 100
- Spores, 37; 12, 38, 55, 70, 80, 86, 88, 89, 94, 96, 98, 100
- Sporoblasts, 87; 38, 89, 93, 100
- Sporocysts, 22; 38, 89, 96
- Sporogony, 37, 89
- Sporont, 36, **37**, **92**
- Sporozoa, 87; 8, 43, 44
- Sporozoites, 36; 87-100 (*passim*)
- Spumellaria, *see* Periphylaea
- Squilla*, 392; *mantis*, **391**
- Stainers, 476
- Stalk (Peduncle), of Brachiopoda, 613; of Cirripedia\*, 377, 378, 379, 380, 382; of Pelmatozoa\*, 625, 654, 655, 658, 659; of Protozoa\*, 8, 65, 86, 111, 115, 116; of Pterobranchia, 668; Proboscis, 662
- Stalked gland organ, 211
- Staphylinidae, 495
- Staphylocystis*, 229
- Statoblasts of Polyzoa, 609
- Statocysts (Otocysts), of Calyptoblastea, 156; of Crustacea, 342; of Turbellaria, 202
- Statolith of ascidian tadpole, 676
- Stauromedusae, 172
- Stegomyia*, **252**, 509
- Stenopodium, 334, 335
- Stentor*, 110; **18**, 104, **105**; *coeruleus*, **23**, **110**
- Stephanoceros*, 241
- Sterna, 332; of Arachnida\*, 522, 525, 537; of Crustacea, 332, 409; of Myriapoda\*, 421, 424
- Sternites, *see* Sterna
- Sternorhyncha, 476
- Stewart's organs, 645
- Stigma of Odonata, 472
- Stigmata (Spiracles), of Arachnida, 519, 536, 537; of Insecta, 440, 441, 444, 508, 509; of Myriapoda, 421, 424; of Onychophora, 320
- Stigmata of Tunicata, 672, 673
- Stimuli, Effect of, on Protozoa, 38
- Stipe, 170; 171
- Stipes, 427
- Stolon, of Alcyonaria, 183; of *Hydratuba*, 178; of Hydrozoa, *see* Hydrorhiza; of Tunicata, 677, 678, **678**, 680, 681, **683**
- Stomach, 130. *See also* Alimentary canal
- Stomatopoda, 391; 336, 353, 389
- Stomodaeum (Fore gut), 130; of Anthozoa\*, 182, 187; of Arthropoda, 314; of *Ciona*, 669; of Crustacea\*, 344, 358, 379; of Ctenophora, 195; of Insecta, 432; of Nematoda, 248; of Onychophora, 320; of Rotifera, 240; of Tricladida (pharynx), 206; of Trochosphere, 282
- Stone canal, 626, 627, 637, 639, 646, 647, 658
- Strepsiptera, 429
- Streptoneura, 563; 552
- Strobilation, of *Aurelia*, 178, 180; of Cestoda, 143, 225
- Stromatocystis*, 658
- Strombus*, 563
- Strongyloid larva, 251
- Strongyloides stercoralis*, 254
- Structureless lamella (Mesogloea), 146, 150, 156, 161, 174, 179, 180-6 (*passim*)
- Stylaria*, 291; 286; *proboscidea*, **292**
- Stylets, of Hemiptera, 474; of Nemer-  
tea, 233; **234**
- Stylommatophora, 570
- Stylonichia*, 111; 42; *mytilus*, **112**
- Stylops*, 514
- Subchela, 339
- Subchelate limbs, 391, 401, 415, 515, 530
- Subdermal cavities, 123

- Subgenital pits, 174  
 Subimago, 481  
 Submentum, 427  
 Subneural gland of Tunicata, 672  
 Suboesophageal ganglion, *see* Ganglion, Suboesophageal  
 Substratum, 3  
 Subtentacular canals, 656  
 Subumbrel pit, 174  
 Subumbrellar cavity, 156, 158; ectoderm, of Medusa, 156; of trochosphere, 282; musculature, 156  
 Suctoria, 114; 8, 19  
 Sulcus, 54  
 Summer eggs of Cladocera, 367; of Mesostomum, 213  
 Superlinguae, 428; 306, 463  
 Supero-marginal ossicles, 634  
 Superposition image, 313  
 Supraoesophageal ganglia, *see* Ganglion, Cerebral  
 Surface, of Ciliata, 105; of Protozoa, 12, 20, 22. *See also* Ectoplasm  
 Suture line of ammonoid shell, 605  
 Swarm spores, 38  
 Swarming of Polychaeta, 278.  
*Sycon*, 126; 119; *raphanus*, **125**  
*Sycon* grade, 120  
*Syllis*, 268; 264, **266**, 279; *ramosa*, 280; **279**  
 Symbiosis, 44 n.; 44, 47, 52, 68, 111, 193, 213, 470  
 Symmetry, 143, 633; of Actinozoa, 182; of Echinodermata, 623, 624, 633; of Metazoa, 143; of Protozoa, 8. *See also* Bilateral symmetry, Radial symmetry  
 Sympathetic system, of Crustacea, 340; of Insecta, 448  
 Symphyta, 500  
 Sympylasts, 10  
*Synagoga*, 386; *mira*, **386**  
*Synalpheus*, **386**  
 Synapse, 138, 149  
*Synapta*, 652; 650, **653**  
 Synaptida, 652  
 Syncarida, 392; 389  
 Syncytia, 10, 100, 102. *See also* Plasmodia  
 Syngamy, 30; 6, 37; of Ciliophora\*, 30 n., 33, **34**, 35, 107, 114, 115; of Dinoflagellata, 54; of Mastigophora, 45; of Sarcodina\*, 72, 80, 83, **85**, 86; of Sporozoa\*, 88-100  
 (*passim*); of Volvocina\*, 31, 46, 56, 57, 58; of Zoomastigina, 59  
*Syracosphaera*, 50; *pulchra*, **51**  
*Syringopora*, 186  
*Syrphus*, 511  
 Syzygy, 88 and n.; 89, 90, 94, 95  
  
*Tabanus*, 506  
*Tachardia lacca*, 478, 481  
 Tachinidae, 512  
 Tactile organs, *see* Sense organs  
*Taenia*, **224**, 230; *coenurus*, 228; *echinococcus*, 229, 230; *serrata*, 228; *solium*, **226**, **227**  
 Taenioglossa, 563  
*Taeniothrips inconsequens*, 485  
 Tagmata, 308; of Arachnida, 308; of Crustacea\*, 308, 332, 370, 387; of Insecta\*, 308, 483; of Myriapoda, 308; of Onychophora, 308. *See also* Abdomen, Cephalothorax, Head, Mesosoma, Metasoma, Opisthosoma, Prosoma, Pygidium, Thorax, Trunk  
 Tail, 662; 622; of Chaetognatha, 618, 619, 620, 622; of Chordata, 662; of Tunicata, 675, 677, 679, 686  
 Tail fan, 388; 391, 392, 393, 398, 404  
 Tanaidacea, 395  
*Tanais*, **395**  
 Tardigrada, 539  
 Tarsus, 428; 464, 483, 485, 493, 495, 512  
*Tealia*, 193  
 Tectibranchiata, 567  
 Teeth, of Echinoidea, 645; of Ophiuroidea, 639. *See also* Radula  
*Tegenaria guyonii*, **532**  
 Tegmen, 655  
 Tegmentum, 549  
 Tegmina, 466  
 Telosporidia, 88; Reduction division of, 27-8, 37  
 Telson, 306-7; of Arachnida\*, 517, 524; of Crustacea\*, 326, 328-9, 332, 355, 358, 368, 372, 386, 395, 400; of Lithobius, 421; of Trilobita, 324  
*Temnocephala*, 216; *minor*, **217**  
 Temnocephalea, 216  
 Temperature, 4, 42  
 Tentacle sheath, 608  
 Tentacles, of polyp and medusa, 150, 151, 152, *see also* Tentaculocysts;

- Tentacles (*cont.*)  
of Ctenophora, 195, 196; of Gasteropoda, 544, 550, 555, 567, 569; of Holothuroidea\*, 649, 652; of Hydrozoa\*, 155-69 (*passim*); of *Nautilus*, 603; of Polychaeta, 263, 265, 268, 270, 271; of Polyzoa, 606; of Scyphomedusae, 173, 174, 178; of Suctoria\*, 19, 115, 116; of Turbellaria, 202
- Tentaculata, 196
- Tentaculocysts, 176, 177
- Terebella*, 264
- Terebratula*, 613, 618; *semiglobosa*, **614**
- Teredo*, 586; 560, 587, **587**
- Terga (Tergites), 332; 334, 415, 421, 424
- Terga of *Lepas*, 378
- Tergo-sternal muscles, 441
- Termes*, 470
- Terminal arborization of axon, 137; organ, nephridial, 197; tentacle of Echinodermata, 630, 641
- Terricola, 214
- Tertian ague, 93
- Test of Tunicata\*, 669; 675, 677, 679, 680, 686
- Testacella*, 570; 572
- Testes, *see* Generative organs
- Testicardines, 618
- Tetrabranchiata, 602; 588
- Tetractinellida, 127 n.
- Tetragraptus*, 171; **171**, 172; *denticulatus*, 172; *hicksi*, 172; *similis*, **170**
- Tetraphyllidea, 229
- Tetrarhynchidae, 229
- Tetrastemma*, 237
- Textrix denticulata*, **532**
- Thalassema*, 304; *misakiensis*, 304; *neptuni*, 304; *taenioides*, 304
- Thalassicolla*, 81; *pelagica*, **41**
- Thaliacea, 681; 677, 679
- Theca, of corals, 190; of Pelmatozoa, 658
- Thecoidea, 658
- Theridium*, **516**
- Thompsonia*, 384; **386**
- Thoracic limbs, of Crustacea\*, 328-9, 330, 336, **337**, 339, 356, 362, 372, 379, 380, 387, 388, 389, 391, 392, 393, 397; of Eucarida and Pericarida, 336. *See also* Legs, Maxillipeds
- Thoracic membrane, 270
- Thoracica, 377
- Thorax, of Arthropoda, 308; of Crustacea\*, 333; 330, 353, 356, 370, 371-2, 387, 389, 390-400 (*passim*); of Insecta\*, 309, 428, 472, 476; of *Iulus*, 424; of Polychaeta, 270
- "Thorax" of Tunicata, 674, 677
- Thysanoptera, 485
- Thysanozoon, 216
- Thysanura, 463; 430
- Tibia, 428
- Ticks, 537
- Tiedemann's bodies, 637, 646
- Tinea biselliella*, 436, 491
- Tintinnidium*, 110; *inquilinum*, **108**
- Tintinnina, 110
- Tipula*, **97**; *ochracea*, **510**
- Tocophrya quadripartita*, **108**
- Todarodes sagittarius*, 601
- Tomoceros*, **465**
- Topotaxis, 38
- Tornaria* larva, 668; 145, **666**
- Torsion of Gasteropoda, 551
- Toxiglossa, 563
- Trabeculae, of *Ciona*, 673; of coelom of Crinoidea, 656
- Tracheae, 314; 139; of Arachnida\*, 517, 519, 531, 534, 537; of Insecta, 439, 440, **443**; of Myriapoda\*, 421, 424; of Onychophora, 320; of *Velella*, 169; of Woodlice, 314, 348. *See also* Stigmata, Tracheal gills
- Tracheal gills, 444, 471, 472, 481, **482**, 486, 487
- Trachelomonas*, Flagellum of, **16**
- Tracheoles, 440
- Trachomedusae, 164; 153
- Trachylina, 154; 162, 164, 177
- Transverse fission of Protozoa, 29
- Trematoda, 216; 198, 220, 230, 232
- Triaenophorus*, 229
- Triangle of odonate wing, 472
- Triarthrus becki*, **324**
- Triatoma*, 64
- Trichinella spiralis*, 255
- Trichobranchiae, 408
- Trichodina*, 111; *pediculus*, **108**
- Trichomonas*, 65; 17; *muris*, **66**
- Trichonympha*, 67; 435; *campamula*, **67**
- Trichoptera, 486; 444

- Trichosphaerium*, 74; 72  
 Tricladida, 214; 211  
 Trilobita, 323  
 Trilobite stage of Xiphosura, 529  
 Triploblastic animals (Triploblastica), 1; 129, 136  
 Tripylaea, 80  
 Tritocerebrum, 310, 340  
 Triungulin, 492  
 Trochal disc, 239  
 Trochanter, 428  
*Trochocystis*, 658  
*Trochodiscus longispinus*, 80  
 Trochosphere larva, 282; 1, 2, 145, 618; of Annelida, 1; of Mollusca, 1, 547, 582; of Polychaeta, 263, 281, 282; of *Polygordius*, 284, 294; of Polyzoa, 2, 609, 610  
*Trochostoma*, 652; **653**  
 Trochus, 239  
*Trochus*, 552  
 Trophallaxis, 498  
 Trophi, 240  
 Trophochromatin, 26  
 Trophozoite, 88  
 Trunk, of Arthropoda, 308; of Crustacea\*, 308, 327, 330, 331, 333, 360, 364; of Trilobita, 323. *See also* Abdomen, Thorax  
 "Trunk" of ascidian tadpole, 675  
 "Trunk" ganglion, 676  
 Trunk limbs, of Crustacea\*, 326, 327, 329-30, 362, 363, 364, 368, 370; of Onychophora, 319. *See also* Abdominal limbs, Thoracic limbs  
 Trunk segments of Polychaeta, 265. *See also* Abdomen, Thorax  
*Trypanosoma*, 64; *brucei*, **62**, 65; *cruzi*, 64; *equiperdum*, 64; *gambiense*, 64; *lewisii*, 64; *rhodesiense*, 64  
 Trypanosomidae, 63  
*Trypanosyllis*, 280; *gemmaipara*, **279**  
*Tryphaena pronuba*, 491; **488**, **497**  
 Tube feet (Podia), 623; 625, 627, 630, 638, 639, 641, 643, 647, 648, 649, 650, 655  
*Tubifex*, 293  
*Tubipora*, 185  
*Tubularia*, 158; 154, **159**, **160**, 162  
 Tunicata, 669; 661  
 Turbellaria, 213; 197, 198  
*Tylenchus devastatrix*, 253; *dispar*, 256; *tritici*, 253  
 Tympana, 468  
 Typhlosole, 287  
*Tyroglyphus*, 534; *siro*, **535**  
 Umbo of Brachiopoda, 613  
 Umbrella of trochosphere, 282  
 Umbrellar surfaces, etc., of Medusae, *see* Exumbrellar, Subumbrellar  
 Uncini, 270  
 Uncoiling of Cephalopoda, 605  
 Undulating membranes, of ciliates, 17, 104, 109; of flagellates, 17, 64, 66  
 Uniramous limbs of Crustacea, 338  
 Urochorda, *see* Tunicata  
 Uropods, 388; 395, 397, 398, 407, 415  
 Urosome, 372  
 Uterus, of Cestoda, 211, 225, 228, 232; of *Chirocephalus*, 359; of *Cyclops*, 373; of *Paludina*, 566; of Platyhelminthes, 211; of *Rhabditis*, 250; of Rhabdoceolida, 211; of Scorpionidea, 524; of Trematoda, 211, 230  
 Vacuolaria, 54  
 Vacuoles, 12; Contractile, 20, **21**, 49, 52, 69, 70, 80, 83, 86, 107, 111; Food, 19, 20, 65; Gas, 72, 74; Hydrostatic, of ectoplasm, 40, 76, 80, 83; of Dinoflagellata, 54  
 Vagina, *see* Generative organs  
*Vahlkampfia*, 69  
 Valves of shell, of Brachiopoda, 613, 615; of Conchostraca, 333, 354; of Lamellibranchiata, 545, 585, 586; of *Lepas*, 379; of Ostracoda, 333, 368  
*Vanadis*, **276**  
 Vas deferens, *see* Generative organs  
 Vasa efferentia, of Insecta, 447; of Platyhelminthes, 210  
 Vascular system, 132; of Anostraca, 348; of Araneida, 530; of Arthropoda, 314; of *Balanoglossus*, 664, 666; **665**; of *Carcinus*, 414; of Chaetopoda, 263, 273; of *Ciona*, 674; of Crustacea, 348; of Insecta, 437; of Lamellibranchiata, 579; of *Lernanthropus*, 349-51; of *Limulus*, 529; of Malacostraca, 348-9; of Myriapoda\*, 421, 424; of Nemer- tea, 233, 235; of Scorpionidea, 522



- "Vascular" system of Echinodermata, *see* Lacunar system; of Scyphomedusae, 174  
 "Vascular" tissue of Echinodermata, *see* Lacunar tissue  
 Vegetative phase, 36  
 Vegetative pole, 281  
 Vein, Abdominal, 594; Afferent branchial, 581; Branchial, 594; Efferent branchial, 581; Genital, 594; Ink sac, 594; Longitudinal, of kidney, 581; Pulmonary, 556. *See also* Circulus venosus, Sinuses, Vena cava  
*Veleva*, 168; **168**  
*Veliger* larva, 547  
 Velum, of Medusae, 156, 176; of Rotifera, 239; of *Veliger* larva, 547  
 Vena cava, 582, 594  
 Ventilators, 504  
 Ventral, *see* Dorsal and ventral  
 Ventral blood vessel, of *Balanoglossus*, 668; of Chaetopoda, 263, 275; of Rhynchobdellidae, 299  
 Ventral "blood vessels" of Echinodermata, 629, **643**, 650  
 Ventral cirrus, 265; mesenteries, of Alcyonaria, 182; of Polychaeta, 285; midline of Nematoda, 244; plate of trochosphere, 282; siphon, 574; tube of Collembola, 464  
 "Ventral" plates of Ophiuroidea, **639**  
 Ventricle, *see* Heart  
 Venus' Girdle, *see* *Cestus Veneris*  
 Vermes, 198  
 Vertebrae of Ophiuroidea, 638  
 Vertebrata, 1, 2, 660, 661, 662  
 Vesiculae seminales, *see* Generative organs  
 Vesicular nuclei, 23, 24  
*Vespa*, 496, 503, 504; *crabro*, **494**, 503; *germanica*, 503; *vulgaris*, 503  
 Vespoidea, 502  
 Vestibulata, 109  
 Vestibule, 19; 104. *See also* Gullet  
 Vibracula, 608  
 Visceral clefts, 660  
 Visceral hump, 544, 545, 550, 551, 554, 555, 558, 565, 589, 591, 602  
 Visceral mass, 383  
 Visceral nerves, *see* Sympathetic system  
 Vitellarium, of Platyhelminthes, 210; of Rotifera, 240  
 Vitelline ducts, 210  
 Vitrellae, 310  
 Volvocina, 56; 43, 49; reduction division of, 28, 37; syngamy of, 31, 46  
*Volvox*, 58; 31, 38, 42, 45, 46, **60**, **61**; *aureus*, **59**  
*Vorticella*, 111; 8, **9**, 22, **34**, 104  
*Waldheimia*, 613; **614**, 616, 618  
 Water pore of Echinodermata, 628  
 Water vascular ring, *see* Water vascular system  
 Water vascular system, 626; **627**, 637, 646, 658  
 Wings, 429; 459, **460**  
 Winter eggs, 213  
 Wire worm, *see* *Iulus terrestris*  
 Workers, of Ants, 502; of Isoptera, 469; 470, 471; of Wasps, 498  
 Xanthophyll, 47  
 Xanthoplasts, 47  
*Xenocoeloma*, 376  
*Xenopsylla cheopis*, 513  
*Xestobium*, 435; *rufovillosum*, 493  
 Xiphosura, 526  
*Xylophaga*, 586  
 Yellow cells of Chaetopoda\*, 262, 273  
 "Yellow cells", Symbiotic, *see* Zooxanthellae  
 Yolk gland, *see* Vitellarium  
 Young, *see* Life history  
*Yungia*, 216  
*Zammara tympanum*, **477**  
*Zoea* larva, 389; 353, **389**, 392, 403, 414, **414**, 415, 417  
 Zoantharia, 186  
 Zones of fission, 291  
 Zoochlorellae, 47  
 Zooecium, 606  
 Zooids, of Coelenterata, *see* Hydranth, Polyp; of Polyzoa, *see* Polypide; of Protozoa, 8; 10; of Rhabdopleura, 668; of Tunicata, 677; of Volvocina, 10, 57, 58  
 Zoomastigina, 58; 46, **62**  
 Zooxanthellae, 47; 48, 50, 81, 83  
 Zygoptera, 472  
 Zygote\*, 36; 37, 46, 52, 58, 85, 86, 87, 88-100 (*passim*), 107, 116













