

MBL/WHOI



0 0301 0011021 9

YALE UNIVERSITY
MRS. HEPSA ELY SILLIMAN MEMORIAL LECTURES

IRRITABILITY

SILLIMAN MEMORIAL LECTURES

PUBLISHED BY YALE UNIVERSITY PRESS

ELECTRICITY AND MATTER. By JOSEPH JOHN THOMSON, D.Sc., LL.D., Ph.D., F.R.S., *Fellow of Trinity College, Cambridge, Cavendish Professor of Experimental Physics, Cambridge.*

Price \$1.25 net; postage 10 cents extra.

THE INTEGRATIVE ACTION OF THE NERVOUS SYSTEM. By CHARLES S. SHERRINGTON, D.Sc., M.D., Hon. LL.D., TOR., F.R.S., *Holt Professor of Physiology in the University of Liverpool.*

Price \$3.50 net; postage 25 cents extra.

RADIOACTIVE TRANSFORMATIONS. By ERNEST RUTHERFORD, D.Sc., LL.D., F. R. S., *Macdonald Professor of Physics, McGill University.*

Price \$3.50 net; postage 22 cents.

EXPERIMENTAL AND THEORETICAL APPLICATION OF THERMODYNAMICS TO CHEMISTRY. By WALTHER NERNST, *Professor and Director of the Institute of Physical Chemistry in the University of Berlin.*

Price \$1.25 net; postage 10 cents extra.

PROBLEMS OF GENETICS. By WILLIAM BATESON, M.A., F.R.S., *Director of the John Innes Horticultural Institution, Merton Park, Surrey, England.*

Price \$4.00 net; postage 25 cents extra.

STELLAR MOTIONS, WITH SPECIAL REFERENCE TO MOTIONS DETERMINED BY MEANS OF THE SPECTROGRAPH. By WILLIAM WALLACE CAMPBELL, Sc.D., LL.D., *Director of the Lick Observatory, University of California.*

Price \$4.00 net; postage 25 cents extra.

THEORIES OF SOLUTION. By SVANTE AUGUST ARRHENIUS, Ph.D., Sc.D., M.D., *Director of the Physico-Chemical Department of the Nobel Institute, Stockholm, Sweden.*

Price \$2.25 net; postage 14 cents extra.

IRRITABILITY, A PHYSIOLOGICAL ANALYSIS OF THE GENERAL EFFECT OF STIMULI IN LIVING SUBSTANCE. By MAX VERWORN, M.D., Ph.D., *Professor at Bonn Physiological Institute.*

Price \$3.50 net; postage 20 cents extra.

IRRITABILITY

A PHYSIOLOGICAL ANALYSIS OF THE GENERAL
EFFECT OF STIMULI IN LIVING SUBSTANCE

BY

MAX VERWORN, M.D., PH.D.

Professor at Bonn Physiological Institute

WITH DIAGRAMS AND ILLUSTRATIONS

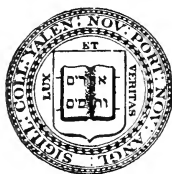

NEW HAVEN: YALE UNIVERSITY PRESS

LONDON: HENRY FROWDE

OXFORD UNIVERSITY PRESS

MCMXIII

COPYRIGHT, 1913
BY YALE UNIVERSITY PRESS

FIRST PRINTED MAY, 1913. 600 COPIES

3931

THE SILLIMAN FOUNDATION.

In the year 1883 a legacy of eighty thousand dollars was left to the President and Fellows of Yale College in the city of New Haven, to be held in trust, as a gift from her children, in memory of their beloved and honored mother, Mrs. Hepsa Ely Silliman.

On this foundation Yale College was requested and directed to establish an annual course of lectures designed to illustrate the presence and providence, the wisdom and goodness of God, as manifested in the natural and moral world. These were to be designated as the Mrs. Hepsa Ely Silliman Lectures. It is the belief of the testator that any orderly presentation of the facts of nature or history contributed to the end of this foundation more effectively than any attempt to emphasize the elements of doctrine or creed; and he therefore provided that lectures on dogmatic or polemical theology should be excluded from the scope of this foundation, and that the subjects should be selected rather from the domains of natural science and history, giving special prominence to astronomy, chemistry, geology, and anatomy.

It was further directed that each annual course should be made the basis of a volume to form part of a series constituting a memorial to Mrs. Silliman. The memorial fund came into the possession of the corporation of Yale University in the year 1901; and the present volume constitutes the ninth of the series of memorial lectures.

PREFACE

The lectures on irritability here published were held at the University of Yale in October, 1911. When the authorities of that University honored me by an invitation to give a course of Silliman memorial lectures, I accepted with the more pleasure as it furnished me with the opportunity of summarizing the results of numerous experimental researches carried out with the assistance of my co-workers during the course of more than two decades in the physiological laboratories of Jena, Göttingen and Bonn, to unite therewith the results obtained by other investigators and thus present a uniform exposition of the general effects and laws of stimulation in the living substance. I have long entertained this plan and this for the following reason:

The physiologist, the zoölogist, the botanist, the psychologist, the pathologist, have to deal, day in, day out, with the effects of stimulation on the living substance. No living substance exists without stimulation. In the vital manifestations of all organisms the interplay of the most varied stimuli produces an enormous and manifold variety of effects. Experimental biological science employs artificial stimulation as the most important aid in the methodic production of certain effects of stimulation. The number of researches in which special effects of stimulation are treated is endless. Nevertheless the systematic investigation of the effects of stimulation have, curiously enough, been strangely neglected. Although countless results of individual effects of stimulation have been studied, the attempt has never been made to establish a general physiology of the laws of stimulation and consider it as an independent problem. This circumstance induced me to systematically investigate the general laws of the effect of stimulation. In the fifth and sixth chapters of my book on general physiology the results of these studies are recorded for the first time. Since then, especially during our own researches on the general physiology of the nervous system, a great number

of new facts of importance for the general physiology of the effects of stimulation have been obtained. All these results I have endeavored to combine and elucidate in the following lectures.

The text of the lectures in its present form was written in German in 1911. The English translation was made by my wife, with the help of our friend, Dr. Lodholz of the University of Pennsylvania, who also undertook the reading of the proofs. We wish here to thank him once again and express our deep appreciation of the great sacrifice of time and labor involved in this task. I am likewise much indebted to Dr. Julius Vészi for his assistance unstintingly given, especially in obtaining a number of curves. Finally, I wish to take this opportunity to render warmest thanks to the authorities of Yale University, and especially to President Hadley and Professor Chittenden, as well as to my special colleagues, for the hospitality and cordial reception extended to me in New Haven and for the pleasant hours I was privileged to spend in their midst.

MAX VERWORN.

Bonn.

Physiological Laboratory of the University.

CONTENTS

I

Contents: Introductory. Earliest period. *Francis Glisson* as founder of the doctrine of irritability. *Albrecht von Haller*. The vitalists. *Bordeu* and *Barthez*. *John Brown's* system. *Johannes Müller* and the specific energy of living substance. *Rudolf Virchow's* doctrine of the irritability of the cell. Discovery of the inhibitory effects of stimulation. *Weber*, *Schiff*, *Goltz*, *Setschenow*, *Sherington*. *Claude Bernard* studies on narcosis. Tropisms. *Ehrenberg*, *Engelmann*, *Pfeffer*, *Strassburger*, *Stahl*. *Semon's* speculations on mneme. 1

II

Contents: Principles of scientific knowledge and research. Origin and meaning of the conception of cause. Cause and condition. Criticism of the conception of cause. The conditional point of view. Conception of cause. The conditional point of view applied to the investigation of life. Conception of vital conditions. Definition of the conception of stimulation. 18

III

Contents: The quality of the stimulus. Positive and negative alterations of the factors which act as vital conditions. Extent of the alteration in vital conditions or intensity of the stimulus. Threshold stimuli, sub-threshold, submaximal, maximal and supermaximal intensities of stimulus. Relations between the intensity of stimulus and the amount of response. The *Weber* and *Fechner* law. All or none law. Time relations of the course of the stimulus. Form of individual stimulus. Absolute and relative rapidity in the course of the stimulus. Duration of the stimulus after reaching its highest point. Adaptation to persistent stimuli. Series of individual stimuli. Rhythmical stimuli. The *Nernst* law. 39

IV

Contents: Various examples of the effects of stimulation. Metabolism of rest and metabolism of stimulation. Metabolic equilibrium. Disturbances of equilibrium by stimuli. Quantitative and qualitative alterations of the metabolism of rest under the influence of stimuli. Excitation and depression. Specific energy of living substance. Qualitative alterations of the specific metabolism and their relations to pathology. Functional and cytoplasmic stimuli. Relations of the cytoplasmic effects of stimuli to the functional. Hypertrophy of activity and atrophy of inactivity. Metabolic alterations during growth of the cell. Primary and secondary effects of stimulation. . . . 65

V

Contents: Indicators for the investigation of the process of excitation. Latent period. The question of the existence of assimilatory excitations. Dissimilatory excitations. Excitations of the partial components of functional metabolism. Production of energy in the chemical splitting up processes. Oxydative and anoxydative disintegration. Theory of oxydative disintegration. Dependence of irritability on oxygen. Experiments on unicellular organisms, nerve centers and nerve fibers. Restitution after disintegration by metabolic self-regulation. Organic reserve supplies of the cell. The question of a reserve supply of oxygen of the cell. Metabolic self-regulation as a form of the law of mass effect, and metabolic equilibrium as a condition of chemical equilibrium. Functional hypertrophy. 87

VI

Contents: Only processes of excitation are conducted, not processes of depression. Conduction of excitation in its two extreme instances. Conduction in undifferentiated pseudopod protoplasm of rhizopoda. Conduction of excitation with decrement of intensity and rapidity. Conduction of excitation in the nerve. Rapidity of conduction. Conduction of excitation without decrement. Relation between irritability and conductivity. Conduction of excitation with decrement of the nerve after artificial depression of irritability by narcosis. Theory of the decrementless conduction of the normal nerve. Proof of the validity of the "all or none law" in the medullated nerve. Theory of the process of the conductivity of excitation. Theory of core model (Kernleiter). Electrochemical theory of conduction based on the properties of semi-permeable surfaces. 118

CONTENTS

xi

VII

Contents: Conception of specific irritability. Alteration of specific irritability during and after excitation. Refractory period in various forms of living substance. Absolute and relative refractory period. Curve of irritability during refractory period. Dependence of the duration of the refractory period on the rapidity of the course of the metabolic processes in the living substance. Dependence on temperature. Dependence on supply of oxygen. Theory of refractory period. Refractory period as basis of fatigue. Fatigue as a form of asphyxiation. Alterations of irritability and the course of excitation in fatigue. Recovery from fatigue. The rôle played by oxygen in recovery. Fatigue as an expression of the prolongation of the refractory period conditioned by the relative want of oxygen. Fatigue of the nerve. 154

VIII

Contents: Examples of effects of interference of stimuli in unicellular organisms. Interference of galvanic and thermic stimuli in Paramecia. Interference of galvanic and thermic stimuli and narcotics. Interference of galvanic and mechanical stimuli. Interference of galvanotaxis and thigmotaxis in Paramecia and hypotin infusoria. Real or homotop interference, apparent or heterotop interference. The two effects of homotop interference of excitations: Summation and inhibition of excitations. Theory of the processes of inhibition. *Hering-Gaskell* Theory. Inhibition as an expression of the refractory period. Individual possibilities of interference of two stimuli. Interference of an exciting and a depressing stimulus. Interference of two depressing stimuli. Interference of two exciting stimuli. Analysis of the interference of two excitations. Interference of two single stimuli. Conditions upon which the result of interference is dependent. Heterobole and isobole living systems. Intensity of the two stimuli. Interval between the stimuli. Specific irritability and rapidity of reaction of the living system. Latent period. Interference of single stimuli in a series. General scheme of the development of the effect of interference. Summation and inhibition. Apparent increase of irritability. Conditions of summation. Tonic excitations. Conditions of inhibitions. Various types of inhibition. Interference of two series of stimuli. Relations in the nervous system. Peculiarities of the nerve fibers. Conversion of the nerve by relative fatigue from an isobolic into a heterobolic system. . . . 189

IX

<i>Contents:</i> Necessity of cellular physiological analysis of toxic depressions by pharmacology. Apparent variety of processes of depression. Depression of oxydative disintegration as the most extended principle in the processes of depression. Asphyxiation, fatigue, heat depression, as a consequence of restriction of oxydative disintegration. Narcosis. Theories of narcosis. The alteration of specific irritability and conductivity in narcosis. Depression of oxydative processes in narcosis. Asphyxiation of living substance when oxygen is present during narcosis. Persistence of anoxydative disintegration in narcosis. Increase of the same by stimuli. Depression by narcosis as a form of acute asphyxiation. Hypothesis on the mechanism of depression of oxygen exchange by narcotics. Possibility of combining the facts with the observations of <i>Meyer</i> and <i>Overton</i>	235
--	-----

IRRITABILITY

CHAPTER I

THE HISTORY OF THE SUBJECT

Contents: Introductory. Earliest period. *Francis Glisson* as founder of the doctrine of irritability. *Albrecht von Haller*. The vitalists. *Bordeu* and *Barthez*. *John Brown's* system. *Johannes Müller* and the specific energy of living substance. *Rudolf Virchow's* doctrine of the irritability of the cell. Discovery of the inhibitory effects of stimulation. *Weber, Schiff, Goltz, Setschenow, Sherrington*. *Claude Bernard* studies on narcosis. Tropisms. *Ehrenberg, Engelmann, Pfeffer, Strassburger, Stahl*. *Semon's* speculations on mneme.

Irritability is a *general* property of living substance but not exclusively so. Irritable systems also exist in inanimate nature. What characterizes living substances is not irritability as *such*, but an irritability of a specific type. The irritability of the living system can, therefore, not be studied alone, but as the properties of a living system are dependent upon each other, so this property must be considered with the others possessed by a living substance. In this sense irritability presents a problem of fundamental physiological importance. For if we could analyze the irritability of living substance to its essence, then the nature of life itself would be fathomed. The analysis of irritability of living substance offers us, therefore, a path to the investigation of life and herein lies the importance of the study of irritability.

I wish to follow this path toward the knowledge of the vital processes and to endeavor to show in these lectures what information the analysis of irritability and that of the effect of stimuli can give us of the mechanism of the processes in living substance. Before doing so, however, I wish to consider somewhat more in detail the question as to how we have arrived at the conception of the nature of irritability.

To the thinkers both in the field of physiology and medicine of ancient and mediæval times the conception of irritability was quite foreign. Even a comprehension of the nature of stimuli had not yet begun to crystallize from vague impressions of the various influences of different agents on the human being. Nevertheless they knew of such influences of the most varying kinds upon the human body. The ancients already possessed a *materia medica*, founded on the real or supposed influence of various mineral, vegetable and animal substances upon the organism. It was also known that heat and cold, light and darkness had an effect upon disease. They likewise believed in the influence of certain factors upon the health of man, which in reality have no effect whatsoever, as the stars and the magnet. But neither in ancient nor in mediæval times was the state of knowledge reached wherein generalizations were made from these agents, which had a real or supposed action upon the organism, and to combine these to a general conception of stimulation.

The conception of stimulation and irritability cannot however be separated.

The founder of the doctrine of the irritability of living substance is *Francis Glisson* (1597-1677), member of the *Collegium Medicum* in London and at the same time Professor in Cambridge. It is a fact also not altogether without interest, that *Glisson* at the same time was in a certain sense a forerunner of those who interpreted nature from a physical standpoint. *Glisson* as an anatomist and physiologist was an excellent observer and experimenter, but the most prominent trait of his character was his inclination to philosophic observation and analysis of nature. His "*Tractatus de natura substantiæ energeticæ*"¹ must, therefore, be considered as the chief work of his life. In this voluminous book *Glisson* develops an entire system of natural philosophy, which in accord with the character of the philosophy of that time is unfortunately of an absolutely speculative nature and which had hardly emancipated itself from the scholasticism

¹ *Franciscus Glissonius*: "*Tractatus de natura substantiæ energeticæ seu de vita naturæ ejusque tribus primis facultatibus perceptiva, appetitiva, motiva,*" etc. Londini M D C L XXII.

of the preceding period of thought. When the ideas of *Glisson* are isolated from the wilderness of scholastic phraseology, the system is somewhat as follows. The basis of all existence, "*substance*," has according to him two general properties, its "*fundamental subsistence*," that is, the essence of its being, and its "*energetic subsistence*," that is, the essence of its activity. To these are added the properties possessed in specific cases, that is, its "*additional subsistence*." The energetic subsistence forms the basis of all life. Life is therefore present not only in organic nature, but in all nature which is characterized by the union of the general energetic subsistence with the special additional subsistence of an animal and vegetable nature. In other forms of life in nature the energetic subsistence is combined with other special forms of the additional subsistence. The universal essence of all life, that is the energetic subsistence, has only three fundamental faculties: the "*appetitiva*," the "*perceptiva*" and the "*motiva*." The *modus* is the result of a "*perceptio*," but the "*perceptio*" is not thinkable unless the object has the "*appetitus*" to receive the external influence. *Glisson's* doctrine of irritability is based on this conception, which he develops in a second work already begun before the "*Tractatus de natura substantiæ*," but not finished until later and only published after his death. In this "*Tractatus de ventriculo et intestinis*,"¹ *Glisson* dwells in detail on the physiological properties of animal structures and develops for the first time his conception of irritability in the chapter "*De irritabilitate fibrarum*." The "irritability" manifests itself in the appearance of the alteration of movement, which is brought about by external influences on the animal structure, for: "*Motiva fibrarum facultas nisi irritabilis foret, vel, perpetuo quiesceret, vel perpetuo idem ageret*." The fundamental factor of this irritability *Glisson* attributes to the "*perceptio*," which he distinguishes as a "*perceptio naturalis, sensitiva and animalis*." The want of clearness produced here by *Glisson's* artificial distinctions and mode of expression is in part removed if we endeavor

1 *Franciscus Glissonius*: "Tractatus de ventriculo et intestinis cui præmittitur alius de partibus continentibus in genere et in specie de iis abdominis." Amstelodami M D C L XXVII.

to transfer his meaning into our present methods of thought. This distinction would then simply point out the different means by which the stimuli can reach the irritable structures. The "*Perceptio naturalis*" is that which today we should call "direct response" to stimulation, that is, the excitation of the fiber by artificial stimuli applied directly to the tissue. *Glisson* shows here, that the intestines and muscles in the body immediately after death and even when removed from the body can be stimulated to movement by means of corrosive fluids or cold. The "*Perceptio sensitiva*" is, according to *Glisson*, the excitation of the fibers by external stimuli which act on the intact body as a whole by way of the sensory nerves. The "*Perceptio ab appetitu animali regulata*" finally is the excitation by inner stimuli proceeding from the brain. The *Perceptio naturalis* is possessed by all parts of the body, even the fluids, the bones and the fat. All of them are irritable. But a "vitale" and a special "animal" irritability they do not possess to a perceptible degree. These forms of irritability belong only to the special parts of the body. Here, however, the distinctions made by *Glisson* are quite vague and contradictory. In his "*Tractatus de ventriculo et intestinis*" *Glisson* sharply distinguishes the "*sensatio*" from the "*perceptio*." The *perceptio* in itself is not a sensation, for although individual organs of the body are irritable, as they all possess a "*perceptio*," they are not in themselves sensitive. The "*sensatio*," the sensation, only arises when the external "*perceptio*" of the individual organs combine through the nerves with the internal "*perceptio*" of the brain. "*Nisi enim percepto externa ab interna simul percipiatur, non est cognitio sensitiva completa.*" Sensitivity is, therefore, a special faculty, that is only based upon irritability.

I have treated the views of *Glisson* somewhat in detail for on the one hand this seemed to me to be only due to the founder of the doctrine of irritability, and on the other we have here for the first time, although in somewhat vague and little worked out form, the discovery of a general property of all living substance, and its fundamental importance for the life of the organisms. One might, therefore, in a *certain* sense, date from *Glisson* the beginning of general physiology, and all the

more so, because *Glisson* from the very first connected the irritability of the living substance through its possessing universal energy with the phenomena in nature generally, just as we do today two hundred years after, on the basis of the modern teachings of energy.

It might appear strange that a teaching of such fundamental importance as that of *Glisson's* theory of irritability was not at once accepted on all sides and further developed. There were two reasons, however, which prevented this. Firstly, *Glisson* did not devote himself to his post of teacher at the University of Cambridge with any particular zeal and so consequently did not establish a school of his own, to further work out and develop his ideas. Secondly, his doctrines were so speculative and difficult to understand, his differentiations and definitions so artificial and labored, that it required the greatest effort to penetrate to his fundamental conceptions and so it happened that *Glisson's* theory of irritability received attention only at a comparatively late date. Even then, of his speculative theories hardly more than the name "doctrine of irritability" was adopted. Since the middle of the eighteenth century this name, however, was destined to lead to excited controversies.

The first attempt to give *Glisson's* expression "irritability" a more concrete meaning was made by *Haller* (1708-1777)¹. Unfortunately, though, he confined this conception solely to muscles, in that he understood by the term irritability "the capability of the muscles to contract, when stimulated, as the result of vital force (*vi viva*)."¹ He, therefore, applied the term "irritability" to that which we today refer to as "contractility." On the other hand he applied the term contractility solely to a property possessed by other living and dead animal as well as vegetable matter, elasticity, that is, the capability to resume its original form after distortion. He makes a sharp distinction between "irritability," which manifests itself by a contraction of the muscles after stimulation by its own vital force (*vi viva*), and the "sensitivity," which is possessed only by the nervous

¹ *Albrecht v. Haller*: "Elementa Physiologiae corporis humani." Tomus IV. Lausannæ M D C L XVI.

system. "*Sola fibra muscularis contrahitur vi viva; sentit solus nervus et quæ nervos acciperunt animales partes.*" By confining the conception of irritability to a single living substance, the muscle, *Haller's* theory represents a great regression in comparison to the correct fundamental thoughts of *Glisson*. This unfortunate use of the term of "irritability," "contractility" and "sensitivity" has opened wide the gates to confusion and misunderstanding. This confusion was still further augmented by the fact that the vitalistic school of Montpellier confused the idea of vital force with that of irritability. In the works of *Bordeu* (1722-1776) these views are comparatively clear, if one bears in mind that he substitutes *Glisson's* term of "irritability" with that of "sensitivity." He assumes a "*sensibilité générale*" or a common property of all living structures, both solid and fluid. Besides this, each different part has according to him its "*sensibilité propre*." Here in place of the clear conception of irritability we find one of more or less mythical nature possessing traces of *Stahl's* "anima." Nevertheless we observe here the idea that all living organisms possess in common a capability to respond to stimuli. Even though *Bordeu's* differentiation of the "sensibilité propre" and the "sensibilité générale" is too artificial and the coexistence of both not justifiable, his discussion of the "sensibilité propre" shows that he is already on the track of the characteristics of the effect of stimuli which only later under the name of "specific energy" was clearly recognized as a fundamental property of all living substance. On the other hand the celebrated pupil of *Bordeu*, *Barthez* (1734-1806), accepted the existence of a meaningless vital principle, the "*principe vitale*," governing all vital manifestations. The two forms of vital force of all living substances, the "*forces sensibles*" and the "*forces motrices*," were according to his views manifestations of this vital principle. He differentiates the "*force sensitive*" into a "*sensibilité avec perception*" and "*sensibilité sans perception*," using the term sensibility in the sense adopted by *Bordeu* and which today we, with *Glisson*, call irritability.

In this way serious thinkers of that time trifled with the words irritability, sensitivity, contractility, perception. This led to

futile conceptions, which equalled the phantasies of the worst period of speculative philosophy and which in no way led to progress. Hence it is easy to understand that numerous attempts were made in those days to reconcile in some way these different conceptions. An explanation, which was the beginning of further development, came from England in the works of *John Brown* (1735-1788),¹ a man who was as talented as he was disolute. *Brown* was an independent thinker, not without genius, whose knowledge in practice and theory, however, was limited. This combination in his mentality enabled him to observe the problems somewhat differently than through the glasses of the usual conceptions of that time. In direct opposition to his teacher *Cullen* (1712-1790), one of the leading minds in the medical school of Edinburgh, who considered irritability only as an effect of sensibility and pronounced the latter a specific property of the nervous system, *Brown* took the standpoint that all living substance, vegetable as well as animal, in contrast to lifeless matter, possessed a fundamental property which he designated as excitability, that is to say, the capability of being stimulated to specific vital manifestations through external factors or "stimuli," in which sensitivity and indeed all mental processes as well as movement are interpreted as specific effects, which the "stimuli" produce on the irritable organs. This was an important advance and from a wilderness of trifling conceptions his observations led to a clearer knowledge of this subject. But *Brown* went even further. In his so-called "theory of irritation," he has presented a whole system of responsivity to stimulation, which in the first chapters of his chief work he expounds with wonderful clearness. The fundamental principles here established must be accepted even today. The essential basis of this "theory of irritability" which he worked out especially for his doctrine of disease, and which has also played an important part in pathology, is the following: Every living, that is, excitable system, is continually influenced by stimuli. The stimuli consist of either external factors, such as heat, food, foreign matter, poisons, etc., or inner factors which result from the influence of the activity

¹ *John Brown*: "Elementa medicinæ." 1778. English translation. London 1778.

of one organ upon another. Only as a result of the continual action of stimuli is life maintained, in that the stimuli produce continual "excitement" in the irritable substance. The degree of irritability differs in various plants, animals, in different structures of the body, and even in the same individual at different times under different circumstances. The strength of the "excitement" depends on the one hand upon the degree of irritability, and on the other upon the strength of the stimulus. The irritability itself is influenced and changed by the action of the stimuli. If the stimuli are too strong and are of prolonged duration, the irritability diminishes as a result of exhaustion; if weak stimuli act during a prolonged time, the irritability increases. The healthy organism has a mean degree of irritability. Disease occurs when this state is altered by *strong* stimuli or by an *absence* of stimulation. Disease and health, therefore, differ not qualitatively but only quantitatively. It is here seen that we have the first attempt at a systematic interpretation of the effects of stimulation, and it is astonishing how sharply and successfully *Brown* has pointed out the foundations of this important field. He has in this way not only amply compensated for the great setback in the history of the teaching of irritability produced by the confusions of conceptions created by *Haller* and the vitalists, but also placed the whole of the physiology of stimulation on a firm foundation upon which it is possible to build further. Though it is true that many of his special theories, in particular those on nature and the origin of disease, are quite erroneous, still a just critic must judge work in relation to the period in which it was written, and I question if at the present day the science of medicine does *not* contain teachings which in a hundred years will also prove untenable.

Johannes Müller (1801-1858) then added an important stone to the building up of our knowledge of irritability. This was the clear recognition of the *specific energy* of living substances. We have already found the germ in *Bordeu's* term "*sensibilité propre*" or "*sensibilité particulière.*" *Brown* was also of the opinion that different living objects possessed different types of irritability and that excitation of their special functions was not dependent

upon the *kind* of stimulus acting upon them. *Johannes Müller*, grasping the idea hidden in this presentation, transformed it into a clear and fundamental conception. Already in the work written in his early years treating of optical illusions he says:¹ "It is immaterial by which means the muscle is stimulated, whether by galvanism, chemical agents, mechanical irritation, inner organic stimuli or sympathetic response from quite different organs; to every means by which it is stimulated and an effect produced, it responds by movement. Movement is, therefore, the *effect* and the *energy* of the muscle at the same time." "Thus it is throughout with all reactions in the organisms." "The sensory nerve, responding to any stimulus of whatever kind, has its specific energy; pressure, friction, galvanism and inner organic stimuli produce in nerves of sight that which is peculiar to them, light sensation; in the nerves of hearing, that which is peculiar to them, sound sensation; and in the nerves of touch, touch sensations. On the other hand, everything which affects a secretory organ produces change of the secretion; that which affects the muscle, movement. Galvanism is not superior to any other methods, of whatever kind, which can bring about stimulation." And in his handbook of physiology *Johannes Müller*² formulates the law of specific energy for the sensory structures briefly in the following words: "The same external factor produces different sensations in the different senses according to the nature of each sense, namely, the sensation of the particular sensory nerves; and the reverse: the characteristic sensations peculiar to every sensory nerve can be produced by several internal and external influences." This doctrine of the specific energy of the sense substance possesses an importance which extends far beyond the domain of the physiology of stimulation, for it forms the basis on which the whole theory of human knowledge must be built up, no matter how it may be constructed in detail.

As *Johannes Müller* already clearly emphasizes, it is here not

1 *Johannes Müller*: "Über die phantastischen Gesichterscheinungen. Eine physiologische Untersuchung mit einer physiologischen Urkunde des Aristoteles über den Traum, den Physiologen und den Ärzten gewidmet." Coblenz 1826.

2 *Johannes Müller*: "Handbuch der Physiologie des Menschen für Vorlesungen." Coblenz 1837.

the question of a law confined to the sense substance, but one that applies to all living substances. Every living substance has its "specific energy," that is, its characteristic vital phenomena and this is produced by stimuli of the most varied kind. This doctrine received an extension of inestimable value for its future development by the great discovery of *Schleiden*, that the cell is the elementary building stone of the plant organism. Subsequently *Schwann* at the instigation of *Schleiden* made further investigations and found that this discovery applied also to the animal organism. Irritability having been recognized as a general property of living substance, it followed that, after the foundation of the cell doctrine, every cell must possess irritability and have its own specific energy. It now became necessary to study the manifestations of irritability of the cells in their specific form. Strange to say, this was done at an earlier date in pathology than in physiology. Indeed, since the time of *Brown* the study of irritability was furthered far more by pathology than by physiology. The chief reason for this is probably the great practical interest that the investigation of disease possesses, *Brown* having already quite correctly ascribed the existence of disease to the relations of the organism or its parts to stimuli. *Rudolph Virchow* then, after the establishment of the cell doctrine, arrived at the momentous conclusion, that disease must be considered as reactions of the body cells to stimuli. In his epoch-making "Cellular pathologie,"¹ he has carried out this idea in a classical manner. By irritability *Virchow* understands "a property of the cells, by virtue of which they are set into activity, when affected by external influences." There are, however, various kinds of actions which can be brought about by external influences. But essentially there are three kinds. The effects produced are functional, nutritive, formative. The result of excitation, or if one will, of stimulation of a living part, can, therefore, according to circumstances, be either merely a functional process, or there can be a more or less intense nutritive activity produced without the function being necessarily at the same time activated, or finally, it is possible

¹ *Rudolph Virchow*: Die Zellularpathologie in ihrer Begründung auf physiologische und pathologische Gewebelehre. 1 Aufl. Berlin 1858—4 Aufl. 1871.

that a process of formative change may occur which produces new elements in greater or less numbers. *Virchow* touches here for the first time upon a question of extraordinary moment, the important bearings of which have only now begun to be recognized and seriously considered. We now know, for example, that the functional excitation can be separated to a certain degree from the cytoplasmic excitation of the muscle. If the muscle is acted upon by functional stimuli, the excitation takes place mainly in the form of functional metabolism, nitrogen-free substances are broken down in increased quantities, whereas cytoplasmic metabolism, which produces more profound alteration in the living substance, and which goes so far as to bring about a breaking down and building up of the nitrogen containing atom groups, is hardly at all increased. It would be an error, however, to look upon these different kinds of metabolism as quite independent. Considering the close correlation which all the phases of metabolism bear to each other, this idea cannot well be entertained. If, however, we question in what manner, for instance, the functional and the cytoplasmic metabolism are linked together, we have a problem before us which does not belong to the past, but to the present and future. Indeed, *Virchow* seems already to have felt that a sharp division between the different phases and parts of functional metabolism in the cell does not exist, for he says: "It is true that it cannot be denied that, especially between the nutritive and formative processes and likewise between the functional and nutritive, intermediate gradations occur." Still they differ essentially in their characteristic action and in the internal alterations which the stimulated part undergoes, depending on whether it functionates, nourishes itself, or is the seat of special growth. Disease consists of the influence of stimuli upon these physiological processes. The law of the specific energy of living substance is as clearly expressed in functional disease as it is in the physiological effects of stimuli. The pathological disturbance of function is purely quantitative, "nowhere is there a qualitative divergence." The function exists or it does *not* exist. If it is present, it is either strengthened or weakened. This gives the three fundamental forms of disturbance: absence, weakening

and strengthening of the function. No function other than the physiological, even under the greatest pathological alterations, exists in any *structure* of the body. "The muscle does *not* perceive, the nerve moves no bone, the cartilage does not think." In this way *Virchow* rediscovered in the domain of pathology the law that his great teacher, *Johannes Müller*, had already clearly established in the field of physiology. But this law can no longer be applied to all pathological disturbances of the nutritive and formative activities of the cell. Here processes occur which do not consist of a quantitative change of the normal phenomena, but in the appearance of wholly foreign states, as in the case of amyloid degeneration or heteroplastic tumors. The question today and for the future arises, therefore, as to where the limits of the validity of the law of the specific energy of living substances are to be placed, a question closely connected with the other before mentioned, of the relations between functional and cytoplasmic metabolism.

By means of cell pathology *Virchow* has laid the foundations upon which our modern medical attitude is built and which must remain essentially forever the basis of all future medical thought. Certain critics, lacking in appreciation of the interrelations between things and ignoring the safer and established knowledge, have considered, in view of the unfoldings of the researches on immunity and of serum therapy, that the time of cell-pathology was *passed* and must be replaced by the humoral-pathological teaching. These ultramodern critics, however, have here completely ignored the fact that, on the one hand, the life of our body is built up from the life of all of the contained cells, for life in our body exists only in the cells; and on the other, a fact not considered by them is that the components of the body fluids originate from vital activity of the cells either directly or indirectly. No result, indeed, of present serology can alter in the least degree the fact that every disease represents only a disturbance of the physiological processes of cell life of the organism and the harmony in their combined workings. Indeed the more recent observations of serology and chemotherapy are so little opposed to cell-pathology that they are in fact only possible when

based on the latter. They are only comprehensible then from the unfoldings of cellular pathology.

Until quite recently all those effects of external factors on the living substance which consist in excitation, that is, in an increase of their specific vital processes, have always stood in the foreground of all researches and observations on irritability. It was gradually, however, more and more recognized that the depressing influence of stimuli played a great rôle in the vital process of the organism. *Brown* was acquainted with exhaustion produced by stimuli, and the discussion of "asthenic" diseases, in which the irritability was reduced, occupied an important place in his pathology. That, however, in the normal activities of the organism such depression or lessening of vital manifestation could result from the influence of stimulation, first became clear after the brothers *Weber*¹ in 1846 discovered the inhibitory effects of the galvanic stimulation of the vagus upon the heart.

Since then the inhibitory processes in nerves have been frequently investigated by *Schiff* (1823-1896), *Goltz* (1834-1901) and others, who gave us a theory concerning the same. Only a small number of inhibitory processes were known at that time, as for instance the inhibition of the croak reflex of the frog, or the inhibition of the grasp reflex during copulation of these animals through skin stimuli, and a few other cases. They regarded the inhibitory nervous processes as a special state, of which the inhibition of the heart through the vagus was the best illustration. Further, the Russian physiologist *Setschenow* succeeded by directly stimulating certain parts of the central nervous system, especially the optic lobes of the frog, in producing inhibition. It was, therefore, frequently assumed, as *Setschenow* did, that in the brain there exist special inhibitory centers, just as there are motor centers. This view was later shown to be untenable. It is only quite recently, and especially since *Sherrington* has shown that inhibition plays a part in all antagonistic muscle movements, that we have obtained a broad and more thorough understanding of the inhibitory processes in the life

¹ *Eduard Weber*: "Muskelbewegung." Article in *Wagner's Handwörterbuch der Physiologie*, Bd. 3. Braunschweig 1846.

of the organism, and a physiological explanation of this important group of activities of the central nervous system. This inhibitory effect of stimulation, brought about by the involvement of the central nervous system in the normal organism, was studied side by side with the depressing effects of stimulation. *Claude Bernard* (1813-1878)¹ first discovered that the excitation of all living substance could be depressed or totally suspended through the influence of certain anæsthetics, such as ether or chloroform. By a series of experiments, as simple as they were convincing, the French scientist showed that irritability could be depressed in mimosa leaves, the growth of germinating plant seeds and the ferment action of yeast cells stopped, likewise the disintegration of the carbon dioxide in the cells of the green leaf, as well as the development of the egg cells, and also the movements of the animal organism and the sensations of man. By this means he recognized that not only does all living protoplasm possess irritability, but that it can also by means of certain substances be put into the condition of "anæsthesia," a state dependent upon a change of the protoplasm, which he termed "semi-coagulation." Finally, besides the more apparent processes of excitation and those less so, belonging to the group of inhibition and depression, in the last century the knowledge of the subject was greatly increased by the addition of another group, which recently in consequence of various reasons has met with particular interest. These being effects of stimuli on the direction of movements of motile organisms, it became more and more recognized that these curious manifestations of irritability, which appeared to have such a surprising likeness to the mysterious attraction and repulsion in the sphere of electricity and magnetism, occur universally in the vegetable as well as in the animal world. These movements are of the greatest biological importance for the obtaining of food, propagation, protection against disease, etc. Botanists have long known of the geotaxis of the roots and stems of plants, the heliotaxis of their leaves and flowers and of the thigmotaxis of their tendrils. Likewise the phototaxis of freely moving

¹ *Claude Bernard*: "Lecons sur les phénomènes de la vie communs aux animaux et aux végétaux." Paris 1878.

protistæ had been often observed, especially by *Ehrenberg*¹ of Berlin, well known for his researches on infusoria. Then *Engelmann*, *Pfeffer*, *Strassburger*, *Stahl*, and many others discovered and studied more carefully the facts concerning chemotaxis, thigmotaxis, rheotaxis, geotaxis, phototaxis, etc., of bacteria, motile spores, rhizopoda, and so on. The question arose if one should regard this singular behavior of the unicellular organisms as an expression of conscious sensations, discrimination or will. This view was as determinedly denied on the one hand as it was accepted on the other. Whilst even today certain scientists still consider the reactions of the unicellular organisms as a manifestation of conscious sensation, discrimination or will, others look upon them as unconscious reflex reactions of cell organism, taking place as purely mechanically as the spinal cord reflexes of vertebrates. This divergence of opinion would have practically no value for the development of our knowledge of irritability had not here, as in the case of the relations between the mental and physical processes in man, the view been entertained with more or less fervor, that at some stage or other in the chain of the purely physiological processes of responsivity, an intangible factor had been introduced which was considered as the essential "cause" of the peculiar reactions to stimuli. It is not here the place to enter into the question if, and in what degree, animal psychology may be a field of scientific research. Even if one looks upon conscious processes as effects of stimulation, in both lower animals and in man, in no case should one assume them to be factors of an essentially different nature, interrupting the chain of the mechanical reactions; neither should one consider the particular characteristic responses observed in unicellular organisms as effects of non-mechanical "causes." As a result, a mysticism, in reality quite foreign to it, would be introduced into physiology. As a matter of fact the physiological investigations for the tropic reactions of stimuli, which have been carried out in great number since the end of the eighties, have shown more and more clearly that this peculiar behavior of unicellular organisms towards unilateral stimuli is produced

1 *Ehrenberg*: "Die Infusionstiere als vollkommene Organismen." Leipzig 1838.

by a comparatively simple mechanism. The analysis of this shows a difference in the intensity of the exciting or depressing effect produced by the stimulus. The stimulus exerts its influence unequally upon the specific activity of the motor elements of different parts of the surface of the cell body. This difference in response causes the axis of the freely moving organism to assume a different direction in which to move. It is *compelled* to move in a definite direction and so, in this field, the apparently mysterious attraction and repulsion of living organisms toward stimuli has, by means of the most simple analysis, been robbed of its mystical character.

Finally, I should like to touch briefly upon a view of the irritability of living substance which has recently been brought forward by *Semon*.¹ It assumes the proportions of a whole system and is proclaimed as a basis for the comprehension of organic phenomena. It originated with an idea which *Hering*² developed many years ago and which later was accepted by *Haeckel*,³ namely that heredity is a species of memory of the living substance. *Semon* attributes to living substance, in contrast to non-living, a "*Mneme*." By "*Mneme*" he understands the capability of living substance to assume, through the influence of a stimulus, a permanently altered condition. The latent alteration resulting from the stimulus he terms "*Engramm*." These "*Engramms*" can later, however, not only be activated by the reapplication of the original stimulus, but also by other stimuli, so that the state of excitation once brought about by the original stimulus reappears. *Semon* calls the reproduction of the state of primary excitation by a later stimulus "*Ekphorie*." A great number of other new word formations, such as "*chronogene Engramme*," "*phasogene Ekphorie*," "*mnemische Homophonie*," "*mnemisches Protomer*" and countless others are supposed to serve for the better understanding of a series of special facts, chiefly in the

1 *Semon*: "Die Mneme als erhaltendes Princip im Wechsel des organischen Geschehens." Zweite verbesserte Auflage, Leipzig.

2 *Ewald Hering*: "Über das Gedächtniss als allgemeine Function der organischen Materie." Wein 1876.

3 *Ernst Haeckel*: "Die Perigenesis der Plastidule oder die Wellenzugung der Lebenstheilchen." Berlin 1876.

domain of the processes of heredity. That which is termed "*Mneme*" and "*Engramm*" is not further analyzed. *Semon* expressly declines to discuss the kind of alterations in which the physical or chemical nature of an "*Engramm*" consists. Hence physiological analysis has not been advanced in any way by *Semon's* new formation of words applied to long-known facts. With a series of new expressions the originator of the "*Mneme doctrine*" deceives himself, as well as a number of his readers not endowed with the critical faculty, into supposing that he has achieved a serious analysis. Of such, however, there is not a trace. As can be conceived, this way of treating the manifestations of life has met with no further attention from the physiological side. For indeed, what physiologist would consider that the fact of muscle responding by a contraction to an induction shock, or to any other stimulus, is sufficiently analyzed by the explanation that we have the "*Ekphorie*" of a state of excitation that was once previously produced by an original stimulus of some unknown kind, and of which the living substance of the muscle, in consequence of its "*Mneme*," has retained a latent "*Engramm*"? Here the deep gulf is apparent which exists between the demands of a physiological analysis and the futile explanation of the mneme doctrine. Physiological investigation must reject such a manner of treating its problems.

With this the history of the doctrine of irritability enters into its present phase of development. To future research remains then the problem of further analyzing irritability, this common property of living substance, and finally rendering it into its simplest chemical and physical components. This last goal can only be approached very gradually, step by step. With the analysis of irritability we shall investigate life itself. In the following lectures it will be my endeavor to show how far, with our present knowledge, we can penetrate by this path into the great secret.

CHAPTER II

THE NATURE OF STIMULATION

Contents: Principles of scientific knowledge and research. Origin and meaning of the conception of cause. Cause and condition. Criticism of the conception of cause. The conditional point of view. Conception of cause. The conditional point of view applied to the investigation of life. Conception of vital conditions. Definition of the conception of stimulation.

The common problem of all scientific research is the investigation and formulation of natural laws. The assumption of a unity in the happenings and of existence in the world, in accordance with definite laws, forms the indispensable foundation of all scientific study and is fully justified by experience. Experience has taught us, as a result of innumerable individual observations, the existence of such an accordance, whereas in not a single instance has it been shown that this is not the case. We are thus justified in assuming without further discussion that every scientific research, every new problem which we approach, is likewise founded on this unity of occurrences in accordance with natural laws. Only on the firm basis of this assumption has scientific investigation a purpose, and every success is a new proof of this. There is an unanimity of opinion concerning this among scientific investigators in all fields.

Not such complete agreement, however, exists in regard to the question by what symbols of human thought and speech these laws can be described in part as well as *in toto*, so that existing laws can not only be *fully* and conclusively defined, but at the same time without the use of *superfluous* terms. According to *Ernst Mach*, thought is an adaptation to facts. Our speech is

simply a method of expression of our thoughts and indeed the most satisfactory form we have. We must, therefore, use those symbols which are most closely adapted to facts as the most precise expression of these existing laws. What forms of expression have we?

It might appear that a discussion of this fundamental question has not a close connection with our special subject of physiology of stimulation. This, however, is not the case. Indeed, it is an irremissibly previous requirement not only for the elucidation, but also for the understanding itself in this particular field. We *could not* come to a clear understanding in this field without such analysis. The interpretation of the unity of being and happenings in accordance with natural laws, which today is widely accepted in the scientific world as the only exact one, implies the assumption of a "causation" according to which things are explained by the law of "cause" and "effect." I¹ have already on various occasions taken the opportunity to criticise this view and to show the error and confusion to which it leads. I should like here to enter somewhat more in detail into the reason for this criticism. It is particularly directed against the scientific use of the term "cause" on the basis of our best-known theoretical principles. It is clear that all scientific observations and explanations are founded on experience. Can it be said that the conception of "cause" originates from experience?

We can say with absolute certainty that the conception of cause dates from prehistoric times. Its beginning reaches back to the stone age, at least to neolithic, possibly to palæolithic culture. This is demonstrated by the careful reconstruction of these prehistoric races based on a critical comparison of the remains of their culture with that of primitive races living today. The ideas of these primitive races show an inclination to an extraor-

¹ Compare with this *Max Verworn*: "Die Entwicklung des menschlichen Geistes." Jena, Gustav Fischer, 1910.

Max Verworn: "Die Erforschung des Lebens." II Auflage. Jena, Gustav Fischer, 1911.

The same: "Die Fragen nach den Grenzen der Erkenntniss." Jena, Gustav Fischer, 1908.

The same: "Allgemeine Physiologie." V Auflage. Gustav Fischer, 1909.

dinary degree to explain all happenings in the world anthropomorphously. All happenings in surrounding nature are given the same origin as the activities of man himself. To man, on this plane of phantastic religious speculation, all events in nature appear as acts of the will of invisible powers, which, having originally proceeded from the souls of dead human beings, think, feel and act exactly as *he does*. This anthropomorphic conception of the occurrences in the surrounding world is one of the many conclusions which ensue from the supposition of an invisible soul, which can be separated from the body. It was this conception which gave the impetus for the transition of human thought from the era of the naïvely practical to the era of the theoretical spirit in that far removed age. In this anthropomorphic transference of personal subjective impulses of will to the objectively observed events of the surrounding world, lies the origin of causal conception, which since then has been generally used as the explanation of the happenings in the world. One cannot assert that the formation of the conception of cause is purely a product of *experience*, but rather a result of *naïve speculation*. Even if a later evolution of human thought shows a continued endeavor to dismantle the conception of cause of its primitive trappings and to modernize, as it were, its outer appearance, we still find today many inner components clinging to it, which do not agree with the strict demands of critical scientific exactness, demands which must particularly be made concerning a conception which has been given such fundamental importance in theoretical knowledge.

I wish to observe here, however, that the conception of cause, even though more or less unconsciously so, is still the remains of a part of the old anthropomorphic mysticism carried over into our own times. This shows itself especially in the conception of *force*, which is nothing more than a form of the conception of cause. Force is the cause of movement. One has here in anthropomorphic manner transferred the action of the *will* of man, which produces movement of the muscles, into lifeless nature. The force of the sun attracts the earth, that of the magnet attracts iron, etc. In short, one has introduced a mysterious

unknown factor instead of being content with the simple description of facts, such as *Kirchhoff*¹ has advanced in the field of mechanics. Although of late natural science has also dispensed more and more with conception of force as a means of explanation, it is still today not wholly done away with. That which applies to the conception of force is likewise true of the conception of cause.

Another point concerning the application of the conception of cause seems to me, however, to be of much more importance, namely that a single cause is held responsible for the taking place of a process. One endeavors to explain a process in general by seeking for its "cause." The cause being found, the process is considered as fully accounted for. This idea is not only widely spread in everyday life, but is even found frequently in natural science, especially in biology, although here, it should be known, the processes are decidedly more complicated. The search for the "cause" of development, for the "cause" of heredity, for the "cause" of death, for the "cause" of the respiration, for the "cause" of the heart beat, for the "cause" of sleep, for the "cause" of disease, etc., was for a long time and frequently even today a characteristic of biological investigation. As if such a complicated process as development, death or disease could be explained by a single factor! In reality, one has obtained very little as a result of the analysis of a process by discovering its cause; and in addition the false impression arises that through the finding of this one factor the process has been definitely explained. It has been generally recognized in the natural sciences in recent times that no process in the world is dependent upon one single factor and attempts have been made to give this fact more consideration.

It is the custom at the present time to hold the view that every process or state is brought about by its *cause*, but that a series of *conditions* are also necessary to the production of the process. Such a view, however, which considers that two different factors existing at the same time are necessary to the accomplishment of

¹ *Gustav Kirchhoff*: "Vorlesungen über mathematische Physik. Mechanik." Leipzig 1876.

every happening or state, namely, the cause and the conditions, leads to new difficulties, for then, upon a more exact analysis arises the question: Which is the cause and what are the conditions? It is very soon found, however, that this does not permit of any strict differentiation, as the two conceptions can not be sharply separated. This difficulty was brought to my notice with particular force during an animated discussion with a friend and colleague about twenty years ago, which I have always remembered. I had observed at that time the dependence of pseudopod formation of amœboid cells on the oxygen of the medium, and had found that the expansion phase of protoplasmic movement, that is, the extension of pseudopods, the centrifugal flowing of the protoplasm into the surrounding medium and with this the enlargement of the surface of the cell body, only takes place when oxygen is contained in the surrounding medium and never occurs in its absence. Being at that time wholly under the influence of the conception of cause, I believed that oxygen was the cause of the formation of the pseudopods. To this my friend made the objection: "Yes, I quite acknowledge the fact of the dependence of the formation of pseudopods on oxygen, but what informs me that the oxygen is really the *cause*? It might be simply a necessary *condition*." This objection led to a long debate, which ended, however, without our being able to agree. We were not in a position to distinguish between the conception of cause and that of condition, and at that time the idea *did not occur* to us to emancipate ourselves from the conception of cause deeply implanted in us as a result of our training. In fact, one is greatly embarrassed if one attempts to sharply distinguish by a definition the conception of cause and that of condition. A condition is a factor on which a state or a process is dependent for its existence or its taking place. To the conception of condition belongs, besides the factor of *relation*, that of *necessity*. Every condition is necessary to the existence or taking place of this state or process. Without the condition in question the state or process does not occur. The same must be demanded for the conception of cause. No state exists, no process takes place, without its cause. The

cause then has itself the specific character of a condition, it is itself a condition. Has it perhaps then some specific peculiarity in contrast to the other conditions, which would give it a prominent place? Experience teaches us that nothing, that is to say, no state or process in the world, is dependent upon a single factor alone. There are always numerous factors which bring about the state or process. Would it be possible to distinguish which of these particular conditions is of the greatest importance?

First of all, it must here be taken into consideration that the importance of a condition is not one which is capable of increase or decrease, for the simple reason that necessity, which forms an essential component of the conception of cause cannot be varied. A factor cannot be *more* than necessary for the existence of a state or the taking place of a process. If, however, it is less than necessary, then it is not necessary at all, and the state or process exists also without it, that is to say, the factor is not a condition. In other words: *all conditions for a state or process are of equal value for its existence, as they are all necessary.*

If one attempts to prove by means of concrete examples this statement obtained by purely logical deduction—a control which, considering the experimental nature of modern thought, never should be neglected even in the simplest of reasoning—it might appear that an objection could still be made against its general validity. From various instances it might be concluded that there are conditions, which as such are not absolutely necessary for a state or process, but can be replaced by other factors. An example may serve to make this clear. I pour diluted hydrochloric acid on powdered carbonate of sodium, and carbon dioxide is set free. The addition of hydrochloric acid is here a condition for the liberation of the carbon dioxide. Without the presence of the hydrochloric acid the process does not occur. Nevertheless I can substitute diluted sulphuric acid for the hydrochloric acid. Here it would appear that one condition can be replaced by another. But one must not be deceived. A closer observation soon shows that the process has not been sufficiently analyzed if we look upon the addition of hydrochloric acid as a condition

for the liberation of carbon dioxide. It is not the presence of hydrochloric acid or sulphuric acid, as such, which is a condition for the process, but rather the separation of the sodium atoms from their combinations with the oxygen in the molecule of the carbonate. This reaction can occur as a partial component in very different complexes of processes. Or to quote another example, taken from the subject with which we are especially here concerned. I allow an induction shock to act on the nerve of a nerve muscle preparation of the frog. The muscle contracts. The electric stimulus is the condition for the muscle contraction. But I can substitute for the induction shock a mechanical stimulus by sudden pressure of the nerve. The muscle again contracts. The analysis again shows that the induction shock as such was not the condition for the muscle contraction, but the excitation of the nerve which it produced and which is conducted as a specific impulse to the muscle. This excitation of the nerve can, however, be induced by very different kinds of processes, namely, by all processes which possess in common the condition that they suddenly increase certain disintegration processes in the living nerve substance. Indeed, the further analysis of the whole process shows in addition that the nerve impulse as such likewise does not form a condition for the contraction of the muscle, but it first of all produces the necessary condition for the muscle contraction by suddenly greatly increasing certain chemical processes, which take place in the living substance of the resting muscle. The nerve impulse can, therefore, also be replaced by other processes, if only these contain the condition for an increase of disintegration of the muscle substance, as in the case of the direct stimulation of the curarized muscle, where the influence of nervous impulses is totally eliminated. In a further analysis of this process we should penetrate even more deeply into the differentiation of the individual constituent processes and the isolating of the special conditions on which each link in the chain is dependent.

Such an analysis then shows us the following: Every thing, every state or process, is a complex of numerous components, of which *one* always conditions the other in the manner that the

individual conditioning components are themselves in their turn contained as constituents of other complexes and are conditioned here again by other factors. These factors in themselves as such are not directly necessary to the taking place or existing of the special component and can, therefore, be replaced by others. Closer observation shows that there is a constant interdependence between all things in the world. *Every* thing in the world is *indirectly* dependent upon *every other*, although often so remotely that we are not able to trace the connection. Absolute things, completely isolated and independent of others, *do not* exist in the world. In observing and studying complexes individually, we must not forget that we only *think* of them as isolated from the great eternal coherence, from which they are in reality not separated. The conception of condition, however, only then has meaning, if we refer to it in connection with the direct dependence of one factor upon another. Nevertheless if we understand by conditions those which are connected by multitudinous intermediate components, then we would render the conception of conditions useless. For if every thing in the world were the condition for every other, the conception of relation would lose its value in special states or processes. Should the conception of condition have a meaning in regard to a *certain* state or process, then we should only look upon *that* part of a complex upon which the other is *directly* dependent as a condition. When, however, we meet with a factor for a process or state, which can apparently be replaced by another factor, we have not carried the analysis far enough. Upon deeper penetration into the subject, it is found that the essential condition for the process, which exists, is a component common to both factors, one of which in consequence can replace the other.

It is the task of all scientific research to penetrate deeper and deeper into these relations, these connections and the order of succession of states and processes and to separate them into their individual components, and in this way gain a more thorough knowledge of the constancy of existence and happenings in the world.

This analytical process, it is true, only advances very grad-

ually, and we must accept for the present, especially in the complex biological processes, that a whole complexity of members appear conditioned, and that a complex aggregate is a condition of the whole process. We are not yet in the position to define the special components of the constituent processes. It is only step by step that we are able to differentiate the necessary from the accessory parts in these complexes. However, we are here only concerned for the present with a purely theoretical question and we may be permitted to say: If we maintain that the conception of condition has as an integral part the element of necessity and of relation to a special thing, then there are no substituting conditions. For then every condition for a state or process is of equal value. There is no justification to give more prominence to one condition and place it in the position of being the "*cause*."

If the cause is elevated, then it is done from some superficial motive. This is confirmed by a glance at the practical use of the term cause. The cases in which the cause is always at once clearly recognized and named without doubt or hesitation are those where a new factor is added to an already existing system of conditions, which bring about a process. When such a process is produced, the last added condition is considered as "*cause*." A shock acts on an explosive body, the body explodes: the shock is considered the cause. An induction shock acts on a muscle, the muscle contracts; the induction shock is looked upon as the cause of the muscle contraction. To regard only the last added condition as being of especial importance to the taking place and the explanation for a process is, however, a standpoint which could satisfy only the most superficial of observers.

In a scientific investigation such methods should play no rôle. For to every careful observer it must appear quite clear from the beginning, that the previously existing conditions have as great a value for the taking place of the process and its explanation as that last added.

The induction shock would not have produced the characteristic effect had not the other conditions been already previously combined, had not certain special atoms in the molecule of the

explosive combination in consequence of former processes assumed quite a peculiar labile position, had not in the evolution of the muscle in the growth and metabolism certain combinations been formed, and certain chemical processes taken place.

Therefore if I do not analyze these previously existing processes and the conditions brought about by them in the system of the explosive substances or the muscle, and simply know the condition added last, then I have learned nothing of the process itself, have *explained* nothing. The time of application of a new condition does not justify in any degree the assignment of a dominant position to a factor. But more: in many cases there is not a question at all of the *addition* of a process to an existing state, but rather of the *simultaneous* interference of two or more processes. Several conditions can appear at the *same* time. In other cases the sequence of the combination can be reversed. Which then is the cause? Has the process several causes, or has it no cause? Here one sees plainly to what absurd results it leads if time alone is used as a basis of the conception of cause. To illustrate this I return to the case of the liberation of carbon dioxide from carbonate of sodium. I place anhydrous carbonate of sodium in a beaker and add hydrochloric acid. The carbon dioxide escapes. Here the addition of hydrochloric acid would be assumed to be the cause of the freeing of the gas. Then I put hydrochloric acid in a beaker and add carbonate of sodium. The same process takes place, but now the addition of *carbonate of sodium* would be considered the cause for the formation of gas. Now I put both simultaneously into a beaker. Again the same process. Which was now the cause? Has the process now *two* or has it *no* cause at all? Finally I put anhydrous carbonate of sodium and hydrochloric acid in ether solution into the beaker. The formation of gas does not take place, and *yet* both causes for this formation of gas are present, the carbonate of sodium and the hydrochloric acid. Only when I add water to the mixture does the formation of carbon dioxide take place. Here water would be considered the cause. Hence every condition would be in succession the cause for one and the same process. Under some circumstances the same process would have *several* and in others

no cause at all. It is scarcely necessary for further comments upon the value of the conception of cause for the scientific explanation of a state or process. If we do not seek to introduce into exact science the antiquated symbols which have become useless and belong to a primitive phase of development of human thought, there cannot be a moment's doubt that a strict scientific analysis in whatever field of investigation it may be carried on can consist only in the study of all the conditions concerned in a state or process. If this is done, then the work of exact research is accomplished. Further problems do not exist. The use of superfluous terms or symbols for the definition of things would be in opposition to the fundamental principle, already brought forward by *Kirchhoff*, especially for mechanics, namely, that of formulating comprehensively and in the simplest manner the processes which take place in nature.

At first glance one might be tempted to find an incompleteness in the observation and description, when a conditional standpoint is adopted. It might be thought that conditionalism were a purely *formal* method of observation, and only considered the *interdependence* of things, but not the *properties*, the *nature* of the objects themselves. Regarded more closely, however, it is seen that this objection does not hold good. For what is a condition?

A condition is in itself a *thing* of quite distinct *properties*. The properties of a thing are, however, determined by the specific combination of conditions which characterize the thing. The conditions by which a thing, that is to say, a state or process, is determined, are *identical* with its being and nature; in other words, they are the thing itself. Purely formal relations without essence would be altogether an absurd fiction *not* in accord with reality, and which even the science of mathematics does not acknowledge, for we cannot have a conception without concrete content, just as in nature we do not find a form existing independently of a thing. Every thing is equal to the sum of all its conditions and depending upon the uniform constancy in accordance with natural laws is solely determined by its conditions.

The problem of all scientific research consists wholly in the ascertaining of the conditional interdependency.

A state or process is solely determined by the sum total of its conditions. A state or process is identical with all of its conditions in totality. From this it follows that equal states or processes are always the expression of equal conditions and wherever unequal conditions exist, unequal states or processes will result; and further, a state or process is completely investigated when the entire number of its conditions is ascertained.

This fundamental statement of conditionism should be engraved over the portals to the entrance of every scientific investigation.

That there is not the least difficulty in presenting scientific observations strictly according to these principles of conditionism, and that one can perfectly well do without the causal conception in a scientific description, I have shown by a concrete example, namely, in the fifth edition of my "General Physiology." In the whole volume the conception of cause is only mentioned in one place, where its theoretical value is criticised, elsewhere not at all, and yet I do not think that any one will miss this conception, and indeed, if their attention is not especially called to the fact, even notice the omission.

These principles of an exact conditional investigation must also guide us in the analysis of the processes of stimulation. The process of stimulation is especially apt to tempt one to employ the old conception of cause, for it belongs to that group of processes which originate from an already existing system by the addition of a new factor. An electric stimulus acts on the muscle. The muscle contracts. The stimulus is considered the cause of the contraction. But what would I explain if I were to prove that the stimulation is the cause of the contraction?

The history of physiology shows us that this subject has advanced long since far beyond the stage of being satisfied with such an explanation. Today the process would only then be fully investigated if we knew the entire number of its conditions and had traced the dependency of the individual partial constituents of the whole complex process upon one another. For

this, however, it is essential that we study the conditions already existent in the entire system previous to the action of the stimulus.

That which we describe with the word life is an exceedingly complex process. If we analyze life, it is found to be composed of an immense number of separate constituent processes, each one being conditioned by the others. These constituent processes are the vital conditions. A vital process occurs, and must occur, where and when the whole sum of vital conditions is realized. It is identical with the sum total of the vital conditions. If only one condition is absent, then life does not exist. It is then expedient to reserve the expression "life" for the *entire sum* of the vital conditions. When we speak of the individual constituent processes as "*vital processes*" in the plural, we must bear in mind that in reality each is not in itself life. Only the whole complex "lives," not an individual constituent of the same. Living substance is rather the *whole* system, and not a constituent part of the same, not a piece of protoplasm, not a nucleus and not a specific protein combination in the cell.

A property of this system should receive our consideration at this point. It is a characteristic of every system in the world, namely, the fact that a system *is not isolated* from its surroundings. It is a deception resulting from the selective action of our sensory organs, if we consider the bodies as separated and isolated from their environment. This deception disappears upon further analysis and when we assist our organs of sense, which only respond to certain parts of the whole process, by experimental methods of investigation. Our experience then shows us that an isolated system does not exist, but that there are instead everywhere connections which extend further and further into the infinity of the world. An organism is consequently no delimited system and the vital process cannot, therefore, be sharply separated from the processes in the medium. We cannot draw a sharp line between vital processes and say: on the right we have factors which are necessary for the maintenance of life, and on the left factors which are not necessary. The conditional connection between individual processes extends to

the entire world, and likewise a great series of constituents, each influencing the others, extend from the medium into the organism. The nature of our sense perception, and consequently the knowledge derived therefrom, is such that we are obliged to arbitrarily take into consideration merely *fragments* from the endless interdependence of all things in the world, and so we separate the vital conditions of the organisms from their surrounding factors, as though they were independent. A conscientious theoretical analysis requires that we should never forget that in reality such an isolation does not exist. Only with the recognition of this can we distinguish for practical purposes between *internal* and *external* vital conditions. In such a differentiation the *internal vital conditions* which compose the living system conceived to be isolated, are the organs, the tissues, the cells, the protoplasm and the cell nucleus, and within the protoplasm and the nucleus the arrangement and quantitative relations of certain substances, such as proteins, salts, water and the thousands of special components with their interactions and continued alterations. On the other hand, the *external vital conditions*, which act on the periphery, are the conditions of the surrounding medium, as foodstuffs, water, oxygen, static and osmotic pressure, temperature, light, etc. But this distinction has only a *practical* value for the study of the organism as an *independent* system. Theoretically it is as impossible to make a sharp distinction between internal and external vital conditions, as to distinguish between the vital conditions generally and the more remote conditions of the environment. All these conditions form a widely branching system of factors of which one is conditioned by the other reaching continually from the interior of the vital system into the surrounding medium, so that on the periphery of the system it cannot always be said whether or not a component still belongs to life. Considering these circumstances we can roughly for the present define the conception of stimulus as follows:

A stimulus is every change in the vital conditions.

The most essential point in this definition is the relation of the conception of stimulus to that of vital conditions. These relations, however, call for a brief explanation. Here again the

conditional method of observation saves us from error, for it would be wrong to place the conception of stimulus and vital conditions in contrast to one another, one excluding the other. On the other hand, this method of observation shows that the stimuli are likewise only conditions, but conditions producing certain changes in the vital system. If a stimulus acts, that is, if there is any change whatever in the vital conditions, the whole complex of life in consequence of the dependency of the constituent parts upon each other is also changed, and a new state of living substance occurs. Stimuli are, therefore, also only vital conditions, but vital conditions for new vital manifestations. The *relation* of *one* given state to *another*, forms an indispensable point in the understanding of vital conditions as well as that of the stimulus. The stimulus becomes a vital condition for the new state which it produces. It is only a stimulus *relatively* to the original state, which *previously* existed. The essential point, therefore, in the conception of the stimulus is that of alteration. An example will serve to make this clearer. If *Amæba limax* are bred in a hay infusion they appear in countless masses. Observed in water in a watch glass they show at first the well-known form of *Amæba proteus* with short, broad, lobate pseudopods. (Figure 1, A.) After a period of rest, however, they gradually assume the characteristic elongated *limax* form. (Figure 1, B.) In this shape they constantly move about. But if I add to the water only a faint trace of diluted solution of caustic potash, the amœbæ first assume the shape of a ball (Figure 1, C), and then after a time, stretch out long, pointed pseudopods, which give them the characteristic form of *Amæba radiosa*. (Figure 1, D and E.) They remain permanently¹ in this form. I have observed them for several hours at a time. They move in the same manner as *Amæba radiosa*. They draw in one pseudopod, stretch out another and float freely in the water in contrast to their *limax* state, in which they are always attached to some support. The long, pointed, often threadlike pseudopods, yield to every movement of the water, bending in consequence like whipcords. In this example

¹ *Max Verworn*: "Die polare Erregung der lebendigen Substanz durch den galvanischen Strom." In *Pflügers Archiv f. d. ges. Physiologie* Bd. 65, 1896.

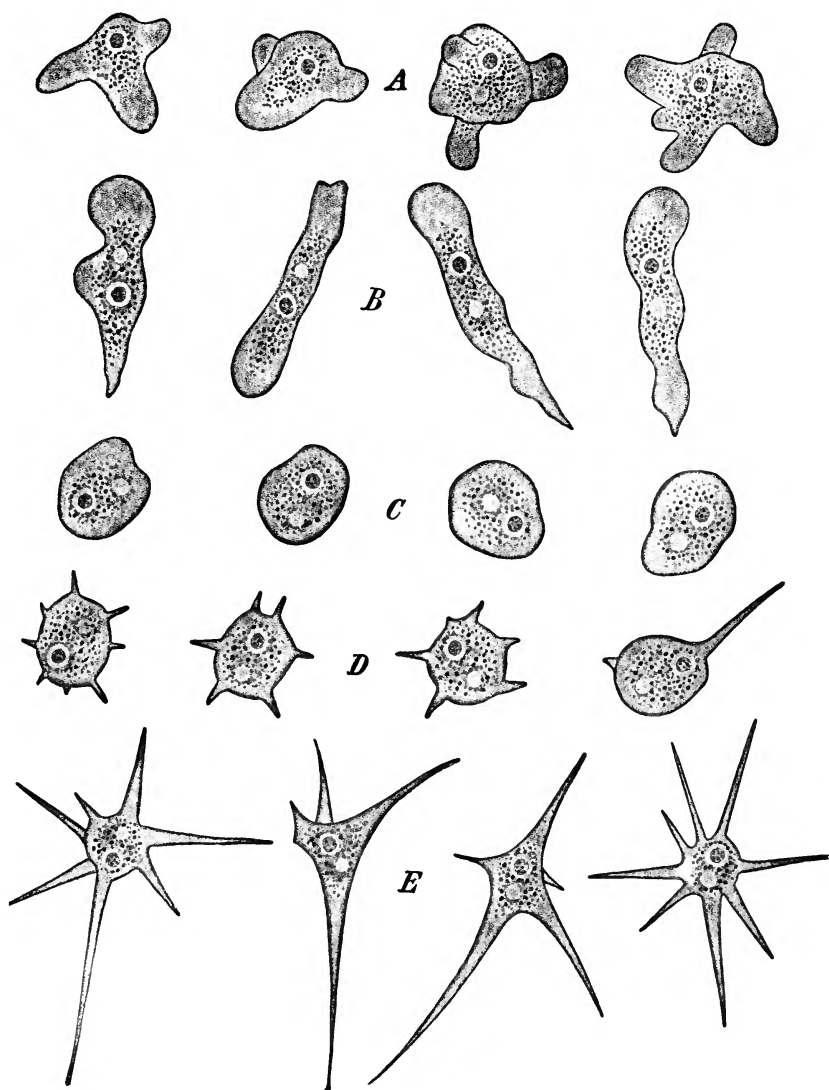

Fig. 1.

the amœbæ under the vital conditions existing in tap water have *limax* form. The vital conditions undergo a change by the addition of a solution of caustic potash, which acts as a stimulus. The consequence is a reaction, in which the animal assumes *radiosa* form. By the action of the stimulus a new state of the living substance is produced, and remains as long as the solution of caustic potash is contained in the medium. The solution of caustic potash is, therefore, a stimulus for the state of the vital system, which is manifested in the *limax* form, whilst for the state of the system which shows itself in the *radiosa* form, it is a vital condition. If I place the amœbæ of the *radiosa* form once again in tap water, they assume the *proteus* and then the *limax* form. The withdrawal of the solution of caustic potash, the presence of which is a vital condition for the *radiosa* state, acts as a stimulus, which results in a transition of the vital system to another state. By altering the medium I can at will bring about this change of form in the same individuals. In this way one and the same factor can figure as stimulus and vital condition, according to the state of the vital system on which it acts. Whilst its addition acts as stimulus in the one state, its withdrawal acts as a stimulus in the other state, which it has produced. The same fact is shown by the well-known example of *Artemia salina*, which on being placed in fresh water changes into *Branchipus stagnalis* and, when again introduced into sea water, becomes once more *Artemia salina*.

These facts show clearly that some stimuli can also be considered as vital conditions. In the absence of certain stimuli, life could not exist for any length of time. In the highly differentiated cell community of the animal organism, for instance, as a result of the coexistence of the cells and the tissues, many parts have forfeited in a measure their independence. An example of this is the skeletal muscle, which, in the absence of impulses from the nervous system, reaches a low level of chemical change and energy transformation. Here the nervous impulses which act as momentary stimuli, are also in the course of time indispensable vital conditions. Without them the muscle would gradually become atrophied from inactivity. The same applies

to all other tissues of our bodies. The functional stimuli are for them at the same time vital conditions. These vital conditions undergo fluctuations and interruptions but at each alteration from a given state they act as stimuli.

Stimulus is every change in the vital conditions. But is this definition complete? Are we really justified in regarding *every* alteration in the vital conditions as a stimulus?

In considering this question, one point must not be omitted. This is the fact that one of the chief characteristics of the vital process is, that it undergoes continuous change. A vital process involves not simply an alteration in metabolism or transformation of energy in the sense that the same chemical processes continuously reoccur in the same manner. Such a view could only be admissible for the observation of living substance during a limited period. An investigation over a long period of time shows rather that every living system alters as long as it exists, although this alteration is very gradual. The constituent processes, in short, continuously undergo metabolic change both quantitative and qualitative in nature.

If we observe the occurrences in a living system at various moments of the cycle of life, we will find that the condition differs qualitatively at each period. The progressive alteration of the system is such that every state of living substance conditions another, by which it is followed. No state can permanently exist as such. Every state is the product of the preceding, as it in turn conditions its successor. Consequently the relations of the system to the surrounding medium also undergo alteration, even when the external factors themselves in no way alter. That which today is still a vital condition, is not in consequence necessarily one tomorrow. These progressive changes exist continuously until the death of the system takes place. They characterize life. It is development, and life cannot exist without development. Death is only the last phase of development. The individual constituent processes of metabolism gradually change to such a degree that they can no longer work harmoniously together. Then the chain of processes is interrupted at one point or another. The system develops into

death or, on the other hand—and this, as *Weissman* especially emphasizes, is realized in the case of unicellular organisms—a corrective process takes place, a process of cell division by which the original state of the cell is restored and development begins anew and in a similar manner.

Ought we to designate these constant alterations in the inner vital conditions as “stimuli”? Usage in this connection has already answered in the negative, by applying to them the word “*development*.” And this use is in a certain sense justified. Let us imagine an organism or any other object for the purpose of investigation as isolated from its surroundings. This conception, which we have already stated, proves untenable on closer analysis, but it, however, is based on the nature of the methods of human observation and is indispensable for practical use within certain limits. Then the inner vital conditions belong to the organism, the external to the medium. They differ in so far that the external vital conditions can exist permanently without alteration, that is, independently of the development of living systems, whilst the inner vital conditions of every living organism continuously and progressively undergo alteration. In this sense, but only in this, there is evidently a difference between the inner and outer vital conditions, which permits a separation of the two groups. But we should always bear in mind that this separation cannot be sharply defined. On the same basis we assume that the organism for purposes of study is separated from its surroundings as an independent system, which leads us in consequence to contrast the alterations in the internal with those in the external vital conditions, in which we designate the first as processes of *development*, the latter as stimuli. This distinction, as all differentiations and separations in nature, gives us only a practical working basis.

In this way we confine the conception of the stimulus to all alterations in the external vital conditions of a living system, considered as isolated. This view does not exclude the fact that stimuli can also occur and act within an organism. If a nervous impulse is conducted from the cerebral cortex through the pyramidal tract to a skeletal muscle, this impulse acts upon the

muscle cells as a stimulus. Although the explosion of the impulse is an alteration within the body, nevertheless, as far as the muscle is concerned, it may be looked upon as an external vital condition, therefore as a stimulus. As the conception of stimulus involves the relation to a given state, it likewise involves at the same time the relation to a given living system, upon which it acts from the exterior.

What is the value then of all this theoretical discussion?

In presenting the conception of stimulation from a conditional standpoint, I desired to show what difficulties stand in the way of a theoretical isolation of a fundamental conception in the field of physiology, which indeed is used in our practical research work at every step. "*Natura non facit saltus.*" I wished to demonstrate that the sharp separation of the conception of stimulation, like all artificial divisions which we make in nature, must always contain an arbitrary note, as in reality isolated systems do not exist in the world. I wished to show that, for this reason, the conception of vital system, the conception of life, the conception of vital conditions are not sharply defined. I wished likewise to show that as a necessary consequence of this fact a sharp separation of the conception of stimulation, which can only be made in relation to that of vital conditions, cannot be maintained theoretically. I wished to show further that there is no sharp line of division between inner and outer vital conditions, and that we cannot, therefore, make a strictly theoretical distinction between the conception of stimulation and that of the processes of development. I wished to show that, for these reasons, we must not expect from the conception of stimulation, as we understand it, anything beyond its possibilities. But finally I wished also to show that, whilst fully conscious of and with due consideration of all these difficulties, it is possible to work out a definition of stimulation which is of great *practical* working value. The definition in short is: "*Stimulus is every alteration in the external vital conditions.*"

This definition gives to the conception of stimulation its most complete, that is to say, its generally applicable and simplest form. The great importance from a methodical standpoint of

this definition of stimulation for the research of life is evident. Our whole experimental natural science always employs for investigation of any state or process the same method: the state or process to be observed is studied under systematically altered conditions. By stimulating the living substance it is brought under changed external conditions. A systematic employment of stimulus is, therefore, the experimental means for the research of life.

CHAPTER III

THE CHARACTERISTICS OF STIMULI

Contents: The quality of the stimulus. Positive and negative alterations of the factors which act as vital conditions. Extent of the alteration in vital conditions or intensity of the stimulus. Threshold stimuli, sub-threshold, submaximal, maximal and supermaximal intensities of stimulus. Relations between the intensity of stimulus and the amount of response. The *Weber* and *Fechner* law. All or none law. Time relations of the course of the stimulus. Form of individual stimulus. Absolute and relative rapidity in the course of the stimulus. Duration of the stimulus after reaching its highest point. Adaptation to persistent stimuli. Series of individual stimuli. Rhythmical stimuli. The *Nernst* law.

We have found that stimuli are alterations in the external vital conditions and that the irritability of living substance consists in the capability to respond to stimuli by changes of the vital processes. It now behooves us in the interest of experimental research to investigate the relations between the nature of the alterations in the external vital conditions on the one hand, and that of the alterations of the vital process on the other ; that is to say, to systematically study the effects of stimulation on the living organism. For this purpose it is above all necessary to become acquainted with the almost countless numbers of alterations which take place in the external vital conditions of an organism, and to create a systematic scheme of stimulation which differentiates and presents in comprehensive order those various elementary factors which, among the innumerable varieties of stimuli, would prove effectual. For this purpose it is necessary to select the various factors which are involved in an alteration of the external vital conditions.

The first of these factors is the *quality of the stimulus*. The external vital conditions are, in short, a series of chemical factors, such as foodstuffs, water and oxygen; the presence of a cer-

tain temperature; the existence of a certain light intensity; the existence of a definite static pressure; and finally the presence of an equal osmotic pressure. The stimulus according to its quality can be differentiated into chemical, thermal, photic, mechanical and osmotic varieties. To these must be added other forms of stimuli not ordinarily operative, for instance, many uncommon chemicals, and certain kinds of rays. The form of stimulation, par excellence, which has acquired the greatest importance for the *experimental* investigation of life, is electricity. In its manifold forms it permits, as no other, of such fine gradations of intensity and duration that it has become in the hand of the physiologist an invaluable means of research.

Alterations in those factors which act as vital conditions compose the great mass of physiological stimuli which act continuously on every living organism. The first point to be considered in every alteration is its *direction*. The alterations produced by stimuli may be of two different kinds, either positive or negative. The quantity of foodstuffs, water or oxygen, in the surrounding medium, can undergo an increase or diminution; as may the temperature, intensity of light, the atmospheric and osmotic pressure. The strength of the electric current, which may be applied, can also be regulated. In accordance with the definition of stimulation already referred to, we must consider these alterations, whether negative or positive, as forms of *stimulation*. Now the question arises: Is this point of view justifiable? Should one also consider, for example, the lessening or total removal of a vital condition as a stimulus? Should one consider the removal of water or oxygen, cooling or darkening, as a stimulus? It has, in point of fact, been occasionally attempted *not* to regard these negative deviations as forms of stimuli. These observers permitted themselves to be led by the dogma, that only that which produces an excitation, that is, an increase of the processes in the living substance, should be regarded as a stimulus. Such a limitation of the conception of stimuli would only result from the one-sided consideration of an all too limited circle of facts. Considered from the point of view which results from a broader range of experience, this narrow view becomes untenable.

In the first place it does not follow that only *positive* fluctuations of a factor, acting as a vital condition, result in *excitation* in the existing vital processes. The *withdrawal* of water produces a diametrically opposite effect. A muscle, from which water has been removed, if exposed to dry air or placed in a hypertonic salt solution, shows violent *excitation*, which manifests itself in great increase of irritability and development of fibrillary contractions. The breaking of a constant current which has for a long time flowed through a nerve or muscle also elicits a momentary excitation. Further, the abrupt removal of light may also bring about stimulation. To cite an example from the physiology of the single cell, I should like to call to your attention the interesting observations of *Engelmann*¹ on the *Bacterium photometricum*, of which he was the discoverer. When the field containing these organisms is suddenly darkened, all the individuals contained in the drop immediately dart forward for some distance, at the same time, as is usually the case, quickly rotating around their own axis, and then after a moment of immobility, swim on quickly in another direction. An analogous responsivity has also been shown by other single cell organisms, as has been pointed out by several observers and especially by *Jennings*.² In all these cases the excitation was produced by a lessening or total withdrawal of the factors which act as vital conditions; and even those who take the standpoint that only such factors are to be considered as stimuli which produce an *exciting* effect, are compelled to regard these alterations as stimuli, in spite of the fact that they are *negative* variations of external vital conditions.

But further, the restriction of the term stimulation to those alterations which increase the course of the changes in the living substance involves the observer in still greater contradictions. It can easily be shown that one and the same factor in one and the same form of living substance has now an exciting, now a depressing effect on the vital processes. This fact can be readily

1 *Th. W. Engelmann*: "Bacterium photometricum ein Beitrag zur vergleichenden Physiologie des Licht-und Farbensinns." In *Pflügers Archiv*. Bd. 30, 1883.

2 *Jennings*: "Behavior of the lower organisms." New York 1906.

demonstrated¹ by means of the infusoria *Colpidium colpoda*, which can be grown without difficulty in a hay infusion. A number of individuals in a drop of fluid may be placed in a warm stage and observed under the microscope; one then sees that at room temperature they swim about by moving their ciliary processes at a definite rate. Now if the temperature is raised to about 35° C., the ciliary movement becomes enormously increased. The infusoria swim madly through the field of vision. They are in a state of violent excitement. The increase has, therefore, acted as a strong, exciting stimulus. But if one allows the temperature to further increase only a few degrees the ciliary movements are suddenly greatly retarded. The infusoria now swim sluggishly through the field of vision and finally remain stationary. In this case the increase in the temperature has had a depressing effect. If the infusoria are not quickly removed, the depression is followed by death. Should the increase in temperature be regarded in the *first* instance as a stimulus, and *not as such* in the *second*, in which the temperature rises only a few degrees higher? Here the change in the vital conditions concerned is in both instances positive. In all cases of overstimulation we are confronted by the same question. Nevertheless it is not at all necessary to refer to such strong or even life-endangering stimuli for the observation of these conditions. In this connection I would like to cite an even more striking instance and which is of special interest for the understanding of the phenomena in nerve centers. If the posterior spinal roots of a *Rana temporaria* are severed, and the eighth root stimulated with a faradic current, whilst the *musculus Gastrocnemius* of the same side is connected with a writing lever, one obtains, as *Véssi*² has found, at the moment of the beginning of stimulation a contraction of the muscle. The faradic stimulus has, therefore, produced an excitation reflexly. If instead of the *eighth* the *ninth* posterior root is stimulated, the result obtained is also an excitation of the muscle. In this case, however, the excitation in the form of a tetanic contraction lasts for

1 *Max Verworn*: "Physiologisches Practicum für Medizinen." Jena 1907.

2 *Julius Véssi*: "Der einfachste Reflexbogen im Rückenmark." In *Zeitschrift f. allgemeine Physiologie* Bd. XI, 1910.

some time, provided that the stimulation is not at once stopped. If now during tetanic stimulation of the ninth root the eighth is at the same time stimulated, with a strength of current equal to that which previously brought about contraction of the muscle,

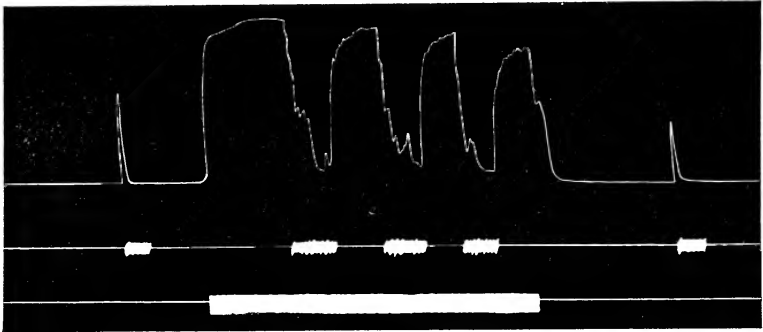

Fig. 2.

Lower thick line shows duration of stimulation of 9th root; upper thick line that of 8th root.

instead of an *increase* and a *strengthening* of contraction there is, on the contrary, an *inhibition* which continues throughout the time during the stimulation of the eighth root. If the stimulation of the eighth root is discontinued, the tetanic response of the ninth root reappears. If, on the other hand, the faradic stimulation of the ninth root is interrupted and the eighth root now again stimulated, one obtains once more, as in the beginning, with each stimulation a contraction of the muscle. This fact is illustrated by the accompanying tracings. (Figure 2.) In this investigation undertaken in the Göttingen laboratory it was further shown that a faradic current of the same strength and the same frequency had at one time an augmenting, at another an inhibitory effect, and these effects could be produced alternately at will. Should the faradic current at one time be called a stimulus, at another not? It is here clearly shown to what absurd consequences it leads if the conception of stimulation is limited solely to the cases in which an external factor has an exciting effect;

and yet an immense number of instances of a like nature could be cited to show the untenability of this view.

It follows from this, that it is altogether impracticable to define the stimulus itself in relation to the nature of the effects which the stimulus has upon the substances in the living system. One can only appreciate the nature of stimulation in relation to the vital conditions and without considering the nature of the action of the stimuli on the living substance. It is true that every stimulus is followed by an alteration in living processes, but this is to be expected when one clearly understands the nature of vital conditions. A stimulus is in all cases an alteration in vital conditions and, in that each of the vital conditions is necessary for the continuance of life, it follows of necessity that every alteration in the vital conditions, so intimately connected with the living processes, will also be followed by an alteration in the processes occurring in the living system. In short, response is produced. Nevertheless, a definite alteration of an external vital condition, depending upon the state of other vital conditions, that is, according to the state of living substance at the moment, can produce quite opposite effects. Although it may appear expedient to include in the conception of stimulation in given instances, distinctions between stimuli according to the nature of their effects upon the living substance, in all cases the conception must under all circumstances be so formulated that it comprises *all* alterations in the external vital conditions, either positive or negative, that is to say, an increase or decrease, an augmentation or diminution in those factors, acting as vital conditions.

Besides the quality there is another highly important factor to be considered in the study of every alteration in the living process, namely, its *amount*. The chemical concentration of the medium, temperature, amount of light, the static and osmotic pressure may undergo more or less variation. The electric stimulus can rise from zero to great intensity and from great intensity can fall to zero. The extent of the alteration determines the intensity of the stimulus. In relation to the intensity, a differentiation of stimulation has been introduced, which is not

dependent upon the absolute intensity of the stimulus, that is, upon the extent of the alterations in the external vital conditions, but the intensity of the response that can be observed. One refers frequently to threshold stimulation, to stimulation beneath the threshold, to submaximal, maximal and supermaximal stimulation. Such a classification is in many ways very valuable. It is not only of practical value for the establishment of definite intensities of stimulation, but also for the study of the state of irritability in the living organisms.

The threshold of stimulation furnishes roughly a standard for the degree of irritability of a living system. The threshold value of a stimulus is then that degree of intensity which is just sufficient to bring about a perceptible response. The threshold of stimulation is low, that is, the irritability is great, when the intensity of the threshold stimulus is small; the threshold is high, that is, the irritability of a system is small, if the intensity of the threshold stimulus is great. All intensities of stimuli beneath the threshold are sub-threshold stimuli. Here a point must not be overlooked, which in older physiology did not generally meet with sufficient attention. From the fact that the sub-threshold stimuli produce no apparent effects, the wrong deduction must not be made, that they have no effect whatsoever. The conception of the threshold of stimulation originated in the field of muscle physiology and that of the special senses. Here the indicator of the response is, on the one hand, contraction of the muscles, and on the other, conscious sensation. There was a great temptation to consider the stimulus altogether ineffectual, if it produced no conscious sensation or no contraction of the muscle. Today with our finer and more sensitive indicators for the study of the alterations in the living substance, we know in reality that sub-threshold stimuli, which produce no apparent effect in the living substance, can have an effect in reality.

I will call your attention later to the fact that these sub-threshold stimuli play a very important rôle under certain conditions in the activities of the central nervous system. It only depends upon the sensitivity of our special senses, or the indicators used for this purpose, as to whether the alterations can

be observed or not. The conception of the threshold of stimulation, therefore, has meaning only when used in relation to a certain indicator. The threshold of the same living system may be different for different indicators. When we use the term threshold we must necessarily know the indicator employed in its determination. The threshold stimulus produces only barely perceptible effects. The amount of response in most living substances increases with the intensity to a certain limit. If this limit is reached, that is, if the response is maximal, the stimulus of the weakest strength necessary to produce this result is termed the *maximal stimulus*, whereas all intensities lying between the threshold and the maximal stimulus are termed *submaximal stimuli*. If the intensity of the stimulus is increased *above* that of the maximal, the response, as in the case of the muscle, does not increase, and therefore one could say that all intensities above the maximal could also be called maximal stimuli.

In reality, however, the response to stimuli of different intensities is never equal, even though it may appear so, when measured by an indicator, as for instance, the height of the maximal muscle contractions. This is clearly shown, for example, when the electrical stimulus is increased far beyond that intensity which is necessary to produce maximal effect. Injury is thereby produced, which is manifested, for instance, in the muscle contraction by the nature of its course and also by its height. One is, therefore, justified in a certain sense in calling the intensities of the stimulus, which are above the value which barely produces maximal contraction, "*supermaximal stimuli*," notwithstanding this is logically far from being a happy expression. The term "maximal stimulus," then, is limited to the intensity of the stimulus which just produces a maximal effect. I wish to point out this distinction between maximal and supermaximal stimulus, as there is often a lack of clearness in the use of these terms.

In that the nomenclature of intensity of stimulation is based upon the intensity of response, the question arises as to the *relation between the intensity of stimulus and the amount of response*. It is well known that this question has met in one special field

of physiology with a very detailed and comprehensive treatment. I allude to the teaching concerning sensation. *Ernst Heinrich Weber*¹ first called attention to the relation between increase in sensation and that of the stimulus in the case of the sense of touch. His observations, which have been formulated into "*Weber's law*," have been the object of animated discussion. A presentation of this law is the following: "The amount of pressure necessary to produce a perceptible increase of sensation always bears the same ratio to the amount of the stimulus already applied."

If in accordance with *Ziehen*² we designate the relative increase in pressure to that already applied, which is necessary to produce a perceptible increase in sensation, as the *threshold of relative differentiation*, we can formulate the law in the simplest way thus: *The relative threshold of differentiation is constant.* *Fechner*,³ who indeed attempted to apply this law, applicable to the sense of pressure, to all the other special senses, has given us a mathematical formula, based on the assumption that the just perceptible increase of sensation has the same value at all levels. By this assumption he was able to establish for the first time a relation between the intensity of sensation and that of stimulus, for it follows that "*the sensation increases in intensity in arithmetical progression, whereas the intensity of the stimulus increases in geometrical progression.*" From this *Fechner* has worked out a psychophysical formula, which today is generally termed the *Fechner law*. This is the law: *The intensity of sensation varies with the logarithm of the intensity of the stimulus.*

Soon the *Weber* as well as the *Fechner* law had been extended over the whole field of sensation and stimulation. In this connection *Preyer*⁴ has formulated his "myophysical law," which states that there is the same relation between strength of stimulus and the intensity of response of the muscle as is laid down by the

1 *Weber*: "Annotationes anatomicæ et physiologicæ." Lips. 1851. The same: "Der Tastsinn und das Gemeingefühl," in Wagner's Handwörterbuch d. Physiologie Bd. III. 2. Braunschweig 1846.

2 *Zichen*: "Leitfaden der physiologischen Psychologie in 15 Vorlesungen." VI Auflage. Jena 1902.

3 *Fechner*: "Elemente der Psychophysik." Leipzig 1860. 2 Auflage 1889.

4 *Preyer*: "Das myophysische Gesetz." Jena 1874.

Fechner law for stimulation and sensation. *Pfeffer*¹ has found that *Weber's* law applied also to the relations of the chemotaxis of bacteria, to the intensity of the chemical stimulus, and likewise the attempt has been made to show that all living substances respond in the manner laid down by the *Weber-Fechner law*. Unfortunately the innumerable investigations in this field have shown more and more clearly that it is not possible to formulate a general mathematical law, which strictly fixes the relations of the intensity of the stimulus and the intensity of response. Even in the field of the physiology of the special senses many voices have opposed the general application of the *Weber* and the *Fechner law*. *Lotze, G. Meissner, Dohrn, Hering, Biedermann* and *Löwitt, Funke* and numerous other investigators have already demonstrated for some decades, partly by means of critical inquiry, partly by experimentation, that these laws are not strictly valid. Above all these experiments have shown that logarithmic relations are not tenable and likewise are not applicable to very strong stimuli. The assumption made by *Fechner*, that is, the acceptance that all barely perceptible increases of sensation have an equal value, has been set aside as incorrect, and with this his mathematical formulation within those boundaries of intensity of the stimulus, in which the *Weber* law has proven itself valid, must also be abandoned. That which we can say today with certainty concerning the relation between the intensity of stimulus and the amount of response is as follows: A law generally applicable to the relation between the strength of the stimulus and the amount of response cannot be mathematically formulated. For a great number of living systems the rule which holds for the intensity of stimulation within certain boundaries is the following: With increase of the intensity of stimulation the *response* at first increases rapidly and later more and more slowly.

This rule of course only applies within the boundaries of the intensity between the threshold of stimulation and maximal stimulus. The interval, however, between these intensities varies

¹ *Pfeffer*: "Ueber chemotaktische Bewegungen von Bacterien, Flagellaten und Volvocineen." Untersuchungen aus dem botanischen Institut zu Tübingen. Bd. II, 1888.

considerably in different living substances. In this connection there are several forms of living substance which call for our special attention. In these the surprising condition seems to exist, that the interval between the threshold and the maximal stimulus is zero; that is, every stimulus which acts at all always produces a maximal response. *Bowditch*¹ first observed this behavior in the frog's heart and this has also been confirmed by *Kronecker*.² The induction current produces, as *Bowditch* says, either a contraction or nothing. If the former, it is the strongest contraction which can be produced by an induction shock at the given time. Here for the first time a constancy of response was discovered which has been termed the *all or none law*. *McWilliams*³ has later verified the same fact for the mammalian heart. *Gotch*⁴ has also arrived at the same conclusion in connection with the nerve. He states that "the comparison of submaximal with maximal responses shows that although there is an obvious difference in the amount of E. M. F., there is little or no difference between such time relations as the moment of commencement, the moment of culmination of E. M. F. and the rate at which E. M. F. disappears." Further: "the rate of propagation of the excitatory wave is the same whether this is maximal or submaximal." He likewise assumes that the "all or none law" is applicable to the constituent fibers, and that the variations in the strength of response with weak and strong stimulation are brought about in the first instance by stimulation of a few, in the latter by a greater number of fibers in the nerve trunk. The same conclusion has been reached by *Keith Lucas*⁵ for the single cross-striated fiber of the skeletal muscle, founded on the fact that

1 *Bowditch*: "Ueber die Eigentümlichkeiten der Reizbarkeit, welche die Muskelfasern des Herzens zeigen." In *Arbeiten aus der physiologischen Anstalt zu Leipzig* VI. Jahrgang 1872.

2 *Kronecker*: "Das charakteristische Merkmal der Herzmuskelbewegung." In *Beiträge zur Anat. und Physiol. Als. Festgabe Carl Ludwig gewidmet von seinen Schülern*. Leipzig 1874.

3 *McWilliams*: "On the rhythm of the mammalian heart." *Journal of Physiology*, Vol. IX, 1888.

4 *Gotch*: "The submaximal electrical response of nerve to a single stimulus." *Journal of Physiology*, Vol. XXVIII, 1902.

5 *Keith Lucas*: "On the graduation of activity in a skeletal muscle fibre." *Journal of Physiology*, Vol. XXXIII, 1905-06.

by direct stimulation of a bundle of curarized muscle fibers, the contraction only increases inconstantly and not regularly with the increasing intensity of the stimulus. This is only comprehensible if one takes into consideration that, with the increasing intensity of the stimulus, a greater and greater number of fibers are stimulated. *Keith Lucas*¹ came to the same conclusion in the case of the muscle stimulated indirectly through the nerve. He, therefore, sees, because of the nature of the response of the single muscle cell, no difference between heart muscle and skeletal muscle. The "*all or none law*" applies to the individual muscle cells of both kinds. The difference between the heart and skeletal muscle, according to him, lies in the fact that in the heart the individual muscle cells in their totality stand together as conductors of excitation, whereas in the skeletal muscle the individual muscle fibers are separated, as far as conduction of excitation is concerned, by the sarcolemma. Finally, the recent investigations of *Vérszi*² with strychnine poisoned ganglia cells of the posterior horns of the spinal cord, have made it appear probable that "the all or none law" can be applied likewise to the individual ganglion cell. He draws this conclusion not only from the fact that all reflex contractions of a muscle of a strychninized frog are maximal, whether they are produced by weak or strong stimuli, but also especially because of the loss in the strychninized spinal cord of the capacity of the summation of irritability. The normal spinal cord does not reflexly respond at all to weak single stimuli, but responds to equally weak faradic stimulation very readily. Therefore, the threshold lies very high for the individual induction shock and very low for faradic shocks. But these differences are equalized in the strychninized frog. This seems intelligible, when we assume that the strychninized cell responds to every stimulus, to which it responds at all, to the maximal extent which is permitted at that moment by its stored up energy, otherwise the excitation would necessarily be summated by faradic stimulation.

¹ *Keith Lucas*: "The all or none contraction of skeletal muscle fibre." *Journal of Physiology*, Vol. XXXVIII, 1909.

² *Vérszi*: "Zur Frage des Alles oder Nichts-Gesetzes beim Strychninfrosch." *Zeitschrift für allgemeine Physiologie* Bd. XII, 1911.

Such are the instances to which one has up to the present applied the "all or none law." The question if, as a matter of fact, such a condition has ever been realized in any living substance has until now found no final answer. Most authors, who accept the validity of the "all or none law" for certain living substances, do so with a certain reserve and speak only of the possibility or probability of such behavior. The subject has, however, as will be shown later, a great and even vital interest in another direction. For this reason I should prefer to postpone the treatment of the same to a later occasion. Here I wish simply to say, that *if* the "all or none law" is valid in a strict sense for certain structures, then there exists no general constancy of the relations of the intensity of the stimulation and the amount of response, applicable to all living organisms.

We will now return from this digression concerning the relations between the intensity of the stimulus and the response, to the further characterization of the properties of the stimulus. Besides the quality, the direction and the intensity of every alteration in vital conditions, an equally important factor is the duration of the alteration. The time relations, under which a deviation of the external vital conditions takes place, present immense and manifold variations in nature. In many cases the change is very complicated, as for instance, the alteration of the static pressure or the temperature under the influence of air or water currents, the osmotic pressure or chemical factors in diffusion currents, and the light intensity produced by the movement of clouds. These very irregular alterations have practically little interest for us. Here we are concerned rather with the differentiation of the time alterations of the processes of the simplest fundamental types, which are of importance in studying the course of the reaction. For it is of such simple elements that the complicated and irregular alterations of the above-mentioned kinds are composed.

The simplest form of an individual change in the external vital conditions would be a regular and constant alteration of intensity which can be graphically represented as a straight line, wherein the intensities are the ordinates and the time the abscissa.

(Figure 3, A.) A regularly rising pressure would, for instance, represent a stimulus in its simplest form. But such forms of stimuli are only very rare in nature and are also experimentally very difficult to produce. It is, for example, not easy to give the *electrical* stimulus, so much used for experimental purposes, this form. *Fleischl* and *v. Kries* have only accomplished this by means of complicated apparatus. The usual *form of the individual stimulus* is not a straight line, but a logarithmic curve. (Figure 3, B.) The alteration hardly ever progresses with equal rapidity from its beginning until it reaches its highest point, but as a rule, with decreasing rapidity. This is the usual course of alterations of concentration, also of chemical and osmotic stimuli, of changes of temperature and of electric stimulation.

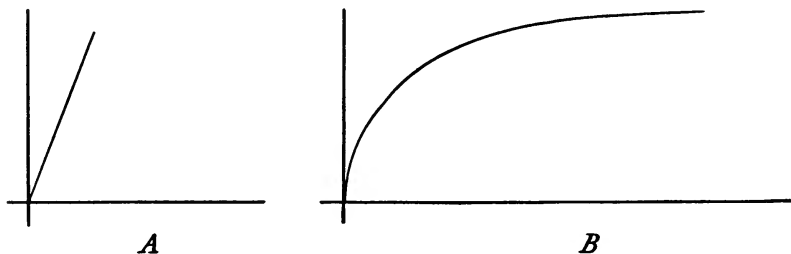

Fig. 3.

The *rapidity of alterations* in vital conditions has quite an important influence on the development of the response to stimulation. It is well known that if a constant current, which reaches its highest intensity rapidly, is permitted to act upon a muscle, the effect differs from that following the application of a current of the same intensity but in which this is reached very slowly. In the first case there is a sudden strong twitch, in the second none at all. In spite of this there can be no doubt whatever of the current in the last case being effective. That the muscle is also excited when the current is slowly increased is shown by the contracture, which grows more and more plainly perceptible with the increasing intensity of the current and in higher intensities by the so-called *Porret's* phenomenon, which consists in a curious wave-like movement of the muscle-substance. In reference to

the rapidity of the alterations in the factors which act as stimuli, the behavior varies greatly. Many stimuli because of their nature never have a steep ascent or descent of intensity, as, for instance, alterations in the concentrations of soluble substances, that is, chemical or osmotic stimuli; likewise temperature variations may be mentioned. They always act relatively slowly. On the contrary there are forms of stimuli which have now a rapid, now a slow, ascent or descent of their intensity, such as the photic and mechanical stimuli. Finally, there are other stimuli that nearly always show a very abrupt change of intensity, such as the electrical form.

The most important factor to be considered in producing the response to variations of intensity, is not the *absolute rapidity*, but rather the *relative rapidity*; that is, the rapidity in relation to the characteristic rapidity of reaction of the particular living substance concerned. The rapidity of the reaction to stimuli is very different in various forms of living substance. On the one hand, we have forms reacting very quickly, as the nerve and the striated muscle; on the other, those which respond very slowly, such as a great number of unicellular organisms. Between these are a great number of living substances which, as far as the rapidity of the reaction is concerned, occupy intermediate positions of every varying degree. It is clear that the adequate stimuli for slowly reacting substances must be those having also a slow change of intensity; for quickly reacting, those having a rapid change of intensity.¹ If a nerve muscle preparation is simulated with the single induction shock, the "break" as well as the "make" shock has effect. But even here a difference is noticeable. The "make" shock has a weaker effect than the "break" shock. This difference is due to the difference of abruptness in its course, which when the current is made is less than that of opening, for, when the current is made, the ascent of the primary current is retarded by the extra current flowing in the opposite direction, whereas, when broken, with the fall of the intensity of the primary current, the extra current in the

¹ Vergl. *Julius Schott*: "Ein Beitrag zur electrischen Reigung des quergestreiften Muskels von seinen Nerven aus." *Pflügers Archiv* Bd. 48, 1891.

primary coil flows in the same direction. In consequence of this there is a perceptible difference in the rapidity of the alteration of the "make" and "break" shocks. (Figure 4.)

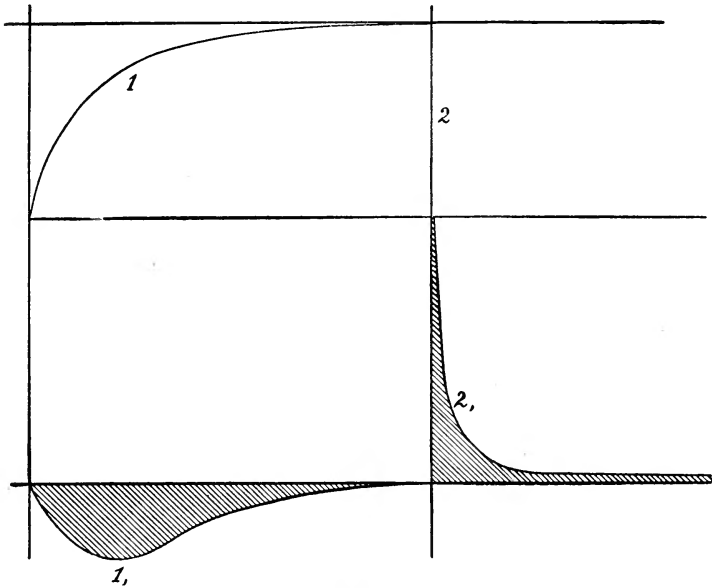

Fig. 4.

Course of induction shocks. 1 and 2 make and break of the primary current.
 1_1 and 2_1 make and break induction shocks. (After *Hermann*.)

Now slowly reacting forms of living substance, such as certain foraminifera, in which the extended pseudopods are stimulated with single induction shocks, the break as well as the make shocks are wholly without effect, as both take place far too quickly for the slow responsivity of these organisms. I have made such observations on various forms of foraminifera of the Red Sea, on *Orbitolites*, *Amphistegina* and others. The movement of granules in the pseudopods is not influenced by the induction shocks in the least. It also continues without interruption when the pseudopods are extended. Even with the strongest induction shocks at my disposal I could *not* induce them to contract; the faradic current,

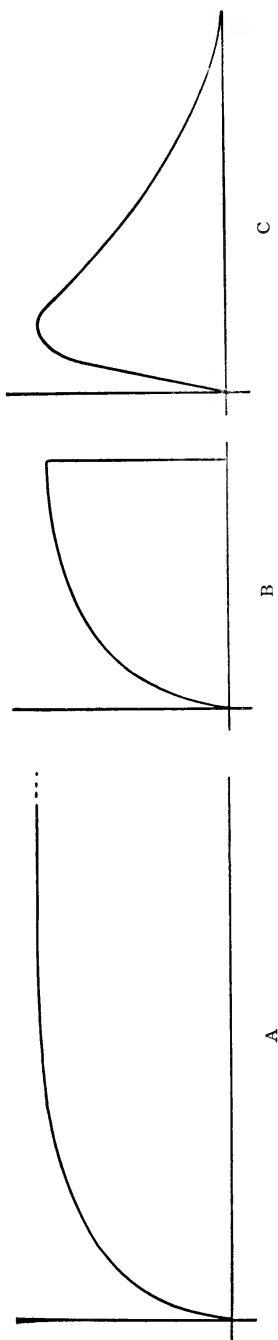

Fig. 5.

also, the intensity of which I found quite unbearable, remained utterly without effect.¹ These two extreme cases, the nerve and the foraminifera, show plainly that the effect of a stimulus is not produced by the absolute rapidity of the increase of intensity, but is solely influenced by the relative rapidity of the same.

A further point for consideration in the duration of an alteration in a vital condition in producing a stimulant action is the *length of time the stimulus remains after reaching its highest point*. In the forms of stimuli occurring in nature the duration of the alteration after reaching its highest level can vary considerably. The stimulus may remain indefinitely at a certain level, when this is once reached. (Figure 5, A.) The alteration likewise persists. This would be the case, for instance, with the changes of concentration in the transfer of an organism from fresh into sea water. The alteration can also, however, immediately after attaining its highest level, return, so that the original state is at once reestablished. (Figure 5, B and C.) Here it is a case of a quick deviation in the external vital conditions. A *sudden jar* would be a case in point. Between these two extremes we have all variations in the duration of all natural and experimental forms of single stimuli.

Now we arrive at the question: Has a prolonged stimulation really a prolonged effect? This question might seem superfluous, as from a conditional standpoint it is self-evident that every alteration in any one of the conditions of a system is followed by an alteration in the system. But this very question played an important rôle in older physiology and led to prolonged discussions for the reason that a special case was taken into consideration in this connection, which at that time was not clearly understood. *Du Bois-Reymond*,² as a result of his investigations on the nerve muscle preparation of the frog, formulated a law of nerve excitation, according to which it is not the *absolute value* of the intensity of the constant current which produces an excitation of the nerve and contraction of its muscle, but an alteration

1 *Max Verworn*: "Untersuchungen über die polare Erregung der lebendigen Substanz durch den constanten Strom." III Mitteilung, Pflügers Arch. Bd. 62, 1896.

2 *Du Bois-Reymond*: "Untersuchungen über tierische electricität." Bd. I. Berlin 1848, p. 258.

of the intensity from one moment to another. The more rapidly these changes are produced, the greater is the excitation. His arguments were based upon the fact that a contraction can only take place on the "making" or "breaking," or by rapidly strengthening or weakening the constant current; it is possible to subject a nerve muscle preparation to a current of considerable strength without a muscle contraction resulting, provided it is slowly increased. One might be disposed to conclude from this that the constant current, when showing no fluctuations, has no stimulating effect whatsoever. Should this observation be carried even further and the attempt made to extend it into a general law of excitation by assuming that the effects of stimulation are only produced by variations in the intensity, not by its continued duration, one would commit the error of judging the occurrence of a stimulus only by the unsatisfactory criterion of an abrupt muscle contraction. Today we know with positiveness that a continued effect also exists during the uninterrupted flowing of a constant current in nerve or muscle, though much weaker, however, than in the case of the excitations produced by sudden fluctuations of the intensity. This is shown in the nerve by an altered excitability, which continues at the poles during the whole duration of the current. In the region of the anode the excitability is diminished, in that of the cathode it is increased. An excitation can also be demonstrated which extends from the cathode through the nerve, which can easily be detected by sufficiently delicate methods. Among other effects of prolonged stimulation is that of cathodal contracture, which remains localized in the region of the cathode and which excitation persists as long as the current continues. This permanent excitation can be particularly well observed in the single cells of the rhizopods. If a constant current is allowed to flow through an *Actinosphaerium*,¹ the straight, smooth, ray-shaped pseudopods of the cell body at the moment of "making," show evidence of contraction by being drawn *in*, particularly those directed towards

¹ Kühne: "Untersuchungen über das Protoplasma und die Contractilität." Leipzig 1864. Max Verworn: "Die polare Erregung der Protisten durch der galvanischen Strom." Pflügers Arch. Bd. 35, 45, 1889.

the anodic and in less degree also those towards the cathodic pole. This excitation, greatest at the time of "making" of the current, though diminishing rapidly in intensity during its continuance, remains, however, to a less degree, and leads to a progressive disintegration of the protoplasm on the side towards the anode, which lasts until the current is again broken. (Figure

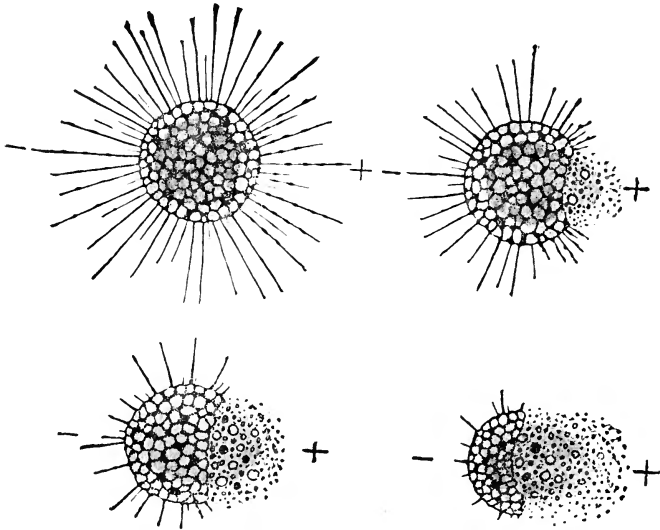

Fig. 6.

Actinosphaerium eichhornii. Four stages showing the progressive influence of a constant current. Protoplasmic disintegration at the side toward the anode.

6.) Thus even though there can be no doubt, on the one hand, that the effect of stimulation, which appears at the moment of the entrance, is to produce alterations, which develop very rapidly, and that by a continuation of this state there is a more or less rapid fall to a low level; on the other hand, it is just as certain that the alterations in the living system persist throughout the duration of the changed external conditions, or to put it more

concisely: the effect of the stimulus never wholly disappears unless the changes in the external vital conditions return to their original state.

But more, an effect of the stimulus cannot indeed take place *without* a certain duration of stimulation, which is related in *its* turn to the rapidity of reaction of particular living system. This can be much more readily observed in more slowly reacting substances. *Fick*¹ first proved this fact on the muscle of the *Anodonta*. I have also been able to demonstrate the same fact in the slowly reacting sea rhizopods² by the use of the constant current. When *Orbitolites* is stimulated with a constant current lasting approximately the tenth of a second, no response is seen in its extended pseudopods, which are directed towards the poles. The same is the case if the induction current is employed. Only when the constant current of the uniform strength lasts approximately .05 seconds, a barely perceptible response occurs, manifested by the sudden stoppage of the centrifugal flowing of granules in the anodic pseudopods, which, however, after the lapse of one to three seconds continues again unaltered. Should the duration of the constant current be still further prolonged, typical symptoms of contraction are seen being manifested by a heaping up of the protoplasm in the pseudopods in the form of spindles and balls, whilst the protoplasm flows in a centripetal direction towards the central cell body. (Figure 7.)

Two effects can be realized by the alteration in the living system as the result of prolonged stimulation. Either a new state of equilibrium is established by the prolonged action, or sooner or later death develops. In considering both results, however, we will ignore for the present the fact that every living system in the absence of such prolonged stimulation is always in a state of change, i.e., development. Only with this restriction can an equilibrium of the living system be spoken of.

1 *A. Fick*: "Beiträge zur vergleichenden Physiologie der irritablen Substanzen." Braunschweig 1863.

The same: "Untersuchungen über die electriche Nervenreizung." Braunschweig 1864.

2 *Max Verworn*: "Untersuchungen über die polare Erregung der lebendigen Substanz," etc. III Pflügers Arch. Bd. 62, 1896.

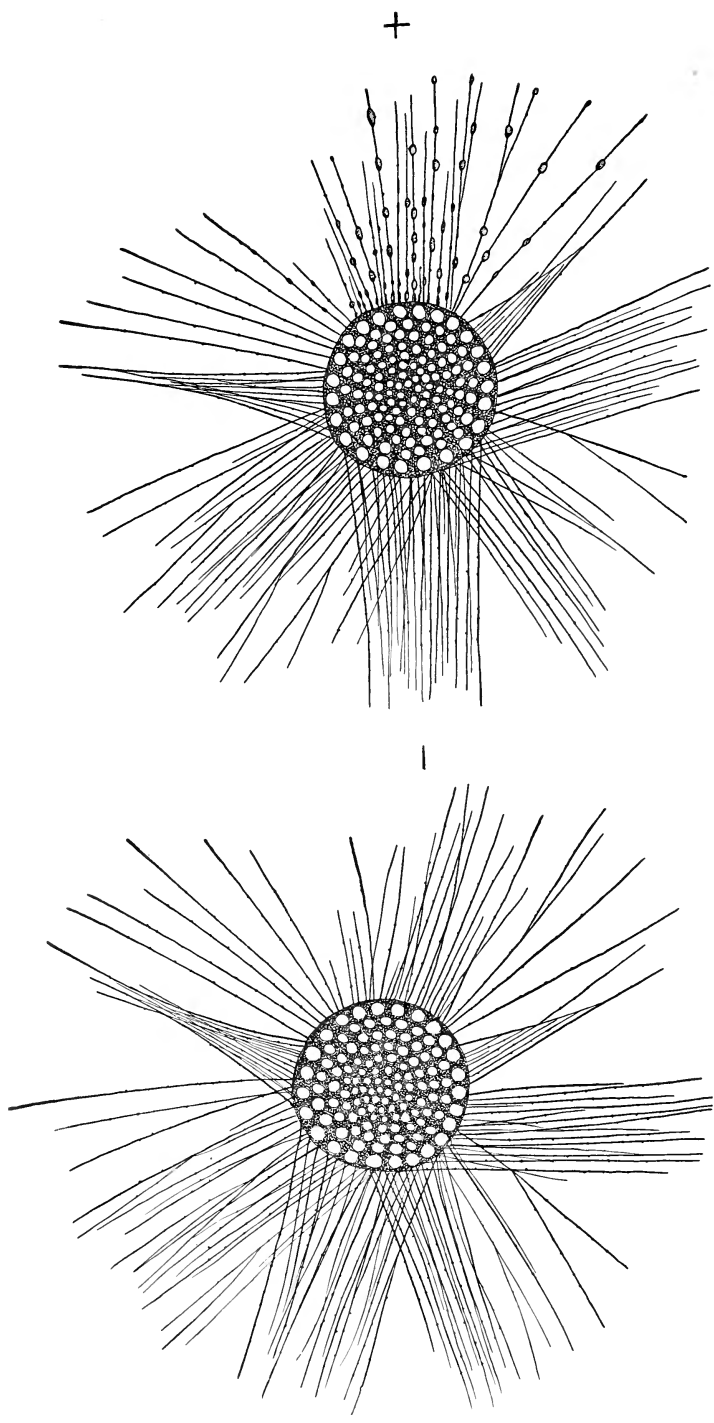

Fig. 7.

A—Before stimulation. B—Under influence of a constant current.

Orbitolites complanatus.

It is sometimes the case that under the influence of a stimulus a new equilibrium is developed, which may remain as long as the stimulus persists. This most frequently occurs as a result of *weak* stimuli. That which is usually termed "individual adaptation" belongs in this category. Likewise some of the natural and artificial immunizations may also be included. The continued stimulation in such cases of adaptation as we learned before in the example of *Amæba limax* and *radiosa* or *Branchipus stagnalis* and *Artemia salina* becomes a vital condition for the living substance in its new state.

The other result, namely, that of death ensuing sooner or later, is most frequently produced by stronger stimulation. Through the effect of the prolonged stimulation, the change in the living system is so great that all harmonious interaction of the various processes of life become after a time impossible. The disturbance of this equilibrium after a longer or shorter time becomes so great that life ceases. By far the greater number of all diseases furnish examples of this kind. Disease is nothing else but reaction to stimulation. Should a constant stimulus persist and if the development of a new equilibrium of this system is not established, the result is premature death.

In most cases, as, for instance, the nerve impulses which move toward an organ, or better still the electrical stimuli as used for experimental purposes, it is not a question of a permanent but of a temporary alteration in the external vital conditions. The stimulus starts, then ceases after a longer or shorter period. In this way there is added to the deviation at the start also the alteration at its termination. The latter takes place with different degrees of rapidity, in a manner analogous to that of the initial alteration, and can bring about response. With this the curve of the duration of the course of the stimulus becomes somewhat more complicated and in consequence a like effect is observed in the response. The "making," duration and "breaking" of the constant current furnishes the example of this type. The "making" of the current being a quick alteration calls forth a strong and sudden excitation (in the muscle contraction); the continuation of the current maintains weak excitation of equal

intensity (in the muscle a continued contraction) and the "breaking," being a sudden alteration, is followed again by a stronger excitation (in the muscle a contraction). The duration of the change can, however, be so short that its intensity does not remain at two periods of time at the same height, but instead the ascent of the intensity is immediately followed by its descent to zero. Induction shocks of short duration, the duration of which have been observed more in detail especially by *Grützner*,¹ offer typical examples. Here a single effect of the stimulus results from the rise and fall of the intensity curve. Hence the induction shocks as momentary stimuli are universally used for experimental purposes.

In contrast to the single stimuli, which find their ideal in induction shocks, another form of stimulation should receive our attention, namely, the series of stimuli which produce a rhythmical alteration of vital conditions. These show among their complex combination of simultaneous and successive actions of their single stimuli relatively the simplest and most easily understood regularity in their effects. They are of particular interest, because they develop in the normal physiological happenings of the animal body in the form of rhythmical intermittent impulses of the nervous system.

Here again it is self-evident that with regard to the course of response, we must first consider the character of the single stimulus of the series, and this must be done from all those standpoints already here discussed. However, a new factor is met with here, that is, the frequency of the single stimuli of the series, or that which has the same meaning, the duration of the intervals between them. This is a feature upon which the result of stimulation depends in a very high degree. But here, too, however, it is not a case of the absolute frequency of the single stimulus, but simply of the relative frequency in regard to the rapidity of reaction of the particular living system. I should like to remark here that it is of greatest importance whether the interval between the two single stimuli of the series is sufficiently long or not to

¹ *Grützner*: "Über die Reizwirkungen der Stöhrer'schen Maschine auf Nerv und Muskel." *Pflügers Arch.* Bd. 41, 1887.

allow the living system time to completely recover from the effect of the *preceding* stimulus. In the cases, for instance, where we have recovery, we have the same rhythm of stimulation as that of response. When recovery *does not* occur, interferences of the response are developed, which are of great physiological importance, with the analysis of which we shall later on find occasion to occupy ourselves in detail. The physiological example for these stimuli is the rhythmical discharge of impulses of the nerve centers; the physical method, which is most widely used for experiments, is the faradic current.

It is apparent that the question of frequency must again be combined with all those factors previously discussed in connection with the *single* stimulus. In consequence another complication arises and with this another point must be taken into consideration, namely, the fact that the duration of the single stimulus in a series undergoes alteration by increasing frequency beyond a certain limit. Beyond this limit the duration of the single stimulus must become less and less. As the result of the fact that stimulation is, as we have seen, dependent on the duration of stimulus, it is evident that, depending upon the rapidity of response of the living system, sooner or later the rhythmical stimulation must become ineffectual. Nevertheless, this effect of shortening the duration of the single stimulus can be compensated by a corresponding increase of its intensity. In this connection *Nernst*¹ showed a very simple relation for induction currents of higher frequency of interruption, which furnishes a law according to which such a compensation takes place. In conjunction with *Barratt* he found, namely, that the intensity must increase proportionately to the square root of the number of single stimuli if the threshold value of the stimulus is to be maintained, that is, $I: \sqrt{m} = \text{const.}$, in which I is the intensity of the current and m the frequency of interruptions. The limits of the validity of this law cannot at present be conclusively established.

This exhausts the small number of elementary factors concerned in the course of the stimulation, and which are of impor-

¹ *Nernst und Barratt*: "Ueber elektrische Nervenreizung durch Wechselströme." *Zeitschrift für Electrochemie* 1904.

tance in considering its effect. The combination of the different varieties of these single factors, that is, the nature, the direction, the intensity, the rapidity, the duration and number of alterations in the external vital conditions of the organism produce the enormous variety of effects of stimulation which we observe in the living world.

CHAPTER IV

THE GENERAL EFFECT OF STIMULATION

Contents: Various examples of the effects of stimulation. Metabolism of rest and metabolism of stimulation. Metabolic equilibrium. Disturbances of equilibrium by stimuli. Quantitative and qualitative alterations of the metabolism of rest under the influence of stimuli. Excitation and depression. Specific energy of living substance. Qualitative alterations of the specific metabolism and their relations to pathology. Functional and cytoplasmic stimuli. Relations of the cytoplasmic effects of stimuli to the functional. Hypertrophy of activity and atrophy of inactivity. Metabolic alterations during growth of the cell. Primary and secondary effects of stimulation. Scheme of effects of stimulation.

In the foregoing lectures we have had occasion to touch more or less often on the subject of the effects of the stimuli. This was the case, however, only when it appeared necessary to obtain a systematic knowledge of the stimuli and the differentiation of the individual factors. We will now proceed to consider the effect of stimulation in a more systematic manner. The conditional method of observation, however, will remain our guide.

We have already pointed out the relations between the conception of stimulation and that of vital conditions, now we will consider that of the effect of stimulation with that of vital processes. Nevertheless, the *effect* of stimulation being a manifestation of the vital process is not, therefore, in opposition to the latter as such. Hence the question presents itself as to the connections between vital process and the effect of stimulation.

When we study the motile flagellate infusorium *Peranema* swimming undisturbed in water, we observe that the swimming movements are absolutely regular in character. The elongated cell body remains unaltered in shape. The long flagellum is extended in a perfectly straight line in the axis of the body and

only the extreme end lashes with regularity through the water (Figure 8, A). There is majestic grace in this perfect uniformity of motion. The picture suddenly alters the moment the *Peranema* is influenced by the slightest jar. The whole flagellum at once executes a few violent movements (Figure 8, B), the body draws together, soon stretches itself again and swims immediately after, in another direction, with the same majestic calm as before.

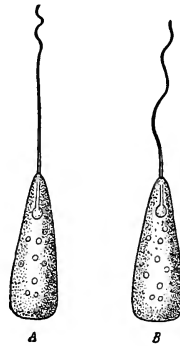

Fig. 8.

Peranema. A—Swimming in non-stimulated condition.
B—Mechanically stimulated at the end of the flagellum.

Another instance. A number of fertilized eggs of the sea urchin are placed in a watch glass in sea water. The temperature of the water should correspond with the mean temperature in which the animals live in the sea, averaging about 15° C. The eggs begin to form grooves and to develop slowly by progressive division. In another glass we observe a second sample of fertilized eggs of the same kind and under the same conditions, but in this case we increase the temperature to 25° C. The increased temperature brings about a decided increase of segmentation and the same stage of development is reached in less than half the time. The increased temperature, therefore, increases the development. Further we take a third sample of the same urchin eggs in a watch glass with sea water of 15° C. and add a little

sea water mixed with ether. The development of the eggs now comes to a standstill. The narcotic has produced an inhibition of development.

To quote another instance. *Bacterium phosphorescens* having been bred upon a putrid fish are exposed in the culture fluid to the air. In the dark the bacteria give forth a phosphorescent light. Then the culture fluid containing the bacteria is put into a glass receptacle, which can be rendered air-tight and all oxygen excluded. After a short time the light formation ceases completely. The absence of oxygen has here had a depressing effect and it is only after air has been again introduced that light is once more produced.

Lastly, an example from the group of mammals may be cited. The metabolism of a dog in complete rest is examined for a prolonged length of time and we ascertain the values of the oxygen consumption, the carbon dioxide production, and the nitrogen elimination in the urine. Under the same nutritive conditions the animal is then allowed to work from time to time in a treadmill. During these working periods impulses of excitation are continually conducted to the muscles from the nervous system. It is now found that under the influence of the constantly recurring stimuli the quantity of nitrogen in the urine has only very slightly augmented, whereas the consumption of oxygen and the production of carbon dioxide has markedly increased.

What conclusions can be drawn from these instances of response to stimuli, of which any number could still be quoted? They show us, first of all, that a state or process existing under given conditions, is altered by the influence of the stimulus. This is a fact, however, which could be expected from the beginning and is self-evident, for stimuli are alterations in the vital conditions, and when these are altered the state of the system or the happenings thereof must also alter. The question with which we are here more closely concerned, however, is a somewhat more detailed characterization of the state or process itself, as well as that of alterations produced by the influence of the stimulus. The instances of response to stimuli already cited furnish us with information in both kinds.

In all these examples, the living processes occur with equal constancy and unaltered rapidity, provided a stimulus is not operative. Here, however, the gradual alterations, the result of development, must not be overlooked. An excellent example of this is seen in the eggs of sea urchin, where the development is readily perceptible. In all these instances, however, the condition is immediately changed by the influence of the stimulus. The previous state of constancy in the vital process is disturbed. The rapidity of its course is changed, being either increased or decreased, and the specific vital manifestations concerned are, therefore, augmented or diminished. We will now study the vital process with the methods of chemical investigation and consider the problem from the standpoint of metabolism. It may be noted here, that other methods, such as the transformation of energy or changes of form of the living system, would serve equally well as indicators for this purpose. In every instance there is a uniformity of the processes; the difference, however, is in the nature of the indicators and the terms used. The methods and the terms used in chemical investigation and description reach proportionately much deeper than those employed when the transformation, energy or the variations of form of the organisms are studied, and permit of the finest differentiation of the processes. The atomistic terminology is, for this reason, preëminently fitted for the description of vital processes. When we study the vital process metabolically, we can, as shown in the above-mentioned instance, divide the processes into a *metabolism of stimulation* in contradistinction to a *metabolism of rest*.

The comprehension of *the metabolism of rest* demands a closer consideration. On closer observation we must say that this much-used conception is merely an abstraction nowhere realized in a strict sense. In truth, there is nowhere in nature a metabolism of rest. No cell exists which in a mathematical sense remains for even two successive moments under absolutely the same external conditions. If we imagine a single living cell of the simplest kind living in a fluid nutritive medium, and if we suppose its body and surroundings so magnified that the single molecules and atoms were respectively of the size of cannon and

rifle balls, the boundary between cell and medium would represent a battlefield, on which a heavy bombardment is constantly taking place. The rain of shot of food and oxygen molecules penetrating into the cell from the medium, would produce an explosion in the existing ammunition depots, now at one point, now at another, creating great breaches through which new masses of shot would reach the interior. The fragments of these exploding molecules would be flung out here and there into the medium and would stem, now at this, now at that point the besieging masses of shot. In this wild confusion on the whole boundary line between cell and medium there can be no question of rest or even equilibrium at any point. The human mind, superior to the material world as we may deem it, is yet always dependent upon the results of experience, and even in its highest flights cannot become wholly emancipated from the concrete objects. For this reason it is of great purport to conceive processes whose dimensions cannot be observed even microscopically, as enlarged and transformed to that method of expression most familiar to the human mind, namely, in the field of optical presentation. This method is of great help in aiding our understanding, and likewise here, even in the resting state, the cell is constantly exposed to local effects of stimulation, now at one point, now at the other. The conception of the metabolism of rest is, therefore, in a strict sense fiction.

Nevertheless, the conception of the metabolism of rest as an abstraction can be of value provided always that it is strictly and definitely limited. It must, for instance, not be applied to short periods of time. The continued local and temporary responses to stimulation constitute a mean value which, although composed of numberless small sub-threshold responses, we can still call a metabolism of rest. Weak stimuli have, however, as already seen, the property, provided their influence is constant, of effecting an adaptation to the stimulus on the part of the living organism, so that the stimulus becomes a vital condition for this state of the organism. Hence the continued existence of a vital process resulting from the constant action of stimulation is made possible. That which we are in the habit of calling metabolism

of rest, would, therefore, be metabolism of stimulation, but one that is characterized by a constantly existing metabolic equilibrium.

This "*equilibrium of metabolism*" distinguishes the metabolism of rest from that form which is developed in response to temporary stimulation, in that every temporary stimulation has the effect that it disturbs the existing metabolic equilibrium for a longer or shorter time. This disturbance of the equilibrium of metabolism can in contrast to the metabolism of rest be termed "*metabolism of stimulation.*" In this, but only in this sense, can these two conceptions be placed in opposition and used to characterize the processes in the living organism. The conception of the metabolism of stimulation must always stand in relation to that of an equilibrium of metabolism characterized by a constantly existing metabolism of rest, just as the conception of stimulus can likewise only be defined relatively to that of vital conditions.

Nevertheless, the conception of the equilibrium of metabolism requires a somewhat more accurate definition before we can feel justified in using this term. Definitions are always trite, nevertheless they are the basis of all our thinking and a definite understanding is impossible unless we first clearly fix their contents. The history of theology and philosophy even to the most recent times furnishes a long line of instances in which the most eminent minds, for the want of fixed definitions of the conceptions which they made use of, failed to find a mutual basis for their ideas. Without a sharp definition every conception is a mere word, which each individual, according to his personal experiences and views, endows with a different meaning. To such conceptions we may apply Mephisto's ironical comment to his pupil:

" Mit Worten lässt sich trefflich streiten,
Mit Worten ein System bereiten."

The natural sciences, if they are to retain their reputation for exactness and precision, require the strictest and clearest definitions of all conceptions. If we seek to penetrate more deeply into the varied happenings in concrete conditions, we must recon-

cile ourselves to dry pedantic definitions. In the case of that of the equilibrium of metabolism indeed we have before us one of the most important conceptions in physiology.

The justification to speak of an equilibrium of metabolism arises from investigations of metabolism in mammals. The classical experiments of the previous century, as is well known, have shown that in the adult mammal receiving a necessary quantity of nourishment and in a state of rest, the intake and outgo of the constituent elements are the same. The carbon, hydrogen, nitrogen, oxygen, sulphur, phosphorus, etc., taken in during a lengthened period in the form of food and respired air, appear again in equal quantity, in other combinations, in the products of excretion of the organisms. Calorimetric experiments likewise show an equilibrium of the consumption and elimination of energy. If there thus exists an equilibrium of metabolism for the whole cell community, it is clear that the same must also apply to the individual cell, that is, for all living substance. The quantitative relations of the foodstuffs taken *in*, and the excreted metabolic products given *off*, are, however, merely a standard of the metabolism. We know that the former are used to build up new living substance and that the latter represent the result of disintegration of that previously existing living substance; for we find, as in the case of the plant, complicated protein combinations, which are built up from comparatively simple constituents of the food and are again broken down into comparatively simple substances. And so the building up and breaking down processes form the two great processes of metabolism, which with *Hering*¹ we can briefly call "*assimilation*" and "*dissimilation*." In the terms assimilation and dissimilation are comprised the sum of *all* processes of construction and disintegration in the living organism. It is apparent that equilibrium of metabolism occurs when assimilation and dissimilation are equal. The formula $A : D$, that is, the relation of the sum of all assimilation to the sum of that of all dissimilative processes, is a factor of fundamental importance in the study of the course of the vital processes, for upon its

¹ *E. Hering*: "Zur Theorie der Vorgänge in der lebendigen Substanz." In *Lotos*, Bd. 9, Prag. 1888.

value depends individual vital manifestation, and, in fact, the continuation of life. I have, therefore, designated the formula $A = D$ "*Biotonus*." The equilibrium of metabolism would then be characterized by the *biotonus*¹ of a living organism being equal to *one*. This would be the metabolism of rest of a system, whilst its metabolism of stimulation would consist in an alteration of the *biotonus*. But is this state of living substance strictly speaking ever realized?

In considering the nature of the equilibrium of metabolism one factor has been disregarded which must be taken into account at every point; this is growth. Growth changes, although varying more or less, are never absent during the life of the organism. An equilibrium of metabolism never exists in a strictly mathematical sense, and here again we are working with a conception which is faulty, because it is an abstraction, originating from experience with rather too restricted boundaries. But an error of which one is aware is not dangerous. In mathematics we also consciously reckon with errors, without the result being altered. In the before mentioned cases the equilibrium of metabolism was maintained, because the investigations involved only a short time in an adult mammal. In the adult mammal the growth processes occur very slowly, so that alterations within a relatively short time are not demonstrated.

If it were possible to subject the adult mammal to metabolic or calorimetric experiments, extending for years, it would be found that the intake would be qualitatively and quantitatively different at the end of the investigation and that the same would apply to the outgo. In the growing egg cell this takes place with much more rapidity. In the organism which rapidly grows, it can be seen at once that the quantity of the outgo of the products of disintegration cannot be equal to that of the intake of food-stuffs. If *biotonus* were equal to one, the organism could not grow. Equilibrium of metabolism can only be understood when we take into consideration a period of time in which the alterations in growth take place with such imperceptible slowness that

¹ *Max Verworn*: "Allgemeine Physiologie. Ein Grundriss der Lehre vom Leben." V. Aufl. Jena 1909.

the resultant error is inconsiderably minute. This period of time is of greatly varying length in different living organisms and this fact must be taken into account in every living form. Only with this restriction can we justify the use of the term "equilibrium of metabolism." Then, however, its use is of great value.

The *metabolism of stimulation* is then a disturbance of the metabolism of rest, that is, a disturbance of the equilibrium of metabolism through the effect of stimuli.

The question here follows: Is there a *constancy of this interruption of the equilibrium of rest produced by the stimulus* which can be formulated into a general law? To begin with, the number of possible responses are greater than the variety of forms of living substance, for every living organism with its specific properties can undergo alteration in its metabolism in various directions. Thereby results an infinite number of manifold reactions to stimuli. However, in answer to the question, in which direction the change in the specific metabolism of rest in response to a stimulus takes place, we find a comparatively simple scheme of general reaction. All phenomena can change in their rapidity as well as in their nature. That is quantitatively and qualitatively. In this way the specific vital process of an organism can be altered by the stimulus, on the one hand, in its rapidity; on the other, in the manner of its action.

The majority of all temporary responses to stimuli consist in *alterations of rapidity of the vital process*, and form either a quickening or retardation of its course. The former is manifested in a strengthening or an increase, the latter in a decrease or repression of the specific action of the living organism. The stimuli have the same effect as in the case of the catalysers in chemical processes. According to *Ostwald's*¹ well-known definition of catalysis a catalyser is a substance which, without appearing in the final product of a chemical reaction, alters its rapidity. This group of reactions can, therefore, be referred to as "*catalytic stimulation and response.*" When the response consists in *increase*, we speak, in a physiological sense, of an

¹ *Ostwald*: "Ueber Katalyse." Verhandl. d. Ges. Deutscher Naturf. und Aerzte zu Hamburg 1901.

excitation, and when there is decrease in the vital processes, we speak of a depression.

The conception of *excitation* and *depression* are purely empirical. They are terms for real things, referring, in fact, simply to alterations in rapidity of life process, which can be as readily observed as the process itself. I wish to lay particular stress on this fact, for the reason that *Cremer*¹ has recently made the extraordinary statement that I have introduced hypothetical processes into the definition of the conception of excitation. I have always considered excitation as merely an increase or change of intensity of the specific actions of a living system, and as such is an established process without a *trace* of the hypothetical element.² If, however, the excitation process is to be regarded as something *absolute*, as a mysterious state *sui generis*, which is entirely independent and totally unlike the metabolism of rest, then, of course, it would appear utterly incomprehensible and would be without purpose. As an *absolute* process excitation is merely a meaningless word. Excitation and depression are *relative* conceptions and can only acquire meaning when the process which is excited or depressed is more closely defined. This is the specific vital process of a given organism, and the two conceptions only have meaning in relation to it. The conception of the vital process, however, is one directly gained from experience. However complex or difficult to analyze the process may be, it still is as little hypothetical as that of the combustion of carbon into carbon dioxide, or the revolving of the earth around the sun. It can be looked upon as something positive and real. Quite another question is the manner in which we are to consider the mechanism of the vital process. In analyzing this mechanism we cannot, at least in the present state of our knowledge, entirely dispense with hypothesis. But these hypotheses are in no way involved in the *definition* of the process of excitation. If we look upon every

¹ *Cremer*: "Die allgemeine Physiologie der Nerven." In Nagels Handbuch der Physiologie des Menschen. Bd. IV, Braunschweig 1909.

² In the first edition of my "*General Physiology*" in 1895 I have sharply and clearly defined it as such, stating in formulating the general law of stimulation: that every excitation is an increase either of individual parts or the whole of vital phenomena, depression every decrease in the individual part or the whole of vital phenomena.

excitation or depression produced by a stimulus as an alteration in rapidity in the specific vital process of a given organism, we are thereby expressing the same fact which *Johannes Müller* has termed "*specific energy*." We give, however, the doctrine of specific energy a more general application in so far as it comprehends not only the increase but likewise the decrease of activity in response to stimuli. *Johannes Müller's* doctrine of specific energy of the living substance at all times has been the subject of most animated discussion. When I refer here to the specific energy of living substance, it is with the knowledge that *Johannes Müller* did not use this expression of "living substance" in this connection. He was already acquainted, however, as we have seen, with the fact of the existence of the specific energy of all living structures. For appertaining to the muscle he says: "This is universal in all organic reaction." The reason why the doctrine of *sense energy* has become of importance in the discussion of the specific energy of the living substance, is in consequence of the theoretical interest, resulting from its connection with the nature of the specific energy of our *sense substances*. The controversies on this subject are still far from settled.¹ Indeed, according to the special philosophical standpoint taken by an observer, the existence of a specific energy of the senses is acknowledged or disputed. For any one acquainted with the general physiological reaction to stimuli, such a discussion is wholly without purport. The sense substances have as a matter of course in common with all living substances their specific energy, that is, the influence of stimuli can produce an increase or decrease of their specific vital processes. "Specific energy" of "sense substance" in this sense is like that of all other living substances, a fact. In that the psychical capability of these sense substances, in which we include not only the peripheral, but also the central portion, are dependent upon their specific vital processes, it must be self-evident that the excitation and the suppression of sense sensation can be brought about by adequate and

¹ Compare: *Rudolf Weinmann*: "Die Lehre von den spezifischen Sinnesenergien." Hamburg 1895.

Further: *Eugen Minkowski*: "Zur Müllerschen Lehre von den spezifischen Sinnesenergien." In *Zeitschrift f. Sinnesphysiologie*, Bd. 45, 1911.

inadequate stimuli, no matter what one may think of the relations between physical and psychical phenomena.

The only debatable question is that concerning the limits of the validity of the doctrine of the specific energy of living substances. This question will involve our attention when we have analyzed somewhat more closely the happenings in the living substance taking place under the influence of stimuli. We will, therefore, return later on to a more detailed consideration of the last question. Nevertheless, we will here refer to a fact which, upon a superficial observation, seems to restrict the validity of the conception of the specific energy of living substance.

In contrast to those reactions to stimuli, which consist merely in the changes of a rapidity of the specific vital process, are another group of reactions in which the influence of stimuli leads to qualitative alterations in the specific vital process. In these instances, the influence of the stimulus directs the metabolism of rest into new channels, so that chemical processes occur in the cell, which under ordinary circumstances do not take place. This group of reactions, which I wish to term "metamorphic stimulation and response," are chiefly observed where weak stimuli act continuously upon the living substance. These are essentially weak chemical stimuli, which last for a prolonged period or frequently reoccur in the life of the cell community. Examples of this are found in the continual ingestion of alcohol and other poisons by the human being, or in the formation of metabolic products of bacteria, etc. The majority of *chronic* diseases belong to this group of reactions; disease being simply response to stimulation. Disease is life under altered vital conditions and altered vital conditions are stimuli. This simple and self-evident fact shows the immense importance which the knowledge of the general laws of the physiology of stimulation has for pathology. The pathologist, who does not wish to confine his observations to a purely superficial symptomatology or a merely histological morphology, must seek above all to penetrate as deeply as possible into the nature of the general reactions to stimulation in the living organism. It is the essential point which meets him everywhere. In spite of their great interest for pathology, however, it is just

these qualitative alterations of the normal vital process produced by continuous stimulation which have up to now been least analyzed. In this field we expect much from pathological investigation which alone has the immense amount of material at its command. This will take place only when pathology adds to the almost exclusively histological direction of investigation, that also of experimental physiology. It is true that the problems of the qualitative alterations of a vital process by chronic stimulation are much more complicated than those of the rapid responses to temporary stimuli, consisting simply in mere alterations of rapidity of the specific vital process. An understanding of the nature of the former can only be expected when a deeper knowledge of the latter is gained, for, as will be seen presently, there is the closest relation between the two groups.

The reactions to catalytic stimuli of short duration, which produce merely an alteration of rapidity in the specific phenomena of a living organism, show on a closer analysis the interesting fact, that it is not always the *entire* metabolic processes of the cell which are perceptibly quickened, but that only certain constituent processes of the same are affected by the action of excitation. This is the *more* noticeable, as, considering the close correlation which all the individual links of the chain of metabolism bear to each other, it is to be expected that the alteration in rapidity of *one* would be followed at once by a corresponding change in all the others. An example of the case in question, in which a special constituent process may be predominately affected, is that of the specific activity of a muscle which is repeatedly stimulated by nervous impulses. Since the classical investigation of *Fick* and *Wislicenus*¹ on themselves, and of *Voit*² on the dog, we know that the nitrogen metabolism is practically unaltered by the functional use of the muscle and there is a remarkable increase only in the breaking down of the nitrogen-free groups

¹ *Fick und Wislicenus*: "Ueber die Entstehung der Muskelkraft." Vierteljahresschrift d. Züricher Naturforschenden Gesellschaft. Bd. 10, 1865.

² *Voit*: "Ueber die Entwicklung der Lehre der Quelle der Muskelkraft und einiger Theile der Ernährung seit 25 Jahren." Zeitschrift f. Biologie Bd. VI, 1870.

Derselbe: Physiologie des allgemeinen Stoffwechsels u. d. Ernährung. In Hermanns Handbuch d. Physiologie, Bd. VI, 1881.

of the living substance. Sufficient importance has not as yet been attached to this knowledge. This fact not only has a particular interest for the much-discussed question of the source of muscle energy, but also affords a deeper insight into the metabolic activity of the living substance. It shows us that we must not imagine a purely linear linking of the individual constituent metabolic processes, but rather, at least at certain points, a branching formation, the individual members spreading in various directions. An alteration in an individual member can occur without an immediate change in the other branches. This *would not* be the case if there were only a linear connection of the constituent processes, for the breaking of a single member of the chain would be followed by a change in all the following members.

It shows us, further, that certain branches are more labile than others. In the case referred to here, the branches of this system, which bring about the nitrogen metabolism, are relatively *firm* and *stable*, the branches, which are disturbed by the stimulus producing functional activity of the muscle, are particularly *labile*. I should like in passing to call here your attention to the fact that as is well known, *Ehrlich*,¹ in another field involving other conditions and other experiences and considerations, has arrived in analogous manner at his "side chain theory." In order to have an expression for those stimuli which involve rapid alteration of the labile constituent processes and which are connected with the specific action of the particular organism, I have called them "*functional stimuli*," and contrasted with them the "*cytoplasmic stimuli*." In the latter the alterations produced include all the constituent processes extending even to the stable processes of nitrogen changes, and sometimes extend to complete disintegration and rebuilding of living substance.² To the first group belong all adequate stimuli within certain limits of duration and intensity, and the greater part of inadequate stimuli of brief duration so

¹ *Ehrlich*: "Das Sauerstoffbedürfniss des Organismus. Eine farbenanalytische Studie." Berlin 1885. Compare further: *L. Aschoff*: "Ehrlich's Seitenkettentheorie und ihre Anwendung auf die künstliche Immunisierungsprozesse. Zusammenfassende Darstellung." Zeitschr. f. allgemeine Physiologie, Bd. I, 1902.

² *Max Verworn*: "Die Biogenhypothese. Eine kritisch-experimentelle Studie über die Vorgänge in der lebendigen Substanz." Jena 1905.

long as they do not exceed a certain intensity. To the latter group belong in general all the stronger adequate and inadequate stimuli of prolonged duration; such as extreme temperature, the stronger electric currents, constant alteration in the supply of food, water, oxygen, the prolonged or stronger influence of extraneous chemical matter, etc.

Considering the close correlation of the individual part processes it would appear very strange, however, if a single one of these could undergo an alteration of its rapidity without the course of the rest of the processes being in the least influenced. One cannot comprehend such *absolute* independence of a process brought about by functional stimulation from all the other constituent processes, particularly when this is of prolonged duration and involves to a considerable extent the alterations in rapidity, for the individual constituent processes are dependent in a high degree upon the quantity of the particular chemical substances of which the living system is composed. The cycle of the individual constituent processes of this system is determined in the most delicate manner in its rapidity and extent, by the relative quantities of the individual substances. Associated with an alteration in the rapidity of an individual constituent process, there would also be a relative alteration quantitatively of the substances. And with the increase in the *quantity* of the disintegration products, and also the increase of the substances for their replacement, there would result, during this time, an alteration in the amount of interaction of the molecules of the other constituent processes, so that these processes secondarily suffer an alteration in rapidity which is perceptible after long continued involvement of the functional part of metabolism.

In fact, in the previously mentioned case of the functional stimulation of the muscle, the proof has been furnished that a long-continued increase of the functional metabolism is followed, although to a less extent, by an increase in the entire cytoplasmic metabolism. *Argutinski* showed this on himself in 1890 in *Pflüger's* laboratory. He found, namely, that after the exertion of a long walk in a hilly district, a considerable increase of nitrogen excretion in the urine took place, which extended

over the succeeding two or three days. This increase of the nitrogen metabolism in its totality is not nearly as great as that of the breaking down of nitrogen-free substances, but it is, nevertheless, present and shows us that functional metabolism cannot experience a lasting excitation without being followed by secondary results in the entire cytoplasmic metabolism. This fact is even more strikingly illustrated in the alteration of the entire volume of a living organism as produced by the lengthened duration of functional stimulation. It has been long known, that the muscle as the result of frequent functional excitation by means of adequate nerve impulses, that is, prolonged activity, is considerably increased in size, whereas in the absence of such it loses more and more in volume. A hypertrophy of activity, produced by functional stimuli, and the atrophy of inactivity, the result of the discontinuance of the functional excitation, is universal and can be observed in the various tissues of our body. We see it, for example, in the glands; we see it in the skin and we see it in the elements of the nervous system. *Berger*,¹ for instance, established the fact that the ganglion cells of the optic lobe in the cerebrum of newborn dogs only reach their full development when functionally excited by adequate light stimuli (Figure 9, B), coming from the eye, whereas they remain in the embryonic state when these light stimuli are eliminated. (Figure 9, A.) The cytoplasmic increase of volume of the neurons under the influence of functional stimuli is a fact of fundamental importance for the entire happenings of the nervous system and forms the physiological basis for reinforcement of reflexes, which, in its turn, is essential for all acts of memory and intelligence. For the increase in volume of the ganglion cell body is, when functionally activated, accompanied at the same time by an increase of specific capabilities and the intensity of discharge. Its excitation impulses can, therefore, be conducted through a greater number of neurons, with which it is connected, than would be the case if development of the volume of the ganglion cell increased to a less extent.

¹ *Berger*: "Experimentell-anatomische Studien über die durch den Mangel optischer Reize veranlassten Entwicklungshemmungen im Occipitallappen des Hundes und der Katze." Arch. f. Psychiatrie, Bd. 33, 1909.

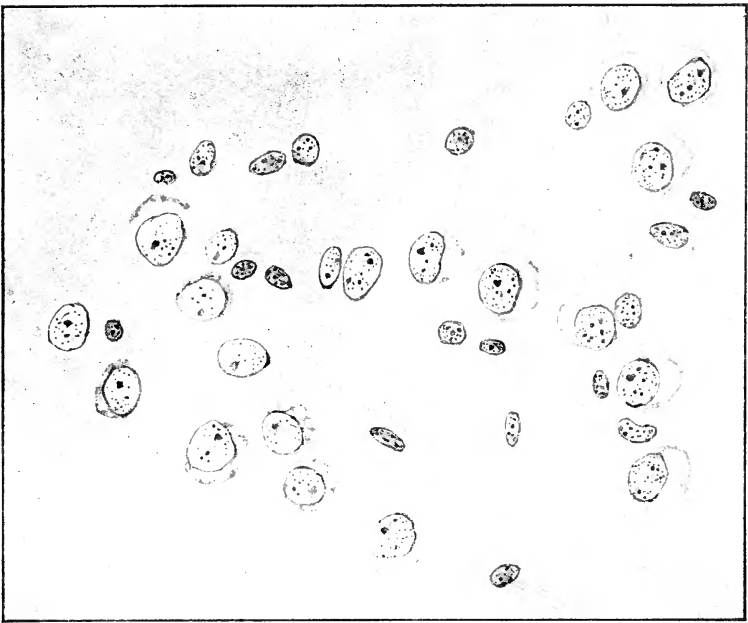

A

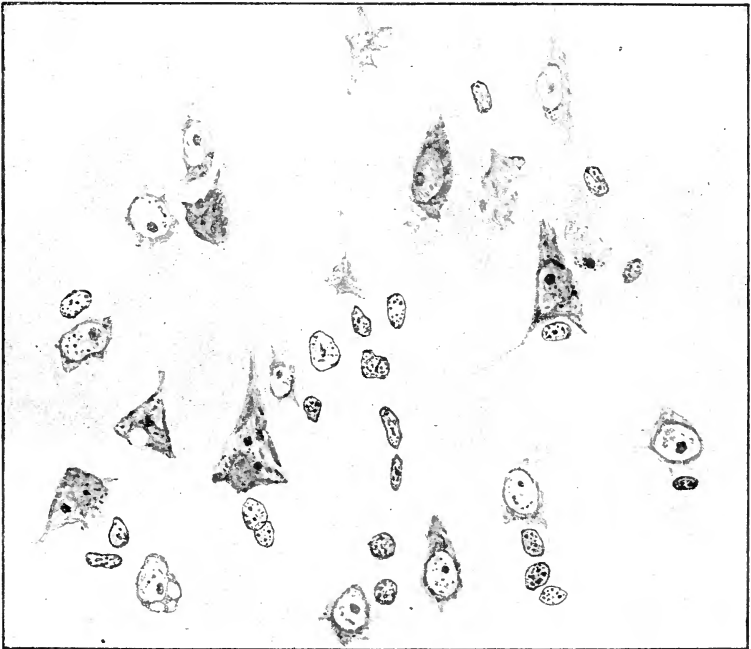

B

Fig. 9.

A—Undeveloped ganglia cells in the optic lobe of a dog, the eyes of which have been sewn up immediately after birth. B—Fully developed ganglia cells in the same region of a normal dog of the same age. (After *Berger*.)

The increase in volume under the influence of stimuli further shows the relation between the group of those solely catalytic effects of stimulation consisting in mere alterations of rapidity of the specific vital process, and that of the metamorphic effects of stimulation, which manifest themselves in qualitative alterations of the vital process. Simple observation shows us that a qualitative change of individual constituent processes must necessarily result from the increase of volume of a cell, and that considering the close correlation of all the individual processes a profound alteration of the entire metabolism must be produced. I have already at another place treated these conditions more in detail and will, therefore, only briefly refer to them here. If we study the growth of a ball-shaped cell, we find that the surface then increases as a square, and the volume as the cube. It therefore follows that, by progressive volume increase, the conditions for the interchange of substance with the surrounding medium must become more and more unfavorable for those cell portions situated in the interior, whereas those at the exterior are at much greater advantage. This must lead to a constantly increasing difference of the rapidity of the metabolic processes between the peripheral and central portions. Accordingly, the intricate interworkings of the individual constituent processes, the rapidity of action of all which is intimately connected, are, therefore, followed by corresponding alterations in the entire metabolism. Sooner or later a stage is reached in which the individual constituent processes become so limited that certain metabolic products, which previously were broken down as soon as formed, can be no longer eliminated and remain in the cell acting as foreign bodies. In this way the relative quantity of the individual cell substances become more and more altered, and as the course of chemical processes occurs in accordance with the law of mass action, the whole metabolism is directed into another channel, so that finally new constituent processes take place, which were formerly not possible. These in their turn produce deep-seated

1 *Max Verworn*: "Die cellularphysiologische Grundlage des Gedächtnisses." Zeitschrift f. allgemeine Physiologie, Bd. VI, 1907.

2 *Max Verworn*: "Allgemeine Physiologie." V. Aufl. 1909, pages 649-671.

alterations of the relations of the cell to its surrounding medium, etc. Hence this mere increase of volume of the cell in growth forms the source of an infinite mass of alterations in the activities of cell metabolism, which we briefly term its "*development*," and which by constant progression, leads either to a process of cell division, and with this to a correction of existing disorder, or finally to irreparable disturbances ending in death. In this way an inseparable relation exists between increase of volume and the development of living substance. We have seen, however, that the catalytic reactions of stimulation, which at first only produce an alteration of rapidity of the individual constituent processes, if of prolonged duration or of frequent recurrence, secondarily effect a change of volume of the entire living organism. One can, therefore, hardly reject the conclusion that seeing the close interworkings of the individual part process of metabolism, every change of rapidity of a single member, if of prolonged duration or of frequent occurrence, must finally lead to qualitative alterations of the entire metabolism. In consequence there results an important dependence between catalytic stimulation and metamorphic reaction. Indeed, it is not unlikely that the metamorphic reactions, which are especially seen in the continued effect of weak stimuli, result from alterations of rapidity, which the individual members of the vital processes have primarily undergone from this influence.

It is perhaps expedient to cite a concrete instance in illustration. A simple example is furnished by asphyxiation. If oxygen is withdrawn from any living organism, the result is a depression of its oxydation processes. Here there is primarily only a change in rapidity, especially a retardation of oxydation processes. The metabolism, however, proceeds, the disintegration of living substance continues, although at a slower rate, but produces an accumulation of other products. Whereas formerly during the existence of a sufficient supply of oxygen an oxydative disintegration of nitrogen-free groups into carbon dioxide and water took place, both of which could easily be eliminated from the cell, the anaërobic disintegration furnishes only complex products, having a higher carbon content, such as lactic acid, fatty acids, acetone,

etc. These, being more difficult to excrete from the cell, accumulate. These asphyxiation products have in their turn a depressing effect and so on. In this way the whole metabolism is forced into a wrong course. The accumulation of fat in those tissue-cells with an insufficient blood supply, as we have seen in the case of the fat metamorphosis, is doubtless brought about in the same manner by relative oxygen insufficiency. The fatty acids accumulate as products of an incomplete combustion and combine with glycerine to form neutral fats. In like manner it may be that the accumulation of amyloid substance in amyloid metamorphosis, of lime salts in arteriosclerosis, etc., is produced by a primary depression of the individual constituent processes of the particular cells.

The relation here described, of the catalytic stimuli to the production of the metamorphic processes, leads us to the distinctions between primary and secondary effects of stimulation. Should the general fact be established, which has up to now only been pointed out in individual cases, that all the metamorphic processes are merely secondary results of primary alterations in rapidity of individual metabolic constituent processes, *then the primary reactions of every stimulus would consist purely in the excitation or depression of the directly concerned constituent.* Whether or not, as may be assumed, this primary effect of stimulation applies to *all* stimuli, is a question which only the future can answer.

The metamorphic processes are not, however, the only secondary effects of stimulation. The influence of long-continued excitation of the functional constituent processes upon the entire cytoplasmic metabolism can be looked upon as a secondary response. Therefore, they may be considered as a *secondary* effect of stimulation which, in contrast to this *primary excitation*, may be called the *secondary excitation*.

Further: While the secondary excitation and metamorphic processes are generally produced by the continued existing effects of weak stimulation, we also observe as the result of a stimulus of short duration or frequently repeated at brief intervals, but otherwise not exceeding the physiological limits of intensity, a

secondary effect, which plays a very important part in the activity of the organism. I refer to fatigue. Here a secondary depression is developed in connection with the primary excitation, for fatigue of a living organism must be characterized as a depression of activity. This case shows that we have to distinguish between a *primary depression*, as for example, produced by temperature reduction, withdrawal of food, deficiency of oxygen, etc., which occurs as a direct effect of stimulation, and *secondary depression*, which as in fatigue is an *indirect* result of primary excitation.

After the cessation of a briefly catalytic stimulus, not exceeding the physiological limit of intensity, another secondary result is observed, which is of the greatest importance for the continued existence of the living substance. The catalytic stimulus brings about a disturbance of the equilibrium of metabolism, which after cessation of the stimulus is reestablished by the living substance. In other words: recovery takes place. This fundamental principle has been known for a long time as the result of observation. If a skeletal muscle of our body has been activated for a prolonged period by nerve impulses, until it has become completely fatigued and incapable of work, a recovery takes place on the cessation of these impulses and the muscle is again capable of action. Likewise, as the result of strong mental activity during the day, we are mentally fatigued in the evening; recovery, however, occurs during the night, which results from the removal of the source of activity. The next morning finds us refreshed. This restitution occurs in every cell, and the return of its former capability of action, which had disappeared under the influence of stimulation, shows that compensation has taken place of the metabolism of rest, disturbed by the effects of the stimulus. *Hering*¹ has aptly termed this restitution as "*the internal self-regulation of metabolism.*" All recovery after disease is based on this self-regulation. The physician simply provides, by means of therapy, for the possibility of its taking place. Healing itself is brought about by the organism. "*Natura sanat, medicus curat.*"

¹ *Ewald Hering: "Zur Theorie der Vorgänge in der lebendigen Substanz." In Lotos, Bd. 19, Prag. 1888.*

Finally, a third kind of secondary effect of stimulation claims our interest. This is the *secondary extension of the result of stimulation* from the part of a living organism directly and primarily affected by the stimulus, to the surrounding structures. All living substance has the capability of conducting an excitation, which is produced locally through a catalytic stimulus, to a neighboring part, not directly affected by the stimulus. It finds its highest development in the nerve, but in no living structure is it completely absent. This capability has been frequently termed "*conductivity of stimulation.*" It is more precise, however, to speak of conductivity of excitation, for it is not the primary influencing external stimulus which is conducted in the living substance, but the excitation which it has produced. I have intentionally considered only the exciting effects of stimulation, and not those of the depressing reactions, as only excitations, not depressions, are conducted by the living substance. These questions, however, demand a closer analysis. Here we were concerned only with a survey of the general effects of stimulation. If I, therefore, once more summarize the results which have been gained, this is most clearly demonstrated by the following scheme:

PRIMARY EFFECTS OF STIMULATION

Excitation	Depression
Functional	Cytoplasmic Functional

SECONDARY EFFECTS OF STIMULATION

Secondary excitation	Secondary depression
Conduction of excitation, Metamorphic processes, Self-regulation of metabolism	

This, however, is simply a scheme, like all other schemes, having for its purpose a superficial survey of the subject.

It brings to some extent order into the overwhelming mass of manifold effects of stimulation but tells us nothing of the mechanism and genesis. Our further task must, therefore, be a more thorough analysis of this field.

CHAPTER V

THE ANALYSIS OF THE PROCESS OF EXCITATION

Contents: Indicators for the investigation of the process of excitation. Latent period. The question of the existence of assimilatory excitations. Dissimilatory excitations. Excitations of the partial components of functional metabolism. Production of energy in the chemical splitting up processes. Oxydative and anoxydative disintegration. Theory of oxydative disintegration. Dependence of irritability on oxygen. Experiments on unicellular organisms, nerve centers and nerve fibers. Restitution after disintegration by metabolic self-regulation. Organic reserve supplies of the cell. The question of a reserve supply of oxygen of the cell. Metabolic self-regulation as a form of the law of mass effect, and metabolic equilibrium as a condition of chemical equilibrium. Functional hypertrophy.

If it is true that all primary effects of stimulation consist either in an excitation or depression of the metabolism, and that all other effects of stimulation secondarily follow this primary alteration of the metabolism of rest, then every thorough analysis of the mechanics of reaction must have its beginning in the investigation of these primary processes. I desire to adopt this method here and will analyze somewhat further the *primary process of excitation* and its immediate and remote sequences. This will be followed later by the analysis of the process of primary depression and its results.

The investigation of the more obscure processes in the living substance places us in a difficult position, for their details cannot be observed by the unaided senses. That which we can perceive is merely the grosser vital action, consisting of a complex combination of the individual processes, the total result of a multitude of different components. For this reason the conception of excitation can only be established by observations based upon the combined vital actions, which are produced by the effect of stimu-

lation upon the complex system. In the beginning, the process of excitation was studied exclusively on the muscle and nervous system. A physical factor served as indicator, such as muscle contraction or production of electricity. These showed, besides the direct and primary effect of stimulation, the secondary process of conductivity. Even graphic registration is merely an expression of the phenomena composed of a great mass of individual elements. The visible course of the phenomena, as shown, for instance, by the latent period by the ascent and descent of the curve of contraction, represents as it were a reflected picture of the actual excitation processes similar to an object seen in a distorting mirror; the first and the last parts of the process are not even perceptible. Later, when organ physiology was extended into a cell physiology the processes of excitation were studied in numerous simple organisms, such as the plant cell, the rhizopoda, the infusoria, etc. Later, in this way, by the use of comparative methods many essential facts were discovered. However, even the single cell, in spite of its minuteness, is, compared with the size of a molecule, a gigantic system, and it would be a grave error if we should consider this system even in its simplest aspect as homogeneous. In order, therefore, to analyze the vital activities in the cell, cell physiology must endeavor to penetrate into molecular conditions. For this purpose the indicators employed must be essentially of a chemical nature, capable of magnifying the processes of molecular dimension to such a degree that we are enabled to base conclusions upon these not otherwise directly perceptible phenomena. To obtain a sufficient magnification we must necessarily place somewhat larger quantities of living substance under observation and apply a stimulus of such frequency or length of duration that the chemical alterations as a result of excitation are so increased as to be plainly perceptible with the aid of our chemical indicators. Unfortunately, we do not possess specific chemical indicators for every individual molecular constituent process of the cell and so cannot dispose with the help of indicators of the combined happenings in a greater quantity of living substance. It remains for us to obtain data concerning the cycle of excitation processes in the living substances by the aid

of the combined employment of the most varied kinds of physical as well as chemical indicators. If we use the most varied types of living substance of widely differing properties, showing us the greatest variety of vital manifestations, we may hope by the use of comparative physiological methods, even though with difficulty, to separate more and more the essential details of the general processes of excitation. At present we are still at the very beginning of this task and vast fields of unexplored regions are yet before us. But it is the unknown which has a particular fascination, especially if we succeed from time to time in making new advances.

If we suppose a living system in a state of metabolism of rest influenced by an instantaneously exciting stimulus, the entire course of excitation extends from the first alteration produced by the stimulation until the complete restitution of the metabolic equilibrium, and we will, therefore, differentiate individually the successive stages of this whole process.

The very beginning of the chain of alterations produced by the exciting stimulus cannot be studied by any indicator. The changes must first reach a certain dimension by conduction from the point of stimulation before they influence even the most delicate indicators. The application of the stimulus is, therefore, followed at first by a measurable "*latent period*," in which the living substance remains apparently at rest. This latent period has been particularly studied in muscle. After its discovery by *Helmholtz*¹ it was made the object of innumerable investigations and met with an interest which can only be explained by the exactness of the methods employed. Among others *Tigerstedt*² has made the most thorough study of the influence of various factors on the duration of the latent period. These experiments have established the fact that the duration of the latent period varies according to the intensity of the stimulus, temperature, loading

1 *Helmholtz*: "Messungen über den zeitlichen Verlauf der Zuckungen animalischer Muskeln und die Fortpflanzungsgeschwindigkeit der Reizung in den Nerven." *Archiv für Physiologie* Jahrgang 1850.

2 *Robert Tigerstedt*: "Untersuchungen über die Latenzdauer der Muskelzuckung in ihrer Abhängigkeit von verschiedenen Variablen." *Arch. f. Physiologie* Jahrgang 1885 Suppl.

or fatigue. This is apparent when it is understood that the amount of the alterations produced by the stimulus must ascend from the value zero to a certain height before the changes are perceptible, and that under various conditions this amount is, on the one hand, attained in different lengths of time and, on the other, must reach a varying amount before it is perceptible by means of the indicator.

The facts concerning the whole latent period and its dependence on various factors would be incomprehensible if it were assumed that no alterations whatever take place during the latent period although the stimulus is already operative. In reality, the alterations following a stimulus occur with imperceptible rapidity in the form of a molecular interchange, and the latent period is simply an expression of the fact that the primary alterations, being limited in nature, are not registered by our indicators.

The question first arises, In what do these first imperceptible alterations consist? *Nernst*¹ has evolved the theory for electric stimulus, that the primary effect produced by the electric current is an alteration in the ion concentration on the surface of the living substance. In fact, we know that the surfaces of all protoplasm possess the property of semi-permeable membranes and that changes in the concentration of ions invariably occur when an electric current flows through two electrolytes separated by a semi-permeable membrane, in which the anions and cations have a different rapidity of movement. It is apparent, therefore, that such an alteration in the ion concentration must be followed by further chemical processes in the living substance. According to the theory of *Nernst* the first impetus for all further alterations, which the electrical stimulus brings about in the metabolism of rest, is the alteration in the concentration of the ions on both sides of the semi-permeable membrane, which represents the surface of the protoplasm. In view of the present findings of physical chemistry, objections can hardly be made to this theory of *Nernst's*. It is a question, however, in how far this theory, especially established for the *electric* stimuli, can be applied to other

¹ *Nernst*: "Zur Theorie der electrischen Reizung." Nachrichten der Königl. Gesellsch. d. Wissensch. zu Göttingen. Math. physik. Klasse 1899.

forms of stimuli and their action. It cannot be denied that the degree of dissociation of an electrolyte can be altered by very different factors, such as heat, light, chemical processes, etc., and in that the surfaces of the protoplasm, acting as semi-permeable membranes, bring about a selective action on the passage of the ions, there arises the opportunity for the development of difference of electrical potential on both sides, and for further chemical alterations in the protoplasm. These observations, however, require further experimental investigations in many fields, before we are justified in extending the *Nernst* theory of the manner of action of the electric stimuli to a general explanation of the primary alterations produced by all stimuli in the living substance. For the present we must confine our observations to *those* alterations which are known to be responses to an exciting stimulus; these are the chemical alterations in the metabolism of rest in the living substance.

If it is asked, which members of the entire metabolic chain are increased primarily by the stimulating excitation of a vital system, we should not be able to answer this question generally for *all* living systems. To begin with, it appears highly probable that the various forms of vital substances in this respect act quite differently. It is to be regretted that, up to the present, this question has not been treated from a comparative standpoint. This inquiry should be extended to the greatest possible number of organisms. Still there is enough material at hand, obtained from the muscles, glands, ganglion cells, nerve fibers and plants, to show that the complexity is by no means so great as one might at first assume.

In considering the two stages of metabolism, assimilation and dissimilation, in their entirety, it appears as a very remarkable fact, that nearly all stimuli produce primarily a *dissimilative* excitation. We are only acquainted with a primary *assimilative* excitation, that is, an augmentation of the building up processes, in short, the *formation* of living substance, occurring as a primary result of stimulation, following increased introduction of *foodstuffs* extending over a prolonged length of time. With this exception it cannot be proved that *any* other stimuli,

either especially those operative in the activity of the animal organism or any of the physiological nerve impulses which regulate the actions of the different organs and tissues, bring about primarily an assimilative excitation, which leads to an increase of new formation of living substance. The much-discussed teaching of the existence of the trophic nerves has not given us a single case in which there was positive proof that a nerve impulse brought about a primarily assimilative excitation. I have endeavored for nearly fifteen years to discover such a case. My efforts have been, however, without avail. In the most recent critical review by *Jensen*¹ on the subject of the trophic nerves, the same conclusion is reached although certain facts, as, for instance, the excitation of assimilative processes in the green plant cell, produced by light, seems at the first glance to clearly demonstrate a primary excitation of the building up processes resulting from a stimulation. Nevertheless closer observation invariably shows that these conditions are much more complicated and that primarily assimilative exciting reaction of the stimulus cannot be conclusively shown. There remains, therefore, as a primary assimilative exciting stimulus only the increased introduction of nutrition in a living organism. This exciting effect on the assimilative portion of metabolism is, as we shall see later, a simple manifestation of the law of mass action.

As a result manifold effects of exciting stimulation, which seemed possible at a first glance, are already considerably restricted. The great mass of exciting stimuli produce an acceleration of the dissimilative processes of the metabolic chain. But here our former observations have already shown that certain constituent processes are especially responsive and very readily increase as a result of the most varied adequate and inadequate stimuli. These are the "*functional*" members of metabolism. These members are particularly labile, so that they are always affected by every influence to which the system is subjected in the form of a stimulus. The functional portion of metabolism of the muscle, which is particularly labile and is always primarily

¹ *Paul Jensen*: "Das Problem der trophischen Nerven." Medicinisch-naturwissenschaftliches Archiv. Bd. II, 1910.

affected by stimulation, consists as demonstrated in increase of formation of carbon dioxide and water, and in the disintegration of the nitrogen-free groups. The innumerable observations on metabolism during the stage of the activity of the muscle, as those of *Hermann, v. Frey, Fletcher, Johannson, Thunberg*, and many others on the individual muscle, and those by *Voit, Fick* and *Wislicenus, Pflüger, Rubner, Zuntz, Lehmann* and *Hagemann, Bernstein* and *Löwy* and others on the muscle of the entire organisms, have sufficiently proved this fact. However, we should not apply in detail the conditions existing in the *muscle* to *all* living substance. Comparative methods show us, rather, that the functional portion of metabolism is very differently involved in various forms of living substance. The formation of carbon dioxide and water is constant in nearly all forms of living substance. We must, however, exclude certain micro-organisms, which have adapted themselves to unusual vital conditions. Further, there appear in some forms manifold special constituent processes consisting in a disintegration of living substance which are in part converted into very complex combinations. In the gland cells this type is represented in an especially high degree. Here the functional disintegration leads to excretion of proteins, glycoproteins, nucleoproteins, cholic acid, enzymes of various kinds, all of which are complex and at the same time nitrogenous organic combinations. This fact must not be lost sight of. The origin of these special members, however, for the present is completely unknown, while on the other hand, it is self-evident that the general and constant constituents of the process of excitation must claim a first place in our interest. It is just at this point, therefore, that we must endeavor to penetrate somewhat more deeply into the mechanism of the excitation process and analyze in greater detail the acceleration of the functional constituent parts of metabolism produced by the stimulus bringing about the formation of carbon dioxide and water.

The question arises: *By what means is the particular labile state of just this constituent part of functional metabolism conditioned?* The lability of the functional portion of metabolism, excited by the stimulus, resembles the processes in the disintegration of

explosive combinations. Iodide of nitrogen, for instance, in a manner similar to the living substance in the state of the metabolism of rest, constantly disintegrates even without the influence of an impact. The disintegration is suddenly enormously increased by the result of a jar. An explosion follows. In a like manner the functional metabolism of rest is explosively excited by the stimulus, the transformation of the energy involved likewise bears a similar relation.

In both instances the transformation of energy, *constant* in the resting state, is by the impact of the stimulus suddenly increased. The dynamic method of investigation of the excitation process with its physical indicators, forms, therefore, in many respects an excellent addition to the chemical analysis. A development, that is, exothermic formation, of energy can only occur in a chemical process when the chemical affinities which are to be combined are stronger than those which have been separated. When this process is brought about by a simple impact, the energy value of which bears no relation to that of the quantity of energy in the process itself and which occurs with explosive rapidity, then it can be simply a question of a liberation process, that is, a process by which the impact brought about a conversion of latent chemical energy into that of kinetic energy. The comparison of the functional excitation process with that of an explosion does not, therefore, consist in a merely superficial analogy, but is founded on the same dynamic principles.

When we study the chemical process which occurs in the explosive transformation of potential into kinetic energy we find two types of chemical processes. The first type includes the synthetic processes. For this, the synthesis of water from explosive gas may serve as a simple example. Here the weaker affinities in comparatively simple molecules ($H + H$ and $O + O$) are separated and stronger affinities are combined in the formation of more complicated molecules ($H + O + H$). The second type represents the process of cleavage. As example for the latter, the explosive disintegration of nitroglycerine may be quoted. Here the atoms, held together in a complex molecule by weaker affinities, are changed by transposition of nitroglycerine. For in-

stance, the hydrogen atoms loosely combined with carbon enter into strong combinations with oxygen and the oxygen loosely combined with the nitrogen enters into strong combination with carbon, so that water and carbon dioxide are formed and nitrogen and oxygen set free.

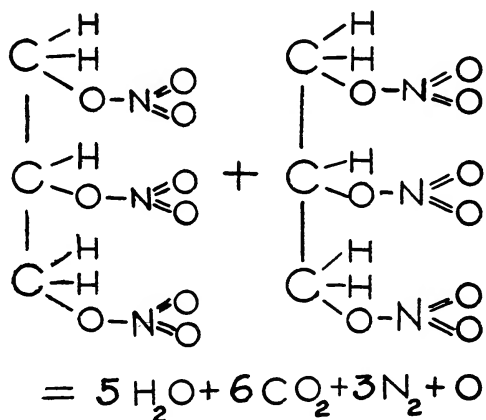

In the functional disintegration of living substance, the last type is realized. Living substance contains loose complex combinations, and we know that functional disintegration is accompanied by the consumption of these organic combinations. In the functional disintegration of muscle substance the nitrogen-free groups are concerned, and we must, consequently, first consider the carbohydrates. However, without further study we should not generalize from that which is true in the case of muscle. There are other forms of living substances which contain different combinations, which disintegrate as a result of the contact of a stimulus and yield carbon dioxide. A clue as to which combinations in individual cases undergo disintegration as a result of exciting stimulation, is furnished by the metabolism of rest in the particular substance. Plants and microorganisms have been investigated more thoroughly in this connection than animals. Plant physiology has demonstrated that

the material employed for the CO_2 formation and with it the production of energy is carbohydrate, but that, on the other hand, various plant organisms and protistæ also use a quantity of other substances, such as fats and protein, indeed even such comparatively simple organic combinations as alcohol, formic acid and methan. It may be accepted that in all these various instances of excitation of the functional metabolism as a result of stimulation, the specific respiratory material of the substance concerned is used in greater amount in the decomposition and likewise invariably yields carbon dioxide.

The point of most essential interest for the analysis of the excitation processes is, above all, the *mechanism* of the organic combustion and the associated energy production. Here we may base our observations on the disintegration of carbohydrates, which is most extensive in the animal as well as in the vegetable kingdom. We may now ask how dextrose, for instance, disintegrates in the living system into carbon dioxide, for it is this, or a sugar of similar chemical nature, which is generally concerned. Plant physiology, which here, as in many other respects, is in advance of animal physiology, has indicated two ways by which this can be accomplished in the living substance. One is oxydative, the other, *anoxydative* disintegration.

In the *oxydative disintegration* of dextrose, taking place in aërobic organisms, if sufficient quantities of oxygen are present, there occurs a splitting up of the carbohydrate molecule, as a result of the introduction of oxygen, into simpler substances and finally into carbon dioxide and water, just as the dextrose molecule, when subjected to oxydative processes, is split up into simpler molecules. In the living substance the oxydases play the important rôle of oxygen carriers. It cannot be denied, however, that up to now no carbohydrate splitting oxydases have been obtained from living substance. This, of course, does not prove its nonexistence. But this deserves consideration in connection with an assumption very widely spread among plant physiologists in regard to the aërobic disintegration of the carbohydrate molecule, which I shall touch upon presently. If we suppose that oxydases exist, which bring about primarily the oxydative disin-

tegration of the dextrose molecule, its first point of attack must obviously be sought in the aldehyd group. Here would be situated the activator, as it were, for the whole carbon chain, from which, as by a spark, the entire series of links would be ignited.

In an *anoxydative disintegration* of dextrose as observed in anaërobic as well as in aërobic organisms, provided the latter have an insufficient supply of oxygen, the dextrose molecule, by enzymic action as a result of the splitting off of carbon dioxide, is converted into substances having a comparatively large carbon content. The best-known example of this anoxydative disintegration is the formation of alcohol by fermentation in which the dextrose molecule is split up by the yeast into alcohol and carbon dioxide. ($C_6H_{12}O_6 = 2C_2H_5OH + 2CO_2$.) Instead of the production of alcohol and CO_2 we may have other enzymic actions with the formation of other carbon-containing disintegration products, such as lactic acid, fatty acids, hydrogen, etc. Of course in such an anoxydative disintegration, which does not lead to the formation of such simple combinations as carbon dioxide and water, the *quantity* of energy set free is much less in amount than in complete *oxydative* decomposition, the energy production of the alcohol fermentation being only 11 per cent of the latter. In order to produce the same amount of energy as in the former, a much greater number of molecules is required. We find, therefore, that the anoxydative type of disintegration develops either only where the respiratory substances are present in sufficient amounts, as for instance, in the case of yeast cells, existing in nutritive solutions rich in sugar; or where the chemical and energy transformations occur only to a limited extent, as, for example, in the presence of low temperature. In this respect *Pütter*¹ has demonstrated in the leech that at a higher temperature, the oxydative, at a lower, the anoxydative, decomposition predominates. These are important facts in that they show us the superiority of oxydative to that of the anoxydative disintegration in the cell economy. This is of particular interest when we consider those organisms in which great demands are made

1 A. Pütter: "Der Stoffwechsel des Blutegels (*Hirudo medicinalis* L)." I Theil. Zeitschrift für allgemeine Physiologie Bd. VI, 1907. II Theil. ebenda Bd. VII, 1908.

upon the capability of movement, above all, in homothermous forms, the metabolism of which takes place on a continuously high level. For this reason, in homothermous animals the respiration of oxygen is the almost exclusive source of energy production.

The previously mentioned facts make it clear that in one and the same form of living substance both oxydative and anoxydative decomposition processes are found, depending upon the conditions. This does not apply merely to the individual organic forms, such as the facultative anaërobic organisms, but generally to all aërobic living substance. If oxygen is withdrawn from an aërobic organism the disintegration does not cease in consequence. In place of the oxydative we have anoxydative decomposition. The various aërobic organisms are, however, adapted in very different degrees to the possibility of an anaërobic existence. While the facultative anaërobic organisms can continue to exist without oxygen, the homothermous animals become asphyxiated in a very short time in the absence of oxygen, in that they are poisoned by the products of the anoxydative decomposition, which are eliminated with much more difficulty than carbon dioxide and water. The fact, however, that disintegration also continues in an anoxydative form, if oxygen is withdrawn, has given rise to the thought, which has been accepted especially by plant physiologists with great readiness, that the decomposition of organic respiratory substances of the aërobic organisms invariably takes place in two stages; in that the dextrose molecule—to again use this as an example—is split up first by an enzyme into larger fragments, which then in the second stage of the process undergo combustion to the formation of carbon dioxide and water. Such a possibility cannot be repudiated. I wish, however, to state that one should be very reluctant in generalization of this assumption for all aërobic organisms. The types of metabolism in the different organisms are so manifold and of such immense variety that we should be very careful in our generalizations before being in possession of material extending over a great number of groups of organisms. Above all, it does not seem justifiable to also accept this type for life existing at higher

temperatures, and still less to apply it to those instances in which the production of energy following stimulation is suddenly increased to great amounts. Let us suppose that the disintegration process occurs in two phases, the first of which after the type of the fermentation of dextrose separates the molecule into larger fragments, while in the second phase these fragments are split up through oxydation into the formation of carbon dioxide and water. We can then say with certainty that in the first stage only a comparatively *small* amount of energy production occurs, for energy production by enzymic processes of this kind is never great; the second phase, on the other hand, must be associated with a very considerable energy production, for by the addition of oxygen and the formation of carbon dioxide and water the strongest affinities possible are combined. With this assumption in certain cases, as, for instance, in the sudden production of energy in muscle contraction, which necessarily occurs in the purely oxydative phase of the whole process, the view is forced upon us, that, in these cases, the entrance of oxygen into the molecule from the very beginning, even the first impact, produces oxydative decomposition of the whole molecule. The view that, in the reactions of warm-blooded animals, which occur with great rapidity and considerable energy production, the oxygen primarily explosively breaks up the whole carbon chain, certainly presents no more difficulties than the supposition that the simpler substances are attacked secondarily, provided sufficient oxygen be present. This method would be obviously the simplest. This is, however, mere speculation and a definite decision between the two possibilities cannot be made at present. However, whether the process takes place in two phases, an anoxydative and an oxydative, or simply in an oxydative phase, in *any case, the sudden discharge of energy in the aërobic organism set free by the stimulus, is brought about by the addition of oxygen.*

This is a highly important fact and as such requires the most thorough confirmation, and is best accomplished by the investigation of the state of excitation of aërobic substances on the withdrawal of oxygen. Experience gained by observation in this respect on a great number of living substances shows that exci-

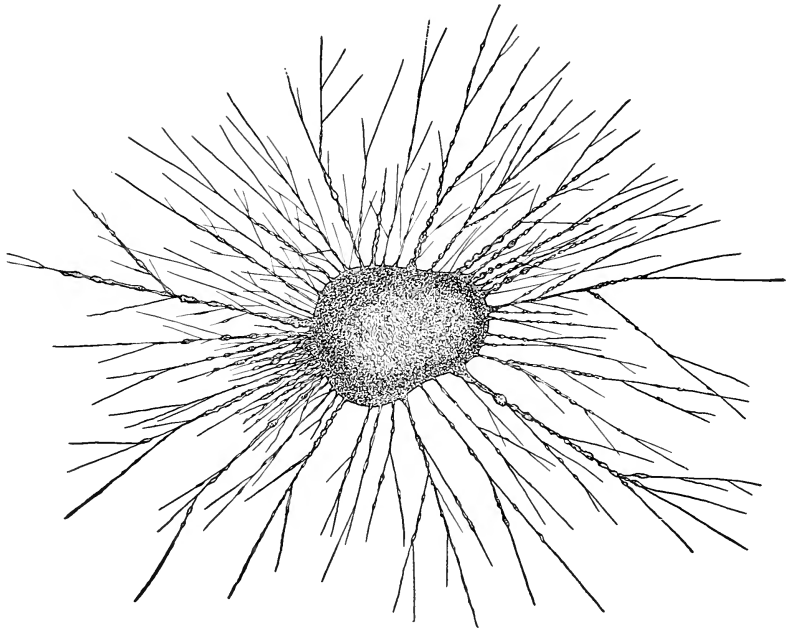

A

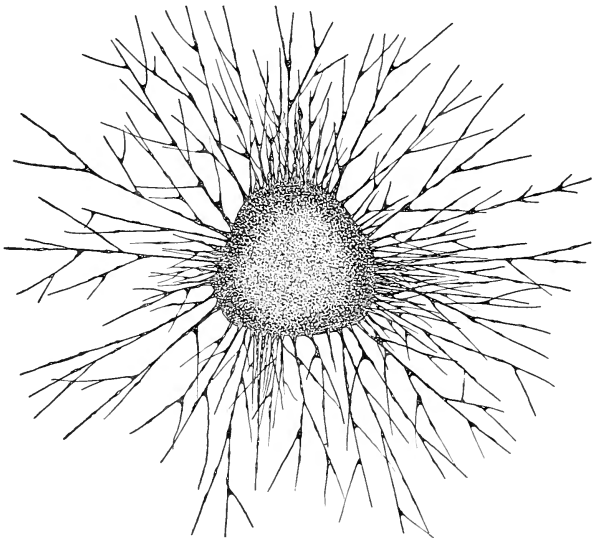

B

Fig. 10.

Rhizoplasma kaiseri. A—Under normal conditions.
B—In an atmosphere of pure hydrogen.

tability decreases upon the withdrawal of oxygen. In this connection I should like to cite some particularly significant instances.

During a sojourn at the Red Sea in 1894-95 I was able to establish this dependence in the single-celled organism, the *Rhizoplasma Kaiseri*, a large naked orange-colored rhizopod. (Figure 10, A.) Mechanical stimulation, which under normal vital conditions of these organisms brings about contraction in the long-branched pseudopods, becomes ineffective with a cessation of the movement of protoplasm, when oxygen is removed and is replaced by a stream of hydrogen. (Figure 10, B.) With renewed introduction of oxygen there is a return of the protoplasmic movement and entire recovery takes place.

This dependence of irritability upon oxygen is most clearly demonstrated in the *nerve centers*. For this purpose I have employed the spinal cord of the frog.¹ A canula is introduced and fixed into the aorta of the animal and the blood is replaced by a current of oxygen-free saline solution. The centers of the spinal cord are thereby wholly isolated from the supply of oxygen. The indicator for the irritability here used is reflex excitation from the skin to the gastrocnemius, or better, stimulation of the central stump of the sciatic nerve with single induction shocks, bringing about reflex response of the triceps. The reflex may be considerably augmented by increasing the reflex excitability of the spinal cord by poisoning the animal with strychnine. On testing the reflex excitability at the beginning of the experiment it will be found that the reaction to each individual stimulus consists, in consequence of the strychnine poisoning, of a long-continued maximal tetanus. The longer the deficiency of oxygen continues, the briefer become the tetanic reflex contractions following a single stimulus. Soon reflex tetanic responses are merely short single contractions, which decrease more and more with the continuance of oxygen deficiency. Finally, the same stimuli which previously produced strong tetanic contractions of long duration are altogether without effect. Although by

¹ *Max Verworn*: "Ermüdung Erschöpfung und Erholung der nervösen Centren des Rückenmarks. Ein Beitrag zur Kenntniss der Lebensvorgänge in den Neuronen." *Archiv. f. Anat. u. Physiologie. physiol. Abteil.* 1900 Suppl.

The same: "Ermüdung und Erholung." In *Berliner Klin. Wochenschrift* 1901.

increasing the intensity of stimulation brief contractions can again be brought about, irritability decreases more and more, until at last even the strongest stimuli remain without result. If the oxygen-free saline solution is now replaced by one saturated with oxygen, or blood of the ox, rendered arterial, the excitability returns within a few minutes and soon reaches the maximal height which it possessed under the influence of the strychnine poison. Even the weakest single stimuli now again produce tetanus. The same process reoccurs, if the fluid used for transfusion containing oxygen is again replaced by an oxygen-free saline solution. In this way, by repeated change of the perfusing fluid, we can demonstrate in the most positive manner this alteration in irritability, the result of the alternate presence and removal of oxygen. This is perhaps the best example of the close dependence of irritability on oxygen.

This same fact can be observed with equal clearness in the nerve. At my suggestion *H. v. Baeyer*¹ showed as the result of investigations made in the Göttingen laboratory the dependence of irritability of the nerve upon oxygen for the first time. By employing as the method the ascertainment of the threshold of stimulation I then made a closer study of the alterations in irritability during asphyxiation. These observations were soon after continued by *Fröhlich*.² The method is as follows: the nerve of a nerve-muscle preparation of the frog is drawn through a glass chamber which is made completely air-tight and containing platinum electrodes. The air in the chamber is then displaced by a stream of pure nitrogen. (Figure 11.) On testing that part of the nerve situated within the glass chamber with single break induction shocks it can be observed that its irritability, measured by the threshold of stimulation for muscle contraction, decreases more and more, until after the lapse of some hours, the stimulation required is so strong as to reach the region of the "Stromschleifengrenze." If in place of the stream of nitrogen, air or pure oxygen is now allowed to flow through the chamber, the

1 *H. v. Baeyer*: "Das Sauerstoffbedürfniss des Nerven." *Zeitschrift f. allgemeine Physiologie* Bd. II, 1903.

2 *Fr. W. Fröhlich*: "Das Sauerstoffbedürfniss des Nerven." *Zeitschrift f. allgem. Physiologie* Bd. III, 1904.

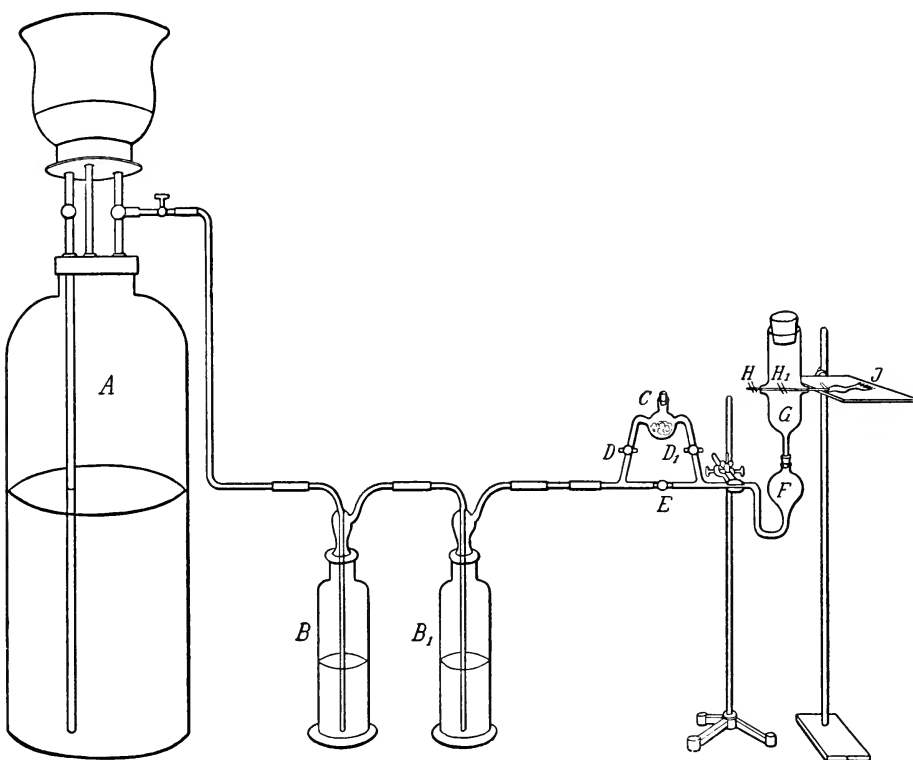

Fig. 11.

Arrangement for asphyxiating the nerve. A—Gasometer containing pure nitrogen. B and B₁—Vessels for washing the gas. C—Ether chamber for eventual experiments with narcosis. D, D₁ and E—Glass faucets. F—Moist chamber. G—Asphyxiation chamber. H and H₁—Two pairs of electrodes over which the nerve is laid. I—Nerve muscle preparation.

nerve recovers almost instantaneously. Within the space of a minute its irritability has risen again to its full height and the same experiment, with the same result, can be repeated. Finally, as *Fillié*¹ has shown, the like result is obtained when the nerve is asphyxiated in a fluid medium.

All these facts, the number of which indeed could be increased greatly for other aërobic forms, suffice to establish the fundamen-

¹ H. *Fillié*: "Studien über die Erstickung des Nerven in Flüssigkeiten." Zeitschrift f. allgemeine Physiologie, Bd. VIII, 1908.

tal importance of oxygen to the maintenance of irritability of living substance. *Oxygen is of greatest importance for a high degree of irritability in all aërobic organisms.* All living systems which are characterized by a great capability of activity and evince strong responses under the influence of stimulation, such as the vertebrates and insects, are necessarily aërobic, whereas the living organisms of pronounced anaërobic character, as some bacteria, yeast cells, parasitic organisms, etc., manifest on the average much less capability of activity.

Finally, to briefly summarize the foregoing, the following picture presents itself of disintegration produced by a momentarily acting stimulus. It is immaterial how the stimulus produces an exciting effect in the given case, whether through changes in the ion concentration of the living system, by increase of intramolecular atomic movement or in any other manner, it invariably accelerates the disintegration of the complex molecules concerned in functional metabolism, the nature of which varies in the special cases. In the great majority of instances nitrogen-free organic combinations serve as material for the functional constituent members of metabolic processes. In the anaërobic organisms this decomposition takes place anoxydatively with the coöperation of enzymic processes, and as larger fragments generally result from the disintegration of the complex molecule, the production of energy is accordingly smaller. The disintegration of aërobic organisms, on the other hand, occurs in the form of an oxydative splitting up of the complex molecules into carbon dioxide and water so that the production of energy attains a high value. The details concerning the manner in which the individual stages of this decomposition take place and the interactions by which its end products are reached is at present beyond our knowledge. It would be a mistake to generalize in this connection from the behavior of certain groups of organisms. The assumption that under certain conditions the disintegration occurs in two phases, the splitting up resulting from enzymic action of the complex molecule into larger fragments, followed by an oxydative splitting up of these into carbon dioxide and water, can in no case as yet be justifiably applied to

all conditions and all aërobie organisms. This is more or less the impression which we derive of the functional excitation process as seen today.

Under normal conditions the functional excitation is at once followed by a succession of secondary processes, the "*self-regulation of metabolism*." Self-regulation after a functional excitation is a fact demonstrated by experience. But in what manner does it take place in detail?

As the functional constituent members of metabolism involve a disintegration of the nitrogen-free atom groups, the functional self-regulation must necessarily furnish in sufficient quantity and in proper form the carbon, hydrogen and oxygen atoms, which have been removed in the production of carbon dioxide and water. This is accomplished, as is well known, by the food and the intake of oxygen. It is of importance to the maintenance of living substance that after every functional activity it is as soon as possible again capable of reaction. Therefore, it is absolutely necessary that this material is in the proper place, where building up is essential, and is at the same time constantly in proper form. Indeed, the restitution of the original state follows under favorable conditions with lightning rapidity, although varying in different forms of living substance. This occurs in the nerve in an extremely short time. From this it might be supposed that the living system by accumulating a store of the necessary compensation substances in suitable form, had made itself independent to a certain degree of the frequently varying supply of material obtained from the medium.

This may be held as the proper view, first with regard to compensation substances. The fact that living organisms can under some conditions remain for a lengthened period in a state of starvation, without losing their capability of activity, can only be explained by the presence of a great quantity of reserve supplies of compensation substances. In the course of work in the laboratory every physiologist has become acquainted with the fact that frogs which have been kept without food for a year, although much reduced in weight, are still capable of some muscular activity.

Organs and tissue, which are cut off from all food supply through the blood and lymph, may remain active for many hours. *H. v. Baeyer*¹ has shown that the ganglion cells in the frog, in which saline solution was transfused at room temperature and

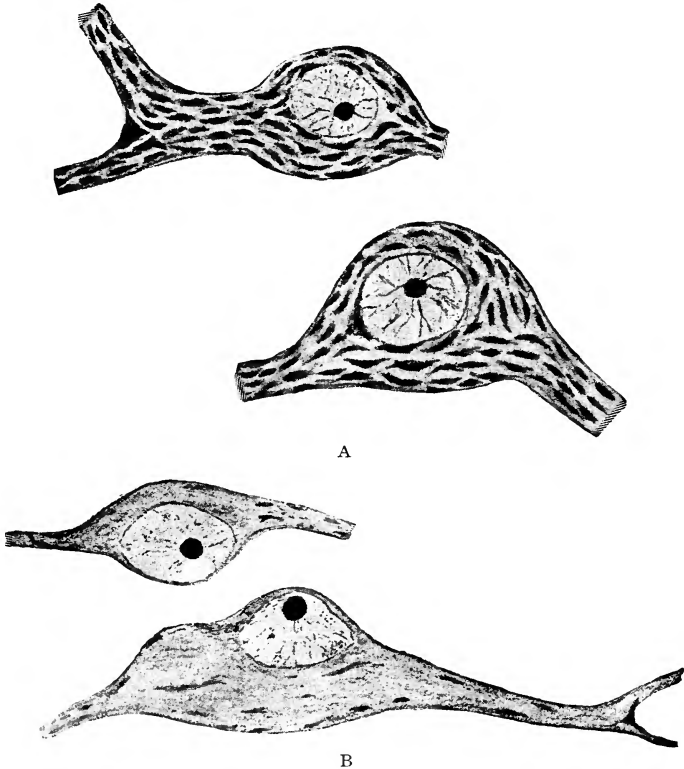

Fig. 12.

Motor ganglia cells from the spinal cord of the frog. A—In normal state.
B—After an asphyxiation lasting 8 to 9 hours. (After *Gordon Holmes*.)

containing no trace of organic substances and where irritability has been increased to the maximal by means of strychnine, were capable of strenuous work for nine or ten hours before losing

¹ *H. v. Baeyer*: "Zur Kenntniss des Stoffwechsels in den nervösen Centren." *Zeitschr. f. allgem. Physiol.* Bd. I, 1902.

responsivity. The nerves and muscles of the animal retain their excitability for even a longer period under the same conditions. Indeed, we have histological evidence of the existence of organic reserve material in the various cells in the form of embedded bodies in the protoplasm. As for instance the disappearance of the *Nissl* granules in the ganglion cells following great activity,¹ (Figure 12), or that of the granules in infusoria cells during starvation.² (Figure 13.) We assume that a certain amount of

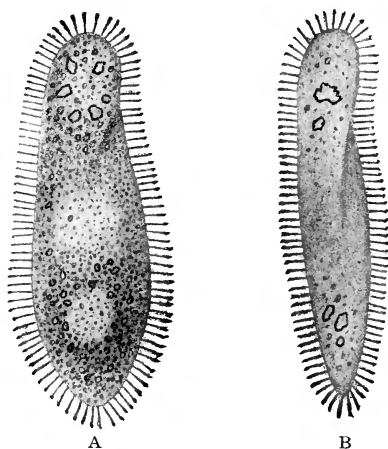

Fig. 13.

Paramecium aurelia. A—In normal state. B—In a state of starvation.

organic foodstuffs in a state properly prepared is present in the cell. As the amount of these prepared substances is consumed, new quantities of stores, having undergone various preparatory processes, among which the enzymic actions may be considered to play a chief rôle, are brought into that form in which they appear suited to fill the gap produced by disintegration. Plant physiologists in particular have here again furnished us with some

¹ *Gustav Mann*: "Histological changes induced in sympathetic motor and sensory nerve cells by functional activity." In *Journ. of Anat. and Physiol.* 1894. Further: *Gordon Holmes*: "On morphological changes in exhausted ganglion cells." *Zeitschrift f. allgem. Physiol.* Bd. II, 1903.

² *Wallengren*: "Inanitionserscheinungen der Zelle." *Zeitschrift f. allgem. Physiol.* Bd. I, 1902.

essential data for the assumption of the existence of such processes which regulate the transformation of reserve substances as well as its extent. *Pfeffer*¹ has found in several fungi and bacteria that there exists a compensation between the diastatic breaking down of the carbohydrates stored as reserve material and the quantity of dextrose introduced. He further found that the more the reserve substance is split up into dextrose the less of the latter is introduced from without and *vice versa*. *De Bary*² some time ago also observed in the *bacillus amylobacter* an analogous relation between the enzymatic cellular digestion and the quantity of dextrose introduced with the food. An equilibrium, therefore, exists between the required amount of dextrose and the extent of enzymic splitting up processes of the reserve material. A great number of similar processes have been observed. Even though the details of the whole preparatory assimilative processes are beyond our knowledge we can still say with certainty that, on the one hand, everywhere great quantities of organic reserve substances are always present in the cell, and on the other, that these substances are subjected to a transformation into suitable material for building-up processes, the extent of which is controlled according to need, by the processes of self-regulation.

Entirely different is the question if the cell also possesses a reserve store of oxygen. In this respect views have widely differed, and even today no conformity of opinions has been arrived at. The fact that many purely aërobic organisms and tissues can exist under complete exclusion of oxygen for a longer or shorter period, retaining their excitability and producing carbon dioxide, has for a long time led a great number of investigators, such as *Liebig*, *Matteucci*, *Engelmann*, *Pettenkofer* and *Voit*, *Claude Bernard*, *Verworn*, *H. v. Baeyer* and others, to the supposition that a reserve store of oxygen must exist in the living substance which maintains its excitability for a time. More recent information, however, of the transition of the oxydative to the anoxydative disintegration under a deficiency of oxygen,

1 *W. Pfeffer*: "Ueber die regulatorische Bildung von Diastase." In der math. phys. Klasse d. Königl. Sächs Ges. d. Wiss. zu Leipzig 1896.

2 *De Bary*: "Sur la fermentation de la cellulose." In Bull. de la Soc. bot. de France 1879.

as can be observed in plants and certain invertebrate animals, indicates that here also there is the possibility of another explanation of these facts. Various attempts have been made to solve the problem if reserve oxygen is present in the cell or not. The experiments of *Rosenthal*,¹ carried out with his respiration calorimeter, seemed to point directly to an oxygen reserve in the organism of the mammal. He observed that during respiration in an atmosphere rich in oxygen the respiratory quotient ($\text{CO}_2:\text{O}_2$) became lower than in ordinary air, that is, that oxygen, and that indeed in considerable quantity, must be retained in the organism. Nevertheless *Fallose*² found that when rabbits, which had been kept in an atmosphere containing 80 per cent of oxygen, were asphyxiated, the time necessary to produce death was no longer than in animals which had been kept previously in ordinary air. The correctness of the observations of *Rosenthal* have been disputed by *Durig*.³ *Winterstein*⁴ also, employing the microrespiration methods of *Thunberg* upon the spinal cord of the frog, believed that he had found proof that an oxygen reserve cannot take place. He reasoned thus: If the cells of the spinal cord contain reserve oxygen, which is used up when pure nitrogen only is breathed, then it necessarily follows that after reintroduction of oxygen, following asphyxiation, a definite quantity must be stored up again as reserve. In consequence, the respiratory quotient following the intake of oxygen after asphyxiation should be smaller than when the animal is in air. He found, however, that the respiratory quotient does not essentially change and concluded from this that storage of oxygen does not take place. In these experiments, however, there exists no certain indicator as to the state of the spinal cord during asphyxiation and recovery in the given case. The spinal cord may be severely injured and

1 *Rosenthal*: "Untersuchungen über den respiratorischen Stoffwechsel." Arch. f. Anat. u. Physiologie physiolog. Abt. 1902 und Suppl. 1902.

2 *Fallose*: "Influence de la respiration d'une atmosphère suroxygénée sur l'absorption d'oxygène." Travaux du laborat. de physiol. de L. Frédéric Liège, T. VI.

3 *Durig*: "Ueber Aufnahme und Verbrauch von Sauerstoff bei Aenderung seines Partialdruckes in der Alveolarluft." Arch. f. Anat. u. Physiologie physiolog. Abt. 1903 Suppl.

4 *Winterstein*: "Ueber den Mechanismus der Gewebeatmung." Zeitschr. f. allgem. Physiol. Bd. VI, 1907.

even undergo degeneration during asphyxiation, and the recovery following the reintroduction of oxygen may be either incomplete or nil, without there being a method for its determination. Apart from this, *Lesser*¹ has already emphasized, in opposition to these experiments, that the respiratory quotient in recovery is no criterion to guide us. It is immaterial whether during asphyxiation oxygen respiration occurs following a reserve supply, or that an anoxydative formation of carbon dioxide has taken place, for in both instances the respiratory quotient would be less *after* asphyxiation when there is again an oxygen supply. It is, therefore, quite impossible to decide the question by the employment of this method. For this reason *Lesser* has attempted to solve the problem by means of quite another method, and was convinced that he had refuted finally the belief in the existence of reserve oxygen. His method consists in the employment of the *Bunsen* ice calorimeter, by which he determines the heat production of frogs, kept first in air, then in nitrogen, and at the end of each experiment ascertaining the amount of output of carbon dioxide, respectively in air and nitrogen. He found that the quantity of heat, calculated in terms of 100 grms. body weight per hour, produced in nitrogen was considerably less than that under corresponding conditions in air, but that the production of carbon dioxide, on the other hand, during the first hours in nitrogen was doubled in amount, as compared to that in air. From this he concludes that the carbon dioxide formation in nitrogen must be different from that in air, as it is associated with a reduced heat production. In other words, carbon dioxide formation, while the animal is in a nitrogen atmosphere, does not have its origin in oxydative processes at the cost of stored up oxygen. I regret that I am unable to accept these arguments as conclusive evidence against the assumption of an oxygen reserve, as this question cannot be decided by the use of such methods. *Lesser* does not measure the amount of carbon dioxide until the end of his experiments, that is, he learns merely the

¹ *Lesser*: "Die Wärmeabgabe der Frösche in Luft und sauerstofffreien Medien. Ein experimenteller Beweis dass die CO₂ Production der Frösche im sauerstofffreien Raum nicht auf Kosten gespeicherten Sauerstoffs geschieht." Zeitschr. f. Biologie Bd. 51, 1908.

entire carbon dioxide production during a period of many hours. No conclusions can be drawn from this as to the conditions existing in the first period of time, directly after the animals have been subjected to an atmosphere of nitrogen. It is quite possible that subsequent to the change to nitrogen an oxydative carbon dioxide formation may have continued in decreasing degree, without this being shown in the final result. The problem of the existence of a reserve supply of oxygen is in no way solved by these experiments.

In assuming the presence of a reserve supply of oxygen in the cell we must above all entertain no false conception as to its amount. This must be, as I have often had occasion to emphasize, exceedingly small and in no way comparable with the great masses of organic reserve substances contained in the cell. The assumption, especially for the *nerve centers* of the frog, that the excitability remains after complete exclusion of oxygen must be looked upon as demonstrating a reserve supply of oxygen, would oblige one to suppose the presence of such a small store of oxygen that it would be completely exhausted by continued activity in room temperature within ten to twenty-five minutes. Strychninized frogs, in which the blood has been replaced by an oxygen-free saline solution, lose, as I have shown,¹ their excitability completely within ten to twenty-five minutes after the blood has been displaced. Nevertheless the assumption of the existence of a small oxygen supply in the cell can hardly be evaded. It must not be imagined that the moment the blood of the frog has been replaced with an oxygen-free solution, there is not a trace of oxygen left in the organism. Were such the case, the irritability, if measured by the extent of the response, would sink *momentarily* to a very low level, for the anoxydative disintegration processes are associated with an incomparably smaller production of energy than those of oxydative disintegration. We see, however, that the irritability in the muscles, nerves and nerve centers of the frog even after the complete withdrawal of oxygen at first remains practically at the former height and only very gradually

¹ *Max Verworn*: "Ermüdung, Erschöpfung und Erholung der nervösen Centra des Rückenmarks." Arch. f. Anat. u. Physiol. physiol. Abt. Suppl. 1900.

decreases. Above all it would seem to me to be in the interest of the preservation of the organism and especially of those parts in which there is a high energy production and particularly those substances in which energy production predominates, that the material necessary for its formation is always at its disposal in sufficient quantity. Otherwise the capability of action of the organism would be impaired at every moment or at least suffer great fluctuations.

In accordance with this we must suppose that under physiological conditions all those substances required to replace the disintegrated molecules are always present in the cell in sufficient quantity and suitable form to replace at once those lost by excitation. Further, without doubt, in the organism which is always aërobie, oxygen must be present in certain quantities to assure at any moment oxygen replacement following oxydative disintegration, to guarantee sufficient amount for succeeding stimulation.

A further question arises: How is it that the material lost in disintegration is always replaced in just sufficient quantity to establish the metabolic equilibrium? In short, how are we to understand in a mechanical sense the self-regulation of metabolism?

In the preservation of metabolic equilibrium, we have a process before us, the principle of which is nowadays restricted to living substance. In my "Biogen hypothesis,"¹ I have associated the self-regulation of metabolism with the chemical equilibrium in interreacting masses. I have considered the metabolic self-regulation as the expression of the formation of a mass equilibrium between the quantity of foodstuffs and the quantity of a hypothetical combination of living substance, the *biogen*, which continuously disintegrates and builds up again of its own accord. In fact, however, we have in the chemical equilibrium of reacting mixtures in the non-living world, a principle which is completely analogous to the self-regulation in living substance. The chemical facts are, indeed, well known. If we take the classical example of the formation of ethylacetat from acetic acid and alcohol,

¹ *Max Verworn*: "Die Biogenhypothese." Jena 1903. Compare also *Max Verworn*: *Allgemeine Physiologie* V. Aufl. Jena 1909.

we have a case of an inanimate system, in which the amounts of the reacting substances are in constant equilibrium. The reaction following the mixture of equal amounts of alcohol and acetic acid is as follows:

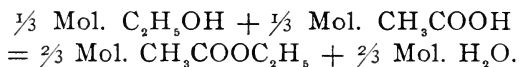

In this reaction there is an alteration only in the absolute quantity of the individual constituents but never in the relative amount. In the living system we have a completely analogous instance, which apart from its course differs from the inanimate example merely in the following points: In the first place, certain quantities of substances reacting on each other are continually introduced into and certain reaction products continually removed from the living system. Secondly, the reacting mixture of the living substance is not homogeneous, and at the same time is more complicated than that of the inanimate example. Thirdly, the sum total of the reaction is not reversible in its entirety. The question arises, should any essential difference between metabolic self-regulation and the maintenance of chemical equilibrium be assumed upon this statement? I must confess that this does not appear to me to be the case. The fact that organisms exist in a stream of substances by which their nutrition is introduced and the metabolic products removed, cannot have any influence on the state of equilibrium so long as the conditions are again and again replaced in the same manner. The equilibrium can only be influenced when the introduction of foodstuffs or the output of metabolic products is changed in value. Then they occur as the inanimate example, when various amounts of material are brought together. A new equilibrium takes place, having a higher or a lower mass level. This is also true in the living substance, in growth and in atrophy. The equilibrium is disturbed as happens in the inanimate reacting mixture, where different quantities of reacting substances are brought together. In both instances we have in principle a conformity of behavior of the inanimate and the living system. Secondly, as far as the greater complexity and inhomogeneity of the living reacting mix-

ture is concerned, it is self-evident that this likewise does not constitute an essential difference, for we are acquainted with conditions of equilibrium in chemical reactions possessing a number of members and in inhomogeneous mixtures. Finally, the fact that the reaction in the living system is not totally reversible, forms no barrier to the assumption in principle of metabolic self-regulation as a chemical equilibrium. It is quite possible to conceive of a chemical equilibrium in a reacting mixture, of which only certain constituent processes are reversible, without the totality of the reactions as a whole being necessarily so. Let us assume, by way of example, that the assimilative processes of the metabolic chain are reversible, then under constant quantitative relations of foodstuffs, following every disintegration of assimilative products with removal of the decomposition products, the same amount of assimilatory processes is required for building up. And this is just that which we observe in metabolic equilibrium. Accordingly, we may look upon the metabolic equilibrium as a special, although a very highly complicated, instance of chemical equilibrium, and we may explain the metabolic self-regulation following a dissimilative excitation of the same, by those principles on which the rebuilding of chemical equilibrium is founded. It is true that the special details of this process can be differentiated in only that degree in which it is possible to penetrate at all into the details of metabolism of the given cell form. In this, as is well known, the advance is extremely slow.

The rebuilding process following decomposition of living substance in response to an exciting stimulus consists not merely in compensation for the decomposed atom groups but also in the removal of disintegration products. This removal can be accomplished, in so far as simple chemical substances such as carbon dioxide and water are concerned, by diffusion. Observations have shown that the semi-permeable protoplasm surface is pervious to water and carbon dioxide. The latter can, therefore, depending upon the amount of concentration, be eliminated from the living substance. Output of water likewise takes place in so far as the specific water content of the living substance is exceeded and which is osmotically regulated by its amount of salt

content. When, finally, osmotic pressure within the living cell and in the surrounding medium is equal, the interchange of water ceases. All these processes are explained by diffusion. Self-regulation takes place in this regard simply by osmotic means. The conditions in respect to those decomposition products consisting in more complicated organic combinations, such as lactic acid, fatty acids and nitrogen derivatives of protein disintegration, are somewhat different in that the protoplasm surface possesses the property of hindering the passage of these substances into the medium. These are, as is well known, first transformed by secondary chemical processes into transfusable substances. In this transference the oxydative decomposition with the formation of simpler substances plays the most important rôle, so that the substances thereby formed, namely, carbon dioxide, water and ammonia, are osmotically eliminated as the result of the selective permeability of the surface of the protoplasm. In this way the living cell rids itself of the useless products of metabolism.

Finally, the question remains, is the original state, as it existed before the influence of the stimulus, really completely recovered by metabolic self-regulation, or does even individual excitation of brief duration produce a continued change in the protoplasm? It is quite impossible to prove that such an effect follows the momentarily acting single stimulus, if stimulation has not exceeded the physiological limits of intensity. Should it exist, it must be imperceptible. Nevertheless, it ought to be possible by frequently repeated application of the stimulus to increase this which is imperceptible to an extent in which it is perceptible. This is, indeed, the case and is manifested as we have already seen in the increase of the volume of living substance by frequently recurring functional excitation. We can, therefore, assume with great probability that even the momentarily acting individual stimulus produces, although not perceptible *per se*, lasting effect in the cell. The functional excitation must be followed secondarily by an increase of the assimilative phase of the entire cytoplasmic metabolism. Otherwise the taking place of the increase of volume of the living system following frequent excitation of the functional constituent members of metabolism, is

unintelligible. But how are we to interpret these secondary results from a physical standpoint? First of all, it must be stated that we do not know of such hypertrophy following activity in unicellular organisms, but only in the tissues and organs of multicellular forms, in muscles, nerve cells, glands, etc. In the cell community of the vertebrates, however, the studies on the relations between activity and the blood supply of the particular tissue or organ furnish a physical interpretation for the existence of the functional hypertrophy. The active portions show a dilation of the blood vessels, therefore an increased supply of blood and consequently an increase in the circulation of lymph. In other words: the supply of nourishment to the individual cell and the removal of the metabolic products in a unit of time is increased. The preceding discussion of the dependence of the conditions of equilibrium upon the quantitative relations of the reacting substances makes it clear that under these conditions a metabolic equilibrium on a higher quantitative level must occur; that is, the living substance must increase in amount just as in the inanimate example the absolute amount of the æthylacetat increases if more alcohol and acetic acid are introduced to an equal degree. Some time ago¹ I expressed the opinion that the increase of the blood supply in a functionally active organ must be based on a physical self-regulation, which takes place as a result of the fact that metabolic products of the tissue cells influence the cells of the vessel walls in that part, so that the vessels dilate and more lymph is formed. In the meantime this has been proved to be indeed the case. *Schwarz und Lemberger*² and *Ishikawa*³ have shown that especially the weak acids, which are produced in larger amount as a result of strong activity of the cells, bring about vessels' dilation. By the demonstration of this highly important process of self-regulation the last link has been added for the physical understanding of the hypertrophy of activity of the tissue cells by continued functional excitation.

1 *Max Verworn*: "Die cellularphysiologische Grundlage des Gedächtnisses." Zeitschr. f. allgem. Physiol. Bd. VI, 1907.

2 *Schwarz und Lemberger*: "Über die Wirkung Kleinster Säuremengen auf die Blutgefäße." Pflügers Arch. Bd. 141, 1911.

3 These investigations have not yet been published.

Whether or not the same applies to the single living cell, if the unicellular organism likewise undergoes a quantitative increase by a continuous functional excitation, and if the single cell possesses in itself a corresponding mechanism of self-regulation similar to the cell community in the vertebrates, cannot be answered, for concerning all these problems information is lacking for the present.

CHAPTER VI

CONDUCTIVITY

Contents: Only processes of excitation are conducted, not processes of depression. Conduction of excitation in its two extreme instances. Conduction in undifferentiated pseudopod protoplasm of rhizopoda. Conduction of excitation with decrement of intensity and rapidity. Conduction of excitation in the nerve. Rapidity of conduction of excitation without decrement. Relation between irritability and conductivity. Conduction of excitation with decrement of the nerve after artificial depression of irritability by narcosis. Theory of the decrementless conduction of the normal nerve. Proof of the validity of the "all or none law" in the medullated nerve. Theory of the process of the conductivity of excitation. Theory of core model (Kernleiter). Electrochemical theory of conduction based on the properties of semi-permeable surfaces.

When the response to a stimulus is studied in a living system, whether it be a single cell, a tissue, or a complex organism, the indicator used, either that of movement, current of action, production of certain substances, the development of light, of heat or the alteration of form, is the result of two distinct processes. The first of these is primary excitation, brought about by the stimulus at a local point, and the second is an extension of the excitation to the surrounding tissue. We are not in a position to experimentally bring about a response to stimulation, in which the primary excitation occurs and not the secondary process, that of conductivity. All living substance contains this property, although to a very different degree, as all living substance possesses irritability, and this presents the condition not only for the taking place of the process of excitation but also that of its conduction.

If I here speak only specifically of the conduction of excitation instead of the conductivity of response to stimulation this is not

only primarily for the reason that we intend especially to analyze the conductivity of excitation on this occasion, but also because no other effects of stimulation except those of excitation can be conducted from the part affected by the stimulus to the surroundings.

Although considered on theoretical grounds it appears more or less improbable that depression is extended from the place of its origin, it is very easy to convince one's self experimentally of the fact that depression following a stimulus is invariably localized to that portion directly affected by the stimulus. The nerve furnishes a very favorable object for this purpose. If a nerve muscle preparation of the frog is made and introduced in the glass chamber previously described containing platinum electrodes, and another pair is applied to the nerve between the chamber and the muscle, it is possible to subject the stretch of nerve in the chamber to various agents, producing a paralyzing effect. In this way it may be exposed to an atmosphere of pure nitrogen for example, or to narcosis as by ether, chloroform, carbon dioxide and other gases, to an increase in temperature or to other agents, without these in any way affecting the irritability of the nerve stretch situated over the electrode between the chamber and the muscle. The contractions of the muscle, which are produced by stimulation of the periphery region of the nerve with stimuli of a definite strength, remain unaltered, even when the asphyxiated stretch of nerve in the chamber is already completely degenerated. The central depression of a ganglion cell of a motory neuron is likewise wholly without influence on the degree of excitability of its nerve fiber, as I was able to demonstrate¹ in the reflex inhibition of the motor neurons of the spinal cord of the dog. (Figure 14.) That which is conducted by the nerves is solely the process of excitation.

It is our task to analyze in detail the conditions involved in the conduction of excitation in order to obtain a deeper insight into the physics of this process. A comparative survey of a series of various types of living substance shows us that they differ in

¹ *Max Verworn*: "Zur Physiologie der nervösen Hemmungserscheinungen." Arch. f. Anat. u. Physiol. physiol. Abt. Suppl. 1900.

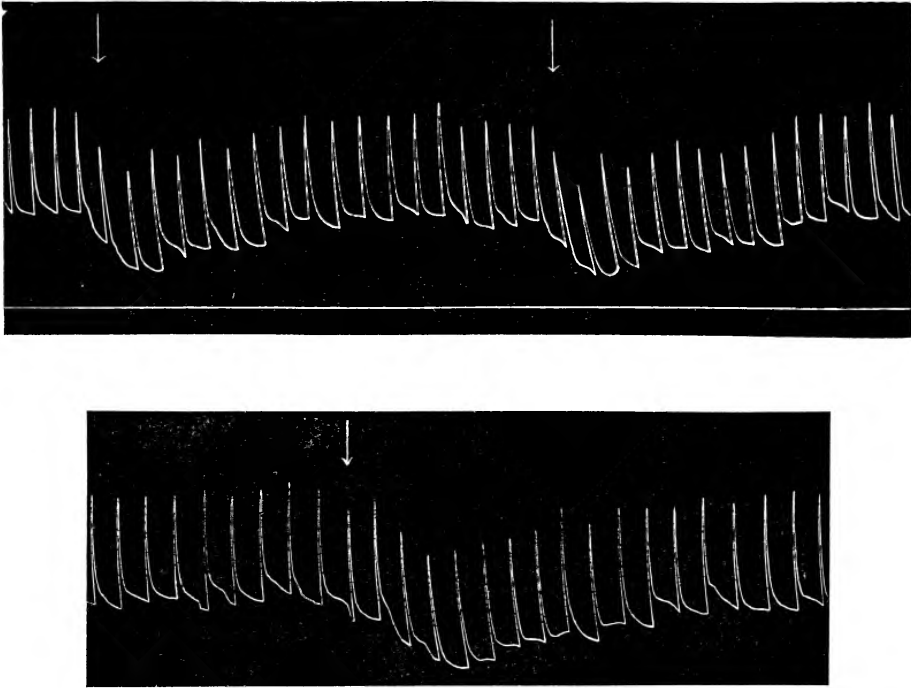

Fig. 14.

Contractions of the musculus extensor digitorum communis longus of the dog, brought about by rhythmic stimulation of the nervus peroneus. The muscle is in the condition of tonic excitation which proceeds from the center. The arrows indicate the point where reflex inhibition of the central tonus is produced. The height of the single contraction undergoes no diminution.

respect to the conduction of excitation in the following points: In regard to the rapidity with which the excitation is conducted, the extent of the area over which it spreads, and the intensity with which it extends. These conditions may be best illustrated by citing two extreme examples. The one is formed by the rhizopods, the other by the nerve fibers. Between these two extremes we have manifold gradations in the conditions of conductivity. Not all cell forms are suitable objects for the study of conductivity. There are forms of rhizopods which are as favorable to investigation as the nerve; this is due to the fact that,

although they are often of microscopic dimensions, they possess elongated fingerlike or threadlike pseudopods.

Indeed, a rhizopod cell, with its straight, elongated pseudopods, is preëminently fitted as an object of comparison with a neuron. Although the difference in respect to the individual points is so far-reaching, still, based on their outward morphological similarity various physiological parallels in both are forced on our observation. A comparison of the rhizopod cell with the neuron can consequently guard us from many erroneous generalizations which we might be inclined to deduce from a one-sided investigation of the nerve. This is especially the case in regard to the conductivity of excitation, which was formerly studied almost exclusively on the nerve and only occasionally on the muscle, which offers similar conditions. The nerve, in which the function of the conductivity of excitation is particularly highly developed, was considered at the same time as the type in which this process could be most readily analyzed, and from which it was believed general information of the process of the conductivity of excitation could first be gained. This view has led to serious errors, as the nerve, resulting from the high development of its conductive capability, shows quite one-sided specialized conditions, which can by no means be transferred to other forms of living substance.

A very suitable object among rhizopods for the study of conductivity, and which is everywhere easily procured, is *Diffugia*. This species living in small pools has a delicate urn-shaped, pear-shaped or flask-shaped capsule built up of sand grains, diatoms or material produced by the organism itself. From the opening the protoplasm extends often to a considerable length its finger-shaped hyaline pseudopods. When *Diffugia* is placed in a flat dish in water and observed under the microscope, it is frequently seen to extend from the opening long pseudopods in exactly opposite directions, which reach for a considerable distance on the bottom. These offer particularly favorable conditions for the study of the conduction of excitation. When this animal is placed under a microscope, the pseudopods are very readily stimulated at any position to a desired extent by means of a sharp

needle, to which fat has been previously applied and subsequently the excess removed. The extension of the response from one point toward the other can then be followed with great ease. The pseudopod of the rhizopod has the great advantage over the nerve that its excitation can be directly observed. The excitation following weaker stimulation is manifested by a wrinkling of the previously completely smooth surface; stronger stimulation produces differentiation of the hyaline protoplasm to a strongly refractive strand in the axis and a turbid myelinlike mass at the periphery, the pseudopod at the same time retracting toward the central cell body. In spite of all these occurrences being of microscopic dimensions, still with some practice it is quite possible to experiment on them under the microscope. In this way I found it comparatively simple to study the fundamental principles of conductivity.

All these factors, the intensity with which the excitation extends from the point of stimulation, the rapidity of the extension, and finally the area over which conduction takes place, are manifestations of the intensity of stimulus, and as such alter with these in corresponding manner. If the end of a pseudopod is barely touched and thereby weakly stimulated, the response is restricted to a slight wrinkling of the surface, which slowly extends to the immediate neighborhood, whilst the more distant parts of the pseudopod are not affected at all by the excitation. (Figure 15, A.) On a stronger stimulation of the pseudopod by slight pressure, the response is likewise stronger, and the characteristic differentiation of the protoplasm, consisting in the strongly refractive strand in the axis and the turbid myelinlike outer mass, appears at the point of stimulation. From here a peculiar alteration spreads gradually further over the pseudopod, in that first upon its smooth surface a few myelinlike droplets are seen, which become larger and with the development of the strand in the axis, dissolve into a wrinkled mass on the surface. The further this process extends from the point of stimulation, the weaker it becomes and the more slowly it proceeds, until at

¹ *Max Verworn*: "Psycho-physiologische Protistenstudien. Experimentelle Untersuchungen." Jena 1889.

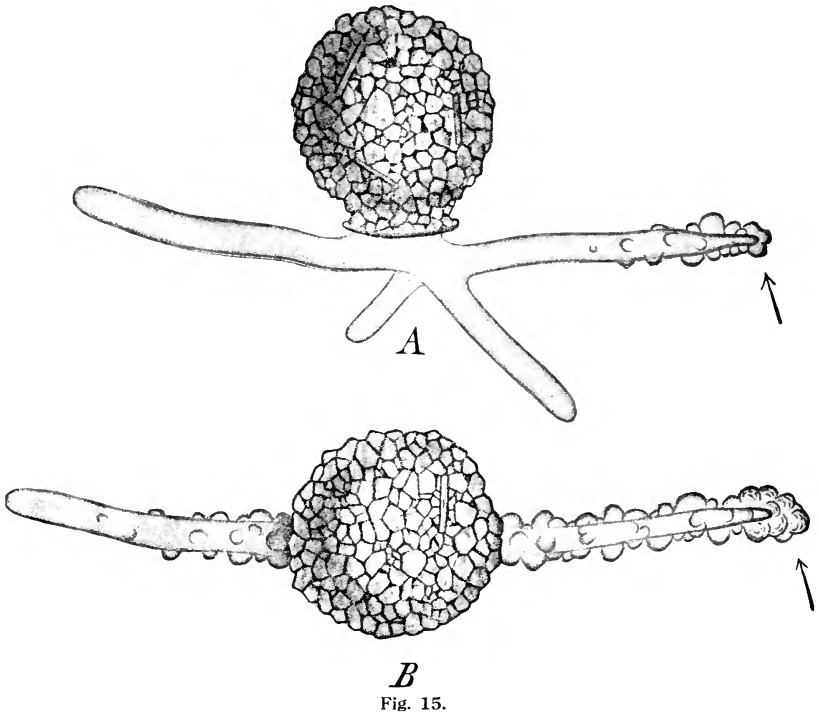

Fig. 15.

Diffugia urceolata. A—Weak local stimulation at the end of a long extended pseudopod.
 B—Stronger local stimulation applied to the end of a long pseudopod.

last there is complete disappearance. (Figure 15, B.) The pseudopod has at the same time retracted to a considerable degree. If a still stronger stimulus is applied by firm pressure at the end of the pseudopod the process takes place with much greater violence. The differentiation of the protoplasm spreads centripetally from the point of stimulation over the whole pseudopod with great rapidity, and produces a quick retraction in the same, then involves the oppositely directed pseudopod, in which it then extends more and more slowly, until, proceeding in a centrifugal direction, it is at last gradually completely obliterated. When strong stimulation is applied, the process occurs with such rapidity that the contraction of the pseudopod is almost twitchlike. As the rapidity of the conduction alters

within a wide limit according to the strength of the stimulus and the distance from the point of stimulation, it is self-evident that no constant figure can be stated. To give a general idea of the rapidity, they might be estimated according to observations I have made with second watch and ocular-micrometer as from

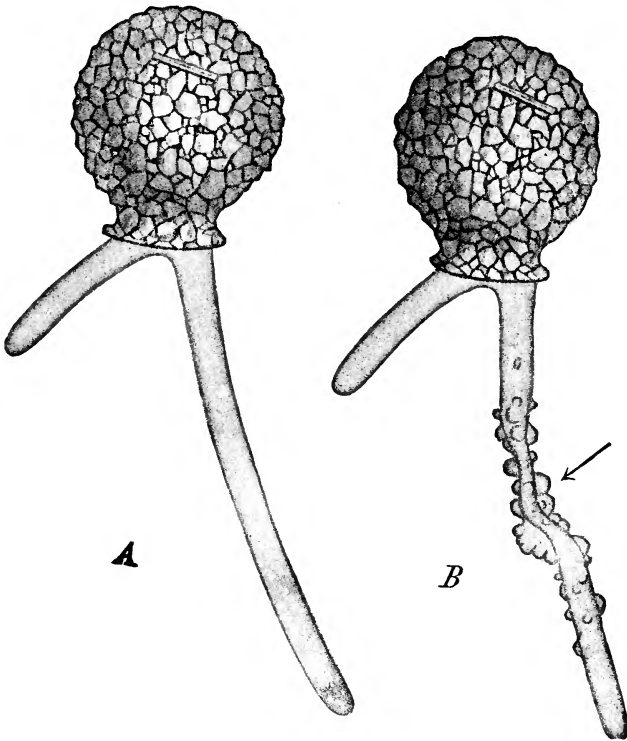

Fig. 16.

Diffugia urceolata. A—In non-stimulated condition. B—The same individual locally stimulated in the middle of a long extended pseudopod. The excitation spreads in both directions, centripetal as well as centrifugal.

within a slight fraction to that of a millimeter in the second. When a very long extended pseudopod is locally stimulated in the middle, the response spreads from the point affected in both directions diminishing in intensity and rapidity. The excitation extends equally in all directions. (Figure 16.) These facts

show very clearly that in *Diffugia* the excitation following a localized stimulus is dependent on the intensity of the stimulus, and that according to the degree of this, the wave progresses in either stronger, more rapid and extended, or weaker, slower and more limited manner. With the greater distance

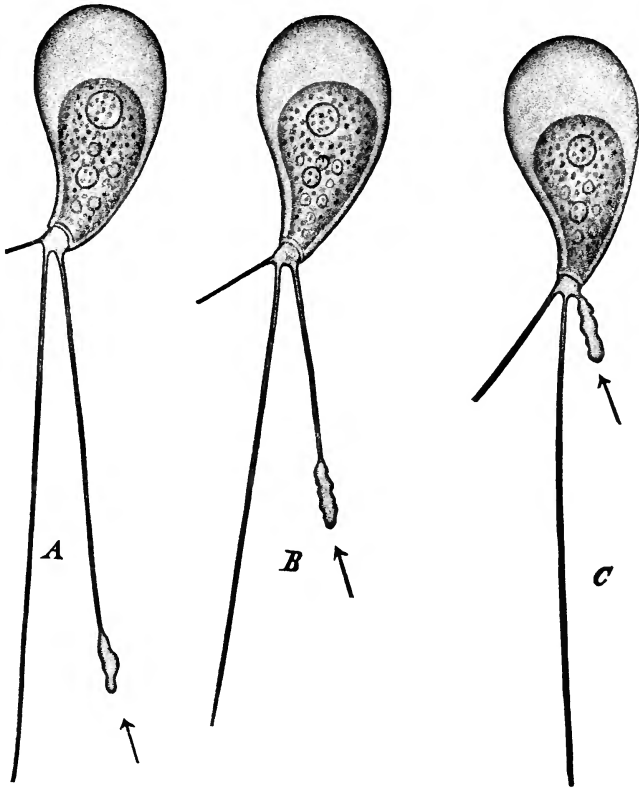

Fig. 17.

Cyphoderia margaritacea. Result of localized mechanical stimulation at the end of a long extended pseudopod. A, B, C—three successive stages.

from the point of stimulation the excitation undergoes an increasing decrement of its intensity and rapidity of conduction. Different species of *Diffugia* which I have investigated, *Diffugia lobostoma*, *urceolata*, *pyriformis*, have shown a complete con-

formity in this respect. A great number of other fresh water and marine rhizopods, the pseudopods of which I have used for analogous experiments, although differing in the manner of reaction in regard to the extent and rapidity of the course of excitation, manifest exactly the same fundamental principles. A very

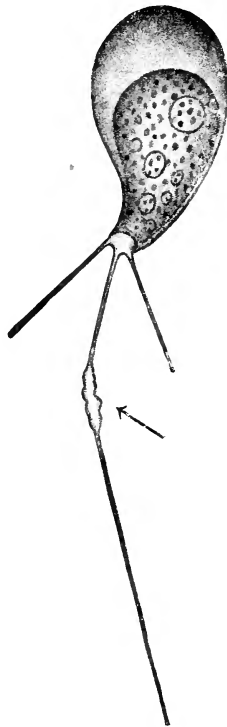

Fig. 18.

Cyphoderia margaritacea. Result of localized mechanical stimulation in the middle of a long extended pseudopod.

favorable form is, for instance, the much smaller *Cyphoderia margaritacea*, which is distinguished by a somewhat higher degree of excitability and rapidity of reaction.¹ The long straightly extended pseudopods are thinner and more threadlike than those

¹ Max Verworn: "Die Bewegung der lebendigen Substanz. Eine vergleichend physiologische Untersuchung der Contractionserscheinungen." Jena 1892.

of *Diffugia* and show upon stimulation as a result of their local excitation a simple contraction into clumps of the stimulated protoplasm without the characteristic differentiation of that of *Diffugia*. (Figure 17.) In the case of the marine rhizopods,

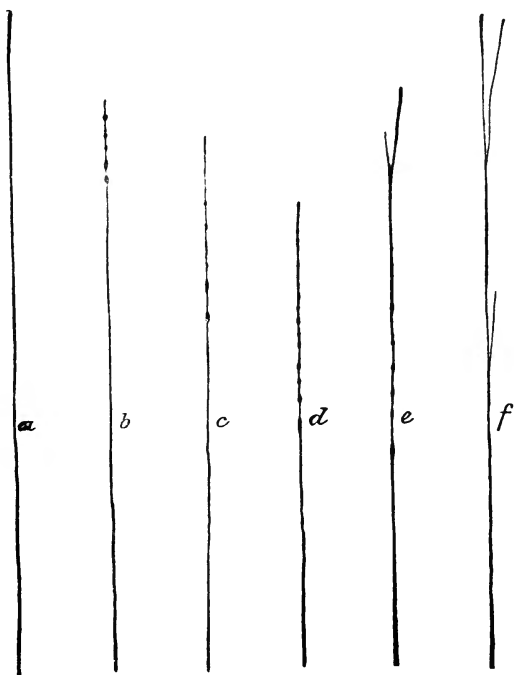

Fig. 19.

A pseudopod of *Orbitolites complanatus* (cf. Fig. 7). *a*—In normal condition. *b*—Severed by a cross section near the end. *b-f*—Five successive stages of the effect. *b-d*—The pseudopod retracts by centripetal flowing of the protoplasm contracted in the shape of microscopic balls and spindles. *e* and *f*—The pseudopod begins to extend again. The centripetal flowing balls and spindles begin to disappear.

Orbitolites (Figure 19), *Amphistegina*, etc., which I investigated at the Red Sea, the conduction of excitation takes place also as in *Diffugia* with a decrement of intensity and rapidity becoming larger with the distance from the point of stimulation until the wave of excitation is obliterated.

A sharp contrast to this type is formed by the other extreme as represented by that of the medullated nerve. As an indicator of the course of excitation we will take the action current in an isolated nerve of the frog. If this is stimulated at one end, we can test the intensity of the conducted excitation by leading off the action current from two points at varying distances from the one influenced by the stimulus. Since the classical discovery of *Du Bois-Reymond* of the action current of the nerve, we know that in the fresh medullated nerve, if observed under favorable experimental conditions, no decrement of intensity of excitation during its course from the point of stimulation along the length of the nerve can be demonstrated.¹ If unpolarizable electrodes are applied to a nerve in such a position that they are equidistant from the cross section and are connected with apparatus for testing the current, it will be found that there exists an "unwirk-same Ableitung" in the sense of *Du Bois-Reymond*, that is, in which there is no demarcation current. When a tetanizing current is applied to one end of the nerve, no difference of potential between the two nonpolarizable electrodes is observed, which indeed would be the case if excitation with its current of action would have a decrement on its way from one to the other point of leading off the current. *This fact, which has been repeatedly confirmed, shows us that the medullated nerve, under normal conditions, conducts excitation without a perceptible decrement of the intensity.*

This specific property of a medullated nerve is in conformity with the conditions in connection with the rapidity of conductivity. Since *Helmholtz*² has devised the method for measuring the rapidity of conduction in the nerve, this investigator himself and numerous others have studied the rate in different nerves.³ *Helmholtz* found the rate for motor nerves of the frog to be 27 meters per second, for the sensory nerves of man 60 meters,

1 *Du Bois-Reymond*: "Untersuchungen über tierische Electricität." II Band. 1849.

2 *H. Helmholtz*: "Messungen über den zeitlichen Verlauf der Zuckung animalischer Muskeln und die Fortpflanzungsgeschwindigkeit der Reizung des Nerven." Müller's Archiv. 1850.

The same: "Messungen über die Fortpflanzungsgeschwindigkeit der Reizung in den Nerven." Zweite Reihe, Müller's Arch. 1852.

3 Compare: *Hermann*: "Handbuch der Physiologie." II, 1 Leipzig 1879.

and the motor nerves of man 34 meters. Other investigators have obtained quite different results; *Hirsch*, for the sensory nerves of man, 34 meters; *Schelske*, for the same, 25-33 meters; *De Jaager*, 26 meters; *v. Wittich*, 34-44 meters, and *Kohlrausch*, 56-225 meters; *v. Wittich* for the motor nerves of man, 30 meters; *Piper*¹ finally in the most recent investigations about 120 meters in the second.

These differences may be explained in a *large* measure by the variety of the methods used, in part also by the difference in the structures. The methods employed for the study of the velocity have also been used to solve the question, whether the velocity of the excitation wave in its course over the nerve meets with a decrement as it moves further and further away from the point of stimulation. Here the endeavor was made to study the difference in time of the latent period, which is observed by the indicator, when the nerve is stimulated at two points at different distances from the muscle, used as an indicator, or from the wires leading the current to the indicator. The more recent investigators, as *René Du Bois-Reymond*,² *Engelmann*,³ *G. Weiss*,⁴ have arrived at the same conclusion, that the rate of conductivity in the medullated nerve under normal conditions is the same at all distances from the point of stimulation. (Figure 20.)

The medullated nerve shows, therefore, under normal conditions neither a decrement of its conductivity, nor of its *irritability*, as the distance of the wave of excitation increases from that of the position of stimulation; this means, in other words, that excitation is conducted with the same intensity with which it is started, and with a constant rate throughout the entire course of the nerve.

There is, nevertheless, a third point of considerable difference

1 *Piper*: "Ueber die Leitungsgeschwindigkeit in dem markhaltigen menschlichen Nerven."

The same: "Weitere Mitteilungen über die Geschwindigkeit der Erregungsleitung im markhaltigen menschlichen Nerven." *Pflügers Arch.* Bd. 127, 1909.

2 *R. Du Bois-Reymond*: "Ueber die Geschwindigkeit des Nervenprinzips." *Arch. f. Anat. u. Physiol. physiol. Abt. Suppl.* 1900.

3 *Engelmann*: "Graphische Untersuchungen über die Fortpflanzungsgeschwindigkeit der Nervenregung." *Arch. f. Anat. u. Physiol. physiol. Abt.* 1901.

4 *G. Weiss*: "La conductibilité et l'excitabilité des nerfs." In *Journ. de Physiol. et de Pathol. générale* 1903.

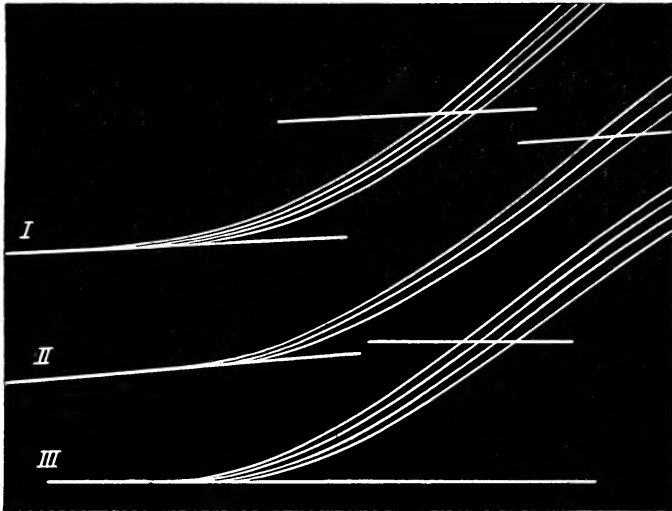

Fig. 20.

Curves of muscle contraction obtained by stimulation of 3 and 4 points situated at equal distances from each other on the sciatic nerve of the frog. The increase of length of the nerve stretch corresponds with an equal increase of the latent period of contraction. From this follows, that the rapidity of the wave of excitation is the same at all points of the entire length of the nerve. (After Engelmann.)

between the types of conduction of excitation in the rhizopods and in the nerve. Whereas in the rhizopods the rapidity of conduction is dependent upon the *intensity* of the stimulus, it has been long known as the result of investigation by *Rosenthal*, *Brücke* and *Lautenbach* and at a more recent date by *Gotch*¹ and *Piper*,² that in the nerve of the frog, as well as in man, the velocity is *not* dependent upon the intensity of stimulation. (Figure 21.) Contrary results have been obtained by a few early observers wherein the latent period was shorter when the stimulation was strong. *Nicolai*³ explains this shortening of the latent period,

1 *Gotch*: "The submaximal electric response of nerve to a single stimulus." *Journal of Physiology*, Vol. XXVIII, 1902.

2 *Piper*: Ueber die Leitungsgeschwindigkeit in den markhaltigen menschlichen Nerven. *Pflügers Arch.* Bd. 124, 1908, und Bd. 127, 1909.

3 *Nicolai*: "Ueber Ungleichförmigkeiten in der Fortpflanzungsgeschwindigkeit des Nervenprinzips, nach Untersuchungen am marklosen Riechnerven des Hechts." *Arch. f. Physiologie* 1905.

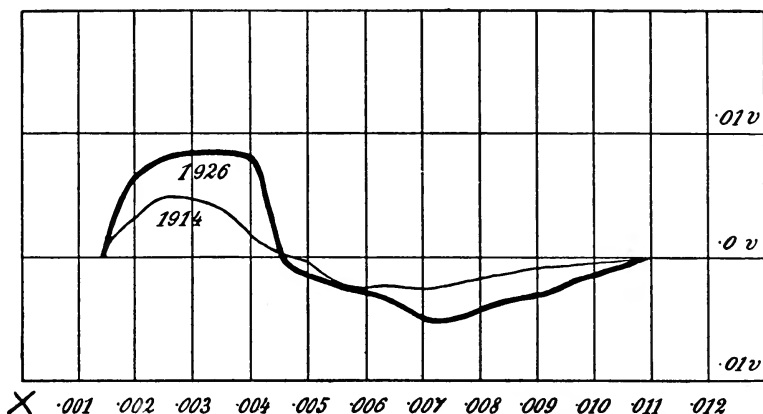

Fig. 21.

Course of the action current of the nerve. The thin line indicates the action current produced by a weak, the thick line the action current produced by a strong stimulus. The duration of the action current is the same in both cases. (After Gotch.)

resulting from the application of strong electrical stimuli, to a spreading out of the "Stromschleifen" from the point of application and consequently there is a shortening of the stretch of nerve between the point of stimulation and the indicator.

This conspicuous difference in the conduction of the two extreme types of living substance, which we have already observed, arouses the question as to what properties of living substance bring about these differences. In order to answer this question, it is necessary, first of all, to make some general statements concerning the processes of conductivity.

As already emphasized, all living substance possesses the capability of conducting excitations to a definite degree. We may, therefore, assume that the same fundamental *property* of conductivity exists in all substances. A fact to be considered in the conduction of excitation, is that the primary breaking down of the complex molecules at the position of stimulation act in turn as exciting stimuli upon the neighboring portion of the living substance, which in turn undergoes a similar decomposition. And so this process continues. This fact is evident from the observations on the process of excitation. But the nature of the stimulus

which produces the breaking down of the complex molecules upon the surrounding molecules is a problem which can only be studied later. Here only one point will be mentioned in advance concerning the intensity of the stimulus. It is apparent from the experiments on the rhizopods, that the greater the intensity of the stimulus the more extensive must be the breaking down of the living substance. A stronger primary stimulation must also secondarily produce a stronger stimulus in the neighborhood. In other words: the *conduction of excitation* is a function of irritability. The greater the irritability, that is, the greater the number of molecules broken down in a unit of time and space by a stimulus of a certain intensity, the greater also is the conductivity of the living system, that is, the stronger, the more rapidly and the further excitation is extended. Conductivity of excitation is, therefore, unthinkable without irritability. Both are inseparably connected. The conclusion forced upon us by this chain of reasoning admits of no argument. Nevertheless the endeavor has been made, because of certain evidence at hand, to show that the property of conductivity could exist without irritability. A number of authors, such as *Schiff*,¹ *Erb*,² *Grünhagen*,³ *Effron*,⁴ *Hirschberg*⁵ and *G. Weiss*,⁶ have observed the fact that in spite of a more or less strong decrease of *excitability* of a stretch of nerve, stimuli applied above this stretch can still produce a conduction of excitation through the affected part. They have concluded from this that it is possible to separate the conductivity from irritability. *Erb* and *G. Weiss* have even gone so far as to directly express the opinion that capability of conduction and irritability involve two different histological elements. In contrast to this,

1 *Schiff*: "Über die Verschiedenheit der Aufnahmefähigkeit und Leitungsfähigkeit in dem peripherischen Nervensystem." Henle u. Pflügers Zeitschr. 1866.

2 *Erb*: "Zur Pathologie und pathologischen Anatomie peripherischer Paralysen." Deutsches Arch. f. Klin. Med. 1869.

3 *Grünhagen*: "Versuche über intermittierende Nervenreizung." Pflügers Archiv. Bd. 6, 1872.—*Funke-Grünhagen*." Lehrbuch der Physiologie Bd. I, 1876.

4 *Effron*: "Beiträge zur allgemeinen Nervenphysiologie." Pflügers Arch. Bd. 36, 1885.

5 *Hirschberg*: "In welcher Beziehung stehen Leitung und Erregung der Nervenfasern zu einander?" Pflügers Arch. Bd. 39, 1886.

6 *G. Weiss*: "La conductibilité et l'excitabilité des nerfs." Journ. de physiol. et de pathol. générale. T. V. 1903.—"Influence des variations de température et des actions mécaniques sur l'excitabilité et la conductibilité des nerfs." *Ibidem*.

other investigators, such as *Hermann*,¹ *Szpilmann* and *Luchsinger*,² *Gad*,³ *Piotrowski*⁴ and *Wedenski*,⁵ have more or less decidedly taken the stand that an actual separation of irritability and of conductivity does not exist. The apparently contradictory evidence as well as the conflicting theoretical views have been cleared up by *Werigo*,⁶ *Dendrinos*,⁷ *Noll*⁸ and *Fröhlich*.⁹ These investigators have shown that the length of the narcotized stretch of the nerve plays an important rôle in the obliteration of conductivity. It has been found by the application of a stimulus above the narcotized stretch of nerve, that the longer this stretch is, the less is the reduction of irritability which obliterates the excitation wave reaching this area. Further: The shorter the stretch, the greater must be the reduction in irritability before this result is brought about. (Figure 22.) In other words, the conductivity in the narcotized nerve is dependent upon the length and the irritability of the narcotized stretch. From this observation the important fact is evolved, that the wave of excitation meets with a decrement of its intensity in the narcotized area. This decrement becomes larger as the wave progresses through the involved stretch. Further it is progressively increased as the amount of the irritability is reduced. Finally, when the stretch is long enough, the wave

1 *Hermann*: "Handbuch der Physiologie." Bd. II, I Leipzig 1879.

2 *Szpilmann und Luchsinger*: "Zur Beziehung von Leitungs- und Erregungsvermögen der Nervenfasern." Pflügers Arch. Bd. 24, 1881.

3 *Gad*: "Ueber Trennung von Reizbarkeit und Leitungsfähigkeit des Nerven." (Nach Versuchen des Herrn Sawyers) Arch. f. Anat. u. Physiol. physiol. Abt. 1888.

Derselbe: "Ueber Leitungsfähigkeit und Reizbarkeit des Nerven in ihren Beziehungen zur Längs und Querschnitts erregbarkeit." Nach Versuchen des Herrn Piotrowski Arch. f. Anat. und Physiol. physiol. Abt. 1889.

4 *Piotrowski*: "Ueber Trennung von Reizbarkeit und Leitungsfähigkeit des Nerven." Arch. f. Anat. u. Physiol. physiol. Abt. 1893.

5 *Wedenski*: "Die fundamentalen Eigenschaften des Nerven unter Einwirkung einiger Gifte." Pflügers Arch. Bd. 82, 1900.

The same: "Excitation, inhibition et narcose." Compt. rendus du v. Congres internat. de Physiologie à Turin 1901.

6 *Werigo*: "Zur Frage über die Beziehungen zwischen Erregbarkeit und Leitungsfähigkeit des Nerven." (Nach Versuchen von stud. Rajmist. Pflügers Arch. Bd. 76, 1899.

7 *Dendrinos*: "Ueber das Leistungsvermögen des motorischen Froschnerven."

8 *Noll*: "Ueber Erregbarkeit und Leistungsvermögen des motorischen Nerven unter dem Einfluss von Giften und Kälte." Zeitsch. f. Allgem. Physiol. Bd. III, 1907.

9 *Fr. W. Fröhlich*: "Erregbarkeit und Leitfähigkeit des Nerven." Zeitschr. f. allgem. Physiol. Bd. III, 1904.

of excitation is obliterated. This important fact has been further established by the experiments of *Boruttau* and *Fröhlich*,¹ in which they studied the intensity of the current of action,

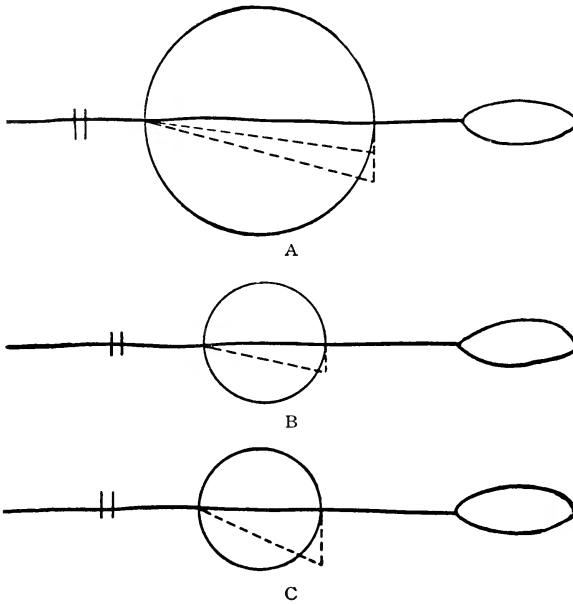

Fig. 22.

Scheme of the decrement of the excitation wave in the narcotized stretch of a nerve. A—The narcotized stretch (indicated by the cross section of the chamber) is 30 mm. long. The ordinates of the dotted lines indicate the amount of the decrement. If the decrement is slight (upper dotted line), the excitation wave passes the narcotized stretch and increases again on entering the normal stretch. If the decrement is great (lower dotted line), the excitation wave is obliterated towards the end of the narcotized stretch and the muscle remains at rest. B—The narcotized stretch is 15 mm. long. The decrement is slight. The excitation wave can therefore pass into the normal stretch and here increase again. C—The narcotized stretch is 15 mm. long. The decrement is great. The excitation wave is obliterated, therefore, in the narcotized stretch, and the muscle remains at rest.

produced by a wave of excitation, from two points in the narcotized stretch. The wave of negative variation, brought about by

¹ *Boruttau und Fröhlich*: "Erregbarkeit und Leitfähigkeit des Nerven." *Zeitschrift f. allgem. Physiologie* Bd. IV, 1904. The same: "Electropathologische Untersuchungen ueber die Veränderungen der Erregungswelle durch Schädigung des Nerven." *Pflügers Arch.* Bd. 105, 1904.

the excitation, gradually decreases in the narcotized stretch as the electrode is further removed from the point of entrance. Beside a decrement of *intensity*, as the investigations of *Fröhlich*¹ prove, the wave of excitation shows a decrement of the *velocity* in the narcotized stretch. And it is probable that the wave of excitation extends with *progressive* reduction in the velocity, corresponding to the decrement of intensity. The work of *Koike*² under the direction of *Garten*, in which the conclusion arrived at is that the reduction in the velocity is the same throughout the narcotized area, should not be accepted as conclusive in spite of the delicate method employed. These investigations are extremely difficult, being in the field of the most delicate of present-day methods. The decrement, which the wave of excitation meets with in its progress in the narcotized stretch, makes the conflicting testimony concerning the apparent separation of irritability and conductivity intelligible. It depends entirely upon the length of the narcotized area, and the amount of reduction in irritability on the one hand, and the strength of the stimulus used for testing the irritability on the other, whether the conductivity will disappear *before* the irritability or *vice versa*. If I test the irritability in the narcotized stretch with a weak stimulus, just slightly *above* the threshold, then by slight reduction in the irritability complete absence of response occurs, when the same stimulus is applied. This occurs at a time when excitation reaches the narcotized area from above and meets with a decrement so slight that it can pass through the whole narcotized stretch, that is, when the narcotized stretch is short enough. If I test the irritability of the narcotized area with a strong stimulus, far above that of the threshold, irritability will be found to be present at a time when the conductivity for the excitation, coming from above, is already obliterated. This is due to the fact that the decrement in the narcotized area is already great enough to bring about the complete disappearance of the

1 *Fröhlich*: "Die Verringerung der Fortpflanzungsgeschwindigkeit der Nerven-
erregung durch Narkose und Erstickung des Nerven." Zeitschrift allgem. Physiologie Bd.
III, 1904.

2 *Izuo Koike*: "Ueber die Fortleitung des Erregungsvorgangs in einer narko-
tisierten Nervenstrecke." Zeitsch. f. Biologie Bd. 5, 1910.

wave of excitation coming from above. This, of course, only occurs provided the length of the narcotized stretch is great enough. The separation of conductivity and irritability is, therefore, only an apparent one. In reality, the facts obtained from experimentation indicate that with the reduction of irritability the decrement of the wave of excitation increases, whilst the shorter the stretch, the smaller is the decrement. This shows that *conductivity is a manifestation of irritability*.

The facts just mentioned have, however, a much deeper meaning. They show us that it is possible by means of narcosis to convert an extreme type of a living system, with decrementless conductivity, into another extreme type of living substance, in which excitation in its progress meets with a strong decrement, like that seen in the rhizopods. The same results may also be obtained by asphyxiation and other forms of temporary and permanent injury of the nerve. We are, therefore, in the fortunate position in the case of the medullated nerve of having a substance to study, which, depending upon conditions which are under our control, may become a type in which conductivity occurs with or without the presence of a decrement. We can likewise reduce the irritability to various degrees, producing all intermediate gradations between the two extremes. This latter is particularly valuable in that it permits us to study the conditions in one and the same substance necessary to bring about the various peculiarities of conductivity. The great differences in the conductivity of excitation are conditioned by variations in the degree of irritability. If the irritability of the nerve is at the normal level the wave of excitation progresses to the end of the nerve without manifesting a decrement of its intensity or rapidity.

If the level of irritability of the intact nerve is artificially reduced, the wave of excitation meets with a greater decrement and reduces in velocity, and in fact disappears the more quickly in the stretch of nerve, as the reduction in irritability is increased. These three factors, irritability, intensity and velocity of the progress of the wave of excitation, are inseparable. All living substances may be grouped according to their capability of con-

ducting excitation into a long series, starting with those possessing the least irritability, as we found in the rhizopods, then those having greater irritability, as the smooth muscle and ganglion cells, then those with still greater irritability, as the striped muscle, and finally those having the greatest degree of irritability, as the medullated nerves of the warm-blooded animal. Should the processes of excitation, as we saw, result from the energy production following the disintegration of the labile molecules of the living substance, then the degree of irritability is determined by the chemical constitution of the disintegrating molecules, by the number of molecules which are broken down in a definite space and a given time, and by the nature of the disintegration itself. All of these individual components, if we observe the problem from the physical standpoint, are manifested by the quantity of energy production. The higher the irritability of a living system, the greater is the amount of energy production in a given time and space which the stimulus produces. This has particular interest from the standpoint of the extreme cases of medullated nerves of the vertebrates with their most highly developed conductivity, and which will be analyzed in somewhat greater detail. How are we to explain their decrementless conductivity? When we study the decrement of the excitation wave in the series of living substances, before alluded to, we see that this reduces with a progressive increase of irritability. Consequently the extreme irritability of the nerve is a manifestation of its decrementless conductivity. If we study the course of a process of excitation and its conduction in its molecular details, the fact of the decrementless conduction indicates that in excitation, produced by a stimulus, the same number of specific molecules capable of disintegration are broken down in the same manner at every following cross section, as at the point of stimulation; or in other words: an equal amount of energy is set free at every cross section, which, in its turn, acts as stimulus to the next, etc. Such a condition presupposes, however, in an elementary fiber of the nerve, that by the conduction of the wave of excitation from cross section to cross section, all those molecules capable of disintegration are broken down. If it is assumed that

the entire number of molecules capable of disintegration do not break down, but only a certain per cent. of the same, then it would not be possible to conceive of a molecular structure of the nerve in which this would take place without decrement of the wave of excitation. With the assumption of a generally homogeneous molecular structure (Figure 23, a) of the elementary fibers it

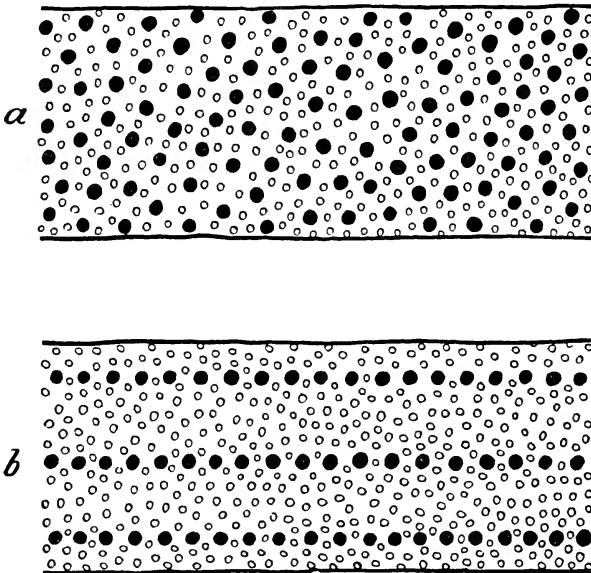

Fig. 23.

would be entirely incomprehensible how, with the decrementless extension of the excitation, individual molecules capable of breaking down could escape disintegration. If, on the contrary, the molecular structure is not homogeneous it only is possible to explain a conduction, on each cross section of which an equal per cent. of irritable molecules break down, by the hypothesis that the irritable molecules are in their turn ordered in fiber-shaped series (Figure 23, b) within the elementary fiber and are thus protected to a certain degree from one another and from transverse conduction of excitation. This hypothesis would, therefore, only mean that the elementary fiber is not such in

reality and would thus transfer the difficulty to the ultimate fiber unit, for which a homogeneous molecular structure would have to be presumed. In short, whatever may be the assumption on which molecular structure of elementary fibers is based, the fact of the decrementless conduction peremptorily demands, from the physical standpoint, that from cross section to cross section the entire number of irritable molecules are broken down. This conclusion is highly important, for it indicates very clearly that the "all or none law" is applicable to the nerve.

This gives us occasion to return to the discussion of the question, if living systems really exist which respond in accordance with the "all or none law." The medullated nerve forms an object particularly suited to serve as a starting point for the treatment of this especially important problem. The question arises in this connection, if the validity of this law for the nerve can be tested by other means.

At first it would seem as if the application of the "all or none law" to the nerve were in contradiction to the well-known fact that a weak stimulation of the nerve produces a weak, a strong stimulation, a strong response. In this connection *Gotch*¹ has pointed out, as the result of experimental studies of the wave of activity of the nerve, that the difference in response, following the application of stimuli of varying strengths, is understandable from the fact that threshold stimuli stimulate only a few of the fibers of the nerve trunk, whereas progressively increasing the intensity of the current involves more and more fibers. There can be no doubt that this factor explains the difference in the strength of the response. Therefore, in reality we do not find here a contradiction of the "all or none law." On the other hand, the fact that the nerve, in contradistinction to many other forms of living substance, the ganglion cell, for example, upon a weak stimulation does not show the phenomena of summation, even when the stimuli follow each other in a rapid succession, indicates very strongly that the weakest operable stimulus produces maximal excitation, so that the response

¹ *Gotch*: "The submaximal electrical response of nerve to a single stimulus." *Journal of Physiology*, Vol. XXVIII, 1902.

cannot be further increased. But above all, there is a series of facts, which have been gained in the Göttingen laboratory, which demonstrate apparently without doubt the validity of the "all or none law" for the medullated nerve. These observations I wish now to consider in greater detail.

If a nerve of a nerve muscle preparation is drawn through a specially devised glass chamber so that the middle portion can be narcotized or asphyxiated and the nerve so arranged that it rests upon a pair of electrodes in the chamber and upon a second pair without the chamber and centrally located, then the nerve can be narcotized or asphyxiated and thereby the alterations in the irritability as well as the conductivity can be followed. In order to obtain as distinct a picture of this alteration as possible, I tested continuously the threshold of stimulation, which just produced minimal contraction in the muscle, and *Fröhlich*¹ continued these observations. As a result the following very remarkable conditions were observed. During the increase of the depth of narcosis or asphyxia the irritability sinks more and more with regularity. The conductivity remains unaltered for a long time, as the strength of the threshold stimulus is not changed until irritability has fallen to a definite point. When this is reached, conductivity disappears. (Figure 24.) The most important point in this connection, however, is, that the conductivity disappears simultaneously and practically momentarily for the excitation produced by both weak and strong stimuli. When the stimulation at the electrode placed centrally to the chamber does not bring about response for threshold stimuli, maximal stimuli at the same time also become inoperative. This is a very interesting point, the importance of which has not until now been recognized. This fact is not in harmony with the view held until now, that in the nerve fiber different strengths of stimuli bring about excitation of different intensity, and are then conducted. Let us now clearly comprehend this problem.

We have already seen that the wave of excitation meets with a decrement of its intensity in the narcotized stretch, which

¹ *Fröhlich*: "Erregbarkeit und Leitfähigkeit des Nerven." Zeitschr. f. allgem. Physiologie, Bd. III, 1904.

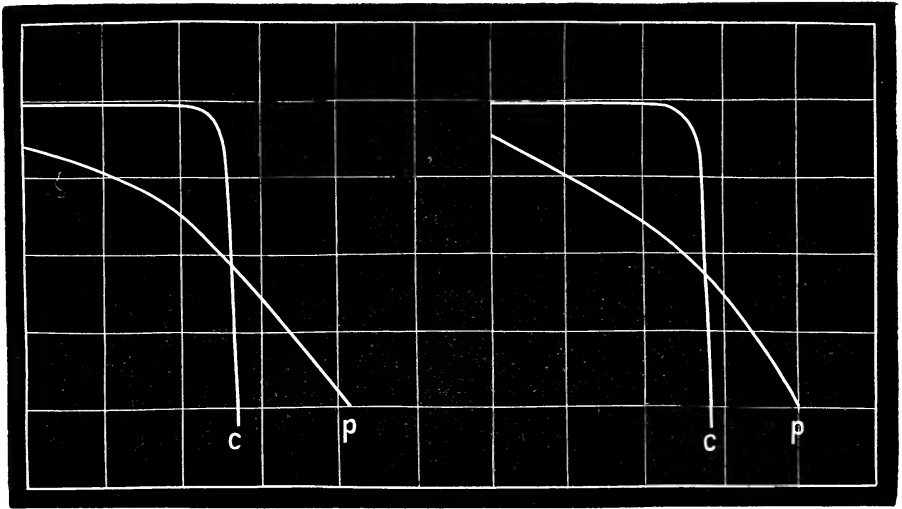

Fig. 24.

Curves of the changes in irritability (p) and conductivity (c) of a nerve under the influence of narcosis or asphyxiation. (After Fröhlich.)

increases in strength as the irritability diminishes. If the value of the threshold is learned by stimulating the nerve at the electrodes centrally placed to the chamber with minimal stimuli, it would necessarily follow that this weak stimulus would bring about a corresponding weak excitation of the individual fibers and the wave of excitation already in the beginning of narcosis would be obliterated, for it would meet with a decrement, the result of the reduction in the irritability. A wave of excitation of minimal strength could under these conditions no longer reach the muscle, even in the beginning of narcosis. In spite of this the excitation, even when produced with threshold stimuli, passes through for a long time, even when the irritability in the chamber is greatly reduced, as shown by testing with the electrodes within the chamber. This is not consistent with the assumption that a threshold stimulus brings about the minimal excitation, even in the individual nerve fiber. But further: with a definite decrease of irritability of the narcotized

stretch the capability of conductivity disappears, and indeed simultaneously for the weakest as well as the strongest stimuli. If it is assumed that weak stimuli bring about weak excitations in the nerve fiber, it must most certainly be expected that on the cessation of the response, weak stimuli applied at the central nerve end would still, by slight increase of the intensity of stimulation, be followed anew by reaction in the muscle. This is all the more to be expected, because the irritability of the narcotized stretch, as shown by stimulation with the electrodes inside the chamber, very gradually decreases, so that within the chamber stimuli of moderate strength are still effective. Instead the capability of conduction is completely obliterated, and even the strongest stimuli, applied to the end of the nerve, produce no response in the muscle. This in turn does not agree with the assumption that the intensity of excitation varies with the strength of the stimulus in the individual nerve fiber. The facts here alluded to are, therefore, either not correct, or the intensity of excitation in the individual nerve fibers is independent of the strength of the stimulus, and the view which we have entertained up to the present in this respect is incorrect.

In order to examine these facts once more on an extensive scale, and at the same time obtain an understanding of the development of the decrement in the narcotized stretch, I have requested *Dr. Lodholz* to register as many accurate curves as possible in which the positions of the secondary coil of an inductorium are the ordinates indicating the threshold of stimulation at four points of a nerve stretch. Of these points three are situated at prescribed distances from each other in the narcotized or asphyxiated stretch; the fourth is centrally placed. (Figure 24.) As

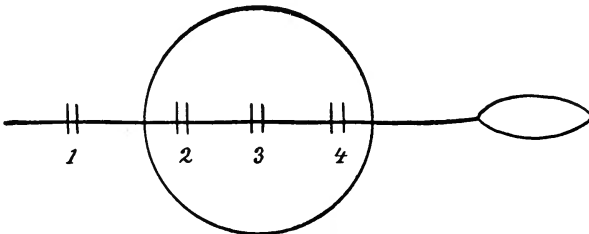

Fig. 24.

might be expected the result was the same as in former investigations. They show however even more strikingly the abruptness of the disappearance of conductivity simultaneously for the weakest and the strongest stimuli. The curve produced by the centrally placed electrode remains at the same height for a considerable period, then suddenly abruptly declines. Those of the electrodes within the chamber likewise sink, at first slowly, then with increasing rapidity in successive order corresponding to the distance which they are situated from the point of exit of the nerve, so that the curve of the most distant electrode reaches the abscissa first, that of the electrode nearest the muscle in the chamber, last. The experiments demonstrate with complete clearness that in contrast to all those points within the affected stretch, where the conductivity, though already obliterated for weaker stimuli, still exists for stronger, that with stimulation of a point towards the center *above* the affected stretch, conduction ceases simultaneously for all different strengths of stimuli. This last state at the points within the affected stretch might be ascribed to the diminution of the excitability of this stretch, and the idea entertained that the weak stimuli no longer produce excitation capable of further conduction.

This assumption is contradicted, however, by the fact that subsequently to the disappearance of the response at a point situated at the *greatest distance* from the place of exit, an effect of stimulation can be obtained at the *nearest* point to the exit with the same or even less strength of the current. As the irritability in the affected stretch is reduced at all points in equal measure, the fact of a weaker stimulus becoming inoperative whilst a stronger remains effective can only be attributed to the circumstance that the wave of excitation set free at some point of the influenced stretch by a weaker stimulus is sooner obliterated on its way to the muscle than that produced at the same point by a stronger stimulus. These experiments, in which the manifestations of the nerves in response to stimuli applied centrally above the chamber in the normal stretch are compared to those in response to a stimulus acting on the affected stretch, clearly demonstrate the totally different effect in both cases. In stimula-

tion of the centrally situated normal stretch, the wave of excitation, which enters from here into the influenced stretch, is obliterated at the same point simultaneously for the weakest as well as for the strongest stimulus; stimulation of the affected stretch, the wave of excitation which is set free at one point by a weak stimulus, is obliterated sooner and after passing through a shorter stretch than that which is produced by a stronger stimulus. It is self-evident that in the first instance, in which the stimulus acts on the centrally situated normal stretch, the wave of excitation, thereby set free, must in passing through the affected stretch undergo a decrement of its intensity. If, therefore, the wave of excitation, coming from above, is obliterated exactly at the same point, whether brought about by weak or strong stimuli, the inevitable conclusion must be drawn that, whether either a weak or a strong stimulus is operative, the wave of excitation must have entered into the influenced stretch from the normal stretch with exactly the same intensity. In other words: the weakest as well as the strongest stimuli produce excitations of equal intensity in the normal nerve, that is, the "*all or none law*" is *valid for the nerve*.

This information can no longer be doubted in the presence of such evidence as was presented above. This indeed is a fact of far-reaching importance in the understanding of the functional activity of our nervous system, for it is evident that the difference of intensity in the conduction of excitation is not, as has been assumed until now, the result of the conduction of varying strengths of a single excitation in the same elementary fibers, but rather the involvement of a various number of fibers, and that a series of processes which we have to the present attributed to the varying intensities are now to be explained by difference in the duration and form of excitation. This gives us an entirely different but nevertheless a more definite picture of the physiological character of the processes in the nervous system. Still, this question belongs to another chapter of physiology. Here we are interested in the fact that we have in the nerve a form of living substance, in which irritability has reached a high degree, and every stimulus which is at all oper-

ative brings about disintegration of all the material involved in excitation, and consequently the property of conductivity in the nerve reaches the state of highest development of all living structures, in that the medullated nerve conducts with the greatest rapidity on the one hand, and on the other, there is no decrement of the velocity and intensity of excitation. All these characteristics: the existence of the "all or none law," the rapidity of the conduction of excitation, the absence of a decrement in the velocity, the absence of a decrement of the intensity of the excitation wave, the want of the capability of summation of excitation, are all dependent upon one another, for they are the combined expression of one and the same factor, that of the high state of irritability. When the irritability is artificially reduced, then the nerve approaches more and more, depending upon the amount of reduction, to the series of living substances in which we found the protoplasm of the rhizopoda to occupy the other extreme. Between the normal medullary nerve with its maximal, and the pseudopods of the rhizopods with their minimal capability of reaction, we find innumerable gradations in groups of living substances. Whether or not other forms of living substances follow the type of the nerve, whether for example the "all or none law" can be applied to the skeletal muscle as the investigations of *Keith Lucas*¹ seem to show, requires further investigation.

Finally, there arises the important question as to the finer mechanism of conductivity. The progression of excitation from cross section to cross section in a living system is brought about by the decomposition of the molecules in one region acting as a stimulus and producing a disintegration of the molecules in another region, etc. We have already seen that the intensity is dependent upon the amount of energy produced by the disintegration of the molecules following the stimulus, that is, upon the amount liberated in a definite space in a definite time. The question which now arises is this: What form of energy is produced

¹ *Keith Lucas*: "On the gradation of activity in a skeletal muscle fiber." *Journal of Physiology*, Vol. IX, 1888. The same: The "all or none" contractions of the amphibian skeletal muscle-fiber. *Journ. of Physiology*, Vol. XXXVIII, 1909.

by the stimulus at the point of stimulation, which acts upon the neighboring molecules? The conduction of excitation is a property of all living substance, and we may presume that this occurs in all living systems in the same manner. If one examines the forms of energy which are produced in a living substance by the breaking down of the molecules, we find that chiefly three forms of energy may be taken in consideration in the problem of conductivity: heat, electricity and osmotic energy. Light cannot be looked upon as a form of energy which is produced by all living substance, and the other forms of energy, as the chemical energy and surface tension, remain local. At a first glance one is inclined to assume that heat is the form of energy which is liberated by the breaking down of the stimulated molecule and which spreads to the neighboring molecules and brings about their decomposition. For we know that heat facilitates dissociation, and the analogy between living substance and explosive material is very close. In both instances the decomposition, which extends over a great mass of molecules, is accomplished by the heat produced in the breaking down of a few molecules. In fact, the conduction of excitation of a nerve can in many respects be compared with the burning of a fuse.¹ Nevertheless, it must not be forgotten that this analogy, which on first glance seems so apt, upon closer observation presents serious difficulties. It can be experimentally shown that an increase in the temperature in the living substance follows stimulation, but it is also known that in momentary excitation following a single stimulus, as in the muscle after the application of an induction shock, the heat production is extremely small. This difficulty becomes particularly apparent if we endeavor to gain an approximate idea of the numerical proportions of the irritable, that is the disintegrating molecules to the remaining mass of a living system. The water content above all represents an enormous proportion. If we calculate this to be for the nerve, for instance, roughly about 75 per cent., which is a low estimate, only 25 per cent.

¹ Compare *Pflüger*: "Ueber die physiologische Verbrennung in den lebendigen Organismen." In *Pflügers Archiv*. Bd. 10, 1875. Further: *L. Hermann*: "Handbuch der Physiologie, Bd. II, Allgemeine Nervenphysiologie," 1879.

of dry substances remain. Even of this 25 per cent. by far the largest part is apportioned to connective tissue, for which 15 per cent. is certainly not too high a figure. Neither can the remaining 10 per cent. of dry substances be regarded as consisting entirely of molecules capable of decomposition. For in this is also included the organic reserve material of the axis cylinder protoplasm, which is doubtless of very considerable amount. Further, the salts and products of disintegration, for which the estimate for the sum total would probably not be too low if we assume the amount to be equal to that of the group specially concerned in the process of excitation. As, however, a constant metabolism of rest takes place, these last molecules or atom groups are certainly not at the moment of entrance of the stimulus in their entirety in a condition capable of decomposition. It is quite certain, therefore, that we are still overestimating the amount of the molecules capable of disintegration, if we put them down as 5 per cent. of the entire nerve substance. If we now suppose that this 5 per cent. of irritable molecules are broken down as a result of stimulation, 95 per cent. of nonirritable substance, separating these irritable molecules, must become heated to such a degree by the disintegration of the latter that the amount of heat suffices to bring about decomposition of the nearest surrounding molecules or atom groups, for otherwise conduction of disintegration could not take place in this manner. This condition presents a serious difficulty for the assumption that heat is the form of energy responsible for the conduction of disintegration. It is true that we cannot reject this view at once as being completely incorrect, as the possibility of conduction does not depend upon the absolute amount of heat which reaches the next molecule capable of decomposition, but upon the relative amount of heat in regard to the degree of lability of the irritable molecules, of which we cannot even approximately make an estimate. However, by a comparison with other highly explosive substances, such as iodide of nitrogen, we find that a slight trace of water applied to the iodide of nitrogen suffices to prevent the extension of the disintegration process, and with this the explosion of the whole mass. Nor does the view of *Pflüger* remove this difficulty,

which assumes that the atom groups capable of breaking down are joined together by a chemical linking of atoms to long fiber-shaped giant molecules through the whole nerve fiber, for this assumption of a firm structure can hardly be reconciled with the principles concerned of metabolism.

In consideration of this difficulty it seems easier to assign the rôle of mediator of disintegration not to heat but to electricity. Production of electricity is likewise a property of all living substance. Differences of electrical potential between two points may be equalized in the stretch by conduction through the intervening space. Electricity would then fulfil the important conditions, which must be demanded for the form of energy, acting as mediator for the conduction of disintegration from cross section to cross section.

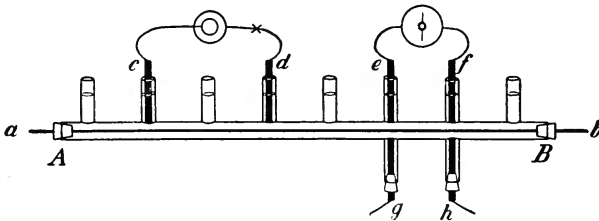

Fig. 25.

Model of a "Kernleiter." A, B—Glass tube, with a number of side tubes filled with saline solution, through which a wire is passed. *c* and *d*—Side tubes with electrodes for stimulation. *e* and *f*—Tubes for connection with a galvanometer. (After *Hermann*.)

Physiologists even at an early date, misled by the apparent likeness in the conduction of excitation, especially in the nerve, to that of electricity in a metal wire, regarded both processes as identical. When, however, *Helmholtz* first demonstrated experimentally the rapidity of the conduction in the nerve, the thought that electrical conduction was concerned, such as takes place in a metal wire, had to be abandoned, as the velocity shows too great a difference in the two cases.

The observations, on the other hand, on the conductivity in the so-called "core model," seemed to offer another possibility of attributing the conduction of excitation in the nerve to electric

processes. *Matteucci*, later *Hermann* and finally *Boruttau*¹ have endeavored to apply the results obtained when electricity is introduced in a wire covered with a moist envelope (saline solution), to the explanation of conductivity in the nerve. (Figure 25.) The fact has been shown, that in such a model the application of electricity to a point, as a result of polarization between the moist envelope and the metal, produces a weak local current, which in turn disturbs the electrical potential in the next cross section and consequently a new local current is produced and so on through the whole length of the wire. (Figure 26.) This fact, in con-

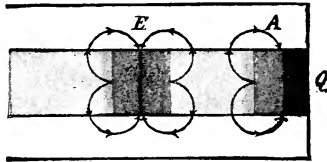

Fig. 26.

Scheme of the conduction by local electric currents
in a "Kernleiter." (After *Hermann*.)

nection with the apparent similarity in the differentiation of the axial fibers and peripheral envelope in the nerve, has led *Boruttau* to apply the principles of conductivity in the "core model" to that of the nerve. Then, however, *Nernst* and *Zeyneck* brought forward their theory, according to which the galvanic current is operative as a stimulus in that it brings about an alteration in the concentration of the ions at the junction of two different electrolytes which, in turn, produce local currents. *Boruttau* then dropped the assumption of the existence of a simple physical polarization between the wire and the envelope and replaced it by the assumption of an alteration in the concentration of the ions at this position. Thereby the "core model explanation" was already altered in principle, in that only the differentiation of a central fibrilla and a peripheral enveloping substance was appropriated. It seems to me that this factor can likewise be consid-

¹ The enormously extensive literature on this subject up to the most recent date is quoted in *Cremer*: "Die allgemeine Physiologie der Nerven." In *Nagels Handbuch der Physiologie des Menschen*, Bd. IV, 1909. Braunschweig.

ered as completely dispensable and may, therefore, be omitted; thus nothing remains of the "core model explanation" of the conduction of excitation in the nerve.

The results of continually increasing numbers of investigation in recent times make it appear almost as a certainty that the elementary fibrillæ in the axis cylinder are nothing else but skeletal substances. *Wolff*,¹ *Verworn*² and others have first expressed the view that the neurofibrillæ must be looked upon as skeletal fibers for the soft neuroplasm, and more recently *Lenhossek*³ and especially *Goldschmidt*⁴ have confirmed this assumption in detail. *Goldschmidt* has shown by extensive comparative studies of cell mechanism the rôle played by the neurofibrillæ in a physical connection as internal skeletal formations, and has proved at the same time, in complete unanimity with other investigators, their continuity with other undoubted skeletal fibrillæ. By this the numerous combinations and speculations of *Apathy* and *Bethe* concerning the part taken by the neurofibrillæ have been rendered untenable. In no case is there the slightest justification to regard the apparent "Kernleiterstruktur" of the nerve as the principal condition for the process of conductivity, for should we dispense completely with this point for the theory of the conduction of the nerve, we can obtain, solely by the aid of the facts known today in physical chemistry, the foundations for a theory of the conductions of excitation which not merely renders the specific case of the conduction of the nerve intelligible, but contains at the same time the principles of the process of the conduction of excitation for all living substance.

On the basis of investigation in the physical chemistry on the properties of semi-permeable membranes, we know that such membranes produce an elective effect on the diffusion of dissolved

1 *M. Wolff*: "Ueber die fibrillaren Structuren in der Leber des Frosches." *Anatom. Anzeiger* Bd. 26, 1905.

2 *Max Verworn*: "Bemerkungen zum heutigen Stand der Neuronlehre." *Medicin. Klinik*, Jahrg. IV, 1908.

3 *M. v. Lenhossek*: "Ueber die physiologische Bedeutung der Neurofibrillen." *Anatom. Anzeiger* Bd. 36, 1910.

4 *Richard Goldschmidt*: "Das Nervensystem von *Ascaris lumbricoides* und *megalocephala*. Ein Versuch in den Aufbau eines einfachen Nervensystems einzudringen." III Teil. Festschrift zum 60 Geburtstag *Richard Hertwigs* Bd. II, 1910, Jena.

substances. This is in the way that the two different solutions, separated by a semi-permeable surface, do not follow the known laws of diffusion, but are altered in that certain substances in contrast to their rapidity of diffusion pass through the membrane or are prevented from entering by the latter. This applies likewise to the two kinds of ions, which are dissociated in diluted substances. If the surface exercises a selection in the way, for instance, that the positive kations are allowed to pass through, whilst the negative anions are held back, a difference of potential must exist between the two. In this manner, wherever two different solutions are separated from each other by a semi-permeable surface, an opportunity occurs for the taking place of galvanic currents. As we know, living protoplasm by reason of its colloidal components possesses, in common with all colloidal substances, on its surface the properties of semi-permeable membranes. Between the cell and the medium, therefore, there is always the opportunity for the occurrence of differences of electric potential. But more. We likewise know that protoplasm itself

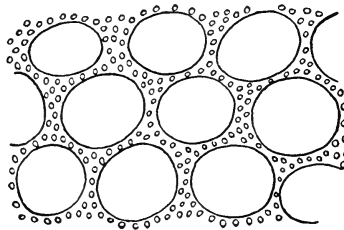

A

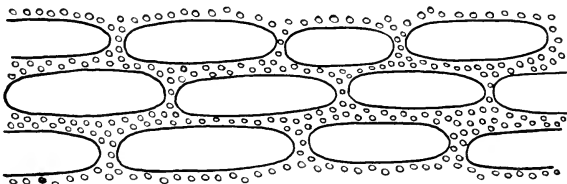

B

Fig. 27.

Scheme of the foam structure of living substance. A—In undifferentiated protoplasm. B—In fibrillae protoplasm.

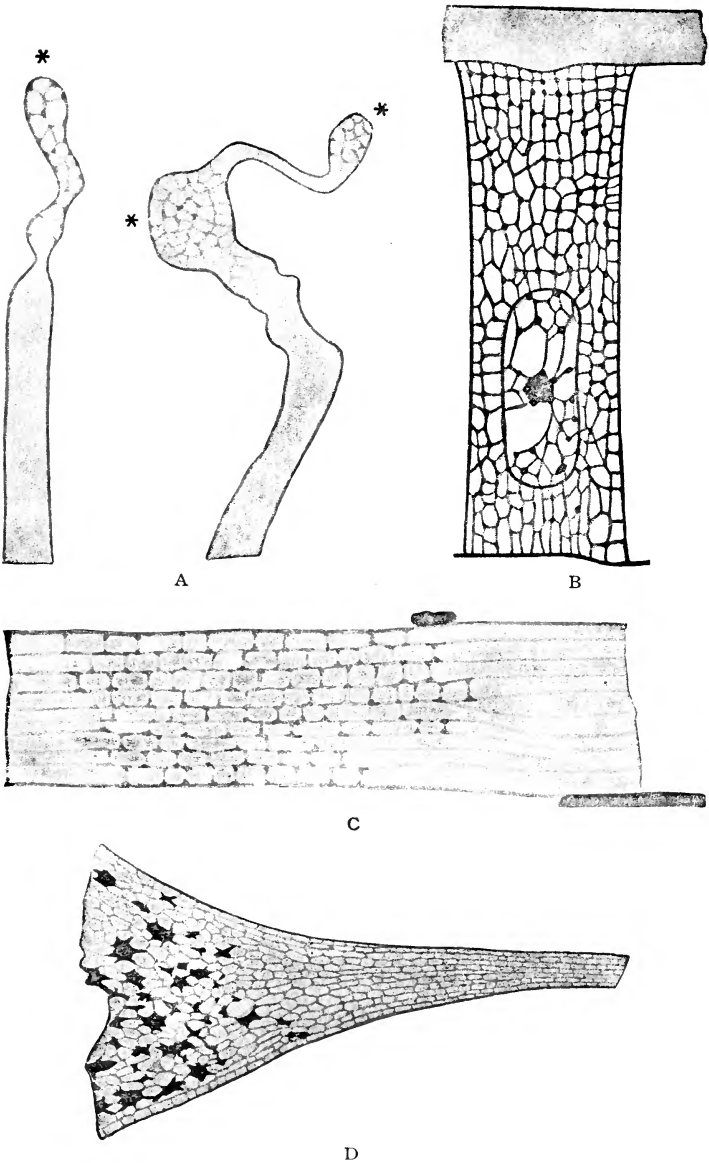

Fig. 28.

Protoplasm of different cells, showing foam structures. A—Pseudopod of a marine rhizopod. The protoplasm only shows foam structure at the point of stimulation. B—Epidermic cell of lumbricus. C—Nerve fiber. D—Part of the cell body of a ganglia cell. (A-C after *Bütschli*, D after *Held*.)

represents a mixture of colloid substances and actual solutions. Frequently, if not always, living structure presents a morphological differentiation of two types, when seen under the microscope, in the form of a foam structure described by *Bütschli*. (Figures 27 and 28.) If we suppose that with the disintegration of complex molecules, which we must assume as taking place in the material of the walls of the protoplasm network, substances are formed which are subjected to electrolytic dissociation, the anions and kations hereby liberated must be diffused from the place of their separation into the surroundings. Their diffusion, however, is restricted by the protoplasmic network. The positive ions may pass through, but the negative ions may not. As a result: the reticulated substance is the seat of electric discharge, which in turn gives the impact to the breaking down of new molecules and with this to the occurrence of new potential differences, and so on, consequently the disintegration is extended further and further through the connected masses of the protoplasmic framework.

This theory, founded on facts gained entirely from investigation, would involve those forms of energy which play the rôle of activator in the extension of the breaking down of the molecule from cross section to cross section, namely, the osmotic and the electrical energy. Based on the general properties of physical chemistry and those of morphology of the living substances, they would be applicable to all vital systems. It would be premature to attempt to extend this assumption and further develop its specific details, above all to make it responsible for the specific differences in the process of the conduction of excitation in various forms of living substance. For this our knowledge of the properties of living substance is still far too incomplete. Nevertheless, it furnishes us even now with various points of view for the further analysis of a series of vital manifestations, as, for instance, the facts concerning the production of electricity, of galvanotaxis, chemotaxis and so on. This, however, exceeds the limits of the task we have here mapped out. We are concerned here solely with the general principle on which the conductivity of excitation in the living substance is founded.

CHAPTER VII

THE REFRACTORY PERIOD AND FATIGUE

Contents: Conception of specific irritability. Alteration of specific irritability during and after excitation. Refractory period in various forms of living substance. Absolute and relative refractory period. Curve of irritability during refractory period. Dependence of the duration of the refractory period on the rapidity of the course of the metabolic processes in the living substance. Dependence on temperature. Dependence on supply of oxygen. Theory of refractory period. Refractory period as basis of fatigue. Fatigue as a form of asphyxiation. Alterations of irritability and the course of excitation in fatigue. Recovery from fatigue. The rôle played by oxygen in recovery. Fatigue as an expression of the prolongation of the refractory period conditioned by the relative want of oxygen. Fatigue of the nerve.

Every living system possesses, as we know, a peculiar and characteristic manner of reacting to stimulation. The muscle responds with a contraction, the salivary cell with production of saliva, the luminous cell with the emission of light. This is the *specific energy* in the sense of *Johannes Müller*. Every living system is likewise characterized by a certain degree of irritability, which can be expressed by the threshold value of the stimulus at which the specific reaction is just perceptible. This degree of irritability, by which the system concerned is distinguished, may be termed its *specific irritability*.

From the standpoint of the conditional method of investigation it is at once apparent that specific energy, as well as specific irritability, must be solely determined by the specific conditions existing in the particular system. It follows from this that every alteration in the conditions of the system, that is, every change of its state, likewise entails a corresponding alteration of its specific energy and its specific irritability. It is, therefore, self-evident that the alteration of the state, which is undergone by the living

system in the process of excitation, brings about an alteration of its specific irritability. Likewise as the original state of the system is restored by the metabolic self-regulation after the course of an excitation, the specific irritability of the system must be re-established. The specific irritability is, therefore, a property of the living system, which, like the metabolic equilibrium, undergoes restitution by the process of self-regulation after variation produced by a stimulus of any kind. It is scarcely necessary to repeat each time that this is only applicable within the physiological variations and for a limited period, during which the alterations in development need not be considered.

These alterations of the specific irritability following an excitation and their compensation through the metabolic self-regulation will now claim our attention.

That the specific irritability of a living system undergoes a diminution as the result of a stimulus of long duration has been long known through the study of fatigue. This is especially so with frequently recurring exciting stimuli. It is only within the last decade, however, that the observation has been made in a few instances that a single momentary excitation is likewise followed by such a reduction of the specific irritability. But that this is a fact of general physiological fundamental importance for the whole field of response to stimulation in the living substance has only been recognized within the last few years.

In 1876 *Marey*¹ found that the irritability of the heart in response to artificial stimulation was greatly reduced during the systole, and that recovery took place during the following diastole. (Figure 29.) This fact was already apparent from the observations made by *Bowditch*² and *Kronecker*,³ that by stimulation of the isolated frog's heart with single induction shocks, an

1 *Marey*: "Des excitations artificielles du cœur." Travaux du lab. de M. *Marey* II, 1875. The same: "Des mouvements qui produit le cœur lorsqu'il est soumis à des excitations artificielles." Comptes rendues de l'academie des sciences T. L. XXXII, 1876.

2 *Bowditch*: "Ueber die Eigenthümlichkeiten der Reizbarkeit welche die Muskelfasern des Herzens Zeigen." Arbeiten aus der physiologischen Anstalt zu Leipzig, 1872.

3 *Kronecker*: "Das charakteristische Merkmal der Herzmuskelbewegung." Beiträge zur Anatomie und Physiologie als Festgabe f. Carl Ludwig zum 15. Oct. 1874, gewidmet von seinen Schülern. Leipzig 1874.

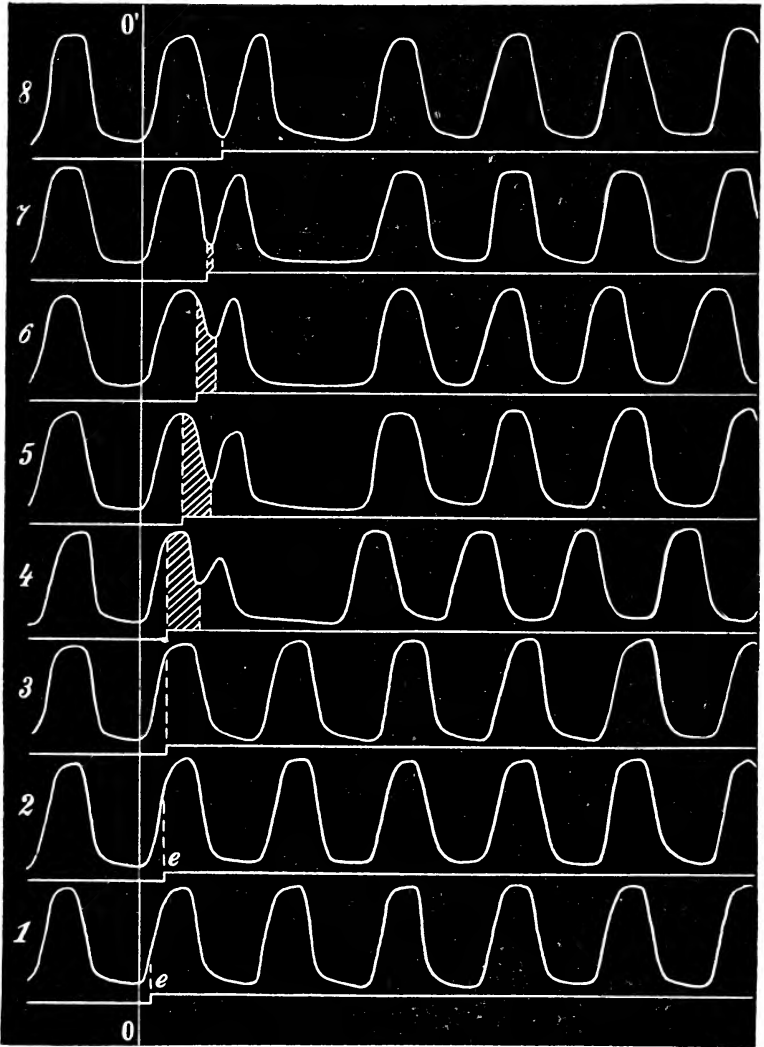

Fig. 29.

Eight series of heart contractions. The dotted lines *e* show the moment of an artificial stimulus. The artificial stimulus is ineffective if it is applied before the height of a systole. The artificial stimulus becomes the more effective in producing an extra systole, followed by a compensatory pause, the later it is applied after the height of the systolic contraction. (After *Marey*.)

artificial systole can only be produced with certainty when the stimuli succeed each other at certain intervals, which must be the longer as the strength of the stimulation is weaker. *Marey* calls this period of reduced irritability "*phase réfractaire*" of the heart. The refractory period of the heart has been made the subject of a great number of investigations, especially by *Engelmann* and his pupils. It was *Engelmann*¹ especially who determined more exactly the duration of the course of the refractory period. He found, namely, that irritability disappears immediately before each systole and reappears shortly before the beginning of the diastole, and again reaches its original height at the end of the diastole. For a long time, however, this refractory period was looked upon as a special peculiarity of the heart. It was not until *Broca* and *Richet*,² twenty years after *Marey's* investigations, discovered an analogous refractory period for the motor centers of the cerebral cortex of the dog. They first made this observation on a dog affected with chorea, in which the choreic movements rhythmically occurred in intervals of one second. They found that after each movement electrical stimulation of the cortex remained without result for about .5 seconds. During the next .25 seconds stimulation was followed by a weak response and it was not until the last .25 seconds before the next movement that a strong effect was produced. They also found in the normal dog a refractory period after every artificial stimulation equal to .1 second, so that the number of contractions brought about by rhythmical electrical stimulation were only ten per second. Following this, numerous other investigations of the refractory period have been made on the central nervous system. *Zwaardemaker*³ and *Lans* have observed a refractory period in the eyelid reflex of the human being which, on stimulation of the optic nerve,

1 *Th. W. Engelmann*: "Beobachtungen und Versuche am suspendierten Herzen III. Refractäre Phase und compensatorische Ruhe in ihrer Bedeutung für den Herzrhythmus." *Pflügers Arch.* Bd. 59, 1895.

2 *Broca et Richet*: "Période réfractaire dans les centres nerveux." *Comptes rendus de l'academie des sciences* 1897. Further *Richet*: "La vibration nerveuse." *Revue scientifique* Déc. 1899.

3 *Zwaardemaker und Lans*: "Ueber das Stadium relativer Unerregbarkeit als Ursache des intermittierenden Charakters des Lidschlagreflexes." *Centralblatt für Physiol.* XIII, 1899.

amounts to about .5-1 second; on the stimulation of the trigeminus produced by blowing on the cornea on the other hand, it is somewhat shorter, less than .25 seconds. *Zwaardemaker*¹ also was able to demonstrate an analogous refractory period for the swallowing reflex of the cat. Further a refractory period was found and closely analyzed by *Verworn*² for the reflexes in the spinal cord of the strychninized frog. *Dodge*³ found a refractory period in the knee jerk reflex of man. *Gotch* and *Burch*⁴ showed, by two induction shocks following each other in quick succession, a refractory period of the nerve, which is characterized by its extremely brief duration. They found, depending upon the temperature, a period of nonirritability of .001-.008 seconds after every stimulus. The investigations of Miss *Buchanan*⁵ lead us to conclude that there is a refractory period for the cross striated skeletal muscle. Miss *Buchanan* stimulated the muscle at times through the nerve, at other times directly after elimination of the nervous element, with very frequent electrical stimuli (about 1000 in the second) and found by means of the capillary electrometer a rhythmical reaction of the muscle of about 50-100 excitation shocks per second. Likewise the *Ritter* tetanus produced by the breaking of an increasing current proved to be a rhythmical reaction of an analogous nature. In a more direct manner *Keith Lucas*⁶ has determined the refractory stage for the musculus sartorius of the frog. He allowed two induction shocks to act successively on the muscle at intervals

1 *Zwaardemaker*: "Sur une phase réfractaire du reflex déglutition." Arch. international de physiologie Vol. I, 1900.

2 *Max Verworn*: "Zur Kenntniss der physiologischen Wirkungen des Strychnins." Arch. f. Anat. u. Physiol. physiol. Abth., 1900. "Ermüdung Erschöpfung und Erholung der nervösen Centra des Rückenmarks." Ibidem, 1900. "Die Biogenhypothese." Jena 1903. "Die Vorgänge in den Elementen des Nervensystems." Zeitsch. f. allgem. Physiologie Bd. VI, 1907.

3 *Dodge*: "A systematic exploration of a normal knee jerk, its technique, the form of the muscle contraction, its amplitude, its latent time and its theory." Zeitsch. f. allgem. Physiol. Bd. XII, 1911.

4 *Gotch and Burch*: "The electrical response of nerve to two stimuli." Journ. of Physiology, Vol. XXIV, 1899.

5 *Florence Buchanan*: "The electrical response of muscle in different kinds of persistent contraction." Journ. of Physiology, Vol. XXVII, 1901-1902.

6 *Keith Lucas*: "On the refractory period of muscle and nerve." Journ. of Physiology, Vol. XXXIX, 1909-1910.

of varied duration and then registered the action currents by means of the capillary electrometer. He then found that the second stimulus was ineffective for about .005 seconds after the application of the first stimulus. If the second stimulus follows somewhat later, it produces a contraction which is weaker and has a longer latent period the nearer the second stimulus approaches the first in point of time. (Figure 30.) *Massart*¹ and *Jennings*² likewise observed the existence of a refractory period for the myoids of unicellular organisms brought about by mechanical stimuli. *Massart* attributes this cessation of reaction to stimuli following each other at certain intervals, to fatigue, an explanation which has been disputed by *Jennings* as the result of his investigations made on *Stentor* and *Vorticella*. *Jennings* looks upon the behavior of the infusoria rather as an "adaptation" to the stimulus. *Pütter* was the first to see in this the existence of a refractory period. His experiments on *Spirostomon ambiguum* in 1900 showed a refractory period in the reaction to rhythmical mechanical stimuli. I wish to state, however, that these observations of *Pütter* have not as yet been published. Thus the existence of a refractory period has even today been proved for a whole series of very different kinds of substances.

We will now examine the alterations of irritability which are perceptible during the refractory period to complete restitution of the specific irritability of the particular system, and endeavor by the analysis of their special conditions to render them comprehensible from a physical standpoint of view.

The first fact to take into consideration is, that, as is shown in the heart, the refractory period begins at the moment of the appearance of the systolic excitation. The irritability of the heart is absent and remains so until the excitation has reached its highest point, that is, shortly before the beginning of the diastole. From this point the restitution of irritability begins, which does not reach the maximum until the end of the diastole. In other words: irritability undergoes the greatest reduction by dis-

1 *Massart*: *Annales de l'Institut Pasteur* 1901.

2 *Jennings*: "Studies on reactions to stimuli in unicellular organisms." IX. *American Journal of Physiology*, 1902.

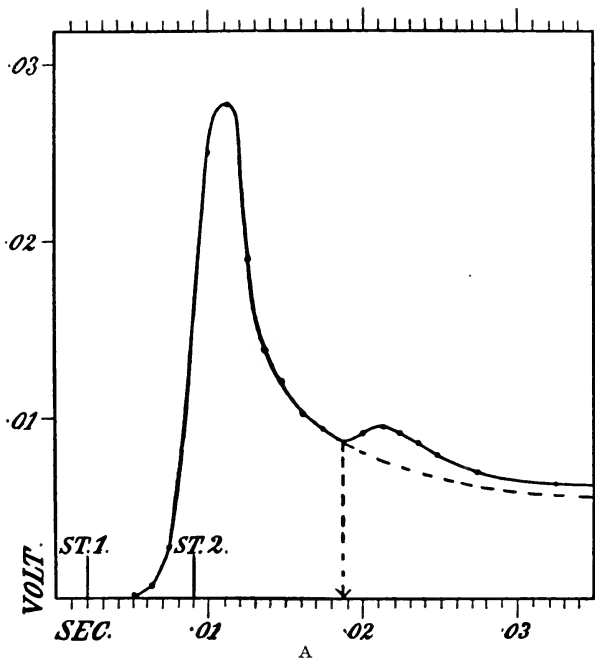

A

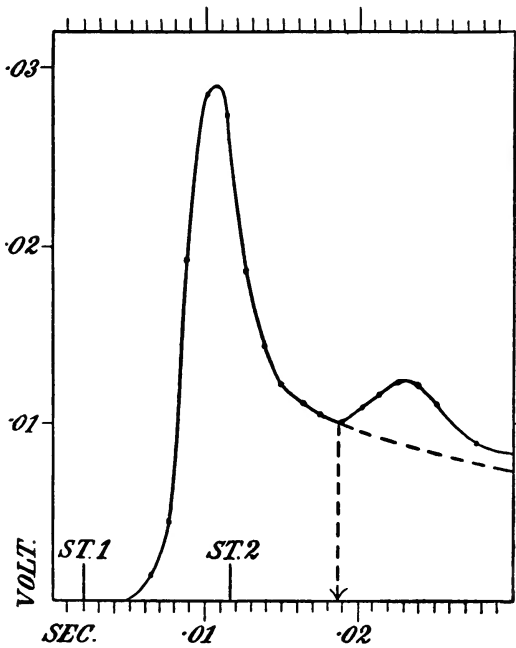

B

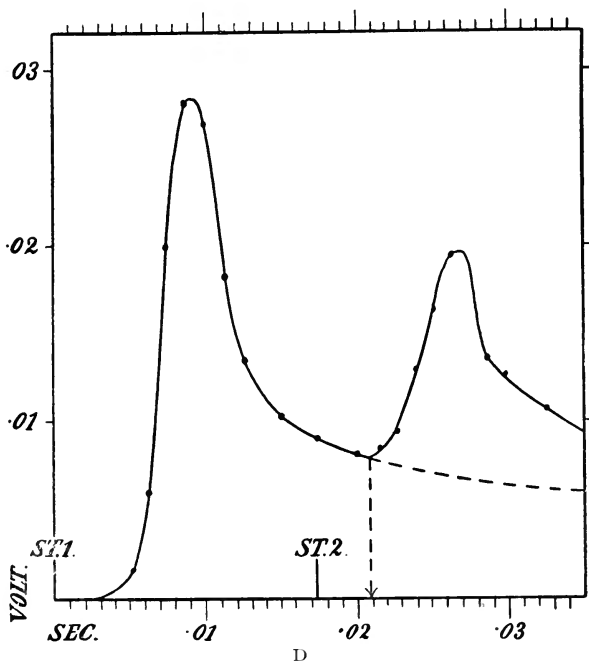
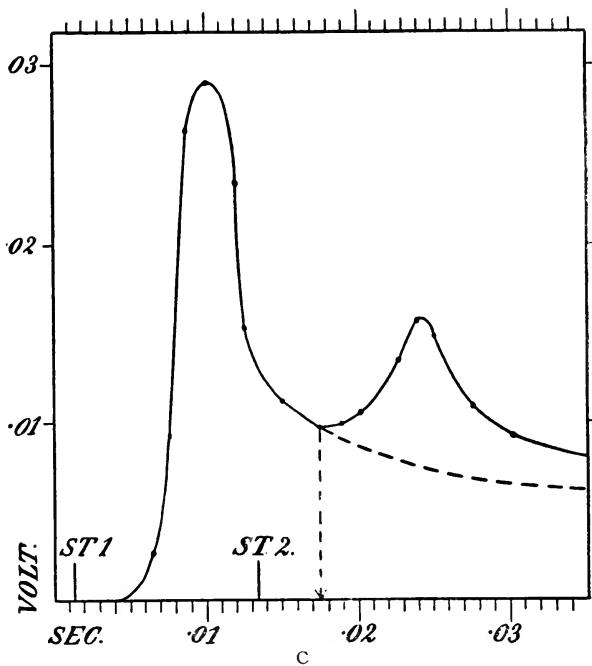

Fig. 30.

Curve of action current of the musculus sartorius excited by two successive stimuli (St. 1 and St. 2). The effect of the second stimulus is the less and the latent period is the longer the more quickly the first stimulus is followed by the second. (Keith Lucas.)

integration produced by the stimulus and is restored by the metabolic self-regulation following the decomposition.

This point of view enables us to interpret this state from a physical standpoint. In this discussion on the relations between irritability and the extension of excitation, I have taken the amount of energy which is produced during the time unit and space unit in a living system as the general standard for the degree of irritability, at the same time duly regarding the individual components involved. This amount of energy is determined in a given system by the quantity of substance broken down by a stimulus of a given intensity. It is, therefore, clear that during the time in which an increased disintegration produced by a stimulus takes place, the irritability in response to a second stimulus must be reduced, as during this period the second stimulus has less of necessary decomposable substances at its disposal, and at the same time there are more products of disintegration in a given space. If a living organism is the subject of consideration, to which the "all or none law" is applicable, as, for instance, the heart at the moment of the beginning of excitation, irritability is completely obliterated, as shown by the fact that the second stimulus of any strength remains without response, for during the excitation there is a complete breaking down of all the substances capable of decomposition. If, on the contrary, a system is the subject of observation, for which the "all or none law" is not valid, then irritability is merely reduced but not wholly obliterated during an excitation, and whether or not a response is obtained to the stimulus depends upon its strength. To impress the relations between the degree of irritability and the intensity of the stimulus, I have, therefore, employed the term "*relative refractory period*" in contrast to the "*absolute refractory period*," in which irritability is obliterated even for the strongest stimuli. It is self-evident that irritability must again increase in the same degree as the restitution of the living system by metabolic self-regulation takes place, for the more molecules capable of disintegrating are restored and the more products of disintegration removed, the more molecules necessary for decomposition in the unit of space are attacked and broken down by the stimulus. All

these are self-evident facts which are in accordance with the conception we have here developed of the course of the process of excitation and its physical nature. But another important point is evolved from the observations we have made of the nature of the process of self-regulation. The process of self-regulation is founded on the same principle as that which governs the taking place of all chemical equilibrium, for metabolic equilibrium is merely a special kind of a chemical equilibrium. The development of a chemical equilibrium between reacting substances and reaction products has, as known, a characteristic course in regard to its duration. If the rapidity with which the equilibrium is reached is expressed by a curve in which the abscissa represents the time, while the ordinates signify the number of contacts of the interacting molecules, the rapidity of reaction is altered with the approach to the equilibrium in the form of a logarithmic curve; that is, the approach to the state of equilibrium, which is represented by ordinate value zero, takes place at first very rapidly, then with more and more decreasing speed, for with the decrease of the number of reacting molecules and the increase of the amount of products of reaction, the contact of the interacting molecules and with this the opportunity for the reaction occurs less and less frequently. Although the self-regulation of metabolic equilibrium is by no means such a simple process as, for instance, that of the well-known example of the forming of ethylester from acetic acid and æthyl alcohol, we have still in every case to deal with the taking place of a chemical mass equilibrium. Hence the progress to the metabolic equilibrium must likewise correspond with a logarithmic curve, i.e., restitution after a disturbance of the equilibrium must take place at first rapidly, then at a constantly decreasing rate. For reasons readily to be understood the special form of this restitution curve has so far not been accurately ascertained for any kind of living substance. Even in those cases where the restitution occurs very slowly we meet with the difficulty that, when the tests are applied which are necessary to determine the restitution at different intervals, with each testing stimulus irritability is each time reduced. Hence the construction of the restitution curve

can only be achieved by indirect means, and we must content ourselves with the ascertainment of a smaller number of its points from which by interpolation its form can be constructed. Indeed in this connection a certain number of results have already been gained quite sufficient to experimentally confirm the correctness of these types of curves, primarily obtained by purely theoretical deductions. That irritability very gradually reaches its maximal height has been already shown, as previously mentioned by *Bowditch*¹ in his investigations on the influence of rhythmical induction shocks on the apex of the heart of the frog. He found that in order to produce response, the weaker the stimuli the longer must be the intervals between them. It follows from this, that after a discharge the irritability in response to strong stimuli reappears more rapidly than for weak, i.e., that they only *gradually* regain their maximum. The exact periods of time for the course of the return of irritability for the heart have unfortunately not been so far ascertained. On the other hand, the investigations of *Ishikawa*² furnish the material for the construction of the restitution curve for the centers of the spinal cord of the frog. *Ishikawa* did not employ the threshold of stimulation as an indicator for the course of restitution, but used instead the duration of the reflex time following on a stimulus of a certain strength. The reflex time is greatly prolonged after an excitation of extended duration and only regains its normal value in the same degree as restitution takes place. By a great number of painstaking experiments *Ishikawa* ascertained the duration of the reflex time at intervals of thirty seconds to one minute, and obtained figures which show that restitution does actually take place, at first rapidly and then with constantly decreasing speed. The detailed study of the course of self-regulation of the individual forms of living substance will doubtless be more exactly determined in the near future. But even at the present we are fully justified in describing the form of restitution curve as a *logarithmic* in type. Therefore, a relative refractory

1 *Bowditch*, l. c.

2 *Hidetsurumaru Ishikawa*: "Ueber die scheinbare Bahnung." Zeitschrift f. allgem. Physiologie Bd. XI, 1910.

period must be present in every metabolic self-regulation after an excitation, during which stronger stimuli produce response, while weaker are still without result. This is a fact which, as we shall see later, is of fundamental importance for the comprehension of the various kinds of interference responses to stimuli.

From the information here gained on the nature and origin of the refractory period the conclusion must inevitably be drawn that in all living substance there must exist, directly following an excitation, a period of time in which its irritability is reduced, that is, under proper conditions a refractory period can be demonstrated for every living organism. Every living system possessing irritability undergoes a period of reduced irritability at the time of and subsequent to every excitation, for every excitation momentarily decreases the amount of products capable of disintegration and increases the disintegration products in the unit of space. As restitution involves time, a stimulus occurring in the phase preceding complete restitution cannot break down the same quantity of molecules as would be the case after the establishment of complete restitution, that is, the response is weaker, the irritability is decreased. The refractory period during and subsequent to excitation is as much a general property of the living substance as irritability and metabolic self-regulation.

This conclusion appears so self-evident that it would seem hardly to call for emphasis were it not that even at the present time the view is still widely held that the refractory period is a special characteristic of certain forms of living substance. This assumption is explained on the one hand by the fact that our information concerning the refractory period is still of comparatively recent date and that few physiologists are in the habit of connecting special observations with general physiological conceptions, but also for the reason that some investigators have vainly tried to find a refractory period in certain forms of living substance. *Langendorff* and *Winterstein*,¹ for instance, have not succeeded in proving a refractory period for the spinal cord of the frog. *Langendorff* stimulated the central sciatic stump

¹ *Langendorff u. Winterstein: "Beiträge zur Reflexlehre." Pfüger's Arch. Bd. 127, 1909.*

with two stimuli in quick succession and used the contractions of the triceps as indicator of the response. He found that when the stimuli, if consisting in either single induction shocks or faradic shocks, followed each other even at intervals of .004 seconds the second stimulus was still operative, this being perceptible in an increase of the contraction or with greater intervals of time in a summation of two contractions. *Winterstein* concludes from this that the development of a refractory period after a stimulation is not a general property of all nerve centers. If the experiments of *Langendorff* failed to show the presence of a refractory period it is not for the reason that this does not take place in the centers of the spinal cord but rather results from the fact that the conditions for the investigation were not suited for its demonstration. In fact, *Fröhlich*¹ and especially *Vészi*² have incontestably proved the existence of relative refractory periods in the normal spinal cord.

If the existence of the refractory period is based on the fact that during the time of and subsequent to an excitation the quantity of substances necessary for disintegration is decreased and that of the breaking down products increased, and if it is limited by the restitution of the substances required for decomposition and the elimination of the disintegration products, its duration must be dependent upon the length of these processes. All factors which lessen the decomposition and hasten the metabolic self-regulation must, therefore, shorten its duration. This is completely confirmed by experimental investigations. As can be understood, the factors of special interest for us are those which influence the duration of the refractory period in the physiological occurrences of the organism.

One of these factors is temperature. As we know, the rapidity of chemical reactions increases with ascending and decreases with falling temperature. As in the disintegration as well as in the restitution, processes are chemical in nature, it is to be expected

¹ *Fr. W. Fröhlich*: "Beiträge zur Analyse der Reflexfunction des Rückenmarks mit besonderer Berücksichtigung von Tonus, Bahnung und Hemmung." *Zeitschrift f. allgem. Physiologie* Bd. IX, 1909.

² *Julius Vészi*: "Der einfachste Reflexbogen im Rückenmark." *Zeitschr. f. allgem. Physiologie* Bd. XI, 1910.

that the duration of the refractory period is influenced in like manner by temperature. Indeed, *Kronecker*¹ found some time ago that in the isolated frog's heart a much more frequent rhythm of stimulation is effective at a higher than at a lower temperature. When the heart is stimulated at a temperature of 11-12° C. with twelve rhythmical induction shocks in the second, every stimulus is operative and produces a systole. If a stimulus of the same frequency is used at a temperature of 5° C., the heart responds merely to every second stimulus. This shows that the refractory period is of longer duration at a lower than at a higher temperature.

A factor of particular interest is the supply of oxygen, for we know its fundamental importance in all aerobic organisms in the breaking down of the living substance. The life of these organisms is primarily dependent upon the supply of oxygen from without. Organic reserve substances for restitution after disintegration are contained in ample quantity in the reserve stores in the living cell substance, whereas oxygen is present in very small quantities in relation to the former. It is, therefore, self-evident that the rapidity of the breaking down processes is very closely dependent upon the amount of available oxygen at hand. Nevertheless it is not the absolute quantity but the relative amount of oxygen in relation to the momentary requirement which is of importance. For instance, the quantity of oxygen present may completely suffice for the oxydative disintegration in the metabolism of rest or at lower temperature, whereas the same amount would be much too small to meet the demand increased by excitation or at higher temperature. In the latter case "*a relative deficiency of oxygen*" occurs. I have introduced the term "*relative deficiency of oxygen*"² for I have found that a number of authors by neglecting the relations of the available oxygen to that which is required at the moment have been led to false conclusions. There is no living object so preëminently fitted to demonstrate in such a striking manner the dependence of

1 *H. Kronecker*: "Das charakteristische Merkmal der Herzmuskelbewegung." Beiträge zur Anatomie und Physiologie als Festgabe Carl Ludwig zum 15 October 1874 gewidmet. Leipzig 1874.

2 *Max Verworn*: "Allgemeine Physiologie." V. Auflage. Jena 1909.

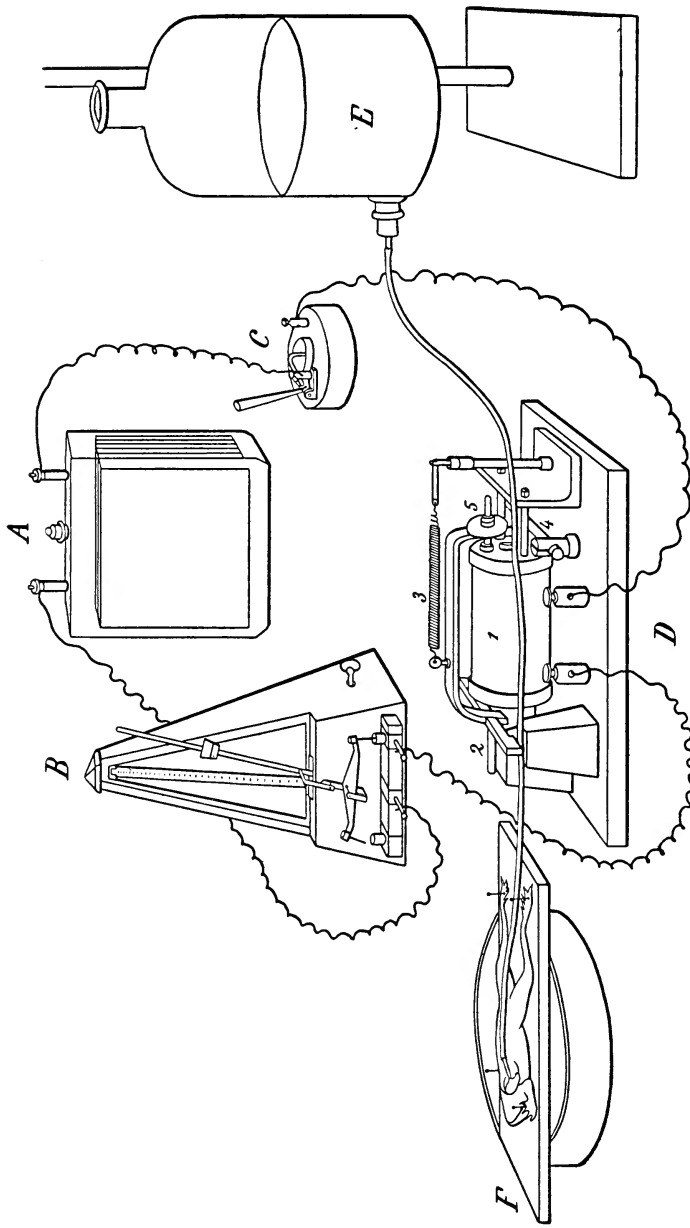

Fig. 31.

Arrangement for an artificial circulation in the frog. A—Accumulator. B—Metronom. C—Mercury key. D—Electromagnetic apparatus for compressing the rubber tube: 1, wire spool with magnet; 2, anchor for pulling back the anchor; 3, spiral spring which pulls back the anchor; 4, axis on which the anchor turns; 5, plate for arresting the anchor. E—Vessel containing saline solution. F—Slab of cork with frog.

the duration of the refractory period upon the supply of oxygen as the spinal cord centers of the frog, when their irritability has been increased to the maximum by strychnine.¹ Various observers, such as *Loven, Buchanan, H. von Baeyer* and others, investigated the action current by the capillary electrometer. As a means of studying the number of impulses in the strychnine tetanus, we can upon the basis of their figures roughly assume the number of impulses to equal ten per second at room temperature. In short, in the freshly strychninized frog the duration of the refractory period is about .1 second. By means of the method of artificial circulation already mentioned a deficiency of oxygen can readily be brought about. It has been demonstrated that the rhythmic in contrast to the continuous method of introduction of circulatory fluid is superior in that the former reproduces more closely the natural conditions of the circulation of the blood and renders the smallest capillaries more permeable. In consequence I have recently constructed a small appliance for artificial circulation, which accomplishes this in a manner as simple as it is complete. (Figure 31.) The fluid flows from a vessel, E, provided with an outlet tube through a thin rubber tube into a glass canula, which is introduced into the general aorta of the frog, F. The tube is automatically occluded by the rhythmical movement of the armature of an electromagnet, D, produced by a metronom, B. The pressure of the circulating fluid can be readily changed at will by varying the level of the vessel and the frequency of the pulse by the rhythm of the metronom, which makes and breaks the current to the electromagnet.² In this way it is possible to artificially replace the normal circulation with satisfactory exactitude and substitute for the blood, circulating in the vessels of the frog, any desired fluid. If the entire quantity of blood of a frog is displaced by a continuous stream of oxygen-free saline solution and a weak strychnine solution is injected with a Pravaz syringe, a violent strychnine tetanus appears after

¹ *Max Verworn*: "Ermüdung Erschöpfung und Erholung der nervösen Centra des Rückenmarks." Arch. f. Anat. u. Physiol. physiol. Abt. Suppl. 1900. The same: Ermüdung und Erholung. Berliner Klin. Wochenschrift 1901.

² As I have not yet described this method elsewhere the above figure will suffice for demonstration.

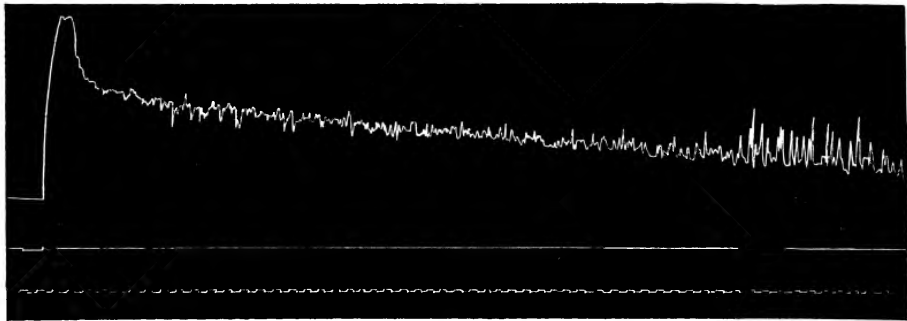

A

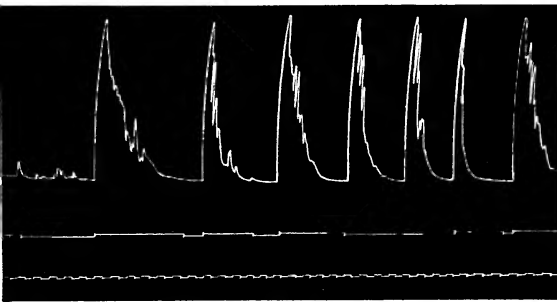

B

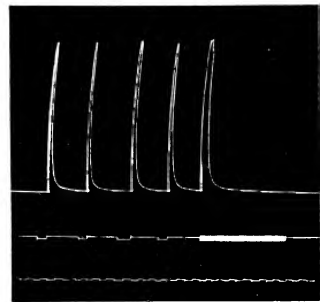

C

Fig. 32.

Muscle curve of strychnine tetanus in a frog with artificial oxygen-free circulation. Lower line indicates seconds. Upper line indicates stimulation by induction shocks. A—A single shock produces a long tetanic contraction. B—In a more advanced stage each shock produces a tetanus only of short duration. C—In a still more advanced stage each shock brings about only a single contraction if the stimuli do not succeed each other too rapidly. If they succeed more rapidly, as, for instance, in a faradic current, only the first shock is effective.

the lapse of a few seconds. (Figure 32, A.) If the artificial circulation with oxygen-free saline solution is now contained in the rhythm of the natural heart beat, the further reactions can then be readily observed. The first long-continued tetanic attack, which can be produced by a slight touch of the skin, is followed by a whole series of tetanic convulsions of prolonged duration, which are repeatedly followed by periods of exhaustion. I wish to emphasize this fact once more, as it appears to me as not without interest for the understanding of the question of reserve sub-

stances. If we assume that at the moment when the entire amount of blood is removed from the vascular system, no oxygen remains in the cells of the spinal cord and muscle, then disintegration of the living substance could from this instant take place exclusively anoxydatively, and there would be no further oxydative breaking down into carbon dioxide and water. The energy production compared in equal number of molecules, taking the figures of *Lesser* for the fermentation of sugar, would approximately amount to about 3.8 per cent. of that of the energy production in the oxydative disintegration of dextrose into carbon dioxide and water. In reality, however, the tetanic convulsions are at first exactly as violent as in the frog with a normal circulation. There simply remains the assumption, therefore, that either the disintegration as soon as it becomes anoxydative involves relatively greater number of molecules than would be the case if it were oxydative in nature, or to suppose that even after the complete displacement of the blood a certain, though relatively small, amount of oxygen is present in the cells which for a short time suffices for the taking place of oxydative disintegration and with this an almost maximal production of energy which naturally decreases as the oxygen is consumed. It seems to me that the latter supposition contains more probability than the first. To return, however, from this observation to a further consideration of the animal we are studying, we see how the complete tetanic convulsions in the refractory period which we assumed to be .1 second are gradually transformed into incomplete tetanus. After a time the tetanic convulsions become shorter after each stimulus (Figure 32, B) and permit us to distinguish their individual movements, even though the latter at first succeed each other still very rapidly. Gradually this incomplete tetanic convulsion assumes the form of a short series of individual contractions, distinctly separated from each other and soon a stage is reached in which each reaction to a peripheral stimulus consists merely in a single contraction. (Figure 32, C.) The refractory period is, however, even now less than a second. Nevertheless, with a further continuation of the experiment, the refractory period becomes more and more prolonged, so that stimuli succeed-

ing each other at intervals of less than a second are without effect. It is possible at this stage, as *Tiedemann*¹ did, to graphically record the reactions. He severed the sciatic nerve on one side and stimulated its central stump, at the same time connecting the triceps with a writing lever. It is then found that when the single induction shocks follow each other at intervals of a second or more every stimulus produces a contraction, but that on the contrary only the first stimulus of a rhythmical series is operative and all those succeeding ineffectual, if the stimuli follow each other at shorter intervals. The refractory period becomes, however, more and more prolonged. The rhythm of the stimulus

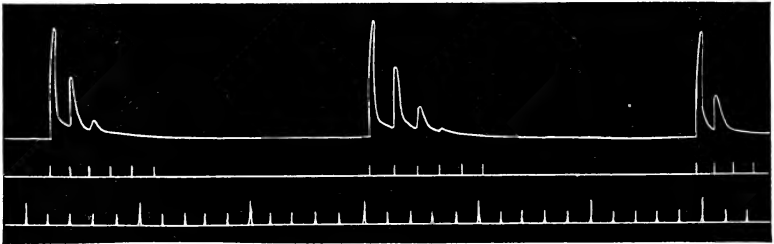

Fig. 33.

Development of the refractory period in the spinal cord of a strychninized frog. Lower line indicates seconds; upper line stimuli. Of a series of stimuli only the first ones are operative with decreasing effect.

must become continually slower if each individual stimulus is to remain effective. If the rhythm is even slightly too rapid only the first few stimuli of a rhythmical series are effective and this with decreasing response and later no contraction at all is observed. With a further continuance of the experiment, the stimuli are only effective when following each other at long intervals. It is necessary that a period of recovery lasting several seconds must take place before the following stimulus can meet with response. (Figure 33.) The refractory period can gradually be prolonged for the space of a minute or longer,

¹ *Tiedemann*: "Untersuchungen über das absolute Refractäer stadium und die Hemmungsvorgänge im Rückenmark des Strychninfrosches." Zeitschrift f. allgem. Physiologie Bd. X, 1910.

until finally irritability does not reappear at all, and even the strongest stimuli fail to produce the least contraction. The continuous manner in which the refractory period is, in the absence of oxygen, more and more prolonged until eventually a prolonged state of nonirritability is developed, can be better followed by observing the experiment than when described in words. If at this stage instead of the oxygen-free saline solution, defibred blood of the ox shaken in air or a saline solution saturated with oxygen is circulated in the frog, restitution is often within a few minutes so complete that tetanic attacks are once more produced by a single stimulus, that is, the refractory period has from being practically nil returned to the normal. This experiment can be repeated several times on the same animal. It is invariably found that the refractory period is prolonged by the withdrawal of oxygen and shortened with a renewed supply.

I have described this experiment somewhat in detail as it contains facts which are the key for the comprehension of a general physiological process of paramount importance. I refer to fatigue. The refractory period and fatigue are inseparably connected, for fatigue is founded on the existence of the refractory period and is an expression of prolongation of the former, brought about by want of oxygen. This is shown at once by closer analysis. It is here necessary to differentiate somewhat more in detail the factors which bring about the *prolongation of the refractory period in deficiency of oxygen*.

If we first turn our attention to the normal refractory period which occurs in a system in metabolic equilibrium of rest in direct connection with dissimilatory excitation, following a momentary stimulus, we find that reduction of irritability or, more exactly expressed, the lessening of the response is, as we have seen, determined by the time involved in the metabolic decomposition and recovery. Both these processes require time and until their completion the quantity of substance demanded for the oxydative disintegration is decreased in a given space, and every stimulus must consequently be followed by a weaker response. Our conceptions of the physical details of these pro-

cesses depend essentially upon the question, if the oxydative disintegration itself in the given living system occurs in one single phase, in that the oxygen is the activator for the oxydative splitting up of the carbon chain, or if this takes place in two periods, in which the carbon chain is first anoxydatively split up into larger fragments by the stimulus, which are then seized upon by the oxygen to be split up into carbon dioxide and water. As we have seen, this question must remain for the present undecided as far as the metabolism of rest as well as the excitation produced by a single momentary stimulus is concerned. It is highly probable that a uniformity of the process for all living systems does not exist. We are, therefore, not justified in assuming that these special chemical processes resulting from single stimuli are uniform throughout the refractory period.

On the contrary it is different in the case of oxygen deficiency. Here we see with increasing want of oxygen a constantly increasing duration of the refractory period, a prolongation which may be attributed to the retardation of the oxydative disintegration. It is necessary, however, that we now study more clearly these alterations brought about by the deficiency of oxygen.

If we follow the course of the changes from that of the normal state of equilibrium of metabolism, wherein oxygen is sufficient to bring about complete disintegration of the molecules to the formation of carbon dioxide and water, we must assume in spite of the great explosive rapidity of this process on the basis of our chemical knowledge, that first a series of intermediate products are produced before finally the end products are formed. In this way the oxydative disintegration produced by a stimulus becomes more and more prolonged by an increasing want of oxygen. If, as I have previously suggested, the amount of energy which is liberated in a given space and time by an exciting stimulus is taken as a standard of irritability, it is apparent that the more the oxydative disintegration following a stimulus is retarded, the greater must be the decrease in irritability. The less oxygen there is at disposal and the more incomplete the oxydative breaking down, the smaller is the degree of irritability, the weaker the response and the slower the return of irritability after every

stimulus. In other words, with the increasing deficiency of oxygen, the response is not merely reduced for every stimulus, but the duration of the refractory period is likewise progressively prolonged until finally with an absolute want of oxygen, constant and complete depression takes place. In the genesis of this process another factor, however, has the same effect.

While with a sufficient supply of oxygen disintegration leads to the formation of carbon dioxide and water, therefore to end products, which can quickly and easily be removed by diffusion, the want of oxygen produces complex products of incomplete combustion and finally of anoxydative decomposition, such as lactic acid, fatty acids and even more complex substances in constantly increasing quantities. These products permeate the protoplasmic surfaces with great difficulty, if at all, and as they cannot subsequently be oxydatively split up, constantly accumulate. These asphyxiation substances, as they may be briefly termed, produce a depressing effect on further disintegration. This can be experimentally demonstrated.

For this purpose I have modified the experiment previously described in the way that after every introduction into the blood of oxygen-free saline solution and after the injection of strychnine, the artificial circulation was stopped so that stagnation of the oxygen-free saline solution took place in the vascular system. The processes then occurred in exactly the same manner with the exception that the state of non-irritability appeared somewhat earlier. If after the beginning of complete depression artificial circulation with oxygen-free saline solution was again started, a certain degree of recovery took place within one or more minutes. The stimuli were once more effective and produced a number of contractions. At times, several single contractions, following each other in more or less quick succession, could be brought about. But complete recovery or the appearance of even incomplete tetanic convulsions was never again obtained, whereas by the introduction of oxygen complete recovery could at once be brought about. If, however, the circulation with oxygen-free saline solution was continued, irritability gradually decreased. The refractory periods after the individual stimuli became longer,

and in spite of continuous artificial circulation irritability *again* disappeared. The experiment shows that by the circulation of oxygen-free solution irritability can simply be reduced up to a certain degree. This partial restitution is produced by washing out the depressing metabolic products. Being desirous to verify the results of this investigation with greater exactitude I have requested *Dr. Lipschütz*¹ to repeat the experiments, taking the utmost possible precaution in respect to the absolute exclusion of oxygen. *Lipschütz* has tested the normal saline solution made oxygen free with the sensitive *Winkler* method, in which the slightest trace of oxygen is shown by the oxydation of manganous chloride to manganic chloride in which the latter in a saline solution sets free an amount of iodide from iodide of potassium corresponding to that of the consumed oxygen. These experiments of *Lipschütz* have shown that even with the absolute exclusion of the slightest trace of oxygen a partial recovery can be brought about by artificial circulation. There can be, therefore, no doubt that recovery is actually founded on the removal of the depressing asphyxiation substances by artificial circulation. Moreover *Fillié*² has previously succeeded in the laboratory at Göttingen in obtaining by the same methods a corresponding result for the nerve. In both cases the experiments are extremely complicated and must be carried out with the most painstaking care. The depressing influence of the asphyxiation products need not be regarded as a specific effect of poisoning. It can be solely an expression of mass relations, if we assume that the anoxydative decomposition is controlled by a chemical equilibrium between masses capable of disintegrating and products of the disintegration. It is not possible to give any detailed account as to the part taken by accumulating asphyxiation substances in the prolongation of the refractory period. Indeed, we must for the present relinquish the attempt to delimitate quantitatively the part taken by the individual constituent processes in the symptoms of depression resulting from the deficiency of oxygen. We can merely

1 *Alexander Lipschütz*: "Ermüdung und Erholung des Rückenmarks." Zeitschr. f. allgem. Physiologie Bd. VIII, 1908.

2 *Fillié*: "Studien über die Erstickung und Erholung des Nerven in Flüssigkeiten." Zeitschr. f. allgem. Physiologie Bd. VIII, 1908.

say, the individual alterations produced by the want of oxygen, that is, the restriction and retardation of the oxydative disintegration, the corresponding increase of the anoxydative decomposition and the accumulation of the products of incomplete oxydation and anoxydative breaking down have the same influence in that they decrease the strength of the response and retard the rapidity of the decomposition process. These are the general effects perceptible in the refractory period by the deficiency of oxygen.

The establishment of these facts of the dependence of the refractory period upon oxygen are of the utmost importance for the genesis of fatigue, for the state of fatigue in all aërobic organisms is invariably brought about by deficiency of oxygen. In other words: *fatigue is invariably asphyxiation*. A deficiency of organic reserve substances never occurs in fatigue before the effect of oxygen deficiency leads to complete depression, for the quantity of organic reserve substances at the disposal of the cells is greater comparatively than that of oxygen. This is shown by transfusion experiments in which the time involved before complete paralysis was brought about in the frog by the introduction of an oxygen-free saline solution was ascertained and compared with the period which elapsed before complete paralysis took place, when the same solution saturated with oxygen was used.

Although the previously described experiments on the strychninized frog show clearly the relations of fatigue to the refractory period, I should, nevertheless, like to illustrate them somewhat further.

The state of fatigue as it is developed in a living system by a continuous functional activity is characterized by a series of symptoms which can be best studied in the fatigue of the muscle, the nervous centers, and the peripheral nerves.

If the muscle of the frog is isolated and rhythmically stimulated with single induction shocks and the muscle contractions graphically recorded, it will be found that the first perceptible alteration during the course of stimulation is the increasing height in the curve, which appears directly after the first contraction and becomes more and more noticeable after every

succeeding one. With the isolated apex preparation of the frog's heart an effect is produced which *Bowditch*¹ has termed the "Treppe" and *Tiegel*,² *Minot*³ and others have obtained the same result for the skeletal muscle. The *Treppe* has been often regarded as an expression of increasing of capability of the muscle following each succeeding stimulus in spite of the fact that it is physiologically incomprehensible that an isolated muscle can become more capable by increased demands. *Fröhlich*⁴ first threw light on this seeming contradiction by showing that the increase in height of the muscle contraction in the *Treppe* is in reality the first indication of the beginning of fatigue, and *Fr. Lee*⁵ arrived at the same result. The increase in height of the contraction curve depends upon the retardation of the course of contraction. As the contraction extends over the muscle substance in the form of a wave, a longer stretch of the muscle will be in a state of contraction when the wave is more extended than when it is shorter, that is, the shortening of the muscle will be greater, the contraction curve higher, when the wave is more extended. With increasing fatigue the retardation in the course of contraction, as *Rollet*⁶ already has shown, becomes continuously greater. (Figure 34.) The consequence of this retardation in the course of contraction is, therefore, perceptible in the rhythmically activated muscle in the form of contracture. As fatigue increases, the muscle requires an increasing length of time to relax to its full extent and in consequence the period between the two stimuli is very soon insufficient for this to occur. There

1 *Bowditch*: "Ueber die Eigenthümlichkeiten der Reizbarkeit, welche die Muskelfasern des Herzens zeigen." Arbeiten aus der physiologischen Anstalt zu Leipzig VI Jahrgang 1871, Leipzig 1872.

2 *Tiegel*: "Ueber den Einfluss einiger willkürlichen Veränderungen auf die Zuckungshöhe des untermaximal gereizten Muskels." Arbeiten aus der physiol. Anst. zu Leipzig X Jahrgang 1875, Leipzig 1876.

3 *Minot*: "Experiments on tetanus." Journ. of Anat. and Physiol. Vol. XII.

4 *Fr. W. Fröhlich*: "Ueber die scheinbare Steigerung der Leistungsfähigkeit des quergestreiften Muskels im Beginn der Ermüdung. (Muskel Treppe), der Kohlensäurewirkung und der Wirkung anderer Narcotica (Aether, Alkohol)." Zeitschr. f. allgem. Physiologie Bd. V, 1905.

5 *Frederic S. Lee*: "The cause of the Treppe." Americ. Journ. of Physiol. Vol. XVIII, 1907.

6 *Alexander Rollet*: "Ueber die Veränderlichkeit des Zuckungsverlaufs quergestreifter Muskeln bei fortgesetzter periodischer Erregung und bei der Erholung nach derselben." Pflügers Arch. Bd. 64, 1896.

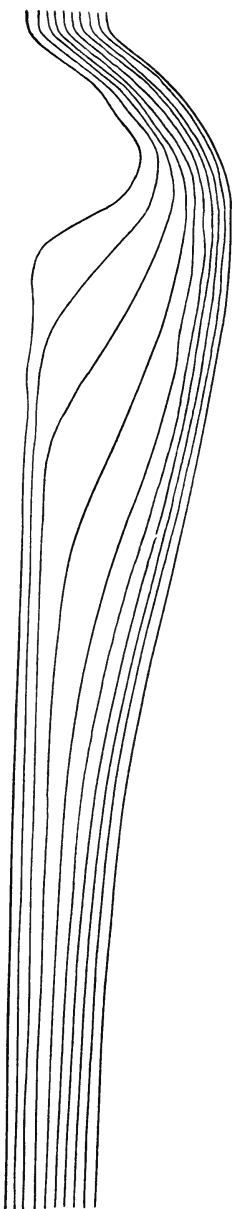

Fig. 34.

Series of muscle curves graphically recorded one over the other, showing the retardation in the course of contraction with increasing fatigue. (After Rollet.)

remains a certain amount of shortening, when the next contraction begins. This characteristic extension of the individual contraction curve of the fatigued muscle is an expression of the retardation of the oxydative disintegrating processes and of the *Treppe*. It shows us that fatigue is perceptible to a slight degree even after the first excitation. After every succeeding stimulus the oxydative decomposition in the fatigued muscle is increasingly prolonged. It is, therefore, self-evident that the capability of action of the muscle likewise becomes less with increasing fatigue. Every state of fatigue is, in fact, distinguished by the decrease of response. This is perceptible in the later stages by the decline of the height of contraction. Hence all symptoms of fatigue which we observe form the expression of one single process; it is the constantly increasing slowness of oxydative disintegration with increasing fatigue.

Exactly similar conditions as those of the muscle are seen in the central nervous system. The reflex contraction of the triceps of the frog produced by stimulation of the central end of the sciatic nerve with single induction shocks demonstrates clearly as *Ishikawa*¹ has proved in certain stages of fatigue, an increase in height and a strong relaxation which does not depend upon the fatigue of the muscle but on that of the centers. If the fatigue is greater, the height of the contraction then decreases, whereas the extension of the course of relaxation increases further. The possibility of fatigue of the muscle during these experiments was, of course, precluded by proper precautionary measures. Irritability and the course of excitation in fatigue of the centers show exactly the same alterations as developed in fatigue of the muscle. The processes of oxydative breaking down are retarded more and more with increasing fatigue, that is, fatigue is characterized by exactly the same processes as is the prolongation of the refractory period by the deficiency of oxygen, and likewise in fatigue this retardation of the oxydative disintegration processes is conditioned by the relative deficiency of oxygen. This is shown by the rôle played by oxygen in recovery after fatigue.

¹ *Hidetsurumaru Ishikawa*: "Ueber die scheinbare Bahnung." *Zeitschr. f. allgem. Physiologie* Bd. XI, 1910.

It was found by *Hermann*¹ in 1867 and confirmed by Mademoiselle *Joteyko*² in *Richet's* laboratory, that the isolated muscle of the frog, which was completely nonirritable as the result of fatigue, does not regain irritability in an oxygen-free medium, but does so when oxygen is introduced. The previously described experiments of artificial circulation in the frog show clearly how dependent the centers are upon the oxygen supply for the restoration of irritability. In consequence of the strychnine poisoning the irritability of the centers is so enormously increased that the "all or none law" is applicable to the centers of the spinal cord under these conditions.³ These are the best conditions for the production of fatigue. One can readily demonstrate the importance of the oxygen supply for the rapidity with which irritability returns after fatigue if in the strychninized frog an artificial circulation is used, at the same time varying on one hand the amount of oxygen, on the other the activity of the centers. If a saline solution containing merely a trace of oxygen is circulated, the centers recover very slowly and incompletely after every fatigue. Subsequent to every reaction produced by a stimulus, an increasing length of time is required until irritability is so far recovered that a new stimulus can meet with response. If, however, a saline solution is circulated which has been saturated by being shaken with oxygen and is continuously in a pure atmosphere of oxygen, recovery takes place in comparison with far greater rapidity and completeness. If the supply of oxygen is ample and the stimuli act at longer intervals on the frog, irritability always is quickly restored in the periods of rest between the stimuli. With continuous stimulation of quickly succeeding stimuli, irritability is soon completely obliterated, even though an abundant oxygen supply be present, and it is not until a pause is interpolated that oxygen is capable of bringing about a recovery. By manifold variations of these experiments the connection between fatigue and the refractory period can be more and more

1 *Hermann*: "Untersuchungen über den Stoffwechsel der Muskeln ausgehend vom Gaswechsel derselben." Berlin 1867.

2 *Joteyko*: "La fatigue et la respiration élémentaire du muscle." Paris 1896.

3 *Julius Vészi*: "Zur Frage des Alles oder Nichts Gesetzes beim Strychninfrosch." Zeitschr. für allgem. Physiologie Bd. XII, 1911.

clearly recognized. *Fatigue is simply the refractory period prolonged by deficiency of oxygen.* In both cases there is a diminution of irritability. In both cases this diminution is conditioned by a retardation of oxydative disintegration following every stimulation. In both cases it is the relative deficiency of oxygen which produces this delay. In both cases the oxydative decomposition can be quickened and irritability restored, that is, the refractory period lessened and fatigue removed by a sufficient supply of oxygen. The amount of oxygen which suffices to constantly maintain the specific irritability of a living system in an undisturbed metabolism of rest is not sufficient if the system is continuously functionally activated by stimulation. The refractory period increases after excitation and merges, although very gradually, finally into permanent nonirritability, that is, into complete fatigue.

The knowledge that fatigue represents a prolonged refractory period resulting from relative deficiency of oxygen has enabled me with the aid of my coworkers to demonstrate the existence of fatigue and produce the typical symptoms experimentally for a living tissue, which up to then was considered indefatigable: I refer to the medullated nerve. After having found that the condition necessary for the production of fatigue in the nervous centers is a deficiency of oxygen, I arrived at the conclusion that fatigue could only be obtained in the medullated nerve when subjected to a deficiency of oxygen. Up to that time, however, no consumption of oxygen was known for the nerve. It was, therefore, necessary to first ascertain if the nerve possessed an oxydative metabolism. At my request, *H. von Baeyer* investigated these questions. After many vain attempts to obtain absolutely pure nitrogen, we finally succeeded in finding a method by which it is possible to gain nitrogen gas, which is, one might almost say, in a mathematical sense absolutely pure. It was then possible for *H. von Baeyer*¹ to asphyxiate the nerve and subsequently to bring about complete restoration by the introduction of oxygen. It was shown that the nerve requires merely a minute quantity of

¹ *Hidetsurumaru Ishikawa*: "Ueber die scheinbare Bahnung." *Zeitschr. f. allgem. Physiologie* Bd. III, 1904.

oxygen and only completely asphyxiates when the last trace of oxygen is removed, and further that recovery takes place within a fraction of a minute if the oxygen is again supplied. These experiments which have been carried further by *Fröhlich*¹ were afterwards confirmed in other laboratories,² and form the basis for proving the existence of fatigue of the medullated nerve. Shortly after, *Fröhlich*³ was able to demonstrate symptoms of fatigue in the medullated nerve. He found that the refractory period of the nerve, which, as previously mentioned, *Gotch* and *Burch* fixed at about .005 second duration, was prolonged by oxygen deficiency to .1 second, so that stimuli following each other oftener than ten times per minute produced merely single initial contractions in the muscle concerned, that is, in a series of stimuli of which the intervals are less than .1 per second, only the first produces response, whereas the following occur in the refractory period, brought about by those preceding, and are, therefore, inoperative. The nerve is fatigued by the quick succession of stimuli. The normal nerve on the contrary invariably responds, as known, to an even more rapid succession of stimuli with a rhythmical excitation corresponding to the number of stimuli and which is manifest in the muscle by a tetanus. This again confirmed the identity of fatigue with the prolonged refractory period, conditioned by the relative want of oxygen. It likewise explained the conditions of the analogous behavior that *Wedensky*⁴ had observed in the narcotized nerve, but had neither

1 *Fr. W. Fröhlich*: "Das Sauerstoffbedürfniss des Nerven." Zeitschr. f. allgem. Physiologie Bd. III, 1904.

2 *K. H. Baas*: "Zur Frage nach dem Sauerstoffbedürfniss des Froschnerven." Pflügers Arch. Bd. 103, 1904.

K. Frick: "Die Abhängigkeit der Erregbarkeit des peripherischen Nerven vom Sauerstoff." Inaugural Dissertation vorgelegt der medicinischen Facultät der Univers. Berlin (Aus dem physiologischen Institut der Univers.). Berlin 1904.

Uchtomsky und Dernoff: "Zur Frage nach dem Sauerstoffbedürfniss der Nerven." Travaux du laboratoire de Physiologie a l'université de St. Petersburg II Année 1907.

3 *Fr. W. Fröhlich*: "Die Ermüdung des markhaltigen Nerven." Zeitschr. f. allgem. Physiologie Bd. III, 1904.

4 *Wedensky*: "Die fundamentalen Eigenschaften des Nerven unter Einwirkung einiger Gifte." Pflügers Arch. Bd. 82, 1900.

The same: "Erregung, Hemmung und Narkose." In the same place. Bd. 100, 1903.

recognized as manifestation of the prolonged refractory period nor as fatigue. A further advance was made by the investigations of *Thörner*. He placed two nerves of the same frog in a double chamber under completely identical conditions with the exception that one remained in a state of rest, whilst to the other tetanic stimuli were applied. (Figure 35.) If this took place in

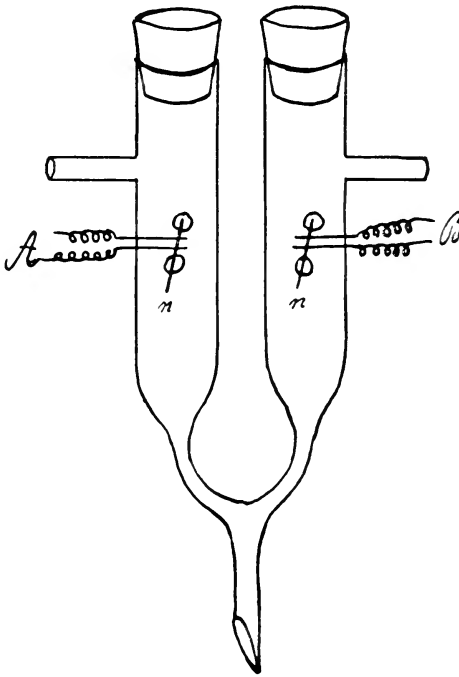

Fig. 35.

Double glass chamber for comparative experiments on fatigue of the nerve (*n n*). A and B—Wires of the electrodes. (After *Thörner*.)

nitrogen, the irritability of the stimulated nerve invariably sank with much greater velocity than that of the nonstimulated, whereas after an introduction of oxygen, even when the stimulation was continuous, both again recovered. In these experiments of

*Thörner*¹ the action current and not the muscle contraction served as indicator. Here the fatigue of the medullated nerve brought about by the deficiency of oxygen during prolonged stimulation is demonstrated in the most obvious manner. (Figure 36.)

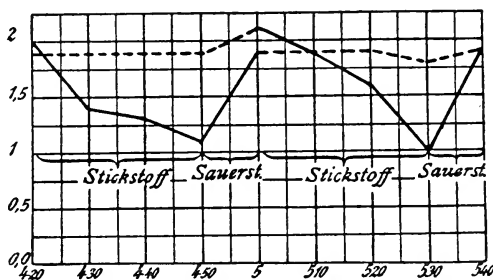

Fig. 36.

Curve of action current of two nerves, one of which is stimulated (plain line) whilst the other remains at rest (dotted line). After decrease of irritability of the stimulated nerve in nitrogen, oxygen is introduced into the chamber and irritability increases again. Then the previously resting nerve is stimulated in nitrogen and the stimulated nerve remains at rest. (After *Thörner*.)

*Thörner*² further succeeded by a continuous stimulation of the nerve in obtaining even in atmospheric air the indications of primary fatigue. The symptoms were exactly the same as those characterizing fatigue of the muscle; the extension of the course of excitation and, as a consequence of this, the appearance of a summation of excitation produced by tetanic currents and a reduction of irritability in response to single stimuli. The form of the curve, resulting from alteration of irritability in fatigue and recovery, likewise shows complete conformity with that of the muscle. (Figure 37.) Finally *Thörner*³ proved that the nerve, when fatigued by continuous tetanic stimulation in nitrogen, could also partially recover in the latter if the stimulation was

1 *Thörner*: "Die Ermüdung des markhaltigen Nerven." Zeitschr. f. allgem. Physiologie Bd. VIII, 1908.

2 *Thörner*: "Weitere Untersuchungen über die Ermüdung des markhaltigen Nerven. Die Ermüdung in Luft und die scheinbare Erregbarkeitssteigerung." Zeitschr. f. allgem. Physiologie Bd. X, 1910.

3 *Thörner*: "Weitere Untersuchungen über die Ermüdung des markhaltigen Nerven. Die Ermüdung und Erholung unter Ausschluss von Sauerstoff." Zeitschr. f. allgem. Physiologie Bd. X, 1910.

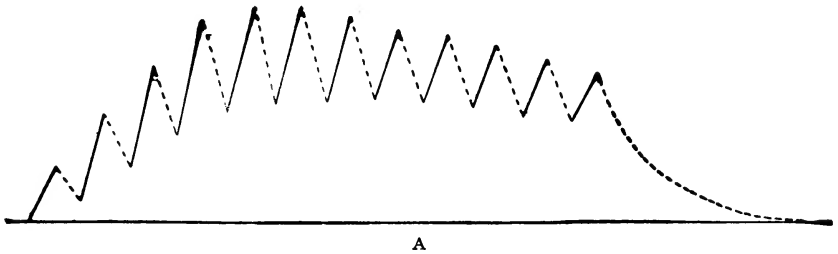

Scheme showing course of fatigue (plain line) and recovery (dotted line) of the nerve as it is manifested on testing the irritability with tetanic stimuli, when fatigue and recovery alternate at equal intervals. The curve shows at the beginning an apparent increase of irritability corresponding to the "Treppe" of the muscle. (After Thörner.)

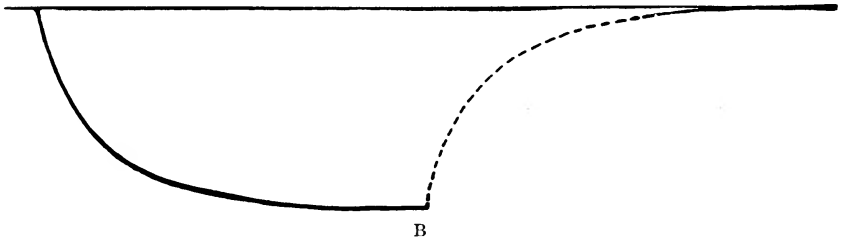

Fig. 37.

Scheme showing course of fatigue (plain line) and recovery (dotted line) on testing the irritability of the nerve by single induction shocks. In fatigue irritability sinks at first rapidly, then more and more slowly until a state of equilibrium is reached. Recovery shows the same in reverse succession. (After Thörner.)

interrupted, whereas a complete recovery could not take place unless a supply of oxygen was introduced. (Figure 38.) This fact is in perfect accordance with the relations found by *Verworn*, *Lipschütz*, in fatigue of the nervous centers. It is the expression for the accumulation and removal of fatigue substances, the depressing effect of which *Ranke*¹ first established for the fatigued muscle. The fact that the nerve could also partially recover in an atmosphere of nitrogen would seem to likewise contain the proof that among the fatigue substances products in the form of gas must be present. It is probable that an escape of carbon dioxide has taken place.

¹ *Ranke*: "Untersuchungen über die chemischen Bedingungen der Ermüdung des Muskels." Arch. f. Anat. u. Physiol. 1863 u. 1864.

As a result of all these investigations, linked together in a systematic series, the proof has now been obtained that the nerve like all other living substances is fatigable. Its fatigue is solely the manifestation of a prolonged refractory period and the extension of the latter by continuous stimulation is, as in all aërobie substances, a result of relative deficiency of oxygen.

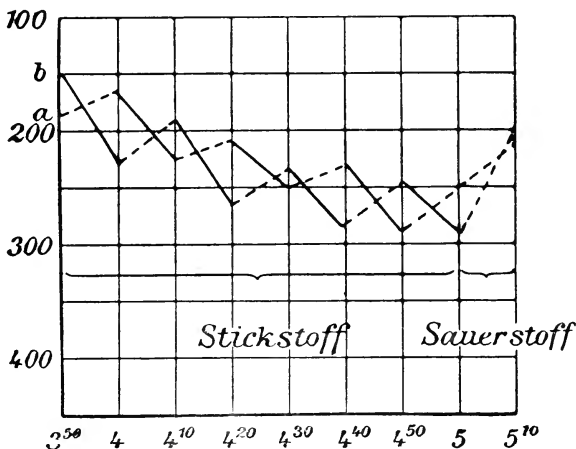

Fig. 38.

Curve of irritability as demonstrated by action current of two nerves in nitrogen, which are alternatively stimulated (plain line) and at rest (dotted line). Recovery in nitrogen is always merely partial and relative. It only increases on introduction of oxygen. (After *Thorner*.)

To briefly summarize in conclusion, I will repeat that just as all living systems show a refractory period after an excitation, in which irritability is reduced, all living systems are likewise capable of fatigue. Both are most intimately connected and are based fundamentally on the facts of metabolism.

An exciting stimulus disturbs the metabolic equilibrium of rest by suddenly bringing about increased decomposition of certain substances. During and directly after the breaking down, irritability is reduced in the same degree as the amount of substances required for disintegration in response to a succeeding stimulus is decreased and the quantity of the decomposition

products is increased. This is the refractory period. By the metabolic self-regulation in accordance with the principle of chemical equilibrium, the original metabolic equilibrium is restored after every excitation. Irritability, therefore, increases in the same measure as this occurs, that is, in the form of a logarithmic curve, until it again reaches the specific degree of irritability of the particular system. The refractory period diminishes. If the processes of disintegration and self-regulation are delayed, either by want of substance necessary for breaking down or the accumulation of decomposition substances, the refractory period is prolonged and the response to every further stimulation decreased, that is, the system is fatigued. In all aërobie organisms the retardation of the course of excitation and self-regulation under a continuous influence of stimuli is the result of the relative want of oxygen. The processes of oxydative disintegration are prolonged and restricted by relative deficiency of oxygen and merge more and more into anoxydative decomposition. The products of incomplete oxydative and anoxydative decomposition accumulate. Both factors decrease the strength of the response after every stimulation. Thus the want of oxygen leads to reduced activity. In the anaërobie organisms the refractory period and symptoms of fatigue are, of course, produced by the relative deficiency of other substances. Fatigue in the anaërobie systems has, however, so far not been investigated. We advance very slowly, step by step, in physiology, and, as in every science, an acquirement of a new knowledge means a new problem. In this lies the inexhaustible charm of our scientific research.

CHAPTER VIII

INTERFERENCE OF EXCITATIONS

Contents: Examples of effects of interference of stimuli in unicellular organisms. Interference of galvanic and thermic stimuli in Paramecia. Interference of galvanic and thermic stimuli and narcotics. Interference of galvanic and mechanical stimuli. Interference of galvanotaxis and thigmotaxis in Paramecia and hypotrich infusoria. Real or homotop interference, apparent or heterotop interference. The two effects of homotop interference of excitations: Summation and inhibition of excitations. Theory of the processes of inhibition. *Hering-Gaskell* theory. Inhibition as an expression of the refractory period. Individual possibilities of interference of two stimuli. Interference of an exciting and a depressing stimulus. Interference of two depressing stimuli. Interference of two exciting stimuli. Analysis of the interference of two excitations. Interference of two single stimuli. Conditions upon which the result of interference is dependent. Heterobole and isobole living systems. Intensity of the two stimuli. Interval between the stimuli. Specific irritability and rapidity of reaction of the living system. Latent period. Interference of single stimuli in a series. General scheme of the development of the effect of interference. Summation and inhibition. Apparent increase of irritability. Conditions of summation. Tonic excitations. Conditions of inhibition. Various types of inhibition. Interference of two series of stimuli. Relations in the nervous system. Peculiarities of the nerve fibers. Conversion of the nerve by relative fatigue from an isobolic into a heterobolic system.

Until now the mechanism of the single excitation has received the major portion of our attention. It was not until we reached the subject of the origin of fatigue that we became acquainted with the effects of repeated stimulation. Here we found a case of interference of individual excitations. But fatigue is simply a special instance of such interference, for the subject of interference action occupies a much greater field.

Every cell of the larger organisms, and more especially the single celled organisms, is subjected to manifold stimuli. It is

indeed, quite common that two stimuli interfere with each other and manifold effects follow, depending upon the specific reaction of the cell and the quality, intensity and duration of the interfering stimuli. Sometimes the interference effect is readily understandable from a knowledge of the specific effect of the individual stimuli concerned. At other times, however, the specific reaction seems entirely different in nature than would be expected from a study of the effects of the individual stimuli.

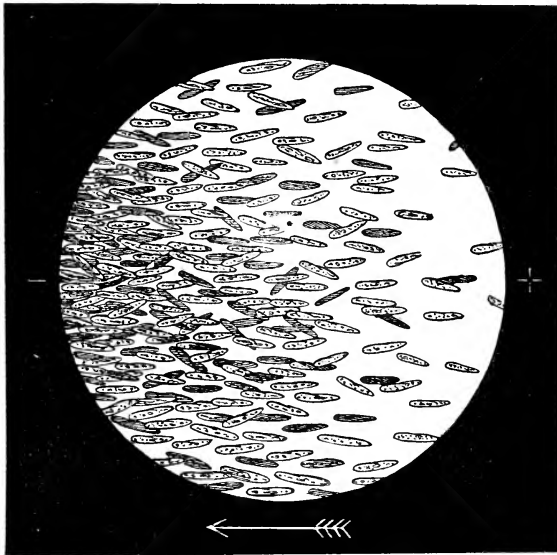

Fig. 39.

Galvanotaxis of *Paramecium aurelia*.

When I place a drop of *Paramecium* culture on a slide having on two sides parallel pieces of baked clay which serve as electrodes and allow a constant current of about .2 milliampère to flow through, it will be seen that the infusoria at room temperature move toward the negative pole at a rate averaging 1-1.4 mm. per second. (Figure 39.) If I increase the temperature, the rate of movement is increased. Here the galvanic and the thermal stimuli influence each other in such a manner that the reaction

to the galvanic is increased by the thermal stimulation. This summation of excitation is readily understood on the basis of the laws concerning the effect of temperature upon the velocity of chemical change established by *van't Hoff*. If, however, the *Paramecia* are in a 1 per cent. alcoholic solution, then, as was shown by *Nagai*,¹ the rapidity of movement following galvanic stimulation is decidedly reduced. The interference effect between the galvanic and chemical stimulation is, because of the depressing effect of the latter, likewise readily understood.

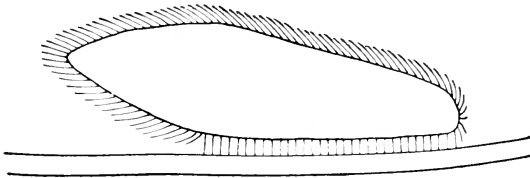

Fig. 40.

Thigmotaxis of *Paramecium aurelia*. (After *Jennings*.)

Greater difficulty meets us, however, in the following instance. The forward movements of the *Paramecia* follow in consequence of the fact that the individual cilia of the body lash more powerfully backward than forward. If now the *Paramecia*, while moving forward, meet with a resisting body, they withdraw sideways while executing a sudden strong forward ciliary stroke. The strong mechanical stimulation brings about retraction of the organism. Entirely different are the results when the impact is weak. If *Paramecia* while slowly swimming touch a resisting object with the anterior portion of the body, withdrawal does not occur. The infusoria remain under proper conditions in contact with the resistance, and the rhythmic activity of the cilia directly against resistance, as well as those on the other side toward the posterior portion of the body, are more or less inhibited. (Figure 40.) The degree of inhibition brought about by this weak mechanical stimulation may vary considerably. At times the cilia

¹ *Nagai*: "Der Einfluss verschiedener Narcotica, Gase und Salze auf die Schwimgeschwindigkeit von *Paramecium*." *Zeitschr. f. allgem. Physiologie* Bd. VI, 1907.

of the whole body suddenly cease their movement. (Figure 41, A.) At other times, this cessation is limited to the cilia in the anterior portion of the body (Figure 41, B), while the movements of those on the posterior portion of the body are of less amplitude or are irregular and weak. In all cases the infusorium remains quiescent in the water in contact with the resistance, and it is not uncommon to find numerous individuals in apposition with particles of ground, slimy detritus, plant fibers and so forth. (Figure 41, C.) In short, the rhythmic activity of the cilia of

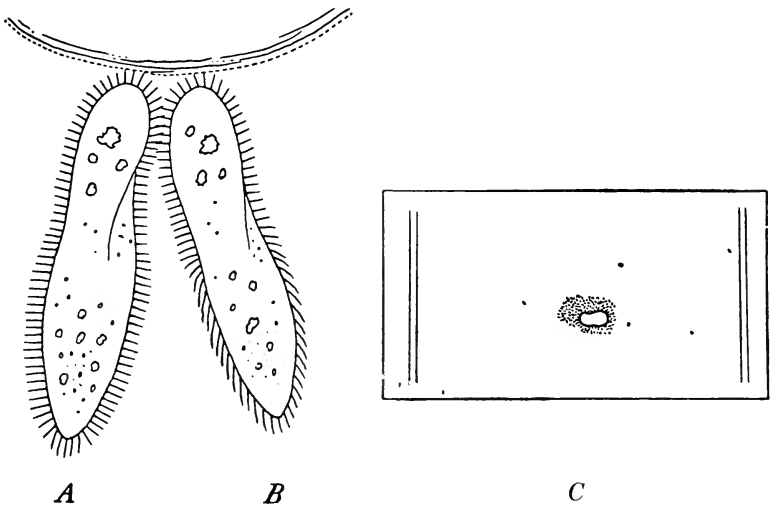

Fig. 41.

Thigmotaxis of *Paramecium aurelia*.

the *Paramecia* receiving their normal impulses of excitation from the ectoplasm of the cell body interfere with strong mechanical stimuli in such a manner that a negative thigmotaxis develops; following weak mechanical stimuli a positive thigmotaxis results. Here is an instance of the relation between the intensity of the stimulus and the manner in which its effects interfere with an already existing excitation.

However, the strength of the inhibitory effect of a weak contact stimulus upon another excitation is best appreciated when

positive thigmotaxis is interfered with by the effect of a thermal or galvanic stimulus. *Jennings*¹ and especially *Pütter*² have, at my request, more thoroughly investigated my original observations and have given us a complete analysis of these interesting interference effects. If the freely swimming *Paramecia* are subjected to a constantly increasing temperature, the movements of these infusoria become more and more active. At 30° C., the rapidity is very violent and at about 37° C. they reach their maximal. If now the same experiment is repeated with *Paramecia* which have in consequence of thigmotaxis fixed themselves to particles of slime, the temperature may be increased to 30° C. without an observable effect. The infusoria remain throughout in contact with the resistance. Only when the temperature is 37° C. do they release their contact and move violently through the water. If a drop containing *Paramecia* is placed on a slide, between parallel pieces of fired clay which serve as electrodes, it will be seen that some freely swim about, whereas others remain thigmotactically in contact with particles of slime. When a constant current of about .2 of a milliampère is passed through, it is observed that the freely swimming individuals hasten towards the cathode. Those attached to objects, on the contrary, do not respond in this manner to the electrical current. (Figure 42.) The intensity of the current can be greatly increased without bringing about detachment of the individuals from their position of fixation. The typical influence of the strong current upon the movement of the cilia of the thigmotactically fixed individuals can be clearly seen. Nevertheless, the inhibition, brought about by the contact stimulus, predominates over that of the exciting effect of the current, so that a freeing of the organisms from their position does not occur. Not until the current becomes very strong is the excitation thereby produced sufficient to bring about a separation of the infusoria, whereupon they immediately swim toward the cathode. In this

1 *Herbert S. Jennings*: "Studies on reactions to stimuli in unicellular organisms. I. Reactions to chemical, osmotic and mechanical stimuli in the ciliate infusoria." *Journal of Physiology*, Vol. XXI, 189 F.

2 *Pütter*: "Studien über Thigmotaxis bei Protisten." *Arch. f. Anat. und Physiologie, physiol. Abt. Suppl.* 1900.

interference between the contact stimulus, on the one hand, and the thermal or galvanic on the other, the inhibitory effect of the former may overpower the strong excitation of the latter.

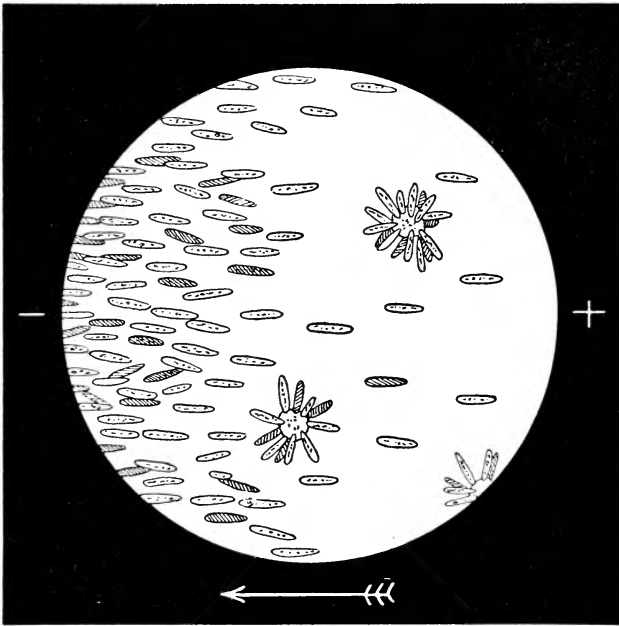

Fig. 42.

Interference of galvanotaxis and thigmotaxis in *Paramecium aurelia*. The individuals which are thigmotactically attached to slime particles remain at rest while the freely swimming individuals move toward the cathodic pole.

Still more complex and striking is finally the following case of interference between thigmotaxis and galvanotaxis. The hypotrichous infusoria as *Stylonychia*, *Urostyla*, *Oxytricha*, etc., have a marked functional and morphological differentiation of their cilia. They possess a bow-like row of perioral cilia, which sweep in the food; a number of cilia on the ventral surface used for locomotion by which they move about upon objects in the water; a row of border cilia on each side, which, during swimming, contribute the propelling force. The perioral cilia also

form the elements which bring about a screw-like movement on the axis. They further possess several cilia, which permit a rebounding of the organism, and finally certain forms have anal-cilia, which probably serve as breaks and to steer the organism. (Figure 43.) Their usual mode of locomotion is that of creeping, moving by means of the cilia on the ventral surface. These movements depend upon the positive thigmotaxis of the cilia of locomotion. At the same time there is inhibition of the cilia on

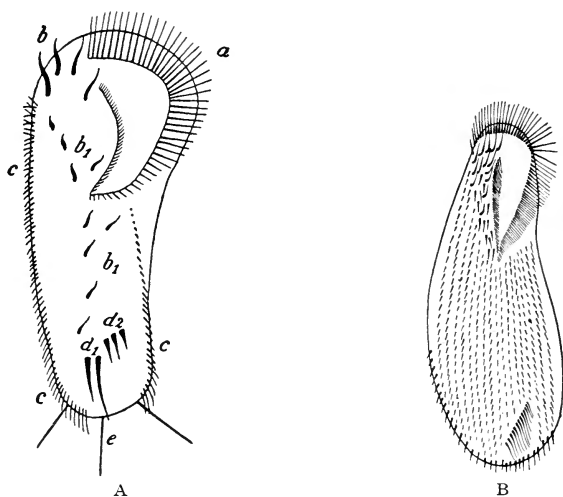

Fig. 43.

Hypotrichous infusoria. A—*Stylonychia*. B—*Urostyla*.

the sides. When the infusoria are excited by a new stimulus, the cilia used for rebounding become active, the body frees itself from its position of attachment and begins to swim, wherein the cilia on the sides, as well as the perioral cilia, act in the manner mentioned above. I have made the striking observation that the hypotrichous infusoria respond differently to the galvanic current, depending on whether they are swimming or in a fixed position. If one places a drop of water with numerous *Urostyla* on a slide between parallel pieces of fired clay which serve as electrodes, it will be seen, upon the closing of a current, that all

of the individuals which are freely swimming and turning in a screw-like manner around their axis, steer immediately toward the cathode, exactly as in the case of the *Paramecia*. On the other hand, those which are fixed to the bottom of the slide as a result of thigmotaxis, upon closing of the current, make a short turn and assume a position wherein the long axis is at right angles to the direction of the current, and the perioral rim is directed toward the cathode. In this position they move through the field. (Figure 44.) When the current is broken the indi-

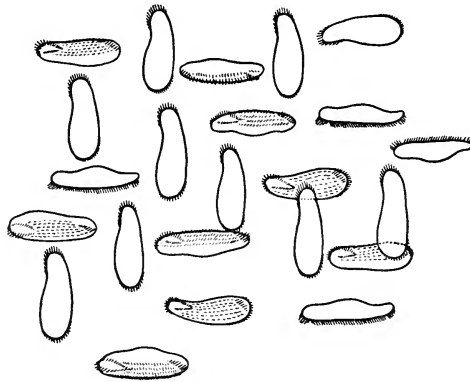

Fig. 44.

Urostyla grandis. Interference of galvanotaxis and thigmotaxis. The freely swimming individuals move towards the cathode (left side). The creeping individuals move in transverse direction.

viduals draw backwards, distribute themselves and creep and swim in all directions in the water. If during the course of the passage of the current, an individual which has been swimming begins to creep, the axis immediately assumes the position above described in the case of the organisms which are in contact with the bottom and *vice versa*. The thigmotaxis, therefore, influences galvanotactically swimming organisms in a most characteristic manner. As a consequence of the interference of thigmotaxis and galvanotaxis, the organisms move in a direction transversely to the direction of the current. This most striking reaction has been cleared up by *Pütter*,¹ the explanation being based upon an

¹ *Pütter*: 1. c.

accurate investigation of the mechanism of ciliary activity. The galvanotactic swimming toward the cathode is explained by the same principle as that applicable to all galvanotaxis.¹ As a result of the excitation produced by the anode, the cell body must assume a position wherein the border cilia, which are of greatest importance in swimming, are equally stimulated on both sides of that part of the body directed toward the anode. It is only in this position that forward swimming is possible, for as a result of *unsymmetrical* excitation of the border cilia a turning must at once occur, which automatically brings about a resumption of the position of the long axis. The perioral cilia bring about the screw-like movement around the axis during swimming. It follows that the freely swimming individuals must necessarily move towards the cathode. In the case of the thigmotactically moving individuals the activity of the border cilia is inhibited. The perioral and the locomotion cilia bring about the assumption of the position of the axis, above described. The perioral cilia during movement bring about a turning of the body on the vertical axis toward the side opposite that of the orifice and it follows that the body can occupy only that axial position wherein the perioral cilia are least excited. This is, however, only the case when the long axis of the body is transverse to the direction of the current, and the perioral cilia are directed toward the cathode, for stimulation arises from the anode. The reason why the infusoria do not turn toward the anode from this transverse position of the axis is to be found in the fact that the anterior locomotion cilia are stimulated to a greater extent by the turning toward the anode, and bring about a movement in the contrary direction. The transverse position of the axis is thus the result of an antagonistic action between the perioral and the anterior locomotion cilia. It therefore follows that the characteristic position, which is necessarily assumed by the thigmotactically creeping individuals, is brought about by an interference action between tactile and galvanic stimulation.

These, then, are a few examples of the interference action of various stimuli on the single cell. They show us in part fairly

¹ *Max Verworn*: "Allgemeine Physiologie." V Aufl. Jena 1909.

simple, and in part very complex states. It now behooves us to obtain a general understanding of interference action, to learn the fundamental *laws* in connection with these complex actions, to shell out, as it were, the general factors involved in the special conditions. In this connection the examples already referred to furnish all of the data necessary for our first orientation. In the simple instance in which the effect of galvanic stimulation was augmented by increase of temperature and again in the case where there was a diminution of excitation resulting from the alcohol, the interference of the two stimuli is consequent upon the fact that the location of attack is the same. The constant current acts upon a portion of the infusorium, which also responds to elevation of temperature. We have a *real*, or, as I may term it, "*homotopic interference*," for it is an interference in which the general point of attack is the same for both stimuli.

In contradistinction to this case, we have the examples of the interference of thigmotaxis and galvanotaxis in the hypotrichous infusoria. Here the effect of interference, the characteristic position of the axis of the cell body, is brought about by the fact that the galvanic stimulus affects different elements than the mechanical. The turning of a creeping *Stylonychia* or *Urostyla*, when the current is closed, in which the anterior portion of the body was previously directed towards the anode, results from excitation of the perioral cilia from the anodic pole. The mechanical stimulation, on the contrary, exerts its effect upon the locomotion and border cilia. Only when there is a turning of the anterior portion of the body towards the anode, would the galvanic stimulus affect also the anterior locomotion cilia and thereby counteract turning towards the anode. Therefore, we have before us in this case of the assuming of a characteristic position of the axis of the cell body the expression of an *apparent*, or, as I prefer to express it, a "*heterotopic interference*," in which the two stimuli do not actually interfere in their action, but rather influence the final result, in that the condition for the state of the system in its totality is dependent upon its individual components. This heterotopic interference is of particular importance in the bringing about of the movements of the living system.

The locomotion of the animal and especially the direction is in part a manifestation of heterotopic interference of response. At the same time, however, especially in the coördinated movements of nervous origin, the homotopic interference *also* plays an important rôle and, not rarely, is combined with heterotopic interference.

Although the physical analysis of heterotopic interference is extremely attractive, we must, however, temporarily set aside its consideration, for at this point the question arises as to what happens when there is interference of two stimuli at the same point. In the heterotopic interference the effect of each stimulus is the same as if it were applied singly. In the homotopic interference the interfering effects of stimulation influence each other.

The above examples of homotopic interference introduce us to the two principal types of these manifold kinds of interference effects; the excitation brought about by galvanic stimulation is summated by the excitation produced by temperature. The other type consists of an inhibition of one effect of stimulation brought about by another. The depression produced by alcohol on the *Paramecia* weakens the excitation of the galvanic current. These examples of the two principal types of interference effects are quite simple; nevertheless, in other cases, the conditions are very complex. This is especially true in the field of nervous inhibition, so important in the functionation of the nervous system, and which has presented the greatest difficulties to physiological investigators until the last few years. That a stimulus bringing about excitation in a ganglion cell can be inhibited by another exciting stimulus, or that the development of excitation in a ganglion cell may be prevented by another exciting stimulus cannot be easily understood. The problem as to how two interfering excitations can bring about inhibition is one that has received many explanations. An interesting incident in the history of physiology is that the first explanation of the principles of inhibitory processes was close on the track of being a correct one, but was subsequently abandoned by its originator. *Schiff*¹ (1858) has endeavored to explain this inhibition as a manifes-

1 *M. Schiff*: "Lehrbuch der Physiologie des Menschen." Bd. I, Lahr 1858.

tation of fatigue, and this idea he defended with the greatest tenacity for a long time, until finally, twenty-five years after, in a treatise which he called "Abschied von der Ershöpfungstheorie," he renounced the idea as untenable.

Among other investigations, which since this time have been made to explain the mechanism of inhibition, those of *Gaskell*,¹ *Hering*² and *Meltzer*³ have received widest consideration. These theories are built upon the existence of the two phases of metabolism, and assume that inhibition, in contradistinction to dissimilatory excitation processes, depends upon an increase of the assimilative processes. The principal evidence which *Gaskell* advances is that when the vagus nerve of the tortoise heart, a typical inhibitory nerve, is stimulated, a positive variation of the demarcation current of the heart muscle occurs, whereas when a motor nerve of a skeleton muscle is stimulated the attached muscle shows a negative variation of the demarcation current. I must confess that this explanation of inhibitory processes, from the standpoint of an interpretation of processes in the living substance, seems very plausible, and I have accepted this even in my address on excitation and depression before the Frankfurter Naturforscher Versammlung.⁴ I have since then endeavored to obtain experimental evidence to substantiate this theory, in that I attempted to prove that increase of the assimilatory processes brought about by stimulation would be associated with a reduction of the specific irritability. For this purpose I have sought for such cases in which a stimulus primarily and momentarily increases assimilative processes in a system in a state of metabolic equilibrium. I was disappointed, when, after years of investigation, I could not find such cases. There is only one kind of stimulus of which we can say with positiveness that it primarily increases the assimilative processes, that is, increased supply of

1 *Gaskell*: "On the innervation of the heart with especial reference to the heart of the tortoise." *Journ. of Physiology*, Vol. IV, 1884.

2 *Ewald Hering*: "Zur Theorie der Vorgänge in der lebendigen Substanz." *Lotus IX*. Prag 1888.

3 *Meltzer*: "Inhibition." *New York Medical Journal*, 1899.

4 *Max Verworn*: "Erregung und Lähmung. Vortrag gehalten in der allgemeinen Sitz. der Gesellsch." *Deutsch. Naturf. u. Aerzte zu Frankfurt a. M.* 1896. *Verh. d. Ges. Deutsch. Nat. u. Aerzte* 1896.

food. But here the increase in the processes of assimilation never occurs momentarily, and indeed this increase is so extremely slight that it can only be demonstrated over a long course of time. These totally negative results of my investigation had awakened strong doubts concerning the assimilation hypothesis of inhibition. Above all, this explanation seemed to me to be impossible for the nervous system. I searched, therefore, for another explanation for the processes of inhibition in the nervous system. If the increase of energy production resulting from the application of a stimulus is dependent upon an excitation of a dissimilative nature, then one is justified to look upon the reduction of functional energy production as an expression of an antagonistic process to that of dissimilatory excitation. In this respect the *Gaskell-Hering* hypothesis of inhibition rests upon a firm foundation. When, however, this hypothesis assumes an antagonism between dissimilatory and assimilatory excitation, then it must not be overlooked that a second antagonism is possible between dissimilatory excitation and dissimilatory depression. The antagonism need not involve the two types of metabolism, it may depend upon variations of *one* type. When, therefore, the hypothesis that inhibition is brought about by assimilatory excitation meets with insuperable difficulties, the possibility should be considered if it is not more likely dependent upon dissimilatory depression. These reflections induced me to investigate if conditions could not be produced experimentally wherein dissimilatory depression could bring about inhibitory processes in the nervous system. The most essential requirement was, that dissimilatory depression should quickly develop and pass away with like rapidity, for inhibition of the nervous system sets in momentarily and disappears again momentarily. Another important requisite is, that both interference stimuli are individually capable of producing dissimilatory excitation, for the inhibitory processes of the nervous type may be assumed to be the result of dissimilatory excitation which produce by their interference inhibition, for the nerve fibers, as already stated, are capable of conducting only dissimilatory excitation to the responding organ. As I studied the problem in this manner, it became clear to me that all

the conditions necessary for the genesis of inhibition are realized in the existence of the refractory period, and that I had already produced inhibition by prolonging the refractory period, by oxygen withdrawal, in the strychninized frog. If we take a strychninized frog in which the refractory period has been somewhat prolonged by oxygen withdrawal, so that the reaction is simply a short reflex contraction, and rhythmically stimulate the skin, a reaction is only obtained with the first few stimuli, which

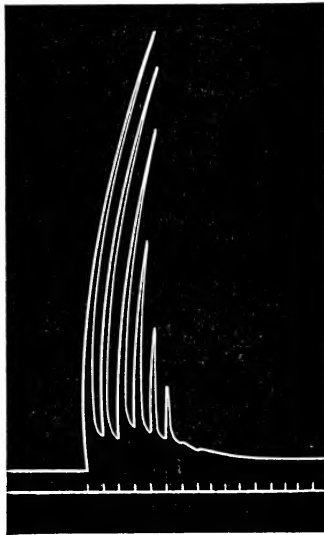

Fig. 45.

Lower line indicates stimuli.

reactions rapidly decrease until a stage is reached wherein the succeeding stimuli are completely inoperative. (Figure 45.)¹ This inhibition is demonstrated even more clearly by the following experiment. Contractions of the triceps muscle of a strychninized frog are recorded which reflexly follow from stimulation of the

¹ *Max Verworn*: "Zur Kenntniss der physiologischen Wirkungen des Strychnins." Arch. f. Anat. u. Physiol. physiolog. Abth. 1900. The same: "Ermüdung, Erschöpfung und Erholung." Ibidem Suppl. 1900.

central end of the cut sciatic nerve. Oxygen is withdrawn in the manner already referred to. At the proper stage of oxygen deficiency, rhythmic induction shocks applied to the central end of the nerve, the interval between the individual stimuli of which being longer than the duration of the refractory period, elicit reflex contractions of the muscles of the posterior extremity on the opposite side following each individual stimulus. If, however, in the same stage the central end of the nerve is stimulated with induction shocks at intervals briefer than the duration of the refractory period, a contraction is only observed during the

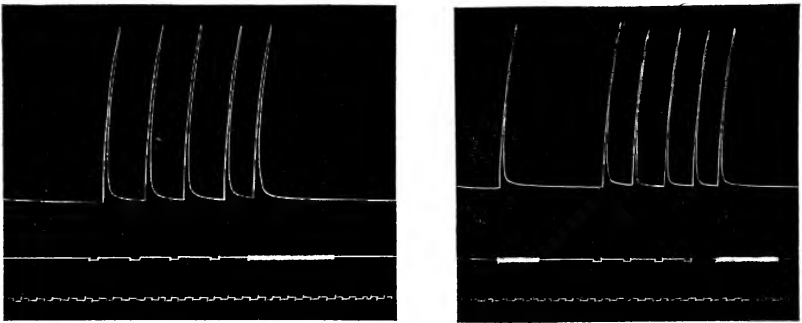

Fig. 46.

Reflex inhibition in the strychninized frog. Lower line indicates seconds, upper line stimuli. When stimulation with single shocks at longer intervals is applied, each single stimulus is effective. When faradic stimulation is used, only the first stimulus is operative, and during the further continuance of stimulation inhibition takes place in the spinal cord.

very beginning, being brought about by the *first* stimulus, whereas the subsequent stimuli are ineffective, the muscles remaining at rest during their entire application. (Figure 46.) *Tiedemann*¹ at a later date continued these observations and analyzed them more in detail. In all these experiments, therefore, there is an interference of the frequent stimulus, because each succeeding stimulus occurs in the refractory period of the proceeding. In

¹ *Tiedemann*: "Untersuchungen über das absolute Refractärstadium und die Hemmungsvorgänge im Rückenmark des Strychninfrosches." *Zeitschr. f. allgem. Physiologie* Bd. X, 1910.

consequence there is a strong reduction of irritability and reaction is absent. That is, the centers during application of the frequent current are *inhibited*. If cessation of stimulation by frequent shocks takes place, stimulation by slowly succeeding individual shocks becomes effective again in a few seconds. This is the simplest example of the process of inhibition and by it I was led to seek in the refractory period the key of the mechanisms of the process of inhibition. This principle once recognized, further material for the more detailed working out and extension of the theory was gathered from the experiences already gained during the course of the preceding years in the researches on fatigue and the refractory period in the nerve. Here it became apparent that the processes resembling inhibition discovered by *Schiff* in the nerve preparation and which were studied anew at a later date by *Wedenski*, *F. B. Hofmann* and *Amaja* and in part attributed by *Hofmann* to fatigue of the nerve endings, by *Fröhlich* to fatigue of the nerve itself, were in principle of the same nature as the central inhibitions themselves. *Fröhlich*,¹ by his analysis of the observations of *Richet*, *Luchsinger*, *Fick*, *Biedermann* and *Piotrowski* on inhibition in the claw of the crab, then showed that inhibition can be influenced by the alteration of the intensity of the stimulus as well as its frequency. In a series of experimental researches he could then demonstrate that the widely extended antagonistic inhibitions and other special processes of inhibitions in the centers could on the basis of the same principle be physiologically explained. Here the supposition was confirmed that the development of a relative refractory period plays a very important rôle in the inhibition of the nervous centers. Thus, the relations of the processes of inhibition to the refractory period, once established, their entire field, up to then

¹ *Fr. W. Fröhlich*: "Die Analyse der an der Krebssschere auftretenden Hemmungen." Zeitschr. f. allgem. Physiologie Bd. VII, 1907. The same: "Der Mechanismus der nervösen Hemmungsvorgänge." Medizin. naturwiss. Arch. Bd. I, 1907. The same: "Beiträge zur Analyse der Reflexfunction des Rückenmarks mit besonderer Berücksichtigung von Tonus, Bahnung und Hemmung." Zeitschr. f. allgem. Physiologie Bd. IX, 1909. The same: "Experimentelle Studien am Nervensystem der Mollusken 12. Summation und scheinbare Bahnung, Tonus, Hemmung und Rhythmus am Nervensystem von *Aplysia limacina*." Zeitschr. f. allgem. Physiol. Bd. XI, 1910.

shrouded in darkness, has gradually in the course of years been completely elucidated.

Before going back to the cases of inhibition and explaining them by this general principle, it is necessary that we penetrate more deeply into the details of the characteristic course of the refractory period. By this means we will find the conditions which universally determine the interference in the effects of stimulation.

First of all, it is self-evident that the occurrence of interference of stimulation in a living system can only take place when the succeeding stimulus is applied before the effects of the previous one have completely disappeared. Within the interval, however, which is involved from the moment of the beginning of a stimulus until its effect disappears through the self-regulation of metabolism, there is the possibility of various interference results from stimulation.

If we take into consideration the various instances which can arise, perhaps we may best start with that type wherein the first stimulation produces depression, whereas the second has an exciting effect on disintegration. In this type the response to the second stimulus is weaker than when the second stimulus alone is applied. As a concrete example of this type, we may refer to the interference of an induction shock in a nerve during the relative want of oxygen. We arrange a nerve of a nerve muscle preparation of a frog in a glass chamber, as already described, and determine the threshold of stimulation of the stretch within the chamber by the weakest induction shocks which produce response. The oxygen is then removed and the effect on the threshold determined. As shown by *Baeyer* it is found that with increasing asphyxia the threshold of stimulation for induction shocks becomes continually higher. The irritability is likewise decreased. This occurs, as the investigations of *Lodholz* show, at first slowly, then more and more rapidly. The curve of the decrease of irritability has a logarithmic form. During the continuation of the depressing stimulus, i.e., the want of oxygen, the exciting stimulus has less and less effect. If oxygen is again brought in contact with the nerve, irritability immediately returns to its original

height. The cessation of the depressing stimulus has, therefore, the effect that the exciting stimulus again brings about its original response.

A second type of interference is produced when both stimuli bring about depression. As an example, we may select the interference of cold and deficiency of oxygen. If we assume, for instance, that each of these stimuli of itself brings about only a partial reduction of living processes and not a *complete* suppression, then it would be possible to think of a summation of both depressions. Nevertheless, the conditions for the summation of depression have never been carefully analyzed. Quantitative investigations upon the interference of depressing stimuli are entirely lacking. One should not, however, in physiology presuppose what may happen under certain given conditions without first making the necessary experiments. The strength of scientific investigation depends upon the fact that every deduction, no matter how small, must be substantiated by experience before further progress can be made. So, likewise, we must await the results of thorough experimentation upon the interference of depressing stimuli before we can establish a law. The conditions are not as simple as they appear on first observation, for the point of attack of the various kinds of the depressing stimuli upon the chain of metabolic processes may be very different. In such a case it is not at once possible to understand the results of the interference.

There is a third type in which two dissimulatory excitations interfere with each other. Fortunately there is a great amount of experimental data at our command so that today we have a clear understanding of the essential points of the conditions necessary for the development of summation of excitation on the one hand, and inhibition on the other. If we take an instance of a momentary dissimulatory excitation operating upon an aërobic system in metabolic equilibrium, it is necessary to recall the two effects thereby produced. The stimulus brings about an oxydative decomposition of the living substance. Likewise there is a reduction of irritability. Both of these alterations are the foundation of interference. Both processes have a specific time

of occurrence. The disintegration, determined by energy production, reaches a maximum suddenly, then diminishes, at first rapidly, then more and more slowly until the zero point is reached. In an analogous manner the irritability abruptly reaches a minimum, then increases rapidly, then more slowly, until it again reaches its previous value. When we represent these processes by a curve, they assume the following form. (Figure 47.) In

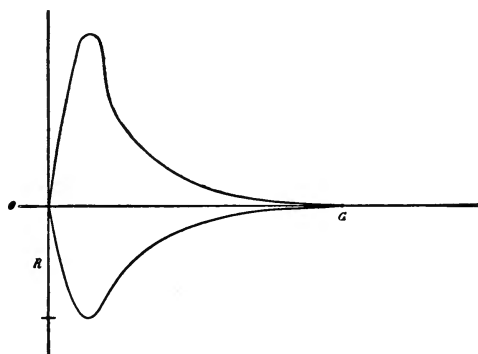

Fig. 47.

this diagram the abscissa is the time, the ordinate value zero is the level of the metabolism of rest and the specific irritability. The points above the abscissa represent disintegration, that is, energy production, those under the abscissa, the reduction of irritability. A consideration of the latent period may be omitted. At the end of the curve the effect of stimulation may be assumed to have disappeared and the state of metabolic equilibrium re-established. If we base our further observations upon this curve of excitation, we can study in them the factors upon which responsivity is dependent when a second exciting stimulus is operative during the course of the first.

It is from the beginning apparent that the response to the second stimulus is determined by the intensity of the second stimulus in relation to the degree of irritability which exists at the moment when this is effective. This relation is dependent first upon the absolute intensity of the second stimulus. In the following diagram the intensity of the existing threshold value is

fixed for convenience as ordinates beneath the abscissa. If, for example, at the time point x , a stimulus of weak intensity R_1 acts, this stimulus being under the existing threshold, produces no perceptible effect. (Figure 48.) If now instead of a weak stimulus, one of stronger intensity acts at the time point x , this stimulus

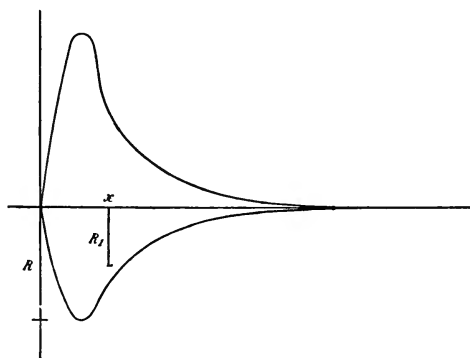

Fig. 48.

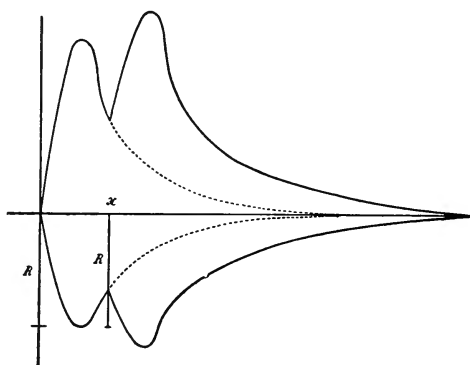

Fig. 49.

will produce an appreciable response. (Figure 49.) If the second stimulus is of the same strength as the first, this second stimulus will bring about relatively less disintegration, because the system is then in a state in which irritability is still reduced. But this lessened disintegration in that it summates the excitation still existing as the result of the first stimulus can produce an absolute increase of the height above that of the abscissa.

Here then we see the possibility of an increase of response resulting from summation. Accordingly the increase of disintegration must occur simultaneously with a diminution of irritability and this must fall below the level of the reduction of irritability produced by the first stimulus. This augmentation of the response through summation above the level of that produced by the first stimulus acting upon an unexcited system is, however, connected with another condition. The above example refers to systems in which weak stimuli bring about weak response and strong stimuli strong response, that is, the response is capable of increase. In systems in which the "all or none

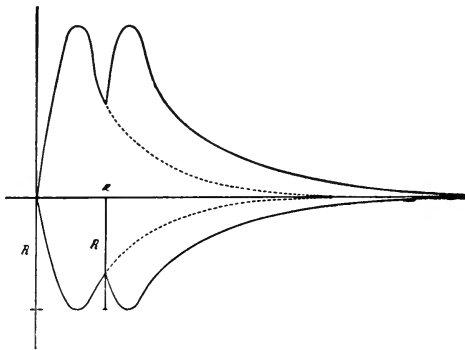

Fig. 50.

law" is applicable, such an alteration in the absolute height of excitation, as results in summation, is not possible. In order to characterize these two types of living systems by a short expression rather than by a long sentence, we will call the first a "*heterobolic system*," the latter in which the "all or none law" is operative an "*isobolic system*." The former term expresses various degrees of discharge depending upon the intensity of the stimulus, the latter term refers to the constancy of discharge following stimuli of various intensities. Isobolic systems are in contradistinction to the heterobolic systems not capable of summation. The response to the second stimulus of equal intensity cannot be greater than that of the first, it may be equal to the first (Figure 50) or be less in extent, but it can never be greater

than that resulting when a single stimulus is applied. These facts have been known for a long time in the case of the heart muscle. A word is necessary, however, concerning the effect of stimuli beneath the threshold in heterobolic systems. We must here distinguish between the "ideal" threshold, beneath which the influence of a stimulus is nil, and the *threshold of perceptible effect*, beneath which a stimulus apparently has no effect; nevertheless a weak effect does occur, as is shown by succeeding reactions. This effect is manifested by a sub-threshold disintegration and a corresponding slight reduction of irritability. (Figure 51.) The presence of such a sub-threshold effect is

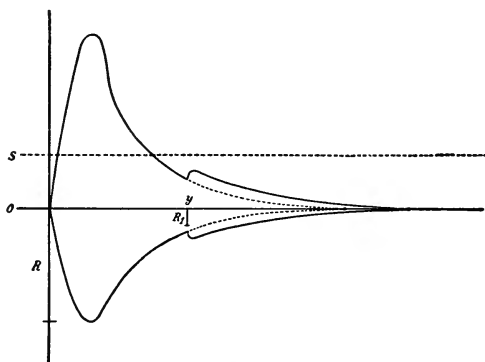

Fig. 51.

Effect of sub-threshold stimuli. *o*—Level of the ideal threshold.
s—Level of the threshold of perceptible effect.

recognized by various facts as, for example, the summation of the sub-threshold stimuli to production of a perceptible result. Thus stimulation of a sensory spinal cord root with a single sub-threshold induction shock will not produce any evidence of a reflex excitation, whereas, when induction shocks of the same strength and of sufficient frequency are applied, a strong reflex contraction results. The fact that sub-threshold stimuli can bring about sub-threshold effects is also important in consideration of the result of interference. The relation between the intensity of the second stimulus and the degree of irritability of the system, the intensity of the stimulus being absolutely constant, depends,

secondly, upon the momentary amount of irritability which exists just at the time when the second stimulus produces its effects. It is, therefore, clear that the response produced by interference must also alter with the momentary degree of irritability in a manner analogous with variations of the intensity of the second stimulus. One must, therefore, know the factors which control the momentary degree of excitation.

The first factor to be considered is the moment of time in which the second stimulus is applied, that is, the interval between the first and the second stimulus. If, for example, a weak second stimulus follows very quickly after the first, the stimulus will bring about no response, as the system at the time of its application is in a relative refractory period. (Figure 48.) The stimulus is, therefore, under the threshold. If, however, a stimulus of the same strength is applied somewhat later, when the irritability has already increased to a somewhat greater extent, then at this moment the stimulus is above that of the threshold and a response is obtained which, on account of the state of irritability

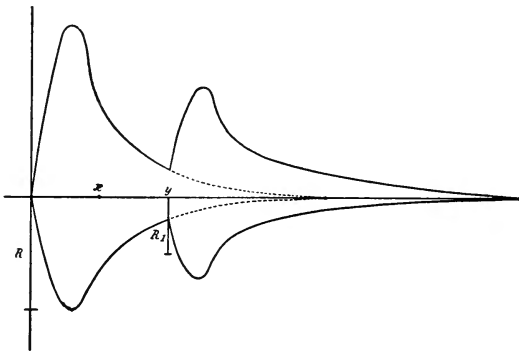

Fig. 52.

existing, is summated. (Figure 52.) But further, it is not a question of the *absolute* interval between the stimuli, but rather to the *relative* interval to the *specific rapidity of the reaction of the living substance under consideration*. There are living substances, as we have seen, in which the refractory period is unusually short, as, for instance, the nerve. There are other sub-

stances wherein this period lasts a considerable time after stimulation, that is, before the irritability returns to the original level, as, for example, the smooth muscle. Indeed, depending upon the specific properties of a system, a short or a long interval is required before a stimulus of a given intensity is again operative. Finally, in one and the same living system the duration of the refractory period can be very different, depending upon the *momentary state of the system*. Above all we know that the refractory period is considerably prolonged in fatigue and likewise after the influence of other agents, as narcotics, lowering of the temperature, etc. In such states a second stimulus remains inoperative when it follows at a definite interval from the first, whereas under normal conditions the same stimulus applied at the same interval would be operative.

Finally, there is another factor to be considered, namely, that the latent period of the second stimulus is more and more prolonged as the second stimulus approaches more closely to the absolute refractory period of the first. In the above schemes the latent period was not taken into consideration because practically for all the intervals of stimulation considered at that time it could be assumed to be the same. When, however, a decrease of the intervals between the individual stimuli takes place, the prolongation of the latent period can then not be overlooked, as it leads to a retardation of response. (Figures 29, 30.) This fact was shown in the classic investigations of *Marey*¹ upon the refractory period of the heart, and more recently has been the subject of study by *Samojloff*,² *Keith Lucas*³ and *Gotch*⁴ in the muscle and nerve. These, then, are the essential factors which bring about interference, and although there are special details which deserve

1 *Marey*: "Des excitations artificielles du cœur." Trav. du lab. de M. *Marey* II, 1875. The same: "Des mouvements que produit le cœur lorsqu'il est soumis à des excitations artificielles." Compt. rend. de l'acad. des sciences T. LXXXVII, 1876.

2 *Samojloff*: "Actionsströme bei summierten Muskelzuckungen." Arch. f. Physiologie Suppl. 1908. The same: "Über die Actionsstromkurve des quergestreiften Muskels bei zwei rasch aufeinanderfolgenden Reizen." Zentralblatt f. Physiol. 1910.

3 *Keith Lucas*: "On the refractory period of muscle and nerve." Journ. of Physiology, XXXIX, 1909-10. The same: "On the recovery of muscle and nerve after the passage of a propagated disturbance." *Ibid.* XXXXI, 1910-11.

4 *Gotch*: "The delay of the electrical response of nerve to a second stimulus." Journ. of Physiology, XXXX, 1910.

more close analysis, nevertheless, we are in a position to attribute to them the origins of summation and inhibitory processes, which occur in all living systems, especially the nervous system.

For the analysis of summation and the inhibitory processes which occur in the physiologically active organisms or which are experimentally produced, a very important point should be observed, that is, the fact that the stimuli which bring about these phenomena are practically always a *series of single stimuli*. The nerve impulses, for example, consist of a shorter or a longer series of single discharges which follow each other in rapid rhythmic sequence. Here, then, we have the conditions necessary for the production of interference effects when these single stimuli follow each other with sufficient frequency and also when there is the combined action of *two* series.

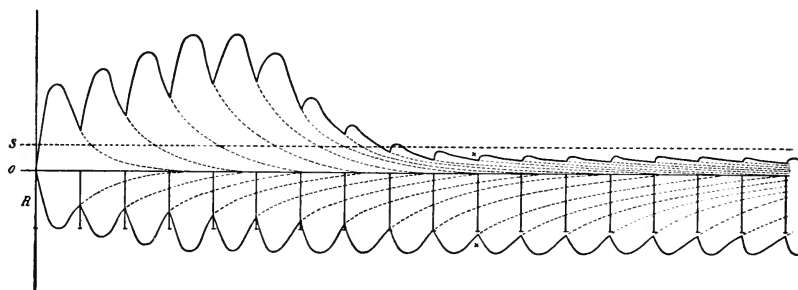

Fig. 53.

Curve showing the general development of the effect produced by interference of the stimuli of the same series in an heterobolic system. The effect is first summation and then inhibition. *R* indicates the intensity of the stimuli, *S* the level of the threshold of perceptible effect.

We will first direct our attention to the simplest case brought about by an interference between the individual effects of stimuli in the same series. We will study the effect, which here occurs, in the accompanying diagram, which shows the facts involved in the interference of *two* stimuli of a *series* of stimuli. (Figure 53.) The curve shows the development of summation and inhibition. The single stimuli of equal intensity follow at the same intervals, so that the succeeding stimuli meet with an incomplete

recovery of excitation and accordingly a decreased state of irritability. In spite of the diminution of the relative response to each stimulus the summation of excitation brings about an absolute increase of the same. At the same time the irritability decreases more and more, for after each stimulation the oxydative disintegration as well as restitution require a progressively greater time and a relative fatigue must, therefore, necessarily develop. The summation, consequently, reaches its limit very soon and then decreases progressively, for, as a result of the increase of fatigue, the oxydative decomposition which occurs at the instant of every stimulation reduces and with this the energy production becomes less and less. The system is relatively refractory for the given intensity of stimulus. Accordingly the response to stimulation falls below the threshold of perceptible response (dotted line S) and finally an equilibrium between disintegration and restitution occurs, wherein the small amount of material used at each stimulation by oxydative decomposition is again replaced before the next stimulus. In other words, the irritability is reduced at each stimulation to an amount equal to that of the recovery in the interval. If this all takes place beneath the threshold of perceptible response, the system during the continuance of the stimulation seems responseless, that is, inhibited. The *inhibition* consists then of a reduction of irritability below the perceptible threshold of response of the stimulus concerned. It depends upon a continued lessening of dissimilative excitation to a low level through the delay of the oxydative decomposition processes. The inhibition is according to this a relative fatigue, which is conditioned, as is true of every fatigue, by a lengthening of the refractory period following a relative deficiency of oxygen. *The processes of inhibition are simply and solely an expression of a refractory period persisting as a result of dissimilatory exciting stimuli.*

Accordingly the general conditions requisite for summation on the one side and inhibition on the other may be formulated as follows:

A *summation* may develop in a heterobolic system and by the use of submaximal stimuli. It always develops when the follow-

ing stimulus is applied before there is complete recovery of excitation from the previous stimulus. The absolute increase of excitation as a result of summation is, however, limited by the diminution of irritability. By continuation of the series of stimuli the state of equilibrium between the amount of excitation and the irritability will be established on a higher or lower level. There occurs then, depending on whether the feeble persistent excitation remains above or below the level of perceptible effect, either a tonus or an inhibition.

Summation can be transformed into inhibition by the continuance of stimuli of constant intensity. The principles which underlie both processes are in no way antagonistic and indeed are not separated by distinct boundaries. The diagram here shown (Figure 53) illustrates this development of summation and inhibition. The time required for this development is in manifold ways influenced by variations of the above-stated factors which control the occurrence of interference. Thereby results an immense number of special cases which differentiate themselves in characteristic manner depending on whether an isobolic or heterobolic system is involved, depending on whether the irritability of the system, as measured by the threshold of stimulation, is high or low, depending on whether fatigability is great or small, depending upon the intensity and frequency of the stimuli, etc. Analysis of every instance shows us different combinations of the interaction of the individual factors. It is, therefore, self-evident that we cannot here analyze a greater number of these cases of summation and inhibition. I wish only to refer to a few typical examples at this time.

It is known that summation of excitation in the normal nerve does not occur. As already stated, the nerve is a system in which the "all or none law" is operative. Such isobolic systems do not summate, having no power of summation because each individual stimulus brings about a maximum response. But we have seen that the nerve, as a result of depressing factors, such as deficiency of oxygen, narcosis, fatigue, etc., which decrease its irritability, can be transformed from an isobolic into a heterobolic system. In this state the nerve possesses the capability of summat-

ing excitations. *Waller*,¹ *Boruttau*,² *Boruttau* and *Fröhlich*,³ *Thörner*⁴ and others have shown that the action current of the nerve during the application of tetanic stimulation becomes decidedly greater during a certain stage of narcosis or asphyxiation, so that the wave of negative variation is higher than when the nerve is excited by a single induction shock. *Fröhlich*⁵ first threw light upon this subject in that he made the observation that here a principle is involved which has far-reaching importance in the phenomena occurring in the organism. He showed that as a result of fatigue, cold and narcosis, etc., the course of excitation brought about by the single stimulation undergoes retardation. These conditions within certain limits become more favorable for the production of summation, because each succeeding stimulus meets with a more incomplete recovery of excitation than the one previously applied. In consequence of this, the irritability of the system in the beginning of fatigue, or narcosis, or immediately after the application of cold, is apparently increased. This "*apparent excitation*," as it was called by *Fröhlich*, depends, however, in reality upon a beginning depression which is evident in that the course of the individual excitations are lengthened by this means. The irritability is likewise also reduced. *Reinecke*⁶ later studied in further detail the retardation of excitation in the muscle and attributed to this the characteristic property shown in muscle in the so-called "reaction of degeneration." Fatigue, asphyxia, cold, degeneration, in fact all factors which retard the

1 *Waller*: "Observations on isolated nerve." Croonian Lecture, Philosophical transactions. 1897.

2 *Boruttau*: "Die Actionsströme und die Theorie der Nervenleitung." Pflügers Arch. Bd. 84, 1901.

3 *Boruttau* and *Fröhlich*: "Electropathologische Untersuchungen. Ueber die Aenderung der Erregungswelle durch Schädigung des Nerven." Pflügers Arch. Bd. 105, 1904.

4 *Thörner*: "Die Ermüdung des markhaltigen Nerven." Zeitschr. f. allgem. Physiologie Bd. VIII, 1908, und Bd. X, 1910.

5 *Fr. W. Fröhlich*: "Ueber die scheinbare Steigerung der Leistungsfähigkeit des quergestreiften Muskels im Beginn der Ermüdung (Muskelstuppe), der Kohlensäurewirkung und Wirkung anderer Narkotica (Aether, Alkohol)." Zeitschr. f. allgem. Physiologie Bd. V, 1905. The same: "Das Princip der scheinbaren Erregbarkeitssteigerung." Zeitschr. f. allgem. Physiologie Bd. IX, 1909.

6 *Fr. Reinecke*: "Ueber die Entartungsreaction und eine Reihe mit ihr verwandter Reactionen." Zeitschr. f. allgem. Physiologie Bd. VIII, 1908.

course of excitation, are favorable to the summation of excitation, provided their influence does not exceed certain limits.

Although the nerve as an isobolic system can only be rendered capable of exhibiting summation when artificially influenced, there are other forms of living substance which normally are systems with a slow course of excitation, in which excitation may be summated, for this type possesses at the same time a heterobolic character. For example, a single mechanical excitation elicits a hardly perceptible response in *Amœba*, *Actinosphærium*, *Orbitolites*. When it is perceptible at all, there occurs a short interruption of the centrifugal movement of the protoplasm. After a pause the movement of the protoplasm and the stretching out of the pseudopods again return. But if the organism is agitated one or more minutes by rhythmically shaking the edge of the slide by a special device, as a result of the summation of weak excitations there occurs a complete drawing in of the pseudopods and the amœbæ become bell-shaped.¹ The ganglion cells also possess a great capability for summation. We have already alluded to the fact that single induction shocks below that of the threshold produce no evident effect, whereas when rapidly repeated, summation occurs with reflex reaction.

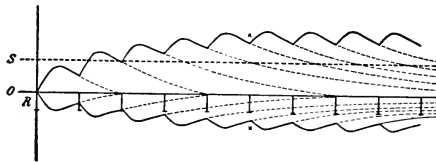

Fig. 54.

Development of tonus by interference of sub-threshold stimuli.
S—Level of the threshold of perceptible effect.

The summation of sub-threshold excitation to a certain height offers very favorable conditions for the development of *tonus*. (Figure 54.) This fact has been established for many kinds of centers (cardio-inhibitory center, vasomotor center, etc.). During the continuance of a series of stimuli, as we have already seen, an equilibrium between disintegration and replacement soon takes

¹ *Max Verworn*: Psychophysiologische Protistenstudien. Experimentelle Untersuchungen." Jena 1889.

The same: "Die physiologische Bedeutung des Zellkerns." Pflügers Arch. Bd. 51, 1892.

place. The level of this state of equilibrium depends upon the relative intensity of the stimuli. It is lower in the case of strong and higher in that of weak stimuli. This fact becomes apparent from the researches of *Thörner*¹ on the fatigue of medullated nerves in air. This investigator showed that during continued tetanic stimulation of the nerve, the irritability fell to a certain level, at which it remained so long as stimulation persisted. The irritability decreased to a new level when the strength of the stimulus was increased. These interesting experiments of *Thörner* show that the level reached when stimulation is continued is higher as the intensity is weaker. It is, therefore, clear that this level in summation of stimulation beneath the threshold can be above that of the threshold of perceptible response, that is, a perceptible tonic excitation may result. In the genesis of tonus in the muscle, there is another point to be taken into consideration. Here we have a combination of a heterotopic interference with a homotopic interference, for the total shortening of the muscle is brought about in part by several contraction waves which occur at various points at the same time and which follow each other, therefore have a heterotopic sequence. If we consider a long stretch of muscle, to one end of which a stimulus is applied, it will be found that the contraction wave moves throughout the entire length. If after a certain interval of time a second stimulus is applied, the resultant wave moves along the muscle but does not necessarily homotopically interfere with the first. In short, there are two waves of contraction occurring coincidentally in the muscle, the muscle is now more strongly contracted. *Fröhlich*² has made the fact intelligible by this means that tetanic shortening of a muscle is greater than that of maximal shortening which can be produced by strong single stimulation. This heterotopic interference dare not be overlooked in the genesis of muscle tonus. If it is true, as appears from the investigations of *Keith Lucas*,³

1 *Thörner*: "Weitere Untersuchungen über die Ermüdung des markhaltigen Nerven. Die Ermüdung in Luft." *Zeitschr. f. allgem. Physiologie* Bd. X, 1910.

2 *Fr. W. Fröhlich*: "Ueber die scheinbare Steigerung," etc. *Zeitschr. f. allgem. Physiol.* Bd. V, 1905.

3 *Keith Lucas*: "On the gradation of activity in a skeletal muscle fiber." *Journ. of Physiology*, Vol. XXXIII, 1905-06. The same: "The all or none law of contraction of the skeletal muscle-fiber." *Journ. of Physiology*, Vol. XXXIII, 1909.

that the "all or none law" applies to striated muscle, then an increase of the contraction from homotopic summation cannot occur, because an isobolic system cannot show an increase of its already maximal excitation by summation. Such being the case, the tonic shortening of striated muscle can only be explained as an expression of a heterotopic interference.

If we assume that the summation of sub-threshold stimulation, by increasing excitation, brings about a state of equilibrium from below, as it were, so also inhibition may be assumed to be the reverse, the level of equilibrium being reached from above, as it were, by decrease of the primary excitation from strong stimulation. This is expressed in our general scheme of the development of summation and inhibition resulting from the effect of a series of stimuli. At the same time the first part of the curve to the fall of irritation to the level of the sub-threshold equilibrium can be shortened to a minimum by strong stimulation or greater frequency of the same, and we have then the type of *inhibition with primary excitation*. As example of this I wish to again recall the strychninized frog which was used in the fundamental experiments for understanding of the theory of inhibition. If we stimulate a sensory nerve of a strychninized frog, in which the refractory period is already lengthened, with rhythmic single induction shocks of slow frequency, the muscle arranged to make a graphic record will show reflex contraction following each stimulus. If, on the other hand, we apply a series of stimuli, consisting of single stimuli rapidly repeated, contraction is produced only by the first, or the first few stimuli (Figures 45 and 46, pages 202, 203). For the succeeding stimuli the centers remain inhibited, because each succeeding stimulus occurs in the refractory period of the former. The origin of this inhibition shows us with particular clearness how excitation produced by each single stimulus depending upon the frequency of the same, falls rapidly or slowly beneath the threshold of perceptible response. In this case, the state of equilibrium is reached which is maintained by the following stimuli. That a single stimulus is not entirely without effect upon this state of equilibrium follows from the fact that during the continuation of the stimulus a recovery to the point of observable

response does not occur, whereas such is the case immediately upon the discontinuation of the stimulus. In inhibition, then, the dissimilatory excitation produced by a single stimulus falls to a low level as a result of the reduction of irritability and remains at this level continuously. *Inhibition as well as tonus is based upon the development of a state of equilibrium between excitation and recovery, or disintegration and restitution of the living substance under the continuous effect of a rhythmic series of stimuli. They differentiate themselves essentially by the height of this equilibrium, which is dependent upon the intensity of the stimulus.*

We have to the present considered only the *simplest* conditions existing as a result of the effect of a *single* series of stimuli and also of the interference of its individual members. These elementary conditions are at the basis of an understanding of complicated *interference effects which arise when two series of stimuli interact*. In that these processes can be readily explained by the elementary processes previously described, I will, therefore, dwell but briefly on this subject. From the standpoint already taken it may be readily presumed what will happen when two series of stimuli act upon the same system.

When there is interference of *two series of stimuli*, there are two resultant possibilities. In one type the stimuli of the one are active simultaneously with that of the other. In this instance both stimuli would act as a single stimulus of greater intensity, and we have essentially the same condition as exists when a single series is operative. Nevertheless, such cases are practically hardly realized in the physiological happenings of the organism. More often a state exists wherein the single stimuli of one series occur in the intervals of the stimuli of the other. In these cases there is an increase in the frequency of the stimuli applied in a given length of time. We have here, then, in principle the same conditions as when a series of greater frequency is operative. (Figure 55.) The effect of such alteration in the frequency consists in an increase of the velocity of the development of summation or inhibition, as the general scheme (Figure 55) has shown us. Depending upon the special combination of the factors involved in inter-

ference, we may have a summation of the exciting effect of each series of stimuli or an inhibition of one series by the exciting effects of the other series. If the frequency of both series is essentially different, we may have here the conditions for periodically increasing and decreasing excitations. Nevertheless these conditions have not been systematically analyzed and experimentally studied.

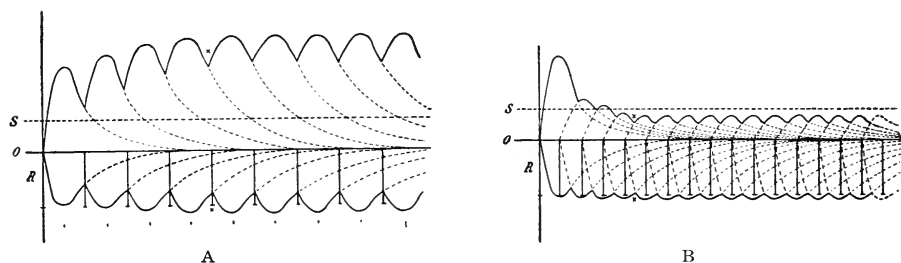

Fig. 55.

Interference of two series of stimuli. A—Effect of the one series alone. Development of tonus by summation. The dots below the curve indicate the points of time at which the stimuli of the second series will operate. B—Effect resulting from the interference of both series. By the addition of the second series the frequency has been doubled. The result consists in an inhibition.

The greatest number of instances of the interference of two series of stimuli have been given to us by investigation of the physiology of the nervous system. In the functioning of the nervous system the fact that two series of stimuli from different tracks affect the same ganglia plays a very important rôle. It is this to which *Sherrington*¹ has alluded as “*the principle of the common path.*” Where two nervous excitations involve the same paths, there arises an interference of the effect of the two series of stimuli, for the impulses in the nervous system, as already stated, possess a rhythmic character. This principle has a broad application in the phenomena of association in the cerebral cortex. The simpler and, therefore, the most easily understood cases are, however, in the spinal cord. The motor neurons of the anterior horns of the spinal cord are the junction of a

¹ *Sherrington*: “Ueber das Zusammenwirken der Rückenmarksreflexe und das Princip der gemeinsamen Strecke.” *Ergebnisse der Physiologie*. Jahr. IV, 1905.

great number of tracks, for example, the sensory neurons of the spinal cord at different levels, the neurons of the cerebellum, the pyramidal tracks from the motor areas of the cerebral cortex, etc. On the contrary, for example, the sensory neurons of the spinal cord are strictly "*private paths*" in the sense of *Sherrington*, for excitation can enter by this means only from the special paths of the spinal ganglia and, therefore, from the periphery. The motor neurons of the anterior horns offer, therefore, excellent opportunities for the experimental investigation of the interference of two series of excitations which enter by different paths. The spinal cord consequently has become a much-used object of investigation for this purpose. In fact, we can observe and produce all types of interference in the spinal cord. These conditions have been quite thoroughly investigated by *Sherrington*¹ and his coworkers on the dog, and *Fröhlich*,² *Véssi*,³ *Tiedemann*⁴ and *Satake*⁵ on the frog.

A *summation of two excitations* was observed already by *Exner*. This investigator connected the abductor pollicis of the rabbit with an apparatus for making graphic records. He then stimulated first the paw and then the motor areas of the cerebral cortex with faradic shocks, the intensity of which was just sufficient to bring about perceptible effect. If both stimuli were simultaneously operative, an increase in the response was observed. Even when the stimuli were sub-threshold in type, as a result of summation there was a perceptible muscle contraction. (Figure 56.) *Exner* had at that time referred to this increase of the response as "*Bahnung*" (reinforcement). However, the word "*Bahnung*" has more than one meaning, for processes of various types are involved in this term. Thus writers have differentiated

1 *Sherrington*: "The integrative action of the nervous system." New York 1906.

2 *Fr. W. Fröhlich*: "Der Mechanismus der nervösen Hemmungsvorgänge." *Med. Natur. Arch.* Bd. I, 1907. The same: "Beiträge zur Analyse der Reflexfunction des Rückenmarks, etc." *Zeitschr. f. allgem. Physiologie* Bd. IX, 1909. The same: "Das Princip der scheinbaren Erregbarkeitssteigerung." *Ibid.*

3 *Julius Véssi*: "Der einfachste Reflexbogen im Rückenmark." *Zeitschr. für allgem. Physiol.* Bd. IX, 1910.

4 *Tiedemann*: "Untersuchungen über das absolute Refractärstadium und die Hemmungsvorgänge im Rückenmark des Strychninfrosches." *Zeitschr. f. allgem. Physiologie* Bd. X, 1910.

5 *Satake*: The researches are not yet published.

real and apparent "Bahnungen." On account of this lack of clearness in the meaning of the term "Bahnung," I wish to discard its use as it is not at all essential. We will speak simply of a *summation of excitation*, for here it is simply a question of summation of two excitations of the motor cells of the spinal cord.

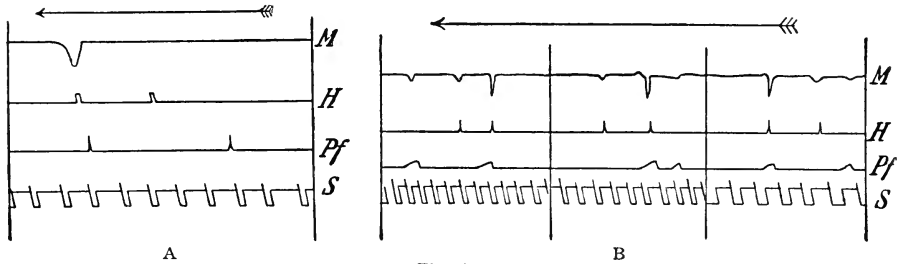

Fig. 56.

Summation of two excitations in the rabbit. The one proceeds from the paw, the other from the motor sphere of the cerebral cortex. *S*—Time in seconds. *Pf*—Stimulation of the paw. *H*—Stimulation of the motor sphere. *M*—Contractions of the abductor pollicis. (After Exner.)

Fröhlich has shown that summation of two excitations upon a motor cell of the anterior horn coming by way of different paths is more readily obtained when the stimuli are somewhat strong, or when the duration of the excitation processes in the ganglion cells are somewhat prolonged by fatigue.

On the other hand, the conditions for the production of *inhibition* are favored when the intensity of the series of stimuli is weak. Here it is a question of the development of a relative refractory period for the weak stimuli by increase in their frequency. A relative fatigue of the motor ganglion cells for weak stimuli rapidly occurs, and there develops a state of equilibrium beneath that of the threshold of perceptible effect throughout the continuation of stimulation. *Véssi* succeeded in isolating these types of summation and inhibition in the spinal cord. His method consisted in cutting the posterior roots of the spinal cord of the frog and stimulating faradically the central ends, and at the same time graphically recording the response of the gastrocnemius muscle. Upon faradic stimulation of the ninth posterior root, one obtains tetanic reflex contraction of this muscle. When the tenth poste-

rior root is then stimulated, tetanus is also produced but of somewhat shorter duration. If, while obtaining tetanus reflexly by stimulation of the ninth root, a faradic current of short duration and not too weak is applied to the tenth root, then a summation of excitation occurs, an increase in the reflex contraction. (Figure 57, A and B.) When, on the other hand, the tenth root

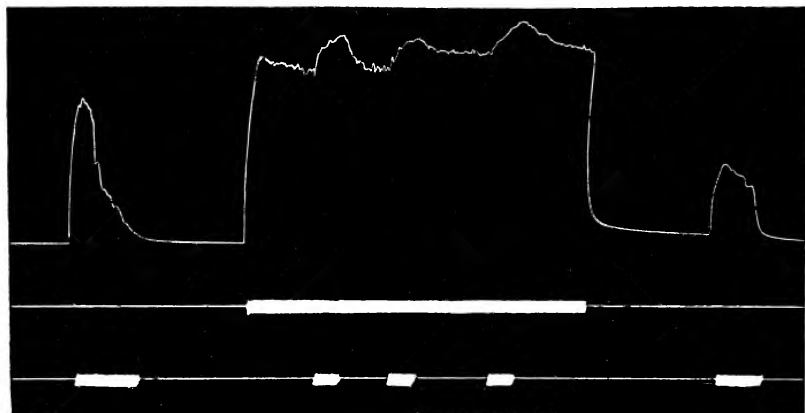

A

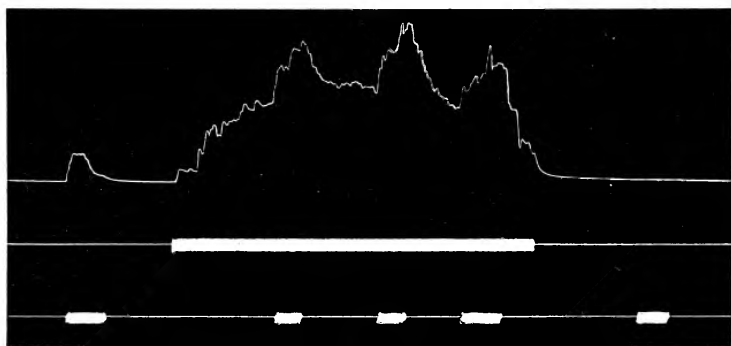

B

Fig. 57.

Summation of two excitations in the spinal cord produced by stimulation of the ninth and tenth posterior root. Lower line indicates faradic stimulation of the tenth, upper line of the ninth root.

is stimulated with weak shocks, one can obtain an increase of the tetanus of short duration followed by inhibition. Here, as the result of interference, we have an instance of inhibition with primary tetanus. (Figure 58.) When the tenth root is stimulated

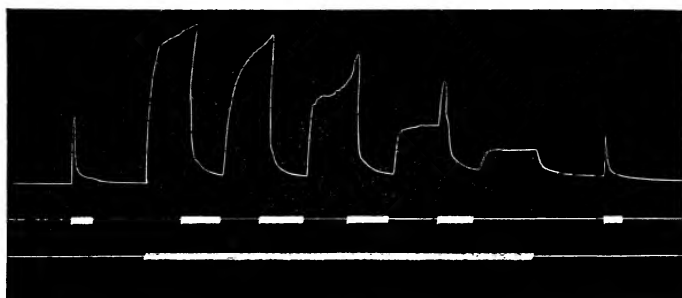

A

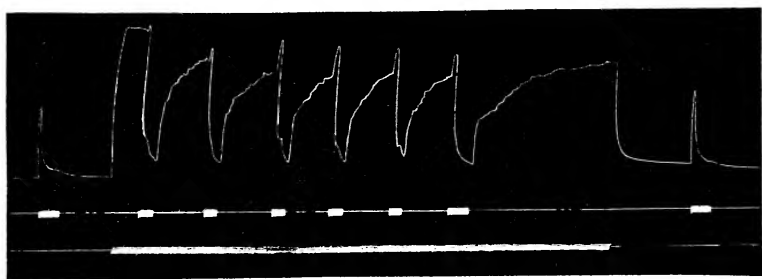

B

Fig. 58.

with very weak shocks, inhibition of the tetanus produced simultaneously from the ninth root occurs without primary summation. (Figure 59.) The fact that two series of stimuli, both of which produce dissimulative excitation, bring about an inhibition by their combined action, is sufficient to show the untenability of the *Gaskell-Hering* hypothesis, that inhibitory processes result from assimilatory excitation. It would be impossible to understand how two dissimulatory exciting stimuli, by their simultaneous action, could bring about assimilatory excitation. When

the eighth or the seventh root is stimulated with stronger faradic shocks during the time when tetanus is produced reflexly by faradic stimulation of the ninth, an inhibition is practically always obtained. Indeed, faradic currents that are so weak as to be *far* below the threshold of perceptible response bring about when applied to the seventh or eighth root a decided inhibition of the tetanus, brought about by simultaneous stimulation of the ninth root. The inhibitory effect of weak sub-threshold excitations are here particularly apparent. This inhibition resulting from excitation far below that of the threshold of perceptible response

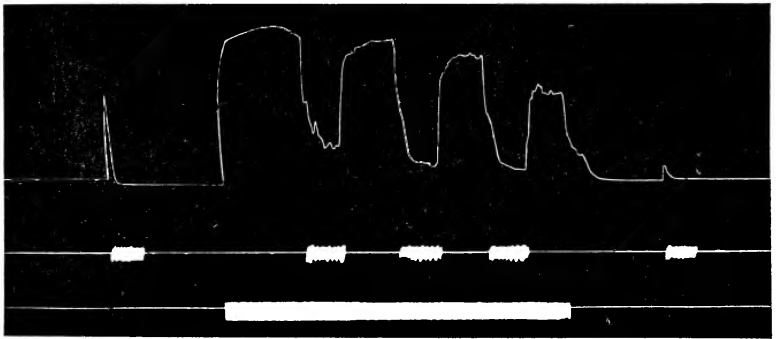

Fig. 59.

is a common occurrence in the functional activities of the central nervous system. In various parts of the nervous system, the excitation in its conduction is weakened when passing through intervening ganglion stations so that it has undergone a strong decrement before reaching the responding structure, where an inhibitory effect may be manifested. In this connection it is of interest that the reciprocal "antagonistic reflexes" discovered by *Sherrington*,¹ who recognized their importance in the functional processes of the nervous system, can be explained, as *Fröhlich* showed, upon this principle of inhibition resulting from weakened excitation. On the basis of numerous investigations in the

¹ *Sherrington*: "Experimental note on two movements of the eye." *Journ. of Physiology* XVII, 1895. The same: "On the reciprocal Innervation of antagonistic muscles." *Proceed. of the Royal Soc.*, 1897.

Göttingen laboratory as well as that of Bonn¹ we have come to look upon the reflex arc in the spinal cord as consisting of the following elements: a neurone in the spinal ganglion, a neurone in the posterior horn and a motor neurone in the anterior horn. This is the most direct route between the point of stimulation and that of the responding organ of a unilateral reflex. (Figure 60.) It is known that the excitation becomes weaker in passing

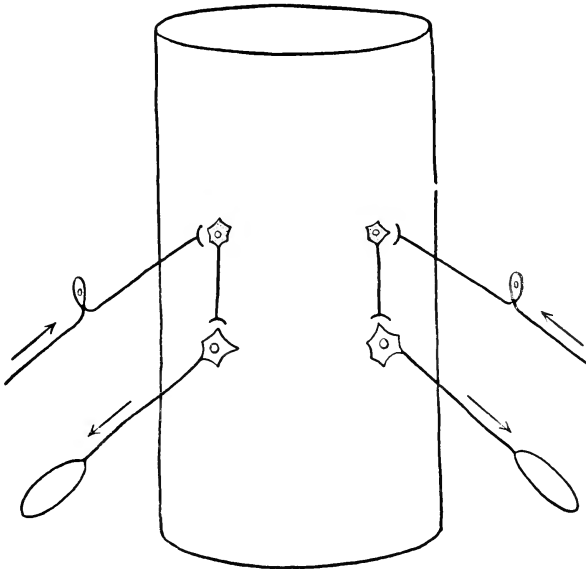

Fig. 60.

Scheme of the simplest unilateral reflex arc of the spinal cord.

from the entrance of the excitation into the spinal cord to the motor elements of a lower level on the same side or to those on the opposite side. In order to obtain a response a stronger stimu-

¹ *Max Verworn*: "Die einfachsten Reflexwege im Rückenmark." *Zentralblatt f. Physiologie* Bd. XXIII. *Tiedemann*: "Untersuchungen über das absolute Refraktärstadium und die Hemmungsvorgänge im Rückenmark des Strychninfrosches." *Zeitschr. f. allgem. Physiologie* Bd. X, 1910. *Julius Vészi*: "Der einfachste Reflexbogen im Rückenmark." *Zeitschr. f. allgem. Physiologie* Bd. XI, 1910. *Oinuma*: "Ueber die asphyktische Lähmung des Rückenmarks strychninierter Frösche." *Zeitschr. f. allgem. Physiol.* Bd. XII, 1911. *Satake*: Not yet published.

lus is necessary. Here the weakening of the excitation as well as the prolongation of the reaction time is brought about by the introduction of intercalated neurones. The reflex arc contains more stations. (Figure 61.) If we accept the most plausible

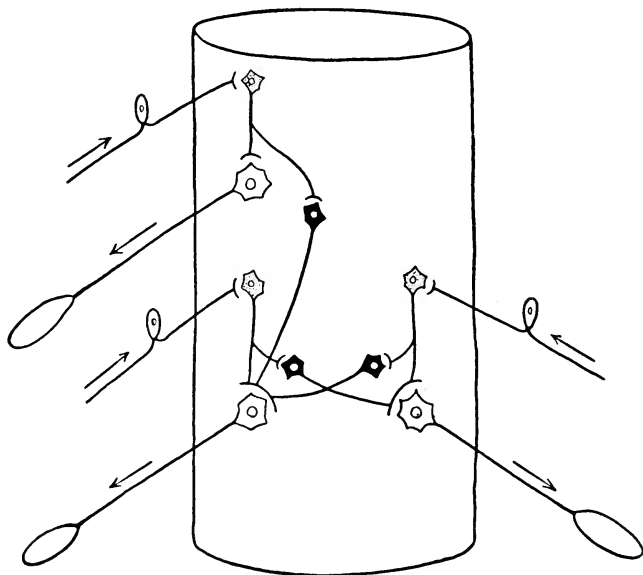

Fig. 61.

Scheme of the simplest reflex arc from one to the other side, and from a higher to a lower level.

assumption that the central connection of antagonistic muscles possesses like relations, then the effects discovered by *Sherrington* are self-explanatory. In this case stimulation of the sensory path, which brings about a strong reflex excitation of the motor neurons of the anterior horns controlling a muscle, at the same time stimulates the antagonistic muscle with sub-threshold stimuli. The result of this as shown by the experiments of *Véssi* is not a motor response of the antagonists, but an inhibition if the motor neurons of the antagonists are at the time in a state of excitation. It is, therefore, understandable that reflex excitation of a

muscle under normal conditions of irritability has an inhibitory effect on its antagonist.

Finally, I wish to conclude this discussion on the origin of central inhibition and its dependence upon the strength of the stimulus by referring to a point which apparently is contradictory. We have already met with the fact that series of stimuli by their interference in the nervous system may have different effects depending upon their intensity; if this is strong, we obtain summation of excitation, if weak an inhibition. The question may be asked, how is it possible that a weak stimulus can have a different effect when it is believed that the nerve as an isobolic system responds to intensities of all gradations to the same extent, namely, with maximum excitation? If the "all or none law" is applicable, then the same intensity of excitation is always carried to the centers and yet we see that various kinds of responses follow various intensities of stimulation. Here, indeed, is a difficulty which has not as yet been explained. Naturally between the two facts there can be no contradiction. But the question arises, how are we to bring them into harmony? Two entirely different possibilities present themselves. If the various intensities of stimulation always bring about excitation of the same strength and we see in spite of this that various intensities of stimulation produce various kinds of effects, then we must think of the possibility that various intensities of stimulation bring about some other effect than that of variations in intensity in the course of the wave of excitation. In this connection variations in the time involved must be taken into consideration. One might think that *strong* stimuli may develop a longer wave of excitation than such of *weak* intensity. *Gotch*¹ tested these questions experimentally with completely negative results. A single strong stimulus does not result in an excitation differing in its course from that of a weak stimulus. But there is another possibility that requires testing. This was brought to light by the investigation of *Thörner*² on the fatigue of the nerve. His inves-

¹ *Gotch*: "The submaximal electrical response of nerve to a single stimulus." *Journ. of Physiology*, Vol. XXVIII, 1902.

² *Thörner*: "Weitere Untersuchungen über die Ermüdung des markhaltigen Nerven: Die Ermüdung in Luft," etc. *Zeitschr. f. allgem. Physiologie* Bd. X, 1910.

tigations showed that in a normal nerve in air the first typical beginning of fatigue resulting from faradic stimulation can be demonstrated in the characteristic summation of excitations. This is shown by the nerve after fifteen minutes of stimulation with faradic shocks applied for short intervals. The irritability, when tested with single induction shocks, is at the same time reduced. Thereby the amount of fatigue of the nerve, that is, the amount of the reduction of irritability, is dependent upon the strength and frequency of stimulation producing fatigue. When the nerve is stimulated with weak faradic shocks of a slow rate of frequency, there is a slight or a complete absence of the reduction of irritability. On the other hand, if the nerve is fatigued with strong faradic shocks of great frequency, the irritability falls very considerably. This shows that when the nerve is stimulated for a longer time, even under conditions favorable to the supply of oxygen, a diminution of irritability occurs and with it naturally an actual diminution of the wave of excitation, a diminution the intensity of which becomes greater as the strength of the stimulus increases. In other words, long-continued faradic stimulation converts the nerve from a system isobolic in character to that which is heterobolic in that the intensity of the excitation which is conducted differs depending upon the intensity of the stimulus. We have found other cases in the investigation of the nervous system in which, as in fatigue, an isobolic is converted into a heterobolic system. *Vésszi*¹ has shown that the centers of the strychninized frog, which are isobolic in character, when fatigued by *weak* faradic stimuli can be brought to react again when the faradic stimulation is increased. According to this and other experiments of a like nature, it is beyond doubt that an isobolic system during the refractory period may assume a heterobolic character, and only after completion of the refractory period and entire recovery of the equilibrium of metabolism does the isobolic character return. This permits us to understand the characteristic properties of an isobolic system more accurately and precisely than has thus far been possible. The "all or none law"

¹ *Vésszi*: "Zur Frage des Alles oder Nichtsgetzes beim Strychninfrosche." Zeitschr. f. allgem. Physiologie Bd. XII, 1911.

with its associated properties, such as the conductivity without decrement and the incapability of summing excitations, have in a system of this character only relative validity. They are realized only in the state of an equilibrium of metabolism. Only when the stimuli follow each other at intervals greater than the duration of the refractory period is there a response of equal extent to stimuli of all intensities which are above the threshold. During the refractory period and consequently in fatigue, asphyxia, cooling and narcosis, etc., in short, in all states in which the refractory period is prolonged this system loses its isobolic properties and becomes heterobolic. In order that there may not be a misunderstanding, we will consider more in detail the capability in this state of summation of excitations. When we refer to a summation of excitation of such a system under the influence of one of these factors, we, of course, at no time mean an increase of response beyond that of the degree of excitation which exists in an isobolic system in a normal state consequent upon the application of a single stimulus, for this degree of excitation is maximal. We refer rather to a summation which has become reduced as a result of fatigue.

On the basis of these facts it is readily understood when a level of equilibrium of lower intensity has been reached that excitation produced by weak faradic stimulation must have weaker effects than when strong stimuli are applied, for when the system assumes a heterobolic type as the result of relative fatigue weak stimuli bring about weak, and strong, stronger excitation. Consequently, during interference induced by a second series of excitations, in the first case we have the conditions favorable for inhibition, in the second for those of summation. If we also assume that this characteristic alteration of the isobolic character of the elementary nerve fibers which has been shown to occur in fatigue, as seen when continued faradic stimulation is employed, develops immediately after the beginning of stimulation then we can readily understand the various kinds of effects produced by interference observed in the reflex response following weak and strong faradic stimulation to the different nerves in spite of the fact that the nerve in the state of rest is a system isobolic in type. Experi-

mental evidence, therefore, must be brought forward to show that faradic stimulation of short duration produces the above-mentioned alteration in the character of the system. *Thörner* in his experiments on the nerve stimulated it faradically at least four minutes and always found after this that excitation was reduced. After shorter intervals of stimulation *Thörner* made no test of the state of excitation. It is, however, highly probable that a reduction of excitation is much more quickly reached. Indeed, we are unavoidably compelled to accept the assumption that even after the first single stimulus of the faradic current, alterations of a slight degree are present which, after repeated stimulation, become constantly greater and give to the system a heterobolic character. As a result of fatigue, as we have already seen, the refractory period becomes more and more prolonged. As the individual shocks in faradic stimulation follow each other at regular intervals, a necessary consequence is that the shocks are operative before the refractory period has completely disappeared, otherwise *Thörner* could not have obtained fatigue produced by continued stimulation. The intervals of the individual shocks must be somewhat shorter than the duration of the refractory period, even in fatigue of a very slight degree. It is very interesting in this connection that *Thörner* invariably obtained positive evidences of fatigue by the application of stimuli at the rate of 10-12 per second. When the number of stimuli per second was less than this the above-mentioned result was not always obtained. From this we can easily estimate the refractory period of the nerve, which is present after reaching a state of equilibrium under certain conditions. If we assume ten stimuli per second to be the number required to produce slight fatigue when stimulation is prolonged, we can conclude that the refractory period in this state is somewhat longer than one tenth of a second. Even though *Gotch* in his investigations already cited placed the refractory period of the normal nerve at about .005 second, this statement is in no way contradictory to the figure which we have just given. *Gotch* measured simply the duration of the absolute refractory period of the normal nerve, in other words, the duration of the period in which no excitation at all could be brought

about. On the contrary, my estimate, based upon the investigations of *Thörner*, refers to the *total* refractory period of the nerve, that is, to the point of *complete* recovery of the equilibrium of metabolism and of the specific irritability. Experimental proof of this assumption is already under way.

I have endeavored to show the elementary principles at the basis of these extremely varied interference effects and to make a few generalizations concerning the complicated conditions here concerned. It has been shown that a great number of interference effects possess characteristics in common if one takes into consideration the process occurring in the course of a single excitation. The altered state which exists in living substance until the complete disappearance of excitation is the basis upon which to explain the altered effects produced by a second stimulus. This state alters during the whole course of the first stimulus until the original equilibrium of the metabolism of rest is, by self-regulation, again reached. It is, therefore, self-evident that the second stimulus must have different effects depending upon the momentary state of the living system at the time of its application. The state of the system differs depending on the length of the interval in which the second stimulation follows the first. The most important factor is the phase of the excitation period and the reduction of irritability. The second important factor is the intensity of the second stimulus; the relation of the two with each other determines the response. But the specific properties of the given systems must also be taken into consideration. It is important to know if the living system possesses isobolic properties, that is, every intensity of stimulation produces a *maximal* liberation of energy, or if it possesses a heterobolic character, that is, stimuli of different strength bring about the liberation of *different* amounts of energy. It is further important to know the rapidity of reaction, whether the system rapidly or slowly fatigues. In all cases it depends whether the second stimulus produces a perceptible excitation or whether it occurs in the refractory period and produces no perceptible effect. Upon these factors depend the results of the interference of two rhythmic series of stimuli, whether a summation or inhibition of

excitation takes place. Here is the key to the understanding of the great variety of interference effects. By determination of these various factors in a given case and their sequence, we can anticipate the nature of the interference which will follow. The complex actions brought about by the various factors, which we cannot at first clearly understand, can be at once interpreted as soon as we convert them into their elements.

CHAPTER IX

THE PROCESSES OF DEPRESSION

Contents: Necessity of cellular physiological analysis of toxic depressions by pharmacology. Apparent variety of processes of depression. Depression of oxydative disintegration as the most extended principle in the processes of depression. Asphyxiation, fatigue, heat depression, as a consequence of restriction of oxydative disintegration. Narcosis. Theories of narcosis. The alteration of specific irritability and conductivity in narcosis. Depression of oxydative processes in narcosis. Asphyxiation of living substance when oxygen is present during narcosis. Persistence of anoxydative disintegration in narcosis. Increase of the same by stimuli. Depression by narcosis as a form of acute asphyxiation. Hypothesis on the mechanism of depression of oxygen exchange by narcotics. Possibility of combining the facts with the observations of *Meyer* and *Overton*.

The processes of *excitation* of all the effects of stimulation are those which have invariably claimed place in the interest of physiologists. The study of the processes of *depression*, on the other hand, has remained more or less in the background. This is readily understood when it is considered how much more apparent the processes of excitation are than those of depression. Nevertheless, these latter possess no less importance for the course of vital phenomena than those of excitation. Without depression no excitation can take place in the vital activity of the organism, for, as we have seen, every excitation is secondarily followed by a refractory period. To this must be added the great number of *primary* depressions, directly brought about by the most varied stimuli, such as cold, want of oxygen, poisons, etc., without the presence of a preceding excitation. Thus it is essential that the processes of depression should be studied with no less interest than those of excitation, and it is much to be desired that the former should receive a more detailed analysis than has up to now been the case. Even as it is, extensive material has

been obtained for the analysis of this group of reactions. With the closer study of the process of excitation the facts in connection with the refractory period and fatigue make it necessary that the processes of depression be taken into consideration. Toxicology and pharmacology likewise furnish innumerable effects of depression produced by poisons and drugs. Unfortunately the investigation of these reactions has been in the main purely superficial. This arises from the recency of the development of these sciences. Even later than physiology they are only now beginning to extend their investigations, directed up to the present to the grosser organic reactions, to the cellular analysis of the effects of poisons. How rarely we find instances in which the effect of some drug is studied at the point of attack and systematically followed to the specific cell form, and its primary exciting or depressing effect on this or that constituent process of the metabolic activities ascertained. And how great, on the other hand, is the number of "medicines" making their appearance each year in pharmacology of which nothing further is known than a few secondary effects on the action of the heart, the blood pressure, the secretion and excretion and on some other outwardly perceptible organic actions! This deplorable condition of present-day pharmacology must be ascribed to the regrettable circumstances that pharmacological research is only in a very small degree the result of careful investigations, carried out by biologically and chemically trained pharmacologists, but is for the most part undertaken at the instigation of chemical manufacturers. This eager haste to obtain superficially practical results has lessened in great degree the interest in the close and painstaking theoretical analysis of reaction to poisons. Thus it happens that, in spite of the numberless examples of the depressing effects of poisons discovered by pharmacologists, it is only in rare instances that the physical nature of these processes is more closely studied. Therefore, investigation in pharmacology and toxicology in so far as they are carried out in a purely scientific spirit and not influenced by the desire for merely superficial results, may find here a wide field of research work, rich in future promise. It is from such investigation that we may

expect an abundance of material for the closer analysis of the processes of depression. For the present, however, we must restrict ourselves to the consideration of some individual cases which have been studied somewhat more in detail by physiologists.

Simple reflection shows the possibility that depression, that is, the retardation of the normal vital processes, can be brought about in various ways. As on the one hand the normal metabolism of rest is composed of very numerous chemical constituent processes, and on the other hand the closest interdependence exists between these individual constituent processes, it follows that every factor which increases or retards even one of these must secondarily influence the course of the entire activity. Hence a wide range of possibilities exists for the processes of depression. As the complicated works of a clock can, by the stopping of a single moving part, be brought to a standstill, so in like manner the metabolic activity can be depressed by very different constituent members. In spite of this we have every reason to assume that the greater number of all processes of depression result from the primary effect of one or a few constituent members. A primary simultaneous depression of all or at least of numerous constituent processes of the entire metabolism may only be assumed as possible, resulting from decrease of temperature within certain limits. But even in the case of "*cold depression*" it is not probable, owing to the great effect of every alteration in the relations of masses in the cell, that depression is solely the manifestation of a *uniform* retardation of all individual constituent metabolic processes. If, therefore, the greater part of the processes of depression are brought about by the primary effects of an individual constituent process, then the possibility must be admitted that *any* component of the chain can by the means of some specific external influence form the starting point for a depression. The number of the various kinds of processes of depression would be, therefore, enormous. The knowledge obtained up to the present shows, however, that this variety is not quite as great as the above facts might lead one to expect. Even though future investigation will certainly not do

away with the assumption of the existence of the most manifold physical types of depression, the analysis of a few processes which have been studied up to now demonstrates the singular fact that a number of these which are brought about by quite different external factors, are based on an absolute uniformity of their mechanism. As we have previously seen, a certain constituent of the metabolic chain can be *excited* primarily by very different kinds of stimuli. In like manner there exists in metabolic activity a certain point of predilection for different kinds of stimuli, from which their *depressing* effects proceed. Here the highly interesting fact is shown that this point of predilection, which represents that of the most frequent attack, is the same for *excitating* as for *depressing* stimuli. These are the *oxydative* processes. As our knowledge of the reactions to stimuli in anaërobic organisms is still almost nil it is not possible at present to ascertain which component in the metabolism of these organisms, adapted to life without oxygen, plays an analogous rôle to that of the oxydative in aërobic systems. Our investigations must, therefore, be restricted to the world of aërobic organisms. Here we have seen that the different stimuli which produce an exciting effect invariably increase the oxydative disintegration of the living system and we now find that these constituent processes of metabolism likewise form a point from which *depressing* responses to stimuli very readily proceed.

The prototype of this group of processes of depression in which this is manifested in a most striking manner, is that of a simple *asphyxiation* by the withdrawal of the oxygen supply from the exterior. If the supply of oxygen is withheld from an aërobic organism, oxydative disintegration is gradually found to be more and more decreased and further breaking down takes place *anoxydatively*, as oxydative decomposition forms the chief source of energy production, and energy production consequently undergoes a gradual decrease. Exciting stimuli, therefore, meet with less response than when a sufficient supply of oxygen is present, that is, *irritability is diminished*. As a result of this decrease, a corresponding decrement in the extension of excitation takes place, which, in turn, is likewise manifested by the

restriction of the perceptible response to stimulation. In the same degree in which oxydative disintegration becomes less, *anoxydative* breaking down products are accumulated. The accumulation of these products likewise plays a part in the production of depression and increases the decrement in the conduction of excitation. The decrease of energy production by decline of the oxydative decomposition, as well as the accumulation of *anoxydative* breaking down products, therefore, similarly reduce irritability; that is, their effect is depressing. This whole series of processes, which we have previously considered in detail, takes place on the withdrawal of oxygen and leads to the depression of asphyxiation. It can readily be observed in the most varied kinds of *aërobic* organisms in rhizopods and infusoria, in plant and ganglion cells, but finds its most complete demonstration in the nerves. Here these processes can be easily produced with any rapidity desired, accordingly as a relative or absolute want of oxygen is brought about. These same typical results are likewise shown in numerous processes in which the external conditions are quite different in nature.

We have previously become acquainted with such a case and studied it in detail. This is the state of *fatigue*. Fatigue is a typical state of depression, that is, a state in which the vital process is retarded and irritability in response to stimuli correspondingly decreased. Fatigue is, however, as we have found, the result of a relative deficiency of oxygen. The amount of oxygen at disposal is not sufficient to allow of disintegration, increased by constant functional activity oxydatively taking place, to develop to its full extent. In consequence the previously cited sequence of processes takes place. A "depression of activity" is produced. Fatigue is true asphyxiation and it is here evident that depression proceeds from the same constituent processes of metabolism as excitation, brought about by a single stimulus. Excitation produced by constant stimuli gradually merges into depression as the amount of oxygen at disposal, even if augmented in the intact organism by the increased blood supply, for instance, is still insufficient to meet the demand made by the increased oxygen consumption as a result of continuous functional activity.

A further very interesting example of depression produced by oxygen deficiency is furnished by *heat depression*. It has long been known that with increasing temperature the vital manifestations of all poikilothermic organisms at first undergo a heightening of their intensity. If, however, after a maximum is reached, the temperature is still further increased a sudden depression sets in. The increase in the rapidity of the vital process as a result of increased temperature is readily understood when based on the well-known law discovered by *van't Hoff*. Numerous investigations on the rapidity of the course of special vital manifestations, as, for instance the growth of the eggs of the frog and sea urchin, the assimilation of carbon dioxide in green plant cells, the number of vacuole pulsations in the infusoria cells, the frequency of the heart rate of the frog and of the mammal, etc., have shown that their increase does in fact follow the *van't Hoff* law, being doubled or tripled in amount with every increase of ten degrees of temperature. The genesis of depression produced by *heat*, developed in different organisms at various heights of temperature, requires a closer analysis. This depression takes place at temperatures below that in which coagulation of proteins occurs. Therefore, under certain conditions, with which we shall presently become acquainted, it is capable of being recovered from, whereas in higher temperatures, in which albumen coagulates, vital activity is permanently obliterated. Depression produced by heat is, therefore, in itself not a necrobiotic process, which, as such, must necessarily lead to death. But rather like fatigue it must be looked upon as an asphyxiation process. Its relations to oxygen exchange have been chiefly demonstrated by *Winterstein*¹ by his investigations on the central nervous system of frogs and on medusæ. He found that when placed in a heated chamber in a temperature of 32-40° the activity and reflex excitability of the frog are at first augmented. Within the lapse of a short time this increase has become so great that the slightest touch produces tetanic contractions, simi-

¹ *H. Winterstein*: "Ueber die Wirkung der Wärme auf den Biotonus der Nervenzentren." *Zeitschr. f. allgem. Physiol.* Bd. I, 1902. The same: "Wärmelähmung und Narkose." *Ibid.*

lar to those characteristic of strychnine poisoning. Very soon, however, this state of high excitation is followed by one of depression, in which no response to stimuli can be obtained. The animal remains entirely motionless in any position in which it is placed, in the same manner as a frog whose nerve centers have been completely exhausted by strenuous activity. On the basis of our knowledge of the rôle played by the deficiency of oxygen in the bringing about of exhaustion the thought arose, if in this heat depression exhaustion might not likewise be the result of oxygen deficiency. This assumption has been most strikingly confirmed by the investigations of *Winterstein*. It has been demonstrated that recovery of the animal in a state of heat depression cannot be obtained by mere cooling, but is only brought about when at the same time a renewed oxygen supply is provided. For instance, a frog is depressed in the warm chamber and even when a strychnine injection has been introduced, does not show the slightest reaction to stimuli. In the warm water bath artificial circulation is now applied in the previously described manner with an oxygen-free saline solution at 30° C., so that the blood is displaced and thus the renewed oxygen supply to the nervous centers prevented. The animal can now be cooled and the warm saline solution be replaced by a cooled one without the least recovery taking place. If, however, blood of the ox with contained oxygen is substituted for the oxygen-free saline solution, the frog shows signs of recovery within a few minutes and after ten or fifteen minutes responds as a result of the strychnine to the merest touch with tetanic contractions of the whole body. By modifying these methods of investigation to a certain extent *Bondy*¹ has confirmed these results to the fullest extent. Later *Winterstein* by quantitative determinations of oxygen consumption on medusæ showed that at 30-35° C., at which temperature heat depression sets in, the consumption of oxygen shows an increase of about three and a half times compared to that in a temperature of 11-12° C. These facts show that we have in heat depression a process which, as far as its genesis is concerned, is completely analogous to that

¹ *Oskar Bondy*: "Untersuchungen über die Sauerstoffaufspeicherung in den Nervenzentren." *Zeitschr. f. allgem. Physiol.* Bd. II, 1904.

of fatigue. In fatigue, a relative want of oxygen is produced by the increased consumption following functional activity, in heat depression by the increase of the entire metabolism producing a corresponding increase of oxygen requirement. In both instances we have an excitation produced by external stimuli which result in an increase in the amount of oxygen required, and in both instances the oxygen at disposal is not sufficient to permanently meet the augmented demand. In both types, therefore, decomposition must become more and more anoxydative and the well-known series of processes is developed, which find their expression in depression.

In another direction likewise heat depression is of special interest, that is, in regard to the theory of nature of the processes in the living substance. According to the *van't Hoff* law we may assume that every individual constituent metabolic process, if we imagine it as isolated and taking place in a test tube, undergoes in more or less the same degree as all others an increased rapidity of reaction as a result of increased temperature. At the same time, in living substance we find on the contrary that the *van't Hoff* law is only within certain narrow limits more or less applicable to the sum total of all metabolic processes. Beyond certain degrees of temperature no further increase of the vital process takes place, instead a retardation occurs. The analysis of depression produced by heat shows us in the clearest and simplest manner the reason for this apparent deviation from the general law of *van't Hoff*. This reasoning is based on the fact that the rapidity of reaction of a chemical process is not merely dependent upon the temperature, but likewise upon the mass relations of the reacting substances. In spite of the effect of the temperature in increasing the rapidity of reactions, the process undergoes retardation which extends to a complete cessation if the supply of material necessary to its existence does not keep pace with the increase produced by temperature. In the present instance the amount of reserve supplies for the building up of the disintegrating molecules exists in abundance, and it is merely the available oxygen which is in relatively a very small quantity. As soon, however, as metabolism in its entirety, or even merely in

those parts in which oxygen is directly required, is increased by whatever means, the oxydative processes would be the first to fail and it must be from this point that the disturbance of the harmony in the interacting of the individual metabolic processes proceeds. This principle which we here see manifested in its simplest form in the effect of temperature on oxygen exchange in the form of a disturbance in the correlations of the individual constituent processes based on an alteration of the mass relation and the rapidity of reactions of individual members is, however, not merely restricted to effects of temperature and the results quickly following on a relative oxygen deficiency. It has, indeed, a much more general significance for all manner of constituent metabolic processes, for it is applicable to all nutrition and to all growth, and forms one of the most important factors which influence the process of development, that is, the gradual "metachronic" alterations in metabolism to which all living systems are subjected as long as life endures.

A very extensive group of depression processes is produced by the action of chemical stimuli. Among these the processes to which we apply the collective term of "*narcosis*" must claim our special interest. As is well known, an enormous number of substances of very different chemical nature, such as carbon dioxide, alcohol, ether, chloroform, chloral hydrate, etc., exist, which, possessing the property of producing cessation of the vital activities in all living systems, after withdrawal of their application, if it has not been too prolonged or intense, permit a complete restoration to normal vitality. These are the *general* narcotics. Besides these there are a series of substances which have a depressing effect only upon certain forms of living substance, and which we may, therefore, term *special* narcotics. As, however, the particular nature of depression following the application of chemical substances has hitherto been closely studied only in a very few instances, we are not, at present, in a position to sharply define the limitations of the conception of narcosis, a conception which originally had hardly any further meaning than the production of unconsciousness by chemical means. In the following discussion, therefore, we shall deal

merely with narcosis produced by the well-known general narcotics, such as carbon dioxide, alcohol, ether, chloroform, etc. From the time of the introduction of ether narcosis into medical practice by *Jackson* and *Morton* in the year 1848 up to the present day, the theory of this process has awakened the liveliest interest. Many attempts have since been made to explain the physical nature of this interesting process without, however, any generally acknowledged theory of narcosis being established. I will refrain from entering into these former theories in detail as they have been exhaustively treated by *Overton*¹ in his studies on narcosis.

In connection with our present observations, however, I will more closely analyze the process itself, following the results of investigations extending over more than ten years carried out by my coworkers and myself. In these investigations it has been found that narcosis belongs to this group of depressing processes. A satisfactory theory of narcosis, however, and this I must explain from the first, can even today not be arrived at. Such a theory would require the ascertainment of all primary and secondary alterations produced by the narcotic in the course of normal vital activity. For this, however, a number of minute details are still lacking. Nevertheless, the careful and detailed investigations during the last ten years have acquainted us with a large number of alterations, which, acting as conditioning factors for the process of narcosis, must be taken into consideration, and which to a certain extent give us an idea of the mechanism of this process. They are equally interesting from a theoretical as well as from a practical point of view. The presentation will become more detailed as more of such conditioning factors are established by the deeper penetrating of future analysis. I will deal here with the facts found up to the present and then proceed to the deductions which these furnish for the theory of narcosis.

In the first place narcosis is stamped as a typical process of depression, being characterized by a *decrease of irritability with a corresponding decrement of the extent of excitation*. The chief feature of all narcotized systems is, that in slight narcosis exci-

¹ *E. Overton*: "Studien über die Narkose, zugleich ein Beitrag zur allgemeinen Pharmakologie." Jena 1901.

tating stimuli produce a greatly weakened excitation, and that in deep narcosis no perceptible response is obtained. This can readily be ascertained in the various forms of living substance. According to the previous observations on the inseparable relations between conduction of excitation and irritability, it is self-evident that with decrease of irritability there must be a corresponding decrease in the capability of the conduction of excitation from the point of stimulation. This decrease in conductivity must, therefore, be the greater the more irritability is reduced; that is, the deeper the narcosis, the greater must be the decrement undergone by the wave of excitation in its extension from the point of stimulation. These facts can be observed in the highest perfection in the nerve, and have, as we have seen, been demonstrated by the investigations of *Werigo*, *Dendrinos*, *Noll*, *Boruttau* and *Fröhlich*.¹ Upon deeper analysis of this process of depression, the next task for the investigator must be the ascertainment of the special components of the metabolic activity, which are depressed as a result of the narcotic.

As a consequence of the result of my investigations on fatigue, the idea occurred to me to test if possibly oxygen exchange likewise undergoes depression during narcosis. The spinal cord centers of the frog, which had served me in ascertaining the rôle played by oxygen in the bringing about of the depression of activity, appeared likewise a favorable object for this investigation. Indeed, the question if consumption of oxygen takes place during narcosis, could be experimentally determined in direct connection with the investigations on fatigue. This was based on the following consideration. If an oxygen-free saline solution is introduced into the aorta of a frog and in order to increase the activity of the spinal cord centers to the maximum the animal is poisoned with strychnine, after a very short time complete exhaustion takes place as a result of oxygen deficiency. This exhaustion can only be removed by the introduction of oxygen. In this condition the oxygen requirement of the centers

¹ I have previously on another occasion briefly communicated the conclusions derived from the investigations made at the Göttingen laboratory by my coworkers and myself. Compare: *Max Verworn*: "Ueber Narkose." *Deutsche medicin. Wochenschrift*, 1909.

is enormously increased. If the centers are narcotized by adding a narcotic to the oxygen-free circulating fluid in amounts which, as experience has found, would produce complete loss of reaction in the normal animal, for example, about 5 per cent. of alcohol, it can then be tested if, in this state of narcosis, the centers are capable of oxygen consumption. It is merely necessary to replace the oxygen-free saline solution containing alcohol by blood rich in oxygen, containing alcohol in an amount sufficient to continue the narcosis, but supplying an abundance of oxygen. If, after this artificial circulation has lasted for a sufficient period, the blood is then displaced by an oxygen-free saline solution containing alcohol, and then this, in turn, is replaced by an oxygen- and alcohol-free saline solution, so that cessation of the narcosis is now produced, it can be ascertained by the responses of the animal if consumption of the oxygen, when at the disposal of the centers during narcosis, has taken place or not. If the former is the case, then on the cessation of narcosis reflex contraction must occur in the same manner as in every strychninized frog totally exhausted by oxygen deficiency and into which a saline solution containing oxygen is reintroduced. If during narcosis, on the other hand, oxygen has not been consumed by the centers, depression must continue to be present after cessation of narcosis. Testing the recovery of the animal on the introduction of blood, rich in oxygen, serves as an indicator for the vital activity and capability of recovery of the centers. A great number of experiments based on this scheme of investigation were undertaken at my request by *Winterstein*.¹ These were carried out with alcohol, ether, chloroform and also carbon dioxide. His experiments have shown in the most uniform manner that, in spite of the requirement of oxygen by the centers being increased to its highest extent, and notwithstanding the most ample oxygen supply during narcosis, after cessation of the same and the introduction of an oxygen-free saline solution *no trace of recovery occurred*, whereas after a supply of oxygen was introduced tetanic contractions reappeared

¹ *H. Winterstein: "Zur Kenntniss der Narkose." Zeitschr. für allgem. Physiol. Bd. I, 1902.*

at once. *During narcosis, therefore, the centers, in spite of their great requirement of oxygen, lose their capability of oxydative splitting up and consumption of oxygen.*

After the methods for asphyxiation of the *nerve* had been worked out and perfected the wish arose likewise to carry out for these structures an analogous series of experiments to that employed for the centers and based on the same chain of reasoning. These investigations have the advantage of essentially simpler conditions. After having convinced myself by experiments, that the results on the nerve were in complete conformity with those on the spinal cord, at my suggestion *Fröhlich*¹ repeated and continued these experiments on a more extended scale. A nerve was asphyxiated by the previously described method. This is accomplished in the simplest manner by the opening or closing of stop cocks in the apparatus I have employed which permit of pure nitrogen, or nitrogen with ether, and finally also oxygen with ether or pure oxygen being conducted at will through the glass chamber. If the nerve was so far depressed in pure nitrogen that conductivity became obliterated for about two cm. of the asphyxiated stretch, it was then narcotized in nitrogen. Following this oxygen with ether was supplied for a time. Then the oxygen-ether mixture was displaced by one of nitrogen and ether and finally by pure nitrogen. Even after a prolonged period, a recovery in pure nitrogen never took place. On the other hand, the nerve recovered at once, as soon as oxygen without ether was introduced. The results of these investigations are, therefore, completely in harmony with those undertaken by *Winterstein* on the nervous centers. They were later likewise entirely confirmed by similar experiments of *Heaton*.² All these investigations furnished the proof *that in narcosis, living substance, notwithstanding even the greatest oxygen deficiency, is not capable of producing oxydation, neither can consumption of oxygen take place, with which, after cessation of the narcosis, oxydative splitting up can be carried out.*

1 *Fr. W. Fröhlich*: "Zur Kenntniss der Narkose des Nerven." *Zeitschr. f. allgem. Physiol.* Bd. III, 1904.

2 *Trevor B. Heaton*: "Zur Kenntniss der Narkose." *Zeitschr. f. allgem. Physiol.* Bo. 1910.

Recently *Warburg*¹ has likewise found an oxydative depression during narcosis in the eggs of the sea urchin and in the red corpuscles of geese, and the same fact has lately been also demonstrated by *Joannovics und Pick*² for the oxydative activity of the liver cells of the dog.

This fundamental establishment of the fact that narcosis prevents oxydations in living substance is at once followed by the further problem, in what *manner* do the disintegration processes undergo alterations during narcosis? *That* they must be altered, and this in the form of a reduced energy production, is clearly shown by the decrease of irritability and the increase of the decrement of the conduction of excitation. Both become the greater the deeper the narcosis. The observations just discussed render these facts at once self-evident. They follow as a simple and necessary result of the elimination of the oxydative processes. If these are suppressed further breaking down, if not influenced by addition of other factors, proceeds anoxydatively. The previously observed series of processes is developed, which invariably take place when oxygen deficiency occurs and which produce in the clearest form the results of asphyxiation on the withdrawal of oxygen supply. If, therefore, the disintegration processes are not influenced in some other manner during narcosis, they must then take place in the same way as in the withdrawal of the oxygen supply. The question, if this is actually the case, can be experimentally decided by comparing, on the one hand, the development of the course of asphyxiation during narcosis, and on the other, the withdrawal of the oxygen supply. We have carried out this comparison for the spinal cord centers as well as for the medullated nerve. A prolonged series of experiments have been made by *Bondy*³ with the apparatus constructed

1 *Otto Warburg*: "Ueber die Oxydationen in lebenden Zellen." *Zeitschr. f. physiol. Chemie* Bd. 66, 1910. The same: "Ueber Beeinflussung der Oxydationen in lebenden Zellen nach Versuchen an roten Blutkörperchen." *Zeitschr. f. physiol. Chemie* Bd. 69, 1910.

2 *Joannovics und Pick*: "Intravitale Oxydationshemmung in der Leber durch Narkotica." *Pflügers Arch.* Bd. 140, 1911.

3 *Bondy*: "Untersuchungen über die Sauerstoffspeicherung in den Nervencentren." *Zeitschr. f. allgem. Physiol.* Bd. III, 1904.

for this purpose by *Baglioni*.¹ Two frogs under uniform conditions of temperature were submitted to artificial circulation, the one merely with an oxygen-free fluid, the other with the same, but with the addition of 5 per cent. of alcohol. In order to render the least trace of irritability perceptible, responsivity was increased in both animals by the employment of strychnine. It then appeared that, on the average, irritability was obliterated in the narcotized frog in about the same time as in the animal simply asphyxiated. These experiments were controlled by introducing at their conclusion a saline solution containing oxygen into both frogs and by ascertaining the degree of recovery. In like manner *Fröhlich*² has established the same fact for the nerve. The period of asphyxiation for the nerve in a nitrogen-ether mixture is approximately the same as in pure nitrogen. Analogous experiments have been carried out in amoebæ by *Ishikawa*.³ Here also it has been shown that living substance becomes asphyxiated in narcosis and can finally recover only when oxygen is supplied. In more than a hundred experiments *Ishikawa* has, however, obtained the uniform result that amoebæ asphyxiate rather sooner in narcosis than in pure nitrogen. The most striking experiments are those which *Heaton*⁴ has carried out on the nerve. Using both sciatic nerves of the same frog, he passed each one through a separate glass chamber, as previously described, and laid the central stumps projecting from the chamber over a pair of platinum electrodes, while the stretch within was likewise placed on platinum electrodes. The muscles served as indicator of the capability of conduction and irritability. The alterations thereof were tested by the ascertainment of the threshold of stimulation. The nerve in the *one* chamber was then subjected to a pure nitrogen current, that in the *other* merely to one of pure air with ether. In order to test the degree of

1 *Baglioni*: "Beziehungen zwischen physiologischer Wirkung und chemischer Constitution." Zeitschr. f. allgem. Physiologie Bd. III, 1904.

2 *Fr. W. Fröhlich*: "Zur Kenntniss der Narkose des Nerven." Zeitschr. f. allgem. Physiologie Bd. III, 1904.

3 The experiments of *Ishikawa* have not as yet been published.

4 *Trevors B. Heaton*: "Zur Kenntniss der Narkose." Zeitschr. f. allgem. Physiologie Bd. X, 1910.

asphyxiation the air-ether current in the latter chamber was replaced from time to time by an ether-nitrogen current, and then by one of pure nitrogen, so that the narcosis was interrupted without the entrance of oxygen being possible in the mean time. During this suspension of the narcosis, the nerve recovered each time in nitrogen, its irritability again increasing and its capability of conduction returning with every test. However, recovery showed itself as less and less complete. Finally irritability had sunk so low that the capability of conduction disappeared entirely. At the end of the experiment as control, nitrogen was displaced by air in the two chambers and in both nerves recovery took place.

In both cases recovery could only be brought about by an introduction of oxygen. From the sum of all these experiments it results that during narcosis in air the nerve, even when a sufficiency of oxygen is present, gradually asphyxiates and loses its capability of conduction, and this in about the same length of time as the other nerve in pure nitrogen. These investigations furnish two important facts for the theory of narcosis. First, that in narcosis living substance becomes asphyxiated notwithstanding the presence of an ample oxygen supply, and secondly, that asphyxiation occurs in the same time, or somewhat more rapidly, in pure nitrogen under otherwise similar conditions than without narcosis. In other words, it is shown that the breaking down processes of metabolism continue in narcosis as anoxydative disintegration. *In narcosis, therefore, asphyxiation takes place with approximately the same or a somewhat greater rapidity than that in an oxygen-free medium.*

The fact here established explains in the simplest manner the often described observation that in the human being and in mammals during prolonged anæsthesia typical products of insufficient combustion, such as fatty acids, lactic acid and above all acetone, in not inconsiderable quantities are eliminated, as the case may be, by the urine or the respiratory air.¹ If, as has been shown by

¹ For the very extensive literature on this subject see *Reicher*: "Chemisch-experimentelle Studien zur Kenntniss der Narkose." *Zeitschr. f. klinische Medicin* Bd. 65, 1908.

the foregoing experiments, the processes of disintegration can continue to anoxydatively take place during narcosis, the problem arises, if this anoxydative breaking down can be further increased by exciting stimuli. This question has been answered likewise by means of experiments on the nerve made by *Heaton*.¹ The two sciatic nerves of the same frog were drawn through a double glass chamber of the form previously described so that each nerve lay on an electrode and with the central stump protruding out of the chamber hanging likewise over an electrode. As in the former instances the muscle contraction of the shank again served as indicator. Both nerves were then subjected to the same current of nitrogen-ether. When, as a result of the narcosis, their irritability has sunk to the level of "stromschleifen" the central stump of the one nerve was continuously stimulated with faradic shocks during a prolonged period, while the other nerve remained at rest. Finally, by displacement of the current of nitrogen-ether with one of pure nitrogen, cessation of narcosis was brought about. It was then seen that the irritability of the continuously stimulated nerve showed a much greater decrease than that of the nonstimulated. The control made by introduction of air demonstrated that both nerves recovered in an oxygen supply. *There can, therefore, be no doubt, by comparative experiments we find, that during narcosis anoxydative disintegration can be still further increased by the action of stimuli.*

In view of this knowledge of the influence of narcotics on oxygen exchange it may be considered as a firmly established fact, that a process of depression is developed during narcosis, which can be classified with the large group of depressions, resulting from deficiency of oxygen. This is followed by the important problem, is it possible to attribute the whole series of alterations, produced by the narcotic, solely to this *one* factor? In other words, is narcosis the result of acute suppression of the oxydative processes?

If the individual symptoms which characterize narcosis are investigated from this point of view, one must indeed confess that they are all readily understood when regarded as the results

¹ *Heaton*: l. c.

of suppression of the oxydative processes. Indeed, the disappearance of the perceptible vital activities, the decrease of irritability, the restriction of the conduction of excitation, the continuance of an anoxydative breaking down, the recovery on cessation of narcosis, provided oxygen is present, etc., in short, all the characteristics of narcosis so far known must be expected and *demanded* if a suppression of the oxydative processes exists during narcosis.

There is only *one* point which at the first glance would not seem to agree entirely with the assumption. This is the fact that depression sets in with a relatively greater rapidity in narcosis than when the supply of oxygen is completely withdrawn. Depression of the centers in the spinal cord, which begins in about five to ten minutes after artificial circulation of an oxygen-free, alcohol-containing, saline solution, is not brought about for more than an hour when the same saline solution but without alcohol is introduced. This difference is still more strikingly apparent in the nerve. The same degree of depression, which is produced in the nerve in a nitrogen-ether mixture within about *five* minutes, is not reached in pure nitrogen without ether until after the lapse of from *two* to *four* hours. In order to investigate this relation somewhat more closely I have questioned if it is possible for a living system, which has been narcotized to a certain extent, to regain its irritability in a completely oxygen-free medium, if cessation of the narcosis takes place after a period essentially shorter than the time of asphyxiation of the system under equal conditions. If the depression of narcosis is founded exclusively on asphyxiation, it would be expected that no recovery could occur. Experiments which I have made on the spinal cord centers as well as on the peripheral nerves have, however, demonstrated exactly the contrary. If a frog is subjected to an artificial circulation of an oxygen-free saline solution containing 5 per cent. of alcohol until reaction is lost, being certain of this by the injection of a weak dose of strychnine, and if now a cessation of the narcosis is brought about by the transfusion of oxygen-free saline solution, the centers of the animal recover completely within ten to fifteen minutes, as shown

by typical strychnine tetanus. If a nerve is placed in a gas chamber through which a mixture of nitrogen and ether is allowed to flow until irritability is greatly decreased, and is then displaced by pure nitrogen, irritability increases more or less completely according to the time which has passed from the beginning of asphyxiation. This investigation proves that living substance, even after the deepest narcotic depression, may recover on cessation of the narcosis, although in an entirely oxygen-free medium. *Fröhlich*, *Bondy* and *Heaton*, by the methods of their experiments above described, have proved this fact in a great number of instances. On the other hand, *Ishikawa* could not observe a pronounced recovery in amœbæ from narcosis in pure nitrogen. But it is possible that here the difference is perhaps merely quantitative.

What position should be taken in the face of these facts? Does recovery of a deeply narcotized tissue in an oxygen-free medium really make it difficult to suppose that narcosis is the result of an acute suppression of the processes of oxydation? On closer view, it will be found that this difficulty is merely apparent. In reality it is quite possible to bring these facts into harmony with the assumption that narcosis consists in a suppression of these processes. If one proceeds from the supposition that living substance possesses a certain, even though merely a small supply of oxygen in its interior, then it is at once evident that a more or less complete recovery of irritability from narcosis depression is possible, even in an oxygen-free medium. It can take place at the cost of the oxygen still present in the living substance and which during the narcosis, on account of the suppression of the oxydation processes, could not be consumed. If the presence of a certain oxygen reserve in living substance is entirely set aside and a different explanation sought for the primary continuance of irritability after a complete withdrawal of the oxygen supply from without, the great difference of time in the setting in of the depression in narcosis and that of the complete elimination of the oxygen supply from without would make it necessary to assume the processes occurring in narcosis are entirely different in nature. The explanation that narcosis is the result of suppression of the

oxydative processes would indeed be out of the question in such a view.

The assumption, however, that in a living system at the same moment when oxygen is removed from the neighborhood, let us say by a stream of nitrogen, no oxygen would be present and that in consequence every oxydative process must cease, contains so little probability that I have rejected it on various occasions.¹ The way in which irritability is lost in asphyxiation of the nerve likewise very clearly demonstrates the untenability of this view. The recent investigations of *Lodholz*² have shown that decrease of irritability takes place after a sudden displacement of all oxygen from the surrounding medium uniformly and gradually in the form of a logarithmic curve. If at the moment of oxygen withdrawal from the outer medium, metabolism became entirely anoxydative, the curve of irritability must under all circumstances show a sudden *steep decline* at this point, and subsequent to this a further *slower* decrease. For, as the oxydative processes constitute by far the *chief* part in the energy production of living substance, the production of energy, and with this irritability, would undergo considerable loss at the same moment in which oxydative was replaced by anoxydative disintegration. The curve of decrease of irritability during the transition period from oxygen supply to oxygen withdrawal shows, on the contrary, a completely uniform course and it is not until later that a very slow decline takes place, which only after a prolonged time assumes increasing rapidity. But the assumption that "at the moment when the supply of oxygen ceases, anoxydative breaking down could acquire such enormous dimensions that it furnishes just exactly the same amount of energy as was before supplied oxydatively, is a view which no one will seriously entertain. In connection with this I wish to call attention to the experiments of *Fröhlich*³ in which he compared the time required for asphyxiation to take place in the nerves, when, on the one hand, the frogs had been kept several days previous to the experiment in tempera-

1 Compare lecture V; lecture VII.

2 The investigations have not yet been published.

3 *Fr. W. Fröhlich*: "Das Sauerstoffbedürfniss des Nerven." *Zeitschr. f. allgem. Physiol.* Bd. III, 1904.

ture of 14-40° C., and on the other, in one merely a few degrees above zero. He found that the nerves of the cooled frogs required on an average twice or three times as long for their irritability to sink to the same degree as those of the heated frog, although during the experiment the same temperature was present in both. It was also shown that the asphyxiation period was prolonged up to a certain limit, depending upon the length of time the animals were kept at a low temperature. It would seem to me that these facts admit of no other explanation than that in a low temperature a greater amount of oxygen is stored in the nerve than in high temperatures. From the standpoint that from the moment of withdrawal of oxygen from without, disintegration likewise takes place exclusively anoxydatively, these facts would be completely incomprehensible. When, however, the assumption is made, and this would appear to me as inevitable, that living substance contains in itself a certain even though a very slight quantity of oxygen, which in low temperature is greater, in a high temperature less, the recovery from narcosis, when oxygen is withheld, is not at all surprising. The comparatively rapid setting in of depression in narcosis finds a simple explanation in the *violent* manner in which the oxydative breaking down, notwithstanding the presence of oxygen, is suddenly suppressed by the flooding by the narcotic. Finally, this view receives unlooked-for support by a group of facts which at the first glance would appear to bear no relation whatever to the process of narcosis.

In a series of investigations on the mechanism of movement in naked protoplasm,¹ I have pointed out the rôle played by oxygen in the genesis of the amœboid protoplasm movement. We can distinguish two antagonistic phases in the movement of amœboid cells, the expansion phase and the contraction phase. The first consists in an increase, the latter in a diminution of the surface, the mass remaining the same. The expansion phase is manifested

¹ *Max Verworn*: "Die physiologische Bedeutung des Zellkerns." Pflügers Arch. Bd. 51, 1891.

The same: "Die Bewegung der lebendigen Substanz. Eine vergleichend-physiologische Untersuchung der Contractionserscheinungen." Jena 1892.

The same: "Allgemeine Physiologie." V Auflage. Jena 1909. In the last place the same theory of the contraction movements with some new corrections is described.

in the stretching out of the pseudopods by a centrifugal outflowing of the protoplasm into the surrounding medium, the contraction phase by the indrawing of the pseudopods by the centripetal inflowing of the protoplasm to the cell body. In total contraction, such as occurs, for instance, in strong excitation following stimuli, the cell body becomes ball shaped. In local contraction of the long thread or net-shaped outstretched pseudopods of the sea rhizopoda, the protoplasm of the retracting pseudopod forms balls and spindles. Considered from a physical point of view the expansion phase of amoeboid movement is an expression of decrease, the contraction phase an increase of the surface tension. I have shown that the factor which under physiological conditions decreases the surface pressure and thereby brings about the expansion phase is the introduction of oxygen into the living substance. With removal of oxygen the stretching out of the pseudopods ceases. The cell gradually draws in all pseudopods and assumes the shape of a ball. On the reintroduction of oxygen the outflow of the pseudopods begins anew. This fact can be observed in all amoeboid cells. When, therefore, consumption of oxygen and oxydative changes is suppressed during narcosis it is to be expected that all naked protoplasm masses by being narcotized lose their capability of assuming the expansion phase of movement and contract into the shape of balls. Experimentation confirms this deduction in the most striking manner. When amoebæ are placed in a drop of water under the microscope in a gas cell through which air and a little ether are allowed to flow, the pseudopod formation of the amoebæ ceases within a few minutes and they all assume the shape of a ball. (Figure 62.) In asphyxiation in pure nitrogen, the changes in the amoebæ take place in exactly the same manner with the exception that in this case a longer period ensues according to the size and activity of the animals. About 20 to 60 minutes elapse before depression becomes complete. If larger sea rhizopoda are narcotized in the same manner all pseudopods are more or less retracted and the contained protoplasm flows centripetally and contracts in the characteristic manner into balls and spindles. (Figure 63.) If the narcosis is removed by displacing the ether by pure air, the

stretching out of the pseudopods then begins anew, provided the narcosis has not been too deep or too prolonged.

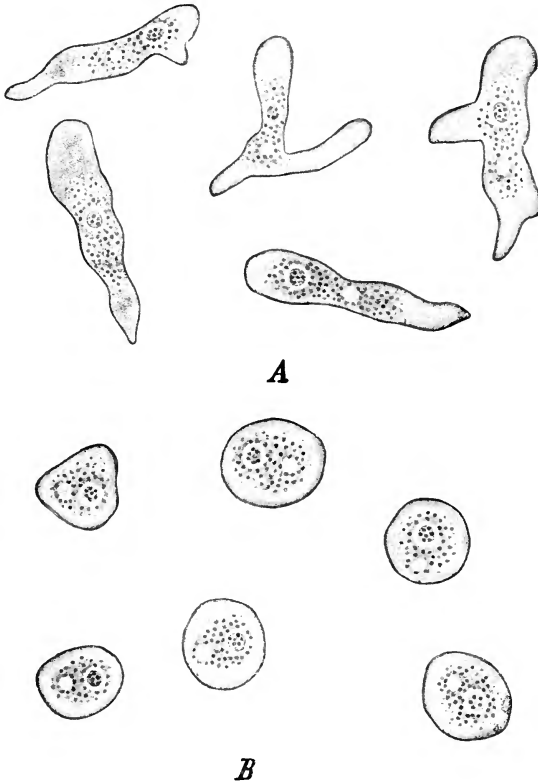

Fig. 62.

Amoeba limax. A—In normal state. B—Narcotized by ether.

In the face of all this evidence there can be indeed no further barrier to the assumption that the symptoms in narcosis are a result of a suppression of the oxydative processes. Nevertheless, I would not at present venture to maintain that the entrance of the narcotic into living substance produces no alterations whatever, except just this oxydative suppression. For the present it seems to me that the possibility is in no way precluded that

the same process, which is expressed in the oxydative suppression, is connected with other alterations in the living substance, of which we are as yet ignorant. As far as the effects of larger doses of narcotics are concerned, the assumption that other alterations take place in the living substance can in any case hardly be avoided. An application of larger quantities of narcotics brings about destruction of the living system with great

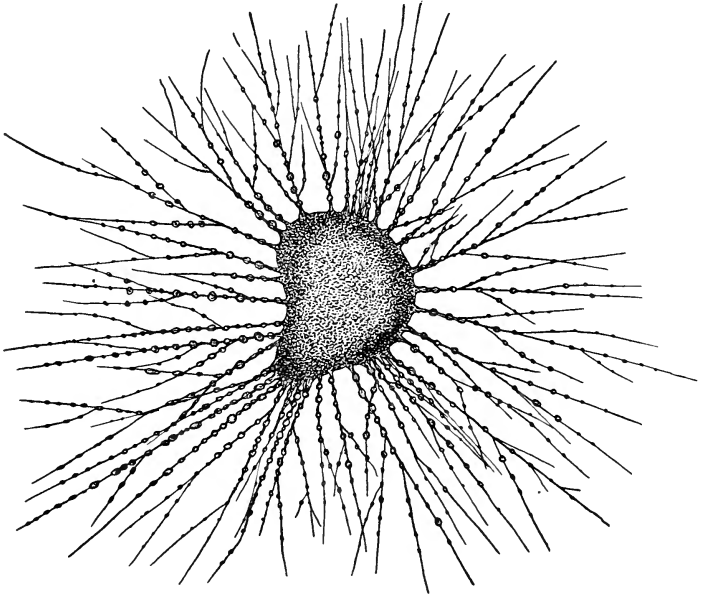

Fig. 63.

Rhizoplasma Kaiserii. Effect of chloroform.

rapidity. Here the alterations in the optical properties of the cell are of such magnitude that the changes are directly perceptible under the microscope. *Binz*¹ has observed such alterations in the nerve cell and looked upon them as coagulation. In unicellular organisms these optical alterations can readily be followed. If amœbæ, sea rhizopods or infusoria are narcotized with stronger doses of ether or chloroform, the protoplasm be-

¹ *Binz*: "Vorlesungen über Pharmakologie für Aerzte und Studierende." II Aufl. Berlin 1891.

comes opaque and granulated, it appears darker than formerly and in many cases displays a yellowish brown color in transmitted light. Cells altered in this way no longer recover after removal of the narcotic. These intense and rapidly appearing alterations of protoplasm resulting from the application of stronger doses of the narcotic can scarcely be explained as simply the result of a mere decrease of the oxydative processes. They would seem to consist rather, as suggested by *Binz*, as coagulation, in an alteration of the state of certain components of living substance. Whether these alterations are already present in a correspondingly slight amount in those degrees of narcosis after which complete recovery can take place and further whether in this case they are in any way concerned in bringing about the individual symptoms of the former, are questions the decision of which must be left to future investigations. *Höber*¹ indeed makes such an alteration of the colloidal state of the lipid the basis of a theory of narcosis. But such assumptions are scarcely more than speculations. This is one of the points in which our present knowledge is lacking.

Even if we restrict ourselves to the actually established alterations produced by the narcotic in living substance, new problems present themselves, the investigation of which requires further effort. Above all, the question arises as to the finer mechanism of oxydative depression. In what manner does the narcotic molecule, entering into the living substance, suppress the oxydative processes? Here there are very different possibilities to be taken into consideration and up to the present in our investigations of a suppression of the oxydative processes resulting from narcosis, we have stood on the firm ground of assured facts. However, the discussion of the nature of this suppression leads us into the domain of *hypothesis*. But without hypothesis there can be no progress in knowledge. In all branches of scientific research, working hypotheses are required for the obtainment of new facts.

On closer reflection, there are chiefly *three* possibilities, which,

¹ *Höber*: "Beiträge zur physikalischen Chemie der Erregung und der Narkose." *Pflügers Arch.* Bd. 120, 1907. The same: "Die physikalisch-chemischen Vorgänge der Erregung." *Sammelreferat. Zeitschr. f. allgem. Physiol.* Bd. X, 1910.

considered from the standpoint of our present knowledge of the processes in living substance, offer an explanation of the oxydative suppression as a result of narcosis.

One of these possibilities is, that the *narcotic itself consumes the oxygen which activates living substance* and uses it for its *individual* oxydation, so that the specific oxydable material of living substance receives less oxygen from the oxygen carriers. Based on a series of interesting experiments this view has been recently maintained by *Bürker*.¹ He observed that with the electrolysis of acidulated water, to which a small per cent. of ether was added, a much less amount of oxygen was at the anode than in one used as means of control, containing acidulated water without ether. The oxygen was replaced at the anode by oxydation products of the ether, such as carbonic oxide, carbon dioxide, acetate aldehyde and acetic acid. In experiments with various narcotics he likewise found that the stronger the effect produced by narcosis, the greater the oxygen amount required for the oxydation taking place of electrolysis. *Bürker* applies these results obtained for electrolysis to the processes in living substance and takes the view that the narcotic seizes on the active oxygen, and so withdraws it from the masses of living substance possessing a great oxygen requirement. It cannot be denied that this conception of the nature of certain narcotics deserves careful investigation. It seems to me, however, that before considering it in the light of a serious probability a grave difficulty would first have to be removed. In living substance the narcotic would occur under conditions essentially different from those existing during the experiment in the voltameter. In the former case there would be the struggle for oxygen of the specific oxydable cell masses to be met with. Considering the small amount of chemical activity of the greater number of narcotics it would appear at least doubtful if in this battle for supremacy the latter would achieve a victory. For some narcotics, as, for instance, carbon dioxide, this method of a depression of the oxydative processes would have no bearing whatever.

¹ *Bürker*: "Eine neue Theorie der Narkose." Münchener Med. Wochenschrift, 1910.

This is rather to be looked for in the effects of oxydative suppression of the aldehydes, which *Warburg*¹ has recently observed and investigated. Here, however, it is not a true narcosis which is concerned.

A second possibility of a suppression of oxydation would be the *fixation of the molecules of the oxydable substances by chemical or physical combinations* in that they would lose their capability of oxydative disintegration. Such a supposition would, however, likewise contain but few elements of probability. As has been shown, an anoxydative breaking down continues during narcosis, which, and this we may assume with certainty, furnishes very different products in great variety. These anoxydative disintegration products, as recovery on the cessation of narcosis shows, are removed during recovery by oxydation. If the effect of the narcotic consisted in the prevention in spite of the presence of oxygen of the oxydation by combination, it would be necessary to assume that the narcotic was bound to a mass of completely heterogeneous substances, a conclusion we should find difficult to entertain.

If, however, depression of the oxydative processes is founded neither on the seizure of oxygen by the narcotic nor the fixation of oxydable substances by the former, there remains the possibility *that the narcotic suppresses the transmission of oxygen to these points of consumption*. We assume that the oxygen transmission to those points where its consumption takes place is carried out by special substances, the existence of which has been established in the most varied vegetable and animal cell forms. Unfortunately we only know these oxygen-carrying substances by their effects. Of their chemical constitution we have no knowledge, but we usually assume that the transmission of oxygen occurs in the same manner as in catalytic processes. On another occasion I have previously expressed the suggestion,² that the narcotic suppresses oxydation by producing incapability of the groups acting as oxygen carriers to carry out this func-

1 *Warburg*: "Ueber Beeinflussung der Sauerstoffathmung. II Mittheilung. Eine Beziehung zur Constitution." *Zeitschr. f. physiolog. Chemie* Bd. 71, 1911.

2 *Max Verworn*: "Ueber Narkose." *Deutsche med-Wochenschrift*, 1909.

tion. If we assume that the substances possessing the character of oxygen carriers, which activate the molecular oxygen and so render it capable of attacking the oxydable substances, lose this capability under the influence of narcotics, this supposition would not only make all of the facts of suppression of oxygen exchange in narcosis comprehensible, considered from one point, but likewise, as careful investigation has shown, be in complete harmony with all knowledge obtained up to the present of the process of narcosis.

Here is the point where the interesting observations of *Hans Meyer*¹ and *Overton*² on the relations of the depressing influence of narcotics to their solubility of fat and water may be connected with the facts of the suppression of oxydation. *Meyer* and *Overton* have quite independently of each other made the same observation, that the depressing effect of a narcotic is the greater, the larger the coefficient of distribution between substances of a fatty nature and water. Those narcotics produce the strongest effects which are readily soluble in substances of a fatty nature, but not easily so in water, that is, in which the coefficient distribution between fat and water is very great. This law, which has been demonstrated by *Meyer* and *Overton* for a large number of narcotic processes, is in itself not a theory of narcosis, as has been often erroneously assumed. It shows us, however, an important condition, which must be considered in every theory of narcosis. It demonstrates that it is the ease with which transmission in the lipid occurs which allows a substance to develop narcotic effects. These facts would seem to indicate that the lipoids of the cell are connected in some way or other with the exchange of oxygen. If we assume that the oxygen carriers, the chemical constitution of which is so far not known, bear the character of lipoids and belong, say, to the generally extended group of phosphatides, there results at once an apparent

1 *Hans Meyer*: "Welche Eigenschaft der Anaesthetica bedingt ihre narkotische Wirkung?" Arch. experimentelle Pathol. u. Pharmacol. Bd. 42, 1899. Further: *Fritz Baum*: "Ein physiologisch-chemischer Beitrag zur Theorie der Narkotica." *Ibidem*.

2 *Overton*: The first communication of the results obtained by *Overton* were made by *Rost*: "Zur Theorie der Narkose" in the Naturwiss. Rundschau Jahrg. 1899. *Overton* has treated the subject in detail in his work, "Studien über die Narkose zugleich ein Beitrag zur allgemeinen Pharmakologie." Jena 1901.

connection of the law established by *Meyer* and *Overton* with the nature of narcosis.

The depressing effect of the narcotic would then consist in producing incapability of the lipoids transmitting oxygen to act as carriers of the same, and it is, therefore, self-evident that the effect of the narcotic would be the stronger the more readily it found entrance into the lipoids. It is perhaps not without interest that in similar manner *Mansfeld*¹ has attempted to establish a connection between the facts which *Meyer* and *Overton* have found and those ascertained by my coworkers and myself. He expressed the view that the lipoids of the cells represent the channels followed by the oxygen on its entrance, and that in consequence of their accumulation in the lipoids, the narcotics bring about asphyxiation by physically obstructing the transmission of the oxygen from the outer medium through the surface layer of the lipid into the protoplasm. The divergence in our views is not essential in their nature, and I attach the less importance to them as we find ourselves here, as I must again emphasize, on purely hypothetical ground.

In consideration of these observations we may perhaps establish the following hypothesis of the effect of the oxydative suppression of narcotics: The narcotics obstruct, either by absorption or loose chemical combination the oxygen carriers of the cell and render them incapable to activate the molecular oxygen. In consequence, oxydation of the oxydable substances cannot take place and disintegration occurs of an *anoxydative* form. The cell asphyxiates.

In conclusion I wish to warn against erroneous assumption that *all* oxydative depressions by chemical substances are *narcosis* and that the mechanism is the same. It is true that a number of chemical substances depress the processes of oxydation. But the latter can be brought about in very varying ways. I would like to mention the effect of oxydative depression of aldehydes. To this *Warburg*² has added hydrocyanic acid,

¹ *Mansfeld*: "Narkose und Sauerstoffmangel." *Pflügers Arch.* Bd. 129, 1909.

² *Warburg*: "Ueber Beeinflussung der Sauerstoffatmung. II Mitteilung: Eine Beziehung zur Constitution." *Zeitschrift f. physiol. Chemie* Bd. 71, 1911.

arsenic acid, ammonia and substitution compounds of ammonia. These substances do not follow the *Meyer-Overton* law of the coefficient of distribution. We cannot consider them, therefore, as narcotics. Future investigation will establish the existence of a large number of substances belonging to this great group of oxydation suppressing poisons, which are not narcotics. And it is likewise certain that depressing substances will be found, the depressing effects of which will not have their point of attack in the oxygen exchange, but will be shown to exist in other constituents of the metabolic chain. Our research in these fields, as already said, is still in the first beginnings and its perspective reaches into infinite space.

